





A.

J

# INDEX TO VOLUME CXVII THE AMERICAN ARCHITECT

239 WEST 39th ST., NEW YORK

JANUARY TO JUNE, 1920  
*overcasting see p. 44*

## EDITORIAL COMMENT

*Figures refer to text pages*

156794  
23/10/20

—A—

Advertising Methods for Religious Propaganda, 644.  
Americanization Boom, 340.  
"Americanism," 581.  
Americanism, To insure, 339.  
Americanization, Means of, 340.  
Americanizing the Plague Spots, 79.  
Architect and the Government, 181.  
Architect and Organization by Glenn Brown, 405.  
Architect and Public Service, 15.  
Architectural Education, 47.  
Architectural Exhibition, A Tri-City, 761.  
Architecture, Bernard Shaw on, 248.  
Architecture, Good, A Commercial Asset, 461.  
Architecture, Popularizing, 279.  
Architecture, Regional Style of, 151.

—B—

Billboard, Case Against the, 218.  
Billboard Nuisance, Joseph Pennell Sketches, 151.  
Billboards, 761.  
Block Party Methods, Extending, 309.  
Building Material Quotations, Instability of, 762.

—C—

Carillons as War Material, 279.  
Civic Untidiness, 182.  
Competitions, Matter of, 762.  
Contracts, Forms of Construction, 247.  
Convention and State Societies, 611.  
Craftsmanship, Retarding Development of American, 433.  
Convention, A. I. A. Second Day's Proceedings, 643.

—E—

Education, Nationalization of Architectural, 309.  
Education, Report of Committee on, 643.

—F—

Farm Building, Developing the, 248.  
Farmer's Home Life Studied, 727.  
Framing Pictures, 492.  
Frozen Credits, 680.

—G—

General Wood on Roosevelt and the Fine Arts, 727.  
Gold Medal of Honor or Architectural League, 433.

—H—

Hotel Life, Tendency Toward, 182.  
Housing Commission, State of New York, Report of, 462.  
Housing Corporation Replies to Senatorial Criticism, 181.  
Housing Shortage, 819.

—I—

Industrial Art, Progress in American, 339.  
Inter-Professional Relation, 16.

—K—

"Kidding" Themselves, 519.

—L—

Labor, Dilution of, 491.  
Labor Plays at Cross Purposes, 548.  
Landmarks, Passing of, 280.  
Lesson From a Tragedy, 48.  
London, Remodeling, 581.  
Lumber, Price of, 820.

—M—

Motor Truck as Solution of Transportation Problem, 817.

—O—

Official Denial, Need for, 727.  
Old Order Changeth, 547.  
Opportunity, the Architect's, 111.  
Organizing for Efficiency, 15.  
Originality, A Plea for, 79.

—P—

Profiteering in Labor, 582.  
Protest, A Mild, 80.

—R—

Rents, High, As Affecting Building in New York, 371.  
Report of National Commission of Fine Arts, 520.

—S—

Seeing Things, 461.  
Service A Contributing Factor to High Costs, 434.  
Simplification, 491.  
Stabilization of Labor and Materials, 370.  
State Societies, Model Constitution for, 48.

—T—

Temporary Beauty, 370.  
Trade Unions, Reaction in, 217.

—W—

Walled Towns, 310.  
Wisconsin Sets a Good Example, 519.

## TEXT ACCORDING TO SUBJECT

*Figures refer to text pages*

—A—

Albany City Hall Alterations. Ogden & Gander, 809.  
American Institute of Architects, Annual Convention, 601, 633, 674, 681, 694.  
Anti-Litter Bureau Summarizes Activities, 822.  
Architect and the Government. By Glenn Brown, 169.  
Architect and Organization. By Glenn Brown, 393.  
Architect and the Post-War Committee. By Glenn Brown, 299.  
Architect and Public Service. By Glenn Brown, 1.  
Architect, the Public's Faith in the, 37.  
Architects and the Public. By Francis S. Swales, 359.

Architectural Departments, Uniform Business Organization of Public, 39.  
Architectural League Exhibition in New York, 139.  
Architectural Relations, Debate at Convention, 681.  
Architectural Service by Airplane, 120.  
Architecture, An Indigenous. By George W. Maher, 335, 555.  
Architecture, State Departments of, 42.  
Architecture, Department of, and the State Architect of the State of New York. By A. L. Brockway, 35.  
Art After the War, 306.  
Art, Monastic, 430.

—B—

Babel, Towers of, 521.

Beaux Arts Institute of Design, 117, 183, 647, 688.  
Belgian Reconstruction, 818.  
Berne, City of Mediaeval Fountain Statues, 580.  
Billboards, "Other Side" of, 824.  
Birmingham, Englaod, Housing Competition, 464.  
Bloomington, Ill., Victory Square and Civic Center. Edward H. Bennett & Wm. E. Parsons, Architects, 401.  
Boston Museum Buys Colonial House, 120.  
Building Injured by Cleaning Acids, 823.  
Building, A Secret of Bad, 14.  
Bush Building as a Commercial Museum, 735.  
Bush Terminal Building in London. Helmle & Corbett, New York, Architects, 407.

# TEXT ACCORDING TO SUBJECT

(Continued)

- C—
- Chicago Annual Architectural Exhibition, 719.  
Chinese Paper, Paris Has A, 254.  
Church Design, Modernizing, 431.  
Church, The English Paris. By Albert C. Phelps, 425.  
City Plans, Types of. By John Nolen, 213.  
City Planning Progress, Public Opinion and. By John Nolen, 275.  
Civic Centers in New England. By Oliver H. Howe, M. D., 173.  
Civic Forum for New York City, 10.  
Client, Best Sort of, 277.  
Concrete, Its Use and Abuse. By Irving K. Pond, 177.  
Contract, The Emergency. By Major Ralph H. Case, 489, 522.  
Contract, Some Advantages of the Fixed-Fee. By F. A. Wells, 237.  
Construction Legislation in Congress, 338.  
Craftsmen, For Better Education of, 149.
- D—
- Delaware School Buildings. James O. Betelle, Architect, 751.  
Duluth Architects Aid Low Cost Housing, 432.
- E—
- Egyptian Art, Revival Contemplated by Decorators, 252.  
Electric Distributing Station, Boston, Mass. Bigelow & Wadsworth, Architects, 653.  
Engineers Effect National Federation, 792.
- F—
- Fabrics, American, for Home Decoration, 368.  
Factory Design in England, 116.  
Federal Prison, Atlanta, Ga. Eames & Young, Architects, 697.  
Foreign Language Newspaper, 816.  
Foundations of Classic Architecture. By William H. Goodyear, 269.  
France, Reconstruction of Devastated. By Ralph Fanning, 781.  
France Evolves National Planning Scheme, 369.  
French Planning Reports, Two Recent, 404.
- G—
- Game, Playing the, 791.  
Gardens on the Roof, 736.  
Georgian House. John Russell Pope, Architect, 5.
- H—
- Heating a Building with Waste Air, 821.  
Hotels, New York's Large Need for, 369.  
Housing Brevities, 817.  
Housing Corporation Replies to Senatorial Criticism, 343.  
Housing Problem and Earth Masonry. By Thomas Crane Young, 467.  
Housing, Teach School Children to Appreciate, 403.
- I—
- Industrial Art Survey Inaugurated, 6.  
Industry and Education, Alliance Between (Mass. Inst. Tech.), 13.  
Institute, Supreme Position of the, 679.  
Interprofessional Relation, Conference at Convention. Addresses of Dr. Ebersole and Thomas R. Kimball, 674.
- J—
- Japan's Housing Troubles, 337.  
Joseph McGinniss. By C. H. Blackall, 543.  
Jurisdictional Awards, National Board of. By E. J. Russell, 429.
- L—
- Landscape Architect, Relation Between, and Architect. By William Pitkin, Jr., 327, 363.  
Landscape Architecture, Volume in Preparation, 541.  
Law as to Architectural Practice. By John Simpson, 74, 700, 736, 766, 790.  
Ledge Stone House. By E. Sidney Wills, 67.  
London, Notes from, 453, 730.
- N—
- Natoriums. By Edwin H. Wood, 281.  
Natural Influences in Building, 49.  
New York's Housing Shortage, 791.
- P—
- Peking, The Violet City, 344.  
Persian Art, 733.  
Planning, Charm of Natural, 253.  
Polk, Willis, An Address by, 733.  
Pompeian Wall Painting, 583.  
Preble County Court House, Eaton, Ohio. H. H. Iliestand and Richards, McCarty & Bulford, Architects, 511.
- R—
- Prehistoric City, Preserving, 822.  
Presumption and Proof, 408.  
Prison, Psychiatric Classification in. By Lewis F. Pilcher, 97.
- S—
- Robert Bacon House. John Russell Pope, Architect, 397.  
Roosevelt and the Fine Arts. By Major General Leonard Wood, 715.  
Rotch Travelling Scholarship, 537.
- T—
- School Buildings, Delaware. James O. Betelle, Architect, 751, 785.  
Sears, Roebuck & Co., Philadelphia Plant of. George C. Nimmons & Co., Architects, 8.  
Sing Sing Prison, Clinic Building at. By Walter B. James, M. D., 107.  
Specification Clauses. By Francis W. Grant, 303, 732.  
Spuyten Duyvil, House at. Titus de Bobula, Architect, 667.  
Stadium on the Lake Front, Chicago, Competition for, 205, 241.  
Stage Design in Communal Buildings. By George M. P. Baird, 507, 549.  
Standardization and the A. I. A., 578.  
Standardized House, Artistic Development of, 571.
- U—
- Trimstone and Building Ornaments. By Adolph Schilling, 483.
- V—
- Unsanitary Housing As Affected by Political Elements, 50.  
Uruguay Has Large Building Program, 734.
- W—
- Water Power, Wasted, 794.  
Wingdale Prison Site. By Lewis F. Pilcher, 114.
- Y—
- Yellowstone Park Menaced by Commercial Purposes, 699.
- Z—
- Zoning Helps Real Estate and Business. By Herbert S. Swan, 216.

## CURRENT NEWS

Figures refer to text pages

- A—
- Academy in Rome Asks Funds, 286.  
Aeronautical Exposition, New York, 125.  
Aeronautical Research in England, 494.  
Aircraft Fusion in Great Britain, 494.  
Airplane to San Francisco, 470.  
Air Traffic, Cities Prepare for Future, 495.  
Alabama Architects Elect Officials, 285.  
Albany's Building Situation is Tense, 347.  
Alcohol, Real Uses of Wood, 251.  
Aldrich, Thomas Bailey, Home Sold, 86.  
Alloy, Valuable, Produced, 83.  
American Association of Engineers on Trade Unions, 17.  
A. I. A. Fifty-third Convention Announced, 525.  
American Students Going to French Universities, 24.  
Archaeologists Excavate Palace of Edward the Confessor, 586.  
Architects Ask House Investigation, 51.  
Architects' Building for Chicago, 190.  
Architects Reduce Rates to Encourage Building, 283.  
Architects, Registration of, 223.  
Architects Seek Uniform Building Code, Wash. State, 53.  
Architects Stop Urban Deformity, 620.  
Architects' Work More Pressing than Jury Duty, 411.  
Architects, Would Bar American, 493.  
Architectural Courses at Columbia, Spring, 255.  
Architectural League Exhibit, Deferred, 255.  
Architectural Press, Value of, 84.  
Architectural Registration Boards, Council of, 767.  
Architectural, Avery Library of, at Columbia, 190.  
Architecture, Business of: American Ambassador to England Speaks of, 122.
- B—
- Bahai Temple Plans Explained at Museum, 83.  
Barnes Sees Drop in Prices at Hand, 379.  
Bathing Was a Crime, When, 829.  
Beaux-Arts Architects' Pageant, 437.  
Beaux Arts Post Established, 378.  
Beaux Arts Post, 469.  
Belgium, Building Materials High in, 703.  
Belgium to Build Workers' Homes, 24, 52.  
Belgium Quarries During the War, 314.  
Belgium, Trade with, 158.  
Biltmore, Town of, Sold, 471.  
Books for All, 588.  
Boston, Mitigating Historic, 223.  
Boston Plans Memorial, 346.  
Brazil, Pantheon for, 191.  
Brazil Plans New Capital in Interior of Republic, 83.  
Brick Design Competition, Awards in, 437.
- C—
- Bridge, Biggest Bascule, 655.  
Bridge Building, Architectural Aspects of, 438.  
Bridge Designs, Denmark Offers Prizes for, 493.  
Bridgeport Chamber Attacks Smoke Nuisance, 19.  
Britain Proposes Subsidy to Solve Housing Problem, 23.  
British Garden City Scheme, 703.  
British Railway's Leader Warns People, 346.  
Brooklyn Chapter to Make Special Awards, 17.  
Brooklyn Chapter Meets, 409.  
Brumidi Paintings, Discovery of, 251.  
Brussels Fair, 158.  
Build on City Owned Land, Request \$2,000,000 to, 738.  
Build, Why It Costs to, 346.  
Building Commissions in New York State, 225.  
Building Conditions in Salvador, 557.  
Building Guild, 701.  
Building Heights, Chicago Regulates, 768.  
Building, Home Loan Banks and Tax Exemption to Aid, 438.  
Building Material, Age-Old, 283.  
Building Material Still "Non-Essential," 557.  
Building in Milan, 347.  
Building Operations in 1919, 620.  
Buildings, Public, 525.  
Building Trades Wages in Middle West, 469.  
"Bungalow" in Bengalese, 524.  
Bungalows, 620.  
Burnham Library Open at Chicago Art Institute, 523.  
Business Art Criticized, 471.  
Buy Homes or Have to Move, 411.
- D—
- California Land Settlement Scheme Favorably Progressing, 191.  
Camouflage, 704.  
Canada Places Time Limit on Soldiers' Applications for Retraining, 85.

## CURRENT NEWS

(Continued)

Carillon, World's Most Famous, 586.  
 Cathedral Again Postponed, Work on, 283.  
 Cement Sacks, Keep at Work, 470.  
 Ceramics, 221.  
 Chateau of Louis XV Damaged by Fire, 15.  
 Chicago Architects Have Lectures on Furniture, 84.  
 Chicago Architects Prepare for Annual Exhibit, 409.  
 Chicago's Architectural Transformation, 51.  
 Chicago Art Institute Extends Work, 525.  
 Chicago's Building Plan, 524.  
 Chicago Contractors Encounter Difficulties, 558.  
 Chicago Goes Tenting, 703.  
 Chicago Home Building, Financing of, 444.  
 Chicago Improvements Approved for South Park, 346.  
 Chicago Loop District Hopes to Revise Building Code, 380.  
 Chicago Needs Houses, 158.  
 Children and Apartment Houses, 587.  
 Christiania, Building Material Exhibition at, 18.  
 City Planning in a Nutshell, 438.  
 City Planning, Real, 440.  
 Civic Association, Annual Convention of American, 472.  
 Clothing Workers' House in New York, 589.  
 Como Island for Artists, 828.  
 Competition for Architects' Certificate, Pennsylvania, 20, 85.  
 Competition for Capitol Building, Nebraska, 226.  
 Competition for Cover Design, Chicago Exhibit, 285.  
 Competition for Milwaukee County General Hospital, 411.  
 Competition for Remodeling New York Tenement Block, 497.  
 Conference on Concrete Housing, 20.  
 Co-operative Building Plan, Forty Million Dollars in, 738.  
 Co-operative Plan at M. I. T., 825.  
 Corcoran Prize Awards, 81.  
 Craftsmen Form School, 52.  
 Credit Expansion or Production, 318.  
 Cubist Painting, Inventor of, Dead, 190.

—D—

Dewey's Former Home Turned Into Store, 739.  
 Draftsmen, Government Needs, 225.  
 Duluth Art Association Active, 437.  
 Dwellings Rebuilt, Called "Birth Control Houses," 525.

—E—

Edison's Eight Hour Day, 769.  
 Educating Through Play, 346.  
 Electric Drill Cuts Labor Cost, 701.  
 Electric Wiring, Importance of, Ample, 526.  
 England-France Chunnel Tunnel, 740.  
 England Builds, 225.  
 England Dealing with Housing Shortage, 285.  
 England's Building Program Provides Work for Million, 493.  
 England's Disabled Service Men, 379.  
 England Gripped by Housing Shortage, 378.  
 England's Unemployment Insurance Bill, 585.  
 English Names for English Streets, 794.  
 Eskimo Home, The Comfortable, 315.  
 Exchange Rates and Material Prices, 379.  
 Exposition Building, Permanent for Furniture Trade, 588.

—F—

Farm Buildings, Improving, 191.  
 Farm Houses, Better, Being Erected, 285.  
 Farmhouse Buildings, Model, 526.  
 Farm Movement Noted, Back to the, 20.  
 Farm Woodlands, Profitable Use of, 559.  
 Farmer's Relation to Our National Well Being, 317.  
 Farming on the Desert, 190.  
 Federal Bureau of Housing, Chicago Women Urge, 588.  
 Federal Reserve Banks, Buildings for, 22.  
 Federal Reserve System Reports on Financial Situation, 87.  
 Financing Rural Settlers, 22.  
 Fine Arts Building, New York, Burned, 19.  
 Fire Losses in United States and Canada, 18.  
 Flanders Mud Used to Build Winter Homes, 83.  
 Flats, First in America, 377.  
 Fly, To Kill the House, 739.  
 Foreign Trade Convention to be held in San Francisco, 20.  
 Foreign Trade Service, 313.  
 Forest Engineers for India Make Tour Here, 469.  
 Forest Policies, For Better Administration of, 221.  
 Forests, Roads in the National, 469.

Forests Shrinking, 125.  
 France, Reconstruction in, 825.  
 Franklin Fund, City to Use, 825.  
 French Art Passes to Other Lands, 53.  
 French Historical Structure, Replica, Proposed for San Francisco, 84.  
 French National Expansion, 25.  
 French Remodel Hotels, 83.  
 French Windmills to be Removed, 347.  
 Fuel Value of Wood, 471.

—G—

Garden City for South London, 54.  
 Garden of Inspiration, 380.  
 Germany Must Refuse \$5,000,000 for Art, 558.  
 Glasgow Foresaw Housing Shortage and Planned Ahead, 557.  
 Glasgow's Municipal Housing, 702.  
 Glass, Safety First in, 828.  
 Glass Shortage Induced by Motor Cars, 740.  
 Government Patronage, 55.  
 Grand Central Palace, To Alter, 739.  
 Greece, Fine Arts of, Exhibited, 283.  
 Greece Imports Houses, 124.  
 Greek Architecture in the Age of Pericles, 381.  
 Green Timber, Durability of, 345.

—H—

Hambidge's Measurements, 496.  
 Health Cabinet, 559.  
 Health More Important than Picturesque Landscape, 189.  
 Health Service, 703.  
 Heat Energy from Air a Possibility, 25.  
 Highway Construction, Extended Interest in, 494.  
 Historic Home of Dr. Priestley Honored, 347.  
 Historic New Orleans Building for Sale, 411.  
 Holland Buys Art, 588.  
 Home Building Bill in Congress, 588.  
 Home Building, State Aid Advocated for, 441.  
 Hongkong Constructed in Tiers, 84.  
 Hospital and Institutional Planning, 655.  
 Hospitals, Municipalization of, Advocated, 221.  
 Hotel as an Industrial City, New York, 380.  
 Hotel Property, Guests Buy, 738.  
 House Boats and High Rents, 589.  
 House Building Must Increase, Why, 380.  
 House Shortage Drives People from New York, 494.  
 Housing Body, Sherman Protest Bill to End, 25.  
 Housing Conditions in New York, 470.  
 Housing Conditions in New Zealand, 469.  
 Housing Notes from Various Cities, 654.  
 Housing Plans in Chicago, 559.  
 Housing Plans in Paterson, N. J., 411.  
 Housing Problem Acute in Berlin, 557.  
 Housing Shortage and Fire Hazard, 621.

—I—

Illinois Bulletin Discusses Journeymen Plumbers, 440.  
 Illinois Chapter, Sculptors Meet with, 255.  
 Illinois Chapter Meeting, 471.  
 Illinois Society Meets, 345.  
 Immigration Policies Discussed, 495.  
 Immigration To-Day, Character of, 590.  
 Increased Production Convention, 318.  
 Independent Art Exhibit, 437.  
 Indian as an Artist, 586.  
 Indiana Limestone Quarries Reorganize, 53.  
 Industrial Art, To Revive, 495.  
 Industrial Art School Formed, 85.  
 Industrial Arts and Tyrannical Unionism, 586.  
 Industrial Construction Revived in South, 411.  
 Inter-Allied Housing Congress, 121.  
 Inventors, New Organization will Encourage, 157.  
 Irrigation Reclaims the West, 157.  
 Italian Government Aids Housing, 738.  
 Italy, Building Conditions in, 24.  
 Italy, Housing Problem in, 123.

—J—

Jade, 438.

—K—

Kansas Chapter, A. I. A., 124.

—L—

Labor Board for New York State, Plea for, 439.  
 Labor Plentiful on Coast, 85.  
 Labor Shortage in England, 410.  
 Landscape Architects Meet, 82.  
 Landscape, Making Use of, 471.  
 Landscape, Painting the, 795.  
 Lighting Idea, Iias Novel, 378.  
 Lincoln Statue, Seek Site for, 82.  
 Lithographers Differ, 494.  
 London Disapproves of Skyscrapers, 827.  
 London Building, Ban on, 825.  
 London Forced to Erect Skyscrapers, 377.  
 London's Housing and Building Problems, 410.

London May Have Housing Committee, 24.  
 Lumber Association Formed, American, 379.  
 Luminous House Numbers, 702.

—M—

Madrid to be Improved, 621.  
 Maintenance Men, 441.  
 Marne Statue to France, Americans to Donate, 52.  
 Material Handling Machinery Manufacturers Association Meets, 158.  
 Memorial Designs, Competition for, 192.  
 Memorial Trees to be Planted on Arbor Day, 587.  
 Michigan Architects Elect Officers, 190.  
 Midget Furniture for Museums, 439.  
 Minneapolis Architects Have New Building, 655.  
 Minneapolis Architects Form Society, 523.  
 Mooring Towers, for Dirigibles, Britain to Use, 381.  
 Mosque in the Agra Fort, 19.  
 Motion Picture Producers Recognize Architects, 157.  
 Mound Builders' Homes Sacrificed, 768.  
 Movies Teach Process of Home Owning, 348.  
 Museum for Designers, 826.

—N—

National Federation of Construction Industries Presents Plea to Congress, 17.  
 National Foreign Trade Convention, Chambers Pledge Aid to, 84.  
 National Housing Commission Requested by American Institute Architects, 82.  
 National World War Memorial, 84.  
 Navy Program for 1921, 20.  
 Nebraska Chapter Meets, 126.  
 Negro and Americanization, 284.  
 Negro State on the Rio Grande, 123.  
 New York Lists City-Owned Land Available for Housing, 441.  
 New York Names Housing Committee, 703.  
 New York Organizes Housing Drive, 769.  
 New York Society of Architects Meets, 52, 345, 472, 585, 701.  
 New York's Smallest Newspaper, 20.  
 New York State Association of Architects Holds First Annual Meeting, 156.  
 Niagara Gorge, New York to Take Possession of, 472.

—O—

Office Buildings, Dearth of, in London, 587.  
 Office Space in Many Cities, Quotations on, 621.  
 Ohio Builders Urge Fire Prevention, 192.  
 Organization Needed in Housing, 284.  
 Orient Needs Development, 655.

—P—

Paint and Iron, Removal of, from Iron and Steel, 739.  
 Paint Instead of Wallpaper, 826.  
 Painter's Art Exhibits New Orleans' Beauty, 346.  
 Palace, Desecrating a, 121.  
 Paris Building for World Buyers, 223.  
 Paris Gets Back Ancient Art Windows, 23.  
 Paris Housing Shortage, 84.  
 Paris to Construct Homes for Workers, 656.  
 Paris, Project for Making, World's Center, 313.  
 Pennell's New Book on Etchers and Etching, 85.  
 Pennsylvania Architects Must Register, 23.  
 Pennsylvania University Opens Fine Arts School, 795.  
 Philadelphia Condemns Historic Residences, 121.  
 Philippines, House Shortage in, 826.  
 Picture Bought for Song May be Priceless, 225.  
 Picture Post Card, 189.  
 Pilcher, Receives Medal of Merit, State Architect, 654.  
 Planning Commissions, Three, in One City, 124.  
 Pottery Designs in Great Britain Improve, 125.  
 Pratt Institute Exhibits Evening Work, 258.  
 Profiteers After Mark Twain's House, 796.  
 Pueblo, Ruins of Ancient, Uncovered, 440.

—R—

Railroad Transportation, Production in, 655.  
 Red Cross Sanitary Survey in Eastern Europe, 656.  
 Registration of Architects in Pennsylvania, 409.  
 Remodeling in New York, 493.  
 Research Council Elects Officers, 826.  
 Roads, Good, Past and Future, 797.  
 Roman de la Rose Scripts Found, 225.

## CURRENT NEWS

(Continued)

Rome, Important Building Program at, 191.  
Roosevelt's Birthplace, Restore, 122.  
Roosevelt Road of Remembrance Proposed, 739.  
Rotch Traveling Scholarship, Announcement, 191.  
Rotch Traveling Scholarship, 654.  
Rug Made a Drapery by National Etiquette, 125.  
Rugs, Oriental, and American Floor Coverings, 257.  
Rugs, Serbians Again Making, 19.

### -S-

School of Design and Liberal Arts Opened, 124.  
School Posters Educate the Country, 124.  
Scotland Home of First Skyscrapers, 704.  
Sculptor, American, is Honored by Belgium, 124.  
Sculptor's War Loss in Germany, 284.  
Seattle Architects Hold Exhibit, 256.  
Senate to Investigate Housing Crisis, 702.  
Service, Must Have, 702.  
Signboards, Old English, 827.  
Slums, Prize Offer to End, 23.  
Skyscrapers, American, Replace Dickens Slums, 221.  
Snow, Melted, Harms Roads, 590.  
Southern California Architects Meet, 81.  
Southern California Chapter, Monthly Meeting, 157.  
Spain Introduces the Skyscraper, 225.  
Spain Solving Farm Labor Shortage, 767.  
Spurns \$5,000,000 Offer, Orpen, 346.  
St. Gervais, Restoring of, 377.

Stadiums, Municipal, 656.  
Stanford White's House Bought by Y. W. C. A., 559.  
Stanford White, In Memory of, 524.  
State Aid in Building Houses Urged, 123.  
Steel Bars, Standardizing, 233.  
Steel, New High-Speed, Invented, 159.  
Stock Exchange, Proposed Addition, in New York, 314.  
Stonehenge to be Protected, 495.  
Stout Institute, Wisconsin, Industrial Arts, 158.  
Strasbourg Cathedral, To Strengthen, 190.  
Streets Same Width as in 1620, 85.  
Sweden Amplifies Educational Methods, 158.  
Sweden, Impressions of, 589.  
Swedish-American Paintings in Sweden, 285.  
Swedish Housing Scheme, 346.

### -T-

Tapestries, American-Made, 437.  
Tapestries Returned to Mantua, 53.  
Tasmania Has Housing Problem, 125.  
Tax to Restrict Building, 627.  
Temple of Peace Proposed for Los Angeles, 702.  
Tenants, New Laws Protect, 25.  
Texas Campaign for Civic Beauty, 558.  
Theatre Buildings, Double Deck, 827.  
Times Square, 585.  
Tree Seeds for Europe, 191.  
Trees, Male and Female, 470.  
Trees, Street, 189.  
Tunnels, New York's New East River, 348.  
Tuscany, Rehabilitating, 225.

### -U-

Uruguay Announces International Architectural Competition, 85.

### -V-

Valparaiso, Building in, 157.  
Vanderlip's Speech to Economic Club, 128.  
Ventilation, School, in Chicago, 379.  
Virginia Accepts Rare Paintings, 284.

### -W-

Walls Have Ears, Why, 53.  
War Memorial Plans Crude, 620.  
War Memorials, Bishop to Approve, 225.  
Warsaw, to Modernize, 767.  
Water, High Cost of Wasting, 314.  
Water Tanks, Sightly, 126.  
Westinghouse Employee, Insurance Given to, 437.  
Westminster, Important Improvements in, 410.  
Wisconsin's Housing Plan, 377.  
Women Painters, Address, 81.  
Wooden Houses in England, 189, 257.

### -X-

X-ray Being Used on Old Masters, 740.

### -Z-

Zoning Rule, Simple, 122.  
Zoning Setbacks as Gardens, 829.

## TEXT ACCORDING TO AUTHORS

*Figures refer to text pages*

### -A-

Ackerman, Frederick:—  
Mediaeval Guilds and Labor Unions, 153.  
Arnold, G. I. H.:—  
Factory Stairs and Stairways, 129, 161.

### -B-

Baird, George M. P.:—  
State Design in Communal Buildings, 507, 549.  
Bellman, Lawrence S.:—  
Architectural Engineering, 311.  
Betelle, James O.:—  
School Buildings for Delaware, 751, 785.  
Blackall, C. H.:—  
Architectural Engineering, 342.  
Joseph McGinniss, 543.  
Bobula, Titus de:—  
House at Spuyten Duyvil, New York, 667.  
Brockway, A. L.:—  
New York State Department of Architecture, 35.

Brown, Glenn:—  
The Architect and Public Service, 1.  
The Architect and the Government, 169.  
The Architect and the Post-War Committee, 299.  
The Architect and Organization, 393.  
Butler, F. C.:—  
Foreign Language Newspaper, 816.

### -C-

Case, Major Ralph H.:—  
The Emergency Contract, 489, 522.  
Cheney, Charles H.:—  
Building Zone Ordinance of Portland, Ore., 659.  
Clay, Wharton:—  
Work of Trade Associations, 563.  
Cooper, Frank Irving:—  
One-Story Schoolhouse, 451.

### -E-

Eames & Young:—  
Federal Prison, Atlanta, Ga., 697.

### -F-

Fanning, Ralph:—  
Reconstruction of Devastated France, 781.

Forster, Henry W.:—  
Fire Protection for Schools, 264, 289, 323.

### -G-

Gardner, Henry A.:—  
Waterproof Glues, 265.  
Spray Painting, Practicability of, 801.  
Goodyear, William H.:—  
Foundations of Classic Architecture, 269.  
Grant, Francis W.:—  
Specification Clauses, 303, 732.

### -H-

H. H. Hiestand and Richards, McCarty & Bulford:—  
Preble County Court House, Eaton, Ohio, 511.  
Holsman, Henry K.:—  
Swartwout's Opinion on Competitions, 153.  
Expense of Estimating, 475.  
Howe, Oliver H.:—  
Civic Centers in New England, 173.

### -K-

Kimball, Allen Holmes:—  
Architectural Engineer, 375.  
Knowles, Wm. W.:—  
Sub-Station at Flushing, L. I., 195.  
Knowlton, Lynn O.:—  
Architectural Engineering, 342.  
Kohn, Robert D.:—  
Architectural Engineering, 312.

### -L-

Levitan, Benjamin W.:—  
Unique Institutional Building, Blackwell's Island, 415.

### -J-

James, Walter B.:—  
Clinic Building at Sing Sing Prison, 107.

### -M-

Maher, George W.:—  
An Indigenous Architecture, 335, 555.

Marshall, R. C., Jr.:—  
Practical Economics Secured by Standardization of Construction Specifications, 165.  
McGrath, George Bangs:—  
Story of Limestone, 319.  
Mueller, O. N.:—  
Architectural Engineering, 312.

### -N-

Nichols, George B.:—  
Mechanical Equipment of Wingdale Prison, 57.  
Nolen, John:—  
Public Opinion and City Planning Progress, 275.  
Types of City Plans, 213.  
Nolan, Thomas:—  
Architectural Engineer, 375.

### -O-

Ogden & Gander:—  
Albany City Hall, 809.

### -P-

Perrot, Emile G.:—  
Architectural Engineering, 341.  
Phelps, Albert C.:—  
English Parish Church, 425.  
Pilcher, Lewis F.:—  
Psychiatric Classification in Prison, 97.  
The Wingdale Prison Site, 114.  
Pitkin, William:—  
Relation Between the Architect and the Landscape Architect, 327, 363.  
Polk, Willis:—  
Architectural Engineer, 375.  
Pond, Irving K.:—  
Concrete, Its Use and Abuse, 177.  
Pope, John Russell:—  
Robert Bacon House, 397.

### -R-

Russell, E. J.:—  
National Board of Jurisdictional Awards, 429.

### -S-

Schilling, Adolf:—  
Trimstone and Building Ornaments, 483.

## TEXT ACCORDING TO AUTHORS

### (Continued)

- Simpson, John:—  
Law as to Architectural Practice, 74.
- Steele, Wm.:—  
Designing the Low Cost House, 375.
- Swales, Francis S.:—  
Architects and the Public, 359.
- Swan, Herbert S.:—  
How Zoning Helps Real Estate and Business, 216.
- Swanson, W. R.:—  
Unique Construction in Reinforced Concrete, 30.
- T—
- Tucker, William C.:—  
Isolated Sewage Disposal System, 529.
- W—
- Waddell, J. A. L.:—  
Payment for Estimating, 155.
- Wells, F. A.:—  
Fixed-Fee Contract, 237.
- Wentworth, Franklin H.:—  
Correct Building of Chimneys and Flues, 95.
- Whitney, Albert W.:—  
Safety Education in Public Schools, 297.
- Wills, E. Sidney:—  
The Ledge Stone House, 67.
- Wood, Edwin H.:—  
Natoriums, 281.
- Wood, Major General Leonard:—  
Roosevelt and the Fine Arts, 715.
- Y—
- Yardley, R. W.:—  
Architectural Engineer, 27.
- Young, Thomas Crane:—  
Housing Problem and Earth Masonry, 467.

## CRITICISM AND COMMENT

*Figures refer to text pages*

- Architectural Engineer. By Allen H. Kimball, Willis Polk, Thomas Nolan, 375.
- Architectural Engineering. By Emile G. Perrot, C. H. Blackall, Lynn O. Knowlton, 342.
- Architectural Engineering. By Lawrence S. Bellman, O. N. Mueller, Robert D. Kohn, 311.
- Competitions, Swartwout's Opinion on. By Henry K. Holsman, 153.
- Designing the Low Cost House. By William Steele, 375.
- Guilds, Mediaeval, and Labor Unions. By Frederick Ackerman, 153.
- Payment for Estimating. By J. A. L. Waddell, 155.

## DEPARTMENT OF ARCHITECTURAL ENGINEERING

*Figures refer to text pages*

- American Concrete Institute, Annual Convention, 385.
- American Society Mechanical Engineers, Annual Meeting, 135.
- Architectural Engineer. By R. W. Yardley, 27.
- Automatic Sprinkler System for Hot Water Heating, 625.
- Balance, The, 629.
- Bibliography on Chemical and Engineering Laboratories, 295.
- British Housing Schemes on Town Planning Lines, 423.
- Building Code Suggested by Lumber Organization, 423.
- Bureau of Standards, U. S., 268.
- Cement, Effect of Storage, 839.
- Checking Details and Superintending Construction, 356.
- Chimneys and Flues, Correct Building of. By Franklin H. Wentworth, 95.
- Civil Service Examinations, U. S., 424.
- Clocks, Historically and Architecturally Considered, 445, 499.
- Cold Storage Rooms, 450.
- Common Brick Manufacturers Convene, 232.
- Concrete House Construction, National Conference, 229.
- Concrete, Unique Construction in Reinforced. By W. R. Swanson, 30.
- Construction Division, U. S. A., 168, 204, 294, 506.
- Contract Forms, Formulating Improved, 749.
- Double Concrete Walls in Grain Elevator, 569.
- Electric Arc Welding for Structural Steel Framing, 707.
- Elevator Storehouse, Blackwells Island, New York. By Benjamin W. Levitan, Architect, 415.
- Engineering Council, 266, 450, 808.
- Engineering Notes, 136, 296, 632.
- Estimating, Expense of. By Henry K. Holsman, 475.
- Factory Stairs and Stairways. By G. L. H. Arnold, 129, 161.
- Fire Protection for Schools. By Henry W. Forster, 264, 289, 323.
- Flagpole, Simple Support for Skyscraper's, 358.
- Forest Products Laboratory Decennial, 805.
- Foundations, 294.
- Foundations, Their Selection, Design and Construction, 533.
- Fuel, New Development in Liquid, 532.
- Glues, Waterproof. By Henry A. Gardner, 265.
- Gypsum as a Building Material, 235.
- Heating and Ventilating Engineers Meet, 231.
- Hollow Tile, Proposed Code for, 806.
- Hoover President of Mining Engineers, 233.
- Hydrated Lime in Concrete, 34, 780.
- Illuminating Design, Fundamental Principles of, 261, 479, 833.
- Industrial Safety Codes, Second Conference, 135.
- Isolated Sewage Disposal System. By William C. Tucker, 529.
- Lime, 34.
- Limestone, Story of. By George Bangs McGrath, 319.
- Long Span Concrete Arches Used in Garage, 743.
- Moving a Chicago Building, 662.
- National Board of Jurisdictional Awards, 748.
- National Federation of Engineers, 807.
- National Fire Protection Association, 536, 840.
- National Public Works Convention, 94.
- Niagara Falls Power Plant, 423.
- Pittsburgh City-County Building, 267.
- Plastering Specifications Needed, 134.
- Protective Metallic Coatings for Rustproofing, 93.
- Public Convenience Stations, Need for, 773.
- Public Works, Department of, 666.
- Public Works vs. Public Waste, 482.
- Reinforcing Bars, Available Sizes of, 630.
- Research Graduate Assistantships, 168.
- Safety Education for Engineers, 452.
- Safety Education in the Public Schools. By Albert W. Whitney, 297.
- Safety Engineering, 777.
- Schoolhouse Construction and Fire Protection, 356.
- Schoolhouse, the One-Story. By Frank Irving Cooper, 451.
- Spray Painting, Practicability of. By Henry A. Gardner, 801.
- Stadium, Seattle, 806.
- Standard Specifications for Concrete, 234.
- Standardization of Construction Specifications. By R. C. Marshall, Jr., 165.
- Steel, Experiments on, 779.
- Sub-Station at Flushing, L. I. Wm. W. Knowles, Architect, 195.
- Successful Building in Stucco, 69, 386, 593, 711.
- Sulphur in Coal, Forms of, 236.
- Temporary Roofs for Fireproof Buildings, 351.
- Trade Associations, Work of. By Wharton Clay, 563.
- Uruguay, Construction in, 630.
- Vibration in Structures, 164.
- War to Peace, From, 776.
- Westinghouse Opportunities for Technical Graduates, 423.
- Wingdale Prison, New York. By George B. Nichols, 57.
- Zoning Ordinance of Portland, Ore. By Charles H. Cheney, 659.
- Zoning Regulations, Modifications in New York, 778.

## BOOK REVIEWS

*Figures refer to text pages*

- Reinforced Concrete Handbook, 164.
- Structural Drafting, 392.
- Estimating Concrete Buildings, 392.
- Electric Lighting, 392.
- Architectural Drawing Plates, 392.
- Modern Farm Buildings, 450.
- Hendrick's Commercial Register, 450.
- Retaining Walls, 570.
- How to Use Cement for Concrete Construction, 570.
- Turnpikes of New England, 704.
- American Civil Engineers' Hand Book, 704.

## ILLUSTRATIONS ACCORDING TO AUTHORS

*Figures refer to the number of the issue, not to the text pages*

- Bennett & Parsons:—  
Stadium, Chicago, 2304.
- Benedict, J. B.:—  
James H. Brown Building, Denver, Colo., 2316.
- Bigelow & Wadsworth:—  
Electric Illuminating Station, Boston, Mass., 2318.
- Bodker, Albert Joseph:—  
House of George W. Olmstead, Ludlow, Pa., 2312.
- Coolidge & Hodgdon:—  
Stadium in Chicago, 2305.
- Davis & Kramer:—  
Stadium in Chicago, 2305.
- Delano & Aldrich:—  
Houses at Syosset, L. I., and Oyster Bay, L. I., Gold Medal of Honor Award, 2311.
- Gilbert, Cass:—  
Chapel, Hotchkiss School, Lakeville, Conn., 2314.  
Theological Seminary, Oberlin, Ohio, 2314.  
Atlantic Refining Co., Philadelphia, Pa., 2314.
- Goodwin, Bullard & Woolsey:—  
House of Wharton Poor, Flushing, L. I., 2303.  
House at Hartford, Conn. Architectural League Exhibition, 2302.
- Gregory, Julius:—  
House of C. E. Chambers, Riverdale, N. Y., Architectural League Exhibition, 2302.
- Guilbert & Betelle:—  
Schools for the State of Delaware, 2321, 2322.
- Hiestand, H. H., and Richards, McCarty & Bulford:—  
Preble County Court House, Eaton, Ohio, 2314.
- Hiss & Weekes:—  
House of H. R. Rea, Sewickley, Pa., 2317.
- Hoffman, F. Burrall:—  
Interior of House, 2323.
- Holabird & Roche:—  
Stadium in Chicago, 2304.
- Hunt, Jarvis:—  
Stadium in Chicago, 2306.
- Jackson, A. J.:—  
House at Oceanic, N. J., 2303.
- Jackson, John F.:—  
Alterations, House of Edward M. Hale, Passaic, N. J., 2317.
- MacLaren & Hetherington:—  
Roman Catholic Chapel, Colorado Springs, Colo., 2318.
- James, Thomas M.:—  
Warren Institution for Savings, Boston, Mass., 2320.
- Marshall & Fox:—  
Stadium in Chicago, 2306.
- McGinniss, Joseph:—  
Italian Scenes from Sketches by, 2315.
- Newkirk, Clement:—  
House of Richard U. Sherman, Utica, N. Y.  
House of W. W. Nichols, Rochester, N. Y.  
Wm. Pitkin, Landscape Architect, 2308.
- Ogden & Gander:—  
Albany City Hall Alterations, 2323.
- Pilcher, Lewis F.:—  
Sing Sing Prison, New York, 2299.
- Pitkin, Wm., Landscape Architect:—  
Newkirk, Clement R., Architect,  
House of Richard U. Sherman, Utica, N. Y., 2308.  
House of W. W. Nichols, Rochester, N. Y., 2308.
- Pope, John Russell:—  
House of J. Randolph Robinson, Westbury, L. I., 2298.  
House of Robert L. Bacon, Jr., Westbury, L. I., 2310.
- Purdon, James:—  
House of E. M. Richards, West Newton, Mass., 2312.  
House of Mrs. P. H. Lombard, Pocasset, Mass., 2320.  
House of George Crompton, Pocasset, Mass., 2317.  
House of Robert Cushman, Brookline, Mass., 2309.  
House of Gifford Simonds, Fitchburg, Mass., 2309.  
House of George L. Osborn, Brookline, Mass., 2307.  
House of Chester S. Hardy, Fitchburg, Mass., 2307.  
House of Dr. Martin B. Dill, Newton Center, 2307.
- Searle & Searle:—  
Brantham Village Hall, Essex, England, 2301.  
Factory Group, British Xylonite Co., 2301.
- Spratt & Ralph:—  
Hart House, University of Toronto, Canada, 2313.
- Taylor & Levi:—  
House Interior, New York, 2323.
- Thomas, Charles E.:—  
High School, Durango, Colorado, 2313.
- Ziegler, Carl A.:—  
House of Robert M. Hogue,  
House of C. M. Brown,  
House of John D. McIlhenny,  
House of Franklin Baker, all Germantown, Phila., Pa., 2300.

## ILLUSTRATIONS ACCORDING TO SUBJECT

*Figures refer to the number of the issue, not to the text pages*

**Administrative and Governmental**

- Brantham Village Hall, Essex, England. Searle & Searle, Architects, 2301.
- Capitol Building of the League of Nations. Twelfth Paris Prize, Society of Beaux Arts, Architects, 2301.
- City Hall Alterations, Albany, N. Y. Ogden & Gander, Architects, 2323.
- Preble County Court House, Eaton, Ohio. H. H. Hiestand and Richards, McCarty & Bulford, Architects, 2314.
- Sing Sing Prison, New York. Lewis F. Pilcher, Architect, 2299.

**Ecclesiastical**

- Chapel, Hotchkiss School, Lakeville, Conn. Cass Gilbert, Architect, 2314.
- Roman Catholic Chapel, Colorado Springs, Colo. MacLaren & Hetherington, Architects, 2318.
- Theological Seminary, Oberlin, Ohio. Cass Gilbert, Architect, 2314.

**Educational**

- Hart House, University of Toronto, Canada. Spratt & Ralph, Architects, 2313.
- High School, Durango, Colorado. Charles E. Thomas, Architect, 2313.
- Schools for the State of Delaware. Guilbert & Betelle, Architects, 2321, 2322.

**Frontispieces**

- House of J. Randolph Robinson, Westbury, L. I., 2298.
- General View, Sing Sing Prison, 2299.
- Puerta de Santiago, Segovia, 2300.
- Altar of the Church of San Nicolas, Burgos, 2301.
- Architectural League of New York, Detail, 2302.
- Spanish Armor, Period of Charles V, 2303.
- Old City Gate, Cordoba, 2304.
- Altar in Cathedral, Granada, 2305.
- The City Gate, Cordoba, 2306.
- La Cubola, Palermo, 2307.
- Altar of Santa Lucia in Cathedral, Avila, 2308.
- A Patio in Cordoba, 2309.
- Leaning Tower of Saragossa, 2310.

- Interior of St. Mark's, Venice, 2311.
- Church of St. Maria dei Frari, Venice, 2312.
- Nave of the Carmelite Church, Venice, 2313.
- Museo Civico, Venice, 2314.
- Venice, Sketch by Joseph McGinniss, 2315.
- Detail of Window and Gable, Venice, 2316.
- Library of Venice, 2317.
- Palazzo Ugucioni, Florence, 2318.
- Cathedral of Murano, near Venice, 2319.
- Church of the Saviour, Venice, 2320.
- Grand Canal, Venice, 2321.
- Silver Custodia in Cathedral of Cordoba, 2322.
- Church of Santa Maria dei Frau, Venice, 2323.

**Industrial**

- Atlantic Refining Co., Philadelphia, Pa. Cass Gilbert, Architect, 2314.
- Edison Electric Illuminating Station, Boston, Mass. Bigelow & Wadsworth, Architects, 2318.
- Factory Group, British Xylonite Co., London, Eng. Searle & Searle, Architects, 2301.
- James H. Brown Building, Denver, Colo. J. B. Benedict, Architect, 2316.

**Miscellaneous**

- Stadium on the Lakefront, Chicago. Holabird & Roche, Bennett & Parsons, Davis & Kramer, Coolidge & Hodgdon, Jarvis Hunt, Marshall & Fox, 2304, 2305, 2306.
- Warren Institution for Savings, Boston, Mass. Thomas M. James, Architect, 2320.

**Residences**

- House of Robert L. Bacon, Jr., Westbury, L. I. John Russell Pope, Architect, 2310.
- House of Franklin Baker, Germantown, Pa. Carl A. Ziegler, Architect, 2300.
- House of C. M. Brown, Germantown, Pa. Carl A. Ziegler, Architect, 2300.
- House of George Crompton, Pocasset, Mass. James Purdon, Mass., 2317.
- House of Robert Cushman, Brookline, Mass. James Purdon, Architect, 2309.
- House of Dr. Martin S. Dill, Newton Center, Mass. James Purdon, Architect, 2307.

- House of Edward M. Hale, Passaic, N. J. John F. Jackson, Architect, 2317.
- House of Chester S. Hardy, Fitchburg, Mass. James Purdon, Architect, 2307.
- House of Robert M. Hogue, Germantown, Pa. Carl A. Ziegler, Architect, 2300.
- House of Mrs. P. H. Lombard, Pocasset, Mass. James Purdon, Architect, 2320.
- House of John D. McIlhenny, Germantown, Pa. Carl A. Ziegler, Architect, 2300.
- House of W. W. Nichols, Rochester, N. Y. Clement R. Newkirk, Architect. Wm. Pitkin, Landscape Architect, 2308.
- House of George W. Olmstead, Ludlow, Pa. Albert Joseph Bodker, 2312.
- House of George L. Osborn, Brookline, Mass. James Purdon, Architect, 2307.
- House of Wharton Poor, Flushing, L. I. Goodwin, Bullard & Woolsey, Architects, 2303.
- House of H. R. Rea, Sewickley, Pa. Hiss & Weekes, Architects, 2317.
- House of E. M. Richards, West Newton, Mass. James Purdon, Architect, 2312.
- House of J. Randolph Robinson, Westbury, L. I. John Russell Pope, Architect, 2298.
- House of Richard U. Sherman, Utica, N. Y. Clement R. Newkirk, Architect. Wm. Pitkin, Jr., Landscape Architect, 2308.
- House of Gifford L. Simonds, Fitchburg, Mass. James Purdon, Architect, 2309.
- House at Hartford, Conn. Goodwin, Bullard & Woolsey, Architects. Architectural League Exhibition, 2302.
- House at Oceanic, New Jersey. A. L. Jackson, Architect, 2303.
- Houses at Syosset, L. I., and Oyster Bay, L. I. By Delano & Aldrich. Gold Medal of Honor Award, 2311.
- House Interior, New York. F. Burrall Hoffman, Architect, 2323. Taylor & Levi, Architects, 2323.
- Standardized Artistic Houses. George Gilbert, Mott B. Schmidt, R. W. Bristol, Architects, 2316.
- Architectural League Exhibition in New York. House of C. E. Chambers, Riverdale, N. Y. Julius Gregory, Architect, 2302.



# ILLUSTRATIONS ACCORDING TO LOCATION

Figures refer to the number of the issue, not to the text pages

### Colorado—

- Colorado Springs:—  
Roman Catholic Chapel. MaClaren & Hetherington, Architects, 2318.
- Denver:—  
James H. Brown Building. J. B. Benedict, Architect, 2316.
- Durango:—  
High School. Charles E. Thomas, Architect, 2313.

### Connecticut—

- Hartford:—  
House by Goodwin, Bullard & Woolsey, Architects, 2302.
- Lakeville:—  
Chapel, Hotchkiss School. Cass Gilbert, Architect, 2314.

### Illinois—

- Chicago:—  
Stadium.  
Holabird & Roche and Bennett & Parsons, Architects, 2304.  
Davis & Kramer and Coolidge & Hodgdon, Architects, 2305.  
Jarvis Hunt and Marshall & Fox, Architects, 2306.

### Massachusetts—

- Boston:—  
Warren Institution for Savings. Thomas M. James, Architect, 2320.  
Electric Illuminating Station. Bigelow & Wadsworth, Architects, 2318.
- Brookline:—  
House of Robert Cushman. James Purdon, Architect, 2309.  
House of George L. Osborn. James Purdon, Architect, 2307.
- Fitchburg:—  
House of Gifford L. Simonds. James Purdon, Architect, 2309.  
House of Chester S. Hardy. James Purdon, Architect, 2307.

### Newton:—

- House of E. M. Richards. James Purdon, Architect, 2312.

### Newton Center:—

- House of Dr. Martin B. Dill. James Purdon, Architect, 2307.

### Pocasset:—

- House of Mrs. P. H. Lombard. James Purdon, Architect, 2320.
- House of George Crompton. James Purdon, Architect, 2317.

### New Jersey—

- Montclair:—  
Edward Russ Memorial Dormitory, and others in Delaware and New Jersey. Guillert & Betelle, Architects, 2321, 2322.
- Oceanic:—  
House by A. J. Jackson, Architect, 2303.
- Passaic:—  
House of Edward M. Hale. John F. Jackson, Architect, 2317.

### New York—

- Alhauy, N. Y.:—  
City Hall Alterations. Ogden & Gander, Architects, 2323.
- Flushing, L. I.:—  
House of Wharton Poor. Goodwin, Bullard & Woolsey, Architects, 2303.
- New York, N. Y.:—  
Interior of Residences. J. Burrall Hoffman, Architect, 2323. Taylor & Levi, Architects, 2323.
- Oyster Bay, L. I.:—  
House by Delano & Aldrich, Gold Medal of Honor Award, 2311.
- Riverdale:—  
House of C. E. Chambers. Julius Gregory, Architect, 2302.
- Rehester:—  
House of W. W. Nichols. Clement R. Newkirk, Architect. Wm. Pitkin, Landscape Architect, 2308.

### Sing Sing:—

- Sing Sing Prison. Lewis F. Pilcher, Architect, 2299.
- Syosset, L. I.:—  
House by Delano & Aldrich, Gold Medal of Honor Award, 2311.
- Utica:—  
House of Richard U. Sherman. Clement R. Newkirk, Architect. Wm. Pitkin, Landscape Architect, 2308.
- Westbury, L. I.:—  
House of Robert L. Bacon, Jr. John Russell Pope, Architect, 2310.
- Long Island, Westbury:—  
House of J. Randolph Robinson. John Russell Pope, Architect, 2298.

### Ohio—

- Eaton:—  
Preble County Court House. H. H. Heistand and Richards, McCarty & Bulford, Architects, 2314.
- Oberlin:—  
Theological Seminary. Cass Gilbert, Architect, 2314.

### Pennsylvania—

- Ludlow:—  
House of George W. Olmstead. Albert Joseph Bodker, Architect, 2312.
- Philadelphia:—  
Atlantic Refining Co. Cass Gilbert, Architect, 2314.
- Philadelphia, Germantown:—  
Houses of Robert M. Hogue, C. M. Brown, John D. McIlhenny, Franklin Baker, Carl A. Ziegler, Architect, 2300.
- Sewickley:—  
House of H. R. Rea. Hiss & Weekes, Architects, 2317.

### Canada—

- Toronto:—  
Hart House. University of Toronto. Spratt & Ralph, Architects, 2313.

Shales (probably 2-1/2 in.) also  
 pages as follows: - 16<sup>1-7</sup> 50<sup>1-8</sup> 80<sup>1-9</sup> 116<sup>1-10</sup> 152<sup>1-8</sup> 188<sup>1-9</sup>  
 228<sup>1-6</sup> 252<sup>1-5</sup> 282<sup>1-7</sup> 310<sup>1-8</sup> 342<sup>1-8</sup> 374<sup>1-7</sup> 408<sup>1-7</sup> 436<sup>1-10</sup> 468<sup>1-9</sup>  
 492<sup>1-12</sup> 522<sup>1-9</sup> 550<sup>1-7</sup> 584<sup>1-9</sup> 612<sup>1-10</sup> 646<sup>1-7</sup> 732<sup>1-6</sup> 766<sup>1-9</sup> 792<sup>1-10</sup> 820<sup>1-10</sup>

The following pp. have been merged: - 583<sup>1-8</sup> - 68, 115, 116<sup>1-10</sup>, 199-204  
 298<sup>1-10</sup> - 334. 436<sup>1-10</sup> - 452, 646<sup>1-7</sup> - 650, 685 - 698,  
 732<sup>1-6</sup> - 734.

# *The American Architect* Specification Manual for 1920

THE American Architect *Specification Manual*, edition of 1920, is now being prepared, and will be ready for distribution early in August.

We publish this volume as a service rendered to the profession which supports our publication, and copies of the *Manual* will be supplied (until the stock is distributed) free of charge to all practicing architects sending us requests on their office stationery. Many requests for the 1920 edition have already reached us, and we suggest that promptness in forwarding these requests is desirable in order to ensure the volume being received before the stock is exhausted.

We take this opportunity to express appreciation of the cordial welcome given the 1919 *Manual*. This edition, the first of the annual series which we intend to publish, was supplied to more than 3,000 architects in America, and has proved itself of practical value in their preparation of specifications, as evidenced by hundreds of letters received by us from architectural offices heartily commending the work.

The 1920 edition will be of greater size and importance than its predecessor, and will contain more than 170 specifications of standard building materials and processes. These specifications embody in condensed language the result of many years of experience of hundreds of experts in the use of the materials and methods specified.

The American Architect

from piece # 9702298,



HOUSE OF J. RANDOLPH ROBINSON AT WESTBURY, LONG ISLAND  
JOHN RUSSELL POPE, ARCHITECT

# THE AMERICAN ARCHITECT

VOL. CXVII

WEDNESDAY, JANUARY 7, 1920

NUMBER 2298

## The Architect and Public Service\*

By GLENN BROWN, F. A. I. A

**N**O profession has a right to existence unless it serves the people.

The architect as chief builder (architectōn), for satisfactory and efficient service, must have the mentality to plan and design, the capacity to construct, with a knowledge of materials and stresses, and the ability to manage varied business operations. If we glance back through history, or consider the great men of our own times, we find that those whose work stands as an inspiration to the public had these fundamental qualities.

The public, to satisfy its needs, requires good planners to obtain the most economical and efficient grouping of the utilities and æsthetics, good designers to present a harmonious artistic composition to please the eye, good constructors to secure safe and durable structures, good business men to conserve money and prevent financial or managerial complications.

The chief builder (architect) in planning considers the arrangement of space, the character of structural features, the cost of products, and combines and harmonizes the utilitarian and artistic elements of the structure.

With these fundamental functions under one control, efficiently administered, the client is pleased, the public is served and the architect is rendered a dominant and useful factor. With the control divided into separate forces with no dominant influence, and any of the elements inefficiently executed, the client is displeased, the public loses and the architect becomes a minor factor in producing results.

It may be useful to trace the trend of the architects of our day and see how they have fulfilled their duty, and what right they have to survive as a profession.

We had from colonial days to the Civil War practitioners—first in the East, then in the far South and on the Pacific Coast—who zealously cultivated small spots in a vast arid desert.

Organization of these men appealed to many as

\*This is the first of a series of articles by Glenn Brown on Architecture in the United States, past and present. The second article will appear in an early issue.

a solution of what was the greatest public good and the surest professional advance.

The American Institute of Architects, founded in 1857, was the first practical organization of the profession to attain better construction, more efficient business methods and higher ideals in plan and design. The founders hoped to combine the efforts of all capable practitioners, quality and capacity being the important element, to raise the standard of the least efficient and make the profession an efficient and useful instrument in the public service.

While the progress of the Institute was slow in attaining its ends and it was found difficult to arouse either public or professional interest, the high standing of its presidents, like Richard Upjohn, Thomas U. Walter, Richard M. Hunt, George B. Post, as well as of the directorate and members, gave the Institute standing and influence. The unselfish and indefatigable labors of secretaries like A. J. Bloor and Alfred Stone kept the organization together and increased its scope and efficiency.

During my service as secretary, 1899 to 1914, the Institute grew rapidly as an acknowledged and weighty factor in the public service, because of the national character, capacity and business acumen of the presidents under whom I served, like Henry Van Brunt, Robert S. Peabody, Charles F. McKim, W. S. Eames, Cass Gilbert, I. K. Pond, and from the high standing of its directors who with rare exceptions were men appreciated nationally for their work in plan and design, construction and business capacity. The broad acquaintance of the presidents with men of affairs, officials, the prominent in literature and art and social life, was used without stint in efforts to secure the best results in the Fine Arts. Conventions and board meetings were arranged to secure public and official attention. During Robert S. Peabody's administration a convention was held, during the Session of Congress, devoted to the development of Washington City, at which numerous schemes and papers were presented by prominent men; the first important discussion of city planning. These papers and dis-

## THE AMERICAN ARCHITECT

cussions so impressed Congress that the Senate appointed the Park Commission, and their report was hailed by laymen and experts in this country and Europe as a great solution of the problem.

A notable example of the power of social prestige was illustrated in the celebrated McKim dinner, so called because Charles F. McKim organized and managed the affair to the most trivial detail. Starting six months before the occasion, McKim, by his personal charm and magnetism, enthused, I was about to say hypnotized, many prominent men, among them Nicholas Murray Butler and Elihu Root, inducing them to spread the information that the leaders of industry, government science and literature should meet and take practical steps to advance the Fine Arts. Every phase of the country's interests was to be represented by the man at the top. The dinner was such a success that to-day, some fifteen years after the event, it is spoken of as the most notable event of the kind ever held in Washington. Seventy-five leading men were at the head table, among whom may be mentioned Theodore Roosevelt, President of the United States; John Hay, Secretary of State; Elihu Root, Secretary of War; Joseph Cannon, Speaker of the House; Senator Wetmore, Chairman Library Committee; Jusserand, Ambassador of France; Cardinal Gibbons, Prelate of the Church of Rome; Bishop Satterlee, of the Episcopal Diocese of Washington; Admiral Dewey, the Navy; Gen. Chaffee, Chief of Staff, the Army; J. Pierpont Morgan, Financier; Justice Harlan, Judiciary; Henry Walters, Art Collector; Augustus Saint Gaudens, Sculptor; John LaFarge, Painter; Charles Dana Gibson, Illustrator; Simon Newcomb, Scientist. This dinner resulted in contributions of six hundred thousand dollars for the American Academy in Rome.

Cass Gilbert, during his administration, organized a notable event in the memorial meeting to Augustus Saint Gaudens. In the Corcoran Gallery of Art was assembled, attractively installed, one hundred and fifty pieces of sculpture by Augustus Saint Gaudens. Each ambassador at the time in Washington was invited and participated in a tribute to the world-known artist. Roosevelt, President of the United States, and Elihu Root, Secretary of State, gave well-considered and glowing tributes to the American artist, while Jusserand claimed him for his French ancestry, and Bryce for his Irish nativity. This exhibition, transferred to Pittsburgh, Chicago and Indianapolis, gave over 500,000 visitors the opportunity of seeing and appreciating the work of the greatest modern sculptor.

Through my work as Secretary of the Public Art League of the United States and intimate as-

sociation with Richard Watson Gilder as President, my ambition had been fired with a desire to secure for the public the highest types of the Fine Arts produced by our artists, sculptors, painters and architects, so that our people might enjoy their beauty and be mentally ennobled by a growing appreciation of the Fine Arts.

I was in this frame of mind when the opportunity was offered of becoming Secretary of The American Institute of Architects. I accepted, enthused with the idea of combining the force of all believers in the elevation and refinement resulting from a knowledge of the Fine Arts. I felt that we could use the Association as a powerful machine, use it for the betterment of the architect, use it for the improvement of architecture, use it for the advancement of the Fine Arts, use it in the public service.

In 1900 this machinery was isolated in one plant. The time we felt had come for additional machinery and new branch plants under the central control. With care, thought and the strenuous work of many, the branch plants were established. We might compare the operating base to a great electric machine charged with dynamic force, connected by wires with all the states of the Union, with currents reaching across the ocean.

The superintendent in charge touched a button on one system and three hundred allied art societies, many patriotic, business and literary associations, responded in an output for the benefit of the public.

He touched a button on another branch when newspapers and magazines responded in editorials, descriptive articles and news items in favor of the Fine Arts.

He touched a button on yet another system and able, influential men from all sections of the United States gave of their time and capacity to the public service.

He sent a call from the central office when the thousand members of the Institute responded with vim and energy, upholding their ideals in art.

The operating plant, designed with love and zeal, upon a foundation of disinterested motives and high ideals for the public good, with justice and right for its footing, was erected on the bed-rock of public confidence.

The success of a plant is shown in the character of its output, and in the opinions of thoughtful men as to the value of its operations.

This Institute plant produced, without mentioning many minor products:

The purchase of the Octagon, giving the Association for the first time a fixed and national abiding place.

## THE AMERICAN ARCHITECT

It stopped crude and destructive additions to the White House, which led to the charming restoration of this architectural monument and historic mansion by McKim, Mead & White.

It secured a Park Commission on the development of Washington, whose well-considered and important report has been a moral force in the growth of the Nation's Capital—and an inspiration to other cities and towns throughout the United States.

It secured a National Arts Commission which has proved its public worth by maintaining high ideals in sculpture, painting, landscape and architecture.

It secured the National Charter for the American Academy in Rome, placing this post-graduate school for our brightest young sculptors, painters and architects, to which it hoped to add musicians, on a par with the art schools of other countries.

It conferred the Gold Medal of the Institute on Ashton Webb, Charles F. McKim, Geo. B. Post, J. L. Pascal; making the presentations occasions for national and international tributes to the Fine Arts.

It organized and held the memorial meeting to Augustus Saint Gaudens, making it an international tribute to the greatest modern sculptor and giving hundreds of thousands the opportunity to view his works grouped together.

It placed competitions on an improved basis, so that the public have secured better results.

It prevented the location of the Agricultural Building where it would have destroyed the vista between the Capitol and the Washington Monument, and secured its location according to the Park plans.

It prevented the location of the Grant Memorial where it would have marred the charming view of the White House from the south and secured its location on the site recommended by the Park Commission.

It prevented the execution of crude designs for the office buildings of the House of Representatives and the U. S. Senate and additions to the U. S. Capitol, thus securing the dignified and effective Congressional office buildings designed by Carrère and Hastings.

It prevented the narrowing of the building line on the Mall to 600 feet, and secured through the Senate and Theodore Roosevelt a 900-foot park width, as designed by the Park Commission.

It prevented the location of the Lincoln Memorial, as an addendum to the railway station, as an entrance to the Soldiers' Home, as an attraction on Sixteenth Street hill, and its dissipation into an ordinary highway to Gettysburg, and secured its

location after twelve years of effort on the site so wisely selected for it by the Park Commission where we see it nearing completion from the designs of Henry Bacon in all its simplicity and dignity as a part of the great composition in the development of the city.

It is interesting to know what other people think of our efforts and I am pleased to quote the opinion of a number of prominent men who were in position to judge of the results.

Thomas Nelson Page, author and ambassador: "I have often wondered at the influence which the Washington office of the Institute had in public matters, though I could see well enough that it had been attained through the recognition on the part of the public of the unselfish devotion of the officers of the Institute to the public weal."

Robert Lincoln O'Brien, editor *Boston Herald*; ten years correspondent in Washington for Boston and other cities:

"I have always found that the Institute has possessed the confidence of the community through its advocacy of disinterested ideals for the advancement of the Fine Arts, and by reason of this confidence of the public the Institute's ideals to a surprisingly large extent materialized into realities.

"Its management must have been most efficient to secure these successes.

"It has had continuous opposition from some of the most astute politicians, but it has to a notable degree made its opinions prevail."

Francis E. Leupp, author, newspaper correspondent; resident of Washington for more than a quarter of a century:

"My memory goes back to a time when whoever had the ordering of a piece of work ordered it to suit his own fancy. \*\*\*\* The result of this confusion is nowhere more obvious than in the earlier growth of Washington \*\*\*\* due to its long lack of definite aim.

"To the Institute we owe the change in all this and the evolution of a plan which has received the commendation of experts of all nationalities. \*\*\*\* Its influence has radiated to all parts of the United States. \*\*\*\* In the country at large the capital was almost unknown except as a quiet place where the President lived and Congress held its sessions. Consequently with the adoption of Washington as the Institute's headquarters \*\*\* the tide of travel began to flow Washingtonward: the waking up of the city had attracted universal attention and the first inquiry of most visitors concerned the scheme of improvement they had been reading about in the newspapers.

"The significance of all this was soon made manifest in the attitude of Congress. \*\*\*\* From this

## THE AMERICAN ARCHITECT

center, the Octagon, went out streams of influence which produced a new era in the appreciation of the Fine Arts all over the country. \*\*\*\* Public and domestic architecture made great strides \*\*\* and the country became wholesomely critical where it had formerly been indifferent. \*\*\*\* The new impulse to artistic discrimination is traceable more to the Institute's work and the wise way in which it has been organized and managed than to any other cause."

Hon. Lynden Evans, member of Congress from Illinois, who successfully managed the fight on the floor of the House of Representatives which prevented the transfer of the appropriation for the Lincoln Memorial in Washington to a Gettysburg highway:

"I have just been putting away and classifying my papers and documents acquired during my service in Congress and I have much interest in preserving those relating to the Lincoln Memorial. I wish to express to you my appreciation as the one in charge on the floor of the House on its passage of the great work which the American Institute of Architects performed, and the country owes a debt of gratitude to you which will never be adequately appreciated until the Memorial is finished. Appreciation for such work is very often left unexpressed, and that moves me to say to you and your associates that I believe we could not have carried the Memorial without your aid."

James Bryce, M.O., Ambassador of Great Britain:

"My sympathy is so much engaged in your work that I have not liked to decline the labor. Best wishes for the success of your efforts."

Hon. Elihu Root:

"I have a high opinion of the usefulness of the Institute."

The vital fluid that gave life to the central plant of Institute operations was the unselfish zeal, busi-

ness-like intelligence and personal magnetism of its officers and directorate.

The ramifying wires from central did not vibrate with life from card and filing systems, they responded to the fluid of personal zeal and mental force.

A superintendent, ignorant of the various functions, not comprehending the many adjustments, unfamiliar with the nicely fitted parts, not knowing the ramifications of the wires could easily scrap the plant and make worthless the whole operating base.

Having laid a solid foundation based upon public confidence, it would appear easy to erect a superstructure enlightening the public and ennobling the architect.

Is such a structure in progress with a fair prospect of fulfilling the ideals of the profession and the needs of the public?

From documents I receive from the Institute and from conversations I have had with architects I conclude few are optimistic. We hear of the lack of vision of officials, the commercial spirit of the layman, the aggressive spirit of the engineer and the managing zeal of the builder. It will at least be interesting and possibly profitable to analyze the reasons leading to this pessimism. This I propose to do in several articles, making an effort to discover whether the architect, the official, the engineer or the builder is to blame for this condition.

We know that when the architect executes his work efficiently the public is served by the product in buildings, bridges, monuments and landscape more effectively and advantageously than it can be served by any other profession or combination of professions.

Therefore, it is our duty as a profession to thoughtfully consider and fearlessly rectify any conditions touching toward the public losing the benefit attained by the service of the architect.



# The Georgian House

With Special Reference to the House of J. Randolph Robinson, Esq.,  
at Westbury, Long Island, Illustrated in This Issue

JOHN RUSSELL POPE, *Architect*

IN Burton's *Wit and Humor*, a book long out of print and becoming so rare as to attract collectors, a certain garrulous old lady, of the Mrs. Malaprop type, is said to have once asked Dean Swift if he would have "condiments" in his tea. To which the worthy Dean replied, "Pepper and salt, madam, but no mustard."

This anecdote suggesting a misuse of words reminds us of the misuse among laymen, and it is sad to record, of some architects, of the word, Colonial.

The main reason why people simply say "Colonial," when they mean Georgian, is perhaps that this correct and stately type is more closely identified with our Colonial history than any other.

The Georgian period of architecture in the Colonies saw the erection of many buildings that are of the highest historic interest and of the best architectural character. The names of many of these Georgian buildings will at once suggest themselves to the architectural reader as he will also recall the

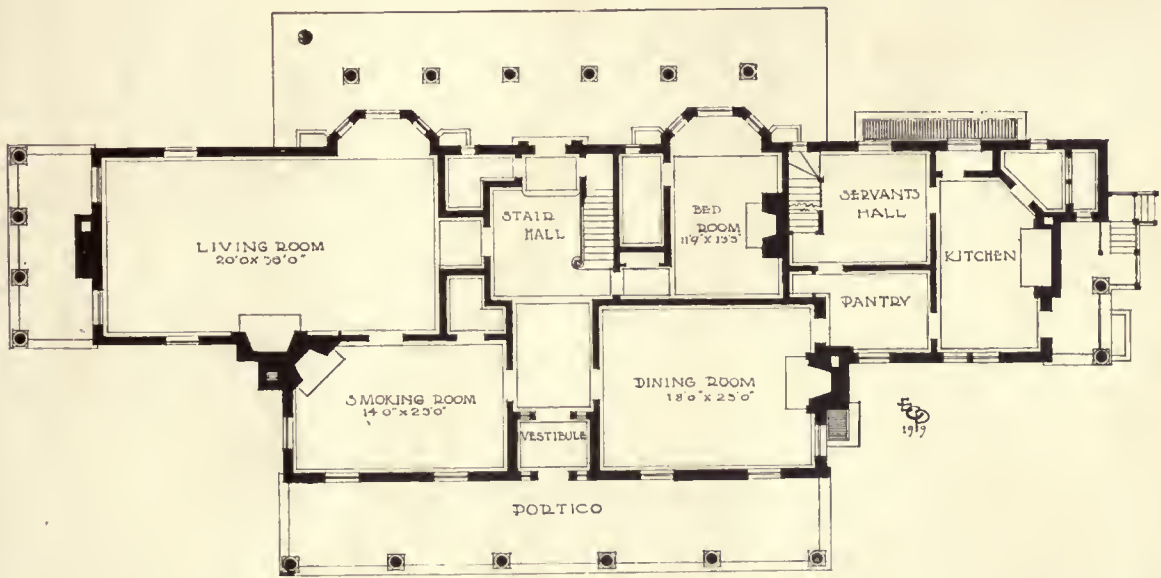

MAIN FLOOR PLAN  
HOUSE FOR J. RANDOLPH ROBINSON, WESTBURY, LONG ISLAND  
JOHN RUSSELL POPE, *ARCHITECT*

As a rule, in applying this word to a type of architecture it is meant to describe the Georgian. So why not say Georgian, if that is what is meant. Or, if reference is had to the various and distinct types of architecture that marked our building during the Colonial period, give to each its proper prefix. For example, we have the Georgian, or English Colonial, along our Atlantic seaboard and on the shores of the James River. There is the Dutch Colonial in New York and nearby New Jersey; the French, the Spanish and the Swedish Colonial, each in those localities where groups of *emigres* from Europe at one time or another settled in our Colonies.

many fine examples of Early Georgian domestic architecture in this country. Undoubtedly, there is a certain refinement and suggestion of culture about the well-designed Georgian house, and it is equally true that in the development of design and the best exposition of the Georgian house no architects abroad have excelled the work of men in this country who competently have studied this type.

The house of Mr. J. Randolph Robinson, designed by John Russell Pope, and illustrated in this issue, presents a good example of the Georgian house of moderate cost.

In this country to-day even our rich men do not

## THE AMERICAN ARCHITECT

belong to an idle class such as is perhaps common in Europe. Every man will have his business activities, those absorbing and often nerve-racking employments that make it necessary that at certain times he shall find a haven of rest, recreation and recuperation. It is this condition as surrounding a largely augmented class that is resulting in the creation in suburban locations of many small but at the same time dignified houses. It is easy to imagine the solace one might find among surroundings so well designed and carried to execution as is this house by Mr. Pope.

Inside and out there is to be seen reminiscence of the best expressed Georgian. The house is, as are all Georgian houses equally well designed, one to live in where contentment and those quiet hours so necessary to busy men and women may be enjoyed to the utmost.

There is a certain patriotism in the Georgian house. It suggests our early struggle for independ-

ence, it brings to mind the stirring scenes of our revolutionary period. Particularly is this true of the extant, well-preserved examples of this period. One may close one's eyes and with but little stretch of imagination people one of these old houses with the folk of the period. The candle-lighted rooms, the gleaming white panelled walls, the mahogany rich in contrast. Or, to the sound of music see the stately ladies in panniered gowns, with powdered hair and "patches," sedately walking through the measures of Sir Roger de Coverly, with the beau of the period.

Certainly the Georgian is a patriotic type. There may be differences of opinion among some as to whether or not it is the most desirable style for our country estates. Everyone may have his preference. We shall not quarrel with him, but if we may spend the end of a busy life in a Georgian house, embowered with elms, quiet, dignified, beautiful, we shall be happy, come what may.

---

## Industrial Art Survey Inaugurated

**T**HE National Society for Vocational Education reports that as a result of present conditions in the field of industrial art brought about by the war an industrial art survey has been determined upon by that organization under the direction of Prof. Chas. R. Richards of Cooper Union, to begin in January. It will cover the whole country and will be supplemented by studies of methods and results in European art schools.

The purpose of the Survey will be to bring together the art schools and the manufacturers in a common program for the training of American designers.

The results of the European War have produced a profound effect upon the art industries of the United States, states the report. The borrowing and adaptation of designs, as well as the importation of great quantities of artistic merchandise, was practically brought to a standstill at the beginning of hostilities. Since that time American industries producing commodities into which the element of art enters in an important way have been forced to find in this country designers capable of developing the necessary ideas and motives. Some few establishments marked by unusual en-

ergy and breadth of vision have made extraordinary advances in artistic achievements and have rendered themselves independent of European assistance. The great majority of American employers, however, have not reached that point and are still greatly in need of trained designers.

The central feature of the survey will be a study of the conditions under which designs are developed for commercial practice, the requirements under which the designer works, and the qualities and training necessary for successful work in design. Among the industries to be studied are the costume trades, textiles, printing, jewelry, silverware, wall paper, lighting fixtures, ceramics, furniture and interior decoration.

An important feature will be an advisory committee of persons prominent in art industries who are counted upon to render material assistance in shaping the policies and scope of the survey. In addition, strong committees will be organized in each trade division to co-operate and advise as to the conduct of field studies.

A study will also be made of the extent to which American art schools are functioning in the training of designers for industries.

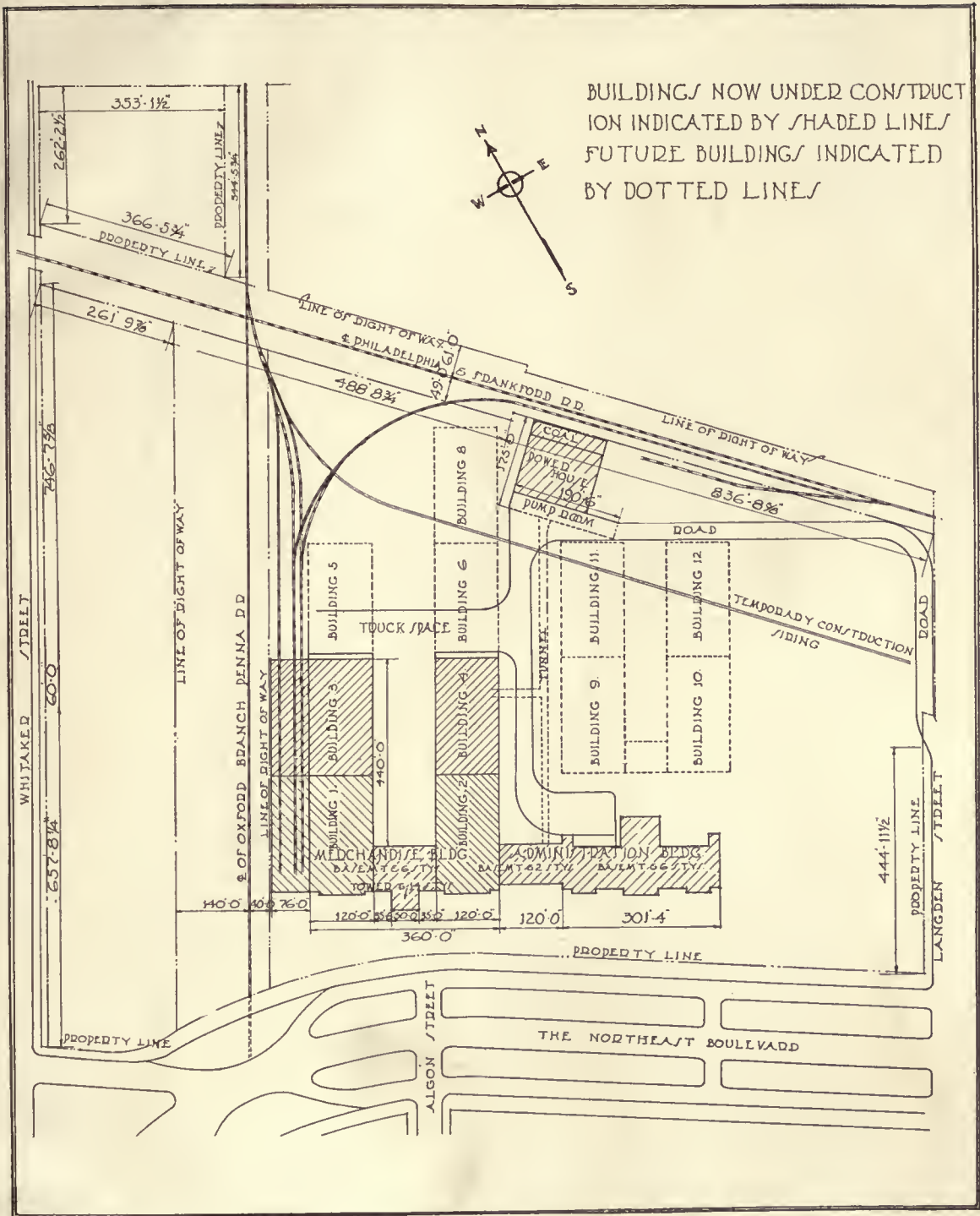

PLOT PLAN

PLANT OF SEARS, ROEBUCK & CO., PHILADELPHIA, PA.

GEORGE C. NIMMONS & CO., ARCHITECTS, MARTIN C. SCHWAB, CONSULTING MECHANICAL ENGINEER

# The Philadelphia Plant of Sears, Roebuck & Co.

GEORGE C. NIMMONS & Co., *Architects*

THE product of an architectural organization is the plan, specification, the interpretation thereof and the supervision of construction. These are the essential directions to the contractor. The true function of this product is to direct the completion of a structure in a way that will make it adequate for the needs of occupancy. That is the essential. The cost and artistic appearance thus become of secondary importance. The needs of the occupant must be served first, that interest dominates and is not directly affected by factors other than utility.

The artistic design is that factor which principally affects the public and the adjoining properties. The importance and value of this element of the design is not to be overlooked and owners are becoming thoroughly appreciative of its value. It is assumed that an architectural organization is operated for a monetary profit as well as artistic achievement, both essential to a complete success. It then follows that the cost of the product is an important element to be considered. Many things affect this cost. The attitude of the organization toward the relative importance of the purely professional and the business phases of its practice influence the cost of production. To secure the proper balance between these two is one of the most important problems that confront the management of such an organization. It is known that such products of the finest quality, both artistic and utilitarian, are produced at a satisfactory cost and because of an efficient and well-balanced organization.

An interesting example of efficient architectural production is one recently accomplished by George C. Nimmons & Co. in planning the new Philadelphia plant for Sears, Roebuck & Co. It is true that Mr. Nimmons had the experience of planning the Chicago, Kansas City and Seattle plants for that company which was naturally an aid in the present instance.

The general requirements of the first units to be erected and their relation to the completed project were determined by consultation with the owners, and the 1/16-inch preliminary sketch plans agreed upon. The location of the plant on the Northeast Boulevard made it imperative that the structure be an artistic as well as a utilitarian success. That the first factor was properly taken care of is evi-

denced by the approval of the plans by the Philadelphia Art Jury before they were submitted to the city building department for permits to construct.

The buildings are located on a tract of land of about forty acres, which is located at the turn in the direction of the boulevard. This is a most advantageous location, as the structure appears to be at the apparent termination of the street. The location of the buildings under construction and the proposed future buildings is shown on the plat plan. The railroad tracks and adjoining streets are also shown. The buildings set back from the boulevard a distance of about 150 feet to allow for lawns and landscape effects, and at the same time adding to the apparent width of the boulevard at that place.

The mercantile building has a frontage of 360 feet, with a depth of 440 feet, nine stories and basement, except the tower of fourteen stories in height. The administration building has a frontage of 481 feet with depths of 75, 81 and 145 feet. The two-story and basement portion adjoining the merchandise building has a frontage of 120 feet, and the balance, with a frontage of 301 feet, is six stories and basement in height. In this two-story portion are located the kitchen, cafeterias and dining rooms for the employees and officers of the company, the balance being used for administrative and executive offices. In the tower of the merchandise building are located the water tanks for the sprinkler system and the house service. The power house is located at the rear, as shown on the plat plan.

The buildings under construction cover a ground area of 4.87 acres, the floors having an area of 48 acres. The buildings are of reinforced concrete construction, the walls faced with dark red brick of varying shades, with trim of gray-colored terracotta. The architectural treatment is in a style that in recent years has been termed industrial gothic. The foregoing description and the illustrations give an indication of the extent and character of the work involved in the preparation of the plans. The mechanical equipment of the plant is designed by Martin C. Schwab, Consulting Engineer.

The order for the preparation of the working drawings, made in ink on tracing cloth, was given

*(Concluded on page 13)*



PLANT OF SEARS, ROEBUCK & CO., PHILADELPHIA, PA.  
GEORGE C. NIMMONS & CO., ARCHITECTS, MARTIN C. SCHWAB, CONSULTING MECHANICAL ENGINEER

# The Civic Forum for New York City

At the beginning of the settlement of America, 300 years ago, the first building which the founders of the Plymouth Colony set themselves to erect was a "Common House", as they called it: a place where they could meet to discuss, arrange and enjoy their communal life. The rough structure of logs suited the life of people who had come to live in a wilderness; not that it was in-

literated in the very nick of time—though with not soon sufficient success as yet to avoid a Civil War—this ease of transportation brought new difficulties. Every community received from elsewhere in America or from Europe newcomers in increasing numbers who did not enter informally into active discussion of the community's affairs and these newcomers were thereby losing one of the qualities of our democracy.

One day each year all men were equal at the ballot box. Yet there must have been a vague apprehension that there was somewhere a social lack. Perhaps that is why the "lyceum" appeared at that time. But the "lyceum," after starting as an ethical movement, became literary and transcendental rather than practical, and there gradually came throughout that period a decadence of general interest in politics. Eventually the lycea were transformed into theatres and libraries.

Continuously in response to increasing economic demand the people came and worked and lived. We talk of a "melting pot" but there was no "melting pot." Economically the newcomers were absorbed; they gave their labor and received their pay; but politically they existed only in the scheme of some professional politician as did most of the rest of our people—and the incoming Europeans knew nothing better. There was no special machinery for knitting these people together or introducing them into our communities and thanks are

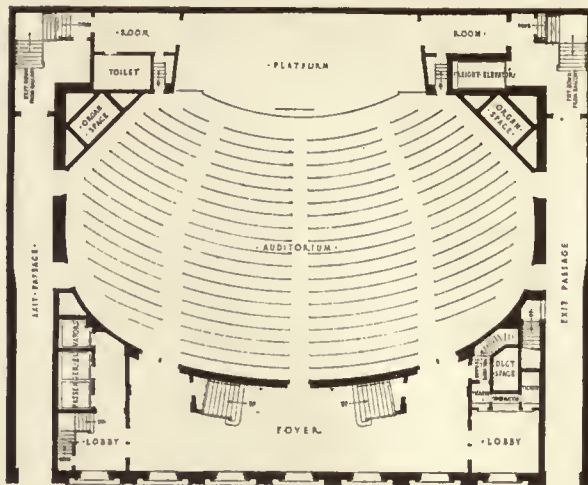

FIRST FLOOR

entionally so suited, but they built the best they knew. The building's service was from our point of view threefold: a church, a government house, and a social center for their community. The three-fold usage became traditional, perhaps the first purely American architectural tradition, and one which still exists in its purity in our small villages.

In the expanding communities with their complication of social life, the governmental function of the "Common House" was, for political reasons, removed to more impressive buildings; the religious function developed churches (in New England traditionally called "Meeting Houses"); and the social center completely disappeared so far as a traditional building is concerned, for the casual political discussion of the citizens seemed not to require a place of its own. It was carried on wherever men met informally. The population was small and everyone knew everyone else in the community, knew his life and what it stood for, knew what he thought with a knowledge kept up to date by constant association.

But soon, as a result of mechanical invention, our people began to move about the country, and while the dangers of parochialism were being ob-

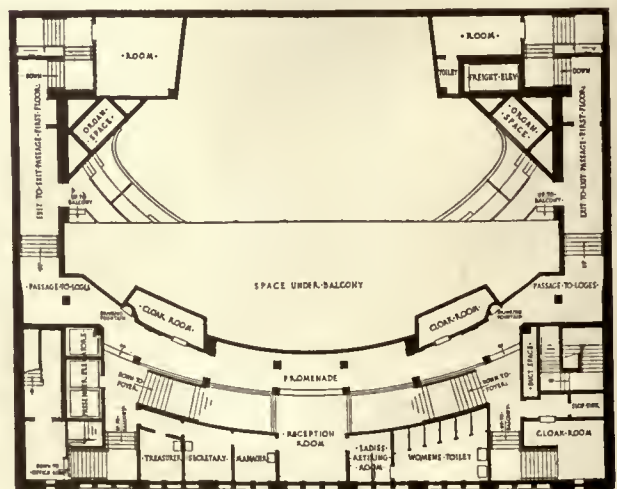

FIRST MEZZANINE FLOOR

due to our system of free education that we are not much worse off than we are.

Of late we have tried settlement houses and

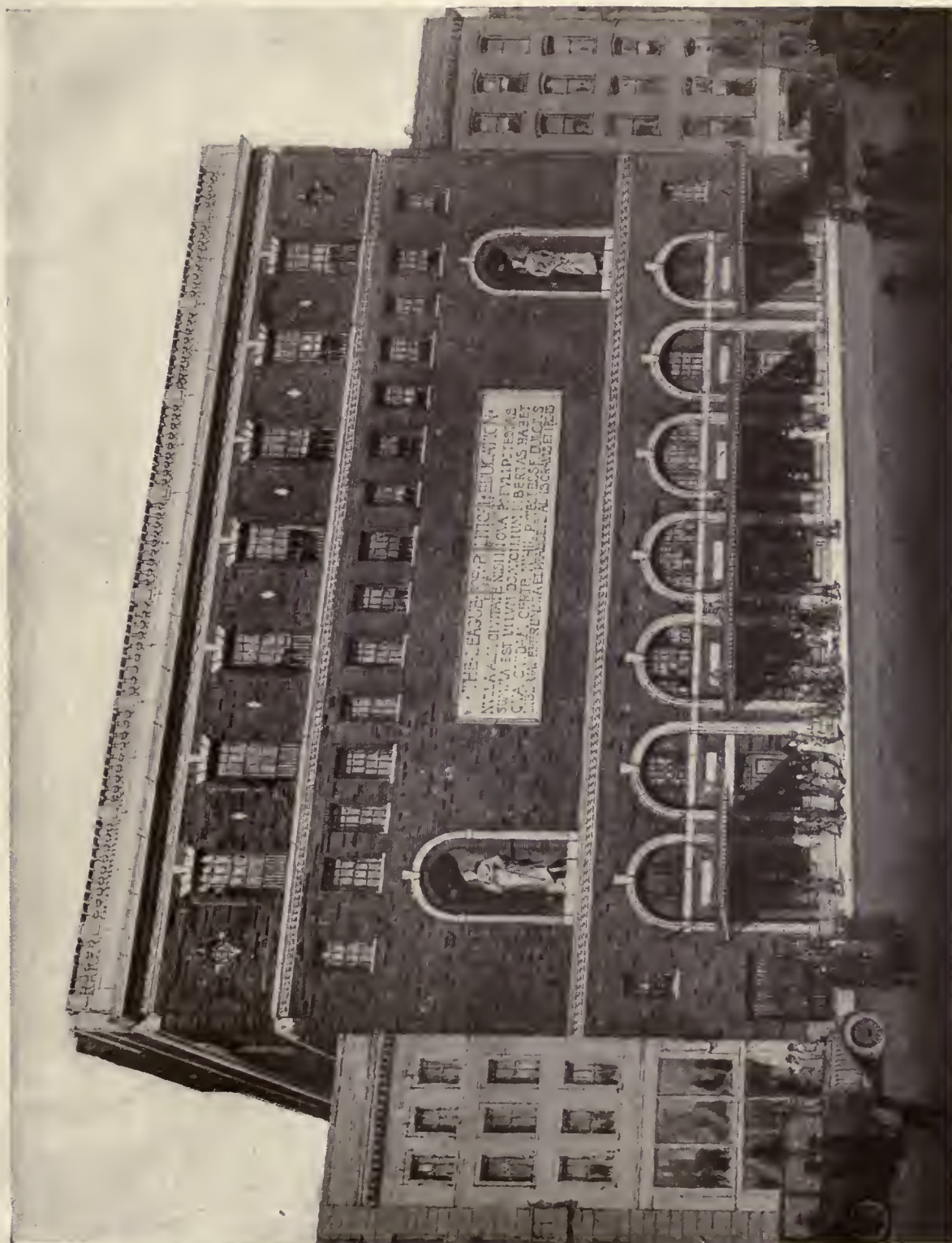

HALL FOR THE LEAGUE OF POLITICAL EDUCATION, NEW YORK  
MCKIM, MEAD & WHITE, ARCHITECTS

## THE AMERICAN ARCHITECT

night schools. While these may be very well in their way, they are beside the point. They educate but they do not amalgamate. They are not democratic. It becomes increasingly evident that our

if they choose—but it isn't. The revolution was in 1620 or 1776.

One way our people mean to express this understanding of their responsibility for their government—and this now seems to be one of the most distinctive features of the period of political consciousness now dawning—is through what has been popularly known for the past ten years as the "civic forum". The "civic forum" is not a new or radical notion, it is not revolutionary, but is rather an institution founded on what undoubtedly is one of the earliest traditions of our society: freedom of speech at a proper time and place. Ten years ago the traditional open meeting received strong impetus and nowadays there are thousands of such meetings being held in churches or within the confined areas of school houses. The movement has become so developed that its housing needs are becoming more clearly defined. In the issue of *THE AMERICAN ARCHITECT* for October 7th there were published plans for civic centers which meet the demands of the towns and smaller cities. The illustrations accompanying this article present the means by which architects propose to meet the situation in New York.

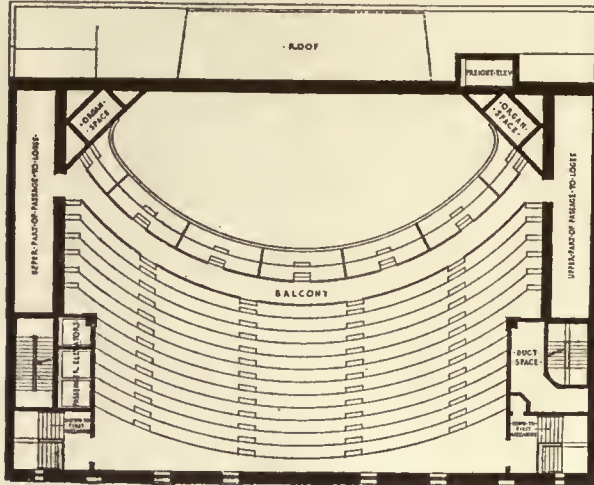

BALCONY FLOOR

social structure has developed and is developing the conscious need of buildings which shall be consecrated to the informal civil life of all its members. We are all interested in our politics today and are beginning to realize that they are an every-day affair and not a business to be disposed of once and for all by primaries and elections. We may be a little excited by the discovery and we may talk of the danger of revolutions and anarchy. But there are no dangers except the one that part of our people shall not know what some other part is talking about, for we speak in many languages of ideas remote and not yet related. It is a simple necessity that these be brought together, understood and related; to accomplish this is our obvious duty. The buildings in which this knitting together takes place will be lasting monuments to our purpose. In such buildings we shall talk things over quietly and at ease. What we don't want, we will discard; what we need, we will keep for legislation.

Elaborate capitols marked but one phase of our understanding of the system by which we are governed. More modest structures will represent the realization that this is not only a government "for the people" but "by the people." Our radicals may romantically call this a revolution in our government

The League of Political Education in that city,

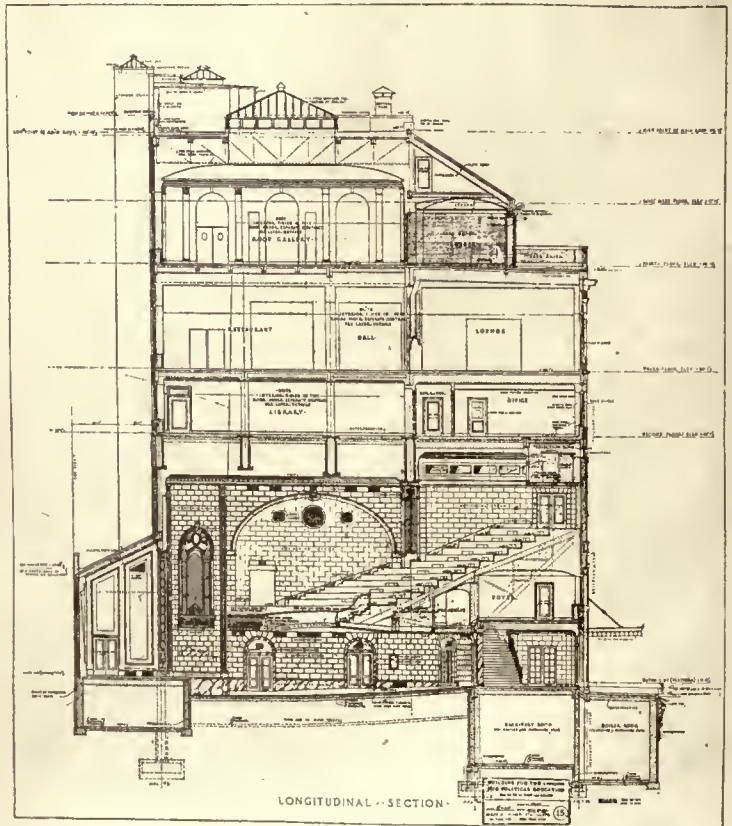

LONGITUDINAL SECTION



## THE AMERICAN ARCHITECT

as a part of its effort toward developing our political standards, has decided to build an auditorium "where law-abiding citizens may get together and really have a chance to discuss their common interests." They have placed the problem of expressing the idea in a building into the hands of McKim, Mead & White.

Ease of access for the city's population is an essential of such a building. The site in New York is accordingly on Forty-third Street between Sixth and Seventh Avenues, within a block of Times Square—the center of the city's transportation system.

The first four floors of the building are to be an auditorium appropriate to serious public meetings, with walls of artificial stone in soft, warm colors and with a small platform under a simple proscenium arch. There is to be one balcony but no boxes, the room seating in all about 1,700 people. There are wide aisles and comfortable seats but no posts or supports to obstruct the view. The lighting is indirect. The swinging doors at the beginning of each aisle are calculated to attain quiet and repose. The general feeling of the room approaches the Greek in its simplicity.

The floor above, which corresponds to a fifth floor, will be used for the offices of the donors—the League of Political Education—and its allied organizations: the Civic Forum and the Economic Club. On this floor there is also to be space for a library to contain 10,000 books. The sixth floor and the galleries on the roof are to be arranged as quarters for a proposed social club of men and women.

Mr. Theodore Roosevelt, Jr., laid the cornerstone of this new civic auditorium on January 24th, and it is expected that the building will commence its important work of public service during the coming summer.

### The Philadelphia Plant of Sears, Roebuck & Co.

(Continued from page 8)

on August 25, 1919, and they were completed, ready for estimates, on September 16. This covers a period of twenty-three days, which included three Sundays and one holiday, Labor Day. There were nineteen working days consumed in the preparation of the complete scale drawings and specifications.

Such a production would be impossible in a vast majority of architectural organizations. It can only be accomplished in an organization that is properly balanced in all its parts and which is animated with a certain *esprit de corps*, which is

necessary for such achievements as this. A banquet and theatre party was given to all the members of the organization to celebrate the success of the undertaking.

### Alliance Between Industry and Education

THE Massachusetts Institute of Technology, Cambridge, Mass., is just beginning to approach the industries of the country with a plan of co-operation which, while it has for its immediate objective the raising of funds to provide more nearly adequate salaries for the members of its instructing staff, is not only almost revolutionary in character, but is bound to have far-reaching effects on the educational and industrial structure of the nation.

Briefly stated, the Technology Plan of Education, as it is called, consists in the various industries retaining the Institute in a consultant capacity, on an annual salary basis. In return for the fee, Technology agrees to permit the corporations so retaining her to make use of the Institute's extensive library, files and plant, and to consult with the members of her staff and faculty on problems pertaining immediately to the business of the company. In addition, the Institute will place at the disposal of these industries a record of the qualifications, experiences and special knowledge of her Alumni which is likely to be of value to them, will advise and assist the various companies in obtaining information as to where special knowledge and experience in any given subject may be obtained, and will give them the first opportunity of securing the services of "Tech" men.

Like many another idea, humble in its beginnings, the Technology Plan may run to lengths far beyond its original scope. It is a perfectly logical conclusion, for instance, that ultimately Technology would be retained by the majority of larger corporations just as they now retain great lawyers or great engineers. In return for the retainer fee, they would receive the potential value of the name and reputation of the Institute with its great plant and laboratories, its library—one of the most famous of its kind in the country—the services of its instructing staff and the benefit of the advice of the experts in various fields of engineering who are among its Alumni. In thesis work investigations by undergraduates, preference would be given problems which confronted the corporations and concerns that retained the Institute.

Carried to its conclusion, the Technology Plan would make of M. I. T. the greatest consulting body in the world, since its range would cover

## THE AMERICAN ARCHITECT

practically every field of technical research and it would follow that since the great corporations of the country retained Technology as a consultant, the great experts of the country would ultimately be members of its instructing staff. In other words, Industry would, in a sense, come to Technology, instead of the instructing staff and students going to Industry as they do now in certain cases.

It is, therefore, quite likely that a new relationship between Technology and the industrial organization of the country will grow out of the Technology Plan. American industry has long been in need of a clearing house of scientific knowledge. The unparalleled resources of M. I. T. are to be placed more than ever at the command of the nation's business, and what the step will mean for the development of American enterprises in every field of endeavor can scarcely be overestimated. The position the United States is to hold in the commerce of the world will depend in a large measure upon the degree to which science is applied to the process of production and it is the technically trained man who will meet and solve the problems of international competition.

Fears that the Technology Plan may conflict with the work of the private consulting engineer are answered by the obvious fact that the great majority of the problems submitted to the Institute are beyond the scope of the private engineer or laboratory.

---

### A Secret of Bad Building

**A** CORRESPONDENT of *The Times* of London, says: "Anyone who has been engaged in drawing and measuring a mansion, say of the seventeenth or eighteenth century, must have been struck by the opulent scale and proportion of its details as compared with the most costly building of the same class erected in the present day. Yet the difference may be traced rather to a system than to any conscious intention on the part of architects, builders, and clients. In a word, the present-day building is erected 'by contract'; the seventeenth-century building was not.

"Where first the idea took possession of the mind of the building owner that he must know the exact cost of his building in advance and obtain a legal contract for the carrying out of it for a specified sum; the building contractor, of course, for the

protection of his own pocket, must know exactly what amount of each material used in the building he had to supply; hence arose the operation called 'taking out the quantities.' In the first instance this quantity-taking was done by the builder at his own cost, as a means of self-protection. But the time came when the builders, as a class, rebelled against this tax on their time, and required the 'quantities' to be supplied to them at the cost of the building owner. Hence arose the separate profession of the 'Quantity Surveyor.' Now on top of all this comes the desire of the building owner to get his building as cheap as possible; so the quantities are supplied to a selected number of builders, who are invited to state respectively for what sum they will carry out the building, and (unless there has been a special *caveat*—'the lowest tender not necessarily accepted') he who will do it cheapest is selected, with the result sometimes that the selected builder leaves himself so narrow a margin for profit as to be under a painful temptation to scamp the workmanship in some way not too obvious to the eagle eye of the architect.

"Thus architecture, which should be a great and noble art for the embellishment and pride of cities, and carried out with that object pre-eminently, is reduced to a kind of business of getting a presentable result at the least possible cost, and in general, it may be added, in the shortest possible time, for in too many cases (in town architecture especially) a new building is regarded by its promoters not as architecture but simply as 'property'; on which money has been expended, and which must be hurried up in order to make money returns out of it as early as possible. An essentially commercial generation may argue that this is the only logical, reasonable, and business-like method of procedure. It may be business, but it is not architecture. Not on such a system will arise such a civic architecture as will leave 'no complaining in our streets.' No great architecture ever has been or ever will be produced on the basis of building as fast and as cheaply as possible."

To the foregoing, printed in *The Architect*, of London, the editors add the following note:

With much of this, many builders and most architects will be in complete agreement; but the unduly heavy scantlings used in the seventeenth and eighteenth centuries were consequent on a very rudimentary knowledge of stresses.

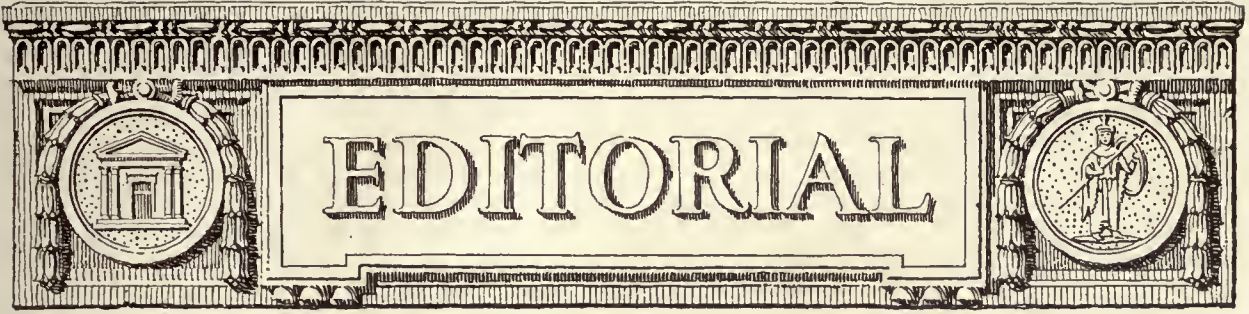

*In order to supply our readers with material of current interest, the news and comment appearing in issues of THE AMERICAN ARCHITECT delayed by the printers' strike will be as of actual rather than stated date of publication.*

## The Architect and Public Service

“NO profession has a right to existence unless it serves the people.” Thus writes Glenn Brown in the opening sentence of his series on “The Architect and Public Service” printed in this issue. While this contention is not new, it is particularly important at this time that it receive the emphasis of repetition.

It is unfortunately true that in certain ranks of professionalism this important fact has been lost sight of and professional service has very largely degenerated into a selfish forwarding of the professional advancement regardless of the public welfare. Just whether or not these conditions exist in the profession of architecture will be left for Mr. Brown to make clear in his articles. Certainly, by reason of long and faithful service to the profession and by the high rank he has attained among architects, no man is more competent than he to discuss the subject.

MR. BROWN will consider the contributory causes which during later years have resulted in largely bringing about a very decided change in professionalism. He will not claim to have first discovered that the profession of architecture, in common with other professions, has been traveling strange and devious paths. That knowledge has been brought home to professional men in all ranks throughout the country and has resulted in an inter-professional conference recently held in Detroit which will undoubtedly be the means of effecting some very necessary reforms.

Just how far and how valuably the profession of architecture may serve the public has been made very plain by Mr. Brown in his series recently printed in this journal, “Roosevelt and the Fine Arts.” So thoroughly was organized architecture serving the public that it had no difficulty in securing the indorsement and support of a National Ad-

ministration in carrying forward its well-formed ideals for the architectural advancement of this country. Does the present attitude of organized architecture command in equal measure that same support and is it doing anything to earn it?

Those who indignantly repel the statement that architecture is in any sense a business, who stoutly claim it is all an art, will need to mold their actions on the lines of those whose influence and abilities at one time put architecture on the highest artistic plane it has ever occupied in this country.

We have much to learn in the profession of architecture as to just what it means to serve the public. It is believed that Mr. Brown's series will very thoroughly point out the only road on which we may safely travel.

## Organizing for Efficiency

DURING the progress of the war comment was many times made in these pages as to specific instances where architects' offices had in unusually short periods of time prepared the plans and specifications for large and often complicated buildings. These references were made with a view to demonstrating that in all architectural offices sufficiently large to handle big operations, the organization had been and was then so very well maintained that no sudden influx of business, no unusual demand, could disarrange their smooth functioning.

In this issue there is illustrated, with an accompanying brief article of description, the Philadelphia plant of a large Chicago corporation, designed by George C. Nimmons & Co.

We note that from the placing of the commission by the client to the delivery of the plans and specifications by the architect there elapsed a period of but nineteen working days. Reference to the drawings and illustrations will enable the technical reader to understand just what was accomplished in this brief period.

## THE AMERICAN ARCHITECT

We believe it will be conceded that nowhere in the world could a better record be made, and we further believe that this combination of speed and efficiency is now generally recognized as a dominating characteristic of a result when American architects and engineers unite to produce that result.

### The Inter-Professional Relation

THE importance of engineering, structural and mechanical elements in building construction is becoming more pronounced with each passing day. How best to co-ordinate the engineering with the many other elements of architecture, in producing plans and specifications, is a problem that demands the serious thought of architects at this time. As the magnitude of building projects becomes greater with the multiplicity of details, this demand will become more insistent.

That engineering and architectural designing are of relatively equal importance in the practice of architecture, is very clearly established in the article by Mr. Yardley printed in this issue of *THE AMERICAN ARCHITECT*. He also suggests a way in which the co-ordination of these things is successfully accomplished and in addition outlines the training and qualities necessary to produce an architectural engineer. In discussing such an engineer he clearly defines his duties and responsibilities and makes it patent to the reader that the technical curriculum of the day is lacking. This is probably due to lack

of appreciation of the need for this particular training on the part of technical educators. The educational effort has apparently been concentrated on training specialists. These specialists are necessary, but the need of the more broadly trained architectural engineer is as great. The recent discussions concerning a broader training of architects and engineers in general cultural topics has borne fruit and men of these professions are aware of the needs.

Owing to the vast number of engineering factors entering into building construction, greater in extent than in any other construction work, the architectural engineer, who is responsible for all of them, must have the broadest and most liberal technical training and in addition thereto a comprehensive cultural training. The road which leads to competency is a most arduous one and it should not be entered upon lightly. There should be some method by which students not qualified for this work might be prevented from engaging in the study. This is a thing that must be worked out by each technical school as best it can. This is one of the most vital matters that concerns the educator to-day.

When the Post-War Committee considers the question of scholastic training for architects it can very profitably consider also the training of architectural engineers. Their work is so allied that the consideration of the first alone would be most unfortunate.



CATHEDRAL OF ST. MARK'S, VENICE  
FROM THE PAINTING BY CANALETTO  
(Courtesy of M. Knoedler & Co.)

16'



PLATE 1 HOUSE OF J. RANDOLPH ROBINSON AT WESTBURY, LONG ISLAND  
JOHN RUSSELL POPE, ARCHITECT





PLATE 2

HOUSE OF J. RANDOLPH ROBINSON AT WESTBURY, LONG ISLAND  
JOHN RUSSELL POPE, ARCHITECT







PLATE 3

HOUSE OF J. RANDOLPH ROBINSON AT WESTBURY, LONG ISLAND  
JOHN RUSSELL POPE, ARCHITECT

163



164



PLATE 4

HOUSE OF J. RANDOLPH ROBINSON AT WESTBURY, LONG ISLAND  
JOHN RUSSELL POPE, ARCHITECT



165-



PLATE 5

HOUSE OF J. RANDOLPH ROBINSON AT WESTBURY, LONG ISLAND  
JOHN RUSSELL POPE, ARCHITECT





PLATE 6

HOUSE OF J. RANDOLPH ROBINSON AT WESTBURY, LONG ISLAND  
JOHN RUSSELL POPE, ARCHITECT







PLATE 7

HOUSE OF J. RANDOLPH ROBINSON AT WESTBURY, LONG ISLAND

JOHN RUSSELL POPE, ARCHITECT



# Current News

## Happenings and Comment in the Fields of Architecture and the Allied Arts

*In order to supply our readers with material of current interest, the news and comment appearing in issues of THE AMERICAN ARCHITECT delayed by the printers' strike will be as of actual rather than stated date of publication.*

### Brooklyn Chapter to Make Special Awards

The Brooklyn Chapter of the American Institute of Architects passed a resolution at a meeting of the Chapter held to give a certificate of merit to the owners and architects responsible for the best designs in the construction of buildings, store fronts and architectural operations constructed during the year 1919 and every year thereafter.

The Chapter is doing this to stimulate artistic designing for buildings throughout the borough and, knowing that the profession has suffered considerably during the war, believes that this is the best way possible to arouse more interest among the architects of Brooklyn.

A committee of three members of the Chapter appointed by the president will inspect and report on the artistic qualifications and merits of the buildings and designs and report their findings to the Chapter as a whole.

The certificate of merit will be given in recognition of Brooklyn Chapter members for work done. Any member of other Chapters may receive a certificate of merit on the same basis and conditions as the Brooklyn Chapter members. By unanimous vote of the Brooklyn Chapter any other architect may be awarded a certificate of merit for meritorious and artistic building operations in Brooklyn.

Every certificate of merit is to be given without prejudice and strictly on the artistic merits of the design, proportions and general results.

### National Federation of Construction Industries Presents Plea to Congress

To the Senate and House of Representatives of the United States of America, in Congress Assembled:

Your petitioners respectfully represent that they are an association of persons and national and local organizations concerned as manufacturers or contractors or otherwise in the building or construction industry of the United States.

That the present condition of shortage in building and structures has been largely brought about through the curtailment of the construction industry by the Government during the war.

That the tendency of the Federal Reserve System, admirable in its general effect upon the business of the country, has been to promote the use of capital upon short term loans, made through national and other banks.

That the attraction of capital to such loans has drawn capital away from long term loans based upon mortgage on real estate.

That the erection of the required dwellings and manufacturing buildings, by increasing the plant facilities of the United States, will tend to increase production and decrease prices.

That there is a need at the present time in the United States for from 600,000 to 1,000,000 new dwellings as homes for workmen and others and of many other buildings for business and other purposes, which constitute cumulated requirements caused by the nearly complete cessation during the war of building for other than war purposes.

That the preference created by the Federal Reserve Law for the investment of capital in commercial discounts and other like forms of investment has resulted in withdrawing large sums of money from availability for loans on building and real estate, and has thus greatly hindered the construction industry and increased the difficulty attendant upon the restoration of normal conditions in the construction industry.

After careful consideration of the situation, as above outlined, the National Federation of Construction Industries is convinced that a comprehensive study should be made of: The sources of capital available for home and other building purposes, the recent withdrawal of capital from long term mortgages on real estate, the causes of such action, the unfortunate results to the construction industry and to those who desire to own and occupy buildings for production or for dwelling purposes, and the possibility of legislative correction of the evils unintentionally created by otherwise beneficial legislative action.

The National Federation of Construction Industries therefore respectfully memorializes the Congress of the United States that a subcommittee of the Committee on Banking and Currency of the Senate and Ways and Means of the House of Representatives, or a joint committee of both Houses of Congress, be appointed to make an investigation of the matters above outlined, to the end that there may be developed a modern system of long term banking, complementing, but not conflicting with, the Federal Reserve System, so that the nation's wealth may be more completely mobilized both for times of peace and for times of emergency, and so that national development may be promoted during the period of reconstruction.

ERNEST T. TRIGG, President.

### The American Association of Engineers on Trade-Unionism

In the present state of industrial unrest the board of directors of the American Association of Engineers has considered it desirable to make a statement defining the position of the Association. This statement follows:

The American Association of Engineers is an incorporated organization responsible for its acts.

The engineer is the medium through which both capital and labor are used in production and in industrial development. The aim of the profession is to advance civilization and render the highest service to society. Except when their acts further this aim, it is an advocate of neither capital nor labor.

## THE AMERICAN ARCHITECT

Production should be increased—not limited. The profession cannot support strikes or lockouts or any other methods that may benefit any class at the expense of the nation as a whole. They are unsound and must inevitably lead to economic disaster. The law for supply and demand for men or material must ultimately prevail. Attempts may be made to limit the supply of either, but looking toward the upbuilding of civilization we believe rather in increasing the demand through the promotion of legitimate enterprises.

Rewards should be according to ability, initiative and constructive effort. Men are not equal in these respects. Each man should be encouraged to do his utmost and be given compensation according to ability and will to increase production and to achieve large results.

The engineer, as an educated professional man, believes in basing his claims for proper and just reward for his services upon the justice of the facts presented, upon enlightenment of public opinion, upon loyalty between employer and employee, and upon the underlying fundamental desire of the great majority to do what is fair and right when the merits of the case in question are clearly presented and demonstrated. We believe in organized representation for the correction of wrong, the advancement of the profession and service to the public, but are opposed to methods inconsistent with the dignity of the profession and which would lessen public confidence.

### Famous Chateau of Louis the 15th Damaged by Fire

The famous and magnificent chateau built by Louis the Fifteenth at Compiegne has been damaged by fire. During the war this great pile had been turned to many uses. Those who knew it when Foch was installed in a neighboring building, will recall the curious spectacle of the interior, where many of the services of general headquarters were quartered. Fortunately, few of the art treasures had been put back in places in the part of the chateau which has most suffered. It is mainly masses of records of the ministry of reconstruction which have been destroyed. Nevertheless the damage is estimated at more than two million francs.

The fire started on the first story of the chateau and soon spread to the second floor, where it gutted two of the finest rooms in the palace, the Salle Du Conseil and the Emperor's (Napoleon III) room.

There was a fine ceiling in the Emperor's room by Girodet, representing the figures of war, force, justice and eloquence. This has been destroyed, as have the wall paintings and fine woodwork which decorated the Salle Du Conseil has also been burnt out, but fortunately the flames were stopped before they reached the Emperor's library, which has even a finer ceiling by Girodet. The roof and interior of the left wing has been very largely destroyed.

### Building Material Exhibition at Christiania

A cablegram from Consul General Marion Letcher at Christiania, Norway, states that there will be a building material exhibition from April 19 to May 3 at Christiania held under the auspices of the Norwegian Housing and Town Planning Association. Among the materials to be shown are those necessary in erecting residences, such as ceiling and wall materials, flooring, tiling for interiors and

for roofs, heating and sanitary equipment of all kinds, electrical equipment for heating and for domestic power. Ready made buildings will also be exhibited.

American concerns are invited to take part and invitations have been issued to the manufacturers of other countries.

Applications for space may be sent to the American consul general at Christiania to be transmitted to the proper authorities, but the consul general cannot assume any responsibility for obtaining such space. The space is limited. The rate of exhibitors, payable in advance, is 55 crowns for each square meter, but a refund will be made if any funds remain at the close of the exhibit. No space may be secured after Feb. 15. The allotments of space is in the hands of the committee, both as to the amount of space and the location.

### Fire Losses in the United States and Canada

The *Journal of Commerce* (New York) prints the following table of fire losses in the United States and Canada by years since 1879:

*1919.....	\$269,000,775	1898.....	\$119,650,500
1918.....	317,014,385	1897.....	110,319,650
1917.....	267,273,140	1896.....	115,955,500
1916.....	231,442,995	1895.....	129,835,700
1915.....	182,836,200	1894.....	128,246,400
1914.....	235,591,350	1993.....	156,445,875
1913.....	224,728,350	1892.....	151,516,000
1912.....	225,320,900	1891.....	143,764,000
1911.....	234,337,250	1890.....	108,893,700
1910.....	234,470,650	1889.....	123,046,800
1909.....	203,649,200	1888.....	110,885,600
1908.....	238,562,250	1887.....	120,283,000
1907.....	215,671,250	1886.....	104,924,700
1906.....	459,710,000	1885.....	102,818,700
1905.....	175,193,800	1884.....	110,108,600
1904.....	252,554,950	1883.....	110,149,000
1903.....	150,195,700	1882.....	84,505,000
1902.....	149,260,850	1881.....	81,280,000
1901.....	164,347,450	1880.....	74,643,400
1900.....	163,362,250	1879.....	77,703,700
1899.....	130,773,200		

Total for 41 years.....\$7,031,966,820

The losses for December were \$27,366,500, to be compared with \$41,737,750 for December, 1918, and \$26,360,300 for December, 1917.

### A Special Exhibition of Reproductions Selected by a Jury of Experts

That any great organization should undertake a country-wide campaign under the slogan "Art in Every Home" is a novelty in American life. Yet under this significant motto The American Federation of Arts, a national organization with 225 chapters (some of which number as many as 800 members), and thousands of individual members in all parts of the country, has grouped a series of efforts for the improvement of American home furnishings. It has just announced an exhibition of prints in color and photographs suitable for home decoration. The prints in question have been selected by a jury of experts. Every taste and fancy of the individual may be satisfied in this exhibition: history, mythology, chivalry, love, the home, childhood, music, patriotism, nature in all forms, figure landscape and sea subjects, in fact subjects eminent-

## THE AMERICAN ARCHITECT

ly suitable for any home are there, and at a figure within reach of every purse. Some 300 subjects will be shown, the great majority of them being by American artists. There will also be a small group of foreign subjects, as well as a number of reproductions of famous paintings by old masters.

There is also an exceptionally good series of photographs, among them a selection from paintings in the Metropolitan Museum of Art, published by the museum as part of its extensive educational work.

The exhibition will be held at the Sage Foundation Building, 130 East Twenty-second Street, Jan. 11 to 25. There will be no charge for admission.

This exhibition will form one of a number sent on tour throughout the country by The American Federation of Arts, thirty exhibitions of paintings, prints, crafts, war memorials, architecture, etc., etc., being on the road all the time, each being shown in a different city each month, thus reaching some 360 cities each year.

The present exhibition of prints for home decoration is the first step in a country-wide campaign which will ultimately embrace many other aspects of home decoration, such as textiles, pottery, etc.

### Bridgeport Chamber Attacks Some Nuisance

The Smoke Abatement Commission of the Bridgeport Chamber of Commerce sent the following letter to the major coal users in Bridgeport in an effort not only to solve the smoke problem, but to relieve the shortage of fuel.

DEAR SIR:

As a big user of coal you have a primary interest in smoke abatement, and the Chamber of Commerce is anxious that this problem be tackled by those who are at once interested and informed.

The question of smoke pollution, with its consequent effect upon health, cleanliness and fog, has occupied many municipalities' attention, sometimes resulting in stringent smoke nuisance laws, which are difficult to meet and usually costly in the enforced alteration of equipment.

Furthermore, the fuel situation is not in a satisfactory state, as is evidenced by the fact that prices have not gone down from their war-time level, and in all probability will rise still further.

The improvement of efficiency, which is necessarily the result of proper smoke elimination, will naturally help to relieve the situation in shortage of fuel, much along the same lines as those so successfully pursued by the local Fuel Administration Committees.

The Chamber of Commerce believes that, following the example of Pittsburgh, much can be done by the manufacturers to save their own money and anticipate the possibility of undesirable smoke restriction laws.

We are confident the enclosed outline will suggest a reasonable approach to the problem, and that you will be glad to join with the other major industries of the city in its solution.—Very truly,

BRIDGEPORT CHAMBER OF COMMERCE,  
Seward B. Price,  
Executive Secretary.

A questionnaire covering the operation of steam boiler plants accompanied the letter, as well as the outline referred to, which is entitled "Outline of Proposed Organization and Work of a Smoke Commission." The Bridge-

port Chamber of Commerce will be glad to supply copies of the questionnaire and outline to any who may inquire for them.

The Smoke Abatement Commission includes thirty power engineers, who are undertaking the work of smoke abatement in the Bridgeport district in a most thorough manner. The Chamber's industrial engineer has specialized in combustion and is well qualified to lead the movement.

### The Mosque in the Agra Fort

Among the most beautiful of Shah Jahan's sculptured monuments is the Pearl Mosque at Agra, states Gertrude Emerson in *Asia*. The entrance gateway of red sandstone contrasts effectively with the interior of white and blue-veined marble. An inscription in letters of black marble states that this mosque may be likened to a precious pearl, for no other mosque is similarly lined with marble. The Indian influence upon Mohammedan architecture of this period is evidenced in the lotus petal cap decorating the domes and in the purely Hindu finials, legitimate Mohammedan mosques bearing instead the simple spire with the star and crescent. The foliated arches come from a Buddhist source, symbolizing the lotus leaf-shaped aura around the body of Gautama. The pointed upper foliage is derived from the shape of the leaf of the bodhi or pipul tree, under which Gautama attained to enlightenment and Buddhahood, and is commonly used in Buddhist idolatry to indicate the nimbus around the head. The master builders of Mogul days were chiefly Indians from Bengal, and since they were artists and artisans rather than mechanical workmen, much of the inspiration of the architecture of this period must be credited to them.

### Fire Destroys New York's Fine Arts Building

A fire, the origin of which is attributed to a short circuit of electric wires, totally wrecked the Vanderbilt Galleries and the Fine Arts building, 215 West Fifty-seventh street, in this city, on the morning of January 30. The exhibition of the Architectural League of New York had been completed in all its details and was ready for the opening ceremonies of the evening. It was completely destroyed. Full particulars of this most regrettable happening, together with complete description and illustration of the exhibition will appear in a later issue of THE AMERICAN ARCHITECT.

### Serbian Again Making Rugs

Once more Serbians are taking up the making of rugs and tapestries, which was one of their principal occupations before the war. Serbian rugs have ever been noted for the richness of their color and design as well as the durability of their dyes. Though the country has suffered much from its seven years of warfare and pillage, the knowledge of weaving and dyeing has been preserved.

Serbian women have organized a school of weaving and here they work almost entirely at hand looms. Red Cross workers, who by feeding and clothing the suffering population helped them to re-establish their normal occupations, are bringing back samples of rugs and tapestries to this country. In making a market for the Serbian wares the Red Cross Commission is fulfilling its object, which includes not only the performance of relief work, but the establishment of means whereby future relief will be unnecessary.

## Competition for Design for Architects' Certificate, State of Pennsylvania

The board of examiners of architects in the State of Pennsylvania propose to hold a competition for the purpose of securing a design for a certificate of registration.

All architects, draftsmen or other designers are eligible to compete. Designs must be delivered to the secretary of the commission, M. I. Kast, 222 Market Street, Harrisburg, Pa., on or before April 1, 1920. The first prize will be \$200, second prize \$100. Competition program may be had on application to the secretary. The State Board of Examiners of the State of Pennsylvania is composed as follows: John Hall Rankin, president; M. I. Kast, secretary; Clarence W. Brazer, Edward Stotz and Edward H. Davis.

## Back to the Farm Movement Noted

According to a report just issued by the Vocational Summary it appears that the back to the farm movement has started in earnest.

The report states that 19,859 pupils over the country were enrolled in agricultural subjects in vocational schools during 1918 and 1919.

The report further states that this is an increase of 4442 students being trained in this subject. It is interesting to note that this is only the second year in which practical instruction of this sort has been within reach of the average child of school age.

The Bureau of the Census approximates an increase of one million farms in the United States during the last ten years. This increase, together with the increase of scientifically trained men to operate them, will secure the future of agricultural America.

## Foreign Trade Convention to Be Held in San Francisco

Notices have been received from the National Foreign Trade Council, New York, of the Seventh National Foreign Trade Convention which is to be held in San Francisco on May 12 to 15, 1920. Emphasis is placed on the fact that this will be the Council's "First World's Conference of American Foreign Traders," and preparations are being made to welcome a large number of American traders living and doing business abroad.

In the plans of the convention provision is made for a series of group sessions, whereby the interests of each country will be discussed and promoted.

This annual convention of the National Foreign Trade Council is a real business conference, planned and directed on a business schedule. When a trader signifies his intention of attending the convention he is invited, in advance of the meeting itself, to state the problem of foreign trade confronting his business. His problem then is given to the organizer of a special group session, or to special trade advisors, in advance of the meeting. The result is that the question is discussed from all angles by the foremost specialists in the field, and it remains for the person interested to profit by the concrete answer.

For further information on the subject of the convention, all interested parties can write to Mr. O. K. Davis, Secretary, National Foreign Trade Council, 1 Hanover Square, New York City.

## New York's Smallest Newspaper

The recent appearance of what boasts to be New York's smallest newspaper has brought forth from Governor Alfred E. Smith the comment:

"While this may be the smallest newspaper published in New York City, the work it represents is most important."

*Better Times*, as the paper is called, is being published in the interest of the United Neighborhood Houses of New York, 70 Fifth avenue. Its diminutive pages, measuring only four by six inches, are filled with news and comment on what is being done in this city to promote community progress.

Of the activities with which the tiny journal concerns itself Gov. Smith said:

"I have been personally acquainted with the work of the neighborhood houses for many years and understand the great good which they accomplish. I am heartily in favor of all its work and activities and trust that *Better Times* will have a prosperous career in making known to the public more generally the activities of the United Neighborhood Houses."

The first regular issue of *Better Times* is now occupying a conspicuous place on newsstands all over the city. Exactly like a metropolitan daily in form, only about a thirtieth the size, it has attracted much attention.

*Better Times* will be issued monthly and will contain contributions from some of the city's leading newspaper men and artists. George J. Hecht, formerly of the Committee on Public Information, is the editor.

## U. S. Navy Program for 1921

Three first-line ships, two battleships, one battle cruiser and twenty-five other vessels, some of which are of a new type developed during the war, comprise the program of naval construction for the United States Navy for 1921 as recommended to the Secretary of the Navy by the Navy General Board. The Board also recommends an appropriation of \$27,000,000 for aircraft production and experimentation. The report adds: "Unless a limitation in the size of armaments is reached by international agreement through the League of Nations, the General Board believes that the policy of the United States upon which its building program is formulated should be continued."

## Conference on Concrete Housing

Modern practice in the execution of concrete housing projects will be one of the chief topics for consideration at the National Conference on Concrete House Construction, which is to be held at the Auditorium Hotel in Chicago on Feb. 17, 18 and 19. During the same week the annual meetings of the American Concrete Institute, the Concrete Products Association, the Concrete Block Machinery Association and the American Concrete Pipe Association will be held at the same hotel, so that an opportunity is offered each visitor for attendance at the sessions of most interest to him in the several conventions.

The purpose of the conference is twofold: First, to consider the housing problem in the United States and Canada; second, to present, crystallize and make available information regarding the most modern practice in the construction of concrete houses and concrete housing projects. Every phase of the housing problem will be considered.

# News from Various Sources

France prohibits the exportation and re-exportation of roofing slate and of tiles, as follows: Common tiles not pressed and without flanges, mechanical or interlocking tiles and accessory roofing materials.

\* \* \*

Construction is progressing on the new Wolverine Hotel in Detroit. This building will be seventeen stories high and will include 500 rooms. The announced cost of the project is \$2,000,000. It is expected the hotel will be completed by August, 1920.

\* \* \*

Twenty-five deserters who reached Switzerland during the war have formed a unique league, the object of which is stated by its founders to be "defense of our interests." The members are chiefly from the Central Powers, none being American or British.

\* \* \*

Wisconsin farm crops in 1919 had a total value of \$395,752,000, according to Joseph A. Becker of the Wisconsin crop reporting service. This is 4 per cent greater than 1918 and treble the value of crops in 1909. The acreage increased 1.3 per cent over 1918.

\* \* \*

The London *Daily Mail* claims to know that James Henry Thomas and the other leaders of the National Union of Railway Men, having accepted the government offer with respect to the demands of the men, will resign rather than lead a strike on this issue.

\* \* \*

Great Britain is rapidly converting her wartime extensions in manufacturing plants to commercial uses, particularly in locomotives and railway equipment. Much of this extension is being turned to the supplying of equipment needs, Europe, as a whole, being heavily in need of this sort of manufacture.

\* \* \*

With the acceptance of House amendments, the Senate has completed the adoption of a bill providing for the appointment of a commission to pass upon the practicability and to devise plans for the construction of a public bridge over the Niagara River, near Buffalo, N. Y. The bill now goes to the President.

\* \* \*

A customs union between Canada, British West Indies and British Guiana, such as has produced such good results for the United States, Porto Rico and the Philippines, was recently advocated before Cabinet Ministers and Members of Parliament at the Canadian Club luncheon by T. B. MacAulay, president of Sun Life Assurance Company.

\* \* \*

Coal production amounted to 544,263,000 tons in 1919, compared with 678,212,000 tons in 1918, preliminary estimates announced recently by the Geological Survey show. Bituminous production was 458,063,000 tons, compared with 579,386,000 in 1918. Pennsylvania anthracite production was 86,200,000 tons, compared with 98,826,000 in 1918.

\* \* \*

The entire war debt of America will be wiped out in a comparatively few years on the present basis of Government receipts and expenditures. The total national debt on Dec. 31, 1918, was \$25,837,000,000, a reduction in only four months of almost \$760,000,000. The floating debt at the end of the year was only a little more than \$3,500,000,000, and less than half of this must be funded. This will be taken up in the next few months, in the opinion of the Secretary of the Treasury.

Little progress has been made in house building in London, which continues to be one of Britain's greatest economic problems. The Government is now about to offer a subsidy of £150 (nominally \$750) per house to private builders, but the proposal has not created much enthusiasm. Treasury now proposes to empower local authorities to issue 5½ per cent bonds, from £5 up, free of income tax up to £500.

\* \* \*

The distinction of being the largest lumber and other wood products manufacturing town of its size in the United States is claimed for Lufkin, Tex. It is shown by figures just compiled that during 1919 approximately \$6,000,000 worth of lumber was shipped from there. According to these figures the business done by local lumber mills in 1919 represents an increase of from 15 to 22 per cent over that of 1918.

\* \* \*

Leading Chicago bankers and other business men interviewed criticised the Government for excessive and inequitable taxation, particularly the excess-profits tax, which, they say, is the main contributing factor in the present high cost of living. Suggestions for a substitute include a consumption tax, lifting of the virtual money embargo to Europe, so American business may profit by a more equitable money exchange, and various means of taxation.

\* \* \*

The Norwegian budget for 1918-19 contained an item of 22,250,000 crowns (\$5,963,000), to be expended by the Government in the development of water power, in addition to 1,000,000 crowns (\$268,000), appropriated under special acts. The corresponding appropriation in the budget for the present fiscal year is considerably larger, totaling 29,972,000 crowns (\$8,032,496). It is expected that the appropriation for the same purpose in the budget for the year 1920-21 will amount to 20,000,000 crowns (\$5,360,000).

\* \* \*

In his instructions to the prefects of the ten devastated departments, M. Tardieu said: "France was able in a few months to create out of practically nothing those war factories which made victory possible. The same methods are to be applied to solve the problem of reconstruction. As soon as the list of the industrial machinery necessary to our work will have been established by your reports, I am resolved to take the necessary measures to assure its immediate supply and to set all to work, so that by spring the period of the realization of our work will start as fully as it should."

\* \* \*

One of the largest ship and armament building companies in Great Britain has converted an extensive shell plant into locomotive shops.

The conversion of this plant, which had manufactured 14,500,000 shells during the war, and the production of its first main line locomotive were accomplished within a year from the armistice.

The same company has transformed one of its gun and gun carriage shops into marine engine works, turned another war-material shop into an iron foundry, diverted gun forces to the production of marine shafting, altered armor plate mills to manufacture ship and locomotive plates, re-arranged its shipyards so that their greatest output is now merchant instead of war craft, acquired an electrical works for building its own power machinery, and also expanding in the construction of pumping engines, cranes, dock gates and similar output.

# THE AMERICAN ARCHITECT

## Personals

The Sanoma Corp. and C. K. Sanborn Corp. now have quarters at 149 Broadway, New York.

E. M. Wood, architect, Alma, Mich., has removed his office to 519 Oakland Building, Lansing, Mich.

W. E. Hulse Company, architects, have opened a branch office at 210 Masonic Building, Des Moines, Iowa.

New firm of architects, McDowell & Greasley, have opened offices at 207 Iowa Building, Des Moines, Iowa.

Osgood & Osgood, architects, Herald Building, Grand Rapids, Mich., moved to Monument Square Building.

A. L. O'Brien, architect, is just starting in business and has opened an office at 819 Shipley Street, Wilmington, Del.

M. G. Lepley, architect, Colorado Building, Washington, D. C., has moved to 500 Bond Building, Washington, D. C.

Price lists, catalogs and manufacturers' samples are desired by F. Worthington of 253 Totowa Avenue, Paterson, N. J.

Frank W. Hunt has moved his office from Springfield, Mo., to 410 Commerce Building, Miami, Okla. Catalogs are desired.

H. H. Warwick, architect, Colorado Building, Washington, D. C., has moved to 743 Munsey Building, Washington, D. C.

Keffer & Jones of the Hubbell Building, Des Moines, Iowa, have moved into larger quarters at 204 Masonic Temple, Des Moines.

E. E. Fairweather has moved his offices to 8½ Chambers Street, Cleburne, Texas, and desires manufacturers' price lists, samples, etc.

Irving R. Brown has opened an office for architectural practice at 552 Franklin Avenue, Nutley, N. J., and desires building material samples and catalogs.

Harold Tatum, architect, is now located at 1216 Washington Street, Columbia, South Carolina. He desires to receive manufacturers' samples and catalogs.

F. T. Uzell of Philadelphia, has discontinued the practice of architecture and his business will be carried on by Mr. Andrew C. Borzner, 717 Walnut Street, Philadelphia, Pa.

Eugene T. Benham and William J. Richards announce that they have opened offices at 214 East State Street, Columbus, Ohio, for the practice of architecture. Catalogs are desired.

The Osborn Engineering Co. of Cleveland, Ohio, incorporated for almost thirty years as consulting engineers, has recently organized a department of architecture and is offering professional services in that field.

John P. Krempel and Walter E. Erkes, architects and engineers of Los Angeles, will move their offices from the Henne Building to suite 538-539 Bradbury Building. The new offices are being remodeled and will be occupied by November 1.

Engineer Ellis W. Taylor has returned to Los Angeles after service in the United States Navy for the past two and one-half years. He is now associated with his brother, Architect Edward C. Taylor, with offices at 607 Merritt Building.

W. E. N. Hunter, 1306 Chamber of Commerce Building, and Niels C. Sorenson, 500 Congress Building, Detroit, Mich., have combined their offices to engage in architectural practice at 1306-1307 Chamber of Commerce. The firm will specialize in ecclesiastical and institutional work.

Waggaman & Ray, architects, formerly of 1742 M Street, N. W., Washington, D. C., have moved to 1147 Connecticut Avenue, N. W., Washington, D. C., and John M. Donn has opened a new office at 1147 Connecticut Avenue, Washington, D. C. His office was closed during the war.

## Buildings for Federal Reserve Banks

*(By special correspondence to The American Architect)*

WASHINGTON, D. C.—The National Lumber Manufacturers' Association took exception to the views of the Federal Reserve Board on building operations, as expressed in a public statement recently. The Board had issued orders to member banks to postpone new construction because of high prices. The organized lumber manufacturers pointed out the harmful effect that such a statement would have on the entire construction industry.

Governor Harding's reply, explaining the attitude of the Board toward construction at present prices, reads: "The Federal Reserve Board does not assume to be able to make a forecast of the future, but in view of high construction costs, which now confront all who are engaged in building operations, the Board feels that it will be helpful in the present situation if the Federal Reserve Banks, which can manage to get along with their present accommodations for some time longer, give way to building operations of a more urgent character and avoid competing for labor and materials with those who are compelled to build, regardless of conditions.

"Considerable interest has been manifested in the building trades over the proposed building operations of the Federal Reserve Banks, and in order that the Board's reasons for postponing new construction might be generally known, this statement to the press is made. The statement was not intended as advice to the general public to check building operations, as the Board believes that under present conditions the problem confronting those contemplating building operations is one to be solved by each individual for himself, and the urgency of the case will, no doubt, be the deciding factor in most instances, except where it is believed that costs are going still higher."

## Financing Rural Settlers

*(By special correspondence to The American Architect)*

WASHINGTON, D. C.—The Senate Committee on Public Lands has reported back favorably the Senate bill, providing for extension of rural homes. The bill has been placed on the calendar. It will probably be brought before the Senate within a few weeks.

The measure authorizes the use of the Reclamation Service in the development of reclamation projects to be entirely financed by private capital or by the sale of local district bonds, and is applicable to all sections of the country.

The Department of Interior, which is the sponsor for the bill, believes that under its operations settlers will be able to effect savings equaling as much as one-half and more of the prices they ordinarily pay for small rural holdings.



## Britain Proposes Subsidy to Solve Housing Problem

The housing problem in Britain is taxing the government for an acceptable solution. Plans for 500,000 new houses have failed, for only a few score homes have actually been completed since the armistice. Foundations for but 3400 more have been laid. A plan put forward provides a government subsidy for builders not exceeding £150 a house. Commenting on this proposed policy a political writer says:

"Everybody may get this grant, provided he produces the house. And this grant is intended, as the Prime Minister put it, to bridge the gulf between present prices and permanent prices. A very nice way, too, of putting it. Also, bricklayers are to be appealed to to lay more bricks per hour, and in addition municipalities are to appeal to local patriotism for money for housing loans.

"But nothing was said about the probable return. At present a workingman's official house seems to cost from about £750 upward. A rent of 5s. or 7s. 6d. is the highest you can expect, said Lord Hugh Cecil, speaking of the rural districts, and that rent would leave a deficit of some £40 a year on the house. The deficit might be less in urban districts; it would be a good deal less if bricklayers laid up to the pre-war standard, realizing that they were building their own houses. But the chance of a profit would seem to depend on so many houses being built that the price of materials would fall. But the same causes would bring down rents.

"Every one must hope that the government plan will work, but the finance of the whole scheme is very vague and sketchy, and the House doubts whether it will produce the required houses. There was a great deal of objection to the subsidy. Some who welcomed the new reliance on private enterprise thought that advances at a low rate of interest would be preferable to subsidies. Criticism was for the most part destructive, but every one realized that a solution of this problem lay at the root of nearly all projects of social reconstruction. "Mr. Lloyd George has never done a better piece of exposition than that with which he opened his speech. But it is a painful fact, emphasized by several speakers, that we are now, twelve months after the armistice, no further advanced than we could and should have been when the armistice was concluded."

---

## Prize Offer to End Slums

Prizes aggregating \$6000 have been offered by Vincent Astor, Alfred E. Marling, president of the Chamber of Commerce, and the New York Foundation in a competition having for its purpose the ultimate destruction of all the slums in New York City. The New York State Reconstruction Commission announced that this means had been taken of stimulating the architects and builders of the city to devise means to remove the conditions which had been revealed in the survey of the congested quarters conducted by the commission last spring. The competition has been made possible by the co-operation of the Joint Legislative Committee on Housing, of which Senator Charles C. Lockwood is chairman.

According to Clarence S. Stein, secretary of the Housing Committee of the Reconstruction Commission, there are more than 400,000 apartments in "old-law" tenements, the dwelling places of 2,000,000 New Yorkers, which are not fit to be called homes. The building of 400,000 homes would be a colossal task at a time when new walls were

never so expensive. The problem is to use the old shell and make it into a well-planned, sanitary, light place, fit for habitation. Large-scale plans have been drawn of a characteristic block on the lower east side, showing every wall, door, window, plumbing fixture, court shaft and yard. The competitors are to make drawings showing how this block may be altered to bring it up to present-day standards.

A primary condition of the contest is that such alterations must be commercially possible. The contestants must prove to the landlords that the rebuilt houses will more than repay the cost of repairs in decreased number of vacancies and the returns which will be paid willingly for better accommodations.

According to the statistics gathered by the commission between February, 1909, and March, 1919, there were 58,552 "old-law" tenements torn down. At this rate, it would take a hundred years before they would all disappear. Of 982,926 apartments in New York City in 1919, more than half, or 587,851, were "old-law" tenements, erected before the law of 1901 was passed, thus placing 60 per cent. of the apartments of the city in a class below the standard fixed nineteen years ago.

The competition committee will consist of Burt L. Fenner, Robert Kohn, Andrew Thomas and Mr. Stein. The judges will include the members of the competition committee and Frank Mann, tenement house commissioner; Alfred E. Marling, Senator Charles C. Lockwood, Senator John J. Dunnigan, Alexander M. Bing and Allan Robinson. There will be eleven prizes, including two firsts of equal value.

---

## Ancient Art Windows Restored to Paris

The valuable and ancient stained-glass windows of the Paris churches that were removed to places of safety during the bombardment of the capital by German long-range guns are being rapidly replaced.

The wonderful mediæval glass of Notre Dame and the Sainte-Chapelle has already been returned, and now the windows of five other old churches, Saint-Gervais, Saint-Severin, Saint-Merry, Saint-Etienne du Mont and Saint-Germain l'Auxerrois, are to be put back. These are all very fine specimens of Renaissance art.

The windows of only one of the old Paris churches were seriously damaged by the war, those of Saint-Denis, which were partly shattered by the explosion at Courneuve.

---

## Pennsylvania Law Compels Architects to Register

An enactment of the Assembly of Pennsylvania signed by the Governor provided for the examination and registration of architects by a State Board of Examiners, to consist of five architects, each of whom must have had ten years' or more experience in active practice. They serve for a period of five years with a per diem allowance for expenses for meetings and examinations.

All persons not engaged in the practice of architecture or known as architects at the time of the passage of this act must submit to examination and be registered by the Board of Examiners before being allowed to practice. The board may accept as sufficient evidence of competence a diploma from an architectural school and a statement that the architect has had three years' satisfactory experience with a reputable firm of architects. The board

## THE AMERICAN ARCHITECT

may also accept a certificate of registration from another state or country having similar requirements.

Holders of certificates issued by the board are required to sign all drawings "Registered Architect." The act does not prevent other persons from filing plans for building permits, but it does prevent such persons from using the title "Architect" in any form. Violations of the law are punishable by fines or imprisonment.

---

### Belgium to Build Workers' Homes

The Belgian Government has decided to allocate 100,000,000 francs in 1920 for building workmen's houses, states a foreign correspondent of the *New York Sun*. This money will be lent to the local authorities or approved building societies at 2 per cent for twenty years, at the end of which time a new agreement will be entered into.

The conditions are that no loan may exceed half the cost of the building or a maximum of 6,000 francs and the rent charged must not amount to more than 4 per cent of the total cost of building.

It is officially calculated that the cost of building in the devastated areas will be about 10,000 francs a house. A garden city of 100 houses in Roulers was begun Sept. 21 and is to be finished in 120 working days.

---

### Building Conditions in Italy

Among other proposals to stimulate building in Italy, it has been suggested, says the Trade Commissioner at Rome, that under certain conditions new buildings should be exempted from taxation for a period of 15 years for dwellings for the better class and 20 years in the case of tenements. Previous to 1914 building companies and individuals in Rome constructed from 10,000 to 14,000 rooms per year, which, however, were barely sufficient to take care of the normal development of the city. During the war of course private building operations practically ceased and since the armistice little has been done. The great building institutions have suspended new construction for the reason that the increased cost of materials and the higher wages which must be paid to workmen do not permit their stockholders to derive a reasonable profit. Private builders, according to the Trade Commissioner, are in the same position and are doing nothing. In all the principal Italian centers of population the shortage of housing accommodations is acute and strenuous efforts are being made to stimulate action in order that relief may be afforded.

---

### London May Have Housing Committee

Mr. Aldridge, secretary of the National Housing and Town-Planning Council, speaking at a meeting in connection with the housing and town-planning exhibition at Whitechapel Art Gallery, London, England, said that the Housing and Town-Planning Council was so convinced of the gravity of the London slum problem that it was proposed, following on a conference of all the local authorities of Greater London, to be held early in December, to set up a special committee for the purpose of submitting to the people of London a comprehensive housing and town-planning policy dealing not only with the slums, but also with the development of the suburbs and the evolution of new transit facilities and kindred questions.

Housing reformers, Mr. Aldridge said, were agreed that

the minimum standard of a proper family home was that of a five-roomed house, with bath and an ample garden standing in an estate properly planned. The slums of London, he declared, must not be patched up, but must be made to disappear. It might take 20 years, but if any element of slum property owning barred the way to the local authorities, he hoped Londoners would apply the dictum of Lord Fisher and "sack the lot."

Factories should not be at the great centers, but along the river, and the great trunk lines should be on the outskirts of London. He hoped any endeavor to increase the number of tenement dwellings near the center of London would be steadfastly opposed.

---

### Obituary

Francis Hatch Kimball, born in Kennebunk, Me., in 1845, died recently after a noteworthy career in architecture. He is said to have been first to use the caisson system of foundation for the erection of buildings and was called the father of the skyscraper. At the time of his death he was associated with George K. Thompson in New York, with whom he planned the City Investing Building, Garrick Theatre, Manhattan Life, Trust Company of America Building, U. S. Realty and Adams Express Co. buildings. He was a particularly successful exponent of Gothic architecture in this country.

---

### American Students Going to French Universities

This year is likely to see a great influx of American students to French universities, in the opinion of H. S. Krans, secretary of the American University Union in Enrope. Mr. Krans's new Paris headquarters, facing the Luxembourg Gardens, are being fitted up to receive and advise seekers after knowledge overseas.

Founded shortly after America's entrance in the war, by fifteen of the leading American universities and colleges, the Union now has thirty-three American learned institutions on its membership list, including Harvard, Yale, Columbia, Johns Hopkins, Princeton and other leading universities and colleges throughout the United States.

"Paris is destined to become the brain of the world," said Mr. Krans to a correspondent of the Associated Press. "German universities will be largely avoided by Americans. Dogged determination was shown by one young New York student who arrived here with the problem how to board and live on 6 francs a day. Through the medium of the Union, a French landlady gave him a small room for 2 francs a day. The young man cooks his own meals, and is 'passing rich' on 4 francs a day."

French teachers and students are constant and eager inquirers at the Union's Paris home. Many of them are anxious to take a course of studies in the United States. Fourteen French students are already studying in American universities on free scholarships from a fund collected by 6000 American students in recognition of the hospitality extended to them by French universities during the war.

The Society for American Fellowships in French universities is planning to send twenty Americans each year to the Sorbonne and other French seats of learning; nor will the Alsatian University of Strasburg be neglected. Twenty-five scholarships for American girls in France are already filled.

## For French National Expansion

There has been created, under official decree signed by the President of the Republic, a new bureau to be known as the Office Central d'Expansion Nationale, the object of which is the propagation in France and abroad of economic, artistic, scientific and linguistic initiative.

The creation of this special office has in view a co-ordination of efforts in the various fields designated, as regards both governmental and private enterprises, through a central bureau, instead of passing, as heretofore, through different ministries. This service is to be attached to that of the presidency of the Council. Too much time and effort were formerly lost through lack of harmony between the different bureaus.

## Heat Energy from Air a Possibility

Heat energy of the atmosphere is sufficient to replace fuel for all purposes, according to a paper H. H. Platt of Philadelphia read at the recent convention of the American Association for the Advancement of Science in St. Louis. He urged the scientists to use their energies to bring about means of "abstracting this fuel so as to relieve coal oppressed humanity."

## New Laws Protect Tenants

A law making it a crime for a landlord or his agent not to supply heat, light, and other service specified in a lease, with penalty of imprisonment for not more than a year or a \$1,000 fine, is proposed in the report of the Lockwood Housing and Anti-Profiteering Committee, Albany, N. Y. The committee also favors a law placing the burden of proof on a landlord or his agent when he seeks to break a lease on the ground that the tenant is undesirable.

## Sherman Protests Bill to End Housing Body

L. K. Sherman, president of the United States Housing Corporation, has written to Chairman Fernald of the Senate Committee on Public Buildings and Grounds, protesting against the pending bill to abolish immediately the housing corporation. Mr. Sherman expressed the belief that the corporation should be permitted to proceed with the sale of housing projects so that it may, on June 30, 1920, turn over its affairs in an orderly manner to its successors.

# Weekly Review of Construction Field

Comment on General Condition of Economics with Reports of Special Correspondents in Prominent Regional Centers, Late Quotations in Building Material Field

THE reports from the various special correspondents in regional centers, as well as the quotations on building materials, printed in this issue, are not of January 7th, but are current with the present date of writing, February 1st.

PERHAPS the most serious complication in the building situation in this country is the difficulty of securing materials. In the current issue of the Illinois Society of Architects' Monthly Bulletin, Mr. F. E. Davidson, editor, after a careful survey sums up present conditions as follows:

At present, it is impossible to determine, not only what a building should cost, but to even estimate what it may cost. Nor is it possible under present conditions for any contractor to be assured of his ability to complete any work in time or according to a pre-arranged schedule.

The shortage of materials, the scarcity of transportation facilities, the present intolerable mismanagement of the railroad systems, the loafing of labor, the unholy demands of business agents, the profiteering by organized interests controlling building supplies, all tend to stack the cards for and against the owner and architect in the game of securing 100 per cent of building output for ever 225 per cent of cost.

Probably one of the chief causes for this situation is the present shortcomings and future uncertainty in our transportation system. A telegram from the Cleveland Chamber of Commerce to its Senators in Washington reads: "Industrial production is being curtailed here as a result of the shortage of box cars. Manufacturers and business men point to the vital need for immediate increase in the locomotive and car supply if trade is not to be hampered,

unemployment result and the country generally suffer."

It is already suffering and has been since last August, when the railroad shopmen struck. Bank credits are absorbed in moving crops which cannot be moved. Side tracks are full of cars out of repair.

Carriers, which are due to be returned to private ownership, are earning only fractions of the net income guaranteed by the Government. If the Government continues its support at the present rate and the situation continues to drag along, there is no relief in sight for our needs of the present and of the immediate future.

THE increase of carriers' expenses has been enormous, the increase of the freight rates has been comparatively slight. That good and generous father to us all—the Government—pays the difference. It is worthy of remark that the sharpest increase in commodity costs was late in the year 1915. There was no material increase in rates until August, 1917. From that time the increase in commodity prices was very gradual. The average commodity value of a ton of freight in 1919 has been \$119, as compared with \$56 in 1914. The average freight charge has been \$2.80 as against \$2.00 in 1914. The increase in the cost of the average ton has been \$63, while the increase in freight charges has been 80 cents. Considering, therefore, the tremendous increases which the railroads have had to pay for wages, they naturally expect that with the end of Government regime they will be given some relief.

This, it is believed, is what the carriers want, and that it is the trend of business everywhere to stand on its own feet, and that that is what the people want.

With this transportation muddle satisfactorily settled

## THE AMERICAN ARCHITECT

and the factories relieved of uncertainty as to securing supplies and shipping their product, the occasion, at least, for shortage and in some cases absolute want of material will be alleviated.

The impossibility of securing dependable quotations of prices is another matter. There is first the continual increase of costs for manufacturers' labor. So much has been said and written on this subject that we are still in a turmoil and still hot, but nothing in the way of a solution which is constructive and stabilizing, has been offered, except the Board of Jurisdictional Award.

There is a reduction in the number of strikes and a realization by the working men that the problem is not the simple matter of demand as they had evidently grown to believe. There are tangible evidences of a co-operation between the managers and the more sober element of labor in England and on the Continent which will doubtless be reflected to this country.

Another cause of hysterical prices is the intense speculation which runs through our whole financial fabric as a natural result of its inflation. The Federal Exchange Banks have made one or two ineffectual attempts to cope with this evil. They are now ready to start upon a broader policy which is being discussed at a conference in Chicago.

And another cause, perhaps the most forceful of all, is so obvious that it seems unnecessary to mention it: the unprecedented demand.

---

*(By special correspondence to The American Architect)*

### CHICAGO

Perhaps the one big thing of interest in the architectural field in Chicago just now, aside from the increase in building, is the work of the zoning committees. Discussion of the zoning plan for Chicago has been under way ever since the visit here in December of Chairman Bassett of the New York Zoning Commission. It is expected that reports will be made public shortly.

One of the committees whose report will be submitted to the city authorities in the near future represents the local architects' organization.

The plan which at present seems to be attracting most attention and which is under consideration by the City Council provides for a commission of eighteen members, to be made up of representatives of the city administration, city council and citizens generally. It is proposed to make a wide survey of the entire city to determine the future need of Chicago in an industrial and residential way and to determine the best character of development in the various zones to be agreed upon. The work has been fostered by the Chicago Plan Commission for some years.

As to the building situation: Local architects express themselves as satisfied that prices of building materials have about reached their peak. Labor is scarce, however, and the prediction is made that there will be a very slow reduction in price levels for the next two or three years, probably longer, in both labor and materials.

The labor situation in the building industry promises a condition of greater stability during the coming year, because of the organized dealings between employers and employees with full recognition of the term contract and arbitration principles. Statistics show that 95 per cent of the number of strikes and 75 per cent of the days of idleness in the building trades have occurred through controversies between wage earners themselves, as to which trade should do the work. Only 5 per cent of the strikes have been on questions between employer and employee.

Figuring the cost of the total building during 1919 in the States east of the Missouri and north of the Ohio rivers reported to the F. W. Dodge Co. at \$2,500,000,000, their Mr. Miller estimates the 1920 contracts will aggregate \$2,800,000,000.

---

*(By special correspondence to The American Architect)*

### SAN FRANCISCO

Source of supply and delivery of materials on hand are the most serious difficulties which the architect and building contractor have to face in this section. Prices in practically all commodities are steadily rising and there is constant pressure being brought to bear on the prospective builder in regard to the advisability of not putting off work any longer. Even at the present time it is necessary to place orders considerably in advance of the time they are needed, and the number of large contracts looming up for the downtown section of San Francisco leads the contractor to believe that the situation will not be improved upon for several months at least. The demand arising from the proposed erection of several large office buildings, together with the growing amount of smaller commercial structures which are planned for early 1920 building, and the hundreds of residences of all types, is bound to keep somewhat ahead of the supply, according to the opinions expressed by the leading builders of the State.

Long-term loans of large amount are offered here in San Francisco in order to encourage the reconstruction period to the greatest possible extent, with the argument of advancing prices ever kept before the public.

High rents and scarcity of proper housing facilities in the city districts are stimulating suburban real estate activities and from the outlying regions of this city come reports of constantly increasing construction work.

Both brick and clay material manufacturers and lumber men state that they are behind on production. Lumber mills in this State kept the 1919 season open as long as possible and are planning to commence operations earlier than ever this year.

---

*(By special correspondence to The American Architect)*

### SEATTLE

The fir lumber market and the car supply are synonymous. Responding to urgent pleas of manufacturers in this territory, the car service department has been ordering cars west, and there are to-day more cars on the transcontinental lines bound for the lumber territory than at any time for a year. Plenty of cars mean not only a halt in the upward tendency of the lumber market, but a probable decline.

The mills hold unfilled orders for the Eastern and Middle Western building trade for 12,000 carloads. Should the supply of cars jump to 80 per cent of normal, as has been promised by the car service department of the railroad administration, the market will ease. It is the history and philosophy of the fir lumber trade that where cars are being supplied for loading with reasonable promptness, and volume manufacturers become uneasy and some of the big mills cut prices. During the past week the car supply has increased perceptibly, and this fact alone has tended to check down the speedy and arbitrary strength in quotations. In their telegram to Washington for relief, the mills placed the responsibility for the high lumber market on the car service department. Obviously prices must fall when the car supply increases and the mills are able to make shipments.

# Department of Architectural Engineering

---

## The Architectural Engineer

Being a Discussion of the Inter-Professional Relations of the Architect, the Architectural Engineer and the Engineer

By R. W. YARDLEV, A. I. A., Mem. A. S. M. E.\*

AT the conclusion of an address given by the writer to a class of engineering students, the following question was asked evidently in a facetious spirit: "If I understand you correctly, all that is necessary to prepare oneself to be an architectural engineer is to complete courses of study in civil, mechanical and electrical engineering in some approved university; then to spend a couple of years with a firm of reinforced concrete engineers, a like period in the drafting room of a structural engineer, likewise with a firm specializing in the design of heating, ventilating or power plants, and some time devoted to superintending all these kinds of work. After one has completed such a program of work, would he properly qualify as an architectural engineer?" After the laughter had subsided the reply was made that he *might* qualify provided he did not specialize too much in any one branch and if during his spare time he worked in an architectural office.

This question brings up several interesting phases of the subject of architectural engineering, and architects may well ask, what is an architectural engineer, what are his necessary qualifications and duties, and is he necessary to the practice of architecture? We will consider these questions in the reverse order.

It is not intended to reopen the controversy concerning the action of the Government in calling the engineering fraternity to control the major portion of its construction activities during the war, but is it not probable that this was due largely to an impression that had been fostered by the architects themselves? For many years past the architect has taken every opportunity, and justly so, to emphasize the idea in the minds of the public that the work of the architect is that of an artist and designer and that it is not that of an engineer or a

constructor. Construction has not been entirely sacrificed by architects, but many have looked upon it as a necessary evil that should be concealed as much as possible. The constructional and mechanical parts of a building can nearly always be designed so as to provide for the needs of almost every conceivable condition that may be imposed, and it is this quality of the adaptability of engineering work that causes many architects to design without considering the structural and mechanical features.

Art is not the work of the engineer, and it is entirely proper that architectural design should be first and engineering second, but only within limitations in each which will not cause either poor architecture or bad engineering.

A study of many prominent buildings in this country discloses the fact that the fundamental principles of architecture are violated in that the exterior design in no way expresses the plan, because the plan has been arranged with a view to utility and construction and the exterior considered only as a problem in pure design. The discrepancy between design and construction is often so patent, even to laymen, that a building is considered as having something wrong with it and its value is greatly decreased on this account.

The great advances made in the art of building within the past thirty years have made it impossible for the architect to produce a complete design unaided. An inspection of the plans used for the construction of the greatest buildings erected before that period of time are a revelation as to the limited needs of structural and mechanical knowledge. At that time the architect who was an artist was entirely self-sufficient and the influence of that condition has been unconsciously encouraged among architects until this day. As improvements in steel and concrete construction, plumbing, heating, ventilation and electrical work developed, the

\*Of Perkins, Fellows and Hamilton, Architects, Chicago.

## THE AMERICAN ARCHITECT

designing of these things was done largely by contractors. This often by the wish and consent of the owner who did not then consider it within the legitimate scope of the architect's work. But at the present time it is impossible for the architect to evade the intimate contact and the responsibility for these rather prosaic and often troublesome features of buildings. Although often questioning the architect's knowledge of these things, the owner requires that the architect assume full responsibility for every item included in the structure. This situation compels the architect to give serious consideration to all the engineering elements of buildings.

This forces the consideration of the need, qualifications and duties of the architectural engineer. The matter of engineering for architects is usually handled in two ways, one of which is entirely proper and the other unwarranted. The first method is by employing several engineering organizations which specialize in each of the various branches of engineering work entering into the building. For this service they are paid a commission by the architect which is deducted from his already too small commission. In rare instances they are paid by the client, but this arrangement is apt to be construed as a tacit admission of inability on the part of the architect and often results in at first a loss of prestige and later in the entire work being turned over to the engineers. There is an objection to this method of employing engineering service, admitting each specialist to be competent, in that their work must lack a certain coordination. Each specialist engineer is concerned primarily with his own devices and too often a state of irrelation exists among the engineering parts which is detrimental to the structure. As these specialists often have their individual organizations, located at distant points with relation to each other and to the architect, it is apparent that this element alone is a great obstacle to the method. Another similar method, which is above criticism, is to have an adequate engineering organization as a part of the architects' forces, which will be discussed later.

The second usual method, an unwarranted and indefensible one, is to secure engineering services from contractors and owners of patented articles or systems of construction without cost to the architect. In this case the engineering service is usually paid for through the awarding of contracts to those who have furnished the services to the architect. Aside from the ethics, this places the architect in the position of being often compelled to use work of wrong type and of unnecessary expense for which the owner usually pays an excessive price. The evils incident to this method of

procedure are too apparent to need discussion and it is not countenanced by reputable architects and engineers.

The ideal method of handling engineering work in an architect's office is to have an engineering department. An engineering corps which will render complete service to the architect, as a part of his organization, consists of a structural engineer, who is competent to design all types of steel construction and make shop details for them if necessary, a concrete engineer capable of designing and making complete drawings for reinforced concrete work, including steel lists and details; and one or more mechanical engineers, including those competent to design heating and ventilating systems, power plants, all phases of electrical work entering into building work, water supply, plumbing, sewerage, and sewerage disposal systems. Such an organization is larger than is required by firms not designing public buildings, large institutions, office buildings, and other major projects. The average architect whose practice is limited to the usual commercial and residential commissions can use a much smaller force with satisfactory results. This is accomplished by employing men who are reasonably competent in several of the branches enumerated above.

The average architect is alive to the need for such a service within his own organization as is evidenced by the present demand for engineering draftsmen in architects' offices. The members of such a corps have been referred to as engineers. They are in a strict sense merely engineering draftsmen, and such an organization, without a competent architectural engineer in charge, may be as disadvantageous to the architect as is the turning over of the structural and mechanical work to a number of independent specialized engineering organizations. In order to handle such an organization there must be an architectural engineer. What, then, constitutes this necessary architectural engineer? The architectural engineer must be an especially trained engineer who has prepared himself so as competently to direct such an organization, co-ordinating the work of the various expert engineers and engineering draftsmen with that of the architectural designers so that the completed project will be a harmoniously developed structure.

In order to do this he must be able to decide competently on the type of construction best adopted for the use and for the architectural design of the structure, considering the relative cost of all the types that could be used. Such decisions must also be made in relation to every branch of the mechanical and sanitary equipment and made during the preliminary stages of the work. To render competently this service he must be well

## THE AMERICAN ARCHITECT

grounded in the essentials of all the engineering factors entering into building construction, know the relative costs of the various methods and devices in use, be able to differentiate between the initial costs and those included in operative costs so as to secure ultimate economy, and be able to prepare the drawings for each branch in a manner suitable for the use of the contractor figuring the work, the shop getting out the materials and the mechanic installing the work in the structure. Above all, he must avoid the too common practice of attempting to compel an article, apparatus or system of construction to function in a manner for which it was not intended.

To illustrate the necessity for different designs for similar problems, the writer would cite a recent instance in his office where, within three months' time, the requirements of different commissions required not less than seven different types of steam heating and ventilating systems. Among these were the so-called split system of heating and ventilating, single duct, trunk line, re-circulating, and straight gravity systems of ventilation and gravity, vapor and vacuum systems of heating with various kinds of distributing systems of piping. All these different types were used in important public works and were required owing to differences in conditions. The requirements of various structural problems, during the same period, required the designing of steel frame buildings with tile arches, "mushroom" systems, combination tile and concrete constructions, and "tin pan" and ordinary slab types of concrete construction, as well as several slow-burning designs and ordinary wood construction. It is only by considering every phase of each problem that a logical decision can be rendered as to the proper engineering for any structure and to do so the architectural engineer must be familiar with all the elements embraced in each type, as well as the comparative costs and current market conditions.

Had the average architect, who does not take engineers seriously, been confronted with these problems it is very probable that he would have employed some types of heating systems and constructions that had proved themselves reasonably satisfactory in previously executed works, rather than have made an intimate and intelligent study of each particular project. Under these conditions the client, and indirectly the architect, would eventually suffer in loss, in effectiveness and economy.

The architectural engineer of a prominent New York office recently stated to the writer that during a period of several months he found it necessary to employ eight different types of construction on various work in order to comply with the varied conditions imposed by architectural design, econ-

omical considerations and different building codes. All these designs were made by the engineering force in his office under the direction of this architectural engineer, the work was constructed in record time and without any difficulties or controversies and with *practically no extras*.

The advantages of the services of the architectural engineer to the architect are self-evident. Through his study the too common discrepancies between architectural design and construction and in the requirements of the many types of mechanical apparatus and the provisions made for accommodating them are avoided. This is accomplished because the architectural engineer has a clear and reasonably correct measurement of the requirements of each factor before the final layouts are established. This not only reduces the work of preparing drawings but also eliminates the countless changes and alterations made "at the job" due to the necessity of accommodating some unforeseen condition which was ignored in the design, or the engineering or the construction, which is such a prolific cause of the objectionable "extra."

In addition to his technical ability as an engineer the architectural engineer must be a practical, hard-headed but broad-minded business man. He must be so well fortified by a knowledge of costs and engineering values that a contractor will not be able to make substitutions or use alternate constructions of less value than originally contracted for. Unless the contract values are so safeguarded the architect suffers in the opinion of the client. In other words the architectural engineer must be a combination of an expert engineer capable of working in every branch of engineering entering into a building, an able executive and a fair and square, thorough-going and practical business man.

There are those who doubt if there are engineers capable of fulfilling the requirements as outlined above. The fact that a number of men are now successfully managing such work is evidence of the fact that they exist, and they are to-day recognized as leaders in the engineering profession. They will undoubtedly not only continue as leaders but will be found capable of handling additional branches of engineering should it develop that any more are required in connection with this work.

As building operations and needs increase and develop, architectural practice must develop apace. When it develops, the broad-minded architect will realize that an expert executive co-ordinating engineer is as essential a part of his organization as is the designer and there will be a demand for capable men for the work. It is certain that the successful architect of the future will have to impress on his clientele that he is not only a picture-maker, but is entirely capable of handling all en-

## THE AMERICAN ARCHITECT

gineering problems as well, and the architectural engineer with his staff in an architect's organization is his only means of retaining complete control of his commissions. When the public becomes aware of the fact that any architect is capable and expert, through his organization, in all things pertaining to the work entrusted to him, there will be no need of argument or discussion as to the architect being ignored by his client in favor of the engineer. Then the architect will have assumed his rightful position as the one in entire and responsible charge of building operations.

There has been a demand for competent architectural engineers for some time and it is increasing at the present time. The manager of one of the largest companies in this country, having to do with the securing of assistants for engineers and architects, recently stated that it was practically impossible to secure architectural engineers or engineering draftsmen, since those capable of doing this work either become members or associates with large architectural firms or engage in practice as consulting engineers doing specialized

branches of engineering for architects. A number of colleges and universities have courses of architectural engineering but they seem to be unable to interest students in this course which is probably due to the desire on the part of the average student to specialize in one phase of engineering. This apparently requires much less hard preparation and promises more ready returns. An architectural engineer must practically specialize in several branches of engineering and be firmly grounded in others as well, and this does not seem alluring to those who endeavor to seek comparatively easy success through specializing in one branch.

As there are real doctors who have a broad and competent knowledge of the human body and its ills, so there are real lawyers who have a thorough understanding of all phases of jurisprudence. There are also those in vast numbers who are simply doctors and lawyers and specialists. And again there are those who are simply engineers and specialists. Perhaps the facetious student quoted at the beginning of this article was unconsciously correct in the inclusiveness of his question.

---

## Unique Construction in Reinforced Concrete

By W. R. SWANSON

**D**URING the years since reinforced concrete was first introduced into building construction in this country, this type has been gaining numerous advocates due to its many peculiar advantages over other types of construction. Chief among these is its adaptability to meet varied conditions, owing to the fact that it is placed in a plastic state.

A condition was recently encountered in connection with the alteration and extension of a fire-proof storage warehouse in Chicago, which called for the use of unusual construction.

The addition to the original building which fronts on Lawrence Avenue is 50 ft. wide by 50 ft. deep and extends the building through to a narrow alley at the rear. Certain conditions imposed by reason of the size of building lot, the nature of the owner's business and the width of the alley to which the building was extended required a peculiar arrangement of the columns as shown on the plan. The owner desired to use the greater part of the first story as a shipping court, and particularly to be able to back his large moving trucks to the elevator, located in the old building and approximately 50 ft. back from the alley line.

Since this alley is but 12 ft. wide, being one of

the narrowest in Chicago, and also on account of the fact that the building lot has a frontage of but 50 ft. on the alley, it was practically impossible to place any intervening columns along the alley line. The location of even one column at the center of the 50 foot width was out of the question, since a truck would not then have had a sufficient turning radius to permit its backing up into the building.

After taking into consideration the various factors involved and the necessary turning radius required for trucks of the size which would enter the building, it was found that if the columns were spaced as shown on the plan, namely set back 8 feet 6 inches from the alley line, a sufficient turning space would then be provided for all necessary trucking.

Had the wall of the building been set back this distance (8 feet 6 inches) from the alley line, the owner would have lost a valuable amount of space, viz: 8 feet 6 inches by 50 feet on all the floors above the first, and since the building is five stories high, this would have entailed a serious loss in the amount of storage space possible of rental.

Therefore, it was most desirable to provide some



THE AMERICAN ARCHITECT



FRONT ELEVATION

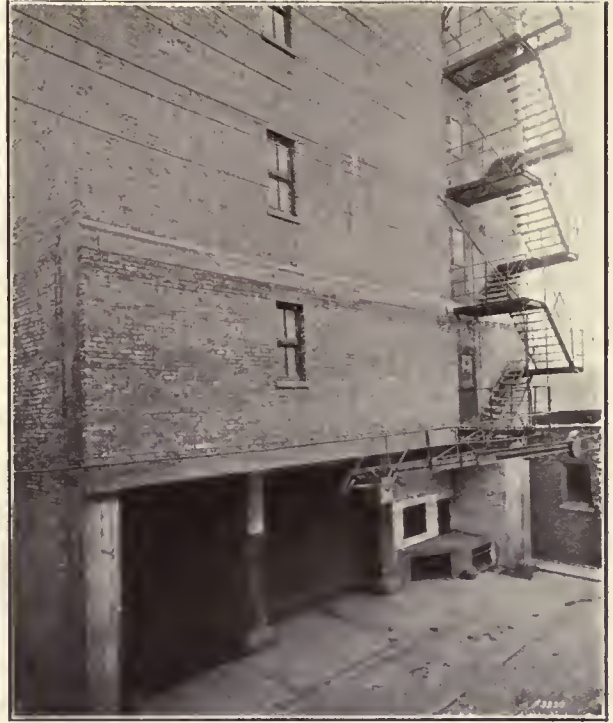

REAR ELEVATION SHOWING LOCATION OF RE-INFORCED CONCRETE TRUSS IN SECOND STORY

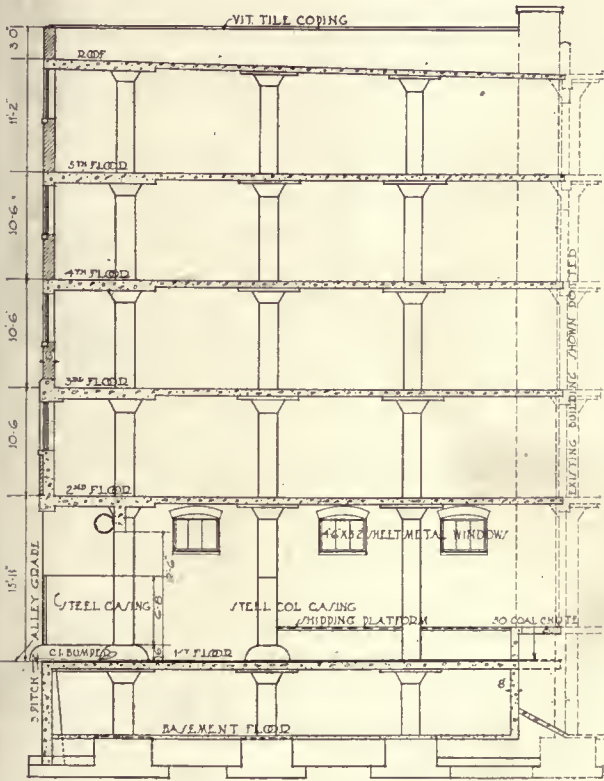

LONGITUDINAL SECTION

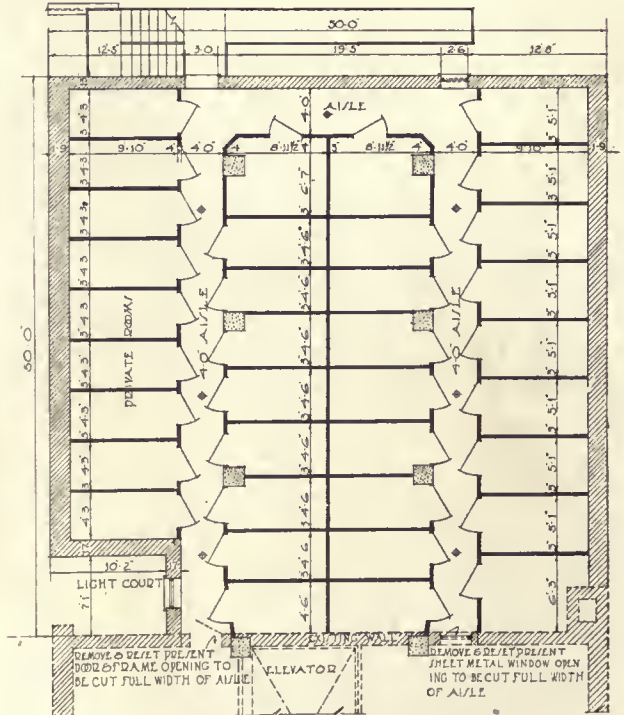

SECOND FLOOR PLAN

STORAGE WAREHOUSE BUILDING, CHICAGO, ILL.

S. H. DUNFORD, ARCHITECT—FLAT SLAB ENGINEERING CO., CONSULTING ENGINEERS

## THE AMERICAN ARCHITECT

type of construction which would permit the necessary spacing of the first columns and at the same time allow the wall to come out to the alley line above the first story, in order to utilize the full area of the lot.

While the interior construction was designed of the reinforced flat slab type, yet a cantilever slab design which was at first considered proved to be impracticable and it was subsequently decided to use

and lower chord members of the truss, had in addition to the direct stresses also to be designed for bending between the panel points for the reason that the floor slabs of both the second and third floors bring a uniform load along the entire length of the upper and lower chords.

In working out this design, very careful consideration was given not only to the design proper, but also to the detailing of the reinforcing steel in or-

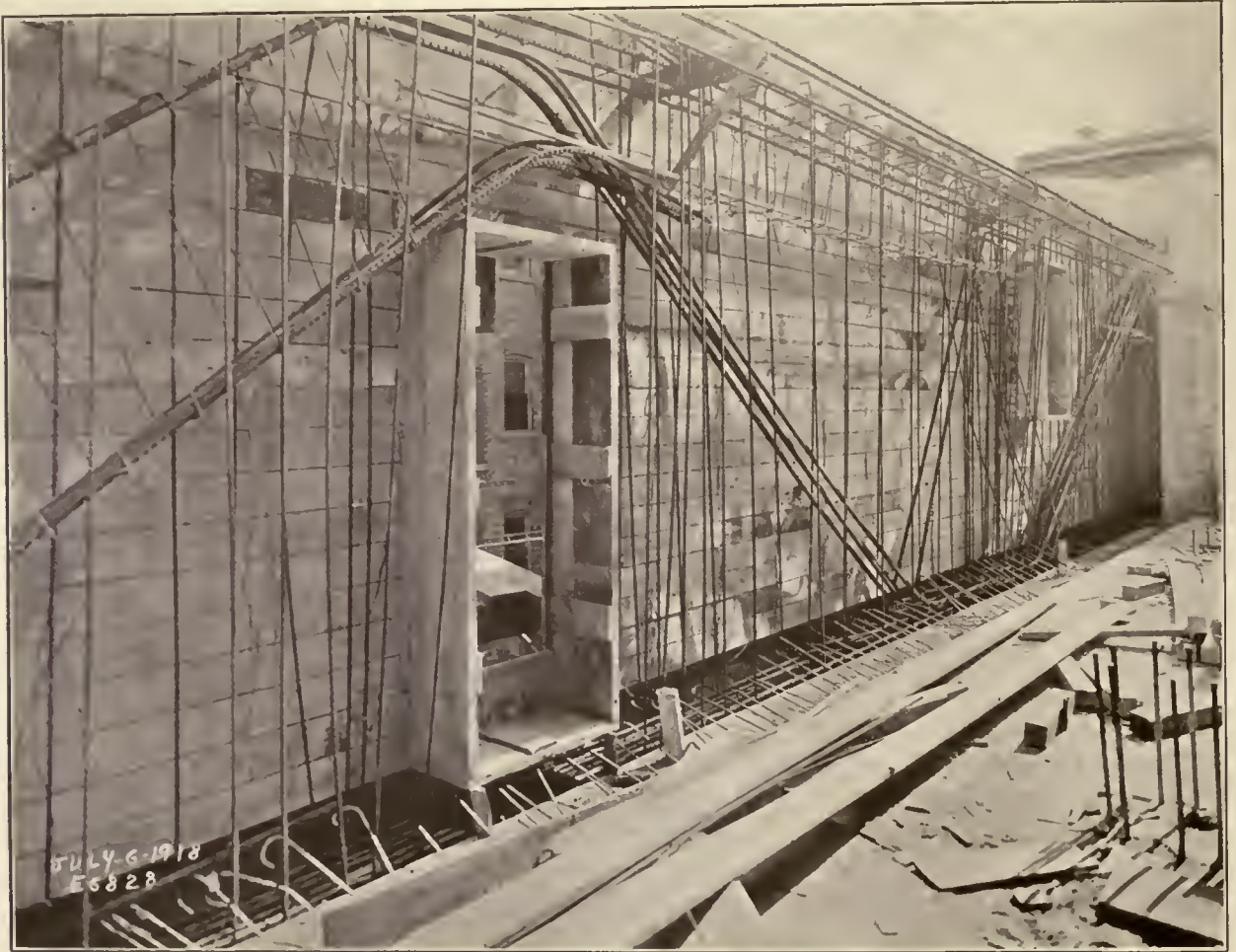

PHOTOGRAPH ILLUSTRATING METHOD OF PLACING REINFORCEMENT FOR REINFORCED CONCRETE TRUSS SO AS TO ALLOW FOR THE TWO OPENINGS

a reinforced concrete truss as shown. It will be noted that there are two necessary openings in the alley wall of the second story, one being a corridor window and the other a fire escape door. For this reason it was not possible to use reinforced concrete girder construction. In addition, these openings due to their unsymmetrical location further complicated the problem because it was thus necessary to design the truss with unequal panels. Naturally the height of this truss was limited between the second and third floor levels, and the upper

der that each individual bar, stirrup, etc., should be of the proper length and fit in its proper location. Special supporting chairs were designed to accurately support the steel in a correct position and also to insure that proper bond would be obtained between the concrete and steel.

While it is not necessary to go into any detailed description as to the actual working out of the truss design, the calculation of the stresses, etc., a study of the stress diagram and drawings reproduced in connection with this article will show that such

# THE AMERICAN ARCHITECT

analysis of the stress and design of the members followed as closely as possible to standard engineering practice.

rived at by adopting the deep beam type of footing which is capable of simple analysis. This design is clearly shown on the foundation plan. The

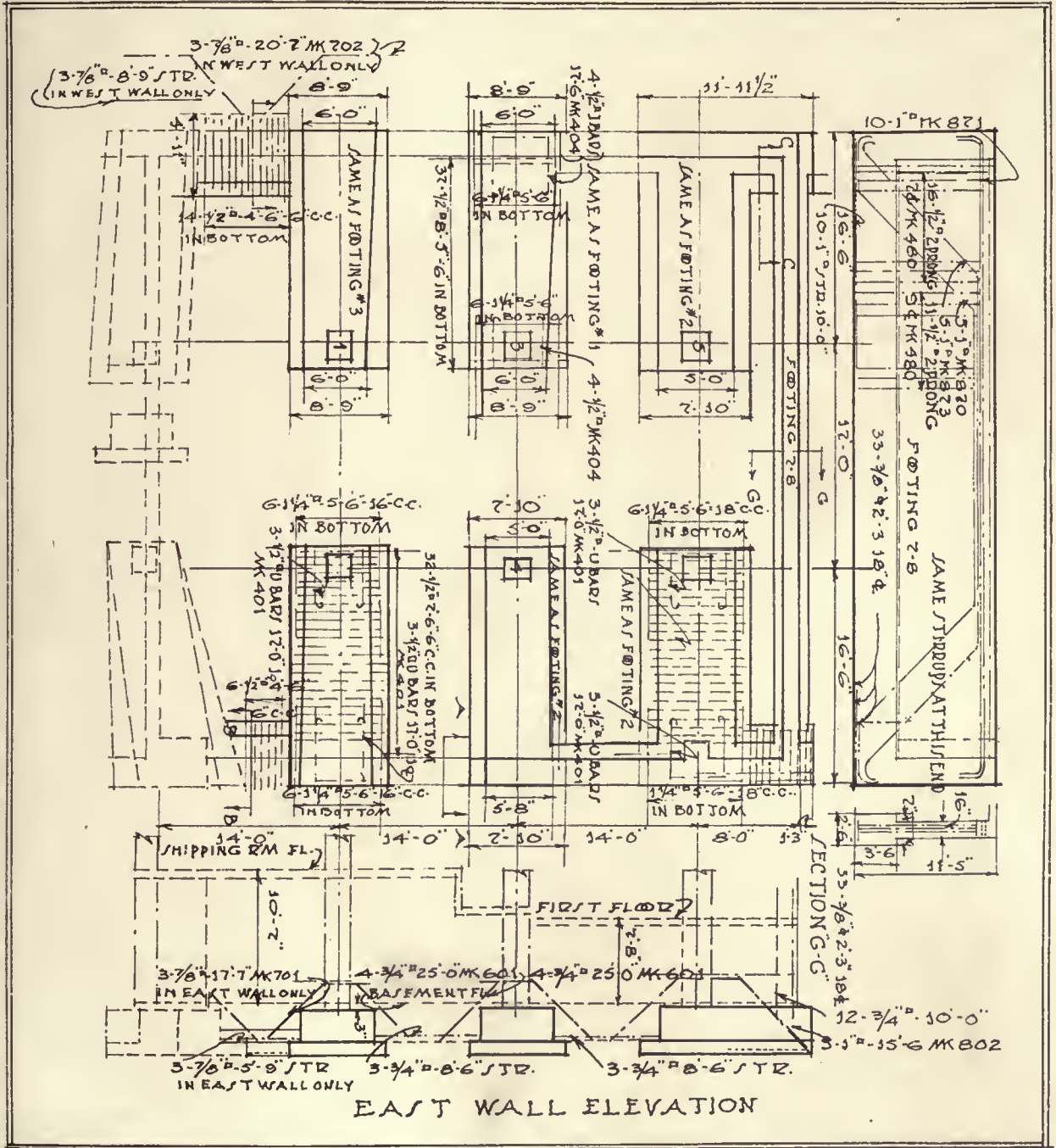

PLAN OF FOUNDATIONS FOR ADDITION TO STORAGE WAREHOUSE BUILDING, CHICAGO, ILL.  
S. H. DUNFORD, ARCHITECT—FLAT SLAB ENGINEERING CO., CONSULTING ENGINEERS

Due to the heavy load brought upon the end columns carrying this reinforced concrete truss, the design of such columns and the footings presented an additional problem. The solution of this was ar-

of an interesting nature since the building, except for the truss condition at one end, is an exterior wall bearing one and the loads are brought down

and carried on continuous reinforced concrete spandrels of the height of the basement walls. The reaction of these spandrels are carried by the combined footings shown on the foundation plan, the analysis of whose stresses are readily obtained since they follow out the usual engineering prac-

after years of close study by prominent investigators to a point where it is now definitely established that the strength of concrete depends to a very large extent upon the quantity of water used during the process of mixing and placing. This is true whether hydrated lime is used or not. The length of time of mixing, quantity of cement, etc., are factors, which, of course, must be taken into consideration and controlled in making tests, but as mentioned, the quantity of water is the real big element.

Another important factor which must be taken into consideration in conjunction with the development of strength is the workability of the concrete. These two subjects must go hand in hand and be developed together, as it appears now that the effect of lime on workability will determine the future action on this subject.

It is now known that by using smaller quantities of water the strength of concrete is increased, also when water is used in quantities which produce high compressive strengths the concrete is not sufficiently workable and cannot be placed without excessive labor charges. This is a practical condition which must be met, consequently the larger and excessive quantities of water are used in field work. If the lime introduces into the mixture a degree of workability which permits the concrete to be placed with smaller quantities of water, then the ultimate strength will be automatically increased.

Up to the present time there has not been developed a method for accurately measuring the workability of concrete mixtures. This is the problem upon which the Bureau of Standards is now working and it seems likely that it will be developed in the near future.

### Random Notes on Lime

A representation of the Dutch Lime Manufacturers' Association, recently visited this country to secure information relative to the uses and applications of burnt lime products as developed in the United States. They made a special study of modern methods of manufacturing and handling lime, with a view to improving the Dutch lime industry so that it may be better prepared to meet the problems presented by the present reconstruction period.

The commission put itself in touch with the staff of the National Lime Association, through which an itinerary was arranged that enabled them to visit several of the most up-to-date plants in this country and to examine various types of kilns, hydrators, automatic handling devices and other means of modern lime production and distribution.

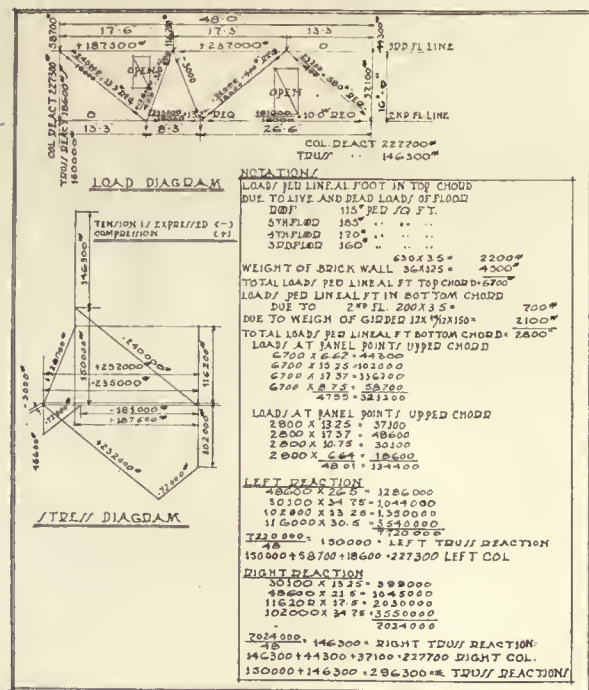

STRESS DIAGRAM AND DESIGNING DATA FOR REINFORCED CONCRETE TRUSS

tices in connection with the design of combined footings.

The completed work is shown in the photograph, and the enlarged building is now being used to the entire satisfaction of the owner.

The architect for this building was S. H. Dunford of the present Chicago firm of Moores and Dunford. The engineering work was performed by the Flat Slab Engineering Co., of Chicago.

### U. S. Bureau of Standards Investigating Effect of Hydrated Lime in Concrete

ACCURATELY to determine the effect which lime has on concrete is an intricate proposition; there is so much more to the question than was supposed when the investigational work was started a few years ago. The main point is, of course, does hydrated lime produce an increase in the compressive strength of concrete? This whole question of the development of strength in concrete as a general proposition finally has been run down

# THE AMERICAN ARCHITECT

Founded 1876

Volume CXVII

WEDNESDAY, JANUARY 14, 1920

Number 2299

## Contents

THE DEPARTMENT OF ARCHITECTURE AND THE STATE ARCHITECT OF THE STATE OF NEW YORK. By A. L. Brockway, F. A. I. A. . . . .	35
THE PUBLIC'S FAITH IN THE ARCHITECT . . . . .	37
UNIFORM BUSINESS ORGANIZATION OF PUBLIC ARCHITECTURAL DEPARTMENTS . . . . .	39
STATE DEPARTMENTS OF ARCHITECTURE . . . . .	42
EDITORIAL COMMENT . . . . .	47
NATURAL INFLUENCES IN BUILDING . . . . .	49
UNSANITARY HOUSING AFFECTED BY POLITICAL ELEMENTS . . . . .	50
CURRENT NEWS . . . . .	51
WEEKLY REVIEW OF THE CONSTRUCTION FIELD . . . . .	55

## Illustrations

GENERAL VIEW, SING SING PRISON. (Frontispiece)  
SING SING PRISON, NEW YORK. Lewis F. Pilcher, State Architect. (8 plates.)

## Department of Architectural Engineering

FEATURES OF THE MECHANICAL EQUIPMENT OF THE WINGDALE, N. Y. PRISON BUILDINGS. By George B. Nichols . . . . .	57
---	----

Published Every Wednesday by  
THE ARCHITECTURAL AND BUILDING PRESS, INC.  
No. 243 West Thirty-ninth Street, New York

E. J. ROSENCRANS  
President and Treasurer

FREDERICK S. SLY,  
Vice-President

WILLIAM H. CROCKER, Editor

EDWARD F. HAMMEL  
Engineering Editor

ARTHUR T. NORTH  
Western Editor

Board of Directors

E. J. ROSENCRANS  
FREDERICK S. SLY

H. J. REDFIELD  
H. M. SWETLAND

G. E. SLY  
WILLARD C. HOWE

CHICAGO, Mallery Building, Page A. Robinson, Western Manager  
CLEVELAND, Guardian Bldg. SAN FRANCISCO, 320 Market St.  
Subscriptions in the United States and Possessions, Mexico and Cuba, Ten Dollars. Other Countries,  
Twelve Dollars. Single Copies (Regular Issues), 25 Cents.

**NO WEAR** **JASPERITE** **NO DUST**  
**A PURE ADAMANT SILICA FOR FLOOR TOPPING**

Introducing Jasper, the concrete finishing expert—

*Jasper Says:—*

Jasperite, discovered during the war by tube mill men when they couldn't get Belgian and Danish imported flints, has been made available for floor topping.

Jasperite is pure quartz; is 4 times as hard as ordinary granite; has a wearing surface 15 times that of iron.

Crushing strength of Jasperite is 47,000 pounds.

French co-efficient of Jasperite is 24.7.

Jasperite forms an unbreakable bond with cement.

Jasperite is 94 per cent pure silica.



Let us send you full particulars about JASPERITE and its uses.

**JASPERITE COMPANY**

QUARRIES - JASPER, MINN.

OMAHA

OFFICES 616-18-20 KEELINE BLDG.

frontispiece to No. 2299.



GENERAL VIEW, SING SING PRISON  
LEWIS F. PILCHER, NEW YORK STATE ARCHITECT



# THE AMERICAN ARCHITECT

VOL. CXVII

WEDNESDAY, JANUARY 14, 1920

NUMBER 2299

## The Department of Architecture and the State Architect of the State of New York

By A. L. BROCKWAY, F.A.I.A.

THE Post-War Committee of the American Institute of Architects could have saved itself a good deal of speculation and at the same time have conserved a goodly amount of paper, if it had met at Albany, New York, early in its existence and had there examined and made itself familiar with the Department of Architecture and the State Architect, Lewis F. Pilcher, LL.D. It is, in fact, a most refreshing sight amid the reams of paper covered with suggestions as to what the architect could and should do as a professional man, to find that the State Architect of New York has been doing, not writing; has been accomplishing, not telling, the things that ought to be done.

The war showed us up as a profession in a way we all regret. Aside from the splendid list—all too short—of those who were given a chance in the housing work, in some of the cantonments, in camouflage work—the great mass of the profession found, when it came to trying to offer its services to our Government, that it was the engineer who was apparently wanted, and the architect had short shrift.

Personally, I think we have ourselves, in very large measure, to thank for this attitude. We failed to realize what the public expected of us, and we failed in making any effort to let the public know just what service we expected ourselves to render to them. This was true both before and during the war.

There had been, of course, local exceptions, such as certain publicity work at Milwaukee, at Minneapolis and in central New York State by the Central New York Chapter of the American Institute of Architects. Being familiar with and having assisted in this campaign in central New York, of trying by paid newspaper advertising and the ac-

companying unpaid news and editorial comment furnished by the papers themselves, to give to the public a clear presentation of what the professional service of an architect really was, and noting the effect which this advertising had in our own community, and, in fact, in other and distant communities, we felt impelled to submit it to the annual convention of the Institute. This was done at Washington, I think, in 1916. Some of it was published by the *Architectural Review* in November, 1916. I have never heard a criticism as to the character of the professional service which was there outlined as being what the architect should render to his client. The convention gave it a deaf ear, on the ground that the definition was ideal, but that architects were not, like a certain brand of soap, 99 44/100 per cent pure and, to quote another well-known New York City architect: "I thought we were a body of professional men." Had the Institute been able at that time to see itself as the Public saw it, and had it undertaken to put itself in harmony with the perfectly evident trend of great economic and sociological forces, it would not now be picking itself up after a knock-down blow and be looking around more or less dazedly and wondering what had happened. Now that the horse is stolen, we lock the barn door. And so the Post-War Committee puts our profession on the witness stand to testify in its own behalf.

Now the fact is that beyond all question there were here and there large numbers of individual architects who were doing exactly what this publicity outlined. They are doing so to-day. Their deeds and their work were bearing witness to what constituted the professional service of the architect. But the results of these individual efforts lacked the force and strength of united effort. Like

## THE AMERICAN ARCHITECT

a beacon light in this mist of professional endeavor stood the work of the State Architect of New York and has continued to this day on and along exactly the lines that were presented to the public in this advertising done by the Central New York Chapter.

Knowing this department and its head intimately as I have since its reorganization in 1913, I feel it a moral obligation to see that the work done there is presented to the profession. The Institute members in New York State, aside from the Central New York Chapter, have taken very little interest in its work, and it is time they began to realize the service which has been rendered to our profession. This service results from the fact that Mr. Pilcher has kept always before him an ideal of citizenship and professional service whose sole object was responsibility and duty to the State. His official acts have demonstrated the proposition of professional service not only as outlined in the publicity campaign mentioned, but in many other ways. And think of his problem. Appointed by Governor Sulzer (D); reappointed by Governor Glynn (D); reappointed by Governor Whitman (R); and just now again reappointed by Governor Smith (D). New York State is his client, consisting of well over one hundred individual commissions, boards, committees, heads of departments, etc., many of them with shifting personnels. The work covers hospitals, charitable institutions, prisons, armories, normal schools, educational, public buildings, regulative and general. There is a State Hospital Commission and fourteen State Hospitals for the Insane. There is a State Board of Charities and seventeen institutions for the feeble-minded. Each of these has its own local board of managers and its superintendent. Then there is the Prison Commission and the Superintendent of Prisons. Also the Hospital Development Commission and the Commission on New Prisons, of both of which the State Architect was made a member. There are also the Trustees of Public Buildings, namely, the Governor, Lieutenant-Governor and the Speaker of the Assembly, who have charge of the Capitol at Albany and all public buildings owned by the State in Albany, or rented for various departments. The largest part of the work of the Trustees of Public Buildings is dependent entirely upon the State Architect, and he is relied upon absolutely for its successful prosecution. In the preparation of the State's Budget of appropriations for building construction of every character, which work is done by legislative committees and by the Governor, the State Architect is relied upon absolutely. That is so because the quality of professional service he has rendered has

been so sane, so carefully prepared upon scientific, economic, utilitarian and aesthetic grounds that the men upon whom rests the responsibility of government know by experience that his judgment is to be relied upon and is their safeguard. That work is preliminary to legislation and appropriation. Out of a prison condition in this State which was a scandal and a disgrace the Commission on New Prisons has developed a program of prison construction and management based upon the most advanced scientific and sociologic knowledge and data available. Here the prison inmate is subjected to the most exhaustive observation and study, almost a laboratory process, in order to determine whether his criminal acts are due to disease, subnormality which may be corrected, or to criminal characteristics inherited or due to environment. Sing Sing is being rebuilt as a great receiving, scientifically equipped institution, where classification will take place. This may be a matter of months; but before the prisoner is finally located where he belongs, every means will be exhausted for his reclamation. The architecture of this institution and of Wingdale, also under way, is noteworthy for its psychological effect upon the prisoner and both institutions form architectural groups of imposing merit in composition and design.

The same general statement can be made of the Hospital Development Commission. In the development of both of the programs, Mr. Pilcher has been a close student and enthusiastic co-operator with public-spirited men, the scientific man, the sociologist, the physician, and has enabled them to accomplish in practical buildings all of their ideas and at the same time to help and guide these efforts. He has placed the architect in exactly the place of importance and necessity that we professional men know he should have, and he has convinced the layman, both public official and private individual, of that fact, so that they have the highest respect and regard for the architect. In fact—and this I can supplement by knowledge which I have and which I cannot now make public—I believe he has done more to advance the position of architecture as one of the fine arts and as a profession than our American Institute of Architects has done in recent years.

Therefore, I will submit in evidence as "Exhibit A," the Department of Architecture at Albany and the State Architect. I have no fear of not winning my case. Some later articles will go exhaustively into the details of organization of the department, showing the machinery in full operation and working under high pressure as it has been

for the last five or six years. In this introductory paper I have confined myself mostly to the larger aspects of the work of the department and of the personality of the State Architect himself, who is responsible for the present organization and its effective work. From what I have written, one can appreciate why the Department of Architecture occupies a unique position in the big organization of departments, commissions, legislative committees, trustees and individuals which make up the Governmental machinery of this State. At present writing work under contract and in preparation amounts to sixteen million dollars. Mr. Pilcher, by his strong

personality, his high ideal of professional service, his proven strong executive ability, his high quality of technical education and preparation, has rendered service of such high quality that he has created a *deep-seated respect for architecture and the advice and counsel of an architect* in the minds of the men making up all these different Governmental agencies. The profession of architecture through his work enjoys a standing with the Government of New York State which is in strong contrast with that of the Supervising Architect's Office or even of the profession itself with the Federal Government.

## The Public's Faith in the Architect

### His Integrity Never a Matter of Debate

IT has been said that the architect is trusted to a greater extent than the physician is trusted—because the former is trusted with the expenditure of large sums of money. This spending is seldom or never questioned by the client, says *Building Review*. Continuing, it adds:

However this may be, the point is that architects enjoy the highest confidence of the public, when it concerns the decisions regulating expenditures or selection of materials or specialties that are to go into a structure. The architect's integrity is seldom or never a matter of debate. He is taken at his own valuation, as that of an absolutely disinterested party whenever the money part of a building is concerned. The only question that may ever have been raised against him was that in some of his designs he has aimed to create prestige and glory for himself rather than to produce a building best suited to the owner's needs.

But as to his say-so regarding just what was to go into the work, or the amounts to be spent, his word is taken to be final, and his approval is acquiesced in with little or no questioning as to his motives. He is not suspected of having ulterior or mercenary motives guiding him in the selection or naming of certain materials or equipment.

The high standing, well earned by the architectural profession by its past acts and proved and tested by long years, is a precious asset that must not be lightly ignored. In anything that is done by the profession in the future to further adjust itself to world changes and conditions, its integrity as a

just arbiter between interested parties, its honor built upon disregard for selfish profit from the operations which it supervises, must be maintained.

It is the bedrock upon which the foundations of the whole architectural professional structure rests. No profession, no organization, can desire a finer basis upon which to establish itself. And such a basis cannot be acquired overnight. Taints cannot be eradicated in one generation. Reputations for character such as are enjoyed by architects are the cumulative products of generations of honorable acts on the part of the architects themselves.

All honor to those of the past who helped sustain this high integrity! The profession to-day, in the swirl of world changes, is beset on every side by temptations to do as others seem to be doing. Its traditional slowness, its traditional unwillingness to depart from custom, mayhap, is the reason for the profession's proceeding so cautiously along the road to-day, to find its way out under the new set of world conditions which it is facing.

The unique glory of the architect rests not alone in his practical work for humanity, the betterment of living conditions and surroundings, in the creation of objects of beauty which further lead to the higher inspiration of the rest of his fellow-men, and which lead, too, to an encouragement of men to continue their efforts toward higher things. The architect's glory is due in part to these things, but, after all, his highest honor is that which is awarded him universally—in America at least—of that of being an honest man, incorruptible.

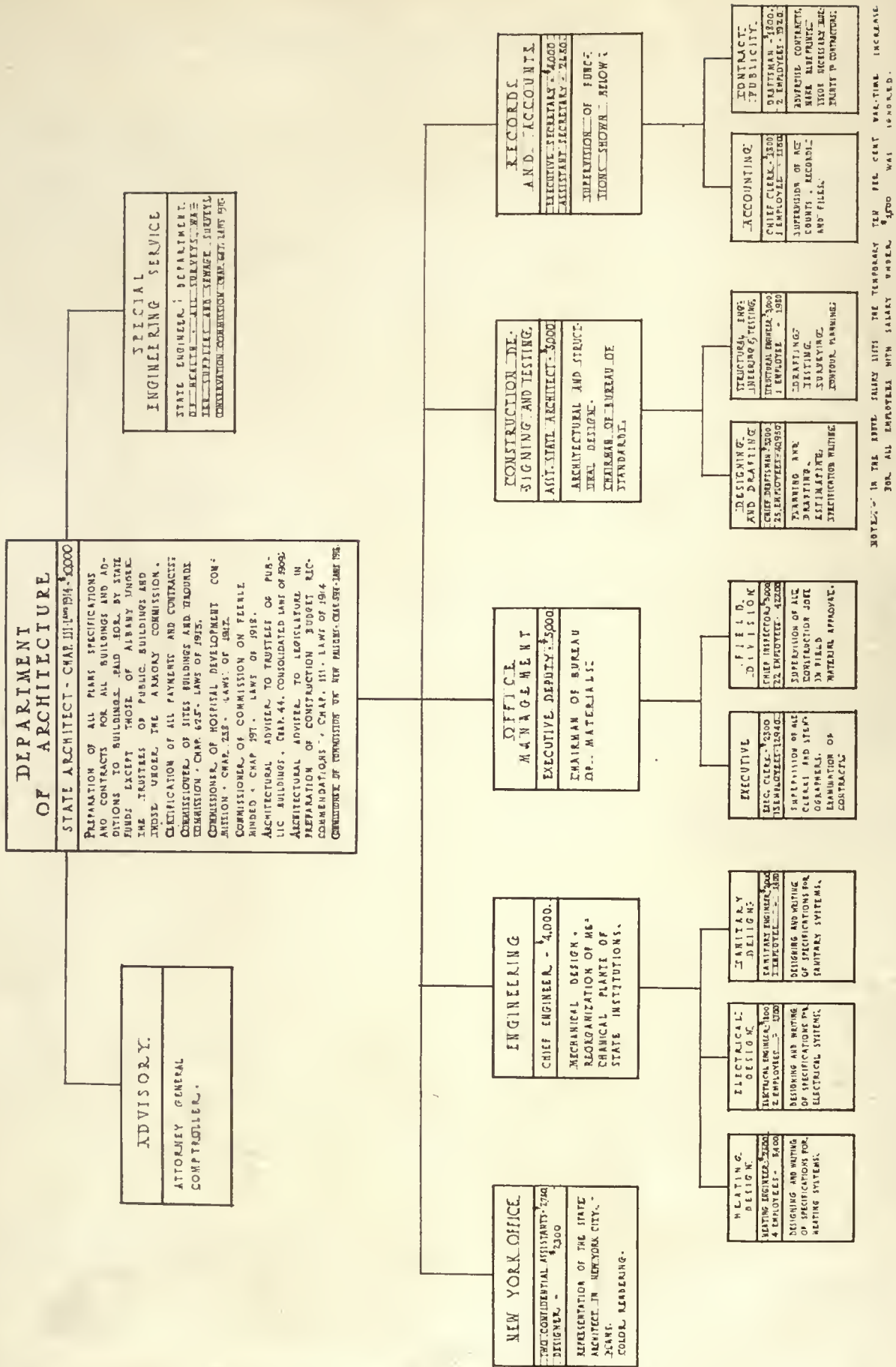

ORGANIZATION PLAN, DEPARTMENT OF ARCHITECTURE, STATE OF NEW YORK  
LEWIS F. PILCHER, NEW YORK STATE ARCHITECT

NOTE: IN THE FUTURE SALARY LIMITS THE TEMPORARILY TEN PER CENT VALUATION INCREASE FOR ALL EMPLOYEES WITH SALARY ABOVE \$5,000 WILL BE ADOPTED.

# Uniform Business Organization of Public Architectural Departments

THE educational value of architecture in the construction of public buildings and the consequent care and improvement of dependents is of an importance equal to any existing in professional or scientific fields. The layout of an institution and grouping of its buildings, the design and arrangement of each building to co-operate in every way with scientific classification requirements, together with an harmonious and simple beauty that helps to eliminate from the minds of inmates the fact that they are patients, would make of an architect an assistant physician in the reclamation of the State's dependents.

The Administrative  
 Executive  
 Design  
 Engineering  
 Construction and Inspection  
 Blue Print and Plan File

All information and data of whatever kind passes through the Executive Bureau, and, after a complete record is made of its receipt and contents, together with its ultimate destination, goes into the Administrative Bureau, which consists of the State Architect and his Executive Deputy, and from there is distributed to the various bureaus for attention.

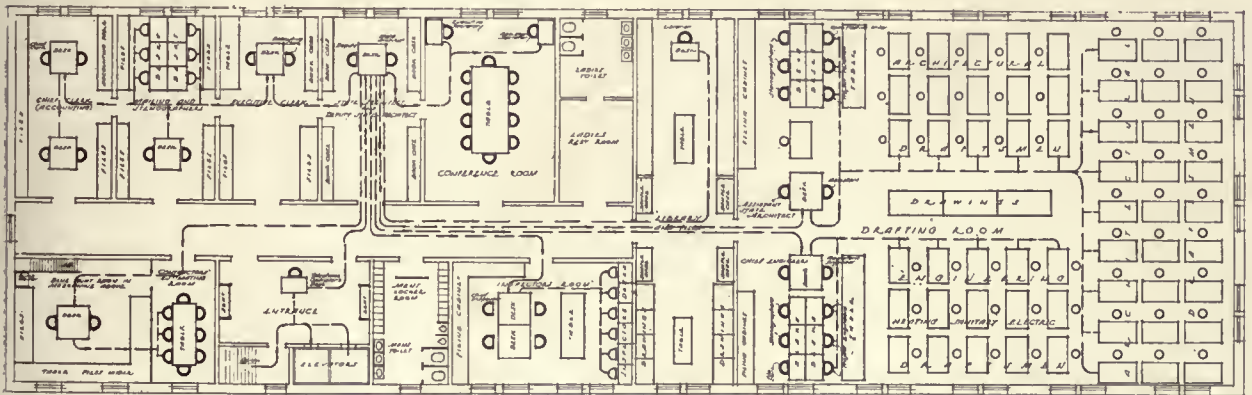

INTERCOMMUNICATION MAP, DEPARTMENT OF ARCHITECTURE, STATE OF NEW YORK  
 LEWIS F. PILCHER, NEW YORK STATE ARCHITECT

One of the first steps toward this end is the organization in every State of a Department of Architecture having absolute jurisdiction over all State construction, and following, so far as possible, a scheme for the complete development of the needs and resources not only of the State in its entirety, but, in co-operating with other States, to develop the resources of the entire country that the best results may obtain.

The first essential of such a department is an efficient business organization, which because of the artistic temperamental equation has been somewhat lacking in the past in the architectural profession. Following is a short résumé of such an organization, which has proven its high grade of efficiency in the State of New York:

The department is divided into six bureaus:

The work of the Executive Bureau includes all recording of data, checking of appropriations and accounts, tabulation of bids, preparation and following up of execution of contracts and bonds, purchase of supplies, accounting, clerical and stenographic work, filing, outgoing mail and general messenger service—in general, all the executive clerical work necessary for the administration of the department.

To the bureau of design are referred all requests for appropriations for the preparation of preliminary construction sketches and estimates upon which the amounts of appropriations requested in the budget are based; all requests for plans and specifications after appropriations have been granted; the checking of construction bids received, with preliminary estimates made; the preparation and estimating of all plans and specifications for work

## THE AMERICAN ARCHITECT

done under the Special Fund Estimate system; the preparation of working drawings after award of contract, and the checking and estimating of all changes, additions or omissions necessary in their final analysis.

The head of this bureau is a deputy designated as the Assistant State Architect, who has as his assistants a Chief of Institutional Design, and a Chief Draftsman, who, in their turn, each have under their immediate supervision a corps of designers and draftsmen, structural engineers, specification writers and tracers; the draftsmen and designers being divided into five groups—the Hospitals for Insane, Charitable Institutions, Prisons, Education and Miscellaneous, each group being under the immediate direction of an assistant directly responsible to the Assistant State Architect.

To the Engineering Bureau are referred all requests for appropriations pertaining to heating, lighting and plumbing and all engineering work in connection with power plants, water supply and sewage disposal plants, for preliminary sketches and estimates upon which the final amounts appropriated in the budget are based; all requests for plans and specifications, after appropriations have been granted; the checking of engineering bids received with the preliminary estimates made; the preparation and estimating of all plans and specifications for engineering work done under the Special Fund Estimate system; the preparation of working drawings after contract is awarded, and the checking and estimating of all changes, additions or omissions necessary in their final analysis.

The head of this bureau is a deputy designated as Chief Engineer and has as his first assistant an assistant Chief, who has general supervision of the mechanical draftsmen and special charge of the heating and ventilating engineering group; the two other groups being the sanitary and electrical divisions, each in direct charge of an engineer working under the supervision of the Chief Engineer and his first assistant.

In connection with the Bureau of Design and Bureau of Engineering is a special library of Architectural and Mechanical books and magazines for ready reference and reading. Study in all architectural and engineering lines, outside of regular office hours, is encouraged, and any employees interested are at all times given personal attention and help by the Bureau Chief. The Assistant State Architect, a Beaux Arts graduate, established an Atelier and acted as its patron several years previous to the outbreak of the war. When he left for service abroad, several of the men in attendance at the Atelier had passed examinations qualifying them to carry on the work. This gives the young

men of the department an opportunity for study, which, coupled with their daily employment giving them the further opportunity of immediately practically applying the results of their study, qualifies them not only for rapid advancement in their chosen profession, but greatly increases the efficiency of the bureau and grade of workmanship performed.

To the bureau of inspection are referred all matters in connection with work after contracts have been awarded. This bureau is in charge of a Chief Inspector, who has as his assistants a corps of Superintendents of Construction, Engineers and Engineering Inspectors, who are located in different parts of the State, traveling about among a small segregated group of the Institutions, supervising and inspecting contracts as they progress; or, in cases of many or large contracts at any one institution, being temporarily assigned to that particular institution. All requests for payments made by contractors are checked and approved by these local superintendents and engineering inspectors, before being finally checked and passed by the Chief Inspector.

The Blue Print and Plan File Bureau serves the needs and demands of all the Bureaus in the department. The electric blue printing machine, with washers and drying equipment, has a capacity of about six thousand feet of blue printing per day.

The original tracings of all projects are placed in long metal tubes for final filing, thus preserving them for future reference.

This Bureau is in charge of a Chief Blue Printer who has as his assistants an expert blue printer and photographer and two Junior Clerks.

Two secretaries complete the personnel of the Department, the work of each being under the direct supervision of the Administrative Bureau.

A branch office has been established in New York City to provide for better facilities in handling work at institutions in the Metropolitan district, centralizing the administrative force nearer the field of operation, and so enabling the State Architect to keep in closer personal touch with these large projects. The permanent personnel of this branch office consists of two Confidential Assistants with such other assignments as are from time to time deemed necessary.

A résumé of the above will show that all work handled by the department passes through the Administrative Bureau, is from there distributed to the various bureaus and by the bureau heads to their various subdivisions for attention, passing back to the Administrative Bureau through the same channels and there finally checked by the State Architect or his Executive Deputy, before being sent out of the department. This subordination of one

# THE AMERICAN ARCHITECT

part to another and the orderly intercommunication of the various bureaus is a salutary restraint on the development of the unessential and tends to eliminate all duplication of work or effort.

Such an orderly and efficient organization, guided by the keen mind, broad sympathies and true artistic perception of the man at its head, cannot but result in an architectural production worthy of the most careful study and emulation.

ment of the so-called artistic side of the profession, has been very slow in recognizing and meeting these conditions. THE AMERICAN ARCHITECT, through knowledge gained by a personal inspection of the New York State Department, has been much impressed with its organization, which seems to have combined to a remarkably harmonious degree the practical, scientific and artistic sides of the profession, crystallizing all its possibilities for the high-

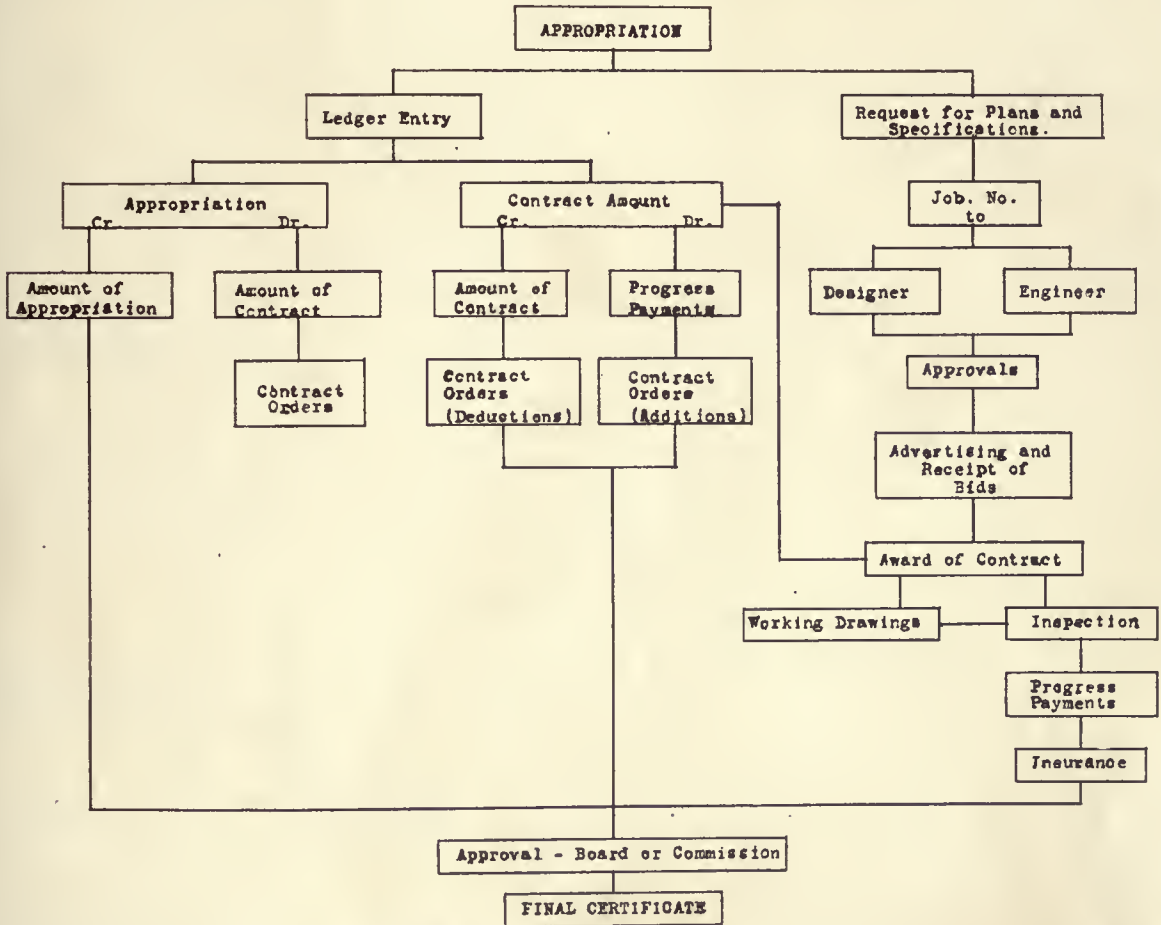

PROGRESS CHART, DEPARTMENT OF ARCHITECTURE, STATE OF NEW YORK  
LEWIS F. PILCHER, NEW YORK STATE ARCHITECT

The world, in its course, has reached a period of such large problems and undertakings, modern science has so welded together its most remote corners that an entire readjustment of values must be made, and no problem should be considered without giving full value to its effect upon the world at large. This fact has been felt and largely discounted in the industrial and commercial world, but the architectural profession, because of its heretofore peculiar lack of close relationship to the practical activities of life on account of an over-develop-

est type of service into a tangible working organization. Uniformity, harmony, education, utility, economy and scientific co-ordination, in equal parts, should be the ingredients put into every project undertaken by an architect on public buildings, and this can only be accomplished through a co-operation which must be obtained by the establishment of uniform architectural departments in all States, and the fundamentals of the organization of such departments might well be based upon the present organization of the New York State Department.

# State Departments of Architecture

Their Correct Organization and Efficient Functioning a Logical Solution of Many National Architectural Problems

IT has become more and more recognized in the architectural profession, and, it might be added, all professions that aim toward the creation of physical beauty, that one of the essentials to such beauty is harmonious uniformity. Such recognition, in architecture, has resulted in efforts at "Standardization." Certain buildings have been standardized, and from their architecture their purpose is easily recognized, such as armories, schools, churches; or, we recognize a certain type of architecture, and wherever or whenever seen, that type is associated with the period and country in which it originated. While European countries have recognized the value of standardization, within certain limits, our own Government has been too busy furnishing buildings to keep pace with its phenomenal growth in business and population, to stop and survey its work, or take the necessary time to lay out a comprehensive scheme of uniform standardization.

Owing to the vast areas covered, the great difference in climatic and topographic conditions, it is manifestly impossible to standardize, under one plan, the public architecture of the entire country. It would seem, however, not only possible, but most desirable, that uniform localities or regional districts be standardized, meeting in each section the peculiar requirements of that region.

The Federal Government at present, while recognizing but one Supervising Architect, has many architectural bureaus, each making its own plans and building its own buildings, regardless of the projects of any other bureau. This has resulted in a heterogeneous mass of Government buildings throughout the country, each embodying the ideas and conceptions of its special architect, but totally disregarding the architecture of any other buildings in the vicinity, or buildings in other parts of the country used for the same purpose. This has also been true, to some extent, in both State and Municipal architecture.

The large majority of States in the Union have a State Architect, or Department of Architecture, for the designing and construction of State institutions or improvements. In many States these Departments are comparatively new and therefore in their infancy of organization. Some States, particularly New York State, have gone far toward standardizing plans and specifications for the various types of construction. As the Federal build-

ings are located within the various States, and must necessarily form a part of the architecture of that State, would it not be feasible, instead of the numerous bureaus now existing in the Federal Government that the one now recognized Supervising Architect have for his advisory board the State Architects of every State in the Union, each State Architect to survey and advise upon the designs of the Federal buildings to be erected in his particular State; the same co-operation of survey and advice to exist between the State Department and Municipalities?

This would result in both Federal and Municipal architecture conforming to an harmonious degree to the standards established for each particular State or regional district. If then the various States would, through the forming of a National Society, in conventional consultations plan their methods and principal features of standardization, uniformity would result, not only pleasing to the eye but of the highest economical efficiency. How many architects make a special point of the use of native material in construction work in each particular locality or region? How many, in designing buildings, take into consideration the atmosphere of the locality as well as climatic and topographic conditions? The forefathers of our country of necessity made use of only native materials, and while the structures are crude, their durability and utility are unquestioned, and, because of their peculiar fitness for the purposes for which they were built, they were artistic in the truest sense.

The economic and artistic uses of such materials have been recognized throughout Europe, with a resultant harmonious beauty, making the buildings seem a very part of their environment. while at the same time reducing their cost by a large percentage, and the peasant's cottage is as beautiful and appropriate in its setting as the artistic and expensive villa with its wonderful treasures of art and sculpture.

But in England, or any other of the European countries, the areas to be considered are very limited compared with the extent of our own country, and the problems confronted here can only be solved by the highest type of co-operation between the Federal and Municipal Governments, with the State Departments.

The Department of Architecture of the State of



## THE AMERICAN ARCHITECT

New York has solved, to a large degree, many of these problems. Its origin in 1883 was the appointment, by the Governor, of a Capitol Commissioner, principally to complete the construction of the present Capitol. This Capitol Commissioner continued in office as State Architect by Chapter 566, Laws 1899. Previous to the appointment of the first State Architect, and for some years after, the majority of buildings at the State Institutions were designed by architects employed sometimes for a particular building only, sometimes for the partial development of an institution, while all the buildings of large magnitude were designed through competition, the State Architect functioning in a supervisory and auditing capacity only, after the contracts were awarded. This practice left little opportunity for the State Architect to develop his own ideas or obtain any uniformity of construction through a general plan of development. This method has gradually been eliminated and the present Department of Architecture was established by Chapter III of the Laws of 1914. This has gradually grown into a Department whose wide scope and splendid efficiency is beginning to be recognized throughout the United States and Canada. Within the past year one of its designs was sent to South America, through Dr. McCoy of the Hygienic Laboratory at Washington, D. C., at the request of the Bolivian Government, while but recently it was visited by a Commission from Japan upon its representation as one of the most efficiently organized Architectural Departments in the country.

Inheriting, as it must, a collection of buildings at the various institutions built with no comprehensive scheme for the complete development of any one of the institutions, and with but few of these buildings designed by the same architect, it has been a most difficult problem gradually to evolve an harmonious continuity and uniformity that would at the same time comply with the needs and demands of modern science and research. Architecture has, in the past, been considered an art. In these modern days it is not only necessary for an architect to be an artist, but in order to be successful in public work, his designs must combine art, science, education, humanitarianism, economy, business and utility. This composite ability is rarely found in one man, but when such a man is found, he should be given the greatest possible freedom, as well as co-operation, in the carrying out of his ideas.

Into the administration of any public office will always enter a certain element of political exigencies. In all purely professional or technical departments this should be eliminated if the best results are to be obtained. A truly professional or technical man is never a politician. The character-

istics and temperament necessary for the making of a good politician are entirely at variance with the qualifications necessary for the highest type of professional man. The often unfair criticisms that are leveled at politics and politicians in general have tended to keep out of public office many men of absolute integrity and high professional ability. It has therefore, in the past, been necessary in many instances to be content with men of mediocre ability as the heads of public professional and technical departments. Our country, our States, our cities need men of the highest type at the head of the various departments, and every possible inducement should be offered them to accept such appointments. It is only through men who are big enough to give absolutely altruistic service that order and harmony can hope to be created out of the present architectural chaos.

The efforts of the Department of Architecture of the State of New York, toward an humanitarian cure rather than a permanent punishment or incarceration, have resulted in a scientific classification in the layout of institutions and the construction of their buildings that will be a long step toward the solving of problems in connection with all humanity coming within the scope of correctional, curative or educational institutions. The one great aim of the department has been so to correlate the construction at all institutions that their work may be carried on in co-operation with all other institutions throughout the State. This can only be accomplished by the gradual working out and adoption of a comprehensive plan encompassing through scientific classification the resultant humanitarian benefits, and this plan should be strictly adhered to during the years necessarily required for its accomplishment in spite of changing politics. Such a plan necessitates, of course, the co-operation of the best scientists, physicians, surgeons, penologists, etc., together with a large amount of good, hard, common, business sense.

The administrative policy of the New York State Department has been gradually to clear away the more or less worthless accumulation of past generations, and evolve out of a conglomerate chaos a comprehensive plan so correlating the whole that the best results might be obtained in the most economical manner. To this end a thorough survey of each institution has been made so that upon a request for a new improvement, the department might not only be able to furnish the institution with an intelligent preliminary sketch and estimate covering its requirements, but could also advise as to the desirability of the improvement requested. Requests by institutional heads are usually made with a view to the development of that particular institution, whereas the best result can only be obtained by developing each

## THE AMERICAN ARCHITECT

institution with a full knowledge of its relation to all other institutions of the State, and so correlating its growth and improvement as best to serve a complete plan for the care of all needy humanity in that State.

The Hospital Development Commission, created by Chapter 238 of the Laws of 1917, drew into the field of operation men of the highest professional type, and the State Architect, as a member of that Commission, and through his work with the Commission on New Prisons of the State of New York, the National Prison Association, The American Prison Association, The National Commission on Prisons and Prison Industries, the National Committee on Mental Hygiene, the State Charities Aid Society, the American Academy of Medicine, the American Institute of Architects, the Heating and Ventilating Engineering Society, The Illuminating Engineering Society, and the National Guard of the State of New York, which placed its Generals at his disposal for advice and counsel, has commanded the advice and co-operation of the best professional men in the country. The plans are formulated, and if the opportunity for their complete accomplishment is guaranteed, will be as far-reaching as the end of all suffering humanity.

In order competently to carry out plans of such wide scope and magnitude it is absolutely necessary to have an executive and business organization of the highest efficiency. The New York State Department of Architecture has attained this efficiency to a remarkable degree and a brief outline of its method of functioning is given below:

When an institution, or its representative in the form of a Commission or Board, decides upon the necessity of an improvement, its requirements are transmitted to the Department of Architecture, with a request for a preliminary survey and sketch, upon which an estimate of the amount necessary for the desired project is based. This sketch and estimate is an assurance to the Budget Committees and the Legislature that the improvement desired can, under normal conditions, be accomplished within the amount requested, thus reducing the disadvantage of having money appropriated lying idle because it is not sufficient for the purpose for which appropriated.

The preliminary sketch and an approximate estimate made by the Department are returned to the institution or its representative and by them included in their requests to the Legislature. These requests are checked and analyzed by the Department of Architecture, preliminary to the hearings held by the Executive and Legislative Budget Committees in co-operation with the Department of Architecture prior to the final development of the Budget Bill for submission to the Legislature.

The appropriation being granted, preliminary plans and specifications are prepared. After the plans and specifications have been approved by the various Boards, Commissions or other State representatives having jurisdiction, the work is publicly advertised and, upon their request, plans and specifications sent to contractors for bidding. Fifty copies of specifications are always printed, thirty-five bound for immediate use, the remainder held in reserve. In large projects one hundred specifications are printed, fifty bound for immediate use. The average number of plans and specifications sent out for bidding for each of the four branches of a construction contract, involving the expenditure of about one hundred thousand dollars, is between thirty and thirty-five. This involves approximately nine thousand feet of blue printing before bids are received.

Bids are received by the Board or Commission representing the State. They are then sent to the Department of Architecture for tabulation, checking and recommendation as to the fairness of the bid in comparison with the estimate made by the Department. Upon the receipt of a resolution from the Board or Commission awarding such contracts, the Comptroller's copy of contract covering each branch of the work is prepared and sent to the Comptroller for checking and approval as to funds available for the purpose. Upon the receipt of such approval, an official Notice of Award, authorizing the contractor to begin work, is issued by the Department of Architecture, and contracts and bonds prepared for final execution.

Bonds in the sum of 50 per cent of the amount of contracts are required covering State work. In the past, the failure of the State to require a bond with a performance clause, and strictly to enforce same, allowed contractors of mediocre ability and questionable reputation to figure on State work and often obtain contracts. However, the form now in use and established by the present Department of Architecture guarantees the strict performance of all work by the bonding company in case of default of the contractor and this has eliminated from State work all but reliable contractors, the requirements of the bonding companies making it possible for only contractors of good repute to qualify. The work performed under these conditions is, therefore, of the best quality obtainable, the contractors, like all good workmen, taking a personal pride and interest in carrying out, to the best of their ability, the State Architect's desires as expressed by the plans and specifications, which co-operation naturally results in a building of the highest type.

A copy of the Official Notice of Award of Contract is sent to the various bureaus of the Depart-

## THE AMERICAN ARCHITECT

ment, which is their authority to begin the work of supervision and a Superintendent of Construction is detailed to cover the work. A detailed estimate is required from the contractor, showing the proportion of his bid on the various items of work involved. This estimate is used as a basis for granting payments as the work progresses. The Superintendent of Construction is supplied with a copy of the contract and bond, containing a copy of specifications, detailed plans and working drawings, detailed estimate and copies of all letters, instructions or transactions of any kind between the State and the Contractor. Deviations from the specifications, whether involving additions or deductions, are submitted to the Board or Commission representing the State, checked by the Department of Architecture as to their structural value, and a written order, designated as an "Order on Contract" issued covering same. This order clearly defines the deviation made from the specification, and a copy of same is sent to the State Comptroller, the Board or Commission representing the State, the Contractor, the Superintendent of Construction in charge of the work, the Inspection Bureau of the Department, and one copy attached to the Department's executed copy of the contract. Applications for payments are made on blanks furnished by the Department and contain an affidavit of the contractor as well as an affidavit by the local Superintendent of Construction that the payment requested is just and due the contractor according to contract provisions covering payments. These applications are checked by the Chief Inspector and certificates of payment prepared in the accounting bureau. Monthly payments of 85 per cent of work or materials incorporated in the building are provided for in contracts: When the work is reported completed by the contractor, and application for final payment made, a special inspection is made by the Chief Inspector, or in engineering work by the Chief Engineer. The application is then submitted to the Commission or Board representing the State, for their approval and statement as to any loss or damage suffered by the State because of violations or delays by the contractor. Upon the affidavit of the Chief Inspector that the work has been properly completed, and a resolution from the Board or Commission representing the State approving same, final certificate is issued and sent to the Comptroller for payment.

Contractors are required to file policies of fire insurance covering all payments on work, excluding underground work and excavations, foundations, etc., up to the first floor tier beams. These policies are retained by the Department of Architecture until final certificate is issued or the building is occupied by the State.

The Comptroller being the financial agent of the State, certificates are sent to him for payment and check sent by him direct to the contractor.

The clerical work involved in each transaction of this kind is, of course, enormous. In connection with the preparation of working details, additional blue printing of approximately seven thousand feet is required for each contract, making the total amount of blue printing necessary for each project as described above approximately sixteen thousand feet. Nine copies of contracts and bonds are prepared for each branch of the work, making necessary the preparation of seventy-two original forms in connection with the award of each construction contract. It is necessary to prepare eight copies of each certificate or contract order issued to file for reference and accounting purposes with the various Boards, Commissions and Department Bureaus interested. One hundred and sixty-six contracts were issued by the Department during the first ten months of the present year, aggregating approximately \$7,000,000, while plans and specifications for an additional \$9,000,000 are in course of preparation. During the month of June the Blue Print and Plan File Bureau averaged eight thousand feet of blue printing a day, at an expense of \$1,200 for blue print paper during that month.

The incoming mail, averaging upward of two hundred letters a day, is opened and read by an assistant in general charge of the clerical and administrative force of the Department, stamped received, numbered consecutively and referred to the various bureau heads having jurisdiction over the subject-matter of the letter. Before being distributed to these various bureau heads all mail of every kind is recorded in a letter record book showing the consecutive number of the letter, institution, from whom the letter is received, a short synopsis of its contents and to whom referred. This record enables the department at all times readily to trace all mail received.

Separate files are kept for each institution, commission or special project, together with a letter press book covering same. This requires separate letters covering work at each institution, both incoming and outgoing. All outgoing mail, whether letters, reports or blue prints, is sent to the private office for signature by the State Architect or his authorized deputy. A letter press copy of all letters and reports is made while a carbon copy of the letter is attached to the one answered, for filing.

A "follow up" system has been instituted, under which all queries not finally disposed of are placed in a separate file, with a small card index on the desk of each Bureau head, for ready reference.

An account is kept covering each contract, show-

ing the money appropriated, the amount mortgaged for each branch of the work contracted for, all contract orders issued, and all certificates issued. This account is closed when final certificate is issued, and any small remaining balance lapses by law. Should a balance be re-appropriated for another purpose, a new account is opened.

When a project is undertaken by an Institution, to be done wholly or in part by inmate labor, plans and specifications are prepared by the Department of Architecture the same as though the work was to be advertised for competitive bidding. An estimate of required quantities is made and prices obtained by the Institution, together with a detailed estimate of outside labor required, if any. The work under these estimates is checked by the department as to quantities and manner of execution, and is known as the Special Fund Estimate System.

It must be conceded from the foregoing that the organization of the Department of Architecture of the State of New York has been developed to a very high grade of efficiency and is worthy of emulation, and the beneficial suggestions to be derived from its organization should be placed at the disposal of all other Architectural Departments throughout the country, whether Federal, State or Municipal.

Certainly the accomplishment of the plan as outlined would be far reaching enough to stretch over

our entire country, and finally encompass the world. And should not the man who has been foremost in its development and adoption, in whose virile brain it first originated, be given the highest type of co-operation by all men, be they architects or not? The young men of our country have just passed through the acid test of war, cheerfully giving their all that an ideal should survive. Shall the professional men of this country do less than give their best thought and active co-operation toward the development of an Architecture that will be the highest art ever accomplished, in that it will serve humanity to the utmost? This will be characterized by some as being too idealistic and its suggestions therefore incapable of being carried out. Architecture is ideals expressed in stone and concrete, and to hitch your ideals to a star is none too high for the real architect, who desires to make his profession one of the highest arts rather than one of commercial exploitation.

The dreamer lives forever,

The toiler dies in a day,

but the dreams of the dreamer must be based on rational, structural philosophy, with a rock foundation firmly imbedded in the needs of the world. All creative art is the result of some one's dream, but unless that dream be put in concrete form and meets in some way the needs of humanity it is of no inherent value.



VENICE—FROM THE ORIGINAL PAINTING BY R. BELLOTTO  
(COURTESY OF M. KNOEDLER & CO.)



## Architectural Education

UNDOUBTEDLY the causes underlying the expression of dissatisfaction as to present conditions in architectural practice can be traced directly to faulty educational methods; the Post-War Committee has in its reports practically conceded this. The correct form of educational method as affecting inter-professional relations has been seriously considered by the committee appointed at the recent conference in Detroit. There was unanimity of opinion announced at the Nashville Convention as to the pressing need for a drastic revision, one that would be the result of the labors of architects in practice and not of those who are so deeply immersed in the present system as to be firm in the belief that present methods are, if not absolutely correct, the only methods which can be contemplated.

Many members of the Institute have placed themselves squarely on record as not content with present methods of architectural education. The Board of the Illinois Chapter much more than a year ago presented a comprehensive report on this important subject. This report contained the essence of a plan that was very generally approved and would seem to be worthy of careful consideration in the evolution of any revision. Other reports, also carefully prepared, are available. Why then longer delay action? Why continue to agree that there is need for revision—why not revise?

WHATEVER conclusions are reached cannot be secured in formal meetings, nor can it be expected that the Post-War Committee with all the many important matters that now engage it can give this subject the full measure of time to which it is entitled. If education affects the inter-professional relation then the revision will not only be necessary as to the curricula of architectural schools, but it will also be necessary to give careful consideration to that part of the education of those in many related fields which meet the wide and diverse extent of architectural practice.

All of the professions have many things in common and all of them during the past five years have undergone many changes in their methods of practice. The barriers that at one time kept each profession isolated either have been swept aside or so lowered as to become practically non-existent.

The Committee of the Inter-Professional Conference to consider the fields in which co-operation would be helpful recognized in the housing movement an important instance. In such cases there is needed the technical knowledge of architects, engineers, sanitation experts, landscape gardeners and the legal profession. Problems of housing or town-planning engage at one time or another the services of men in all these professions as well as groups of workers whose labors closely touch on each one of these.

IT is undoubtedly the opinion of the men in the profession who have given most thoughtful consideration to this important question of architectural education that present methods too largely accentuate the value of class-room work and are not sufficiently cognizant of the practical out-of-door examples which lie at hand awaiting exposition, and the students therefore do not realize the application of the profession which they are studying.

It happened that by the extraordinary circumstances of its environment the "University of Beaume" of the A. E. F. was compelled to work out different methods. There were no class-rooms and the students therefore were put to work out-of-doors measuring and dissecting buildings. They learned more in six months about how a building was put together than they could possibly have done in twice the length of time spent sitting in a class-room.

In our colleges a great deal of attention has been paid to the development of college spirit. Each youth becomes firmly imbued with the idea that there is no university but his alma mater. Do the universities hope by this method to increase their prestige and attendance?

## THE AMERICAN ARCHITECT

OUT of this grows a pronounced snobbishness of each alumni for the others, of each profession for the others—which does not speak well for the cultural effects of education as it to-day exists. If culture means a perception of the relative forces of civilization, it makes a poor start when it accepts the idea that all professions but its own are subordinate.

The architectural student must be taught the relation of his own calling in present-day society. His education must be based upon the essentially practical things which he needs to know in the practice of his profession. And there may be eliminated many of the non-essentials, as our universities are eliminating from their other departments courses which for more than a hundred years have been considered essential. It should rest with experienced practitioners to decide what the essentials and what the non-essentials are.

---

### Model Constitution for State Societies

THE Committee on State Societies of the Post-War Committee on Architectural Practice performed a very valuable service and took a long step in advance when it drafted and made public a model constitution and by-laws to aid in the formation of State Societies of Architects. This action on the part of this committee lays the basis of a very firm foundation in the formation of State Societies. It insures the co-ordination of effort. It secures the community of interest and solidity of purpose of all the Societies that shall be formed in the future. And it would be well if present Societies in various States working under entirely dissimilar constitutions and by-laws would substitute the present model form for those that are now in operation.

This action of the Post-War Committee is exactly in line with the policy that has been from time to time urged by THE AMERICAN ARCHITECT not only in the formation of State Societies but in the codification of State laws as affecting registration for architectural practice.

There are no good reasons why there should be basically any difference between the laws in various States, with certain very unimportant exceptions. If the American Institute of Architects had proceeded, when registration first became a debatable question, in the same manner as has the Post-War Committee's special committee, much of the confusion that now exists would have been obviated and

it is logical to believe that the smooth working of these matters in the various States would have caused the passage of laws in many States where such laws do not at present exist.

Referring to the model constitution prepared by the Committee on State Societies, a careful reading fails to disclose any very serious omissions or anything that could be adversely criticized. It presents a clean-cut, well-considered working platform for the State Societies. In most localities men are too busy to give this intricate matter the careful consideration that it deserves and it is for this reason that State Societies have not been more generally organized. With the constitution and by-laws fitted exactly to their requirements, groups of men in all the various States where State Societies do not now exist may confidently, fully and speedily organize for the best interests and advancement of the profession as the most arduous part of their work has been performed for them by this very efficient committee.

---

### The Lesson From a Tragedy

THE "Sun and New York Herald" in a recent issue and under the above heading comments editorially on the tragedy that was enacted in a New York house where a woman prominent in society and her two children were smothered to death as the result of a fire caused by an overheated furnace. It further comments on the fact that it was a singular coincidence that on the day of this accident the Committee of Fire Prevention of the New York Chapter of the American Institute of Architects issued through its Chairman, William O. Ludlow, a warning against the dangers of improperly managed heating apparatus.

It is astonishing with all the supposedly efficient fire prevention methods in New York City and the service of inspection that the taxpayer has the right to believe is being made, that a furnace in a pretentious house in a dignified residence of the city should be so improperly located and protected as to set fire to the building.

Possibly this lamentable accident will rouse the authorities to activity and strict precaution, but it is unfortunate that it should be necessary, as it has been equally unfortunate in the past, to sacrifice human life to awaken in the public mind the sentiment that will enforce a better compliance with fire prevention rules.

# Natural Influences in Building

## The Problem of the Country House and the Only True Method of Its Successful Solution

SINCE building is necessarily a creative art, writes M. H. Baillie-Scott in *The Architects' Journal* of London, and since houses take their places in the midst of fields and trees as man's contribution to the beauty of the world of Nature, it follows that some sympathetic knowledge of this natural world is desirable for those who would build in the right way. The old home fitted into its place in the country which it adorned mainly because its creators were permeated with country influences, and were themselves almost as much a part of their natural surroundings as the old home was. Their ways were Nature's ways, their thoughts and conceptions were akin to hers, and so it followed that they created, quite naturally, without any art education in schools and museums, without attending lectures or ruling lines on drawing boards, these old houses which we find it now so difficult even to imitate successfully. The same processes of civilization which have made man artificial instead of natural in his conceptions and ideas have also made of the modern country house a blot on the landscape and a deplorable desecration of sylvan solitudes. It seems essential then that those who build in the country should study not building alone but Nature also. It will be found that the trees and flowers all have their lessons for the builder, and that we can learn something more from them than from any books. The first thing we have to observe in all natural creations is that beauty is always intimately associated with practical functions. Nothing is too exquisite for its uses, and all forms are the inevitable result of the nice adjustment of means to ends. Here we find at once the same great principle which underlies the old buildings, and which is so painfully absent from modern work in which art is so often supposed to be a matter quite apart from the utilities. We hear nowadays of what is called pure art, existing for beauty alone without any vulgar taint of usefulness. We shall find no precedent in Nature for pure art, and even in the human form function is still the paramount fact. The leaves of the trees we shall find are but after all the lungs of an organism, and the tremulous movement of the foliage of the poplar is not merely for our delight, but is a contrivance for the prosaic purpose of keeping these lungs free from dust. In the flowers the brilliance of the corolla is but the guiding signal for the fertilizing bee, and as such may

be compared to the brightness of the modern hoarding. It is a natural example of the uses of advertisement. In other cases color of the greatest beauty is used for the opposite purpose of concealment, and the strange markings in feathers and furs of birds and beasts are devised for the same object which leads us in stress of war to paint our gun-carriages with the variegated tints of the post-impression picture. These two opposing principles of advertisement and concealment give us the contrasts and harmonies which make up so much of the beauty of Nature. Another noticeable quality in Nature is its infinite variety combined with approximate similarity. No two nightingales pour forth exactly the same song. No two blades of grass cut the April air with exactly the same curve. Of all the millions of human beings on the earth no two are exactly alike. Each has his individuality and its peculiar differences in form and character. Similarity is always only approximate, and apparent uniformity is in reality coupled with constant individual variation.

The application of these natural principles may lead us in building a country home to introduce the principle of protective coloring to bring its walls and roof into harmony with its surroundings, and this seems particularly desirable in the case of houses surrounded by woodlands, or at least such materials may be used as Nature will color in her own way.

It will also follow that all the bricks and tiles used should, though apparently similar, have slight individual differences in form and color, and the same principle may well be applied throughout the whole construction in a thousand ways, and this need not be a difficult matter. In fact it is the natural result of human hand-work where the eye is the only guide without mechanical aids. Let us take for example the turned balusters to an old staircase. They look as if they are all the same pattern and as if they are all exactly the same distance apart, but as a matter of fact they have the same infinite variety as the grass blades in the meadow. No unnecessary trouble has been taken to destroy this variety by exact mechanical accuracy. But the modern mechanically-trained workman is at great pains to destroy all this subtle variety, and so his work is a lifeless and entirely uninteresting thing. Or if we consider the plans of old houses we shall find that the same general ar-

rangement of rooms is used again and again. Certain localities had very often certain standard plans. But in spite of this general uniformity each house had its difference. Each was individual. The modern builder on the other hand reproduces his stock plans with exact mechanical regularity, although variation in his case would not help us much, because it would be variations in different shades of ugliness.

If we take a wider view of the natural world and consider the sun and moon and the stars in their courses we shall find how the old builders without scientific knowledge of what we now call the solar system, yet instinctively divined and demonstrated in their work those cosmic laws of which they had no conscious knowledge. All these works of man fashioned under the guiding influence of natural law became a microcosm of the solar system. Each had its focal point, its sun which either as the altar in the church or the fire-place in the hall was the dominant note in the conception. For the great mystery of building lies in this. We take brick and wood and stone, all things which seem dead in themselves, and in arranging them in certain ways they acquire life and meaning. They seem to speak to us. The house so created, compounded of dull inanimate materials, takes to itself a personality. It may be full of charm and depth and earnestness of appeal. It may be shallow and frivolous, or cold and forbidding. But some such measure of life it has achieved. The charm begins to work with the putting of one brick upon another. For no work of this kind can be done without demonstration of the laws of the world. As in allegories and fables truths of deepest import are captured and fixed, and so brought within the range of our understanding; so building is a kind of allegory which may bear witness to the same great principles as those on which the universe is planned. Truly it is no small matter, this building art. Not a fit subject for mere commercial speculation, or to be practiced as a dull mechanical trade. It is something more, too, than a dilettantism concerned with revivals and renaissances and réchauffés, or any resurrection-pies of any sort. No learning or erudition will suffice to build rightly. It is more important to be a certain kind of person than to know a certain number of things. A knowledge too diffused cripples the creative initiative of the mind, which should be a clear, unclouded mirror and an instrument sensitively aware of all the influences of Nature, and in tune with those great truths of the world which it is the function of building as an art to express and confirm.

## Unsanitary Housing as Affected by Political Elements

A terse analysis of the relation between housing and politics was recently made by Dr. James Ford of Harvard University and is here presented. Dr. Ford appeared before the recent meeting of the Committee on Public Buildings and Grounds of the House of Representatives in Washington. It was in the course of a hearing on the creation of a bureau of housing and living conditions in the Department of Labor that this clear summary was given. Dr. Ford said:

"I have a statement here from the 1910 census indicating that there were 20,255,000 families in the United States, of whom 10,697,000, or more than 50 per cent, were living in rented houses. I think there is an element of very real danger in this condition. Over half of our population living in rented houses! They are virtually nomads; they have no stake in the community. A man is not a good citizen unless he can vote conservatively and safely on such matters as public appropriations. No man is so safe a voter until he understands business principles, understands the problems which face the city. He does not understand those problems, or is not much interested in them, as a rule, until he has a financial stake in the community. I have found in my own city, fortunately, perhaps, that a considerable number of our tenement house and apartment house dwellers do not vote. They do not stay in any one place. They move from one suburb of a city to another. That might be fortunate, but still it is unwholesome to have any element in the community which is not working for the general public advantage, and these men do not work for the general public advantage.

"Those who do vote are persons who have lost all interest in good conservative and constructive public action, and the Bolshevik element is recruited from this group.

"On the other hand, there are complaints of rent profiteering, bitter complaints, which are a source of discontent, and yet property-owning interests claim that they cannot build houses to rent at a profit under present prices of materials and labor. It seems to me that this is a matter of such vital importance that it should be studied by a disinterested agency to find out what constitutes rent profiteering, what is a proper return to invested capital, and what kind of houses can be constructed that can be rented at a profit to skilled workmen and to unskilled workmen."



BUILDING NO. 7

BASEMENT CONTAINS A SHOWER ROOM AND CLEAN AND SOILED CLOTHES ROOMS FOR INMATES OF THIS BUILDING

A FAN AND HEATER ROOM, SUPPLYING HEATED AIR TO CELLS, IS ALSO SHOWN

BUILDING NO. 8

THE BASEMENT CONTAINS A DINING ROOM WITH THE NECESSARY KITCHEN, SCULLERY, SERVICE AND REFRIGERATING ROOMS FOR THE ATTENDANTS OF THIS BUILDING  
AMPLE STORAGE SPACE IS ALSO GIVEN

SUPPLIES FOR THIS BUILDING ARE TAKEN IN AT THE REAR AND DISPOSED OF THROUGH ELEVATOR AND DUMBWAITER SERVICE

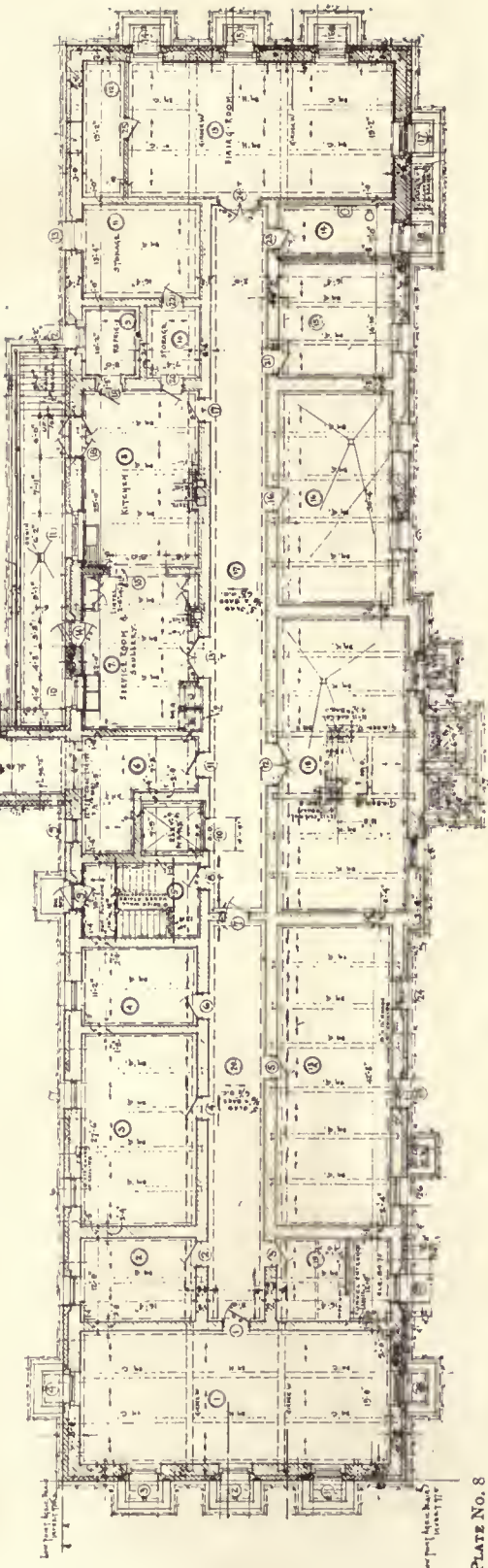
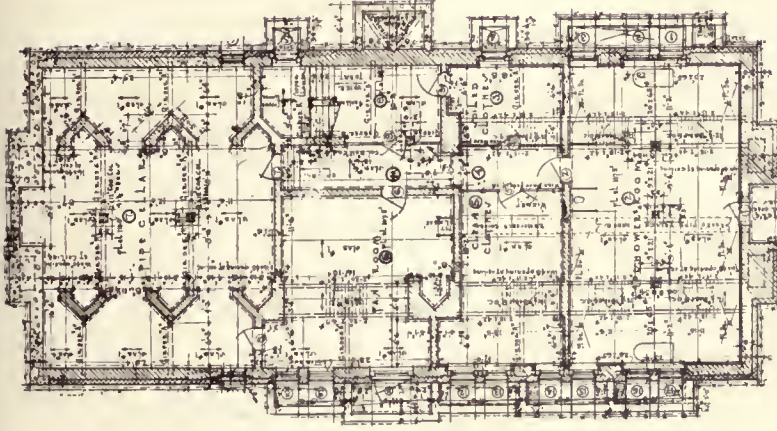

BASEMENT PLAN,  
CLINIC BUILDINGS NOS. 7 AND 8,  
SING SING PRISON, NEW YORK  
LEWIS F. PILCHER, STATE ARCHITECT

BUILDING NO. 7  
BASEMENT PLAN





BUILDING NO. 7

FIRST TIER OF OUTSIDE CELLS, THIS FLOOR HAS A CONNECTING STAIRWAY TO CLINIC BUILDING AND AN INDEPENDENT OUTSIDE ENTRANCE. PROVISION HAS BEEN MADE TO ALLOW FOR CONNECTION BY ENCLOSED PASSAGE TO FUTURE CELL BUILDING EAST

BUILDING NO. 8

ROOMS FOR MENTAL AND PHYSICAL EXAMINATION OF INMATES, LABORATORIES AND ADMINISTRATION ROOMS

FIRST FLOOR PLAN,  
CLINIC BUILDINGS NOS. 7 AND 8,  
SING SING PRISON, NEW YORK  
LEWIS F. PILCHER, STATE ARCHITECT

BUILDING NO. 7  
FIRST FLOOR PLAN

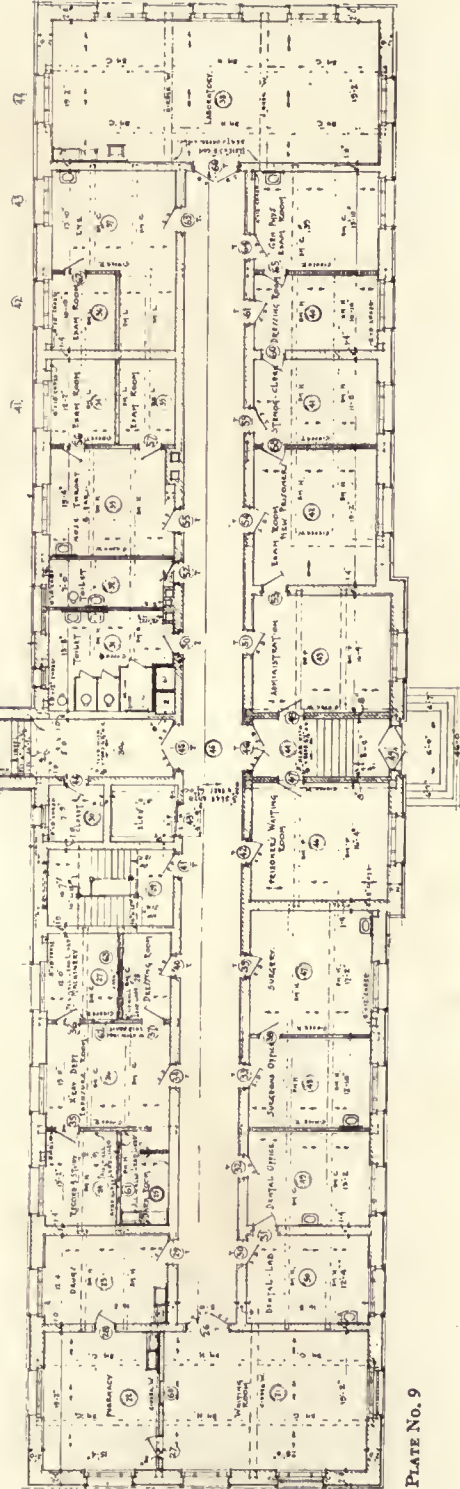
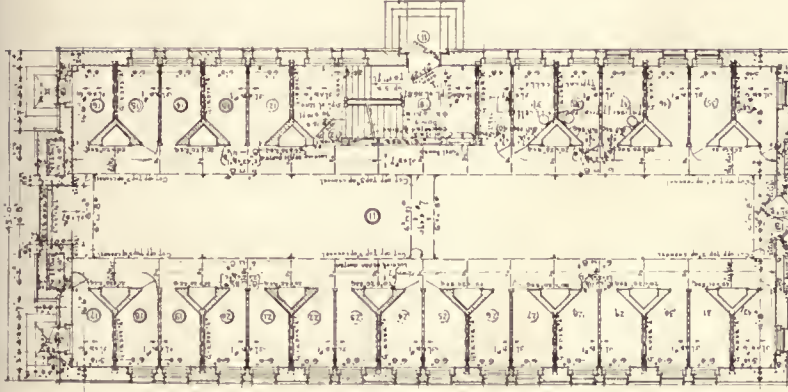



SECOND FLOOR PLAN,  
 CLINIC BUILDINGS NOS. 7 AND 8,  
 SING SING PRISON, NEW YORK  
 LEWIS F. PILCHER, STATE ARCHITECT

BUILDING NO. 7  
 SECOND TIER OF OUTSIDE CELLS  
 --GUARD WALKS AND CENTER OPEN  
 WELL

BUILDING NO. 8  
 EXAMINATION ROOMS, MUSEUM,  
 LIBRARY AND LABORATORIES FOR  
 RESEARCH WORK, LECTURE ROOMS

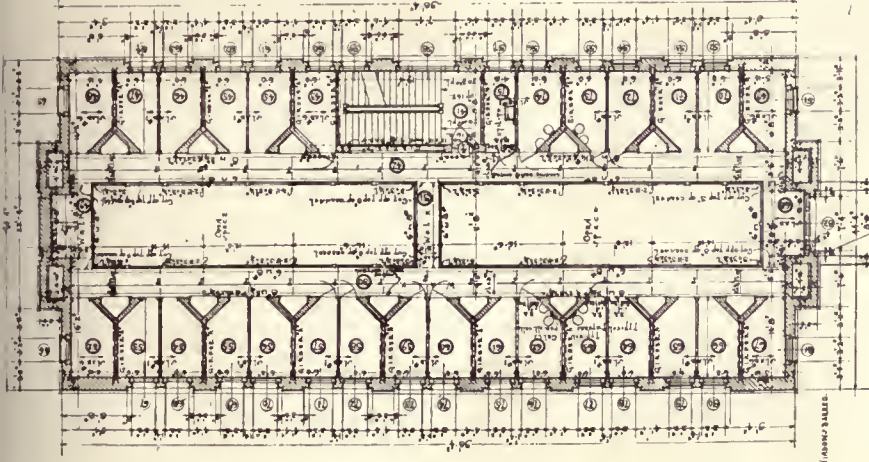

BUILDING NO. 7  
 SECOND FLOOR PLAN



NOTE: ALL LETTERS, NUMBERS, DIMENSIONS

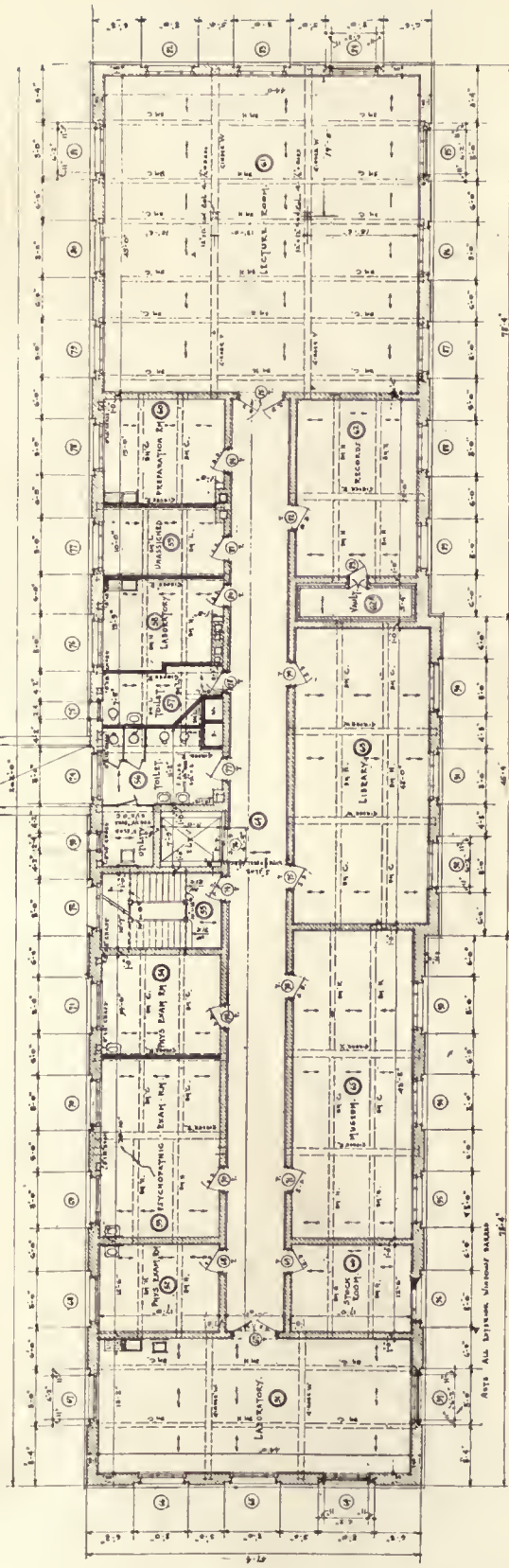

NOTE: ALL LETTERS, NUMBERS, DIMENSIONS



BUILDING NO. 7  
 THIRD TIER OF OUTSIDE CELLS,  
 SHOWING GUARD WALK AND OPEN  
 WELL.

BUILDING NO. 8  
 HOSPITAL FLOOR, WITH NECESSARY  
 WARDS FOR INMATES IN NEED OF  
 MEDICAL ATTENTION AND OBSER-  
 VATION. DOCTORS' AND NURSES'  
 ROOMS—TOILETS AND BATHS AND  
 SERVICE ROOMS—ARE PROVIDED

THIRD FLOOR PLAN,  
 CLINIC BUILDINGS NOS. 7 AND 8,  
 SING SING PRISON, NEW YORK  
 LEWIS F. PILCHER, STATE ARCHITECT

BUILDING NO. 7  
 THIRD FLOOR PLAN

App. ALL TYPES ROOMS, BATHS

App. ALL TYPES ROOMS, BATHS

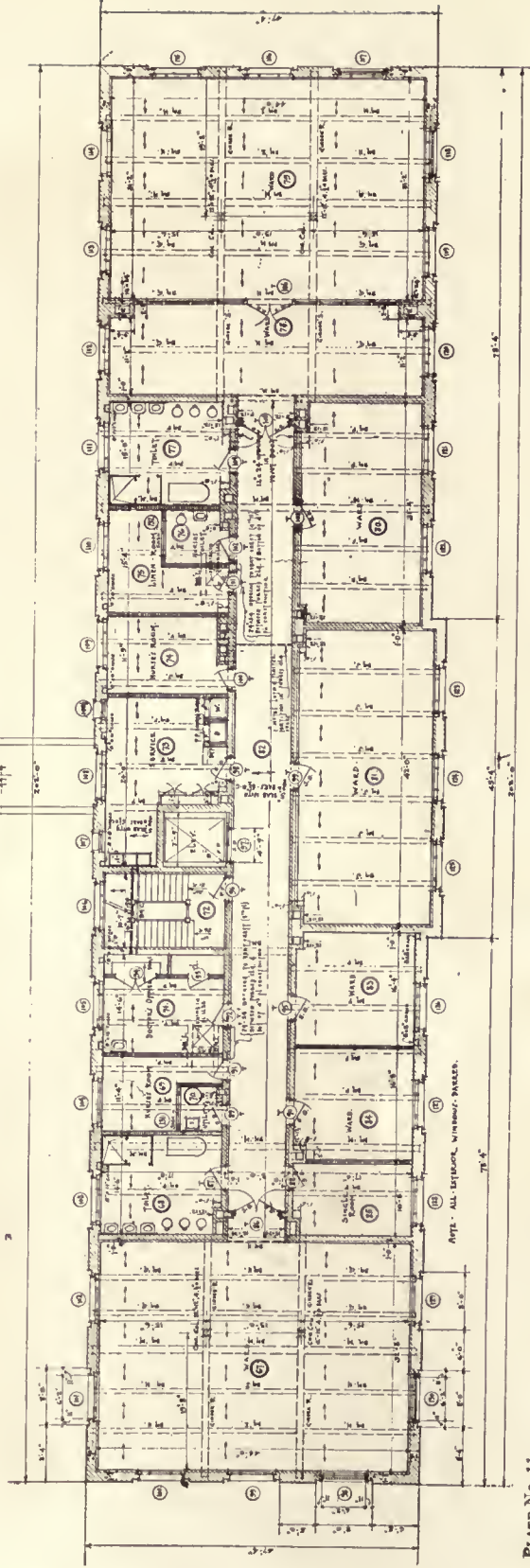
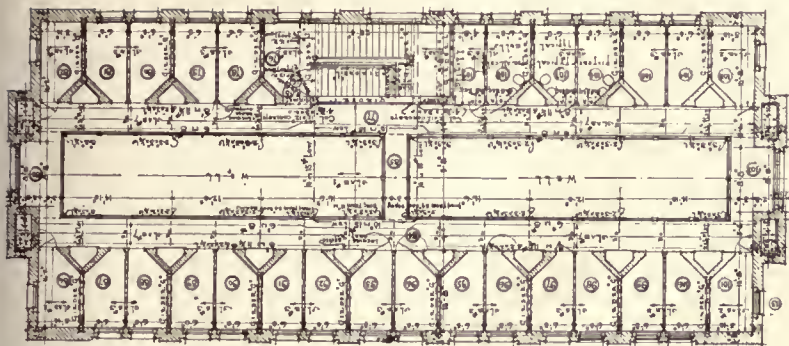

304





BUILDING NO. 7  
 ATTIC PLAN SHOWING VENT  
 DUCTS AND FAN ROOM

BUILDING NO. 8  
 OPERATING AND NECESSARY  
 PREPARATION ROOMS, A  
 ROOF SOLARIUM 150 FT.  
 ABOVE THE HUDSON FOR IN-  
 MATES UNDER MEDICAL  
 TREATMENT, ROOMS FOR  
 NURSES

FOURTH FLOOR PLAN,  
 CLINIC BUILDINGS NOS. 7 AND 8,  
 SING SING PRISON, NEW YORK  
 LEWIS F. PILCHER, STATE ARCHITECT

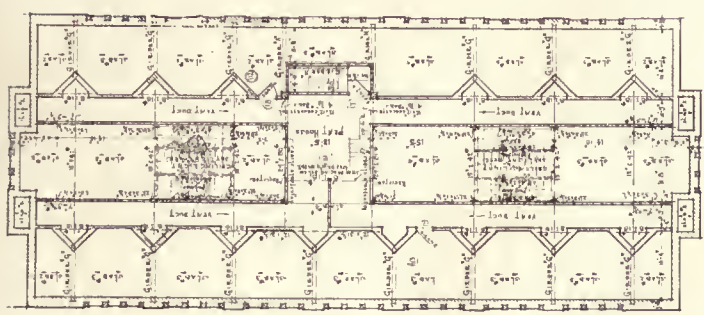

Building No. 7  
 Attic-Floor-Plan  
 - BUILDING NO. 7 & 8 -



NOTE: WALLS TO BE FINISHED WITH PLASTER.  
 FLOORS TO BE FINISHED WITH POLISHED CONCRETE.  
 ROOF TO BE FINISHED WITH PLASTER.

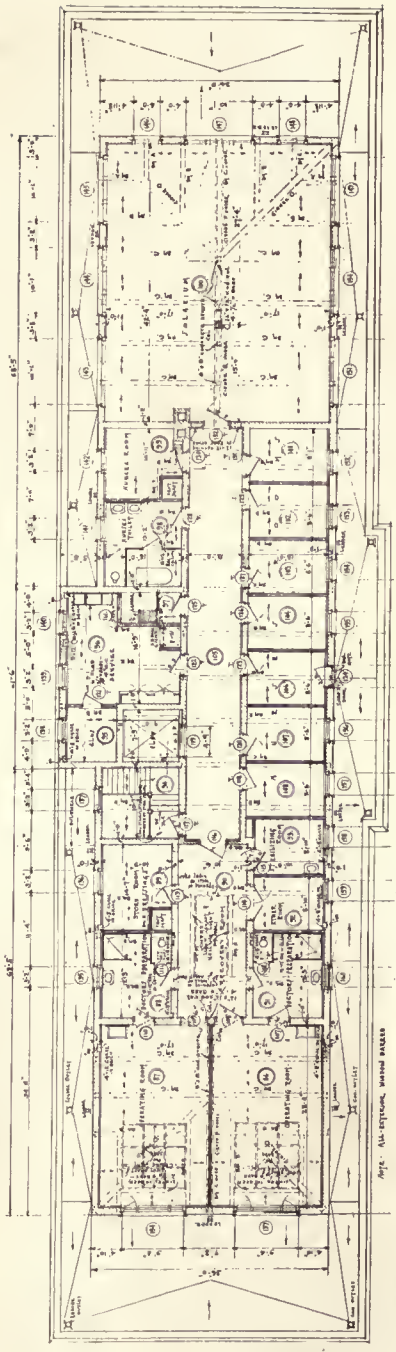

NOTE: ALL DIMENSIONS, UNLESS NOTED OTHERWISE.

PLATE No. 12



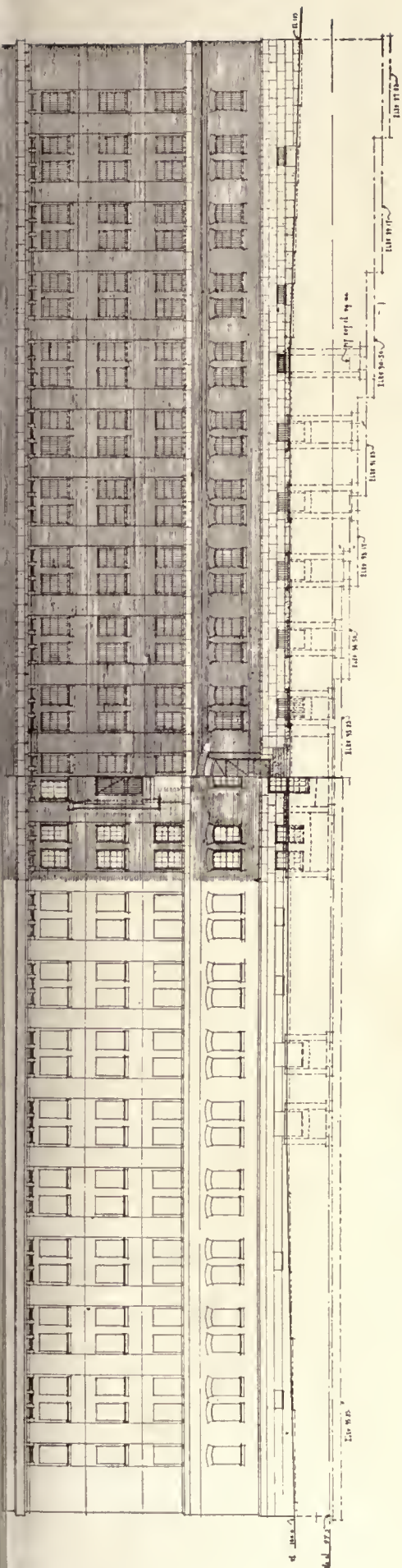

1/2 REAR ELEVATION

1/2 FRONT ELEVATION

DETENTION BUILDING NO. 5

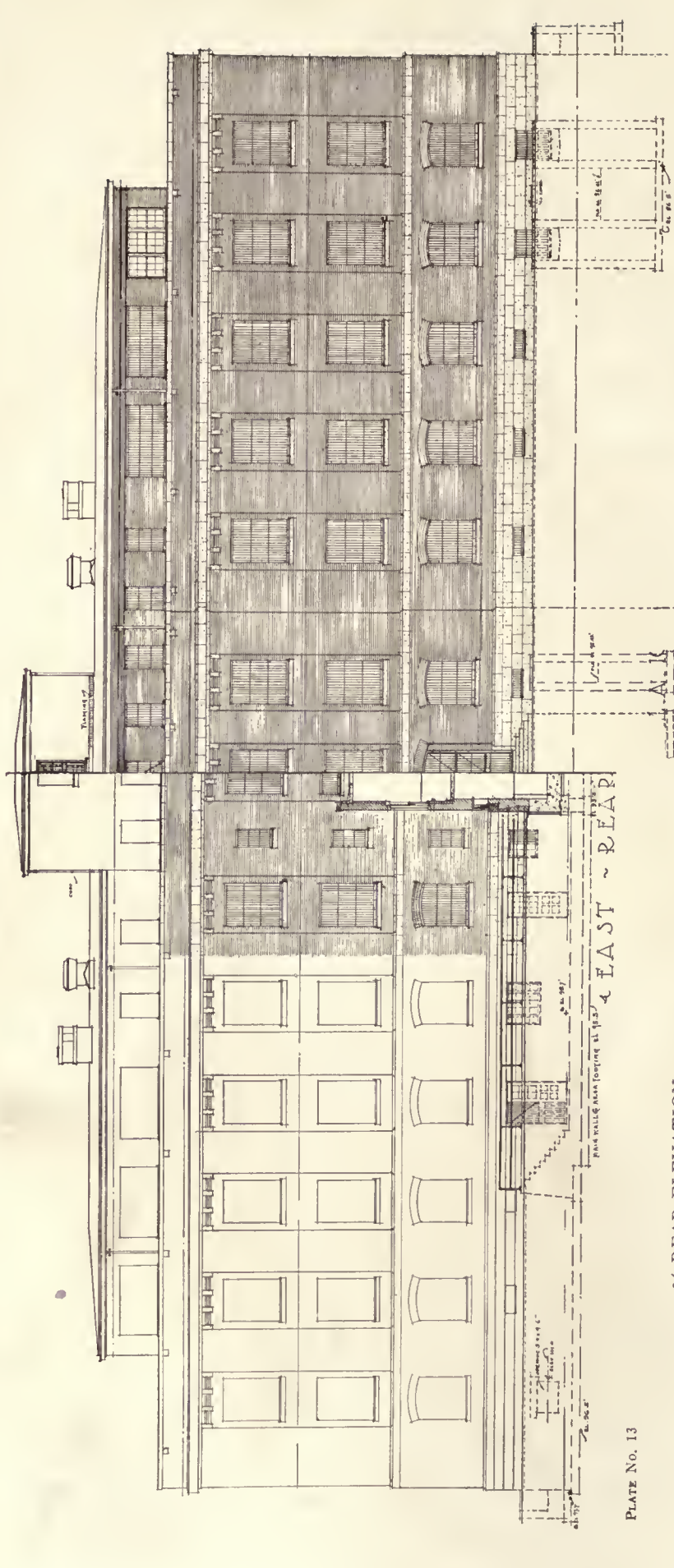

1/2 REAR ELEVATION

1/2 FRONT ELEVATION

CLINIC BUILDING NO. 8, SING SING PRISON, NEW YORK

LEWIS F. PILCHER, STATE ARCHITECT

UPPER HALF.—Front and rear elevations of the basement and four-story Detention Building No. 5 (Outside Cell Building). Walls below first floor faced with granite; upper walls brick, laid in Flemish bond, with granite sills, belt course and cornice. The front of this building overlooks the Hudson River at an elevation of approximately 110 ft. above high water. Shower bath and clothes storage rooms are provided in the basement and the upper floors are fitted with outside cells. All windows and doors are heavily barred.

LOWER HALF.—Front and rear elevations of the basement and four-story Clinic Building No. 8. This building is used for the mental and physical examination, the classification and medical treatment of incoming prisoners. Walls below the first floor are faced with granite; the upper walls are of brick, laid in Flemish bond, with granite sills, belt course and cornice. The front of this building is, approximately, 110 ft. above the River and from the solarium there is a magnificent open view. All windows and doors are heavily barred.



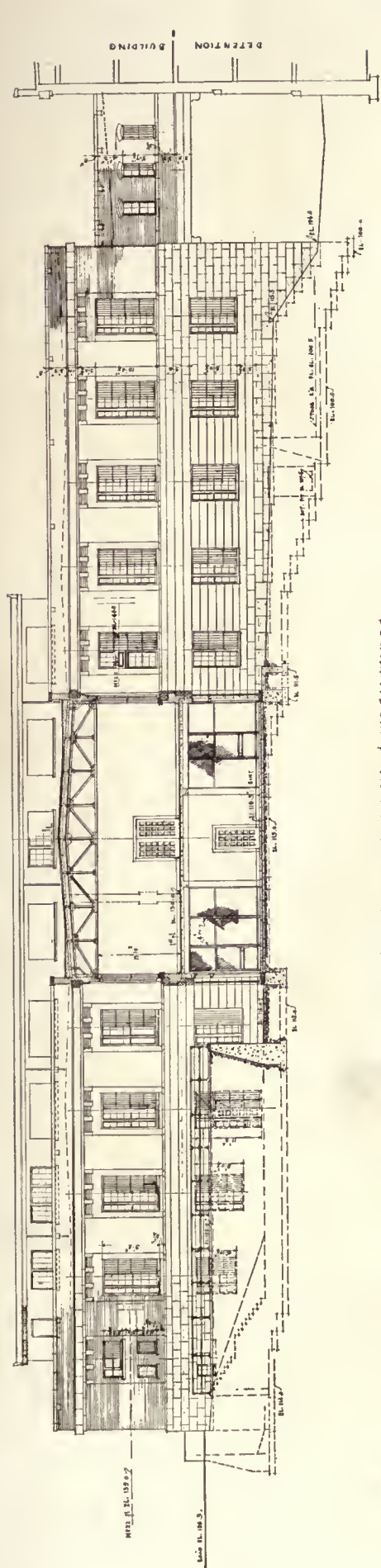

NORTH ELEVATION OF EAST & WEST WINGS

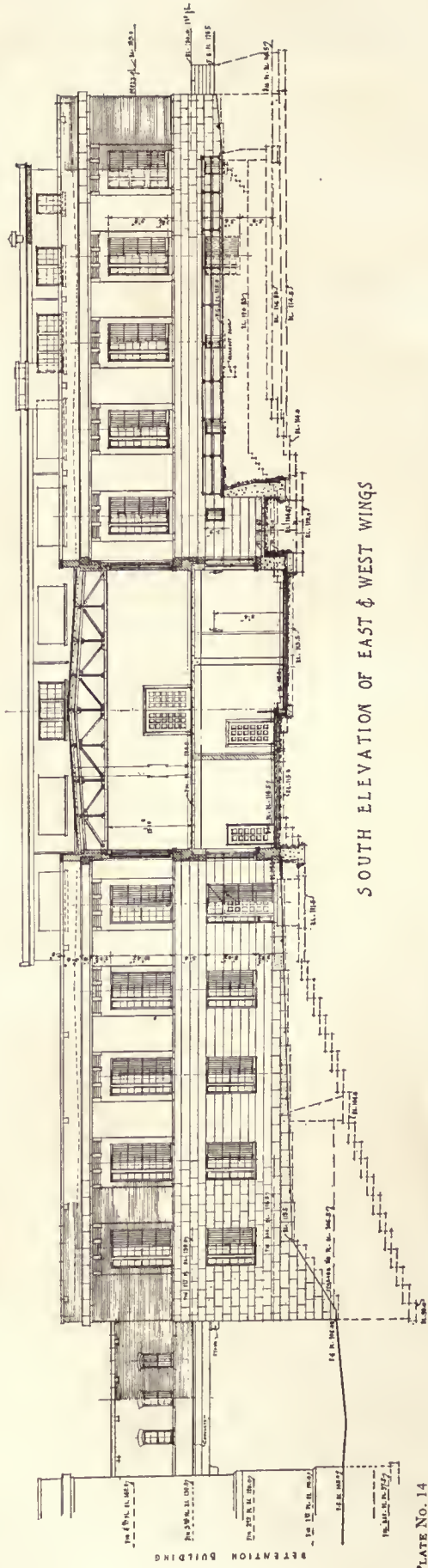

SOUTH ELEVATION OF EAST & WEST WINGS

PLATE No. 14

MESS HALL AND KITCHEN BUILDING NO. 4, SING SING PRISON, NEW YORK  
LEWIS F. PILCHER, STATE ARCHITECT

Elevations of Mess Hall and Kitchen Building.  
Walls below first floor faced with granite; upper walls brick, laid in Flemish bond, with granite sills, cornice and coping.  
Here again is emphasized the advantage of terracing. The basement floor level in West Wing is above finished grade. A Mess Hall is placed on the basement of this wing.  
An enclosed passage bridges the gap between the Detention Building and the Mess Hall and Kitchen Building.



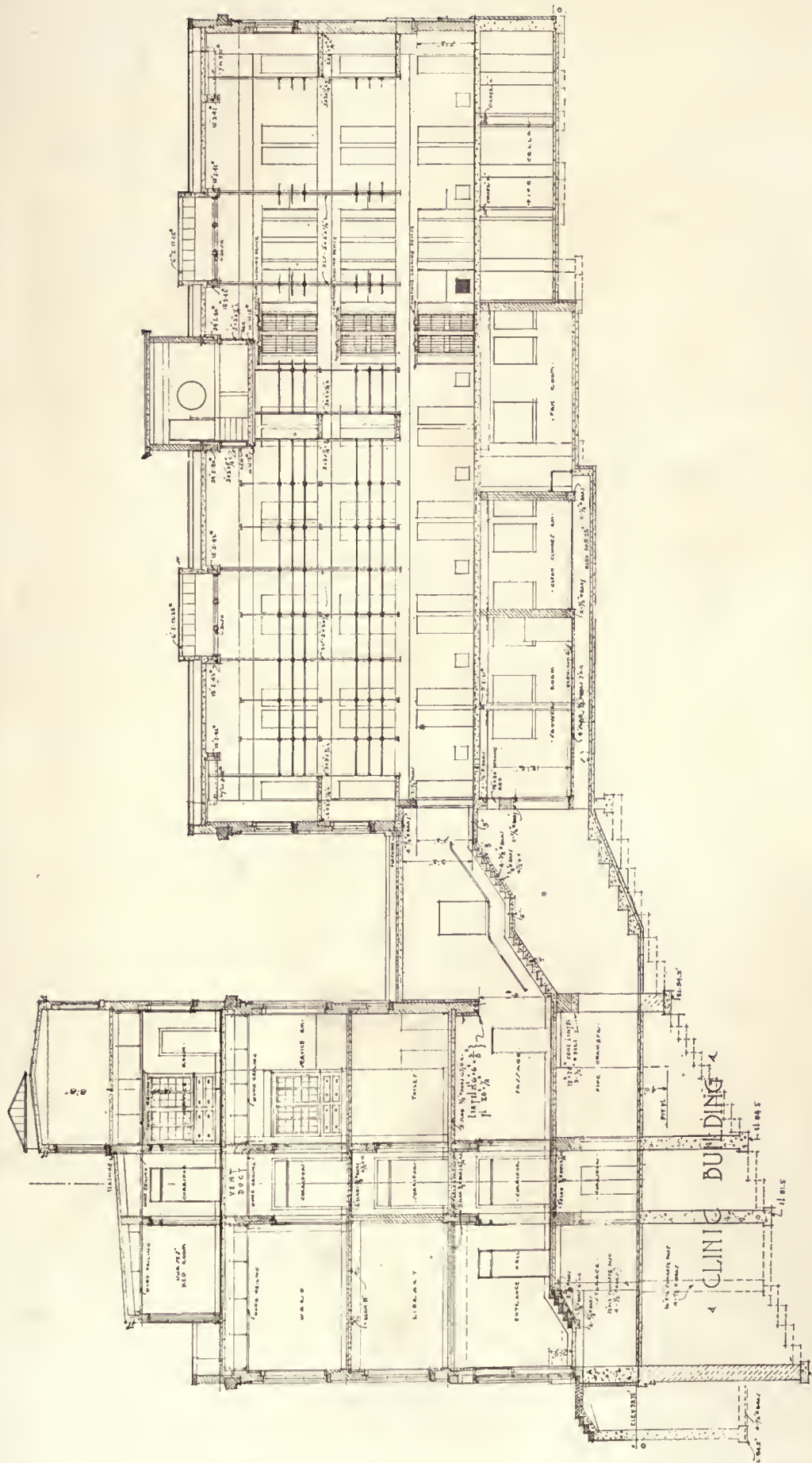

PLATE NO. 15

OUTSIDE CELL BUILDING NO. 8, SING SING PRISON, NEW YORK

LEWIS F. PILCHER, STATE ARCHITECT

This section is taken on the center line running East and West. The connection between the Clinic Building and the Outside Cell Building are shown. Building No. 7 has an open well in the center and tiers of cells with guard walks are placed on either side of this well.

508





# Current News

---

## Happenings and Comment in the Fields of Architecture and the Allied Arts

*In order to supply our readers with material of current interest, the news and comment appearing in issues of THE AMERICAN ARCHITECT delayed by the printers' strike will be as of actual rather than stated date of publication.*

### Chicago's Architectural Transformation

Is Chicago developing a distinctive architecture of its own? Is the new City Plan for which the Chicago Plan Commission has been working for years going to result in an individual style of municipal architecture to be found nowhere else in America? Is Chicago, the original home of the modern "skyscraper", destined to have its skyline changed? Are beauty and utility to go hand in hand in the new scheme? It would seem so.

The transformation, if it may be so described, has begun along the lake front—Michigan Boulevard—with the completion of the Field Museum, a structure which with its immediate environs represents an investment of probably \$12,000,000. Recently, when the city council passed an ordinance providing for the proposed lake front parkway improvement to cost \$160,000,000, it was stipulated that the new railway passenger station of the Illinois Central and Michigan Central railroads must conform in architectural design and finish to the museum building which will occupy the site nearby. As one architect expressed it, architectural harmony would not permit the station to "swear at the Museum."

Then the South Park Commissioners, who exercise jurisdiction over Chicago's famous Grant Park, decided to construct an immense Stadium south of the station and museum buildings and in order to harmonize this group the same adaptation of Grecian lines was ordered carried out. This stadium will in future years become the center of Chicago's municipal playground, where athletic events will be held and where it is hoped the international Olympic games will be staged in the not distant future.

But this is only one phase of the enormous municipal improvements under way. Connecting the lake front development there is now being completed a system of parkways to reach out into the western section, passing through the business section, which already is beginning to reflect the new idea of city planning. And within a few blocks of the Grant Park group is Chicago's new Union Station, now being built at a cost of more than \$65,000,000. This station, together with the recently built Northwestern Railroad Station, and the proposed new Post Office Building, to cover the two blocks between, form another group harmonizing in their architectural lines with the lake front group. Again, no "swearing" is to be permitted between these two groups.

Within the last few weeks there has crystallized along the North Shore of Chicago's lake front, along an extension of the Michigan Avenue parking, a definite program on the part of the property owners to censor the character of buildings to be erected in that section in order that the architectural harmony of the entire lake front may not be destroyed. In this program the architects interested in the Chicago Plan have agreed, with the result that the

entire north side, from the "loop" to the Lake Shore Drive, is to be built up in the future with a definite idea in view—to preserve the architectural beauty of Chicago's lake front and future skyline.

The present program is to take into consideration the present Municipal Pier as a part of the scheme—as has always been in the minds of members of the Chicago Plan Commission. What the ultimate result of the present tendency will be; whether it will actually bring about a distinctive Chicago architecture in the broad sense, is, of course, a matter of conjecture. Yet there are architects of vision here who see this probability.

In the meantime, the city is working forward in its zoning scheme on a broad plan, this zoning to fit in the general plan for a more beautiful as well as efficient city.

---

### Architects Ask House Investigation

In view of the continued shortage of housing accommodations throughout the country President Wilson's Industrial Conference has been asked to make a thorough investigation of the situation. Declaring that in New York City alone more than 30,000 new dwelling places are immediately required, the American Institute of Architects has called attention to the crisis in a letter to all members of Congress. The Institute says in part:

"The causes for this condition are no doubt many and various. They relate to the war, to the cost of buildings, to wages, rents, land and building speculations, and, incidentally, to the whole fabric of our industrial system. The house and home are an indissoluble part of the national fabric. They cannot be isolated and studied as detached symptoms. They must be considered as a part of the whole problem, and we believe the Government of the United States should at once take steps toward making a complete and impartial investigation into the problem of adequate shelter for its increasing population."

---

### Artificial Daylight Practically Achieved by New British Invention

A light has been perfected in Great Britain which is understood far to surpass any existing arrangement of artificial light, and to be the closest approximation to actual daylight ever accomplished.

The apparatus consists of a high-power electric light bulb, fitted with a cup-shaped opaque reflector, the silvered inner side of which reflects the light against a parasol-shaped screen placed above the light. The screen is lined with small patches of different colors, arranged according to a formula worked out empirically by Mr. Sheringham,

the inventor, and carefully tested and perfected in the optical engineering department of the Imperial College of Science and Technology.

The light thrown down from the screen is said to show colors almost as well as in full daylight. A test was made with such articles as colored woods, Chinese enamels, pastels and color prints, each being subjected successively to daylight, ordinary electric light and the new Sheringham light. Under the new light delicate yellows were quite distinct, indigo blues were blue, cobalts had their full value, and violets lost the reddish shade which they display in electric light.

## New York Society of Architects Meets

The monthly meeting of the above organization took place on Tuesday, January 20th, at the Society's headquarters, United Engineering Societies Building, 29 West 39th Street, New York City, President James Riely Gordon in the chair. There was a good attendance of members. The matter of the formation of a Junior League in affiliation with the Society, which has been under consideration for some time past, was discussed and it was finally decided to have a conference with other architectural organizations regarding the Union of Draftsmen. A committee of five members was appointed to represent the Society.

The bill giving the Board of Appeals power to subpoena witnesses was then discussed. Opposition to this bill in its present form developed and it was finally ordered that the Senate Cities Committee be notified that the Society is opposed to the bill and desires public hearing on the same.

## Belgium to Erect Workmen's Homes

The Belgian Government has decided to allocate \$20,000,000 in 1920 for building workmen's houses. This money will be loaned to the local authorities on approved building societies at 2 per cent for 20 years, at the end of which time a new loan will be entered into.

The conditions are that no loan may exceed half the cost of the building, or a maximum of \$1,200, and the rent charge must not amount to more than 4 per cent of the total cost of building.

It is officially calculated that the cost of building in the devastated areas will be about \$2,000 a house. A garden city of 100 houses at Roulers has been begun.

## Americans to Donate Marne Statue to France

In commemoration of the victorious stand of the French on the River Marne in 1914, a colossal stone statue, one of the largest of the world's sculptures, will be placed there by American children, according to plans announced recently by Thomas W. Lamont, of J. P. Morgan & Co., Chairman of a committee of representative Americans who have the project in hand.

The exact location of the statue has not been determined, but it will be at a spot near the little town of Meaux, which formed the high-water mark of the German advance in 1914. Marshal Joffre and Marshal Foch will fix upon the exact location. The erection of the memorial has received the official sanction of the French Government.

Frederick MacMonnies has been selected as the sculptor.

It is expected the monument will cost \$250,000, which will be raised by a free-will offering of citizens in all parts of the country.

## Craftsmen Form School

As an educational extension of its work, the National Society of Craftsmen has established at 535 Lexington Avenue, New York City, "The School of Craftsmen," under the direction of Mr. C. Scapecchi. The prospectus of the new school, written by Mr. Scapecchi, explains the interesting educational idea in back of the school:

"In olden times when the Arts and Crafts were more appreciated and Art manifestations were a result of love for beauty and aesthetic conception was intense and multi-form, Schools of Art were unknown.

"The craft's master in his own bottega was the teacher of his own discipoli to whom he was prodigal of advice and instruction, thoroughly preparing his pupils for their vocational craft. Drawing, as well as practical work, materials and proper tools were at the disposal of future craft's masters and each one felt himself free to develop his individuality. This was the way to form and build the real artist or craftsman in the old days; and when the National Society of Craftsmen decided to start an educational extension to be called The School of Craftsmen, and bestowed upon me the great honor of being chairman, they conceived the idea to run the School on a practical system of instruction.

"Voluntarily a group of distinguished craftsmen of wide experience joined in the pleasant attempt to materialize the idea and in this prospectus book every one of them is given the definition of their craft related with the Industry. Though the world's war has brought sorrow and sadness to the various nations engaged, it has revealed to us many useful things of which America should take advantage. It is almost the duty of this country to prepare its own artists and craftsmen and to create artistic taste where it is not. It is very commendable to have placement offices, but it is of a more tangible success if you prepare the students to face the situation created for them by the newly acquired position. Because there is a step, a big one, between the Art School and the manufacturers' need.

"The creation of a practical school is imperative; the students should know the secret of how to do well and build their own artistic education through a period of apprenticeship as in the case of our school, and such a gradual education would be accomplished with the frequency of courses.

"Schools like ours will create in the near future a new form of institution. The Factory School, the ideal institute where the students of limited financial resources can obtain instruction on their vocational craft and acquire the practical knowledge while they would be self-supporting. It is a dream of the future, but I wish this country would build many Factory Schools so as to be able to meet the need of architects, decorators and manufacturers. Too much energy and power are dissipated to-day and are working apart, therefore the beauty of an idea sometimes gets lost or is not generally appreciated."

C. SCAPECCHI,

*Chairman of the School of Craftsmen.*

Among the patrons and patronesses of the new school are the following: Mrs. John W. Alexander, Mr. John Quincy Adams, Mr. Arthur S. Allen, Mrs. Herman B. Baruch, Mrs. Charles W. Cooper, Mrs. Cleveland H. Dodge, Mrs. Wm. Henry Fox, Mr. Francesco Paola Finochiaro, Mrs. Charles Dana Gibson, Dr. James P. Haney,

Mr. William Laurel Harris, Mrs. Ripley Hitchcock, Miss Susan Johnson, Mr. Frederic W. Keough, Mr. E. N. Khouri, Mrs. Charles R. Lamb, Mrs. Philip Lydig, Mrs. Howard Mansfield, Mrs. Henry Mottet, Mrs. Walter Scott Perry, Mrs. Mary Hall Page, Mrs. Charles P. Richards, Mr. Eric K. Rossiter, Dr. W. L. Russell, Mrs. Henry Watrous, Mrs. M. C. Ripley Weisse, and Miss Irene Weir.

## Washington State Architects Seek Uniform Building Code Legislation

Members of the Washington State Society of Architects at their January meeting went on record in favor of a state law creating a commission to draft a state building code to standardize the requirements for the respective classes of buildings.

Edgar Blair, Julius A. Zittel and Harry H. James were appointed to serve on a committee to prepare a draft of the act proposed and to take the matter up at the next session of the Legislature.

Standardization and simplification of the building laws in the larger cities of the state would be desirable, the architects declare, as present city building codes vary widely. There also is a need, they say, for a building code for the smaller cities of the state which could be made to reduce their fire risk.

## Modern Home Equipment for Australia

Following a recommendation of a new working standard for domestic servants and the consideration of conditions which tend to make domestic service in Australia distasteful, a largely attended meeting of women in the Sydney Town Hall a short time ago, decided to appeal to the Institute of Architects for more attention, in the designing of homes and flat buildings, to the domestic working side of them. One speaker declared that if she had her way she would make every architect serve six months in a kitchen before he was deemed competent to plan that department of a house. There is widespread interest here in the labor and space-saving features lately developed in the planning and building of homes and apartments in the United States; first of all, in the design—the arrangement of rooms; the special attention paid to the needs of the housewife, her comfort and ease; then the planning of built-in closets, sideboards, kitchen and bath cabinets, wall-beds, etc., which not only save space and provide many conveniences, but render unnecessary the purchase of considerable furniture.

Sydney officials have received numerous inquiries from Australian property owners for information concerning the design and construction of American homes and apartments and their interior labor and space-saving arrangement, and would be glad to hear from American architects, builders and manufacturers of household fittings willing to forward descriptive matter for distribution. Lists of architects, plumbers and builders of Sydney (copies of which may be obtained from the Bureau of Foreign and Domestic Commerce or its district and co-operative offices upon referring to FE—23002, FE—23003, FE—23004, respectively) are transmitted in order to make it possible for American designers and manufacturers of labor-saving household appliances to get in direct touch with them and possibly work out a comprehensive plan of co-operation whereby the introduction of these fittings might be increased.

## Reorganization of Indiana Limestone Quarrymen's Association

The Indiana Limestone Quarrymen's Association, with headquarters at Bedford, Indiana, in anticipation of a year of unprecedented building, has recently been reorganized and expanded with a view to increasing its facilities for serving the architectural profession.

The Association maintains a staff of field representatives who, unhampered by the bias of salesmen, are able to render valuable help in the solution of problems connected with their industry.

## French Art Passes to Other Lands

As the result of the ruinous rate of exchange France is being robbed to a frightful extent of her art treasures.

Rich foreigners, especially Americans, Spanish, Argentinians and Brazilians, are said to be flocking to Paris, changing their native currency into French francs, doubling their original amount as a consequence, and then buying up everything that is available in an art and antique line. The cost to them is of course just half what it would be were the rates of exchange normal.

Paintings, statuary, old engravings, rare books, Sevres vases, and in fact just about everything in the art line that France considers a "heritage of French civilization," is rapidly becoming an acquisition by some civilization that did not produce it.

While in many instances the state is given the opportunity to buy these things before they pass into the hands of foreigners, France has too many war debts on her hand at the present time to think of buying art treasures.

## Why "Walls Have Ears."

"Walls have ears," the cautious say. This expression originated with a courtier of the days when Marie Medici sat upon the throne of France, writes a correspondent. The queen was a suspicious woman and the troublous times in which she lived probably made her more apprehensive than she otherwise would have been. Her fear of the plots and plotters led to installation in the Louvre of a system somewhat like our modern dictagraph. This consisted of numerous tubes running from one room to another, which were called "auriclares." These were supplemented by hollow passageways in which the queen or her agents might listen to a conversation beyond the wall. A writer of her time records that a follower of the court to whom he was talking one day in the Louvre suddenly halted and with finger to lips reminded him that "walls have ears."

## Tapestries Returned to Mantua

Mantua—famous for its Renaissance and for the part it played in the struggles between the dukes of Mantua and Gonzaga—has regained its celebrated tapestries, lost when the city was ceded to Austria.

Nine in number, done from paintings by Raphael and inspired by and illustrating the lives of St. Peter and St. Paul, these wonderful masterpieces of the tapestry-maker's art are so precious that a sonnet was dedicated by Eugisto Callides to Signora Antonia Carre-Lovenzini, who repaired them. The tapestries are now on exhibition in the galleries of the Ducal Palace, whence the

tapestries were taken. Since their return, the palace has become the scene of brisk battle between the critics, one faction declaring them to be out of harmony with the severity and coldness of the architectural setting, another holding that the neo-classicism of the palace gives the tapestries their best effectiveness as rich and vivid designs in color.

## Garden City for South London

A garden city near Grove Park railway station, costing about £4,320,000, is the joint proposal of the Deptford, Bermondsey, and Lewisham councils to meet the overcrowding in South London. They contemplate the acquisition of about 450 acres belonging to Lord Northbrook on the Bromley Road at Catford, and to put up 5,400 houses costing £800 each. It is estimated that the purchase of the land will mean an additional £250,000.

## Personals

H. Robert Diehl and Samuel N. Vance have opened offices in the Virginia Carolina Building, Norfolk, Va., for the practice of architecture and engineering under the firm name of Diehl & Vance. Mr. Diehl has been engaged in the practice of architecture in Norfolk for a number of years and Mr. Vance has been connected with the firm of Anderson & Christie, Engineers, Charlotte, N. C., for the past six years.

W. D. Tunstall and Millard F. Arrington have recently opened offices in the National Bank of Commerce Building, Norfolk, Va., for the practice of architecture and engineering under the firm name of Tunstall & Arrington.

Sharove, Friedman & Krieger, architects and engineers, have opened offices at 307 Berger Building, Pittsburgh, Pa., and desire catalogues and samples for building material corporations.

David A. Lown has severed connections with the firm of Schoepel & Hardy and has opened an architectural office at Room 218 Central Trust Building, San Antonio, Tex. Literature and samples from manufacturers are desired.

George W. Backhoff, George Elwood Jones and J. Frederick Cook announce the formation of a co-partnership for the general practice of architecture under the firm name of Backhoff, Jones & Cook, with offices in the Union Building, 9-15 Clinton street, Newark, N. J.

Frederick Law Olmsted received a medal from the American Society of Landscape Architects at its recent annual meeting at the Architectural League, 215 West Fifty seventh street. The award was in recognition of his services in city planning. Mr. Law was also re-elected president of the society for the ensuing year.

Scott & Prescott, architects, William O. Prescott, R. A., and David Cairns Scott, R.A., have announced their removal to a larger studio at 34 East Twenty-third street. During the war Scott & Prescott were architects for the Army Hospital for shell-shock patients, the Soldiers' and Sailors' Club of New York, the recreation building for the Navy Aviation Camp at Montauk Point, L. I., and the Navy Post Office.

Benton & Benton, of Wilson, North Carolina, have opened a new office at Richmond, Va., Room 606, Times Dispatch Building. L. T. Bengtson, in charge.

## News From Various Sources

Announced that world's greatest radio station, with aeriels swung upon eight 900 feet steel towers, was completed at Bordeaux by United States and will be in operation next Spring.

\* \* \*

The United States paid \$222,129,292 in pensions to 624,427 persons last year. The largest number of persons ever on the Federal pension roll was 999,446 in 1902 and the total amount paid to them was \$137,502,267.

\* \* \*

Senate, January 14, confirmed District of Columbia Rent Commission. Action of Senate turns over to Commission thousands of rent controversies between tenants and landlords for consideration and decision.

\* \* \*

Representatives of Negro race advocated before House Judiciary Committee, January 15, establishment of a separate State under protectorate of United States for segregation of Nation's Negro population.

\* \* \*

Senate, January 15, passed Water Power Development bill, different in some respects from measure adopted by House in July, but following in general way same bill that has been before Congress in one form or another for past ten years.

\* \* \*

Bureau of Memorial Buildings issued four bulletins in Community Buildings as War Memorials series. Titles: A Living Memorial; Existing Community Houses; Existing Public Auditoriums; Provisions for Art, Music and Drama in Memorial Buildings.

\* \* \*

H. L. Kerwin, Director of Conciliation, states that United States entered New Year with fewer pending industrial disputes than at any time during last three years, according to reports from Department's conciliators in the 35 great industrial centers of country.

\* \* \*

Charleston, W. Va., announces that housing conditions in and around that city have become so acute that a corporation, with a capital of \$500,000, has been formed by the Chambers of Commerce of Charleston and St. Albans to provide homes for 1,500 additional Federal employees.

\* \* \*

Senate, January 26, passed Kenyon Americanization bill, which would require all citizens of United States of 16 to 21 years of age, not mentally or physically disqualified, and all alien residents between ages of 16 and 45, who cannot speak, read or write English, to attend school not less than 200 hours a year.

\* \* \*

Office of Chief of Staff announces that second session of conference of Army Staff Officers, which is being held at Washington, met January 13, with Major General W. G. Haan presiding. A tentative detailed and comprehensive War Department plan for reserve officers' training camps was explained to assembled officers by specialist from War Plans Branch of General Staff.

\* \* \*

Associated Press announces from New York that all building records in territory north of the Ohio and east of the Missouri rivers will be broken in 1919, according to statistics made public, December 14, which shows that contracts totaling \$2,332,902,000 were awarded for 11 months ending December 1, 1919, or \$700,973,000 more than in the corresponding period last year, the previous high record.

# Weekly Review of Construction Field

Comment on General Conditions of Economics With Reports of Special Correspondents in Prominent Regional Centers

## Government Patronage

The dictum of ex-Secretary Glass upon the question of our governmental relation to the international financial situation has received the most serious attention not only in the almost bankrupt nations of Europe, whom some of our financiers believe were addressed somewhat too abruptly, but in this country as well. It is a statement which indicates a change in the tendency of affairs of a fundamental character. We, being the creditor nation, were forced to take the lead in the matter.

It is not an isolated opinion, but stands in harmony with Mr. Hoover's objection made months ago to our proposed extension of efforts for European relief. And almost simultaneously with Mr. Glass' statement that the Government must "get out of banking and trade," six national farmers' organizations have memorialized Congress: "the attempt to thwart natural economic laws by legislation is useless;" and with commendable enthusiasm they assert that there is nothing wrong with the country. Surely it is not one isolated view, nor is it limited to international credits.

The alternative of governmental support of individuals, of industries, of finance which has existed in Europe since the war and toward which we were drifting, is work. It was so stated by Mr. Hoover, by Mr. Glass and by the farmers. It will be so believed by every man whose common-sense has not become perverted by dreams of socialized Utopias.

With the withdrawal of government patronage, the phrase "more production" must become popularized and be put into practice. People generally may not look back over the past few years with a realization that this unproductive period in the army or navy was so much reduction of capital and of available supplies of material. They will, however (being led) set to work unanimously rebuilding that capital. This is the reconstruction of which we have talked.

There are objections to this tendency. There is an organized movement among speculators against the contraction of credit, which they associate with the Federal Banks' reduction of reserves. It is possible that the objections are well founded and that some very serious difficulties will be encountered before the present attempts of the Government to withdraw its support of the inflation have become accomplished.

The general direction, however, is clear: a reduction of governmental patronage and an increase in production. Whether the economies which accompany this deflation will be voluntary or enforced depends upon the adaptability of our national temperament. The speculators will surely be quick to adapt themselves and although there is at present a great uneasiness among manufacturers, they have the least to fear. The eventual result must be a stabilizing rather than reduction of prices and a more freely moving supply of manufactured material. Our neglected, our growing needs are far beyond their capacity to satisfy.

Governmental patronage of the building trade, if it is

to be escaped, will be avoided by a narrow margin; for there is nowadays among the public-spirited an enthusiasm for bulk housing ideas which is rapidly mounting to hysteria. The schemes and ideas cover acres of newspaper space and drip from the mouths of politicians.

No architect would deny the facts: that an adequate housing for our population is essential; none but has observed that the available space was falling far behind the increases in demand. It has also been easy to observe that those people who depend upon someone else to supply month by month their home with a roof had difficulty in finding one last Fall, or that those whose rents were advanced along with the prices of everything else have started a hue and cry for Government intervention, for legislation, and for municipal building programs.

These various substitutes for building are all on the way. They have not and doubtless will not have the slightest effect upon the space available for housing. The construction industry continues to build with as much speed as the supply of materials and the weather permit. So far as progress of building is concerned, it goes as fast as it may. There is nothing to be gained by stimulating it from behind or dragging it on. It is, in fact, most probable that with the political negation of the natural laws of supply and demand the work would not be permitted to follow its free course and would instead over-develop in some phase where the need is least urgent.

The worst effect of this public attitude and of the deflation is the possibility of a stoppage of industrial construction by the dominance of housing, hotel and apartment building. Considering the present inability of factories to keep abreast of the demands, this one-sided development would be most unfortunate when it hampered an increase of production.

At present, however, the difficult transportation situation still has a most powerful influence upon the production. Its effect has been so pervasive that months will elapse before it will be possible to eliminate consideration of this factor.

The steel mills, for example, are seriously hampered by lack of fuel. Tracing back a step farther: the coke ovens are being supplied with but from 30 to 40 per cent of the cars required. Coke is piled up as high as the plants themselves and banking of the ovens seems inevitable.

As the car shortage impedes the supplying of steel mills with raw materials, so does it impede the shipment of their output to the fabricators.

From the standpoint of the railroad officials, the outlook is not encouraging. The shortage is a fundamental one and to be overcome only by construction and rehabilitation of the rolling stock. Moreover, February is one of the hardest months on freight movement.

Therefore, although the manufacturers in every department of the building materials industry are making great efforts to relieve the present famine, it seems impossible to hope for any sudden change of the present situation or any great recessions of prices for months to come. Undoubtedly the increasing demands will keep pace with

## THE AMERICAN ARCHITECT

whatever may be accomplished in facilitating transportation and increasing supplies of materials.

(By Special Correspondence to THE AMERICAN ARCHITECT)

### SAN FRANCISCO:

With the lumber market on the incline and steel extremely difficult to get hold of, architects and builders in the Pacific Coast section are facing a material shortage which has been accentuated this year by the continuation of building through the winter months to a degree not experienced for many years.

The need for houses has resulted in a demand for materials which cannot be filled under present production conditions. From all the lumber yards in this vicinity come reports of under-supply with no indication of prices dropping until the let-up on orders comes and that is not expected for many months.

Brick manufacturers are in a similar position. With production practically ceased for the usual winter shut-down, it is said to be impossible to fill all orders, and it is admitted by more than one dealer in clay building materials that the situation promises to become really acute before the reopening of the plants this spring.

In regard to the steel question at the present time, it is stated by local firms that stock is badly depleted. Some sizes of construction steel cannot be secured here at all and the specifications of an order, of necessity, greatly influence both the price and the actual filling of it. Exporters find it very hard to place business and are discovering that the demand for steel can only be met by placing their orders far in advance—and then taking a chance on the orders being filled.

Architects report that their offices are full of plans and the consensus of opinion is that 1920 will carry as much or more building activity as the year previous.

Building commitments for this city are centered on new business buildings in the retail shopping and manufacturing districts and in dwellings of \$5,000 and up and homes costing \$15,000 to \$25,000. For some inexplicable reason the apartment house idea is dormant. Some of the jobbing trade ascribe it to the stringent so-called "rent hog" ordinance passed by the city council this winter in response to public clamor which requires all owners or agents to maintain a fixed degree of heat through the cold season on penalty of arrest, imprisonment or fine. There have been several prosecutions under this law.

Jobbers declare they cannot raise the price of brick and meet the situation, and are standing off of 7 cents each which they would require if quotations were to be advanced. The price of fire brick is \$60 at the warehouse, against \$45 in carload lots a year ago.

Reinforcing bars have advanced 15 cents per cwt on base price.

Prices of homes for sale are advancing rapidly. This has been brought about through the concession to probable rising costs of all building materials.

(By Special Correspondence to THE AMERICAN ARCHITECT)

SEATTLE:—The quotations on all building materials in this territory continue to ascend, but this fact does not seem to check the zeal of investors in contracting ahead for all items that enter into the season's projects.

The most serious aspect of the situation is the delay in arrival of materials from the East due to the car shortage and, as it is believed here, reactions from the steel strike. Lumber is higher, the mills accepting only the

higher grades of finishing stock which pay the largest profits. The coastwise water rates between California and Puget Sound, under which the Nevada plaster used so generally in this territory has been traveling, have been advanced 85 per cent in 60 days, compelling material corporations to use the all-rail routes. This is gradually stiffening quotations. Claybourn fire brick, imported in large quantities from British Columbia, is costing jobbers \$2.50 per 1000 more money than a week ago, and enquiries have now centered round Troy, Idaho, where a price differential can be secured.

There has been a slight easing off in the supply of cultivator steel which has been scarce through the last 30 days. Jobbers report their ability to resume quotations.

(By Special Correspondence to THE AMERICAN ARCHITECT)

### BIRMINGHAM:

Birmingham reports many new buildings projected. Among the number several apartment houses, a new hotel and half dozen store buildings. "The Dulion" Apartments, a seven-story fireproof building on the corner of Eleventh avenue and Twenty-first street South was commenced this week. The approximate cost of this building is \$300,000.00. It is also rumored that the Loew theatrical interests will build a new theater here this year, with a seating capacity of 2500. A contract for two mercantile houses was let to-day and it is claimed in real estate circles that many more are now under negotiation. The demand for business houses continues strong. It is stated upon reliable authority that large Eastern hotel operators are seriously considering Birmingham with a view of constructing a 600-room commercial hotel.

As spring approaches, many inquiries are made regarding home building and there seems a probability that this year will break all previous records for residence construction.

The price of building material shows no signs of immediate decline: in fact, it is believed that there will be further advance as the urgent need for buildings increases.

The output of lumber will have to be increased by southern mills if they are to meet the pressing demands of the country upon this source of supply. The labor question is materially affecting this situation, likewise the matter of transportation—car shortage being reported from many points. January weather conditions have seriously retarded logging operations. Many lumber sections are poorly provided with roads upon which logs can be hauled in bad weather. Extensive road building now planned for 1920 will relieve this trouble to some extent and permit the use of heavy trucks where now it is practically impossible to utilize them for that purpose.

(By Special Correspondence to THE AMERICAN ARCHITECT)

CHICAGO:—Architect Chas. Herrick Hammond, president of the Illinois Society of Architects, is predicting a serious condition in the building situation in the near future unless something is done to relieve the shortage in some lines of material as well as in labor. He points out that the shortage, particularly in glass and in steel sashes, has already caused delays in many of the improvements in the Chicago district. The lack of production, due to labor conditions and congestion in transportation, are the principal causes at this time. Mr. Hammond predicts that present high prices of materials will continue for at least two years longer.

# Department of Architectural Engineering

---

## Features of the Mechanical Equipment of the Wingdale, N. Y., Prison Buildings

LEWIS F. PILCHER, *New York State Architect*

By GEORGE B. NICHOLS\*

FOR a number of years the State of New York has had numerous commissions and departments studying the problem of the proper housing of State dependents, particularly that division housed in the State's prisons. The outcome of these studies has been the development of two State prisons, one being constructed at Wingdale, to be known as the Wingdale Prison, and the other to be a new prison at Sing Sing.

In the development of a State institution it has been found by experience that at least forty per cent of the total cost of the institution is required for the mechanical dependencies of said institution. In the majority of cases in institutional planning these items have been somewhat ignored, making it necessary, during the life of the institution, completely to remodel the system installed, and never having a completely balanced unit. This is particularly noticeable in the central heating plants in most of the State institutions, the original design for which was not adapted for the final institution, making it necessary from time to time completely to remodel the central plant as the institution increased in size.

For the past six years the State Architect, Lewis F. Pilcher, has required that his Engineering Department accumulate such data as was available in all of the State institutions so that in the planning of Wingdale Prison this data would be utilized, and the institutional mechanical equipment would, as nearly as possible, meet the wants for which each particular item was to be installed. It is believed that the buildings now under construction will fulfill these requirements to a great extent.

In the selection of the site for any institution one of the first problems that arises, which should be thoroughly investigated before the purchase of

land, is that the site has available a suitable and sufficient water supply and that the sewage from the institution can be discharged into certain creeks or rivers without detriment to the surrounding communities, and that no objections or injunctions will be raised by surrounding property owners. It has been found in a large number of cases that objections by property owners have raised sentiment to such a pitch that it was impracticable to proceed with the development of an institution.

At Wingdale these two points were carefully considered by the State Health Department and by numerous experts employed by the State. The water supply is to be taken from impounded water held back by a large dam to be constructed on the upper portion of the property, from whence the water will be delivered to mechanical water filters at the site of the dam, and from thence the water will be piped to the institution, delivering to same by gravity. The sewage from the institution will be delivered to a trunk sewer which will lead to a sewage disposal plant consisting of screen chambers, Imhoff settling tanks, sand filters and chlorinating apparatus, from whence the purified effluent will be discharged into a nearby creek on the property.

The base of the design has been planned for an ultimate population of fifteen hundred prisoners, although the equipment at the present time is for a much smaller number. In the heating of an institution of this size there still appears to be a considerable difference of opinion existing regarding individual, isolated heating plants and centralized heating plants. It may be possible to find certain institutions with moderately sized groups, heated from a group central plant, where each boiler plant is of sufficient size so that fairly economical operation may be maintained. These cases, however, rarely, if ever, exist, as these small isolated

\* Chief Engineer, N. Y. State Department of Architecture.

## THE AMERICAN ARCHITECT

plants are unable carefully to study the problem of combustion, etc., so as to produce a high efficiency. It is also unwarranted to stokerize such boilers on account of their size, thereby eliminating in most cases the use of soft coal on account of its objectionable smoke with hand firing; so that in practically all cases the boiler plant efficiency, obtained from a number of isolated plants, is far below one centralized heating plant under the direction of one high class engineer.

The amount of labor, also, can be materially reduced by one centralized heating and lighting plant, and all waste of steam can be brought to a minimum. It is also possible, in prison construction, by having a centralized plant, to have all of the operating labor done by inmates with the exception of one chief engineer and an assistant on each watch.

In the location of a power house the same should be situated in close proximity to the railroad so that the coal can be delivered as nearly as possible to the firing space in front of the boilers. The plant should also be located as nearly central to the group of buildings as practicable, making it possible to radiate from same to all of the groups by the shortest heating lines. Quite often in centralized plants the location of the power house has to be varied from the above position on account of the architectural surroundings.

In the heating of institutions a large amount of discussion has been carried on over a period of ten years, in respect to the proper heating medium for group heating, whether the same shall be by steam (either gravity or vacuum) or by forced hot water.

After going over all of the literature and various plants installed throughout this country and abroad, the writer is convinced that any one of the above heating mediums or methods can be successfully undertaken at any institution.

There are certain groupings of buildings and methods of administration which have a material bearing upon which system should be selected. The main point to decide is which system is the cheapest to operate during the life of the institution, including yearly charges on original cost, maintenance and yearly depreciation. One of the main considerations in central heating is that the system must be as simple as possible, and if a steam system is selected, all traps and moving mechanism must be accessible, positive in their operation and easily inspected.

Each of these systems has developed a certain number of advocates, and the writer is surprised to note the various arguments and discussions advanced, a large number of which are not based on

actual operating facts and fundamental, established values. Any statement made that all types of institutions can be heated more successfully by one system alone is incorrect.

After going over the entire lay-out of the prison at Wingdale it appeared, on account of certain fundamental designs and conditions of administration, that a vacuum system of heating was preferable for Wingdale Prison. It would, however, have been possible to have heated this institution successfully by forced hot water, but the selection in system can only be arrived at after a careful balance of all the factors surrounding the institution in question.

There is one point that the writer wishes to bring out in favor of a hot water system which is that the deterioration of the piping system is undoubtedly a minimum on account of the same water being kept continuously in the piping, thereby reducing to a minimum the amount of activity of the water on the inner surface of the piping system. This, it is found, is a large factor in the up-keep of various institutional plants, as it appears that steam piping systems have to be renewed in a large number of localities at least once in about thirty years, and in a great many cases the return steam lines in a shorter period. This, of course, is dependent on the character of the water encountered and its activity, and the amount of make up water required to take care of the losses in the institution. In a majority of steam systems it is found that the amount of make up water is surprisingly large. The writer believes, however, that if the institutions throughout the State would study this phase of the work more, these losses could be materially reduced, thereby prolonging the life of their heating distribution systems and equipment, and also reducing the annual coal consumption.

The central heating and lighting plant for Wingdale Prison consists of two main rooms, namely, a boiler room and an engine and pump room. In the boiler room are located four 150 hp. return tubular boilers with reserve space for two additional boilers of equal capacity, the present boilers being furnished by the Ames Iron Works.

Various opinions have been raised regarding the type of boilers which should be installed. Of course, no hard and fast rule can be set, but in general central heating plants should consist of at least four units. If, therefore, the plant is less than 1000 total hp. it would make the units approximately 250 hp. each, and this is a small sized boiler to adopt for the water tube type. This would have a tendency, therefore, for plants under 1000 total hp. to have boilers of the fire tube type. Plants of this kind are in general not warranted in install-



ing overhead coal bunkers and coal and ash conveyors, as with the moderate amount of coal used and with sufficient prison labor the coal and ash can be handled direct from wheelbarrows or four-wheel coal cars with side dump. There is, however, considerable to be said regarding the installation of simple, mechanical stokers, even in plants of

prisoners operating the plant can be completely under the control and observation of the engineer or guard. Two additional small rooms were provided, one for general storage of supplies, and an engineer's office for the keeping of all records, etc. In the engine room provision has been made for the installation of four direct connected A.

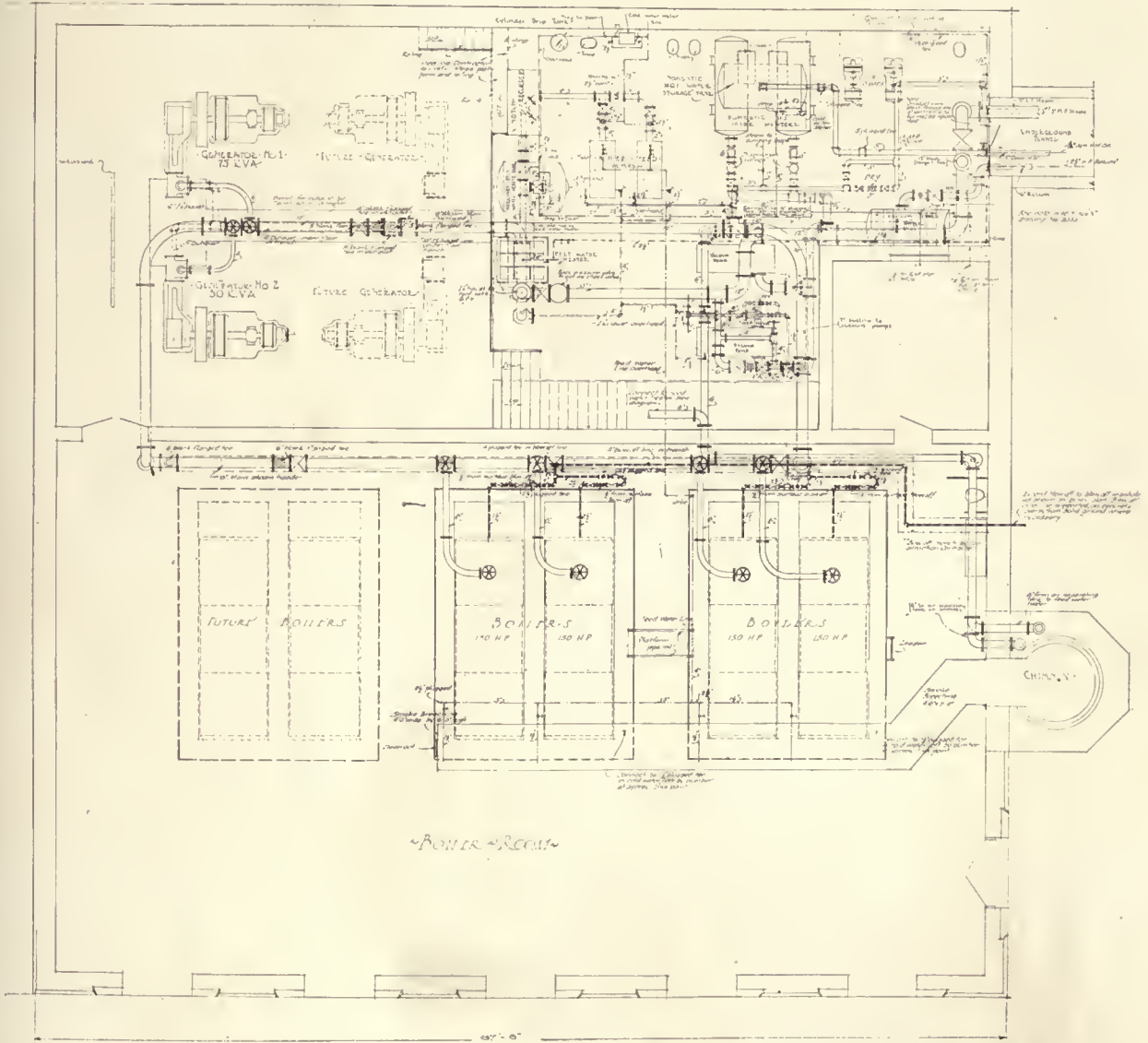

PLAN—CENTRAL HEATING AND LIGHTING PLANT, WINGDALE PRISON, NEW YORK, SHOWING LAYOUT OF MECHANICAL EQUIPMENT. NOTE UNDERGROUND TUNNEL FOR STEAM AND DOMESTIC HOT WATER MAINS

this size, with plenty of labor, so as to reduce the smoke nuisance and make the boilers as efficient as possible. In this plant, however, no stokers have been provided at the present time. Undoubtedly these will be installed at some future date.

The engine and pump room, for prison work, should be combined in one large room so that all

C. 2,300 volt 3-phase engine-driven generating units with direct connected exciters, together with main switch board. At the present time two generators, one being 50 K. V. A. and the other 75 K. V. A., are being installed, space being provided for two future units of equal capacity, the units being arranged with cylinder heads facing

each other, thereby making a large open space in the center for the desk of the operating engineer.

In the pump room are located the boiler feed pumps, open feed water heater, vacuum heating pumps, auxiliary feed water tank, vacuum return tank, with numerous traps, etc. All of the feed

water to the boilers will be delivered through a V notch meter indicating the flow and also provided with a recording mechanism so that the total amount of water fed to the boilers for any period can be determined, making it possible to definitely know each day the amount of water evaporated per pound of coal, or the efficiency of the plant.

So as to fully utilize the exhaust steam from the engines during the summer and to properly control the temperature from one central point, a central hot water heating system was installed in the pump room with distributing mains to the various buildings for domestic hot water service, thereby placing same directly under the control of the chief engineer. This plant consists of two domestic hot water heaters, water tube type, each with a capacity of 5000 gallons per hour, together with a storage tank of 700 gallons. From the storage tank the domestic hot water is supplied to the buildings, from each of which is a small return circulating line, the circulation being kept up by two motor-driven centrifugal pumps located in the pump room.

From the power house there is installed, underground, in tile conduit the following service lines: one low pressure heating main to utilize the exhaust steam from the engines; one vacuum return line; one medium pressure steam main for cooking and sterilizing purposes, which will be run at approximately 40 pounds; one medium pressure return line; one domestic hot water line and one domestic circulating line. Sufficient expansion chambers are installed along the above lines. At each building the domestic hot water and circulating lines are cross connected, and no circulating line is run inside the building as it is believed that there will be sufficient draw to keep the domestic hot water warm up to the fixtures without undue waste.

At this prison two types of cell blocks are being built, one known as an Interlocking Building, in which there are day and dormitory rooms on each floor with a certain number of outside cells. The day and dormitory rooms are to be heated by direct radiators and also to be furnished with forced ventilation. The outside cells are to be heated by forced hot air rising through vertical ducts and distributed in a horizontal air duct in front of the cells, with openings above each cell door. This has the advantage of eliminating all radiators in the cells, and also provides a good circulation of air.

The inside cell block building is heated by direct radiators located along the outside walls and at the level of the lower tier of cells. From each cell, however, there is a vertical tile duct leading to a horizontal exhaust duct running the length of the attic, which duct is connected to a motor-driven

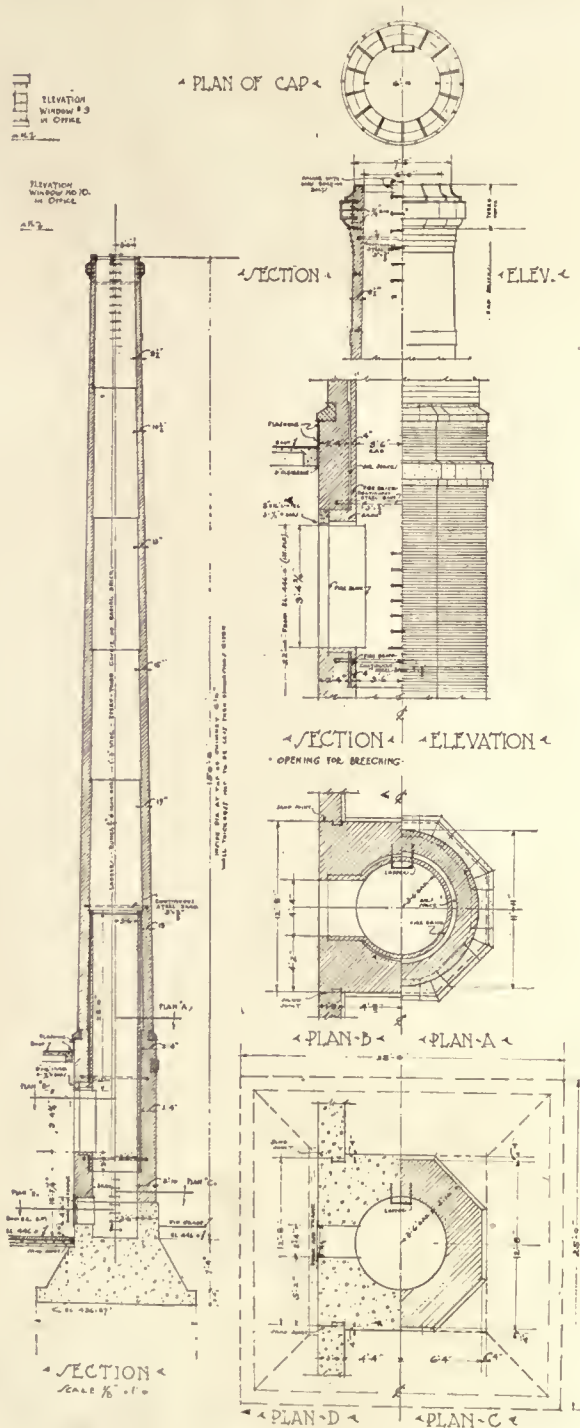

CHIMNEY DETAILS—CENTRAL HEATING AND LIGHTING PLANT, WINGDALE PRISON, NEW YORK

# THE AMERICAN ARCHITECT

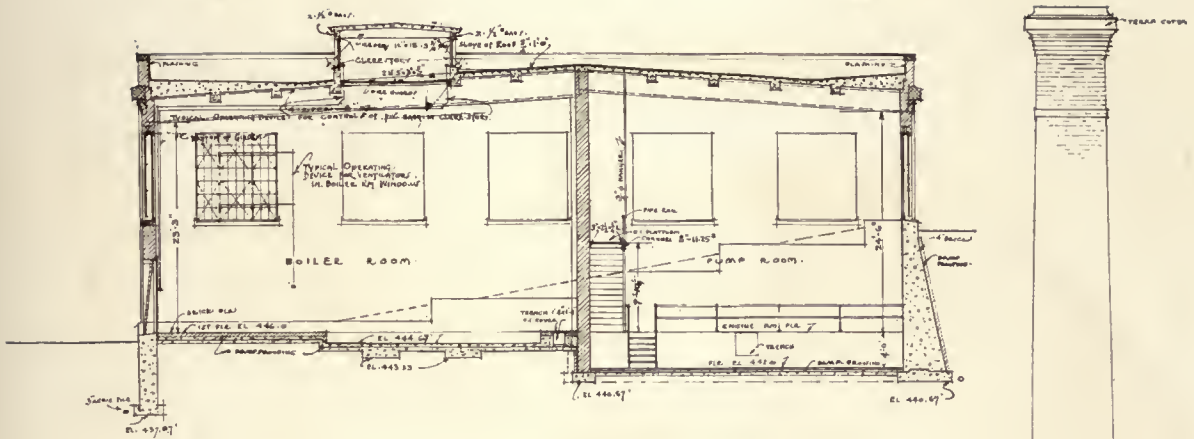

SECTION THRU BOILER & PUMP RMS. <

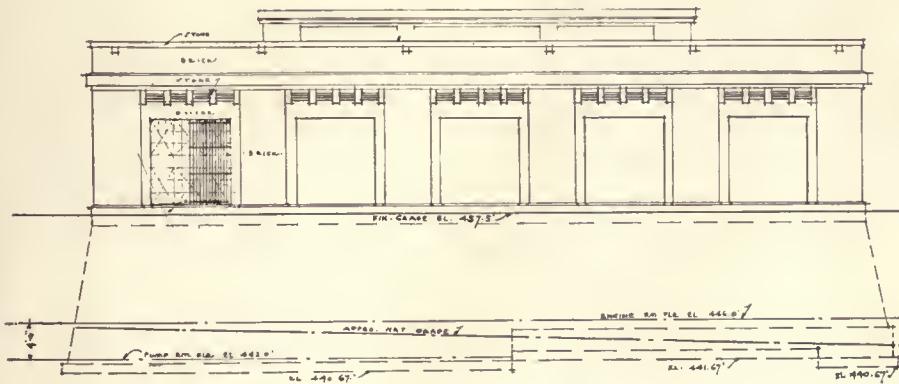

< EAST ~ DEAR ~ ELEVATION <

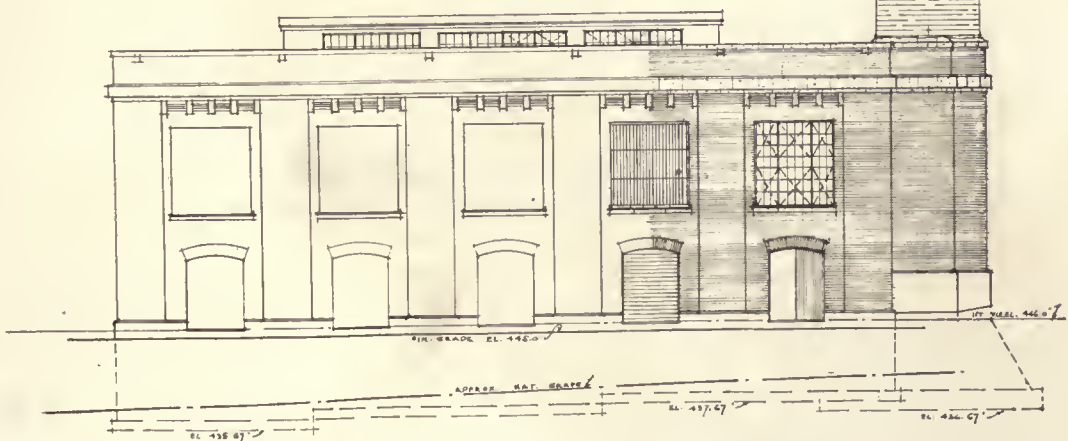

< WEST ~ FRONT ~ ELEVATION <

CENTRAL HEATING AND LIGHTING PLANT, WINGDALE PRISON, NEW YORK  
LEWIS F. PILCHER, NEW YORK STATE ARCHITECT

# THE AMERICAN ARCHITECT

exhaust fan, thereby drawing fresh air from the space in front of the cell through the cell door into the cell, and exhausting from the cell in the above-mentioned flue. It can, therefore, be seen that the amount of air entering each cell is directly under the control of the employees of the prison.

One of the unique features in the sanitary work

building will be supplied with the usual toilet and locker rooms. In the basement of the interlocking building and cell block building are large shower rooms, tile walls, with sufficient shower heads running along two sides of the room, each side being controlled by a mixing valve under the direct control of the guard and near the entrance door.

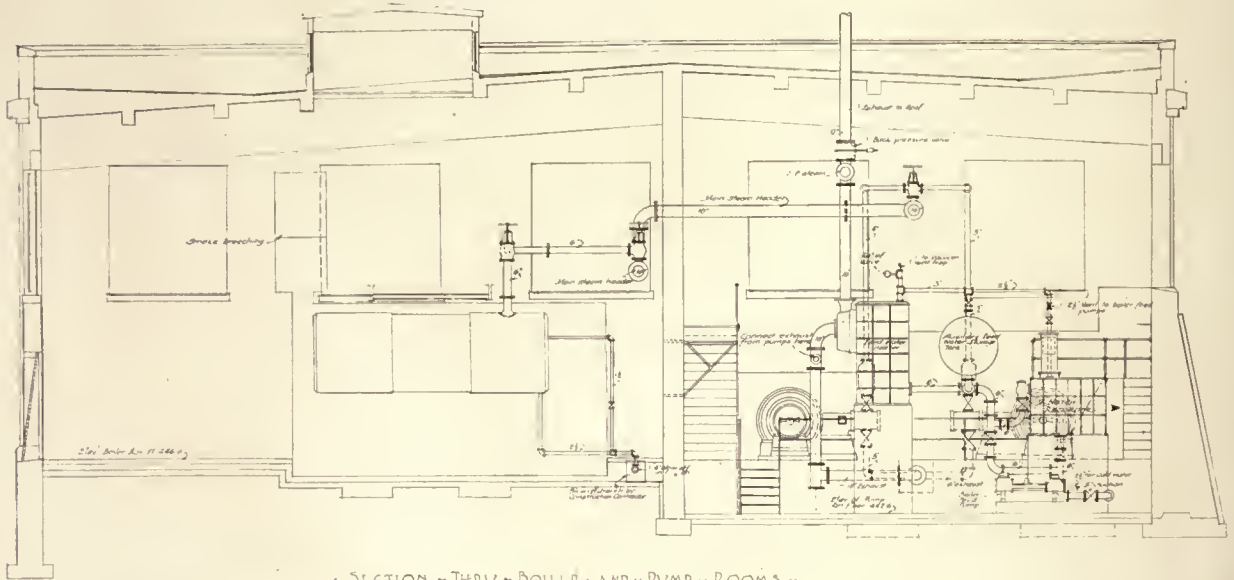

SECTION - THRU - BOILER - AND - PUMP - ROOMS -  
SCALE 3/4" = 1'-0"

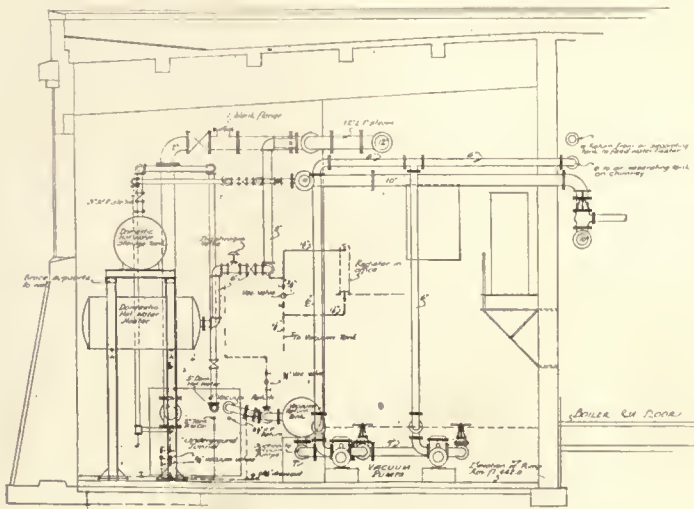

SECTION - THRU - PUMP - ROOM -  
SCALE 3/4" = 1'-0"

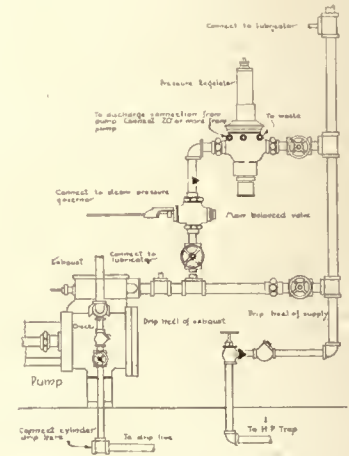

DETAIL OF SPEED - AND - PRESSURE - REGULATOR

## SECTIONS—CENTRAL HEATING AND LIGHTING PLANT—WINGDALE PRISON, NEW YORK

and conforming with modern practice is that each cell is provided with a separate toilet and lavatory with push button valve control, the valves being located in a V-shaped pipe chamber running vertically and located between adjacent cells so that one pipe riser serves two cells on each floor.

The day and dormitory rooms in the interlocking

Considerable discussion arose whether it was necessary to have partitions between the shower heads, and it was decided that this was not advantageous to the proper administration of a prison.

The mess hall has been provided with three refrigerating rooms cooled by an isolated refrigeration plant, motor driven, located in the basement,

## THE AMERICAN ARCHITECT

of sufficient capacity also to make a certain amount of cake ice.

All of the cooking will be done by steam as experience has demonstrated this to be the most satisfactory method in an institution of this nature.

The main feature to be considered in the mechanical installation of a prison is that all equipment used

Therefore, all mechanical equipment should be of the best.

While it is not possible in an article such as this to describe in any great detail the features entering into the design and installation of the mechanical equipment of all the various prison buildings, it is felt that the matter presented is sufficient to convey

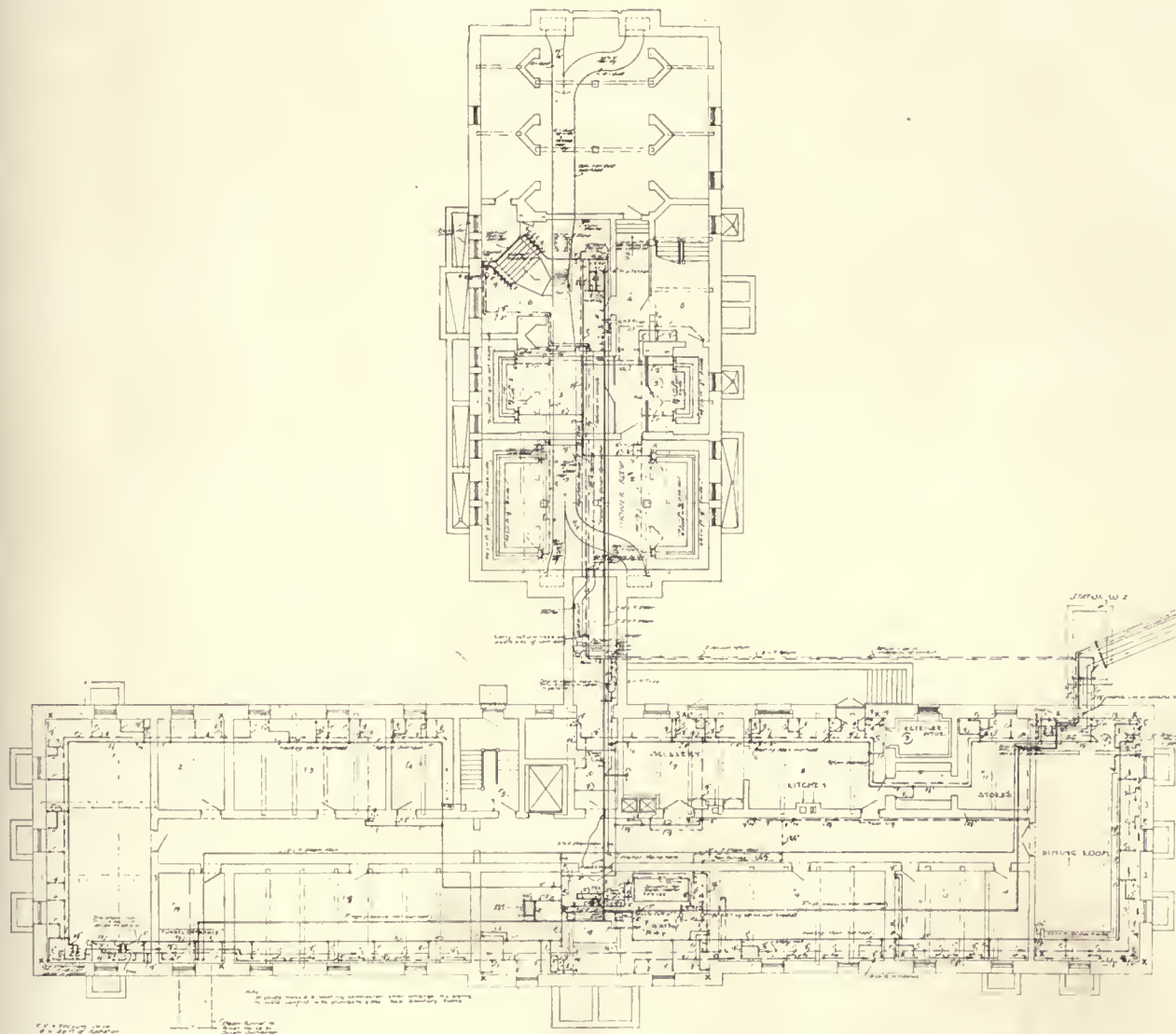

APPARATUS FLOOR—MECHANICAL EQUIPMENT, CLINIC BUILDING AND CELL BUILDING.  
ONE BLOWER TO FURNISH FRESH AIR FOR 82 CELLS

must be simple, rugged and long-lived. It should also be taken into consideration that this class of building is generally constructed for over a hundred years' service and there is no reason why the type now being erected should not last longer.

the salient points to be considered.

The drawings accompanying this article illustrate various phases of the heating, lighting and plumbing equipment of several of the buildings, and are worthy of careful study.

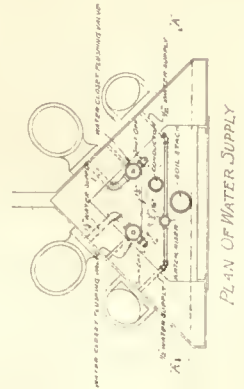
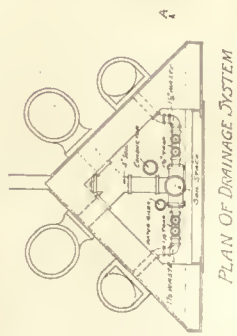
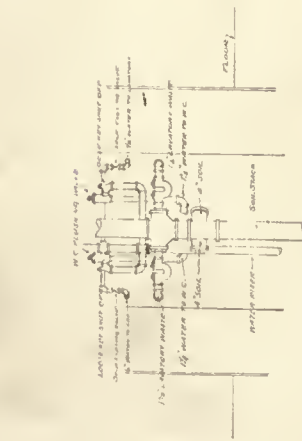
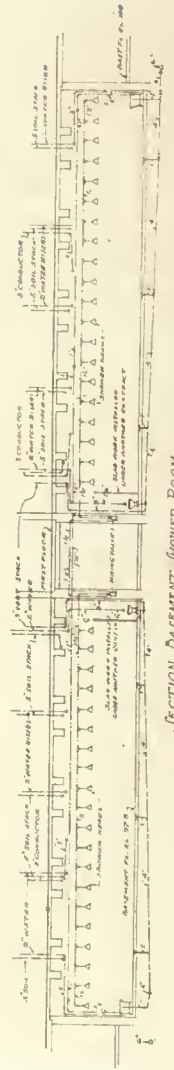
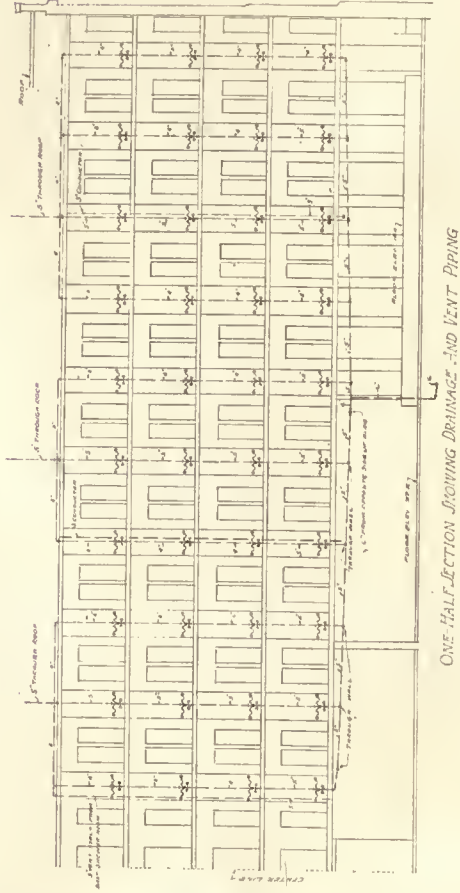
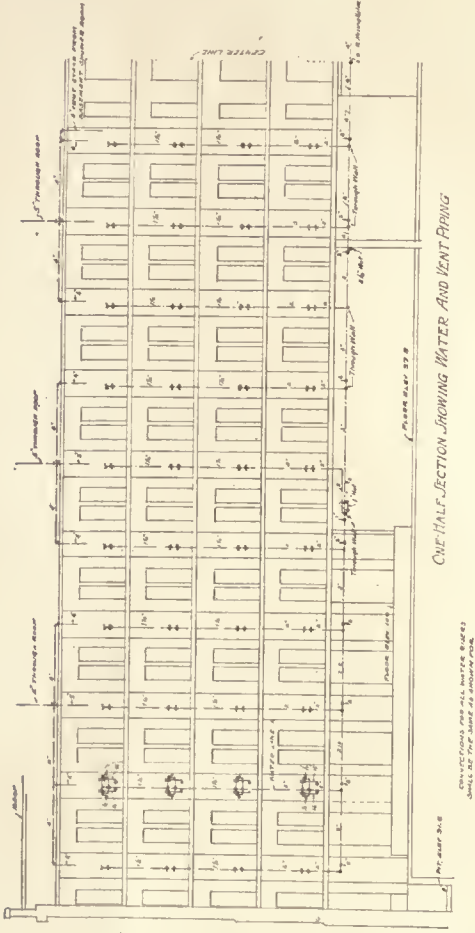
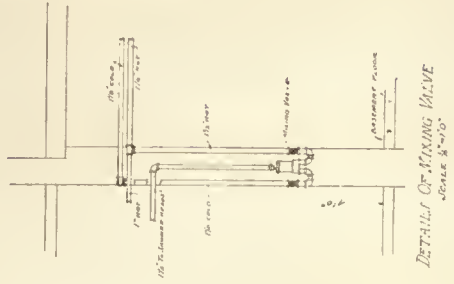
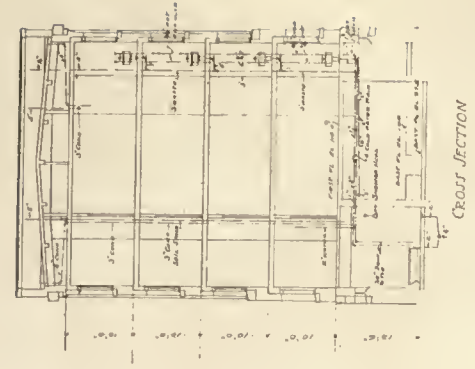

DETAILS OF ROUGHING IN FOR CELL FIXTURES

SCALE 3/4"=1'-0"

PLUMBING SECTIONS AND DETAILS—OUTSIDE CELL BUILDING, WINGDALE, NEW YORK  
SHOWING ALSO FACILITIES FOR BATHING, ON LOWER FLOOR, 40 INMATES AT A TIME  
LEWIS F. PILCHER, NEW YORK STATE ARCHITECT

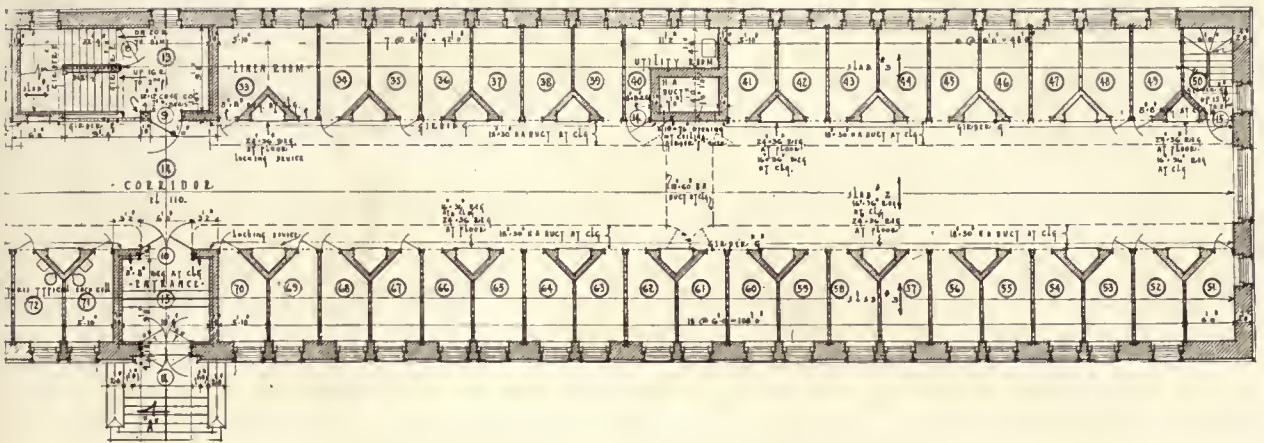

FIRST FLOOR PLAN—DETENTION BUILDING NO. 5

Showing detail of construction of cells. A reinforced concrete partition between each cell, brick exterior walls and brick pipe shaft wall. All windows are heavily barred.

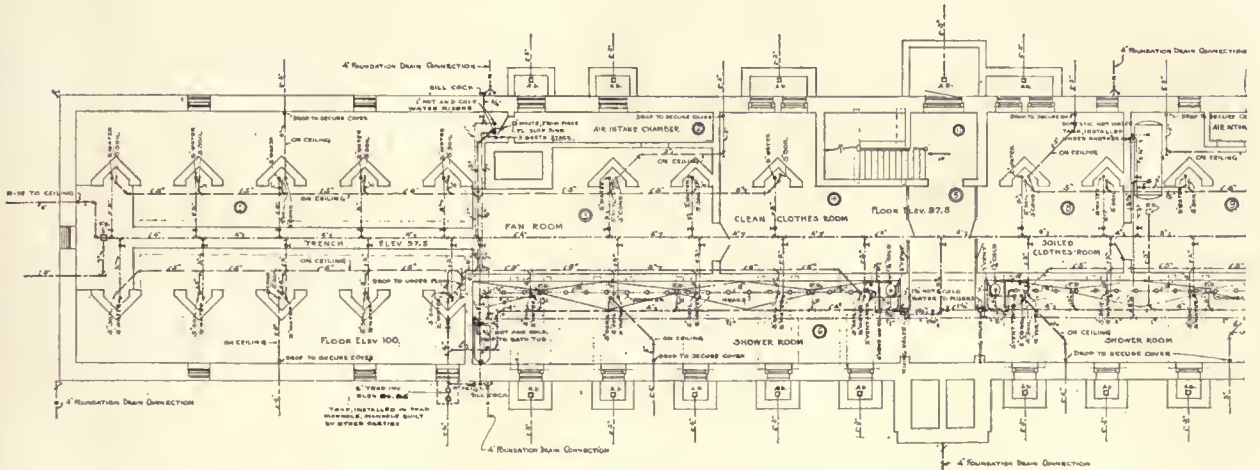

SERVICE SYSTEM OF PLUMBING PIPING—OUTSIDE CELL BUILDING

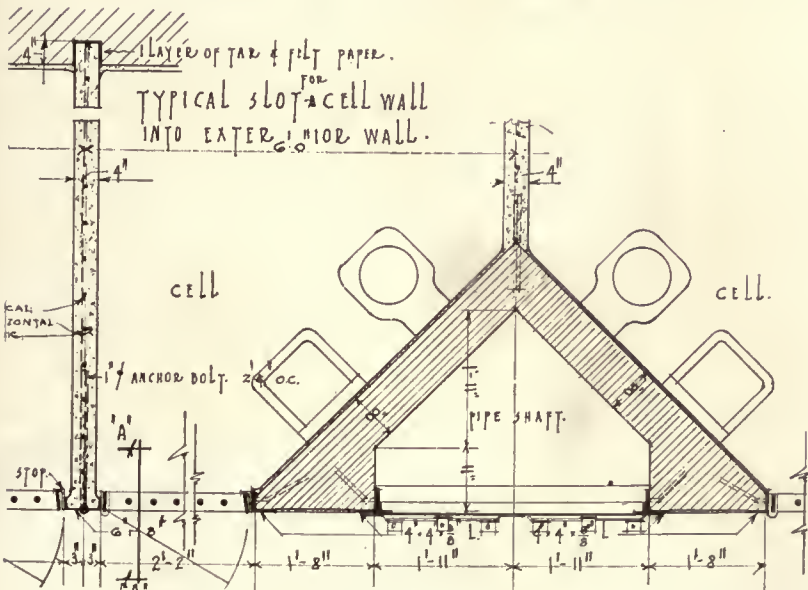

CELL PLUMBING FIXTURES—PIPING AND VALVES IN PIPE SHAFT ACCESSIBLE FROM CORRIDOR

PLANS AND DETAILS

PRISON BUILDINGS  
WINGDALE, NEW YORK

LEWIS F. PILCHER  
NEW YORK STATE ARCHITECT

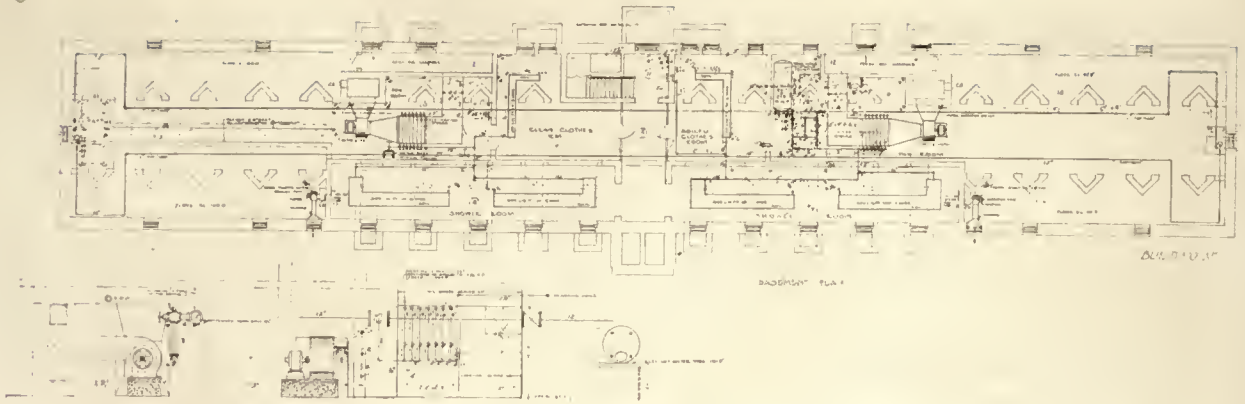

APPARATUS FLOOR—MECHANICAL EQUIPMENT, OUTSIDE CELL BUILDING  
TWO BLOWERS TO FURNISH FRESH AIR FOR 286 CELLS

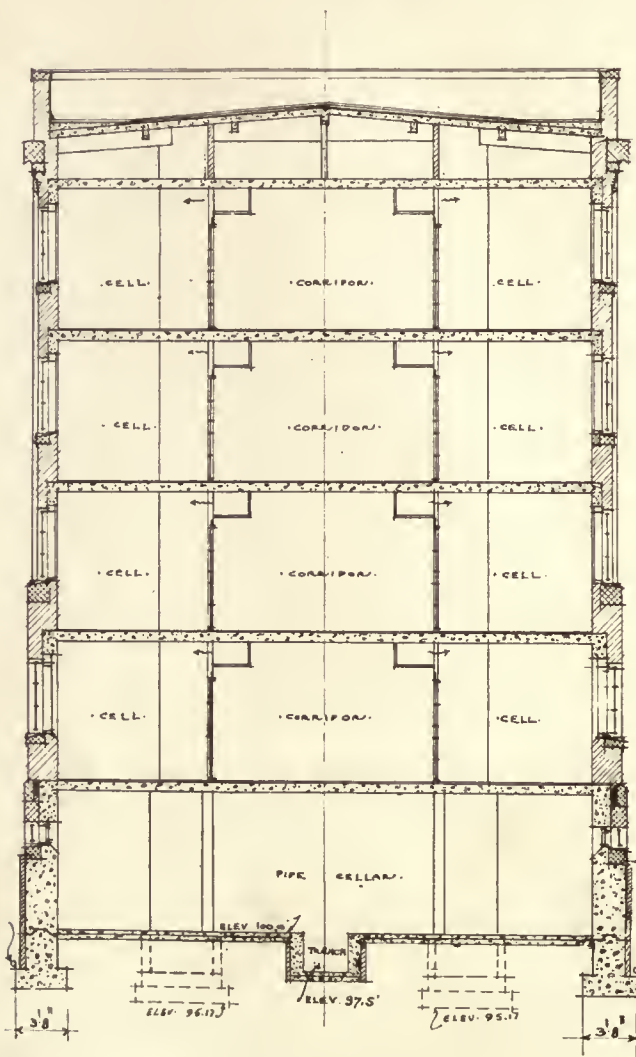

SECTION NO. 5  
OUTSIDE CELL BUILDING  
Fresh Air to Each Individual Cell

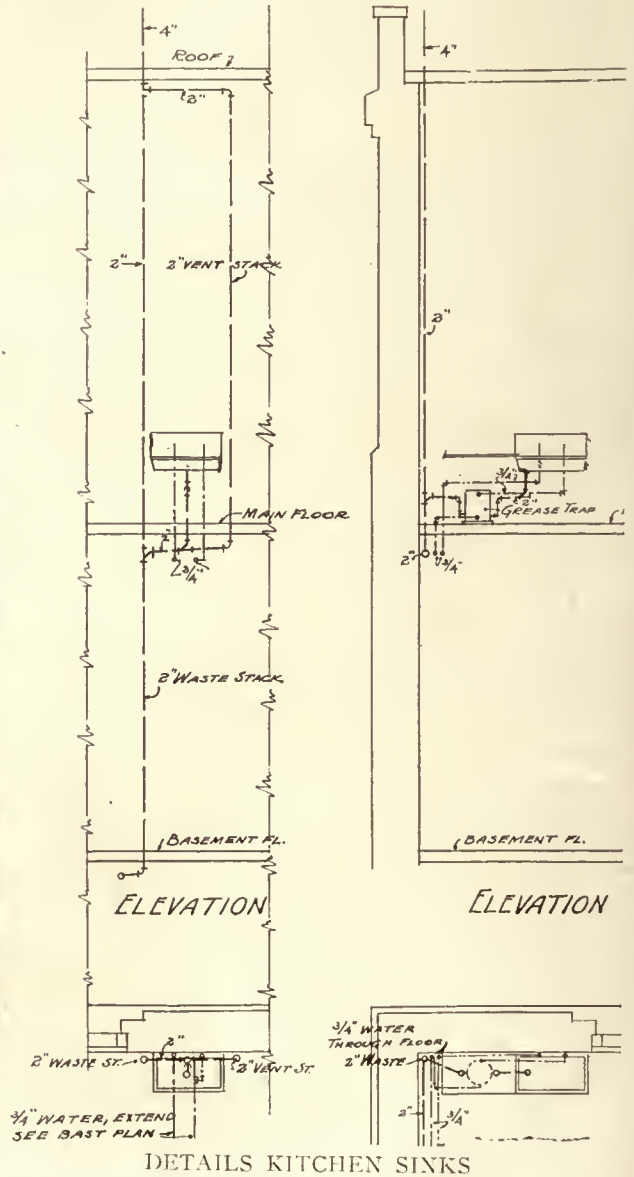

3/4" WATER, EXTEND  
SEE BASE PLAN

DETAILS KITCHEN SINKS

PRISON BUILDINGS, WINGDALE, NEW YORK  
LEWIS F. PILCHER, STATE ARCHITECT



✓  
66

John's price \$ 2300



PUERTA DE SANTIAGO, SEGOVIA

*THE AMERICAN ARCHITECT*

# THE AMERICAN ARCHITECT

VOL. CXVII

WEDNESDAY, JANUARY 21, 1920

NUMBER 2300



DETAIL, HOUSE OF MR. C. M. BROWN, GERMANTOWN, PHILADELPHIA, PA.

## The Ledge Stone House\*

By E. SIDNEY WILLS

MUCH has been written about the beauty and adaptability of the ledge rock of Philadelphia and vicinity and its influence upon architectural design in that locality, particularly in its relation to house building. This influence may be traced from the early Colonial days down to the present day, but perhaps the most clever handling of this material has been accomplished during the past ten years, as exhibited in the work of Duhring, Okie & Ziegler, E. B. Gilchrist, Mellor & Meigs, and Robert R. McGoodwin.

\*Illustrated by a group of houses at Germantown, Philadelphia, Pa., by Duhring, Okie & Ziegler, Architects, executed under the personal direction of Carl A. Ziegler.

Ralph Adams Cram, in an article on "The Promise of American House Building," says, "There may be those that find our official architecture artificial and verbose, our churches eclectic, reactionary and archæological, our schools either illiterate or damned by intensive (and offensive) efficiency, our municipal monsters, such as shops and hotels and office buildings, menaced on the one hand by the Scylla of anarchic individualism plus an intemperate logic, on the other by the Charybdis of inherited but unaccommodating 'orders'—I do not know. But if there are such, the picking and stealing fingers of criticism are withheld from the

## THE AMERICAN ARCHITECT

whole category of house building." This statement is particularly applicable to house building in Philadelphia, and much of the beauty of these houses may be attributed to the successful use of the long, flat, micaceous stone which is found in stratified

greatly influenced by this fact. I can recall the statement made by one of the newspaper critics in writing of the League Exhibition in New York a few years ago, when he naively said that, "Duhring, Okie & Ziegler's houses are reminiscent of home."

The houses of Rufus W. Scott, Clarence M. Brown, and Robert M. Hogue show the ledge rock laid up in the Colonial manner, with wide, white pointing following the natural outline of the stones, so different from the thin, hard, white lines of "patent plaster," used by the operative builder in that vicinity, who with great ingenuity has devised a stock plan which, when painted white, is advertised as Colonial after the best traditions, and when stained a reddish brown, is a gem of the Elizabethan Period.

No attempt is made to give the stones in these houses a dressed level bed, but great care is used to have the stone laid horizontal with natural ends. The texture of the surface of the wall depends upon the ruggedness of the rock face, and the width, texture and color of the pointing. The photographs do not show the wonderful color effect of these walls. The blue vein of the rock is carefully avoided for face work, although it is a harder stone than the gray, and particularly adapted to foundation work. The face stone varies in color from a silvery gray showing a great deal of mica, to rich brownish tones caused by the cleaving of the rock along the seams, which gives a fine weathered effect. Mr.



CARVED DOOR  
HOUSE OF MR. JOHN D. McILHENNY

form close to the soil in that vicinity, and may be easily pried out with a crowbar or wedge in long, flat pieces.

It is quite common in Germantown to obtain sufficient stone from the cellar excavation to erect the entire building, which fact explains the very low cost of the many interesting houses in Germantown, where stone houses are less expensive to build than either brick or tile.

The houses illustrating this article are by Duhring, Okie & Ziegler, Architects, designed and erected under the personal direction of Carl A. Ziegler, whose home is in the center of the Germantown district, in close proximity to the houses shown and the quarries from which the stone was taken. It is an unusual privilege for an architect to live in such intimate connection with his work, where the quarrying of the material and the erection of the building is really one operation, and the homelike character of these houses was no doubt

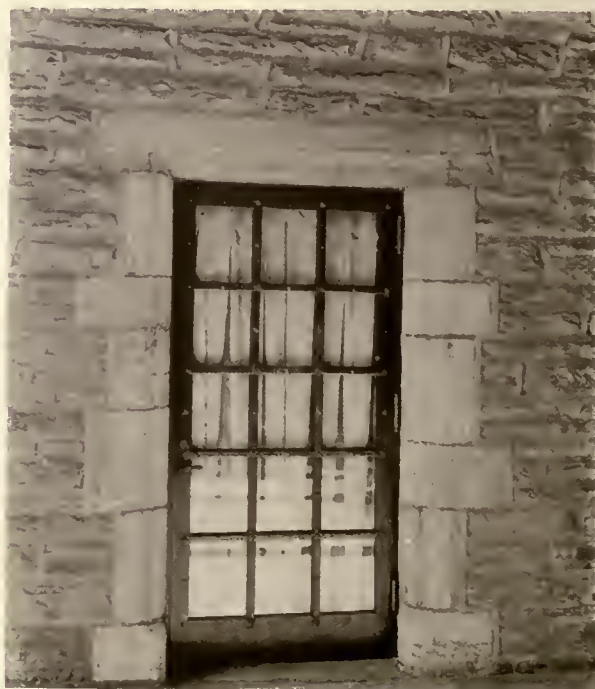

DETAIL OF DOORWAY  
HOUSE OF MR. JOHN D. McILHENNY



HOUSE OF MR. RUFUS W. SCOTT, GERMANTOWN, PHILADELPHIA, PA.  
WORK IN GERMANTOWN, PHILADELPHIA, PA., BY DUHRING, OKIE & ZIEGLER, ARCHITECTS  
EXECUTED UNDER THE PERSONAL DIRECTION OF CARL A. ZIEGLER

## THE AMERICAN ARCHITECT

Ziegler calls attention to the fact that the Italian masons who do most of the mason work in this vicinity soon acquire the ability to select proper color combinations, and show great interest in properly placing the large and small stones in the walls, which may seem a very simple matter, but in reality can only be done effectively by those having a true art sense, and a proper appreciation of the material they are using.

The detail of the house of Mr. Clarence M.

analyzing this house, and he suggested that I call it "Transitional," if it must have a name.

To my mind one of the most charming things about this house is the introduction of features quite foreign to the traditional Colonial forms. The pergola which serves as a dining terrace, recalls very delightfully the well known pergola of the Capuchini Convent at Amalfi; yet how well it fits into the picture! The walls of this house are laid up of rough stone, but with very little rock face.



DETAIL, HOUSE OF MR. C. M. BROWN, GERMANTOWN, PHILADELPHIA, PA.

Brown is a particularly fine example of the use of larger stones at the corners forming natural quoins, which tie the walls together in an informal and practical manner, and give the impression of stability and true craftsmanship so sadly lacking in most building structures to-day.

Much stone is being shipped from Germantown to other sections of the country, but the art of laying it up in this interesting manner is not yet generally understood.

In the house of Mr. Franklin Baker we have a very interesting example studied from the Dutch Colonial type. I asked Mr. Ziegler's assistance in

The joints between the stones are filled flush with a mortar made of screened Jersey gravel to give it a fairly rough texture, the whole is then given two coats of Government whitewash such as is used on our lighthouses, and after a year of weathering the walls have a texture very similar to some of the old walls about Naples. The addition of a few face stones here and there adds to the charm. What a contrast to the ordinary unimaginative stucco walls we see so much of!

I think the term, "Glorified Pennsylvania Farm-houses," describes this group of Colonial houses better than any phrase I can think of.

## THE AMERICAN ARCHITECT

In the English house of Mr. John D. McIlhenny we find the Germantown ledge stone put to another use. Here it supplants the limestone commonly used for cut stone in this vicinity. I have never seen another case of this stone being pierced, as

family life. The restraint exhibited in the designing of the interior is worthy of comment. It is seldom that the collection itself is permitted to form an architectural feature of the building, but it is evident in this house that the architect was principally interested in furnishing a background that would best harmonize with the objects that were not to be exhibited, but really to form a part of the building. What a contrast to the manner in which the craftsmanship of bygone years is exhibited in some of our Museums, where the classic lettering over the entrance would be more descriptive if it were spelt, "Morgue"! Art is not a dead issue, and it really requires very little imagination to hear the thud of the mallet, as we contemplate the craftsmanship exhibited in a vigorous bit of mediaeval sculpture where every tool mark stands out as clearly as in the day when, inspired by a religious devotion, the blow was struck.

It is to be hoped that Mr. McIlhenny's example may find many followers, and that we may find more specimens of truly great art brought into closer contact with our daily life. It is only through intimate contact with really fine art that we can comprehend its true message, which is to all people, and not by treating it as an exotic thing, to be taught in "finishing schools" for young ladies, as a subject for light conversation. It is a sad fact that one may finish a full college course in this country without



DETAIL OF CORNER OF RUG ROOM  
IN HOUSE OF MR. JOHN D. McILHENNY

shown on the stone balcony of this building. It required courage to use so soft and porous a stone for this purpose, and I understand the masons objected to making the attempt, but the result has amply justified the designer's faith in the material; for the soft, weathered effect of this balcony and the cut stone forming the heads and jambs of the doors and windows recalls the texture which we admire so much in the old mansions of England.

The building is a fireproof structure, and was designed to house Mr. McIlhenny's wonderful collection of pictures, furniture and rugs. It has been done in an informal manner, which is such a pleasant contrast to the usual "Art Gallery" attached to so many of our large American homes, where the treasures of art are treated as exotic things, and are not brought into intimate connection with the



XV CENTURY CAEN STONE MANTEL  
IN HOUSE OF MR. JOHN D. McILHENNY



VIEW IN RUG ROOM, LOOKING TOWARD TRAVERTINE STAIRWAY  
LEADING TO LIBRARY

HOUSE OF MR. JOHN D. McJHENNY, GERMANTOWN, PHILADELPHIA, PA.  
WORK IN GERMANTOWN, PHILADELPHIA, PA., BY DUHRING, OKIE & ZIEGLER, ARCHITECTS  
EXECUTED UNDER THE PERSONAL DIRECTION OF CARL A. ZIEGLER



VIEW IN RUG ROOM SHOWING OLD VERONA MARBLE  
DOORWAY AT END

HOUSE OF MR. JOHN D. McJHENNY, GERMANTOWN, PHILADELPHIA, PA.  
WORK IN GERMANTOWN, PHILADELPHIA, PA., BY DUHRING, OKIE & ZIEGLER, ARCHITECTS  
EXECUTED UNDER THE PERSONAL DIRECTION OF CARL A. ZIEGLER



## THE AMERICAN ARCHITECT

having devoted one hour to the study of Fine Arts.

It was not so in the early days of our history when our forefathers were face to face with the stern realities of life. Their problems were solved by straight thinking and hard work, and this fact is faithfully recorded in their architecture. From

the manuscripts of Washington and Jefferson and many less prominent men of the period we learn that the study of architecture and the kindred arts was part of the education of every intelligent man. As a result we fail to find examples of illiterate buildings recording the history of that period.



VIEW IN LIVING ROOM, LOOKING TOWARD RUG ROOM  
HOUSE OF JOHN D. McILHENNY, GERMANTOWN, PHILADELPHIA, PA.

# The Law as to Architectural Practice

## Construction of Contracts as to Amount of Architect's Compensation

By JOHN SIMPSON

**E**VEN where there is a definite written contract as to the amount to be paid an architect for his services, it does not follow that this is an absolute assurance against disputes and litigation on the subject, though there is no doubt that a written contract, properly drawn, is much preferable to allowing the matter of compensation to rest upon *quantum meruit* or the reasonable value of the architect's services. The present article is concerned solely with cases where the courts have been called upon to construe definite written contracts, for a specified compensation, usually on a percentage basis, where claims have been made and disputed as to what the wording of the contract, as apparently contemplated by the parties at the time of execution, includes. In such cases the cardinal rule is that the parties will be held strictly to the terms of their contract where that is clear and unambiguous. That disputes may arise upon contracts which are apparently clear and unambiguous, however, is well evidenced by a very recent case, where the contract stipulated for "a commission of 5 per cent. of the cost of the work," and no less than four disputed claims arose after completion of the work as to what these words included.

An architect wrote a bank as follows: "I propose and agree to furnish the plans, specifications, and detailed drawings necessary to erect your building, including supervision of the work, preparing of contracts, and the usual and customary services of an architect, for a commission of 5 per cent. upon the cost of the work, exclusive of the interior equipment of the vaults and wood furniture, rugs and draperies." This proposition was accepted by the bank, which made a contract for the erection of the building at a price of \$59,000, \$1,000 more than the architect estimated it would cost. This contract was prepared by the architect, and contained a clause providing that all questions in dispute should be determined by him. As the work proceeded changes were made in details. These changes required revised drawings, which were prepared by the architect as required. In this way the cost of the building was gradually increased until it amounted to \$114,880.87. The specifications, which were also prepared by the architect, contained this provision:

"All old material to become the property of the contractor, and may be used in the new work upon the approval of the architect." The architect was paid without question 5 per cent. on the total cost of the building. He sued to recover additional amounts as follows: First, a claim for services for preparing revised drawings; second, for services as an arbitrator under the clause in the contract requiring him, as an architect, to settle all disputes; third, an additional commission on the value of the material in the old building which was given the contractor to be used by him in the new building; fourth, a claim for compensation because there was delay in the construction of the new building, the original date fixed in the contract being February, 1914, when in fact the structure was not completed until October, 1914.

In affirming a judgment for the defendant, the Pennsylvania Supreme Court, *Osterling v. First National Bank* (1918), 105 Atl. 633, dealt with these items as follows:

As to the first item of the claim, the architect "proposed and agreed to furnish all necessary plans and specifications to erect the building." This was held to contemplate not only the plans which he had already prepared, but to include any and "all" plans which in the process of erection might be called for. As an architect he was doubtless familiar with the fact that most owners in the course of building make changes in both plans and specifications, and he was fairly to be presumed to have contemplated that when he stated that the cost would be \$58,000. If he regarded the work of preparing the drawings as work outside of the contract, he should not have accepted the percentage on the total cost, \$114,000. He could not claim both the percentage on the total cost and extra compensation for preparing the drawings, which increased the total cost, but he must be held to his contract, which was clearly expressed.

It was held that he was not entitled to extra compensation for his services as an arbitrator in a dispute between the owner and the contractor, as this was included in his contract obligation to perform "the usual and customary services of an architect."

The third item was also held dependent upon the

## THE AMERICAN ARCHITECT

contract, and not allowed. By a clause in the specifications the material in the old building became the property of the contractor, but leave was given to him to use it in the new building or so much of it as was suitable therefor under the architect's approval. The architect offered to prove that its value was \$25,000. When he made his offer he knew that the old material was in existence, and that it was to be used by the contractor. With this knowledge, in his own contract, he fixed his commission at 5 per cent of the "cost of the work." Obviously, the court said, neither he nor the bank contemplated a commission on an additional sum of \$25,000, nor did the value of the old building material enter into the calculation at all. If he had said that he was to be paid a commission on the cost of the work, plus the value of the old material, there would have been a basis for his claim.

The claim for compensation for delay was also held to be without merit. The contract under which he claimed fixed no time within which his services were to be completed. The building actually cost almost double the amount originally contemplated, and his commissions were correspondingly increased. "This," the court said, "was adequate compensation for the delay incident to the construction of the enlarged building, but this is not the reason for our refusal to allow his claim. He was not entitled to make it under the contract which he himself prepared."

Other cases in various jurisdictions illustrate this principle. Thus, a county employed a contractor to build a courthouse according to plans and specifications furnished by architects, the work to be completed December 15, 1884, the contract providing that any charges by the architects for supervising the work after the time for completion on account of the contractor's failure to complete should be deducted from the amount of the contract. The architects, familiar with the terms of this contract, agreed to superintend the work for \$700. The first contractor abandoned the work, and it was let to another. The second refused to insert the provision as to the completion by December 15, 1884, and the work was not completed until August, 1885. The architects sued the county to recover for extra services in superintending after December 15, 1884. It was held they could not recover, since their contract was without limit or conditions as to time, and all the county was obliged to do was to have the work done within a reasonable time. — *McDonald v. Whitley County* (1887), 8 Ky. L. Rep. 874.

A written offer was made to prepare plans and specifications of a building for 3 per cent on the total cost and supervise the construction for 1½ per cent. It was accepted in the following terms:

"Payments to be made on monthly estimates. Accepted, conditioned upon this agreement terminating in twenty-four months from June 1, 1896," to which the architect signified his agreement in writing. It was held that the agreement clearly contemplated payments each month of 3 per cent upon the estimated cost of each month's work, and the architect could not recover in the absence of any monthly estimates having been made, or of any fact entitling him to payment upon this construction of the contract. Of course, if the action of the owner in postponing the work until June 1, 1918, so as to avoid the contract, could be traced to bad faith, it is probable that such delay would found an action for damages for breach of the contract.

When the action began, the plaintiff had completed the plans and specifications. He relied upon a custom entitling architects, under contracts of this general nature, upon such completion, to 2 per cent of the total estimated cost of the work. It was held that evidence of such a custom was in direct conflict with the written agreement of the parties, and the latter must govern. As the contract was free from ambiguity, evidence of conversations preceding and accompanying its execution as to the time of payment analogous to the custom, was also held inadvisable.—*Davis v. New York Steam Co.* (1898), 33 N. Y. App. Div. 401.

A contract fixed the architect's compensation at 2½ per cent of the cost of the proposed courthouse building for the plans and specifications, and 2½ per cent additional for supervising the erection thereof, but provided that "should contract for building not be let," the architect was to receive "\$1,000 only for plans and specifications, same to be applied as part payment in the event of the building going ahead at some future time." The county afterwards completed a courthouse on other plans and specifications accepted after advertisement. It was held that the contract was clear and unambiguous and parol evidence was inadmissible to show that "the building" did not mean any courthouse building the county might afterwards erect, but only such as might be erected according to the plaintiff's plans and specifications, and the county was not liable in excess of the \$1,000.—*Gauntt v. Chehalis County* (1913), 72 Wash. 106, 129 Pac. 815.

A contract stipulated for 2½ per cent of the estimated contract price for the plans and specifications and 2½ per cent of the actual construction cost for supervision. It was held the architects were entitled to 5 per cent on work completed, plus 2½ per cent on buildings never constructed, but for which they furnished plans and specifications. — *Spencer v. New York* (1917), 179 N. Y. App. Div. 69, 166 N. Y. Supp. 177.

Where the evidence showed an express contract of employment as architect of a building for a specified percentage of the cost it was held that an additional charge for providing a superintendent for the work was unwarranted — *Espert v. Ahlschlager*, (1905), 117 Ill. App. 484.

The owner cannot read into the contract conditions which it does not contain. An architect was employed under an express contract to prepare plans and specifications for a building, which were accepted and submitted to contractors. The price was expressly agreed upon, and was to be 3½ per cent of the estimated cost, \$70,000. The lowest bid offered was \$69,800. The owner refused to build and also refused to pay the architect any compensation for his services, a defense that only 1¾ per cent was to be paid if the owner should not build, and that the plans were defective and discontinued to city ordinances were held not supported by the evidence and the architect was allowed to recover.—*Vaky v. Phelps* (Tex. 1917), 194 S.W. 601.

An early case, often cited, illustrating this principle is *Chicago v. Tilley* (1880), 103 U. S. 146. A city and a county made an agreement for the erection of a city hall for their joint use, whose general exterior design should be of uniform character and appearance, one half to be built by the city, at its own expense, and the other by the county. The county had previously appointed its own architect. The city appointed the plaintiff as its architect, and he prepared plans and specifications for the city's part of the building. These did not harmonize with the plans and specifications prepared by the county's architect, and the city refused to accept the plaintiff's services in supervising the erection of the building. The trial court held that he was entitled to compensation at the rate for which he was to do the whole work under the contract for drawing the plans and specifications and superintendence. On appeal the city claimed that the architect's contract was not only to prepare the necessary plans and specifications for the city's portion of the building, but to obtain the approval and adoption of his plans by the Board of County Commissioners. The Supreme Court of the United States held that this was not the meaning of the contract. The city could not reasonably expect any architect to give his time and labor in devising plans for a building on the condition that he was to receive no compensation unless he procured the assent to his plans of another body of fifteen persons, which had employed its own architect to devise plans for the same building. No prudent man would agree to such a contract. It seemed to the court reasonably clear from the contract itself, and the circumstances under which it was made, that the city took the risk

of securing the agreement of the county to some mutually acceptable plan.

The terms of the contract may be clear as to the commission to be paid, but there may be a dispute as to what amount it is to be computed upon. Letters constituting a contract showed clearly that the architect was to be paid 5 per cent on the total cost of materials and labor furnished for the construction of a tomb. The evidence showed that while the parties might have originally contemplated a \$70,000 tomb, they subsequently agreed on plans for a \$40,000 tomb, and the plans actually prepared and accepted were for a tomb not to exceed in cost \$40,000, the actual cost of the tomb as erected. It was held error to permit the architect to recover commissions for plans of a tomb which was to cost \$70,000. — *Osterling v. Carpenter* (1911), 230 Pa. 153, 79 Atl. 405.

An owner agreed to pay 2½ per cent upon the estimated cost of the buildings, but there was nothing in the contract to show what that was. It was held that estimated cost meant the reasonable cost of buildings erected in accordance with the plans and specifications, and not necessarily the amount of some actual estimate agreed upon by the parties, nor an estimate or bid accepted by the owner. Therefore, estimates and bids by builders, which the architect had obtained for the owner in pursuance of the contract, were admissible in evidence to show what the estimated cost was, although the bids had not been accepted. — *Lambert v. Sanford* (1887), 55 Conn. 437.

In an action by an architect to recover under a contract entitling him to a percentage on the cost of a building, expert evidence is admissible to show what the cost of such a building would be where the actual cost is capable of proof. *Israels v. Macdonald* (1907), 123 N. Y. App. Div. 63, 107 N. Y. Supp. 826.

If a contract is made to superintend the construction of a building for a specified lump sum, and the owner during the progress of the work makes changes requiring a longer time to complete the building than was originally contemplated, entailing extra work upon the superintendent, the latter can recover compensation therefor, though the owner acted in bona fide in making the changes. The superintendent need not, in such a case, give the owner notice that he expects additional compensation for such additional service. *Smith v. Bruyere* (Tex. 1912), 152 S. W. 813. So, where it would have taken only eight or nine months to perform the work as originally planned and specified, whereas it required eighteen to nineteen months because of alterations, reasonable compensation could be recovered for extra services in superintending the

building and additional improvements, if such extra services were not provided for by the superintendent's contract. — *Shear v. Bruyere* (Tex. 1916), 187 S. W. 243.

Similarly it was held in *Baker v. Pulitzer Pub. Co.* (1903), 103 Mo. App. 54, 77 S. W. 585, that where architects, in addition to the work which they had contracted to do for a fixed price, do other work for the owner, they may recover the reasonable value of such extra work, provided it was ordered by the owner to be done, or he had promised to pay for it.

But it appears that an architect would not be entitled to recover an additional percentage to the contract 5 per cent on a recovery had by the contractor against the owner for damages caused by a delay in the work whereby the contractor was obliged to pay an advanced price for materials, the delay entailing on the architect no extra expense, or damage.—*Boller v. New York* (1907), 117 N. Y. App. Div. 458, 102 N. Y. Supp. 729.

An order by an owner who changes his mind as to the kind of building he wants, necessitating entirely new plans, accepted by the architect, makes an entirely new contract, and both sets of plans must be paid for. An architect agreed in writing with an owner to make the plans and specifications for a proposed building and superintend its construction for a stipulated price. After accepting the plans and specifications made, the owner abandoned the idea of erecting the building in accordance therewith, and ordered the architect to make new plans for an entirely different structure, which he did. The accepted order for the second set of plans constituted a new contract which had no relation to the work done under the written contract, and the architect was entitled to compensation for the second set in addition to the price agreed upon in the written contract.—*Fitzgerald v. Walsh* (1900), 107 Wis. 92.—*Hand v. Agen* (1897), 96 Wis. 493. Such work cannot be said to be in the contemplation of the parties when the original contract was made. There was no meeting of minds on the subject. In such circumstances an implied promise arises to pay for the extra or independent work, in the absence of anything in the contract to the contrary.

On the same principle, where an architect employed to draw plans for a building, the cost of which will not exceed a specified sum, submits plans and specifications in compliance with the agreement, he cannot be deprived of his compensation by the owner's action in insisting upon various additions and embellishments not contemplated when the contract was entered into.—*Diboll v. Grunewald*, 7 La. Ann. 59 (Orleans, 1910).

An even stranger case illustrating this principle is the following: A contract by a county with an architect for plans and specifications for a courthouse and superintendence provided the cost should not exceed \$100,000, and if the bids should exceed that limit, or the county require changes of the plans or new plans, the architect should furnish these without additional expense. The contract provided the architect should receive 5 per cent of the actual cost of the completed building. The architect did prepare plans as contracted for, but after acceptance the county made changes requiring a building costing \$149,603. It was held that, though the contract was badly drawn, and apparently contained inconsistencies, the architect was entitled thereunder to his commission on the total cost of the building.—*Weatherbogg v. Board* (1901), 158 Ind. 14, 62 N. E. 477.

Changes made in the plans of a building so that it would contain more stores and produce a greater rental made at the request of the owners and after the contract for erection under the original plans had been entered into, are extras for which the architect may recover additional compensation.—*Johnson v. O'Neill* (1914), 181 Mich. 326.

ENTIRE AND SEVERAL CONTRACTS

A contract for architect's services may be several or entire. A party to an entire contract who has partly performed it and subsequently abandons the further performance according to its stipulations, voluntarily and without fault on the part of the other party or his consent thereto, can recover nothing for such part performance. Where an architect is employed to prepare plans and specifications for and to superintend the construction of a building at a compensation of 5 per cent of the contract price of the building, that is an entire contract, and if the architect afterwards sues, alleging only the drawing of the plans and specifications, without alleging any excuse for the failure to superintend the erection of the building, there can be no recovery.—*Spalding County v. Chamberlin* (1908), 130 Ga. 649, 61 S. E. 533.

But if, after such a breach of the contract by the architect, the owner not only retains the plans and specifications, but puts them to his own use, this is equivalent to an election to abide by the terms of the original contract, and he thereafter holds the plans under these terms. Even when work to be performed under an entire and indivisible contract has not been done according to its precise terms, still, if the service is received, and is of benefit to the owner, he is liable for the value of the service rendered, and the architect may recover such value in a suit on a *quantum meruit*.—*Collins v. Frazier* (Ga. 1919), 98 S. E. 188.

## THE AMERICAN ARCHITECT

An architect contracted with a board for plans and specifications of a building and its superintendence for "5 per cent on the cost of construction." He completed the plans and specifications and superintended the work until he was, legally, discharged. He was held entitled to recover the contract price for his plans and specifications and his services as superintendent up to the time of his discharge, and the value of his plans and specifications for that portion of the work which he did not superintend, on a *quantum meruit*. The contract afforded no data by which the relative value of the plans, etc., as distinguished from superintendence, could be ascertained. *Shipman v. State* (1877), 42 Wis. 377. In *Hand v. Agen*, *supra*, there was proof that where the total percentage contracted for was 4 per cent of the cost, the proportion applicable to preparation of plans, etc., was  $2\frac{1}{2}$  per cent.

Architects were employed by owners to prepare the plans, specifications, etc., and oversee the construction of a building in consideration of 4 per cent of the cost. The architects had reduced the terms negotiated for from 5 per cent to 4 per cent actuated by the fact that their employment was to extend to the interior decorations. When considerable work had been done under the contract, but little of it on the interior decorations, the owners wrote the architects they had concluded to do the interior decoration work themselves. Six weeks

later the architects ceased work. It was held they were not entitled to recover for work on the interior decorations during that six weeks, unless it was done by the owner's request. The contract was an entire contract. The owner could repudiate it in part, and order such part of the work not to be done. But in such case, the architects could either treat the repudiation of the part as a breach of the entire contract, and discontinue all work, or could waive the breach as to all other parts of the work not contained in the part repudiated, by continuing the work.—*De Prosse v. Royal Eagle, etc., Co.* (1902), 135 Cal. 408, 67 Pac. 502.

When a contract provides for separate items and the price is apportioned to each item, it is severable, and the architect may recover for one item, though he may not recover for other items. An example of such an agreement is the following: An agreement to furnish complete working drawings and specifications, and also to supervise the construction of the building, for a fee of 5 per cent of the cost thereof for all services as architects, providing that "one-fifth of this fee is payable upon the acceptance of the preliminary sketches, balance two-fifths additional upon the completion of the aforesaid working drawings and specifications, and the remaining two-fifths of the fee to be payable pro rata with the architect's certificates as issued."—*Audubon Bldg. Co. v. Andrews* (1911), 187 Fed. 254.

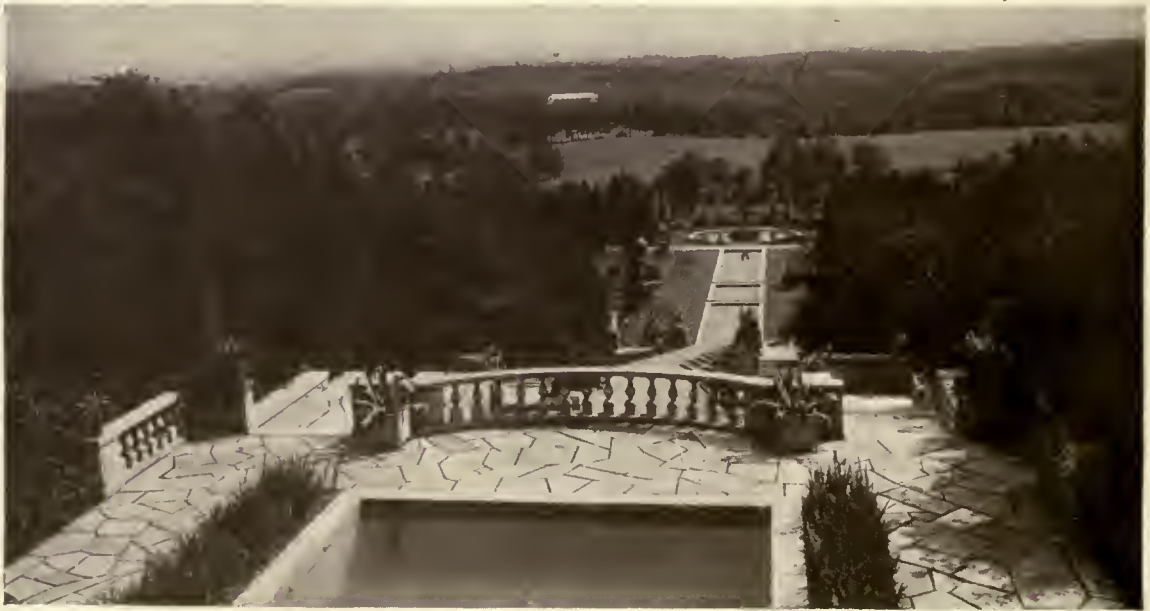

THE ROSE GARDEN, ESTATE OF CHARLES M. SCHWAB, LORETTO, PA.  
CHARLES WELLFORD LEAVITT, LANDSCAPE ARCHITECT



*In order to supply our readers with material of current interest, the news and comment appearing in issues of THE AMERICAN ARCHITECT delayed by the printers' strike will be as of actual rather than stated date of publication.*

## Americanizing the Plague Spots

THOSE who are interested in the better Americanization of our alien population will be gratified to learn that it is proposed to Americanize the oriental section in New York City, commonly known as Chinatown. This section, for a long time maintained a certain theatrical aspect and in many instances not historically correct, has been the Mecca for out of town visitors and a lucrative spot toward which the sight-seeing cars have taken thousands yearly. While its outward aspect has possessed a certain attractiveness, beneath the surface there is always to be found such squalor and depravity as to make Chinatown notorious in our criminal court records.

At last there arises a movement to "clean up" this section. Such work should not be confined to this special location. There are "ghettos" and "quarters" equally plague spots and where our own tongue is rarely spoken.

One thing the war has very thoroughly taught and that is the need of encouraging every movement seeking to better Americanization. We shall never be the solidly united people necessary to the formation of a great national spirit until all these locations in every city in the United States where aliens congregate and where the language and daily habits are but a transplantation from some foreign country, are cleaned and the broad light of our American ideals permitted to penetrate.

## A Plea for Originality

CAREFUL examination of the design submitted in recent important architectural competitions again suggest the query: Is architecture as practiced both an art and a business or is it entirely a business and have we been deluding ourselves and the public in claiming that art was an important attribute?

Those who successfully practice any art must originate and create the beautiful. This being true,

and undoubtedly it is, the copyist can never hope successfully to become an artist. In fact, the more he copies the further will he be from the attainment of artist rank.

In the many competitive architectural designs that have been submitted in recent important competitions, who could find any trace of originality except in plan, or more than a most indifferent appropriation of motives, which have been so many times and so poorly appropriated as to show the utmost disrespect for the classic original? This utter lack of originality is not new, there is no sudden decadence in original motive. The habit is as old as the history of competitions in this country and the record is indelibly stamped in the façades of most of the monumental buildings in the United States.

If architects are to be seriously taken as artists as well as business men they must comply with the simple test that all artists successfully pass. They must originate. They must show that they can stand alone, that they have passed the childish stage when with uncertain steps they pursued the way of their profession. We have a surfeit of classic precedent in this country.

IT would seem that we might at least expect to see some evidences of originality emanate from the offices of those who scorn to be classed as business men. Unfortunately, however, that is usually not the case.

There has been much talk as to a national type and it has been patriotically declared that we should produce one. No time has offered greater opportunities than the present for the practice of originality and the attainment of a national type.

Architects will say they can indulge in no luxury of leisure that would enable them to evolve a type, that clients are insistent for speed. So they are, but the commission that will later come, from what source no one may know, is not insistent for speed and an architect may cherish a day-dream even

## THE AMERICAN ARCHITECT

while engaged in hackneyed effort, evolving a motive that will be the child of his brain, an original creation, and a thing of beauty. That is what the salon is for.

Architecture is a business. It is also an art which will have to be practiced just as any other art. The profession cannot successfully claim that the art of architecture is the embodiment in modern buildings of elements of design that are exact replicas of classical examples. Architects must approach the same originality in conception of design as do the painter and the sculptor.

A recent program for a large competition was notable as it suggested the style of design that the competitors should follow. Such a program simply encourages a continuance of copying. Would it not be worth while to try the experiment of stating in a competition program that the jury will largely favor designs that show departure from precedent and are not at once indicative to the trained observer of any one of a dozen buildings scattered all over Europe, every detail of which was fully memorized by architectural students before graduation.

### A Mild Protest

THE writings of "Aero" in the department of Architectural Causerie in *The Architects' Journal* of London have many times been commended in these pages, and often quoted. The mature thought expressed, and a disposition to give credit to American architects and their work were noted with appreciation, and received with pleasure. But, just now we are disposed hesitatingly to reject the opinions of this man, especially when we read what is undoubtedly meant to describe an actual interview.

This is what "Aero" sets down:

"It was in Kingsway, three days ago, that I stood by the hoarding enclosing the Aldwych site, beyond which you may see the north front of Somerset House as drawn on the cover of the *Journal*. As I stood waiting for a friendly taxi-driver to carry me to Westminster a stranger approached and talked in a cheery manner. Needless to say, he was a New Yorker. 'You don't mind me speaking to you,' was his opening remark. 'I am a stranger to London; in fact, I am an American architect looking around at your old buildings.' 'This is indeed fortunate,' was my reply; 'I also take an interest in architecture, and just now I am wondering what kind of building it is that a fellow citizen of yours intends to place on this open site after the weeds have been destroyed.' 'Gee, you don't

say.' 'I do, and, furthermore, there is a rumor to the effect that this enterprising artist has been studying the noble building opposite, designed by Sir William Chambers, with a view to emulating the character and detail.'

"My acquaintance asked me to enlarge on the fact, which I did, pointing out how difficult it was for London architects to obtain commissions of this nature either in the metropolis or in any of the provincial towns, especially the latter, where opinion favors the employment of local talent. Further, I asked my chance friend, who seemed to be sympathetic, if New Yorkers would countenance a Briton building a replica of the old Town Hall in New York in proximity to the existing building. His reply was emphatic. 'There would be some talk before that took place; we just love you English, but we don't want you fooling around with your tarnation boxes of bricks in our land.' 'Those are my sentiments, exactly; we don't mind you Americans exploiting the very gentlemanly style our great-great-grandfathers took over to America, but when you come back here to set up a rival establishment outside the windows of what was the front of our first Royal Academy we feel tempted to ask Sir Oliver Lodge to communicate forthwith with the shade of the austere Sir William.' We exchanged cards, shook hands, and departed, my American friend to the Soane Museum and I to Tothill Street."

THE whole thing smacks of Martin Chuzzlewit. It is too reminiscent of Dickens, too far fetched in its phrasing to be exact. It is to be noted that "we (the writer and a certain American architect) exchanged cards, shook hands and departed." This would seem to put the stamp of actuality on the interview, but we are yet doubtful.

Does the American architect of to-day, traveling in England, use the vernacular of the poorly educated? Does he reply to an unusual statement, "Gee, you don't say?" Does he say "tarnation boxes of bricks," etc? We have lived among architects in this country for many years, we have intimately known them, but we have never experienced this sort of conversation, nor have we heard the word "tarnation" seriously used, except in books now almost out of print. We have found the architect in this country fully up to the high average of professionally bred men, and we are, therefore, led mildly yet firmly to protest against such misrepresentation of American architects as set down in this interview.





VIEW SHOWING KITCHEN WING

HOUSE OF MR. ROBERT M. HOGUE, GERMANTOWN, PHILADELPHIA, PA.  
 WORK IN GERMANTOWN, PHILADELPHIA, PA., BY DUHRING, OKIE & ZIEGLER, ARCHITECTS,  
 EXECUTED UNDER THE PERSONAL DIRECTION OF CARL A. ZIEGLER



80<sup>2</sup>



PLATE 17

TERRACE VIEW—GARAGE IN DISTANCE

HOUSE OF MR. ROBERT M. HOGUE, GERMANTOWN, PHILADELPHIA, PA.  
WORK IN GERMANTOWN, PHILADELPHIA, PA., BY DUHRING, OKIE & ZIEGLER, ARCHITECTS  
EXECUTED UNDER THE PERSONAL DIRECTION OF CARL A. ZIEGLER





PLATE 18

STAIRWAY

HOUSE OF MR. ROBERT M. HOGUE, GERMANTOWN, PHILADELPHIA, PA.  
WORK IN GERMANTOWN, PHILADELPHIA, PA., BY DUHRING, OKIE & ZIEGLER, ARCHITECTS  
EXECUTED UNDER THE PERSONAL DIRECTION OF CARL A. ZIEGLER



80<sup>f</sup>



RECEPTION ROOM



DINING ROOM

PLATE 19

HOUSE OF MR. ROBERT M. HOGUE, GERMANTOWN, PHILADELPHIA, PA.  
 WORK IN GERMANTOWN, PHILADELPHIA, PA., BY DUHRING, OKIE & ZIEGLER, ARCHITECTS  
 EXECUTED UNDER THE PERSONAL DIRECTION OF CARL A. ZIEGLER





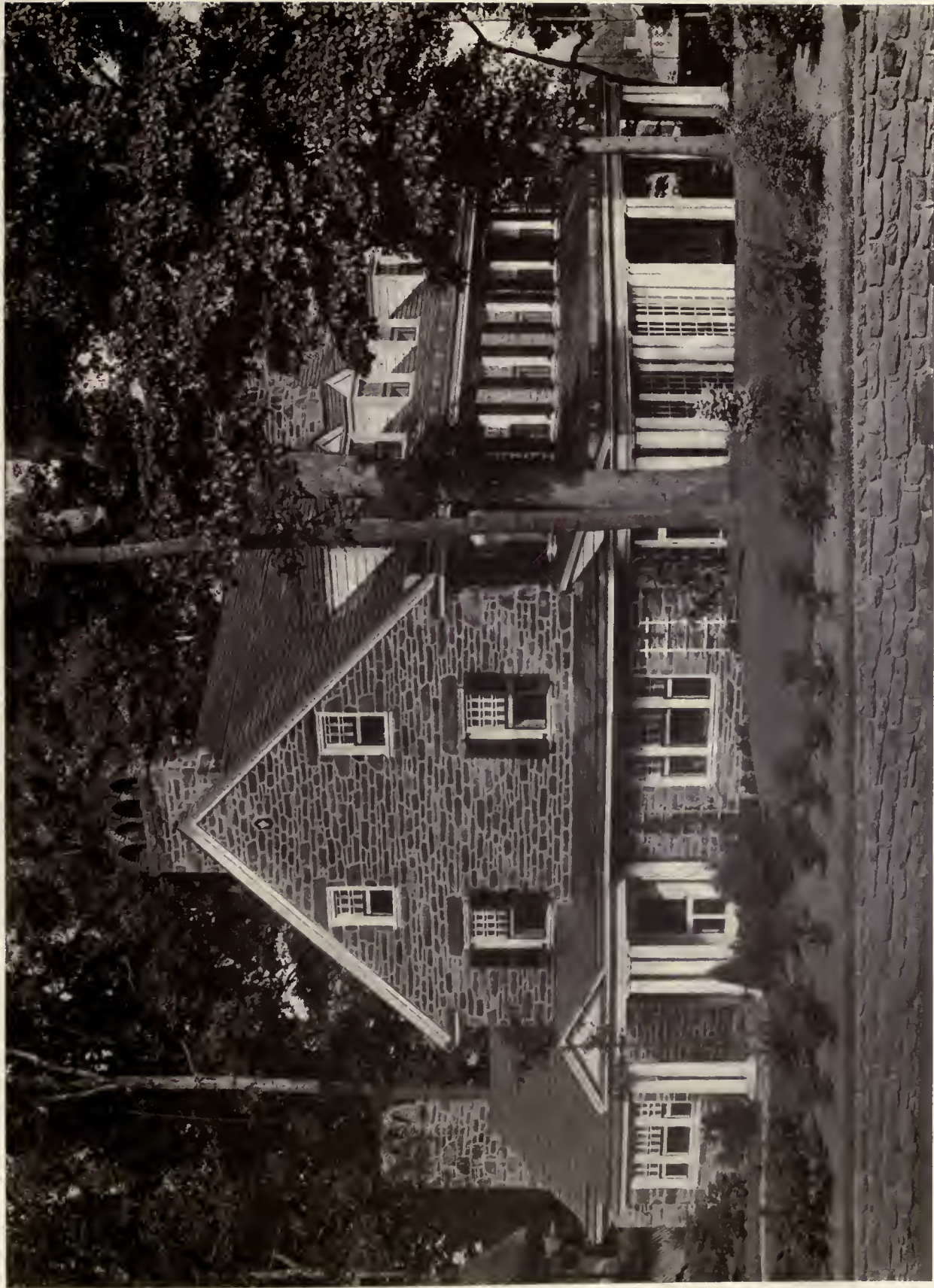

02  
5



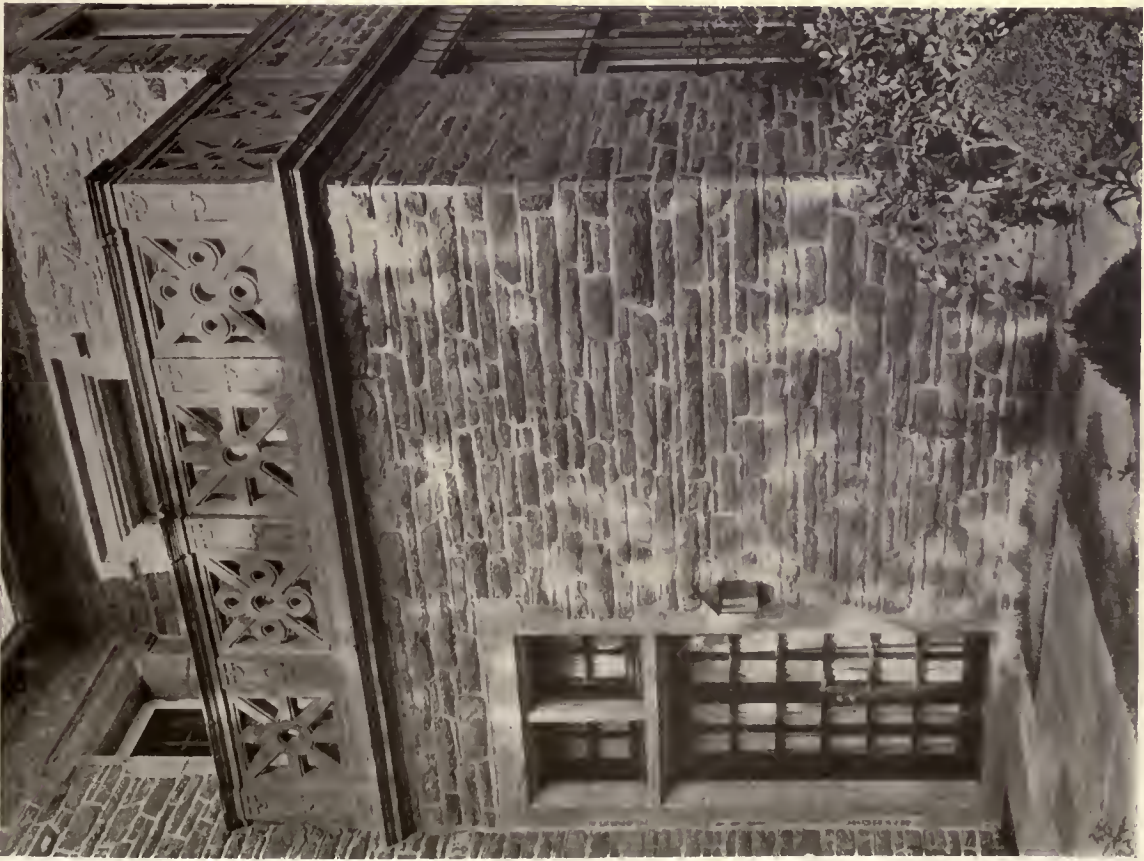

PLATE 21

DETAIL OF TERRACE FRONT

HOUSE OF MR. JOHN D. McILHENNY, GERMANTOWN, PHILADELPHIA, PA.  
WORK IN GERMANTOWN, PHILADELPHIA, PA., BY DUHRING, OKIE & ZIEGLER, ARCHITECTS  
EXECUTED UNDER THE PERSONAL DIRECTION OF CARL A. ZIEGLER





DETAIL OF DOOR FROM GARDEN TO LIVING ROOM

Pl 2 w



VIEW FROM TERRACE

HOUSE OF MR. JOHN D. McILHENNY, GERMANTOWN, PHILADELPHIA, PA.  
 WORK IN GERMANTOWN, PHILADELPHIA, PA., BY DUHRING, OKIE & ZIEGLER, ARCHITECTS  
 EXECUTED UNDER THE PERSONAL DIRECTION OF CARL A. ZIEGLER





PLATE 23

HOUSE OF MR. FRANKLIN BAKER, JR., GERMANTOWN, PHILADELPHIA, PA.  
WORK IN GERMANTOWN, PHILADELPHIA, PA., BY DUHRING, OKIE & ZIEGLER, ARCHITECTS  
EXECUTED UNDER THE PERSONAL DIRECTION OF CARL A. ZIEGLER

808





80?



PLATE 24

HOUSE OF MR. FRANKLIN BAKER, GERMANTOWN, PHILADELPHIA, PA.  
WORK IN GERMANTOWN, PHILADELPHIA, PA., BY DUHRING, OKIE & ZIEGLER, ARCHITECTS  
EXECUTED UNDER THE PERSONAL DIRECTION OF CARL A. ZIEGLER



# Current News

## Happenings and Comment in the Fields of Architecture and the Allied Arts

*In order to supply our readers with material of current interest, the news and comment appearing in issues of THE AMERICAN ARCHITECT delayed by the printers' strike will be as of actual rather than stated date of publication.*

### Corcoran Prize Awards

The prizes which have been awarded to the Seventh Exhibition of Contemporary American Oil Paintings, held recently in the Corcoran Gallery, Washington, D. C., are as follows:

First W. A. Clark Prize of \$2,000 (accompanied by the Corcoran Gold Medal) to Frank W. Benson for his "The Open Window." Second W. A. Clark Prize of \$1,500 (accompanied by the Corcoran Silver Medal) to Charles H. Davis for his "Sunny Hillside." Third W. A. Clark Prize of \$1,000 (accompanied by the Corcoran Bronze Medal) to Edward F. Rook for his "Peonies." Fourth W. A. Clark Prize of \$500 (accompanied by the Corcoran honorable mention certificate) to William S. Robinson for his "October."

The jury on awards consisted of Mr. Willard L. Metcalf, New York, chairman; and Daniel Garber, Philadelphia; Richard E. Miller, Paris and St. Louis; Lawton Parker, New York, and Charles H. Woodbury, Boston.

### Southern California Architects Meet

The one hundred and thirty-first regular meeting of the Southern California Chapter, A. I. A., was held at the City Club, December 11, H. M. Patterson presiding and nineteen members present.

As guests there were present: Mr. Mickeljohn, J. C. Hillman, Walter S. Davis, and John Bowler.

Upon the suggestion of A. F. Rosenheim, the business of the evening was postponed in honor of the guests, and the president introduced Mr. Mickeljohn, who spoke very interestingly and at length upon the life and political conditions in Mexico as have existed in the past five years. Following this the minutes of the 130th meeting were read and approved.

Under "Committee Reports," Mr. Withey of the City Planning Committee, stated that there had been held two conferences of the City Planning Committees of the Chamber of Commerce, Municipal League, City Club, City Planning Association, Southern California Chapter and other societies, together with the members of the City Council, and as a result resolutions had been sent and requests made upon the council to appoint a commission of fifty to take up city planning.

Mr. Rosenheim of the Special Committee appointed at the October meeting rendered a report on the work performed in the last month relative to the program for selecting meritorious architectural work in the city. After a general discussion it was moved, seconded and passed that the Chapter indorse the program and that the committee proceed with its plan as called for by the program, reporting at the next meeting the amounts of such funds as will be necessary for the undertaking.

Upon the Secretary calling attention of the members that at this time delegates should be chosen for the next In-

stitute Convention, it was moved, seconded and carried that the selection of delegates be postponed until it has been learned definitely when and where the convention for 1920 will be held.

Under "Communications" the following were read:

From E. C. Kemper, executive secretary of the Institute, relative to the Institute desiring to foster public sentiment in favor of the creation of a Department of Public Works. Said letter was accompanied by a circular giving details of this plan. Letter was ordered filed.

From E. C. Kemper, as to the progress of the Post-War Committee, inclosing report. Same was ordered filed.

From Charles Whitaker, editor of the *Journal*, stating that he would be visiting Los Angeles on or near the 21st of January, and desired a meeting of the Chapter at that time. It was moved and duly voted that the president and secretary make arrangements for this meeting.

Annual election of officers being the next item on the program, the secretary read the report of the Nominating Committee made at the last meeting. There being no other nominations made, it was moved, seconded and passed that the secretary cast the ballot. Whereupon the president declared the following officers elected to office: G. E. Bergstrom, president; H. F. Withey, vice-president; R. G. Hubby, secretary; August Wackerbarth, treasurer; A. M. Edelman, member of the Executive Committee.

The secretary reported an invitation given by the Washington Iron Works to the Chapter to visit its manufacturing plant, and it was voted that the next regular meeting be held there.

H. F. WITHEY, *Secretary*.

### Address Women Painters

At the recent dinner of the National Association of Women Painters and Sculptors at the Architectural League, the speakers were H. Van Buren Magonigle, past president of the League and also of the American Academy at Rome, and Captain Ernest Peixotto, one of the eight artists who made the official war paintings for this country and who was one of the directors of the American School of Art of the A. E. F. at Bellevue, France.

Mr. Magonigle spoke of mural paintings from an architect's point of view, and said the paintings must have certain architectural characteristics to harmonize with the architectural surroundings, and that a broad line of study was needed for the mural painter to obtain the necessary understanding for the work. Captain Peixotto, in describing the work of the American students at Bellevue, said that the A. E. F. men were given a broad point of view, as sculptors, painters and architects were obliged to take in all the lectures, each learning something of the other's work.

"Poor boys, they had no redress; they were all soldiers," said Captain Peixotto. "It was squad right, and off they went to the lectures. Later they appreciated the benefit they gained."

## Seeks Site for Lincoln Statue

WASHINGTON, D. C., Jan. 17.—For once in its history Washington has no place for a work of art. Where to place the monument of Lincoln, which was erected in 1869 by popular subscription, is a problem the solution of which had led to a lively controversy. The statue, it seems, is out of artistic proportions and out of a site, for its removal has been authorized and delayed.

The old courthouse of the District of Columbia which was lacking in artistic merit was remodeled last year. The work now being completed, Col. Clarence S. Ridley, in charge of public buildings and grounds, finds that the statue is not in harmony with the architectural beauty on account of its present location and general design. The base of the pedestal is six feet from the sidewalk and the statue is thirty feet higher. Furthermore, it is out of line with the center of the courthouse.

Citizens of Moline, Ill., have heard of the controversy. In reply, they have petitioned Congress to permit the removal to that place for sentimental reasons. Lincoln is reported to have practiced law in Moline. In connection with the transfer, the Washington Society of Oldest Inhabitants has questioned the right of Congress to donate and transfer a statue erected by popular subscription by the residents of the District of Columbia.

The suggestion has been made that the statue be placed at one of the approaches to the new Lincoln Memorial; in the Botanic Garden, near the incomplete Grant monument; along the boulevard in the rear of the Washington monument, or in the public parks. The American Forestry Association wants the statue placed at the end of the Speedway facing the South Potomac and surrounded by trees.

## Annual Meeting of Landscape Architects

A. D. Taylor of Cleveland, O., was elected president of the Mid-West Chapter, American Society of Landscape Architects, at the annual meeting in Hotel Statler. Other officers chosen are: Frank Burton of Chicago, vice-president; Professor F. N. Evans, University of Illinois, secretary-treasurer; T. Glenn Phillips, Detroit, trustee. Revision of the by-laws and constitution and matters concerning ethics were discussed. O. C. Simonds, retiring president, read several chapters from his forthcoming book, "Landscape Gardening." R. H. Wilcox, Detroit architect, spoke briefly on his contemplated trip to Europe and studies at the Academy of Rome, provided by the Charles Eliot scholarship, which Mr. Wilcox won. Mr. Phillips, consultant to the city plan commission, reviewed the commission's work in this city.

## Request for National Housing Commission

(By special correspondence to *The American Architect*)

WASHINGTON, D. C.—The American Institute of Architects has addressed a letter to members of Congress and national civic bodies urging the appointment of a commission to study the housing situation of the nation.

The letter submitted to the President's Industrial Conference, now in session here, reads:

"The question of living conditions is seriously engaging the peoples of every civilized nation. In the United States, as elsewhere, the problem has been forcing itself upon

public attention for many years, and even before the war, the measure of its gravity was steadily increasing. To-day, due to the impact of factors strikingly emphasized by the five years of war, this nation finds itself confronted with problems of the greatest perplexity, every phase of which may be said to relate to living conditions.

"The house, and the home, must be accepted as the base around which the problem revolves. No solution of our industrial unrest can be possible until the primary requisite of shelter is acknowledged as a crucial factor. In principle, it may perhaps be said, without fear of contradiction, that we are faced with a shortage in dwelling-places of formidable proportions. Likewise it may also be said that no satisfactory plans for meeting this shortage have as yet been advanced.

"No figures are at present available to indicate the measure of the need for new dwellings. In New York City alone it has been computed by careful survey that no less than 30,000 new dwelling-places are needed to care for the present shortage. Almost without exception, every great city reflects a like condition.

"The causes for this condition are no doubt many and various. They relate to the war, to the cost of building, to wages, rents, land and building speculation, and, incidentally, to the whole fabric of our industrial system. The house and the home are an indissoluble part of the National fabric. They cannot be isolated and studied as detached symptoms. They must be considered as a part of the whole problem, and we believe that the Government of the United States should at once take steps toward the making of a complete and impartial investigation into the problem of providing adequate shelter for its increasing population.

"A vast field of experience, as developed in other countries, lies ready for cultivation. The advances made by other peoples, as expressed in such recent legislative enactments as the English Housing Act of 1919, the Canadian Act of 1919, the Saskatchewan Act of 1919, the proposed New Zealand Act, together with the exhaustive studies and reports issued by these and other countries, provide a large amount of information which is vital to any clear conception of the magnitude of the problem. By combining the experience of other nations with that gained in our own country through the work done by the Government itself, as a war measure, we believe that there can be constructed a comprehensive report which will deal with the problem in an adequate and intelligent manner and which will be of infinite value to the hundreds of perplexed communities that are now seeking information and light.

"Such a report, to be of any value, must be made by a group of men and women qualified to deal with the facts in a fearless and straightforward manner, for it is only through an impartial presentation of all the evidence that there may be gained any broad national understanding of the extent of the problem and the principles involved. We do, therefore, urge upon your consideration the creation of a competent agency for the making of this sorely needed study. Various bills introduced into the last Congress indicate that the need for governmental action has already been felt, but action, to be most useful to the people of the United States, should not longer be delayed.

"For this pressing problem of housing we bespeak your earnest consideration, and we shall be glad to present evidence in support of our contentions if you so desire.

"Very truly yours,

"WILLIAM STANLEY PARKER, *Secretary.*"

By order of The Board of Directors, American Institute of Architects.

## Bahai Temple Plans Explained at Museum

Faculty and students of the department of architecture, Syracuse University, went to the Museum of Fine Arts, Library Building, and heard a lecture by Charles Mason Remy of Washington, D. C., on the architectural problems of Bahai Temple, to be erected in Chicago.

He spoke of the influence of religion upon civilization and architecture, stating that each style of architecture had been evolved and developed in the temple or religious edifice of an age of civilization.

He also spoke of the coming universal style of architecture eventually to be developed in the great temples of universal religion, which will be erected as the peoples of all religions, nations and races come together, uniting in one great world religion and civilization. The lecturer said this unity will prove to be the true solution of the present struggle and difficulties between the different races, religions, nations and classes.

"Many people have had the vision of a great universal temple in which peoples of all races, sects and religions, would come together for worship," said Mr. Remy. "Now the people interested in the Bahai movement, for religious unity and brotherhood, have arisen to erect such a temple.

"The temple proper, a polygonal building surmounted by a dome in the midst of a park, will accommodate the worshipers and be a place for reading, meditation and prayer. This temple will be the central feature of a group of buildings housing auxiliary, philanthropic and charitable institutions, such as a hospital with a free dispensary, an orphan asylum, a home for the aged, a home for incurables, schools of various types and a university, all of which group of buildings will form a great institutional center, uniting religion and practical service to humanity."

## A Valuable Alloy Produced

A metal lighter than any yet known, and as strong as or stronger than steel, has for years been the dream of many, and every now and then rumors are circulated to the effect that at last it has been discovered. The advantages which such a metal would have, especially for aircraft, remarks the Scientific American, are obvious, but unfortunately it is generally found on investigation that there is a "snag" somewhere.

The latest report to be circulated relates to a new magnesium alloy said to have been discovered by a metal company of Montreal, Canada. The new alloy, it is stated, is only two-thirds the weight of aluminum and is "as strong as steel." It is to be hoped that some of the qualities attributed to the new alloy may, on closer examination, be substantiated.

## French Remodel Hotels

The National Chamber of Hotel Keepers has begun an active campaign to make French hotels attractive to Americans, writes a correspondent. American ideas are being sought through an agent of the chamber in the United States. A series of articles for hotel men is being published by the organization's official paper. The necessity of modern toilet conveniences, honest treatment, and otherwise conforming to the standards of the United States are emphasized.

Cleanliness is given the most attention by the chamber's agent in the United States, and he cites conditions in some of the French hotels that would be surprising to an American. He recommends the use of white or light paint to prevent the gloominess of interiors, greater illumination, recognition of the bathtub from the American point of view, removal of various unsanitary quarters from near the kitchen, elimination of little service charges and other changes.

The hotel men are cautioned by the correspondent against "a veritable organization to boost prices" which he said had been reported to him. Otherwise, he reasoned, returning travelers would spread the bad news and "we would thus lose the chance we now have to make enormous profits."

To prevent such overcharging, a government agency is obtaining pledges from hotels to charge only posted rates to tourists directed to them through the government's international publicity campaign to attract visitors.

## Brazil Plans New Capital in Interior of Republic

Transfer of the Federal capital from Rio de Janeiro to the high plateau lands in the State of Goyaz in the interior of Brazil, within five or six years, is the aim of a project introduced in the Federal Senate. The Brazilian constitution already provides for the transfer and the present measure is intended to hasten the move.

The measure gives two months from the date of signature of the proposed law for the world-wide publication of the plans, six months for the reception of competitive proposals and five years from the signing of contracts for the completion of the new capital. The successful bidder will enjoy 20 years monopoly of water, drainage, lighting, telephonic and urban traffic services in the new capital.

The plan contemplates a modern city with all the latest improvements and hygienic installations, built in accordance with approved town-planning ideas, with a government house, a national congress building, a palace of justice, public department buildings, schools, libraries, theaters, a penitentiary, hospital, barracks, markets, post offices, telegraph and telephone offices, etc.

No estimate is made in the measure as to the cost.

## Flanders' Mud Used to Build Winter Homes

Flanders' mud, the bane of all armies operating in Belgium, is of some use after all, according to reports from Roulers, Belgium.

Lime is practically unobtainable in Belgium to-day and in many of the ruined villages the refugees are laying stones and bricks with mud for temporary shelter against winter. Others fill the chimneys in their chimneys and walls with it, and altogether it is becoming as much of a comfort to the refugees as it was a handicap to the soldiers who lived in it for months.

At Dixmude the mayor divides his time between public affairs weighing out coal, distributing supplies and cleaning mortar off old bricks from the ruins of his house. He is laying these in mud, too, for his winter's shelter. His example is being widely followed in Dixmude and surrounding villages, and Flanders' mud is playing an important part in the making of temporary homes until new materials can be obtained in the spring.

## Replica of Historic French Structure Planned for San Francisco

A donation of \$320,000 has been offered by A. B. Spreckels and Alma Spreckels, his wife, to the San Francisco Park Commission for the erection of a building to be devoted to art treasures in Alta Plaza, at Jackson, Scott, Clay and Steiner streets. It is given as a consideration of beautification and patriotism and to promote useful ends and will be dedicated as a memorial to the American soldiers and sailors who died in the world war and to the purposes of art and culture in San Francisco and to coming generations.

The building is designed as a complete reproduction of the celebrated Palace of the Legion of Honor at Paris, one of the architectural glories of Europe. The structure will probably be called "The California Palace of the Legion of Honor." It will be a one-story building, with part basement, will include a court of honor and will occupy an area of 175 by 200 feet.

The materials will be reinforced concrete, faced with stone.

Henry Guillaume, architect of the French building at the 1915 exposition, is the designer, assisted by George Applegarth, of this city. On its completion Mr. and Mrs. Spreckels will provide a nucleus of art contents by giving many pieces of sculpture and paintings by the famous artists of the world.

## Paris Housing Shortage

Although approximately 300,000 persons desire to rent apartments and are living in hotels and lodgings in Paris, little building is going on, according to the *Era Nouvelle*, a recently established newspaper. Virtually all the construction work in progress, it is said, is confined to moving picture houses, stores and sheds.

When the war began there were about 1000 buildings being erected and most of these were left unfinished. In 1915 work on 130 was commenced while in 1916 ground was broken for 200. During the year since the armistice was signed only 51 structures have been started. In building trades circles it is said that lack of labor and materials and high prices have precluded extensive developments.

## Chicago Architects Have Lectures on Furniture

Period furniture has become such an important feature in the work of the architects that the Illinois Chapter of the American Institute of Architects has arranged for a series of illustrated lectures, the first to be given on Tuesday evening, Feb. 10, at the Chicago Art Institute when English furniture decoration will be discussed. Later, Italian furniture will be discussed to be followed by lectures on other period decorations. Director Eggers of the Chicago Art Institute will also speak on the Interdependence of Arts, and Miss Belle Walker, a local sculptress, will discuss Sculpture and Its Relation to Architecture.

## National World War Memorial

(By special correspondence to *The American Architect*)

WASHINGTON, D. C.—Congress will be asked to authorize the erection of a national memorial building to honor the men and women of America who died in the World

War. This action was proposed this week at a meeting of the officers and representatives of Army, Marine and Navy and welfare organizations.

In order to support the proposed movement, steps are under way to create a national memorial association. It is proposed to have Franklin D'Olier, national commander of the American Legion, act as chairman. The executive board for the Army consists of Major-Generals Leonard Wood, James G. Harbord and Charles P. Summerall.

It has not been determined whether Congress should be called upon for a special appropriation or raise the fund by popular subscription.

## Chambers Pledge Aid to National Foreign Trade Convention

Local chambers of commerce in all parts of the country are taking an active interest in the plans for securing delegates to the Seventh National Foreign Trade Convention, which will be held at San Francisco, May 12-15, 1920, under the auspices of the National Foreign Trade Council, the chairman of which is James A. Farrell, president of the United States Steel Corporation.

So that the American business men may obtain first hand information regarding the market conditions in foreign countries, the Council has invited special trade advisers from the leading nations of Australia, the Far East and South America. The services of these trade advisers will, of course, be offered to the convention delegates as a part of the regular convention program.

Information is being furnished by O. K. Davis, secretary National Foreign Trade Council, No. 1 Hanover Square, New York City.

## Hongkong Constructed in Tiers

Hongkong is built in three stories after the fashion of a Chinese pagoda, states an exchange. There, however, the resemblance to a temple ends. For Hongkong is a mecca of trade, a stronghold of Anglo-Saxon society and a packing box in which Chinese and other varieties of orientals are squeezed so tightly that they seem perpetually out of breath and used to it.

This three-layer system of municipal architecture, which should be an extremely lucky arrangement according to Chinese superstition, is made possible by a hillside rising near the harbor. Up this hillside the city seems to have backed steadily until it reached the crest, where it stopped without attempting to progress down the other side.

## The Value of the Architectural Press

The practice of architecture is undergoing a change since the war, in the opinion of Architect Albert Saxe.

"The general public is at last awakening to the value of architecture to a community," he said, in discussing what he believes is a new interest in the arts. "I have been impressed with the fact many times recently that the public is acquiring a new interest in what architecture really means in their lives. The practice of architecture is the most comprehensive of all professions, including as it does all phases of engineering as well as the arts. To my mind this means that America is developing a love for the beautiful in architecture which will require that future public and private improvements must express something more than mere utility. And this has come about in no small degree through the efforts of our architectural publications."

## Width of Streets Same as in 1620

One thing remains as primitive in 1920 as in 1620 in lower Manhattan; the width of streets which, notwithstanding that two-story buildings have been superseded by those of thirty-two, forty-two, or fifty-two stories, still retain in many instances the narrow, inadequate vehicular and sidewalk accommodations. In order to facilitate the movements of pedestrians and save time and money, to say nothing of aggravation, all pedestrians should use the right of way known to vehicle traffic. "Keep to the right" should be made mandatory by the traffic policeman.

## Industrial Art School Formed

The Silk Association of America has recently urged the establishment of industrial art schools to promote a high degree of development in industrial art in relation to commerce and the general welfare of the country. The association points out that it is doing its part in this great work through exhibits, competitive prize offers and other methods of education, in order that artistic talent may be encouraged and stimulated and that all influences may be fostered for the advancement of public taste.

The association recognizes the demand for well-trained designers and craftsmen in industry, shows that the demand is increasing and points out that the supply has been inadequately met through lack of proper facilities for training.

The establishment of such schools, in the opinion of the association, would fill a long-felt want in silk and other artistic industries and would afford an opportunity of putting American finished products on an equal footing with other nations.

## Labor Plentiful on Coast

(By special correspondence to *The American Architect*)

SEATTLE: Conditions here are satisfactory for an active building season. Labor is plentiful, and building labor generally is now being employed on the American or open-shop plan as the result of the failure of the strike of the Allied Building Trades.

Election of officers of the Washington Chapter of the American Institute of Architects was held here this week. The following were chosen: President, Charles Alden, Seattle; vice-president for Tacoma, George Gove; vice-president for Spokane, L. L. Rand; vice-president for Seattle, Harlan Thomas; secretary, F. A. Naramore, Seattle; treasurer, E. G. Park, Seattle.

## Competition for Architects' Certificates

HARRISBURG, Jan. 17.—The new Board of Examiners of Architects named a few months ago by Governor Sproul has called upon all the architects of Pennsylvania to enter a competition for the designing of the certificates to be issued by the commonwealth to architects under the registration contemplated by the act of 1919.

M. I. Kast, of this city, secretary of the board, says the idea is to get a design "of a character and artistic quality worthy of the profession." All architects and designers have been made eligible to compete, and the board has obtained the following architects to act as a jury: L. C. C. Zantzinger, Philadelphia; Edgar V. Secler, Phi-

adelphia; Paul P. Cret, Philadelphia; Reinhardt Dempwolf, York, and Frederick A. Russel, Pittsburgh. The designs must be anonymous. However, the name of the person submitting the design should be placed in a plain envelope. There are two prizes, one of \$200 and one of \$100. Designs must be filed with Mr. Kast on or before April 1.

## Pennell's New Book on Etchers and Etching

A book of the keenest interest to all lovers and collectors of etchings and of value to any lover of pictures by reason of its fine reproduction of many of the greatest etchings by Whistler, Rembrandt, Merryon and Duevneek, is "Etchers and Etching" by Joseph Pennell (Macmillan, N. Y.). The book is a large quarto with paper good enough for its illustrations and with a clear and elegant typography worthy of its treasures of illustration.

## Canada Places Time Limit on Soldiers' Applications for Retraining

Canada is advising her disabled soldiers to apply for vocational training before February 1, 1920. After that time only men who are still in hospitals may apply and they are given only three months after their discharge to file application for retraining.

The United States Government is not acting so hastily. The Federal Board for Vocational Education has given, and is giving, nation wide publicity to the retraining of our disabled service men. Not satisfied with that, the Government is doing all in its power to persuade every disabled man to take retraining whether he desires it or not.

Canada announces 8000 already trained and 10,000 still in training. The Federal Board for Vocational Education announces more than 21,000 men now in training and, before the opportunity to apply for this training is closed, at least 25,000 more applications are expected.

## Uruguay Announces International Architectural Competition

Architects of the United States will be interested to learn of the international contest just announced for plans for the construction of a convalescent sanatorium to be erected at Montevideo, Uruguay. The National Charity and Welfare Association of that city has set June 30, 1920, as the prescribed date for the submission of tentative architectural designs.

The sanatorium is the bequest of Gustavo Saint Bois. It is to be situated on a tract of land owned by the association at Melilla, Department of Montevideo, and is to be devoted exclusively to the cure of convalescents under medical care. Patients suffering from rapidly developing or chronic diseases or from tuberculosis will not be admitted. Convalescents of both sexes and children over the age of seven are eligible and it is desired that the buildings for the use of men shall be as separate from those for women and children as is consistent with efficient administration. It is desirable that space be allowed for the accommodation of from 150 to 200 persons in each section.

Special attention must be paid to ventilation so that

there may be a constant change of air day and night, and to provision for hygiene, baths, etc. A large dining room, proportionate kitchen and pantries, reading rooms, ward-ropes and annexes for the Sisters of Charity (chapels, etc.) must be suitably arranged. A separate administration building, affording easy access to other buildings, and one for the examination of entering and resident patients, which shall contain space for a free clinic, are required. Isolation wards with complete equipment for patients who may contract contagious diseases are necessary for each dormitory. A suitable building must also be designed for helio-therapy treatment with covered courts (patios) or protected spaces for use on rainy days.

The designs should be plain but attractive and the combined cost of the building should not exceed 300,000 pesos (Uruguayan peso=\$1.04 U. S.). Each design must be complete.

The contest will consist of two grades, the first will be a general competition, and the second a contest between those whose plans were found acceptable in the first. A jury composed of the director of the Board of Charity and Welfare Association and five architects will decide on the merits of the submitted plans and prizes will be awarded in both grades. Details as to the plans and other features of the competition may be had from the Uruguayan Legation at Washington, D. C.

## Norway's Housing Exhibition

(By special correspondence to *The American Architect*)

WASHINGTON, D. C.—American manufacturers of building material have been advised of the Norwegian Housing and Town Planning Association's invitation to participate in the national exhibition at Christiania, April 19 to May 3. Applications for space are now being sent to the American Consul General, Marion Letcher. Already certain American firms have shipped ready-made homes for the exposition.

## Thomas Bailey Aldrich Home Sold

Mrs. Mathilda Hoyt of New York has sold her estate on Washington Street, Canton, consisting of a large Colonial house, garage and three acres of land, to John H. Bissell of Keokuk, Iowa. The house is more than one hundred years old and at one time was the home of Thomas Bailey Aldrich, the well-known writer.

## Personal

F. S. Montgomery, for the past six years advertising manager, National Metal Molding Co., Pittsburgh, and prior to that for several years district manager in charge of the Atlanta office of the same company, tendered his resignation, which took effect Dec. 31. He is now associated with the Ivan B. Nordhem Co., New York City. Mr. Montgomery's successor has not been announced.

After a two months' extended tour of the important cities of the East, studying types of new buildings by personal observation, Andrew C. P. Willatzen, architect, has returned to Seattle, Wash., where he has practiced his profession for the past twelve years. Included in the itinerary of Mr. Willatzen were the following points, Chicago, New York, Philadelphia, Boston, Washington, D. C., Kansas City, St. Louis, Savannah and New Orleans.

## News from Various Sources

The list of war criminals to be demanded by the Allies for trial has been considerably revised and reduced from the originally proposed 1,200 to about 300, according to the *Daily Mail*.

\* \* \*

OTTAWA, ONTARIO.—For the twelve months ending Nov. 30 there were 114,768 immigrants entered Canada. Of these 54,641 came from the British Isles and 52,141 from the United States.

\* \* \*

San Francisco won the Democratic National Convention for 1920 on the first ballot of the National Committee sitting in its quadrennial session. The convention will be called to order at noon June 28.

\* \* \*

United States Bureau of Standards tests have shown that concrete made with coarse gravel withstands heat with less danger of disintegration if protected by a coating of cement an inch thick reinforced with wire mesh.

\* \* \*

Dispatches from France state that the entire road construction program in that country will cost nearly two billion francs, which, it is estimated, will give France a road system superior to the one she had before the war.

\* \* \*

Senator John J. Dunningan, Democrat, of New York State Legislature, has proposed a bill authorizing cities to create dwelling house commissions, acquire lands and erect houses to be rented at cost. It was referred to the Cities Committee.

\* \* \*

The gigantic Vickers airplane "Vigilant," with which the Royal Air Force has been experimenting secretly, carries 100 passengers or their equivalent in an enormous number of bombs and has six engines which develop 4,000 horse-power. The airplanes have an extraordinary wing surface.

\* \* \*

COLUMBUS, OHIO.—The State Board of Administration has made an offer of \$75,000 for the land and \$150,000 for buildings at Ancor, near Cincinnati, where a Government nitrate plant was started during the war. There are 500 acres of land with improvements. It is proposed to locate one of the State institutions on the tract.

\* \* \*

By way of relieving the housing situation in New South Wales, a contract was made with America to erect concrete houses, with a guarantee to turn out a cottage a week for every 50 ordered. The cost of these houses is estimated at \$2,187 on \$243 worth of land, which would render the homes within the means of the workman.

\* \* \*

High wage demands of garment industry workers were blamed for the "almost prohibitive prices of ready-to-wear goods" before the committee which Gov. Smith of New York recently named to investigate the differences between the employers and employees in the garment industry, when the committee held the first hearing in the City Hall recently.

\* \* \*

Two large theatres, chiefly for the presentation of moving pictures, are contemplated for Melbourne, and the services of the best known American theatre architects engaged for their construction and equipment, which is to comprise all the newest features from the home of the moving picture—America. The costs of these two buildings are estimated at \$2,430,000 and \$1,458,000.



## Weekly Review of Construction Field

Comment on General Condition of Economics with Reports of Special Correspondents  
in Prominent Regional Centers

### Federal Reserve System Reports on Financial Situation

THE banks of the Federal Reserve have made a review of the business and financial conditions for January, in which they find heavier trade demands and greater prosperity than has before been known, but the review calls particular attention to the shortened lending power and uneasy credit situation.

As relating to the labor situation, this review is most encouraging. It states: "There has been an evident improvement in general labor conditions during the month. In the East and North employment is reported as being full, and labor is said to be in a more contented mood than for some time past. High wages and generally satisfactory conditions of employment are given as the reasons for this improvement. At some manufacturing centers efforts are made to increase wages on the ground that higher living costs make them necessary, but this argument in behalf of higher wages is apparently losing its force, employers feeling that the strong demand for luxuries indicates that there is a large surplus of buying power in the hands of consumers."

#### IRON AND STEEL

THE report states that the production of the iron and steel industry has reached high record levels. The mills, however, are far behind their contracts and the fabricators are so heavily sold that they are not able to quote for definite deliveries. The demands are phenomenal: for new plants and power companies in this country, for office and apartment buildings in Japan, for rails in Siam, for the government's housing projects in Rome, etc., etc.

An announcement from the Iron and Steel Trade of the North of England shows a situation like our own. The capacity for production has been doubled since 1914, but there are 80,000 tons of finished steel lying at the works. If the railways could take away the output the production which is now below that of 1914 could be enormously increased.

This does not indicate reduced prices. And with the steel there follows to a greater or less extent the demand and prices of everything else in building supplies. The price fabric in the building field represents more closely the result of supply on demand than do the ranges in other fields.

#### DEPRESSION OF MARKETS

GRAIN, cotton, stocks and money values may quickly react to the demoralized condition of foreign exchange; but the objection of Europeans to paying high prices for dollars with which to purchase American goods will have—if any effect—that of the remotest sympathy upon the markets of American building materials. In the first place, if the Europeans need our steel, it is a raw material, and representing as it does an investment of capital rather than an expenditure for current consumption—they would purchase at any price they can possibly pay. In the second place, the internal requirements for building are what might be called an accumulated demand; if our

requirements for bread of last year were not fully satisfied we have to a certain extent gotten over it. We have not accumulated an added need, as we have for apartment houses and factories. In the third place, the markets are much less speculative than those suffering depression through liquidation—if indeed they be speculative at all. And so, although the prices for building materials must ultimately feel the effect of so general a disturbance, the relations between the cause and such an effect are so remote and involved that by the time they become evident they will have a hardening, reassuring effect rather than a debasing one.

#### FOREIGN EXCHANGE

THE foreign exchange situation, which is at present so much in the public eye, is more a matter of finance, than of economics, but it has its ultimate effect upon our local markets. With the high value of the dollar as it exists at present in Europe, it will be natural for the Europeans to reduce to as low a level as possible their purchases in this country and to sell as much as possible in order to acquire these abnormally valued dollars. And while, as is emphasized in the newspapers, this will rapidly lower the value of our exchange from its present fantastic height, it will also increase the quantity of goods available for sale in this country and prices will naturally fall.

This does not happen over-night, and the long and widespread anticipation of such reductions in prices (which may prove to be disappointingly slight) gives the elasticity by which our markets will reach such a consummation without shock.

With the more even balance of exchange and of the prices paid for supplies between this country and Europe it follows that in order for our products to be able to compete with those of other nations the factor of labor costs must also to some extent parallel theirs. If it does not there will be an influx of foreign labor which will bring them down. Indeed, it is a question whether such a fundamental law could be denied its action.

#### THE URGENCY FOR PRODUCTION

THE foreign exchange situation, however interesting it may be in its many ramifications, is as yet remote from the field of practical economics in this country, and it is particularly remote from the construction industry. But uneasiness is infectious. It spreads through the stock exchanges and the produce exchanges; gossip becomes more and more fictitious until it becomes a mighty hubbub. Borrowing trouble is all very well in Wall Street, where they will borrow anything they can get their hands on, but it is out of place among those who are handling actual materials and developing them into actual wealth.

If a man needs to be uneasy about something, let him fear that our industries will relax their present efforts to keep abreast of the demands. Everywhere, all over the world, more goods are needed, or—which amounts to the same thing—a distribution of the goods which are already available or being made available. Tilbury docks are

## THE AMERICAN ARCHITECT

blockaded, and so are the grain elevators of America; people are starving in Austria and shelterless in many of our American cities. Foreign trade doesn't balance so easily as foreign exchange, but it balances, nevertheless. The consumers' needs which are apparent everywhere must be filled if we are to rebuild our commercial fabric.

The time may be ripe for retrenchment in speculation and luxuries, but it is no time for conservatism among those who manufacture, deal in, or supply such an essential as the roofs which cover us. They know it. They realize there is no way to go but ahead, and at full speed. When a fellow crawled up out of the trenches a couple of years ago and got a good look at no-man's land, he knew at once that there was only one way to go, and that was toward Berlin, and he went. It is possible that our industries are going to get into a similar situation (the word "panic" is being mentioned in hushed tones), but if they do get out into a "no-man's land" they will do just the same thing: they will go ahead—and for the same reason—that there is nowhere else to go. A man may feel "yellow," but he goes just the same.

### THE GENERAL SITUATION THROUGHOUT THE COUNTRY

**I**N its review of conditions, the Federal Reserve Bank gives a canvass of the important factors as they appear to the several districts. Of these we give the following résumé:

District No. 1 says: "never in the history of the mercantile life of New England was Christmas trade so enormous and never was purchasing power exercised with such extravagance," but "in spite of the orgy of spending, the people of New England have put into its savings institutions during the last year approximately \$190,000,000. There is no reason to become pessimistic with respect to existing conditions."

District No. 3 reports: "manufacturing business continues in large volume." The retail trade is "in excess of last January. The stores report difficulty in procuring supplies, due to heavy demand. Collections are excellent and cash payments comprise a large part of total receipts." (This is Philadelphia.)

District No. 4 (Cleveland) says: that the present demands for manufactured products have not reached the zenith and that foreign trade is rapidly developing.

District No. 5 (Richmond): "The end of the year brings a repetition of the reports of unprecedented prosperity. Farmers, merchants, manufacturers and bankers have all had record years. Collections were never better and many old accounts have been liquidated."

District No. 6 (Atlanta) says: "the public mind is giving more thought to the economic situation. There has been little if any slackening in the wholesale or retail trade during January. All lines report very limited stocks on hand and new supplies difficult to obtain."

District No. 7 (Chicago): "The demand for commodities outruns any possibility of providing a supply. The general volume of business in the Middle West continues at a high level. Farming communities continue to enjoy the prosperity which has resulted from several years of very high prices. Nevertheless there is running through the banking mind the thought that this country cannot long continue the extraordinary volume of foreign exports, while there has been a rather liberal use of credits in all lines."

District No. 8 (St. Louis) says that "the holiday trade was in many instances unprecedented, while prices continued high. Demand for money is at record levels and collections good."

District No. 9 (Minneapolis) reports "there is sufficient work for all who care to work. Factories are running full time and booking all the orders they can fill. There is a continuous demand for larger supply of skilled labor."

District No. 10 (Kansas City) says that 1919 was a record year for business effort and that at the opening of the new year the business situation continues active. The tremendous buying power of the people has continued.

District No. 12 (San Francisco) reports no strikes or labor disturbances are in progress, that bank clearings have increased. Retail trade continues active, averaging 45 per cent greater than in December, 1919, and there is a strong demand for all classes of products.

"The housing situation in the Middle West continues to be fundamentally important," says the statement of the Federal Reserve Board. "In the Kansas City district the year 1919 recorded an increase of 130 per cent over 1918, the estimated cost of new buildings amounting to more than \$64,000,000. In district No. 1 the period of building postponement has apparently been passed, immediate necessities being of such urgent character that they must be met. It is predicted that the current year will break all records. Certain classes of materials, however, seem to be absolutely impossible to deliver. In the Philadelphia district a good volume of demand for many classes of materials is reported. Stocks of lumber on hand are scanty. In Chicago the structural trades are operating at one-half normal speed owing to inability to obtain structural steel. Prohibitive prices and extreme scarcity control the brick situation. In Atlanta district the demand for lumber is in excess of the supply and prices continue very high. Taking the country as a whole, the characteristics of the situation are extremely strong demand for building materials, particularly for lumber, and very low stocks, coupled with unfavorable transportation conditions which have prevented deliveries. Early spring building operations will be correspondingly difficult.

This doesn't look as though we were up against it, or that it was time to hibernate. It looks, rather, as though everybody had got to get into the game and dig.

# Department of Architectural Engineering



HOUSE OF FREDERICK GODFREY, WAUWATOSA, WIS.

CLARE C. HOSMER, ARCHITECT

STUCCO ON WOOD LATH. THE LIBERAL ROOF OVERHANG GIVES CONSIDERABLE PROTECTION TO THE STUCCO

## Successful Building in Stucco

### IV.—Wood Lath on Frame Wall Construction

**S**TUCCO on wood lath applied to balloon framing is a well known type of construction and has been in use for many years. The effect of metal lath on its continued use is problematical. At the outset it was claimed by some that the introduction of metal lath would cause the gradual elimination of wood lath for exterior use. The facts have not sustained this contention.

To-day the use of wood lath as a base for stucco is strongly advocated by some and as strongly condemned by others. Economy forms one of the important factors in its use. Because of the lack of definite information, it does not seem good pol-

icy unconditionally to condemn the use of wood lath for this purpose. Several details of construction are pointed out and illustrated in this article, which, if carefully observed, will tend to reduce the probability of unsatisfactory results.

The wood lath most generally used for stucco work is identical with that employed for interior plastering. Conditions to which this material is subjected when used as a base for exterior stucco are more severe than when employed in interior work. The fact that wood lath has proven satisfactory in the latter case is no criterion by which one may accurately judge its fitness for exterior use.

Well seasoned wood although possessing a slight moisture content, is still capable of absorbing considerable water. Therefore after the application of cement stucco, water will be absorbed by the wood lath. This will cause a volumetric change in the lath, commonly termed swelling. Such swelling is not always the direct cause of the stucco cracking, since this is usually in a plastic state when swelling occurs.

During the process of setting, the combination of water and cement results in chemical action and much of the water in the original mix takes a crystalline form, known as water of crystallization.

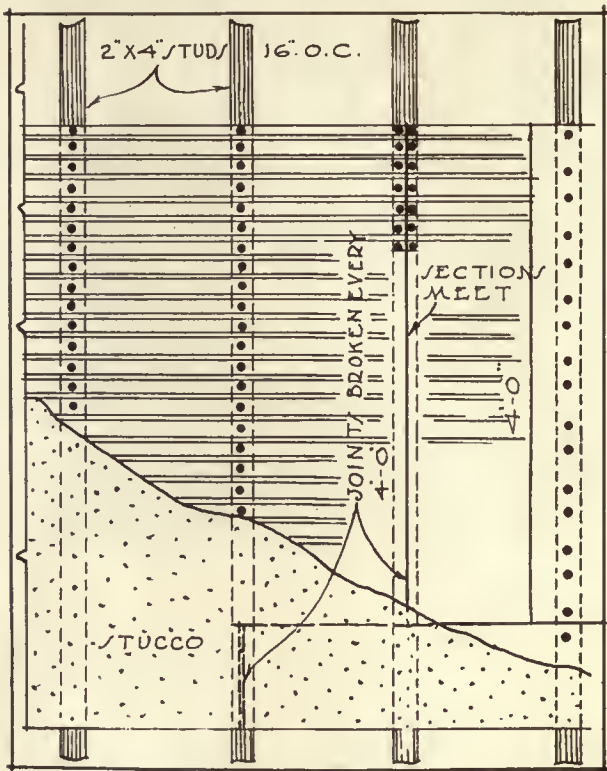

CORRECT METHOD OF CONSTRUCTION WHERE STUCCO BOARD IS APPLIED DIRECT TO STUDS. NOTE BREAK IN JOINTS

If the stucco mix is stiff (a dry mix), practically all the water used in mixing is taken up by this chemical process and the wood lath may even yield some of the moisture previously absorbed. On the other hand when wet mixes are used, there is an excess of water and the lath remains damp for a considerable period after the stucco has set. This excess water must be gotten rid of by evaporation. When hot weather prevails the stucco dries out, the wood lath shrinks, twists, and causes the stucco to crack. In order to avoid swelling of the lath after the stucco has been placed, it is advisable to spray the lath prior to applying the first plaster

coat. The lath should not be saturated so that water remains standing on the surface. Only an amount which can be readily absorbed should be used. The tendency is to use an excess.

A weak point and one where cracks are especially liable to occur exists at each corner of the building. Here there is a shrinking away in two directions at right angles to each other. The remedy requires that the corner posts of the timber frame be chamfered and a vertical strip of metal lath at least six inches wide lapping the ends of the wood lath be wrapped around each corner post. This is illustrated on page 91.

In most cases it is not practicable to provide just sufficient water in the stucco mix for setting purposes, since such a mixture would be too dry to be workable. Hence, the problem of reducing the liability of cracks from wood shrinkage has, during recent years, received considerable attention and careful study.

Investigations indicate that the use of a narrower lath laid with wider keying space and more firmly nailed to the furring strips will produce better results with a cement stucco. A keying space between the lath at least one-half inch wide is recommended.

The use of an integral water-proofing material in the final coat is to be advocated, provided the material used is one manufactured by a reputable concern and has real merit. The durability of the construction will be increased by reducing the absorption of moisture by the stucco. In fact the durability of stucco, irrespective of the base, depends largely on this point.

In an endeavor to provide a better form of construction when wood lath is used, buildings have been built with the lath arranged lattice fashion. So far as can be judged at this time, this arrangement is not advisable. The results reported by the Bureau of Standards, Washington, D. C., so far as they relate to test panels with stucco on wood lath, show that *nearly all* such test panels developed *large cracks*. The tests indicate that counter lathing (in which the laths are applied lattice fashion), produces no more satisfactory results than plain lathing. As this latter construction is considerably more expensive, and without special merit to compensate for the increased cost, there seems to be no good reason for further specifying it.

The wood frame of the building should be built as described in Article III, published in the issue of December 17, 1919. After the application of the sheathing boards, the weather-proof paper should be placed and over this 1" x 2" furring strips, set vertically and spaced 12 inches on centers should be nailed. The wood lath are then laid

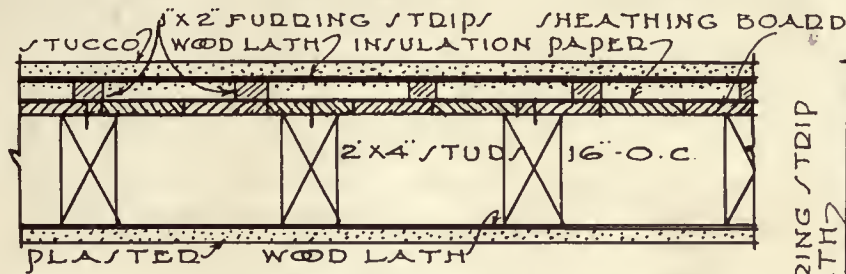

HORIZONTAL WALL SECTION

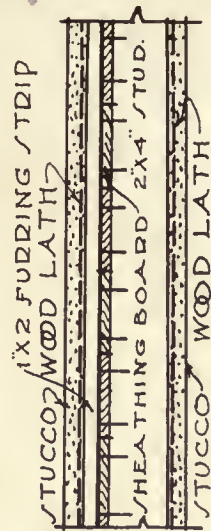

VERTICAL SECTION

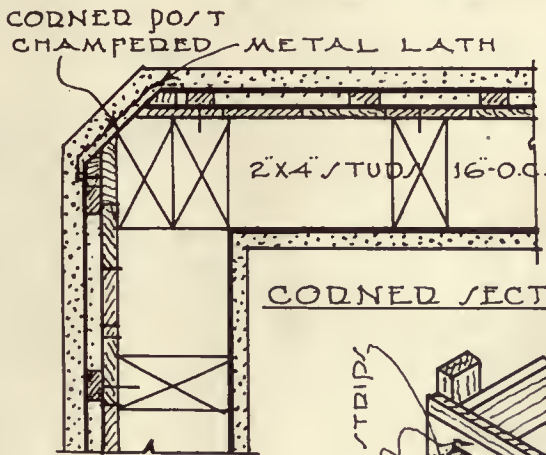

CORNED SECTION

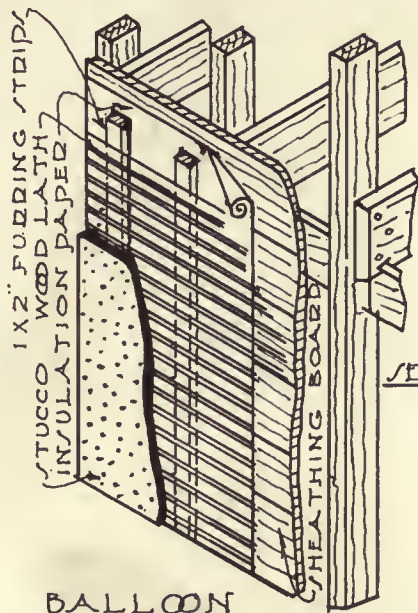

BALLOON FRAMING WOOD SHEATHED TYPE

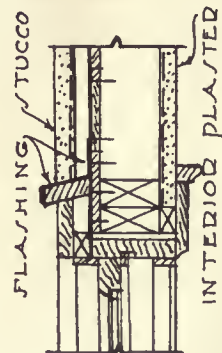

SECTION THRU WINDOW HEAD

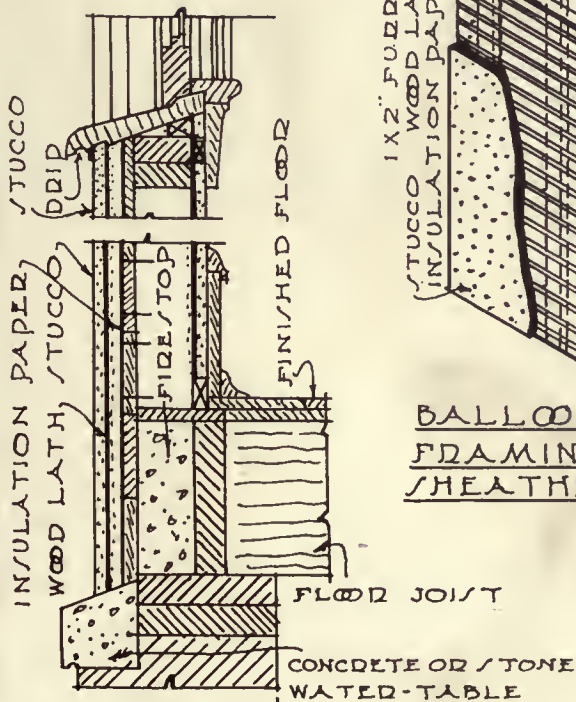

SECTION THRU SILL

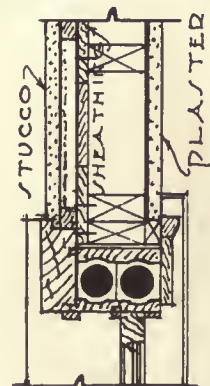

SECTION THRU WEIGHT BOX

CONSTRUCTION DETAILS, STUCCO ON WOOD LATH

## THE AMERICAN ARCHITECT

horizontally and nailed to the furring strips, breaking joints vertically every twelfth lath. Each lath should be nailed at every furring strip with 4d. nails. The proper nailing of the lath is most important. In nailing the furring strips, 6d. nails driven not over 8 inches apart are necessary. At the corners the metal lath previously recommended, must be firmly stapled over the wood lath with  $1\frac{1}{4}$  inch by 14 gage galvanized staples.

While pointing out the precautions to be taken when wood lath is used, the writer believes that Portland cement stucco on ordinary wood lath is not a wise investment. Much better and more per-

nailed directly to the studding. This, of course, materially reduces the cost. When such material is applied directly to the studding, the lath should be placed horizontally, and the vertical joints broken every four feet; if used with sheathing laid horizontally, the lath should then be placed *vertically*, unless attached to furring strips over the sheathing. A safe rule to follow is to lay the lath at right angles to the under surface on which it is nailed.

While the subject of the magnesite stucco will be fully treated in a subsequent article, it is advisable at this point to state that in many of the struc-



A STUCCO AND HALF-TIMBER HOUSE AT MOUNT VERNON, N. Y.

LEWIS BOWMAN, ARCHITECT

MAGNESITE STUCCO ON WOOD LATH WITH COMPOSITION WEATHER PROOF BACKING. ROOF IS OF SLATE, AND HAS ADEQUATE OVERHANG. STONE FOUNDATION WALLS ARE CARRIED SLIGHTLY ABOVE GRADE

manent results can be obtained by the use of metal lath applied as recommended in the previous article.

In treating this subject, cognizance must be taken of that type of construction now becoming quite popular, in which dovetailed wood lath is backed up by a weather-proof membranous material, integral with the construction. The lath is cut in four foot lengths and the material shipped in rolls.

In such form it is easy to handle and after delivery can be conveniently applied to the timber frame work. It is believed that a more substantial structure results when sheathing boards are incorporated in this type of construction, but many buildings have been erected utilizing such material

tures in which wood lath has been used with entire success, the over coating was composed of magnesite stucco. No water, but a liquid chemical is used in mixing this material for application and it adheres firmly to the wood. Ordinary lath laid with a keying space of only  $\frac{1}{8}$  inch appears to give good results. Due to its toughness and non-freezing qualities, the danger of cracking, even when applied in cold weather, is remote. On some of the governmental housing developments magnesite stucco was placed at temperatures considerably below zero, and no cracking occurred.

The argument in favor of wood lath as a base for stucco is mainly economy of construction.

Those against its use are its liability to crack and its lack of fire resistance. A wide field still exists for its use, and with proper precautions fairly satisfactory results should be attained.

Many architects and builders have found the combination of wood lath (or wood lath mounted on weather-proof backing), and magnesite stucco

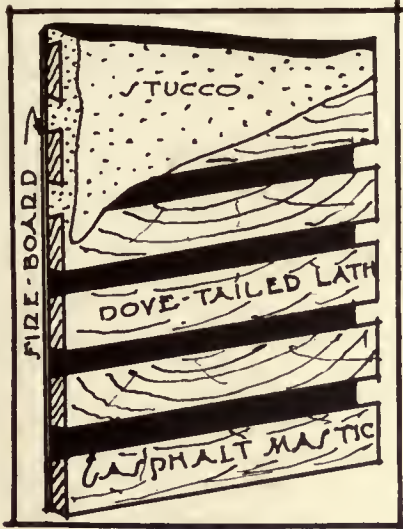

STUCCO BOND COMPOSED OF DOVE-TAILED LATH WITH COMPOSITION WEATHER-PROOF BACKING

to give entirely satisfactory results, at the same time permitting greater economy than could be obtained with other forms of construction. As already stated, this type has been used in many large housing developments, and so far as can be observed at the present time, no serious defects are evident.

Further investigation will no doubt reveal that additional modifications and improvements in present methods of construction are necessary to the end that stucco on wood lath may be used with confidence where, due to existing conditions, such a type of construction is deemed advisable.

### Protective Metallic Coatings for the Rustproofing of Iron and Steel

UNDER the above title the U. S. Bureau of Standards have issued circular No. 80, which gives the results of exhaustive study relative to the corrosion of iron and steel and the relative values of various materials used for forming metallic coatings to protect the base metal from corrosion.

Among the various types of coatings treated in this paper are zinc, aluminum, tin, lead, and their alloys, copper, nickel, cobalt and brass. The vari-

ous methods of application of the coatings and their relative merits are described, as well as the preparation of the surface before the application of such coatings.

At the conclusion of the paper eight recommendations are given which are worthy of careful note. These are as follows:

1. Zinc coatings should be given preference over all others when the object of the coating is protection against corrosion only.

2. For general use on large, smooth surfaces, sheets, rods, wires, pipes, etc., the hot-dipped zinc coatings are entirely satisfactory, although some of the other processes are more economical in the amount of zinc used. On articles which must be sharply bent or shaped, too heavy coatings of this hot-dipped type should not be used on account of the tendency of the coating to flake off at such points.

3. One ounce of zinc per square foot of surface exposed (0.0017 inch thickness) may be considered as satisfactory for most purposes, but less may be sufficient if evenly distributed.

4. Of the different types of zinc coatings the hot dipped and sherardized are not to be recommended for hardened and tempered steels (springs, etc.): the plated zinc and the sherardized coatings are both recommended for accurately machined parts; the "spray" coatings are valuable for large or complex parts which must be coated *in situ* or after assembling.

5. For indoor and to a limited extent outdoor use, for parts which are so placed as to be easily inspected and which are kept well oiled, other coatings than zinc (e.g., the oxide and other black finishes) may be used. For severe services zinc only should be depended upon.

6. In general, nothing is gained, from the standpoint of resistance to corrosion, by first coating an article with copper, or a similar metal, and then finishing with zinc. If a zinc coating is to have a black finish, black nickel may be used as a finish.

7. The use of oil, and like substances, on any type of coating is to be strongly recommended. The life of zinc coatings, particularly those of a porous character, may be prolonged almost indefinitely by periodically oiling them.

8. The time required for the appearance of rust on zinc-coated articles when exposed to salt spray may in a general way be taken as an indication of whether or not the coating is satisfactory for outdoor exposure, e.g.—24 hours, unsatisfactory; 48 to 72 hours, satisfactory for mild exposure, and 96 to 144 hours, satisfactory for severe exposure.

Copies of this circular may be obtained without charge upon application to the Superintendent of Documents, Washington, D. C.

## Second Convention, National Public Works Department Association, Washington, D. C., January 13 and 14, 1920

DELEGATES to the recent convention of the National Public Works Association left here with full realization of the gigantic task that confronts proponents of the plan to create a new Federal department. For the most significant development of the conference was the acknowledgment that the time was not ripe to urge the immediate enactment of the Jones-Reavis bill. It was tactfully admitted that organized architects, engineers and contractors could not immediately successfully push the measure through Congress. Rather than being discouraged, however, those interested are more determined than ever to accomplish this much needed governmental reform.

That the majority of congressmen have little or no knowledge of the tremendous effect of such a measure has been definitely determined. The delegates devoted considerable time to a personal canvass of their representatives at the Capitol. Comparative reports showed that the legislators were generally open to argument. They claimed that their constituents must have a word to say in the matter. It was at the conclusion of these interviews that the delegates knew that their obvious task of enlisting outside help was no easy one.

The direct outcome of these enlightening visits to the Capitol was the passage of a resolution admitting civic and industrial organizations to participate in the movement. Furthermore, it was decided to make the National Public Works Department Association permanent for the purpose of conducting nation-wide propaganda in behalf of the proposed bill.

There were 95 delegates at the conference held at the Hotel Willard, Jan. 13-14, representing societies with an aggregate membership (eliminating obvious duplications), of 90,000. The American Institute of Architects had four representatives: E. J. Russell of St. Louis, Mo., member of committee on resolutions; E. W. Donn, Jr., of this city, member of committee on text of bill; Waddy B. Wood of this city, member of committee on new organizations and E. C. Kemper, executive secretary of the A. I. A. M. O. Leighton, chairman of the executive committee on the National Public Works Department Association, presided at the meetings. He discussed the necessity for co-ordination of various government bureaus for economy and efficiency.

Congressman C. Frank Reavis, one of the authors of the bill, declared that the Government of the United States was the worst managed business in the world. He pointed out the advantages of the proposed legislation for a reorganization of the Department of the Interior into a Department of Public Works. It was his contention that great savings could be effected with a specialized organization to do all the technical work for the Government, thus eliminating competitive bureaus. He predicted that the economies under the proposed bill would amount to \$250,000,000 annually.

Gen. R. C. Marshall, chief, construction division, of the U. S. Army, advocated the standardization of all specifications covering every material that enters into Federal construction projects. The army officer claimed that the adoption of standard specifications and centralized control over all purchases was largely responsible for the remarkable success of his division during the war. He believes a Department of Public Works could establish a standard specification in Government work which would insure both safety and economy of design. This address will appear in a later issue.

Governor Frank O. Lowden of Illinois addressed a paper to the convention outlining his efforts to co-ordinate state departments and bureaus. He grouped several independent commissions and other state organizations under one head known as the Department of Public Works and Buildings. He held fast to the theory that "it is individuals who do things, and not boards or commissions." The Governor found that the inauguration of a budget system for the state worked wonders. For the purpose of illustrating the savings brought about by this department, Mr. Lowden stated that the general property tax rate for state purposes had fallen twenty per cent.

Commenting upon the proposed transfer of various bureaus, the fate of the bureau of education was discussed in a lively fashion. The conference decided to let Congress handle the matter in its own way without suggestion from the supporters of the measure.

A digest of the Jones-Reavis bill and reasons for the proposals have been prepared in pamphlet form and are now being distributed to all co-operating agencies.



# Correct Building of Chimneys and Flues

By FRANKLIN H. WENTWORTH\*

**I**N connection with the construction of chimneys, and with a view to reducing the fire hazard, it is urged that the following recommendations be observed in chimney and flue construction.

Build all chimneys from the ground up. None of their weight should be carried by anything except their proper foundations. Foundations should be at least 12 inches wider all around than the area of the chimney and be started well below the frost line.

No chimney should be started or built upon any floor or beam of wood. When a chimney is to be cut off below, in whole or part, it should be entirely supported by brick or stone work, or steel construction, properly erected from the ground up. The practice of supporting chimneys or flues on wooden or iron brackets, or iron stirrups, however carefully devised, is hazardous. A small fire around the base from any cause may drop the flue and allow draft for rapid spread of fire.

Build all chimneys to a point at least 3 feet above flat roofs, and 2 feet above the ridge of peaked roofs.

Under no circumstances should the brick work of the chimney be extended out over the roof by the projection of the course of brick nearest to it. Such a shoulder or overhanging projection will inevitably cause cracks in the chimney in case the chimney settles, the roof in such event lifting the upper portion by means of the overhang, or shoulder, and causing a crack at the most dangerous of all places. The chimney should be carried up of uniform thickness to the top, copper flashing being relied upon to prevent leaks at the joint with the roof.

Never build a chimney wall less than eight inches in thickness, and use only cement mortar up to the first floor and above the roof line.

Chimneys with but 4-inch exterior walls are commonly permitted, and if lined with fire clay are reasonably safe, but they frequently crack and are also easily chilled, which causes a bad draft. Where fireplaces are built of stone, the minimum thickness of the wall should be 12 inches.

The upper part of chimney walls may be only four inches in thickness, from a point at least six inches above the roof to the top of chimney, provided the chimney be capped with terra cotta, stone

or cement, or the bricks are carefully bonded or anchored together.

The best coping is a three-inch bluestone, and it is important to see that the holes cut in the capstone correspond in size with the flues, otherwise shoulders will be formed and the draft of the flue interfered with.

In brick buildings the walls of buildings when not less than 13 inches in thickness may form part of chimney or flue. In no case should a chimney or flue be corbeled out more than 3 inches from the wall, and in all cases the corbeling should consist of at least five courses of brick. Flues in party walls should not extend beyond the center of said walls.

Build all chimneys large enough to give a separate flue for each fire, using fire clay or terracotta tile linings at least one inch in thickness.

The fire clay lining is not subject to disintegration by any of the ordinary flue gases.

The lining should be put in as the flue is constructed, using great care to see that the joints in same are carefully made.

When two or more separate flues are provided in chimney, the division walls between flues may be only four inches in thickness.

Two connections to a single flue will result in fire from one communicating to the opening of the other, and thousands of fires have originated in this manner.

Flues in throat capacity should not be less than eight inches square on the inside, and for fireplaces in which wood is to be used they should be eight by twelve inches (or better, 12x12 inches) in the clear. A good rule is to make the flue size not less than one-tenth the area of the fireplace opening. Green or unseasoned firewood will require a flue of this size to insure a good draft and prevent smoking. The furnace flue should also be not less than eight by twelve inches in any case.

Be careful to see that the flues are properly built. Faults cannot be remedied afterwards. All flues should be as nearly vertical as possible.

Masons are often careless about lining the flue even where the specifications call for it, and are apt to omit it until they get to the straight part of the flue. This makes the flue dangerous at its hottest point, near the fireplace, especially if it be surrounded by only four inches of brickwork. Make

\*Secretary, National Fire Protection Association.

sure that the flue lining is carried up from the throat of the fireplace.

Where flue linings are not provided, be careful to see that all joints are struck smooth on the inside, and that projections of bricks or mortar are not allowed, and also that no pargeting nor plastering of the inside of the flue is permitted under any circumstances. The plastering is liable to fall afterward under the influence of heat and rain, and not only stop up the flue, but tear out the plaster between the joints of the bricks. The flue lining will prove the cheapest in the end, for it will maintain a smooth throat and thus discourage nest-building by chimney swallows.

All flues in every building should be properly cleaned and all rubbish removed, and the flues left smooth on the inside upon the completion of the building.

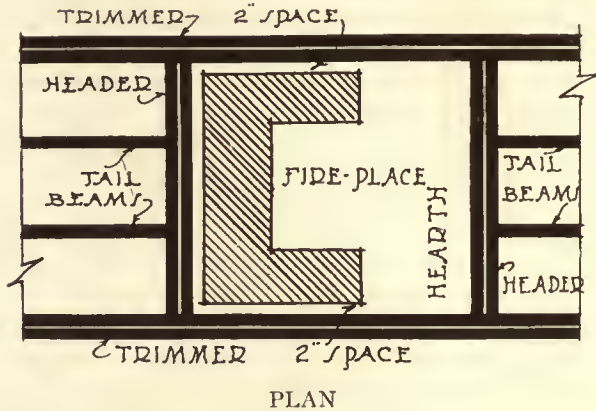

Do not run floor joists or other woodwork into chimneys or flues nor allow wood casing, lathing or furring within two inches of chimneys. All spaces between the chimney and the wooden beams should be solidly filled with mortar, mineral wool or other incombustible material.

Where the chimney breast over the fireplace or mantel is furred out and finished with lath and plaster, only metal lath should be used. If the mantel is of wood, it should not project far enough to be blistered or ignited. Care should be exercised in its selection.

All floor timbers should be "trimmed" clear of the hearths and brick work of the chimney, so as not to be in contact with it at any point.

This is easily secured by "header" beams, carried in front of the fireplace and at least twenty inches from the chimney breast, supported by the "trimmer" beams, which enter the wall on each side of the chimney, as shown in the illustration. These should not approach the side of the chimney closer than four inches. The intervening "tail

beams are mortised into the header. Where more than three tail beams are framed into the header, however, it should be supported in iron stirrups by which the weight is carried on the trimmer beams without mortising into them by "tenon and tusk" joints, which sacrifice material and carrying capacity. In this way the floor beams are free of contact with chimney flues. All hearths should be laid on trimmer arches of brick or a reinforced concrete slab carried across from the chimney breast to the header beam, so that the hearth shall

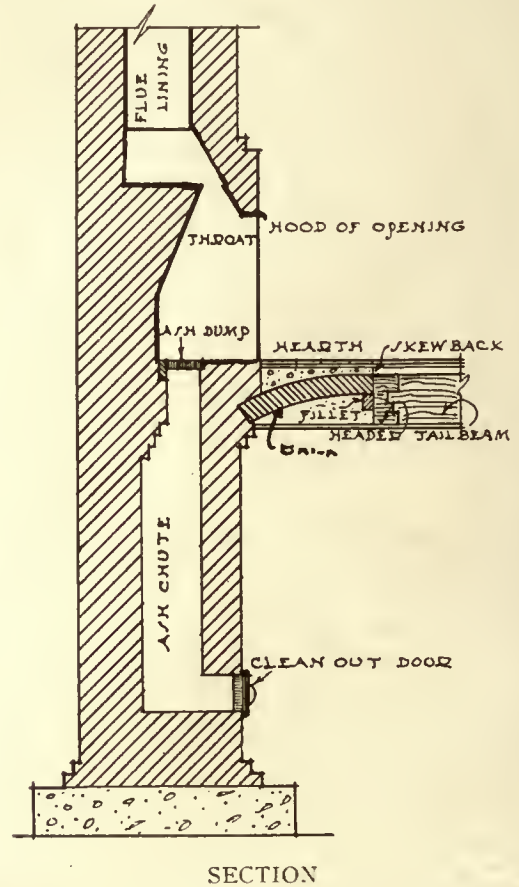

not rest upon or near wooden beams in any case. The length of trimmer arches should not be less than the width of the chimney breasts nor their width less than 20 inches in any case measured from the face of the chimney breasts.

Line fireplaces with fire brick or cast iron.

When a heater is placed in a fireplace, the hearth should be the full width of the heater, and the mantels should be non-combustible. Fireplaces should never be closed with a wood fireboard; nor should a wood mantel or other woodwork be exposed back of a "summer piece"; the iron work of the latter should be placed against the brick or stone work of the fireplace.

96<sup>a</sup>

frontis piece to No. 2301

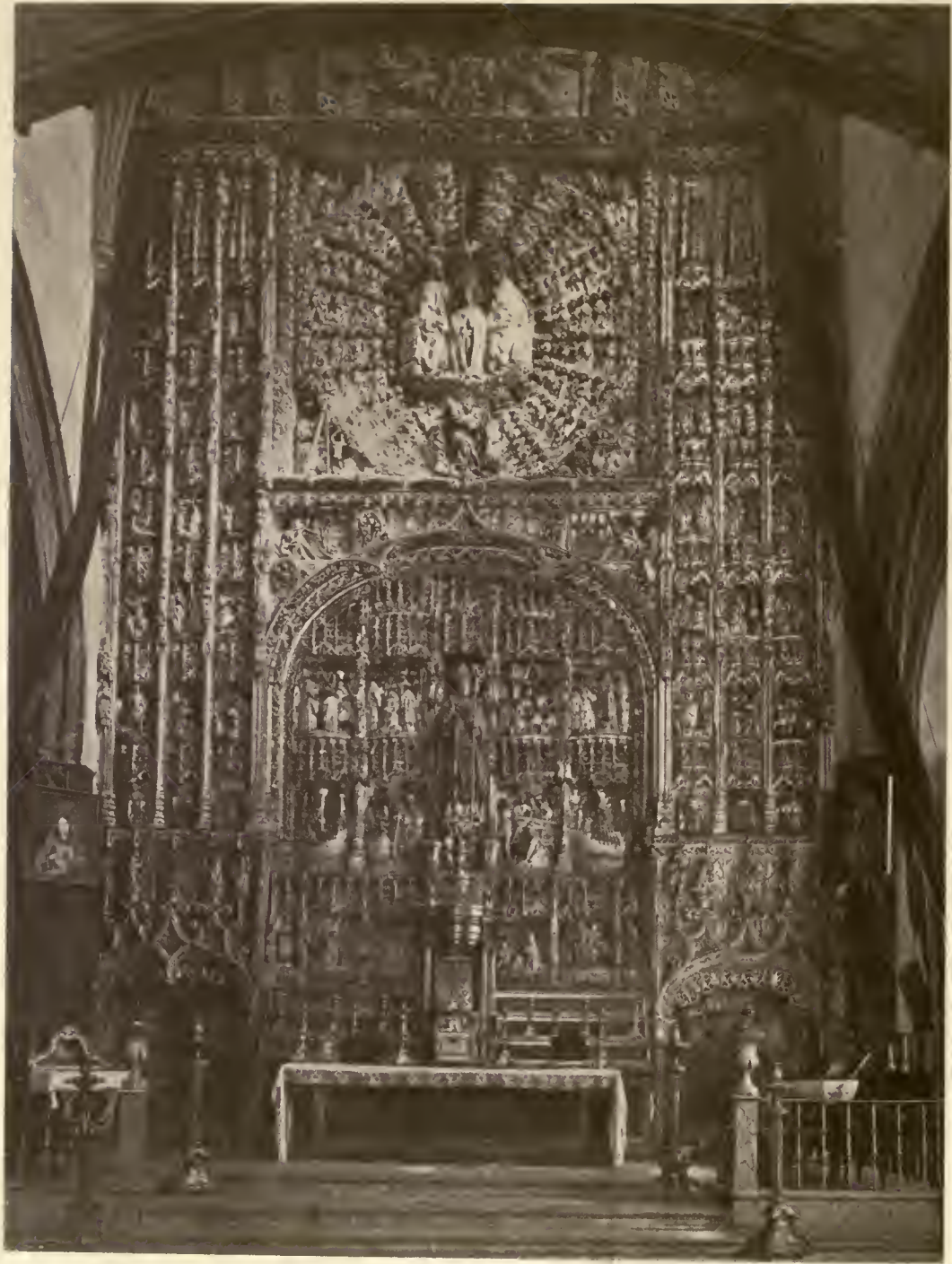

ALTAR OF THE CHURCH OF SAN NICOLAS. BURGOS

# THE AMERICAN ARCHITECT

VOL. CXVII.

WEDNESDAY, JANUARY 28, 1920

NUMBER 2301

## Psychiatric Classification in Prison

By LEWIS F. PILCHER, *New York State Architect*

COMMERCIAL efficiency is determined by the use of the by-products of manufacture. Prisoners are by-products of society.

The modern enterprise that used to discard as waste the by-products of its plant now aims to reduce its overhead and better its system by returning to the community in usable form that which in past times had been considered as lost and unavailable material. Is it not true that the criminal has been for the most part considered in the past as an irreclaimable waste of society, his progress toward a better life inhibited by being held in the strait-jacket of strictly materialistic institutional management and maintenance? As in the case of manufacturing concerns so in the modern penal system, its success will be determined by the economic use, and measured, not by the development of model prisoners enchained securely behind bastioned walls, but by returning to society decent citizens.

In the past the achievement of positive human results has been seemingly impossible to obtain. The chief reason for this failure was due to the inevitable clash between institutional and political interests that always arose and rendered abortive the many attempts that have been made to treat successfully the complex questions of crime and punishment.

Any betterment procedure must be in the direction of individualization. The modern prison, penitentiary, jail or reformatory should embody in their respective organizations the function of scientific study of the individual prisoner—and this should be made the fundamental element of the entire correctional process.

The dynamic unit of all human problems is the individual. Modern medical science makes the appraisal of this unit possible through the medium of psychiatric treatment and social service research. An undertaking, however, which is really consciously intent on reclaiming the individual prisoner to the limit of his capacity with a view of preventing

future returning to misbehavior, would be hampered in its effects if it were to concern itself solely with the native endowments of the individual prisoner. The source of the prisoner's particular being, life, is a dynamic process; and every contact the individual makes throughout life not only leaves its impression on him, but shapes his mental attitude toward his environment. Thus, it is obvious that the housing problem, touching as it does every phase of the life of man, is of fundamental importance, for the environment determines through the influence of the associative imagery of the inmate, a control of his conscious acts and the mechanization of the conscious acts of the prisoner establishes his habits. The manner in which the prisoner has been handled in the past has unquestionably been responsible, if not for the great amount of criminal careers, certainly for the confirming of the individual in his life of crime. The character and kind of prison we have had, in the past, had as its sole aim to achieve mediæval security; a housing condition crude and archaic in conception, which has not helped to relieve and protect society against the spirit of crime, but on the contrary has actually tended to its increase.

Here in New York City the municipality protects the interests of its citizens by the enactment of a structural and sanitary code. Structural safety and physical security and health are provided for all classifications of human activities under the maturely established provisions of that code.

Scientifically, psychologically and practically important as is the structural side of this great prison problem, I have yet to see any workmanlike attempt to establish for prison planners a code, so carefully developed and yet with an elasticity to adapt it to various localities and climates, to the end that the inhumanity of the present day, 1920, toward prisoners would be for all time impossible.

The tremendous security and help that such a code would provide for the development of state

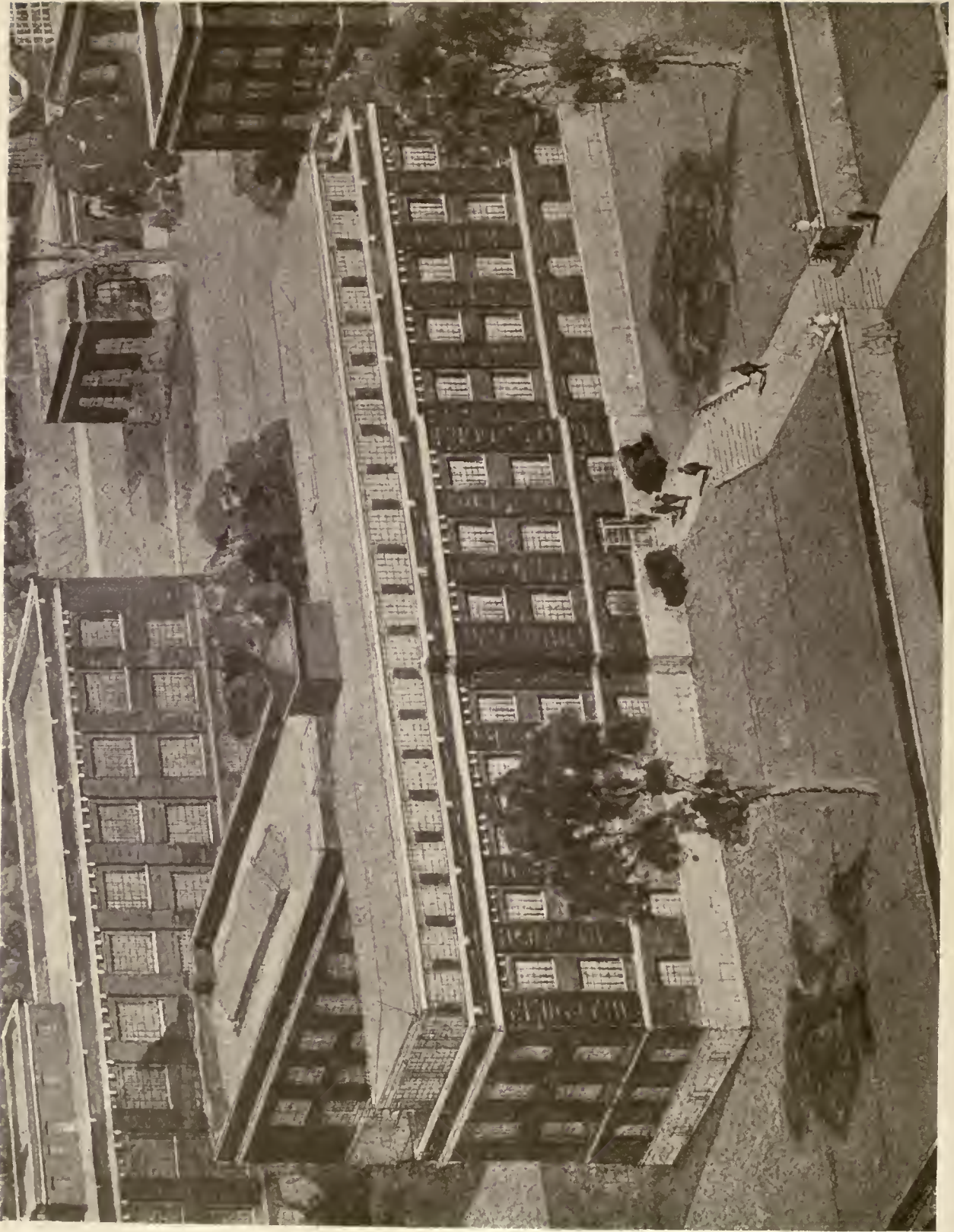

THE PSYCHIATRIC BUILDING, SING SING  
LEWIS F. PULCHER, NEW YORK STATE ARCHITECT

prisons and jails and reformatories is at once apparent.

The complete findings of a competent Code Committee would be the average of the experience of all penal housing problems throughout the country and should be determined by a two-group committee, acting under an organization of national scope. In one group should be available the experience and suggestion of the leaders in penal administration, medicine, psychiatric, industrial, vocational, educational and religious activities. The second group should consist of a small number of architects, engineers or contractual experts—men who have actually planned and structurally executed prison buildings and whose practical experience would enable them sympathetically to translate into constructive form and crystallize the theoretical standards recommended by the sub-committee on strictly scientific phases.

As it is an admitted fact that apperception and interest are the cardinal principles of thought foundation, it may be seen that the chance of improvement in the prisoner will vary in accordance with the thought and action required of him. In order, therefore, that this idea may be efficiently carried out, the prisoner, immediately on commitment to prison, should receive the benefit of an expert clinical examination to determine through his mental and economic possibilities what branch of work he should follow during his term of imprisonment to insure a better existence and a chance to live a decent and productive life after discharge.

The new Sing Sing, therefore, has been planned as a Classification and Distributing Prison, from which the prisoner, after a definite determination has been made of his mental, physical and economic possibilities, will be assigned to that State institution best suited to his individual demands. For example, if it be found that a prisoner is physically unsound, he will be sent to an institution where he can be therapeutically bettered; or, if mentally deficient, to an institution where he can be scientifically treated, and, if possible, given work that will enable him to direct his minimal capacity so as to exempt him from purely custodial care.

The construction and location of the buildings at Sing Sing mean much more, therefore, than the mere erection of a series of large prison buildings for the detention of those who have violated the laws of the State. It will exist as a twentieth century prison elixir, which will take the recrement of society and so purge and refine it that the result will advance, rather than retard, the onward and upward movement of humanity.

In order fully to understand the problem of prison registration, let us follow the course taken by the convict upon his arrival at the Sing Sing of the future: Immediately upon entering the prison grounds, the Court Officer conducts him to the arrival room in the basement of the Registration Building. Here he is turned over to the prison authorities, who take and receipt for his personal property and clothes. The civilian clothes are removed for disinfection and storage. He is then led to the baths, situated across the hall from the property room. After being thoroughly bathed, and subjected to a hasty medical inspection, clean prison clothes are provided. Then, contagion from outside sources having been removed, the prisoner is lodged in a classification cell on the first floor, to await his turn for examination in the rooms provided for that purpose on the second floor. When the examiner is ready for him, he is taken upstairs to be photographed, weighed, finger-printed and generally Bertilloned, and is then sent across the hall to be given a preliminary examination for the determination of his general physical condition. This over, he is led to the educational examination room, where facts concerning his birth, occupation and general history are recorded, and an examination conducted to determine both the extent of his education and his occupational skill. Following that comes a careful mental examination in which the findings of those just preceding are fully utilized. As a result of these different examinations his first classification is made, subject of course to change from examinations to be conducted later.

Besides containing the general Administration Offices, the Bureau of Registration and the Record Bureau the Registration Building will include a reception room where prisoners may converse with visiting relatives and friends. In the past this problem of a reception room for the visitors to prisoners was a difficult one for prison authorities, as it was practically impossible while allowing prisoners a reasonable amount of freedom for the discussion of private and confidential matters to prevent the transfer of weapons, liquors, drugs and implements of escape. This difficulty, however, we think, has now been successfully solved through the following arrangement: Two parts of a large room are separated by two wire nettings, so placed that they form an enclosed passage six feet in width, where guards can be stationed to prevent any attempt to pass articles to the prisoners without, at the same time, interfering in the carrying on of a conversation.

Adjacent to the Registration Building, and on the same high plateau overlooking the Hudson, is the Temporary Detention Building with cell rooms on

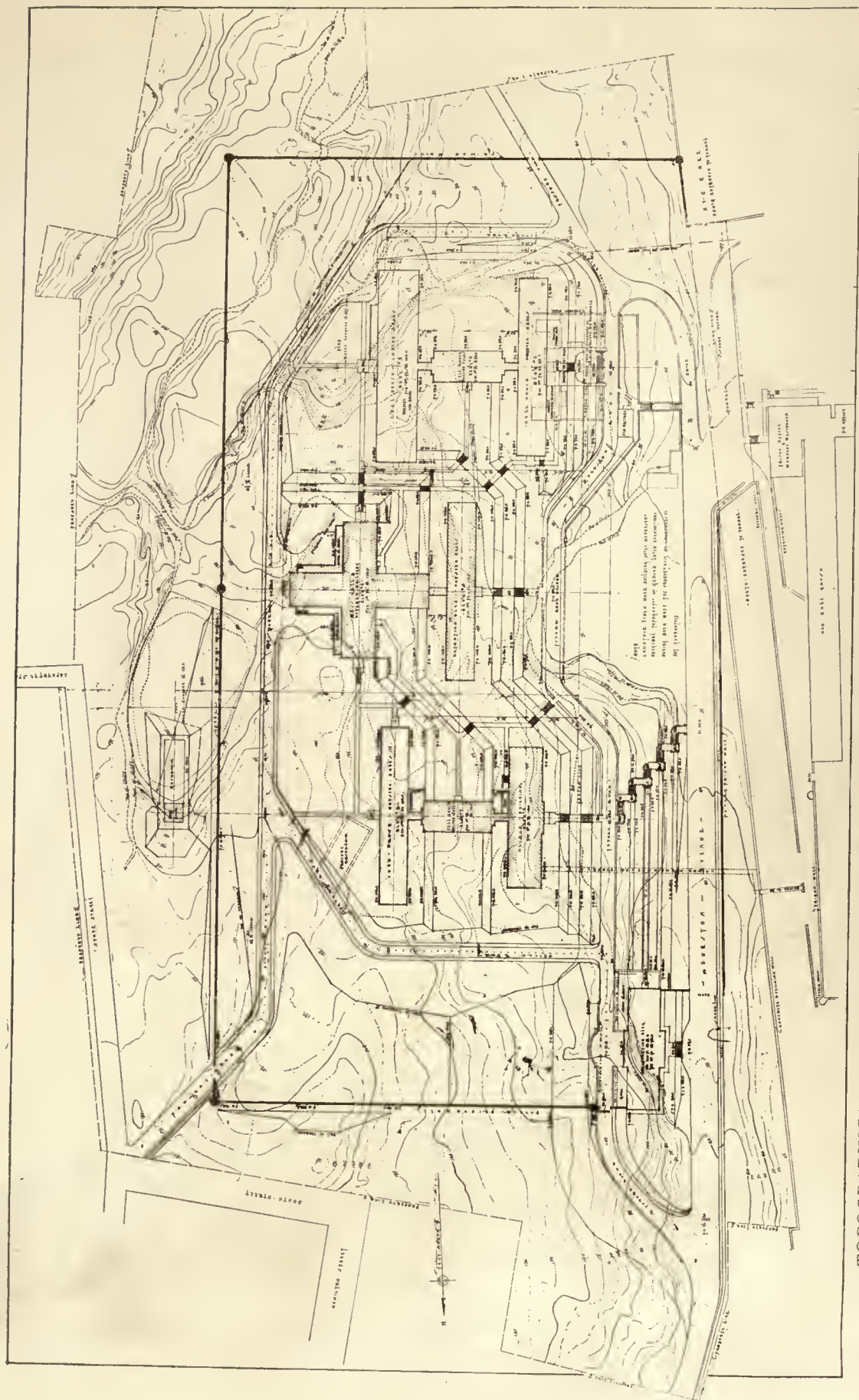

**TOPOGRAPHICAL AND BLOCK PLAN OF SING SING CLASSIFICATION PRISON NOW UNDER CONSTRUCTION**

The site to be occupied by the new buildings is perhaps the best constituted prison site in the country, overlooking the Hudson—isolated from and yet adjacent the city of Ossining—easily reached from New York by both boat and rail. The terracing of the site has made it possible to give to each building its "place in the sun," inside the prison walls—an ever present souvenir to the prisoner of the patriotism of the founders of his country. The old prison buildings occupy the area to the West of the N. Y. C. R. K. tracks which appear at the bottom of the cut. The question that all interested in Prison Reform are asking is why the natural advantages of site were overtly overlooked until the present plan was developed.



## THE AMERICAN ARCHITECT

separate floors, so arranged as to place the prisoners under the constant supervision of the clinical experts, who will conduct their examinations in the adjoining Clinic Building.

The clinical laboratory was developed under a medical commission composed of: Dr. Walter B. James, President of the New York Academy of Medicine; Dr. Charles W. Pilgrim, Chairman, New York State Hospital Commission; Dr. Thomas W. Salmon, Director of the National Committee for Mental Hygiene; Dr. G. H. Kirby, Director of the Psychiatric Institute of the State of New York; Dr.

On the second floor is a quantitative and qualitative laboratory; a museum, a recording room, a library and lecture rooms, and on the third floor are surgical wards, subdivided for major and minor operative cases, together with medical wards, so planned as to have ordinary and chronic medical cases in separate divisions. The hospital is to be freely used for detailed observation as well as for treatment.

The fourth floor contains a complete operating department with two operating rooms, one for major and the other for minor operations, each having

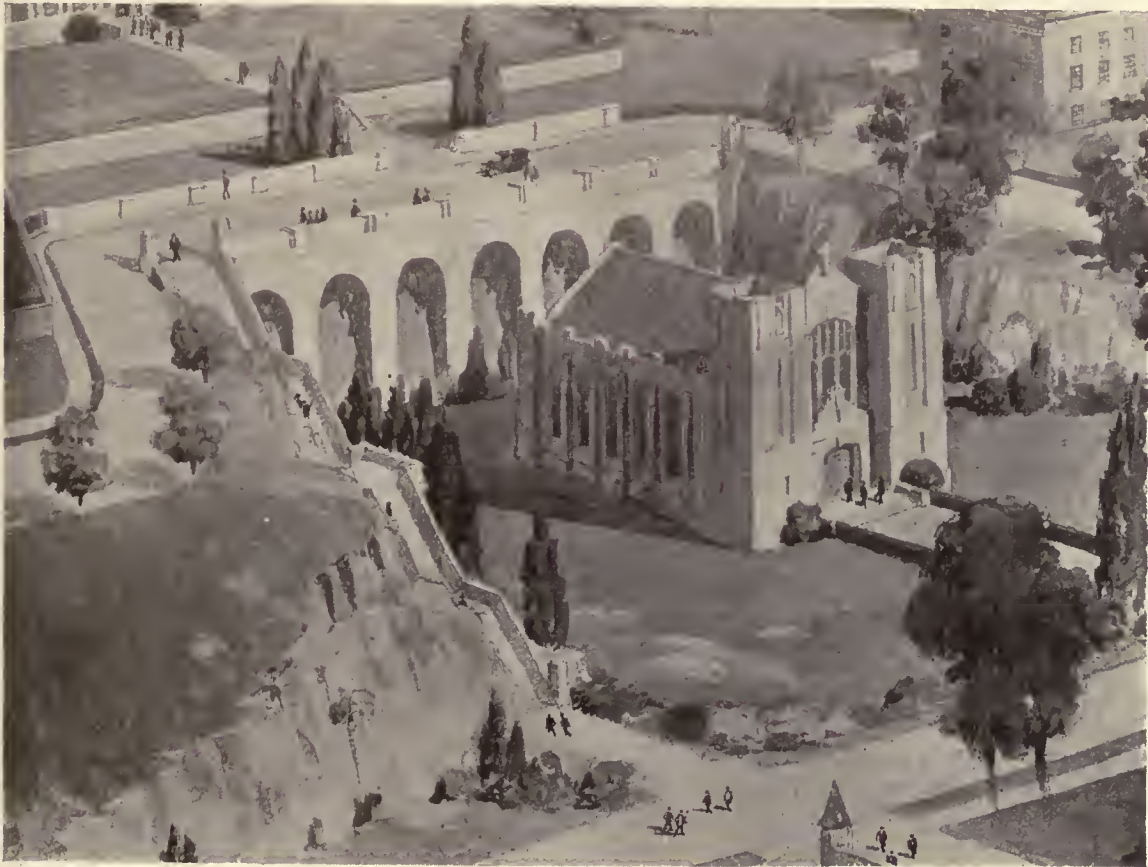

THE ARCADE AND CHAPEL, SING SING PRISON  
LEWIS F. PILCHER, NEW YORK STATE ARCHITECT

Isham G. Harris, Superintendent of the Brooklyn State Hospital; Dr. Carlos F. MacDonald, Alienist, and Dr. W. F. Brewer, Surgeon. Provision has been made on the first floor for a modern X-ray apparatus and its various accessories; three rooms for the physician in charge of the venereal examinations; a surgical laboratory; rooms fitted for the examinations of the eye, ear and throat, psychiatric and psychological examining room, dental operating room and laboratory, and a laboratory for the use of the staff working in the diagnosis and examination rooms.

separate sterilization facilities, together with preparation, etherizing and recovery rooms, while the remainder of the floor is given up to rooms for the male nurses and a convalescent solarium.

In addition to using the building as a clinical hospital for the housing of psychiatric and medical requirements of the prison, it is also planned to use it as a school for the education of male nurses, as it is found that efficiency in prison nursing is directly proportional to the nurse's understanding of the relation of scientific, medical and psychiatric

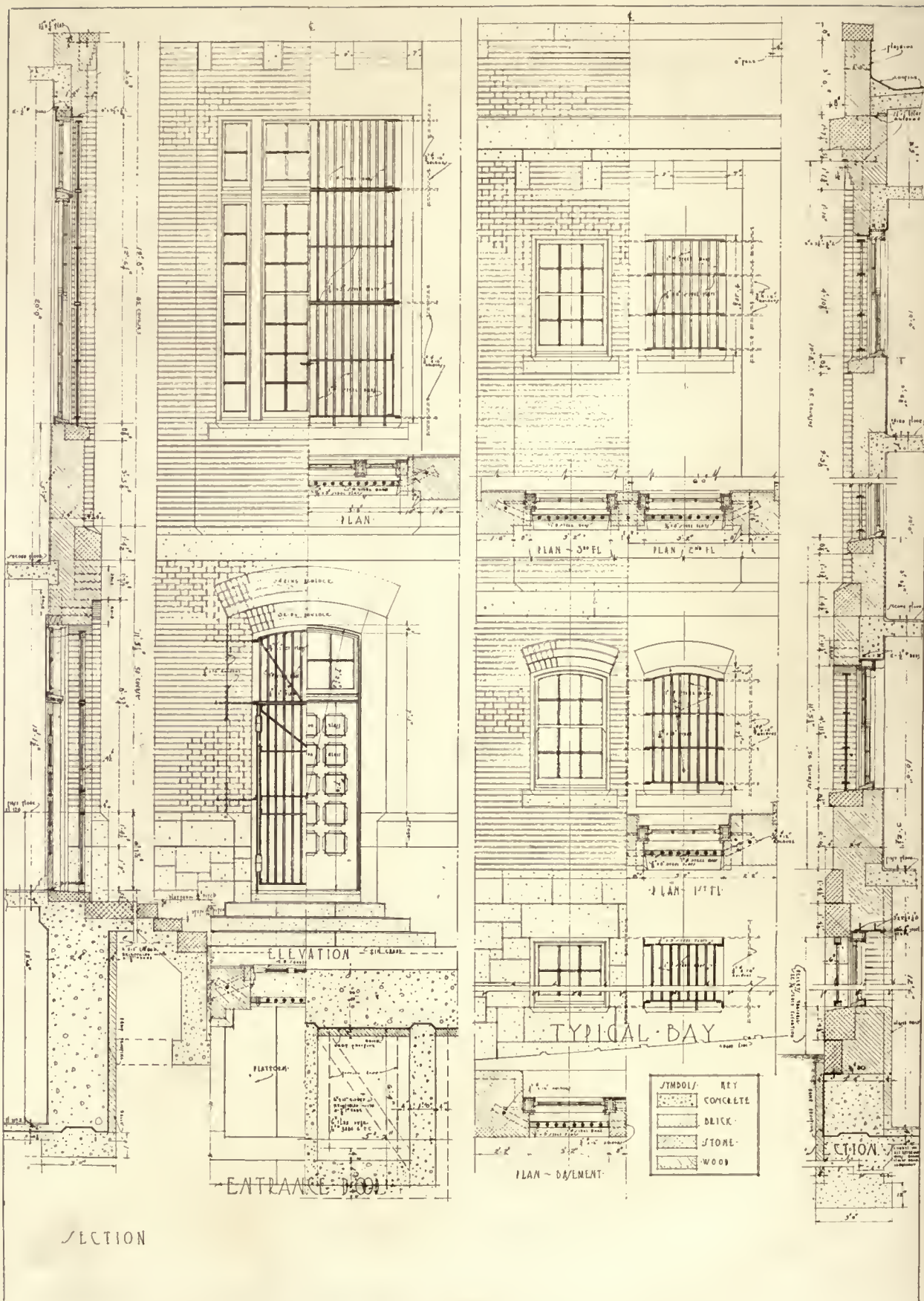

TYPICAL DETAIL OF THE CONSTRUCTION OF ALL BUILDINGS

knowledge to the peculiar problems of a prison community.

To the rear of the plateau, and connected by exterior cell block buildings with the structures just considered, two housing groups have been planned

tutions. In the new Classification Prison a "day-room space" system has been arranged for by which each prisoner is allowed fifty square feet of sleeping space in the dormitory and fifty square feet of space in the day-room. Individual lockers will be

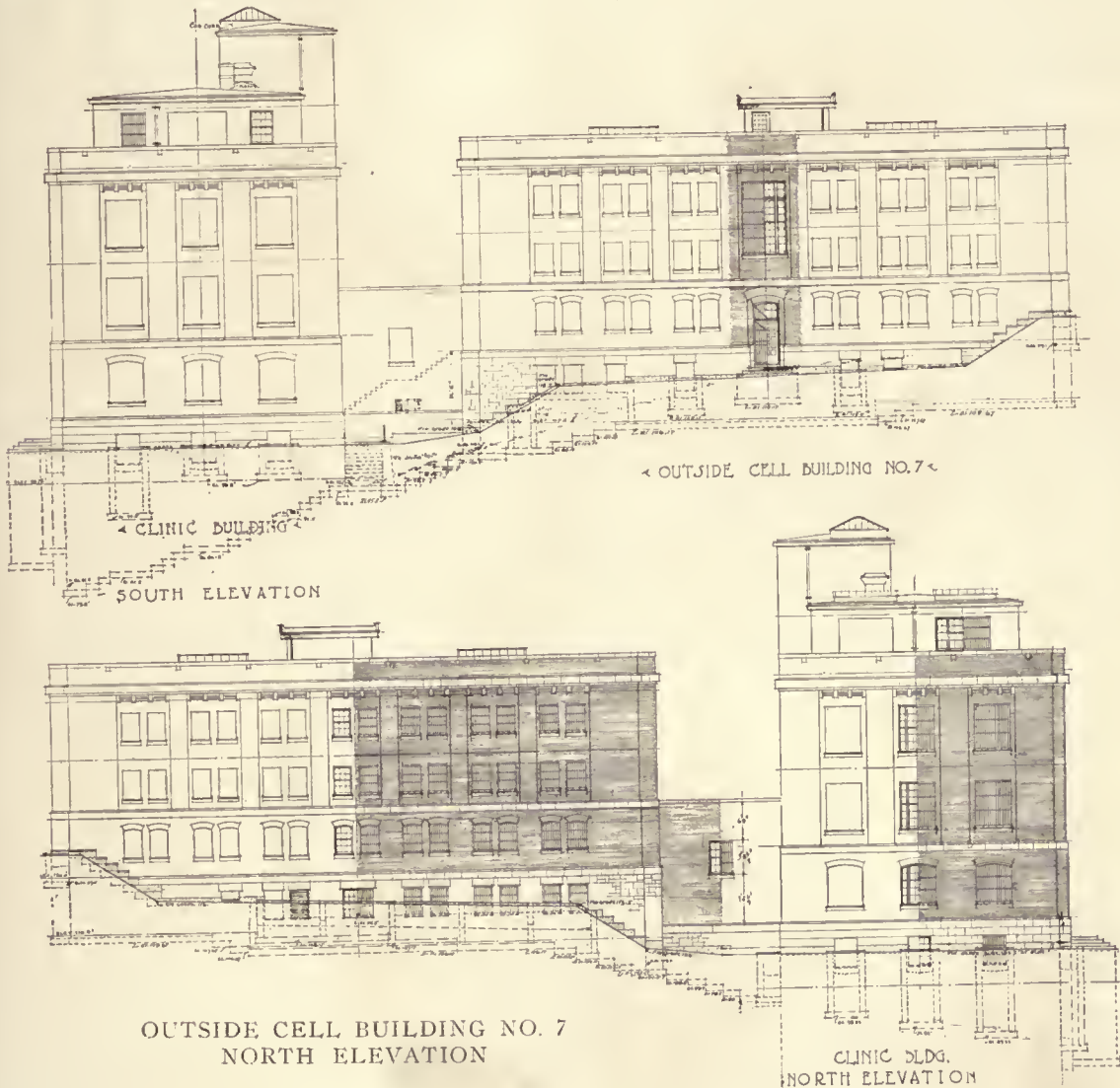

The side elevations show the terracing of the site and the advantages derived from the differences in levels

and constructed in accordance with the interlocking dormitory cell-room type, each having accommodations for three hundred prisoners.

In the past the failure of all dormitory systems has been due to the fact that no provisions were ever made for what is technically known as "day-room space," which is as necessary in prisons as in hospitals for the insane, or in charitable insti-

tutions. provided for each prisoner, as it has been determined through former experiments that a sense of individual responsibility is evoked if each prisoner be provided with a separate locker for the safekeeping of such possessions as he may be allowed to have during his incarceration.

Experiments to determine the most efficient method of guarding dormitory prisoners have dem-

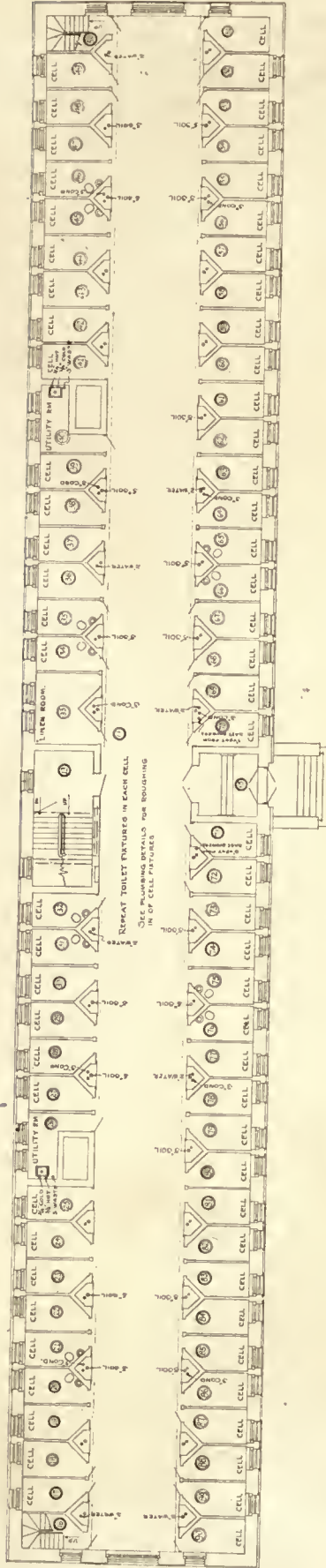

REST FLOOR PLAN

DETENTION BUILDING NO. 5,  
SING SING PRISON

Typical floor plan of Detention Building No. 5, a basement and four story outside cell building. This plan shows the arrangement of cells against outside walls which gives to each inmate direct sunlight and air; a vital factor for the moral development and physical condition of the inmates

onstrated the impossibility of a guard stationed on the main floor of a dormitory overseeing all parts of the room. To correct this difficulty an elevated mezzanine guard walk has been planned situated eight feet above the floor proper, and permitting an unobstructed view of all portions of the dormitory.

The study and practice of mob psychology has demonstrated that when a group of fifty men are continually together there arises an inner controlling group, numbering from seven to eight men, this number decreasing in irregular steps down to the one man who dominates a group of from ten to twelve. Using this fact as a basis for further experiments, it was decided that a mean between these two numbers, twenty-seven, resulted in the most satisfactory group arrangements, and the dormitory units have been designed accordingly.

The interlocking

dormitory cell-room buildings provide the elasticity of classification demanded by the more advanced penological ideals. Each dormitory building will be three stories in height, and will have two dormitory units, symmetrically placed on each floor, each unit consisting of a day room, lavatory, locker room, and dormitory proper. Access to the dormitory floor is by a central stairway, while the cell room floors are reached from intermediate landings in the main stairway.

The entire Sing Sing project includes kitchens, dining rooms, library, school, vocational shops, recreation hall, roads, walks, a modern sewage plant, a power house to heat and light the many buildings and to operate the industrial plants, and a church for the development of religious and community ideals.

In addition to the proper placing and co-ordination of the structures and their component parts, and the abolishment of unsanitary conditions in the interiors, by the architectural treatment of buildings and site, a great step forward has been taken in the creating of a proper and fitting atmosphere and environment. The old idea of the ugly, heavy barred and broken walls, which produced the dismal, forsaken, isolated and jail-like appearance of former prisons, has been discarded. In their places will be many-windowed, substantial brick structures, extending from the river to the plateau in the rear of the elevated site, in dignified and well-proportioned stages.

The causes which formerly created in prisoners the feeling of being entombed, useless and hopeless exiles have been done away with. It is our hope that ideals of respectability, industry, efficiency and co-operation

will arise from these new prison conditions and make strong, beneficial and lasting impressions on the mind of each prisoner.

It is only by such utilization of the experiences in allied fields and their thoughtful application to prison conditions that progress may be hoped for in solving this important human problem.

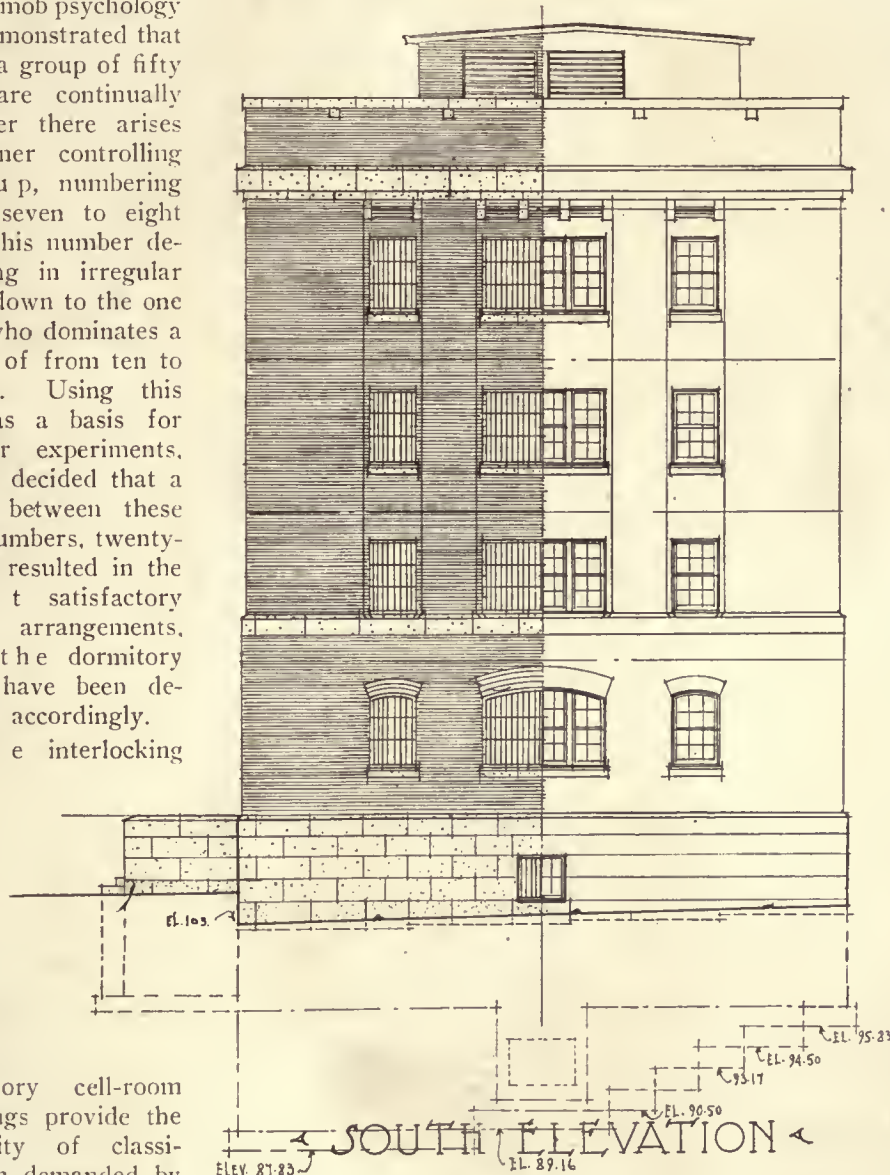

DETENTION BUILDING NO. 5



CHAPEL, SING SING PRISON

# The Clinic Building at the New Sing Sing Prison

By WALTER B. JAMES, M.D.

IT is many years since men began to realize that their diseases were not the result of a divine purpose, and so they have attempted, first, to understand their origin, through study and analy-

and the disease and suffering rate has markedly diminished and is still diminishing.

To-day, resignation and patient submission in the presence of disease of the body are no longer vir-

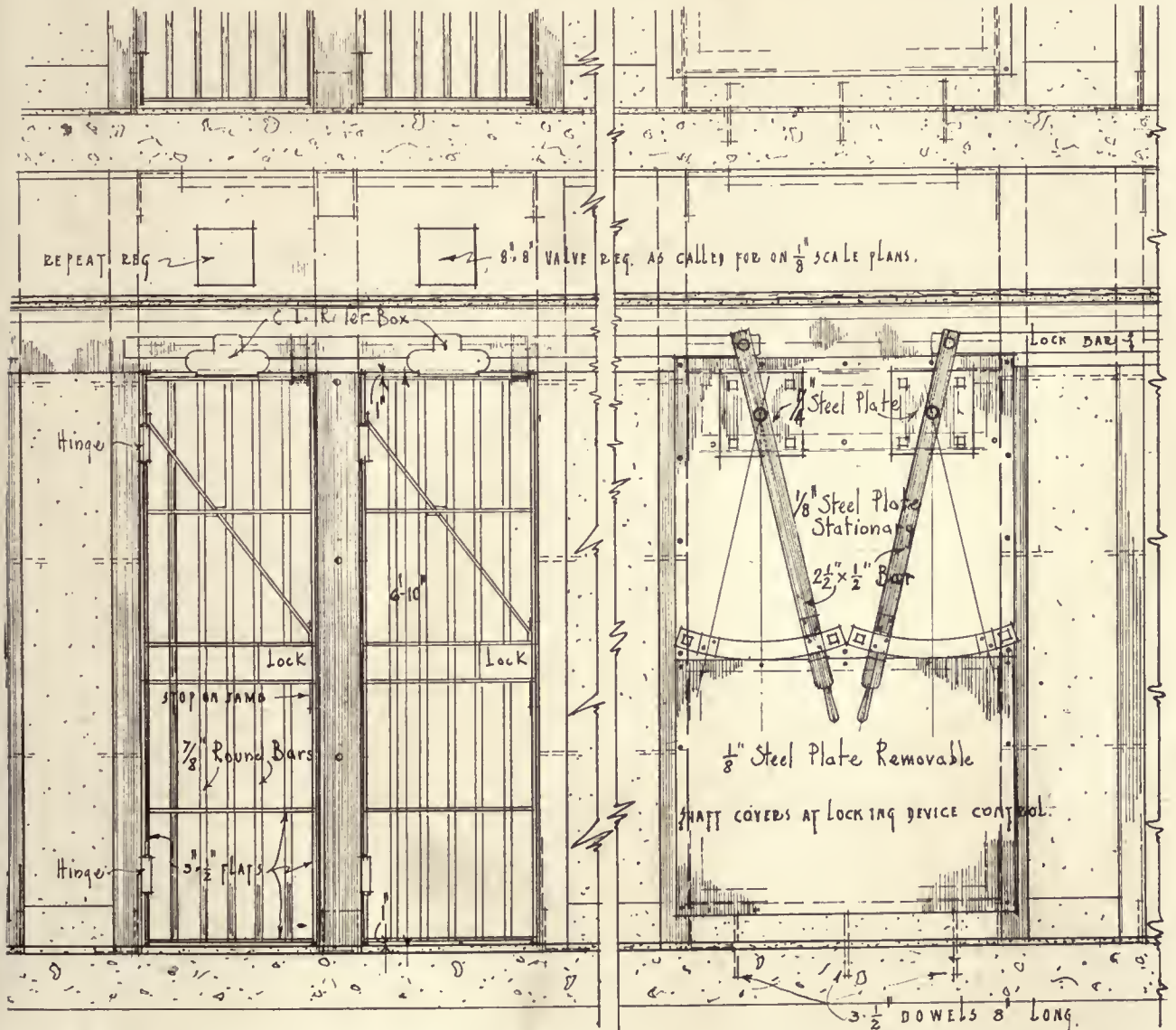

TYPICAL CELL FRONT

LOCKING DEVICE CONTROL

A typical cell front with locking device to hold doors shut while the guard passes down the walk, locks each cell door individually with key and feels assured while he is doing this that he will not be attacked

sis, and then from these to discover means of prevention and cure. As a result of these efforts, the prolongation of human life has more than doubled, and mental disease has only more recently been looked at from this same viewpoint, and gratifying headway is being made in this direction. The world

# THE AMERICAN ARCHITECT

is just beginning to realize that misbehavior or anti-social behavior presents to society a problem somewhat similar to that of physical and mental disease.

I do not mean that misbehavior is necessarily the result of or associated with disease, either phys-

that is, through scientific analysis and classification, the discovery of causes, probably very complex, and the application of remedies, probably chiefly preventive, and based upon these causes. Only in this way can it be hoped to turn this costly waste product of social life into a useful by-product.

THIS FLOOR CONTAINS A BAKERY WITH FLOUR AND BREAD STORAGE ROOMS AND WITH EQUIPMENT TO PROVIDE BREAD FOR THE

THE MAKING OF ICE AND AN AMPLE KITCHEN STORE ROOM.

A MESS HALL WITH INDEPENDENT COAT ROOM

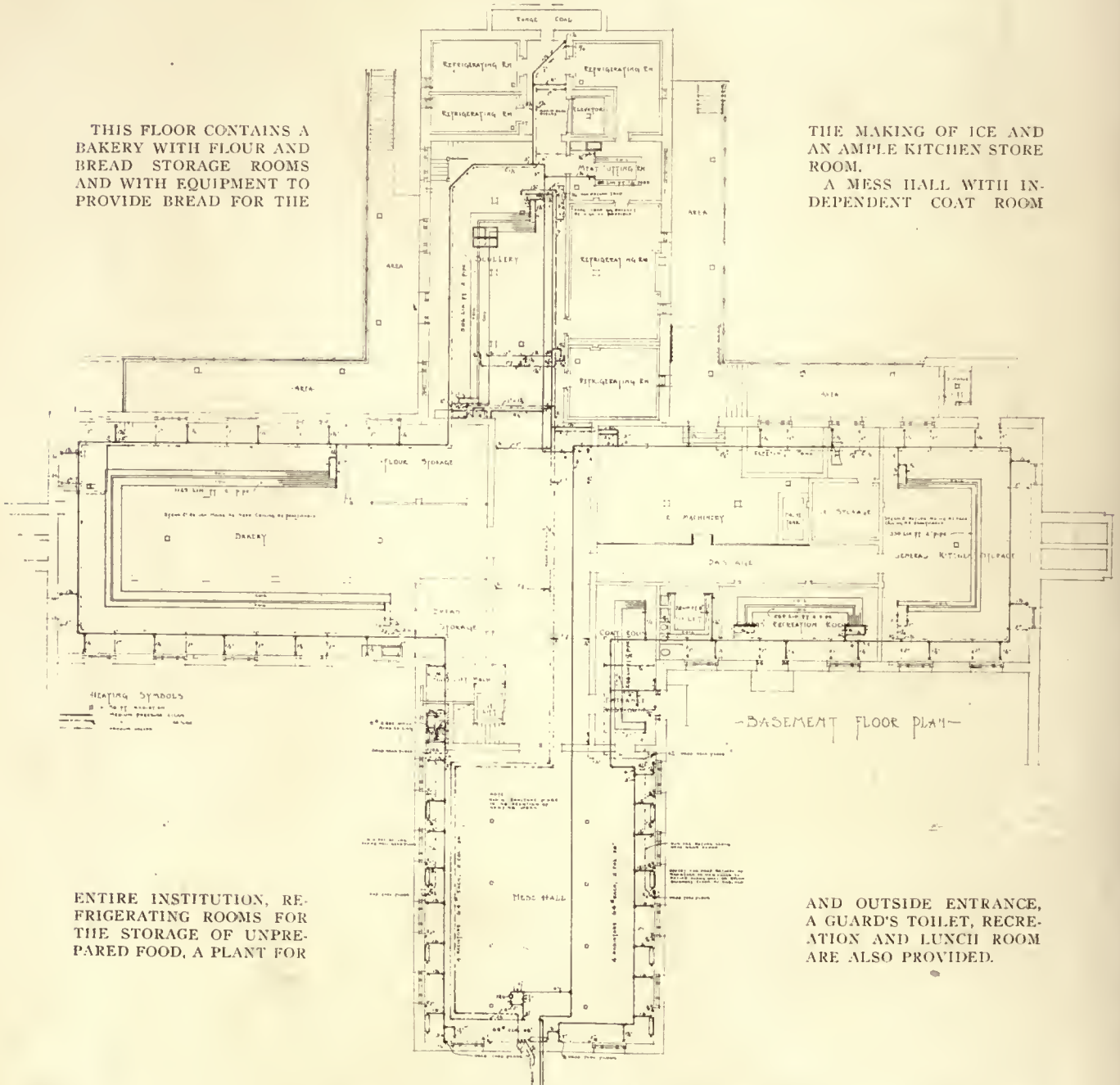

ENTIRE INSTITUTION, REFRIGERATING ROOMS FOR THE STORAGE OF UNPREPARED FOOD, A PLANT FOR

AND OUTSIDE ENTRANCE, A GUARD'S TOILET, RECREATION AND LUNCH ROOM ARE ALSO PROVIDED.

MESS HALL AND KITCHEN BUILDING

ical or mental, although this is often the case, but that it presents an analogous problem to society, and that it should be attacked in the same manner,

When the "Sage Prison Bill" became a law, providing for the demolition of the old Sing Sing cell block and the erection there of a new study, classi-



# THE AMERICAN ARCHITECT

fication and distributing prison, and creating the "State Commission on New Prisons," New York State committed itself to a new and more intelligent policy toward its offenders and toward the whole problem of misbehavior. The new commission, commanded to carry out the above and other pro-

committee was formed. About a year before this, realizing the need of a more thorough psychiatric study of criminals along the lines that had been followed so well by Dr. Healy at the Juvenile Detention Home in Chicago, the National Committee had placed Dr. Bernard Glueck in Sing Sing Prison,

THIS BUILDING OCCUPIES THE CENTRAL POSITION OF THIS GROUP AND IS EASILY ACCESSIBLE FROM ALL CELL BUILDINGS.

THE MESS HALLS ARE SO DESIGNED TO TAKE COM-

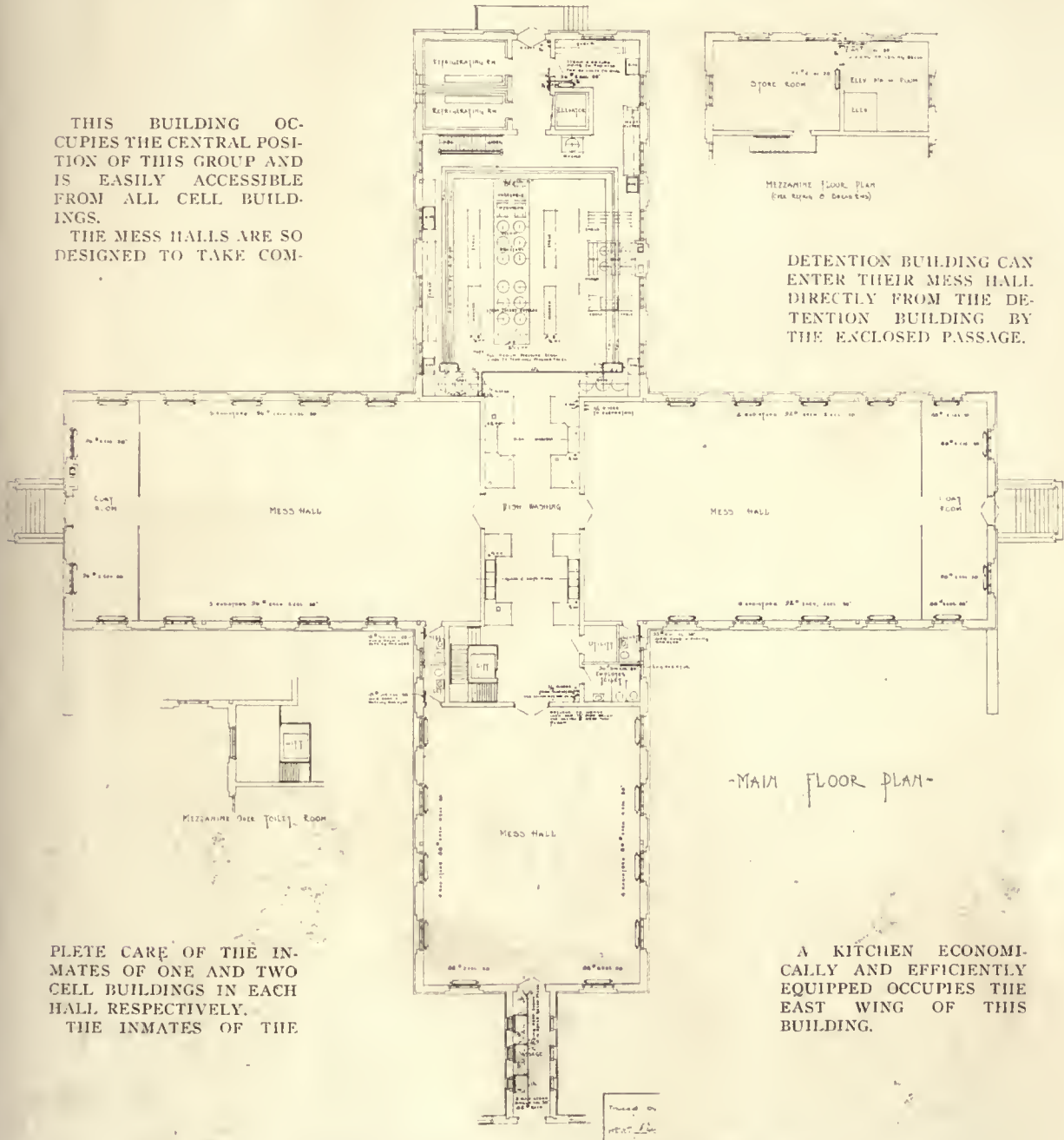

DETENTION BUILDING CAN ENTER THEIR MESS HALL DIRECTLY FROM THE DETENTION BUILDING BY THE ENCLOSED PASSAGE.

-MAIN FLOOR PLAN-

COMPLETE CARE OF THE INMATES OF ONE AND TWO CELL BUILDINGS IN EACH HALL RESPECTIVELY. THE INMATES OF THE

A KITCHEN ECONOMICALLY AND EFFICIENTLY EQUIPPED OCCUPIES THE EAST WING OF THIS BUILDING.

MESS HALL AND KITCHEN BUILDING

visions, soon found itself confronted by problems that belonged essentially to modern medical science, and it turned to the "National Committee for Mental Hygiene" for counsel, and an advisory medical

with the consent and sympathy of the Department of Prisons, to carry out a complete mental analysis of all new admissions.

The results of Dr. Glueck's studies have been

## THE AMERICAN ARCHITECT

published in full in "Mental Hygiene," and elsewhere, and form a valuable foundation for the scientific handling of the mental side of prisoners.

The commission and the state were fortunate in having Mr. Pilcher, the New York State Architect, to translate these ideals into actual construction, and now the completion of an important part of the plans, including the Clinic Building, and, most of all, the final assigning of the contract for the erection, insures the carrying out of this interesting and important project.

Mr. Pilcher has thrown himself into the undertaking with singular diligence and intelligence, and has entered thoroughly into the spirit of modern scientific treatment and research.

The newest and most original feature of the prison is the Clinic Building, in which the study and classification of the prisoners is to take place, and in which, as well, the general medical and surgical work of the institution will be carried on. It provides for the complete physical and mental examination of every inmate. It contains the hospital wards, dispensary, operating rooms and laboratories and X-ray plant, and

indeed, it corresponds on a small scale to the hospital of any community, but differs from this in that it assumes that the whole population of the community may be abnormal, and therefore requires that every member of it shall at some time pass through the clinic for purposes of study and analysis. For this reason, the psychiatric or mental division of the clinic is relatively more accentuated.

It requires courage to attack such a problem as this, an attack that may carry us into troublesome social fields. It seems to be a fact, however, that no other method gives promise of relieving society of any considerable part of this burden of suffering and cost. We must not expect ever to be entirely rid of this burden, just as we shall never be rid of the burden of physical and mental disease: but just as science has diminished and is still diminishing these latter, so we have reason to believe that similar scientific methods, properly applied, will diminish the burden of anti-social behavior, and help us to approach the irreducible minimum, a minimum which must probably always exist in a human world like ours, but a minimum from which we are at present still very far.



THE SPORTSMAN  
SILK BATIK WALL HANGING, BY ARTHUR CRISP



*In order to supply our readers with material of current interest, the news and comment appearing in issues of THE AMERICAN ARCHITECT delayed by the printers' strike will be as of actual rather than stated date of publication.*

## The Architect's Opportunity

AT the Hotel Sherman in Chicago on March 24 and 25 will be held the first annual meeting of the National Federation of Construction Industries. This Federation was formed for the purpose of extending construction and improving conditions in all the several divisions of the building field. A definite attempt will be made to promote a closer co-operation between architects, engineers, contractors, producers and distributors of materials, realtors, financiers and other construction interests. It is also desired to develop and preserve satisfactory conditions in the relationship of the interdependent elements in the industry to the general public, including the government, labor and consumers. The Federation states the further object of serving as an exchange between and common meeting place for associations representing special building projects. In cases of common interest to the different branches of the construction field in general, the Federation proposes to take the initiative in investigation, policy, propaganda, legislation and in such other ways as will advance this movement. A united organization will, it is hoped, be developed, which will mobilize the entire strength and experience of the various units.

It will be seen from what has been set forth that this meeting will be of fundamental importance to everyone engaged in any aspect of construction. Invitations to be present are extended to every national, regional and local association, and to architects, engineers, manufacturers of supplies and all allied industries.

HERE is presented an opportunity for architects to mingle with the most practical representatives of those allied industries with which it is to their interest to co-operate. Here at the first annual meeting of a vitally important and influential organization, the architectural profession may cre-

ate a precedent. Its members may so participate in the proceedings as to earn recognition among the delegates to the convention as the earnest, capable, farsighted, competent group of men that its practitioners have been striving, and with increasing success, to demonstrate themselves.

Important topics will be discussed. The attitude of architects should, for both personal and impersonal reasons, not be omitted. If the profession is largely represented there will be instilled a certain dignity and unanimity into the meeting that must otherwise be lacking. If architects desire to effect certain reforms, where is a better opportunity afforded than in such a congress, before an open, unprejudiced body of men with only professional ideals before them?

It is therefore urged that architects, individually and collectively, avail themselves of the possibilities of meeting in the forthcoming convention of the National Federation of Construction Industries, of which John C. Frazee, Drexel Building, Philadelphia, is the executive secretary, and learn how far they may aid in the attainment of those very purposes for which they stand.

## Developing the Farm Building

TRAINERS of athletes always object to forms of exercise that only develop the body locally. They seek to build up first the entire body, later giving such attention to specific exercises, as will increase efficiency in the direction desired.

In the development of a nation or even a municipality these same conditions as to proper growth along proper lines obtain. Possibly there is too close attention to the development of cities and not enough to that of our rural communities. And this lack of interest is beginning to have its effect on the rural communities and particularly the farming sections all over the country.

It has been found to be a grave mistake to infer

## THE AMERICAN ARCHITECT

that the farming population is not so thoughtful as are those who dwell in large communities. Recent inquiries by the government have disclosed that there is a decided feeling of unrest among the farmers. It has been proven that the farmer is now prepared to assert his right to recognition and will not longer be considered as a group outside of the real activities of our economic and political lives.

The farmer will demand recognition as a large producer and manufacturer and he will not much longer patiently allow others to gamble on and become wealthy in the things he produces. As he grows in importance, as he most certainly will, he will demand for himself and for his family the same opportunities for advancement as are to be availed of by his city-dwelling brethren. He will insist in the future that his house, his farm buildings and his social relations be fully up to every American standard, and knowing that these may only be attained with money, we may expect to feel the effects of a movement on the part of farmers toward securing for themselves a greater share of the profit realized on their product.

It will not be wise further to ignore either the farmer or the dweller in rural communities. The

American Institute of Architects has been quick to endorse and at times enthusiastic in its co-operation with those large undertakings that affect the city. For now more than two years THE AMERICAN ARCHITECT has urged that some closer attention be paid to the farmhouse and its dependent buildings. Owing to the wide-awake spirit of some of the Middle Western delegates to the Nashville Convention, a resolution appointing a sub-committee on farm buildings was passed at that convention. Nothing as far as we are able to learn has come out of that committee.

Recently, announcement was extensively made of a proposed conference on farm buildings. The committee in charge, a large one, did not contain the name of a single architect. THE AMERICAN ARCHITECT directed attention to this omission and was at once assured that an architect would be added to the committee.

No credit may be taken by this journal for the performance of a simple act of duty, but it may be asked if the Institute or other organized bodies of architects may not be considered as properly sharing the responsibility of conserving the rights of architects to recognition.



A SUBURBAN DEVELOPMENT AT HOPEDALE, MASS.

ARTHUR A. SHURTLEFF, *LANDSCAPE ARCHITECT*



GENERAL VIEW, WINGDALE PRISON  
LEWIS F. PILCHER, NEW YORK STATE ARCHITECT

# The Wingdale Prison Site

By LEWIS F. PILCHER, *New York State Architect*

THE more advanced of the modern penologists are rapidly discarding the old theory that a certain humanity and kindness should be eliminated from society's dealings with its less responsible citizens. They are substituting in its place the idea that the majority of criminals are not inherently bad, but, lacking the idealistic principles of good citizenship which result from environment and education, are only wayward.

If we accept this new theory, and make negligible the assumption that most criminals have inherited a tendency toward wrong-doing, it becomes necessary for us to revise many of our ideas concerning the government, discipline and housing of prisoners, and to acquire an impressionable quality of mind susceptible to new theories and experiments which concern the welfare and advancement of our less fortunate fellow men.

With all these things in mind, and with the desire to do our part in ameliorating prison government, the Commission on New Prisons has endeavored, in the building of the Wingdale Prison, to achieve a good architectural result combined with these essential reforms. In order that these aims may be fully understood, I shall attempt to explain both the architectural plan of this new prison and the reasons for selecting a sloping rather than a level topographical site.

If one surveys the history of civilization and investigates the growth and final results of the structural plan of either religious or civil communities, it is at once apparent that the final housing scheme of any given settlement is determined by the topography of the region in which that settlement is located.

For example, the study of the settlements of antiquity shows that the higher locations were universally chosen as the sites of palaces and temples, and that where the configuration of land did not permit of such natural elevation, mounds or raised crepidomas were constructed, in order that by means of the terraced elevations a distinction might be made between the different degrees of religious prominence.

That the Egyptians who inhabited the level areas of the alluvial Nile appreciated the psychological effect of such terraced elevation is shown by the architectural arrangement of their temples. To emphasize the hieratic mysteries, the worshiper was led from a pyloned gateway into an atrium

with a pavement slightly graded above the level of the dromos. This atrium, open as it was to the effects of the brilliant Egyptian atmosphere, offered a subtle psychic preparation for that elation of soul which stimulated the novitiate when, after ascending the steps on the far side of the atrium, he entered the sombre shadow of the hypostyle hall. This elation increased in many cases to a religious ecstasy when the novitiate ascended from the far side of the hypostyle hall into the upper region where the esoteric mysteries were performed.

A simpler expression of this religious constructive arrangement may be seen in the Temple of Kohn. Here the priestcraft developed a form of temple construction which crystallized all the associative imagery of man and reflected in its different stages of elevation of the various sections the relevant distinctions of class and the progress of humanity toward its idealistic goal.

Thus in the low grade level of the atrium the light, the air, and freedom of movement suggested that lack of function and freedom from formal life which exists among the multitudes; the conscious effort of ascent in walking from the atrium to the hypostyle hall suggested the difficulties of rising from a lower to a higher social order, while the further ascent to the small, calm and dimly illuminated holy-of-holies symbolized the fact that only through struggle, loneliness and pain may a devout one hope to attain the quiet and sublime dwelling place of the gods.

When the Greeks rose to intellectual and artistic position they evolved the Greek form of temple, which was simply an Hellenic translation, through the medium of the Mosaic temple; of the Egyptian hieratic imagery. - Perhaps the most typical of these temples is the great marble Parthenon (438 B. C.) which was reared upon a three-stepped crepidoma, a worthy stylobate support, a marvelous peristyle, reminiscent of the open air atrium of its Egyptian prototype. Further on, and beyond the peripteros, and at a higher level, the pronaos led through a great door into the shrine chamber of Athena. Thus did the architects, Ictinus and Callicrates, express in much the same manner as the Egyptians the essence of crystallized human experience.

In the flat country of Mesopotamia the architects built lofty zekkurats in order to provide high

substructures for the crowning cella or shrine, and these lofty, temple-capped pyramids had a materialistic as well as a spiritual value in that they helped to form in the minds of the people an ideal as to the position in the community of both temporal and spiritual power.

To the north, at Khorsabad, a city of Assyria, the rulers constructed, as part of the great wall, an enormous plateau. This artificial mound, towering as it did some sixty feet above the level of the city, was used as a place of residence for the king and his court, while back of it, and so high that it bathed the plateau with its shadows, was constructed the many-stepped, cella-crowned temple of the priests. Thus religion looked down upon royalty and royalty, in turn, on its walled city with its level streets and multitudinous inhabitants, and thus in this segregated and self-sufficient community a natural and unwitting psychological arrangement of class housing was worked out by these early architects.

This same community phenomenon which we have noted in the Orient existed at the same time at Mycenae, Thyrns, Argos, Attica and Rome,—the heights being always occupied by the rulers, the foot-hills by the nobles and the adjacent plains by the people.

By these few examples taken from the religious and civil architecture of early civilization I have endeavored to show that class distinction tends to express itself through the use of different housing levels, the height of each group being directly proportional to the power of its social division, thus giving a concrete expression to the theoretical grades by which the human mind differentiates the social status of the people who comprise any given group.

If we apply this rather pragmatic psychology to the problem of planning a new prison, we find it obvious at the outset that a prison population forms, together with its dependencies, a complete segregated community and therefore presents few phases which have not been successfully solved in the various treatments of community houses in past eras. Bearing in mind both this and the psychological principles which determine the function of any segregated community, it becomes

perfectly clear that the old system of plotting an entire prison plan on an absolutely level piece of ground does not agree with either the teachings of history or the psychological principles which determine the site of community housing, and it thus becomes manifest that if we are to plan a prison which will be both a protection and a benefit to society we must select our site and construct our plans with the idea of having different grades of elevation for different degrees of social eminence.

If, remembering this, we summon practical experience to our aid we find that a prison population divides itself naturally into three major divisions, two of which are composed of actual inmates and a third of those in authority over them. The first and largest of these groups is made up of sub-normals and general recalcitrants who of necessity must work, eat, and sleep under constant and direct supervision. These will be confined in strong, well-guarded buildings situated within a walled enclosure and the work which they do will be such as can be efficiently done within the comparatively small space to which they are restricted.

The second group, composed of prisoners who have shown themselves worthy of trust, will be allowed privileges which are denied the first. A concrete expression of these privileges will consist of lodging them in buildings situated on a higher level and with no enclosing walls, thus allowing them to carry on dairying, farming, stone crushing and similar industries.

As the working out of our community idea demands that the governing class occupy a higher site than those they govern, we have planned an adjacent but higher elevation for the offices, dwellings and other buildings necessary for the proper maintenance of a model prison.

In our plan for the new Wingdale Prison we have attempted to express a prison which will meet the scientific and historic precedents which we have at our command, and we fully believe that our plan will exert as beneficial an influence on our prisoners as did the noble monuments on the Acropolis at Athens on the humble people who constructed their mud-brick houses at its base.



DRUG AND CHEMICAL FACTORY OF MESSRS. BURGOYNE, BURBIDGES & CO.,  
EAST HAM

MESSRS. SEARLE & SEARLE, ARCHITECTS

## Factory Design in England

**I**N this issue there are illustrated a number of the examples of the work of Messrs. S. Cecil Searle, A. R. I. B. A. and Norman O. Searle, A. R. I. B. A., who form the architectural firm of Searle & Searle of London, England.

In presenting these interesting examples of factory construction it is worth while to comment on the fact that this firm has a history dating back for more than eighty years and the present members are of the third generation of its founders. While these old associations are by no means rare in England they are almost if not entirely unknown in the United States.

There undoubtedly is a very large measure of satisfaction in a relationship between architect and client, one that has been preserved from generation to generation. In some instances it is not unusual to find that there has been a close relationship between architects and clients extending over periods of almost forty years. In the case of some of the work illustrated in this issue, the architects have

joined with their clients at the very beginning of the client's business career, and as the business has prospered they have, bit by bit, unit by unit, added to the buildings required until vast plants covering large areas mark the co-operation and secure the fulfillment of architectural coherency that is so marked in this class of building and so utterly lacking in similar types in this country.

Such very favorable relations will undoubtedly inspire an architect to his very best efforts.

An interesting feature of Messrs. Searle & Searle's work illustrated is the Brantham Village Hall. We need a building of this type in every small town in this country. Nothing can more encourage a true commercial spirit than the availability of similar buildings as a place where townspeople may meet to discuss their problems, celebrate an occasion or socially mingle.

The architects, in very kindly placing at our disposal this group of interesting work, write as to this hall as follows:





BRANTHAM VILLAGE HALL,  
NEAR MANNINGTREE, ESSEX, ENGLAND  
MESSRS. SEARLE & SEARLE, ARCHITECTS

## The Brantham Village Hall

**T**HIS building is erected in the village of Brantham, Suffolk, to the designs of Messrs. Searle & Searle, architects, for C. P. Merriam, Esq., J. P.

Two entrance porches give direct access from the road to the hall, the size of which is 24 feet wide and 45 feet long. The hall is well lighted at the sides and north end by large windows having steel casements and lead lights in diamond panes. The special features in the hall are the massive piers between the windows, carried out in light red brindled bricks pointed with a white joint, and the roof, which is constructed with open timber trusses with curved braces to collars and purlins, oak sole pieces and carved brackets.

At the south end there is a raised platform 3 feet above the floor of the hall and approached by steps at each side.

Cloak rooms and lavatory accommodation for both sexes are provided as shown on the plan, with a connecting corridor at the back of the platform. The cloak rooms give access to the platform and form convenient dressing rooms for dramatic entertainments. From the platform level a staircase descends to a side entrance to the road and to the basement, which extends under the whole of the southern block, and contains kitchen, with copper

and sink, larder, heating and fuel chambers and a large chair store. Convenient openings are provided between the basement under the platform and the main hall, to allow refreshments, chairs, etc., to be passed through.

Heating is by hot water in 4 in. main pipes carried in channels with open gratings in the floor of the hall, and by radiators in the porches, cloak rooms, etc. The main boiler is in the basement. Lighting is by electricity. Footlights are provided for the platform.

The floor of the hall is laid with narrow yellow deal tongued batten flooring carried on floor joists and sleeper walls. The floor over basement is of reinforced concrete, with ideal floor to platform and cloak rooms and granolithic finish to lavatories, corridor, etc.

Seating accommodation is by chairs, and seats are formed between the windows. These lift up to form lockers in which can be kept chess boards, draughts and other games.

Externally the walls are faced with brindled red bricks, with cement plastered gables and panels under hall windows. Roofs are covered with sand-faced hand-made Suffolk tiles.

The cost of the building amounted to just over \$7,500.





INTERIOR VIEW, BRANTHAM VILLAGE HALL, NEAR MANNINGTREE, ESSEX, ENGLAND  
MESSRS. SEARLE & SEARLE, ARCHITECTS

1162



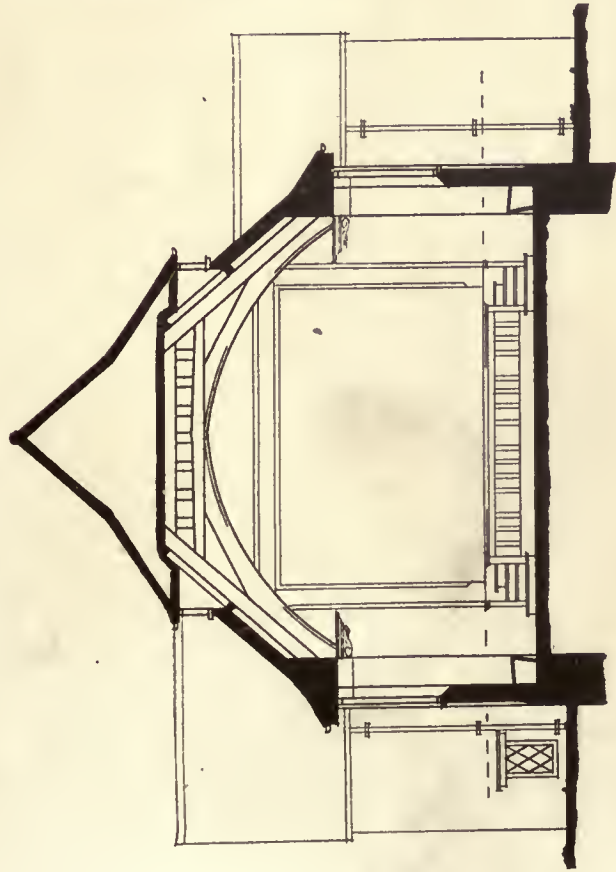

BRANTHAM VILLAGE HALL,  
NEAR MANNINGTREE, ESSEX, ENGLAND

MESSRS. SEARLE & SEARLE, ARCHITECTS

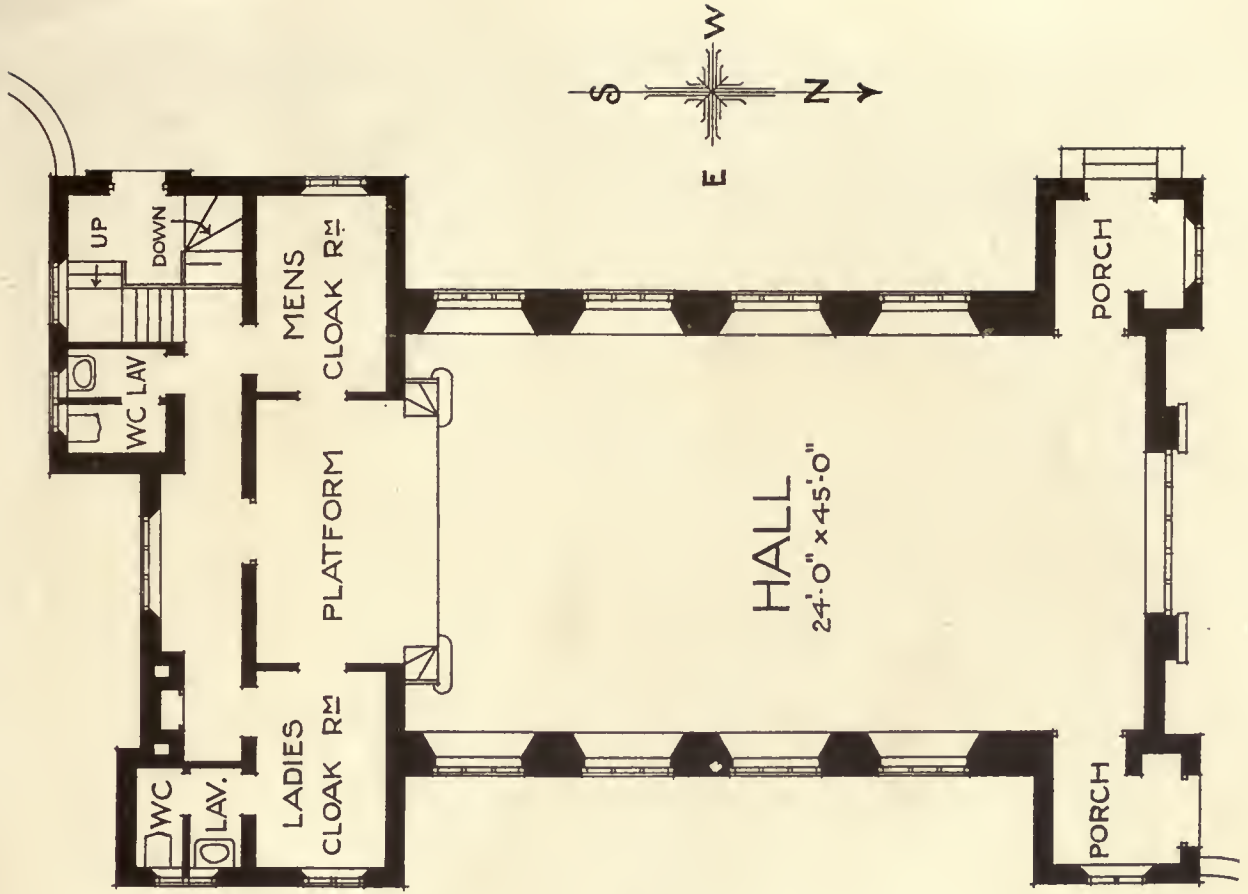



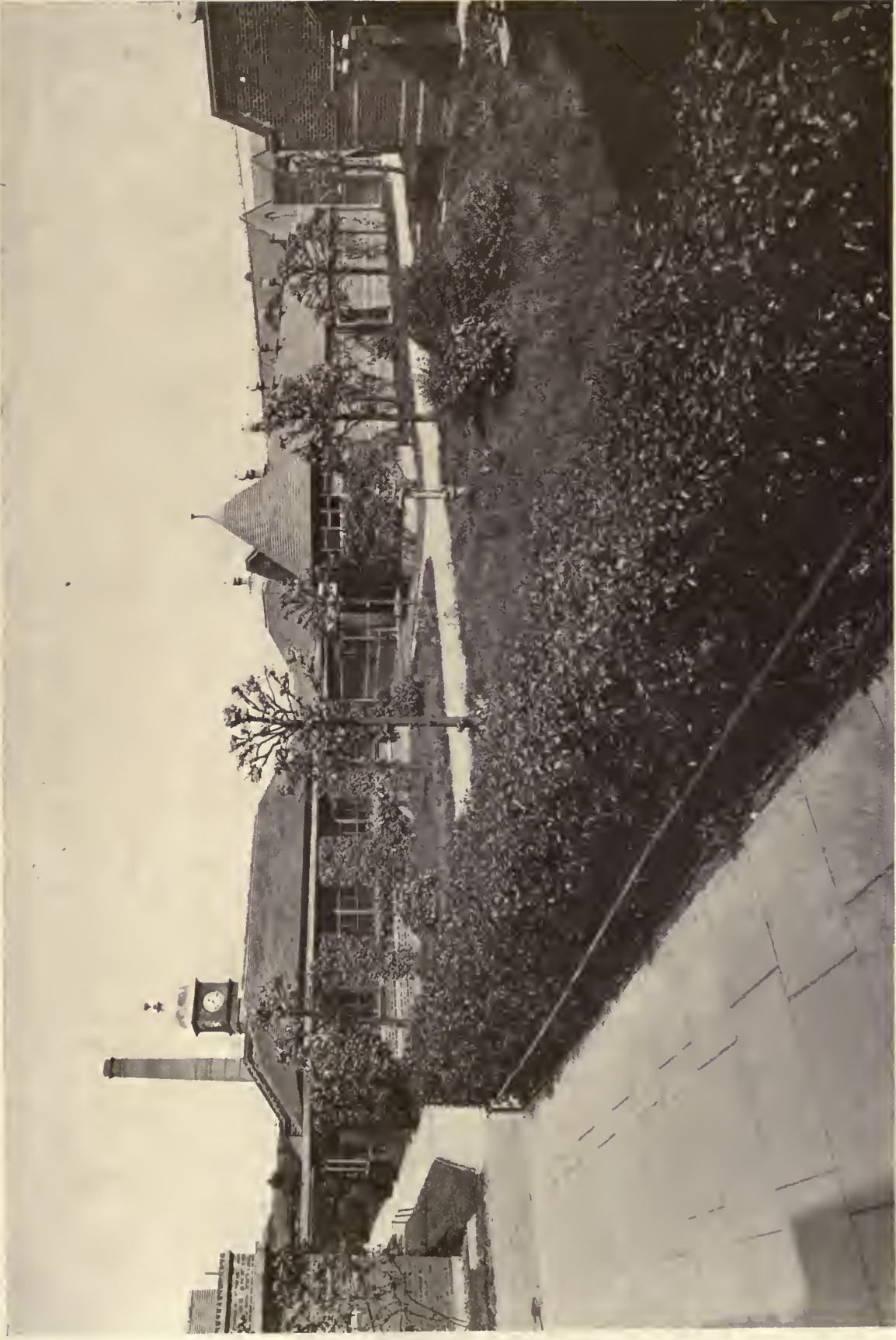

CORNER OF THE FACTORY GROUP OF THE BRITISH XYLONITE CO., LTD., HALE END, LONDON, ENGLAND  
MESSRS. SEARLE & SEARLE, ARCHITECTS

1164







BRANTHAM, A PIONEER WORKMAN'S VILLAGE, BUILT FOR THE BRITISH XYLONITE CO., NEAR MANNINGTREE, ESSEX, ENGLAND  
MESSRS. SEARLE & SEARLE, ARCHITECTS

116 5-





MAIN ELEVATION, OPTICAL WORKS, MESSRS. ROSS, LTD.  
CLAPHAM COMMON, LONDON, ENGLAND  
MESSRS. SEARLE & SEARLE, ARCHITECTS





CAPITOL BUILDING OF THE LEAGUE OF NATIONS.  
TWELFTH PARIS PRIZE, FINAL COMPETITION

SECOND PRIZE DESIGN, SUBMITTED BY D. McLACHLAN, JR., ATELIER HIRONS, NEW YORK  
SOCIETY OF BEAUX-ARTS ARCHITECTS

1167



116

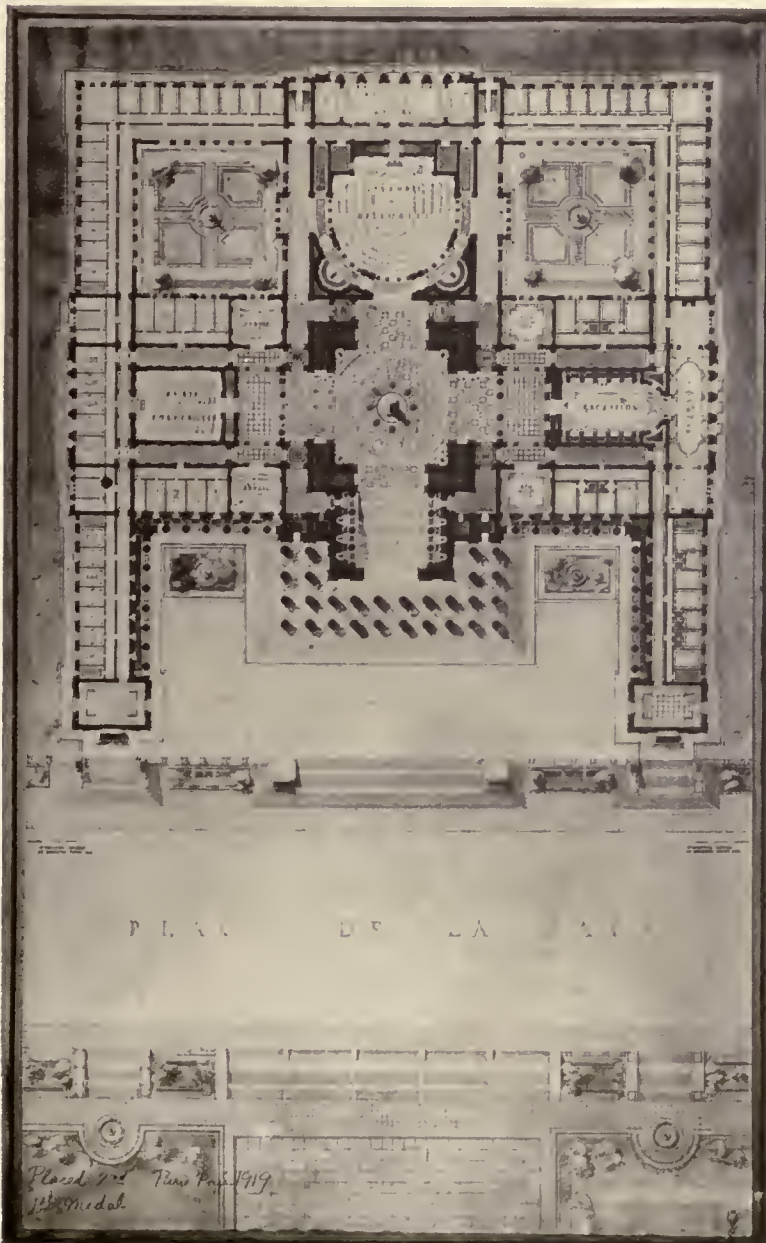

SECOND PRIZE DESIGN

SUBMITTED BY

D. McLACHLAN, JR.,  
ATELIER HIRONS, NEW YORK

TWELFTH PARIS PRIZE

FINAL COMPETITION

CAPITOL BUILDING OF THE  
LEAGUE OF NATIONS

SOCIETY OF BEAUX-ARTS ARCHITECTS







TWELFTH PARIS PRIZE, FINAL COMPETITION

THIRD PRIZE DESIGN, SUBMITTED BY  
 L. FENTNOR, ATELIER WYNCOOP, NEW YORK  
 SOCIETY OF BEAUX-ARTS ARCHITECTS



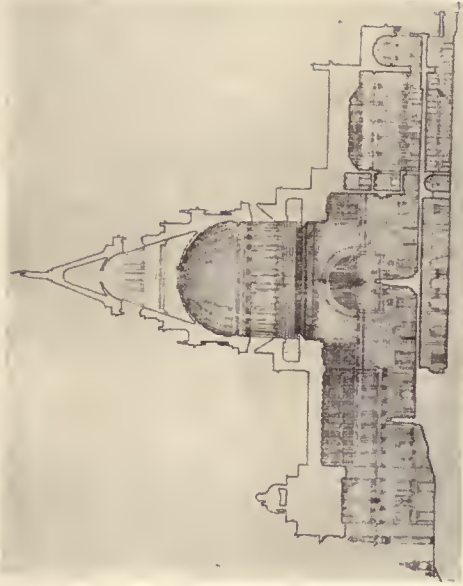
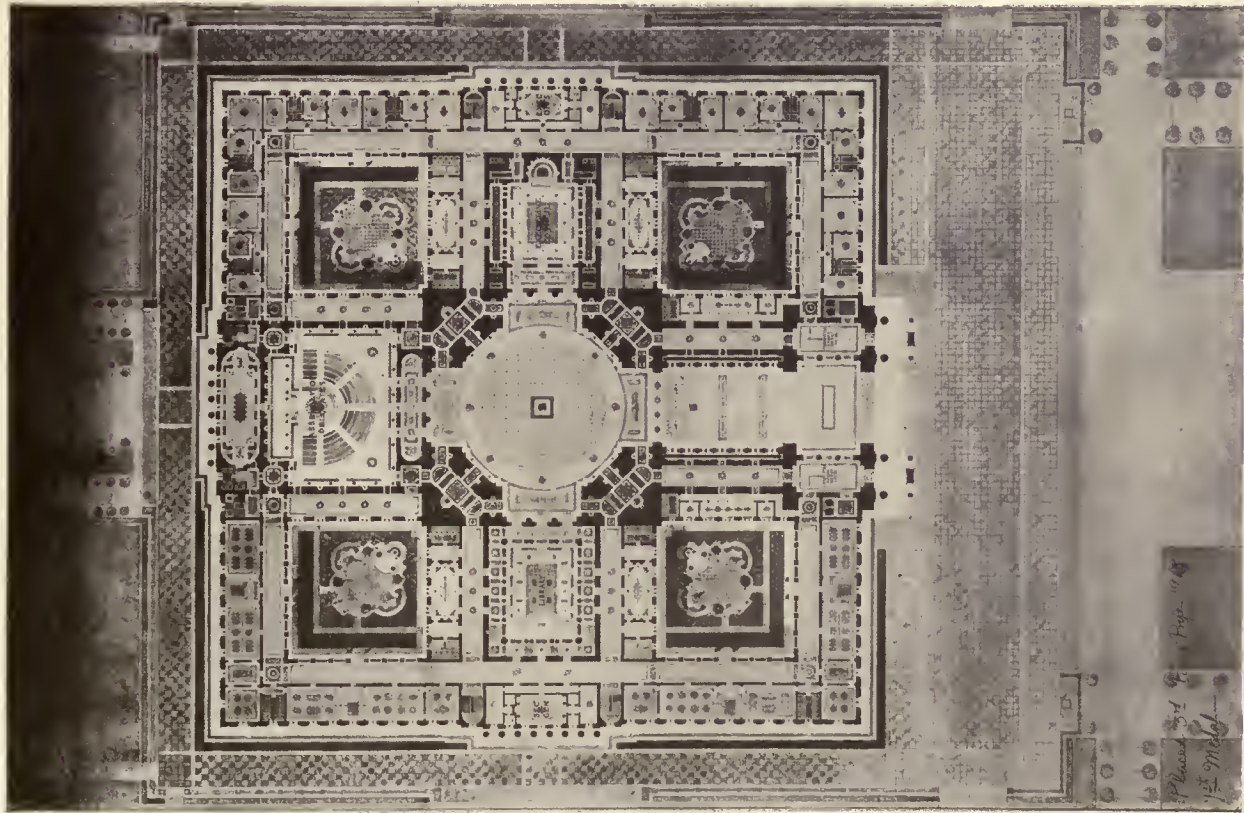

THIRD PRIZE DESIGN

SUBMITTED BY

L. FENTNOR,  
ATELIER WYNCOOP, NEW YORK

TWELFTH PARIS PRIZE, FINAL COMPETITION

CAPITOL, BUILDING OF THE LEAGUE OF NATIONS

SOCIETY OF BEAUX-ARTS ARCHITECTS

*Handwritten notes:*  
P. B. Wood 3rd Pr. 1st Prize 1918  
1st Prize

*Handwritten number:* 116 10



# Society of Beaux-Arts Architects

Official Notification of Awards, Judgment of November 24th, 1919, Final Competition for the 12th Paris Prize of the Society of Beaux-Arts Architects

## PROGRAM

The Paris Prize Committee proposes as subject of this Competition:

*"The Capitol Building of the League of Nations."*

The Committee proposes as the problem of this first after-war Paris Prize the architectural expression of the ideal of the League of Nations as it would be exemplified in a building, which shall be the Capitol of this League.

For the purpose of the program, it is to be supposed that the League, in its final operative form, consists of:

An Executive Council of nine members; one appointed by each of the five great Nations and four elected by the Assembly of Delegates. In the Executive Council is vested the Supreme Executive authority of the League. It meets at frequent intervals and is analogous in its functions to the English Cabinet or the President and his Cabinet in our Government.

An Assembly of Delegates of 150 members. Each member nation of the League appoints three delegates to this Assembly, in which is vested the legislative and judicial powers of the League, subject only to certain veto rights of the Executive Council. It meets at stated intervals or on calls of the Executive Council, and is somewhat similar to our Congress, the English House of Parliament or the French Chambre des Deputies.

The Secretariat. The Secretariat is that part of the machinery of the League which has for its duties the keeping of all its records. With it are filed all treaties, agreements and records. It compiles such data and furnishes such information as it may be directed to do by the Council or Assembly. At its head is the Secretary General, a permanent official appointed by the Executive Council. He also acts as presiding officer of the Council and of the Assembly. This department would have a permanent staff of 300 or 400 members, experts and authorities, besides representatives appointed by various nations to consider general subjects or Committees appointed by the Council or Assembly to investigate and report on particular branches of their legislative or judicial work. No analogy for this department is apparent in our Government. Its head, the Secretary General, is a presiding officer only, without power, except as such may be delegated to him by the Council or Assembly, he, in his department houses, committees or conferences

recording their findings and furnishing them information. He is the international clearing house for information.

This may be considered an outline of those functions which it is proposed to house in the main Capitol Building of the League of the Nations.

In conformity with the ideals which created the League, a small territory, similar to the District of Columbia, has been internationalized; a meeting place of all nations in the common search for justice to all. It is a rolling country on an inland lake. There is to be the city of the Nations, with its national embassies or offices, with its international bureaus or departments and its Capitol Building of the League of the Nations.

The main building only is the subject of this problem, and in it are to be housed the Executive Council, the Assembly of Delegates and the Secretariat. Below is a list of these requirements which are obligatory. This list is not intended to be inclusive of all. What additions to it, how arranged, or in what setting is for the vision and imagination of each competitor to determine. The building houses more than a series of offices—it houses an ideal, an aspiration of mankind.

### Requirements:

- (a) Hall of the Executive Council.
- (b) Suite of offices for each member of Executive Council.
- (c) Hall of the Assembly of Delegates.
- (d) Suite of offices of Secretary General.
- (e) Twenty or thirty Conference or Committee rooms, of which two or three should be of sufficient size to admit of the presence of the public.
- (f) Suites of offices for Secretariat force.
- (g) Archives for 1,000,000 volumes.

The greatest dimension of the building shall not exceed 500'-0".

*Jury of Award:* Lloyd Warren, F. A. Godley, R. M. Hood, L. F. Peck, W. S. Wagner, M. J. Schiavoni and R. H. Dana, Jr.

*Number of drawings submitted:* 6.

*Awards:*  
Paris Prize Winner (1st Medal): E. E. Weihe, Atelier A. Brown, Jr., S. F. A. C., San Francisco.  
Patrons: Messrs. A. Brown, Jr., H. W. Corbett and M. Prevot.

Placed Second (1st Medal): D. McLachlan Jr., Atelier Hirons, N. Y.



CAPITOL BUILDING OF THE LEAGUE OF NATIONS  
TWELFTH PARIS PRIZE. FINAL COMPETITION  
PRIZE WINNING DESIGN, SUBMITTED BY  
E. E. WEIHE, ATELIER A. BROWN, JR., SAN FRANCISCO ARCHITECTURAL CLUB  
SOCIETY OF BEAUX-ARTS ARCHITECTS

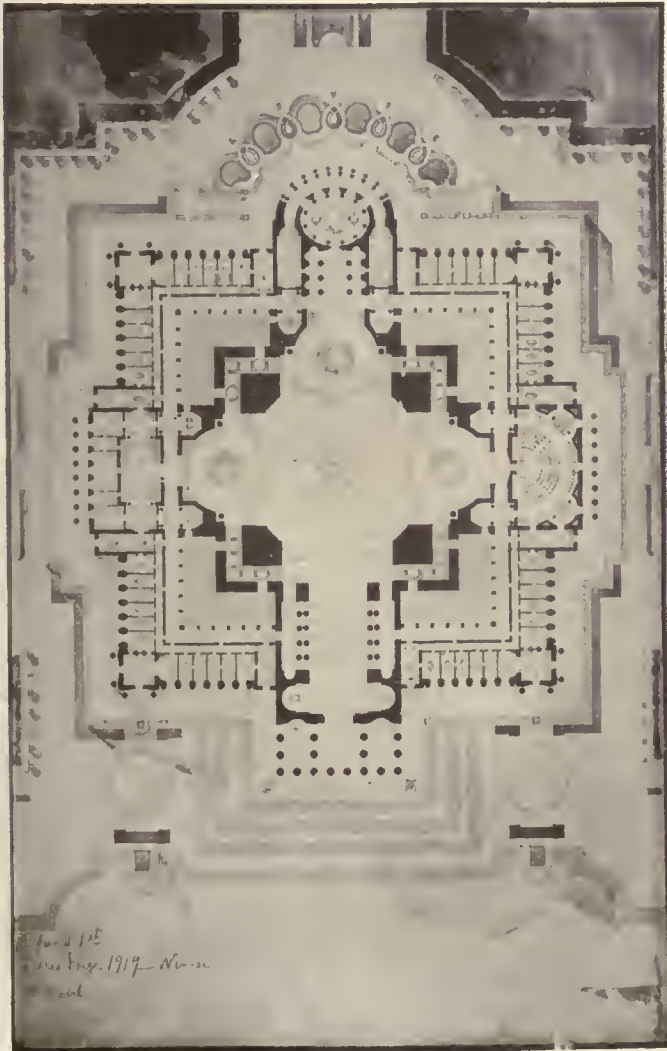

PRIZE WINNING DESIGN

SUBMITTED BY

E. E. WEHLE,  
ATELIER A. BROWN, JR.

SAN FRANCISCO ARCHITECTURAL  
CLUB

---

CAPITOL BUILDING OF THE  
LEAGUE OF NATIONS

TWELFTH PARIS PRIZE,  
FINAL COMPETITION

SOCIETY OF BEAUX-ARTS ARCHITECTS

Placed Third (1st Medal): L. Fentnor, Atelier Wynkoop, N. Y.

Placed Fourth (2nd Medal): A. C. Bieber, University of Pennsylvania, Philadelphia.

H. C.: F. M. Hodgson, Atelier Rebori, Chicago Architectural Club, Chicago.

H. C.: L. Morgan, Atelier Hiron, N. Y.

### Boston Museum Buys Colonial House

The purchase by the Boston Museum of Fine Arts of the old Jaffrey house in Portsmouth, N. H., has just been announced. The house stands on a back street in the center of the town. It has been unoccupied for years and is neglected and out of repair. Changes have been made in the building from time to time so that it no longer presents a typical Colonial exterior, but the fine old paneling and woodwork inside are intact, and it is for these that the Art Museum has made the acquisition.

The interior of the Jaffrey house is to be stripped, and in so doing the Art Museum will be performing a service in preserving for posterity the architectural beauties of a period of which the examples are rapidly vanishing.

The old Jaffrey house in Portsmouth was built about 1750, that especially fine period of Colonial architecture, between the rather rough simplicity of the earliest period and the more ornate decoration of 1800. The house has a wide and ample entrance hall, typical of the period and similar to the hall of the Wentworth Gardner house, also in Portsmouth, which was purchased a few months ago by the Metropolitan Museum of Art, New York. The stairway is wide and easy, with fine baluster and hand-rail, richly turned and moulded. A paneled dado of painted pine with the characteristic wide old panels, all in one piece, runs around the hall. The woodwork is all in excellent condition, and there are many old fittings, such as hinges and latches, still in place.

The two principal rooms on the main floor are paneled across the fireplace end, and have a paneled dado around the other three sides of the room. The fireplace openings are framed in Delft tiles, painted with quaint scenes and surrounded by a heavy moulding. Each fireplace is flanked by fluted pilasters with Corinthian capitals. The windows have seats and deep splayed and paneled jambs. In one room the old contemporary wall paper is especially interesting and is Chinese in design. This, however, is badly torn and out of repair, and it is doubtful if any of it can be preserved.

The dining room has a fine corner cupboard, reaching from floor to ceiling. This has a quaint pilaster treatment and its door has some unusually beautiful paneling and H hinges. The interior of the cupboard is semi-circular in plan and has scroll-edged shelves and richly carved shell top.

All over the house there is a great deal of valuable miscellaneous material in the doors and windows, and much hardware and details of interest and artistic value.

### Architectural Service by Airplane

England having achieved the first non-stop flight across the Atlantic Ocean, she may now add to her records the first instance where an architect has answered a hurry call by airplane. Recording this interesting and epoch-making event, the *Building News* of London states:

"To Mr. Paul Waterhouse belongs the distinction of being probably the first architect in this country to make the air passage from London across the Channel on a client's behalf. These are still early days for such professional excursions, and, with a view to recording the event, Mr. Waterhouse was asked for brief particulars of the voyage. He replies in the current *Journal* of the Royal Institute of British Architects: 'I expect there are other architects who have had occasion to fly on business, so I cannot attach much importance to an event which in any case will shortly become commonplace. But if you really wish to put on record the fact that architects, like other men of business or of art, can enjoy a professional journey overhead, the facts are these. A client wanted me to go to Paris in quick time during the strike, and asked me if I would oblige him by taking the upper route. I very naturally seized the opportunity, and went. Hounslow to Le Bourget took 2 hours 55 minutes. The journey (in a De Haviland 16 machine) exceeds for smoothness and tranquillity any locomotion I have ever experienced, though, of course, it is noisy, with a perpetual and rather restful noise. I made a half-inch scale section of the cabin *en route*. I also slept! My impressions of the voyage were, I suppose, the same as those of most "first-flighters," and need not be communicated. What struck me most were the sight of the Channel as looked down upon from 8000 feet—a sight to which I can attach no adjective but "poetic"—and the ancient majesty of France. Abbeville and Beauvais and the woods and fields between them were things not of to-day but of the Middle Ages.'"



# Current News

## Happenings and Comments in the Fields of Architecture and the Allied Arts

*In order to supply our readers with material of current interest, the news and comment appearing in issues of THE AMERICAN ARCHITECT delayed by the printers' strike will be as of actual rather than stated date of publication.*

### Philadelphia Condemns Historic Residences

Some of the landmarks of Philadelphia, historic mansions occupied for many years by some of the most prominent citizens of the city, will be wiped out by the action of Mayor Smith in signing the ordinance condemning the block between Eighteenth and Nineteenth and Vine and Wood streets for Parkway purposes, comments the *Public Ledger*.

There are more than a score of houses that will be taken over by the city at a cost of more than \$750,000. One of the houses was the home of General George G. Meade, the hero of Gettysburg, and others have been in the possession of prominent Philadelphia families for years.

The city will take over the twelve immense houses facing Logan Square on Vine street between Eighteenth and Nineteenth, ten smaller houses on Eighteenth and Nineteenth and an equal number on Pearl and Wood streets, as well as a number of stables.

The value of the houses on Vine street is estimated to be from \$40,000 to \$60,000 apiece. As far back as Civil War days they were the scenes of sumptuous entertainments, receptions and social affairs which reached a climax during the year of the great sanitary fair in Logan Square.

During that year the family of General Meade, who lived in the four-story brick house at 300 North Eighteenth street, which is on the corner of Pearl, entertained extensively. After his return as the victor at Gettysburg, General Meade was presented with another fine house by the citizens of Philadelphia.

The property is still in the Meade family, being recorded at the present time in the name of Hannah Meade.

Another interesting property to be taken over by the city is the home for cats and dogs, maintained for years in the house at the northeast corner of Nineteenth and Pearl streets by Elizabeth M. Ogden. The properties at 1813-15-17 Vine street belong to William G. Huey, the prominent broker and political light, who was formerly a member of Common Council from the Fifteenth ward. He was one of the sponsors of the Parkway and the author of the Parkway plan known to Philadelphians fifteen years ago as the "Huey plan."

The Kates family owns the big house at 1801 Vine street, which is in the names of Clarence S. and Emily S. Kates and Julia D. Hood. The Catholic Archdiocese owns the property at 1803 Vine street.

The house at 1811 Vine street, now occupied by Dr. Thomas E. Eldridge, was formerly the home of D. B. Martin, head of the great abattoir and stockyard industry on the west bank of the Schuylkill river. Amelia Sellers, widow of William G. Sellers, a prominent manufacturer, is owner of the house at 1819 Vine street.

The block is being taken by the city in advance of future Parkway development which will surround the great

square with beautiful public buildings. The only three of these buildings now constructed are the Roman Catholic Cathedral, at Eighteenth and Race; the Academy of National Science, Nineteenth and Race streets, and the Wills Eye Hospital, on Race street, between Eighteenth and Nineteenth.

West of the Wills Eye Hospital will be erected the permanent home of the anciently established Franklin Institute of the Mechanic Arts and Sciences, while on the western side of the big square and along the west side of Twentieth street will be the buildings of the Municipal Court. These will stretch from Race street to the Parkway line.

On the north side of Logan Square will be the Free Library Building along Vine street, between Nineteenth and Seventeenth.

### Inter-Allied Housing Congress

Delegates appointed by the Governments of the Allied countries will be present at the Inter-Allied Housing and Town Planning Congress to be held in London in June next. Among the subjects to be discussed will be national post-war housing and town planning policies, the preparation and carrying into effect of national programmes to secure proper housing conditions, standards of building construction, and national and regional town-planning developments. The congress will be asked to determine the minimum accommodation which should be provided for a normal working-class family, and the best courses to adopt in order to encourage the development of new methods of building and the use of new material. The proceedings will occupy nine days, and special trains will be placed at the disposal of the delegates, in which they will travel, to inspect the progress made in housing schemes in various parts of the country, including Birmingham, Manchester and Bristol. The countries and colonies represented will include Great Britain, France, America, Belgium, Italy, Australia, Canada, New Zealand, India, Egypt, South Africa, Serbia, Greece, Norway, Sweden, Denmark, Holland, Switzerland, Spain and the neutral Republics of South America. The congress is being organized by the National Housing and Town Planning Council, acting in close consultation with the Ministry of Health and other departments of the British Government.

### Desecrating a Palace

The mansion of the late Cornelius Vanderbilt, in New York, is to be demolished and the site used for a hotel. This has provoked very indignant criticism from the press in all sections of the country. The *Morning Mercury* of New Bedford, Mass., describes the incident thus:

This palace, whose imposing exterior has thrilled New York men and women since its erection in the early '90's, is to change hands and eventually in its place is to rise a structure costing perhaps as much to build, but for another

purpose. The building that will replace it will be a hotel. In place of a home of art and beauty and personal interest that has reached the point of being one of the genuinely beautiful places of the greatest city in the world there will be a commercially operated building which will earn for its owners vast amounts of money. From quiet and unremunerative beauty to hustling money-making commercialism—from a work of art to a cash-drawer institution.

It required a year and one-half for the construction of the Vanderbilt home. Cornelius Vanderbilt, the builder, watched its erection with great interest and, although when first completed it contained only slightly more than as much space as it does now, he declared that he proposed to make of it his own idea of a comfortable and inspiring home. He said he expected to make it as beautiful and as important from an artistic standpoint as any home in the world, and he succeeded. The structure when completed commanded the admiration of architects and designers throughout the world.

Standing between Fifty-seventh and Fifty-eighth streets in Fifth avenue and about a half block to the westward, just where the avenue breaks into the broad plaza to Central Park, where since the Pulitzer fountain has been erected, it ranked for beauty of architecture alongside of any European mansion and was a show place for visitors to the city, as it has continued to be.

In 1893, when additions had been made, it was said the cost was something like \$3,000,000. This figure was increased as years went by. George B. Post & Sons made the plans for the structure.

Standing across Fifth Avenue and looking up at the graceful spires and roof decorations combined with the grand expanse of the building one recalls pictures conjured up in the mind by fairy stories in other years. It is admired alike for its perfect workmanship and pleasing lines. The exterior of the building follows, according to architects, the general style of the Chateau de Blois, on the Loire River, in France, while inside everything conformed to Mr. Vanderbilt's ideas of comfort and elegance.

The age of sentiment thus gives way to the age of commercialism.

### Simple Zoning Rule

City zoning to prevent business encroachment on residential sections is gaining in popularity. Where a city is already well built up it is more difficult to put the plan into operation, but it is not impossible.

Detroit now has a city plan commission investigating residential, commercial and industrial needs. This commission hopes to present a comprehensive zoning program next spring. In the meantime it has put into operation a wise temporary provision for the protection of valued home sections. This order provides that when 60 per cent or more of the frontage in any particular block is used exclusively for residential purposes it shall be deemed a residential district and commercial or industrial buildings or uses shall be banned. This seems to be a simple and ready means of checking the first small commercial inroads upon residence streets. It is a more permanent protection than the placing of building restrictions which are in effect when certain lovely homes are built, but which expire eventually and let in the business block, store or factory.

The recognition, rapidly becoming general, of the fact that a city need not be ugly if its inhabitants are willing to do the necessary planning to make it beautiful, is a hopeful sign. It is such recognition which is speeding up the spread of city planning and zoning programs all over the country.

### Restore Roosevelt's Birthplace

The birthplace of Theodore Roosevelt, at 28 East Twentieth street, New York, is to be restored as nearly as possible to its condition in 1858, according to the officials of the Women's Roosevelt Memorial Association following a recent conference here with Theodate Pope (Mrs. John W. Riddle), the architect having the plans in charge.

An adjoining house at No. 26 has also been purchased and both structures will be remodeled to conform to the architecture of the time of the former President's birth. They will have brownstone fronts and mansard roofs and the interior of No. 28 will be made to resemble the boyhood home of the great American. Old mantels, chandeliers and furniture will be put back in place and childhood friends of the Colonel will supervise the decorations.

A Rooseveltian library, consisting of his books of rugged outdoor life and Americanism and other writings and published speeches, will be placed in the house at No. 26. Many other volumes the Colonel liked to read and dealing with many phases of human knowledge will be placed on the shelves.

According to the architect's plans, the top floor of both houses will be utilized for an assembly hall, suitable for gathering of Boy Scouts, Camp Fire Girls or similar patriotic organizations. When completed the memorial is intended to serve as an institution for the development of sturdy, old-fashioned Americanism.

### American Ambassador to Britain Speaks of the Business of Architecture

The American Ambassador was recently the guest of the Royal Institute of British Architects at a reception held in their Conduit Street galleries, the occasion being the president's address at the opening of the new session. There was an unusually large gathering, and among those present were many of the most prominent members of the profession.

In his address, the president (John W. Simpson) dealt with the many and varied subjects concerning which the architect, if he would be efficient, must have more than a casual knowledge. The architect, he explained, must not only be endowed with the ideals of the artist, but must also possess the qualities of a sound man of business; he must not consider his profession as a thing to be lightly treated, but must realize that he has an important, vastly important, part to play in the national life, a part needing his most minute study and attention and the whole of his efforts.

He impressed his hearers with the necessity for plan in every undertaking and the entire subservience of decoration, for this, albeit an important part in the ultimate issue, was, he declared, by no means the necessity it had so often been considered in the past.

In proposing a vote of thanks to the president for his address, the American Ambassador, Mr. Davis, began with an apology for his position as layman, explaining that, even as a lawyer, "who was supposed to know something of everybody's business," he could not rightly say he had any vast knowledge of the intricacies of the architectural profession. This apologia, if such it may be termed, was followed by a most masterly summing-up of what Mr. Davis conceived to be the responsibilities of the architect.

## THE AMERICAN ARCHITECT

He was an historian, for it was the language of architecture, unaided by spoken words and dictionary, which told us much of what we know of Nineveh and Babylon, of the Romans and the Greeks; and it would be the work of the architects of to-day which would express the life of the present to the inhabitants of the future.

He should be a statesman, because it was architecture which spoke to all who saw it and explained, or should explain, the motive of its existence, and lastly he should be a diplomatist, and in expressing the best and highest qualities of his employers he should do so without stint and with fullest generosity.

The American Ambassador was followed by Sir Aston Webb, president of the Royal Academy, who, speaking from his long experience, called for a wider and broader outlook, for consideration of the masses of a design, rather than the detail, and said he was happy to see this spirit pervading the work of the younger men more and more. He reminded his hearers that the grasp of this problem was an outstanding feature of the work of the architects of America, and in a word he drew attention to the value of constructive criticism. It was better, he said, to tell the young men what you like, rather than what you thought was bad—encouragement being worth more than anything to the beginner.

### The Housing Problem in Italy

In all the principal Italian centers of population the shortage of housing accommodations is acute, and strenuous efforts are being made to stimulate action in order that relief may be afforded.

At Rome conditions are even worse than in other Italian cities. According to the census of 1911, the city contains 79,441 dwelling houses, with 358,587 rooms. While accurate figures showing the increase in the number of dwellings since that time are not available, the building permits issued by the municipality cover only 49,627 rooms, states the *American Contractor*. This figure would represent the maximum increase, since the issuance of a permit does not necessarily mean that the work has been carried out. With the increase indicated by the number of building permits issued, the total number of rooms at the present time would be 408,214, and within these rooms a population of at least 700,000 must be housed.

Owing to the scarcity of accommodations there has been an active speculation in living quarters, and the government has found it necessary to prohibit the increase of rents and has made obligatory the extension of leases which may have expired until 1921. Particularly serious is the position of those occupying furnished rooms, for which measures have been adopted to prevent unreasonable increases in rates.

Previous to 1914 building companies and individuals constructed from 10,000 to 14,000 rooms per year, which, however, were barely sufficient to take care of the normal development of the city. During the war, of course, private building operations practically ceased, and since the armistice little has been done toward a resumption of activity. The great building institutions, for instance, the Institute Romano dei Beni Stabili and others, have suspended new construction for the reason that the increased cost of materials and the higher wages which must be paid to workmen do not permit their stockholders to derive a reasonable profit. Private builders are in the same position and are doing nothing.

Among other proposals to stimulate building, it has been suggested that under certain conditions new buildings should be exempted from taxation for a period of fifteen years in the case of dwellings for the better class, and twenty years in the case of tenements.

### A Negro State on the Rio Grande

The plan outlined by Dr. Moses Madden of St. Louis, before the House Judiciary Committee, for a new State on the Rio Grande, partly from territory that Texas might be willing to yield, partly from country that Mexico might cede, to be inhabited and administered exclusively by negroes, has to be balanced against the scheme of concentration of negroes in Liberia, advocated before the same committee by the Rev. Dr. R. D. Jones of Philadelphia. In essence one is as un-American as the other. The Liberia notion seems rather more workable.

Most of the negroes in this country, writes the *Brooklyn Eagle*, even in Mississippi and Georgia and Arkansas, where mob law is at its worst, do not want to go to Africa and are not anxious to be segregated in a new State. Nor would the South consent to such segregation, for, in so far as it is possible to judge the future by the past, the successful raising of cotton depends on the supply of negro labor. That is one field, almost the only field, where a lifting of the ban on Orientals would accomplish little. Chinese coolies have been tried in the cotton fields and found wanting.

The cleverest agriculturist on earth might well despair of doing much in the Rio Grande country. The negroes are not clever, not advanced in their methods. In bulk and as a rule they are always good natured, fairly industrious and fitted to stand the climate where cotton is raised. There are full Ethiopians, half-Ethiopians, quarter-Ethiopians and near-whites among them. Politicians are not lacking. Let them have a state by themselves, even if there were a stone wall a hundred feet high around it, and toilers would soon get down to the starvation point, while those who had saved in the past would be exploited by shrewd men of their own race. The last state of that race would be worse than the first.

No, the negro wants to stay where he is, and will stay if he can get the common rights of a human being, security of life and property, jury equality, school equality. Social equality he is willing to wait for. On voting equality he is not insistent. He asks little. It is common sense for the Southern whites to muzzle their mobsters and keep their cotton pickers. But that common sense is the most uncommon kind of sense is proverbial.

### State Aid in Building Houses in City Urged

At a discussion of the housing crisis in New York held by the City Planning Committee at the City Club, No. 55 West Forty-fourth street, Clarence S. Stein, Secretary of the Housing Committee of Gov. Smith's Reconstruction Committee, said that whereas before the war, 21,500 apartments had been built every year, last year only 1,500 were erected.

Thus, Mr. Stein explained, 60,000 persons were left in New York without homes. The old apartments, many of which, he said, had been empty, are now being occupied by people accustomed to better quarters, but unable to pay the high rents.

Mr. Stein gave two remedies for the situation—to have the State either go into the purchase and holding of land for dwelling purposes or to lend its credit to builders. Mr. Stein also believes that there should be definite planning whereby workers in an industry, for example, the clothing workers, should have their place of employment moved to Long Island City, where housing facilities might be had.

Agreeing that the situation in the city was very bad, John J. Murphy, former Tenant House Inspector, declared he did not believe in State assistance, as that meant State Socialism. He took the stand that the State could not build as cheaply as the man who was looking out for his own interests.

Walter N. Seligsburg, of the Legislative Committee, said his committee had been considering housing bills now before the Legislature, one of which provides for exemption from taxation for four years.

### Kansas City Chapter of American Institute of Architects

In an address before the regular monthly meeting of the Kansas City, Mo., Chapter of the American Institute of Architects, for January, held at the Savoy Hotel, Max Dunning, of Chicago, chairman of the Post-War Committee, acting under the auspices of the American Institute of Architects, explained the many changes made by the war in the architectural profession and the work of his committee in the readjustment.

Mr. Dunning spoke of the need for improvement in the quality of service rendered by the architect and his unselfish co-operation with all concerned in the erection of a building. In closing his address, Mr. Dunning urged that each architect present give independent study to the problems of reconstruction and co-operate with the Post-War Committee in meeting the changed conditions.

### Three Planning Commissions in One City

City-planning problems in Pittsburgh are at present being dealt with by three different bodies, in addition to the city Department of Public Works and the county engineer's office. There is a City Planning Commission of nine members, appointed by the mayor; a County Planning Commission of some twenty-five, appointed by the county commissioners; and a volunteer Citizens' Planning Commission, which has recently been organized and has engaged a consulting engineer to carry on its studies. The actual official authority of the former two bodies is small, as the city commission has no other definite authority than the approval of lot subdivisions, and the county commission is purely advisory, on subjects referred to it by the county board. The citizens' body is entirely unofficial and will presumably aim to accomplish results by guiding and shaping public opinion.

### American Sculptor is Honored by Belgium

The fine arts class of the Belgium Academy in Brussels has named nineteen foreign associate members. They include Frank Brangwyn, president of the Royal Society of British Artists; Ignacio Zuloaga, Spanish painter; Daniel Chester French, American sculptor, and Ignace Jan Paderewski, the famous pianist and former Polish Premier.

### Imported Houses for Greece

There is a big demand in Greece for houses which can be taken to pieces, removed, and reconstructed at will, and a Swedish offer has been received offering 500 at prices varying from 1,150 to 3,600 kronas Swedish. An American firm has made a proposal to set up workshops in Greece at a cost of 5,000,000f. provided they receive orders for 4,000 houses consisting of two rooms, kitchen, and accessories. They undertake to erect from 100 to 200 houses per day.

### School of Design and Liberal Arts Opened

The School of Design and Liberal Arts has recently opened its new studios at 212 Central Park South in the building occupied by the American Institute of Applied Music, with the aim of permitting the student to create his own career according to the measure of his talent and individual initiative. In co-operation with the Art Alliance of America students are brought into close touch with the best in the applied and industrial arts. A large and liberal cultural background is also sought. The purpose of this school is to give a sound technical foundation in the arts; to develop intellectual breadth through the study of modern history, modern literature and science, and to promote American citizenship by training artists who will work out American ideals in their art.

"The new education in the new America must stand for keen brains and skilled hands. These are not casual products. They are the result of training, judgment and creative energy. Production of fine arts and the cultivation of fine taste are needed to restore balance to life. The artist's contribution is one of peculiar importance. The art future of America depends upon the intelligence, the skill and the vision of the art worker to-day."

Dr. Felix Adler is the rector of the new school, and Franklin C. Lewis its superintendent. Other members of the faculty are: Irene Weir, B. F. A., Yale; George R. Barse, N. A.; Elliott Dangerfield, N. A.; F. Luis Mora, N. A.; Wood Gaylor; Wm. E. Bohn, Ph.D.; Ada Rainey; R. C. Willard, M. A.; Genevieve Joy; Ruth Eddy, B. S.; Gertrude D. Ross; Ann Goldthwaite; Arthur E. Baggs, M. C., and Mrs. J. I. C. Lindsley. The advisory and arts committee includes: H. W. Watrous, N. A.; Royal B. Farnum, George L. Hunter, Walter Ehrich, Maximilian Toch, Dr. Max Wallerstein, Douglas Volk, N. A.; Jonas Lie, N. A.; Mrs. Dorothea W. O'Hara, Mrs. Frances Hellman, Mrs. Felix H. Adler, and Mrs. E. F. Oppenheimer.

### New York School Posters Educate the Country

Posters made in the high schools of New York have, during the last year, been traveling all over the country in a campaign of education. They were originally designed to assist the Brooklyn Committee on the Prevention of Tuberculosis and proved so valuable in their local use that other cities sent for them. The contest was organized under the supervision of Dr. James P. Haney, Director of Art in the High Schools. More than two hundred posters were made in the schools, each school developing a local competition. The best posters from the twenty-five high schools went to the Art Alliance, where they were judged by a committee headed by Mr. Edwin H. Blashfield.

## Our Shrinking Forests

Rough estimates in the *World's Work* put the original forest area of the United States at 850 million acres and the present forest area at perhaps 550 million acres. But in that present estimate 250 million acres are partially cut and burned over and 100 million are so severely cut and burned that, unless supplemented by planting, there will be no succeeding forest of commercial value, leaving about 200 million acres of mature and merchantable timber, or less than one-fourth of the original area.

---

## Improved Pottery Designs in Great Britain

The subject of pottery design is receiving much attention in Great Britain at present, states Trade Commissioner Leonard B. Gary. It is possible that this movement has been influenced by a pamphlet recently issued by the United States Bureau of Education, urging the importance of adequate training in industrial art and asserting that America must turn from its quantity methods and put the country's commerce on a quality basis. Reports from German pottery centers are to the effect that German potteries also are going in for high quality of design and technique as opposed to the cheap wares that formed the bulk of their pre-war manufactures.

---

## National Etiquette Makes Rug a Drapery

Between the British and American attitude toward the United States coat of arms there is a difference, and because of the difference a rug became a mural drapery.

The rug, in which is woven the design of the American eagle, was the gift of the British Red Cross Society and the Order of St. John, and was intended for the floor of an American hospital which was to have been built in London on a site chosen by King George. Building plans were abandoned when the armistice was signed, and the rug was sent to Red Cross headquarters in Washington.

Then followed the difference of national usage. A ruling of the headquarters called attention to the fact that in America it is bad form to set foot on the national emblem or coat of arms, and held that the rug might be used for decorative purposes. It now hangs in the Northern division office of the Red Cross in Minneapolis.

---

## Aeronautical Exposition, New York

When the Manufacturers' Aircraft Association holds its Second Annual Aeronautical Exposition at the Seventy-first Regiment Armory, 34th street and Park avenue, New York, in March, the public will have an opportunity to see what American designers have accomplished in developing commercial airplanes—planes for private use, for sporting or touring purposes, or long-distance transportation of freight and mail.

The airplane owes its development principally to the war. Since hostilities ceased, however, American manufacturers have concentrated their efforts on planes for pleasure, sport and commercial uses. The exhibits will represent all producing airplane factories in the United States. Many of the planes are already assembled and in daily flights. Some of the larger ones are carrying mail between principal cities. Others of advanced construction will receive trial flights a few weeks before the exposition opens on March 6th.

Many of the models have comfortably enclosed cabins with unbreakable glass windows. They seat from four to twelve passengers in chairs as luxuriously appointed as those of a Pullman. Noise of the motors is deadened and passengers enjoy a flight much the same as if they were riding in an observation car or limousine without the wheels touching the ground.

Many of the smaller machines are of the limousine type, accommodating two or three persons. They are, of course, much more expensive both in initial cost and expense of operation. Then there are several types of sporting machines, a majority of them flying boats.

The larger planes have a carrying capacity of from three to six thousand pounds and, driven by three or four motors, will cover half the distance across the United States in a single flight. The cost of operating airplanes has been reduced during the last year from the almost prohibitive figure of one and two dollars a mile until now it compares favorably with motor trucks and railroads.

---

## Tasmania Has Its Housing Problem

The housing problem, which has become an acute one all the world over, is at present engaging attention in Tasmania, comes the news from Hobart. Rents have become exceedingly high, and houses are not to be had for letting, though they can be bought at inflated prices.

Hundreds of houses are being built and estates cut up for building allotments, but tenants are secured before the foundations are in. The scarcity has led to a great deal of overcrowding and sub-letting of rooms, and residential flats are now becoming part of the architecture of the country.

One of the most pressing problems has been to find shelter for people turned out of buildings condemned by the health authorities. This has led to the municipal authorities deciding to go into the matter of building homes for these people, and the government has introduced legislation into Parliament to enable the government to build houses on the hire-purchase system for people in receipt of not more than £300 a year. As a start, the government is to spend £70,000 in building houses. Three-roomed houses with bathroom are to be let at 10s. a week and four-roomed houses at 12s. It is estimated that the capital mentioned will build 100 houses.

The total cost of any building is not to exceed £700, including land. The tenant is to find 5 per cent of the capital. The period of repayment is forty-two years for concrete, brick, or stone, and thirty years for houses built of Tasmanian hardwood.

In addition, 2000 houses are being built for returned soldiers on the hire-purchase system, by the Repatriation Department, and industrial concerns are also assisting their employees to become their own landlords. All these schemes in combination should, therefore, soon appreciably ease the present acute situation.

## Nebraska Chapter Meets

The annual meeting and dinner of the Nebraska Chapter, A. I. A., was held Tuesday, January 20, at the University club, Omaha. Edwin H. Brown, of the firm of Hewitt & Brown, architects, Minneapolis, was the speaker of the evening. Thomas R. Kimball of Omaha, president of the American Institute of Architects, also gave a short address. The officers of the Nebraska Chapter are as follows: President, Alan McDonald, Omaha; vice-president, Ellery Davis, Lincoln, secretary-treasurer, J. D. Sandham, Omaha. The above officers, with Frederick W. Clarke and F. A. Henninger of Omaha, constitute the executive committee.

## Sightly Water Tanks

There is not to be found anything much more unsightly than huge city water tanks which disfigure so many of our towns and cities. Often the residential sections are made unpleasing by these necessary tanks. The city of Cincinnati solved the problem of retaining its water tanks in a residential part of the town and yet transforming them into impressive monuments which add to the appearance of the district.

The steel tanks were surrounded by a concrete shell, artistically designed so that the hill on which these tanks stand is a show place instead of an unsightly spot that one tried to avoid formerly.

The tanks are of steel, and these were filled with water before any of the concrete was poured, as slight changes might take place otherwise and cause the concrete to crack. The forms for the first setting were braced to the ground and supported on the foundation, but the difficulty began when the forms had to be raised for the second section setting. With this problem settled, however, the work went on without any trouble.

## Personals

A. F. Wysong, Charles W. Tufts and Thomas P. Jones announce the opening of new offices at 408 Odd Fellows Building, Charleston, W. Va. Catalogues and samples desired.

Morrison & Stenson, architects of Spokane, Wash., have formed a partnership and will practice in the Symons Building, that city.

Harry Maurer, architect, Reading, Pennsylvania, has moved offices to 234 N. Fifth avenue.

Walter A. Besecke, architect, formerly with the firm of Hoit, Price & Barnes, Kansas City, Mo., is now associated with J. C. Sunderland, 313 Interstate Building, Kansas City, Mo., forming the firm of Sunderland & Besecke.

A. V. Capraro, architect, has opened new office, 628 Reaper Block, 105 North Clark street, Chicago.

Wm. H. Emory, architect, has moved his office to 615 Munsey Building, Baltimore, Md. He was formerly located at 11 E. Lexington street, Baltimore, Md.

C. Le Roy Kinport and C. E. Bell, architects, have affiliated and established offices at 909 Andrus building, Minneapolis. Mr. Kinport was formerly located at 1046 Andrus building. The firm will be known as Kinport & Bell.

## News From Various Sources

Carnegie Corporation of New York has announced its purpose to give \$5,000,000 for use of National Academy of Sciences and National Research Council. Understood that a portion of money will be used to erect at Washington a home for the two beneficiary organizations. Remainder will be placed in hands of Academy to be used as permanent endowment for National Research Council.

\* \* \*

Belgian structural steel, Canadian brick and lumber from Pacific Coast begin to loom up as possible agencies that will halt higher building material prices in most of eastern seaboard cities.

\* \* \*

American Institute of Architects, through William S. Parker, Secretary, has asked Industrial Conference to consider methods of dealing with American housing situation, inasmuch as present housing shortage is regarded by Institute as important factor in industrial unrest. Institute suggests that housing acts of other countries and reports of wartime housing activities of United States Government should comprise sound basis upon which Conference may work.

\* \* \*

Bradstreet states that the value of construction at 151 cities last year was \$1,281,000,000, three times that of 1918 and 80 per cent in excess of that of 1917, while 20 per cent in excess of the hitherto record year, 1916, since when, however, values of building material have gained 80 per cent while wages have in some cases doubled. Only 7 cities of the 151 reporting show a smaller value of building in 1919 than in 1918.

\* \* \*

Statistics Branch, General Staff, announces that discharged officers and men of U. S. Army are entitled to free hospital treatment for sickness or disability arising from sickness or injury incurred in line of duty while in service. This treatment is furnished by Bureau of War Risk Insurance through U. S. Public Health Service. To facilitate handling of cases country has been divided into districts. Statement gives list and location of hospitals.

\* \* \*

Announced from Winnipeg, January 8, that the housing commission operating under city's housing plan will make a loan of 85 per cent of net cost of home. A first mortgage will be taken on property for 20 years, repayable at rate of \$7.13 a month for each \$1,000 borrowed.

\* \* \*

Herbert Hoover makes the declaration that "The whole problem of Americanization would be met in 20 years if nation could systematically grapple with child problem and insure proper conditions of birth, education and nutrition. In order to accomplish this, the conscience of every separate community must be developed."

\* \* \*

Announced from Strasbourg that rapid progress is being made in the reconstruction of devastated areas in Alsace and Lorraine. Stated that sum expended amounts to approximately 150,000,000 francs.

\* \* \*

Federal Reserve Board has advised all Federal Reserve Banks which have not yet begun their building operations to perfect their plans in detail, but to postpone for the present letting contracts for construction. A careful survey of building conditions has demonstrated fact that building materials and construction costs have recently advanced to too high a point to justify Board in authorizing building at this time.

# Weekly Review of Construction Field

Comment on General Conditions of Economics With Reports of Special Correspondents in Prominent Regional Centers

In his address to the Boston City Club, Mr. C. H. Blackall, architect, outlining the future of building, indicated that the price of building material is not due for an immediate slump. After the past four years, he said, the people want to build and it is not difficult to obtain the money to begin building operations, the tendency being toward the erection of commercial buildings rather than homes. Mr. Blackall predicted the largest boom the building industry has ever known.

It seems evident that the hesitation in carrying forward building projects because of an expectation of lower prices and cheaper building costs is now at an end. For one thing, it is found that there is a generous amount of vitally necessary work projected which will go ahead regardless of cost. There is also current a strong body of opinion which does not look upon present conditions as inevitably resulting in a business depression with its consequent reduction of prices of building material and of labor costs. They hold a view that the world-wide inflation has decreased the value of currency everywhere, that wages and prices merely seem high, as all money payments are high. Prices have doubled since 1914 and although the lagging in the increase of some payments behind others produces an injustice yet it gives no sound reason why a man should hesitate about carrying on needed work. To do so would be to make a great mistake. To further retard production is to make more probable an actual business depression with all the suffering it involves.

Aside from the actual money payments, labor costs have been alarmingly high. Part of this was due to the number of unskilled workers doing skilled work, part to the nervous demoralization by the war, part to shirking. But a leading contractor now finds that these costs are coming down again. He says his men are turning out as much work in an hour as they did before the war and in many cases there are indications of improvement over the earlier averages.

When such reports become general through all lines of endeavor we shall have turned in the right direction. Until then we can only look back upon the past with dissatisfaction.

At the conference of trust companies of the United States, held in New York, Mr. Sisson, vice-president of the Guarantee Trust Co. of New York, gave statistics of our under-production during 1919 as follows: "There were 130 million tons less of bituminous coal mined last year than in 1918; there were 12 million tons less of anthracite coal produced than in 1918; 9 million tons less of steel ingots; more than 5 million bales less of cotton than in 1914; 76 million bushels less of wheat than in 1915; 140 million bushels less of corn than in 1917; more than 900 million pounds less of copper than in 1918; more than 10 million dollars less of gold than in 1918; and more than 4¾ million dollars less of silver than in 1918."

It would seem that our prosperity is to be dangerously superficial until we get down to work.

(By Special Correspondence to THE AMERICAN ARCHITECT)

Chicago.—Building contracts for January in the Middle West, while not equaling the monthly average of 1919, were nevertheless almost twice that of any January on record. About 40 per cent was for industrial buildings, 30 per cent for houses, 15 per cent for public works and 15 per cent for business.

There seems to be no sign of reduced buying power and such limitation as is shown comes from physical inability of labor and railroads to keep abreast of the demands for production and distribution. The leading mail order house reports a gain of 50½ per cent in gross sales over January of last year, one-half of which represents higher prices. Chicago is short 75,000 to 100,000 homes. On May 1 there will be rental advances of from 20 to 50 per cent in addition to the two or three advances which became effective during the past two or three years. That rents are high is not surprising; so is everything that goes to make them and so are the wages out of which they are paid.

There is no slackening in the demand for steel products, especially for wire and nails, the buying of which recently has been enormous. This is not considered unusual, however, as the season is now on when jobbers all over the country place orders for anticipated requirements. Some of the independent makers are asking and receiving \$1 or more over the price of \$3.25 per keg asked by the American Steel & Wire Co. But this latter company is still holding to the prices agreed upon with the Industrial Board in Washington in March of last year.

Jobbers in various sections of the country are said to have been receiving on small lots as much as \$5 per keg over the leading manufacturer's price, and the buyers have shown a willingness to pay whatever is asked of them.

Improvement is shown in the market for structural shapes, indicating that the lull in buying reported a week ago was only temporary. Urgent inquiries are now in the market for early deliveries in connection with building operations in many large cities, but the markets are not in position to take this business and in some instances it is likely that the inability to get steel will delay until late Summer operations which were expected to start in the Spring.

The carpenters' strike and lockout of last Fall delayed building operations and held up construction work for months until the wage demand of \$1.00 an hour was granted. Demand has now been made by thirty-three labor unions for \$1.25 instead of \$1.00 an hour.

(By Special Correspondence to THE AMERICAN ARCHITECT)

Seattle.—Increasing difficulty of getting tubular steel products from the East was the outstanding feature of the construction market this week. All operators report that it is now practically impossible to secure quotations for spot delivery on finished steel products, and the only way in which manufacturers of the East will trade is

on the basis of June firming on quotations then in effect.

The situation has improved as to pipe. Eastern mills say frankly that they cannot contract for steel products for the first six months of this year, but that all orders must be subordinate to prices that will be quoted at the time of loading. Larger steel parts are obtainable, but the line of demarkation between essential building and heavy units for other purposes is now more clearly drawn.

It seems to have been necessary for the mills to grow more confidential with the North Coast jobbing trade in formally declining orders for steel building hardware. They have advised the largest interests here that they are unable to get skilled labor for finishing.

Contractors, in view of price and delivery difficulties, are unwilling to bid on any construction job that has to do with futures. Materials are so high and labor in so uncertain a state that bankruptcy and prosperity are but a shade apart. No guarantee of prices is possible, and delays in completion of work threaten at every turn.

Lumber prices have advanced \$2 on common building sizes and \$5 on flooring, ceiling and finish. The fir mills are accepting only such new business as carries the greatest profits, as they have unfilled orders for 400,000,000 feet, placed as long ago as last August, and are unable to get more than 30 per cent of enough cars to meet their requirements. There seems to be no chance for a break in lumber prices at this time. During the week between fifty and sixty wholesalers arrived in person on the fir lumber market, and have been bidding against each other for building stock. The Spring buying season for the East is on and stocks are depleted.

There is a fair reserve of paints, oils and lead. Painters' cutlery, due to the condition of finished steel products, is critical, and jobbers are "rationing" what they have on hand among the retailers.

The plaster and cement markets are firm.

(By Special Correspondence to THE AMERICAN ARCHITECT)

San Francisco.—The reappearance of a law which was struck from the California Statutes several years ago in regard to competitive bids from architects is causing extensive discussion among local architects. The Board of Education of Sacramento, Cal., capital of the State in which the law was repealed, is now advertising for competitive bids from architects for the preparation of plans for school buildings which are to be erected under a bond issue and which will cost in the neighborhood of \$2,000,000. Also, in filing a bid, each architect is obliged to file with it a certified check for \$5000 as a guaranty that he will comply with the bid if required to do so by the Board.

A number of the architects are wondering if competency is to be gauged by the smallness of the fee asked for the preparation of the plans or the ability to put up the certified check for \$5000.

No particular change has been noted in the material market this week with the exception of a general upward trend of prices on lumber and steel. The steel market continues to be more or less difficult, with orders exceptionally hard to fill and prices higher than ever.

(By Special Correspondence to THE AMERICAN ARCHITECT)

Boston.—Statistics of building and engineering operations in New England show that contracts were awarded from January 1 to February 19th, 1920, amounting to \$30,671,000, or an increase of nearly \$22,000,000 over the awards of the corresponding period in 1919. These contracts are not confined to any particular type of structure

but are general in scope—a large proportion being for commercial purposes.

Sales of real estate for the past week have been brisk but little construction has been actually started because of the severe weather conditions.

In Hartford, Conn., a new housing corporation with capital stock of \$1,500,000 has just been formed. It is reported that this organization will erect between 950 and 1,000 houses of the one and two-family type for that city.

Crippled transportation facilities, both rail and water, have caused an acute shortage of materials and of coal. Several manufacturing plants have been obliged to close down temporarily because of the lack of coal. The Shipping Board, however, has promised relief for the coming week.

In many sections the idea is still prevalent that prices of materials and of labor will be less. Therefore building in these localities is still hampered and is, of course, practically completed so far as design is concerned.

(By Special Correspondence to THE AMERICAN ARCHITECT)

Albany:—A bill is to be presented in the legislature by State Senator Dowling which will limit rental contracts of buildings used for residential purposes to a sum which shall be not more than 10 per cent upon the actual valuation. The "actual valuation" will be, according to the bill, "the assessed valuation plus 20 per cent." The bill will provide that in actions upon leases the landlord must prove that his contract is not unlawful. Any excess of rent shall be recoverable by the tenant. It will be allowable, however, for the landlord to assess actual increased costs of operation or maintenance, including taxes, pro rata among his tenants.

## Vanderlip's Speech to the Economic Club

Mr. Vanderlip, in his speech before the Economic Club, expressed the belief that employers should make no effort to reduce wages because a lowering of efficiency in American factories and shops might result. He added that every effort should be made to satisfy American labor, as he thought that the most effective way of increasing efficiency.

"It is now time to look forward to constructive policies," Mr. Vanderlip said. "It was idle to propose constructive policies if they were to stand on a foundation of sand, a foundation of misconception, ignorance, and prejudice. To plan such a policy national leadership must have vision to look ahead. There is a need for a vision that will enable us to see further ahead than a speculator standing over a stock ticker.

"In the period since the armistice national leadership has failed. When there was extreme need for co-ordinated and co-operative effort in this country we have seen the Government fritter away months in frivolous, inconsequential debate and in the play of partisan antagonisms.

"If we had understood the full import of this world crisis we should have demanded from the Administration intelligent information and authoritative leadership; we should have demanded of Congress that the men who occupied time on the floors of both houses should show some comprehension of the existing facts of the economic life of the world. We should have demanded of financial leaders evidence of an understanding of America's financial responsibility to act in the direction of safeguarding our credit situation."

Mr. Vanderlip said he was not pessimistic about the facts, but that he was pessimistic about governmental and national blindness to these facts.



# Department of Architectural Engineering

## Factory Stairs and Stairways\*

### PART I

By G. L. H. ARNOLD

While this article relates particularly to factory stairs, yet most of the features discussed apply with almost equal force to stairways in many additional types of buildings. A careful perusal of the statistics relating to accidents due to slipping and falls brings one to a realization that what has often been considered of minor importance, namely, the detailed design of stairways, halls, public passageways and similar places, is the cause of a large proportion of both serious and fatal accidents. The design of the stairway should be given a place of prime importance in the planning of every building, with a view of reducing this increasing casualty list.—*The Editors, The American Architect.*

**I**N the multi-story factory the stairway is a detail worth much more than passing notice. Bear in mind that the people above the first floor are dependent on the stairs for egress; that four times daily the stairs are crowded by people in a hurry; that a large percentage of the minor accidents, many of the serious ones and many panics happen on the stairs.

A poorly designed stairway may be an effective way to spread fires, smoke or false alarms, and is sure to be a disturber of the heating system. A properly designed and located stairway affords not only a safe and convenient means of entrance and exit but also the handiest and most effective vantage point from which to fight fires on the upper floors.

In solving the stairway problem consideration must be given to: (1) number; (2) location; (3) size; (4) type; (5) materials; (6) safety treads; (7) proportions; (8) landings; (9) handrails; (10) enclosures; (11) lighting; (12) wear. These will be considered in the order named.

#### NUMBER

Where building codes are in force the minimum number of stairways permitted is usually ample. Perhaps the most usual code requirements are one stairway plus one for each 5000 sq. ft. of lot area.

In cases where the code provision is insufficient, and where there is no code, it is essential to consider: (a) safety; (b) capacity; (c) convenience.

*Safety.* No building over two stories in height is safe with less than two stairways. A single stairway may at a critical moment be blocked by a temporary disarrangement of stock or fixtures on the floor, by repairs or by fire.

Large floors require an increased number of stairs even if but few people occupy the floor. As the distance of the extreme point from the stairway increases, so do the chances of floor barricades. Furthermore, in case of panic, fire or other accident the time required to walk or carry an injured or fainting person 100 ft. or more may be enough to produce serious results.

Two 4-ft. stairways for buildings having up to 20,000 sq. ft. of floor area, with one additional 4-ft. stair for each additional 10,000 sq. ft., form the least number that it is prudent to use.

If the building is liable to be used for purposes which may permit the occupants to be closely spaced, the number should be increased to two for the first 12,000 sq. ft. plus one for each additional 6000 sq. ft. At least one and preferably all of the stairways should be carried to the roof.

*Capacity.* In densely populated buildings the number of stairways must be increased to prevent dangerous over-crowding when all the occupants try to leave at once. In such cases 20 in. in width for each one hundred persons, the Boston rule for theater exits, is high, and 10 in. to 14 in. would be ample.

*Convenience.* Avoiding the disturbance of discipline and the loss of time caused by the passage of people through other departments, especial arrangements on one or more floors, the need of accommodating the building to the shape of the plot, the location of exits, and the advantageous subdivision of floors among different tenants or among different departments of the same tenant may make it desirable to increase the number. No

\*Paper presented before The American Society of Mechanical Engineers.

question of convenience should be permitted to cause stairs to be so located that any occupant of a factory would be obliged to travel over 100 ft. to reach an exit.

LOCATION

In the matter of location many items should be considered. Every stairway should communicate directly with an exit from the building. The stairs

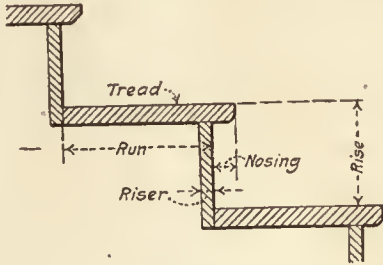

FIG. 1.—THE PARTS OF A STEP

should be distributed with a fair degree of uniformity and so placed as to reduce as much as possible the maximum distance to be traversed to reach an exit. On each floor the landing should be so placed that lines of men going from shop to locker room, locker room to stairs, and shop to stairs should not conflict.

It is also highly desirable to avoid obstructing the foreman's view of the room. When practicable, the separate tower or wing is the most satisfactory location. The locker and toilet rooms and the elevator can be in the tower, thus leaving the main building clear of obstructions and giving the foreman an unobstructed view of the room and permitting greater freedom in the floor layout.

SIZE

A clear width of 44 in. to 48 in. between handrails will allow the passage of two lines of people at once, and the main stairs should never be less than this. If wider, the width should be in multiples of 22 in. to 24 in., the number of handrails being such that it is never less than 44 in. nor more than 48 in. between rails.

Where the number of employees is large it is better to increase the number of 4-ft. stairs than to increase the width. Even when the number of employees in a building is large, only one floor, as a general thing, will be densely populated. This crowded floor is as likely to be at the top as at the bottom. Therefore it is the usual practice to make

factory stairways of constant width throughout their entire length.

Occasionally a factory building must be designed to accommodate dense population on two or more floors. In this case the employees from the upper floors coming down at the full capacity of the stairways will find the lower flights already taxed to the utmost and serious congestion will result. The remedy is increased width for the lower flights.

Additional stairways from the lower crowded floors may not cure the trouble because in the excitement of an emergency, when free and quick egress is most important, the occupants of the lower floors are likely to rush to the busiest stairway and leave their own special exit unused. Special stairs, not used for general ingress and egress, may be as narrow as 20 in. in clear width; they may be steep (Fig. 2), or, if not much used, they may have winders or be spiral.

TYPE

Except for special cases used by but few people for intradepartment shortcuts, spiral stairs and winders should never be permitted in a factory. Straight runs alone are permissible. When the story height exceeds 9 ft. the flights should be cut

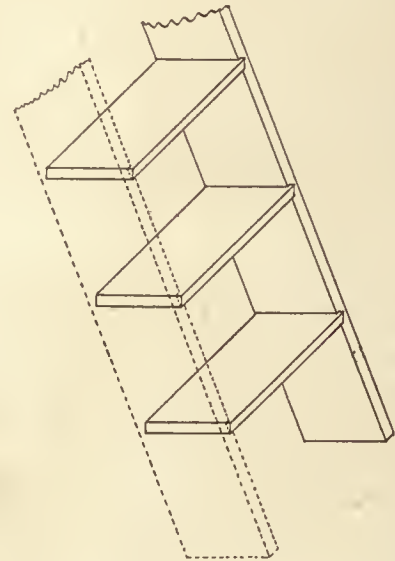

FIG. 2.—STEEP FACTORY STAIRS

and intermediate landings used. The landings should be rectangular and the flights be not less than three risers nor more than 9 ft. high.

The intermediate landing is of little use if the flights are in line. A turn at the landing serves to limit a fall. A 180-deg. turn has the further

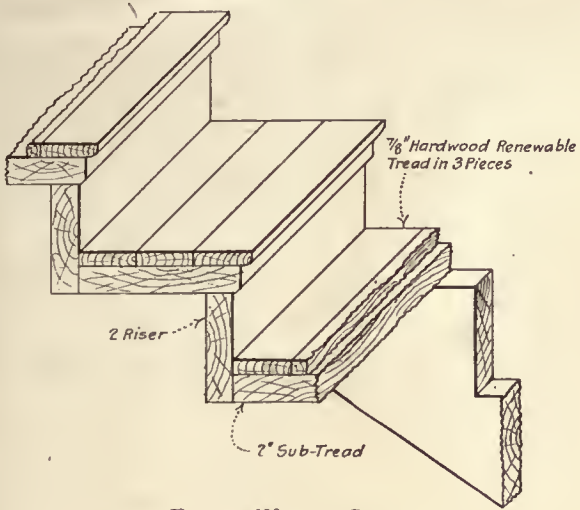

FIG. 3.—WOODEN STAIRS

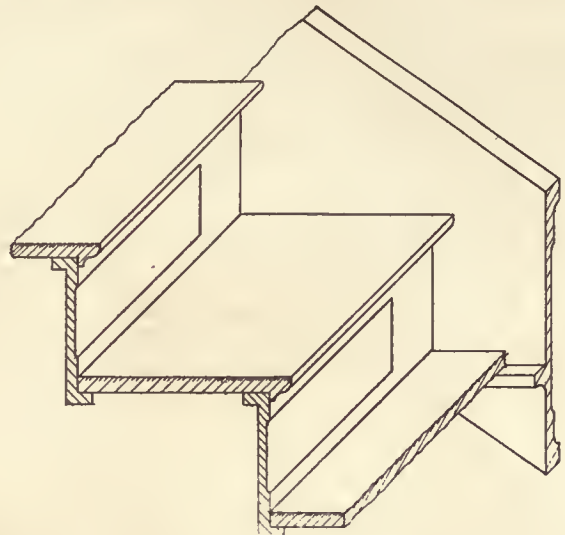

FIG. 4.—CAST-IRON STAIRS

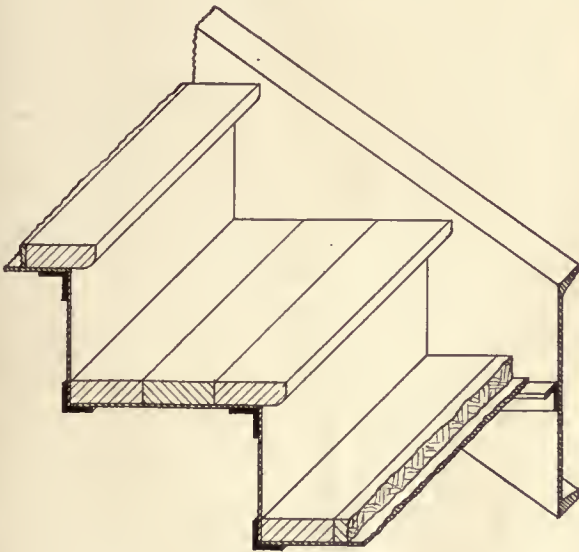

FIG. 5.—STEEL STAIRS WITH WOODEN TREAD

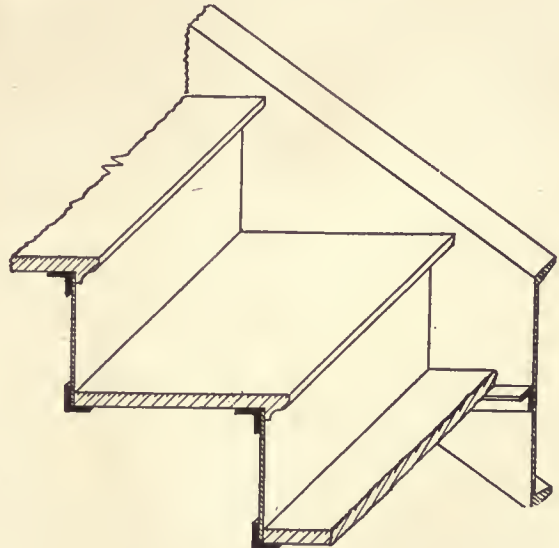

FIG. 6.—STEEL STAIRS WITH CAST-IRON TREAD

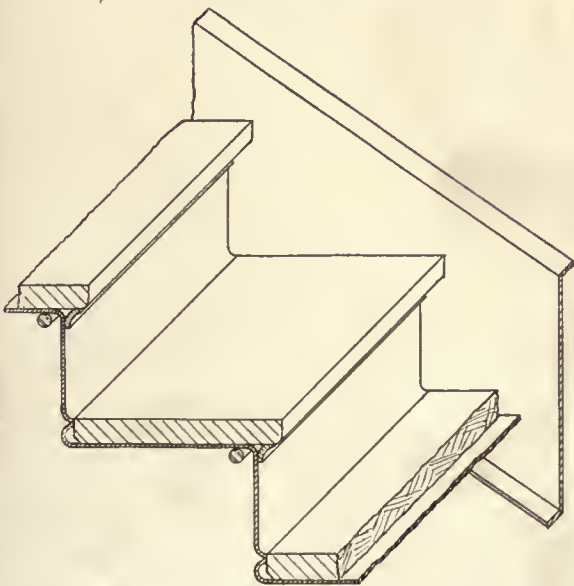

FIG. 7.—STEEL STAIRS WITH STONE TREAD

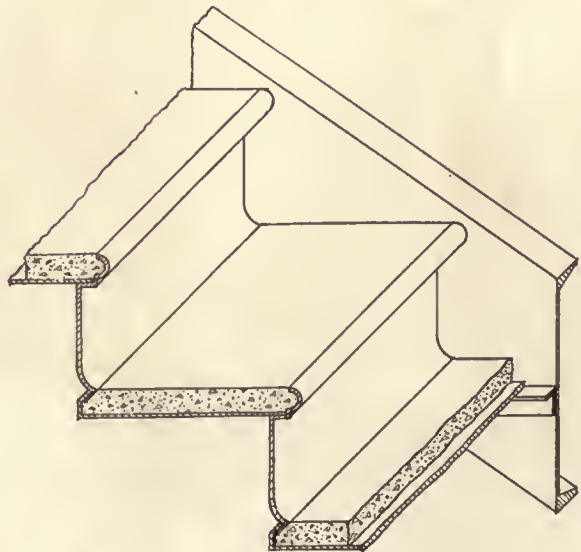

FIG. 8.—STEEL STAIRS WITH CONCRETE TREAD

VARIOUS TYPES OF STAIR CONSTRUCTION

advantage of reducing the floor space required. In fact, the stairway of minimum floor area (barring spirals) has a landing and a 180-deg. turn every 4 ft. in its height.

MATERIALS

The factory stairs are usually of wood, Fig. 3, cast iron, Fig. 4, steel or steel with wood tread, Fig. 5, steel with cast-iron tread, Fig. 6, steel with stone tread, Fig. 7, steel with concrete tread, Fig. 8, or reinforced concrete, Fig. 9.

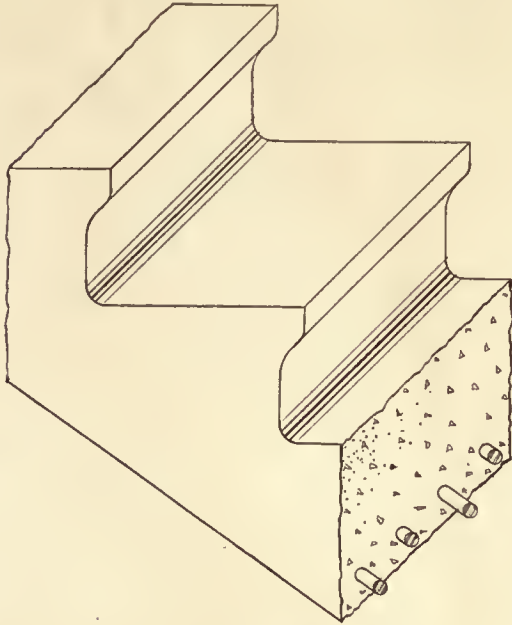

FIG. 9.—REINFORCED-CONCRETE STAIRS

Fig. 5, steel with cast-iron tread, Fig. 6, steel with stone tread, Fig. 7, steel with concrete tread, Fig. 8, or reinforced concrete, Fig. 9.

The wooden stair in multi-story factories is not good practice. It is combustible and unsanitary. In buildings of mill construction, however, especially the smaller ones when not over four stories in height and sprinkled, wood may be acceptable. The wood must be smooth, closely jointed, free from beads and not less than 2 in. thick, making a slow-burning construction. It is imperative that the wooden stairs be enclosed in a fireproof well.

The saving in cost, however, over a non-combustible stairway is not great enough to warrant the risk except in special cases. Cast iron and steel, while non-combustible, are not fireproof. Nevertheless, they are permissible when, as it always should be, the stairway is in a fireproof enclosure, since any fire hot enough to weaken the metals would render the stairway impassable.

Steel channels are more reliable for stringers and, except for short flights, cheaper than cast iron, and

are more generally used. Risers are usually of angle and steel plate or pressed steel. Treads, while usually of cast iron, are frequently of checkered steel plate, wood, slate or concrete.

Cast iron and steel plate wear slippery, and hence they are dangerous and should never be used without some sort of safety tread.

Wood, because of its inflammability, should not be used except as a safety tread over a solid sub-



FIG. 10.—SAFETY STEEL TREAD WITH LEAD PLUGS

tread. Slate does not wear slippery, but it is more expensive. It must be backed up by steel plate, and replacements are expensive.

Concrete as a tread on steel stairs has no special advantage. The steel plate under tread is needed, as it is for wood or slate, and to facilitate casting the steel is usually carried up to form a nosing. This is dangerous. The concrete is liable to crack off or wear below the top of the steel, leaving a lip over which sooner or later someone will trip and fall.

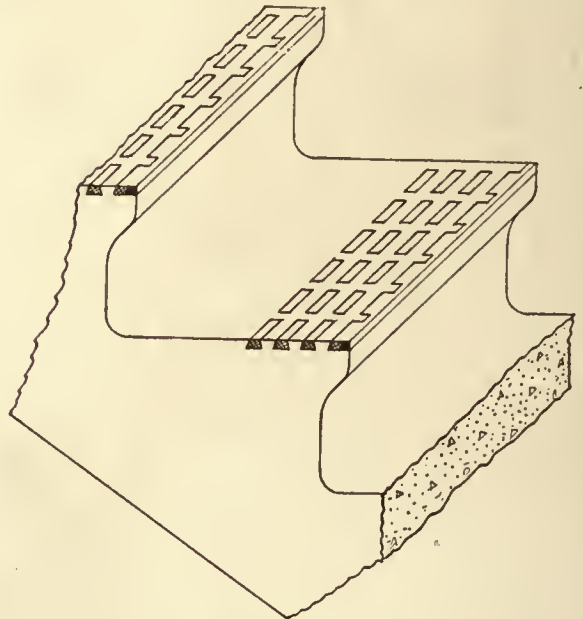

FIG. 11.—LEAD SAFETY TREAD IN CONCRETE STAIRS

Reinforced concrete makes perhaps the most satisfactory stair if properly designed and built. There should be a good filler between tread and riser, for sanitary reasons at least. There should be a nosing, which is not difficult to cast if made with a large fillet.

SAFETY TREADS

Steel, cast iron and concrete wear slippery and so become dangerous. Consequently some form of safety tread must be used. Safety treads are made of: (a) lead; (b) abrasive material; (c) a combination of the two; (d) cork; (e) wood.

*Lead Safety Tread.* The lead safety tread is made by inserting plugs of lead in pockets in a steel frame, Figs. 10, 11 and 12, the whole being fastened to the tread proper by screws. This of course wears more rapidly than cast iron or steel but does not become slippery and has no affinity for ice or snow. It is easily replaced when worn. The

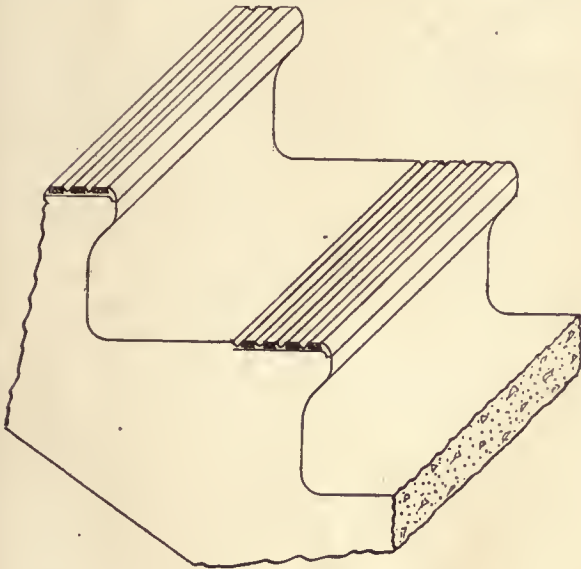

FIG. 12.—ANOTHER TYPE OF LEAD SAFETY TREAD IN CONCRETE STAIRS

chief objections to it are that, owing to the grooves between the lead plugs, it is difficult to keep clean, and there is some chance for a heel to catch in the grooves.

*Abrasive Safety Tread.* The abrasive tread is made of alundum or carborundum cast into hard metal, leaving the grit projecting slightly above the surface of the metal, Figs. 13 and 14. The abrasive is also imbedded in the rounded nosing to prevent slipping on the edge of the step.

This type of safety tread is made to be used as the complete tread as well as the renewable safety tread bolted to a sub-tread. It is also made as a nosing, this form being especially useful on concrete stairs, Fig. 15. This is probably the most durable tread in heavy traffic. It is, however, hard and noisy and, like the lead tread, it is difficult to keep entirely clean. There is also a chance that the grit may be too sharp, and instances are known

where the shoe has been gripped so firmly as to cause a fall.

*Combined Lead and Abrasive Safety Tread.* A third type of safety tread is made of grains of abrasive in a lead matrix, the whole carried on a

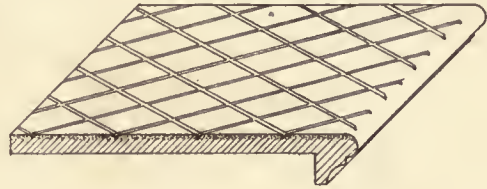

FIG. 13.—ABRASIVE SAFETY TREAD

steel plate. It is made either grooved, Fig. 16, or flat, Fig. 17, and with the anti-slip surface carried to the front edge.

The flat top is a great advantage, as it makes it possible to keep the stairs clean. For outdoor use it shares with the lead tread the advantage that snow or ice do not adhere. It also shares with the other type of abrasive tread the danger of too acute a grip.

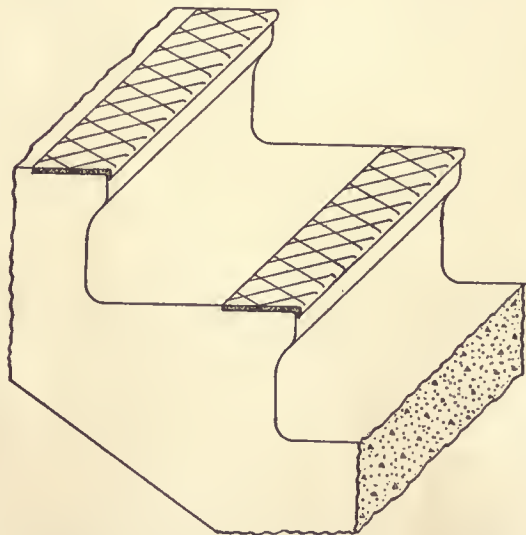

FIG. 14.—ALUNDUM OR CARBORUNDUM SAFETY TREAD

With either of the above three types of tread it is not necessary to cover the entire width of the tread. If the front edge of the step to a depth of 3 in. to 3½ in. is protected by a non-slipping surface the remainder of the tread only needs to be brought up flush with the safety strip.

*Cork Tread.* Cork as a safety tread is not so well known nor so widely used as it deserves to be. It is impervious to almost all liquids and hence is easily kept in a really sanitary condition. It is

noiseless, wears surprisingly well and is the pleasantest of all materials on which to walk.

Unfortunately, its lack of strength makes it necessary to use a metal or wood nosing, Fig. 18. This is not dangerous, however, because owing to the elasticity of the cork, the nosing will wear ahead of it.

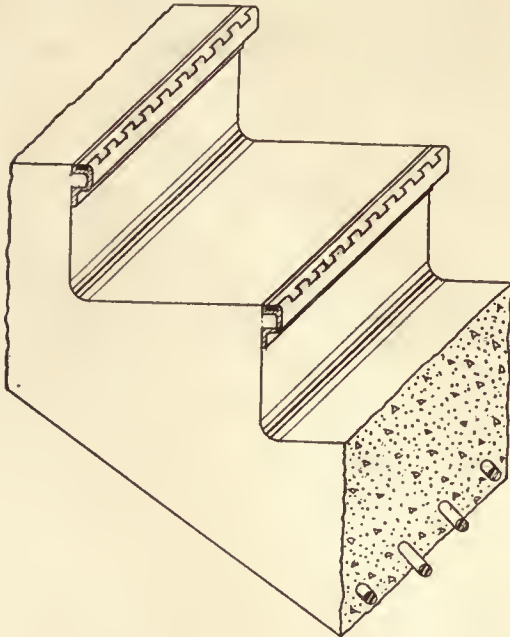

FIG. 15.—ABRASIVE SAFETY NOSING FOR CONCRETE STAIRS

Where stairs are liable to rough usage, as by dragging heavy pieces up or down, the cork tile is sometimes used with a nosing having a lead or abrasive non-slip surface, Fig. 19.

For use as a safety tread the cork is compressed into tiles  $\frac{1}{2}$  in. thick by 9 to 12 in. square. These are cemented to the sub-tread.



FIG. 16.—TREAD MADE OF ABRASIVE GRAINS IN LEAD MATRIX THE WHOLE CARRIED ON STEEL PLATE, GROOVED TOP



FIG. 17.—TREAD MADE OF ABRASIVE GRAINS IN LEAD MATRIX, THE WHOLE CARRIED ON STEEL PLATE, FLAT TOP

*Wood Safety Tread.* Except under the heaviest traffic, wood makes a splendid safety tread. Laid

directly on top of a solid steel or concrete base and exposed only on the top and front edge, the fire risk is practically eliminated.

Wood offers one of the most satisfactory surfaces to step on. It is never slippery and it is

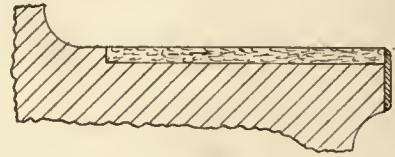

FIG. 18.—CORK TREAD WITH METAL NOSING

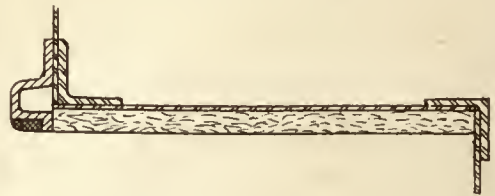

FIG. 19.—CORK TREAD WITH SAFETY NOSING

cheap. The worst objection to it is from a sanitary viewpoint because it absorbs excretion.

The wood should be either oak, maple or edge-grain yellow pine to wear well, the last named being undoubtedly the longest lived. Each tread should be made in three pieces, as shown in Fig. 3. The rear strip will never need to be renewed and the center strip but rarely.

(To be continued.)

## Plastering Specifications Needed

A series of experiments is being conducted to determine what effect the use of lime in various building materials may have on the corrosion of metal with which the material may come in contact. These experiments will have a bearing on the use of lime in concrete.

\* \* \* \*

The subject of preparation of adequate specifications for interior wall plastering is of great interest and importance to both architects, builders and the public in general. Owing to the difficulties involved in the preparation of these specifications the question of responsibility for them has been a matter of serious deliberation. The U. S. Bureau of Standards has recently been assured of the active support of the American Institute of Architects and the American Society for Testing Materials, and will proceed with the work. An advisory committee has been appointed by the Bureau of Standards to assist in the work, and it will get down to business at an early date.

## Annual Meeting of the American Society of Mechanical Engineers

THE fortieth annual meeting of the American Society of Mechanical Engineers was held in the rooms of the Society, Engineering Building, New York City, December 2 to 5, and the matters discussed appealed to engineers from every section of the country. The attendance exceeded in number that of the last two annual meetings. The program for the meeting follows:

### *Tuesday, December 2—Opening Day*

Registration begins on Tuesday, but the Council and Local Sections' representatives are to gather on Monday for meetings, and on Tuesday for a conference luncheon. On Tuesday evening the President's Address and Reception.

### *Wednesday Morning, December 3—Business Meeting*

On Wednesday morning will be held the Annual Business Meeting: Discussion of the Report of the Aims and Organization Committee and of the Joint Conference Committee representing the Founder Societies, besides several technical reports, including the Elevator Code.

### *Wednesday Afternoon—Session on Appraisal and Valuation*

On Wednesday afternoon will be a joint session with the American Society of Refrigerating Engineers, with papers on appraisal and valuation methods, including both industrial and street railway appraisals.

On this afternoon, also, is the Ladies' Reception and Tea, which has invariably proven one of the delightful affairs of the meeting.

### *Wednesday Evening—Memorial Session*

In the evening the Society has been invited to participate with other societies in a commemoration meeting on the work of the famous DeLamater Iron Works and of John Ericsson, the machinery of whose Monitor was built at these works.

### *Thursday Morning, December 4—Keynote Session*

A discussion on the general subject of the Industrial Situation in Relation to Present Conditions will be held on Thursday morning, with the following papers and addresses:

Wage Payment, A. L. DeLeeuw, Consulting Engineer.

Rights of Workers, Frederick P. Fish, chairman National Industrial Conference Board.

Systems for Mutual Control of Industry, William L. Leiserson, formerly chief, Division of Labor Administration, Working Conditions Service, U. S. Department of Labor.

Profit Sharing, Ralph E. Heilman, professor of economics and social science, Northwestern University.

### *Thursday Afternoon—General Session*

General session, with miscellaneous technical papers. Among the subjects to be taken up, either this afternoon or at the simultaneous sessions on the day previous or on Friday, will be internal combustion engines, machine design power plants and fuels and machine-shop practice.

### *Thursday Evening—Reunion and Dance*

In the evening there will be the usual reunion and dance, preceded by a lecture. Friday morning, December 5—Transportation session.

This will be the closing session of the meeting, to include a discussion of the possibilities of locomotive development and of motor trucks.

## Second Conference on Industrial Safety Codes, Washington, D. C., December 8 and 9, 1919

THE second conference on industrial safety codes, arranged by the Bureau of Standards, was held at the offices of that bureau, Washington, D. C., Dec. 8 and 9, 1919, and was in effect a continuation of the first meeting held Jan. 15, 1919.

In the absence of Dr. Stratton, director of the Bureau of Standards, who had unexpectedly been called upon by the acting secretary of commerce for duties that had taken him out of Washington, Dr. Rosa presided.

In opening the conference, which was attended by about a hundred representatives of the various organizations interested in the adoption and enforcement of safety codes, Dr. Rosa restated the object of the meeting as presented at the first conference, namely, to insure cooperation and comparison of notes by all those most interested in safety work and securing the advice and cooperation of representatives of the many engineering organizations, insurance associations, commercial organizations and State and municipal bodies and others who are actively interested in this work. Invitations to attend the conference had been issued to these various interested parties by the Bureau of Standards.

It is hoped that as a result of this conference work will shortly be undertaken for the formulation and development of a series of national industrial safety codes that can be generally used throughout the States and municipalities of the country. Dr. Rosa gave briefly the report of the meeting held in January and also stated the principal events that had occurred since then as far as the particular question of safety codes was concerned.

Inasmuch as this work is intimately related with the adoption of various standards, the organization of the American Engineering Standards Committee and its proposed reorganization had formed one of the topics of discussion at the first meeting. Professor Adams was called upon to report on the reorganization of the American Engineering Standards Committee which had been but recently effected. This reorganization necessitated changing the constitution of the committee, which has now been modified to permit of additional membership.

Professor Adams mentioned that Dr. P. D. Agnew of the Bureau of Standards had been appointed secretary of the committee and will maintain his office in the Engineering Societies Building, New York City. Due to the press of other duties, Dr. Adams has been compelled to resign the chairmanship of the committee, and Mr. A. A. Stevenson, vice-president of the Standard Steel Corporation, has been elected chairman to succeed him.

Relative to the matter of dues, Professor Adams stated that the present five founder societies represented and the three Government departments, *i. e.*, the American Society of Civil Engineers, the American Society of Mechanical Engineers, the American Institute of Electrical Engineers, the American Institute of Mining and Metallurgical Engineers, the American Society for Testing Materials, the War Department, the Navy Department and the Department of Commerce (Bureau of Standards), are supposed to pay a fee of \$500 for each representative, and they will have three representatives each.

The American Engineering Standards Committee does not prepare any standards under the rules of procedure. The Standards Committee appoints a sponsor body and the sponsor body prepares the standards.

Referring to the need of such standardization work, Professor Adams pointed out that in the single matter of symbols for the wiring of buildings there are fourteen different organizations, each with a complete set of symbols. In cases like this, the whole purpose is to reduce these multitudinous standards to a single satisfactory standard.

Dr. Lloyd of the Bureau of Standards then presented a survey of the many subjects now covered by industrial safety codes.

At the afternoon session Dr. W. L. Chancy of the Bureau of Labor Statistics spoke upon the subject of survey of industrial safety codes. He stated that it is not the function of this bureau either to produce or criticize safety codes, but rather to check up results, namely, to find out what is the actual effect of putting into operation safety codes.

Mr. Collett spoke on behalf of the American Society of Mechanical Engineers and reviewed the standardization work done by that body.

Mr. W. S. Paine, representing Mr. Van Schaack of the Aetna Life Insurance Co., recently president of the National Safety Council, said in part: "Speaking in the light of our experience as an insurance company and in working on safety codes with engineering committees, industrial boards and commissions, we have formed the belief that no one organization alone, even with the support of the law, can formulate a code covering any one of the numerous safety subjects in such a way as to be generally acceptable and of the greatest possible service to all.

"A single organization can effectively sponsor a code, but it will obtain practical and uniform results only by giving the engineer, the manufacturer, industrial boards and all organizations interested an opportunity to contribute their criticisms and often add pertinent and valuable information—in fact, to take a real part in the making of the code."

Mr. Rausch offered the following resolution, which was later adopted:

"RESOLVED, That the American Engineering Standards Committee be asked to request the International Association of Industrial Accident Boards and Commissions, the Bureau of Standards and the National Safety Council to organize a joint committee on safety codes, this committee to include representatives of these bodies; second, that this joint committee report upon the safety codes required, giving priority of consideration to the codes that should be taken up and the body that should be sponsor for them; and, third, that this report be put in writing and placed not later than February, 1920, in the hands of the American Engineering and Standards Committee."

Mr. S. J. Williams, secretary and chief engineer of National Safety Council, in discussing the proposal of Dr. Rosa for the appointment of an advisory committee to the Bureau of Standards, stated that to formulate these standards, so that they will be accepted, the various interests must have representation and not merely the chance to criticize and then have the criticism adopted or rejected in a further executive session at which no representation is had.

A motion to the effect that the conference indorse the proposal to put safety standards under the auspices of the American Engineering Standards Committee, as now organized, was unanimously carried.

At an informal meeting of representatives of the three organizations named in the resolution adopted plans were made for organizing the general advisory committee at

once, probably arranging for a meeting in January. Before this time information will be gathered as to what codes are now being written or revised in the various States and the general advisory committee will probably recommend that these subjects be given first attention. This committee will report to the American Engineering Standards Committee not later than Feb. 1, and the definite assignment of sponsorships to the National Safety Council, the Bureau of Standards and others will doubtless follow.

We may, therefore, look forward with reasonable certainty to having within as short a time as practicable codes on at least the most important phases of safety, provided by representative and competent committees, and worthy of general acceptance by State and other authorities.

### Engineering News from Europe

#### Engineers and Architects Co-operate to Revive Agriculture in Belgium

Great efforts are being made to revive agriculture in Belgium. Belgian engineers and architects helped to organize an important exhibition held at the Palais d'Egmont, Brussels, in September, 1919, with the assistance of the Belgian Ministry of Agriculture, which was followed by an important conference. Agricultural work during the war was dealt with, as well as its reconstruction. Models and plans of various types of farm and country houses were shown, which were considered suitable to improve and revive agriculture, and proper drainage, sewerage and sanitation were also dealt with. It appears that during the war many farmhouses were erected and farms formed. Each Belgian Province participated in the exhibition.

#### Belgian Town Planning Information

A big exhibition is being organized at Liège, Belgium, for February, 1920, by the Association des Architectes de Liège, U. P. A. Lg. (Belgium). The association will exhibit any drawings, models, etc., illustrating engineering, architectural and other matters in connection with town planning and allied subjects. These should preferably show planning and construction suitable for Belgium. M. A. Snyers, architecte diplômé, president, Association des Architectes, of 62 rue Louvres, Liège, is president of the exhibition, while the general secretary is M. Maurice Legrand, 44 rue Darchés, Liège. A similar exhibition was held at Brussels during September, 1919.

In regard to the Liège exhibition, it has been decided to display plans showing the proposed reconstruction and remodeling of the city and its environs, models of new bridges to be constructed, and plans and models of various garden cities to be erected on the outskirts.

The Organizing Committee reports that it has the co-operation and assistance of engineers, surveyors, etc., holding official posts, and burgomasters of the adjoining towns. Further, the committee reports that it has been engaged on the problem of the reconstruction of Visé (where the German armies entered Belgium), during the past four years, and has had the assistance of MM. Jacquemin, Ingénieur des Ponts et Chaussées, and Vercheval, Ingénieur des Chemins de Fer de l'Etat.

The new railway track constructed by the Germans in the vicinity is to be preserved, also the station at Visé, but many new tracks are to be constructed in the district, the Meuse is to be canalized, and a number of bridges are to be erected.



136

part, piece & No. 2502

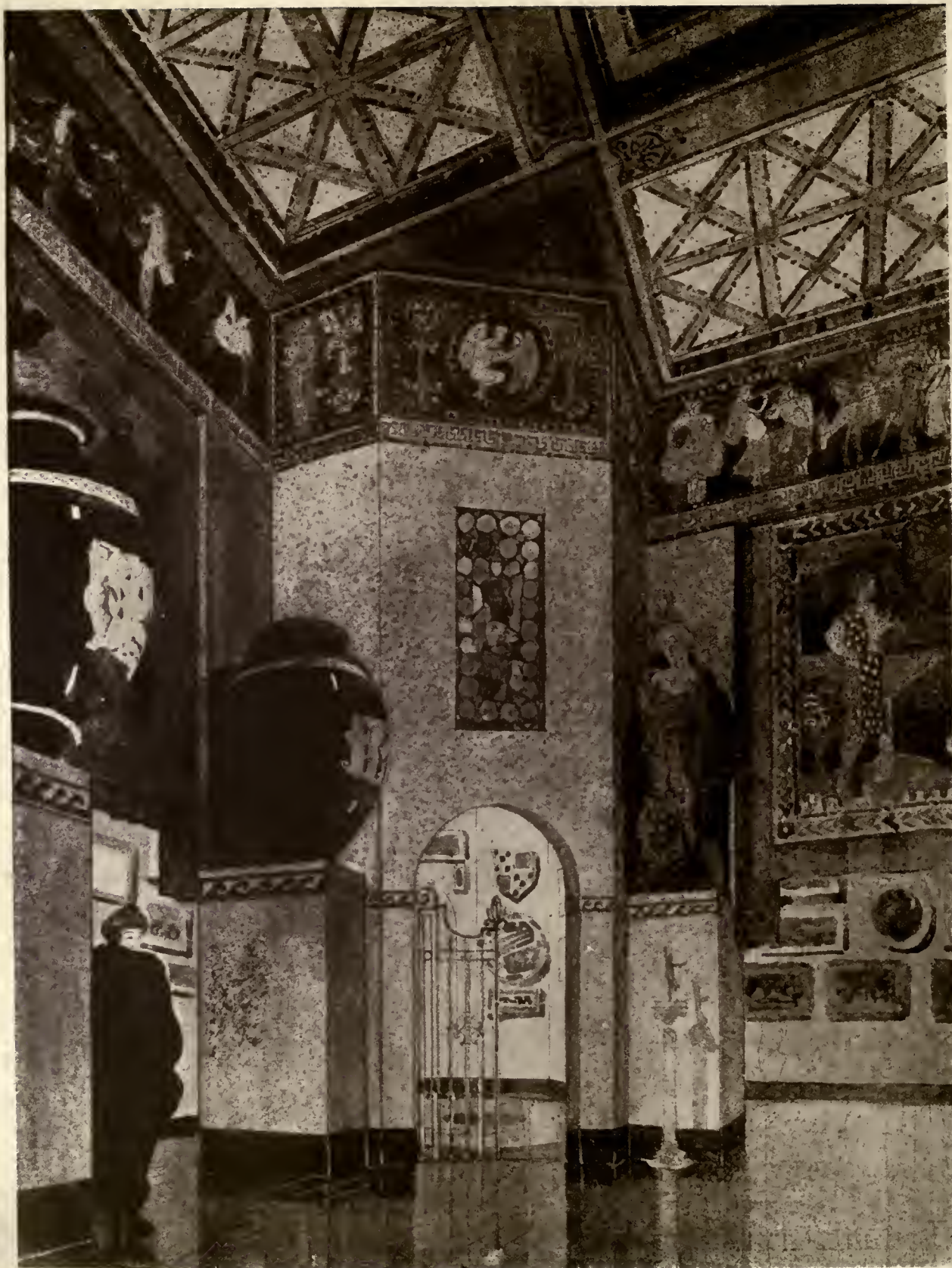

A DETAIL OF THE 1920 EXHIBITION, ARCHITECTURAL LEAGUE OF NEW YORK

# THE AMERICAN ARCHITECT

VOL. CXVII

WEDNESDAY, FEBRUARY 4, 1920

NUMBER 2302



TRUTH AND FORTITUDE  
 PANEL IN GESSO-DURO AND PAINT FOR AN OVER-MANTELS  
 MACK JENNEY & TYLER, DESIGNERS

## The Architectural League Exhibition in New York

### A Fire and Its Lessons

FROM the date of its organization, the Architectural League of New York has been a progressive body. Its annual exhibitions marked the high point in shows of current architecture. It has always been abreast of the times, and it has guarded as a duty, every good phase of architectural practice. The Architectural League of New York was among the first, if not actually the first organization of architects to realize that it was a duty of the profession not only to exploit everything that was good in architecture, but also to take under its care all those many phases of the arts and crafts that are allied to architecture.

In doing this there was displayed the most insistent and the most dignified manifestation that the architect is the master builder and that it is under his patronage, good influence and guidance that all those who contribute to the completed building might rightfully look for support and en-

couragement. With these high ideals always in mind, and with groups of men working harmoniously and in the best spirit of co-operation, the exhibits in New York of the Architectural League have become the art event of each exhibition season.

The very proper attitude of those who have directed the course of the League has inspired confidence in everyone in every art and craft that might properly submit material for exhibition. And, as the League's exhibitions had reached so high a plane of art and of practical work in the arts, those who submitted exhibits felt it a duty to send the very best they had. Every architect took from his files some cherished drawing, some irreplaceable example of his work. The mural painter, who had worked hard and with all the art he had on some decoration that meant hours of patient effort and many dollars in commission, postponed its de-

## THE AMERICAN ARCHITECT

livery that he might first send it to the League. Sculptors sent their finished marbles or casts of heroic size, and craftsmen from all the many branches of their art sent potteries, forged steel and iron, stamped leather and wonderfully woven fabrics. Each one sent the best he had. They knew that nothing less would be fitting for so fine an exhibition.

This is set down to indicate the high artistic value of the great lot of things that the League

charred fragments. The intense heat caused the glass skylighted ceiling to splinter and crash to the floor, bringing with it three of the four walls of the Gallery. The ruin was complete, the loss absolutely total.

Standing in the doorway of the front or practically undamaged part of the building, that occupied as offices by the various societies and the classrooms of the Art Students' League, an indescribable scene of wreck and ruin was presented. One



DIANA OF THE WHITE HORSE  
A MURAL PAINTING BY ARTHUR CRISP

had gathered for this year's exhibition. Everything was ready. In a few short hours the formal dinner that opens these exhibitions was to be held, and then—the fire came.

At about 10:30 on the morning of Friday, January 30th, there was a muffled explosion in the northern end of the Vanderbilt Gallery. A long blue flame shot out, indicating a short circuit of the electrical wiring. This flame leaping to the burlap-covered walls, spread rapidly to every part of the main gallery and thence to the smaller galleries. In the short space of an hour what it had taken weeks to prepare was reduced to a heap of

might look directly out-of-doors where high up on the surrounding buildings, firemen were silhouetted, playing great streams of water that flowed in turbid streams all over what but two hours before was a fairyland of color and form.

Viewing all this, the thought became insistent as to just what it all really meant. There are many points of view that might be considered, the first that of the artists who had created all the many things that had now gone up in flame and smoke. We might, if you like, calculate the money value of anything. We could take the sordid, cold-blooded attitude of the insurance adjuster who

## THE AMERICAN ARCHITECT

with pencil and paper tries to reach a total that will conservatively state the money loss. But he cannot, and no one can, compute the loss that is experienced by any of the many men who had put into some certain creation all they had of skill, of love for their art, the deep and abiding satisfaction that goes with the creation of the beautiful. These things that are lost can never be replaced. There is no matrix in the artist's mind that lets him duplicate his work. But, fortunately, it is such happenings that develop in every true artist a spirit of stubborn resistance to the very fate of things. While we may see no duplication of any of the things this fire has wiped out, there will spring,

humiliation and one is prepared to read in the daily press of other and much smaller cities some comparisons that will hurt New York's artistic sensibilities.

Had there been any other place in New York with gallery space, it is safe to assume that the Architectural League would in twenty-four hours have set about the assembling of a new exhibition and that there would not occur any lapse in the exhibitions annually held by this society. The shame of it is that there is no such place. We have wealth enough in this city, and we have had men who have spent large sums of money in acquiring collections which they have finally given to the city,



THE SHEPHERD

LEAD INSERT IN WINDOW IN BUYERS' CLUB, NEW YORK  
J. SCOTT WILLIAMS, DESIGNER



THE HUNTER

LEAD INSERT IN WINDOW IN BUYERS' CLUB, NEW YORK  
J. SCOTT WILLIAMS, DESIGNER

phoenix-like, from the ashes, a determination to excel, and in this determination, this indomitable spirit that is the very fabric of true art, we shall reap richly in the future as we have sown richly in the past.

A further thought will occur to the man, either professional artist, or of that constantly increasing group of men who love art for art's sake, and who do what they can to encourage its progress. The further thought will be that with the destruction of the Vanderbilt Galleries, the great city of New York with its millions of people and billions of wealth has no home to-day where art and those who create it might find shelter.

The thought is not a pleasant one. It does not bring a sense of civic pride. It creates a feeling of

but only when they were assured it would be properly housed. It may be well enough to gratify civic pride as to money to buy old Dutch masters for \$300,000 apiece and house them in a Fifth Avenue mansion. But we in the United States, we who have the true spirit of nationalism and who want to see this country not only first as a financial power but also as the art center of the world, have small sympathy with ostentation that glorifies an art which is dead and with a curious perversity neglects to encourage an art that is just coming to life.

If some one of our wealthy men would buy three hundred American paintings at a thousand dollars each, and if some other would provide a building sufficiently large, fire-proof and adequate to lodge



HOUSE OF GEORGE MARSHALL ALLEN, MORRISTOWN, N. J.  
CHARLES I. BERG, ARCHITECT  
1920 EXHIBITION OF THE ARCHITECTURAL LEAGUE OF NEW YORK



HOUSE OF GEORGE MARSHALL ALLEN, MORRISTOWN, N. J.

CHARLES I. BERG, ARCHITECT

1920 EXHIBITION OF THE ARCHITECTURAL LEAGUE OF NEW YORK

all of our Fine Arts Societies, they would become public benefactors in the largest sense.

As long as art in New York is confronted with the present difficult conditions as to an adequate home it will be an ill wind if it does not waft to the men who can most readily lend aid, a proper sense of the duty that is always an accompaniment of large wealth.

The art societies are not bankrupt. In fact many of them, particularly the National Academy, have large funds with which to join successfully in any well-considered Fine Arts building. Such a building will be an undertaking of great magnitude. It will need to provide space for offices,



PANEL IN BLACK LACQUER AND TERRA COTTA  
BY TROY KINNEY

meeting or club rooms, but more important than all, it will need gallery space wherein at least two large exhibitions may at the same time be held. If it is made accessible to all the people, there are enough of the masterpieces of the world in this country to afford adequate education in old art. We need some opportunities to study and encourage our American artists. It is a pity that we have to burn up very near a million dollars worth of American art to show the men who could, if they would, help in these matters, how fast we are growing. Unless some arrangement is soon perfected, there will necessarily be a postponement in New York until next Fall of all the projected Spring exhibitions.

The most important of these will be that of the National Academy. This society will require



SILK BATIK WALL HANGING  
DESIGNED AND EXECUTED BY JEAN PAUL SLUSSER

greater wall space than any other, and its important position as the leading art society in this country and the high class of its exhibitions demands dignified surroundings. This exhibition should not lapse because of this fire. There is ample space, or there can be provided ample space in the Metropolitan Museum, and it is there that the Spring Academy Exhibition should be held.

The man who loved New York and who has



THE MARTYR  
EDWIN F. FREY, SCULPTOR



## THE AMERICAN ARCHITECT

been dead these ten years, would if he came to life and witnessed an exhibition of the Academy in the Metropolitan Museum, doubt the accuracy of his eyesight. How he had hoped and hoped for years that he might see a representative collection of American pictures in America's leading art museum! How many hours had he in life spent toiling through galleries hung often with mediocre foreign art, and with many a so-called old master, some of doubtful authenticity? And now, here, in the museum, was to be seen a group of American pictures proving that the artist's claim for recognition was founded on good art, and proving that it

would be neither tactful nor wise in the future to ignore his right to recognition.

These things as the result of this fire, crowd the minds of men who find something in life worth while besides the frenzied chase of the dollar. They hope that the lesson now learned at so much cost will prove a lasting one. Will it? We must patiently wait to know.

Dreaming of these things, and many will sneeringly say they are dreams, we have failed to say much of the exhibition of the League, and must now set out to do so which, in fact, was the very thing it was essayed to do at the outset.



FOUNTAIN, AUDUBON PARK, NEW ORLEANS  
ISADORE KONTI, *SCULPTOR*, THOMAS HASTINGS, *ARCHITECT*



HOUSE OF GEORGE MARSHALL ALLEN, MORRISTOWN, N. J.

CHARLES I. BERG, ARCHITECT

1920 EXHIBITION OF THE ARCHITECTURAL LEAGUE OF NEW YORK



HOUSE OF GEORGE MARSHALL ALLEN, MORRISTOWN, N. J.

CHARLES I. BERG, ARCHITECT

1920 EXHIBITION OF THE ARCHITECTURAL LEAGUE OF NEW YORK



MODERN COMMERCE

DECORATION FOR COMMERCIAL HIGH SCHOOL, BROOKLYN, N. Y.

## The Exhibition

VIEWED in detail, the 1920 Exhibition of the Architectural League of New York came nearer than ever before to what it aimed to be, an exposition of contemporaneous American design and craftsmanship. The general scheme of the exhibition was created under the chairmanship of Howard Greenley. It contemplated the use of the South or entrance gallery for distinctly architectural work, while the Vanderbilt gallery was given over to large sized sculpture and decorative material. Along the four walls of this gallery, alcoves were formed, and these, each in the charge of a member of the League, were made as beautiful as it was possible to achieve. Each room or alcove was complete in itself, and contained all the accessories and refinements that the most skillful craftsmen could produce and the best trained artistic taste could accomplish.

Here was afforded opportunity to attain an object

that they had undoubtedly many times striven for in their practice, but never were altogether able to achieve. That object was the decoration and arrangement of rooms that would harmonize in every respect to period styles of furniture, decoration and accessories. We know the vandalism of the newly rich, and even the but moderately well-to-do. Every architect has had horrible evidence as to what havoc a client could work on a well designed interior when accompanied by a well-filled purse and a poorly developed sense of the fitness of things. So then, the men who set about creating these alcoves, in transferring so many square feet of space into a beautiful and suggestive interior, went about it *con amore*, with all the heart, enthusiasm and good taste they could command.

It is a great pity that the public could not have seen these things. Surely the public needs edu-



BLASHFIELD MEMORIAL FOUNTAIN

EDWARD HOWLAND BLASHFIELD, PAINTER, ELI HARVEY, SCULPTOR, CHARLES W. STOUGHTON, ARCHITECT

cating and in no direction more seriously than that which lets its architect mind his own business. Here was evidence as to what good taste based on knowledge, correct training and a properly developed artistic sense could create. Nor must it be inferred that these alcoves had appeal to but the very rich. Color is color as form is form. So that we may have the most beautiful harmony of color, the most correct interpretation of form, and it will not necessarily be so expensive as to be outside of the reach of the man of moderate means. But any man who retains an architect is not wise if he overrules his judgment. These alcoves would have served to make the impetuous

client pause and consider if it would not be better to give his architect his own way as long as he works within the limit of the appropriation.

It is such object lessons that would have made this a valuable exhibition to the general public exactly in the same way that previous League exhibitions have served to preach quiet texts in the art advancement of the people.

The sculpture, in marble, bronze and the plaster cast, was a beautiful feature of the Vanderbilt Gallery. These are now ruined, and will represent a very decided loss to the sculptor's art. There were examples by Daniel Chester French, Herman A. MacNeil, A. Stirling Calder, Mrs. Whitney, and others whose work is favorably known to architects. The grouping and arrangement was carried out with admirable skill. In fact the Vanderbilt Gallery of the Fine Arts Building had never before contained so much of good art so well displayed.

The South Gallery, while lacking in the spec-



DECORATION FOR AN OVER-MANTEL

GEORGE DAVIDSON, THE AMERICAN ACADEMY IN ROME

tacular aspect of its neighbor, was yet the very foundation on which the entire exhibition based its right to existence. This was the gallery of architectural exhibits. Conservative ones, or those



HOUSE OF GEORGE MARSHALL ALLEN, MORRISTOWN, N. J.  
CHARLES I. BERG, ARCHITECT

who will insist they are conservative, have claimed there was a decadence in the purely architectural exhibition because of the lack, or absence of purely architectural drawings, those strictly technical aspects of plan and section and elevation. But it is to-day acknowledged, and wisely so, we believe, that the true mission of the correctly promoted architectural exhibition is the education of the

public and not of the profession. For this good reason, those in charge of these exhibitions have encouraged the presentation of architectural subjects by means of well taken photographs, either direct or enlarged. The result is satisfactory and gives the casual visitor a much better idea of the work than he could obtain through a series of technical drawings he was unable to comprehend.



LITTLE & RUSSELL, ARCHITECTS

# THE AMERICAN ARCHITECT



FOOT BRIDGE, BRONXVILLE, N. Y.  
CHARLES W. STOUGHTON, ARCHITECT

Of course there were finely prepared competition drawings which showed the skill of draftsmanship and perhaps accented the fact that our recent competitions have not been the means of bringing out a large amount of originality in design. During the war, many men served long and faithfully in the arduous work of the Housing Division of the

Government. Men who for years had successfully planned and designed our most pretentious country and city houses, placed all of this rare experience at the service of the nation, and got down to the problem of the \$1,200 house "in cargo lots." Wherever one might have looked through this architectural exhibition one might have found the work



VIEW FROM SOUTH EAST

CLUB HOUSE FOR THE OAKLAND GOLF CLUB BAYSIDE 1.1

GOODWIN, BULLARD & WOOLSEY, ARCHITECTS

of these men, these major generals of architecture who served as architectural privates, and then attain a correct idea as to the great value of the services of these men in the development of the finest ideals of housing and the most correct way of sheltering our laboring population. We are to-day before all the world in the development and planning of the country house. It would be a revelation if all of the good stuff that covered these walls could be reproduced and sent broadcast. And with this wonderful development of our suburban architecture, who will doubt that the architects are at the same time teaching the people how to live higher and better lives. Certainly a man and all his family will strive for higher ideals in a well designed house than he possibly could do in one that he knew lacked every essential of good architecture.

It is these things that impressed the visitor to this last, and what would have been certainly acclaimed as the League's most successful attempt. No use to mourn a loss that cannot be replaced. But, to indulge a prophecy—the 1921 exhibition of the Architectural League of New York will be the greatest and most complete ever held in this country.

### For Better Education of Craftsmen

The Industrial Arts Council has recently been organized to develop ways and means for establishing a practical method of educating American designers and craftsmen. At the first meeting, held February 10th, in New York, twenty-nine industrial, art and educational organizations were repre-

sented by delegates. W. Frank Purdy of the Gorham Co. was elected chairman and John Clyde Oswald, editor of the *American Printer*, vice-chairman.

The organizations represented included: Architectural League of New York, Art Alliance of America, Chamber of Commerce of the State of New York, Association of Commercial Artists, National Society of Craftsmen, National Society of Decorative Arts and Industries, Association of Manufacturers of Decorative Furniture, Society of Interior Decorators, Monumental Crafts Association, Municipal Art Society, National Arts Club and others.

The subject for discussion was "City, State and Federal Interest in Industrial Art Education." The speakers included William T. Bawden of the Bureau of Education at Washington, Leon P. Winslow of New York State University, and James P. Haney, director of Art in the City High Schools. "We are two generations behind Europe in our art education," said Dr. Haney. "The present situation is that we have an unexpected demand for talent; we have gifted young people but there are few opportunities for training. The economic conditions demand an immediate effort to supply well-trained designers and craftsmen. Manufacturers, artists and educators must unite to accomplish this. Mobilizing our forces is necessary, and the Industrial Arts Council can do much to bring this about. Every manufacturer should feel it his duty and his privilege to aid this movement." Further details can be secured from the office of the Council at 10 East Forty-seventh Street.



THE ADORATION OF TRUTH  
 BY C. G. STICKROTH, PAINTER





*In order to supply our readers with material of current interest, the news and comment appearing in issues of THE AMERICAN ARCHITECT delayed by the printers' strike will be as of actual rather than stated date of publication.*

## Joseph Pennell Sketches the Billboard Nuisance

**T**HE *American Magazine of Art* in its January issue reproduces a series of sketches by Joseph Pennell graphically setting forth his impressions of the ever-present billboard. These pictures present the fact that billboards have now become a serious menace to the aspect out-of-doors in a more insistent way than could any number of well-written words.

They show that there can be no picturesqueness of view, no well-considered civic development that is safe from the blatant and vulgar intrusion of these signs. And they also prove what it is believed will eventually serve to curtail the selfish activity of these advertisers, that billboards depreciate property to a greater or less extent, particularly when placed within city limits.

Mr. Pennell, writing of billboards and the apparently large increase in their number, attributes this increase to the fact that during the war this Government used the billboard to the fullest extent to further its recruiting service and its various loan "drives." The necessities of that strenuous period silenced all objections. It was a usual sight to see billboards fronting monumental buildings and lining the most aristocratic thoroughfares. The wily promoters of billboard enterprises have been keen to sense the advertising value of such desirable locations and have in many instances been able to continue a nuisance that was only originally tolerated through patriotic patience.

It is now time that every municipality should see to it that billboards are restricted in their placement and that such locations as are permitted should be decided with reference to their damaging effect on neighboring real estate values.

The large number of people that form the traveling public also have rights and privileges in the out-of-doors that the promoters of billboards constantly infringe. To the person who likes to view

the open country from motor car or railroad train or more slowly while afoot, the presence of these atrocious signs is a source of irritation that even the most patient mind cannot restrain.

Just how long a patient and much suffering public will tolerate this sort of thing cannot be foretold, but it seems impossible to believe that the rights of many should be so seriously infringed by the sordid graspings of these sign-board promoters.

In fighting to make the world safe for democracy was not a principle as herein involved part of what we fought for?

## A Regional Style of Architecture

**I**T would be futile to strive for the evolvement of a national type of architecture in this country. The difficulties are too well known to require any extended recapitulation. The one and perhaps principal retardant, that of the widely varying climate, is in itself an insurmountable obstacle.

But it is, as *THE AMERICAN ARCHITECT* has many times contended, quite possible to create regional types, and it should be the duty of designers everywhere to develop such types as far as possible. The idea of regional types is not new. It is now at least ten years since certain men prominent in the Middle West set about the creation of original types of architecture. The efforts of these men, excepting perhaps those of Louis H. Sullivan, were not received with the respect and encouragement that might later have led to better results. Men who strive for originality always have to confront and combat the criticism of those other and greater numbers who are content to follow precedent straight on to monotony and the realm of the commonplace.

Why is it that while the whole country is agreed on the great benefits to be secured from an absolute Americanization, the profession of architecture should as a critical body withhold its influence and deny support to any effort to Ameri-

## THE AMERICAN ARCHITECT

canize our architecture? Why is the Institute so neglectful of these important things? THE AMERICAN ARCHITECT has been recently directing attention to certain important competitions and found occasion to deplore the absence of originality of expression in any one of the six designs submitted. There was an opportunity for some brave man with an open mind as to architectural design to have submitted something that contained elements of originality and the suggestion of a new type. Undoubtedly such a design would not have been seriously considered, but undoubtedly it would have given inspiration to other competitors in other competitions and led the professional advisers to a more open mind for something besides "classical precedent."

THIS movement toward the development of regional types will require the development of a new mental attitude toward architectural design. Men in the profession will need to become more tolerant, more receptive. Architectural journals will also need to show a freer disposition to give space to the exponents of this new movement.

Here again, as in most things that now affect the future development and logical practice of architecture in this country, looms the question of education. As long as the demonstrative elements of our educational methods depend on century-old types to instill new knowledge we shall continue to copy and to be commonplace. The pedagogical rut must needs be filled in and a smooth and easily traveled way be blazed for the architectural student of the future. This broad path can only be indicated by the practical element of the profession, and it is safe to predict that any future educational methods that are not originated in the working ranks of architecture will achieve nothing of reform and only serve further to prolong systems now known to be obsolete.

If we are to evolve those distinctive regional types that are possible and to encourage the efforts of the men who will strive to achieve them, the future revision of architectural education must be in the hands of that practical element, who by long experience, are able to detect the germs of a new and better standard of design, one that will Americanize our architectural development.



VENETIAN COMMERCE

GEORGE DAVIDSON, PAINTER, THE AMERICAN ACADEMY IN ROME  
1920 EXHIBITION, ARCHITECTURAL LEAGUE OF NEW YORK



HOUSE OF C. E. CHAMBERS, RIVERDALE, N. Y.  
JULIUS GREGORY, ARCHITECT  
1920 EXHIBITION OF THE ARCHITECTURAL LEAGUE OF NEW YORK

152



1522



HOUSE OF C. E. CHAMBERS, RIVERDALE, N. Y.  
JULIUS GREGORY, ARCHITECT  
1920 EXHIBITION OF THE ARCHITECTURAL LEAGUE OF NEW YORK



3  
162



ENTRANCE DETAIL  
HOUSE OF C. E. CHAMBERS, RIVERDALE, N. Y.  
JULIUS GREGORY, ARCHITECT  
1920 EXHIBITION OF THE ARCHITECTURAL LEAGUE OF NEW YORK





4  
152



HOUSE OF C. E. CHAMBERS, RIVERDALE, N. Y.

JULIUS GREGORY, ARCHITECT

1920 EXHIBITION OF THE ARCHITECTURAL LEAGUE OF NEW YORK



5  
152



HOUSE OF C. E. CHAMBERS, RIVERDALE, N. Y.  
JULIUS GREGORY, ARCHITECT  
1920 EXHIBITION OF THE ARCHITECTURAL LEAGUE OF NEW YORK



152



A HOUSE AT HARTFORD, CONN.  
GOODWIN, BULLARD & WOOLSEY, ARCHITECTS  
1920 EXHIBITION OF THE ARCHITECTURAL LEAGUE OF NEW YORK



152



ENTRANCE DETAIL OF A HOUSE AT HARTFORD, CONN.  
GOODWIN, BULLARD & WOOLSEY, ARCHITECTS  
1920 EXHIBITION OF THE ARCHITECTURAL LEAGUE OF NEW YORK





1528



HOUSE AT HARTFORD, CONN.  
GOODWIN, BULLARD & WOOLSEY, ARCHITECTS  
1920 EXHIBITION OF THE ARCHITECTURAL LEAGUE OF NEW YORK



152  
8



HOUSE AT HARTFORD, CONN.  
GOODWIN, BULLARD & WOOLSEY, ARCHITECTS  
1920 EXHIBITION OF THE ARCHITECTURAL LEAGUE OF NEW YORK



# Criticism and Comment

---

*The Editors, THE AMERICAN ARCHITECT:*

I am writing with a view of making certain comments upon the attitude which run through your issue of November 26th, in reference to "labor." During the last five or six years I have made a very thoughtful study of the subject, particularly the subject of Guild organization, and I cannot agree with Mr. Hewlett's report either as to its general conclusions or as to his statements which have to do with the organization and purposes of the Guilds. As a matter of fact, the Guilds exercised a more drastic control over production than unionism has ever attempted to exercise; and the break up of the Guilds was due more largely to the gradual break down of control than perhaps to any other condition. The Guilds were associated with petty trade and they controlled production. The entrance of price competition and the contamination of the spirit of the Guilds by this institution was what occasioned their disappearance. This, however, is rather beside the point.

What I would call your attention to is that throughout this issue it is apparent that you assume that the way to stimulate production is to force labor to accept the conditions which were in force in pre-war days. Now I do not question your conclusion if this can be accomplished, but in my judgment no power on earth can force the proletariat back into a position in which it is not to exercise a far greater control than ever before over the process of production. This is the outstanding fact which we must recognize in our study of recent history and in the development of our new program of action.

I rate your editorial comments and the attitude of the Board of Directors as merely talk about it. It is utterly beside the point. I grant that undoubtedly for a certain length of time business enterprise as it is carried on through its system of price competition may be able to hold the great proletariat to the practice of the past, but the force will accumulate and such an attitude will make an overthrow only the more certain. I will not continue this argument, but I would suggest that if you were to read "Intellectuals and the Wage Worker," by Herbert Elsworth Cory, published by the Sunwise Turn, 53 East 44th St., New York, you would more clearly understand what I am driving at and more accurately grasp the nature of this movement and the problem we are facing.

Throughout this issue of *THE AMERICAN ARCHITECT* there runs the implied suggestion that it is labor which is exercising sabotage. Now I main-

tain that the sabotage which is exercised by labor is but a part of the sabotage which is exercised by the modern industrial system at this time. It seems to me that if you study carefully the British situation where not only the Government, but the contractors, labor and everyone seems to be ready to embark upon the national scheme of home building, you will discover that the only factor which holds up the operation is the sabotage of capital; that is to say the building program is held up because it does not appear that under the present conditions of production and distribution, capital can be guaranteed a sufficient return and a sufficient reward in the line of increment to be derived from investments on houses. Of course you may not rate that as sabotage, but I cannot differentiate between the sabotage of labor which stands out for shorter hours and higher wages from that of capital which stands out for a certain interest return and increment of value to be derived from investment. At the present juncture in England the only force which stalls the whole operation is the withdrawal of capital.

I am not making a plea necessarily for "labor" or the proletariat, I am merely suggesting that the attitude which is now being so generally assumed toward this problem will get us nowhere. The attitude is not that of a scientific investigation into the causes which have made for the conditions of mal-adjustment. We take it for granted that the only solution of this problem is to return to the conditions of status quo ante. I maintain, and I have all history to back me up, that there is no such thing possible as the return to the conditions of status quo ante. On the whole the labor movement revolves around the idea of gaining control over the process of production; and the problem of those who rate themselves as intellectuals or what not is to take recognition of this fact and so to organize their program as to avoid an overturn which is absolutely certain to follow if we continue in our policy of attempting to suppress this movement.

New York, FREDERICK L. ACKERMAN.

*The Editors, THE AMERICAN ARCHITECT:*

Replying to "An Opinion on Competitions" by Mr. Egerton Swartwout, published in a recent issue of an architectural magazine: it is unfortunate that the writer has so confused the subject he debates as to retard a practical solution of the difficulties the Institute is experiencing in its endeavors to establish a working code of ethics or

rules that accord with the best ethics outside the profession and in accord with the practical nature of the functions of architects in general society.

Mr. Swartwout has, perhaps unconsciously, led the reader to the inference that those of the Illinois Chapter who proposed to revise the code on competitions so as to eliminate the present untenable and really impractical definitions of a competition, do not really understand what the code really means, or were not in any way cognizant of the conditions which led to the adoption of the code in its present form.

There is, apparently, underlying this lengthy criticism of the attitude of the men who are endeavoring to revise the code—not the program, as erroneously stated—an endeavor to discredit their motives and to impugn their knowledge of the matter and the correctness of their sources of information.

He advances the opinion that if architects were paid for submitting their several schemes or sketches for the solution of the same problem "the Institute would forget its rules of fairness (the model program, not the code), and allow the old scramble;" "that a client who cannot afford to pay his competitors is bound by certain rules, but the richer client can have everything his own way;" but he hastens to credit the proposers of the idea that architects should be paid for submitting sketches when no formal competition is instituted with the good sense that "they did not look at it in that way at all."

It is hardly likely that they did, for in practice if a poor owner could not afford the luxury of two or more architects devising schemes for his building and if architects would not submit sketches without adequate pay for them he would not order or receive them, whereas the rich client who desires to find the best invention for the solution of his problem and retain the right of being his own judge of what he wants could have as many minds at work as he cared to pay for without in any way stultifying the architect or asking him to violate his code of ethics.

The evils cited by Mr. Swartwout as having at one time and another been encountered by him in his early experience in competitions are no different from those experienced by many others to-day. These could be avoided by the simple expedient proposed in the revision of the code, which is, that each competitor should be paid for the work he does unless he enters a formal unpaid competition. The banker would not have asked Mr. Swartwout to submit sketches to show his inventive genius for the solution of such problems when he had already contracted for the architectural serv-

ices with other architects if he had known Mr. Swartwout belonged to an honorable profession that considered it unethical to think out a scheme for nothing, unless, perchance he thought Mr. Swartwout was likely to suggest something so valuable that he could afford to pay for both architects, which might have been the case had the custom of paying for services rendered been established, but which Mr. Swartwout of course could not have inferred under the present prevailing status.

The fact is that instances can be shown where, under the present code, not less than five representative older Institute architects submit sketches for the same problem without an agreement or understanding for payment, and when confronted by the Institute code, each stands on the alibi that he did not know (in fact probably could not know), that the same owner asked in the same manner other architects to submit sketches for the same project. Moreover, they can all take cover under the provision of the code (also proposed by the same gentleman of the same Chapter to be eliminated), whereby it is ethical to submit sketches without remuneration where personal or previous business relations warrant it.

The contention that "the principle of competition has been inherent in architecture since the beginning" is to state a cause constructed merely from the owner's point of view. This point of view will, and unfortunately, always prevail. A promise based on what men have or have not done in the past is not a logical one to argue the future, as no one may know what the attitude may be toward the constantly changing present conditions as influencing future action.

It is for this reason that a direct solution of the problem of competitions is not correctly possible. There can be no definite selection of an architect as representing a certain definite scheme, and it is for this reason that competitions of one sort or another will always be the resort of owners, particularly when the problem presented requires adherence to specific details of a program. No codes or rules formulated by the Institute can alter the fact.

Mr. Swartwout rightfully admits that the Institute "could not say to owners they must conduct their competition along certain lines—that would be an infringement of rights." But certainly the Institute can fairly help to establish among its members such common principles of ethics as that the owner must pay each man for the effort he makes, or if not willing to pay each competitor, and the architects are willing to gamble on who gets the pay, they can withhold their participation un-

less the rules of the competition are expressed and the gambling conducted on a fair basis. This, as I understand it, is what was proposed in the revision of the code in respect to competitions.

Is it not possible that the men who made a certain proposal and whom Mr. Swartwout says "misunderstood," "did not know," "did not consider the matter carefully," "were dissatisfied with restrictions," considered all of these matters and realized that unless the Institute abandons the untenable definition of its prohibited competitions and eliminates the suggestion that schemes and sketches may be worked out by its members without remuneration and brings its code of so-called ethics into harmony with common higher standards of ethics and makes its mandates and prohibitions accord with the present day advanced principles of service in regard to the servant and his hire, it will continue to repel the more self-respecting and conscientious architects and lose whatever of good influence and respect it may have attained among other professions and businesses?

It has long been realized by architects, due to actual experience, that it is not possible to practice the code as to competitions just as it is written. Naturally, in view of this, and the attitude shown by architects in this connection, the public logically surmises that any group of men who will agree to accept such and such a code and then continue to violate it, are lacking in respect for the Institute, are equally lacking in a punctilious regard for agreements with one another and to put it but mildly, have a perverted sense of ordinary professional honesty.

The Illinois Chapter did not make any suggestion or recommendations for changing the Institute form of competitions. What it urged was a revision of the code as applying to such competitions. It is therefore difficult to comprehend why Mr. Swartwout's championship of competitions, a field in which he has most successfully engaged, should have, in its fervor, led him to overlook the wisdom of a revision of a code of ethics, which in its failure to safeguard the dignities of these important architectural undertakings, he undoubtedly has found many times good reason for dissatisfaction.

Chicago.

HENRY K. HOLSMAN.

*The Editors, THE AMERICAN ARCHITECT:*

In response to the request in your favor of the 17th inst., I take pleasure in sending you my opinion on the question of "Payment for Estimating," which was discussed in your issue of September 24.

It is my belief that all estimates required by the projectors of enterprises which involve engineering

should be made by independent and unprejudiced engineers, who should compute more or less accurately (according to the desire or necessity of the projector and to his willingness to pay adequate compensation for professional services) the quantities of all materials that will enter into the construction, determine by careful investigation the unit prices therefore which will probably govern at the time of the letting, from these, as data, estimate the cost of each item, sum up the costs thus found, and add to the total a certain percentage thereof (generally ten) to cover engineering and contingencies. The result will often be just what the projector requires; but in some cases there should be added also allowances for cost of organization, brokerage, loss by selling securities below par, promoter's overhead expenses, and interest during construction.

The standing of the engineer who makes these computations should be so high as to render his estimate just as reliable as that of any contractor—in fact more reliable; because the said contractor would be giving the opinion of one man only—and of an interested party at that—while the engineer would aim, in determining his unit prices for labor and materials, to express the average judgment of several reasonably low bidders. Moreover, he could, if he should see fit, report the probable limits, for low but responsible bids, above and below his estimated total. In calling for tenders, the specifications should be as full and complete as it is possible to make them, giving the bidders such an exhaustive statement of all conditions, that the expense to which they need be put in tendering would be a bagatelle. Under such circumstances the bidders should not be paid anything for their estimates.

But if the projector is not willing to retain a competent engineer, or if he objects to trusting entirely to his engineer's judgment in estimating the probable total cost, he can submit to the bidders specifications of a very general character, and thus necessitate for each one of them an investigation of all the governing conditions, a more-or-less-complete design, and a detailed estimate of cost, with profit added to form the bid. In that case it would be only just and proper to pay each bidder, with the possible exception of the successful one, a fair amount of money to compensate him for his time and cash expenditure in preparing the bidding papers.

The result of this method is never as truly satisfactory as that of the one first described, although the projector may think it is; and it is sure to cost him much more, because the work will have been done several times in one case and only once in the other.

The preceding statement expresses my personal opinion based upon a large professional practice extending over a period of forty-four years, with seven of them devoted mainly to the contracting

side of construction, six all told to teaching engineering, and the last twenty-eight entirely to private practice.

J. A. L. WADDELL.

---

## Current News

### Happenings and Comment in the Fields of Architecture and the Allied Arts

*In order to supply our readers with material of current interest, the news and comment appearing in issues of THE AMERICAN ARCHITECT delayed by the printers' strike will be as of actual rather than stated date of publication.*

---

#### First Annual Meeting New York State Association of Architects

The first annual meeting of the New York State Association of Architects was held at Rochester on Feb. 14. There were about seventy-five members present.

The principal topic of discussion at the afternoon session related to the unionization of the draughtsmen employed in architects' offices. A letter was read from the general organizer of the International Federation of Technical Engineers, Architects and Draughtsmen Union, which is affiliated with the American Federation of Labor, asking that the New York State Association consider the advisability of supporting its movement for the unionization of architects and draughtsmen.

After a lengthy discussion it was moved that a committee be appointed to confer with committees of other architects' societies and with associations of draughtsmen on the subject of unionization of draughtsmen. This committee will report back to the association. The intent of the association is to give the committee an opportunity to discover the proposed union and to discover whether such unionization is intended to improve the conditions, opportunities and educational advantages of architectural draughtsmen, or whether it is being formed simply to obtain higher wages.

It was reported to the meeting that the Governor's Reconstruction Commission was about to report a recommendation for constructive housing legislation for the state. This recommendation may include a clause giving the state and the municipalities power to issue bonds to provide a fund, not to build houses, but to loan money on mortgage security, for the erection of houses built up to a standard of light, air, accommodations, etc., to be determined by the state and municipal housing commissions. A committee was appointed to do everything possible to further this end. The members of the association were heartily in approval of the work of the Reconstruction Commission.

A lengthy discussion of the proposed amendment to the bill requiring the registration of architects was included in the afternoon session. The matter was referred to the legislative committee.

The outline of the scheme of the city planning com-

mission of Syracuse was presented, and E. S. Gordon, of Rochester, talked on "School Buildings in Rochester."

The subject of civic war memorials was taken up at the session following the dinner. It was felt that more care and thought should be put into the erection of these memorials, and the association will appoint a committee of architects, which will confer with any communities that propose to erect these memorials.

The scarcity of building materials and the general high prices was another topic that was considered by the association, and a number of architects from various parts of the State told of conditions in their different communities.

In conjunction with the meeting of the state association a meeting of the Central New York Chapter of the American Institute of Architects was held at 1.30 o'clock. This Chapter includes architects from Rochester, Syracuse, Ithaca, Rome, Birmingham, Utica and Elmira. Prof. George Young, Jr., of Cornell University, presided in the absence of Leon Stern, of Rochester, who is president of the Chapter. Robert D. Kohn, of New York, made a brief address.

There have been a number of local architectural societies formed in the cities of the State within the past year or so, and the New York State Association is on record as actively fostering the formation of such societies, so that the architects of each community may act as a unit on all civic matters and at the same time become better acquainted.

The next issue of the Bulletin of the New York State Association will be issued by the Rochester Society of Architects, with John W. Viccary as editor, the later issues to be made up by the architects of other cities, Utica, Albany, etc.

The following were elected: President, Ornan H. Waltz, of Ithaca; first vice-president, Robert D. Kohn, of New York; second vice-president, Edward B. Green, of Buffalo; third vice-president, Frank H. Quimby, of Brooklyn; secretary, Walter G. Frank, of Utica; treasurer, Harry W. Greene, of Watertown; directors, J. Riley Gordon, of New York; Frederick L. Ackerman, of New York; Gordon A. Wright, of Syracuse; Maurice M. Feustmann, of Saranac Lake; and W. P. Bannister, of Brooklyn. The place and date of next meeting were settled as New York in May.



## Monthly Meeting Southern California Chapter

The one hundred and thirty-second regular meeting of the Southern California Chapter A. I. A. was held Jan. 13. Retiring president, H. M. Patterson, in the chair and seventeen members present.

The guests of the evening were the honorary members, Charles F. Lummis, former curator of Southwest Museum and one-time librarian of Los Angeles Public Library, and John W. Mitchell, attorney and art student.

A. F. Rosenheim, chairman of the committee to undertake the selection of the most notable examples of architecture in Los Angeles and vicinity, made the announcement that the selection of the jury to judge the contest had been made as follows: Charles H. Cheney, city planning consultant of San Francisco; Winsor Soul, architect, Santa Barbara; John T. Vawter, architect, San Diego; John W. Mitchell, attorney and art student; John A. Comstock, curator of Southwest Museum, Los Angeles.

The architects of Los Angeles will be asked to make nominations from which the jury will make its selection. It is planned to have the jury meet the latter part of February to make selections as follows: Ten most notable examples of architecture; three most notable examples of landscape architecture; two most notable examples of public sculpture; five most notable examples of small house architecture costing less than \$5,000. The selection to be made of examples within a twenty-mile radius of the City Hall.

The object of the contest is to arouse interest on the part of the public in what really constitutes good architecture.

On retiring from the presidency, H. M. Patterson reviewed the work accomplished in the chapter during the year. He outlined the improved conditions and the bright outlook for the future of the building business during the coming year, bringing larger opportunity and obligation to the chapter.

The newly elected officers for the coming year were installed in office as follows: Edwin Bergstrom, president; H. F. Withey, vice-president; R. G. Hubby, secretary; August Waskerbarth, treasurer; A. M. Edelman, member of the executive committee.

Mr. Bergstrom, in his speech, outlined a general program for the activities of the chapter during the coming year.

The motion was carried that the award of medals be made this year for the best designed and constructed buildings during the previous year.

Announcement was made that the convention will be held in Washington on May 5, 6 and 7.

The following nominations were made for delegates to the convention: Octavius Morgan, Albert C. Martin, A. F. Rosenheim, A. M. Edelman, Robert Farquhar, A. B. Benton, Myron Hunt and J. E. Allison.

## Building in Valparaiso

The municipality of Valparaiso plans to construct municipal lodging houses for the poor. Bonds are to be sold to finance the construction, in Valparaiso, of cheap but sanitary houses for workmen. The Chamber of Deputies has appropriated 2,290,000 pesos to complete the building for the School of Engineering and Architecture and 100,000 pesos for the completion of the structure for the course of Anatomy in the School of Medicine. One hundred and forty thousand pesos have been allowed for

the construction of the Morgue of Santiago. A Museum of History is to be built and an architect for this purpose is to be chosen. An Industrial School for Men is to be established in Concepción and the Minister of Industry is now soliciting a site for this project.

## New Organization Will Encourage Inventors

The National Laboratory Foundation for the Development of American Inventions and American Industries has been founded by leading inventors, engineers, financiers and manufacturers of the country. The institution's purposes are to be "philanthropic in character, to foster, aid and develop the idea and perfect the invention regardless of whether the inventor be rich or poor." It was proposed to found an endowed institution with a complete modern research laboratory, machine shop and research and patent library and with a suitable corps of engineers, chemists and mechanics in charge.

## Motion Picture Producers Recognize Efforts of Architects in the Productions

The important motion picture producers are fast realizing the commercial value of good architecture. This fact is becoming evident in the recent presentation of "feature films." Among those legends which announce the various people who shared responsibility in the production of a scenario, it is becoming customary to include the name of the architect who designed the exteriors and planned the arrangement and decoration of rooms which serve as a background for the story. Architects will appreciate this recognition of their co-operation in these matters.

## Irrigation Reclaims the West

Two million acres of worthless desert have within two decades been made productive by government irrigation. On this land, it is learned, there are now housed 400,000 persons. The present value of crops produced in the reclaimed area approximates \$70,000,000 annually.

In the *Reclamation Record* for December, Arthur P. Davis, Director and Chief Engineer of the U. S. Reclamation Service, Washington, has summarized the important results of this vast undertaking as affects housing, crops and other natural and artificial resources. He says in part:

"Since 1902 the Reclamation Service has constructed the irrigation system to supply completely 1,780,000 acres of land. Also the capacious storage reservoirs of the Government are furnishing a supplemental supply of stored water to a million additional acres in other projects, or a grand total of 2,780,000 acres.

"On the Government-project lands are 40,000 families in independent homes. The population in cities, towns and villages in these Government projects has been increased by an equal number of families. That is to say, on the 1,780,000 acres reclaimed there are now profitably employed and satisfactorily housed 400,000 people. The arguments for increasing and making permanent the nation's virility, prosperity and growth by creating more homes

of this kind were never more forcible and unanswerable than just now. American people cannot rightly claim to have measured up to their opportunity until the deserts of the West and the unused agricultural lands of the balance of the nation have been replaced by vistas of prosperous farmsteads.

"When measured by the yardstick of the financier—the dollar—the results of the Reclamation Service activities are interesting.

"As a creator of wealth, its service to the nation and the state has been as great as in its principal task of home-making. Out of the uninhabited and almost worthless desert it has carved an empire of nearly 2,000,000 acres, intensively cultivated, and producing crops whose annual average gross returns per acre are about double those for the rest of the country.

"In 1902 an acre was worth \$10. To-day it is worth \$210."

---

## Material Handling Machinery Manufacturers' Association Will Hold Convention

It is announced that a convention of the above-named organization will be held on Feb. 26 and 27 at the Waldorf-Astoria Hotel, New York. Manufacturers from any part of the country are invited, and especially those making overhead, locomotive, gantry cranes, hoists, gravity and power conveyors, industrial trucks, elevators, and all forms of equipment and supplies used in the construction and operation of mechanical machinery. Papers and discussions will be an important feature. Zenas W. Carter, 35 West Thirty-ninth Street, New York, secretary.

---

## Chicago Needs Houses

Half a million persons in Chicago "are living like pigs in the slum districts" to-day, according to a statement to the Association of Commerce made by E. J. Rosenthal, head of the Chicago Housing Association. Housing facilities in the city are inadequate, he said.

"People are sleeping, six, eight and ten in a room; men, women and children, many of them not even related to each other," according to the statement. "Children are playing in our gutters and alleys."

He declared "the number of young people whose downfall is due wholly to the dangerous intimate contact into which they are forced by lack of adequate rooms or decent living conditions" was astounding.

---

## The Stout Institute (Menomonie, Wisconsin) Apace with the Times

This institute, supported by the progressive State of Wisconsin, represents an investment of three-quarters of a million dollars.

The school is wisely organized to prepare instructors for the industrial arts and household art subjects. For administrative purposes there are two co-ordinated departments each taking care of its particular problems.

Every course has been organized with the definite purpose in mind of preparing teachers who shall know their subjects, and shall be able to teach them. They will also be given a ground work which will stand at the bottom of the ladder—upon which they will climb to a better

understanding, and an appreciation of the larger aspects and responsibility of their work.

While the officers of the institute cannot guarantee positions to students upon graduation, they do everything in their power to assist them to positions they seem best qualified to fill. The entire problem is solved with a human touch unequaled in most of the institutes with the same interests in view.

---

## Sweden Amplifies Educational Methods

Sweden has wisely solved the problem of child education, in that it advocates the combined technical and liberal system, which recognizes the cast value of manual instruction together with the usual thorough course—proving the need, on the part of the child of some actual and tangible results.

They are taught to look upon this phase of the work that they do as useful in its purpose toward the community in the hands of a clever teacher. The work is not merely vocational—as would first appear—but literature, art and culture play an important part in the general educational scheme.

---

## Trade with Belgium

Our trade with Belgium since 1900 has aggregated considerably over \$1,000,000,000, of which more than one-third has been in the form of imports from that country and approximately two-thirds were exports thereto. Our principal imports from Belgium in normal years, according to a statement by the National City Bank of New York, consisted of diamonds, India rubber, wool, glass, hides of cattle, manufactures of flax, silk yarns, cotton and silk laces, ivory, nickel ore and a large number of minor articles, chiefly manufactures. Our exports to that country in 1914, the latest normal year, consisted chiefly of cotton, wheat, meats, mineral oils, tobacco and lumber.

---

## Brussels Fair

The Merchants' Association has received a communication from the American Belgian Chamber of Commerce in Belgium, inclosing information with regard to the First Annual Commercial Fair, which is to be held in Brussels between April 4 and 21, 1920.

The object of this fair is to establish connections between producers and buyers, the fair being open to any manufactured or natural product.

The sale of goods is prohibited during the existence of the fair. Participants will be required to confine themselves to the registering of orders.

Applications for admission and for stands should be addressed to the Committee Managing the Commercial Fair, Grand Place 19, Brussels, Belgium. All applications must be in the hands of the committee not later than February 1, 1920.

The American Express Company, Foreign Trade Department, 65 Broadway, New York City, are the recognized agents for the Brussels Fair for 1920. Information, application forms, etc., may be obtained from the American Express Company, which will also have charge of the forwarding of exhibits.

## New High-Speed Steel Invented

Metallurgical and scientific circles have been much interested in a new invention of high-speed steel due to Dr. J. O. Arnold, professor of metallurgy at Sheffield University. The Defence-of-the-Royal-Act prevented him from making known the particulars, but now it is announced that the British Government's embargo has been lifted.

The new steel is said to possess cutting powers far superior to those of any high-speed steel known heretofore. Dr. Arnold, in 1908, obtained wonderful results by the addition of vanadium to the commonly accepted formula. He finds now that in high-speed steel the best results can be obtained from molybdenum, and he adds that if large quantities of the molybdenum can be found and the price reduced, tungsten will have to take a back seat, because 6 per cent of molybdenum will replace 18 per cent of tungsten, and with much better results.

Molybdenum is a comparatively rare alloy, found chiefly in Canada. The current market price is 10 shillings a pound, compared with 2s. 11d. for tungsten.

## Personals

Frederick Putnam Platt & Bro., architects, have moved their offices to 680 Fifth Avenue, New York.

Eames & Young announce the removal of their offices to Suite 1876, Arcade Building, St. Louis, Mo.

Glenn Allen, architect, has moved to the Georges Co. Building, Market and Aurora Streets, Stockton, Cal.

Clapp & Glasgow have opened offices at 208 Crowds Building, Fort Worth, Tex., for architectural practice. Manufacturers' samples and catalogues are desired.

E. H. Blumenthal has opened an office for architectural practice in the First National Bank Building, Albuquerque, New Mexico. Samples and catalogues desired.

Selligman & Edelsvard, 206 Pine Street, Pine Bluff, Ark., have dissolved partnership. G. A. Edelsvard will continue the practice of architecture under his own name.

James E. McLaughlin announces that he has taken into partnership G. Houston Burr, and they will continue architectural practice under the firm name of McLaughlin & Burr, 88 Tremont Street, Boston.

# Weekly Review of Construction Field

## Comment on General Condition of Economics with Reports of Special Correspondents in Prominent Regional Centers, Late Quotations in Building Material Field

THE present system of Federal taxation prevents mortgages from entering a successful competition with tax-free securities. The prospects of continued demands for materials encourage continuance of the present scales of prices. The uncertainty whether even these prices can be maintained and need not be advanced places the contractor in a situation where he must protect himself with "cost-plus" operations. These, with the loud-voiced objection to increases of rent, are the factors which make doubtful any enthusiastic financial support toward accomplishments in the way of housing relief through this coming year.

ON the other hand—labor promises to be much easier. The present outlook of long and steady employment is of great encouragement to the men. The result of abnormal rates in foreign exchange begins to show in cargoes of foodstuffs from Denmark and Holland. After such imports attain volume the high cost of living and the demands for high wages to support the high cost of living are bound to be reduced in importance as factors in our labor problems. With the railroads returning to private ownership on March 1 and the expectation that transportation difficulties will be gradually eliminated by practised hands, the optimists of the building field hope that the stores of supplies will be made available and increased.

### TRANSPORTATION

THE striking exposition of how important to the price of materials is their dependence upon transportation has been one of the many salutary lessons the World War has given us. An overstock of lumber on the Pacific Coast or steel lying at the mills has slight effect upon

market prices or the paucity of materials in the builder's hands. We had often used the words "place value" but had failed fully to realize how important a support to our economic structure was the railroad. Probably the lesson is not thoroughly learned even now, or more would be said about equipment, more about new railroad lines and about the development of waterways, and less of the Government guarantees for maintenance.

After the experience of the past two years, no one would seriously propose that the railroads should be run as a benevolent institution. We have had enough of that. But accent seems never to be placed upon what is to be done in the way of transporting and distributing materials. It is discouraging to the absolute economist that active public interest in the railroads comes from only two points of view—the Federation of Labor and Wall Street. It seems to be a process of dividing the profits, with some board of arbitration acting as umpire. If the Interstate Commerce Commission is to resume its old rôle of umpire in the division of economic profits between the railroad and the shippers, we shall have the system complete so far as money-making potentialities are concerned. But when the service of public development is apparently to go on, hit or miss, without benefit of an umpire, we do not directly aim to achieve the much-talked-of "production" or the distribution of the materials produced to the dealer and builder.

The return of railroads to private ownership is not a panacea for all their ills. In this country's achievement, forward-looking railroad officials were most influential. But they worked on a purely competitive basis which is not now possible. It is strange, if not ominous, that there is public interference from two quarters but not

## THE AMERICAN ARCHITECT

from the particular quarter in which our whole economic life is interested: the matter of service to be rendered.

"With competition restored and all of the railroad companies fighting to hold and recover business," says one of the daily papers, "conditions from the viewpoint of the public will be greatly improved." It goes on: "Railroad men interviewed admitted that millions of miles of freight and passenger train service have been saved annually under Government operation; but, it was declared, this saving has been more than offset by the quantity and quality of the service performed," which one may presume it was intended to imply was poor. It would be further argued that there was no particular incentive to make great effort for good service when there was so little chance of a man profiting by it.

### PROFIT AND PRODUCTION

**I**T is practical to assume that men will accomplish less when working under such circumstances that their own personal profit does not furnish the chief incentive. It is not a slander particularly applicable to railroad employees or sub-executives. It applies almost anywhere, even in the building industry, which is unfortunate for the schemes of idealists.

If our most urgent economic need is to increase production, as seems so obviously true, the mere vague appeal is going to accomplish little—however passionately or poetically the plea is being stated. Rather, each man must see that he himself is going to get something out of it. It is much easier to find out these selfish reasons than it is to change us into a nation of philosophic altruists.

Capital will not invest in buildings to its own disadvantage: the money will move naturally into more profitable securities. In order to meet outside competition, it is believed that the Lockwood Committee of the New York State Senate which has been investigating housing accommodations will propose that mortgage holdings be exempt from taxation.

The building contractors have a right to their profit. Yet with all her urgent necessity for housing, England is accusing a most reputable organization of contractors as a "band of profiteers." If we cannot have production without the stimulus of profit, we must have production, and increased production, none the less. The quantity and quality of the production is the vital thing and it does not seem the appropriate time to prune profits.

In his address to the Mining and Metallurgical Engineers, Mr. Hoover said: "We are hoping that Congress will find a solution that will be an advanced step toward the combined stimulation of the initiative of the owners, the efficiency of operation, the enlistment of good-will of the employees, and the protection of the public. The problem is easy to state. Its solution is almost overwhelming in complexity. It must develop with experience, step by step—toward a real working partnership of its three elements." While these words were applied specifically to the railroads, they may well be applied to any of our great industries and be found applicable and true.

*(By special correspondence to The American Architect)*

SAN FRANCISCO.—Another general rise of lumber prices which went into effect during the last week, will make considerable difference in the architects' and contractors' estimates. However, it is not expected that any decrease of construction work will result. In fact, the coming spring promises to be one of the busiest in many years.

Both in the lumber and steel markets the architect finds dealers reluctant to give quotations except for immediate acceptance. The steel situation is fraught with more difficulties at the present time than is lumber, it being almost impossible to get orders of any size filled within a reasonable length of time, with prices depending on the amount of the order and then quoted only from day to day. According to an opinion expressed by one of the leading architects of this city, unless improvement is made in the steel market on the Pacific Coast within the next month or so, the shortage will affect the building program for 1920 to no small extent.

Development of the outlying residential sections of San Francisco and the adjacent suburban districts is placing an unusual amount of work in local architects' offices, and plans and specifications for future execution are indicative of a continuation of the present volume of building activity for some time to come in spite of the material shortage and high scale of prices.

*(By special correspondence to The American Architect)*

SEATTLE.—Increasing difficulty of getting orders filled is harassing wholesalers of building materials in the North Pacific coast territory in firming building commitments. Withdrawal of quotations on steel products, or price advances have been of almost daily occurrence during the week. Nails ordered in August in carload lots, according to telegraphic advices to wholesalers, have just been loaded at Pittsburgh. This instance can be repeated in the experience of practically every large operator in this territory.

The advance in the price of radiation was less pronounced than was expected last week, jobbers getting only a 6 per cent advance. Plaster moulding is \$3 higher. Wholesalers have been able to absorb this in part through the favorable all-rail rate granted as against the rail-and-water haul. In other words, the all-rail rate is lower than the rail and water due to the rapid advance in coast-wise tonnage, where the vessel performs the long-distance haul from the supply stations in Nevada. Another strengthening factor in the plaster market was the advance in jutes to 20 cents each.

There has been a factory advance in corner bead, now selling at 6 cents per foot. Plaster board is 3 cents per yard and plaster wall board is up \$3 per 1000 ft. to \$46 delivered first zone. Quotations on all channel iron from the eastern factories were withdrawn this week and factories have notified wholesalers that they will not firm orders until June and will accept only on the basis of the market at that time.

The fir lumber market has advanced sharply. There were actual sales through the week, mill basis, of No. 1 vertical grain flooring at \$97, No. 2 at \$94 and No. 2 and better ceiling at \$78. Boards and shiplap and all uppers have gone \$10 to \$12 higher, while common dimension is \$4 over prices a week ago. The fir mills of the West Coast district hold unfilled orders for the eastern building trade, extending back into last fall, for 400,000,000 feet. Inability to get more than 30 per cent of the required number of cars for loading is responsible to a large degree.

Notwithstanding the daily fluctuations in building materials, all jobbers and wholesalers are able to report that building plans are proceeding.

The demand for homes already built now runs to round \$6,000, but few are for sale. This is forcing many well-to-do investors to build.

# Department of Architectural Engineering

## Factory Stairs and Stairways\*

### PART II

By G. L. H. ARNOLD

IN the opening paragraphs of this article, published in the preceding issue, it was stated that in solving the stairway problem consideration must be given to twelve major items. Six of these have been already considered in Part I. Consideration will now be given to the remaining six items.

#### PROPORTIONS

Although the pitch of stairs must be kept within comparatively narrow limits for best results, still it is possible to make a safe and reasonably comfortable stair at almost any pitch if due regard is paid to the relation of rise to length of run.

The natural length of steps decreases rapidly as the grade increases, even on a ramp where the surface offers equal foothold at all points. Failure to take this fact into consideration results in a stair which is awkward and tiresome, with a pronounced tendency to produce stumbling and falls.

The length of the foot, or rather of the shoe, is not an important factor. For one thing, the actual length of the tread exceeds the run by the amount of the nosing. For another, practically all the work of ascending and descending stairs is done by the ball of the foot (Fig. 20). In ascending the weight is borne on the ball of the foot in the middle of the step while the heel projects in the air. In descending, the toe projects, the weight being borne on the ball, on or just back from, the edge of the step, the heel barely touching the step.

For adults, making the length of the run (tread exclusive of nosing) plus twice the rise equal to 24 in. to 24½ in. can be relied upon to give satisfactory proportions. By this rule the rungs of a ladder should have a 12-in. spacing, which is the recognized standard, and a 45-deg. stair would have an 8-in. rise and an 8-in. run, which a wide experience shows to be entirely satisfactory. A horizontal grating would have a 24-in. spacing, which,

although a trifle short, is nevertheless within the bounds of practicability.

In factory practice the tendency is to make the stairs steep in order to save room. Observation by several people over a period of years and under a wide variety of circumstances confirms the opinion that an 8-in. rise by an 8-in. run is the steepest stair practicable for general use and that 7½-in. rise by 9-in. run is much better. Some building codes prescribe 7½ in. as the maximum height of rise. Although 7-in. rise by 10-in. run makes probably the easiest of all stairs, the improvement over 7½ in. by 9 in. is not usually worth the extra floor space consumed.

Out-of-doors stairs or steps should be made with only 6-in. rise, if possible. In any case, the rise and run must be uniform throughout the entire length of the stairway. Otherwise, falls will be frequent.

#### LANDINGS

All landings should be rectangular and at least as deep as the stairs are wide. The surface should be of the same material as the stair treads. Attempts to save room by cutting off corners or reducing the size of landings, or by the introduction of winders or straight steps invariably result in accidents, especially when the stairs are crowded and every one is in a hurry.

#### HANDRAILS

Each line of people on the stairway should have a continuous, firmly supported handrail at a convenient height and of such size and shape as to be readily and securely grasped. The material may be wood or metal. If of metal, the rail will usually be iron or occasionally brass pipe and of 1½-in. or 1¼-in. iron-pipe size. The 1¼ in., although somewhat small, has the advantage that the fittings are more generally carried in stock. Large sizes are used, but they are objectionable, as they cannot be grasped securely in the frantic effort to recover

\*Paper presented before The American Society of Mechanical Engineers.

from a misstep, especially by a person with small hands.

T-bars and special rolled, drawn or cast handrail sections are frequently used, but, except for the architectural effect, they have no advantage over

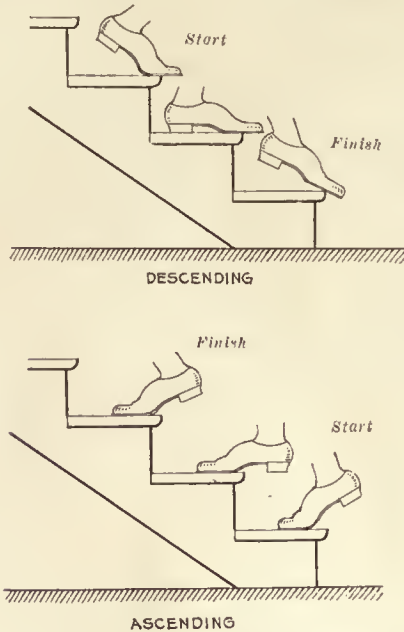

FIG. 20.—DIAGRAM SHOWING HOW WORK OF ASCENDING AND DESCENDING IS CARRIED BY BALL OF FOOT

the cheap and homely wrought-iron pipe. If the rail is of wood it should be of oak, ash or some other non-splintering hardwood; never yellow pine. It may be a round bar not less than  $1\frac{3}{4}$  in. in diameter nor more than  $2\frac{1}{4}$  in., or it may be one of the stock patterns carried by the mills. In any case it must be strongly supported at a height of 31 to 33 in. above the front edge of the step. Around the landing the height should be 36 in. Often stairs require either a second rail at half height or a strong wire netting between stair and rail.

ENCLOSURES

Notwithstanding the fire risk, the danger from things dropped or thrown, the chance for falls and the increased difficulty of heating, open stairways are frequently found in factories. Every stairway should be enclosed in a fireproof well. In many cities a wire grill is permitted between stairs and elevators in the same well. A solid partition is more satisfactory and pays for the extra room and expense. Choice of material will be governed by the same considerations as in the case of the other partitions. The space

under the bottom flight must be left open and kept clear unless filled up solid with non-combustible material.

If the stairs extend to the roof the enclosure should be carried above the roof in the form of a bulkhead or penthouse high enough to allow a door 6 ft. 6 in. to 7 ft. in height. If the roof flight is a ladder or a very steep stair the penthouse may be replaced by a scuttle, or better, by a companion as shown in Fig. 21. The door or scuttle should be hooked, latched or bolted in such a way that at any time it can be opened readily from the inside. The roof of the stair well should be a skylight with a wire netting under the glass to catch pieces of glass in case of breakage.

At each story liberal wire-glass windows with metal frames should be provided so that the whole shaft shall be as light as may be in daylight. The better the illumination is the fewer days in a year will artificial light be required.

All stairway openings should be closed with Underwriter automatic fire doors opening with the outgoing current. The outside doors need not be fire doors, but should open out. Where there is much traffic the fire doors may be supplemented by glazed double-acting doors. The locks on all these doors should be such that under no circumstances can a person be locked in.

Care should be exercised to locate these doors so that they may be opened without risk of crowding some one off the landing and so that a stream of people descending cannot prevent them from being opened. Fig. 22 illustrates a dangerous location of the doors. With that arrangement a person descending might collide with the edge of the door, or if this

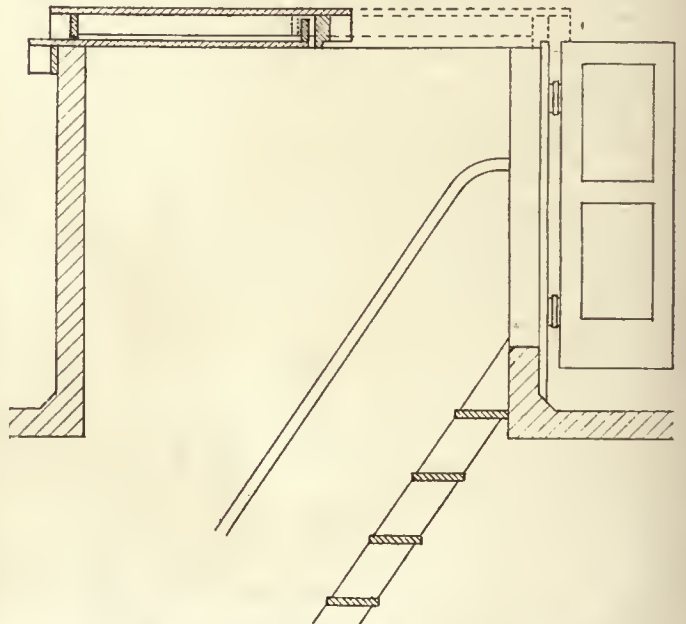

FIG. 21.—PENTHOUSE FOR STEEP STAIRS

is suddenly opened it may knock someone off the top step. In Fig. 23 the landing is too narrow, a descending crowd interferes with the opening of the door, and Fig. 26 illustrates another dangerous location. The distance *B* in Figs. 24, 27 and Fig. 28,

if the traffic is very heavy. On wooden stairs or on metal or concrete stairs with wooden treads the tread should be in three pieces. This will minimize repair bills.

Mr. F. A. Waldron, during the years 1896 to

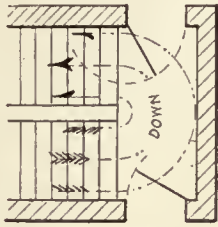

FIG. 22.—DANGEROUS LOCATION OF DOORS

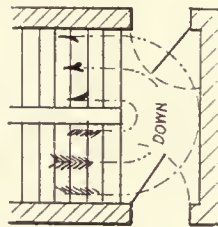

FIG. 23.—EFFECT OF NARROW LANDING

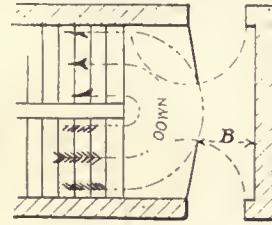

FIG. 24.—WRONG SWING OF DOORS

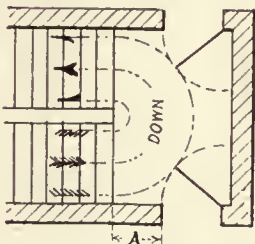

FIG. 25.—PROPERLY HUNG DOORS AND CORRECT WIDTH OF LANDING

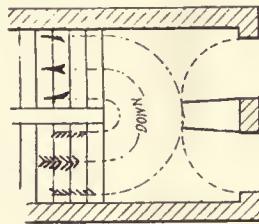

FIG. 26.—WRONG SWING OF DOORS

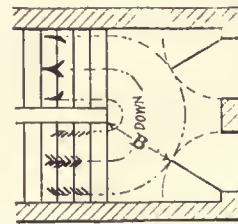

FIG. 27.—PROPERLY HUNG DOORS

page 164 should be not less than the width of the stairs, and distance *A* in Fig. 25 should be at least 2 ft.

LIGHTING

In the artificial illumination of the shaft brilliancy is not required, but thorough distribution is. A light should be placed at each floor and each turn. The lighting should be in duplicate. Since there is always a likelihood of a small group of employees being in the place at night after the stair lights are out, it is quite necessary to reduce to a minimum the distance one must grope in the dark. For this reason the electric lights should have double-acting switches at each end of each circuit and the emergency lights, whether gas, candle or lantern, should be so placed that each flight can be lighted on the spot.

WEAR

Steps, subject to ascending traffic only, wear as shown in Fig. 29 at *A*. If the traffic is descending only, the wear is as at *B*. If subject to traffic in both directions, the wear will be as at *C*.

In any case renewal of the front third of the tread will usually restore the worn step. At long intervals the middle third may have to be renewed

1906, at the Yale & Towne Manufacturing Co., made extensive experiments on wooden treads constructed in three pieces as described. Hard maple, on account of its superiority for flooring, was taken

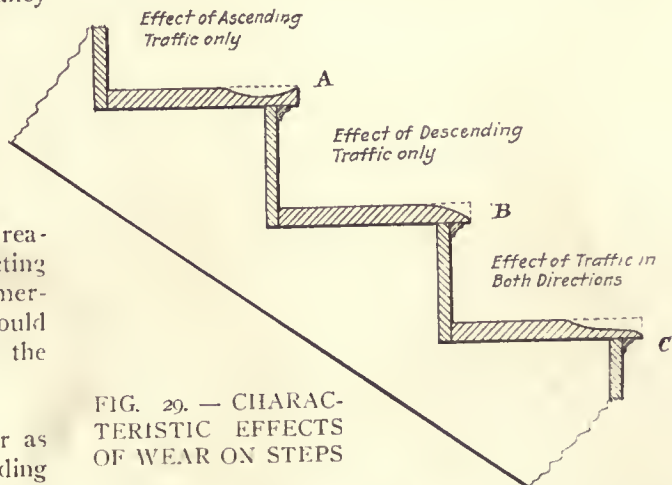

FIG. 29.—CHARACTERISTIC EFFECTS OF WEAR ON STEPS

as the basis of comparison. Mr. Waldron's method was to use the hard maple on every other step, putting the wood on trial on the alternate steps. Ordinary yellow pine proved to be very short-lived.

Edge-grain yellow pine, on the other hand, proved to be by far the most durable, outwearing the maple two to one.

Where safety treads 3 in. or 3½ in. wide are

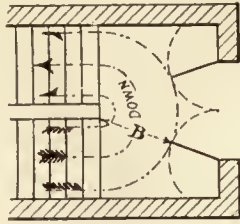

FIG. 28.—PROPERLY HUNG DOORS

used, practically all the wear will come on the safety tread, and only this will need renewal. Cork treads being made in tiles 9 in. to 12 in. wide by the depth of the tread, it is necessary in case of wear to replace only those tiles which are worn.

Arthur Boniface in discussing the foregoing paper stated that a type of safety tread not touched upon was one in which alundum tread blocks 6 in. by 7½ in. by 1 in. thick were imbedded in a concrete stairway at the time of its pouring. In 1914 he had constructed a public stairway of this kind to care for a daily traffic of about 25,000 persons. After nearly four years of service test the alundum treads showed little or no wear, which would indicate that renewals would be unnecessary during the life of the stairway. They presented a slip-proof surface at all times, and the grip on the shoe, while positive, was no so pronounced as to hinder the momentum of the body. They had proved to be practically noiseless, easy to keep clean, and had been successfully applied also to stairways with wood treads, as well as to skeleton steel stairs.

## Book Review

### A REINFORCED CONCRETE HANDBOOK.

Useful Data on Reinforced Concrete Buildings for the Designer and Estimator by the Engineering Staff of the Corrugated Bar Co. Leather, 5x8 in., p. p 216.

Nothing has been of such great assistance in saving time and eliminating tedious computations for the steel designer, as the hand-books issued by the various steel companies, such as Carnegie, Cambria, Bethlehem, etc. Since the advent of reinforced concrete construction, designers have been, to some extent, handicapped due to the lack of an analogous compilation of tables, data, etc., dealing with this subject. Various engineering organizations have, independently, accumulated tables

for simplifying their designers' work. These however, have never been made available for public use.

In the book here reviewed, an attempt, and an apparently successful one, has been made to provide reinforced concrete designers with time-saving data similar to that provided by the structural steel hand-books. It is a step in the right direction, and gives promise of further future development. Part of the book is devoted to the usual list of mathematical tables common to all hand-books. The major portion, however, contains tables and diagrams for designing purposes, covering fairly well the field of reinforced concrete construction.

This work should not be considered in any way a text book on concrete design, but in the hands of the experienced designer, will prove of great value. The book may be obtained by those of the engineering profession interested, for a nominal price, charged to cover the cost of printing, etc.

## Definite Information on Effects of Vibration in Structures Desired

Four years ago the Aberthaw Construction Co. started an investigation on the vibration of buildings, particularly manufacturing buildings. The study was intended to cover not only the causes of vibration but also the effects on the structures, on the machinery installed, on the health and well-being of the workers, and on the quantity and quality of production.

A preliminary report was published in the fall of 1916; but our entry into the war, and the many new problems which that brought, put a summary stop to the work. It is now being taken up again with the idea of following it through to a point where a complete report can be published. The Aberthaw Construction Co., will therefore be glad to have architects, engineers, and others having knowledge of the subject, or having had specific experiences which would throw light on any of its phases, communicate with the company at 27 School Street, Boston.

The previous work on this problem showed a wide diversity of opinion on some of its angles. It also developed that there is very little quantitative information extant which can be relied upon as giving authoritative data. It is particularly desired, therefore, that information of this character, however limited in its application, may be made available for the study.



# Practical Economics Secured by Standardization of Construction Specifications\*

By R. C. MARSHALL, Jr.,

Brigadier General Q. M. C., in charge of Construction Division, U. S. A.

THESE are at the present time twenty-seven separate and distinct Federal agencies engaged in the construction of public buildings. There are sixteen separate Government departments building roads, and nineteen, which in one way or another, have to do with hydraulics, river and harbor work. None of these agencies are co-ordinated. The standards in one department vary greatly from those in another, and the methods employed in construction and the detail requirements of the mass of specifications emanating from these sixty-two different sources are too complex, too contradictory, too involved, for any normal man to differentiate between them. The inevitable result is that the Government pays the bill in loss of time, in high bids, and in a confusion of tongues worse than that which stopped man's most ambitious and daring building scheme, the record of which may be found in the eleventh chapter of Genesis. The Tower of Babel might never have reached high heaven, but its progress chart would have at least shown better than 5 per cent if that famous confusion over the specifications had never occurred.

There is to-day but little less confusion on Government work than that which existed on the above mentioned job, and out of this condition there is gained a well-merited prejudice against Government work on the part of those contractors who are accustomed to handle construction in a more direct and business-like manner.

It is fundamental that in all construction work there are certain elements more or less identical. Certainly there are a large number of operations which can be standardized, and which should not be subject to the whim or opinion of some individual who, for reasons of his own, desires to depart from the fundamentals of common practice. For instance, there is no tenable reason why a standard specification covering the quality of cement, or of stone, or of roofing material should vary materially because it happens to be required for work under different Government departments. There should be no basis for uncertainty in the mind of the contractor when he bids upon a

specification as to what the text of the specification means, and yet, because of the varied language in which even the most commonplace building operations are described, the personal equation of the engineers in the many offices writing the specification necessarily enters very largely into the contractor's estimate of cost, if he is going to protect himself against such a varying contingency. A standard specification, whose meaning is definite and understood, eliminates the expensive hazard of guess work.

The most remarkable achievement in the industrial history of this country is the outstanding success made by Henry Ford in standardizing both design and shop practice so that a single model of automobile is produced at a price so far below his competitors that he has no real competition. This is more remarkable when it is realized that it is accomplished with a wage scale as much above the normal as the selling price of his car is below, and with a working day which at least approaches the Utopian dream advanced by the coal miners in their most recent strike for a 5-day week. It is not argued that all automobiles should be of the Ford type but there is a lesson for the engineering and building profession and for the Government itself in the fact that by the standardization of design and construction methods a tremendous increase to output, with a resulting decrease in cost, can be obtained with no sacrifice in the utility and quality of the finished product.

The importance and value of time, which is the prime thought in the mind of a business man paying interest on unproductive capital, is lost sight of on Government work. Up until the war we were accustomed to see Government projects drag through an interminable period. Buildings which would be completed for a commercial client within six months or a year required two or three years for their construction, largely because of the minutia of the specifications and the details of procedure which had to be satisfied in order to pass a Government inspector and secure payment. The constructor, knowing this, was forced to include in his bid an allowance to cover possible advances in wages and material costs between the beginnings and completion of his work and the overhead of his

\*Extracts from an address before the second convention of the National Department of Public Works Association.

## THE AMERICAN ARCHITECT

office. It sometimes happens that appropriations authorized for certain work become totally inadequate before the job is well under way and either the contractor goes broke or additional appropriation involving resubmission to Congress is necessary to provide the necessary funds to complete the project. Time is the working capital of both the contractor and the Government. For every extra day of delay two days are lost. The contractor loses a day's profit or use which would be derived from the completed job. This is true whether the work be private work or public work, for just so long as the building period is extended, just so long will the invested capital be deprived of its earning power, labor rendered unavailable for other jobs, and the use of the plant deferred. A standard plan and specifications, and centralized control of the work through a single department would undoubtedly save both time and money for all concerned.

Any idea can be carried to absurd proportions, and no man of common sense will argue that specifications and design should be so standardized as to destroy all originality or prevent improvement, but there is a sensible course between those two extremes which may be readily attained. To say that varied operations coming under Government control are not capable of such treatment is to use an argument which has long ago been proven fallacious. It was not so many years past that the thought of fitting a man with anything but a tailor-made suit was scoffed at, and not many years before that it was thought necessary to have a shoemaker make an individual pair of shoes for each customer, and yet to-day both clothes and shoes are almost universally made on standard specifications, and the world is both well clothed and well shod, with a saving in both time and cost and with increased satisfaction to the wearer. The same arguments against standardization were used in connection with railroad work. The arguments for and against a standard gauge track would fill a book, and yet, in this country at least, we have attained a standard specification for almost every element of railroad construction, so that rolling stock, equipment, and structures are largely interchangeable.

Standard accounting methods have been established and made compulsory, so that cost records and expenses on railroads, electric light, telephone companies, and practically every public utility are now comparable on the same basis and can be interpreted in accordance with their true meaning.

The building game is probably the oldest of all trades, and within recent years many of its major operations have been standardized greatly, to the

advantage of the profession. There are now standard technical specifications for cement, steel, lumber, fire protection apparatus, roofing, and many other elements, which have been compiled under the direction of Manufacturing Associations and of the National Technical Societies, so that much of the confusion and the many technical differences have been eliminated.

If Government work is to be done at a cost comparable with commercial construction the methods of handling it must keep pace with those in commercial life. Due to the war and the conditions growing out of it, construction work has been tremendously complicated, labor is restless and demands an increase in wage, generally with a decrease in production. The high cost of materials and uncertainty of transportation and many other elements which are entirely outside of the control of the designer, the supervising engineer, and contractor, all tend toward an increase in construction cost. If these varied elements cannot be controlled the one remaining factor subject to control is the standardization of plans, specifications and methods, so that the building problem is simplified to the utmost and so that labor by the constant repetition of construction processes becomes increasingly familiar with the best and most expeditious field methods.

I do not believe that there is any immediate likelihood that these conditions will change, for there is a present shortage of from six to ten million common laborers in this country due to the curtailing of immigration during the war, and its diversion into the channels of the semi-skilled worker by reason of the shortage of trained men. Because of this shortage in man power, with its resulting high rate of wage far in excess of anything heretofore experienced, every possible means must be employed to reduce to a minimum the man hours which enter into a building project. No more certain method occurs to me than to reduce the tailor-made feature of every Government job to an absolute minimum by the fullest use of standard plans and specifications. The elimination of competition between the Government departments, which will certainly come if all work is placed under a centralized control, the discontent among the civilian employees now so apparent in the several bureaus because of the varying salaries paid for work of a similar character as well as the tremendous money advantage which might be derived through a centralized purchasing agency for those Government materials, such as cement, steel, lumber, iron pipe, plumbing and electric fixtures, common to the work for every bureau are so apparent as to need no comment.

## THE AMERICAN ARCHITECT

These generalities are convincing enough. I cannot think of this subject without applying the argument to the vast amount of work handled by the Construction Division. When I think of the delay, the extra cost, the many mistakes and the lack of co-ordination which might have resulted, had the 589 jobs under the jurisdiction of the Construction Division during the World War been attempted without a standardized specification and a centralized control, I know that, instead of their being made ready for service ahead of schedule time, as many of them were, they would not have been finished until this very day.

A Department of Public Works, in conference with the national technical societies, could establish in the most effective manner a standard specification for Government work which would insure both safety and economy of design and the results would in a very few years pay a thousand-fold return on the investment.

Only a great war such as we have just been engaged in could have presented the opportunity for the testing out of such a scheme as you now propose on a large scale. Up until this time the proposal to consolidate under a single head the many construction activities of our Government might have been stigmatized as visionary and impossible, but if the experience of the Construction Division has proven any one thing, it is this: that there can be gathered together in a single organization of construction experts, engineers, architects and builders who are capable of playing together as a team and with a minimum amount of duplication, completely serve the varied requirements of any and all bureaus, carrying to successful completion a building program of any size.

In this unequalled school, I have learned that the economic problem with which this country is now confronted can only be solved through the hearty and intelligent co-operation of both the Government official and the civilian engineer and contractor, and by intelligent co-operation with those who control labor. It must be done on the same basis as commercial work and not under special rules which penalize the public Treasury to the detriment of all concerned.

There must be a new basis of relationship between the contractor and the Government. The Government has no right to so draw its contract or so specify its requirements in such a way that the financial ruin and bankruptcy of the contractor might result. There is an old engineering maxim that what might happen will happen. It is unjust, it is inequitable, it is uneconomic. Neither should its specifications be capable of such interpretation as will unduly penalize the contractor when the

letter of the text is carried out, any more than should the interests of the Government suffer if the spirit of the specification is fully met.

We are in thorough accord with the fundamental idea of a Department of Public Works. We naturally believe that the plan of organization that we worked out during the war was based upon fundamentals that should govern in any large governmental construction department. We had a number of clients in the War Department quite as large, quite as set on their own purposes, and quite as technical in their requirements, as the separate departments of the Government will be in the future. The fact that our construction program ran twelve hundred million dollars, in a year and a half, shows that the amount expended would be as much as a Department of Public Works could reasonably expect to have to expend in times of peace. Further, the diversity of work was, perhaps, quite as great, although we did not generally use the high sounding terms of hydraulic, geographic, geodetic, or reclamation. To me, all of the energies, the thought and experience of this country within its own continental lines during the past two years of its world struggle shall have been in vain unless out of it shall grow a permanent institution solidifying the economic relations between the Government and the contractor, which will permit the vast amount of governmental construction work now in prospect to be handled intelligently and fairly with every uncertain element reduced to a minimum. I shall watch with deep interest the efforts which you are making toward the co-ordination of governmental construction work under a single head. Whenever and wherever the experience of the Construction Division can be helpful to you or your officers, I now place it at your service.

I see before you the prospect that out of your efforts there shall grow a powerful agency in which the intricate problems of Government construction work will find intelligent consideration and solution. My hopes are fervent that from this hall shall go forth a propaganda that will help make easy the solution of those perilous economic questions which now face us as construction men.

The trend of the times is toward simplification of control. If, instead of sixty-two separate outfits, each trying to do more or less the same thing, each in competition with the other, each trespassing on the others' sacred prerogatives, each doing the same thing differently, some better than others, some as best they can—if all of these activities can be centralized under a single control, having a definite and simplified specification, a single method of accounting, a single bureau of purchase, a

## THE AMERICAN ARCHITECT

single point of contact available to that unfortunate citizen who now spends days and weeks chasing the buck from one Government department to another, there shall have been accomplished the most constructive step in the history of Government work, and to this end I bid you God speed.

### Activities of the Construction Division, U. S. A.

THE Construction Division of the United States Army, under Brigadier-General R. C. Marshall, Jr., was, during the period of its greatest activity the largest construction organization that ever functioned and the largest employer of labor in the history of this country. It had at the time of the armistice more than 200,000 laborers at work on its various projects.

One of the most important functions of the construction division was to provide for the tremendous expansion of the hospital accommodations of the country, and in carrying out this work it not only built new buildings of a temporary or permanent character as might be decided on, but it also took over a number of hotels, mercantile buildings, etc., and altered them for hospital purposes; in all, a total of 294 hospitals, accommodating 121,000 patients, at an approximate total cost of \$127,725,000, was provided.

In general, the activities of the construction division were confined to this side of the Atlantic, but as a notable exception it must be stated that to this division was assigned the duty of designing, assembling and finally of furnishing the personnel for erecting and operating the huge refrigerating plants built in France for the supply of the army at the front.

Greater than any other projects in importance and perhaps in magnitude were the embarkation depots necessary to insure the rapid and systematic supply of troops and supplies to Europe. This work included the construction not only of tremendous fire-proof warehouses, but also of wharves and docks, (See THE AMERICAN ARCHITECT, issue of Nov. 26, 1919, for description of Brooklyn, N. Y., and New Orleans, La., bases), some of them of greater extent than any heretofore existing in this country, and the construction of miles of railway track for the handling of cars and freight received from the various interior points and intended for shipment.

### Research Graduate Assistantships

TO assist in the conduct of engineering research and to extend and strengthen the field of its graduate work in engineering, the University of Illinois maintains fourteen Research Graduate As-

sistantships in the Engineering Experiment Station. Two other such assistantships have been established under the patronage of the Illinois Gas Association. These assistantships, for each of which there is an annual stipend of \$500 and freedom from all fees except the matriculation and diploma fees, are open to graduates of approved American and foreign universities and technical schools who are prepared to undertake graduate study in engineering, physics, or applied chemistry.

An appointment to the position of Research Graduate Assistant is made and must be accepted for two consecutive college years, at the expiration of which period, if all requirements have been met, the degree of Master of Science will be conferred. Not more than half of the time of a Research Graduate Assistant is required in connection with the work of the department to which he is assigned, the remainder being available for graduate study.

Nominations to these positions, accompanied by assignments to special departments of the Engineering Experiment Station, are made from applications received by the Director of the Station each year not later than the first day of March. The nominations are made by the Executive Staff of the Station, subject to the approval of the President of the University. Nominations are based upon the character, scholastic attainments, and promise of success in the principal line of study or research to which the candidate proposes to devote himself. Preference is given those applicants who have had some practical engineering experience following the completion of their undergraduate work. Appointments are made in the spring, and they become effective the first day of the following September. Vacancies may be filled by similar nominations and appointments at other times.

The Engineering Experiment Station, an organization within the College of Engineering, was established in 1903 for the purpose of conducting investigations in the various branches of engineering, and for the study of problems of importance to engineers and to the manufacturing and industrial interests of the State of Illinois. Research work and graduate study may be undertaken in architecture, architectural engineering, ceramic engineering, chemistry, civil engineering, electrical engineering, mechanical engineering, mining engineering, municipal and sanitary engineering, physics, railway engineering, and theoretical and applied mechanics.

The work of the Engineering Experiment Station is closely related to that of the College of Engineering.

Additional information may be obtained by addressing The Director, Engineering Experiment Station, University of Illinois, Urbana, Illinois.

Griffiths to 2503



SPANISH ARMOR, PERIOD OF CHARLES V.

# THE AMERICAN ARCHITECT

VOL. CXVII

WEDNESDAY, FEBRUARY 11, 1920

NUMBER 2303

## The Architect and the Government

By GLENN BROWN, F. A. I. A.

THE Government officials with whom the architect has to deal, whether it be the legislator, a Cabinet officer or a bureau chief, are typical citizens, chosen because they have demonstrated in some line their capacity and fitness. With few exceptions they are striving to secure the best results for their masters, the people, and bow gracefully when the public emphatically expresses an opinion. They follow the voice of their constituents, rarely attempting to guide them and are anxious to secure the best for the public.

Their experience has made few of them familiar with the fine arts, just as only a limited number have knowledge of great financial transactions or engineering schemes. They are generally open to enlightenment; their ambition is to see the United States progress, become the leading influence for good in the world in all lines. Show them or impress their constituents with the practical importance of the fine arts and they will become partisans.

Government work in the fine arts, because of its usual importance and magnitude, will exemplify and measure our culture and enlightenment to future nations and generations. With our future standing at stake it is vital to our good reputation to secure the best in sculpture, painting and architecture when the Government is the client. There is no dearth of talent, for we have individuals practicing each of the arts not surpassed in the world. The important factor is to get the Government to use the services of these men and we need not fear the results.

How to impress the people and the official with the value of such service is the question.

In my first paper I explained how the American Institute of Architects accomplished this for a period of twelve years. In recent years the organization, judging from convention and committee reports, has lost the public confidence and failed to impress officials with the value of its service. This became conspicuously manifest during the war,

but the seeds of distrust and disintegration were planted and allowed to grow some years before the war began.

From the seed of disintegration have sprung weeds choking off valuable plants. The results may be seen in divided and multiplied authority, distrust in the capacity of architects shown in selecting outsiders for important offices, and delegating independent authority to committees and individuals.

The case of Cass Gilbert illustrates their blighting effect. Here was an architect whose efficient service is lost to the organization, a man of affairs, eminent in knowledge of construction, brilliant in plan and design, upholding to his personal detriment the strict ethical rules and giving unstintingly of his talents and time in the public service.

For many years I was intimate with and appreciated his value to the profession and the public as shown in his work as director and president of the Institute.

He stood for zeal and enthusiasm in public service, justice and right in business, the highest ideals in art; holding to the big things and wiping aside the exploitation of trivial and non-essential things.

No one did more than he to give the Institute prestige, or secure the confidence of Government officials by his intelligent and business-like presentation of a subject; by his diplomacy and, when required, by his aggressive fighting qualities. How was he rewarded? There was an active clique in the Society, the same who transferred the important offices of the Institute to outsiders, over-anxious to guard the morals of others, who made a personal attack on Gilbert. His advice was ignored, his wise and farsighted policies were abandoned, his attitude was misunderstood, and his own sacrifices counted for nothing. The attack came to nothing, but left a deep sense of disgust and injustice. This snapping at Gilbert's heels continued, but he withstood the exasperating personal pricks until methods which he and many others considered detri-

## THE AMERICAN ARCHITECT

mental to the morale of the profession were inaugurated, when he resigned.

This growth from the seed of disintegration started by borrowing from the reserve fund to help pay an increase of some \$10,000 in office and Journal salaries. It seems doubtful from a statement by the treasurer whether three thousand of this was a loan or a gift not to be returned, and the auditors fail to show it in their account of the reserve fund.

The reserve fund was started by Cass Gilbert when he was president, with the idea of eventually providing an endowment that would at least pay for the maintenance of *The Octagon* and possibly the office expenses of the Institute, hoping that it would finally pay all expenses and put the Institute on a plane with the National Academy of Design. Gilbert wrote a serious letter to the president, T. R. Kimball, explaining the origin and purpose of the fund and objecting to its dissipation through gift or loan.

The following discussion occurred at the Nashville Convention on the subject:

The Chairman (Mr. Waid), in his statement, said: "It is a satisfaction to have a letter that has come to my knowledge, addressed to President Kimball from Cass Gilbert, who was first instrumental in establishing this fund. The letter is so long that unless requested I believe we had better not take time to read it."

Mr. Pond: "Is it along the same line in favor of withdrawing from the fund \$10,000?"

Mr. Waid: "This does not touch that particular point, and there is nothing in the record to prevent the Convention withdrawing the money . . . or even appropriating it outright." . . .

Mr. Du Fais: "Mr. Gilbert has written a letter on that subject to the president, which, I believe, he would permit me to read." . . .

The Chairman (Mr. Waid): "That is a letter that was so long and we were so pressed for time" . . .

Mr. Du Fais finally got the letter before the Convention; it took between three and four minutes to read. It was a serious letter, giving the cause and history of the reserve fund, what it was expected to accomplish and his opposition to its being used for current expense. After further discussion, the resolution was carried by a vote of 83 to 40, receiving two votes above the necessary two-thirds to carry. With the doubt expressed frequently on the floor as to who had a right to vote and the doubt expressed on how to vote proxies, one cannot help wondering if it legally passed. Gilbert and other members who had been fostering this fund were shocked at the growth from this

weed which was reaching out and sapping the strength of a nobler growth.

The weed continued its rank growth, oozing out poison in the form of an editorial, easily construed from the assertion, "Every vested right is in reality a vested wrong," as a bolsheviki document, striking at the fundamentals of our Government. This was such a grave offense, placing the organization and the profession in such a false position with officials and the people that Gilbert wrote the president, demanding the writer be removed if an employee of the Institute. This was answered in a perfunctory way by the president.

The Board in Nashville states: "The responsibility for the editorial is shared by the president, the committee on publication and the editor. Regardless of whether or not the article in question expresses the opinion of the Institute and without consideration of its merits or demerits . . . the Board believes such an article was not of the type which should be published in the Journal. Therefore, the Board instructs the Committee on Publication that the columns of the Journal should (a weak command) not be devoted to matters which may become the subject of political or religious controversy."

With this official statement that the president and Board, equally with the editor, were responsible for exploiting such principles, Gilbert, as others have done, felt that he was unwilling to be made a party to such pernicious principles through membership in the organization and resigned about the middle of May. This demonstrates the effect of the management produced by the influence of the non-professional which has apparently dominated the professional for several years.

This weed, with its tangled growth, has cut the Institute off from the great oak whose fame had been a landmark known to the world for its strength and nobility, whose outspread branches had sheltered the profession in storm and stress, always standing firmly in its dignity and purity. This seed of disintegration, producing divided authority and distrust in the efficiency of its own members, produced the resignation, I understand, of men like Thomas C. Young, of Eames & Young, St. Louis, and of Breck Trowbridge, of Trowbridge & Livingston, New York, nationally known for their efficiency and ability, and caused many other members of standing to cease participating in Society affairs.

From the seed of intolerance, insisting on rule and regulation for the conduct both of the profession and the public, have grown vines strangling public confidence.

A healthy plant had sprung from the public confidence of the Secretary of the Treasury in the Institute's management and ideals. It had become



## THE AMERICAN ARCHITECT

the custom of the Secretary to call in the officers of the Institute for advice on architecture and the other fine arts, and he usually followed their advice. In a system just beginning at the time of taking authority from the official staff and vesting it in regulating committees, a large committee was empowered to confer with the Secretary of the Treasury, excluding from the committee all who had become familiar with the wants of officials. This conference was on competitions and the relations between the Supervising Architect's Office and the private practitioner. The delegation made uncalled-for demands and were so infatuated with their rules and regulations that they were intolerant of suggestion.

This conference was the last opportunity the Institute had to exercise its influence for the public good through the Secretary of the Treasury, as neither its officers or members were called on again.

The pendulum swung so far the other way that when the last supervising architect was displaced a lawyer was made acting supervising architect. Although several years have passed the lawyer still holds the office. The Assistant Secretary, after experience with a supposedly inefficient architect and the intolerance of Institute advice, believes, although we know he is mistaken, that the office can be managed more effectively without an architect. It is a stinging reprimand to the profession, which we know is not deserved. Thus this lusty plant of confidence has been sapped and killed by the weed of intolerance.

From the seed of exclusiveness, belief that architects should confine their efforts to the artistic, has sprung a rank weed with hypnotic influence, convincing the public that the architect's vision is in the clouds and cannot be brought down to common ordinary mundane affairs.

What might have been the disastrous effects of this policy is illustrated by one of the campaigns for the Lincoln Memorial. The management of the Institute instructed (the disintegration had begun) the Secretary to confine his efforts to the importance of the artistic side of the question and to ignore the practical questions involved when presenting the case for final decision on the floor of the House of Representatives, between a Memorial to Lincoln expressed in a Public Highway to Gettysburg, and the classic structure shown as an important part of the composition of the Mall. In the face of instructions to the contrary, I determined to show the practical side of the question, as I knew the majority of Congress, just as a majority of the people, would appreciate more clearly the practical questions involved than they would the artistic.

The attorney for the Automobile and Highway

Associations was proposing a second Appian Way to last centuries, making very impressive propaganda to enthrone Congress and the people. I investigated the construction of the Appian Highway and made an estimate of what a similar roadway would cost at the time. This was before 1914, and I found it amounted to over \$300,000,000. I secured an itemized estimate made by the Engineer Corps, U. S. A., for a memorial boulevard from Mt. Vernon to Washington. Taking the prices in this as a basis, I made a careful itemized estimate of the cost of a similar road from Washington to Gettysburg. This boulevard showed the lowest expression required of a Memorial Highway. A tabulated sheet was made showing the cost per yard of the different kinds of roadbed and surfacing, as well as the total number of yards required to complete the project. We found that such a highway would cost \$20,000,000 and take \$1,000,000 annually for maintenance. My data and estimates were submitted to Col. W. V. Judson, Eng. Corp, U. S. A., who had constructed the fine roads in Porto Rico and had charge of the streets and highways in the District of Columbia. Colonel Judson went over them and certified to their accuracy before the Congressional Committee. Then Col. A. Y. Worthington, one of Washington's most distinguished lawyers, agreed, *pro bono publico*, to take the practical data, the artistic considerations and to investigate the legal side and manage the case before the Committee, cross-questioning the engineers and others interested in the highway. He showed up plainly the \$2,000,000 they were aiming to get would build a poor grade macadamized country road 15 feet wide instead of a cut-stone Appian Way, a commonplace memorial belittling the name of Lincoln. This data before the Committee was printed and presented to the House just before the question was brought up on the floor, where it was handled in a masterly way by Representative Lynden Evans, of Chicago.

I was told by the attorney for the other side, representing Highway and Automobile Associations, that we won on the practical data, handled in a competent way by Colonel Worthington and Representative Evans. I can well believe this to be a fact, as Senator Elihu Root and Representative Slayden, of the Library Committee, both believing in our side, told me two weeks before the question came up in the House and before our data was published that we would lose out in the House. This shows how the weed of exclusiveness may be killed by the application of ordinary common sense.

From the seed of shirking, avoiding the performance of duty, of the same genus as the weed exclusiveness, springs the transfer of responsibility in construction, sanitation, decoration and land-

## THE AMERICAN ARCHITECT

scape. These weeds, widely disseminated, have poisoned the public mind with the idea that the only function of the architect is to design ornamental features and make pretty pictures, which the public think non-essential or trivial. This opinion would be just if that was the only way in which an architect made himself useful.

During war-times the profession was needed in the interest of the public as no class was as well qualified to plan, construct and economically manage building operations as the qualified architect. But the weed shirking has choked public confidence and the people have lost the benefit of efficient architectural service.

The experience of one architect well illustrates the effects of this growth. He was an architect of long practice who had designed machine shops, bridges, dwellings, department stores, office buildings, difficult foundations in quicksands and in water, landscape and roadways, who was an authority on plumbing and heating and made his own structural details, computing strains on trusses, arches, retaining walls, and who personally supervised his work. This architect thought his services would be useful in war work and was eager to have a hand in downing the boches. He thought it was only necessary to offer his services and that they would gladly be accepted. After many interviews with officials in the War Department, the Navy Department and Special Boards he found that he was not wanted. The reason in every case was that they wanted practical men, engineers and builders, and turned a deaf ear to any explanation as to the practical efficiency of the architect. This architect determined to stand a civil service examination for superintendent of construction. He filled in his papers as instructed and had the endorsement of five well-known architects. After about three months a notice was received from the Civil Service Commission, stating, "Your application has been cancelled for lack of experience." This seemed so ridiculous to an architect who had been actively designing and superintending all classes of construction for thirty years that he went with fire in his eye to the Civil Service Commissioner. They referred him to one of the examiners.

The applicant was told in effect that they did not want architects. They wanted engineers, as

they were practical men. They were asked if the work of this architect was not practical work. The reply was, "We all know an architect has nothing to do with the structural work or the superintendence of his buildings. He only makes drawings for the ornamental parts. We do not consider the endorsement of architects (all the endorsers for this candidate were prominent architects) as they do not know anything about these practical questions."

Instead of appealing this, on the face of it, unjust decision, which would have taken four or five months passing through the various boards, the architect determined to stand for four similar positions, in which the circular stated they were much in need of capable men: one under the Army, one under the Navy and one at large. In this case he swore to the fact that he designed and superintended his structures, enumerating machine shops, bridges and buildings where that had been the case. Instead of architects to endorse him, he got structural engineers, railroad engineers and a sanitary engineer who knew he was a practical man.

After several months he received a rating—85 the lowest and 95 the highest—on these three examinations. The lowest rating because he had no degree in engineering.

Although his name, being very near the top, was certified to the officials in the departments wanting such help, nothing was heard from them for months, and in the meantime the armistice was signed.

The officials probably selected some one calling himself engineer, although the rating may have been lower, instead of the applicant calling himself an architect.

This case clearly shows how the weed of shirking responsibility as practiced by some architects, but never tolerated by the men who have been most successful and of the greatest public service, has been allowed to grow where it is fast poisoning public opinion and sapping public confidence.

Let us as individual architects and the Institute as the society of architects root up the weeds that have grown in rich ground and replant and sedulously cultivate useful and nourishing plants.

The Post-War Committee, to which apparently everything relating to the Institute and the individual practitioner has been referred, is making an effort to do this rooting up and replanting.

In the next article I propose to treat of the problems which they have had under discussion.

# Civic Centers in New England

By OLIVER H. HOWE, M.D.

MUCH of the attractiveness and dignity of our New England towns consists in the possession of a civic center. Guided to it by the white spire of a Colonial church or by the tasteful and dignified tower of a town hall, we find a green with trees or shrubbery, about which are grouped the principal public buildings of the town. We immediately feel that here is expressed the true personality of the community. Other towns may have well-shaded streets and attractive residences, but if the public buildings are scattered along a main street, so that no two of them can be seen at once, we seek in vain for the center and feel that a civic and artistic opportunity has been lost.

Such a center should be at or near the center of population and movement. If principal streets radiate from it, public convenience will be served

properly to see the buildings and enjoy their architecture, for if placed close to a narrow street or obscured by foliage they lose much of their charm. Moreover, churches, schools and libraries require some isolation to secure the necessary quiet.

The several buildings of the group should be harmonious in architecture and purpose, should face properly with relation to each other and the locality should be free from unsightly construction. Buildings excellent in themselves, if too dissimilar in style or material, may destroy all good effect by unpleasant contrast. It is unwise to place beside a plain Colonial building, a decorated Gothic or Ro-

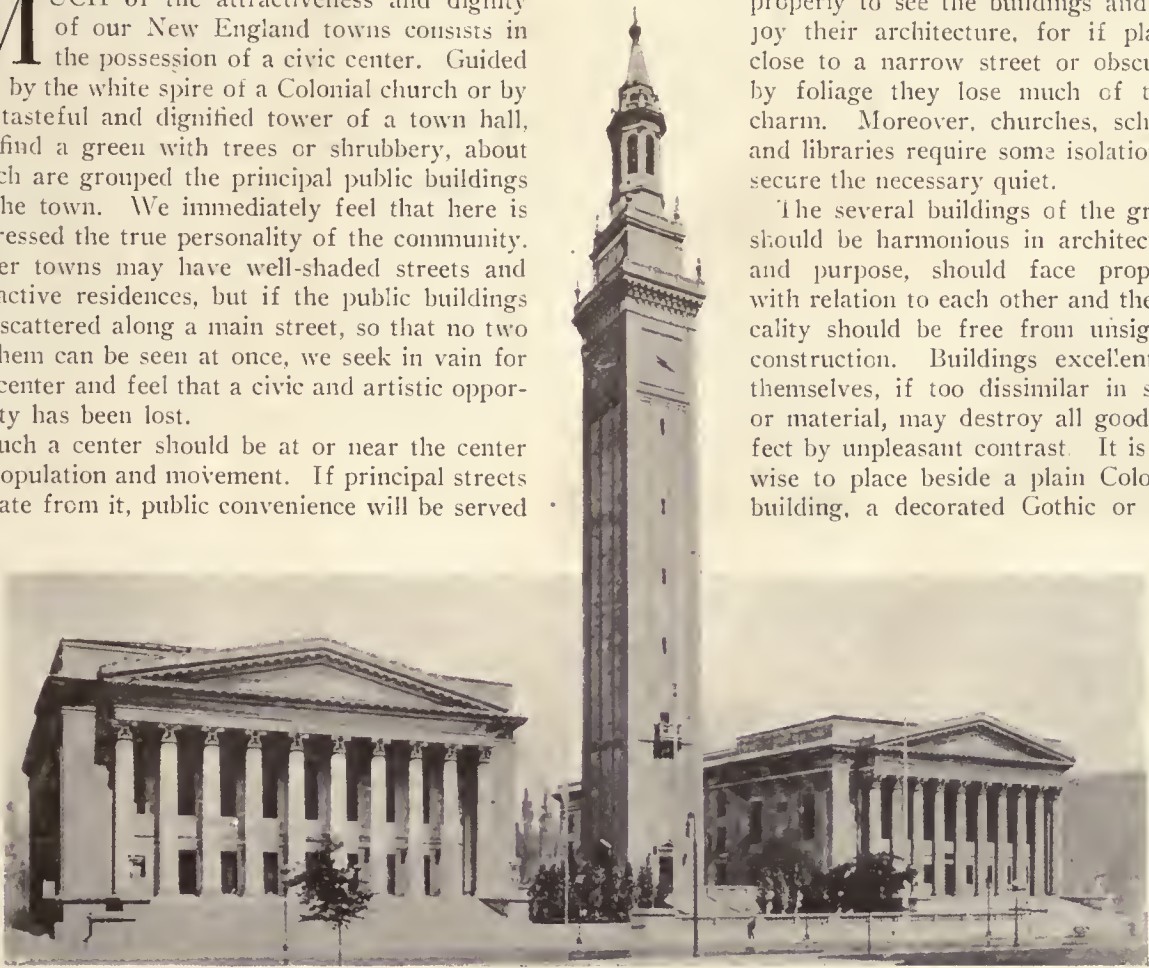

THE SPRINGFIELD, MASS., MUNICIPAL BUILDINGS

PELL & CORBETT, ARCHITECTS

and the situation will be recognized as well planned and logical. It should be visible from the main highway, so that every tourist may see and appreciate the personality of the town. Sometimes, as in Warren, Massachusetts, the civic center is grouped about the railroad station and if the group be attractive, a passing glimpse will favorably impress the traveler by train.

A civic center should preferably be on a slight eminence, so as to give dignity to the buildings. Level ground is less advantageous, although often necessary. A hollow is always disadvantageous, although proper treatment may redeem it. A common or open space is necessary to give opportunity

manesque structure. Instances of this are too numerous to mention. Likewise a bright yellow brick building may seriously intrude in a group of quiet, low-toned stone or red brick structures. Buildings of a group may effectively face each other, but one building facing in the opposite direction may destroy the harmony of an otherwise admirable group.

The buildings most suitable for civic centers are town halls, churches, libraries, schools or academies, court houses, and post-office and bank buildings. Fire department and police headquarters may serve as subsidiary parts of the group, but should not be placed too prominently. An attractive hotel will

## THE AMERICAN ARCHITECT

often add to the effectiveness and contribute an air of hospitality to the scene.

To form a pleasing combination, one building should dominate the group. It may be a massive town hall, or perhaps a church with lofty spire. Whatever it is, the chief interest should there be concentrated. Spacious grounds give the proper distinction to such a building and its tower or spire should not be hidden by trees. Residences with tasteful grounds always make a good setting for a civic center; and business blocks, if of good archi-



THE COMMON, RUTLAND, MASS.

itecture and well kept, may form a part of the group. In large towns and cities the business center may more properly be separated by a little space from the civic center. Unfortunately, stores, business blocks and factories do much to mar civic groups by their ugly or ill-assorted architecture and their advertising features. A civic center should have repose and harmony and be free from ugly and distracting elements. If a common or park is included in the scheme, such open space should have a central point of interest; either a fountain, flag-pole or memorial of some kind, or perhaps a bandstand, if tasteful and appropriate.

A study of the different types of civic centers in New England may be of interest. A rectangular common with streets radiating from it and the public buildings grouped about it is the one seen at Foxborough, Massachusetts. The public library, hotel and three churches face the common and seven important streets radiate from it. A similar arrangement with rather narrow common is seen at Concord, Bridgewater and Shrewsbury, Mass., and Woodstock, Vt. Such an open space corresponds in position with the market-place seen in English towns, of which Ripon in Yorkshire furnishes a good example. The market-place, however, is generally paved and used for the display and sale of produce, while the New England common is a grass plot beautified with trees or shrubbery.

A more frequent type in New England is the

long, narrow common with a street on each side of it, as at Amherst, Longmeadow and Cohasset, Mass. Sometimes the street is in the middle of the plot as at South Hingham, Mass., and in some instances on one side only, as at Williamstown, Mass. Such commons are frequently half a mile or more long. The widest example is that of Hadley, Mass., whose common is also a full mile in length. These commons were used as training fields in Colonial and revolutionary times and again recently by companies of the Massachusetts State Guard. A common of this type is admirably suited to display of the civic buildings if they are properly placed and many beautiful examples are found in New England, including Suffield and Enfield, Conn., and Stockbridge, Mass.

Another type of center is found where two main roads cross each other at right angles. If both streets are wide and the buildings have ample grounds, this type may be very attractive. A good example is found in Dedham, Mass., the county court house and registry building, occupying two corners and a Colonial church with its green a third corner.

Perhaps the most generally successful form of center is that where three main roads meet. Often a triangular common is found, upon which a Colonial meeting house or some other public building is placed. In other instances the common is an attractive open space. If no common exists, the fork of the road offers a particularly favorable site for a building. In such a location stands the city hall of Meriden, Conn. Occupying the brow of the hill, it is in full view for a half mile as it is approached by the main street. With the public



PUBLIC SQUARE, DEDHAM, MASS.

library, high school and three churches as neighbors, all combine to make a civic center of which any city might be proud. The triangular intersection has decided advantages over the cross roads, for it is less formal and usually gives better display

of its buildings. Examples of this type are found in Wayland, Wrentham and East Bridgewater, Mass., and Jaffrey, N. H.

A similar favorable location for a building is found when one main street meets another in the form of a T. Trinity Church, New York has such a location and its front is seen to good advantage from any point in Wall Street. A building at the higher end of a narrow common is also favorably



A TYPICAL NEW ENGLAND COMMON

placed, as for instance the Academy at Bridgewater, Mass., and a Colonial church in North Attleboro, Mass.

Where the center must be on one straight street without prominent intersections, the problem is usually more difficult and seldom reaches so happy a result. Narrowness of the street and lack of space for set-back have spoiled the effectiveness of many a village group. An admirable solution was reached in the case of Lancaster, Mass., whose civic center is ideal in every respect. There is a rectangular common at the side of the main street and about this are a fine Colonial church designed by Bulfinch, a public library, a town hall and a high school. The magnificent municipal group in Springfield, Mass. has the same kind of plan. Beginning with a square park and an ancient Colonial meeting house, the city has built a city government building, an auditorium and a lofty clock-tower. Across the park is a fine court house and nearby is the fire department headquarters. In New Haven, Connecticut, the ample "green" forms an effective setting for three fine churches, offering a striking demonstration of the importance of proper spacing in such situations. The recent erection of a fine United States post-office and court house facing the churches, and of a city library at one side, are serving to evolve for New Haven a civic center of noble proportions. Milton, Mass., has a fine civic group. On a street of generous width are a town-hall and two churches and parish house, while in the rear are the high school and fire and police

headquarters. Across the street and completing the group is a fine public library. The town hall in the center, standing on the highest ground, dominates the group, being flanked by a church on either side. These buildings are set back from the street about 100 feet and have ample space around them. The town of Leicester, Mass., has a similar arrangement, the town hall, two churches and high school occupying the summit of the high hill on which the town is built.

It is not desirable that every town should develop a civic center in precisely the same way—rather the contrary. Some towns have important natural features—a lake shore, a forest background, an attractive knoll or a rocky eminence, which may guide and enhance the civic arrangement and every advantage should be taken of such features, for they will conduce to individual charm and make it appear that the center grew there.

Some may question the wisdom of so much thought upon such a subject as this, in view of the fact that few towns can be planned in their entirety and that most communities have already occupied their land in such a way that changes are costly and impracticable. I would reply that many towns which I knew in my boyhood have since added important public buildings and developed situations which have greatly improved them as civic centers. Every town has to rebuild more or less as time goes on. The important thing is to see that such rebuild-



LANCASTER, MASS.

ing is wisely done, that it shall be fitting and appropriate for the situation involved, that it shall reflect credit upon the town possessing it and that, if possible, it shall enhance the beauty and significance of the structures already there. Often there is a choice of sites for a new building. If placed with relation to the civic center, it will enhance the effectiveness of the group, while if remotely placed, such bond of unity will be lost.

Various minor and less expensive changes may materially improve a town's civic center. Widening and straightening of streets, planting of trees or shrubbery, removal of unsightly buildings or fences, grading and improving of village greens, opening up of vistas, the addition of a flagstaff or fountain or the defining of a well-planned arrangement of paths; all are of this nature.

We are not careless about our dress or manners, for we know that other people will judge us by them. In the same way, the life and spirit of a town are judged by the character and appearance of its public buildings and by the taste displayed in their surroundings. If they show an inviting aspect to the world, the stranger will say: "Here is the abode of an intelligent and right-minded community. Its people have good taste and self-respect. I would like to know them better." Such good opinion as this is an asset for every town. It is not only worthy of thought and planning, but it will justify all the expense of its attainment.

A city or large town may very readily have more than one center.

If one group includes the town hall, court house and one or two churches, the other may contain school houses and library, or the churches may form a separate group if desired.

Each group should be large and important enough to be effective. Business centers in towns should also receive some thought and care, both on account of convenience and of creditable appearance. The buildings should harmonize well and the street intersection should be of ample width to indicate the importance of the locality.

A town that possesses a common or an ample lot of land for town buildings, although bare of other attractions, has a good nucleus for further improvement as from time to time other buildings are needed. Unfortunately in many instances public space has not been reserved and the community has

become closely built up. There is frequently difficulty in obtaining additional land for public uses, not only because of the expense, but because the owners are unwilling to sell. Patient waiting, however, will sooner or later develop opportunities. I know an instance where a piece of property was tenaciously held by its owner for thirty years, but the time arrived when he was desirous to sell. Citizens grasped the opportunity, by combined effort the necessary amount was contributed and the scheme of town improvement was perfected. The greatest requisite is vision. Some public-minded individuals must look into the future and see the needs and possibilities that lie there. Everyone

can recognize an improvement after it is made and many say, "Why did we not do this before?" The man that can see a transformation before it is unfolded and can patiently and persistently work for its accomplishment is the man most needed in town improvement to-day. There is a splendid field for village improvement societies. Stockbridge, Mass., was the pioneer in this kind of work, having



THE CHURCHES ON THE GREEN,  
NEW HAVEN, CONN.

formed the Laurel Hill Association in 1841. One can readily see how Stockbridge has been steadily moulded to lines of beauty, all its natural attractions conserved and a public sentiment created that constantly strives for the best things and insists on a high standard of civic life. Any town may easily have an improvement association provided the impulse to form one is present. A town that thus develops and improves its natural situation will not only maintain a high degree of self-respect, but will be recognized as a community of high ideals and genuine worth. It will become more desirable as a place of residence and its material prosperity will be in every way enhanced. It will develop a character and a personality which will reflect the taste and the public spirit of its citizens and which will be a joy to all who behold it.

# Concrete, Its Use and Abuse

An Address Delivered Before the National Conference on Concrete Housing,  
Held in Chicago, February 17, 1920

By IRVING K. POND, F.A.I.A.

*Past President of the American Institute of Architects*

I HAVE written so much abstractly on architecture and architectural principles that it is good again to get down to hard and fast matters and fix my hypotheses in the concrete. I say "again," for many years ago as chairman of the Committee on the Allied Arts of the American Institute of Architects I was the author of a widely circulated report from that Committee dealing with concrete as a medium of architectural expression. I have had but slight occasion to put into practice the theories I then advanced, but I have continued to hold, and still maintain them.

Since that time the use of concrete in building operations has grown apace and enthusiasts and specialists have arisen to scatter their words and their works broadcast—sometimes, though not always, the words being more attractive than the works—sometimes the words and works alike bordering on the grammatically atrocious—as, for instance, when the beauties of cast rock-faced-concrete blocks have been urged and the monstrosities themselves have made pitiable what otherwise might have been semi-respectable structures—"semi," mind you, not "wholly," respectable; for the taste which could advocate and incorporate into its product such base imitations could not create or fashion a thoroughly respectable structure. Some two years ago while acting as chairman of a board to adjust, and settle perchance, jurisdictional differences between the carpenters, the architectural iron workers and the sheet metal workers of Chicago, I suggested facetiously that the fabricators of imitations should be penalized by giving over to the trades whose products were imitated the erection of all such imitations. Thus stone masons should erect all tin fabrications simulating stone cornices, architraves or entablatures, and do plastering where plaster simulated Caen-stone—one might put it "con"-stone—on walls and in vaulted ceilings. My pleasantry was met with hearty and strenuous disapprobation—each trade wanted to tell its own little lie and to reap the benefits which each felt certain would accrue to it in a world so slightly endowed with the elements of sincerity or of good taste.

So my first item of advice, if I may be permitted to offer advice to a body of men interested in the development or handling of a comparatively new

and altogether worthy building material, is to treat the product with respect, to shun and scorn imitations, to recognize limitations, which attach to all materials, as well as to all men, and to work within those limitations. This is not saying that because a thing has been done, and frequently and appropriately done, in one material it shall not be done in another or a new material which may be employed with equal propriety; however, the new material should not employ forms which are purely distinctive of the old, but should develop forms which inherently characterize the new.

What these characteristic forms may be is a subject for very searching study and analysis. Possibly through synthesis rather than analysis will the characteristic forms disclose themselves. So was it in the past with the old materials—so probably will it be with the new.

NOW concrete is a material which lends itself to many kinds of manipulation. It can be cast, poured, pressed, assembled in the shop or on the job; it can be applied in liquid or in solid form to the work immediately in hand. So many are the possible methods of its application—such a diversity of means may be employed toward its legitimate ends that some of its enthusiastic sponsors see in it a panacea for structural ills and possibly for aesthetic building ills, a substitute for all previously employed building materials—excepting, possibly, door hinges—and a perfect end in itself. Therefore, it behooves those who can impartially survey the entire field to offer both warning and encouragement—encouragement in its legitimate use; warning against its too free employment, especially where other materials may better serve the conditions. The economics of the general situation favor concrete, and through this factor alone there may arise a tendency toward its too general employment; toward its substitution for other materials which, though perhaps costing more in mere money, satisfy the senses and better fulfill geographic and climatic conditions. The cheapness and ease of casting a flat slab of concrete has led certain enthusiasts to advocate the general adoption of a flat slab type of roof in any and all parts of the country (and ultimately of the world). It is advocated

for a northern climate because it can very cheaply be made strong enough to hold a load of snow and ice. But that is not what a roof is for—it is to shed snow and ice. The flat slab roof is advocated for a southern climate because the overhang for shade is so cheaply procured. The shade is desired, but not at the expense of ugliness which results from unembellished overhangs—and concrete embellishments are expensive. The factors of ease and economy in manufacturing concrete slabs, whether to be applied vertically or horizontally, contribute to a “simplicity” which tends toward stupidity and to a barrenness which begets ugliness. Where the general form is stupid and ugly not much in the way of reclamation can be effected by proportioning of windows or application of superficial ornament. If the mass is interesting and appropriately conditioned, geographically and climatically, slight defects in details will not too seriously challenge the taste, but an ugly mass is fatal.

In spite of the fact that the learned ones will point out that concrete was a favorite building material with the ancient Romans, and that traces of it are found attaching to Greece, Egypt and the ancient Orient, concrete as employed by modern Americans is a new material, the science and art relating to which are not fully developed. Much has been done to satisfy the conditions of its employment—much more remains to be done. The newness of an art, or the suspected newness of an art, is a sufficient cause for criticism or antagonism in the average American eye. We are the most conservative people as regards art and the arts on the face of the earth. We will not accept materials and methods on their merits and attempt to develop their intrinsic qualities or worth. Art is about the only line along which we are conservative, however; that is, we conserve very little along material lines—and we do sling dead art about recklessly and embalm its form in lasting and eternally reinforced concrete in which they appear more dead than heretofore conceivable. The fact that they are embalmed in a vital and vigorous material emphasizes the fact of death. There are those who claim that these dead forms are alive—but only to the dead do the dead live! Concrete is a vital material full of character—let us give it its vital forms.

**B**ECAUSE concrete has for so long a time been poured into moulds or forms, and because of the coarseness of its ingredients, one of which was stone which could go through a two-inch ring, the earlier designers, and I fear there were architects among them, coupled in their minds concrete with crudity and coarseness of detail and, being dependent upon precedent, and knowing not where else

to look, fell upon the crude Spanish detail and broad masses of the early Spanish Missions as representative of what best might be embalmed in concrete, and so Spanish missions distorted into bungalows and cottages and palaces spread like a rash over the face of the country. As technical and mechanical difficulties were overcome and processes refined, the rash itched to take another form of disease and turned into a classic fever, with now and then a touch of Gothic “pains” noted particularly in the traceries on solids and in voids. The fever still burns, the pains still grip. Expensive forms are built up and destroyed to produce effects which already, ad infinitum, ad nauseam, have been better achieved in stone. However, this is not always to be.

The waste entailed in the destruction of specially constructed and expensive forms has become apparent to many concrete users and exploiters, and their efforts to prevent the consequent loss, especially in case of the smaller residences and the houses with which this conference is more particularly concerning itself, has introduced an element which may well call for restraint in its application. For the sake of economy, forms are used and reused in close proximity. When such forms are not perfect in themselves and in utmost good taste, monotony in repetition becomes deadly, and woe is it to him whom cruel fate has condemned to inhabit a unit in an environment so constituted. Life and joy and self-respect must be absent from the dweller amid such surroundings. Even where the forms are charming and singly in good taste, repetition robs them of individuality and unfits them for occupancy by anyone possessed of character and personality. Individuality of character and personality are absolutely necessary in the units which go to make up the mass of a civilized and self-respecting society. Consequently another injunction, which I offer by way of advice, is to avoid wastage of forms—but even more to avoid the monotony which must follow the unrestrained employment of any “motif,” ugly or charming. Introduce spice into life in the way of variety. The principle underlying this admonition is just as applicable to a mill town as it is to the most highly developed suburb. In point of fact, little or no distinction should be drawn between the mill town and the “swell” suburb. It should exist possibly only in the size of units; it should not exist in the expression of good taste and mental and bodily comfort. Perhaps I am getting ahead of the age and of the present topic. I hope not.

In spite of the manifold and varied means, methods, processes, applications, manipulations, textures, surfaces and colors appertaining to the use and employment of concrete as a medium of archi-



## THE AMERICAN ARCHITECT

tectural expression and embodiment, I am not certain that I should advise its sole and unlimited agency in housing the activities of any one neighborhood or community. Indeed, I am quite certain that I should not so advise; and this not altogether on the ground of a needed variety, but that there are other materials which transcend even concrete as a medium of certain desired expressions of the human spirit in the art of architecture. And I should desire to see no community curtailed of, or denied, the right and power to express the best that is in it in the materials best adapted to that expression. Thus marble, granite, iron, bronze, brick, slate, each one possesses inherent qualities or characteristics not translatable into concrete even through the agency of base and artificial imitation. In the matter of brick, for example, there is scale to the unit which relates the mass to human desire and experience in an intimacy possible with no other material, while in natural color and texture the range is boundless. But even with all that, brick needs other materials in its neighborhood for contrast and variety, purple-green of slate, soft white of stucco, weathered gray of timbers, with carvings and turnings, and craftsmanship which cannot be imparted by a mould, however exquisitely the surface be wrought by the modeler's hand.

I ASSUME that as an architect I am expected to say that the only way to make concrete an accredited and acceptable building material adapted to all human material and aesthetic needs is to have its essence filtered through the alembic of the architectural profession or its representatives.

If you wish me to say it, of course I will—with reservations. Now the most stupid of anachronisms are perpetrated by so-called architects (they really are untutored archaeologists or, rather, grave-robbers), and the most blatant of modernisms, cut off from all context of history, have emanated from, again, so-called architects (they really are unlettered sentimentalists). But I will say that the possibilities of concrete as a medium of aesthetic expression in building may best be apprehended by a sincere architect, with knowledge of modern social conditions and tendencies, working in cooperation with those who know the material at first hand and who also are sincerely working to exploit nothing but to develop the latent and inherent possibilities of a worthy material. Such architects exist, such material men exist. They should come together. It should be a function of such conferences as this to bring them together.

I must say one word here as to what should characterize the architect in whom the material man and the public may well place their confidence, being assured that his will be leadership—real leadership

and not selfish and autocratic domination. That architect must not exploit any material or system, but must be able to recognize and free to employ the most effective and appropriate under the individual conditions. He must sense the sociological, including the social, ethical and aesthetic tendencies of his time so as to aid his client in the sympathetic expression of them, curbing wasteful, demoralizing, disintegrating tendencies, and aiding toward social unification; diagnosing present conditions and meeting the situation with skill and clarity of vision rather than in applying formulae learned by routine in the schools. The architect should think in advance of the public and see the goal and the way thereto more clearly. Pity the public which follows, and condemn the architect who pursues the selfish and blind course.

Now, in so far as this paper constitutes a report to be discussed or otherwise sent to oblivion or laid aside for future reference, which amount to about the same thing, its elements may be summarized and augmented as follows:

### IMITATIONS

Concrete has a character of its own; there is no call to torture it into imitations of stone, wood, bronze or other material. Details cast in moulds should bear the plastic touch of the modeler and not the chisel marks of the sculptor.

### ECONOMY

Forms suited to the special purpose should be used—and forms extravagant of labor and material should be avoided and should be employed only where duplication can be accomplished without monotony.

### MONOTONY

Even a good thing ceases to be a good thing when used in excess, and two concrete houses from the same forms, placed side by side, is an excess—such treatment is permissible only in barracks where men are in uniform and drilled into the same line of thought, act and movement, all individuality being eliminated.

### SLABS

Flat slab roofs may at times and in places be appropriate. A general use would be deadly unless counteracted by features the initial expense of which would more than offset the element of economy, which alone would seem to call for a wide prevalence of such roofs.

### MONOLITHIC FORMS

This method presents advantages in certain types of structure. The appearance of mass and strength is enhanced by monolithic treatment. Openings and corners can be characteristically and ornamentally treated at slight or no additional expense.

## THE AMERICAN ARCHITECT

Houses pre-cast from monolithic forms and transported as slabs or as units are to be looked upon with suspicion as tending to create types and general monotony.

### BLOCKS

(a) *Units.* Concrete blocks laid to be effective as units may perform a legitimate aesthetic as well as structural service. Texture and color can be given them. Their danger lies in exaggerated scale and general uniformity. Stone has the advantage of lending itself to cutting and fitting in length and height without consequent economic waste. The manufacture of concrete blocks should be studied with variety of size as well as appropriate scale in mind. Corners and angles should be true, and crude and rock-faced surfaces avoided.

(b) *Backing for Stucco.* This is a legitimate field for the use of concrete blocks. Scale need not be taken into account; neither need such matters as sharpness of corners and angles or crudity of surface. Uneven chipping where blocks are cut approximately to the desired outline presents no obstacle to the perfect finish. Surfaces should be such as to which the stucco will most readily adhere.

### COSTS AND PERMANENCE

In a letter from an official of the United States Housing Corporation I find these words: "We were satisfied that there were certain types which would produce a good practical house at a very moderate cost, but it appeared to us that this could be done only where the same unit was repeated indefinitely, and our belief was that this would produce a deadly monotony." As to the monotony we have already heard; as to the cost and permanence or durability, let me say that there may be cases where permanent houses would be a drawback in a developing community. There would be very little salvage in a wrecked concrete house, while the wrecking would entail almost as much expense as the constructing. Unless a community is well "zoned," buildings of a too permanent nature are an economic waste, even though the initial cost may be the same as for a building of less permanent character. Where, as in many of our communities, change is the order of the day, well constructed buildings of a more temporary na-

ture are desirable. Buildings of a temporary nature can be "fire stopped" and made safe for occupancy.

### FIREPROOF CHARACTER OF CONCRETE HOUSES

In the letter above referred to, these words appear: "We found that the people who were interested in the concrete house were, almost without exception, trying to build every part of the house in concrete, including porches and all the trim." This would seem to me to indicate a deficient sense of humor on the part of the people referred to, as well as defective vision. I will grant that the designs of many architects who never intended to make a joke of their work are such as to be readily translated into concrete and would not lose in the process; but a concrete man with a sense of fitness, I'll call it humor, would not deign to effect the translation. I must still warn the enthusiast against excess; excess of imagination as well as excess in material means, or some of them may wish to make the door hinges out of concrete after all! Fireproofness, so to speak, and permanence are good qualities, for which it is possible at times to pay too much.

### METHODS AND MEANS

How to make the house reasonably fireproof, reasonably durable, reasonably attractive and reasonably economical in cost and in upkeep presents a series of problems for the architect and the concrete expert. As an architect, I shall receive the findings of the concrete expert and will make such application of the methods and means presented as may suit the particular case. I will even present the case beforehand to the expert—if it is not already covered—and aid him in his solution. I will even ask him now to present types of floors in structure and finish which are durable, economical and appropriate to a small house? I will ask the same concerning the roofs, high-pitched, low-pitched and flat.

There are many problems to be solved in connection with the design, construction and location of the concrete house, and I congratulate the concrete and cement interests that they have enlisted the services of so many serious-minded and enthusiastic men in the quest for the best along these lines. I hope that architects of vision and deep feeling may be called upon to co-operate.



*In order to supply our readers with material of current interest, the news and comment appearing in issues of THE AMERICAN ARCHITECT delayed by the printers' strike will be as of actual rather than stated date of publication.*

## The Architect and the Government

**J**UST how to impress the people and those in high position in the Government with the value of the architect's services is further discussed by Glenn Brown in the second of a series printed in this issue on the relations of the architect.

"With few exceptions," writes Mr. Brown, "public officials are striving to secure the best results for their masters, the people, and bow gracefully when the public emphatically expresses an opinion."

The present attitude of the Government toward the profession of architecture is compared by Mr. Brown with that of eight to twelve years ago and an analysis is made of the present attitude of the Institute which he believes fails to impress on those in high authority the real status of the architect in his relationship to the Government or to emphasize his right to leadership in all building operations.

Every member of the profession will undoubtedly follow this discussion through its various phases as presented in future issues with increasing interest. The editors invite from architects the fullest expression of opinion on these important matters.

---

## The Reply of the Housing Corporation to Senatorial Criticism

**T**HE reply of the United States Housing Corporation to the criticisms of the Senate Committee on Public Buildings has been published. It refutes inaccuracies of statement contained in the Senate report and successfully answers the charges that have emanated through a superficial knowledge of facts.

It is necessary to bear in mind that all of the housing operations carried forward during the war were not conducted by the Housing Corporation. As a matter of fact, there were in all six agencies or

departments. All of the houses built by these departments for industrial workers were of a permanent construction and of modern type. The question that the Housing Corporation asks, in its reply is—was this construction of modern and permanent type wrong? Should the Housing Corporation simply have erected short-lived, temporary shacks to serve only the war's emergencies? It is stated that the loss to the Government in dollars and cents will be about the same in both types.

A material salvage loss was created in the selling of a large number of houses and at a material increase over previous housing costs. The temporary housing, while having less salvage value, is compensated for in part by the lower cost of construction. All things being equal, that is to say, if the salvage in both types were the same, the Government has secured at a minimum cost the very decided advantage of having created a decent type of American industrial housing.

The injustice of the criticism on the part of the Senate Committee lies principally in the omission to take this very important factor into consideration. The amount of work that was successfully accomplished by these six departments and the groups of competent men who administered them is of a greater value than is generally known. The Senate Committee might well have considered these things before they hastily created a feeling of distrust toward men who unselfishly gave the best they had toward working out this splendid result.

Unfortunately, just what large measure of good result was secured, just how great the advance has been in the development of industrial housing, is known only to the comparatively few who came in contact with these things during the war. We need an appropriation by the Government that will permit the widest circulation of a report embodying these things. The publication of a meager edition some three months ago barely furnished a copy each to the many employes of these departments.

## THE AMERICAN ARCHITECT

THE AMERICAN ARCHITECT has received scores of letters from architects complaining that application for copies of these reports received the reply that a very limited edition was almost immediately exhausted. If these reports could be at once reprinted and made available to that large number of people who would use them, curtailing if necessary as a matter of economy many senatorial speeches circulated by millions—an accurate knowledge of facts would be obtained and the censure of the Senate Committee proved to have been based on misinformation.

The report of the Housing Corporation closes with the significant statement: "The last houses in demand by the tenants or the prospective house owners have been the cheap, temporary houses recommended by the Senate Committee's report."

---

### The Tendency Toward Hotel Life

THE rapidly increasing number of apartment hotels in all of the larger cities indicates a very radical change in methods of living. Buildings of this type, which are subdivided into small groups of two or three rooms and bath, with a general dining room on the ground floor or, in some instances, on the roof, are being projected in large numbers. As an investment this type of building presents attractions. The rents which are asked and readily paid would ordinarily secure twice the floor area in the usual domestic types.

In this connection it is interesting to learn that a large apartment hotel on Park Avenue, in New York, that will not be ready for occupancy until next October, has already enough applications to more than fill its apartments.

The hotel dwelling habit is largely on the increase all over the United States and it is astonishing, says the proprietor of one of the larger hotels, to note the present tendency to secure permanent living quarters in these buildings. Investigations show that the better class of hotels have to-day rented to permanent dwellers all the space that they are willing to allow. These conditions aggravate the shortage of transient hotel accommodations and are the principal reason for the many new hotels now being erected.

It would seem that the allurements of a home do not attract that class of people who are able to pay the high prices asked for permanent hotel accommodations and that the dweller in cities is drifting toward either the usual type of hotel or else the apartment hotel, which is slightly less expensive, because of its less complete service.

---

### Civic Untidiness

A BESETTING sin of all large cities is that of untidiness. This fault has two aspects, that of the individual who carelessly strews litter and that of the authorities who allow disordered conditions to exist and often become acute.

The Merchants' Association of New York has submitted a report summarizing its activities during the months from January, 1919, to January 1st, 1920. This summary shows a comprehensive range of activities and discloses conditions of slackness in the city government that should be no longer permitted to exist. The complaints received by this bureau have been tabulated under a classified heading. It will hurt the civic pride of the true citizen to learn that in spite of a heavy tax rate which should insure the most perfect public service, the majority of these lapses from essential tidiness comprise the removal of garbage, of dead animals, accumulated rubbish, and in many instances violations of public decency. As naturally will be inferred, the most flagrant violations occurred in the thickly settled districts so largely populated by foreigners. It seems difficult to secure co-operation from these people in the observance of simple regulations or in the use of receptacles provided to insure tidiness. Further, it is made subject of extended comment that the stores of these districts are so slovenly kept as to become not only eye-sores, but to create unsanitary conditions and a menace to health.

These matters suggest the ever-present problems of Americanization. It is in that direction that prevention of a city's untidiness lies. Good citizenship promotes civic pride. The quicker we set to work on this phase of Americanization the sooner we will attain those ideals that are reasonably looked for as fundamentally essential.

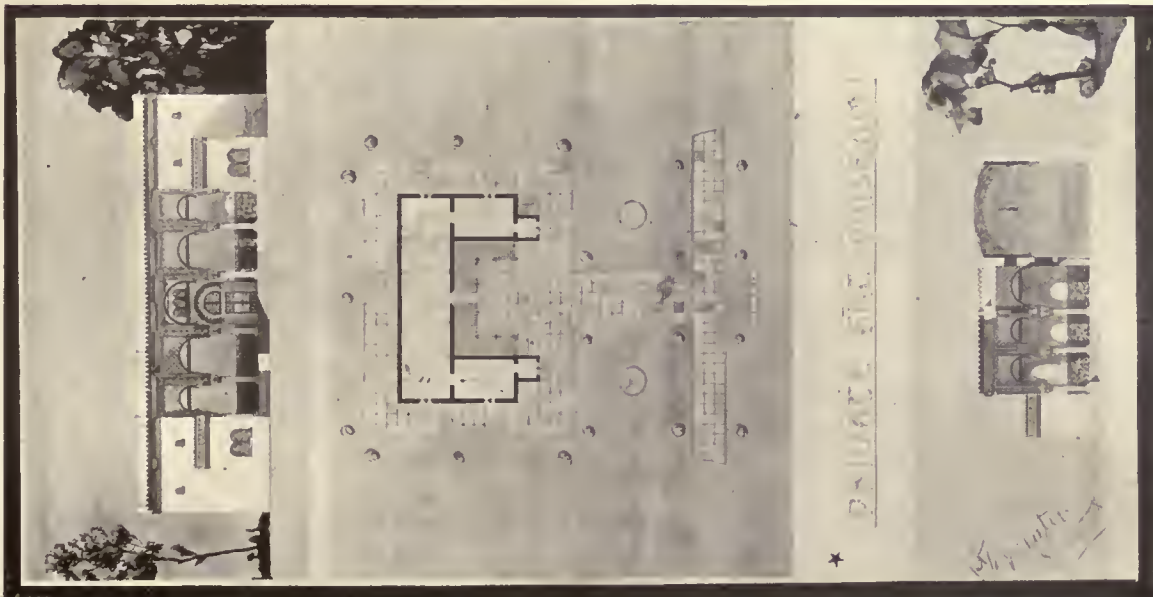

W. E. VIRRICK  
 FIRST MENTION PLACED  
 COLUMBIA UNIVERSITY  
 CLASS "B" I. PROJET, A PRIVATE ART MUSEUM  
 STUDENT WORK, BEAUX ARTS INSTITUTE OF DESIGN

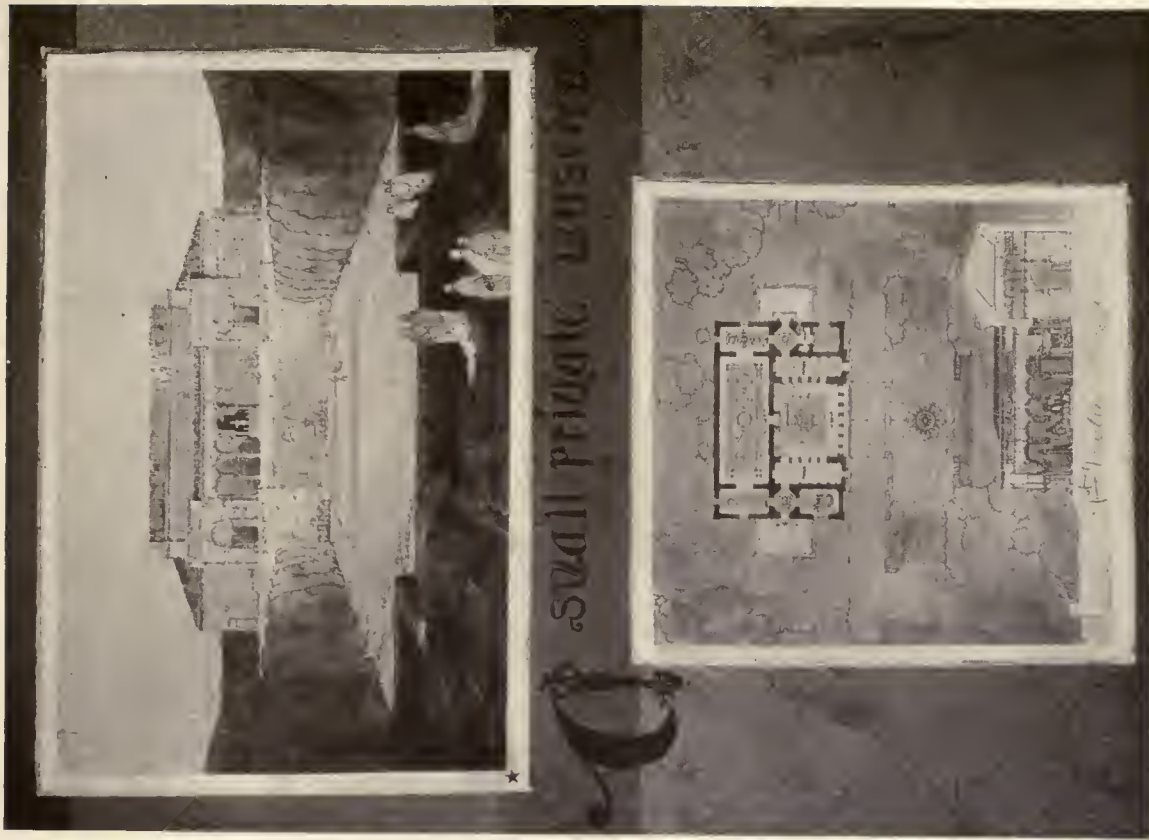

G. W. TROFAST-GILLETTE  
 FIRST MENTION PLACED  
 COLUMBIA UNIVERSITY

# Beaux-Arts Institute of Design

DIRECTOR OF THE INSTITUTE, LLOYD WARREN

ARCHITECTURE, WILLIAM F. LAMB

SCULPTURE, JOHN GREGORY

MURAL PAINTING, ERNEST C. PEIXOTTO

INTERIOR DECORATION, ERNEST F. TYLER

INDUSTRIAL ART DESIGN, ARTHUR CRISP

## Official Notification of Awards— Judgment of December 16th, 1919

PROGRAM

CLASS "B"—I ANALYTIQUE

The Committee on Architecture proposes as subject of this Competition:

"THE ENTRANCE OF A CITY CLUB"

A club in a large city is planning a new entrance motive for its Club House. As the club house is situated on one of the main avenues of the city it is the purpose of the committee in charge not only to embellish the entrance but to provide a balcony from which passing parades may be reviewed. The main floor of the club house is three feet above the sidewalk. The face of the building is set ten feet back of the building line, but the entrance motive shall be brought out to this line and shall be crowned with a balcony entered from a French window at the second story. The second story level is twenty-two feet above the main floor.

JURY OF AWARD: R. M. Hood, H. R. Sedgwick, E. Gugler, H. M. Woolsey, Mr. Ludlow, J. T. Haneman and C. F. Gould.

Number of drawings submitted—110.

AWARDS:

FIRST MENTION PLACED:—S. Grillo, Atelier Corbett-Gugler, New York; C. Contreras and O. Betts, Columbia University, New York; F. J. Brince, Atelier Hirons, New York.

FIRST MENTION:—C. F. Wright, Boston, Architectural Club, Boston; M. Marsh, Columbia University, New York; W. S. Boice, Atelier Hirons, New York; R. Weber, Thumb Tack Club, Detroit; L. Hamilton, Yale University, School of Fine Arts, New Haven.

MENTION:—C. B. Bengtson, M. E. Witmer and R. W. Arnold, Boston Architectural Club, Boston; J. C. McClymont, Atelier Brazer, Chester; J. P. Bennett and S. Juster, Atelier Corbett-Gugler, New York; C. H. Dornbusch, A. Gilman, F. W. Brown, H. W. Gill, J. M. Shaw, F. F. Williams, A. K. F. Volmer, M. Grisez, H. J. Hoefener and K. Sasagawa, Columbia University, New York; G. E. Tucker, C. A. Lake, L. E. Considine, C. J. Pellegrini, C. B. Marks, E. H. Hughes, J. O. Cahill, G. D. Schoonover, F. O. Rennison, F. P. Kefalos, A. W. Chesterman, F. H. Floyd and I. W. Truxell, Carnegie Institute of Technology, Pittsburgh; E. J. Rutledge and P. F. Dowling, Catholic University, Washington, D. C.; G. S. Beach and J. Schierhorn, Chicago Architectural Club, Chicago; A. Wuchterl, Atelier DeGelleke, Milwaukee; W. P. Sutherland, Jr., Atelier Gougner, Newark; C. A. Smith, Jr., George Washington University, Washington, D. C.; W. A. Schabel and E. C. Rising, John Huntington Polytechnic Institute, Cleveland; D. W. Earel, Patron—R. M. Hood, New York; O. Colby, A. Gambell and R. G. Clifford, Portland Architectural Club, Portland; H. R. Gamble, R. A. Schwarter, W. L. Gibb, Jr., C. E. Maule and J. W. Minick, Pennsylvania State College, State College; E. B. Stanley and H. A. Martin, Syracuse University, Syracuse; W. R. Fisher, W. Kumme, E. S. Young and

E. A. Beihl, "T" Square Club, Philadelphia; L. C. Neilson, Atelier Treganza, Salt Lake City; K. B. Niven, University of Texas, Austin; M. W. Gill, Rosalie Haas, A. A. Shay, D. A. Seibert, E. A. Gorospe, D. P. Thomas and E. Wendland, University of Washington, Washington, D. C.; H. F. Neville, R. R. Hibbs and A. E. Evans, University of Kansas, Lawrence; M. D. Williams and C. H. Hinman, University of Minnesota, Minneapolis; L. Lentelli,

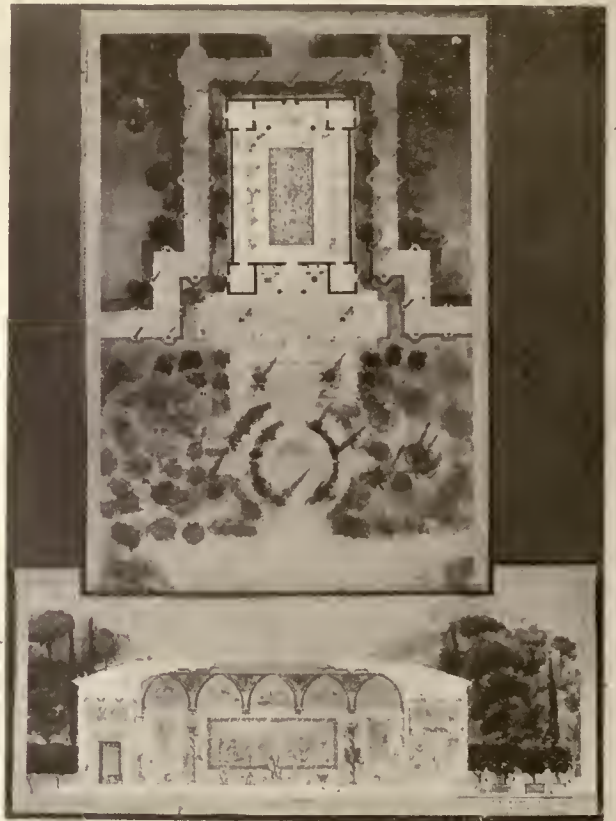

J. LUCCHESI ATELIER HIRONS  
FIRST MENTION PLACED

CLASS "B" I. PROJET, A PRIVATE ART MUSEUM

Atelier Wynkoop, New York; W. Douglas, C. B. Lewis, B. S. Georges, D. Weinstein and H. S. Kelly, Yale University, School of the Fine Arts, New Haven.

PROGRAM

CLASS "B"—I PROJET

The Committee on Architecture proposes as subject of this Competition:

"A PRIVATE ART MUSEUM."

An Art Lover who has made a collection of paintings, statues and "objets d'art" is planning a small one-story

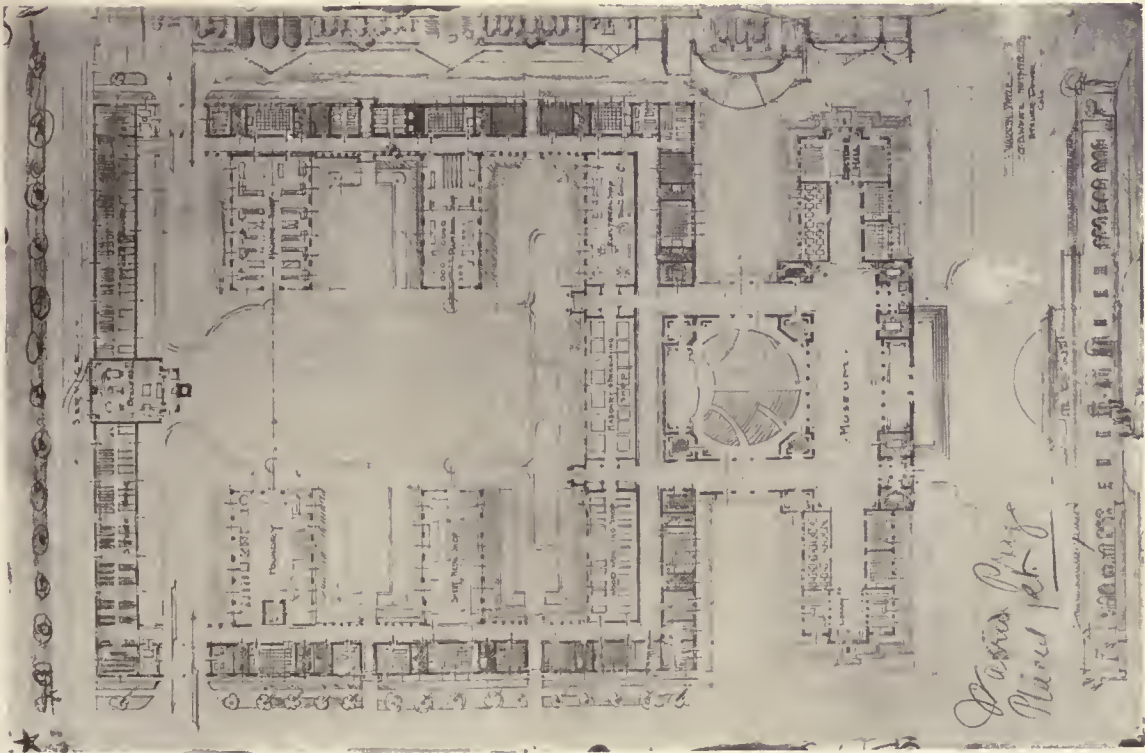

G. D. WHITE

PLACED FIRST

ATELIER DENVER  
A TRADE SCHOOL

WARREN PRIZE COMPETITION

STUDENT WORK, BEAUX ARTS INSTITUTE OF DESIGN

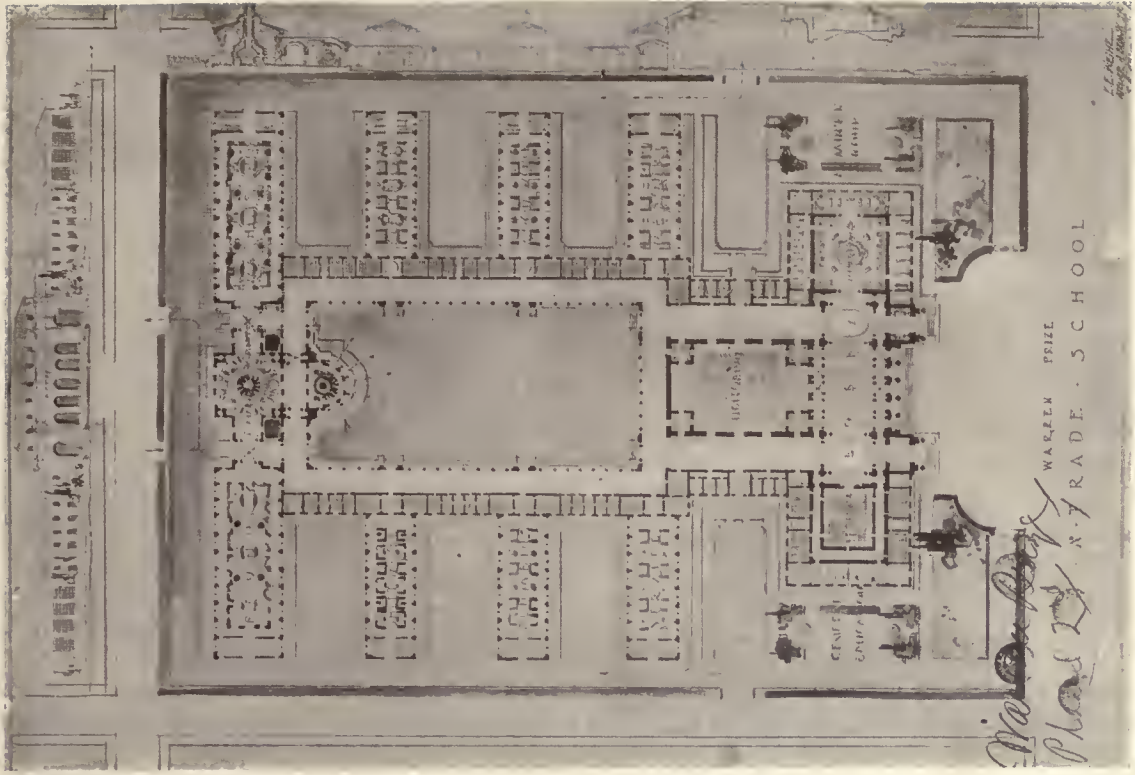

E. E. WEIHE

PLACED SECOND

ATELIER A. BROWN, JR.





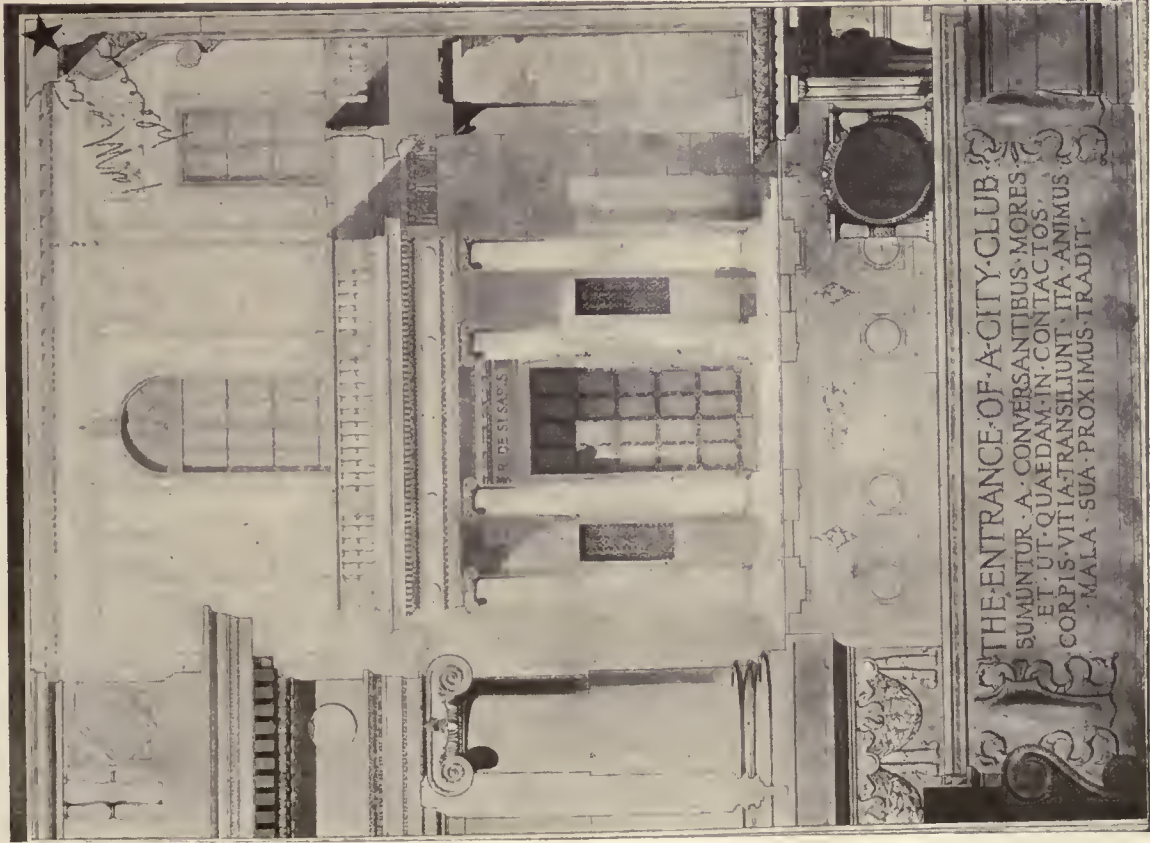

S. GRILLO FIRST MENTION PLACED ATELIER CORBETT-GUGLER  
 CLASS "B" I. ANALYTIQUE THE ENTRANCE OF A CITY CLUB  
 STUDENT WORK, BEAUX ARTS INSTITUTE OF DESIGN

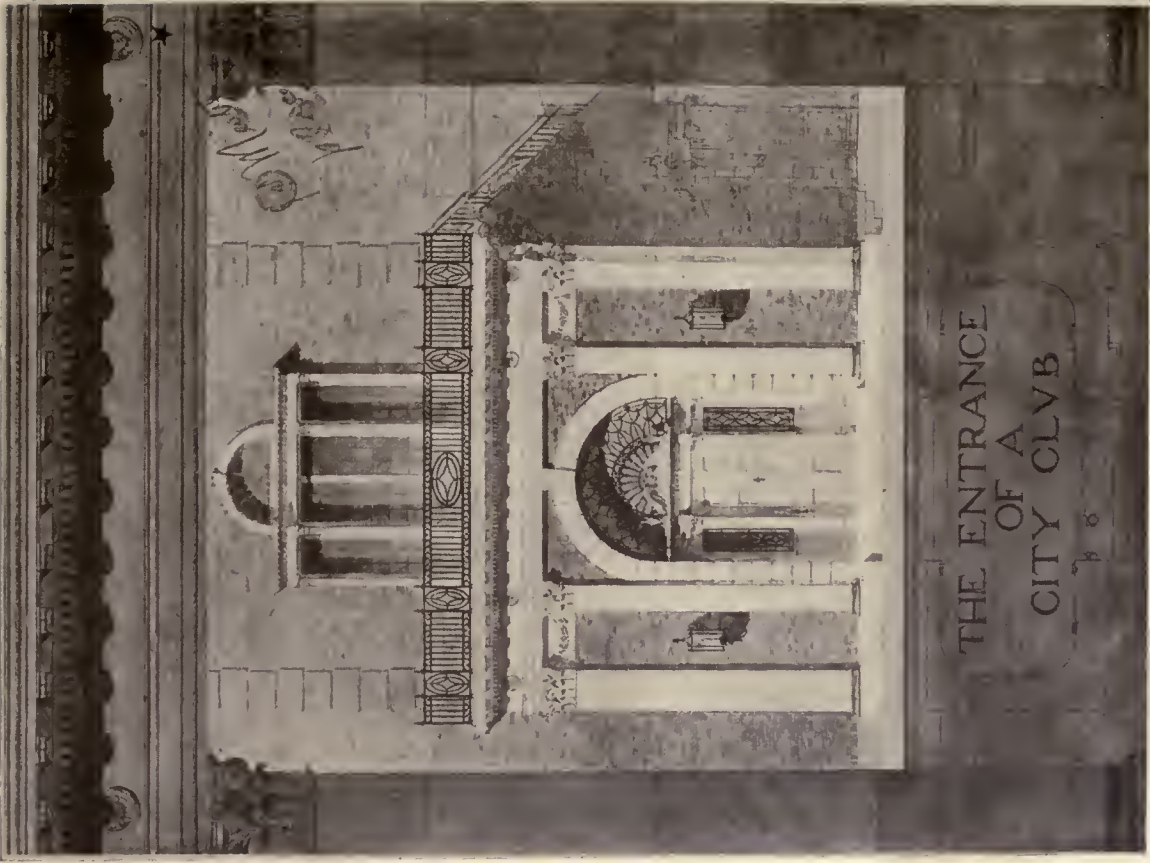

O. BETTS FIRST MENTION PLACED COLUMBIA UNIVERSITY

and rubbish. It should also be borne in mind that while concentration is desirable, light and air are of prime importance. While for the purpose of defining the elements of the problem, they have been grouped under four headings, it is not the intention of the program to limit the students to four buildings or groups of buildings, and perfect liberty should be exercised in combining or dividing the elements with due consideration of the required circulation for men and for materials. The bulk of the requirements will naturally be found on one main level, but certain ones, particularly in the Administration and General Instructive groups, may be found on other floors. In any case, their location shall be plainly indicated, by additional plans if necessary.

The elements are as follows:

1. The Administration group shall provide a Public Lobby, Offices for the President, Secretary, Dean and Registrar with the necessary clerical force, an Auditorium seating about 800, a Small Library and a Small Trades Museum, with an Exhibition Room for the work of the students.

2. The General Instruction group shall provide a Lecture Hall to seat about 300, three or four Class Rooms and two Drafting Rooms.

3. The Trades group shall provide six shops as follows:

- A Foundry
- A Machine Shop
- A Masonry and Brick Laying Shop
- A Woodworking Shop
- A Sheet Metal Shop
- A Plumbing Shop
- An Electrical Shop

Each of these shops shall have a small class room, an office for the professor in charge and one for his assistant, a storage room and a locker room with toilet accommodations; these in addition to the main shop working space. In the foundry and machine shops this working space shall be about 8000 sq. ft., in the other shops about 5000 sq. ft. Ample height shall be provided in all shops for the character of work to be done, as well as for light and ventilation.

4. A power plant and small service building shall be provided.

One or more courts should be provided to serve for service and as spaces where small sections of buildings might be erected by the students.

JURY OF AWARD:—F. A. Godley, B. W. Morris, R. M. Hood, C. Collens, B. Delchanty, J. T. Haneman and F. B. Chapman.

Number of drawings submitted—38.

AWARDS:

PLACED FIRST:—G. D. White, Atelier Denver, Denver.

PLACED SECOND:—E. E. Weihe, Atelier A. Brown, Jr., S. F. A. C., San Francisco.

PLACED THIRD:—W. F. McCaughey, University of Illinois, Urbana.

PLACED FOURTH:—J. S. Whitman, Cornell University, Ithaca.

PLACED FIFTH:—G. S. Underwood, Yale University, School of Fine Arts, New Haven.

Civic Beauty

At a time when many American cities were yet lacking in the fundamentals of safe, healthy and decent conditions of community life, the "city

beautiful" movement began to strike root, and soon after suns were appropriated for aesthetic objects which must have struck the older cities of the western world as altogether prodigal. Now that these essential services are, in most cases, provided for or under way of accomplishment, the movement apparently is suffering a set-back. The *Survey*, discussing this, calls attention to the curious fact that at the recent fifteenth annual convention in Philadelphia of the American Civic Association—which has always represented the aesthetic branch of the town planning and improvement movement—speaker after speaker apologized for mentioning "beauty" at all as an element of importance in community life.

The reason, of course, is not far to seek. Too often in the past the beautification of our cities has been on the principle which has been described as Queen Anne in front and Mary Ann at the back. The ambitious light standards in Main street were balanced by a complete absence of any standards in rear alleys and smaller byways. At present the tendency seems to be to swing too far in the other direction and to demand a demonstrably utilitarian and "paying" reason for every improvement.

Unfortunately, the new insistence upon the practical brings its own exaggerations and pitfalls. These were evident, for instance, when the architect of America's most beautiful war town deplored the fact that the population was not made up exclusively of one category of workers and their families, or when the provision of good homes for work-people at prices within their means was held up by speaker after speaker as a certain panacea for social unrest. As at many other gatherings of civic reformers, one also heard repeatedly the popular fallacy that the problems of our overgrown cities can be solved by extending these still further in area and in population.

The Civic Association convention was both practical and inspiring, however, when it discussed the topics traditionally near to the heart of its membership. The war against dirt and noise, against the disfigurement of town and country, against low taste in public and commercial recreation, against anarchy in architecture, still needs its champions and its cohorts. A new era, marked outwardly by unrest and bitter economic strife, but inwardly possessed—for all the sneers of cynics—by high ideals of social reform, must find expression in appropriate environments. The war memorial movement, directed into desirable channels largely by the energy of this association, is one way. Another is the application to the modern problems of city planning and zoning of the imaginative quality which was often evident in the discussions at this convention.



HOUSE AT OCEANIC, NEW JERSEY  
A. J. JACKSON, ARCHITECT

128-





HOUSE AT OCEANIC, NEW JERSEY  
A. J. JACKSON, ARCHITECT

188.2





HOUSE AT OCEANIC, NEW JERSEY  
A. J. JACKSON, ARCHITECT

1883







LIVING ROOM  
HOUSE AT OCEANIC, NEW JERSEY  
A. J. JACKSON, ARCHITECT

1884

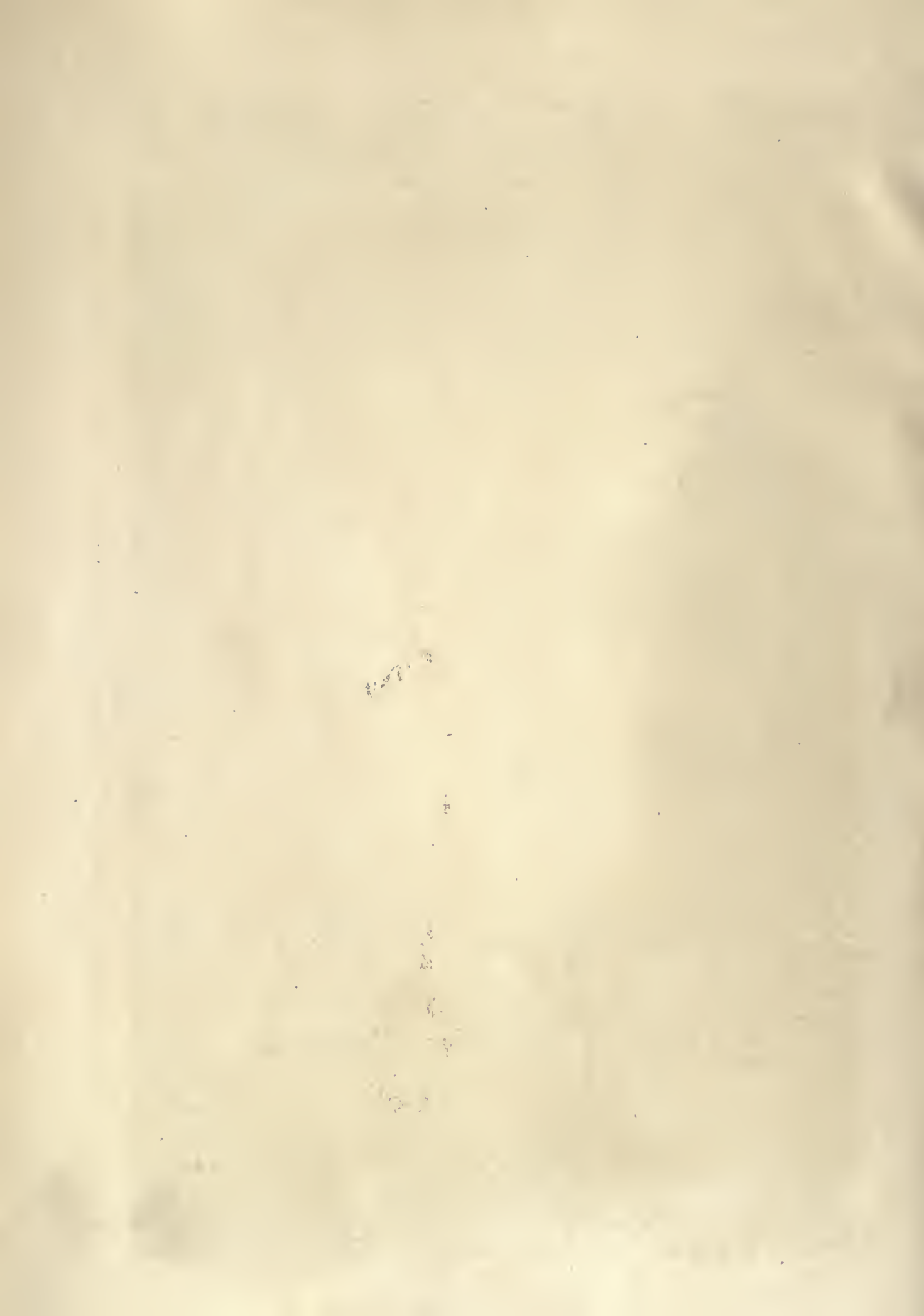

1885-



DETAIL OF MAIN ENTRANCE  
HOUSE OF WHARTON POOR, FLUSHING, L. I.  
GOODWIN, BULLARD & WOOLSEY, ARCHITECTS



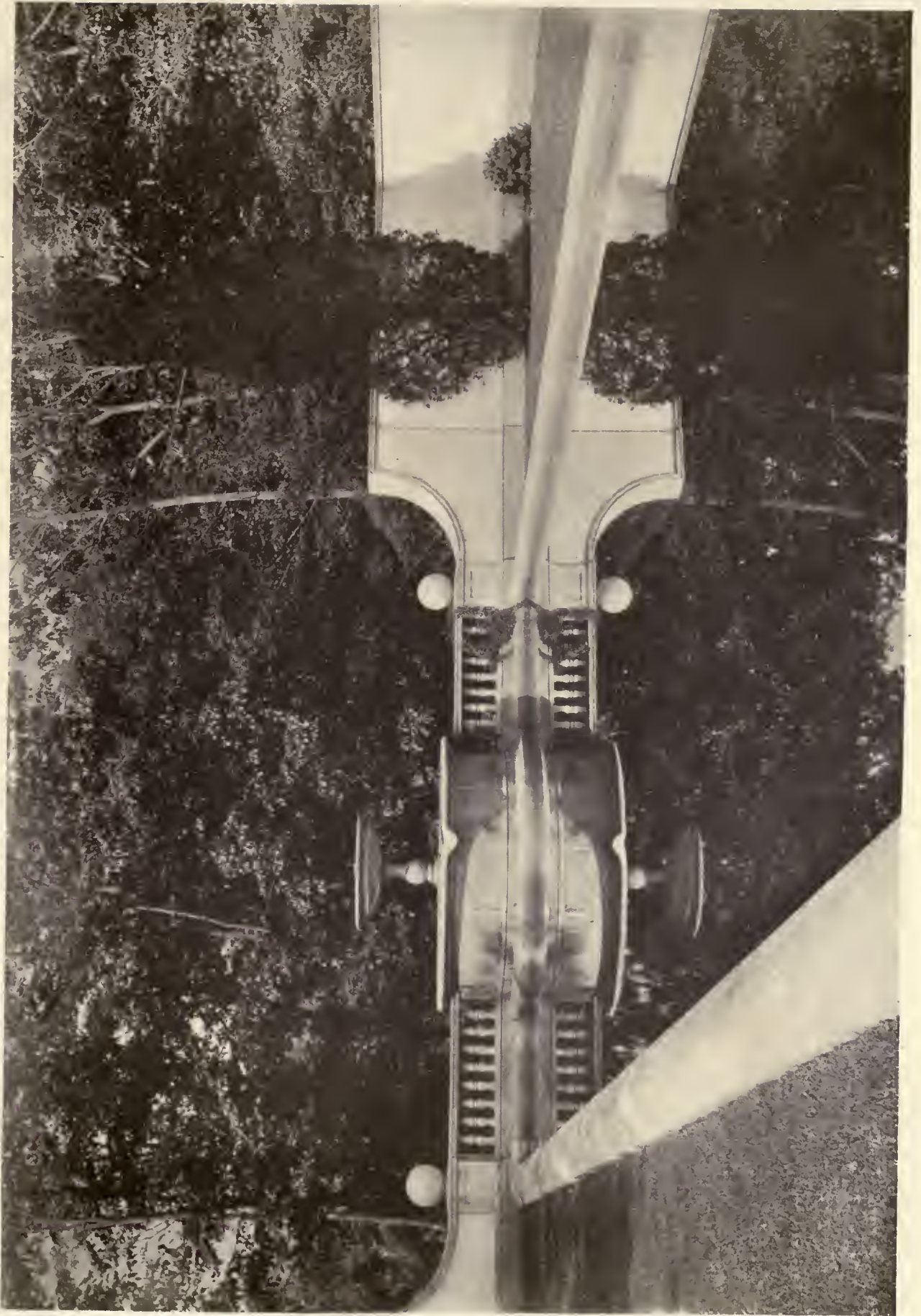

GARDEN OF A HOUSE AT OYSTER BAY, L. I.  
DELANO & ALDRICH, ARCHITECTS

188  
6



# Current News

---

## Happenings and Comment in the Fields of Architecture and the Allied Arts

*In order to supply our readers with material of current interest, the news and comment appearing in issues of THE AMERICAN ARCHITECT delayed by the printers' strike will be as of actual rather than stated date of publication.*

### Street Trees

Providing shade on city streets is as much a municipal function as providing lights or sidewalks and should therefore be cared for by public officials, says one of the horticulturists of the U. S. Department of Agriculture in a recent bulletin on "Street Trees." Trees on well-shaded streets not only contribute enjoyment but health by transpiring moisture and producing a restful effect on eyes and nerves.

Good shade trees add to the value of adjoining properties. In fact, even in pictures, a house with trees and shrubbery will attract a buyer when the same structure without them would be disregarded.

Mixed plantings of different kinds of trees are not so pleasing and effective as the use of a single species for considerable distances. On the other hand monotony will result if the same species is used for an entire town or section. The varieties of trees suitable for city planting are not many, so all native to the section may be used, usually assigning one variety for a long stretch of street. Street trees are often planted too close together for the mature tree to thrive, a common practice being to plant them 35 feet apart although 50 or 60 feet would be ultimately a better distance.

A street tree must have healthy foliage that withstands dust and smoke, a root system adapted to unusual soil conditions, restricted feeding area and root pruning where street improvements are made. In the smoky heart of a city the ailanthus or tree of heaven will probably thrive when nearly all other kinds fail. So also may the sycamore and plane. These are suitable for nearly all sections of this country. The maple is not so suitable a tree for street planting as many suppose because it is not sufficiently rugged except under suburban conditions.

The top of a street tree should be in proportion to the width of the street on which it stands, and should be of open growth without being too spreading. Narrow streets should be planted with columnar trees like the Lombardy poplar, or sometimes with small trees; broad streets with spreading trees like oaks or elms. The oak is designated as best for nearly every section of the country because of its hardiness and beauty.

The planting and culture of street trees makes up a goodly part of this interesting bulletin.

### Wooden Houses in England

The first permanent wooden house under the new building scheme was completed and occupied near Norwich, England, the last of November, according to the American Consul at London. The house was erected by a Norwich firm which has converted its aircraft factory into a workshop for making standardized sections for these houses. The manufacturers state that they will be able to turn out similar houses at the rate of 50 per

week. The total cost, providing for six rooms, is about \$3275 (at normal exchange) and such houses may be completely erected within one month.

### Health More Important Than the Picturesque Landscape

The old oaken bucket that hung in the well may be dear to the heart, but it's dangerous to the system, writes *Modern Hospital*.

The time-honored wellsweep and windlass were one of the picturesque features of the typical Polish landscape—until Polish and American Red Cross sanitarians at the head of the Polish public health work decreed that health was more important than landscapes. Though the bubbling spring by the roadside sounds well in poetry and the maiden drawing water from an old-fashioned well is pretty in pictures, every open well is a potential epidemic breeder. With typhus and cholera raging throughout Poland, these wells are considered by the health authorities a direct means of contagion, exposed as they are to all sorts of contamination.

The American Red Cross health experts, who are co-operating with the native government in formulating a permanent health program, have discovered substitutes for the old wells. In the supplies abandoned by the Germans when they were forced to quit the country were found hundreds of pump connections, suction joints and valves in salvage warehouses. These will be used in addition to the modern wells which the Americans are constructing in several towns.

### The Picture Post Card

A valuable idea is contained in the suggestion of Thomas E. Tallmadge, of the architectural firm of Tallmadge & Watson, and director of the Municipal Art League, Chicago, who has sent the following notice to members of that organization:

The picture post card has long been secure in its place, not only as a cheap and convenient means of communication, but as a silent educator in geography, history and art. Very little consideration has been given the publication of post cards, and their educational possibilities have not been appreciated. The result has been that, with few exceptions (such as the beautiful series published under the direction of the Art Institute), the local market has been flooded with cards which have misrepresented our beautiful city and must have exercised an evil effect on the artistic perception alike of the purchasers and the recipients.

The Municipal Art League believes it would be a good work to direct the publication of a worthy series of cards of Chicago and vicinity. They should depict the most valuable and interesting subjects and be executed in the

most artistic manner possible. To this end members of the League are asked to send a list of subjects or photographs of points of especial historic or artistic interest or of natural beauty with which they are acquainted or any similar subjects anywhere in or near the city which it is believed have been neglected.

The ramifications of this idea are of course extensive, and if it were generally accepted much good would be accomplished in bringing the dignities of art before the public.

## Farming on the Desert

More than 200,000 persons now occupy prosperous homes in what were American deserts and produce an annual crop worth \$100,000,000 from lands which a short time ago returned nothing. Director Arthur P. Davis, of the United States Reclamation Service, Department of Interior, says in his annual report that the progress being made by these communities equals that of the most prosperous regions of our country.

"During the present year the service is in position to deliver water to about 1,600,000 acres of irrigable land, covered by crop census, of which about 1,120,000 acres are now being irrigated," Mr. Davis says. "Besides this, storage water is delivered from permanent reservoirs under special contracts to about 950,000 acres more. The projects that have been undertaken have been planned to provide for an area of about 3,200,000 acres.

"Agriculture in the arid region where irrigation is feasible has several important advantages over that in the humid region. The soils of the arid region by the nature of the case have generally not been leached of their mineral plant foods as have those in the humid region and they are, therefore, much richer in this respect on the average and are seldom or never acid.

## Inventor of Cubist Painting Found Dead

M. Modigliani, an artist who claimed to have invented cubist painting, was found dead in a miserable hovel in the Latin quarter of Paris a week ago. He used to frequent artist cafes dressed in trousers with the legs made of different materials.

## An Architects' Building for Chicago

Chicago architects are to have an office building of their own in the near future, if plans now under way are successful. The building project grew out of the recent membership campaign of the Western Society of Engineers, which has added to its roster materially, thus increasing its financial stability. Consequently, when the local architects were approached on the subject of a distinctive architects' building, which would house not only architects, but engineers, contractors and building concerns as well, the Illinois Society of Architects, of which Chas. Herrick Hammond is president, took up the matter and appointed a committee to aid in the work. D. H. Burnham was chosen as chairman of the committee from the society.

The proposed building will have not only space sufficient to house the leading architects' offices of the city, but will be provided with club rooms and meeting rooms for the various affiliated societies of architecture and engineering. It is probable that a bond issue will be floated to aid in financing the structure which it is hoped to make one of the finest buildings in the loop. Several locations are under consideration.

## Avery Library of Architecture at Columbia University

The largest architectural library in the Western Hemisphere, and probably the second or third largest in the world, has been definitely linked with the School of Architecture of Columbia University by the appointment of William B. Dinsmoor as librarian and as the member of the instructing staff of the school.

This library, consisting of 25,000 volumes relating to architecture and the allied arts, is located in Avery Hall on the Columbia campus. It was completed in 1912 as a memorial of the late Samuel P. Avery and of his son, the late Henry P. Avery.

Although the School of Architecture has been occupying three floors of this same building, and has been in constant contact with the Avery Library, the school and the library have been distinct departments of the university. A definite connection is now assured by the appointment of Mr. Dinsmoor.

Mr. Dinsmoor holds a degree from the Architectural School of Harvard University and has specialized in the history of architecture and art. He is the author of numerous articles and books on this subject and has made extensive archaeological studies in Greece.

The Avery Library Building makes ample provision for drawing, drafting and study. Rooms are set apart for the study of books and photographs and there is a large exhibition room for design and other current work. The Architectural Library is open to the public daily from 9 a. m. to 6 p. m. and from 7 to 10 p. m.

Frequent public exhibitions in the library have included the collections of the works of the late Belgian sculptor, Meunier, and of Gutzon Borglum; the late J. Pierpont Morgan's collection of mediæval and renaissance manuscripts; engravings of French masters of the seventeenth and eighteenth centuries; American tapestries and furniture; prize competition works in architecture; and sculpture and paintings of the American Academy in Rome.

## To Strengthen Strasbourg Cathedral

The foundations of Strasbourg Cathedral, Alsace-Lorraine, which for several years have been in such condition as to threaten the safety of the building, are being removed and new foundations will be built. The Cathedral stands on oak piles driven into the ground and in recent years these have begun to rot.

Strong reinforced concrete walls are being built on either side of the old pile foundation. Hydraulic jacks will be fitted on these walls to support the weight of the building. Passages will be pierced between the concrete walls to permit the removal of the old foundations and the installation of the new.

## Michigan Architects Elect Officers

The Michigan Architects' Society has elected the following officers:

President, Clarence L. Cowles, Saginaw; first vice-president, Alvin E. Hartley, Detroit; second vice-president, H. L. Madd, Grand Rapids; third vice-president, J. B. Churchill, Lansing; secretary, Roy L. Barnes, Detroit; treasurer, H. J. Keough, Detroit; directors, Gustav Stefens, Harry Angel, E. A. Schilling, W. G. Malcomson, George Haas and Richard Marr, all of Detroit; Fred Beckissinger, Saginaw, and A. E. Munger, Bay City.



## Improving Farm Buildings

Just now, before the spring sowing season is on, the farmer can well plan for the betterment of his buildings, justly comments the National Lumber Manufacturers' Association of Chicago. The loss of implements from poor housing has been a frequent subject for agitation, to say nothing of the loss of time and convenience to the farm worker who has to use rusty and ill-kept machinery; the inadequate return from stock which are poorly sheltered and warmed is well worth investigating; and the discomfort and dissatisfaction to the farmer, his family and help from working and living quarters which are not modern, convenient, well-kept and commodious is a condition that can be remedied, especially now that the farmer is so well paid for his produce.

## Pantheon for Brazil

Proposal has been made that a national pantheon for all the illustrious personages of Brazil should be erected there in connection with the celebration of the centenary of Brazilian independence in 1922.

Plans for this 100th anniversary which have been submitted to the Chamber of Deputies would cost \$12,500,000. They include an exposition of fine arts, erection of a national historical museum, and composition of an historical opera and a drama.

The scheme also provides for the organization of a great university. Sports will be one feature of the celebration.

It is proposed to hold the celebration in September. Brazil separated from the Kingdom of Portugal and was proclaimed independent by Don Pedro I, the first Emperor of Brazil, September 22, 1822. This proclamation took place in Sao Paulo and it is proposed to erect there one of the finest commemorative monuments in the new world.

## Announcement of Examinations for Rotch Travelling Scholarship

The Rotch Travelling Scholarship on account of war conditions has not been awarded for two years, but will be resumed this year. Preliminary examinations will be held at the office of the secretary, C. H. Blackall, 20 Beacon Street, Boston, on Monday and Tuesday, April 12 and 13, 1920, at 9 a. m., to be followed by the sketch for Competition in Design on Saturday, April 17, 1920, at the Boston Architectural Club, 16 Somerset Street. The successful candidate will receive annually for two years an amount which it is hoped will not be less than \$1400 per year and maybe more, depending upon the funds, this amount to be expended in foreign travel and study during two years in the employ of a practicing architect residing and must have been engaged in professional work for two years in the employ of a practising architect residing in Massachusetts. Holders of a degree from a recognized architectural school may present their certificates in lieu of the preliminary examinations. Candidates are requested to register at the office of the secretary as long before the examinations as practicable.

## Tree Seeds for Europe

To reforest the devastated areas in France and Belgium and to replace the British forests cut down for war purposes, the American Forestry Association has formally

presented to these countries through their consuls, thirty-five million tree seeds. The bags containing these seeds were piled on Boston Common before shipping and made a mound some eight feet high and as many feet square.

## Important Building Program at Rome

An interesting feature of the new building program at Rome, according to the U. S. Trade Commissioner in that city, is provision for the immediate erection of two entirely new suburbs outside of the present city limits and for these suburbs an attractive type of small cottage has been selected which resembles American or English design more than Italian.

One of the new "garden cities" as they are called, located east of Rome, will have sufficient houses to accommodate several thousand families. More than 2000 families, including many officials and employes of the State Railway Administration, have already made application for accommodations. Every effort will be made to render the new suburbs as attractive and complete as possible. Many thousands of shade trees will be planted and schools, churches and other public buildings will be erected immediately. Within the city limits an extensive building program is being carried out, the housing problem in Rome having reached an acute stage some time ago and many thousands of people living in temporary and crowded quarters. The execution of the program has been entrusted to a special committee, presided over by an Under-Secretary of the Ministry of Industry, Commerce and Labor.

## California Land Settlement Scheme Favorably Progressing

Although but little more than a year old, the California State Land Settlement at Durham, just north of Sacramento, is attracting widespread attention as the first settlement of its kind in the country. When the 6219 acres were purchased by the state in 1918, mostly from Stanford University, for somewhat over a half million dollars, no landowner had lived on it for 20 years. To-day 120 families live in their own homes and till their own fields and in these homes are more than 200 children. All the homes are built of wood and are mostly in bungalow style; 22 acres, a part of which is an oak grove, have been set aside for a community center.

Not only is provision made for farm owners but it is recognized that some settlers may not wish to have the responsibility of owning and keeping up a home, but may prefer to work for wages. There is need also for carpenters, blacksmiths, etc., and smaller tracts for these wage-earners have been allotted.

Attention has been especially directed to the movement because of its being an attempt to solve in a definite way some problems of rural life. In 1919 the state legislature appropriated a million dollars to continue the settlement policy and it is hoped that the next area purchased will be large enough to provide homes for 250 settlers; more than twice this number have already registered as applicants for farms or farm workers' homes. In its report the Board is asking to hear from owners or others interested as to where suitable land may be purchased for other settlements.

The work does not end with buying land and selling it to settlers on favorable terms; it promotes a strong community spirit and helps settlers overcome obstacles which lack of capital always presents.

## Competition for Memorial Designs

The Memorial Crafts Institute, a society of designers, craftsmen and dealers in memorials and carved stone, is holding a competition among architects and others interested for designs for a small public memorial. It is the purpose of the exhibition committee to create a more general appreciation of the architectural possibilities of cemetery and public memorials. There will be three prizes, of \$150, \$100 and \$50 respectively. The competition will close on March 10. Further details may be had by addressing Ernest S. Seland, 56 Ninth Avenue, New York City.

## Ohio Builders Urge Fire Prevention

This resolution was passed by the Ohio Builders' Supply Association at the convention held at Columbus, Ohio, January, 1920:

WHEREAS, The housing shortage in the United States to-day creates a serious situation, and

WHEREAS, The fire losses reported in 1917 to the National Board of Fire Underwriters amounted to \$66,166,420, in 232,021 residences; and

WHEREAS, The cost of material and labor is constantly mounting so that individual losses are likely to be greater year by year, cutting down our national resources to a tremendous extent, and aggravating the housing situation to an unnecessary degree;

BE IT THEREFORE RESOLVED, That this Association go on record as to the necessity of giving more adequate fire protection to the combustible members of residences.

BE IT FURTHER RESOLVED, That each member of this Association be advised of the situation and be requested to advise prospective owners of the situation and furnish full information as to the best available methods of protecting such structures.

## News from Various Sources

The Utica Chapter of the New York State Association of Architects has been formed.

\* \* \*

Many new fire hazards are being introduced by the fuel shortage. The most serious of these arises from the large amount of soft coal which is being stored in the basements of dwellings, apartment houses and mercantile buildings and on the premises of factories.

\* \* \*

Plans for the reconstruction of Rheims, prepared by George S. Ford of New York City, formerly an officer in the American Red Cross, have been virtually adopted by the Municipal Council of that City.

They affect principally the damaged districts and the Cathedral, where the general aspect of the quaint old thoroughfares and the characteristic ancient architecture will be preserved.

\* \* \*

Senate provisions authorizing the Secretary of War to turn over to the public health service such surplus hospital furniture and medical supplies as may be required by health service hospitals were recently adopted.

\* \* \*

Department of Agriculture announces issue of bulletin, Rural Community Buildings in the United States.

\* \* \*

Bureau of Memorial Buildings of War Camp Community Service, New York, issued publications: "Architecture of Large Memorial Buildings"; "The Architecture of Memorial Community Houses."

## Personal

O. P. Dennis has opened an office in Room 322 Markham Building, 6372 Hollywood Boulevard, Los Angeles.

G. E. Griewank, structural engineer, has opened offices at 516 Call-Post Building, San Francisco.

Richard C. Farrell, who has been practicing architecture in Long Beach, Cal., has opened an office at 532 Mason Building, Los Angeles.

Walter Webber has removed his architectural offices in Los Angeles from 718 Ferguson Building to 1017 Hibernian Building.

Edward Cray Taylor and Ellis Wing Taylor have moved their offices from 605 Merritt Building to larger quarters in suite 807 Merritt Building, Los Angeles.

J. Constantine Hillman, of Pasadena, who has been away for some time attending to outside work, has returned and established an office in the Central Building, Pasadena.

Edgar H. Cline, who served two years as captain in the construction division of the quartermaster's department, U. S. A., has returned to Los Angeles and resumed the practice of architecture, with office at 446 Douglas Building.

Houghtaling & Dougan, architects, who have maintained offices in the Henry Building, Portland, Oregon, for some time, have had new offices and a studio fitted up on the second floor of the Elk's Club Building, Portland. They are now prepared to receive catalogues and literature to complete their files.

A. G. Nelson, architect, formerly of Ironwood, Mich., now has charge of the architectural department for Heuer & Cargill, Hibbing, Minn.

Donald C. Bollard, architect, has opened offices in the McCague Building, Fifteenth and Dodge streets, Omaha. Mr. Bollard was with the Bankers Realty Investment Company.

Commander Clyde Kelley has returned to Duluth after eighteen months of strenuous experience in the United States Navy, and has returned to the architectural firm of Kelley & Schefchik, Alworth Building.

Charles R. Kaufman has withdrawn from the firm of Morse & Kaufman, architects, Twin Falls, Idaho, and has opened offices in the Babcock Building, that city, for the practice of architecture. Samples and catalogues are desired.

Wallace W. Donaldson has opened an office at 69 Rugery Building, 20 East Gay Street, Columbus, O., for architectural practice. Catalogues desired.

J. M. Whitehead, architect and engineer, Okmulgee, Okla., has opened offices, Room 12, Reibold Building, and desires catalogues and samples.

F. A. Bishop, architect, Sycamore Street, Petersburg, Va., has moved to the Terminal Building, Petersburg, Va.

Carl E. Macomber, architect, has opened an office in the Forrester Building, Franklin and Federal Streets, Saginaw, Mich.

William Emerson, New York architect, recently accepted the directorship of the Department of Architecture at the Massachusetts Institute of Technology.

# Weekly Review of Construction Field

Comment on General Conditions of Economics With Reports of Special Correspondents in Prominent Regional Centers

HERE are at least two spots of labor unrest in the building trades, at New York and Chicago, respectively, which endanger the movement of building operations. Whether prices of building materials are at a peak or on a plateau are questions which drop into insignificance before the suggestion that strikes are in prospect.

So imperative is the need for building that speculation upon a possible reduction of prices could not detain its progress. Neither would it wait for the time when a reduced cost of living and an increased immigration might combine to produce a reduction of labor expense. The need for housing is so vital to society that it must be satisfied.

If the refusal of capital to invest in building ever could stop such development the enormous figures of business contracted carry the implication that it has no intention of doing so just now. It is also conceivable that contractors might refuse to accept business because of the almost insurmountable difficulties of accomplishment, but this also is far from the present fact. But far more serious obstacles are placed in the way of supplying the public demand for housing when labor reiterates its right to strike and even proposes to make that right effective, and those who feel responsible are deeply concerned.

English builders in a similar effort met with a similar handicap. The wage rates in their building trades had increased 110 per cent during the war; yet at its close the feeling that it was right and proper to take a holiday upon an unemployment pension worked havoc with building plans—to the discomfort and even suffering of the people. Inactivity of labor in such cases is a clear case of a shirking by the public of responsibility to satisfy its own needs.

In the preparation of our new railroad bill the right to strike has been considered and, at the request of labor, has been affirmed. The right of the public to depend upon adequate service is thereby revoked. However competent a service may be, if it cannot be depended upon when it is needed it isn't worth much.

It seems as though not only prices reach peaks and then come down but that the public endurance of the arrant failures to satisfy its needs also must reach a peak. There are well developed methods of arbitration, but more forceful with the public than the intelligence that strikes are unnecessary is its enforced realization that it is paying with discomforts while the dispute goes on.

The dramatic fiasco of the railroad strike in France should encourage us to believe that the destructive phase of labor radicalism is losing whatever influence it had. The French people saw no reason why they should put up with inconvenience and loss, or why they should declare sympathetic strikes in order that a radical minority might dictate to the Government its railroad policy. It is well for France that they had the good sense to avoid such costly and dangerous methods. It will be well for our economic comfort when we make it known that we arrive at a similar conclusion regarding our strikes and lockouts.

A stoppage of needed work in order to enforce demands for higher wages, a tearing down of steel framework in

order that it may be erected by union men, are actions which will certainly antagonize a nation which is impatiently clamoring for that work to be done.

Day by day new evidence of the public opinion in such matters comes out. From St. Louis it is reported that a temporary restraining order has been issued which forbids the calling or fostering of strikes in the International Brotherhood of Electrical Workers by the local officials of that organization. The order was issued on application of a telephone company, which asserted that thirty-nine striking wiremen were interfering with interstate business.

OUR exports are shrinking each week. The large industrial companies are beginning to show decreased earnings. And the people must soon realize that war profit days are over, that extravagance and speculation must end. This will leave a more open field for the production of such necessities as buildings. The country's building construction is almost five years behind and it cannot be expected that an overproduction will lower the prices of buildings or of the materials and labor which go to make them, at least for years to come. In fact, it is going to be difficult to keep the production up to the constantly growing demands.

IN its monthly survey, the Federal Reserve Board says of the building situation: "In spite of exceedingly high costs of building material, the intense shortage of accommodations is causing a great growth in building operations in many parts of the country. On the Pacific Coast an increase of nearly 30 per cent is noted as compared with December, while as compared with January of last year permits issued are nearly four times as great.

"In the Southwest an even larger ratio of increase has been noted. On the basis of incomplete statistics: District No. 10 (Kansas City) reports a relative increase of 467 per cent. during the past year, while District No. 11 (Dallas) reports 839 per cent. Great building expansion in 1920 in the southwestern part of the country is accordingly anticipated. In the Middle West permits issued have been far in excess of the corresponding month of last year. In the East and Northeast, where the movement toward increased building started perhaps earlier than it did in the other parts of the country, the growth is not always so noticeable, relatively speaking, but the activity is still considerably on the increase.

"Difficulty in obtaining deliveries of building materials have been severe. Scarcity of cars has prevented the movement of lumber and heavy building materials and the effect of this situation will be to restrict the early Spring progress in construction.

"Labor conditions are quite generally reported throughout the country as being in fairly stable position. The most unfavorable aspect of the labor outlook is the tendency reported from various districts toward restriction

## THE AMERICAN ARCHITECT

of output. Even in those cases, however, where this tendency is noted, the opinion is occasionally expressed that the effect of the restrictive policy in injuring those who practise it is beginning to be better understood. Scarcity of labor is noted in many districts, particularly in the agricultural regions, and as a result reduction in the acreage of farms and the output in some manufacturing lines is foreseen. An especially acute situation in farm labor is reported from the Southwest. In the Eastern manufacturing districts notable increases in the number of men employed and in the advance of factories toward capacity production have occurred. In some specialized industries, however, either strikes or shortage of raw material have led to restriction of output, although such interferences have not been extensive. Many plants which during the war were not able to bring more than a substantial percentage of their machinery into active operation have succeeded in getting much closer to total activity. It is noted, however, that even those plants which are running at full capacity are in some instances unable to turn out as much as in pre-war days. From Cleveland it is reported that one large employer of labor finds that while the numerical strength of his staff has increased 11 per cent., the augmented force is producing 14 per cent. less than the old force. On the Pacific Coast labor has been fully employed and unemployment during the Winter months has been purely nominal."

In regard to financial changes, the Reserve Board says: "During the month of February there was a continuation of the heavy demand for funds which had been characteristic throughout the country for more than ninety days. Advances in rates of interest, both for call and time money, and for commercial paper, carried the general cost of loan funds up to a figure probably in advance of any that had been recognized in the United States for some years past. Coincident with these advances in the cost of loan funds was a decline in the quotation of the best investment securities, while on the whole a shrinkage or contraction in the volume of trading in all classes of securities through the country was observed. In the opinion of some districts there were also indications of a reduction in the volume of speculation in commodities. The effects of the increase in rediscount rates at Federal Reserve Banks made themselves evident in a more conservative attitude on the part of banks in general with respect to industrial expansion and in the cutting of commitments on speculative account."

A SPECIAL correspondent to THE AMERICAN ARCHITECT reports from San Francisco that the general rise in building material prices seems to have little effect on the volume of buying. Stock in various lines of material is just as largely ordered as it was before the new scale of prices went into effect.

Steel continues scarce, with the market exceedingly tight on nearly all types of steel construction material. According to reports from local dealers, the difficulty in filling orders is constantly growing.

Hardwood, too, is in just as big demand, despite the acute jump taken last week in the price of finishing woods. While it was impossible to quote decisively on a number of other lumber prices, it was the general opinion of local yard dealers that prices on California woods, pine and

redwood, were liable to take another jump before the mills were started on 1920 operation.

Labor difficulties are said to be responsible for the increase in common and face brick and in hollow tile. Factories in this vicinity are sold up to the last notch and all quotations are now being based on present freight rates, as another advance is anticipated shortly.

From local offices of architects come the reports of plenty of business at this time, as well as a good line-up of future contracts which are planned for later in the year.

(By Special Correspondence to THE AMERICAN ARCHITECT)

SEATTLE.—Scarcity of the finer essentials in building hardware is bearing down heavily upon building commitments in the North Coast building and distributing territory. Many unfinished buildings are exposed to the ravages of weather, pending relief. Small nails, plumbing fixtures and small pipe are leading in the scarcity.

Fir lath is off \$5 per 1,000. Glass sidewalk lights are up 10 per cent. Small building projects are easing off for lack of materials and high lumber prices have broken this week \$5 to \$10 per 1,000 feet. Oak flooring has gone to \$300 per 1,000 feet. As a direct result of the advance in finishing materials, the larger projects, running from \$25,000 to \$30,000, are being abandoned and smaller and less pretentious buildings are being erected. Office room is very scarce and it is almost impossible to secure a modern three to five-room apartment in the city.

There is a plentiful supply of cement, but the car shortage local production. The market is firm but unchanged. Because of the excessive costs of lumber, builders have from time to time contemplated the use of hollow building tile for dwellings, but it is believed that investigation has shown that in this climate, which is rainy from October to April, the material absorbs moisture and dampness would ultimately make such a house uninhabitable. However, the hollow tile is being utilized for warehousing.

Steel manufacturers of the East are still firm in the declaration that they will undertake no new commitments until after June, and then only at the market prices of the date of loading. Seattle jobbers report that there are a number of houses brought to completion excepting the plumbing, but which now stand idle awaiting a supply.

There is a plentiful supply of cement, but the car shortage is preventing delivery.

Jobbers of building hardware report that Eastern manufacturers are facing the problem of getting out heavy material while far behind in orders for eight-penny nails and the like. Jobbers are now rationing nails out with a small percentage of kegs to each job. Veterans of the trade declare that not in forty years has there been such a scarcity of building hardware. All the ¾-in. and larger steel tubing that is necessary can be secured, but the smaller sizes are almost unobtainable. There are plenty of spikes of 5 inches and larger, indicating the scarcity of all smaller essentials of building.

Due to the official announcement by one of the largest manufacturers in the State—of reductions of \$10 to \$20 in all building sizes of lumber—the lumber market is unsettled. Transit cars are massing in the East due to lack of sale.

The car supply is improving.

# Department of Architectural Engineering



SUB-STATION AT FLUSHING, L. I., BUILT FOR NEW YORK & QUEENS ELECTRIC LIGHT & POWER CO.  
WILLIAM W. KNOWLES, ARCHITECT

## Architecture and Engineering

Efficiently Combined in Sub-Station Recently Completed at Flushing,  
Long Island, for New York & Queens Electric  
Light & Power Company

By WILLIAM W. KNOWLES, *Architect*

**D**URING recent years the invention of many additional machines and devices for use in both the industrial plant and the home, which utilize electricity as the motive power, has resulted in a greatly increased demand for such service, and this is daily growing larger. The result of this demand has been the construction of

additional power plants or the enlargement of existing ones, and also the construction of many additional sub-stations properly to distribute the power to the districts most needing it.

The New York and Queens Electric Light and Power Co., organized in 1900, at present serves a territory covering an area of some 108 square

miles and having a population of approximately 350,000 persons. Included in this district are Long Island City and the Astoria section, two of the most rapidly developing industrial sections of the Greater City, as well as Flushing, Jackson Heights, Garden City, Kew Gardens and many other residential sections where housing developments are being carried forward on a large scale.

After the completion of the Queensboro bridge, which connects Manhattan Island with Queens Borough, and also due to the extension of the traction system, large areas in Queens Borough became immediately available for development. The building activity at the present time is such as to lead one to prophesy a phenomenal growth within the next few years.

which is illustrated in this article, is located on Lawrence Avenue, Flushing. Its function is to step down the high voltage current delivered from the generating power house to a low voltage suitable for commercial use.

The drawing reproduced on page 195 illustrates the appearance of the completed building as it will look after the planting scheme has been worked out. While to the casual observer the structure might not be taken as an electric power sub-station, yet in fact it is a heavy commercial building and its different elevations are designed to express the use of the building with sufficient architectural treatment to make it attractive in appearance and a worthy addition to this quaint community.

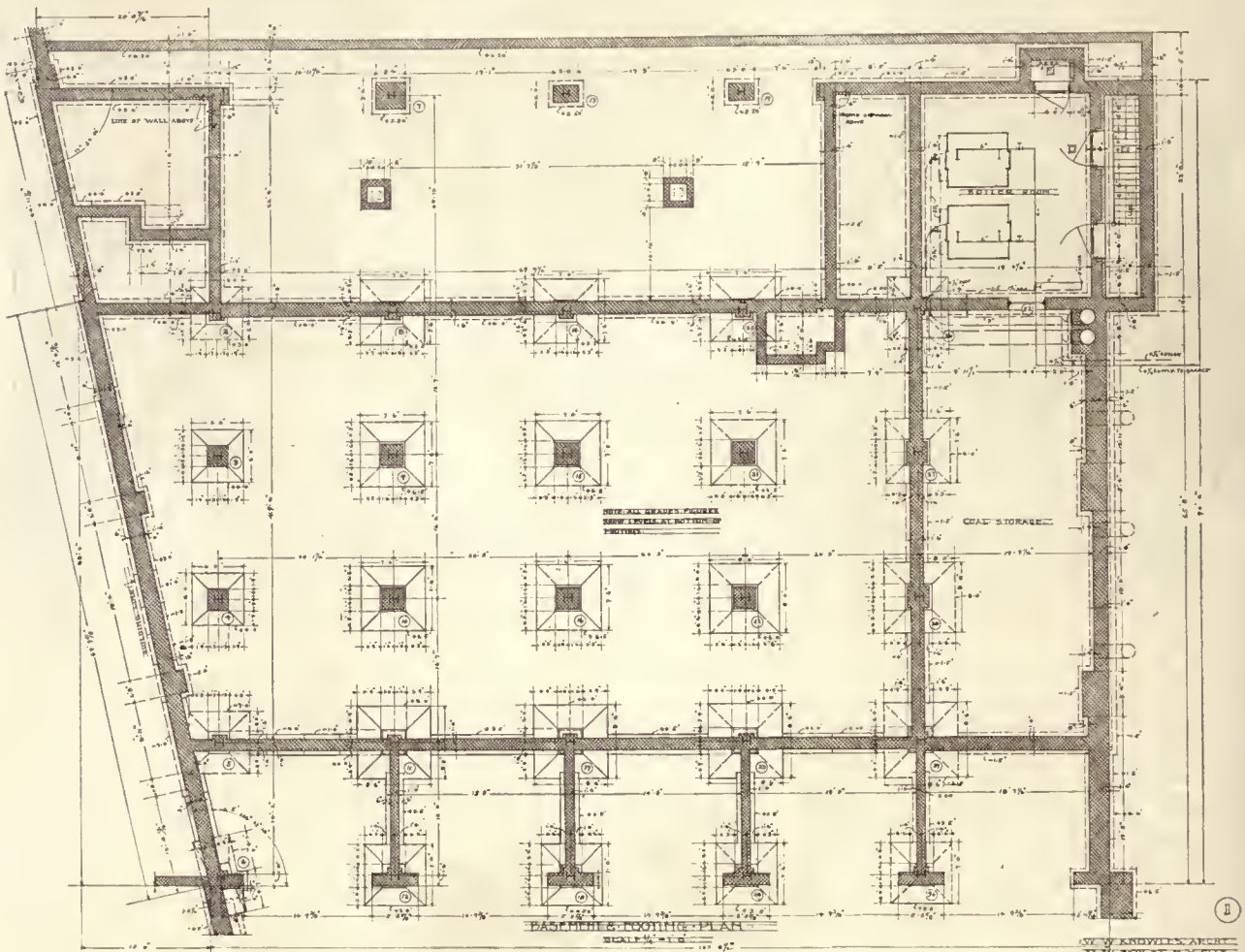

FOUNDATION AND BASEMENT PLAN

In order to meet the increased demands for electric current the New York and Queens Electric Light and Power Co. have been obliged constantly to extend and increase their facilities. Two additional sub-stations, supplying the outlying districts, have recently been completed. One of these,

Since in a plant of this nature there are no power boilers or reciprocating or other vibrating machinery, the operation is practically noiseless, and the additional expense of building the structure along artistic lines is believed by the owners to have been a wise expenditure.

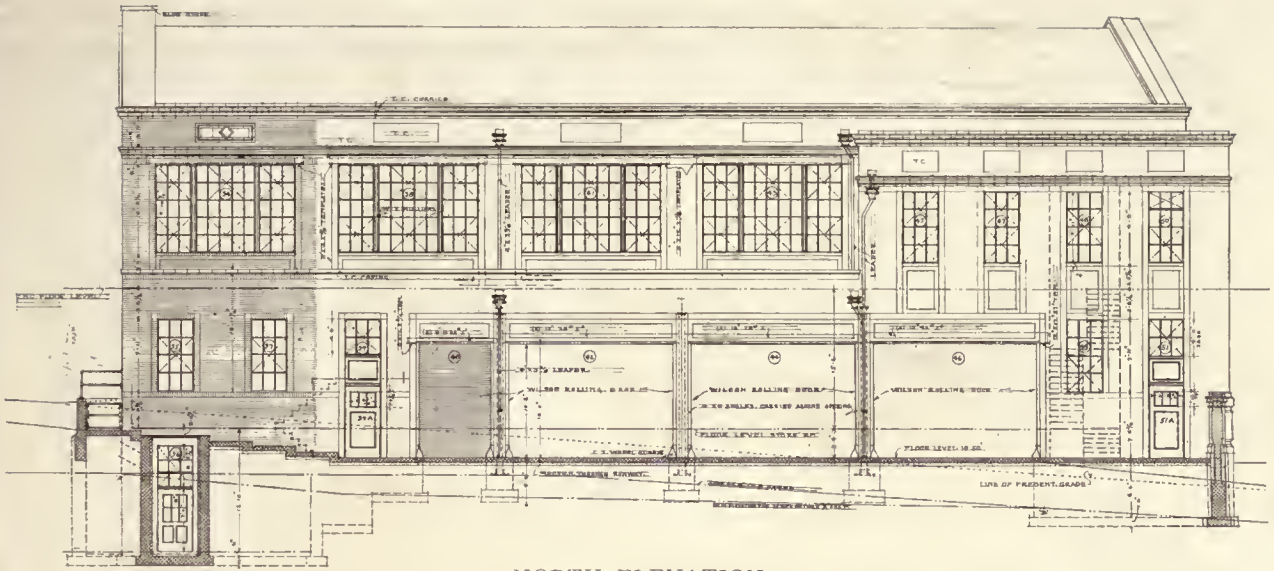

NORTH ELEVATION

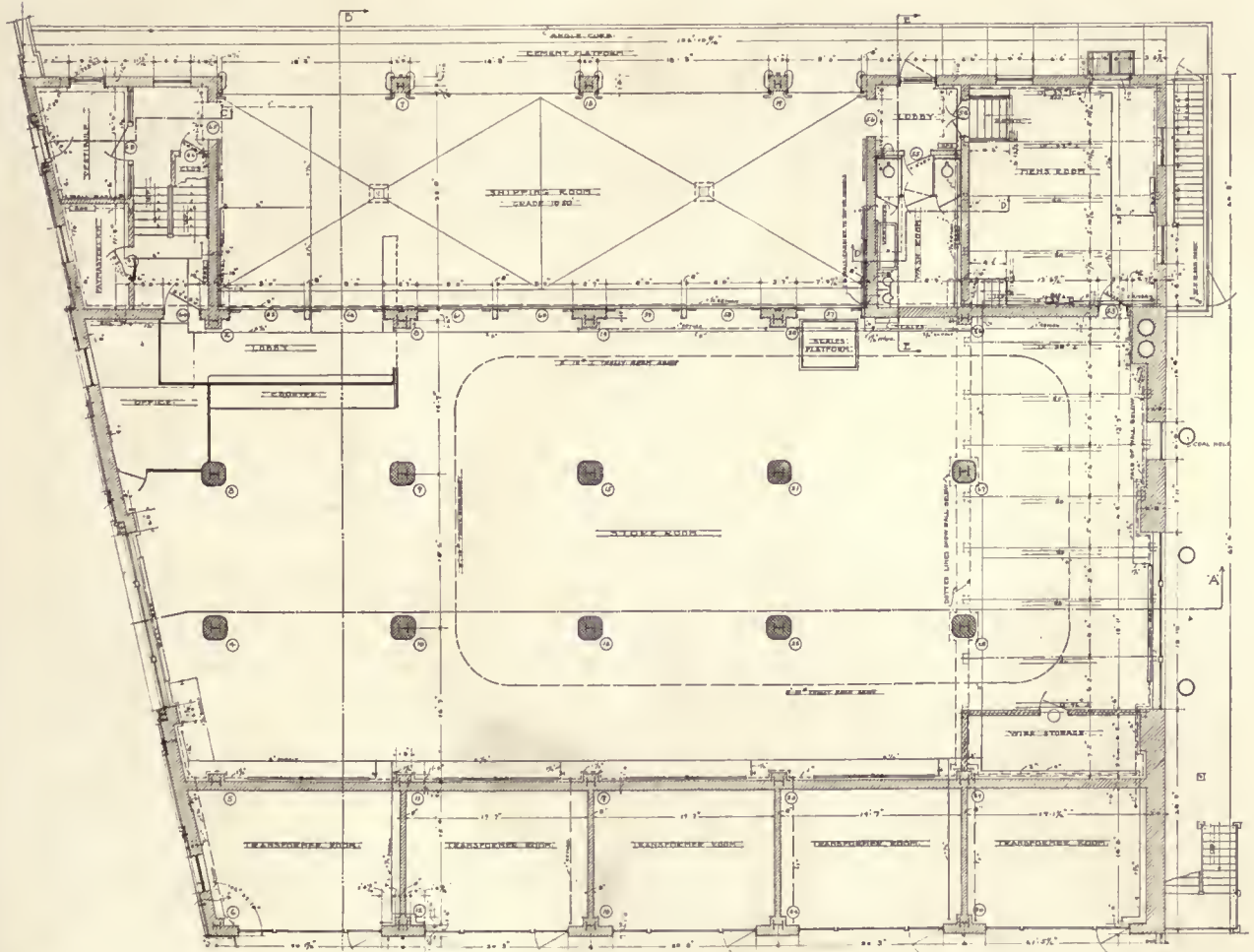

GROUND FLOOR PLAN

# THE AMERICAN ARCHITECT

Due to the irregular shape of the plot the street façade does not form right angles with the side walls. This, however, while slightly complicating the construction, does not in any way detract from the general appearance of the building. In ground plan the building has a frontage of 95 feet on Lawrence Avenue, a width at the rear of 92 feet, with an average depth of 113 feet. The height from grade to top of ridge is approximately 48 feet. The building is purely utilitarian. The essential features of such a plant are the compartments housing the transformers, and a large oper-

ating room for the control and distribution of the current to the street surface lines. The transformers are of heavy weight, namely, 30 tons each, and it is necessary so to arrange the compartments for their housing as to require a minimum amount of handling in their placement. This is the reason for locating these compartments on the ground floor, and it will be noted that they open on to the south driveway. The balance of the ground floor is used for the storage of street line equipment

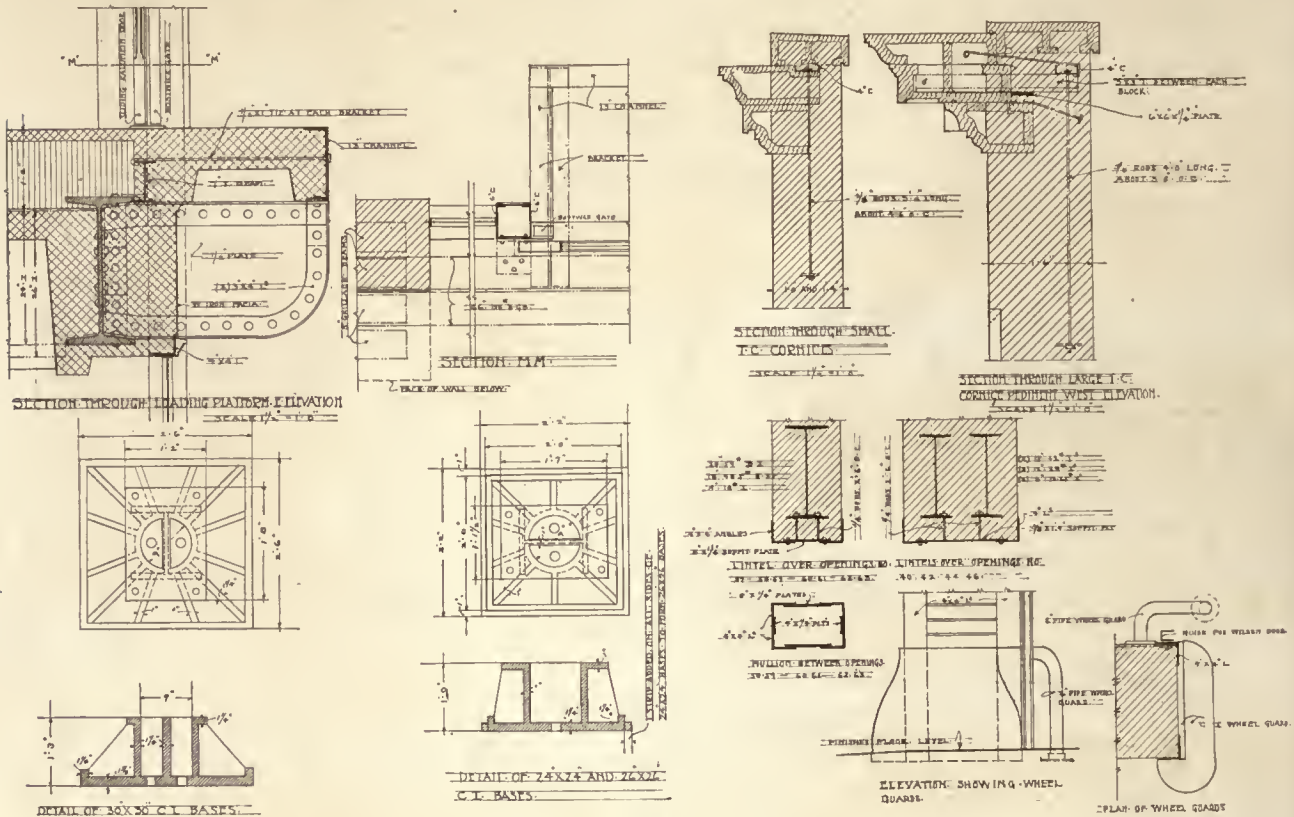

CONSTRUCTION DETAILS

ating room for the control and distribution of the current to the street surface lines.

As these two features, namely, transformer compartments and operating room, do not occupy the entire structure which is required for their proper housing, and as leaving waste space would be extremely uneconomical, especially at this time of high building costs, the balance of the building is utilized for the storage and distribution of street line equipment, and in addition provision is made for the night storage of the emergency trucks.

As will be noted from a study of the ground floor plan, there are laid out along the southerly side five fireproof transformer compartments, so located

and the distribution of same, both over the counter in small lots and by automobile trucks for working crews. In addition a men's room and lavatory and also offices are provided on the ground story. The automobile trucks used for repair and emergency work are backed into the building against a loading platform on the north side, and loaded during the night so as to be ready for the following day's work. Incorporated with this latter feature is the large room for the linemen, which is equipped with lockers, showers with washroom adjoining.

The north side of the shipping room is equipped with large vertical sliding doors at the four open-



# THE AMERICAN ARCHITECT



NO. 1. FOUNDATION WORK IN PROGRESS. SOME OF C. I. COL. BASES SET; PART OF STEEL ON JOB AND READY FOR ERECTION. BUILDING OF BRICK WALLS COMMENCED



NO. 2. ONE WEEK LATER. STEEL IN COURSE OF ERECTION



NO. 3. THREE WEEKS LATER. STEEL ERECTION COMPLETED. MASONRY WORK IN PROGRESS



NO. 4. THREE MONTHS LATER. FLOOR AND ROOF ARCHES COMPLETED. WALLS NEARLY TOPPED OUT



SOUTH ELEVATION SHOWING LOUVRE CONSTRUCTION INSTALLED IN LARGE OPENINGS OF TRANSFORMER COMPARTMENTS



REAR ELEVATION. NOTE HOISTING BEAM AND LARGE OPENING OF OPERATING ROOM FOR PLACING EQUIPMENT

PROGRESS VIEWS—FLUSHING SUB-STATION FOR NEW YORK & QUEENS LIGHT & POWER CO.

WILLIAM W. KNOWLES, ARCHITECT

## THE AMERICAN ARCHITECT



FRONT ELEVATION, FLUSHING SUB-STATION,  
N. Y. & QUEENS ELECTRIC LIGHT & POWER CO.  
WILLIAM W. KNOWLES, ARCHITECT

Contemplated Planting Scheme Not Developed When  
Photograph Was Taken

ings, giving ingress and egress to the automobile trucks, and the floor is of cement, provided with two drains so that the trucks may be washed in this space as well as stored therein. These features are clearly shown on the ground floor plan and north elevation.

On the second floor the large operating room, 106 feet by 65 feet clear span, is located. Here the oil switches, switchboards, lightning arresters, etc., are installed, and underneath the finished floor is a network of cables in iron and fiber conduit, all contained within a 12-inch thickness of hollow tile, resting on the supporting concrete slabs. This latter is an interesting feature due to the fact that by the use of a 12-inch hollow tile filler several advantages are obtained. After the supporting concrete floor slabs have been completed the conduits are run in their proper location above this level. It has often been customary to fill the space from the structural floor level to an inch or two above the conduits with concrete, thus adding an additional dead load as well as making access to

the conduits difficult. By the substitution of the hollow tile for a concrete fill, the dead weight is materially reduced and the conduits are more accessible should it at any time be necessary to reach them.

Adjoining the operating room are several offices and a washroom for the operators.

No general excavation of the lot was made, but at the rear a basement is provided for accommodating the boiler-room and providing coal storage space. The heating plant is used for the heating of both this building and others located on the same property.

The building is very heavily loaded and the foundations rest on soil but five feet above mean high water, and only one hundred feet back from Flushing Creek. As there was some doubt as to the bearing capacity of the sub-soil under these conditions, an actual test was made to determine the safe allowable load which might be placed thereon, also to determine whether the spread-footing type of foundation or a pile foundation would be best adapted to the conditions.

As a result of this test it was found that the soil could be safely loaded to three tons per square foot, and therefore the spread-footing type of foundation was found to be most suitable. The foundation plan shows in general the layout of these, which are of reinforced concrete, with cast iron bases



NORTH ELEVATION, SHOWING EMERGENCY  
TRUCK ENTRANCES

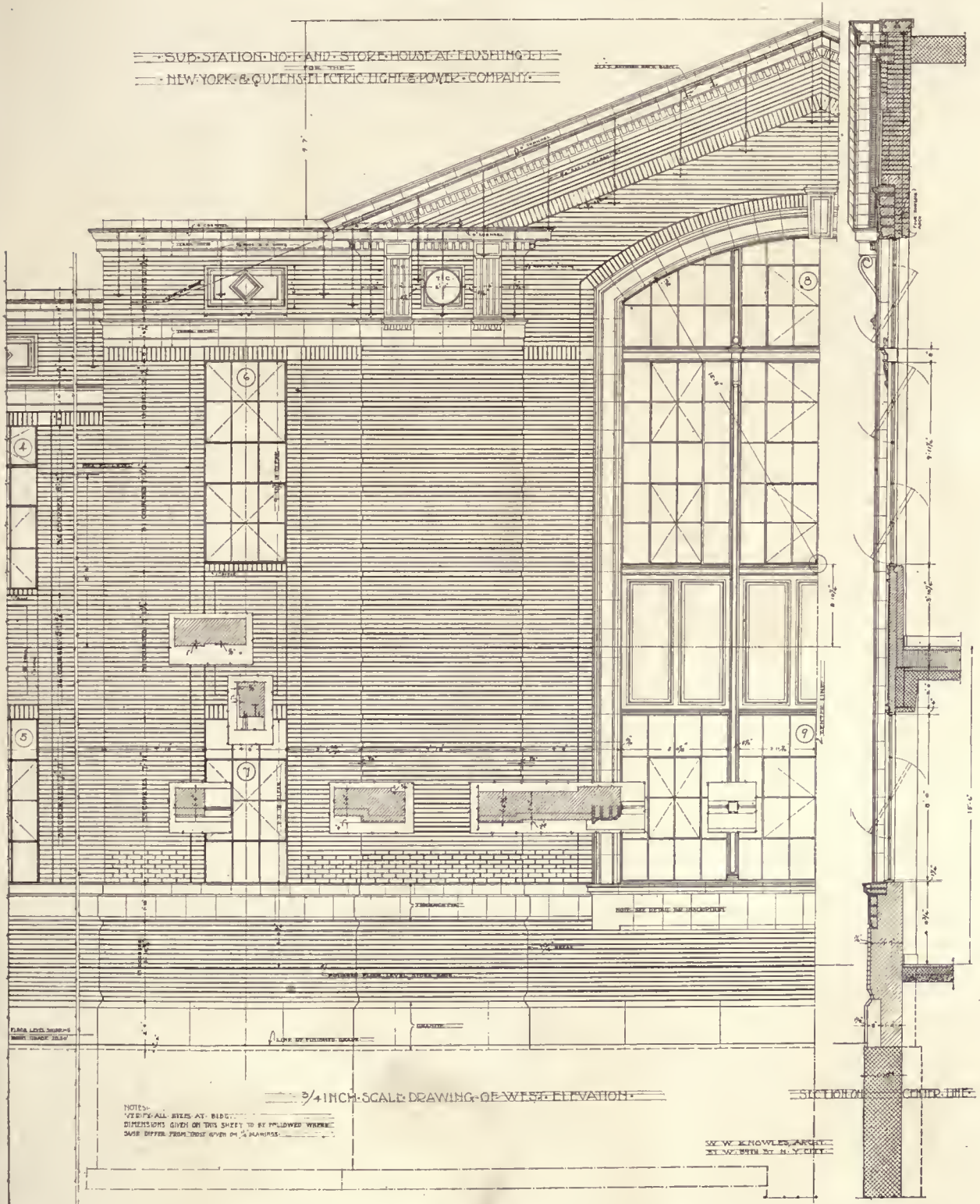

LARGE SCALE DRAWING OF FRONT ELEVATION  
FLUSHING SUB-STATION, NEW YORK & QUEENS ELECTRIC LIGHT & POWER CO.  
WILLIAM W. KNOWLES, ARCHITECT

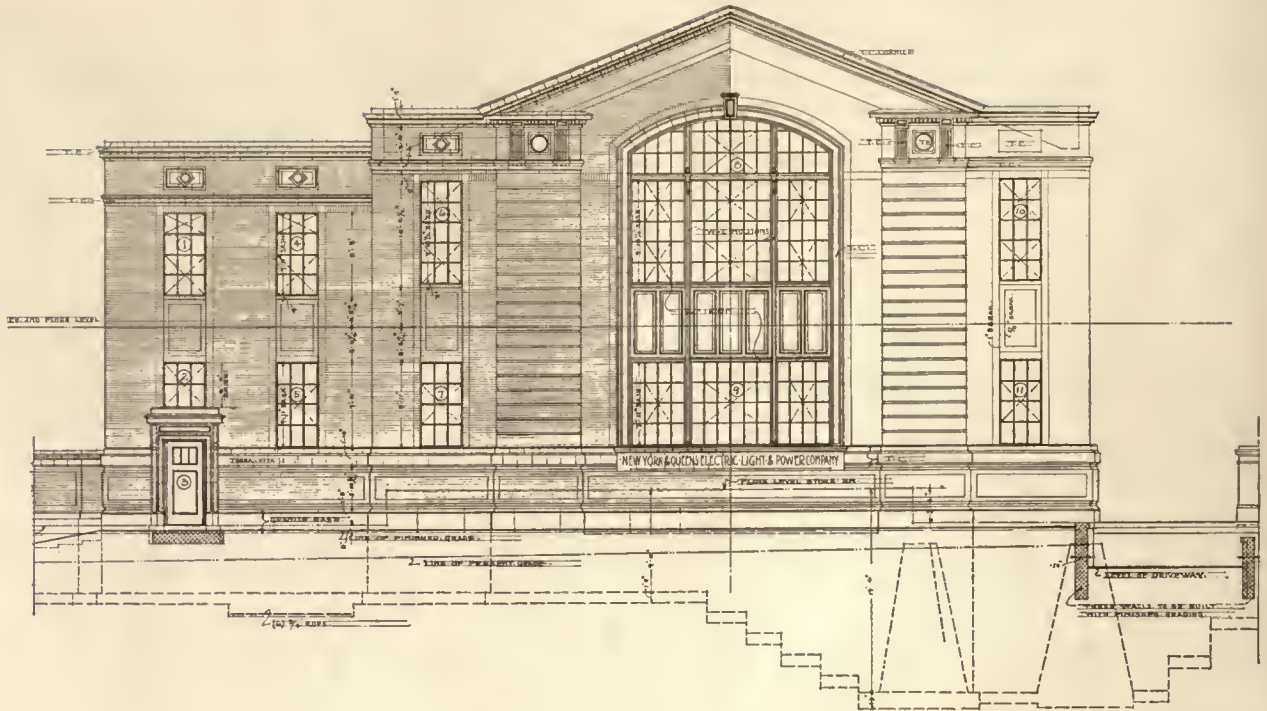

FRONT OR WESTERLY ELEVATION

transmitting the load from the steel columns to the footings proper.

The building is of skeleton steel construction with reinforced concrete short span floor slabs and roof panels. The walls are of brick faced on the outside with tapestry brick and trimmed with architectural terra cotta. The window frames and sash are of steel. The method of anchoring the terra cotta trim is shown in the construction details and in the large scale drawing of the west elevation. It will be noted that  $\frac{5}{8}$ -inch diameter rods four feet long are used to anchor the terra cotta coping to the brick masonry below.

The coarse aggregate of all concrete consisted of broken trap rock. As the building was constructed during a severely cold winter, it was deemed advisable to discontinue the pouring of the reinforced concrete roof slabs. Some of the roof slabs had already been poured during freezing weather and for this reason it was considered advisable to conduct a test upon these in the spring. This test proved most satisfactory. Each of the roof slabs tested deflected but a small fraction of an inch under the full load, and returned completely to the normal position after the load had been removed.

Among the novel features incorporated in the design is the construction of the south drive in front of the transformer compartments. The level of this is truck high from the street, and a great iron eye-bolt is anchored in the opposite end of

the drive to provide a purchase for pulling the transformers in place from the trucks to their proper location in front of the compartments. A free-standing trussed upright on the property line supporting a hoist beam overhead is provided for lifting the transformers and removing their coverings. This is shown at the right of the drawing on page 195 and can also be seen in the photograph of the south elevation. This arrangement was of material aid in placing these heavy transformers.

Beneath the drive there is located a 2000-gallon tank used for the drawing off, by gravity, of the oil from the oil-cooled transformers. In one of the compartments a small tank and pump are provided for the refilling of the transformers after the cleaning of the oil or the repairing of the transformer. The location of this tank is shown at the right hand of the cross sectional drawing.

The front of the transformer compartments is of portable construction, to permit the passage of the transformers, and it is made up entirely of louvres to provide proper ventilation during operation. This construction can be seen in the photograph of the south elevation.

The roof over the operating room is supported by five steel roof trusses having a clear span of 65 feet, and supported by steel columns at each end. The size of the members is shown on the cross sectional drawing. From finished floor of



## THE AMERICAN ARCHITECT

The interior finish of the entrance vestibule, stair hall and offices is plastered and painted; the trim and doors are kalamein. The operating room is lined with a smooth buff brick and all other rooms are finished with cement plaster and painted. All floors are finished with cement treated with a dustless paint treatment to make same dust-proof, and provided with a sanitary base.

In both the designing and equipment of this building, every precaution has been taken for the safety and comfort of the operators and the linemen, in order to guard against possible accidents.

There would seem to be no logical excuse for disregarding the esthetic appearance in designing that class of buildings which are purely utilitarian in character.

Regardless of the purpose to which the structure will be devoted, it should present an artistic exterior and also one which shall, so far as possible, reveal some indication of the character of its occupancy. While preserving both an artistic and dignified appearance, it should be free from excessive ornamentation; the simpler the lines the better is the true intent carried out.

It will be found that by careful planning very little, if any, additional cost, but much benefit, will result.

It is gratifying to note that architects are more and more comprehending this need and it is not too much to predict that industrial architecture of the future will attain high rank.

---

### More Than One Billion Dollars Spent for Buildings by Construction Division of U. S. Army

**I**N an interesting and enlightening paper prepared by Brigadier-General R. C. Marshall, Jr., Chief of the Construction Division, U. S. A., and read at Franklin Institute by Col. G. R. Solomon of the engineering branch of that division, the tremendous task accomplished by this branch of the army was set forth.

When one stops to consider what spending a billion dollars for buildings in the space of a year and a half means, some realization of the magnitude of the work can be had. Perhaps the outstanding feature in connection with the work of the construction division was the speed of accomplishment. Time meant everything, delay might mean defeat. Draft boards were calling men, and the cantonments must be ready to receive them. Gigantic warehouses had to be built at terminal ports for storage of overseas shipping. Perhaps in no other country but America was such work possible of accomplishment.

Abstracts from Brigadier-General Marshall's paper follow:

The work of the construction division during the world war is so far-reaching in extent that it is possible to touch only on the more important of its accomplishments in any reasonable length of time.

The construction division undertook and had completed or under way at the time of the armistice 535 construction operations in 444 different localities, covering every state in the Union but one. In the course of eighteen months it had expended about \$800,000,000, and to date its total expenditures total over \$1,000,000,000.

\* \* \*

The basis on which the construction division was founded was the then existing construction and repair branch of the quartermaster-general's office, headed by Colonel (afterward Brigadier-General Isaac W. Littell, which was charged with the duty of handling all construction, maintenance and repair work at army posts throughout the country.

\* \* \*

On May 17, 1917, the secretary of war assigned to Colonel Littell the task of building the national army cantonments and national guard camps. He was relieved of his former duties and given authority to form his own organization and to report direct to the Secretary of War. It was only through the latitude allowed him that it was possible to accomplish the results required.

Immediately the field of effort broadened and construction of every character, including not only camps for training purposes but arsenals and industrial plants of all kinds, had to be built, as well as hospitals for the sick and wounded and port terminals for handling troops and supplies to be sent abroad.

\* \* \*

With populations ranging from 5000 to 60,000 people, it became necessary to provide these various projects with the most up-to-date systems for the disposal of sewage. It was necessary to cut down the time of construction to the lowest point and at the same time provide disposal plants that could be counted on to run efficiently and with a minimum upkeep cost. The plants designed by the construction division accomplished this.

\* \* \*

What the results obtained by these facilities will be, taken in connection with the merchant marine coming into being in this country and the renaissance of commercial manufacturing which must presently assume tremendous proportions, cannot yet be stated, but their value should be incalculable and their importance to the commercial enterprises of America almost beyond computation. That they have been produced and are ready for utilization is the result of the initiative, the brains and the resourcefulness of the American army.

204<sup>w</sup>

Just piece of 210 2304

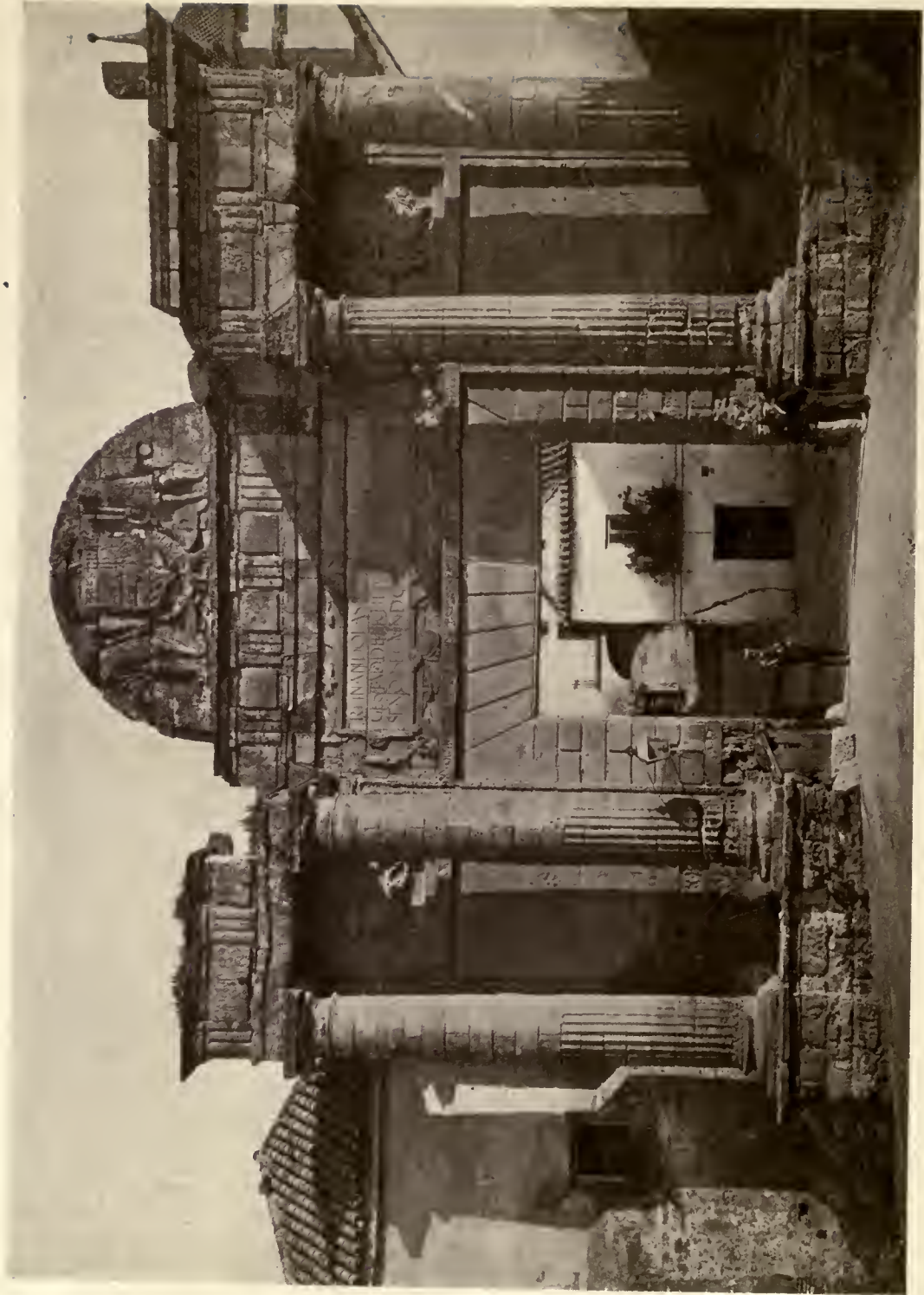

OLD CITY GATE, CORDOBA.



# THE AMERICAN ARCHITECT

VOL. CXVII

WEDNESDAY, FEBRUARY 18, 1920

NUMBER 2304

## Competition for a Stadium on the Lake Front, Chicago

**A**N unusual architectural competition has been held recently in Chicago. It was unusual in the subject, a stadium; unusual in the size, to seat 100,000 persons at maximum capacity. It is only with the increasing popularity of athletic sports that stadiums have become a necessity for carrying on such enterprises. So popular have they become that tremendous audiences congregate to view the major sports. In the larger cities baseball parks with a capacity of 20,000 to 35,000 spectators are common. These are taxed to their utmost when star attractions are played. Football stadiums have been erected that will seat 60,000 spectators and at many universities are found those of 15,000 to 25,000 capacity.

The war, with its great parades, has given the people a taste for pageants. This is a very desirable thing because the American people have not possessed a proper desire for such forms of spectacular amusements. Perhaps we will now absorb somewhat of the spirit of many of our foreign born citizens and rightly enjoy the *fête*. Great pageants, illustrating phases of American history, would not only be illuminating to our foreign born brothers, but might be as much so to many of the native American stock. These festivals have another value in creating enthusiasms and in stimulating the imagination along proper channels.

The need of such a structure in Chicago has been realized for a long time. After several years of consideration and discussion a dual arrangement has been made between the City of Chicago and the South Park Commissioners of Chicago. Under this agreement the City of Chicago is to furnish the funds with which to construct the stadium and the South Park Commissioners are to furnish the site, maintain and operate the stadium. The site is on made ground immediately south of the Field Museum, which is at the southern extremity of Grant Park. The new park system of filled in lands, lagoons, bridges, etc., will extend from Grant Park south to the Hyde Park district, the entire system to be constructed by filling in portions of

Lake Michigan along the shore line. This system of lakeside parks and drives will extend then for a distance of about eleven miles, from the southern end of Jackson Park to the northern extremity of Lincoln Park on the north. The only interruption will be a short distance of about one and one-half miles of North Michigan Avenue, devoted to high class stores, office buildings and hotels.

The new stadium will be nearly midway in this extensive park system and easily accessible to western portions of the city. It will be the geographical center of the finest and most extensive system of parks and boulevards in the world.

The stadium will be unusual in its seating capacity, a maximum of 100,000 and an ordinary of 60,000 persons. It is not easy to visualize a seated audience of 100,000 persons surrounding an arena capable of accommodating many thousands of persons at a time. There is a demand for such structures and Chicago will soon be able to stage outdoor events with better facilities than any other city in the world. With its fine summer climate, due to its location on Lake Michigan, it will be the great rendezvous for summer events on land and water and in winter unexcelled for winter sports.

The competition was held under the direction of the South Park Commissioners under the program as here given. Invitations to compete were extended to Edward H. Bennett and William E. Parsons, Coolidge and Hodgson, Zachary T. Davis and William F. Kramer, Holabird and Roche, Jarvis Hunt, Marshall and Fox.

These six competitors are all of Chicago and well represent the architectural profession in that city.

The Park Commissioners invited a jury to make the award, consisting of Prof. A. A. Stagg, Physical Director, University of Chicago; Martin A. Ryerson; J. F. Foster, General Superintendent, South Park Commissioners; Richard E. Schmidt of Schmidt, Garden and Martin; Peirce Anderson of Graham, Anderson, Probst and White.

# THE AMERICAN ARCHITECT

Mr. Anderson was chosen by the competing architects. Two of the five jurors were architects, Messrs. Schmidt and Anderson.

## The Competition Program

### *Professional Adviser.*

The owner has appointed D. H. Perkins, architect, 814 Tower Court, Chicago, professional adviser for this competition. He has been directed to prepare this program and to give such assistance and interpretation as may be required, either by the owner, the competitors, or the jury. He will confer with the jury but he will have no vote.

### *Anonymity.*

No design will be considered, the drawings or wrappers of which bear any note or mark revealing their authorship. All drawings shall be wrapped in a plain cover on which the words "Stadium Competition" and none other shall be printed. A plain sealed envelope enclosing the author's card shall be attached to the outside of the wrapper.

On the day set for their delivery the professional adviser will engage an expressman, who shall call at the office of each competitor, receive the drawings and deposit them in a vault in the Art Institute of Chicago.

At the first meeting of the jury the adviser will open the wrappers, put a number on each envelope and a corresponding number on each drawing, in the presence of the jurors. The adviser shall retain the envelopes containing the authors' cards, with seals unbroken until the jury has made its award, after which the envelopes shall be opened in the jurors' presence and the authors' names announced.

### *Return of Drawings.*

Within one week after the award all drawings except those of the successful competitor will be returned to their authors. If the owner desires a public exhibition of the entire number of drawings he will so advise the competitors and if their consent is given they will be exhibited and published.

### *One Design.*

No competitor will be allowed to submit more than one design in this competition.

### *Communications.*

All communications and inquiries relating to this competition by the competitors shall be in writing and shall be addressed to the professional adviser. He will send answers to all such inquiries to each competitor, together with copies of the questions.

No such communication received after thirty days from the date of acceptance by all of the competitors will be answered. Competitors will be advised of this date.

### *Time.*

All drawings must be ready for collection on or before November 22, 1919. The jury will make its award on or before December 6, 1919.

### *Award.*

The award to the author of the design adjudged the best by a majority of the jury shall be a commission from the owner to prepare working plans and specifications after the competitive sketches have been revised by the architect and approved by the owner.

To each of the other five competitors a cash payment of \$1,000 shall be made within one month from the date of the award of the jury

### *Agreement.*

The stadium when constructed will be erected by the owner. The architects will not be required to procure contractors' bids, nor to supervise construction. The owner may desire consultation by the architect during construction, in which case a proposition covering such services will be requested.

In consideration of the submission of drawings in this competition the owner agrees to enter into a contract for professional service with the successful competitor within thirty days from the date of the award by the jury.

This contract, among other items, shall contain the following provisions, namely:

That "professional service" shall include the revision of the competitive sketches to conform to suggestions and requests by the owner, thereby making preliminary studies of design complete enough to form a basis for working drawings; also, the preparation of working plans, specifications, scale and full-size details and diagrams for all structural or ornamental work as well as all mechanical engineering work required for the complete construction of the stadium. This shall include diagrams and specifications for all foundation work, superstructure, heating and lighting so that the owner may be able to start construction immediately upon receipt of the same without further architectural or engineering service.

The owner shall make a statement of changes or revisions, if any are desired in the competitive sketches, within ninety days from the signing of the contract, and the architect shall submit revisions if requested within ninety days from the receipt of such instructions from the owner.

The owner agrees to pay the architect the sum of \$5,000 for the revised preliminary studies of design within thirty days from their receipt and to give his approval of the same and his order for working plans within the same period.

The owner agrees to pay for complete plans, specifications, mechanical diagrams and scale and full-size details a fee equal to 3½ per cent on the cost of the stadium, less the previous payment for preliminary studies, when the working drawings and specifications are delivered.

Grading, road construction, filling, planting and other landscape work shall not be included in computing the cost basis for the architect's fees.

Should the owner and the architect be unable to agree upon the proper cost of the structure for the purpose of computing the fee of the architects, such cost shall be determined by arbitration by three arbitrators, one selected by the owners, one by the architect and the third by the two thus chosen.

### *Site.*

The site for the stadium lies on the lake front, south of the Field Museum, east of the Illinois Central right-of-way, west of South Park Avenue, extended and north of Sixteenth Street extended. A plan of the grounds and environs accompanies this invitation.

The site for automobile parking lies south of Sixteenth Street, between the Illinois Central and South Park Avenue.

The ground surface at the north shall be grade 31. It shall slope or step down to grade 15 at Sixteenth Street. The arena will be level at grade 7.

### *Description.*

The proposed stadium shall consist of an open amphitheater for spectators surrounding (wholly or partially) an arena. It shall be so arranged that large numbers of people may view processions, pageants, military maneuvers,

# THE AMERICAN ARCHITECT

concerts, outdoor dramatics, athletic contests, track meets, horse shows, fairs, winter sports, ice carnivals, etc., etc.

## *Construction.*

The construction shall be of fire and weather resisting material.

The design and structure must be up to or better than the standards which would be required under the Chicago building ordinances if this building were under the jurisdiction of the Building Department.

## *General Arrangement.*

South Park Avenue will be at grade 31 at the southeast and southwest corners of the museum site. It will descend to grade 15 opposite Sixteenth Street, and rise again to a higher grade at Twenty-second Street.

The space south of Fifteenth Street is reserved for automobile parking for spectators at the stadium, but the designer is at liberty to arrange parking space north of Sixteenth Street if he considers it advisable to do so. No design will be penalized which does not do so.

The descending grades outside of the stadium will be gradual or in steps to conform to the architect's design and suggestion.

The competitors may wish to show temporary seating both below and above the permanent seats. It may be extended into the arena if it does not interfere with the sight lines. Above or around the main structure a base for temporary seating must be provided. It may be either of concrete construction or of earth filling between retaining walls, or partially of both, but in no case may this base be higher than grade 40.

It is assumed that the ends of the structure will be either semi-circular, elliptical or polygonal, but the designer will not be required to make them of similar size. If he chooses, the long sides need not be parallel.

## *Requirements and Capacity.*

All of the following items are mandatory:

An arena, the longest dimension not less than 1,000 feet. A running track exactly one-third mile long, 12 inches from the inside border. The track shall be 30 feet wide. Provision must be made for portable elevated turns for bicycle races. Provisions for motorcycle races need not be made.

Entrances, one or more, at or near the north and south ends for incoming and outgoing processions so that armies may approach at one end, maneuver within the stadium and leave at the opposite end. These entrances must not interfere with the theater at one end.

Space for these requirements will take all the area that is available and will be sufficient for all other uses to which the arena will be put.

An outdoor uncovered theater is required at one end, presumably the smaller end of the structure if both ends are not alike. This theater must be provided with a temporary platform, stage and screen, shutting off the portion of seats and arena not in use. This shall be for out-of-door dramatics, band concerts, etc.

## *Seating.*

The main structure shall be a series of banks and seats of a capacity to accommodate 60,000.

Provision for temporary seating shall accommodate 40,000 people; it may be partially above and partially below the main permanent structure. It may extend into the arena.

## *Display of Bunting.*

Very liberal provision for festal display of bunting must be provided.

## *Reviewing Stands.*

One or more reviewing stands must be provided. They must be suitable for the most important public occasions.

## *Accessories.*

Beneath the permanent seating provision must be made for:

A suite of offices, the equivalent of ten rooms, 15 x 20. Numerous public comfort stations, distributed throughout the substructure.

A number of hospitals and first-aid stations.

Special provision for storing temporary seats and supports; also, for the stage and screen for the theater.

Stables for horses and cattle during fairs and conveniences for transportation of exhibits.

Dressing rooms in connection with the theater.

Storage for flag poles, decorations and furnishings.

## *Lighting.*

Provision must be made for lighting the space under the seats, as far as possible by natural means, but adequate artificial lights must also be provided for evening use.

The decorative use of lighting for evening use of the stadium must be provided liberally so that spectacular evening displays may be given.

## *Heating and Ventilating.*

All space beneath the seats designed for use must be ventilated by natural means. Such provision must be made as no heating apparatus nor mechanical ventilation will be installed other than heating for the toilets, first aid, emergency rooms and offices if they are used during winter carnivals.

## *Refreshments.*

Convenient spaces must be provided in numerous locations for soda fountains and confectionery and other refreshments.

## *Drawings Required.*

All drawn with black ink on sheets of white opaque paper. They may be mounted on linen, but they must not be mounted on stretchers.

First, a general ground plan showing the stadium and surrounding drives and approaches and the south building line of the Field Museum. Not all of the parking space south of Sixteenth Street need be shown. The ground plan shall be at a scale of 100 feet to the inch. The treatment and use of all of the space between the Field Museum Terrace and the stadium must be drawn on this ground plan and shall show all drives, walks, approaches and entrances.

Second, two plans at a scale of 1/32 feet to the inch, one showing the seating arrangements, the other showing the plan of the substructure and accessories. A third partial plan showing intermediate levels may be made if the competitors wish to do so. (Note—The top of all drawings of plans shall be north.)

Third, two or three exterior elevations at 1/16 inch to the foot, one showing the side, the second showing one end and the third showing the opposite end if it differs from the first.

Fourth, one longitudinal and one transverse section at a scale of 16 feet to the inch.

Fifth, drawings of entrances, special features or typical sections are requested at 1/8-inch scale showing plans, elevations and sections of such portions or details as cannot be effectively shown at 1/16-inch scale.

Sixth, one general view bird's-eye perspective from a point in line with the center of Sixteenth Street, either

# THE AMERICAN ARCHITECT

east or west of the stadium. The view must be taken from an elevation between 300 and 800 feet above the lake.

The rendering shall be in black ink or sepia in pen or brush. No water color perspective will be allowed or considered.

The number and size of the sheets of drawings is optional with the competitors.

## *Description.*

A typewritten description of about 1,500 words, giving the author's ideas of the uses for this stadium as designed by him, the methods by which its features are to be employed and its value to the community developed as well as the method of construction proposed would be received and considered. (This is not a mandatory request.)

The competitors are requested to make a statement of the cubic contents of the structure shown by their plans.

## *Response.*

The owner desires responses from the competitors on

or before August 21, 1919, advising him whether or not they accept this invitation and will agree to enter the competition and comply with its conditions. Such responses may be addressed to the Secretary of the Commission, Washington Park, Chicago.

The jury adjudged the design of Holabird and Roche to be the best of those submitted. The position of the other competitors, if they were placed, has not been announced.

THE AMERICAN ARCHITECT is pleased to publish the six designs and also the descriptions submitted by the competitors. In doing this it furnishes its readers an opportunity to study the various interpretations of the program by the competitors, which study will be interesting and of possible use as the demand for such structures becomes more common.

## Description Submitted with Design for a Stadium on the Lake Front, Chicago

By Holabird and Roche, *Architects*

Selected as the Best Design by the Jury

**I**N the solution of the problem two requirements were considered of paramount importance:

First, that the proposed stadium should in no way conflict with the Field Museum;

Second, that the majority of the permanent seats should be concentrated around a comparatively small area, to afford to the greatest number the best view of those athletic games and similar events as could not be expected to fill the stadium to capacity.

### *Solution of the First Requirement*

(a) The Field Museum is considered the head of the composition, the axis of stadium being the same as that of the museum.

(b) The north end of the arena is left entirely open, affording to each spectator an unobstructed view of the museum.

(c) North from the east and west porticoes, the permanent seats are entirely below grade 31, which is the grade of the esplanade in front of the museum. In this north sector the structure is merely a series of terraces, finishing opposite the end pavilions of the museum in simple sculptured walls and stairways. By this treatment of the north end of the stadium, conflict with the architecture of the museum is entirely avoided.

### *Solution of the Second Requirement*

(a) The width of the arena is made as small as practicable, being 300 feet between walls.

(b) The important east and west stands (marked by porticoes) are made higher than the north sector, to give a larger number of seats in this portion of the stadium. A football field is centered on the center line of these stands. The finish of the one-third mile track and of a 220-yard straightaway is opposite the reviewing stand at the center of the west stand.

(c) The combination of these two stands with the theater seats (semi-circular south end), comprise the large majority of the permanent seats, and these seats are of nearly equal value for most of the events and displays that will be presented in the arena.

(d) In order to concentrate the seats around a small area, it is necessary to extend the height of the stands above grade 40. This is justified,

First, because the spectators are thereby afforded a better view of all details of the spectacles held in the arena, and

Second, because this arrangement permits the north sector to be kept at such a low elevation and to be treated so simply that there is no conflict with the Field Museum.

### *Seating.*

As shown, in the sections, the surface of the amphitheater is slightly bowled, in order to give the proper lines of sight and, at the same time, keep the stands as low as possible. The 60,000 permanent seating includes the main east and west stands, full height, the theater, except the upper terraces and, in the section north of the main stands, the seating below grade 31.

The 40,000 temporary seats are provided for on the upper theater terrace, the three terraces north of the main east and west stands, and a portion of the north end of the arena.

The full 100,000 seats surround the whole stadium uniformly to the top promenade indicated on the drawings.

The terraces form bases for the temporary seats, and, by this arrangement the seating becomes especially flexible, as any number of terraces may be filled with temporary seats, leaving a finished structure in the event they are not all covered.

The terraces also have the advantage of serving as promenades for the spectators and sightseers.



NORTH ELEVATION



TRANSVERSE SECTION LOOKING NORTH



SOUTH ELEVATION

COMPETITION FOR A STADIUM ON THE LAKE FRONT, CHICAGO  
FIRST PRIZE, ACCEPTED DESIGN—HOLABIRD & ROCHIE, ARCHITECTS

*Access.*

A promenade at grade 31 extends entirely around the stadium. From this promenade, at suitable intervals, extended passageways and ramps leading to the banks of seats. People may enter at the north end on this level or any of the terrace levels and proceed to the section they are seeking.

Entrances at suitable intervals are provided along the exterior of the stadium. These lead through the structure and, by tunnels and ramps, to the various banks of seats.

Direct access to upper promenade is furnished by stairways.

In addition all main aisles in the amphitheater lead directly to arena, where egress is furnished by the entire north end, or by passages south of main east and west stands.

Pageants and large bodies of troops would enter from the north, pass south by the west reviewing stand, circle the theater with its reviewing stand and then move north and out again. In this way there would be no limit to the number of troops or the size of pageants.

In addition, two 30-foot passageways from the arena are provided at the south end of the main stands.

*Superstructure.*

The superstructure comprises a wide promenade, covered on the east and west by two monumental porticoes. Along this promenade sockets are provided for display of flags and bunting, also bases for searchlights at the southern end. On the drawings, no special scheme of bunting display has been shown, as this would vary to suit the occasion. At the extreme south, in the scheme as submitted, is proposed a large monument commemorative of the men from Chicago who lost their lives during the war. The idea of the monument might be termed

one of the uses for this portion of the stadium. The site is of such a commanding nature, with the 1,500-foot sweep to the Field Museum that it seems highly desirable that advantage should be taken and that here should be placed a monument worthy of Chicago's effort in the Great War.

*Space Under Stand.*

The space under the main east and west stands and under the theater, has been left free from columns. This is divided into three large halls having approximately 125,000 square feet of floor space, making space available for large automobile, livestock, dairy, industrial and educational, or other exhibitions. Temporary booths or stalls can be erected to suit the requirements of the occasion. Although the program demands only heating for accessories, this space could very easily be prepared for any permanent winter uses that may be required, such as all-year-round swimming baths and gymnasiums, recreation and assembly rooms, or civic concert auditoriums. In the future park development to the east of the site, the interior arrangement of this project would lend itself to permanent or semi-permanent shops along the Boulevard face.

*Parking Space.*

Parking space for automobiles has been provided in the long triangle at the south of the arena site.

*Construction.*

The stadium will be constructed entirely of masonry, using the best materials that the funds available will allow.

*Cubic Contents.*

The cubic contents of the structure as presented total 10,562,000 cubic feet.

## Description Submitted with Design for a Stadium on the Lake Front, Chicago

By Edward H. Bennett and William E. Parsons, *Architects*

*General Purpose.*

The aim has been to design a stadium for general uses rather than one serving any one specific purpose.

The stadium should be suitable not only for public gatherings and spectacles of a military or a non-military character, but also for the more specialized uses of athletics and games.

One of its chief uses will undoubtedly be that of great tournaments and reviews of a military character, of great gatherings on festival days in connection with public parades through the downtown streets and to such occasions as the Olympic games, floral exhibits, horse shows and circuses, in addition to football, baseball, track and other athletics.

The stadium may serve a useful purpose in connection with universal military service, or for the military classes of schools, whose public reviews, prize drills and other contests may be held there.

The theater may be operated separately from the main arena, except on occasions when the noise there will render performances in the theater difficult.

On great occasions all of the temporary seats may be used, but it is thought that for such uses as football games

it will be desirable to mass the temporary seats on the long sides of the arena.

In either case the terrace will be an important factor for the distribution of the crowds, especially on free days. It being continuous the public may circulate from one side to the other and select their seats with freedom.

For ice carnivals the center of the field may be flooded and toboggan slides may be arranged, built up on the seats in such numbers as may be desired.

The value of the stadium to the public will be very great. In connection with the development of the South Shore its construction would encourage the people of Chicago to use the lake front together with the Field Museum, bathing facilities and such other buildings as may conceivably be built in the future to form a group.

The elements of this group would mutually support one another, they would have common transportation facilities and generally would present a variety of opportunity in the way of entertainment and instruction of undoubted value to the community.

*Conception of the Problem*

The conception of this stadium is that of a bowl, modeled in such a way that it is partially sunk in the

ground, rather than that of a building. In view of the existing topographical condition and the proposed road levels such a plan may be carried out admirably.

The general expression of the exterior is that of a terrace with an appropriate terminal at the north end and carrying the more substantial enclosure of the theater at the south end, and arrangement practically dictated by the conditions and orientation of the site.

A free display of bunting and other temporary decoration may be used it is believed, as indicated on the side elevation.

*General Plan*

The form chosen is governed in the first place by the outline of the site, having for its dominant features the Field Museum on the north and the proposed park and lagoons on the south and east. Its exact form, including the rounded ends, has been controlled by the factor of *maximum visibility* of the field from the seats. It is claimed for this plan that there are none but good seats.

It is believed that considerations of good seating have contributed to rather than detracted from the shape of the bowl and its general appearance.

*Main Outlines:* The ends of the structure are dissimilar in size and curved and the sides are straight, but transitional curves are arranged between these straight sides and the ends with a view to avoiding the appearance of narrowing or pinching at the center, common to some of the stadia of the Roman circus form. Straight sides, it is believed, have particular advantage for the lining up of military and other formations.

The theater has been designed as moderate in size as it is believed is consistent with the purpose of the utilization of the stadium arena as a whole. The differentiation architecturally also has been carried as far as seems consistent with unity of expression in the entire composition.

The unsymmetrical arrangement or gradual widening of the field on the north and south axis, it is believed, will give a more ample appearance and a better maneuvering ground. Owing to the fact that it fits the site perfectly it is believed that it will be at once recognized as the most reasonable and finest arrangement.

*Administration Group:* The administration offices are placed where it is thought they will be accessible and will control the entire structure to the best advantage. With them are grouped the various rooms and other services required by the program.

In addition to these are provided lockers, dressing-rooms and toilets, as may be necessary for those engaged in indoor training, the rifle pit, etc., in such manner that the whole group may be economically heated from the central heating plant as indicated on the plans.

*Economic Consideration*

Since the stadium must be built upon land, the greater part of which is submerged and that it will have to be carried in all probability on piles and concrete piers, it is obvious that the expense of unnecessary filling material under the structure should be avoided.

The fullest possible advantage it is thought should be taken of this great space, which may be developed in this way to its greatest usefulness. All the requirements of the program have been included in the plans, but in addition various suggestions have been made for the use of this lower space, to be operated in conjunction with the stadium.

Special attention is invited to the arrangement by which adequate natural light and ventilation is afforded throughout this lower structure.

*Circulation and Access—Ramps*

There are no stairways with the exception of four supplementary flights on the outside.

The stadium, due to the capacity demanded, occupies the greater part of the site selected, but it has been the aim to adapt every foot of the ground remaining to the purposes of circulation of the public.

*Street Cars:* Provision is made for a street car right-of-way bordering the Illinois Central with two loading platforms.

The general circulation for automobiles and other vehicles surrounds the site and between it and the arena is disposed a circulation as broad as possible, for the distribution of the public approaching or leaving the stadium.

There are twenty-six entrances leading to the vast concourse arranged under the platform for the temporary seatings and fourteen additional exits.

This concourse will serve for the distribution of the public or for sheltering them in the emergency of bad weather.

Sixty-three passages practically at street level, lead directly from this concourse and the arcade around the theater to the seating spaces. A maximum of 1,200 seats is served by each passage. In addition a number of ramps lead to the terrace bordering the arena, for distribution to the permanent seats and to the temporary seats which are to be placed on this terrace.

SEATING SPACE AND CAPACITY  
SEATING SPACE (SQ. FT.), INCLUDING AISLES

	Stadium	Theater	Total
Permanent .....	213,248	62,528	275,776
Lower temporary.....	59,040	8,088	67,128
Upper temporary.....	100,800	—	100,800

Total seating space.....443,704

SEATING CAPACITY (PERSONS)

Permanent .....	46,520	13,474	60,014
Lower temporary.....	12,194	2,690	14,884
Upper temporary.....	25,668	—	25,668

Total .....100,566

Standing room in and above colonnade of theater.. 3,000

*Temporary Seats:* From the above figures it is seen that the temporary seats have been so arranged that a large percentage of them are below the permanent seats. These lower temporary seats are easily handled for storage, easily accessible when in use and are generally desirable.

*Dimensions:* The distance back to back of permanent seats is 30 inches, of temporary seats is 28 inches. The risers in the permanent seating range from 8 to 12 inches, as determined by sight lines.

It might be stated that the distance back to back of seats of 30 inches is the same as that used in the Yale bowl. This space is considered satisfactory. The distance of 27 inches used in the Harvard Stadium has been demonstrated to be too small.

The seating capacity is based on seat widths of 17¾ inches to 19 inches, the minimum being at a few points in the curved seating.

The arrangement and dimension of seats, aisles, entrances and ramps was decided upon, the sight lines determined and all problems of operation (for free amusements, for occasions when an entrance charge is made, either with or without reservation of seats and for exhibition use) were studied in the light of a first-hand knowledge of similar features in the largest stadia and halls of the country.

*Storage of Seats:* The lower temporary seats may be stored with minimum effort by shifting them through movable panels in the arena wall. Those on the upper terrace may be carried up and down by trucks, using the special ramps and the freight lift. By these means the seats may be placed or stored with a minimum amount of effort.

### *Theater.*

The theater is segmental in form and the stage may be so placed that all seats will have a good view. It is surrounded by a colonnade and wall, which it may be stated with authority will improve the acoustical qualities of the theater. These qualities are stated to be better in the Harvard Stadium than in the Yale Bowl when used for theatrical performances.

*Pool:* In conjunction with the theater stage it is suggested that a pool be built for aquatic exhibitions. It is believed that if this were done the stage itself should be operated mechanically on runways, the stage itself being thus utilized to floor over the pool and throw its area into the main arena.

*Awning:* It is suggested that the theater may be partially covered with an awning if desired, as shown on the drawings.

### *Space Under Stadium Structure*

A very considerable space is found under the permanent seats and under the terrace for the temporary seats.

Provision is made for the various services required by the program, administration offices and locker rooms for use of contestants in the stadium and for the participants in the performances of the theater, the storage of seats, stables, etc.

In addition to these, provision is made on the plans for the following: 1. Lockers and dressing-rooms available for bathing in the lagoon adjacent to the stadium. 2. An indoor running track for winter training. 3. A 200-yard rifle range. 4. A continuous driveway for the distribution of materials and a freight lift, also additional exhibition space. 5. In the theater in addition to the property rooms, dressing rooms, etc., are indicated a band room and rehearsal room. 6. A small plant for heating is shown on the plans.

*Toilets:* The toilet arrangements have been proportioned to the seating capacity, as established by actual experience in other modern stadia. They have direct outside light and ventilation.

### *Architectural Treatment*

The style selected follows classic traditions, which are adapted to modern requirements. As already stated it is conceived as a vast terrace, the elevation of which does not rise higher than the terraces of the Field Museum, with which the stadium is intended to harmonize in style.

The chief motifs of embellishment are those in conjunction with the main entrance and the two lateral entrances and the theater.

The structural material is intended to be reinforced concrete, stone or pre-cast concrete forming the exterior surfaces.

Throughout it has been thought desirable to be governed by considerations of reserve in the permanent construction, especially where so large a public monument is concerned. Provision, however, is made for a display of temporary decorations and illumination.

### *Natural Lighting Under Seats and Terrace*

The concourse is well lighted in the daytime through the passages, ramps and large entrance ways. The lower level is lighted by areas, through the passageways, and where necessary by wired glass panels in the seat risers. Sidewalk lights have been avoided because of the large cost of maintenance.

### *Artificial Lighting*

In addition it is suggested that movable lighting standards for flood lights be provided in the stadium of sufficient height and number to illuminate the entire arena or such portions as may be necessary for night performances and that searchlights or other illumination be established on the higher points of the composition, such as columns, pavilions and terraces of the theater.

Naturally the general illumination of the composition should include the south façade of the Field Museum, as this building incloses the north end of the stadium, and while dominating the view, will, it is thought, harmonize perfectly with the arrangement of the stadium itself.

### *Stadium*

The space provided under the terrace and seats for uses as required by the program contains 6,985,000 cu. ft.

In addition to the above the unfinished space suitable for use as bath house, lockers, indoor training space, target range and rehearsal rooms contains 2,095,000 cu. ft.

This extra space is left unfilled because filling would be an added expense; also because the space is valuable and may be put to uses as suggested or to other uses.

*Note:* A plan which would contemplate partial filling under the stadium seats and terrace to a level of say 23 feet, instead of to the arena level, which is about 7 feet, as is done in this plan, would materially reduce the storage and exhibition space, greatly increase the yardage of fill required and add to the cost of the structure an amount equal to the cost of the added fill, less a saving in lower level finish of that part which is needed.

It is assumed that foundation, wall and pier and floor construction would be practically the same in each case.

If partial filling, as stated above, were done, exhibition and storage space would be reduced by 260,000 square feet. Earth fill in excess of that required by plan as presented would be 202,500 cubic yards.



# Types of City Plans

By JOHN NOLEN, *Sc.D.*, *City Planner, Cambridge, Mass.*

THE classification of cities according to the type or character of the city plan may be considered under three heads: (1) Types distinguished by the style of the plan; (2) types distinguished by dominant function; (3) types distinguished by size.

Most cities can trace their origin to military, trading, or commercial requirements. In the foundation of Greek cities, for example, four distinct

spider's web plan; the second, the rectangular or gridiron plan.

The radial type has been most common in Europe. The rectangular or checkerboard type has been used widely in the United States and in new colonies generally. It would not be difficult to show that from the point of view of traffic facilities, as well as city attractiveness, the radial system has proved the better one in use. An interesting criti-

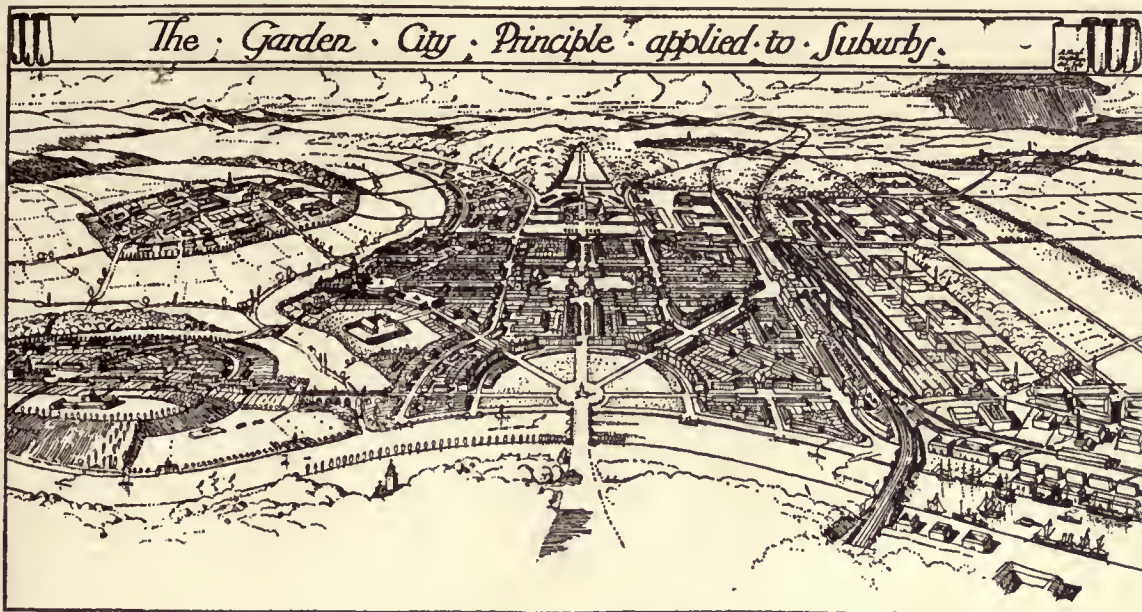

Diagram illustrating the development of a town by means of self-contained suburbs with defining belts of open space.

periods have been noted. In the first of these the city was planned as a place of refuge against hostile attack. In the second, its chief use was in the development of trade. In the third, artistic embellishment was the leading feature. And the fourth period embraces the time of the decline.

Cities generally owe their existence to geography, and such individuality as they have is due largely to topography. The chief topographical characteristics determining cities are the sea, rivers, hills and plains. It has taken decades of urban development and of mistakes to impress upon the cities of the United States the necessity to respect and conserve these natural features, to which they owe not only their form, but often their very life.

Cities that have been laid out upon preconceived plans may be broadly divided into two classes: The first is the radial system, or what is often called the

cism of the limitations of the rectangular plan adopted for New York City by the Commission of 1807 has been given by F. L. Olmsted, Sr., in which he says, "Some two thousand blocks were provided, each theoretically two hundred feet wide, no more, no less; and even since, if a building site is wanted, whether with a view to a church or a blast furnace, an open house or a toy shop, there is, of intention, no better place in one of the blocks than another . . . If a proposed cathedral, military depot, great manufacturing enterprise, house of religious seclusion or seat of learning needs a space of ground more than sixty-six yards in extent from north to south, the system forbids that it shall be built in New York . . . There is no place in New York where a stately building can be looked up to from base to turret, none where it can even be seen full in the face and all at once taken in by the eye; none

where it can be viewed in advantageous perspective . . . Such distinctive advantage of position as Rome gives St. Peter's, London St. Paul's, New York under her system gives to nothing."

A combination of the radial and rectangular systems has many advantages, and is particularly adaptable to the addition of new areas to old cities. The plan of the city of Washington is an interesting study of the combination of the chess-board and the radial systems.

It is not likely, however, that we shall find in

proximately rectangular, because the rectangle is the most convenient form of building block, and for the actual traffic requirements the diagonal system can always be resorted to. The radial form of arrangement is advisable for important focal points; town gateways, railway stations, the approaches and similar situations. Curved streets adapt themselves as a rule better to hilly ground than straight ones; for wide vistas, distant perspectives, and grand monumental effects the straight line asserts itself. The day has gone by for the unqualified em-

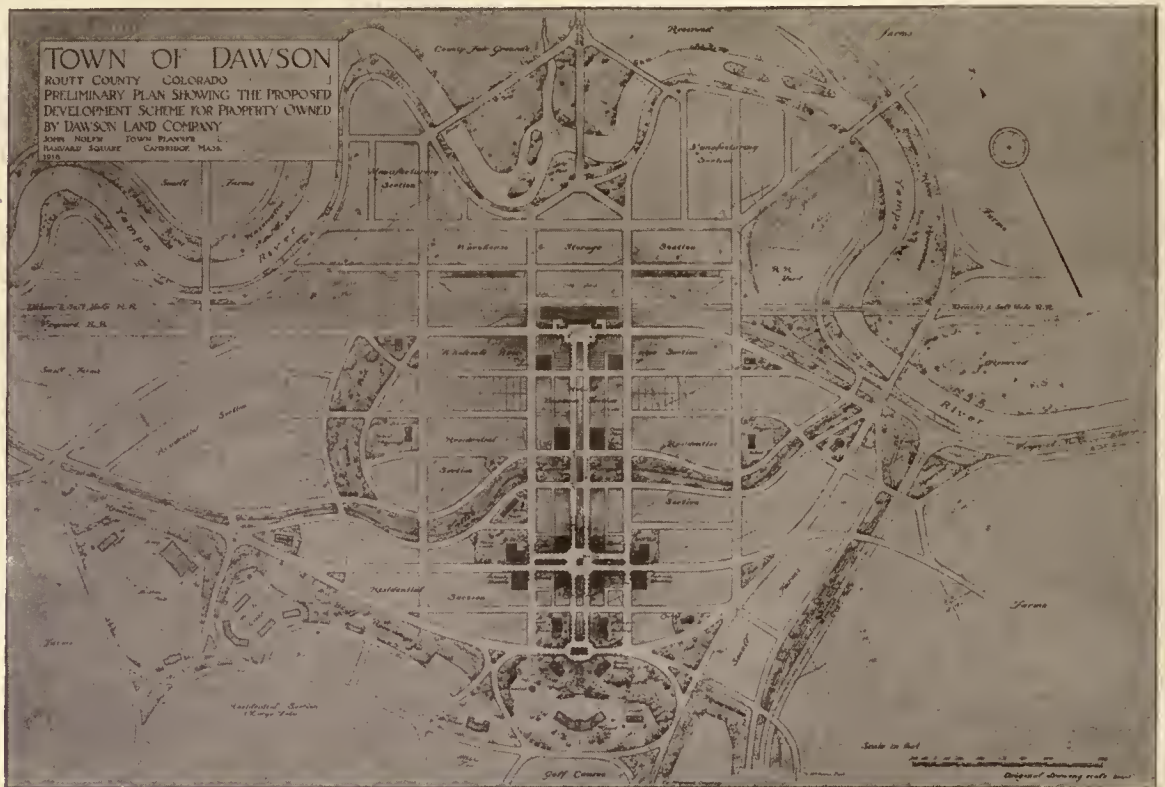

any "system" the correct method of dealing with the traffic requirements of cities in the future. If they are to be fulfilled, no purely rectangular or radiating system is likely to be of great use. "Success in town planning," writes Dr. J. Stübben, the eminent German engineer and writer, "is more likely to be attained by seeking out the natural topographical conditions. A full consideration for the levels, roads, and boundaries must be the basis upon which all schemes must rest, and these considerations can only be left out of account if they become antagonistic to the legitimate requirements of traffic and town extension, or for economic or aesthetic reasons. The closer a town plan adheres to the natural conditions, the more original and attractive it will be. The filling in of the secondary roads to the main network of thoroughfares should be ap-

ployment of definite systems; henceforth they should not play a ruling but a subsidiary role."

The classification of cities according to the types distinguished by dominant functions include government cities, such as national or state capitals; commercial cities, industrial cities, residential cities, especially those serving as resorts; garden cities; and ideal types, as, for example, the city proposed by Mr. H. C. Andersen of Rome, Italy, or the city planned in connection with the memorial project in commemoration of the landing of the Pilgrim Fathers at Plymouth in 1620.

From the point of view of city planning, one of the most interesting types in this classification is that of the "garden city," the best example of which is Letchworth, England. The founding of Letchworth was undertaken in the belief that the problem

of the housing of the industrial classes, which is agreed to be one of the pressing problems of our modern civilization, could only be tackled successfully by a fundamental change in our methods of urban development. The existing methods of haphazard building, which resulted in a few years in the creation of new slum areas, were not only socially bad, but expensive. The increasing wealth of the country, the growth of population, and the extension of trade, were responsible for this urban development, but it was clear that some new method had to be adopted if the new areas were to be anything but gigantic mistakes and burdens for future generations. The garden city of Letchworth is not a fantastic or impossibly idealistic scheme. It is simply town building according to modern town planning knowledge. Among the most interesting publications on this subject are "Garden Cities," by Ebenezer Howard, the founder of Letchworth, and a more recent volume entitled "The Garden City—A Study in the Development of a Modern Town," by C. B. Purdom.

Cities distinguished by size afford examples of types involving planning of our largest cities or groups of cities, as in metropolitan areas, or smaller cities with a population in the neighborhood of 100,000, or towns, and even villages. The planning and replanning of the smaller cities takes on added importance when we consider how great is their number, the population affected, and their relative rates of increase. Of the total population of the United States, according to the census of 1910, more than one-half, or 53.7%, is still rural; only 46.3% is urban. Of this 46% more than one-half or 25.5% of the total population, is included in towns and smaller cities with a population ranging from 2,500 to 125,000, and only 20% in the larger cities with a population of from 125,000 to 1,000,000 or more. Moreover, the relative increase of population is greater in the smaller cities, especially those with

from 50,000 to 250,000, being 41% against 32% for cities of 1,000,000 or more. The number of places of course, grows steadily with the decrease in population. For example of cities of 1,000,000 there are only three; or from 500,000 to 1,000,000, five; of 250,000 to 500,000, eleven; of 100,000 to 250,000 thirty-one; of 50,000 to 100,000, fifty-nine; of 25,000 to 50,000, one hundred and twenty; and of 2,500 to 25,000, twenty-one hundred and seventy-six. Cities with a population of 100,000 or over number only fifty.

The planning problems of the smaller cities are much like those of the larger cities, except that the smaller cities have a better opportunity to head off many of the evils resulting from the early lack of proper planning on the part of cities that have now grown large.

The planning of the most sparsely settled units is now attracting attention, and has recently been well discussed in a bulletin of the American Civic Association by Professor F. A. Waugh. He points out that "Country Planning" must follow. The country has just as great a need and just as good a right to be planned as the city. Something over half the people of the United States still live in the country. Moreover there are sound reasons for thinking that, just at the present time, the general weal of society is more concerned in the salvation of the country than in the next improvements in the city."

This is undoubtedly true, and the dweller in the country has now reached an attitude in these matters that causes him insistently to contend that in the planning and development of his town there shall be equally thoughtful and competent consideration as that given to the

larger communities.

This feeling may be said to extend even to the towns distantly located from urban centers, and this general aspect of society toward these vital problems is one that should be seriously considered by those engaged in town-planning.

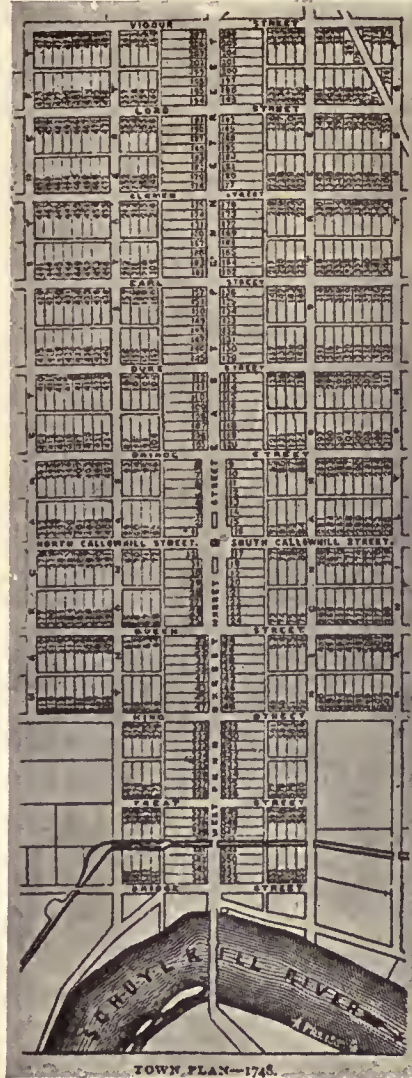

ORIGINAL PLAN OF READING AS LAID OUT BY THOMAS AND RICHARD PENN, SONS OF WILLIAM PENN

# How Zoning Helps Real Estate and Business

By HERBERT S. SWAN, *Secretary, Zoning Committee, New York*

MILLIONS of dollars will be spent within the next few years on new buildings in every city in the United States. This money may just as well be spent toward the permanent upbuilding of the community as upon hit or miss, haphazard growth involving endless construction, demolition and reconstruction without ever achieving any degree of finality. It won't cost any more—indeed, it will cost considerably less and at the same time it will produce a much better city to live in and to do business in for generations to come.

The time to zone our cities is now. Every year that is allowed to lapse without the adoption of zoning means that much less zoning in the end. Wait until next year to adopt a zoning scheme and the erection of two or three tenements will place it in the tenement house class. The erection of a factory or a garage may even put it in an industrial zone. We must have zoning to protect what we have got.

Zoning expresses the idea of orderliness in community development. Just as we have a place for everything in a well-ordered home, so we should have a place for everything in a well-regulated town. What would we think of a housewife who insisted on keeping her gas range in the parlor and her piano in the kitchen? Yet anomalies like these have become commonplace in our community housekeeping. In what city do we not find gas tanks next to parks, garages next to schools, boiler shops next to hospitals, stables next to churches, or funeral establishments next to dwelling houses? What would be considered insanity if practiced in the ordinary house is excused as an exercise of individual liberty when practiced in the city at large. And yet misplaced buildings are to be condemned much more than out-of-place pieces of furniture.

To the owner of neighboring property the invasion of an injurious use often spells financial ruin—a ruin even more complete than if his building were destroyed by fire, for in that event his loss would be made good in part at least by insurance. But for the values destroyed in blighted districts there is no insurance; each owner must stand his own loss.

The individual's loss is also the public's loss. To the former the invasion of offensive uses spells depreciated values, increased vacancies, lower rentals, the calling of mortgage loans, foreclosure; to the latter, reduced assessments, unpaid taxes, tax sales.

The present high cost of labor and materials emphasizes as never before the necessity for orderly building. With two houses worth as much as three several years ago, there is much more to be lost now than formerly through uncontrolled building. Mounting prices make it increasingly more necessary to conserve the value of all buildings, old no less than new, from premature and avoidable depreciation.

Taxes on real estate were so heavy before the war that many cities, hard pressed for additional income, were already searching for new sources of revenue. The tax on land and buildings, it must be remembered, yields all the way from 30 to 70 per cent. of the total municipal revenue in different cities. Under these circumstances it is quite evident that the stabilization of real estate values is of fundamental importance to the improvement of the municipal revenue system. During the next few years the real estate tax promises to assume even greater importance. The tremendous financial demands of the war in forcing the national government not only to increase existing taxes but to impose many new ones have had the effect of shutting off many potential sources of revenue to the local governments and of throwing them permanently back upon the real estate tax as the continued mainstay of their revenue system.

When New York had been taught only too well that unregulated building meant anarchy in its industrial and residential development; that putting apartments next to private houses, gas tanks next to schools, and factories next to department stores proved not only unprofitable, but involved the demoralization, if not the collapse of real estate values—the acceptance of zoning came as a matter of course and now all the wonder is that the city did not effect and exercise control over building a half century ago.

In New York the testimony of real estate experts is almost unanimous that the adoption of the zoning law has stabilized land values. The effect of the zone plan has been particularly noticeable in the districts reserved for detached houses. In such districts there has been an increased demand for private residences since the enactment of the zoning law. The restrictions have resulted in a great improvement of real estate conditions in such neighborhoods. Where the prohibitions against objectionable uses of land imposed by restrictive cove-

*(Continued on page 219)*



*In order to supply our readers with material of current interest, the news and comment appearing in issues of THE AMERICAN ARCHITECT delayed by the printers' strike will be as of actual rather than stated date of publication.*

## Reaction in Trade Unions

**T**HE Building Trades Council of New York, composed of representatives of forty-one unions in the building industry, has recently decided that all steel frame work of new buildings which has been erected by non-union steel workers must be torn down before it will permit all of the members of the various unions comprising this council to complete the structures.

In an interview published in a daily paper, the president of the Building Trades Council is reported to have stated: "What they have spent is a complete loss to them. Those buildings on which no work is being performed to-day ought to serve as an example to others who are contemplating building and having steel work done by non-union firms."

Here, apparently is an example of a labor leader strangely reactionary. He harks back to days when labor was less sure of itself and needed to use the encouragement of bluster and sabotage to gather its force. An extravagance of destruction by the young or in the forwarding of a new idea may be forgivable: it is an exhibition of new-found strength which does not know how to put itself to good use. But surely the labor unions have become sufficiently matured to give up these youthful manners. Their leaders should have intelligence to realize that it is not that they are merely causing financial loss to people against whom they bear a grudge, but that they are also destroying the accomplished work of other men and taking from the public its right to use that accomplished work. It is unfair and illogical, it is childish and it reaches no good or logical result.

**T**HE day has long passed when labor unions must use any means at hand to show their power and to develop that power. The power is obviously there but the intelligence with which the power is to be used is not so apparent. As Americans we are willing to be shown. We are to a great degree a good natured lot of experimentalists but we are, at the same time practical. We want to see results. If buildings are half done, we

want to see them finished and not torn down and started over again. When labor unions are receiving as full attention as has ever been given to any distinct social or economic power in Washington—it is painful to have evidence of a reversion to destructive tactics.

Power doesn't mean a grab at fat-living so much as it means responsibility. Ten years of socialist oratory has drawn from the pages of history to emphasize this point. There is no quarrel with fat-living so long as it is paid for, not only in cash but in moral responsibility. There is no quarrel with unions or with the power of unions, for in America we all work, but, in the present housing shortage, a refusal to work in Chicago and the present similar refusal in New York is a declaration distinctly unwise. Men turn their backs upon a service which they owe the public and go to the movies. The justice or injustice of the dispute has nothing to do with such a plain infringement upon the rights of society,—an infringement which succeeds in nothing but to prove a power to do harm which has long since been sufficiently substantiated.

**T**HERE will never be any satisfactory basis established between labor and the employers of labor until labor both as an individual unit and in its organization of unions, more clearly understands the true meaning of service. When labor accepts employment at a scale of wages it has itself arbitrarily fixed, it carries an obligation that the service rendered shall be efficient and capable. Every large employer is to-day painfully aware that the attitude of his labor is more indifferent as to efficiency than ever before. He knows that costly and careless errors committed during regular working hours have often to be corrected during overtime and the largely increased overtime scale. And he also knows that the corrections are cutting down the profit originally small and now shrinking to a possible loss.

Labor would declare a general strike where an employer failed to adhere strictly to his agreement with its unions but there is no recourse for poor service when by the very nature of the agreement

the character of the labor should be as thoroughly defined as is the scale of wages demanded.

Labor never in the history of its organized effort had better opportunity to prove to a critical public that while demanding a strict adherence on the part of the employers to its agreements, it realized its own responsibilities and by disciplinary measures corrected the indifference and incompetency of its members and the poor quality of their service.

### The Case Against the Billboard

ARCHITECTS are already aware of the unfortunate results artistically that go hand in hand with billboards. Attention has also been called to the fact that real estate values are adversely affected by their proximity. But there are other phases of the subject which directly interfere with the aims of municipal well-being, and hence architecture, which have not in the past been emphasized.

Billboards are mostly temporary frail structures with broad surfaces easily blown over in a storm. They are usually of wood and inflammable. They may either cause the spread of flames or constitute barriers behind which may lurk a cut throat or other dubious characters. They may shut out light from the lower floors of residences, leaving the ugly exterior back of the sign as the only outlook. Rubbish and litter frequently congregate in an unsanitary state at the base of billboard jeopardizing public health.

That the billboard may some day be banished from the public view is a hope which more than ever bids fair to be realized. This tendency is distinct, for the number of regulations to eliminate or control these offensive structures is constantly increasing. Among the most successful agents for the annihilation of the billboard may be mentioned the zoning laws, particularly those of the larger cities. These have in many cases imposed limitations upon the location and construction of billboards. Similar laws should be adopted by every small town.

Those who have community welfare at heart, whether architects or landscape architects, or organizations like the American Civic Association, zoning committees and the like, are unanimous in their desire to regulate the use of the billboard. In a recent issue of the *New York Times*, Herbert Swan, secretary of the zoning committee of that city, has this to say about the billboard:

Prior to the adoption of the zoning resolution

there existed in New York absolutely no safeguards to protect residential districts against billboards. Advertisers were free to erect huge signs wherever they wished—whether the site chosen was opposite a church or a warehouse, a park or a railroad yard, a home or a gas house. No locality had any amenities which the billboard was bound to respect—it could go anywhere. A private dwelling had no more rights in a residential district than fences featuring glaring signs and objectionable signs.

All this has been changed by the zoning resolution, which prohibits property situated in residential districts from being put to any but its legitimate uses and the accessory uses customarily incident thereto.

Dwellings, including dwellings for one or more families, boarding houses, and hotels having thirty or more sleeping rooms.

Clubs, excepting clubs the chief activity of which is a service customarily carried on as a business.

Churches, schools, libraries, or public museums.

Philanthropic or eleemosynary uses or institutions other than correctional institutions.

Hospitals and sanitariums. Railroad passenger stations. Farming, truck gardening, nurseries, or greenhouses.

The term "accessory use" does not include any building or use not located on the same lot with the building or use to which it is accessory. A private garage for more than five motor vehicles is not deemed an accessory use. Presumably the only kind of signboard constituting an accessory use is the ordinary "To Let" or "For Sale" sign affecting the premises on which it is located.

Commercial advertising can in no sense be deemed accessory to any of the uses specifically permitted in residential districts. The erection of signs in the future will therefore be confined to such sections of the city as are situated in business districts or unrestricted districts.

The zoning resolution has at one stroke done more to remedy the billboard evil in the residence districts of the city than all the laws and ordinances previously passed on this subject put together. Instead of merely regulating the height, size and construction of signs, it frankly recognizes the fact that there is no such thing as a billboard respectable enough to rub elbows with churches, schools, and private homes. When hereafter erected the billboard must go where it will cause a minimum of harm—alongside business buildings and industrial establishments.

## How Zoning Helps Real Estate

(Continued from page 216)

nants were formerly limited in their duration they are now permanent.

The zoning law in assuring these districts of an orderly development in the future has strengthened values to a considerable degree. Free from any fear of invasion from garages, stores or apartment houses, the home owners in these districts are settling down to enjoy the relief which the zoning law has given them.

Nearly all the private houses erected in New York since the adoption of its zoning law have been built in the districts set aside by the law for detached houses. Nobody cares to run the risk of having a garage or a warehouse next to his home when he can avoid it.

The beneficial effect resulting from the zone plan is also shown in other ways: vacant land in some sections sold until the war intervened at higher prices than it did before the adoption of the law. New houses now being erected are of a higher type and better finish than the old ones in the same districts. The zone plan is proving of inestimable value to the private home sections of the city.

Business streets, too, are feeling the wholesome effects of the law. Keeping business off residential streets means keeping it on business streets. Haphazard development hurts business property as much as it does residence property. The sporadic store invading quiet home streets not only demoralizes residential values; in decentralizing the shopping district it also disintegrates business values.

The whole purpose of zoning is to encourage the erection of the right building in the right place. It protects the man who develops his property along proper lines against the man who develops his property along improper lines. Rightly understood zoning means the substitution of an economic, scientific, efficient community program of city building for wasteful, inefficient haphazard growth.

The first step in zoning is the enactment of enabling legislation. The exact legislation necessary in any particular state varies according to the degree of home rule exercised by cities. In some states where cities have very broad powers of home rule no enabling legislation is required. In most states, however, cities enjoy only such powers as have been specifically granted them by the Legislature; the powers not expressly conferred upon them are denied. The majority of cities are probably in this situation.

After the enactment of the enabling legislation comes the appointment of the zoning commission. Experience has demonstrated that the best way actually to accomplish anything in the way of zoning

is for the city to appoint in the absence of a city planning commission an unpaid commission of representative citizens, this commission having conferred upon it adequate authority and money to engage the necessary expert help to make a comprehensive survey of the city and to formulate regulations and lay out districts controlling the heights, use and area of buildings throughout the community. Having framed a tentative draft of the regulations and maps, the commission should hold public hearings. Notice of these hearings is generally given in the press in the same manner as notice of any other proposed ordinance. The suggestions made by property owners at these hearings will prove of great value to the commission in preparing its final report which when thus amended is submitted to the city council for consideration. The council, of course, holds public hearings on the final maps and ordinance reserving the right to amend either up to the time the regulations are finally enacted.

The personnel of the commission is a constantly recurring problem to every city that embarks upon a zoning program for the character and ability of the commission will determine as nothing else the success of the work. Shall the commission be composed of city officials or of representative citizens engaged in various lines of work? The primary qualification for membership is that a man should enjoy the confidence of the community and that he should have considerable breadth of vision and a judicial attitude of mind. It is what a man is able, and not only able but willing and ready to contribute to the zoning work that should determine whether or not he is put on the commission. No man should be appointed simply because he happens to be a city official, a prominent citizen, or a member of a prominent organization.

Too large a commission is not desirable. The difficulty of obtaining a quorum, the necessity for many committees and the general shifting of responsibility accompanying large bodies all make a small commission more effective than a large one.

Even a large city will seldom, if ever, require a commission of more than fifteen. New York had sixteen; St. Louis, thirteen; Newark, eleven. A commission of seven would probably suffice for most cities of a hundred thousand. Towns of ten to fifteen thousand might actually find a commission of three or five adequate.

The knowledge of local needs can be obtained very much more satisfactorily through conferences and meetings with interested parties than by increasing the size of the commission. Neighborhood and taxpayers organizations are glad to appoint committees on zoning to co-operate with the commission in elaborating the regulations for different

localities. For exact information concerning the height, use and area of buildings, however, the commission will be forced to rely upon the detailed data compiled by its staff. Many people may think they know all about their city, and in some cases they probably do, but their knowledge cannot take the place of maps and charts classifying different kinds of buildings in defining the several districts.

To be most effective a zoning scheme must be city wide. Piecemeal zoning inevitably results in leaving a large part of the city unzoned and the part zoned will be zoned without reference to the best interest of the city at large. When the whole city is zoned at one time it is possible to treat all districts similarly situated and of like character in the same manner. When one section of the city is zoned at a time this is very difficult, if not quite impossible. Each locality being studied separately, the regulations adopted will, of course, be drafted to suit the idiosyncracies of its own particular development. A comprehensive survey embracing the entire city would, however, reveal the presence of dozens of localities, each perhaps slightly different yet sufficiently alike to be treated together as one class. The establishment of a multiplicity of kinds of districts, when a few would suffice, serves no good purpose—it only creates confusion and tends to bring all zoning into disrepute.

There is also another point to be considered and that is the attitude of the courts toward zoning. In order that the ordinance passed may have its legality sustained it is especially important that every care be exercised in framing the proposed regulations so that they fit local conditions, that they are not arbitrary or discriminatory, and that they do not fall within the ban of class legislation. Above all reasonableness must be the test of both the classification and the districts established. Whether the legality of any particular zoning scheme will be sustained depends more upon the carefulness and fairness put into the preparation of the regulations than upon a lack in the forward-looking attitude of our highest court.

The question of passing a temporary ordinance protecting residential districts appears to come up whenever a city considers the adoption of a zoning ordinance. Once appointed, the zoning commission will be repeatedly urged to formulate restrictions for certain localities before completing plans for the entire city. This the commission should consistently refuse to do for when the legality of the law is tested in the courts the city will be in a much stronger position to defend the scheme if it is able to say that all the regulations are mutually interdependent and part of a common plan. Of course, it is hard to see sections ruined while

protective measures are being formulated but the harm done in this respect will prove very small. If the commission concerns itself with special districts at the start the injury done in the city at large due to the later adoption of the plan will, no doubt, be much larger in the aggregate than the benefits conferred upon a few scattered residence districts temporarily protected. There are also other objections to temporary ordinance. Such regulations having once been imposed, the owners in such sections of the city are apt to consider themselves adequately protected and lose all interest in the final working out of the plan. A tentative plan, moreover, is likely to prevent the erection of buildings in sections where they would be allowed in the final plan. Persons who have their building projects interfered with in this manner will naturally be more or less disaffected and oppose the enactment of any regulations.

The proposed zoning ordinance just prepared for Newark, N. J., establishes several new precedents. One of these has to do with building lines, the other with the limitation of congestion. As these provisions are of more than local interest a few remarks may not be amiss.

In the past the freedom enjoyed by every owner to erect his building on the street line has seriously prejudiced the highest residential development of many streets. There is probably nothing that enhances the attractiveness of a street with private homes more than an open strip of ground between the street line and the building line. Setting back the houses permits the maintenance of a front lawn with grass and trees; it shuts out the dust and noise of the street; it promotes family privacy; and it affords additional light and air. And yet in the absence of any obligation binding all the owners within a block to observe a minimum setback line, each owner has felt it necessary to build his house on the street line. His own self-protection has demanded this. If he did not erect his house on the sidewalk, his neighbors on either side might. Being pocketed between two buildings, his house, instead of facing a street, would really front upon an outer court. Countless owners trusting to the comity of their neighbors have had their values ruined by themselves observing the amenities of the district.

If we wish to preserve the front yards in our residence districts we cannot permit a situation to continue which rewards the despoiler and black-jacks the benefactor of a neighborhood. A method must be found to protect the house that conforms to a minimum setback line. The proposed Newark ordinance suggests such a method which, though it may not be ideal, still affords a considerable degree of protection to residence districts.



## THE AMERICAN ARCHITECT

The proposition is briefly this: Where at least one-half of the buildings situated on either side of a street between two intersecting streets conform to a minimum setback no new buildings may be erected to project beyond it unless an open space is left on each side of the building beyond the setback. Each of these open spaces is required to have a minimum width at every point beyond the setback equal to at least one per cent. of the width of the lot on which the building is situated for each one per cent. that the building projects beyond the setback.

The effect of this provision will be absolutely to prohibit any new building in a block where half the existing buildings observe a minimum setback line from projecting beyond half the distance to the street or from occupying more than one-quarter of the area between the setback line and the street line. In actual practice, however, it is doubtful whether any building would ever project more than one-quarter of the distance to the street.

It is a strange phenomenon that despite a half century fight against bad housing conditions, congestion of population should proceed at an accelerated rate in many cities. More improved and enlightened housing legislation may have effected higher sanitary standards in the environment surrounding the home but it has not checked the ever-increasing concentration of population. Indeed, to a degree, it has even seemed that this overcrowding of the land was due to the very measures which were designed to improve conditions.

In New York, for instance, new bridges and tunnels have only extended the congested area. The rapid transit lines extending far out into the cornfields have not dispersed the population. Bridges over the rivers, tunnels under the rivers, and subway and elevated lines everywhere gridironing the metropolitan district have all helped each in its turn to create new congested centres in the purlieus of the city.

How to control congestion is probably as important and difficult a problem as any that confronts some cities to-day. Height regulations afford no satisfactory solution to the question for even though the height limits adopted be as low as it is practicable to impose, the fact remains that a large number of families can be housed in low buildings. Nor will area regulations get to the bottom of the matter for the court and yard requirements will usually be found to admit of the construction of a fifty-family house as readily as the erection of a three-family house. To prevent an undue congestion of population it is becoming increasingly more clear that it is necessary to go beyond the imposition of height and area regulations.

Experience shows that in the absence of any restriction on congestion there is practically no limit upon the population that can and *will* be housed on a unit of ground. In New York, for instance, the new tenements now being erected accommodate a larger number of persons on a given land area than any of the old slum houses on the east side. The average density of the tenements erected in Manhattan in 1914 was 852 persons per acre (counting 4.6 persons to the family). In Brooklyn for the same year it was 697 persons per acre. The maximum density was over 1,600 per acre. These figures in each case refer to the land within the block exclusive of that in streets. Statistics show that the maximum is rapidly becoming the average. In 1914 there were 119 tenement houses containing 4,125 apartments erected in Manhattan. These apartments which provided accommodations for a population of 18,975 persons, occupied by actual measurement a land area of only 22¼ acres. Making due allowance for the area within streets, this is at the rate of over a half million population per square mile.

To remedy this evil the Newark Commission therefore recommends that no dwelling or tenement house hereafter erected shall accommodate or make provision for more than a given number of families. The number in any particular case varies according to the district and the size of the lot. Thus in the A and B districts the limit expressed on an acreage basis is 140 families; in the C district 105 families; and in the D district 25 families. This is equivalent in the A and B districts to eight families on a 25x100 foot lot, in the C district to six families. In the D district it is equivalent to two families on a 35x100 foot lot. A family is defined as any number of individuals living and cooking together on the premises as a single housekeeping unit.

In Newark, and in Eastern cities generally, the problem is very much more than one of preserving detached house districts. The one-family row house and the multi-family house undoubtedly harm the private detached house, but the same can be said of the big tenement alongside the two or three family house. The establishment of one-family detached house districts, though it limits land-overcrowding in these districts, does not restrict it in those parts of the city left open to apartments. There the owners would be allowed to pile up as many apartments as they might choose.

Keeping all kinds of industry out of residence districts is expected to go a long way in improving social conditions, for zoning offers at one stroke, without any expense or any increase of rents, a method of protecting such housing standards as we have achieved against steady deterioration. It does

## THE AMERICAN ARCHITECT

more than that—in defining the direction and character of city growth, it lays the basis for an ever-increasing improvement in the social and economic conditions affecting the whole community.

Never has the intimate relationship between good housing and successful industry been plainer than it is to-day.

The stabilization of employment conditions and the reduction of labor turnover are dependent to a larger extent upon what improvement can be effected to industrial housing. So long as no protection is thrown about the environment of the workman's home, so long as it is allowed to be hemmed in with manufacturing establishments pouring out grime, dirt and smoke we can expect slums filled with hordes of unskilled nomads who wander from plant to plant and from town to town not only taking no interest in our civic life but bearing our institutions the keenest resentment. If the housing of munition and shipyard workers has taught nothing else it has taught that a most intimate relation exists between social unrest and bad housing.

To man the works we must house the man but the environment of the house is of almost as much importance to the work as the house itself. If there is no house, the man cannot be housed; if the house is not situated in a congenial neighborhood the man will not want to live in the house.

How zoning can be made of as great help to industry as to residence and business is well illustrated in the case of Alameda. Since the adoption of its zoning ordinance the city has commenced the construction in its industrial district of a belt line railroad, which will serve all factories, connecting them not only with each of the several railroads, thus relieving the factories from domination by any one railroad, but with the waterfront so that freight can be floated across San Francisco Bay in carload lots. A highway, nowhere less than 100 feet in width, skirting the edge of the industrial district throughout the length of the city has also been planned. Laid out for the purpose of facilitating the movement of factory traffic, this street will be improved in such a manner that its pavement will stand up under heavy loads and endure hard wear. The protection of the district against fire, too, is being looked into by the city. So long as factories were allowed to locate anywhere in the city, it was difficult to serve them with sufficiently large water mains. But, now, as factories in the future are permitted to be located in only one district, the city can readily afford to give them all

the fire protection that conditions may make necessary.

That the relative competitive strength of a city in the domestic and foreign markets of the world is frequently conditioned to quite as great an extent by the arrangements of the industries within the city as by the availability of raw materials and the proximity of a consuming public is just beginning to dawn upon us. Economical means of transferring and distributing freight within the city contribute proportionately no less to the development and expansion of its commercial and industrial hinterland than efficient outside connections by rail and water. Heavy terminal costs are as much a drag upon a city's prosperity as high freight charges. Every cent saved in needless trucking means just that much more money available for the extension of the city's commercial and industrial radius by rail and water.

When factories and warehouses are not located with reference to freight terminals, a situation frequently develops where the downtown streets are unnecessarily congested to the inconvenience and financial loss of the whole city. A similar condition results where mutually interdependent industries locate in widely separated parts of the city instead of near one another. It is maladjustments of this kind that zoning is designed to remedy.

Among cities similarly situated as to markets and raw materials, it is the city in which manufacturing can be carried on with the lowest overhead expense that will be the most prosperous. The city that drones along and does nothing to promote its industrial development is, in effect, encouraging grass to grow on its own streets. Nobody would consciously subsidize a competitor, yet every possible reduction in operating costs not taken advantage of, really constitutes a bounty to a rival for it may be the money wasted on needless trucking and abnormally high insurance premiums which enables him to earn the margin of profit to remain in business.

That a program of industrial zoning and development is essential in every city cannot be questioned. For years the pecuniary losses suffered on account of unregulated building in certain cities have not only equalled but exceeded those suffered from fire. The city that does not protect its citizens against fire is generally considered derelict in its sense of public duty. The same is rapidly becoming true of the city that does not protect its citizens against unregulated building.

# Current News

## Happenings and Comment in the Fields of Architecture and the Allied Arts

*In order to supply our readers with material of current interest, the news and comment appearing in issues of THE AMERICAN ARCHITECT delayed by the printers' strike will be as of actual rather than stated date of publication.*

### Registration of Architects

Information as to laws for the registration of architects, now in force in the following states, may be obtained as follows:

California, State Board of Architecture, Sacramento; Colorado, State Board of Examiners of Architects, Denver; Florida, State Board of Architecture, Jacksonville; Idaho, Department of Law Enforcement, Boise; Illinois, Department of Education and Registration, Springfield; Louisiana, State Board of Architectural Examiners, New Orleans; Michigan, State Board for Registration of Architects, Lansing; Montana, Board of Architectural Examiners, Helena; New Jersey, State Board of Architects, Trenton; New York, State Board for Registration of Architects, Albany; North Carolina, State Board of Architectural Examination and Registration, Raleigh; Oregon, State Board of Architectural Examiners, Portland; Pennsylvania, State Board of Examiners of Architects, Harrisburg; South Carolina, State Board of Architectural Examiners, Columbia; Utah, State Board of Architecture, Salt Lake City; Washington, State Board for Registration of Architects, Olympia; Wisconsin, Board of Examiners of Architects, Madison. Such laws are pending in Indiana, Iowa, Minnesota and North Dakota.

### Big Paris Building for World Buyers

London correspondence reveals the following information: Plans for the great Marche du Monde, or meeting place for the buyers of the world, which is to be established in Paris in two years, contemplate the erection of a vast building nine times the size of Trafalgar Square and containing not only 5000 shops but many special features, including the most luxurious club and the largest banquet hall in the world. Details of the scheme were given by Sir Charles Dundas, secretary of the Association of Great Britain and France.

"The object," he said, "is to give producers and buyers of the world the facility to perform all their transactions in one place.

"It will be the only building in the world where the rentals will decrease according to the length of the leases, and where the tenants will be considered as valued clients and not as objects of speculation.

"The building will be of six stories, with a frontage of 350 feet. It will be nine times the size of Trafalgar Square and will cost approximately £4,000,000.

"This enormous building," continued Sir Charles Dundas, "will contain 5000 shops, the most luxurious club in the world for buyers and producers, swimming and Turkish baths, gymnasium, restaurant, grill room, roof garden, several lecture-rooms, industrial cinema and the world's largest banqueting room.

"Briefly, what is contemplated is the erection and operation of a veritable city, in which it may reasonably be estimated there will be a floating population of manufacturers, producers, merchants, buyers and the necessary employees, exceeding 30,000 people."

Sir Charles added that the advantages of this huge project to the British buyers and sellers would be enormous.

"One of the principal objects of having this world's market in Paris," he said, "is because the French capital is the pivot of the railway centers of Europe, and the advice of the buyers of the world has been taken on this matter."

### Mutilating Historic Boston

Just at the time when Park Commissioner Gallatin of Manhattan announces that the site of the reservoir in Central Park will be made into a meadow and not used for a stadium or any other construction, word comes from Boston that slices are to be cut off from the little old Common and that an arcade is to be run under the tower of the Old South Church in order to relieve the congestion of the streets.

No spots in America are more crammed with historic memories than these two, comments the Brooklyn *Eagle*, and the presence of the growth of the city must have been intense to force consent to the laying of profane hands upon them. Boston Common is the only survival we have of the old English custom of common lands, it having been laid out originally as a free pasture and training ground. The cows and the training days have long since departed from it, but it remains an unrestricted breathing spot in the very heart of the city, not less sacred in the eyes of the Bostonian than the codfish above the State House door on the hill which looks down upon it. As for Central and Prospect parks they are parvenues, flaunting their modern wealth of equipment in the face of the dignity of the plain old Common, which stands for liberty and not for wealth. Fortunately this historic playground is not to be seriously injured, merely pared off on the Boylston Street and Tremont Street sides so as to give more space for traffic without reducing the grass-grown area, the change being permitted on condition that no further invasion of the Common shall be made.

The change of the Old South Church will be more disturbing, but it is even more necessary for the convenience of the modern city. Fortunately the body of the church, now one of the most interesting historic museums in this country, if not in the world, will not be touched. The tower in front will have an arcade built under it for the sidewalk, so that the curb of narrow and crowded Washington Street can be moved up to the very foot of the tower and the width of the present sidewalk added to the roadway.

Boston Common was bought in 1634 by Governor Winthrop and others as a common cow pasture and training ground, and was one of the several such tracts of communal lands and planting grounds. To-day it is the sole remainder of these ancient commons, other holdings having passed into private hands.

It was on Boston Common that Revolutionary soldiers drilled: from its limits at Park Square, then the Back Bay in fact as well as in name and now "made land," the British started for Lexington on April 19, 1775. On the

common the British mustered their forces to attack Bunker Hill and British artillerymen set their guns on Flagstaff Hill during the siege of Boston. Colonial expeditions set out against Louisburg and Quebec from the old common, and Massachusetts regiments assembled there prior to going to the front in the Civil War.

---

## Ceramics

Perhaps no more than one person in ten knows what the word "ceramic" means; probably not one in a hundred appreciates all it implies in its modern, practical bearings, states Edwin E. Hollenback, president of the Master Builders' Exchange of Philadelphia. The work of the members of the American Ceramic Society now embraces not only the potter's art, to which it was originally limited, but also every branch of industry concerned with the working into form and the burning into permanent shape of silicate rocks and non-metallic minerals. It ranges from sewer pipe, common brick and terra cotta to spark plugs and optical glass. It embraces the foundation stones of modern building. Before the outbreak of the World War, and even during the initial stages of the war's progress, ceramic products held fourth place in the list of manufactures. Their total amounted in value to \$400,000,000 as recently as 1914.

The products incident to the field of hardware and their distribution come home to everyone as intimately, for they include the carpenter's hammer as well as the farmer's plow, and they enter into the construction of the home, the factory and the office building.

People everywhere are affected in the prices they pay, in their health and in every phase of living and working by the developments in the countless departments of modern ceramics.

---

## American Skyscrapers to Replace Dickens' Slums

London's greatest rookery district, valued at more than \$1,000,000,000, formerly a portion of the estate of the Duke of Bedford, has been put on the market to a powerful American syndicate.

The district includes the historic Covent Garden Market, the Drury Lane Theatre, the Waldorf Hotel and the famous Bow Street police station.

All of these places are familiar to thousands of Americans.

The transaction is one of the greatest in the history of London's realty market. It follows on the heels of the acquisition of the Aldwych Island site by the Bush Terminal interests of New York, paying an annual rent of \$220,000.

The territory is situated in the heart of Dickens' London, being bounded by the King's Way, the Strand, Queen Anne Street and Longacre.

It contains the century-old slums which the American syndicate proposes to clear and replace by modern business skyscrapers.

---

## A National Architect Whom Time Almost Erased

Our article in the Dec. 24 issue under the above caption was a review of a paper originally written by Charles C. Wilson, Columbia, S. C. Mr. Wilson's identity with the account was inadvertently omitted.

## Advocates Municipalization of Hospitals

The municipalization of voluntary hospitals is advocated by Dr. Duncan Forbes, medical officer of health of Brighton, England, in *The Hospital Gazette*. He admits that people owe a debt of gratitude to the voluntary subscribers, but since it is the same people every time who are the large subscribers, and since hospitals are getting so expensive, he feels that the taxpayer should be made to pay instead of the few large subscribers.

The establishment of state or municipal hospitals would lead, in his opinion, (1) "to an equitable distribution of the burden of upkeep; (2) to a less wasteful method of collection of funds; (3) to a more equal distribution of beds to which patients would be admitted on doctors' certificates according to the urgency of their cases, and not by subscribers' letters as at present; (4) to an early general increase in the number of hospital beds maintained; (5) to an improved medical service; (6) to closer co-ordination of municipal and hospital work."

---

## For Better Administration of Forest Policies

In an effort to do its share to secure economy in state affairs and a reduction of waste, particularly by avoiding duplication of effort in various state institutions, the New York State College of Forestry at Syracuse has asked Conservation Commissioner George D. Pratt to call a state conference of all state agencies involved in forest advancement, for a delimitation of the respective fields of the various institutions. That the conference be called at the earliest possible date is the hope of the College of Forestry, in order that a program for the coming season may be outlined.

Commissioner Pratt has previously indicated his belief that there should be some such conference, at which arrangements might be made to prevent duplication of effort by such organizations as the State Conservation Commission, the College of Forestry, and the department of forestry of the State College of Agriculture at Ithaca. The present danger is that the various state institutions interested in forestry will overlap in their activities, and instead of conserving state funds by operating each along a definite specific line, will duplicate effort, and at the same time fail in doing specific work which should be done for the good of the entire state. The New York State College of Forestry at Syracuse has already avoided some such duplication by giving up its forest nurseries where trees were formerly grown for the state, believing that the furnishing of forest nursery stock was a province of the Conservation Commission, and not of an educational institution.

"The need is now so great for real constructive work, and the requirements of the various state institutions so great, that we should by all means avoid duplication of effort between various state agencies," said Dean Hugh P. Baker, in announcing the request for a conference on this subject, "and we believe that a harmonious agreement can be reached by such a conference.

"The New York State College of Forestry at Syracuse has believed from its inception that the most rigid economy should be maintained, and it was on this theory that during the war years we actually cut down our requests for state assistance, when other state institutions continued to ask steadily increasing appropriations for their work."

## Inter-Relation of Building Commissions in New York State

A bill has been introduced by Assemblyman Charles F. Mos of Albany, N. Y., creating a commission to select sites for state buildings in the city of Albany. This commission is to consist of the Trustees of Public Buildings, the State architect and the Board of Contract and Supply of the City of Albany, and is created for the purpose of promoting architectural and landscape uniformity and unity of action between the state and the city by the adoption of a plan for the development of land now owned or hereafter to be purchased by the state for the erection of state buildings. This commission is also to be authorized to consider the question of the use of the property heretofore purchased for the proposed new state office building for a state park.

## Plans for Rehabilitating Tuscany

Future American tourists in Tuscany will imagine themselves suddenly transported to California, if the plans of the American Red Cross now under way for rehabilitating the district recently laid waste by the earthquake materialize. As soon as news of the disaster reached American Red Cross headquarters in Italy, states *Modern Hospital*, relief parties were dispatched to Tuscany, the list of workers including two contractors. American Red Cross and Italian contractors discussed plans for rebuilding the devastated area, and the Americans recommended the low, solidly built type of house popular in California—of stone or concrete, with roof firmly attached.

While awaiting the decision of the Italian Government the natives are being housed in tents and portable houses. The portable house manufactured by the Red Cross in France, co-operating with the Friends' Unit and the French Government, has proved invaluable in this emergency. A large shipment of these houses was sent to the stricken district immediately upon receipt of news of the earthquake, and with hammer and nails they were soon erected. Instructions for erection accompanied each house, so that even an inexperienced workman could put it up without difficulty.

## Bishop to Approve War Memorials

LONDON, Feb. 3.—Delightful British parish churches of Norman design are being spoiled by war memorials of typical twentieth century design, according to the bishop of Chelmsford. To erect these memorials, said the bishop, wrong-minded patriots took away a portion of the churches' most picturesque masonry and substituted something modern which was hideous, and which spoiled the whole outline of the buildings.

In the future permission of the bishop of the diocese must be obtained before a memorial may be instituted.

## England Builds

Tilbury, England, has begun a great housing scheme involving an expenditure of £1,500,000 for the benefit of transport workers at the docks.

It is proposed to erect 1520 houses, which will be equipped with baths and all modern appliances for sanitation and comfort. These buildings will be grouped about a triangular central park.

## "Roman de la Rose" Scripts Found in French Peasant's Garden

The "Roman de la Rose," one of the most priceless possessions of the Meaux Museum, has been found, it is learned from the *Public Ledger* of Philadelphia. It was stolen when on its way back to Meaux from the place of safety to which it had been removed at the time of the German offensive in 1918. The precious manuscript was discovered in a thorn bush near the railway line at Chatillon Sur-Seine.

One morning a workman, whose garden abuts on the line, found an old book in his garden. He gave no attention to the find, which did not interest him until he happened, casually, to read in a newspaper of the theft of the rare manuscript. Thereafter he made a search, with the result that all the missing manuscripts have been found. They are damaged slightly by rain, but can be restored.

It seems that the rare mediæval treasures had been packed in chocolate boxes and the thieves thought they were getting something good to eat. One can picture their chagrin on finding merely manuscripts, and their greater chagrin when they discover now they have let slip one of the most valuable rarities in the world to Bibliophiles.

## Spain Introduces the Skyscraper

At a recent conference of property owners and architects in Bilbao, Spain, it was decided that owing to the great increase in land values there, twenty and thirty-story buildings will be built hereafter.

## Government Needs Draftsmen

The United States Civil Service Commission announces that the Government is in need of a large number of draftsmen of various kinds. It is stated that fully 1000 draftsmen were appointed in the Government service during the last calendar year. During this period of reconstruction technical men are especially needed. Besides draftsmen there are openings for surveyors and computers, also assistant and associate engineers, electrical, mechanical, civil, chemical, and ceramic.

Further information and application blanks may be obtained from the secretary of the United States Civil Service Board at Boston, New York, Philadelphia, Atlanta, Cincinnati, Chicago, St. Paul, St. Louis, New Orleans, Seattle, or San Francisco, or from the United States Civil Service Commission, Washington, D. C.

## Picture Bought for Song in South Africa May Be Priceless

A British army officer recently purchased for seven and one-half shillings (\$1.80) in a Pretoria auction room a picture which art critics believe to be a missing Rembrandt—a work of priceless value. The picture, portraying the Crucifixion, has been sent to advisors of the great art gallery at The Hague for examination. The theory is that the picture was brought to South Africa by a member of a family of Dutch noblemen who were patrons of Rembrandt.

## Competition for the Capitol Building for the State of Nebraska

A preliminary program approved by the Nebraska Sub-Committee on Competitions of the American Institute of Architects and adopted by the Nebraska Capitol Building Commission has been issued. The final stage proposed in this competition is to be confined to the three pre-qualified in the preliminary stage and seven, more or less, to be chosen from outside the state and invited by the Commission to compete. The names of the competitors in the final competition have not yet been announced. Each competitor in the final stage with the exception of the winner will receive \$2,000, payable immediately after the award has been made. Thomas R. Kimball of Omaha, Neb., and president of the American Institute of Architects, has been retained as professional adviser. It is the intention to judge and evaluate the competing drawings, theses and cost statements before the identity of the authors is disclosed. The Commission will appoint at the close of the preliminary stage of the competition a competent architect from outside the state to act with it as a jury to determine the winners in the preliminary stage. Judgment will be first rendered on the anonymous showing cost as of two-thirds the value of the whole, the identified exhibits being evaluated thereafter separately and final award made on the average of the two. Further information as to this competition may be obtained by addressing George E. Johnson, acting secretary, Nebraska Capitol Building Commission, Lincoln, Neb.

## Obituary

John C. Olmsted, widely known landscape architect, who designed many exposition grounds and park systems throughout the country, died at his home in Brookline, Mass., in his sixty-eighth year. He planned the grounds of the World's Fair at Chicago, and exhibitions at Seattle and Winnipeg, Manitoba. Park systems laid out by him include those at Boston, Chicago (South Parks), Buffalo, Rochester, N. Y., Hartford, Conn., Louisville, Milwaukee, Seattle and Spokane.

Mr. Olmsted was a nephew and the adopted son of Frederick Law Olmsted, the landscape architect of Central Park, whose partner he became in 1898, and with whom he was associated in his most notable work.

## Personals

Francis Averkamp has moved his offices from 63 Park Row, New York, to 600 West 181st Street, same city.

James Earle Miller, for fifteen months lieutenant in the Quartermaster Corps, U. S. Army, has reopened offices for architectural practice at 23 South Sixteenth Street, Philadelphia. Samples and catalogues desired.

M. Leo Elliott, formerly of Bonfoey & Elliott, architects, and later in the service, has now opened offices in the Hampton Building, Tampa, Fla., for architectural practice. Catalogues and samples are desired.

H. L. Wardner and George D. Tesch announce the dissolution of the firm of Wardner & Tesch. Mr. Wardner continues his practice in the office at 508 Everett Building, Akron, Ohio. Mr. Tesch has opened offices at 404 Everett Building and desires catalogues.

Architects Dittoe, Fahnestock & Ferber have opened offices in the Conrad Building, Cincinnati, Ohio. This was stated in our issue of Dec. 24 with the name Garber for Ferber. Mr. Frederick W. Garber is still of the firm of Garber & Woodward, Union Central Building, Cincinnati.

Paul S. Robinette, Louis U. Bruyere and Donald E. A. Cameron, employees of the late Thomas F. Huber, architect, of Toledo, Ohio, have taken over and are carrying on his practice under the name of Robinette-Bruyere-Cameron, architects and engineers, at the same location, Suite 755, Spitzer Building, Toledo, Ohio. The new partnership will be pleased to receive literature and samples from the building material houses as well as to meet their representatives.

Mr. Fred B. O'Connor, who has been with the architectural department of the State of New York as special architectural designer for the past fifteen years, has resigned to accept the position of chief draftsman and office manager for Russell and King, architects, Syracuse, N. Y. Mr. O'Connor has personally designed some of the most important State buildings and institutions in New York State. Some of his best work is expressed in Cornell Drill Hall, Ithaca; Troop B Armory, Albany, and the development of Sing Sing and Wingdale prisons.

## News from Various Sources

Northern Manitoba is on the threshold of a development era. A railway is to be built into the Athapapusko Lake country, and a smelter to be established. A city of 20,000 people is expected to spring up in the next three years.

\* \* \*

It is understood that an application will be made shortly to the Dominion Railway Commissioners for an increase in freight rates; an advance of 20 per cent all round will probably be asked for, and if it is granted it will have an important bearing upon the cost of living and the entire fiscal situation.

\* \* \*

Dr. Reusch, Austrian Minister of Finance, in requesting the Assembly to sanction the immediate appropriation of 2,750,000,000 crowns, largely for the purpose of purchasing food, disclosed that \$48,000,000 of the American loan has become exhausted.

\* \* \*

Holyoke, Mass., has a rehabilitation school where disabled veterans of the World War can learn trades to make themselves self-supporting. Holyoke furnishes the building, the machinery and the money. The school is in an eight-room building. It has accommodations for re-training men in the following numbers: Machine shop practice, 55 or 60; drafting, 15; pattern-making, 5; carpentry, 10; composition and press work, 6. The school will bring the men back to at least their former earning capacity.

\* \* \*

The American Academy of Fine Arts, overlooking Rome from the Janiculum Hill, has resumed its normal work. Those students who did their duty during the war have laid aside their uniforms and with added fervor have taken up the brush and chisel. The American Academy is by degrees, as the passport regulations become easier, filling up. It now has twenty students and expects soon to have the normal number of twenty-five. It is already so pressed for room that they have had to put a few women students in a nearby villa.

# Weekly Review of Construction Field

Comment on General Condition of Economics with Reports of Special Correspondents  
in Prominent Regional Centers

THESE seems much promise in the policy formulated by the committee of labor relations of the Cleveland Chamber of Commerce. Their plan suggesting constructive work is being directed toward reaching the necessary harmony between labor and employers. "Representative negotiations" is their term used to replace "collective bargaining" and, as defined, is a provision for negotiations between employer and a committee of his employees aided, if they so desire, by an advisor of their own choosing. The plan is an adaptation of the methods of the railroad brotherhoods as well as those of the "shop committee."

The plan opposes compulsion by employer or employee to maintain union or non-union shops, but allows for the possibilities of mutual agreement upon matters of this character. It recognizes that the eight-hour day has become more or less standard. But probably its most important declaration is that the right of the public to service is above the employee's right to strike or the employer's right to "lock out" and that it advocates uninterrupted service to the public pending settlement of disputes and proposes publication of facts relating to labor controversies that the public may be advised of the merits.

All this seems a simple exhibition of common sense. The *New York Sun* made a calculation that the loss through strikes in 1919 was \$2,000,000,000, of which capital lost \$1,266,357,450 and labor \$723,478,300. The public's loss in money and inconvenience is not computed. Figures announced by the U. S. Shipping Board are of a loss by strikes during the month of January amounting to \$37,000,000. This figure also takes no account of the losses to the public due to congestions in the ports, spoilage of perishable cargo and the delays of food and supplies. Such absolute and public waste is plain folly.

WHILE it is true that labor has succeeded in securing the elimination of the anti-strike clause from the railroad legislation; having the right to strike does not mean that they will use that right. The Grand Chief of the Brotherhood of Locomotive Engineers is a member of the Cleveland committee which has placed the public's right to service first.

So wide-spread is the realization of the great need for production and so loud the demand for housing throughout the whole country that it becomes difficult to believe that labor unions will be willing to face the adverse public opinion which a stoppage of work would entail.

The present outlook is dark in Chicago, but the men cannot fail to hear the note struck by the committee of labor relations of the Cleveland Chamber of Commerce nor the response of the long-suffering public who are quite unable to judge whether the claims of striking workmen are, or are not, just. They only know that their urgent wants are not satisfied nor given even the slightest attention. While so many people live in hotels or boarding houses with goods, furniture, pictures and books in storage, waiting for an apartment to be finished that they may move in and live in comfort—and the unfinished apartment stands day after day unfinished and idle—there is a limit to patience and there is a growth of vigorous public sentiment. The lesson, obviously, has little to do with the way the profits of production are to be divided between capital and labor, but upon production it is insistent.

## *Wages and Production.*

It is said by *The Wall Street Journal*: "There is evidence that projectors of building enterprises have to a great extent abandoned the idea of waiting for a fall in prices. High costs as a factor retarding construction are not given the attention that they were a year ago. Although costs are now higher than ever before, the belief is quite general that there can be no material reduction in the near future and many building enterprises planned in the last three years will be started this year."

This is substantiated in many ways. It means that capital accepts its part of the responsibility to satisfy the imperative demand for building production and is going ahead despite all the practical difficulties of the present and the risks that future returns from such expenditures may be inadequate. Despite the objection which is voiced against increases in rent to a point where legislation is being brought to bear upon "rent profiteering." Taxes, with the increase of the cost of government, seem likely to become even more expense, and yet so insistent is the demand for housing and factory space that work is contracted to tremendous values.

The \$235,000,000 reported by the Seventh Federal Reserve District as work contracted for during January, even if divided in half to allow for the increase in comparative costs, is \$52,000,000 higher than the average for that month during the ten years preceding and a gain of 78 per cent over that average. This 78 per cent is not an inflated total but shows capital available for so much of an increase in production.

According to the U. S. Department of Labor, average wages have increased 61 per cent in the past ten years while the regular hours of labor have decreased by 8 per cent per week. The wages of a mason's laborer in New York have increased during that period from \$1.50 to \$6.50 a day. But the most discouraging phase of the situation is that generally throughout the attitude of labor, there can be found no endeavor to increase production and thus make the necessities of life more plentiful and available for all, but there is instead a feeling that wealth is the money which passes from hand to hand and for which they give just so many hours of their time. How that time is spent is not regarded by them as their responsibility. What happens to the material which passes through their hands is apparently not their greatest interest. This, decidedly, is not good craftsmanship. It is a waste comparable to the wastage of strikes and in this case accountable almost wholly to the lack of responsibility of the mechanic. The cause seems fundamental in our national character. Are we called a nation of materialists because we haven't the slightest respect for material? We have gotten on in a way *nouveau riche*. But our natural resources are not unlimited as we shall have some day to learn and it is not too early to start now.

In England, an association is developing equally supported between the employers and the building trades; a conference, so to speak, for the development of constructive ideas and methods of work. It takes no cognizance whatever of the arbitration of wage disputes but centers solely upon the development of working conditions which shall increase production and the standing and reputation of the trades. English radicalism is strongly col-

## THE AMERICAN ARCHITECT

ored nowadays with the guild idea. If it leads the men who work with their hands toward finer craftsmanship, if the mechanic gets to think better of his work in life and less bitterly of the silly extravagances of the rich, the progress of improved living conditions for all the people will make strides.

---

(By Special Correspondence to THE AMERICAN ARCHITECT)

CHICAGO.—Only a few days ago the Associated General Contractors' Convention in Chicago announced that "a building boom amounting to \$6,000,000,000 and lasting five years, which is expected to relieve the shortage of dwellings, is to be launched in the spring." An announcement which referred to the whole nation, including Chicago.

Since then two things have happened in Chicago. The leaders among the building trades unions got their heads together and decided to make a blanket demand for \$1.25 per hour for all union men in the building industry: carpenters, plumbers, masons, etc. This increase was to be asked despite the fact that the carpenters only last fall were given an increase to \$1 an hour for an eight-hour day—after they had remained out on strike for ten weeks and delayed building at a critical time.

Then, added to this complication, is the steady increase in the cost of building materials which climb from week to week until they are almost prohibitive in some regards. Coupled with these labor and material difficulties is the lack of sufficient transportation to enable the needed building construction to proceed. That the return of the railroads to private ownership on March 1, will further complicate matters is almost certain, for the public will demand more of the carriers and expect immediate relief from the shortcomings of federal control.

But so far as Chicago is concerned the outlook just at this time is not very rosy and it looks as though the "building boom" is to be delayed. Already several million dollars' worth of improvements which were planned have been ordered held in abeyance until the owners can figure with some degree of accuracy as to the probable costs.

Voters of Chicago have approved a bond issue of \$20,000,000 to begin work on the Lake Front improvement which is to extend over a period of fifteen years. This is the biggest public improvement ever undertaken by Chicago and ultimately will mean practically a rebuilding of the city. The city council also has passed the zoning ordinance which will be worked out in conjunction with the general city plan.

Conditions affecting the steel market changed but little during the past week. Curtailment of operations is still being forced owing to the car shortage and the railroad

embargoes which are being felt by practically every steel company in the eastern part of the country.

Reports seem to indicate that there was a slight decrease in the demand during the past week, but this is not considered significant as it is probably due to the fact that inasmuch as the mills are sold out for months ahead a policy of waiting has been adopted with regard to accepting new contracts. Consumers have found their recent orders are being declined and they are therefore deciding to wait for some new development which would bring about a different situation, at least temporarily. Some of the largest consumers have recently expressed the opinion that prices will not come down for more than a year and that it should be the policy of all users to place their orders for future requirements.

Official trade figures confirm statements made here that there had been a decrease in structural steel buying during January. It is shown that orders placed amounted to 75 per cent of capacity, compared with 85 per cent in December. February is likely to be somewhat below January, according to some authorities, although a rush of buying between now and the end of the month might change that prospect.

---

(By Special Correspondence to THE AMERICAN ARCHITECT)

SAN FRANCISCO.—No particular change occurred in the local markets for building materials this week. Prices remain as they were quoted the week previous, but various items of material are steadily becoming more difficult to obtain.

The San Francisco architects and contractors find it extremely hard to get hold of steel in the quantity and shape which they need. In fact, the steel situation is so acute just now that a number of contracts have been placed, of necessity, aside until the market is not so tight.

In spite of material problems, however, building activities are still forging ahead, growing steadily in volume, with indications of at least another twelve months of housing shortage.

Brick and clay manufacturers report that they are behind on orders and there is some speculation as to whether the demand can be entirely supplied even after the opening of the plants for the 1920 season.

Unless weather conditions interfere, lumber interests will put their mills into operation a little earlier this year. If the winter continues mild as it has been so far this will be possible. While local offices are hard pressed to meet orders, there are hopes of easing up the market as soon as the new cut is ready for delivery. According to present reports, prices will show an upward tendency and will maintain a high level for an indefinite period.



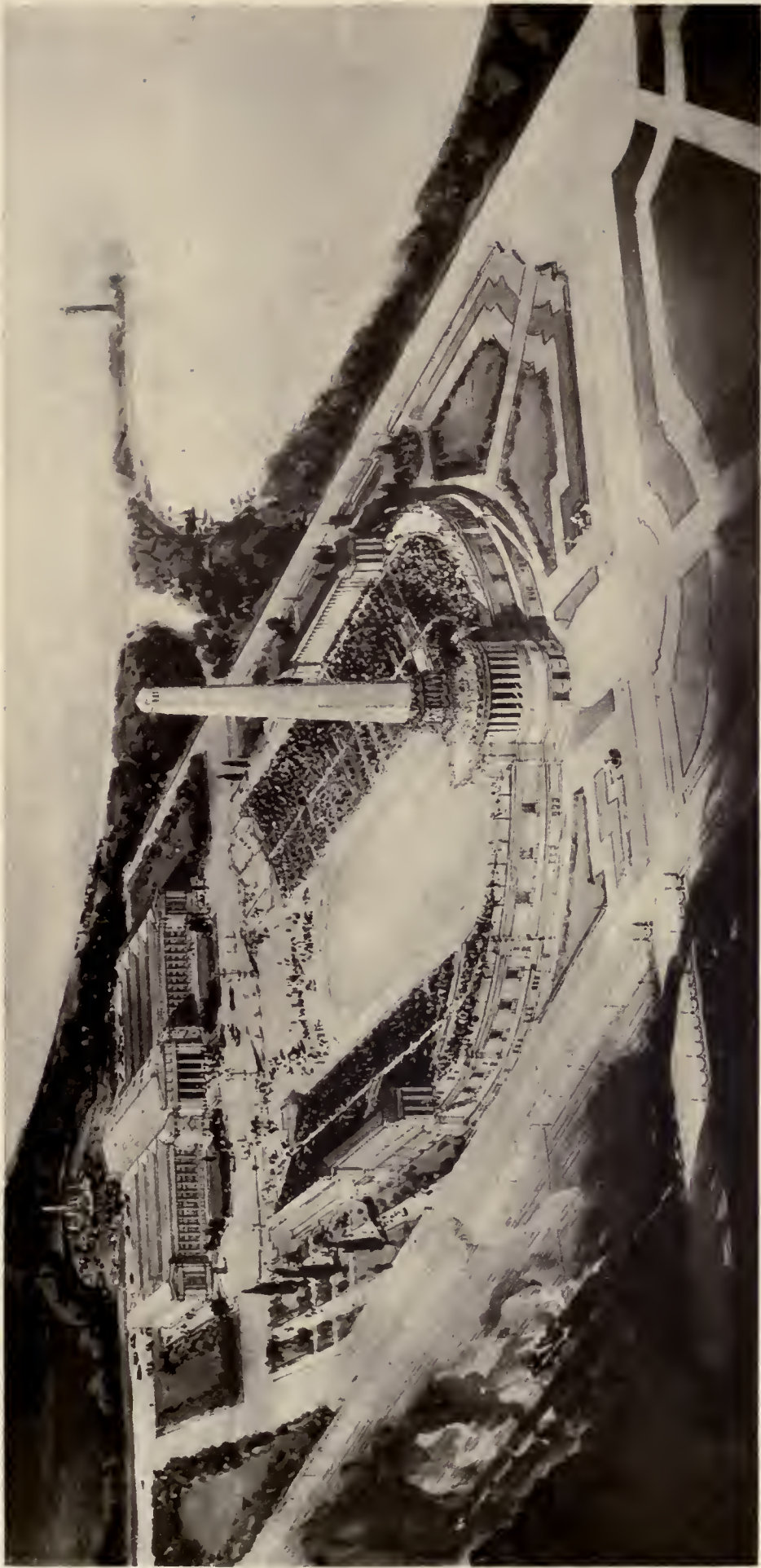

PERSPECTIVE  
COMPETITION FOR A STADIUM ON THE LAKE FRONT, CHICAGO  
FIRST PRIZE, ACCEPTED DESIGN—HOLABIRD & ROCHIE, ARCHITECTS

228 1



2282

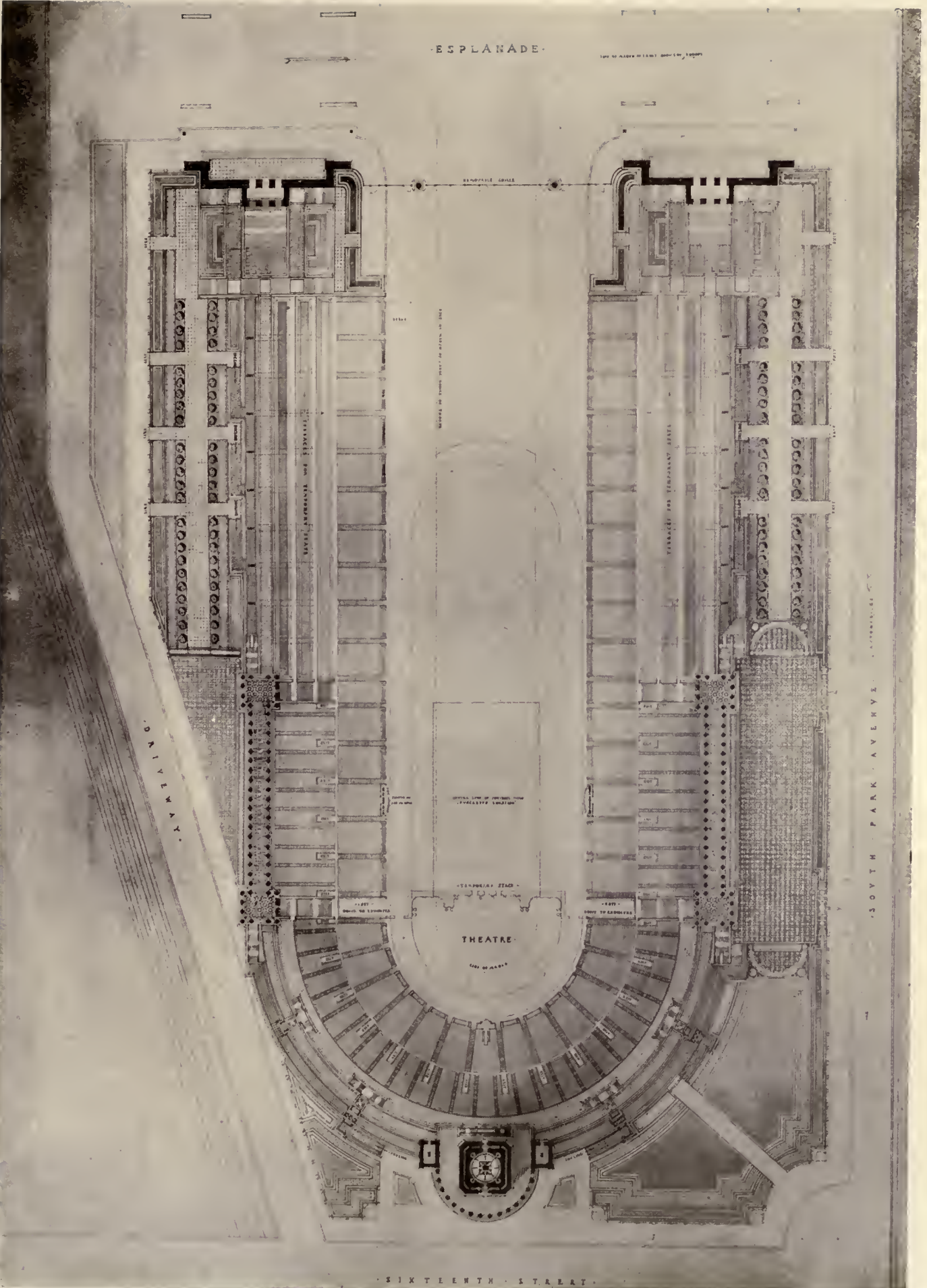

PLAN  
COMPETITION FOR A STADIUM ON THE LAKE FRONT CHICAGO



228 3



2284



PERSPECTIVE  
COMPETITION FOR A STADIUM ON THE LAKE FRONT, CHICAGO  
DESIGN SUBMITTED BY EDWARD H. BENNETT AND WILLIAM E. PARSONS, ARCHITECTS





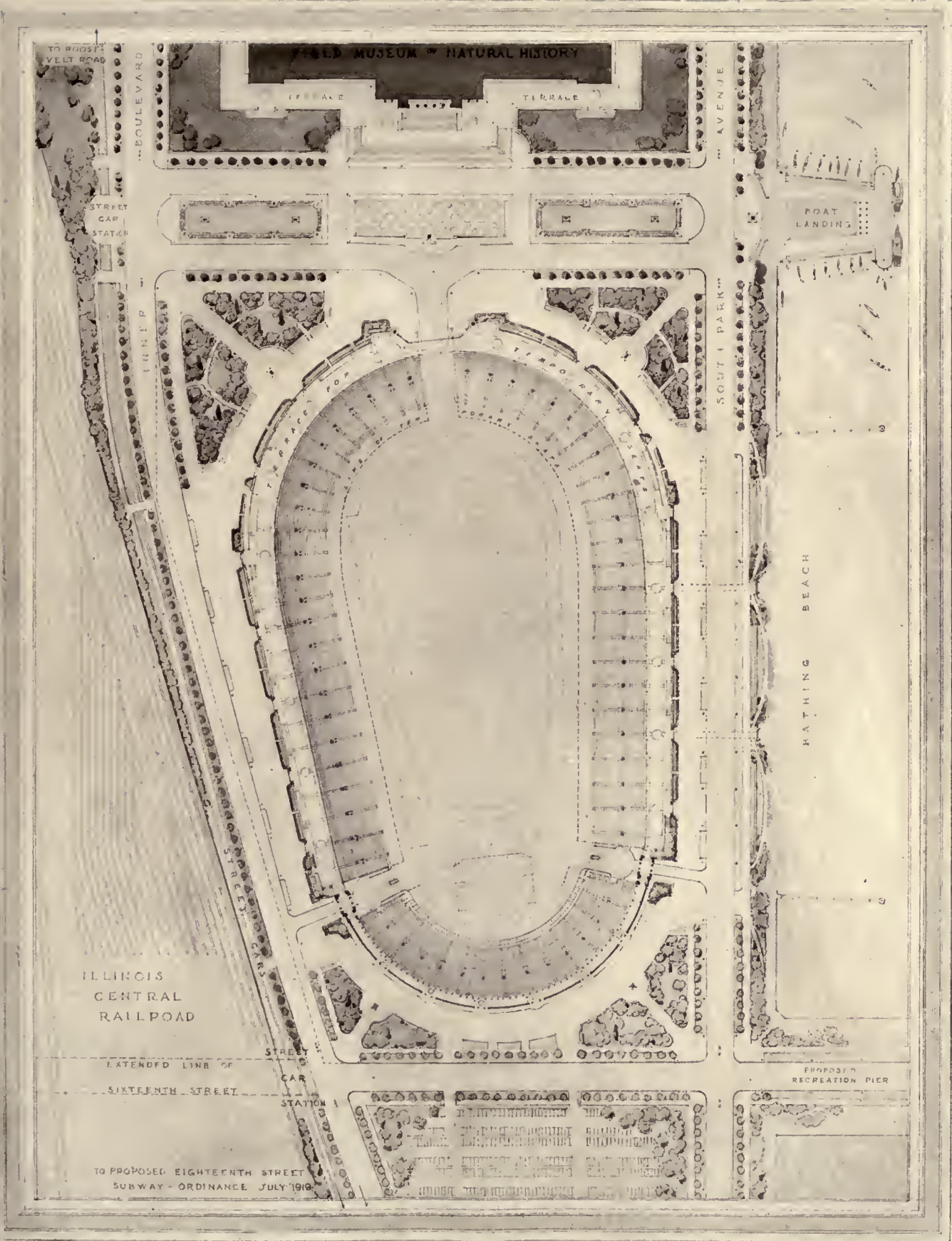

PLOT PLAN  
 COMPETITION FOR A STADIUM ON THE LAKE FRONT, CHICAGO  
 DESIGN SUBMITTED BY EDWARD D. BURNHAM AND WILLIAM W. PARSONS ARCHITECTS







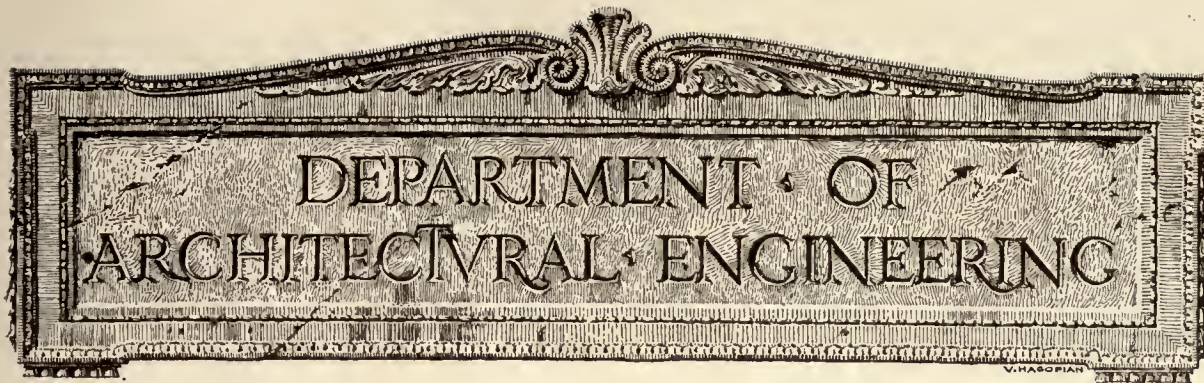

## National Conference on Concrete House Construction, Chicago, February 17, 18 and 19, 1920

CONCRETE, that ancient yet modern material of construction, has been fast coming into its own. During its development, there have sprung up, mushroom like, numerous concerns connected in some way with the industry. These have consisted of cement manufacturers, contractors, manufacturers of concrete handling and other machinery and those turning out various cement products, such as the cement block. These allied yet separate organizations have grown, each along its own line, and each independent to a large extent of the other. Naturally, such a development did not make for the best interests of concrete, and it remained for those who organized and carried through the National Conference on Concrete House Construction to correlate the efforts of all interested in such construction, to the end that the production of much needed houses might be expedited.

While reinforced concrete has been used to a large extent in the construction of commercial buildings, it has been made use of to a limited extent only in house construction. There have been several "housing schemes" in which concrete has been used partially or exclusively for the structural part of the buildings, such for instance as the Ingersoll houses at Phillipsburg, N. J., the Unit Construction Company's work at Youngstown, Ohio, the Van Guilder type of wall construction at the Carnegie Steel Company's housing development at Steelton, Ohio, or the houses at Donora. But these have been the exceptions not the rule.

Realizing that the demand for homes was greater than could be met by the use of the usual types of construction, and believing, as a result of the already successful use of concrete in house construction, that its employment should be increased, many allied organizations combined their efforts in planning and carrying out the National Conference:

No attempt will be made to give a detailed report of the proceedings here, but mention of the papers

presented, some of which will be published in part at a later date, will give some idea of the scope and aims of the conference.

At the opening session, February 17, three papers were read, as follows:

(1) "Housing Needs from the Viewpoint of Industry." By John Glass, Manufacturers' Record, Baltimore.

This was an excellent paper bringing out the correlation between industrial production and proper housing.

(2) "Moral Aspects of the Housing Problem." By John M. Vander Muelen, D.D., Oak Park, Ill.

Mr. Vander Muelen emphasized the fact that the *home owner* becomes a national asset. There is no better way to calm industrial unrest and prevent the spread of Bolshevism, than to induce employees to invest their savings in homes. Another point which received emphasis was the desirability of building *individual* houses instead of the multi-family type. This is an essential feature of a successful industrial housing scheme.

(3) "The Status of the Concrete House as Regards Building Codes." By Fred W. Lumis, Building Commissioner, Springfield, Mass.

The salient feature of this paper was its emphasis of the lack of building codes covering concrete house construction, and the need of formulating a standard and well considered code which might be adopted by all municipalities.

In the evening an informal joint dinner was held with the following organizations: The Building Officials' Conference, the American Concrete Institute, Associated General Contractors of America, Concrete Products Association, Concrete Block Machinery Association. The speakers were John J. Murphy, Ex-Tenement House Commissioner, New York; Hon. James P. Goodrich, Governor of Indiana; James J. Davis, Pittsburgh, Director-General, Loyal Order of Moose.

At the second session, February 18 (afternoon),

papers were presented by Irving K. Pond, Architect and Henry Holsman, Architect. Mr. Pond's paper was published in full in the AMERICAN ARCHITECT issue of February 11, 1920.

Reports were submitted by various committees at the evening session. The several methods of financing home building were presented by James F. Basiger. Among the other things he mentioned the Calder Bill now pending in Congress, which proposes to establish governmental aid to the home builder in a manner somewhat similar to that now given the farmer by the Home Loan Banks. Walter A. Hull reported on fire prevention.

An interesting paper entitled "New Developments in Surface-Treated Concrete and Stucco," by J. C. Pearson, U. S. Bureau of Standards and J. J. Earley, Sculptor, Washington, D. C., was also read and is of sufficient interest to warrant its presentation in full at a later date.

On February 19 (morning) a joint session with the Concrete Products Association was held.

The subject of farm housing was presented by K. J. T. Ekblaw.

An interesting paper on "Concrete and Cement Roofings" by D. Helmuth, indicated that considerable progress is being made in the manufacture of a satisfactory cement roofing tile.

"Insulation and Damp-proofing of Concrete Walls" was presented by Noland D. Mitchell, Structural Engineer, Supervising Architect's Office, U. S. Treasury Department. This is an important phase of house construction.

During the afternoon session the reports were made by the following: Committee on Monolithic Houses, Leslie H. Allen, Chairman; Committee on Unit Constructed Houses, J. J. Boyd, Jr., Chairman, and the Committee on Plastered and Gunit Concrete Houses, Emil G. Perrot, Chairman.

In order to further promote the objects of the conference the following standing committees were appointed:

*Committee on Architecture and Design* (Joint committee representing Illinois Society of Architects and Illinois Chapter American Institute of Architects): Robert Spencer, Chairman; Melville C. Chatten, John Reed Fugard, Bernhard C. Greengard, Ira W. Hoover, George C. Nimmons, Irving K. Pond.

*Committee on Monolithic Houses*: Leslie H. Allen, Springfield, Mass., Chairman; A. C. Irwin, Chicago, Secretary, and nine members.

*Committee on Unit Constructed Houses*: W. W. Boyd, Jr., St. Louis, Chairman; A. C. Irwin, Chicago, Secretary, and four members.

*Committee on Concrete Block Houses*: R. F. Havlik, Mooseheart, Ill., Chairman; E. S. Hanson, Chicago, Secretary, and thirty-two members.

*Committee on Plastered and Gunit Houses*: Emile G. Perrot, Philadelphia, Chairman; J. V. Schaefer, Chicago, Secretary, and four members.

*Committee on Concrete and Cement Roofings*: D. Helmuth, Cleveland, Chairman; E. L. Stephani, Chicago, Secretary, and seven members.

*Committee on Fire Protection*: Walter A. Hull, Washington, D. C., Chairman; J. E. Freeman, Chicago, Secretary, and five members.

*Committee on Financing Homes*: James F. Basiger, Chicago, Chairman; Leslie H. Allen, Springfield, Mass., Secretary, and six members.

*Committee on Farm Housing*: K. J. T. Ekblaw, Chicago, Chairman; W. G. Kaiser, Chicago, Secretary, and six members.

Those who attended look forward with expectancy to a second conference which will undoubtedly result.

It is clearly realized by all who are allied with concrete construction, that it is not by any means a cure-all for building ills, but that it has a rightful and legitimate place in the building industry. It may not always be suitable to construct the structural part of a building entirely of concrete and in such cases it must be combined with other materials to produce a suitable structure. In places where sand and gravel are plentiful, it would seem to have an economic advantage over other products manufactured at a distance.

Probably no more comprehensive and well considered argument setting forth the use and abuse of concrete in construction has been presented than was set forth by Irving K. Pond, F. A. I. A., past president of the Institute, previously referred to.

Concrete houses do not necessarily require extreme standardization to produce economy. Any type of construction which will not readily yield itself to the architect's conception of what a home should be is *not* one which will commend itself to him. The further development of concrete homes along truly artistic as well as economical, sanitary and fire preventive lines will indeed be a notable step in advance, and such a result, it is felt, has been brought nearer realization by the work of the conference just closed.

# American Society of Heating and Ventilating Engineers Holds Annual Meeting in New York City

THE twenty-sixth annual meeting of the American Society of Heating and Ventilating Engineers, held at the Engineering Society Building, 29 West 39th St., New York City, Jan. 27 to 29, 1920, proved to be one of the most lively and interesting as well as the most largely attended of any of the meetings so far held.

E. Vernon Hill, of Chicago, was elected president for the ensuing year.

The outgoing president, Walter S. Timmis, in opening the first business session of the convention, reviewed events of the past year, as related to the heating and ventilating industry, and urged putting into action the motto "LET US WORK."

A number of interesting and instructive papers were read and discussed. John R. Allen, in charge of the research laboratory, presented a paper on "Heat Losses From Direct Radiation," as well as one on "Determination of Radiant Heat Given Off by a Direct Radiator." The experiments from which data for these papers were derived covered a wide range of radiators and included tests on various forms.

One of the sessions was entirely devoted to papers on ventilation, and considerable discussion took place relative to the merits of Natural versus Artificial Ventilation. E. L. Hallett of St. Louis, presented a paper entitled "An Advance in Air Conditioning in School Buildings" and stated that ozone apparatus had been used with good effect in a downtown school in St. Louis where the attendance was made up of children of the foreign element, and the result from a questionnaire submitted to teachers and principals asking their opinion of the system was a statement that the attendance was better, that they did not feel so fatigued, that the children were less restless and that they did better work, and the efficiency of the apparatus was splendid. In answer to several inquiries Mr. Hallett stated that data on the system was available from the Board of Education of St. Louis, and could be obtained at any time.

At the evening session of Jan. 28, papers devoted to heating boilers were presented, including two dealing with the magazine feed boiler, one of which by Charles F. Newport dealt with its relation to fuel conservation and the other by E. C. Molby covered the development of this type of boiler. Both were vigorously discussed.

In the discussion of the subject of boilers, considerable criticism was voiced as to the construc-

tion of chimney flues. Boiler manufacturers and heating engineers stated the impossibility of the heating apparatus functioning properly unless the flue was of the proper size and height and also was well constructed. The opinion was expressed that leaking flues are the source of more heating trouble than any other one item.

The morning session of Jan. 29 was devoted largely to papers dealing with the use of fuel oil. This topic was preceded by the presentation of a paper on the prevention of corrosion of pipe, by F. N. Speller and W. H. Walker. The paper dealt largely with a de-activating apparatus through which the water first passes prior to entering the piping system. The results of experiments were set forth.

The papers presented dealing with the topic of fuel oil were as follows: Oil as a Fuel for Boilers and Furnaces, by H. H. Fleming; Oil Fuel, by F. W. Staley; Fuel Oil Equipment, by John P. Leak; Fuel Oil and Its Application to the Generation of Steam, by W. C. McTarnahan and Oil versus Coal, by David Moffat Myers.

Considerable discussion on the relative merits of oil and coal as a fuel, the availability and cost of oil, etc., transpired after the reading of these various papers.

While the men attending the convention were busy at the professional sessions, various entertainments were arranged for the visiting ladies.

On the closing day former Secretary of Commerce William C. Redfield spoke on the commercial relations of the United States. Among other remarks, Mr. Redfield said: "The primary reason for the Declaration of Independence, which was addressed to the world, was a deep regard for the opinion of mankind. Washington said: 'We shall have no entangling alliances.' We are mixed up in the affairs of the world, for Europe owes us \$15,000,000,000. The problem is how to get unmixed. This problem is of interest to everyone, for the quicker the debt is paid, the quicker the sum on the stub of the check for the income tax will be reduced." In closing he stated: "The problem for American commerce is supplying herself and upholding the world. We must have the good-will of the world. Good-will is an unseen reality and we would not dare to lose it. America is in an inspiring position and it must work and serve."

A dinner at the Hotel McAlpin, Jan. 29, closed the Society's most successful annual meeting.

# Common Brick Manufacturers Hold Annual Convention at Columbus, Ohio, February 16 to 18, 1920

**T**HE Second Annual Convention of the Common Brick Manufacturers' Association of America was held Feb. 16-17-18 at the Hotel Deshler, Columbus, Ohio, and was one of the most enthusiastic and successful meetings of brickmen ever held.

For a young organization—the Association is only one year old—its strength is remarkable, its members now comprising all of the most up-to-date brick manufacturers of the United States. The total output of brick of its members borders on four billion yearly.

One of the first questions decided by the Convention was that of the standard size of brick. A paper was read by one of the officers of the Association recommending the adoption of the American Face Brick size ( $2\frac{1}{4} \times 8 \times 3\frac{3}{4}$ ). Arguments were presented showing the advantages to the architect, the contractor, and the brickmaker himself which would follow the universal adoption of this standard.

Letters were also read from Prof. A. V. Bleininger and Warren E. Enley of the U. S. Bureau of Standards expressing themselves favorably toward the adoption of a uniform standard size for brick.

Committee C-3 of the A. S. T. M. convened in Columbus the following day, and changed their tentative size to meet the size adopted by the Common Brick Manufacturers' Association.

The standard sizes of the A. S. T. M., the American Face Brick Association, the Common Brick Manufacturers' Association of America, and The National Brick Manufacturers' Association are now exactly the same— $2\frac{1}{4} \times 3\frac{3}{4} \times 8$ ".

Mr. Thomas R. Preece, the Vice President of the International Bricklayers' Union, followed with a talk on "How the Brick Manufacturer and Bricklayer May Co-operate." In the course of his remarks Mr. Preece deplored the tendency of the average contractor in refusing to employ apprentices. Mr. Preece stated that twenty-five thousand more apprentices would be in process of training even now if contractors would employ them.

Mr. Warren S. Griffiss, of Baltimore, followed with a paper on "The Beauty of Common Brick." Mr. D. Knickerbacker Boyd, F. A. I. A., of Philadelphia, followed with a paper on "The Architect and the Industry—The Vast Possibilities of Common Brick." After this paper the following resolution was passed:

WHEREAS, The Common Brick Manufacturers' Association of America, in Second Annual

Convention, assembled this eighteenth day of February, 1920, at Columbus, Ohio, has been enlightened and inspired by an address of inestimable value to its organization, its members and the future of the product which it champions, and

WHEREAS, we wish to make proper recognition of the benefits of said address, by the adoption of a resolution complimentary to its author, Mr. D. Knickerbacker Boyd, now, therefore, be it

RESOLVED, that we hereby do so and place our organization on record as firmly believing in the principles herein set forth;

First, that the building policy of the people of this country has heretofore been too largely left to individual initiative which, without authoritative data from any one centralized agency, governmental or otherwise, has been conducted along lines based on lack of adequate information as to the source, nature, and appropriate use of materials.

Second, that the many buildings constructed of wood have been largely responsible for exhausting the supply of lumber and causing the destruction of forests and standing timber produced by long years of growth and development, impossible of replacement without similar long years of growth, if replaced at all.

Third, that the destruction of much of such growths of timber seriously affects the watersheds of this country, results in an enormous economic loss through lack of fullest conservation of the country's natural resources, and impairs the landscape, scenic effects, and privileges of the people.

Fourth, that the products of nature's growths of timber should not be used in vertical structural features of buildings or for their roof coverings or elsewhere that any unburnable material might be used and that, wherever used, wood shall be adequately fire stopped.

Fifth, that all such timber as can through scientific cutting and reforestation be spared, should be made available for such of the other diversified uses of man than which no other more suitable or satisfactory material is obtainable.

Therefore, be it further

RESOLVED, by The Common Brick Manufacturers' Association that the national and state governments be requested to put into effect as speedily as possible a comprehensive plan for a system, observable in every state, for the scientific cutting and reforestation of timber and that the national government be also requested to avail itself of the co-operation of all scientific, professional, and technical organizations versed in conservation meas-



ures, fire prevention, and permanent building construction, to educate and inform the people as to the proper materials to use and methods to employ in the erection of all buildings for the sheltering of humanity, in order to accomplish the following purposes:

- (a) To secure safety to life from destruction by fire.
- (b) To secure the health and comfort of the occupants of buildings.
- (c) To make for durability and consequent decrease in maintenance costs.
- (d) To lessen loss of property and conserve the natural resources of the country.

And that those materials extracted from the earth, whose supply is practically inexhaustible and the nature of which is indestructible when properly manufactured and used, should be taken advantage of to replace destructible or combustible materials, in the interest not alone of safety, health, and maintenance, but to preserve to the world the wealth created by the labors of man, and to decrease the cost of safeguarding America against fires.

And; that The Common Brick Manufacturers' Association call upon the producers of all non-combustible building materials to co-operate with the government and with each other in securing the most appropriate and permanent use of such materials in the various features of building construction, including by reason of demonstrated facts the use of solid walls as proper for fire walls, party walls, or barriers against fire in buildings or for exits, and be it finally,

RESOLVED, that The Common Brick Manufacturers' Association offer to the government, to all scientific, professional, and technical organizations, and to the citizens of the United States, individually and collectively, the services and best offices of its organization and its members in securing, to the interest of humanity, the most advantageous use of non-combustible, permanent and economic materials including solid common brick as a basic building material.

The report by states and districts upon (1) labor, (2) fuel, (3) empty car supply, (4) stock and (5) demand, brought out the fact that in almost every section of the country the manufacturers would be better able to keep up with the demand if they could get railroad cars. The feeling of the convention seemed to be that since building is now of paramount importance—the lack of buildings tending to increase rents and the high cost of living—the railroads should make a special effort to provide cars so that building materials of all kinds could be moved expeditiously.

## Herbert C. Hoover Elected President of Mining and Metallurgical Engineers

AT the 121st annual meeting of the American Institute of Mining and Metallurgical Engineers, held Feb. 16 to 19, at the Engineering Societies Building, New York City, Herbert C. Hoover was elected president for the ensuing year.

Many interesting papers were presented and discussed, those bearing on the subject of coal, probably holding the most important place. The morning session of the opening day, was devoted to papers on oil, and the afternoon session of the same day devoted to a discussion of oil and coal resources and production. A simultaneous session on industrial organization was also held. On Feb. 17 the sessions were devoted to papers dealing with the foreign oil supply and the coal industry.

In the evening a reception was given to the new president and Mrs. Hoover at the Waldorf-Astoria, which was followed by a banquet and dance.

Feb. 18 was devoted to papers on the stabilization of the coal industry, followed by an open forum. Papers on iron, coal and steel production were presented at simultaneous sessions.

The closing day, Feb. 19, was occupied by a visit to the Bush Terminal Buildings at Brooklyn, N. Y.

## Standardizing Steel Bars to Increase Production

IT is interesting to note that in common with other manufacturers who are endeavoring to meet the demand for an increased output, a number of companies manufacturing steel bars have come to the conclusion that continuation of a large number of styles differing but slightly from each other is a decided handicap.

The War Service Committee of the Concrete Reinforcing Industry recommends that an elimination of many sizes which in reality are duplications of equivalent areas, be effected. This would in no wise impair the efficiency of design, but would promote production. The recommendation has been accepted and approximately fifty per cent of commercial sizes of reinforced bars now current, will no longer be manufactured after March 1, 1920.

The various corporations who are co-operating in this movement are the American System of Reinforcing, Chicago; Concrete Steel Co., New York; Corrugated-Bar Co., Inc., Buffalo; Paul J. Kalman Co., St. Paul; Truscon Steel Co., Youngstown; and the Edward A. Tucker Co., Boston.

# New Joint Committee on Standard Specifications for Concrete and Reinforced Concrete Organized

The Joint Committee on Standard Specifications for Concrete and Reinforced Concrete has just been organized. The committee consists of five representatives from each of the following organizations:

American Society of Civil Engineers.  
American Society for Testing Materials.  
American Railway Engineering Association.  
Portland Cement Association.  
American Concrete Institute.

The purpose of the committee is to make a thorough study of all available data on the subject of concrete, concrete materials and reinforced concrete and to incorporate the most modern information and experience into a general specification which may serve as a pattern for detailed specifications covering specific types of concrete construction.

The new "Joint Committee" may be considered as the successor of the "Joint Committee on Concrete and Reinforced Concrete," which was organized in 1904, through the co-operation of the same engineering and technical societies. The original Joint Committee presented its final report to the parent organizations in 1916.

The membership of the present "Joint Committee" is given below:

## *American Society of Civil Engineers.*

R. P. Miller (Chairman), Superintendent of Buildings, New York City.  
W. K. Hatt, Professor of Civil Engineering, Purdue University, Lafayette, Ind.  
A. E. Lindau, General Manager of Sales, Corrugated Bar Co., Mutual Life Building, Buffalo, N. Y.  
W. A. Slater, Bureau of Standards, Washington, D. C.  
S. E. Thompson, Consulting Engineer, 136 Federal St., Boston, Mass.

## *American Railway Engineering Association.*

J. J. Yates (Chairman), Bridge Engineer, Central Railroad of New Jersey, 143 Liberty St., New York City.  
G. E. Boyd, Division Engineer, Delaware, Lackawanna & Western Railroad, Buffalo, N. Y.  
F. E. Schall, Bridge Engineer, Lehigh Valley Railroad, Bethlehem, Pa.  
C. C. Westfall, Engineer of Bridges, Illinois Central Railroad, Chicago, Ill.  
H. T. Welty, Engineer of Structures, New York Central Railroad, New York City.

## *American Concrete Institute.*

S. C. Hollister (Chairman), Consulting Engineer, 320 Widener Building, Philadelphia, Pa.  
R. W. Lesley, 611 Pennsylvania Building, Philadelphia, Pa.

A. R. Lord, Lord Engineering Co., 6 North Clark St., Chicago.

E. J. Moore, Turner Construction Co., 224 Madison Ave., New York City.

L. C. Wason, Aberthaw Construction Co., 27 School St., Boston, Mass.

## *Portland Cement Association.*

F. W. Kelley (Chairman) President, The Helderberg Cement Co., Albany, N. Y.

Ernest Ashton, Chief Chemist, Lehigh Portland Cement Co., Allentown, Pa.

J. H. Libberton, Manager Service Bureau, Universal Portland Cement Co., 210 South LaSalle St., Chicago.

E. D. Boyer, Cement Expert, Atlas Portland Cement Co., 30 Broad St., New York City.

D. A. Abrams, Professor in Charge, Structural Materials Research Laboratory, Lewis Institute, Chicago.

## *American Society for Testing Materials.*

R. L. Humphrey (Chairman), Consulting Engineer, 805 Harrison Building, Philadelphia, Pa.

L. S. Moisseiff, Consulting Engineer, 69 Wall St., New York City.

H. H. Quimby, Chief Engineer, Department of City Transit, 3920 Girard Ave., Philadelphia, Pa.

A. T. Goldbeck, Engineer of Tests, U. S. Bureau of Public Roads, Washington, D. C.

E. E. Hughes, Vice-President and General Manager, Franklin Steel Co., Franklin, Pa.

The organization meeting of the committee was held at the Engineers' Club, Philadelphia, on Feb. 11, 1920.

The following officers were elected:

R. L. Humphrey, Chairman, Philadelphia.

J. J. Yates, Vice-Chairman, New York City.

D. A. Abrams, Secretary-Treasurer, Chicago.

The following committees, consisting of 5 to 7 members each, have been organized:

Committee 1—Concrete Materials.

" 2—Metal Reinforcing.

" 3—Proportioning and Mixing.

" 4—Forms and Placing.

" 5—Design.

" 6—Details of Construction.

" 7—Waterproofing and Protective Treatment.

" 8—Surface Finish.

" 9—Form of Specification.

A number of the committees have organized and are actively engaged in the preparation of their preliminary reports. The next meeting of the committee will probably be held at Asbury Park, N. J., about June 22, during the annual convention of the American Society for Testing Materials.

# Gypsum as a Building Material

## A Description of Its Characteristics and Uses, and Its Adaptability to Interior Plastering

**T**O-DAY, as never before, there is a constant search by architects for materials which more nearly approach the ideal and at the same time effect economy in building construction. It is due to this tendency that new types of construction are being developed. Not only are the various elements of the structures being built with materials heretofore but little known and hence little used, but also many well-known materials are being adapted to new uses. While manufacturers are apt from the start to claim success for their product, it is only after the test of time that judgment can competently be passed. Broad experience in building work will often prove of value in judging the merits of new forms of construction.

Among the various materials used in the building industry, perhaps none has in recent years forged to the front more rapidly than gypsum. Due to this rapid development, there has been lack of exact knowledge as to the characteristics of the material and the various uses to which it is best adapted. It will be profitable to survey the field of its usefulness.

Gypsum is one of the most ancient of building materials. The Greeks used gypsum in Pliny's time. The writings of this naturalist of ancient history (23-79 A. D.) are included in thirty-six books, book XXXVI dealing with the different kinds of stones and marble, including lime, sand and gypsum. Pliny also minutely describes the removal of a beautiful gypsum plaster frieze from Lacedæmon to adorn a public building in Rome. Going still further back, the Temple of Apollo at Bassæ, built four hundred and seventy years before Christ, affords an excellent example of the use and permanent structural qualities of gypsum. The great pyramids of Egypt contain plaster work of gypsum executed at least four thousand years ago.

The common name plaster of Paris is often applied to all calcined gypsum because of the large quantities of gypsum rock beds found near Paris, France. In France and Germany gypsum is used for many building purposes, including inside and outside plastering, walls, floors and roofs. In the United States and Canada gypsum has for years been used to a large extent for interior plastering. In proper form gypsum is also used structurally for floors, roofs and outside walls. The United States Government, in its war building operations, used many million square feet of reinforced gypsum roofs.

Gypsum is hydrous calcium sulphate (the sulphate of calcium with water of crystallization in chemical combination), and is expressed chemically as  $\text{CaSO}_4 + 2\text{H}_2\text{O}$ . It contains when pure 79.1 per cent of calcium sulphate ( $\text{CaSO}_4$ ) and 20.9 per cent of water ( $\text{H}_2\text{O}$ ). The dehydration of ground gypsum rock by physical process yields calcined gypsum, and this is the base from which gypsum plasters and other gypsum products used in building construction are made.

It is the method of calcination employed, and the degree to which such calcination is carried forward, that determines the possibilities and uses to which the calcined product may be applied in the field of building construction.

Gypsum usually occurs in beds of considerable area from four to thirty feet in thickness. It is quarried or mined in eighteen states and the territory of Alaska. It is also imported from Nova Scotia, New Brunswick and Ontario, Canada, into the United States.

### GYP-SUM PLASTER

**G**YPSUM plasters are prepared from calcined gypsum. They may be classed in a general way, as follows:

*Ready Mixed Gypsum Plaster.*—This plaster (sometimes called Prepared or Sanded Plaster) is a plastering material in which the predominating cementitious material is calcined gypsum, and which is mixed by the manufacturer with sand and other necessary constituent parts in proper proportion. It requires but the addition of water to make it ready for use. It is advantageous to use this material in cases where good clean sand is hard to procure. Where good sand is procurable and the freight rates amount to more than the cost of the sand, the use of ready-mixed gypsum plaster is not economical.

*Gypsum Wood Fiber Plaster.*—This is a plastering material in which not less than 80 per cent by weight is calcined gypsum and not less than 1 per cent consists of a non-staining wood fiber. The remainder is composed of hydrated lime, ground clay, asbestos, sand, retarder or cementitious material other than calcined gypsum, mixed in the required proportions by the manufacturer. This plaster is used with or without the admixture of sand, and is in demand where light weight, tough, insulating and highly fire-resistive surfaces are required.

*Neat Gypsum Plaster.*—Neat Gypsum Plaster (sometimes termed Gypsum Cement Plaster) is a plastering material in which not less than 85 per cent by weight of the cementitious material is calcined gypsum. The remainder is composed of hydrated lime, ground clay, asbestos, retarder fiber, or cementitious material other than calcined gypsum, mixed in the required proportions by the manufacturer. This plaster is identical with "Ready Mixed Gypsum Plaster," but requires the addition of from two to three parts by weight of sand before mixing in water and applying.

*Other Gypsum Plasters.*—It is not within the scope of this article to enter into the details of other gypsum plasters manufactured and sold in large quantities for specific purposes, such as "Gauging Plasters," "Keene's Cements," "Bond Plasters," "Molding Plasters," "Trowel Finishing Plasters," etc., except to state that in practically all building operations there is a demand for some or all of the plasters named.

#### CHARACTERISTICS OF GYPSUM PLASTERS.

Gypsum plasters possess high tensile and compressive values. The American Society for Testing Materials, Committee C-11 on Gypsum, in specifications for "Calcined Gypsum," and a "Tentative Report on Gypsum Plasters" makes note of these strength properties.

The hardening action of gypsum plaster is one of crystallization. This takes place quickly and uniformly from face to face through the entire mass, and at the same time, due to the water of crystallization combining chemically with the calcined gypsum. As the result of this chemical action the problem of getting rid of dampness and moisture in the building is not a serious one when the proper quantity of water has been used in mixing.

Gypsum plasters set rapidly. This permits the carpenters to follow the plasterers in about 48 hours. Thus the work of erecting trim, casings, base-boards, chair-rails, mouldings and similar interior finish can proceed without delay. The setting properties permit rapid plastering, since plaster coats can at once follow, thus obviating the repeated moving of scaffolding.

Due to this quick setting, the danger of freezing is not as great with gypsum. The U. S. Government in the construction of industrial houses, used gypsum plaster, and was particular that it should be used in localities and at periods, where freezing temperatures were to be expected, and where, for reasons stated, speed was necessary.

Tests made as to its fire-resisting properties show gypsum to be, from this standpoint, an admirable

material. All materials are injured by the action of high temperatures in one way or another; some fuse and melt, others warp, buckle, crack and disintegrate. The changes due to fire which are least injurious to the construction as a whole, and the material in question, are such as are due to slow calcination without appreciable expansion and consequent disruption due to warping and buckling.

The water of crystallization liberated from gypsum rock by physical means (in order to obtain the calcined product from which gypsum plaster is manufactured) is taken back again during the setting of the gypsum plaster in chemical crystalline form.

During the period of a fire, calcination of the exposed gypsum plastered surface again takes place and the recombined water of crystallization is again slowly liberated. So long as this process of calcination of the plastered surface is continuing, and water of hydration is being liberated, steam will be present and for this reason it is not possible under such fire conditions to increase the temperature of the back side of the gypsum plaster coat to a temperature appreciably above 212 degrees Fahr.

Gypsum plaster may be applied upon any plastering lath or base. It is especially adapted to plastering on gypsum blocks and plaster board, and on account of its quick setting and strength properties is extensively used for plastering on metal lath.

From the foregoing it will be seen that in the field of plastering, gypsum forms an admirable material and has a wide and legitimate use.

### A Study of the Forms in Which Sulphur Occurs in Coal

Under this title the University of Illinois has issued a bulletin No. 111 by A. R. Powell and S. W. Parr, giving the results of a thorough investigation of the subject made in the chemistry department of the Engineering Experiment Station of that university. The nature of the four sulphur compounds in coal, the quantity of each form present, and the change which characteristic forms undergo when the coal is allowed to stand or is subjected to coking formed the basis of the investigation.

The devising of methods of analysis has been much sought after in recent years by coal and coke investigators, but without satisfactory results up to the present time. The methods proposed in this bulletin have been put to extended tests with exceedingly satisfactory results.

Copies of bulletin No. 111 may be had without charge by addressing the Engineering Experiment Station of Urbana, Ill.

236<sup>u</sup>

Forstispiece No 2305

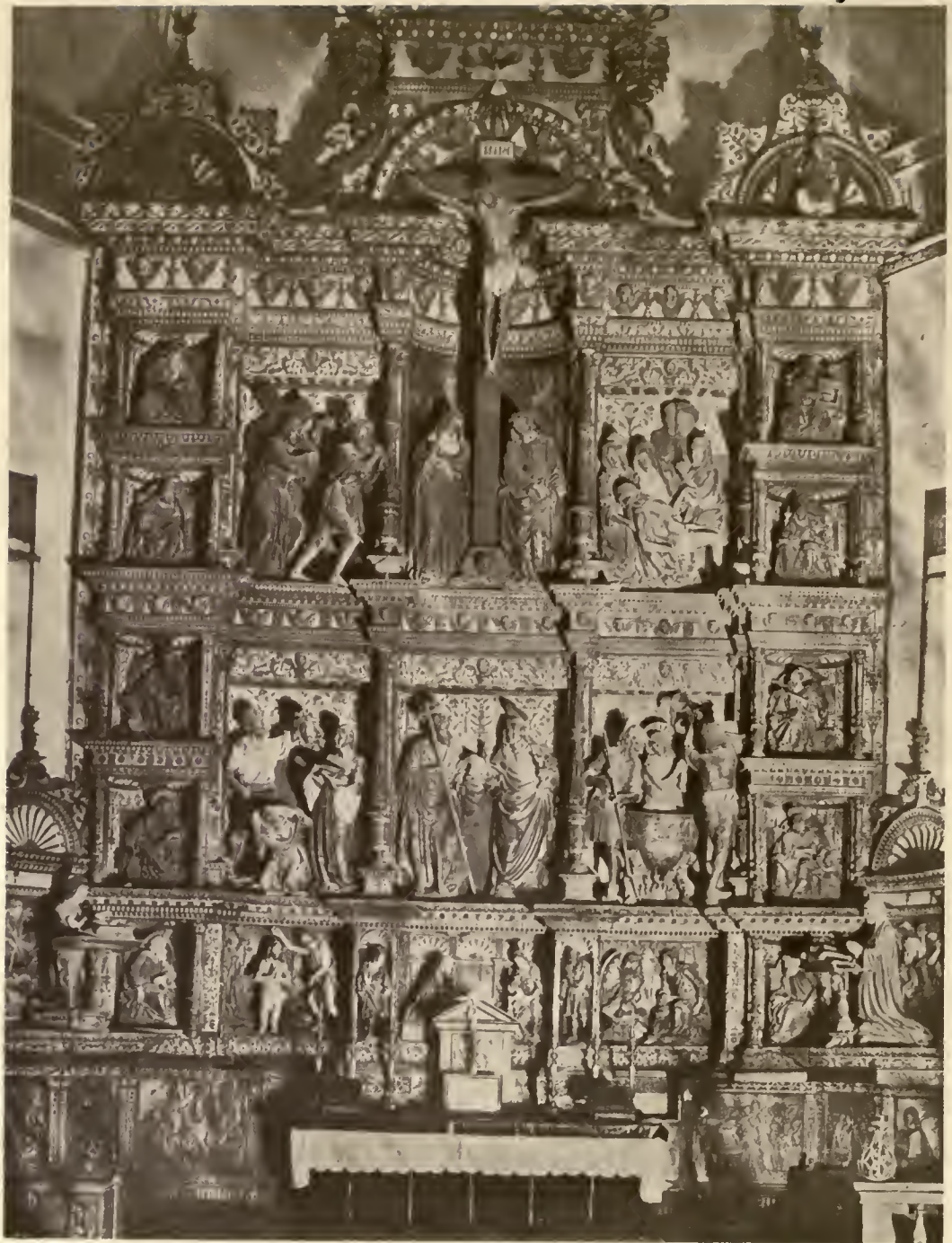

ALTAR IN THE CATHEDRAL, GRANADA

# THE AMERICAN ARCHITECT

VOL. CXVII

WEDNESDAY, FEBRUARY 25, 1920

NUMBER 2305

## Some Advantages of Fixed-Fee Contract\*

**I**S the general contractor to remain a constructive force in the building industry? We would hardly be attending this meeting were we not certain that the general contractor renders a needed service to the owner and architect and engineer. Certainty of delivery within the set time, reasonableness of the cost of construction, and the carrying out of plans and specifications without undue difficulty to owner or architect in getting that compliance, are dependent upon the existence of concerns such as are represented in the memberships of this association.

Yet there are certain individuals who see this matter differently, and who, noting certain things wrong, believe that the remedy is to be found in the elimination of the general contractor and the assumption of his duties by the architect. What are some of these difficulties and what is the true answer? A well-known Middle West architect recently stated one side of the question in a letter to an architectural paper. That letter is significant to the members of this association as outlining a definite effort being made to get work done without the general contractor. It started with the right premises. I do not feel, however, that we as an organization or as individuals can agree with the conclusions. Let me quote:

"Curiously enough, the architect has little or no direct dealings with the craftsman who executes his designs, and the worst of it is that the head contractor is placed in a position in relation to the architect which is the very opposite of what it should be to secure the ideal results for architecture.

"Our system of letting work by competitive bidding and then placing the contractor in a position where his profit depends largely on doing as little as the contract will allow for the final execution of the work is a vicious system which has always resulted in making impossible that sympathetic cooperation between architect, master builder and

craftsman, which must exist in order to secure the best results in the work."

I think little explanation of this statement is necessary. We all know it to be true. It is a clear portrayal of the situation under the Lump-Sum Contract. Regardless of the builder's ability, the amount remaining for profit is little or much, precisely according as the builder is fair or unfair, generous or tight in his interpretation of specifications.

But what is the answer? The author quoted has one idea and we have another. This architect goes on to say:

"An architectural firm with an architect at the head, a master builder and all of his assistants, including a competent force of skilled craftsmen to carry out sympathetically all of the details of the work, would make an organization which it must be admitted would undoubtedly be far superior in every way to the organization it is at present necessary to gather together for every architectural problem undertaken."

I submit that the Fixed-Fee Contract is a better solution of the problem. It requires that a reasonable fee be paid for a definite service.

**S**OME architects may handle their clients' work through letting all operations to subcontractors and may accomplish a good result, but there is no inherent necessity for the architect to broaden his scope. If he desires to increase his opportunity of making profit by extending his activities into the construction field it is unquestionably permissible, but to do so he must build a special construction organization able to do just what the general contractor now does, and, candidly, most architects would prefer not to be responsible for the larger organization with its certain heavy overhead. In our judgment, after forty years' experience with the various forms of building contracts, the Cost-Plus-Fixed-Fee Contract, when made with a builder of integrity and ability, brings all that a fair-minded owner can expect or want.

\*A paper presented at the convention of the Associated General Contractors of America, at Chicago, Feb. 18, 1920.

## THE AMERICAN ARCHITECT

Ability to co-ordinate work is fundamental to economy. It is second nature to the general contractor. While men available to the general contractor are also available to the architectural firm, yet certain jobs going forward to-day where the architect handles all the work through subcontracts show very conclusively the lack of that co-ordination. A structure cannot be erected piecemeal, particularly in the case of concrete frame and floors. The continuance of identical operations over large areas is vital to economy. The synchronizing of subcontracts is equally important. If the orderly procession of work is not maintained someone is going to lose money or time or both. The subcontractor will not take that responsibility. The architect will do his best to co-ordinate all operations, but the owner holds the bag.

We have, then, merely a merging of architectural and construction activities under one head. That co-ordination may be entirely successful but it does not argue against the general contractor continuing to operate to the advantage of the majority of owners and also of architects who prefer to remain within their chosen field.

Co-ordination means economy, and is dependent upon the absolute dovetailing of all trades represented with each other and particularly with the main structural elements. The framework could be built at least cost if no cognizance were taken of other trades. If that work is let as a separate contract there will be little sympathy on the part of the builder with delays occasioned by or to other trades. Such delays will be the basis for "extras." The better way is to have the structural frame handled by the same organization responsible for the general co-ordination of all work. Therefore the architectural firm handling construction should do exactly what the general contractor now does. But, as a matter of fact, architectural firms do not except in rare cases, retain any part of the work for their own construction force to handle. Therefore such architect's service does not parallel the operations of the general contractor who does from 40 to 60 per cent of the work with his own organization and equipment.

But how will this contract meet our critic's objections? He wants the builder to operate with, instead of against, the architect. On the Lump-Sum basis there is a premium placed upon skinning the job and the multiplying of controverted interpretations of plans and specifications. Remove that premium and the difficulty disappears. The Fixed-Fee Contract does it.

**T**HE "ideal result for architecture" consists in obtaining the best possible building at the lowest cost compatible with a reasonable time for

execution. Now, the best possible building is not reasonably to be expected where the builder can increase his profit by the amount of every omission or undetected substitution. Nor will there be a fine execution of the work where every minor opportunity for betterment of plans and in fact every necessity for change from original layout offers opportunity for extras on which few contractors have ever been known to suffer a loss. Under the Fixed-Fee plan it is possible to order changes, great or small, with absolute knowledge that the cost will be fair and often without increasing the amount of the fee.

Unquestionably the Lump-Sum system has many faults. It often gives opportunity for arbitrary and unfair rulings against the contractor, in favor of the owner. It kills that sympathetic co-operation between architect, master builder, craftsmen and owner, which should exist if the owner is to secure the best results. To revive that co-operation we need only to adopt the Fixed-Fee principle.

May I quote from another well-known architect writing also in the architectural press and answering a question propounded to the membership of the Illinois Society of Architects. That question was: "Can construction costs be lowered?" We are all interested in its solution. Let me quote him briefly.

"On first reading I was inclined to say that it cannot be done . . . one method occurs to me. The idea I had concerns the letting of contracts. . . . There are two methods, first: Letting separate contracts for each branch of the work on a unit price basis. Second: letting a general contract for the entire work on the Cost-Plus-Percentage basis. The latter method is the one I suggest. . . ." Quoting further:

"The question is largely one of buying power. The general contractor can buy and sublet so much cheaper than the architect that he saves not only his own percentage but in most cases considerably more. . . ."

"The organized contractor's buying power is based on the same qualification as that of any business man who goes into the market to buy goods. He knows values and he knows the market. . . ."

"There is still another advantage. The element of divided interest is eliminated. The relation of owner, contractor and architect becomes one of co-operation solely, each striving for the best results at minimum cost. . . ."

Thus we have heard from two architects. There is between them no middle ground. With the premises of the former we may agree, and with both the premises and conclusions of the latter we do agree.



Some of our members are strong partisans still of the Lump-Sum Contract and desire the Fixed-Fee Contract to be dropped. I believe, however, that under to-day's conditions the consensus of opinion of this organization, as well as of most owners, architects and engineers, is that the Fixed-Fee form of contract is wise and necessary.

The case might be different if we knew what carpenter labor would cost six weeks from to-day or whether cabinet work included in the contract will be delivered at an estimated figure or at a considerably increased cost, because of the almost impossibility of securing materials. Are contracts for certain materials worth the paper on which they are written? It is my understanding that certain of the smaller material manufacturers in one field have oversold their capacity several times and can deliver but a fraction of what they have contracted to deliver. Will they make good on their earlier low-priced orders or on their later high-priced contracts? What will we have to pay next summer when excuses take the place of shipments?

I believe these conditions are sufficient reason for the adoption of the Cost-Plus-Fixed-Fee Contract by builders; for its approval by architects and engineers and for its acceptance by owners who are fair enough to expect to pay what their buildings really cost under capable and trustworthy management. We can do our utmost to safeguard an owner against undue cost, but it is not our province to guarantee a cost unless we wish to enter into competition with Lloyd's. On the other hand, were the market falling, surely the owner would desire the advantage of possible lower costs.

**T**HE Cost-Plus-Fixed-Fee Contract is just as adaptable to smaller-sized jobs as to the largest construction work, and the smaller contractors who are honest and capable can do work on this basis as readily as the larger contractors. The inefficient dishonest contractor, whether large or small, will be weeded out, and the standards of the building industry will inevitably be raised to much higher levels than would ever be possible under the Lump-Sum contract.

To me the vital necessity to-day is for this association to get behind the Cost-Plus-Fixed-Fee Contract for Building Construction. General contractors will not lose by its adoption; they have much to gain. Architects and engineers have much to gain. Owners have much to gain.

For neither the owner nor his architect and engineer desires the cheapest building it is possible for a builder to erect under the plans and specifications. But that is exactly what he gets under the Lump-Sum contract. There can be no such thing as complete specifications. A Lump-Sum Contract

is a standing invitation to a builder to skimp the work just as far as he can get away with it.

Of course, a reliable contractor, jealous of his reputation, will not intentionally be unfair, and yet he is not able to look at a problem wholly from the standpoint of the owner if such an attitude jeopardizes his profit. Details not specifically covered in plans and specifications are frequently essential to the success of a building, and the builder is not able under a Lump-Sum Contract both to conserve his own interests and comply with the owner's wishes.

On the Fixed-Fee plan, however, his profit is determined when the contract is signed, and from that date he is seeking to erect the building speedily (so that he may release his organization to earn another fee), to erect it according to plans and specifications plus all later expressed wishes of architect and owner (in order that owner may again seek his service), and to erect it at the least cost compatible with the set standard of quality and speed in order that he may share in the savings.

Naturally, the architect has an interest in these things. His work need be only that of interpreter, and not of watch-dog.

Furthermore, the Fixed-Fee Contract permits work to proceed on the day the contract is signed. Construction may go on coincidentally with the development of details. If speed is paramount, the fixed-fee plan permits saving weeks and often months, required otherwise for completion of plans and specifications, quantity surveys, advertising for bids and final letting of contract. Under the Lump-Sum contract not one step can be taken until the contract is let on completed plans and specifications.

Occasionally a few dollars may be lost to an owner due to the later detailed plans necessitating changes in the preliminary construction, but this seldom occurs.

**A**N interesting comparison of results under the two methods of contracting has come to our attention. Last year two competing mercantile concerns decided at about the same time to enter a new territory, and service could only start after new warehouses were erected. Two reputable general contractors were engaged, one upon the lump-sum and the other upon the fixed-fee basis. The lump-sum job, almost identical in size with the other, was started first but is not yet in service. The fixed-fee job was completed and in use in December. Owners of the latter advised architect and builder of the imperative need for speed and the successful outcome was the result, not of greater contracting ability, but of co-operation, trust and confidence on one job and its lack on the

## THE AMERICAN ARCHITECT

other, and the possibility under the Fixed-Fee Contract of beginning work on the signing of the contract, of excavating while foundation plans were being prepared, and of keeping the work throughout only one step behind the design.

But from the standpoint of the builder (a member of this association), what are the benefits except as we share the satisfaction of owner and architect?

Do we not render a definite service for which we should be paid? Is it not well that we know with some certainty what a given operation is to net us? Is it not legitimate that we put our profession upon a service basis comparable to that of the architect and engineer? Building contracting firms are notoriously short-lived and the fault is not, we believe, in the lack of business ability so much as the system.

But a more fundamental reason exists than those previously mentioned. I believe that the reason that this association should go on record as favoring the Fixed-Fee Contract is that it will eliminate from the field the dishonest builder. It will eliminate the organization which has not the ability to do successful work and that elimination will come about through the impossibility of that firm obtaining new business. Its record in the past will stand against it. Reputation is vital to a builder on fixed-fee operations. It is built up only through years

of painstaking effort. It can be wrecked by a single operation. Therefore, dishonesty or lack of ability will promptly place a builder in such a position that he will be unable to stand investigation and therefore be unable to operate. There should be no room in the building field for other than able, conscientious builders.

To-day's practice with some builders operating under the fixed-fee plan is to refuse to make preliminary estimates in competition. If owner and architect have not enough confidence and trust to make a contract subject to the builder's making a satisfactory estimate of probable cost, then they prefer not to serve, believing that they can do their best where the fullest confidence is reposed in them.

I sincerely believe that in these times of high building costs we can, through the Fixed-Fee plan, turn out a building at the absolute minimum cost. Costs are high at best. Legitimate projects are being passed up daily due to the difficulty of figuring a profit on the use of structures at to-day's costs. Co-operation, identity of interest and early covering in rising markets, permitted through the Fixed-Fee contract will help toward cost reduction.

I can only submit as further proof that the Fixed-Fee plan is right, the fact that my concern's history of repeat business is a surprise even to ourselves and adequate proof to us that such a basis is logical, fair and in harmony with the times.



SILENUS

SILK BATIK HANGING BY C. B. FALLS AND PIETER MYER

# Competition for a Stadium on the Lake Front, Chicago—Part II

Illustrating and Describing the Designs of  
Zachary T. Davis and William F. Kramer and Coolidge & Hodgdon

*(The designs of Jarvis Hunt and Marshall & Fox, described in this issue,  
will be illustrated in issue of March 3)*

## Description Submitted with Design for a Stadium on the Lake Front, Chicago

By Zachary T. Davis and William F. Kramer, *Architects*

IN presenting herewith a design for the proposed stadium to be erected on the lake front and in accordance with the privilege granted in the program for the competition, the following is a résumé of the paramount features of the design, the value of the project to the community and the methods by which these are to be employed.

As the foundation of nationalism was founded in the Roman and Greek empires, by its emperors erecting monuments and stadiums of colossal magnitude and beauty to be used for the sole purpose of providing a suitable setting for that which brought the citizens together; so too, will the erection of this stadium provide for Chicago an adjunct toward establishing true Americanism, a sounder civic pride and international recognition as the builder of a municipal monument unsurpassed in modern times for utility, magnitude and beauty.

The uses of this structure are so extensive and varied that in this brief description only the pre-eminent ones may be enumerated.

The very name suggests a setting for the century-old Olympic games, and thus a provision for the exhibition and contest of every form of physical prowess and development among international participants.

As, now, the eastern colleges look to the Yale Bowl as the most perfect place so far provided for athletics and exhibitions, so will the entire country look upon Chicago as the most probable setting of any great athletic meet. The metropolis of the West will serve the nation with its most adequately provided gathering place centrally located. It will necessarily be the center of national and state athletics, and thus a feature toward promoting a national rivalry in athletics and, by virtue of its magnitude, recognition of the benefits derived from athletic contests and the interests centered therein.

The State and municipality, however, will undoubtedly be served, as they rightly should be, to a greater extent than any other factor, for here every organization recognized may make their presentations. The school children of the city of Chicago can be brought together in one place, heretofore impossible, for drills, exhibitions, demonstrations and other features of the educational system. No matter how small or how vast the gathering it is amply provided for; whether it be a football game between representative colleges, a world's championship baseball game, a national tennis match or Marathon, a track meet, bicycle races, winter sports, including hockey, ice skating, tobogganing and races. There are space and

provisions for all and the necessary prerequisites for their proper execution; also installations to provide for the comfort, convenience and safety of both contestants and audience.

A more serious use, its services to the military and semi-military organizations. Here a brigade of any branch could be maneuvered, drilled or reviewed with perfect ease. An assembly point and a terminus for every parade, and if the numbers become so great they may circulate through, entering from one end and passing out at the other. Both men and animals can be conveniently and comfortably quartered beneath the structure. If an emergency arose a central armory might be established. The police and fire departments would naturally conduct their inspections and reviews within the arena, while drills and maneuvers could be the more efficiently conducted because of the control possible from any point.

A national or legal holiday hereafter need never pass unobserved for want of proper and sufficient provisions. The municipal Christmas tree will be available to all the people rather than the few that can be crowded into the streets of a city block. Each chronicled celebration, every festivity, as historical commemorations, patriotic demonstrations and works for charity, can be given with the ease and provisions for numbers that will necessarily mean success. Every organization of citizens, no matter of what character, whether it be civic, national, fraternal, religious, industrial or commercial, will find the stadium their acknowledged gathering place.

The stadium, if desired, may be created into a source of revenue because of its many utilitarian features. The circus would in truth be a circus, in the way they were presented to the Ancients, if given in this arena. Anticipating that oftentimes there will be paid admissions of various amounts, ample provision has been made properly to segregate the different priced sections, while the extensive use of ramps will necessarily prevent crowding and enable the large numbers of people to arrive and move easily and unhindered to any designated point. The entire ground floor and promenades are admirably suited to expositions of a nature where area is a prime requisite. Objects of great mass may be exhibited and cumbersome but mobile units may be moved about with ease. Again, the crowds that will necessarily congregate can be safely and comfortably handled, as the circulation about the entire structure permits easy ingress and exit. A stock show, which demands a large expanse of ground and numerous buildings, can be more efficiently and effectively



DETAIL OF SOUTH ELEVATION



ENTRANCE DETAILS

COMPETITION FOR A STADIUM ON THE LAKE FRONT, CHICAGO

ZACHARY T. DAVIS & WILLIAM F. KRAMER, ARCHITECTS



PERSPECTIVE

COMPETITION FOR A STADIUM ON THE LAKE FRONT, CHICAGO

ZACHARY T. DAVIS & WILLIAM F. KRAMER, ARCHITECTS

presented here than elsewhere, as the arena serves as the exhibition ground and the animals may be housed underneath the seats.

The open-air theater will provide an appropriate setting and a seating capacity for theatricals and spectacular productions on a scale perhaps not heretofore attempted for want of ample space and proper facilities. Band concerts to a larger and more comfortably seated audience and in a setting unexcelled, will prove most effective, while a Chatauqua could be conducted from the mammoth stage, the elements permitting.

There are features of construction which, though not self-evident on the drawings, are of sufficient importance to be worthy of special consideration and mention herein. In the author's conception it is planned that the structural parts or skeleton, seats, risers, ramps, stairways, floors and roofs shall be of poured reinforced concrete. The ornamental features and parts, such as cornices, columns, balustrades, statuary and the walls around the structural parts shall be of a cast concrete, waterproofed.

The method of construction anticipated is the column and girder. This method permits the circulation of air beneath the structure and seats which will prevent excessive absorption of heat by the concrete on hot days, per-

mitting comfortable occupancy of seats.

Entrances and exits are ample and sight lines free for the 40,000 temporary seats to be placed in front of the structure, in the arena and on the concrete base at the rear. A feature of the construction is the fact that the concrete base for temporary seats at rear provides a brace for the walls and create an architectural elevation because of the increased height. The unnecessary expense of furnishing and erecting supports for the temporary seats at rear of structure was also considered by the author.

The arena for night-time use may be lighted to a daylight brilliancy by a battery of reflectors supported by four steel towers. It is proposed to illuminate the seats with portable standards provided with reflectors which will direct the light but one way, projecting it at the rear of the seats, consequently not into the eyes of the spectators. The exterior elevations are to be illuminated by a series of concealed reflectors projecting a flood light over the principal facades and pavilions. The substructure, accessories and exits to have a direct lighting system.

The author estimates the cubic contents of the structure above the top of foundations to be 8,400,000 cubic feet.

## Description Submitted with Design for a Stadium on the Lake Front, Chicago

By Coolidge and Hodgdon, *Architects*

THE professional advisor states that: "It is the desire of the commissioners that the stadium be subordinated to the field museum. They wish the two to make a satisfactory composition taken together." The stadium is placed on the plot with the long axis turned to compose with the development of the area extending south of Sixteenth Street, which makes it possible to utilize the site to its entire advantage. Furthermore, if all the land is not used for the stadium it will not provide the 60,000 seats required by the program, which limits the base to grade 40, unless the conditions of the program are violated.

The permanent structure is not carried above grade 40, except the entrances and the wall, which serve as a protection for the temporary seats. At the north end the wall has been eliminated so the spectators will obtain an unobstructed view of the south entrance of the Field Museum.

The space allowed for temporary seating will easily accommodate 40,000 people. Two entrances at the northern end and one at the southern end are shown, which will permit a procession to come north on Michigan, turn into Twelfth Street and enter the arena by the northwest entrance, proceed along the westerly side, turn at the south end, going north along the easterly side out of the northeasterly entrance by the east end of the Field Museum, west on Twelfth Street to Michigan Boulevard and then north and this without any difficulty, giving the spectators an opportunity to see the procession at close range. Or a procession may enter at the south of the arena, maneuver in the arena and go out either one of the entrances at the north. There is a third entrance at the north end from the plaza south of the Field

Museum on a level with the base of the stadium for people attending the theater. This is closed with iron gates. The audience may also enter the theater through the northeast and northwest entrances. The entrances, for the spectators, for the general seating, are through archways in the outside wall, from the northwest entrance all the way around to the northeasterly entrance, the openings in the arch and the two northerly entrances are closed by iron gates.

The rooms under the seats in the section between the northwest and northeast entrances may be used for offices, dressing rooms and storage for the theatrical paraphernalia. A large number of rooms are shown throughout the structure for the storing of temporary seats, booths for concessions to sell refreshments, etc., for the stabling of animals, comfort stations, first-aid stations and so on.

The stadium is designed in such a way that no stairways are required, people reaching the seats by easy ramps. The two northerly entrances are designed so there is an easy slope in a total length of 450 feet of 24 feet from grade 7 to grade 31 to the plaza of the Field Museum, or about  $\frac{1}{2}$  inch to the foot. The plaza of the Field Museum is designed with a space at either end, one to provide for arrivals by trains and the other arrivals by water.

Sight lines have been worked out so that each seat has a direct line of vision over the whole arena.

The northwest entrance will be visible from Michigan Boulevard. Two reviewing stands with separate entrances are provided. Permanent roofs have not been shown over these as they would interfere with the line of vision of the spectators back of the stands, and it is the recommendation of this designer that these be more of a

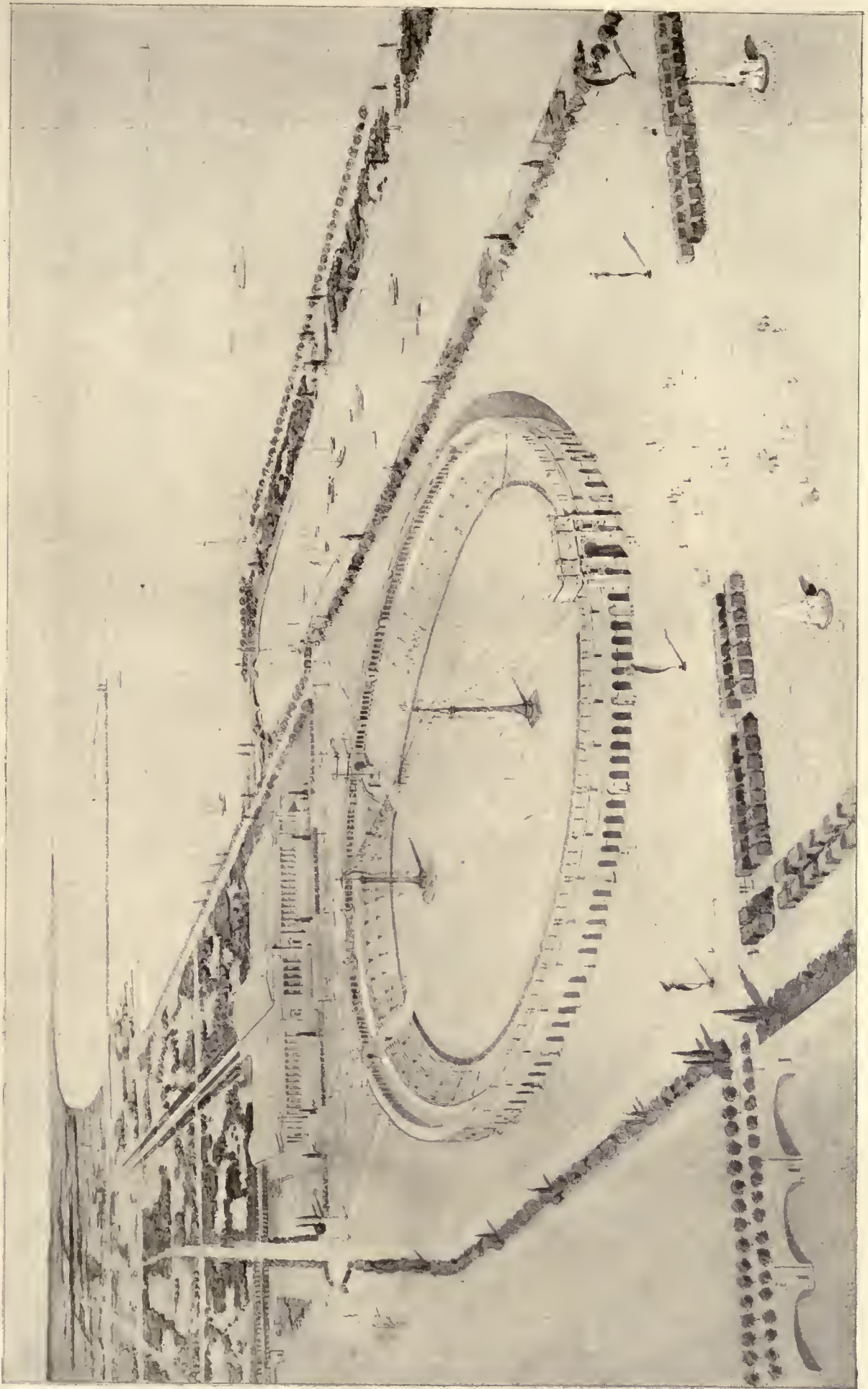

PERSPECTIVE  
COMPETITION FOR A STADIUM ON THE LAKE FRONT, CHICAGO  
COOLIDGE & HODGDON, ARCHITECTS

temporary nature and not made of masonry and iron.

The cubical contents of the stadium are 15,168,555 cubic feet.

*Material:* The best effect would be produced if the outside wall were built of marble like the Field Museum; the second choice would be limestone and the third concrete. The structure and seating to be reinforced concrete.

*Display of Bunting:* Generous provision has been made for flag staffs for banners, flags and streamers.

*Lighting:* Lamp posts have been provided for lighting the exterior wall and approaches.

String courses and cornices to be lighted by rows of lamps.

Two masts are provided with spiral stairs to crows' nests, where searchlights and projectors can be operated

to light the arena. From the masts cables may be run in all directions from which lamps will be suspended. It is believed this will furnish the best illumination.

It is also recommended that the roof over the deck be used for flood and spectacular lighting.

This competitor feels that instead of being detrimental to the general composition to have the stadium asymmetric to the Field Museum, it gives a more interesting layout and the assumption is not without classic precedent.

Mr. Penrose, in his *Principles of Athenian Architecture*, in discussing the Acropolis of Athens, states that: "It will be well to observe the remarkable absence of parallelism among the several buildings. The asymmetria is productive of a very great beauty, for it not only obviates the dry uniformity of too many parallel lines, but also produces exquisite varieties of light and shade.

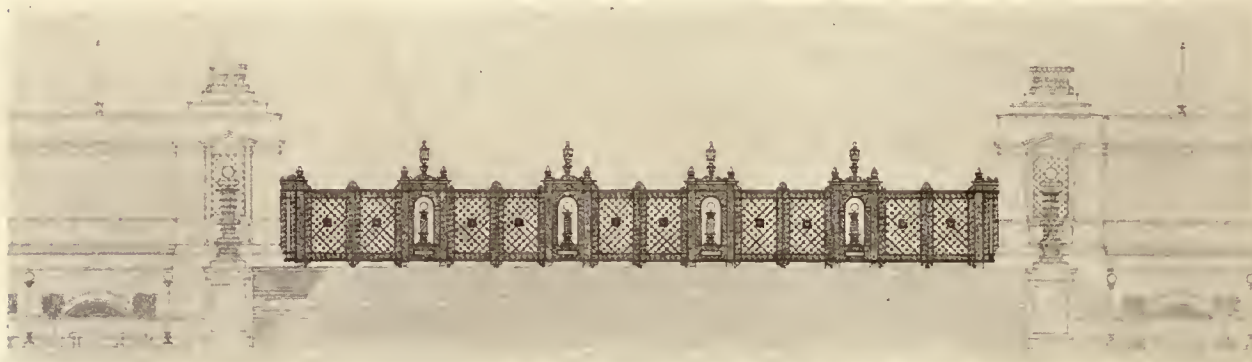

DETAIL OF THEATER ENTRANCE  
COOLIDGE & HODGDON, ARCHITECTS

## Description Submitted with Design for a Stadium on the Lake Front, Chicago

By Jarvis Hunt, Architect

. . . A similar want of parallelism in the separate parts is found to obtain in some of the finest mediæval structures, and may conduce in some degree to the beauty of the magnificent Piazza of St. Mark's at Venice."

The location of the stadium, the size of the arena, the number of permanent seats, the number of temporary seats, have all been fixed by you, and I have complied with all of your requirements.

In making this design we have taken into consideration the approaches to the stadium and the various elevations of streets around same, and have, therefore, chosen the east side as the principal architectural entrance to the stadium for the following reasons:

1. The level of the street on the east side (on the center axis east and west) is the same level as the principal gallery that feeds all of the arena.
2. The rear of the stadium must necessarily be the Illinois Central right-of-way.
3. This point is most easily reached from the north and south.

4. It seems most adaptable for so large a building, as it allows a proper design and capacity of the streets approaching same, and it is also possible to treat the water front architecturally in connection with and emphasizing the entrance.

5. This entrance forms a backing for the temporary seats (which temporary seats are nearest to the center of the arena), and also a setting for the open-air theater.

This treatment, with its broad surfaces, is most adaptable for commemorating wars or sports, as your committee may see fit to adopt.

The design seems to me to tie into and make a better foil for the existing Field Columbian Museum than would one of a colonnade treatment with more or less competitive proportions.

We have suggested on the block plan the means of bringing the street cars through a tunnel at Twelfth Street into a station below the level of the street south of the museum; also extending the same in a tunnel

(Concluded on page 250)





*In order to supply our readers with material of current interest, the news and comment appearing in issues of THE AMERICAN ARCHITECT delayed by the printers' strike will be as of actual rather than stated date of publication.*

## Forms of Construction Contracts

**W**ILL a general adoption of a fixed fee form of contract eliminate the dishonest contractor? Will it put out of business every contractor who has not the ability successfully to accomplish the efficient and economical construction of a building? No less an authority than Mr. F. A. Wells, widely known as the head of a successful construction company, believes that it is the best and safest form of contract that can be devised and he so states in an address at the recent convention of the Associated General Contractors of America, printed in this issue.

It is undoubtedly true that, owing to present abnormal conditions under which construction is now carried forward, the fixed fee contract overcomes many of the present objections to other forms. It is now almost if not quite impossible for contractors to pre-determine the exact cost of a specific building. But, even in face of these facts, the question arises as to the advisability of the architectural profession giving unqualifiedly its approval to a form of contract designed to meet conditions as they now exist but which probably will continue for but a few years longer. There are undoubtedly many advantages contained in the lump-sum form of contract under certain conditions in normal times, but if a fixed fee form of contract becomes firmly established will not contractors combat its being discarded under any circumstances even when we have again returned to more stable conditions?

**T**HE contention is made by Mr. Wells that speed of construction is one of the most important factors in modern building, and that a fixed fee contract contributes more largely to this end, and at the same time insures more economical and efficient construction than any other. While there is much

merit in the contention, particularly at this time, there are many architects, whose years of relationship to construction work entitles their views as to the relative merits of the various forms of construction contracts to respectful consideration, who will not agree entirely with Mr. Wells. They will seek to direct attention to the fact that many important and costly structures have been erected on the now much assailed lump-sum contract system, and that the result has been satisfactory to the owner, the architect and the contractor.

The contractor urges that his is the most highly developed ability to co-ordinate work. Here again there may be room for debate. The co-ordination of work as practiced by every important firm of architects has so many times been effectively demonstrated as to require no further proof.

Volumes might be written as to the desirability of certain forms of construction contracts and these discussions may very properly be participated in by all those who are directly interested in building. But the fact remains and should be clearly kept to the front that the architect who is properly performing his function is in effect the master builder and that any form of contract that does not meet the approval of a large majority of the profession is not one that will best further professional ideals as to just what relation the architect assumes toward the building that is the result of his creative genius and which should therefore be under his immediate control from the preliminary sketch to the completed structure ready for occupancy. The form of contract that best secures this end will, after all, be the one that will eventually gain general acceptance.

In order that there may be obtained the widest expression of opinion on a subject of such great importance, the editors of THE AMERICAN ARCHITECT will greatly appreciate any further communications that they may print on this topic.

## Developing the Farm Building

**T**RAINERS of athletes always object to forms of exercise that only develop the body locally. They seek to build up first the entire body, later giving such attention to specific exercises as will increase efficiency in the direction desired.

In the development of a nation or even a municipality these same conditions obtain as to proper growth along proper lines. Possibly there is too close attention to the development of cities and not enough to our rural communities. And this lack of interest is beginning to have its effect on the rural communities and particularly the farming sections all over the country.

It has been found to be a grave mistake to infer that the farming population is not so thoughtful as are those who dwell in large communities. Recent inquiries by the government have disclosed that there is a decided feeling of unrest among the farmers. It has been proved that the farmer is now prepared to assert his right to recognition and not longer to be considered as a group outside of the real activities of our economic and political lives.

The farmer will demand recognition as a large producer and manufacturer and he will not much longer patiently allow others to gamble on and become wealthy in the things he produces. As he grows in importance, as he most certainly will, he will demand for himself and for his family the same opportunities for advancement as are to be availed of by his city-dwelling brethren. He will insist in the future that his house, his farm buildings and his social relations be fully up to every American standard, and knowing that these may only be attained with money, we may expect to feel the effects of a movement on the part of farmers toward securing for themselves a share of the profit realized on their product.

**I**T will not be wise further to ignore either the farmer or the dwellers in rural communities. The American Institute of Architects has been quick to endorse and at times enthusiastic in its co-operation with those large undertakings that affect the city. For now more than two years THE AMERICAN ARCHITECT has urged that some closer attention be paid to the farmhouse and its dependent buildings. Owing to the wideawake spirit of some of the middle Western delegates to the Nashville Convention, a resolution appointing a sub-committee on farm buildings was passed at that convention. Nothing, as far as we are able to learn, has come out of that committee.

Recently, announcement was extensively made of a proposed conference on farm buildings. The committee in charge, a large one, did not contain the name of a single architect. THE AMERICAN ARCHITECT directed attention to this omission and was at once assured that an architect would be added to the committee.

No credit may be taken by this journal for the performance of a simple act of duty, but it may be asked if the Institute or other organized bodies of architecture may not be considered as properly sharing the responsibility of conserving the rights of architects to recognition?

---

## Bernard Shaw on Architecture

**P**ROLIFIC writers, in courting the spot-light, find value for themselves principally in the ingenuity or originality of their treatment of well-worn topics. Take for example, Bernard Shaw. Mr. Shaw has now turned the activity of his eccentric genius to a discussion of architecture. He favors a new style for each generation and insists that every building should be knocked down when it has reached the age of twenty years. As far as the destruction of houses and of cathedrals are concerned, Mr. Shaw stoutly advances the opinion that one of the good things that comes out of the war is the destruction of such buildings and their rebuilding in a newer and later style. No one will take these things seriously. The Shavian tendency toward this sort of thing is too well known. But with these sensational ideas the question is usually raised whether or not there be in them a grain of good sense.

Creating a new style of architecture for each generation would certainly require the development of originality that has not up to the present time been displayed. In this, as urged by Mr. Shaw, we may find an admonition to avoid the slavish following of precedent and the laborious production of replicas, to set free our creative power and build that which dares comparison with everything which preceded it.

If the things that Mr. Shaw so stoutly urges could but happen and if he may live to see the results, he would undoubtedly seize that opportunity to condemn. A man who has written so much will not be able to remember even a few of the many visionary things he has urged. Possibly he doesn't want to remember and would have the course of architecture follow the methods of his mind.

THE AMERICAN ARCHITECT

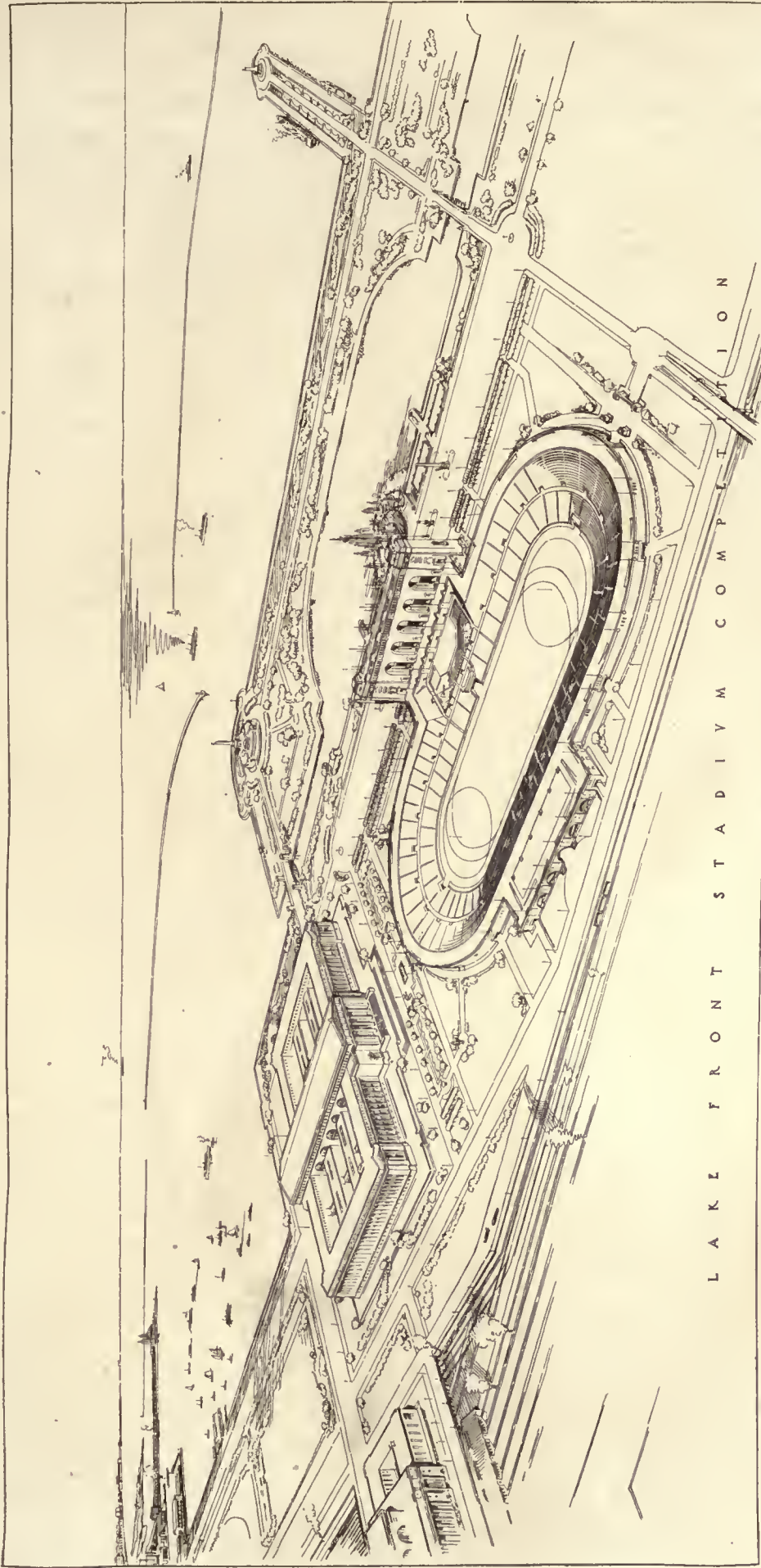

L A K E F R O N T S T A D I U M C O M P E T I T I O N

COMPETITION FOR A STADIUM ON THE LAKE FRONT, CHICAGO  
JARVIS HUNT, ARCHITECT

## A Stadium on the Lake Front, Chicago

(Continued from page 246)

underneath the level of the street on the west side of the stadium. We have also connected it with the Illinois Central Railroad.

On the west side of the stadium are accommodations for housing the different circuses, horse shows or other

pageants for which the stadium may be used. This structure also forms a base for the temporary seats that may be placed above it to correspond with the same temporary seats on the east side of the proposed structure.

The exits and inlets to the stadium for pageants or other large exhibits are so arranged that they do not come on the same level or interfere with the inlets or exits of the public viewing same.

Automobiles may be parked south of the stadium.

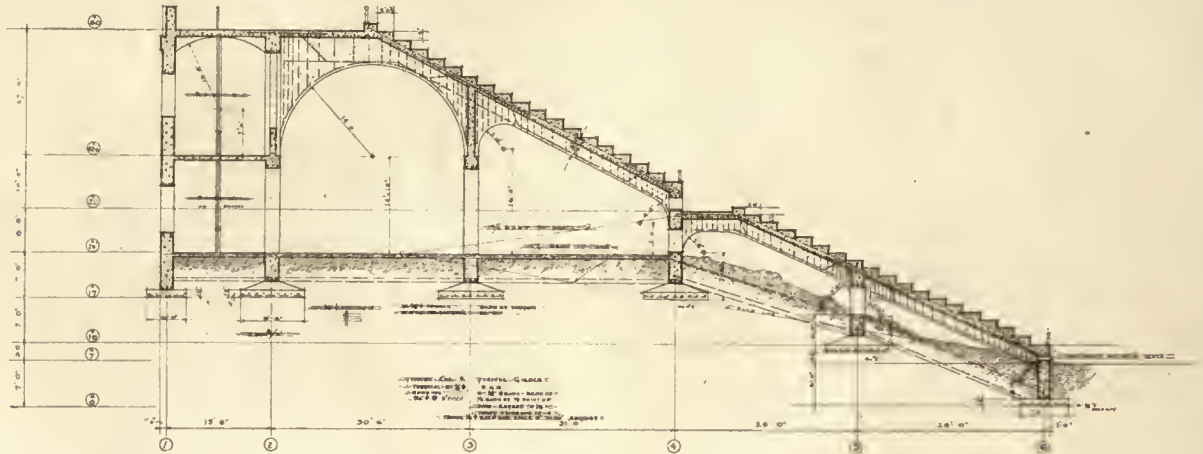

SECTION

JARVIS HUNT, ARCHITECT.

## Description Submitted with Design for a Stadium on the Lake Front, Chicago

By Marshall and Fox, Architects

We herewith submit competitive sketches for the construction of the stadium on the lake front, Chicago.

In preparing a solution of this problem presented by the provisions of the program of the owner that would give adequate interpretation to the owner's highest purpose, it has been our consistent practice to employ a breadth of vision that lifts the whole from materialistic restrictions and places it in its proper significant position: that of a prototype for suitable accommodations in which the citizens of any such great municipality may further their health and happiness and express their national and civic emotions.

Further, it is, we believe, clearly recognized by the owners, in providing this stadium for the lake front, Chicago, to be their obvious duty to make the best possible provision for the health and happiness in leisure of the masses—in short, to provide for the needs of a new world, a new world which the gallant sacrifice of American manhood in the World War has alone made so early possible. It would be unworthy of such a great municipality, in lifting to a higher plane of living the masses of its citizens, to disregard one of the great factors of the uplift. Therefore we provide that this stadium be in a measure a monument commemorative to the American soldiers of the World War. Both this tribute to the past and vision of the future have been suitably expressed in the magnitude of our conception of the whole: in the sublimity of the design, and by the excellence of the plan which leads to the utmost practicability in the stadium's use.

Our preliminary sketches provide for a careful adherence to the requirements of the program of the owner, such as:

1. An arena arranged, per provisions of the program of the owner, for athletic meets, ice carnivals, tobogganing, skiing, fairs, horse shows, military maneuvers, pageants, etc.
2. A theater at one end of the arena with a maximum seating capacity of 9500, providing for concerts, outdoor dramatics, etc.
3. Permanent seating capacity of 60,000, with an additional temporary seating capacity of 40,000, 20,000 of which are placed on the third and top promenade extending around the entire stadium, and 20,000 in temporary seats below the permanent seats, these temporary seats extending into the arena.
4. Reviewing stand which is sufficiently elevated to command the necessary view of the arena, with adequate treatment of seats in carving, etc.
5. The cubic contents of the entire structure is 21,750,000 cubic feet.
6. Construction of reinforced concrete, with all engineering problems reduced to a minimum to eliminate unnecessary expense, that entire stadium may be suitably finished in Buff Bedford ashlar masonry.
7. Adequate provision for storing of temporary seats, stabling, and other storage, baths and locker rooms for athletic contestants, etc.

In addition, we wish to call your attention to the following:

First—Means of ingress and egress provide that the entire stadium, seating approximately 100,000 persons, may be vacated in a period of from three to five minutes. The series of arched entrances around the entire Stadium with ramps provide for this most fundamental requisite for the successful use of the stadium, thereby reducing to a minimum

- (a) The possibility of loss of life by panic, exposure from sudden changes in weather, etc.
- (b) The time and strength consumed by the citizen in approaching and leaving his recreation. His easy access to the stadium is further facilitated by the open plaza about the entire stadium, which eliminates congestion.

Second—Thus having entered the stadium with the minimum expenditure of time and effort at the arch whose number corresponds to the number on his seat, the citizen may in the least expensive seat enjoy a perfection in sight line equal to that of the most expensive seat. After an exhaustive study of amphitheatres and open-air theaters, both ancient and modern, we have for this stadium established the minimum angle permissible for the insurance of perfect sight lines. This, too, is a none the less fundamental requisite for the use of the stadium.

Third—Further, the citizen may during any intermission in performances, or as shelter during inclement weather, enjoy in the covered promenade about the whole stadium, located half-way up the banks of seats, public comfort stations, restaurants and emergency hospital. Off this promenade the administrative offices will be located.

Fourth—In the substructure various separate pools and gymnasiums for men and women, in connection with their separate club rooms, should be provided.

We have made these competitive sketches for a stadium for the lake front of Chicago, employing consistently the vision of a fitting tribute to the past and a pledge to the city's future—an embodiment of both—that will be a means to promote in the most uplifting manner the health and happiness in leisure of the citizens of Chicago.

## Discovery of Brumidi Paintings

An extraordinary art discovery has just been made in Washington when two large boxes, containing twenty-seven oil paintings by an eminent Capitol artist, the late Constantino Brumidi, were found after having been lost for thirty years. The discovery was made quite by accident, when Edward P. Schwartz, executor under Brumidi's will of 1879, after endless searching among all the warehouses of the city, remarked to his friend the banker, J. M. Boteler, of the National Savings and Trust Company, Washington, D. C., "I wish I could locate those Brumidi boxes." And Mr. Boteler answered, "Thank heaven, the mystery is going to be solved at last. Those two big boxes have been in our vaults for the last thirty years, and have accumulated storage charges of almost \$300!"

In the presence of Dr. William H. Holmes, head of the National Gallery of Art, J. G. Langdon, landscape architect and city planner, in charge of the development of Washington's park system; Charles E. Fairman, custodian of the works of art at the Capitol, and others, the boxes were opened and the contents found in perfect condition.

just as Brumidi himself had packed them away, when he willed them to his son years ago.

About thirty pictures were included, many of them undoubtedly the original studies of paintings later placed in various parts of the Capitol. Besides portraits of the artist's beautiful American wife, a painting of George Washington, evidently copied by Brumidi from the celebrated Gilbert Stuart painting, and one of Benjamin Franklin, after Benjamin West, there are others described as follows: "St. Patrick," "Child and Grapes," "The Reaper," "Adoration of the Wise Men," "Woman and Child," "The Five Senses," "Telegraph," "Robert Fulton," "Chariot," "Cupid Asleep," and "Madonna."

Brumidi was a striking figure in Washington years ago, and it is said that visitors from all over the world invariably asked at the Capitol where they could see Brumidi, sometimes waiting for hours to see the old painter hoisted or lowered in his wooden cage to and from his work in the dome, where he painted each day from 10.30 to 3 in the afternoon. A man of cultivated taste and wide reading, he was especially fond of the classic poets and thoroughly conversant with works of historical art. Shakespeare, Dante and the old Italian poets were his favorites. He died in 1880, leaving a will disposing of his works of art and other property, but it was impossible at the time to trace the boxes which have now just come to light. The final disposition of the pictures has not yet been decided, as they relate almost entirely to works at the Capitol.

## The Real Uses of Wood Alcohol

That the proposal of some radicals to stop the production of wood alcohol because of the deaths of scores who drank this alcohol by mistake is ridiculous and not to be considered seriously is the belief of the specialists at the New York State College of Forestry at Syracuse. The wood alcohol industry has no bearing whatever upon the prohibition laws, for wood alcohol is strictly an industrial product, while the potable liquor is the grain alcohol. Their resemblance in odor and chemical properties has brought about the fatal substitution of the poisonous wood alcohol by unscrupulous dealers.

The production of wood alcohol for industrial purposes is an important industry in New York state, a bulletin issued by the New York State College of Forestry in 1917 showing that 192,000 cords of wood annually are used in the destructive distillation of wood, to produce such products as tar, acetic acid, acetone and wood alcohol.

Wood alcohol is a most valuable industrial product, and is largely used in the production of formaldehyde, probably the best known antiseptic, but which is also used in the manufacture of dyes, particularly indigo, and in photography. Wood alcohol is also largely used in the manufacture of varnishes and lacquers, as well as for fuel. Wood alcohol is technically known as methyl alcohol, and is essentially poisonous, causing almost certain death when taken in quantities, and blindness, when used in smaller amounts, or in other ways than internally. Ethyl alcohol or grain alcohol is also used industrially, and forms the spirituous content of wines and liquors. It is usually denatured either with wood alcohol or other substances when used industrially and is then also toxic. Wood alcohol has a multitude of uses. The New York production of wood alcohol has run to nearly 2,000,000 gallons a year. The greatest single use is perhaps in the varnish industry, as a solvent. It was of enormous value in the production of high explosives.

# Revival of Egyptian Art Contemplated by Decorators

**P**HARAOH'S wallpaper and Belshazzar's linoleum may soon be as commonplace as real art may never be—part of the finishing touches in every average home as well as the basis of expensive decorations in the palaces of the rich. So writes Wm. A. McGarry in the *Boston Transcript*. Designers who flock to their old sources of inspiration in Europe after the signing of the armistice, following four years of enforced staying at home, are coming back again to the art of seven thousand years ago in American museums, convinced that it offers far greater opportunity than the relatively modern art of Europe.

For a quarter of a century the directors of these museums and the archæologists employed by them have been dinning into the ears of artists and designers the inspirational value of Babylonian and Egyptian monuments, decorative panels and wall designs. But it was not until the war blocked easy access to Italy that they succeeded in getting an audience. Instructors in applied design have been of considerable help to the movement by constant iteration of the charge that the average American wall and floor covering design is hideous.

Miss Violet Oakley, known nationally both as a painter of portraits and of decorative panels, was one of the first to respond to the appeal of the museums. She made many sketches in the halls of the University of Pennsylvania Museum for the later of her mural decorations for the Pennsylvania State Capitol at Harrisburg. Encouraged by this example, a few of the large wall and floor covering manufacturers sent their designers on experimental trips to the museum in 1915. Since that time the habit has grown.

Until recently, however, the use of ancient models was looked upon merely as a temporary expedient. Now, according to the museum authorities, the designers have had opportunity to compare their work of the last four years with earlier productions, and they are coming back to Babylon. China, also, is coming in for her share of recognition, particularly in rugs. Within the past six months nearly every large manufacturer has started the production of Chinese rugs, the patterns for which in many instances are copies or developments of designs on ancient examples from the Flowery Kingdom. This art is older in some respects than that of Greece. It was at its zenith when Europe was going through the Dark Ages,

when China was the cultural center of the world. Authorities of the museum have taken advantage of this trend to utter an appeal for a revival of the classic in decoration. And right in line with this appeal is an argument put forth by Dr. George Byron Gordon, director of the museum, concerning the essential identity of art and craftsmanship.

The sculptor, the painter and the story teller in their work and in their achievements share the same traditions as the mason, the goldsmith and the weaver, says Dr. Gordon. Whenever in the world's history this identification was an accepted fact, when a close association between art and craftsmanship marked the order of things, when the atelier was the workshop, when the artist and the craftsman were one, then great works were wrought and great names were handed down. Whenever an artificial distinction arose, art, entering a barren field, became the subject of affectation, and craftsmanship was debased. Such a distinction does not correspond with any reality of life. When artists attempt to set up among themselves an exclusive cult based on a belief in some form of special dispensation, it means that art is dead.

For the last six years or more the University Museum has been taking steps to inform those interested that its collections afford an unusual opportunity for guidance in the designing of modern manufactures. We have repeatedly pointed out, says the director, that the application of art as represented by traditional standards and historic precedents to fabrics of all kinds, to the products of the mills and the kilns of modern industry, is a lesson that has to be learned if this country is to hold its own even in a commercial sense in competition with the older civilization of Europe.

A staff of artists and instructors has been engaged to take charge of the general educational work for which the museum is equipped, and especially to help visitors, including the artisan, craftsman, designer, merchant or manufacturer, to translate the collections into terms applicable to the work of each. It is the business of these instructors to explain the design and workmanship that belonged to other times and places and to show how they may and ought to be adapted to modern American conditions and American ideals without in any way violating the essential fitness of things.

In the plan to open up more fully the resources of the museums to the craftsman, the artist, the



PLAN  
COMPETITION FOR A STADIUM ON THE LAKE FRONT, CHICAGO  
ZACHARY T. DAVIS & WILLIAM F. KRAMER, ARCHITECTS





2522



2522

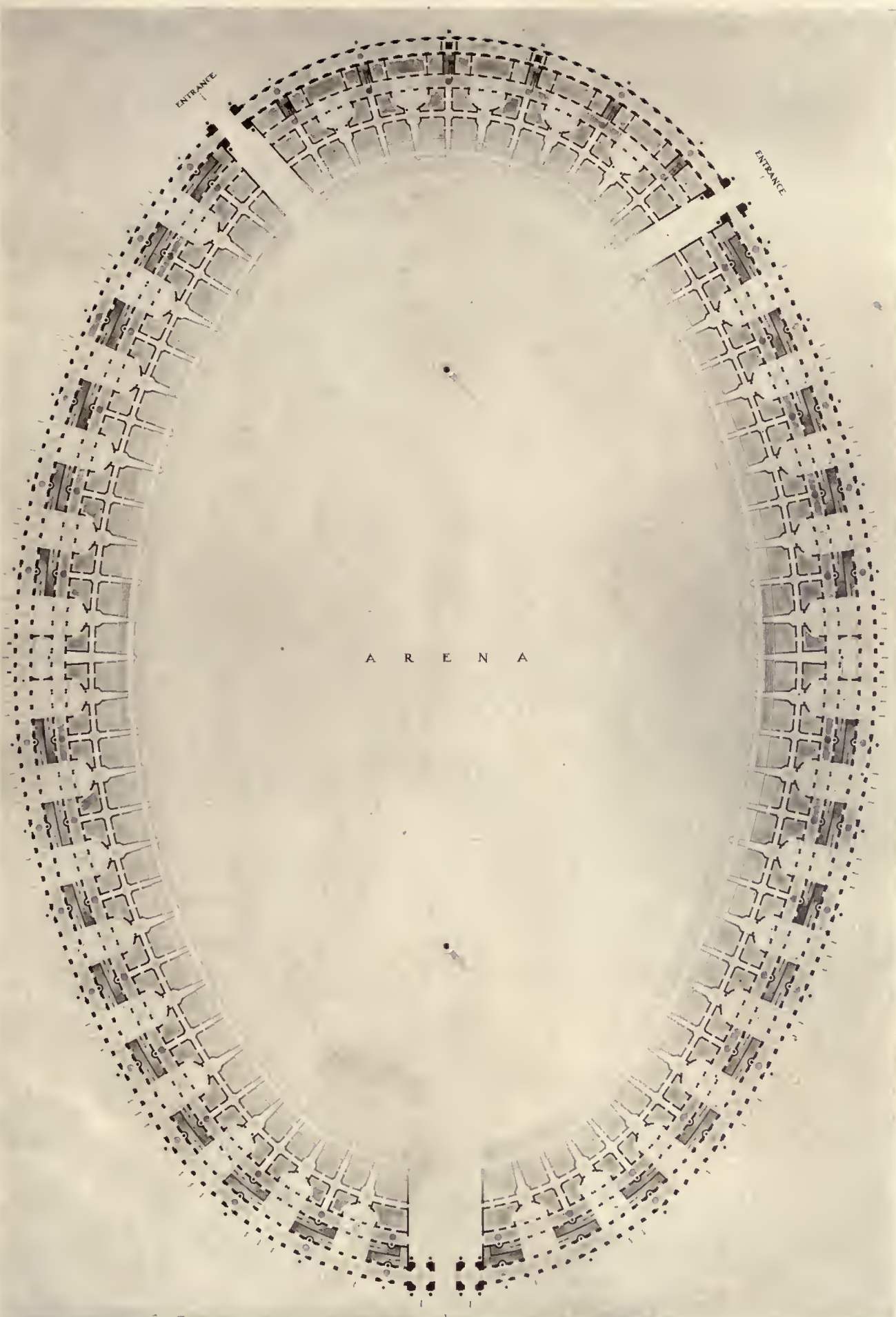

A R E N A

ENTRANCE

ENTRANCE

GROUND PLAN  
COMPETITION FOR A STADIUM ON THE LAKE FRONT, CHICAGO  
COOLIDGE & HODGDON, ARCHITECTS



252<sup>4</sup>



25-25





designer, the merchant and the manufacturer, there is complete recognition of the fact that the interests of the museum are closely related to the interests of modern commerce and industry. In this co-operation the museum's part will be to guide each effort in any line of production to the attainment of a successful decorative performance.

American art in the future may be new, but if it is to be worth anything it must have its background of legend. In this connection it is well to state that American industrial art has recourse to a supply of rich material for utilization that belongs peculiarly to its own province; I mean art and craftsmanship of the various native races of North and South America. It is very interesting to note that there is at present a distinct tendency among designers visiting the museum to take their motifs from these native American sources.

It is being said that the life and legend of the Indian were marked by a rich spiritual experience in keeping with the vast continental spaces in which he dwelt for ages—the first of mankind to gain

a knowledge of the gods that he recognized in forest and lake and mountain and plain of this his native land; the first to live in close communion with them and to give passionate utterance to these themes in his native art. I have no doubt that the appeal that this utterance makes to many Americans and that attracts many designers instinctively to aboriginal American traditions in their search for fresh inspiration has its source in the unconscious influence of nationality.

Perhaps, as some advanced artists claim, these ancient and long-cherished American themes, under the impact of a new civilization, may liberate a spark that will kindle an enthusiasm among Americans for whatever is true and beautiful in their everyday environment. It would be entirely in keeping if the energy thus set free, acting directly on native American design, recast in new molds and informed by European tradition, should prove a powerful agency in the production of an American industrial art with a character of its own.

## The Charm of Natural Planning

**I**N the various schemes which are put forward in these days for city planning and development the main fault seems to me to lie in the attitude of the designer, which is usually that of a cold and calculating schemer, writes M. H. Baillie Scott in *The Architectural Review* of London. This brutal and callous scientific spirit can never give to us the city of our dreams. We must set out to realize as far as we can the New Jerusalem—a heaven on earth—and test all our conceptions by the touch-stone of that ideal. We ought to approach the matter from the right end and start with the unit of our design, which is the house itself. And since it is desirable that houses should be of rectangular form, it follows that groups of houses should be rectangular, too, and that radiating and diagonal lines of roads which chop the buildings adjoining them into awkward shapes should be avoided. The best plan for a city is surely the old one—in which within a walled enclosure four main roads meet in a central market square. The four wards of the city are subdivided into smaller squares by smaller streets, and this scheme logically implies the arrangement of houses into courts approached by archways from the streets. This court arrangement, of which we find so many beautiful examples in old towns, is surely the finest way we can conceive of combining buildings, and more especially

so when the scale is not too large. For an example near at hand, could anything be better than the little court of Staple Inn with its old paving and central tree? Such exquisite surprises as that are worth all the dreary endless avenues our town-planners rejoice to inflict upon us.

Apart from scientific expediency, the modern town planner seems chiefly to aim at "splitting the ears of the groundlings" by something colossal and immense in scale. He has yet to learn that art is not a question of avoidupois and that the best kind of beauty is to be found in quite simple and humble things. The vulgar desire to "lick creation" with some immense building seems to pervade all our modern conceptions. It is the Prussianism of art. Adjoining buildings of reasonable scale are dwarfed by colossal monsters built at huge expense. Examples in this kind are to be found in most of the central parts of London, and all the sane and simple work of the eighteenth century has to give way to hideous vulgarisms in stone. Nothing is more pitiable as a spectacle than this puffing and blowing and strutting like the frog in the fable on the part of our designers. It is a disease of the mind, and in any modest and sane community would be treated as such.

But, bad as such buildings are in their senseless waste of human labor, they are not perhaps so

disastrous as the modern suburb, and more especially when it takes the form of what is called, for some unknown reason, "the garden suburb." Here we have vague and sloppy arrangements of dwellings which go to the other extreme of scale. They are gabled and fussy and petty. They pose and smirk at us in their self-conscious artistry. It is the fashion now to say rude things about the slums, but there are not a few back streets in London which merely wait cleaning up to make them excellent dwelling-places for those who do not want to be waylaid by self-advertised art at every corner. For my own part, I would choose one of these in preference to any garden suburb I have seen. They are restful and peaceable and honest, and they make no pretensions of any kind.

And now we have invented a new horror in building. It is the colony of "dwellings for the working classes." The phrase itself carries with it the condemnation of our social system, implying as it does a broad division of the community into those who work and live in duplicated little dwellings imposed on them by the State, and those who don't work and who live where they like or can.

Would it not be possible to return to the old and better way of building, when towns were definitely outlined conceptions set in natural country surroundings? If in such a case further building is required, would it not be better to start from a series of subsidiary centers instead of creating vague and nebulous, suburban areas which are neither fish, flesh nor good red herring? And why should we isolate and segregate our workers like lepers from the community? In the old village the squire and parson contrived to exist in close association with their humble neighbors.

It is a question how far the making of a town should consist of the realization of a predetermined plan, or how far it should be allowed to develop naturally. It would seem the best way to lay down at least the main lines, and yet leave some possibility of variation in the lesser streets.

If a plan fully takes into consideration the levels of the ground and local features such as trees, it will necessarily become somewhat varied in its general aspect. Planning of the best kind has all the air of natural development, because the designer has yielded to local conditions and allowed them to mold and modify his initial conception.

Where there is no vision the people perish. The

materialism of science as applied to building will never satisfy our souls. Our towns and cities should be the expression of the best of the art powers of the community. That is the proper field of the artist, and not the collection of pictures in a gallery which no one needs, and only a few wish to look at. Building should be the highest expression of the spirit of man, and not merely a dull and soulless record of what are supposed to be his material needs. And we who enjoy the privilege of living in a country which still possesses so many great examples of old buildings have little excuse for ignoring the lessons they convey.

### Paris Has a Chinese Paper

The latest comer in the Paris press is a weekly newspaper printed in Chinese and edited by M. Daniel Fu, states a correspondent of the *London Mail*. The paper is intended for the benefit of the 80,000 Chinese coolies now working in France, 35,000 of whom are in the northern area. The sheet has been very thankfully received by these men, and 8000 copies of it are sold at two cents each. This price does not, of course, cover the cost of production.

As it was impossible to get Chinese type in France, the paper is produced by a photographic process. The sheets of beautiful Chinese characters, handwritten, are photographed and printed from the plates. This is the first Chinese newspaper to be produced in France.

It is significant that Chinese Coolies, known as the poorest classes of that great nation, are not too poor to have acquired an education sufficient to create a desire for papers in their own tongue, and a means for duly availing themselves of such papers. It is also probable that such a paper will sooner or later confront France with a condition similar to what America is now facing—a foreign language press that in self-preservation encourages everything peculiar to the nation it represents, and garbles the actual status of American affairs to breed discontent and disloyalty. There can be no unanimity of feeling while the foreign language press is dominated by un-American interests, and until it is either entirely abolished or at least completely reorganized under an American management this country will have little opportunity to accomplish the purposes for which it strives.

# Current News

## Happenings and Comment in the Fields of Architecture and the Allied Arts

*In order to supply our readers with material of current interest, the news and comment appearing in issues of THE AMERICAN ARCHITECT delayed by the printers' strike will be as of actual rather than stated date of publication.*

### Deferred Architectural League Exhibition Now Being Held

The thirty-fifth annual exhibition of the Architectural League of New York was opened with a dinner on Feb. 26 at the Fine Arts Building, 215 West Fifty-seventh street, where its entire original collection of paintings, sculptures, architectural designs and other works of art, valued at more than \$500,000, was destroyed by fire on Jan. 30 last. The present exhibit includes some of the valuable designs that were saved from that disaster, and they still bear signs of smoke and flames where they hang on the charred walls of the Vanderbilt Gallery.

A plea for the cultivation of a more sympathetic understanding between artists and craftsmen was made by J. Monroe Hewlett, ex-officio Chairman of the league, in the course of his address to the 150 guests at the dinner. The present time, he said, demanded that co-operation should be brought about between those who do the designing and those who produce the manufactured article. The Architectural League, he said, was pre-eminently qualified to promote such an understanding. The speaker said a committee had been appointed and already was at work on plans for a home for the organization.

The medal of honor for the best architectural exhibit was awarded to Delano & Aldrich, represented by a collection of pictures and plans of country houses. For his painting, "Diana and the White Horse," which was destroyed in the fire, Arthur Crisp, vice president of the league, received the medal of honor for the best painting. The honor medal for landscape architecture went to the firm of Vitale, Brinckerhoff & Geiffert.

### Columbia's School of Architecture Offers Spring Courses

In addition to the facilities for architectural study outlined in connection with the Avery Library notice previously referred to, the School of Architecture in Columbia University also has its own departmental library, a collection of about 18,000 photographs and several hundred books, a classified library of many thousands of prints and plates chiefly from current periodicals in the field, and a number of original drawings, including examples of architectural draftsmanship from the Paris Ecole des Beaux Arts and other sources.

A collection of about 16,000 lantern slides, constantly augmented, is in daily use for illustrated lectures on the history and theory of architecture, painting and sculpture, on ornament and the allied arts. The school also possesses a valuable collection of casts for use in the drawing rooms and general illustrative purposes, including fine models of parts of the Parthenon and of Rheims Cathedral and many casts from ancient and modern buildings given by the late Charles Follen McKim.

The illustrative material on the constructional and architectural engineering is extensive, comprising a variety of building materials and appliances and a number of especially prepared architectural models.

Five general fields of construction constitute the full uniform curriculum for all students in the school. They are design, history, drawing, graphics and mathematics, and construction. The work of all students in design is brought together on an assigned date and judged by the members of the school staff assisted by a group of practicing architects.

While the School of Architecture admits only students who are candidates for a degree, provision is made under the Department of Extension Teaching for students who are not qualified for admission to the school or who cannot command the daytime for pursuing the courses. During the spring session extension courses, afternoon and evening, will be offered in a wide range of subjects, including elements of design, descriptive geometry, shades and shadows, stereotomy, perspective, specifications, building materials and construction, structural design, renaissance and modern architecture, ancient ornament, medieval ornament, principles of composition, drawing in water colors, charcoal and life, and pencil and modeling.

Instructions in extension teaching will be given by regular instructors of the School of Architecture, including Professor William A. Boring, Professor G. A. Harriman, Professor Alfred D. F. Hamlin, H. Vandervoort and George M. Allen.

### Sculptors Meet With Illinois Chapter

*(By Special Correspondence to THE AMERICAN ARCHITECT)*

Chicago, Ill.—Architects and sculptors of Chicago got together recently at the Art Institute, at the instance of the Illinois Chapter of the American Institute of Architects, of which Henry K. Holsman is president, and discussed the need of adapting sculpture to concrete construction. The idea was suggested by Miss Nellie Walker, a local sculptor, and endorsed by Lorado Taft, who was a guest at the dinner.

"I am very much interested in this new concrete idea," said Mr. Taft, who spent several months in France among the A. E. F., with the educational corps of the U. S. Army and who referred to his army experiences. "It seems to me that sculptors can do something in concrete that will add materially to a building of this character. I have now under consideration a soldier monument on which the committee in charge does not wish to spend as much as they should, if the design is to be in marble or bronze, and I am going to suggest that I be permitted to try it out in concrete."

Discussing the adaptation of concrete sculpture to the modern concrete building, Miss Walker said:

"It seems to me a touch of decorative beauty might be added to the skyscraper, the warehouse or the apartment building constructed of soft stone or concrete. Of course,

sculptors and architects should get over being afraid of each other and work together toward this end."

In discussing the relation of sculpture toward architecture, Miss Walker said:

"Architects need the aid of sculptors to embellish and enrich buildings, but too few sculptors have any knowledge of architecture and architects are rare who have an understanding knowledge of sculpture. I feel that a little knowledge of architecture on the part of sculptors and a sympathetic appreciation of sculpture among architects would provide a tremendous step forward toward a much desired co-operation.

"I cannot always draw an intelligent sketch for the architect and ask him to develop and refine. I feel that if I had sufficient architectural knowledge to do that, my idea would not be lost in the final work."

English period furniture was discussed before the Illinois Chapter by Robert J. Clark, of John A. Colby Co., with illustrations showing furniture of the Elizabethan, Queen Anne, Charles I. and II. and Henry VIII. periods, including Windsor and Chippendale designs, revealing how the architects of these periods worked with the cabinetmaker and the decorator to create a harmonious building.

Interdependence of the arts was discussed by Director Eggers of the Art Institute.

## Art Students' League Competition

The Art Students' League of New York announces that a scholarship competition open to all art students in the United States, with the exception of those in New York City, will be held at the studios of the league in New York on March 31. Ten scholarships will be awarded for the work showing the greatest promise. Work in any medium, from life, the antique, portrait, etching, composition and also photographs of sculpture, may be submitted. Work should be sent flat, not rolled, and should be forwarded so as to reach the league not later than March 27, and must be sent with return express or parcel-post charges prepaid. The scholarships so given will entitle the holder to free tuition in any two classes of the league during the season of 1920-1921. The jury will consist of the following instructors of the league: George B. Bridgman, Arthur Crisp, A. Stirling Calder, Frank Vincent Dumond, Sidney Dickinson, Thomas Fogarty, Frederic R. Gruger, Robert Henri, Hayley Lever, Kenneth H. Miler, Boardman Robinson, John Sloan, Eugene Speicher, Frank Van Sloun, Mahonri Young.

## Seattle Architects Will Hold Exhibit

An architectural exhibition which bids fair to be the finest yet held in Seattle is being planned by the Washington State Chapter of the American Institute of Architects.

The official notice issued to the A. I. A. members explains the purpose of the exhibition and gives information of importance to those interested in exhibitions of this nature and is published herewith:

There will be an exhibition of Architectural Renderings, Photographs, Sculpture, Pottery and Furniture from March 28 to April 15, 1920, in the Galleries of the Seattle Fine Arts Society, 1213 Fourth avenue, Seattle.

It is not the intention to limit the exhibition to work of chapter members, but every effort will be made to

Seattle.

The exhibition committee consists of Roland E. Borhek, Arnold S. Constable, J. S. Cote, Carl F. Gould, David J. Myers, Ellsworth Storey, Louis Swarz, Joseph Wilson, and Andrew C. P. Willatzen, chairman.

## Why Not Buy American Art?

The 115th annual exhibition of the Academy of the Fine Arts, recently opened to the public in Philadelphia, contains 413 works of art in oil and 105 pieces of sculpture. Whatever may be the final analysis as to the level of such an exhibition, states the *Philadelphia Ledger*, it goes without saying that both oils and sculpture represent a high technical facility and that the paintings, for the most part, have that size and appeal that make them easily handled in the modern home and in every way quite refreshing to live with, the latter factor a quality which, after all, is the test of a picture, ancient or modern. Moreover, in the matter of sculpture the preponderance of small objects which have all the value of bijouterie, as it were, also makes their possession an easy matter, while the fame of the American sculptor, as a creator of artistic garden pieces, also places some striking examples of this form of art at the command of almost every one in a community such as this, which contains more beautiful gardens within an easy radius of the city than any other center in America.

This being the case, it ought to be a matter of course that a very large percentage of the art exhibits should be disposed of during the seven weeks of the exhibition. But in all probability nothing of this kind will happen. The percentage of sales will be small, largely because the general public neither realizes its opportunities nor its responsibilities in this issue of American art. This is one of the curious phases of our art life, for if large purchases of our current art are made, they will be made on other occasions and through other instrumentalities. This has led those who know how vital a thing American art and who believe in it to organize groups calling themselves "Friends of American Art," in one instance, who endeavor to make the sales at the annual exhibitions bear some relationship to the output. Each community, of course, will get at this problem differently; but it would seem to be time for a new movement to be started here which will frankly plan for a greater number of sales and a more practical system of buying the pictures which are shown so as to bring art home as a personal appeal to every one, for the only appeal in the long run that counts is that which touches the pocket and leads one to be anxious to possess a work that the contemporaneous artist has produced.

However we may talk about art or however we may appreciate the artist in the abstract, if we are only moved to buy art which has survived the centuries we do not encourage that thing that all agree is to be the saving thing in American life. It is easy, of course, to speculate as to what might be done and at what outlay, but think what it would have meant to American art, just taking that wonderful period that began with the World's Fair in Chicago in 1893, if the major portion of the best works at our annual exhibitions had been absorbed annually and made rallying points on the walls of our homes. If we are to take the place we should occupy in the world

as a people of broad culture we shall have to stir ourselves and realize that lip service to contemporary art is not the way to encourage that thing that must be of the very marrow of our daily life.

## Wooden Houses in Great Britain

Although there has been much discussion in and out of Government circles lately on the subject of the proposed building of wooden houses as a means toward overcoming the shortage of dwellings in Great Britain, caused principally by the almost total cessation of building operations during the war, it does not appear that steps have been taken toward the systematic popularization of this type of building in Great Britain.

This may be in part because the average citizen of Great Britain has not a very clear idea of how a modern wooden dwelling, with properly constructed cellar containing laundry and heating apparatus, is constructed; his idea of a wooden dwelling is that it is a slightly built structure, suitable for a summer cottage but wholly unsuitable for human habitation in the winter. He has but the faintest conception of how the walls of such modern American wooden dwelling houses are constructed or of the meaning of such building terms as clapboarding, weather boarding, tarred-paper sheathing, furring, and back-plastering, or of the uses of storm doors and windows.

As an increasingly large number of prospective householders are, however, now becoming interested in this subject, it would appear as if there might be a demand in Great Britain for American current literature and publications dealing with the construction of modern dwellings.

## Oriental Rugs and American Floor Coverings

It is conceded that a fine Oriental rug is the most highly prized floor covering known to the entire world. No floor covering of modern times, either European or American, has ever seriously contested the artistic supremacy of the best Oriental weaves, writes *Good Furniture*. They will always remain in the realm of floor coverings what the sculptures of the Parthenon are in the field of sculpture, the great Renaissance murals in the field of painting or the celebrated windows of the Gothic cathedrals in the art of stained glass.

It is admitted that the superb rugs of the Orient cannot be produced by the methods of the Occident and we have not conceded by any means that our carpet designers and weavers cannot produce for us floor coverings which are as appropriate and as beautiful for twentieth century purposes as the carpets of Smyrna, Samarcand or Bokhara were for the purpose for which they were made during the periods of Oriental splendor.

We must not lose sight of the fact that the conditions which fine twentieth century floor coverings are called upon to meet are very different from those for which the famous carpets of the Orient were intended. The Oriental never walked upon his fine carpets with modern shoes. If he wore shoes at all he removed them when he made his devotions, kneeling on his prayer rug at home or in the mosque. The delicate fibre of wood or of silk woven into his carpets did not get the grinding wear of shod feet that the modern carpet is supposed to stand and, consequently, retained indefinitely the soft texture and pile surface of the weaving as it came from the loom. Obviously, our modern carpets must be differently woven to resist the

inevitable wear that comes with daily use. For that reason they need not necessarily be less beautiful in color, design or texture. Oriental rugs can teach us much about the artistry of weaving floor coverings. For durability we must find our own solution.

A time will come when fine Oriental rugs will again be used as wall decorations only, as was the custom in the Orient long ago. They will become as highly prized decorative textiles as are the priceless Gothic and Renaissance tapestries that remain with us to adorn the walls of our art museums and the mansions of the wealthy. Fine tapestries have become comparatively rare. Fine Oriental carpets will become equally rare in the future. They are rapidly becoming scarce and the art of making them is dying out. Our own carpets and rugs are becoming finer in color, design, texture and workmanship, due to the manufacturer's efforts to adapt from Oriental weavers what fits modern conditions. True, machine-weaving has replaced hand-weaving but that was as inevitable as in other modern industries. But machine craftsmanship holds unexplored possibilities when guided by conscientious purpose and talent and skill. In that direction we must look for our fine floor coverings of the future. Our inspiration must come largely from the weaving masterpieces of the Orient but the finished result will depend no less on evolving beauty and integrity in terms of present-day needs.

## Shaw on Architecture

George Bernard Shaw has been so much given to expounding startling theories purely for the pleasure of shocking his readers that no one is now likely to take him seriously in his advocacy of a new doctrine, writes the Decatur, Ill. *Herald*. In spite of the fact that Shaw himself is responsible for it, this discrediting of his utterances is occasionally to be regretted because the Shavian nonsense often encloses a kernel of good sense that the world might profitably take to heart.

Such is the case in the most recent suggestion of the dramatist. Shaw wishes to make a case for better architecture and avoidance of the mistakes of the past in the building that must be done to meet the present housing shortage of the world. Every thinking person is heartily with him in this proposal, but perhaps for this very reason, because it would grieve him to find himself in agreement with any large number, Shaw can not let the matter rest with any such simple and common-sense statement.

He considers it necessary to cloud his argument with some spectacular heresies which will serve to make his audience gasp and preserve his own reputation for eccentricity. For the purpose his statements that every building should be knocked down at the end of 20 years in order to cure "worship of the past" and to force each generation to create its own art; and that so far as the destruction of houses and cathedrals was concerned it would be a good thing to have several more wars in order to destroy all the buildings in Europe, are admirable.

Even in these most extreme statements there is some element of truth. It is in fact desirable that each generation should create something of its own in the field of architecture as in other arts, but the way to attain this end is not by destroying the examples of the past. It is significant that creative individualism was never so much lacking as during the medieval centuries, when the achievements of the past were forgotten or ignored. The creative, individualist spirit appeared in the Renaissance simultaneously with a revised interest in the classic examples of Athens and Constantinople.

simple designs of our own Colonial days and of other recognized types is again bringing dignity and beauty to our residence streets.

Mr. Shaw's plea for avoidance of the mistakes of the past is praiseworthy, but the methods he would advocate are obviously useful only to give his opinions a picturesque setting.

## Annual Exhibit of Evening Work at Pratt Institute

Thursday evening, March 11, will be observed as "Visitors' Night" in the School of Science and Technology of Pratt Institute, Brooklyn, N. Y. The shops, laboratories, and drawing rooms of the school will at that time be open to the public, giving an opportunity to all persons interested in industrial education to observe the students at work in the various courses and to inspect the results and methods.

The School of Science and Technology provides instruction in industrial electricity, technical chemistry, mechanical drawing and machine design, strength of materials, stationary steam engineering and power plant operation, roof framing and stair building.

This school is now giving instruction in its evening courses to more than thirteen hundred men who are regularly employed in various vocations and who use these courses as a means to prepare themselves for more effective service.

## Personals

John H. Bickford Co., architects, 40 Central street, Boston, have moved to 6 Beacon street.

Alexander S. Deserty, designer, formerly of New York City, is now associated with Zink, Sparklin & Condolfo, Inc., architects, Munsey building, Washington, D. C.

Pratt and Witton, architects, have opened offices at 44 Broomfield street, Boston, Mass.

Flournóy G. Hagan announces the opening of an office in the First National Bank building, Paris, Kentucky, for the practice of architecture and structural engineering, the title of the firm to remain as Wm. K. Hagan & Son.

Geo. H. Schwan, architect, Peoples Bank building, Pittsburgh, Pa., has opened a branch office at room 72, Third National Bank building, Cumberland, Md., Gordon S. Barber in charge. They request all catalogues and samples from material houses sent to the new address.

Sorgi, Holmes and Sichtenstein, architects, 15 Ashburton place, Boston, Mass., have moved offices to 120 Boynton street.

Firm name of Somes and Parsons, architects, Beacon street, Boston, has been changed to E. M. Parsons and Company.

James S. McIntyre, architect, Clifford building, New Bedford, Mass., has moved office to Times building.

Hollis Parker and F. S. McBain have formed a partnership and will practise architecture at 210 Levy building, Houston, Texas.

comparatively insignificant sums.

In some cases magnificent properties have brought only from \$5,000 to \$10,000. Dollars are now quoted at from twenty to fifty times their pre-war value.

\* \* \*

Dr. Hugh S. Cumming of Hampton, Va., has been nominated Surgeon General of the Public Health Service by President Wilson. He succeeds Dr. Rupert Blue, whose term expired Jan. 15. Dr. Blue will remain in the Public Health Service, probably with the rank of an Assistant Surgeon General, doing research work which he has under way, including the fight on influenza.

\* \* \*

Earnings far in excess of anything that had been anticipated were reported by the United States Steel Corporation for the final quarter of 1919. The income for the period, after provision for Federal Income and war excess profits taxes and interest on the bonds of subsidiary companies, was \$35,791,302. The fourth quarter earnings were exceeded only by those of the third quarter, when the earnings amounted to \$40,177,232.

\* \* \*

Army recruits must now enlist for three years, except in the Field Artillery, Engineer Corps, and Chemical Warfare Service, in which one-year enlistments are still received. The quota of one-year enlistment men permitted in the army is virtually filled.

\* \* \*

The National Bank of Commerce in New York announced the adoption of a plan by which it will pay half the cost of educational courses taken by its employees. The purpose is to encourage them to study subjects which will aid them in their work and pave the way for their advancement. One out of every five employees of the Bank is taking evening courses.

\* \* \*

Decentralization of the country's banking resources and widespread distribution of wealth, indicated by an increase in banking resources of 1000 per cent or more in sixteen states since 1899, was shown by a comparison of present bank resources with conditions twenty years ago issued by John Skelton Williams, Comptroller of the Currency.

The banking power of the country twenty years ago was concentrated mainly in the East, the report said, and national banks in New England and Eastern States comprising but 6 per cent of the territory of the United States held almost 60 per cent of the total resources of all the national banks in the country.

\* \* \*

Freight transportation through local rail and water terminals stopped and an embargo on shipments was declared as a result of a strike by union freight handlers in Boston. About 1200 men walked out. The men on all three roads are involved in demands now pending with the Railroad Administration for a wage increase, and the strike was declared in an attempt to hasten the decision.

\* \* \*

Shipbuilding companies in the Delaware River district of the United States are offering Canadian mechanics \$100 a week in the hope of making good the shortage of labor which exists in their yards, according to Herbert Lewis, secretary of the local Toronto union, International Association of Machinists.

# Weekly Review of Construction Field

Comment on General Conditions of Economics With Reports of Special Correspondents in Prominent Regional Centers

UPON the release of the railroads from Governmental management there are reports of large orders for equipment. *Iron Age* says that the estimates of car contracts are as high as 100,000. Actual orders have been placed by the Santa Fé for 2,500; the Erie has ordered 1,000 box cars; the L. & N. and the Southern Pacific will build 1,000 cars each; and so on. These reports are encouraging to the belief which heretofore has managed to exist that present transportation difficulties cannot last forever.

Negotiations upon the wage problem are beginning between the representatives of the brotherhoods and the officials of the corporations. It will not be long before the question will be brought before the Labor Court—upon which the public will have representation. This, at least, is the opinion of the representatives of the brotherhoods. Apparently they do not anticipate an agreement between the two committees.

Transportation has been seriously crippled by the snow storms of February. But given time, the melting of snow is as inevitable as is the settlement of wage disputes.

The February car supply in the Pittsburgh district scarcely reached 65 per cent. In Ohio it was nearer 60 per cent.

The shortage of steel is the most widespread deterrent to building construction. It is felt from coast to coast. And it is therefore interesting to see that the statistics of production during February were unusually high. The average pig iron production during January was 97,264 tons per day; the average daily output during February was 105,006. The blast furnaces during February were increased by fourteen, increasing the daily output by more than 5,000 tons. Steel mills are accumulating large quantities of finished product; the manufacturers, however, are suffering two great difficulties—the car shortage and the fuel shortage.

Cars are being ordered, but months must elapse before they become actually available. There are 17,000 Canadian cars now on our lines which we have been asked to return. One of the difficulties in getting them back is that the roads are blocked with snow. It is a pity we haven't the rolling stock which we disposed of with so much difficulty when the A. E. F. left France.

## Building Operations in New York

THE report of building operations in Manhattan as compiled by Rudolph P. Miller, Building Superintendent, show a decided increase for February over the same month of last year. Plans have been filed for 28 new buildings to cost a total of \$9,933,500, as against 16 costing \$3,978,200 in February, 1919.

For the first two months of this year plans were filed for 73 new buildings costing a total of \$23,977,500 as against 32 buildings costing \$5,129,250 in January and February of last year; more than four times as much money for twice as many buildings.

There was an outlay for alterations to 309 buildings of \$3,415,715 during the past month as compared with \$954,480 spent for alterations on 223 buildings during the same

month of last year. The buildings on which alterations were made were of the following types: 105 dwellings, 44 tenement houses, 61 stores and loft buildings, 31 office buildings, 11 hotels, 7 stables and garages, 6 places of amusements, 2 school houses, 1 church, and 1 municipal building.

## Building Production

THERE is some justice in the opinion of the *New York Evening Post* that many of the statements of increased building activity are "a case of optimism born of desire and motivated by want." It is true that the gross figures of contracts placed are giving, because of the decreased value of money, a somewhat exaggerated impression. It is true also that production in the building field has suffered in efficiency during the past five years as in every other field that felt the touch of war conditions. Untiring effort is necessary to re-establish the industry upon a pre-war basis—and better. The building industry feels the same wants as the rest of civilization from which it is in no sense isolated.

But it feels it with a difference. There are items of production which we may learn to do without. For them the outlook is dark. But in a climate such as ours buildings are a prime essential. During the war the reductions in the construction program were most unwise; and subsequently (in 1919) when there began to be a construction program the shortcomings in carrying it through were unfortunate. But housing has not become less in demand nor has the outlook in the building field become discouraging.

Following behind the urgently realized need for housing of our people and of our industries is the building program with its huge figures of projected construction, and keeping up as well as it can is the actual building, hampered on the one hand by the difficulty of securing material and on the other by the greater or less lack in enthusiasm for accomplishment among the building trades. The position for actual production is not at the head of the procession; its place is at the rear. Just now it is a bit too far in the rear but so long as it keeps going there is no occasion for actual discouragement and when it shortens the space between its own and the other two sections, as is expected to be done in this coming season, there is a moment for enthusiasm.

## Labor and Politics

IT is announced that all the Central Labor bodies in the State of New York are urged to support a bill dealing with rent profiteering. Very possibly there is profiteering in rent but bills in Legislature cannot alter the causes for a situation which makes the practice possible. Legislative bills when clever enough to be effective in such cases are like patent medicines which remove a symptom but permit the disease which causes the symptom to go on until it develops a new and sometimes surprising symptom. The best of such palliatives are of a simple homeopathic variety: the interests in the real estate fields should know

best how to curb their avaricious and ruthless associates and it is their advice which should be sought without the introduction of outside agencies. If there is a panacea they will know what it is.

But if rent profiteering is effectively done away with, it does not make housing for the people who have none. The production of new housing is a most important phase of the matter in which the direct application of labor may influence the consummation of an achievement. There is nothing legal or legislative about it.

The politics of this country have outgrown the stage when they were a machinery for mismanaging somebody else's business. A few weeks ago the American Federation of Labor expressed a political program which would bring all of their members to the support of those issues which furthered the interests of labor. Such a concentration of power, wisely used, could be of great benefit to the nation; but if it is to be another unintelligent and short-sighted antagonism to varied interests which seem superficially opposed it can accomplish nothing in the direction of development. The early exhibition of its policies in the New York State Legislature, if indicative, is certainly discouraging.

It would be distinctly appropriate for organizations of labor to become interested in the material production and manufacture of this country. Upon the craftsmanship and upon the quality of the output, upon working conditions and their effect upon production, upon the education of workmen through apprenticeship, and upon legislation and finance as they affect these and similar phases of industry their opinions and influence will be of inestimable value.

## Dr. Eliot Upon Building Economics

IN an article discussing the change of the public attitude toward strikes, published in the *New York Times*, Dr. Eliot, of Harvard, says:

"A decided majority of the American people have of late experienced a new difficulty in owning houses and small shops, and in living in houses of their own. On account of the exorbitant wages in all the building trades and in some of the trades which supply building materials, innumerable American families find themselves obliged to move from their own houses into hired tenements which are much less desirable as regards space, light, air, and the other means of bringing up children in a healthy way. This is a grievous descent in dignity, independence and comfort; and it affects every class in urban and suburban communities, and even in small towns and villages, except the downright rich. Wherever a plumber, electrician, gas-fitter, painter, furnace and stovemaker, mason or joiner charges from 80 cents to \$1.25 an hour, there the American family is forced into narrow, crowded, hired quarters; unless by good fortune or the gift of nature the householder can himself practice two or three of these fundamental trades.

"This degradation of family life is resented by the average American family which has children, and induces in them serious distrust of the prevailing wage-raising processes in trades which have to do with such necessities of life, in the climate of the United States, as shelters, fuels, foods and transportation. The average American reflects that high wages in building trades have at least one drawback for people in the other trades or occupations—they raise rents, prevent new building and congest the population."

(By Special Correspondence to THE AMERICAN ARCHITECT)

CHICAGO.—The building situation in Chicago is summarized for the week in excellent fashion by Gerhart F. Meyne, president of the Chicago Contractors' Association. In discussing the cost of building, he said:

"There has been a tremendous advance in the prices of material, in some instances as much as 175 per cent, and in other only as high as 70 per cent. Take, for example, the prices of cement in 1914 as compared with prices to-day. In 1914 cement sold at \$1.25 net, while to-day it is selling at \$2.65 net, an increase of 113 per cent; sand, which then sold at \$1.60 is now selling at \$2.35, an advance of 103 per cent; stone, which sold in 1914 at \$1.60; is now selling at \$3.25, or an increase of 103 per cent; lime has advanced from 65 cents to \$1.75, or 170 per cent; bank sand from \$1.25 to \$3.25, or 160 per cent; common brick from \$7 to \$14, or 100 per cent; pressed brick from \$22 a thousand to \$38 a thousand, or 73 per cent. The increase in the price of lumber is from \$28 to \$72, or 160 per cent. The average increase, it will be seen, is 120 per cent. Steel has advanced in proportion. Owners of yellow pine land were selling stumpage in 1914 at from \$2.50 to \$5 a thousand; to-day the price of stumpage runs from \$14 to \$20. The land owner is doing the gouging in this instance. Freight rates have advanced 25 per cent, in addition to 1 per cent. war tax. Maple flooring is almost beyond reach. Manufacturers can get almost any price they ask for it. In December there was 9,000,000 to 10,000,000 feet of flooring on hand; now there is a demand for 52,000,000 feet. Hardwoods are in the hands of few and they will not sell. Producers have just begun to cut, and it takes a year or two to season it. Oak flooring shows the greatest advance in price. This is due to the foreign demand; 50,000,000 feet of oak flooring was bought in this country last Fall for export. They are now asking \$250 per thousand for high-grade oak flooring, of the quality we use in high-grade apartment houses and in dwellings.

"Take the cost of pipe. I refer more particularly to that required for steam and hot-water fitting. Radiation in 1914 cost 15 cents; in 1916, 18; in 1918, 36; in 1919 it dropped to 31 cents then advanced to 39 cents, and we are pleased to-day if we can buy it for 45 cents—an increase of over 300 per cent on what it cost in 1914.

"The cost of construction is also influenced by the increased wages paid those employed in manufacturing material. The ultimate consumer is helping to pay for the increased cost of all the material and labor which goes into the construction of a building. Last, but not least, is the increased cost of labor, but it has not kept pace with the cost of material. In 1914 bricklayers were paid 75 cents an hour, as against \$1 now, an increase of 33½ per cent; carpenters, 65 cents, as against \$1, an increase of 54 per cent; laborers, 40 cents, as against 70 cents now, an increase of 75 per cent; bridgemen, 68 cents, as against \$1, an increase of 47 per cent; cement finishers, 65 cents, as against \$1, an increase of 54 per cent; plumbers, 75 cents, as against \$1, an increase of 33½ per cent; plasterers, 75 cents, as against \$1, an increase of 33½ per cent; steamfitters, 65 cents, as against \$1, an increase of 33½ per cent. An analysis of the figures shows that the average cost of material and labor, in comparison with the pre-war figures, is \$1.13. Now practically all of the building trades are asking for \$1.25 an hour."

While building has not been discontinued as a result of the situation in Chicago, it has been delayed materially. Prices continue to advance both in material and labor. There is a decided scarcity of cement, glass, and some grades of lumber, while the money situation is still tight here. A plan is now being discussed by city officials and others to organize a "building corporation" in Chicago to build apartments and flats for rent, to care for the increasing demand for homes. There are no vacant houses of any kind in Chicago and suburbs.



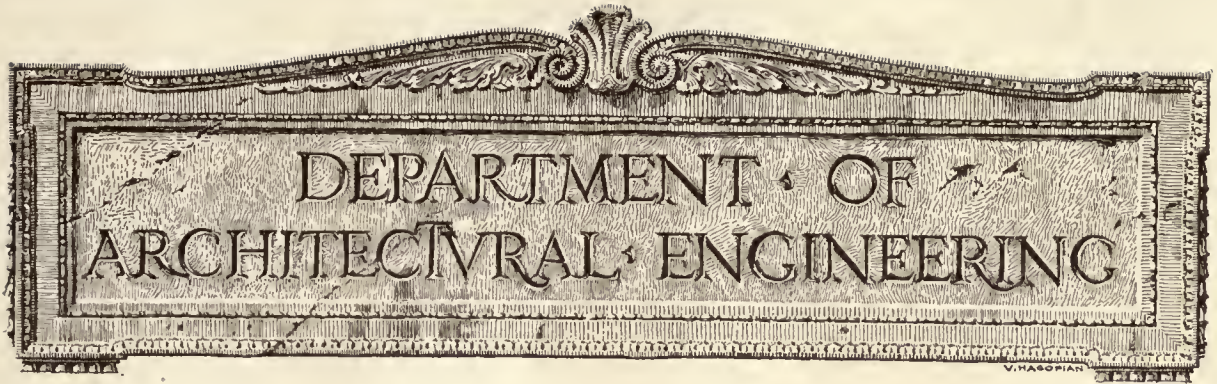

## The Fundamental Principles of Illuminating Design

A Practical Treatment of a Technical Subject in Which Simple Methods of Design Will Be Set Forth

**T**HERE are many subjects in the treatment of which difficulty is encountered in forming a true conception of the materials involved. This is largely due to the lack of any concrete characteristics of the subject dealt with. One is placed in the position of Sir Oliver Lodge's audiences after he has described with much scientific detail that illusive and uncomprehensible material "ether." You come to a definite conclusion that it is and it isn't, therefore you have arrived nowhere.

While many materials as well as certain forms of energy belong to the realm of scientific research, some have a very direct and practical bearing on everyday life. Among these latter is light, especially artificial light.

Since the subject of artificial light is so intimately linked up with building construction, the architect, while he need not necessarily be conversant with all its scientific aspects, should at least acquire a fundamental knowledge of its use and application. As we have reached an era when conservation of our natural resources is essential, artificial lighting systems should be designed to provide the utmost efficiency. No place of business can to-day operate at maximum efficiency when improper lighting facilities are provided, and adequate lighting does not necessarily require a great quantity of light. The quality and distribution are equally important.

In order to predetermine the lighting requirements for any kind of building operation, it is necessary to know the quantity of light required to carry on, without eyestrain, various occupa-

tions. Because continued eyestrain results in serious defects in health, many states have now passed laws specifying minimum light requirements for various industries. Any building erected in such states in which the lighting equipment fails to provide the legal intensity of illumination violates the state law, and such alterations as are necessary to bring the lighting equipment up to the standard set forth can be ordered.

The subject of Industrial Lighting codes was fully discussed in an article by G. H. Stickney, published in three parts in the *AMERICAN ARCHITECT*, issues of May 14th, 28th and June 11th, 1919.

A later article on the subject of illumination will include a table giving required and recommended practice for lighting intensities for various building occupancies.

Before we can intelligently proceed with the subject of light, it is first necessary to become familiar with the units employed in its measurement. Until recently it was common practice to designate lamps as so many candlepower. This method was unsatisfactory and gave a false impression as to the illuminating capabilities of the lamp.

*Intensity*:—To-day the "foot-candle" is the standard unit of measurement of light intensity. It is that intensity of light produced by a standard candle on a plane distant one foot therefrom. This is illustrated diagrammatically in Fig. 1. A practical conception of this value can be obtained by reading a newspaper by the light of an ordinary candle placed one foot distant from the sheet.

*Quantity*:—Light waves emanate in all directions from the source. The aggregate quantity of light

falling on the inner surface of a series of enclosing spheres of varying dimensions (the source being located at the center) would be the same, but the intensity would vary inversely as the square of the distance of the surface from the source of light. Thus it will be seen that a source of light of one standard candle (or one candle-power) will give an illuminating intensity of one foot-candle on a surface distant one foot, but of only .01 foot-candle on a surface ten feet distant. This principle is illustrated graphically by Fig. 2. In the nearest plane the quantity of light included within the projection lines covers but one square foot of surface, while at a distance of three feet it is spread over an area nine times as great. The total quantity of light is the same in both instances

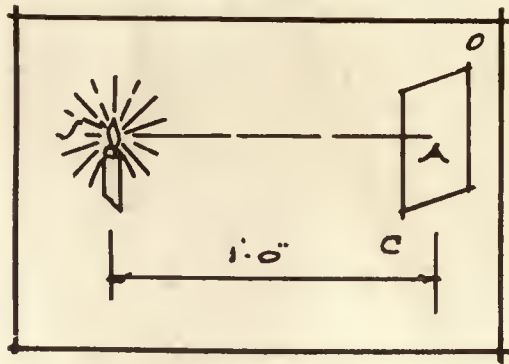

FIG. 1. THE ILLUMINATION AT "A" IS 1 FOOT-CANDLE

but the unit intensity differs. A homely illustration would be to spread one cubic inch of butter on one slice of bread. The amount would be more than adequate. Now if the same amount were used to butter nine slices, it would be very thinly spread out. In each case the total quantity is the same, but the amount per unit area of surface varies.

The quantity of light projected by a source of one standard candle on a plane one square foot in area placed at a distance of one foot is known as a lumen. If a standard candle is placed at the center of a sphere having a radius of one foot, every portion of the surface (being one foot from the source) will be illuminated to an intensity of one foot-candle, and the quantity of light projected on every square foot of surface will be one lumen. Since the area of such a sphere is 12.57 sq. ft., the candle will have a value of 12.57 lumens. In this case unity is the mean spherical candle-power of the lamp, which if multiplied by 12.57 gives the number of lumens emitted. Thus to obtain the number of lumens produced by a source of light multiply the mean spherical candle-power by 12.57.

*Measurement of Light.*—There are various instruments for measuring light intensities, the simplest for all practical purposes being the foot-candle meter, illustrated in Figs. 4 and 5.

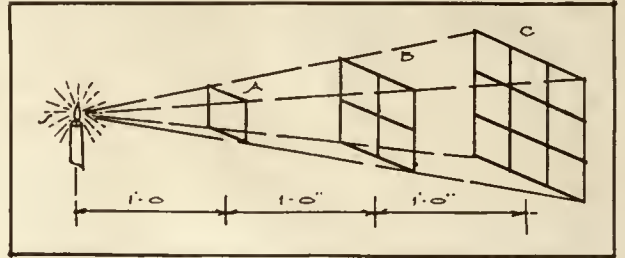

FIG. 2. THE ILLUMINATION ON A SURFACE VARIES INVERSELY AS THE SQUARE OF THE DISTANCE FROM THE SOURCE TO THE SURFACE

In operation it is placed upon or adjacent to the surface on which a measurement of the foot-candle intensity is desired. A standard lamp within the box illuminates the under side of the screen to a much higher intensity at one end than at the other. The voltmeter is set at the designated line by adjusting the rheostat which is in series with the dry cell and standard lamp. We look at the foot-candle scale and determine merely the point at which the brightness of the translucent spots, lighted by the standard lamp inside the light box, equals that of the illuminated background, which receives the intensity it is desired to measure. In Fig. 6 it is apparent that the spots at the right are lighter than the background—those at the left of the scale darker. In between, at some point, the brightness of the spots and of the background is the same, and at this point we read directly,

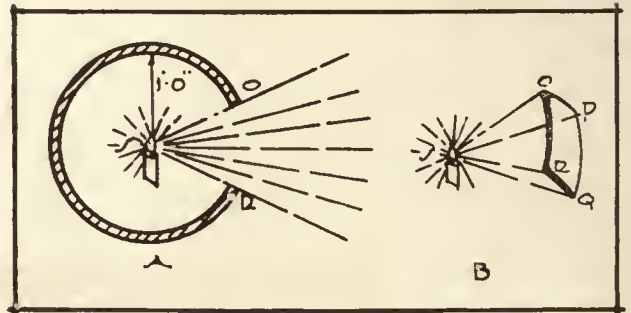

FIG. 3. A—OPENING "O-R" HAS AN AREA OF 1 SQUARE FOOT AND EMITS 1 LUMEN. B—ONE LUMEN FALLS ON SURFACE "O-P-Q-R." TOTAL AREA OF SPHERE IS 12.57 SQ. FT.

without manipulation of any movable parts, the intensity of illumination—in this case, 5.5 foot-candles. Minimum attention is required in making this determination and we are able to walk about, rapidly noting the manner in which the intensity

of illumination varies from point to point in the room and in the different planes at a given point. It soon becomes possible for us to visualize the light conditions in a room quantitatively. It is no more necessary to know the principles involved in the foot-candle meter than to understand the operation of a voltmeter in order to read voltage correctly.

The accuracy of the foot-candle meter is of the order of from 85 to 90 per cent, which is sufficient for all but very exceptional cases. Where accurate comparisons between different lighting equipments have to be made, larger instruments must be employed. The foot-candle meter is, then, distinctly a popular instrument; the other larger portable photometers are professional instruments, and they will be needed just as much in the future as in the past. The foot-candle meter will be found of much benefit to the architect and should be an important part of his equipment.

Now, to get at the practical application of the units of light measurement, let us assume a specific case, remembering that the foot-candle represents the unit for measuring intensity and the lumen quantity. For example:

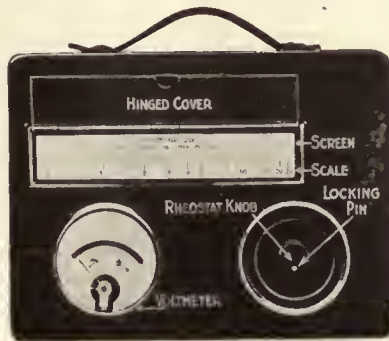

FIG. 4. FOOT-CANDLE METER

What size lamp should be used to illuminate a room 10 feet square, to be occupied by jewelers working at gold and silver polishing?

According to the N. Y. State Industrial Code, a minimum intensity of 5 foot-candle is required at the work. The area to be illuminated is 100 square feet. Since an intensity of one foot-candle over one square foot requires a quantity of light of one lumen, five lumens will be required over each square foot of working surface. The total quantity of light necessary adequately to illuminate the entire surface will be 5 x 100, or 500 lumens. A 60-watt Mazda B lamp (mean spherical candle-power = 47) has a value of 585 lumens. Therefore, if every scintilla of light produced by such a lamp could be evenly projected and distributed over the entire working plane, such a lamp would prove adequate. Such an ideal condition, however, is not



FIG. 5. INTERIOR VIEW OF FOOT-CANDLE METER

possible. To provide for practical limitations several additional factors must be introduced into illumination design. At the beginning of this article mention was made of the importance of quality and distribution of light as well as its quantity and intensity. The next article will deal with methods of light distribution, and we will see how the above calculation must be modified in order to obtain the desired results.

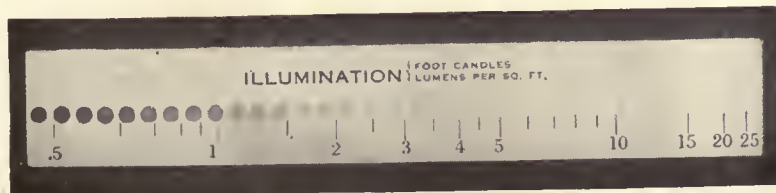

FIG. 6. FOOT-CANDLE METER SCREEN INDICATING 5.5 FOOT-CANDLES

# Fire Protection for Schools

## Part I—General Considerations

By H. W. FORSTER,†

[The National Fire Protection Association's Committee on Safety to Life is actively engaged in studying the school egress problem, and this committee and the whole Association are actively interested in fire prevention and fire protection for schools. It is hoped that this article will prove a timely contribution in the effort to increase the safety of life in schools. The facts presented in this article are as applicable to the colleges and universities as to the grammar and high schools of the country.—*The Editors.*]

IT IS a far cry from the little red schoolhouse on the hill, with its one room, its handful of pupils, its chief fire hazard, the stove, out in the open where it is easily seen, its bucket of water, and its doors opening into the yard, to the modern city school, several stories in height, housing hundreds of children, and presenting complicated problems of fire prevention, fire protection and egress.

The property loss in schools has been large; the loss of life has been considerable; the fire risk in most existing buildings is great. The thought, energy and money put into furthering life and property safety in schools have not even approached that warranted by the jeopardy to the lives of the nation's greatest asset—our children.

While considerable improvement has been made in the last decade in the construction of new buildings, and also in the improvements of many existing structures, the fact remains that the large majority of schools in use to-day may become charnel houses instead of effective agencies of human advancement.

Business men who have created excellently safeguarded manufacturing and merchandising properties when serving on boards of education apparently do not view the American child as worthy of the same protection as buildings, machinery and goods. Possibly they argue that children can walk out of a burning building whereas goods cannot. Generally in event of fire the children do escape, but occasionally heaps of charred bodies of little children scathingly rebuke the judgment exercised and the parsimony practised in the field of creating greater fire safety in schools.

Ignorance of even fundamental principles of fire prevention and fire protection on the part of those

vested with the management of schools is one of the chief factors that make for the existing poor conditions.

No matter how great may be the poverty of an educational institution, it should not disregard any fire precautions that are relatively inexpensive, and it should spend at least a moderate sum each year for the gradual improvement of its most dangerous buildings. When the seriousness of the situation is generally recognized—and it is a fact that over 90 per cent. of our school buildings are potential death-traps—prosperous and philanthropic citizens will leave money to their alma maters and to the school systems of their cities for the furthering of fire prevention instead of for the addition of another building, frequently of inferior construction.

The object of this article is not only to set forth the vital necessity of improving the conditions of our educational institutions, but also to point out specifically the problems which confront substantially every public school, private school, college or other institution.

*Statistical Data.*—At the present time there are in the United States approximately 300,000 buildings used for educational purposes, valued at more than \$3,000,000,000. A very considerable number are erected each year, and it has been estimated that for every two new schools erected each year one is destroyed by fire.

The Actuarial Bureau of the National Board of Fire Underwriters, reporting only on fires where insurance was in effect, advises that for the two years regarding which complete information is now available the facts are as follows:

1916. No. of fires, 2498; property destroyed, \$4,333,025.

1917. No. of fires, 2417; property destroyed, \$4,051,680.

Because of the great extent to which schools carry their own insurance, it is certain that the total number of fires and the amount of losses have been greatly in excess of these figures.

No accurate records have been kept of the lives lost in school fires, or any other type of fires for that matter, and consequently exact data are not available.

\*Abstract (in three parts) of an article prepared and printed for the Department of the Interior, Bureau of Education, by the National Fire Protection Association.

†Chairman, Committee on Safety to Life, National Fire Protection Association. Chairman, Committee on Fire Prevention, National Safety Council.

The essentials of fire safety for schools, and, in fact, for practically all other structures, are developed more in detail later in this article. In order, however, that a clear grasp may be had of certain fundamental and common-sense principles, it is well to summarize in order that those interested may grasp the basic features of the whole problem.

Obviously the way to escape fire danger is to have no fires. That means fire prevention.

The next best thing to preventing a fire from starting is to see that any fire that starts is invariably extinguished while it is still small. The automatic sprinkler system is beyond question the most dependable device for accomplishing this, as is witnessed by a remarkable record of performance covering thirty-five years, which is summarized in the following statement unanimously passed by the National Fire Protection Association at its 1914 convention:

It is to-day an almost unquestioned fact that automatic sprinklers afford the highest degree of protection against fire in practically all cases where there is combustible construction of material, the rapid burning of which is liable to be a menace to the lives of occupants of the building.

Structural improvements and the use of fire-resistant building material in new buildings make possible a degree of safety in them which cannot be secured in existing structures except by the application of automatic sprinklers.

Upon the carefulness and diligence exercised in fire prevention measures, and upon the provisions made for promptly extinguishing fire when fire prevention measures fail, depends to a considerable extent the problem of arranging for satisfactory egress. Obviously a one-story building with doors opening from every room directly to the outdoors has little in it in the way of egress problems. The egress difficulty in the multi-storied school is quite another question. The Committee on Safety to Life of the National Fire Protection Association is now developing the school egress problem in detail. Its preliminary report will be found in the 1919 Proceedings of the Association, and should be studied carefully by all authorities interested in this important matter.

Closely associated with adequate egress facilities are the suitable education and organization of those responsible for fire safety in schoolhouses—the provision of automatic alarms, the systematic conduct of fire drills and the proper education of teachers and pupils.

There is necessarily a close interrelation between all of these various problems, and such interrelation should be borne in mind in reading the following sections of this article.

The data presented are based upon investigations extending over a period of fifteen years, a detailed

examination of several hundred schools located in different States, and a careful study of the available literature on this subject.

*(To be continued)*

## Waterproof Glues

By HENRY A. GARDNER

**I**N THE paint industry, animal glues (gelatine) and vegetable glues (processed starch) have been used as adhesives for cold water paints and calcimines, and for labeling gums. These forms of glue possess the undesirable property of becoming weak when exposed to moisture or subjected to the action of water. As a result of wartime endeavors to develop satisfactory glues for seaplane plywood, laminated gunstocks, and other products, there became available glues produced with casein or blood albumen as a base. These glues have extraordinary water-resisting properties. Plywood made of 3-ply veneer 1/16 inch thick glued with casein glue may be boiled in water for eight hours and still show an average breaking load of not less than 90 pounds per square inch. One-inch test blocks may be placed together with this glue and show a shearing strength of 2200 pounds per square inch.

Casein glue is cheaper than blood albumen glue, and is probably more practical for most commercial purposes where application is made by hand rather than by machine or hot press. It is possible that casein glue might be found useful as a base for label pastes. Its slightly alkaline reaction would etch the surface of tin with the possibility of greater bonding power than some other adhesives. Because of its high waterproofing properties it might also be useful as an adhesive in calcimine and cold water paints. The writer has experimented with such glue as a part of the liquid portion of exterior paints, and secured interesting results. If desired, casein glue may be prepared direct from casein by the addition of moderate and well-regulated amounts of slaked lime, caustic soda, or sodium silicate. As a rule, however, it is advisable to purchase the glue in prepared form, since carefully selected and finely divided casein, having a very low acid, fat, ash, and moisture content, and high nitrogen content, is used for this purpose and skillfully mixed to produce a successful product.

It is of great importance when any type of casein glue is used that it be properly mixed. Otherwise unsatisfactory results might follow. One of the best mixers is of the change can, bladed type, such as is used for mixing paint previous to grinding. The dry powder is placed in the mixer and

from one to two parts of water added, according to the degree of fluidity desired. It is preferable that the container for the material should be of the enameled type, as copper, aluminum and brass vessels are slightly attacked by the glue. After the glue has been mixed, it is usual to allow it to stand for a period of one-half hour before use, in order to develop its full strength. Glue thus made, as a rule, will remain fluid for a period of five hours, although some types may remain fluid for a much longer period. After standing in aqueous admixture for 24 hours, most casein glues set up to a hard, unusable mass, and it is then necessary to make up fresh batches. The glue dries to a very waterproof film of great strength.

## Important Matters Discussed at Meeting of Engineering Council

APPEAL ISSUED FOR SUPPORT BY THE ENGINEERING PROFESSION

**A**N important meeting of Engineering Council was recently held in the rooms of the American Society of Civil Engineers, Engineering Societies Building, New York City. An all-day session was held and many matters of current interest were discussed. A brief summary is appended.

Doctor Alexander C. Humphreys, president of Stevens Institute of Technology, chairman of the committee on curricula of engineering, called special attention to the important field covered by this committee. Attention is directed to the fact that both Columbia University and the Massachusetts Institute of Technology are now providing six-year courses in engineering besides the regular four-year course. The committee has investigated the extension of engineering courses, but is not yet ready to recommend the adoption of a six-year course by engineering colleges. Undoubtedly other universities will take this matter under advisement. Universal military training is favored by the committee, who also recommend the extension of facilities for providing vocational training, especially in the industrial centers of the United States.

### COMMITTEE ACTIVITIES

Employment Bureau reported 17,000 interviews, 4800 men registered, more than 1000 placed and total expenditure \$10,600, in past ten months; 60 to 70 men call daily.

National Service Committee active in connection with national budget legislation, Congressional Commission on Reclassification of Salaries, mileage for former engineer

officers, Interstate Commerce Commission and International Joint Commission vacancies, Industrial Conference, census classification of engineers, U. S. Topographical Mapping and Department of Public Works. Washington office used increasingly by engineers and Government.

Chamber of Commerce has admitted Council to membership. H. W. Buck appointed National Councilor and Delegate, and I. E. Moulthrop alternate.

National Department of Public Works: Petition to Chamber of Commerce was voted by Engineering Council, asking referendum on bill for Department of Public Works.

License Committee, at five-day session in Chicago, October 13 to 17, revised draft of typical law for registration of engineers.

Classification and Compensation of Engineers: Progress in collecting and digesting data on Federal, railroad, State and municipal engineers. Final report on Federal service this month. Increases granted railroad engineers below \$2,500.

Fuel Conservation Committee recommended support of legislation for investigating super-power generation and distribution in Boston-Washington district; so voted.

Joint Conference Report of Development Committees was discussed and letters sent to Founder Societies indorsing general plan for a national engineering council.

Financial statements: Total resources, \$70,393; expended, 9 months, \$32,651, including \$10,601 for Employment Bureau and \$17,038 for Washington office.

Tentative budget 1920: \$60,000 needed for all purposes. Appropriations of Founder Societies must be supplemented by contributions from individuals.

Appeal for funds to be made at once to engineers throughout the country.

Water Conservation Committee reported twenty-seven correspondents appointed in as many States, and much useful information collected.

Curricula of Engineering Schools: Committee reported on six-year course.

Reconstruction Commission. New York: Advisory Committee's recommendations sent to governors of all States and many civic bodies in New York.

Patents Committee: Three bills, based on report of committees of National Research Council and Engineering Council, now before Congress.

Jurisdiction Awards in Building Industry: Board held first meeting in Washington August 11, report by Council's representative, R. P. Miller.

Types of Government Contracts: Important committee appointed.

Payment for Estimating: Three delegates appointed to meet Associated General Contractors and American Institute of Architects in Chicago.

National Budget: Four delegates sent on invitation of committee of House of Representatives discussed budget legislation.

Since this meeting an appeal for financial support has been made by Engineering Council to professional engineers and engineering assistants throughout the United States.

## Economy Resulting from Co-operation Shown in Housing of Local Government Offices in the New Pittsburgh City-County Building

**A**N IMPORTANT step towards the ultimate housing of all local governmental offices in one building was taken by the City of Pittsburgh and the County of Allegheny, Pennsylvania, when they recently jointly erected the handsome ten-story City-County Building. This structure which is built of brick and stone occupies an entire city block and forms an important addition to the civic center of the City of Pittsburgh.

The building contains practically all of the municipal offices and those of the county, and also those of the Allegheny County Bar Association which is said to have the largest law library in the county. It has 22 courtrooms, including one devoted to the use of the State Supreme Court.

The dimensions of the building are 185x300 feet, and the cost was approximately \$3,000,000.

For the convenience of the public, the office of the City Clerk, Tax Collector, Prothonotary, Recorder of Deeds, are located on the first floor. On the floor devoted to general office purposes, there are 65 offices to a floor. All toilets are mechanically ventilated.

Twelve electrically operated elevators with pneumatically operated doors furnish transportation to the various floors.

The grouping of the offices of both city and county in this manner not only makes it more convenient for the citizens, but it also eliminates the expense of maintaining two separate buildings with the attendant expense for heat, light, power for each.

A striking example of the advantages gained by the consolidation of the housing facilities of the two groups of offices is to be found in the control and distribution of the supply of electricity for light and power, which is effected through a carefully designed switchboard installation described below.

Three-phase alternating sixty-cycle current is supplied by the Duquesne Light Co., of Pittsburgh, at a pressure of 2200 volts, through two separate

feeder circuits. This current is carried direct to a six panel, black marine finish slate board installed in the engine room which is 32 ft. by 122 ft. Protection to the incoming lines and the step down transformers is afforded by means of electricity operated oil circuit-breakers with automatic overload trips, which are mounted in a pipe structure at the rear of the board.

For operating elevators, cranes and other devices using directing current, two 300 KW, and one 200 KW, and one 100 KW, six-phase, 250 volt rotary converters are installed. Alternating current for supplying these rotaries is controlled from the six panel board previously mentioned.

The direct-current ends of the rotary converters are controlled from a seven-panel black marine finished slate board, and also two 2000-ampere, two 1200-ampere, and two 1000-ampere feeder circuits.

Both the A. C. and D. C. circuits are controlled by the main distribution board. This board is of the same construction as the two boards previously mentioned. It has 36 panels, is 80 feet long, and is divided into six general sections, three for alternating current and three for direct current.

It controls a total of 111 feeder circuits of 300-ampere capacity or less, 50 lighting feeders and 61 power feeders. The feeders are protected by automatic carbon circuit-breakers, those on the power feeders being equipped with self-contained inverse time element dash pots.

Each of the six sections has an incoming power panel ranging in capacity from 1000 to 3000 amperes protected by carbon circuit-breakers with voltmeter, ammeter, watt-hour meter, and graphic wattmeter for measuring the total amount of power used by each section of the board. In this manner proper charges can be apportioned to the city and to the county for the amount of current used by each.

The entire switchboard installation was built according to the specifications of Edward B. Lee, architect.

# Interesting Investigations Conducted by U. S. Bureau of Standards

THE United States Bureau of Standards has been conducting several experiments of interest to architects. The report of these investigations as summarized in an official technical news bulletin follows:

*Steel Analysis.*—It is becoming increasingly apparent that some non-destructive method for the testing of steel and steel products is urgently needed to supplement the present methods of vicarious testing. The Magnetic Laboratory has for some time past been investigating the possibility of utilizing the magnetic properties of iron and steel as indications of mechanical properties. The results already obtained indicate the possibility of applying magnetic methods to the study of the structure and properties of steel and to the testing of raw material and finished products. This application of magnetic testing has been termed magnetic analysis.

The present work of the laboratory consists of a study of the correlation between the magnetic properties of steel and its structure and mechanical properties, and the development of methods and apparatus for the application of magnetic analysis in a practical way. A method has already been developed for the determination of the degree of homogeneity along the length of a relatively long piece, this method being used by at least one railroad for research on rails. The successful application of magnetic methods which are non-destructive for the testing of steel and steel products will undoubtedly have great commercial value and may be expected to contribute a large measure of safety in cases where perfection of material is of prime importance.

*Reinforced Concrete.*—Work of a preliminary character has been carried out in the flat slab investigation. A slab, 25 by 20 feet, similar in construction to the main slab to be tested, was subjected to a load test which was carried to the destruction of the slab. The slab was built to fail under a live load of approximately 200 lb. per sq. ft. and 65 lb. per sq. ft. dead load. The first load applied was 97 lb. per sq. ft., and the next application 191 per sq. ft., but before the last loading was completed the center deflection had increased to such an extent as to be more than double that allowed by the most liberal city building codes. The under side of the slab was very badly cracked. Computations of the stresses developed in the steel reinforcement indicated that the rods in the middle third of the short span had been subjected to stresses far beyond the elastic limit of the steel, while in the middle third of the long span the rods had practically reached the elastic limit. Examination of a number of rods appears to indicate that failure by bond did not enter into the final failure, which seems to have occurred under tension, as was indicated from the design computations.

*Cement Drain.*—The field inspection of cement drain tiles in alkali soils is being continued. Several plants for the manufacture of this class of materials have been inspected and the subject has been fully discussed with those interested in it in some of the Western cities. Assistance was given to the Bureau by the District Engineer of the Portland Cement Association at Denver, who prepared a list showing localities where cement was said to have been exposed to severe alkali conditions for a number of years. Samples of tile which had been in place for 12 years at Delta Col., together with samples of water to which it had been subjected, were obtained, and will

be used in an investigation to be conducted in the laboratory. The field inspection work for the year has been practically completed and from the data obtained laboratory investigations will be carried out to find means for producing concrete capable of withstanding alkali action.

*Concrete Oil Tanks.*—Continued observations on tanks under test show no appearance of an increased loss in any of the tanks and the exterior surfaces of all of them are dry. Two tanks of 1:1½:3 concrete have been put under test as oil containers and the observations begun. The first readings will show a much greater loss than subsequent ones, and, consequently, considerable attention is being paid to the first gage readings, in order to obtain with accuracy the initial penetration losses.

*Manila Rope.*—Tensile tests have been made on Manila rope to determine the effect of an asphaltum compound used as a protection to the rope against the action of muriatic acid. Results show that rope treated with the compound deteriorated as completely under the influence of the acid as the untreated rope.

*Oxy-acetylene Welding.*—The calibration of oxy-acetylene welding and cutting apparatus is practically\* complete. This work was delayed somewhat owing to the fact that a method had to be devised for determining the effective specific heat ratio of acetylene passing through the acetylene meter. The work has now progressed so far that actual welding can be started in a few days.

*Crane Test.*—At the request of the Navy Department, the Bureau will undertake a complete strain gage investigation of the 350-ton "fitting out" crane at the Philadelphia Navy Yard. It is expected that the low temperatures and winds of high velocity which will probably prevail at this time of year may make the work difficult.

*Corrosion of Lead.*—The investigation of the embrittlement of lead by corrosion has been completed. It has been found that the rate at which the intercrystalline brittleness is brought about is proportional to the amount of impurities and to the concentration of acid in the solution in which the lead is placed. Practically all the impurities which are found in the lead are lodged between the grains. The preferential attack by the corroding agents for these impurities, and perhaps also for the "amorphous intercrystalline cement," accounts for the brittleness produced. Investigation showed that specimens of exceptionally pure lead (99.99 per cent), when immersed for 24 days in a neutral solution of lead acetate, became appreciably embrittled by the formation of minute intercrystalline fissures. No evidence of the existence of an allotropic form of lead similar to gray tin could be obtained.

*Radiator Valves.*—The efficient operation of steam-heating plants depends very largely upon the performance of the thermostatic valves designed to drain the radiators of water. This is returned to the boilers, and thus a maximum amount of heat is maintained in the radiators. Such valves should operate with a minimum loss of steam; in other words, they should allow only water to escape. Performance tests under working conditions have just been completed on two sets of such valves submitted by the supervising architect of the Treasury Department. It is expected that the information furnished will aid in the selection of the proper type of valve for use under various conditions.



268

frontispiece to No. 2306.

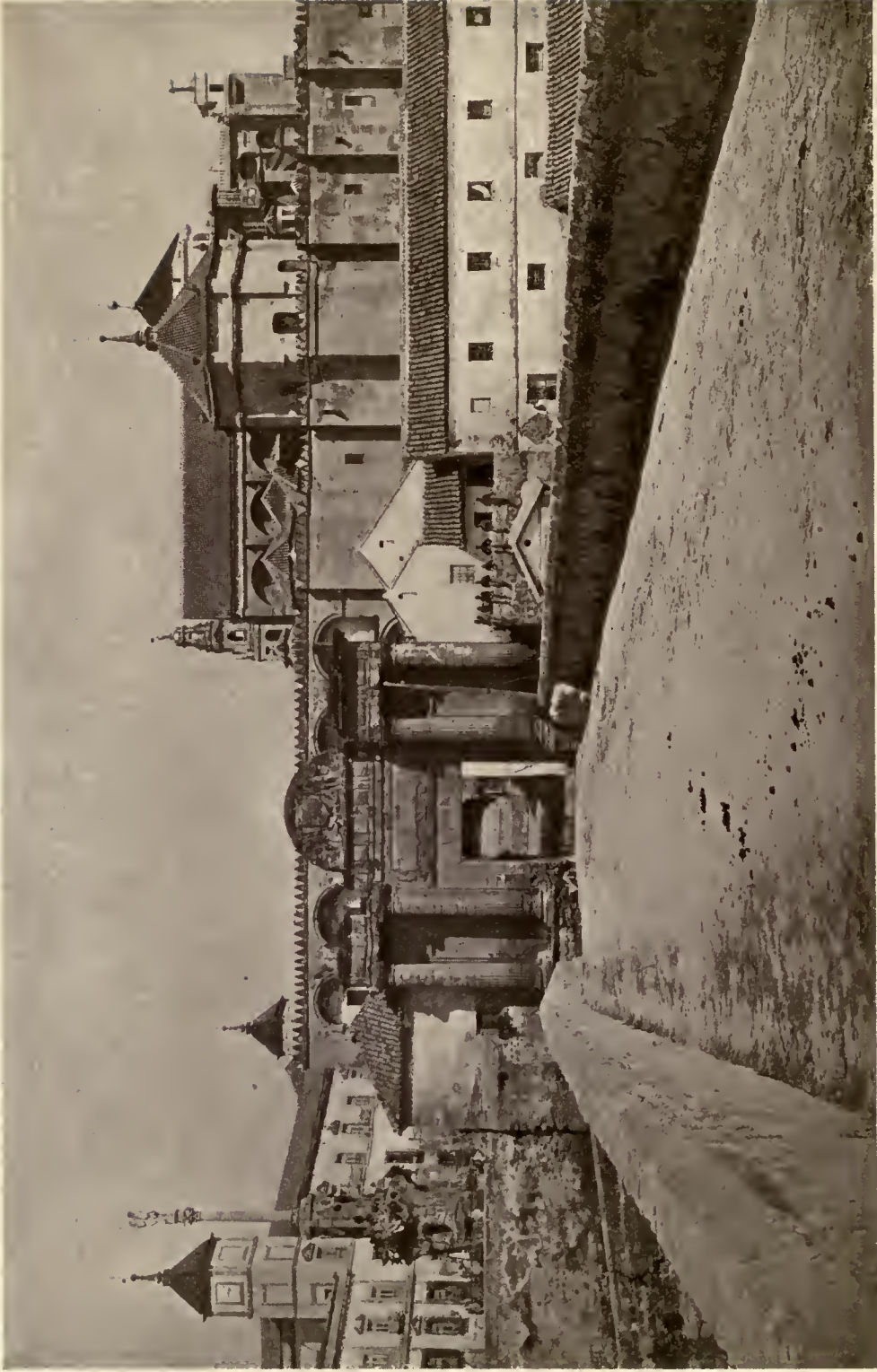

THE CITY GATE, CORDOBA

THE AMERICAN ARCHITECT

# THE AMERICAN ARCHITECT

VOL. CXVII

WEDNESDAY, MARCH 3, 1920

NUMBER 2306

## The Foundations of Classic Architecture\*

BY WM. H. GOODYEAR, M. A., CURATOR OF THE DEPARTMENT OF FINE ARTS  
HON. MEMBER SOCIETY OF ARCHITECTS OF ROME; HON. MEMBER OF EDINBURGH ARCHITECTURAL ASSOCIATION;  
HON. MEMBER ROYAL ACADEMY OF FINE ARTS OF MILAN; HON. ACADEMICIAN ROYAL ACADEMY OF  
VENICE; CORRESPONDING MEMBER AMERICAN INSTITUTE OF ARCHITECTS

PROFESSOR HERBERT LANGFORD WARREN (1857-1917) had been, at the time of his death, for many years Dean of the Faculty of Architecture of Harvard University. His book on *The Foundations of Classic Architecture* is a posthumous work, edited by Fiske Kimball, Professor of Art and Architecture in the University of Virginia, who has supplied an introduction, and selected most of the illustrations, but has otherwise published the text substantially as left in manuscript by Professor Warren, with the exception of the concluding twenty-eight pages relating to the Parthenon and the Erechtheum, which were lacking to the otherwise finished manuscript. It appears from Professor Kimball's Introduction that Professor Warren had planned for many years a work on the general history of architecture, of which this was to be a portion, but it also appears, both from the Introduction and from an examination of the book itself, that it is a complete unit for the subject of Greek Architecture, and the preceding architecture of Egypt and Mesopotamia. Hence the choice of the title, *The Foundations of Classic Architecture*, which appears quite properly to cover the subject matter of the book.

Professor Kimball's Introduction includes an interesting biography of Professor Warren, from which we learn that he was born in Manchester, England, although of New England Colonial ancestry on the father's side; that his school days were passed in Manchester, aside from two years (1869-71) in the gymnasia of Gotha and Dresden; that from 1871-1875 he studied at Owen's College, Manchester, and after entering the office of a Manchester architect, came to this country in 1876. After studying architecture from 1877-1879 under Professor William R. Ware at the Massachusetts

Institute of Technology, he entered the office of H. H. Richardson, and remained there from 1879-1884. In this office he was in close relations with its distinguished head, and when he left his employ in 1884 it was to travel in England, Italy and France. In 1885 he began independent practice in Boston, and also had an office in Troy, N. Y. In 1886 and 1887 he was attached to the editorial staff of "*The Sanitary Engineer*," but continued to practice architecture as a member of the firm of Warren, Smith and Biscoe; subsequently the firm of Warren and Smith, which continued until his death. Although in later years he maintained a connection with the practice of his profession, he was able to give but little time to its actual pursuit, on account of the demands on his time as an administrative officer in Harvard University, and as a distinguished teacher there of his art. In 1893-94 he served as instructor; from 1894-1899 as assistant professor; from 1899-1903 as professor, and from 1903 to his death as Nelson Robinson, Jr., Professor of Architecture. He also lectured on architectural history at the Massachusetts Institute of Technology. At the time of his death he had completed nearly twenty-five years of faithful service to the University.

Thus, among the well known features of Professor Warren's career are his distinction as Dean of the Architectural School of Harvard University, his notable attainments and eminent connections as a professional architect, and his long experience and high reputation as an educational lecturer on the History of Architecture. To these points we may add the serious importance of his various contributions to the literature of the subject in the way of magazine and dictionary articles (which are mentioned in the Introduction of the present work).

All these things would lead to the conclusion that any book which Professor Warren had carefully planned and carefully written would be of great interest and importance. On the other hand let it be remembered that the ground covered by this book has been traversed again and again by the

\* *The Foundations of Classic Architecture*, by Herbert Langford Warren, A.M., Late Fellow of the American Institute of Architects, and Dean of the Faculty of Architecture of Harvard University. Illustrated from Documents and Original Drawings. The Macmillan Company, Publishers, New York, MCMXIX. 8vo. Pages XIV-357. 126 illustrations. Price, \$6.00.

most distinguished architectural historians of the nineteenth and twentieth centuries. Several of these historians are American and English authors whose books are comparatively recent, whose abilities in the matter of literary style and expression have been excellent, whose knowledge of the literature of the subject left nothing to be desired, and whose acquaintance with the original monuments had been intimate and thorough.

Thus, a new book which travels over such familiar ground as the history of architecture in Egypt, Mesopotamia and Greece must be judged not only on its own merits, but also in relation to the merits of its very excellent and numerous predecessors, some of them of quite recent date. The present reviewer was consequently somewhat startled by his own favorable first impressions of Professor Warren's book, which appeared to him to be not only the last, but also the best, of its kind. These impressions have been confirmed by a reconsultation of the most notable preceding works of its class.

Although it is naturally impossible to say anything absolutely new about Egyptian art as a reflex of Egyptian environment, character and history, when we consider what French and German authorities have contributed to this subject, it is the present reviewer's opinion that there is not in the English language an equally readable, sympathetic, thorough, well-digested and artistically projected summary of the subject. Its treatment rises to the rank of inspiration. In the first chapter of his book, which is devoted to Egypt (70 pages), Professor Warren thus establishes his claim to be considered not only as an excellent architectural authority, but also as an eloquent and sympathetic student of the philosophy of history.

What has just been said of the Egyptian chapter is equally true of those which follow—Mesopotamia (in 28 pages); Persia (in 15 pages); the Aegean, i.e., the Cretan and Mycenaean period (in 27 pages); and Greece (156 pages).

In these later chapters, as in the first, Professor Warren's thought and the language used to express it leave nothing to be desired. The style is worthy of the subject. The arrangement of the matter is logical and equally praiseworthy for its selection of the important monuments and for its omission of the less important. It is a constant experience that the multiplication of facts in books tends to confuse and overload the memory. The great merit of this book is that it will not overtax the mind of the reader who is new to the subject.

This result is obtained by restricted and careful selection in the choice of subject matter, combined with a readable, flowing, eloquent and agreeable style of presentation. In compendious books we

must generally contend with a density of style which makes them hard reading—a density which is due to the effort to cover much ground in a limited space. Professor Warren's happy faculty of grasping and projecting his subject as a whole has enabled him to achieve by wise omissions which are not at all prejudicial to his book, but on the contrary rather assist it, the results usually obtained through condensation. Space is thus available for picturesque descriptions, incidental local color and glimpses of the historic or local background. Above all space is available, and is taken, for the statement of both sides of the case when debatable points are in question, for the balancing of evidence, and for the presentation of the independent views and personal arguments of the writer, which almost invariably commend themselves as sane and reasonable. For instance, there is no other equally careful and convincing treatment in the literature of the subject, of the question as to the origin of the Doric style in timber construction. In other cases, as in the downward dating to the late sixth century of the Temple of Corinth, which used to be regarded as the oldest Greek temple ruin, the author shows himself to be an independent and original authority.

As to the special subject of Greek architecture the reviewer holds that there is no book in the English language which contains an equally careful, circumstantial, explicit and sympathetic account of the details of the Doric Order, and this is especially true of the Doric shaft. Following the introductory account of the Greek Doric Order and its details, the method followed by Professor Warren is especially successful because it consists of a series of local descriptions with appropriate illustration and restorations, of each important temple ruin, in its present condition and present surroundings; these descriptions being arranged according to the order of date. Thus is achieved an orderly sequent history of the subject, which is relieved and brightened by local color, and also by interesting details of local history. As a result of this arrangement, and because many of the Sicilian temples belong to the earlier or earliest dates, they are given an amount of emphasis and space which does not always fall to their lot, and which they undoubtedly deserve. At this point and in this particular it is proper to emphasize a feature which makes Professor Warren's book an indispensable part of every architectural library, viz., the circumstantial details derived from the recent Sicilian and Italian surveys of Koldewey and Puchstein.\* Up to 1899 our only authority for Sicily was practically Hitdorff and Zanth, *Architecture Antique de la Sicile*,

\*Die Griechischen Temple in Unteritalien und Sicilien (1899).

dating in the first edition as far back as 1827, and dating in the second edition to 1870.

According to the method followed by Professor Warren the sequent history of the Doric style closes with the Temple of Zeus at Olympia, completed about 456 B. C. The next matter is a description of the Ionic Order and its origins, which is immediately followed by an account of the Athenian monuments, both Doric and Ionic (omitting the Ionic temples of Asia Minor which are known only by literary record). This account closes the book.

It does not appear to the reviewer that any other book on the subject of Greek architecture has achieved the artistic climax of leading up to, and closing with the Parthenon, which Professor Warren has obtained by thus following the order of time in which the surviving Greek temples were built, and combining with this arrangement an account of their local surroundings and their local history. What could offer a better climax than an account of the Parthenon and the Erechtheum? Professor Kimball deserves great credit for his completion of the text for these buildings. It is a worthy counterpart in style, thought and method of the rest of the book. Although the temples of the Corinthian Order which belonged to the Alexandrian period were also Greek, as a matter of course, it so happens that none of their ruins have been sufficiently preserved to allow of descriptive restoration, aside from the older part of the temple of Zeus at Athens, rebuilt by Hadrian. Moreover the title of the book, "The Foundations of Classic Architecture," sufficiently vindicates the arrangement which closes with the Parthenon and the Erechtheum.

In preference to the usual list of illustrations the editor has covered that matter in his Index by page references in italic type to the illustrations, the buildings themselves being listed alphabetically under the cities and towns where they are located. Although this method appears logical when described in print, it probably subjects the reader to more trouble than is caused by looking over a list of illustrations arranged in the order of number. For instance, under "Doric Order" in the Index we find thirty-two italic numbers relating to that number of illustrations, none of which are specified as to subject matter. To this reviewer the old-fashioned method seems to be much the best. The choice of illustrations is excellent. We must not forget to mention and praise the drawings of typical subjects by Harold Broadfield Warren (Professor Warren's brother), which have been contributed by him to head the various chapters. The Introduction is faced by an excellent portrait of Professor Warren.

Professor Warren's knowledge of the origins of

Greek architectural ornament leaves much to be desired. That the Ionic capital and the anthemion were originally identical forms which developed in different directions and were atrophied in other different directions, and that both the anthemion and Ionic capital are derived from an Egyptian highly conventionalized lotiform ornament, is not stated in his book, neither is it even suggested as a possibility, nor are any of the authorities mentioned who have made contributions to this subject. He is equally unaware that the Assyrian "palmetto" and the so-called Assyrian rosette are both conventional lotus motives of Egyptian origin. His extreme attainments and sole contributions to the general subject of lotiform derivations in Greek architectural ornament are the remark that "the egg and dart moulding was probably derived from certain variants of the Egyptian lotus flower and bud ornament" (p. 154), and that the "source of the anthemion or honeysuckle ornament is partly the Egyptian lotus flower and bud ornament, partly the Assyrian palmetto" (p. 155).

As a matter of fact the Assyrian palmetto is a variant of the Egyptian lotus palmette and it is from this Egyptian palmette, which is a combination of a demi-rosette and a voluted lotus trefoil, and not from an "Egyptian lotus flower" as such, that the anthemion is derived. It was not even derived from the Assyrian palmetto as an intermediate form. As to the lotiform origin of the egg and dart moulding and its variant, the leaf and dart, its lotiform origin is not only a probability but is one of the most definitely proven facts in the history of art. Not less positive is the ultimate derivation of the Ionic volutes, and therefore of the capital itself, from the trefoil lotus of Egypt. Professor Warren's suggestion that the origin of the Ionic volutes is in forms of spiral metal work appears to have been offered in ignorance of the evidence, and not in opposition to it, as he is universally disposed to weigh the pros and cons of opposing views on doubtful questions, to state both sides fairly, and to support his own opinions by deliberate and temperate argument. The absence of snap judgments and blunt statements on doubtful points is one of the greatest charms of his book, and is notably illustrated by his consideration of the alleged timber origin of the Doric triglyph.

However, it still remains a problem how so well-read a scholar can have failed to mention the evidence for the lotiform origin of the Ionic capital. Professor A. D. F. Hamlin's "History of Ornament" (1916), for instance, contains categorical statements as to the Egyptian lotiform origin of the Ionic capital, the anthemion, the Assyrian palmette and the egg and dart moulding. His earlier publications on the same subject in THE AMERICAN ARCHITECT and

in the *Architectural Record* were not less conclusive.\* Professor Alfred C. Haddon's "Evolution in Art" (1902) carries thirty pages on this general subject to the same effect. Alois Riegl's *Stilfragen* or "Style Problems" (a History of Ornament, 1893), carries about one hundred pages to the same effect. Oscar Montelius' *Typologische Methode* (1903) contains thirty-four folio pages to the same effect. (Haddon and Riegl are respectively the best British and German authorities on the history of ornament, and Montelius is the most distinguished archaeological authority of Sweden and of all Scandinavia.) My own publications on the subject have been abundantly quoted by these various authorities, and my first announcements preceded in time all which have been mentioned. My own first publication contains an acknowledgment as to the precedence in publication on the Egyptian and lotiform origin of the Ionic capital to the distinguished Persian explorer, Marcel Dieulafoy, and the French antiquarian, Georges Colonna-Ceccaldi.†

This review is disposed not so much to criticize the work of Professor Warren on the given subject as it is to raise a warning voice against a rather general neglect of the evidence for the Egyptian and lotiform origin of the Ionic capital. In view of the great prominence which has been given by authorities on art history and archaeology to the subject of the Ionic capital, the crushing and conclusive evidence, which has now been extant for nearly thirty years on the subject of its true origin and history, ought to be widely and universally known.

Professor Warren's Egyptian chapter is also in error in its description of the lotus of the Egyptian monuments, of which it is said (p. 38) that: "Its leaves do not float on the water but grow above it and are somewhat bell-shaped rather than flat. The seed pod also is of bell shape." This description fits the nelumbium or rose lotus, but this never occurs in Egyptian ornament.‡ The leaves of the Egyptian nymphæes (blue and white) are cleft and float on the water like those of the common pond lily, and the bell-shaped seed-pod is confined to the nelumbium. (The picture in

\* *American Architect and Building News; The Evolution of Decorative Motives*, Vol. 59, pp. 35-36; Vol. 60, pp. 43-45, 67-68; Vol. 61, pp. 11-13; Vol. 62, pp. 87-88 (1895); Vol. 63, pp. 11-12 (1900). *The Architectural Record, A Study of Evolution, Persistence and Reversion in Ornament Motives. Trefoil and Palmette*. Vol. 8, No. 1 (1898).

† The Egyptian origin of the Ionic capital and anthemion, *American Journal of Archeology*, Vol. III, No. 4, 1888; six papers on "The Lotus in Ancient Art", *AMERICAN ARCHITECT* for 1889, pp. 67, 115, 178, 201, 225, 309; *The Grammar of the Lotus*, Royal Quarto, 408 pp. and over 1100 illustrations. Sampson Low, London, 1891. Five articles in the *Architectural Record* for 1892-3-4; Vol. II, No. 2, No. 4; Vol. III, No. 2, No. 3; Vol. IV, No. 1.

‡ See Wilkinson, *Ancient Egyptians*, III, p. 133, 3rd edition. The evidence is complete in the *Grammar of the Lotus*. See chapter on "Lotus Forms Mistaken for Nelumbiums", pp. 25-40. The error also occurs in Perrot and Chipiez, and has been general. My own quoted publications which preceded the *Lotus Grammar* are also in error on this point.

Webster's Dictionary erroneously represents cleft leaves rising above the water.) This matter appears to be of no importance until we consider the difference in the forms of the sepals. The sepals of the nymphæes are only four in number and rise to the height of the petals. Egyptian art always represents three sepals in profile view, and from these, by conventional abbreviation and elimination of the less conspicuous petals, the lotus trefoil of all later art was developed. The sepals of the nelumbium are numerous but short and inconspicuous and they disappear from view and also drop off when the flower expands. The Egyptian trefoil could never have developed from pictures of the nelumbium, and if Egyptian pattern ornament had pictured the nelumbium it could not have developed the voluted trefoil (original Ionic form) or the lotus trefoil in general, or the pattern which ultimately produced the egg and dart moulding.

The Egyptian chapter contains the statement (p. 55) that "the scheme of the normal temple plan is symmetrical . . . all the main doorways connecting the courts and halls are carefully placed on the axis of entrance." On the contrary the plans of various Egyptian temples are out of axis, and so much so that the distinguished British astronomer, J. Norman Lockyer, has advanced the theory that the twists in plan of certain temples are connected with a system of orientation toward certain stars, whose positions changed gradually during the period of temple construction.\* We need not look farther than Baedeker's plan of the temple of Luxor to find a remarkable instance of twisted axes and of asymmetrical ground plans in the various courts and halls. The occurrence of asymmetries of plan in Egyptian temples has been so generally remarked that the term "symmetrophobia" has been coined to characterize this peculiarity.†

Without in the least taking ground as to Professor Lockyer's theory the reviewer simply quotes it as showing how twisted the Egyptian plans frequently are, and especially because the analogy with the deflected plans and twisted axes of many medieval cathedrals is obvious and interesting. The latter are certainly not to be explained on astronomical grounds.

"The History of Architecture," by Russell Sturgis (1906) offers a brilliant exception to the constant and regrettable oversight by other authors on Egyptian architecture, including Professor War-

\* See J. Norman Lockyer, "The Dawn of Astronomy, A Study of the Temple-Worship and Mythology of the Ancient Egyptians (1894); pp. 162-3 and others.

† For the use of this word see, for instance, J. Norman Lockyer, *The Early Temple and Pyramid Builders, Notice*, May 18, 1893; reprinted in *Smithsonian Reports*, July, 1893, p. 95.

ren, of the discovery and survey by Pennethorne, in 1832-33, of curves in plan, convex to the court, in the second temple court at Medinet, Habou.\* With the exception of Auguste Choisy (*Histoire de l'Architecture*, 1899), and my own publications, this most important matter has otherwise been generally ignored. It not only has obvious and serious bearings on the problems offered by the Greek refinements, but also bears on recent observations of similar curves in plan in many mediæval cloisters.

Under the chapter for Mesopotamia it may be noted that various authorities are disposed to hold that the dome (as well as the vault) was known to ancient Assyria, whereas Professor Warren holds (p. 91) that "there is no evidence of any such use." We need not go farther than Sturgis to find a contrary opinion.†

The chapter for Persia does not remark the notable and decisive appearances of Egyptian architectural forms in the buildings of Persepolis. This evidence is to be found especially in photographs which were unknown to the earlier European authorities, and later writers have usually followed the beaten track in this particular, as the actual visitors to Persian sites have been few and far between. Hamlin is, however, a notable exception to the habitual oversight and also verifies the fact by illustration.‡

Our review now reaches some incidental particulars of the chapter on Greece. Aside from the matter on the origins of Greek ornament, already criticized, the general verdict of this reviewer is unstinted praise, but some oversights may still be mentioned. Naucratis was not founded on the site of Alexandria, as stated at p. 261. It was at Nebireh, about 50 miles to the southwest.

In speaking of the Doric temples of the archaic period it is stated (p. 202) that "the intercolumniation of the side is often much narrower than that of the front." This is true, but the converse fact ought also to be mentioned that the intercolumniation of the fronts is often systematically narrower than that of the flanks. This holds of the Basilica at Paestum, which has an average increase on the sides of 9 inches for each spacing, and the following temples have similar arrangements—Temple D at Selinus, with an increase of 5½ inches; and Temple F at Selinus, with an average increase of 5 inches. The sixth century Greek temple at Pompeii, and the sixth century Greek temple near Metaponto (The Tavole Paladine) show minimized phases of the same peculiarity. The Poseidon temple at Paestum also has systematically wider spac-

ings on the sides, with an increase over the fronts of one inch.\* According to this showing there does not appear to have been any preference for the system of making the front intercolumniations wider than those on the sides, as only about seven instances can be quoted for this method to which Professor Warren's mention is confined. To realize that both methods were used indifferently is important, as it would then appear that there was no special cause for the front widening as opposed to that of the flanks. The reason for both systems would then appear to have been a preference for the optical interest created by inconspicuous asymmetry. In this connection it ought to be remembered that the cause for abandoning this kind of asymmetry was the introduction of another kind, viz., the spatial intercolumnar diminutions at the temple angles involved in the problem of the angle triglyphs.†

In the description of the sixth century Temple C at Selinus it is stated that "the spacings of the columns are slightly irregular, as are the diameters." As a matter of fact the maximum variation of intercolumniation on the north side of Temple C is 8 inches, and the maximum variation of columnar diameters is 8½ inches.‡ This is much more than a "slight irregularity," and it is the greatest unsystematic variation of corresponding spaces known in archaic Greek art. The maximum irregular discrepancy of spacings in the Hera temple at Olympia is 5½ inches. Professor Warren has correctly quoted in figures the average increase of the front intercolumniations (of Temple C) as compared with the sides, as being about 22 inches. His statement that the columns in the Basilica at Paestum "are evenly spaced" (p. 215) appears to overlook the nine-inch increment of intercolumniation for each space on the flanks, but is true of the columns of any one side taken together, outside the limits of a mason's error not exceeding 2½ inches.

These minor corrections may be considered worth while because Koldewey and Puchstein are our sole reliable authority for measured surveys of the Italian and Sicilian temples. Their results were not published until 1899, and unless translated must remain unknown to students who do not read German. In so far as inaccuracies are committed or suggested in the use of their results it is best to point it out. It is one of Professor Warren's great merits that he has made a generous use of this unique authority, and a reliable one with the rare exceptions noted.

In the preliminary account of the Doric order

\*See Sturgis, pp. 39, 40 with plan. See also Pennethorne, *Geometry and Optics of the Ancients* p.81 (1878), and Goodyear, *Greek Refinements*, pp. 23, 24, 34-41 (1912).

† *History of Architecture*, Vol. 1, p. 64, with an illustration.

‡ *History of Ornament*, p. 67 (1916).

\*See Goodyear, *Greek Refinements*, pp. 177, 178, 188 for references to Koldewey and Puchstein.

† See Goodyear, *Greek Refinements*, pp. 186-187.

‡ See Goodyear, *Greek Refinements*, pp. 175, 176, for references to Koldewey and Puchstein.

## THE AMERICAN ARCHITECT

it is stated, as regards the correspondence of triglyphs and columns, that "all the other columns (aside from the angle columns) are so placed that the center of each column is vertically on a line with the center of a triglyph, usually of each alternate triglyph." This statement is corrected by implication in the text supplied by Professor Kimball relating to the Parthenon, where it is stated (p. 329) that: "Although the triglyphs do not come quite on axis with the columns, they are delicately adjusted, so that no awkwardness is felt." It is usual, as is done here, to attribute these delicate dislocations to the problem of the angle triglyph and the related intercolumnar spatial diminutions at the temple angles.

Commendable attention is given throughout the chapter on Greece to the subject of the columnar entasis, which is more frequently lacking in Greek temples than may be generally realized. Each instance of the absence or presence of the entasis is specified. Instances of horizontal curvature are also frequently mentioned, but the curves in plan in the Poseidon temple at Paestum (convex to exterior on the entablature of the flanks and concave

to exterior in the entablature under the gables) are not specified, although the horizontal curves in elevation of the same building are mentioned. There is also no mention of the horizontal curves in elevation of the temples of Concord and Juno Lacinia at Girgenti. In justice to Professor Warren it ought to be added that Koldewey and Puchstein have also ignored the curves in plan at Paestum and the curves in elevation at Girgenti, the observation of which is mentioned in my *Greek Refinements* (1912). Jacob Burckhardt quoted the convex curves in plan at Paestum as long ago as 1855. They are also mentioned by Marquand's *Greek Architecture* (1909).

The general subject of the greek refinements is ably treated by Professor Kimball in his matter for the Parthenon, where they have been most completely surveyed. It is gratifying to notice that Professor Kimball has ignored the popular but incorrect opinion that there is an optical effect of sagging in a long horizontal line, and that the Greek horizontal curves in elevation were intended to correct this optical illusion.

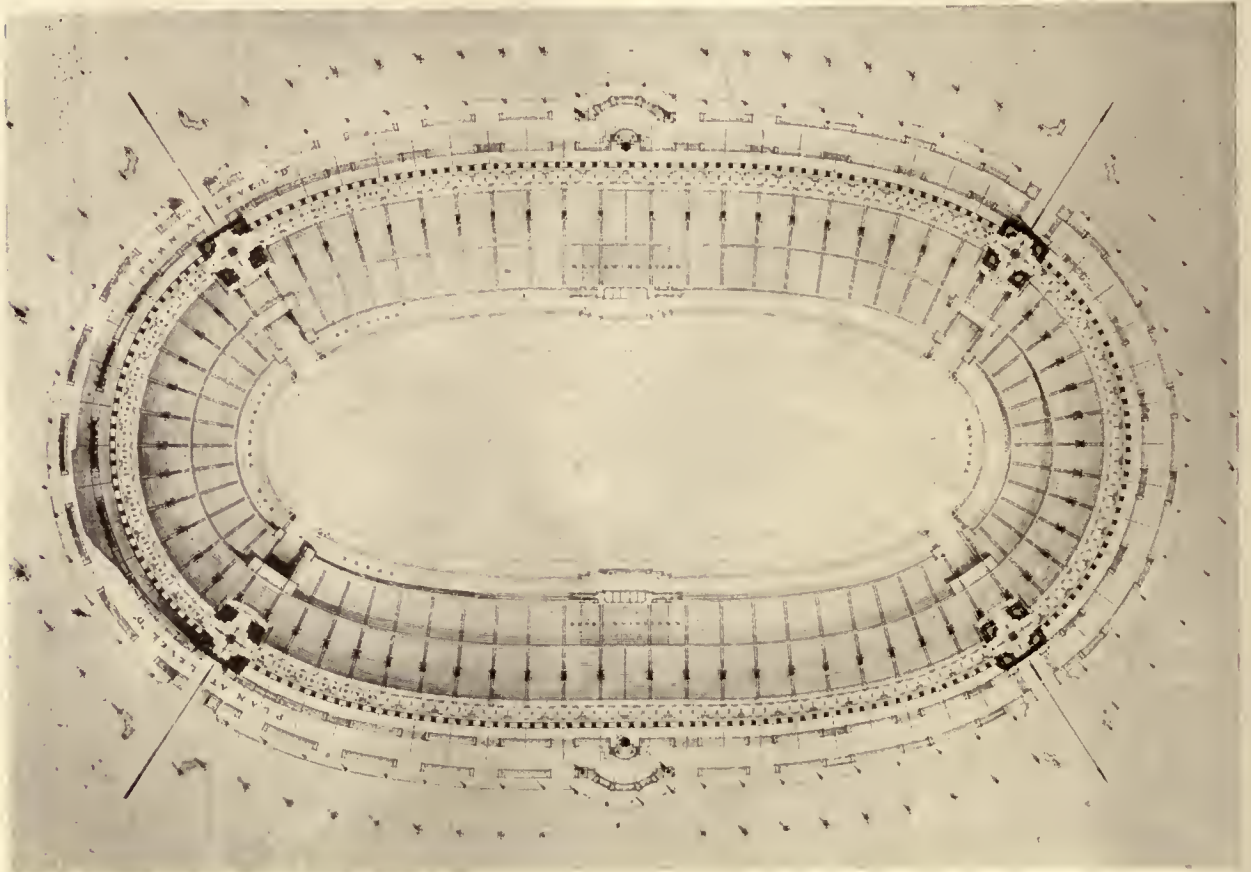

PLAN  
COMPETITION FOR A STADIUM ON THE LAKE FRONT, CHICAGO  
MARSHALL & FOX, ARCHITECTS



# Public Opinion and City Planning Progress

By JOHN NOLEN, *City Planner*

TO stimulate interest and make clear the need of city planning is an important part of the task of establishing new ideals and new standards. It is a publicity job, this work of making intelligible to the public generally what city planning really means. We must aim to get all who are interested in their community to see the planning of a city in its simple, practicable and financially advantageous outlines.

The making of public opinion for city planning is like making public opinion for pretty much anything else. It is done through the newspapers, by public exhibitions of plans, by moving pictures, if they can be made available, by the printing of reports, pamphlets and popular leaflets, by public meetings, illustrated lectures, the use of the stereomograph and attractoscope, and free and wide discussion. One important thing to discuss is the financial results of city plans—that in a big sense, city planning pays. That might be the first appeal. The second appeal is almost opposite. It is the appeal to sentiment, to idealism, to loyalty to one's own community. It is surprising how quickly business organizations, such as chambers of commerce and boards of trade, respond on the ground that city planning promotes the city's welfare. The third appeal is to the imagination. It is the need of actual plans. It is necessary to visualize as graphically and attractively as possible various proposals for improvement, especially as related in comprehensive schemes. The final appeal is that of an object lesson, something actually done, even though it is but a small part of the general plan. This involves the execution of a park, a playground, a garden suburb, a viaduct, a better type of bridge, a union station, a civic center—some feature, but with reference to the whole plan. Such an object lesson will often convince the most skeptical, even those whom the other appeals do not reach.

It is sometimes said that city planning schemes are not carried out. To some extent this statement is true. The execution of comprehensive city plans requires time, often a generation; also money, large sums; also authority, sometimes a change in the state laws or even in the state constitution; also the formation of favorable public opinion. Horace Bushnell, in his agitation for the first city public park in the United States, said, "Many things must be carefully prepared, as carefully watched, and

persistently pushed, by the man who will get any city public into and through a great public improvement. Wearied, and worried, and hindered, he must never sleep, never be beaten, never desist, and if, by a whole five years of toil, he gets his work on far enough to become an interest in itself, and takes care of itself, he does well, and there may rest."

The answers received from a questionnaire sent out recently to more than a score of cities, uniformly emphasizes the same conclusions with regard to the success or failure of city planning proposals. Careful examination of the responses shows that the degree of success is dependent on a regard for and adherence to certain principles. The solution of the whole problem seems to lie in diplomatic, carefully planned, and if need be, a long extended campaign of education aimed to reach not only the well informed and prominent elements of the community, but also the laboring classes and the public at large. In other words, the success of the commissions, from replies which were received, may be graded by the progress of such campaigns of education in their towns and cities.

To one who is familiar with the natural and formidable obstacles to the execution of comprehensive city planning projects and the progress that has been made already, the astonishing thing is that so much has been done, especially in the smaller places. In some cases, as for example, Glen Ridge, N. J., and Walpole, Mass., virtually all the proposals have been carried out, or are definitely authorized for execution. In other cases even though the city plan commissions were not able at the time to get the approval of their recommendations, the plans have been partially executed by the city council or other public authority. The words of Daniel H. Burnham have often proved true: "A logical diagram, once recorded, will never die, but long after we are gone will be a living thing, asserting itself with ever-growing insistency." Furthermore, the city planning movement, it should be recalled, is still in its initial stages. Its merits are not yet clearly understood by the general public, and very little money is available for the making of careful plans, based upon reliable surveys, and the publicity necessary "to sell" those plans to the people for whom they were prepared.

With the possible exception of Chicago, no town

## THE AMERICAN ARCHITECT

or city in the United States has yet taken city planning seriously. Chicago's methods have been more logical, more persistent and more systematic than those of any other city. The whole story is convincingly presented in Walter D. Moody's recently issued book entitled "What of the City?" published by A. C. McClurg & Company, with the sub-title "America's Greatest Issue—City Planning, What It Is, and How to Go About It to Achieve Success." Some of the main facts to record in the program to "put across" Chicago's City Plan are the following:

1. The printing of the report on "The Plan of Chicago" at a cost of \$85,000. This was in the form of a beautiful octavo volume, the very finest example of printers' craftsmanship. It contained 164 pages and 134 drawings, charts and pictures, including 15 full-page, six-color drawings painted by the famous artist, Jules Guerin.

2. The publication of a booklet entitled "Chicago's Greatest Issue—An Official Plan." The basis of this publication was the de luxe Chicago Plan book, issued by the Commercial Club. Many of the drawings of the parent book were adapted to the smaller one. Its 93 pages, carrying the 328 names of the members of the commission, representing every walk of life in the city, told the story of the Plan of Chicago to all the people in simple, easily comprehended, everyday language. Copies numbering 165,000 were issued and distributed at a cost of \$18,000. These were delivered to every property owner of the city and to persons paying a rental of \$25 per month and over. "Chicago's Greatest Issue" was sent, on request, all over the civilized world.

3. A notable pamphlet was printed and issued, entitled "Fifty Million Dollars for Nothing." It showed the people of Chicago how they could obtain 1300 acres of lake front parks, playgrounds and watercourses by utilizing the waste material of the city. It pointed out that by so doing the city could secure in twelve years park lands ready for development and worth fifty million dollars at no cost whatever to the taxpayers.

4. There were many other special pamphlets and reports, but to cap all, the Commission issued a publication entitled "Chicago's World-wide Influence in City Planning." It was an effort to "keep the home fires burning" with community confidence and devotion to its own plan as it was regarded by the rest of the world. This was a compilation of comments and requests for Chicago Plan literature from hundreds of experts, civic workers, municipal authorities, libraries, schools and public-spirited citizens, received by the Commission from all over the world.

5. Following the signing of the armistice in the great war and the announcement of the reconstruction platform of the Chicago Plan Commission, to which the Chicago newspapers devoted twelve columns, an appeal was made to the clergy of the city to preach from their pulpits upon the humanitarian benefits of the Plan of Chicago. The Commission's "Seed Thoughts for Sermons" pointed out the close harmony between the social workers in the churches and the benefits in the plan. This document, together with a resolution and the reconstruction platform, was sent to every clergyman in Chicago.

6. As a direct result of the admonition "Establish the Plan of Chicago with the People," a school text book was printed, entitled "Wacker's Manual of the Plan of Chicago." This came as an inspiration. The Plan of Chicago text book was adopted by the Chicago Board of Education in 1912. The first issue was 15,000 copies. It was used as a part of the curriculum of the eighth grade course. The school authorities followed the wish of the plan executive, whose conviction it was that a larger number of students could thus be reached. It was believed, too, that there was value in an appeal to the children at their most impressionable age. More than 50,000 copies of Wacker's Manual have been published for the current needs of the school.

7. After the school book came the lecture bureau. A popular lecture, showing more than 200 pictures of twenty-four countries of the world, was most carefully prepared, and critics say it compares favorably with the popular lectures of the day delivered by professional speakers. The Board of Education placed the assembly halls of the schools at the disposal of the plan officials without price. How to attract the people to the Plan of Chicago lectures was the task. The difficulties, however, were finally overcome. As many as 150,000 circular announcements of the lectures were mailed to citizens in a single season. Nearly a hundred school lectures were delivered in one year. The schools were selected in order and equitably covered the city. This method was continued from year to year, and during the first seven years of the Commission nearly four hundred lectures were delivered. One hundred and seventy-five thousand people have been directly reached with the plan message; that is, one in every fourteen residents of Chicago.

8. One of the chief aids to the effective publicity for the Plan of Chicago was a motion-picture campaign. This consisted of a two-reel feature entitled "A Tale of One City." It contrasted the plan proposals with existing conditions, and was interspersed with scenes of human interest and attraction

about Chicago. The reels were shown in more than sixty Chicago theaters to an estimated audience of more than 150,000 people. The opening was at the Majestic Theater to an audience which packed the house to capacity and was as representative as a grand opera occasion.

9. The most valuable medium of all for publicity for the Plan of Chicago has been the newspapers. Publishers, editors, reporters, feature writers and cartoonists have co-operated intelligently, heartily and generously to carry to the people of the city the great ideas and the far-reaching benefits contained in Chicago's Plan. One of the papers prints daily at the top of its editorial column its platform, which contains a persistent endorsement of the Chicago Plan, and an appeal for its support. As Wendell Phillipps has well said: "The newspaper is parent, school, college, pulpit, theater, example counselor, all in one. Every drop of our blood is colored by it. Let me make the newspapers and I care not who makes the religion and the laws."

This is not by any means the whole story of Chicago's publicity, but here are given the nine main points. Chicago's publicity campaign on its great plan has been big, far-reaching, inspiring and effective. Behind the conception of a city plan is recognized the necessity to stir the hearts of men, and to inspire in their minds that desire for better city conditions which are the fruits of well executed city planning. Finally, it shows what is necessary to awaken the people to the need of city planning, and how they can be moved to action.

One question remains. Assuming that a publicity campaign is an indispensable feature of a city planning program, how can that campaign be best organized and carried out? Should the work be inaugurated and directed by the city planner, by the city government, by the city plan commission or by some other body? The city planner is not a professional publicity man, and he is often—in fact, usually—not a citizen of the city for which the plan is prepared. It would seem that his contribution would necessarily be limited to the preparation, in as popular a form as possible, of his plans and reports, together with, perhaps, a personal presentation of those plans and reports to a public audience. After that his active participation in a local educational campaign would be of doubtful expediency.

The city authorities, especially the city plan commission, should be relied upon wherever there is a well organized city planning agency to outline, direct and execute the education campaign that must accompany any large city planning program. In no other way can the presentation be wide enough nor the discussion authoritative and far reaching. The city planning authorities, however, cannot hope to be thoroughly effective unless they can secure the active co-operation of the voluntary social, civic and other groups of citizens. The whole public can be effectively reached only by the assistance of chambers of commerce, women's clubs, labor unions, Y. M. C. A., churches and other organizations to which the people of the city are accustomed to look for information and guidance.

---

### The Best Sort of Client

ONE frequently hears, states *The Architect* (London), discussions among architects as to their clients, and sometimes those which take place among clients as to their architects. The employer and the employed naturally take individual standpoints, but from many criticisms it may be possible to arrive at some general conclusions.

To start with, an architect's client, while not possessing the wealth of Monte Cristo, should certainly have enough money to pay for what he wants without undue strain, for the architect who tries to obtain a quart of requirements within a pint measure is doomed to disappointment and difficulty. At the same time it is by no means certain that a client whose wealth exceeds the utmost dream of avarice is an easy client to deal with, for, as we may have

too much of a good thing, there is such a thing as an actual *embarras de richesse*. But architects and clients both vary, and the best client for one architect is not necessarily the best client for another. Some of us can place ourselves without much difficulty in the position of our clients, and others cannot. For the first class of architects it is better to have a client who does not define his views and wishes with absolute precision and finality, while another architect will do his best work within narrower limits. In a word, if a man has imagination and insight his best work will be the result of being given a free hand, while other good architects may actually do their best work in giving shape and form to definite conditions laid down by their clients.

## THE AMERICAN ARCHITECT

As to the vexed question as to whether it is best to work for clients who "know something about architecture" or those who do not, it seems to us to depend on whether the client realizes how little he really knows or whether, on the other hand, the little knowledge becomes a dangerous thing, making the client autocratic and unmanageable. The worst type of client is the man who having seen Hatfield wants its features reproduced in a £2,000 house, and such men will give their architects many a bad half-hour. And as most architects looking backwards on earlier stages can remember the time when their great delight was to "distinguish the different styles," and reproduce their most salient features in student's design, crowding much detail into small space, so the client who has absorbed a little elementary knowledge is very often apt to press his architect in the direction of introducing features which were better omitted. The dreaded element of "cost" is usually in such cases the flaming sword which protects the independence of the architect, who with a little tact can refuse to introduce features he does not wish to have, because the limit-cost renders it impossible, without indicating that he disagrees with his client's taste. One difficulty both with clients and architects is that knowledge and taste are two different things, not always combined in the same individual. We have known of designers whose ability is unquestionable but whose taste is questionable, and who for that reason never quite achieve distinction, while many with less executive ability have an instinctive judgment of what is fitting and suitable in any given case, and in the same manner some clients judge the result of architects' work by a species of mental appraisal, as they possess the instinctive taste to recognize what is good. The result is that we constantly see carefully detailed and well thought out buildings which fail to please us, while the best work which delights us appears to have grown naturally out of the soil on which it has sprung and out of the circumstances which dictated its erection.

We are inclined to think that the best clients are those who possess fairly definite views but who convey them to us by telling us what buildings they admire, and then leave a free hand as to as many of the conditions of the actual problem in hand as possible. A well-known architect told us that when engaged to design an important building for a client he asked to spend some weeks with him that he might judge the sort of house which would best satisfy his wants. Such a process no doubt is useful, but in many cases impossible; most architects in building for men they have known for some time have recollections of many small observations which should render it easy to satisfy their clients on points on which they have no specific instructions. The architect should, like a doctor, be able to diagnose a case from observation rather than from any definite information he receives, and the most successful man and his best work will usually be the result of such observation.

The present times are likely to prove the architect's discretion to the utmost, for it is difficult, and in some cases almost impossible, to make a client understand that the old rate of prices is gone, and that none of us can tell whether in the future we shall approximate to them again. The client is apt to feel that high prices are occasioned by the architect's want of skill, and that greater mental ingenuity would find a way out, but the broad facts that prices are 150 per cent more than they were takes away the architects's chance of proving himself a *deus ex machina*.

To sum up, the best clients seem to us to be: first, those who do not wish their architects to attempt the impossible; second, those who have taste and a certain amount of knowledge; and third, those who tell their architects what they admire or like rather than tie them down with definite instructions; but all of these several elements are qualified by the amount of insight possessed by the architect in question.



In order to supply our readers with material of current interest, the news and comment appearing in issues of THE AMERICAN ARCHITECT delayed by the printers' strike will be as of actual rather than stated date of publication.

## Popularizing Architecture

THANKS to Mr. D. Knickerbacker Boyd, more than two millions of readers have, through the pages of the *Ladies' Home Journal*, become familiar with the most interesting to the lay public of the existing documents of the Institute, thus reaching the very class of readers that would be most concerned with them. It is also interesting to note that this very valuable propaganda was not carried forward in any way by the Institute, an opportunity it unfortunately has failed to avail itself of.

As far back as 1914, the Committee on Publication of the Institute was instructed by the Board to publish in the *Journal* a series of articles that could be reprinted for the information of the public on "How the Owner Should Approach a Building Project," and similar articles for the dissemination of general instruction. Nothing ever came of this, and it has remained for some one, outside the official representation of the Institute, to take up this important work.

"All's well that ends well," as far as the ultimate result is concerned. While the *Journal* has been giving expression to the most abstruse discussion of academic topics, recounting its beautiful experiences while journeying through the Sacramento Valley, or describing the thrills of a first aeroplane flight, some outsider has taken up and very thoroughly performed a valuable service that the *Journal*, it would appear, was long ago instructed to perform.

## Carillons as War Material

Carillons, or chimes of bells, located in well-designed campaniles or towers are forms of memorials that should strongly appeal to architects. Until the publication of a letter addressed to the *New York Times*, in which this form of memorial is strongly urged, we have failed to note any

effort to revive the custom of bell-ringing, now practically dead in this country.

Here in New York on New Year's eve the custom yet continues of "ringing the old year out and the new year in" on the chimes of Trinity church. Hundreds of people congregate there at midnight to hear these chimes. The custom is a good one, and one of the few that link New York to-day with that of fifty years ago.

The carillons of Belgium are famous the world over and Joseph Denys, perhaps the last of a famous number of bell-ringers, yet delights great numbers of people by his masterly handling of these large groups of bells. The number of bells in a carillon varies from 10 to 40. The famous group at Ghent has 48. Many of the most famous carillons in France and Belgium were destroyed during the war. These will be replaced in many instances.

IN this country the days when the peal of church bells marked Sunday and a day of rest have passed. We have too many important night workers in all large cities, whose hours for sleep are governed by their working hours and the day-long Sunday ringing of bells and the early morning calls to prayer were found to be disturbing. Unfortunately the ringing of church bells has been discontinued and the reverberation of their brazen tongues no longer fills the air with calls to worship. Under proper regulation the carillon or chimes may be again restored as one of the most beautiful features of life both in and out of town. Let us not outgrow all these old and good customs that add joy to life.

It therefore seems possible to employ the well-designed bell tower as a memorial to our heroic dead with the most satisfactory results.

These towers could find location in parks of cities, on the commons or "greens" of suburban towns. They would become visual evidence of a

community's gratitude to its heroic sons and its sweetly toned bells could ring forth anthems of praise or patriotic melodies on our many anniversaries. There could also be found among the musically inclined enough men to master the manipulation of these bells, and there might well spring up a friendly rivalry as to the respective merit of the carillons of different locations and the musicians who played upon them.

### The Passing of Old Landmarks

COMMENTING on the passing of the bells and bell towers in Europe and in this country, one is reminded that the so-called march of progress sweeps aside many long-venerated customs, many famous landmarks.

There were comparatively few in this country, and they are fast disappearing. In the older cities on our Eastern seaboard the material evidence of our Colonial days is rapidly being swept aside. Where once the well-designed house, public tavern, or church of long history stood, is now the location of towering buildings given over to trade or apartment dwellings. While it is not reasonable perhaps to contend that land that has become so valuable should be given over to unremunerative purposes to cater just to sentiment, those who venerate

these early examples of our national life cannot repress the expression of regret.

In Europe where the old landmarks are more common, the regret and frequently indignation expressed at their passing often becomes pathetic. It is learned that the world-famous Moulin Redet, which for centuries has crowned the heights of Montmartre, is to be removed to make room for the erection of new houses. Every artist will declare that the picturesqueness of this spot will at once be destroyed. Sentiment has become so strongly aroused that an effort is being made to secure the removal of this old mill to another site.

For many generations artists have visited this picturesque height of Montmartre, and thousands of sketches exist of the Moulin Redet.

It is noted with considerable satisfaction that the veneration of our old landmarks is not entirely dead. Graduate chemists of the Pennsylvania State College have subscribed to a fund to purchase the historic house of Dr. Joseph Priestly, famous as a chemist and the discoverer in 1774 of oxygen. This house is located on the Susquehanna River, near Northumberland, Pa. It will be removed to the campus of the college, carefully restored and maintained for all time in good order. In its present location, where it was built 138 years ago, it was rapidly falling to decay.



LAKEFRONT, HOUSE OF C. G. EDGAR, GROSSE POINTE, MICH.  
WILLIAM PITKIN, JR., *LANDSCAPE ARCHITECT*

# Natatoriums

## A Discussion of Their Architectural Shortcomings

By EDWIN H. ("LARRY") WOOD

*Instructor and Coach of Swimming at the Lewis & Clark High School, Spokane, Washington.*

**I**F our leading aquatic authorities were asked to point out that factor most conducive toward keeping competitive swimming in its present status of a so-called minor sport, they would ascribe it—in nine cases out of ten—to our relatively few and poorly-designed natatoriums.

Swimming—whether we think of it as competitive athletics or as a pastime—is not of itself lacking in those elements that make football and baseball "major" sports. Under inviting conditions—with clean, reasonably warm water, sunlight and pure air, as found at our beaches in summer—more persons swim than actually participate in all other sports combined. But outdoor swimming not being practicable the year round—a few localities excepted—swimming comes to a standstill with the advent of fall; our natatoriums do not duplicate those pleasing features connected with outdoor swimming. Our indoor natatoriums should make swimming as attractive in January as do our rivers and lakes in July. No other sport, major or minor, occupies the unfortunate position in which swimming finds itself. This sport is shut out—automatically excluded—from its rightful place in athletic activity because almost all of our relatively few natatoriums are so badly located and so poorly designed as both to make it almost impossible to create a following for the sport or to accommodate that following if it is created.

I believe—after eleven years' connection with the swimming game, both as an amateur athlete and as a professional coach—that the chief reason underlying these conditions is the fact that the architect seldom consults with an experienced coach of swimming. True, the latter can be of no assistance in the engineering problems involved; but—two heads being better than one—he is able to suggest structural features that only a man experienced in the swimming game—I speak of competitive swimming—is qualified to offer. Pools are no longer merely places in which to bathe; they are places—or, rather, should be—in which to foster a sport unique in its utility and, in its highest stage of development, a most fascinating spectacle.

Let me be specific. First and foremost, pools are almost invariably situated in dark, gloomy base-

ments. Here both the problems of lighting and of ventilation are most unsatisfactorily solved. Sunlight seldom enters these underground "vats"; they are almost always dark, smelly and repellent. Contrast with such uninviting places the natatorium situated above ground in the corner of the building. In such location both natural lighting and ventilation are possible. With properly warmed water in addition to plenty of light and air we have the main attractions of outdoor summer swimming. As for the tank proper, it seems to have been the delight of architects who designed the natatoriums of a decade or so ago—and modern ones, too—to cram as many obstructions in the shape of stairs, ladders, etc., as possible. In many pools not over forty-five feet long and less than half as wide, one frequently sees two broad flights of steps occupying opposite corners of the pool with perhaps a couple of ladders in the other corners thrown in for good measure. It would really seem as though the designer thought swimming to be an exercise for only decrepit men and women, too feeble to leave the pool except by numerous and handy exits. (In fact, after having gazed at such examples of pool construction, I have wondered why the architect didn't do a complete job and install elevators.) Stairs have no place in the modern pool; four ladders, set in niches in the sides of the pool, are sufficient. If some sort of "grab rope" is deemed necessary, an iron chain along the sides and ends, fastening in the corners of the pool in such manner that it may easily be removed, should be provided. In brief, a pool should be so designed as to provide a swimmer with an unobstructed "lane" the complete length of the pool. As to the size of the pool, it should be of standard length—60, 75, 100 feet, etc. Standard racing distances are 50, 100, 220, 440, etc., yards; and these distances should be multiples of the length of the pool. It is better to have a 60-foot pool than one of 67½ feet for this reason. The proper shape for a pool is rectangular. Occasionally pool designers try out a few variations. I have one pool in mind, 60 by 18 feet—narrow enough—which the designer made still less suitable for competition by cutting off the corners of

## THE AMERICAN ARCHITECT

the pool and setting four ladders in diagonally, thus cutting off a good three feet from the ends of the pool and thereby greatly crowding competing swimmers. Another very common mistake in pool design is the use of rounded, glazed tile at the edge. This is not only inconvenient; it is dangerous. Glazed tile is slippery at best; and when it is rounded the feet can get no purchase. The tile at the edge of a pool should be square-cornered and should have a rather rough surface.

The problem of condensation is ever present. Since the air and the water in a natatorium must be heated to a point far beyond the usual temperature of the outside air, a state of high humidity is inevitable. In severely cold weather condensation is usually apparent on all inside surfaces of the natatorium; and even in mild weather those walls facing the outer air continually "sweat," as does the ceiling in this vicinity. For this reason a natatorium should be full-tiled, or, if it is half-tiled, the better plan is to tile the ceiling and half way down the side walls. Most natatoriums have a tile floor, and the walls are tiled about half way up. The ceiling—where condensation is most abundant—is often entirely neglected in this respect. Certainly, the walls and ceiling should be constructed of moisture-resisting material or at least should be coated with such material. This obvious point often is overlooked. For example, the natatorium of one of our leading Eastern preparatory schools is one of the finest of its kind, containing a magnificent pool, built-in concrete bleachers and numerous other excellent appoint-

ments. But its walls are of plaster, and during the severe winters, common to that section, condensation is so heavy as to have practically ruined the walls and ceilings. This natatorium is part of a gymnasium costing ten years ago nearly \$150,000. Thus, in building even the most costly natatoriums, blunders such as these are made.

Lastly, no sport can prosper unless it has a following—unless a reasonable number of spectators can be admitted to contests and be seated with some degree of comfort. Most natatoriums have enough space to accommodate not more than twenty-five persons exclusive of competitors and officials. Thus, if swimming does become popular, three-quarters of the "fans" cannot possibly be accommodated; and the sport naturally expires. I realize, of course, that the matter of seating space does not come within the province of the architect; this is a point that is generally decided in advance by the building committee. Here it is that the experienced coach can be of great aid in making members of the building committee see the folly of building a pool which by its very structural features precludes any great amount of interest in swimming.

Even in spite of handicaps such as I have detailed and in spite of other handicaps almost as deterrent to the best interests of the game, swimming is becoming one of our leading sports. Given a fair chance it will one day eclipse our present so-called major sports; and architects can help in this great work more effectively perhaps than any other class of men.



GROUP OVER ENTRANCE TO A LIBRARY IN  
SAN FRANCISCO, CAL.  
LEO LENTELLI, SCULPTOR



182

# LAKE FRONT STADIUM COMPETITION

ENTRANCE LEVEL PLAN

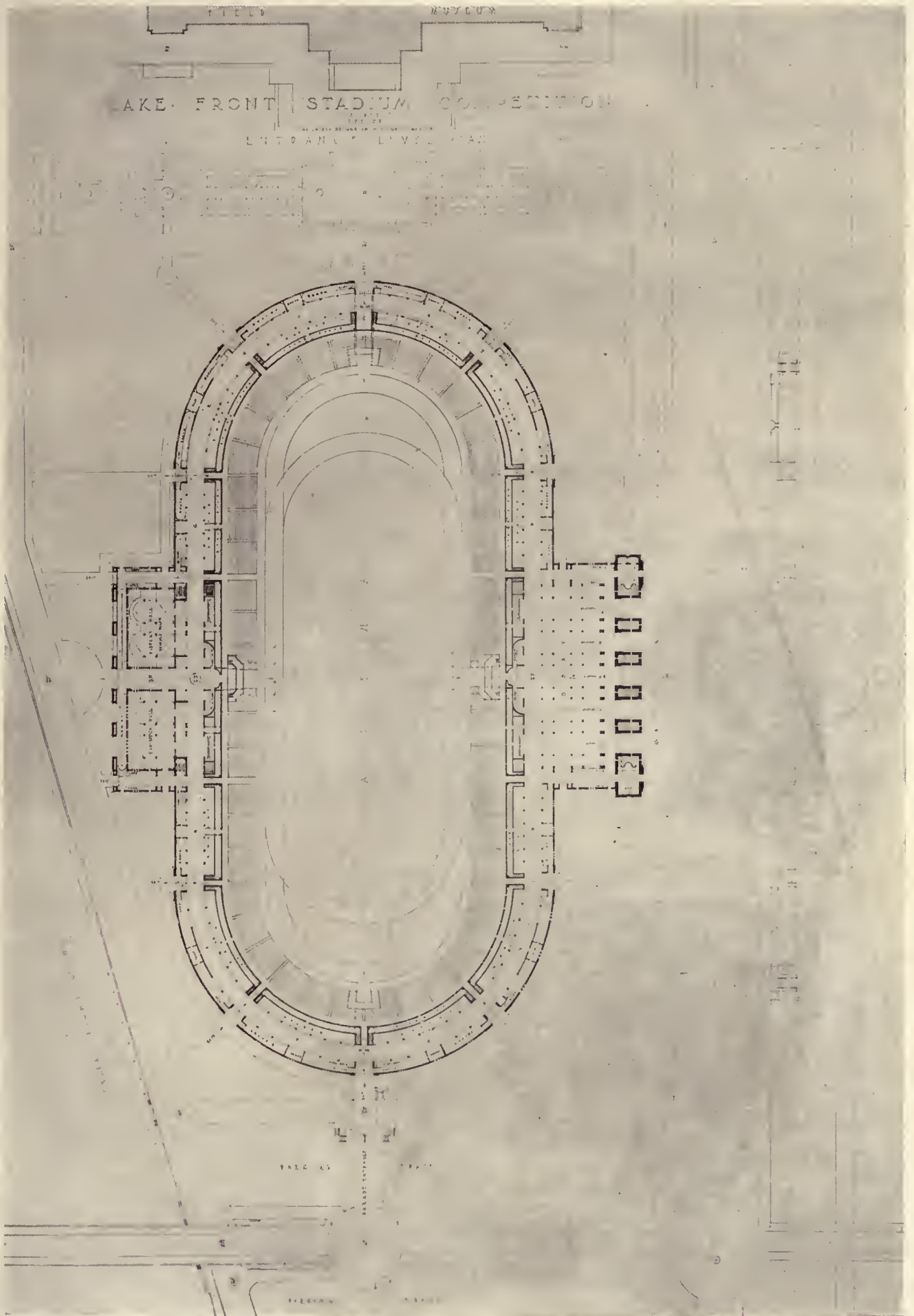

GROUND PLAN  
 COMPETITION FOR A STADIUM ON THE LAKE FRONT, CHICAGO  
 JARVIS HUNT, ARCHITECT



2822

THE FRONT STADIUM COMPETITION  
UPPER LEVEL PLAN

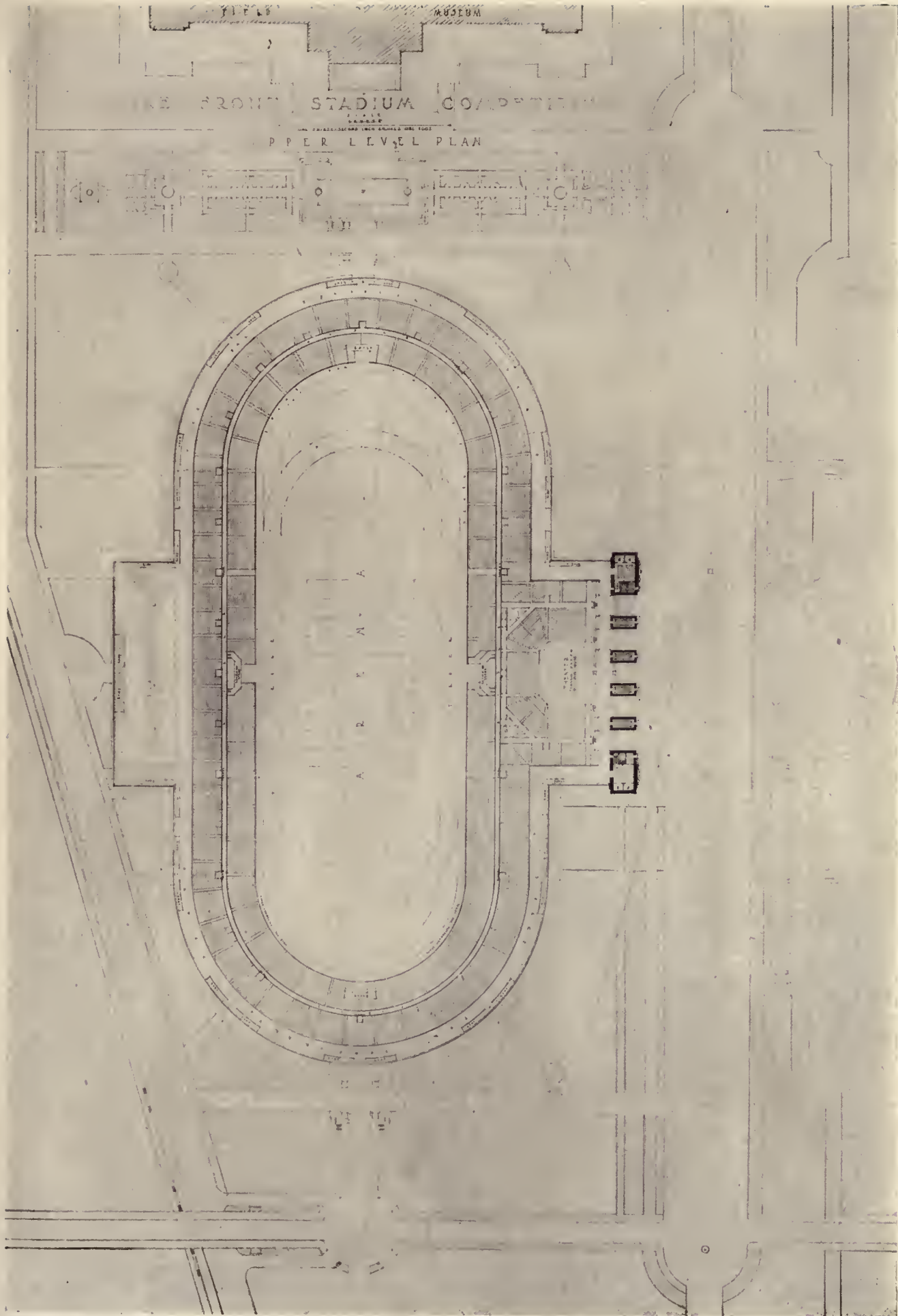

SEATING PLAN  
COMPETITION FOR A STADIUM ON THE LAKE FRONT, CHICAGO  
JARVIS HUNT, ARCHITECT



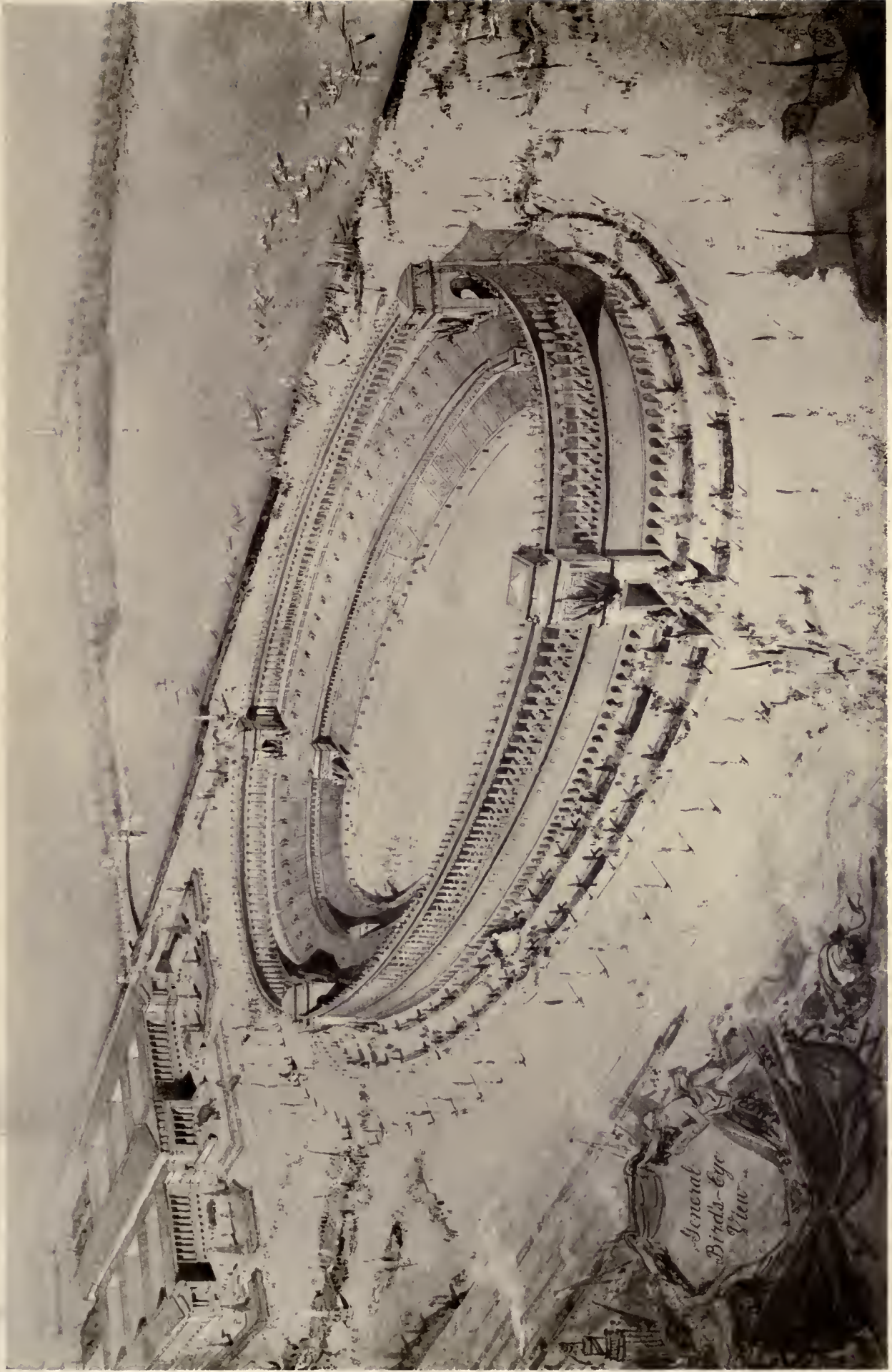

PERSPECTIVE

COMPETITION FOR A STADIUM ON THE LAKE FRONT, CHICAGO

MARSHALL & FOX, ARCHITECTS

General  
Bird's-Eye  
View

282 13









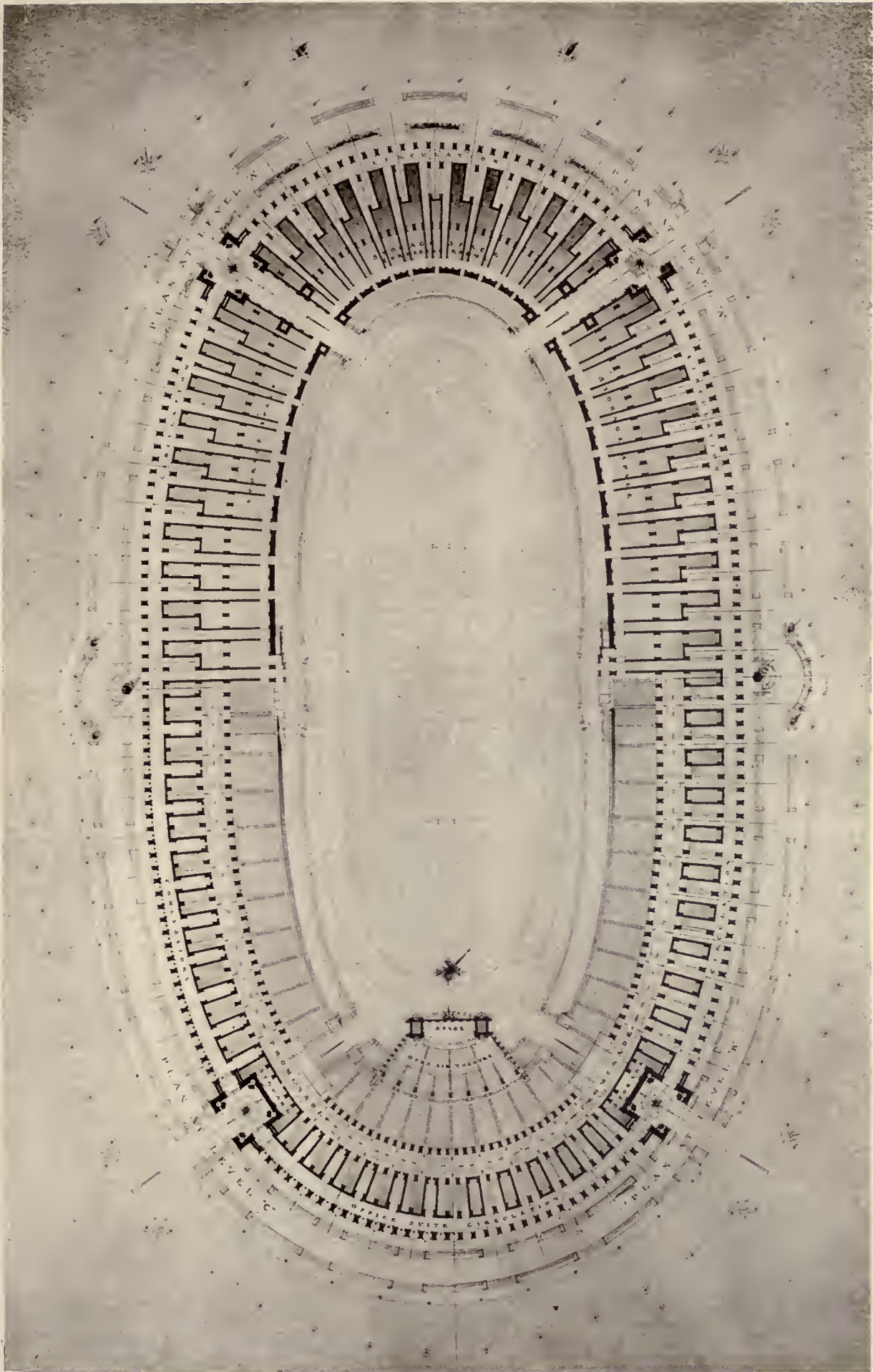

PLANS AT ELEVATIONS A., B. AND C.  
COMPETITION FOR A STADIUM ON THE LAKE FRONT, CHICAGO  
MARSHALL & FOX, ARCHITECTS

1825



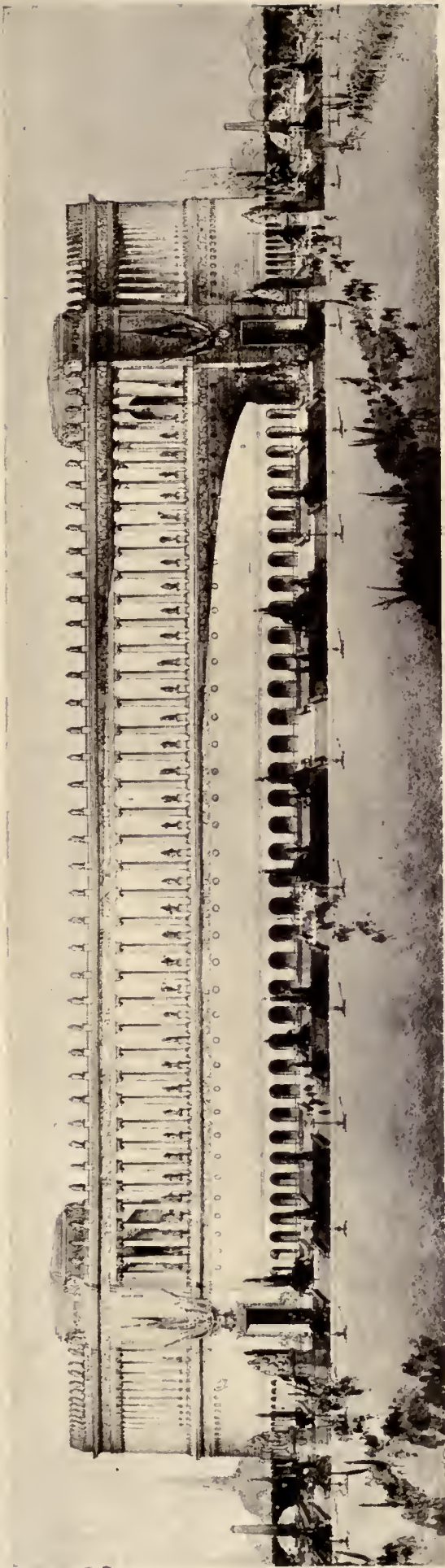

SOUTH ELEVATION

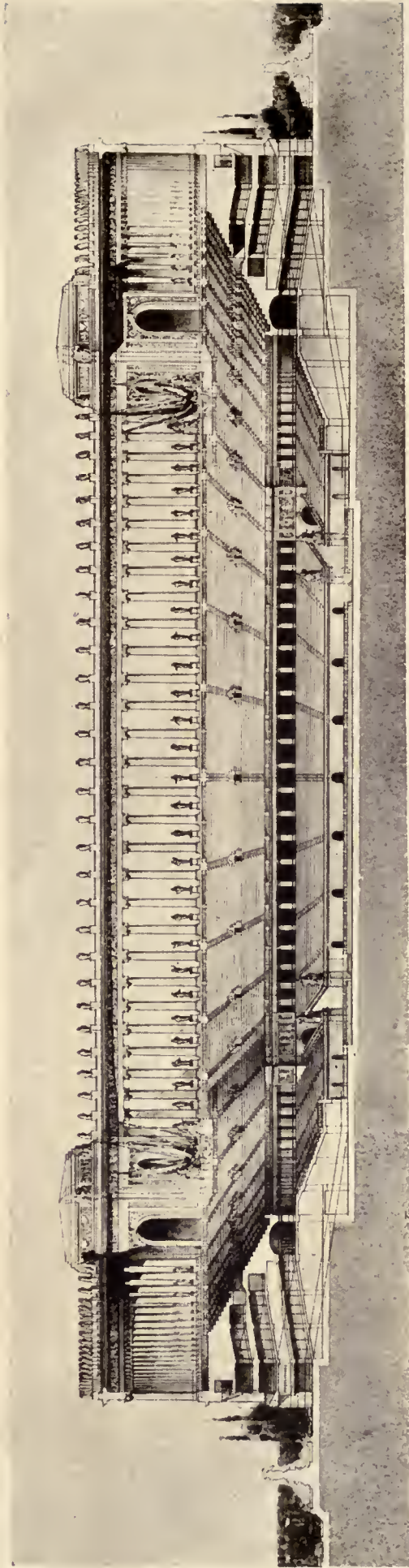

TRANSVERSE SECTION LOOKING NORTH  
COMPETITION FOR A STADIUM ON THE LAKE FRONT, CHICAGO  
MARSHALL & FOX, ARCHITECTS

2826



282



# Current News

## Happenings and Comment in the Fields of Architecture and the Allied Arts

*In order to supply our readers with material of current interest, the news and comment appearing in issues of THE AMERICAN ARCHITECT delayed by the printers' strike will be as of actual rather than stated date of publication.*

### Architects May Reduce Rates to Encourage Good Building

In an effort to assist in the housing movement, and at the same time educate the home seeker in the selection of the best type of house, the directors of the New Jersey Society of Architects considered at a meeting this week the proposition of furnishing plans and designs at special and reasonable rates. The idea involves the preparation by registered architects of about fifty designs to be arranged in a portfolio which will be accessible to all applicants. Upon selection of a particular design, the name of the architect will be furnished and he will be expected to prepare the working drawings at a reasonable charge. Action on the matter was deferred.

Indorsement by the society was sought by advocates of the organization of a union of technical men in the profession, other than employers. The subject was discussed and laid over for further consideration.

### Work on Cathedral Again Postponed

A total of \$300,000 has been contributed toward the construction of the nave of the Cathedral of St. John the Divine in New York, it is learned from Bishop Charles S. Burch, but he and the trustees have decided its construction shall not begin for another year unless \$200,000 is contributed within thirty days.

At a meeting of the trustees the question of whether the trustees would be justified, with the amount on hand, in resuming construction in advance of the campaign for funds, thereby saving a building season, was discussed, a statement said, but "it was decided that the work could not be organized on an economical basis for less than \$500,000 for this building season."

The statement continued: "Unless an additional \$200,000 is secured within the next thirty days there can be no construction in 1920, and the chance to gain a year in building will be lost." The foundation for the nave, at a cost of \$100,000 was completed before the death of Bishop David H. Greer.

The Rev. William H. Owen, rector of Trinity Episcopal Church, Mount Vernon, N. Y., was elected a trustee of the cathedral.

### Exhibition of Fine Arts of Greece

The art exhibition sent to New York by the Greek Government to make better known here the beauties and enterprise of modern Greece as well as the glories of ancient Greece, is now in progress at the Grand Central Palace, New York.

The several hundred guests were received by George

Roussos, Greek Minister to the United States. Officials of the Government of Greece were on hand to give information to the guests. The exhibition, the greater part of which consisted of art photographs by Frederick Boissonnas, was shown in Boeotian Hall in Paris last summer while the Peace Conference was in session. There at least 50,000 people saw the display.

People who know of Greece from books only are likely to think of it as a great ancient country now of little importance, a country of ruins. It was to counteract this impression that the Greek Government, at the instance of Premier Venizelos, caused this exhibition. During March the exposition will be open daily, including Sunday. It will last only a month.

The ancient Greece of heroic days is skilfully blended with the modern country by the cunning camera of the artist, who spent several years in the task. He has been particularly successful with the temples of the country. Those who have never seen Greece were amazed yesterday at the beauty and splendor revealed by the art photographs. There were also beautiful modern reproductions of swords, daggers, pottery, statuary and wall paintings as well as lace work and embroidery of the present day. A vivid idea of Greece present and past may be had by inspecting the art display in the galleries.

The exposition is held under the auspices of the American Hellenic Society of this city, of which Dr. Nicholas Murray Butler is president. This organization, which has the welfare of Greece and the maintenance of friendly relations between this country and Greece at heart, numbers among its members and officers such men as Elihu Root, Charles W. Eliot, Jacob Gould Schurman, Frederic R. Coudert, Thomas W. Lamont, W. Fellowes Morgan and George M. Whicher.

### Age-Old Building Material

What is pise? The word, which in its complete form is written pise de terre, betrays a French origin and, from its general appearance might well suggest some affinity with the world of art. These preliminary impressions, however, will be found misleading. There is nothing peculiarly French in pise dwellings, though they are common enough in some parts of France, and reference to them abounds in French literature of the eighteenth century.

The word itself, traced to its Latin origin, apparently means nothing more artistic than "battered." Perhaps the simplest definition of pise is provided by Pliny the Elder, who calls it "earth battered between boards," meaning by boards a form such as may be used for concrete in construction work.

The Roman sage adds that it was an old and well-tried system of building and remarks that Hannibal used this material for watch towers on the tops of hills in Spain during his campaign.

Who knows whether it was not also in use when Cheops built his Great Pyramid; for there are prehistoric pile buildings in New Mexico and Arizona which, some say, date back almost to that period?

Certainly history cannot trace the system to its origin, and the pile dwellings now visible in France, Spain, America, the British colonies and elsewhere may give no complete indication of the extent to which this material was employed in other centuries.

## A Sculptor's War Loss in Germany

Hendrik Christian Anderson, the American sculptor at Rome, has just filed with the State Department at Washington and the Reparations Commission at Paris a claim of \$300,000 against Germany for the destruction of a group of statues during the war.

Just preceding the outbreak of hostilities in 1914, Anderson, at the request of the German government, sent to the International Art Exhibition at Leipsig a group of bronze statues making up a large sculptural work to be known as The Fountain of Life.

The statues represented fifteen years of work and were designed by Anderson as one of the principal monuments for the international city that is to become the administrative center of the League of Nations.

The group was awarded the first prize at the Leipsig exhibition. The outbreak of hostilities and the closing of the frontier in 1914 rendered it impossible for Anderson to have the group of bronzes returned to his studio at Rome, and nothing was ever learned of their fate or disposition, until a few weeks ago, that they had been seized by the German war minister and destroyed. The huge amount of bronze and copper in their composition was presumably used for war munitions. Valuable as this was, it was still nothing from Anderson's point of view as compared with the fifteen years of work and artistic effort which they represented.

According to the information which has just reached Anderson, the Germans endeavored to seize the group of bronzes almost with the outbreak of hostilities. As America was still a neutral country, it was for the time being deferred. As soon, however, as America entered the war the group was seized and rushed to the melting pot.

The group included, among other things, a central equestrian statue and a series of small child statues representing the progress and development of life.

## The Negro and Americanization

An interesting and thoughtful letter has been written to the Philadelphia *Ledger* by William Pickens of Baltimore. He writes:

We hear so much in these days about Americanization, in conferences, schools, social programs and committees, that it is about time to stop and consider what it is to be American or Americanized. We hear much of teaching English and standards of living, systems of politics and government. These things are important, but they are not all there is to being an American; they are not the most fundamental elements of the American genius. For example, they speak English in Canada, in England and in some guise in the union of South Africa and in Georgia and Texas. But neither the union of South Africa, nor Georgia, nor Texas has anything like the American spirit.

The American spirit is, first of all, a spirit of liberty. It necessarily involves a spirit of equality and of brother-

hood. It is not a shallow matter of getting married and being brothers-in-law. A pure-blooded Mongolian can be "American." A white man can be "American." It is not a color; it is a spirit.

We claim, therefore, that the most vital need in the country is to Americanize thoroughly our native-born. We must Americanize the laws and legislatures of the South. If we are ever to Americanize the foreign-born we must have something to do it with, and that something must be the native product. Those who come to us will tend to become what we are. Have we ever reflected that perhaps our failure to make the immigrant an American is due first of all to our failure in being American?

It happens to be that the negro is the most American group in the country, both in ancestry and in point of attitude of mind. His line reaches much further back than that of the average white man of the country. In spirit he is less arrogant, more liberal and democratic, and believes more sincerely that "all men are born free and equal." He does not believe that he is naturally entitled to more privileges than other breeds of men. That is of the very essence of the spirit that made America. The negro does not lynch, and does not act by virtue of the mob, except in self-defense against white mobs. He wants, the case tried in court. He wants law and order to be supreme and as a group he does not ask any artificial advantage of any other group. That is of the essence of America.

The intelligent negro is therefore puzzled when he hears anybody talking about Americanizing the negro. He knows that the battle would be over if only we could Americanize the white man.

## Organization as Need in Housing

Industrial corporations or community organizations must solve the housing problem in the United States, according to speakers before the Massachusetts Chamber of Commerce at a housing conference held in the City Club this week. Individual initiative, it was pointed out, had been unable to solve this problem, which had become so serious in places as to menace industry.

William M. Ham, manager of the Bridgeport, Conn., development, which was promoted by that city and by the United States Government, laid stress upon the necessity for organization in attacking the housing question, and upon the desirability of "liquid ownership" of homes, so that larger quarters could be obtained as the size of a family increased. Small apartments, he thought, should not be permanently owned.

The organization in New England, which has to do with the building of homes, Mr. Ham said, is not much better than organization here of agriculture; "houses are produced largely by accident and not by plan."

## Virginia Accepts Gift of Rare Paintings

Notification was sent to Judge John Barton Payne of Chicago that the State of Virginia by act of the General Assembly, accepted the paintings offered by him, which are valued at \$1,000,000.

The list includes a Murillo, Reubens, a Reynolds and forty other works. The collection is expected to be housed in the Confederate Memorial Institute. Judge Payne, a native of Virginia, has just been chosen by President Wilson as Secretary of the Interior, to succeed Mr. Lane.



## Swedish-American Paintings and Sculpture to Be Shown in Sweden

An unusual incentive for Swedish-American artists and sculptors to enter specimens of their work in the ninth annual art exhibition of the Svenska Klubben of Chicago, which opens March 27 and continues until April 4, lies in the fact that the larger part of this year's exhibit is to become permanent and after further exhibition in New York will be taken abroad by the Swedish Choral Club on its forthcoming tour of Sweden. The exhibition is to be sent under the auspices of the American-Scandinavian foundation and will include original works in oil, water color and sculpture by living Swedish-American artists.

The local exhibition will be held at the Svenska Klubben, 1258 North LaSalle Street. Pictures and objects of art exhibited at any time during the last ten years will be eligible for the overseas exhibition and will be shown locally at the conclusion of this year's regular art show when a special jury to pass on all objects sent in will select those entries considered most representative of the best in transplanted Swedish art. Only objects that have never before been exhibited are eligible to competition in the local exhibition.

## England Dealing With Housing Shortage

From Manchester, England, comes a new proposal for solving the acute housing shortage there. Manchester needs 20,000 workers' homes at once, and 50,000 within a short time. Private enterprise there, as here, has failed to provide the houses. The bricklayers' organization of Manchester has secured the co-operation of all the other labor organizations engaged in house building and has proposed to the Manchester Council that the workers be given the contract to build 2,000 houses as an experiment. They believe that, working under their own leaders, responsible legally and financially for the output, and with the "team work" engendered by the knowledge that the profits on the project will go to the workers they can do more and better work than would otherwise be the case. The Manchester Council has accepted the offer and awaits formal approval from the British Government. If the experiment succeeds, the workers in the building trades industries propose to expand their committees into a national guild, which shall build houses all over England. It is an experiment that is worth watching.

## Better Farm Houses Being Erected

George Washburn, architect, of Burlington, Ia., calls attention to the fact that a large number of farm houses are planned for construction in that section. There was a time, he says, when the farmer wanted the cheapest thing in the building line that could be furnished. Now it is different. The farmer has discovered that the best is the cheapest, and as he is no longer compelled to count the nickels and pennies, he gets the best. That applies to machinery and clothes and everything that he needs, as well as to houses. He wants all the modern improvements that he can get and he will find that is the kind of a house that will give him satisfaction in the long run.

"There has been much talk of the 'back to the soil movement,'" said Mr. Washburn, "and there is much good in it. At least in the intention. But what is much

better than inducing people to go back to the farm who have fared well in town or getting people to go out on the farms who know nothing whatever of farming, is to make conditions so pleasant on the farm that the young people will not dream of moving to town and forsaking the farm. When they have rooms in a modern farm home and have everything in that home that they can enjoy in the city, they will not be tempted to move into a hall-bedroom in town, where there is scarcely room to turn around. It is better in every way to keep the people on the farm who know farming than to let them get away to town and then to replace them by other people who know little or nothing about farming.

"Between the modern farm home and the auto, the man in the country and the young people growing up on the farms have everything that the city folks have and some things that the city folks have not."

## Alabama Architects Elect Officials

A Birmingham architect, Hugh Martin, was elected president of the state chapter of the American Institute of Architecture at its meeting at Auburn. Other officials were chosen as follows:

George Rogers, Mobile, vice-president; Eugene H. Knight, Birmingham, secretary and treasurer. Frederick Ansfeld, of Montgomery, is the retiring president.

The meeting was held at Auburn in connection with a meeting of the department of architecture at Auburn. W. T. Warren, of Birmingham, an alumnus of Auburn and of Columbia delivered an address to the student body in the afternoon.

Edwin B. Lancaster, Auburn student, won the prize this year for the best design and plans for a building submitted in the annual contest. Mrs. C. C. Thach, wife of President Thach, entertained the visiting architects with a luncheon at her home.

W. M. King, of the firm of Wheelock & King, of Birmingham, was elected a member.

The aims and objects of the Alabama Art League were indorsed by the state chapter and also the national associations of arts in co-operation with the government in meeting the housing problem.

## Competition for a Cover Design

The Architectural Exhibition Committee, of which Frederick M. Hodgdon, Corn Exchange Bank Building, Chicago, is chairman, invites all architects, artists and draftsmen to enter a competition for a cover design for the catalog of the Thirty-third Chicago Architectural Exhibition. The premiated design will receive \$100, the design placed second \$25. Competition closes at 5 p. m., Monday, March 22.

Program: The Architectural Exhibition Committee is desirous of obtaining a design of merit for the cover of its catalog. The size of the cover will be 7½ x 10½ inches, but the size of the drawing must be twice that size or 15 x 21 inches. Not more than two colors can be used in the design besides the natural color of the paper. The design must incorporate the following lettering:

*Thirty-third Annual Chicago Architectural Exhibition,  
April 6 to May 5, 1920, Art Institute*

arranged as the designer sees fit. The design will also be used for poster purposes. Other than the above conditions, the designer will be unrestricted. Drawings are not to be signed or marked in any way.

Delivery of Drawings: The drawing is to be inclosed between stiff cardboards or rolled in a strong tube securely wrapped and addressed to Frederick M. Hodgdon, chairman of the Architectural Exhibition, Room 1614, Corn Exchange Bank Building, on or before March 22, 1920. Drawings not delivered before the time set will positively not be considered. In the wrapper with the drawings is to be inclosed a sealed blank envelope, containing the name of the contestant.

Drawings submitted in this competition are at owners' risk, but reasonable care will be exercised in the handling and keeping.

Jury of Award: Ira Hoover, Allen Philbrick, Hugh M. G. Garden, Emery B. Jackson and J. A. Kane, well known to the profession, have accepted invitations to serve on the jury. The judgment will take place March 23, 1920. The prize and mention designs will be entered in the coming exhibition. Unsuccessful designs will be returned to their authors.

## Academy in Rome Asks Funds

The American Academy in Rome has announced that it would celebrate its twenty-fifth anniversary by seeking a \$1,000,000 endowment fund. It is planned to devote \$450,000 of this fund to general endowment, \$150 to \$150,000 to landscape architecture, \$150,000 to the furtherance of classical studies, \$150,000 to musical composition and \$100,000 to the accommodation of women—a new departure.

The Academy in Rome still owes the late J. P. Morgan \$166,540 of an original debt of \$375,000, which Mr. Morgan agreed to cancel dollar for dollar with new subscriptions. It is hoped new subscriptions will be received to wipe out that liability before May 1.

## Personal

F. C. Thornley & Co., Inc., constructing and consulting engineers, announce the opening of their offices at 31 West Forty-third Street, New York.

The firm of Nolan & Torre, architects, with offices in the Hennen Building, New Orleans, have recently opened a branch office in Jennings, La., with Sedgwick Moss.

Fred B. O'Connor, who has been with the Architectural Department of New York State as special designer for fifteen years, has resigned to become chief draftsman and office manager for Russell & King, architects, of Syracuse.

C. Frank Jobson announces that Bert C. Hubbard, who has been connected with him for seventeen years past, now joins him in the practice of architecture under the name of Jobson & Hubbard, 706 Pullman Building, Chicago.

Vance W. Torbert, formerly with Carrere & Hastings, announces that having been discharged from his commission as Captain in the Construction Division of the Army, he has opened an office for the general practice of architecture at 200 Fifth Avenue, New York.

W. Elliott Dunwody, Jr., and William F. Oliphant, Macon architects, announce the formation of the firm of Dunwody & Oliphant, architects, with offices in the Jaques Building, Macon, Ga. A. Sidney Brown is also identified with the new firm as associate architect. Mr. Dunwody was formerly of Nisbet & Dunwody, well-known Macon architects.

## News from Various Sources

The new plant of the Youngstown Steel Car Co., at Niles, Ohio, is scheduled to be placed in operation in April.

\* \* \*

SYDNEY:—The Federal Government is advancing sums aggregating \$45,000,000 to the New South Wales Government for repatriation purposes.

\* \* \*

The Republican Steering Committee of the House at Washington voted to oppose any appropriations for public buildings or grounds during the present session of Congress.

\* \* \*

The Carnegie Steel Company has appropriated over \$1,500,000 with which to build 250 houses for its employees and a modern community house at the new steel plant at McDonald, Ohio.

\* \* \*

ROME.—Zocchi's colossal statue of Columbus, weighing 600 tons, will be taken to Buenos Aires on Italian steamers free of charge, under a permit granted by Premier Nitti. Requests for the transportation of the statue to Argentina were supported by Dr. Gino Persico, former Italian vice-consul at Buenos Aires.

\* \* \*

Grunewald Villa, in an exclusive suburb of Berlin, has been bought by Americans, according to the *Tageblatt*. The property belongs to the late Robert von Mendelssohn, a banker. The price is said to have been 4,000,000 marks. One report has it that the premises will be the permanent residence of the American Ambassador.

\* \* \*

People who have traveled about the country a great deal say that immense numbers of box cars are standing on the side tracks, all of them out of repair. One of the troubles of the transportation situation dates back to last summer, when the shopmen struck. Scarcity of labor and bad weather have prevented the companies from doing much repair work on the tracks.

\* \* \*

A special mission from southern Russia, headed by the Under Secretary of the Interior, P. P. Gronsky, will start for America soon to establish political relations with the United States. The mission will also take up the work of re-establishing economic relations between southern Russia and America. The members will be specialists in economic, political and military questions.

\* \* \*

The expenditures during 1918 for governmental costs in the 227 cities in the United States of 30,000 population aggregated \$1,172,695,829. The average per capita expenditures, including interest and outlays, amounted to \$34.16; and for all governmental costs, including interest but excluding outlays, the average per capita payments were \$26.05.

\* \* \*

Officers of the United States Marine Corps at Port au Prince, Haiti, have issued special orders to keep the natives from breaking into their model jail. Recently a check roll call of prisoners showed an excess of five over the number regularly committed there by law. Investigation showed that the five had sneaked in with a returning road gang, lured by the prospect of three good meals a day and a comfortable cell in which to sleep. Now every party of prisoners working outside the walls is carefully counted before it is admitted.

# Weekly Review of Construction Field

## Comment on General Condition of Economics with Reports of Special Correspondents in Prominent Regional Centers

During the past week the stronger expression of opinion has come from the conservative element in the building trades. There is good sense in their disparagement of the rough and tumble scramble for contracts which cannot possibly be got under way and for materials which do not yet exist. There is no doubt but that an anticipation of needs has had its influence in bringing prices to their present levels. But as these anticipated needs are realized, which is undoubtedly what is going to happen, the prices will remain where they are. Some contracts may be cancelled because of excessive costs, as they were cancelled last year, but even a most generous allowance for such cancellations cannot support the belief that the markets are to be flooded with building material. The contracts already placed will keep abreast of whatever supply may be expected.

### STEEL

The prospects of an increased steel production have further improved. Transportation conditions are better. The amount of finished steel at the mills has decreased and the railroad officials are now promising additional cars. If it becomes necessary, they say, stock cars are going to be used, which serves to show the sincerity of their intention.

Coke production has increased by 12,000 tons in the Connellsville region.

In Youngstown, however, the production fell off to some extent owing to a shortage of coal. The finishing departments of three steel producers were compelled to close down to a certain extent for two or three days.

The monthly report of *The Iron Age* indicates February's gain in pig-iron production shows a gain over the previous two months. The net gain over the December output was 23 per cent.

It is stated that the Supreme Court decision in the United States Steel Corporation case is not likely to have any effect upon the corporation's price and sales policies, inasmuch as these policies are encouraged largely by banking interests whose conservative attitude is well known. It seems to be more and more accepted in the trade that these policies are to be vindicated. In fact, similar policies are being adopted in other fields.

### STABILIZING THE COST OF MATERIALS

The Wells Brothers' Construction Co. has expressed the opinion that "We may see the wholesale cancellation of contracts for construction which cannot return dividends under present inflated prices. Should such wholesale cancellations occur, we might find no shortage of the basic materials. Yet outstanding contracts for materials to be used on work now going on would still be priced at fictitious values. . . . There was never a greater need for legitimate building, but we shall not get the really essential building done if we attempt to carry on a "paper program" which inflates prices to the point where the home builder and the manufacturer of fairly priced basic necessities are squeezed out of the market."

A Chicago lumber firm is circularizing the trade, notifying its customers that the price of lumber will not be advanced for at least six months, and that all lumber will be sold at the present price level. If it is possible they intend to reduce prices. It is said that other lumber deal-

ers have approved this idea and will also put it into effect. "The next thing," says the head of this company, "is to bring about a condition of coherence in the building trades so that the home builder may enter into contracts for homes with some idea of stability. Only through this stabilization of the material and also of the labor market will it be possible to build the thousands of homes necessary."

### BUILDING PRODUCTION

Superintendent Martin of the Tenement House Department of the Bronx, New York City, states in the *New York Times* that during the first two months of this year plans were filed for ten buildings as against plans for four buildings filed during the same period of last year. But Mr. Martin says that even the unprecedented rentals now being obtained on new buildings are not encouraging builders to go ahead. The building costs, in which high labor prices are no inconsiderable factor, have risen 300 per cent in the last ten years. This will not be a building year, he thinks. It will certainly not be a year in which building construction approaches a fulfillment of the demand, for a survey of that particular district states that apartments are needed for 8,000 families.

After making allowance for the reduction in the purchasing value of the dollar, we shall find that we still have under way a building construction boom which is 40 per cent in excess of anything previously known. The likelihood of this quantity of building being accomplished, however, rests largely upon the ability of those who supply building materials to meet with the demand. To a greater or less extent the disadvantages and difficulties of the past year will persist. The transportation system will probably be improved but we cannot hope for the efficiency of ante-bellum years. The inefficiency and insufficiency of labor must be felt as an impediment even with the most favorable intentions displayed.

The Aberthaw Construction Co. warns "not against undertaking building in general but only against undertaking certain kinds of it." It is their opinion "The big uncomplicated industrial operations will be carried through close to schedule wherever they are intrusted to organization with the capital, the mechanical apparatus and the human organization capable of large scale procedure. If the number of units to be constructed could be materially reduced in number and proportionately increased in size, it is a fair assumption that an expansion of 41 per cent in volume could be made.

"The work that will lag is small scale construction which requires special materials in unusual sizes, instead of standardized design throughout and which, further, because of the necessity for meeting various architectural requirements calls for unusually skilled and conscientious workmanship at all points.

"Therefore, the owner contemplating a big project should be encouraged to go ahead with it; the one with a small one should be counseled to caution and delay, unless he knows himself to be in complete control of all the elements essential to a successful outcome."

### LEGISLATION

The Real Estate Board of New York says that in view of the exceedingly grave housing shortage some legisla-

## THE AMERICAN ARCHITECT

tion should be enacted which would help to relieve this shortage; that the most direct and practical way to get this is to pass a bill exempting from the provision of the income tax law the interest on mortgages secured by real estate.

It seems plain that real estate mortgages, the interest of which is taxed, cannot compete with tax-free securities to which funds are naturally attracted; and that this will operate seriously against the production of new housing.

The New York State Legislature has various bills pending which intend to deal with the evil of rent profiteering. One provides that a monthly tenant may not be evicted unless notice is served upon him sixty days before the expiration of his term. Another prohibits proceedings to recover possession of real property for non-payment of rent unless the rent sued for shall be reasonable. A third provides that no monthly tenant shall be removed from any building on the ground that it is to be reconstructed, unless ninety days' notice has been given. A fourth is to limit rentals to 10 per cent of the actual value of the house and lot plus necessary and actual expenses.

The Mayor of New York City and the Speaker of the State Legislature are expressing much interest in rent profiteering. Speaker Sweet said in a letter to Committee Chairmen: "I believe this matter one of the most serious questions confronting us. I appreciate the constitutional difficulties that arise in dealing with the subject involving the right of contract, but I believe this situation can be overcome by appropriate legislation."

A bill has been introduced in Congress for the establishment of a system of home loan banks, similar in plan to the Farm Loan Banks, which also includes a tax exemption feature. Another bill proposes that building loan associations shall be authorized to issue bonds secured by deposits of their real estate mortgages and thus make the assets of such associations more easily available for further loans.

### FEBRUARY BUILDING OPERATIONS

The statistics of building operations published by the F. W. Dodge Co. show in the districts of New York and northern New Jersey, Pittsburgh, and the Northwest (Minnesota, North and South Dakota) a falling off of February as compared with January in the number of building contracts awarded. New England, Philadelphia, Baltimore and Washington, and the Central West continue to show advances, though not very radical ones.

The total amount of contracts awarded during February in the territory east of the Missouri and north of the Ohio rivers was \$216,663,000—as compared with \$235,848,000 for January. Of the February total 42 per cent was for industrial building, 20 per cent for business buildings, 20 per cent for public work and utilities and 17 per cent for residential buildings.

Although the building figures for 1919 show a substantial increase in values over previous years, Babson's Statistical Index points out that, making allowances for the increase in building costs, including labor, which have risen on an average of 80 to 90 per cent since 1914, the actual volume of building for December, 1919, amounts to about the same as in December, 1912, or December, 1913.

For the past eleven years the annual building figures for 120 identical cities are as follows:

1909.....	\$888,114,741
1910.....	846,991,622
1911.....	824,147,884
1912.....	879,094,308
1913.....	814,509,360
1914.....	728,801,072
1915.....	763,343,811
1916.....	919,435,203
1917.....	633,483,313
1918.....	372,793,978
1919.....	1,170,773,197

*(Special Correspondence to the AMERICAN ARCHITECT)*

SAN FRANCISCO.—In addition to a large amount of construction work under way in the commercial sections of San Francisco, nearly all of the desirable residential tracts are in the process of extensive development. Costs of labor and material do not seem to have produced any slowing up of the general building activity, for all types of structures are badly needed in the West. Housing facilities are still under par and it is expected that it will be some time before normal conditions are again reached.

Realty firms of the larger class are handling many construction contracts through their offices and the loan associations are taking care of a considerable amount of building money. The public is being acquainted with the fact that these firms are willing to promote business of this sort. Through this method of circulation as well as through individual channels, money is plentiful in the building market.

Permits show an unusual amount of construction work for the winter months. Extremely light rainfall has permitted building to go on practically without interruption, so it is probable that a good deal of work will be carried through to completion earlier than was at first figured upon.

The automobile section of San Francisco is expanding rapidly. A number of high-class sales buildings have gone up lately and several other large jobs are in contemplation, in addition to many buildings of the garage and repair-shop type, which are being erected all over the city.

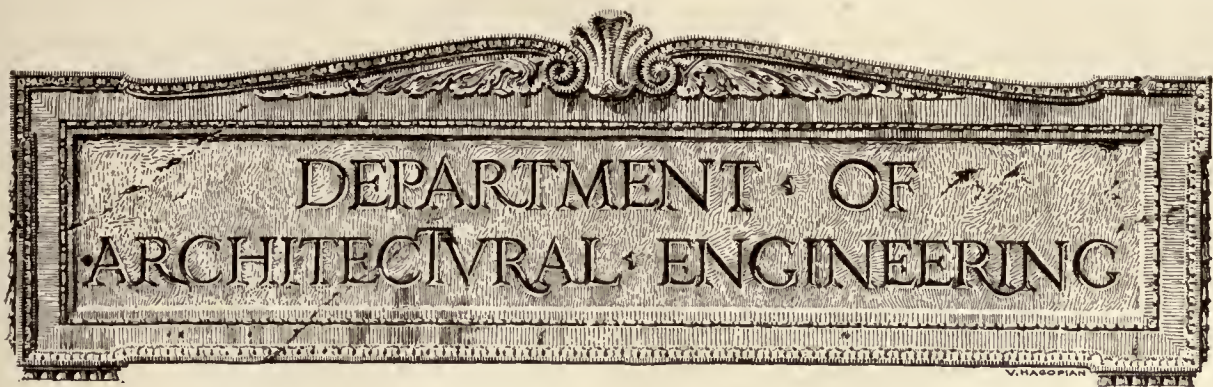

## Fire Protection for Schools

### Part II—Causes of Fire, Its Prevention and Extinguishment

By H. W. FORSTER.

THE records of the Actuarial Bureau of the National Board of Fire Underwriters show the principal causes of fires in schools to be lighting, stoves and furnaces, chimneys, matches and smoking, and spontaneous combustion in various materials. The order here set forth does not necessarily indicate the jeopardy to life or the relative amount of property destroyed.

The ordinary grammar school or recitation building, containing only class-rooms and a basement with heating equipment and storage rooms, has fire hazards limited largely to heating and lighting systems and to poor housekeeping. The more modern schools, and especially high schools and trade schools, contain the hazard created by the use of power-operated machinery, combustible working materials, inflammable liquids, chemical laboratories, etc., thus showing an increase.

In the following sub-divisions the causes of fire, insofar as they are pertinent to the work of the architect are stated, as well as the methods by which the fire hazard may be reduced.

*Lockers.*—The modern tendency is to provide central locker rooms with metal lockers in the place of the old wardrobe and hall lockers. New lockers, no matter where located, should be of metal and have solid backs and side partitions to prevent spread of fire between them. Screen or punched plate doors are preferable to admit of inspection without unlocking.

*Electricity.*—The insurance interests report that in 1916, 86 fires from electrical causes resulted in a loss of \$585,054. In 1917 the number of fires was 70, with a property loss of \$500,307. Electrical fires are therefore a very definite hazard in schools. The National Electrical Code as issued by the Na-

tional Board of Fire Underwriters contains specifications covering every detail of electrical installation, and compliance with these specifications will eliminate practically all fire hazard in connection with electrical equipment.

In grammar schools the electrical equipment consists mainly of wiring, lamps, switches and fuses. In the larger schools, however, especially in high schools and technical schools, the hazard is increased by the installation of rheostats, motors and various types of electrical heating devices. Some of the larger schools even operate generating systems. Only the most common electrical hazards are discussed herein.

Electric wiring should preferably be installed in conduit throughout. Where open wiring is used there is always the possibility of mechanical or other injury.

The insulation on twisted pair cords deteriorates very quickly, and when in contact with metal there is danger of a short circuit which will start a fire. Portable cords should be used sparingly and should be of the heavy reinforced type with a strong guard for the lamp.

The ordinary incandescent lamp gives off heat enough to be a serious fire menace. Wherever there is danger of lamps coming in contact with combustible material or being broken, they should be inclosed in substantial wire guards securely clamped to the lamp socket.

Combustible shades, often of paper or cardboard and sometimes even of celluloid, are found on pendant lamps, especially where these are used about machines. Where shades are necessary they should be of metal.

Heating units, such as flatirons, hot plates, glue

heaters and occasionally stoves, found in domestic science and manual training departments, should receive special attention, as they have a bad fire record. A red pilot light should be installed in the circuit with each heating unit, or connected series of units, to serve as a danger signal whenever the current is turned on. Metal or asbestos stands

Stereopticon lanterns generally require too much current to admit of their being installed on an ordinary lighting circuit. Where they are used it is therefore generally necessary to provide special connections.

*Gas Lighting and Heating.*—The essential features to secure safety from gas lighting, other than care in handling matches, are:

(a) Proper clearance over mantles and burners. Three feet is ordinarily necessary with a Welsbach mantle and two feet with a flat flame burner. Lesser distances than this require heat bells.

(b) No swinging brackets where flames can come into contact with any combustible material.

(c) Wire guards for flames to prevent people and materials from coming in contact with them.

(d) Elimination of key control for gas lights where pupils might play with them.

*Lightning.*—In 1916 lightning started 376 school-house fires in the United States, with a total loss of \$61,811.00. In 1917 there was a loss of \$199,789.00 as a result of 499 fires. Not a building that was struck was provided with lightning rod protection. Contrary to the common opinion, a lightning rod installation, properly designed and installed, affords decided protection for exposed buildings.

*Heating Hazards.*—It is amazing to note the indifference of most people to fire hazards of this type. The cutting of construction expenses by setting beams and floor joists into the brickwork of chimneys is poor economy, as witnessed by the photograph on page 293, which shows a chimney with 4-inch brick walls into which woodwork has been let.

The minimum specification for a brick chimney in a building of more than one story is 8-inch walls and a flue lining. For one-story buildings with an ordinary stove a chimney with a 4-inch wall and flue lining may be built directly on the ground. All chimneys and pipes should be thoroughly cleaned each fall before fires are started.

The hazard of cracked stoves and of poorly supported stovepipes with open joints is obvious. While stoves and furnaces should be operated in a manner to prevent overheating, they should be so located that serious overheating will not set fire to the building or nearby storage.

Any woodwork heated to 150° C. or over for any length of time is liable to ignite, and all heating apparatus must be installed with this fact in mind. (See Figure 1.)

Boilers and furnaces should always rest directly

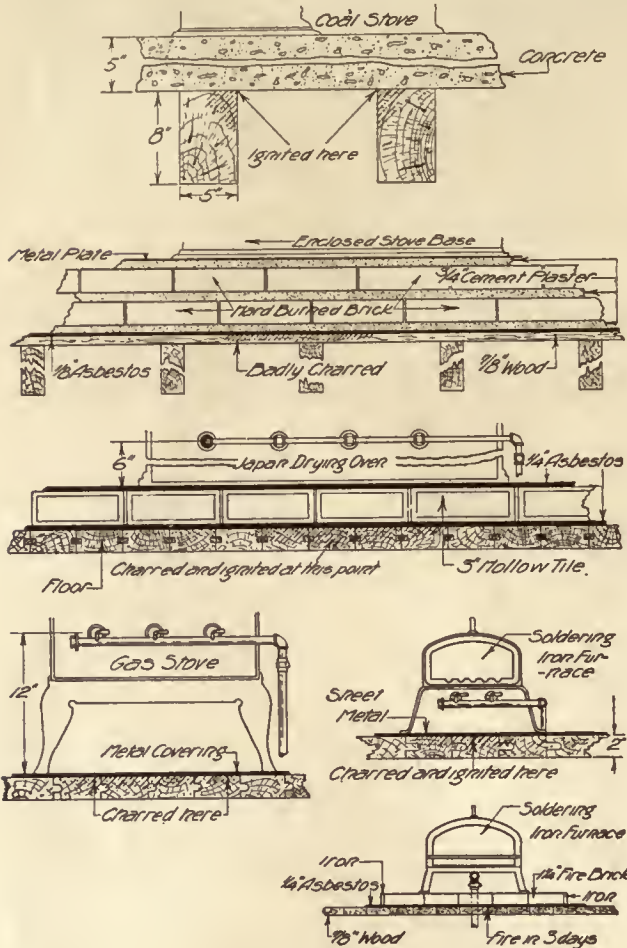

Courtesy Crosby-Fiske-Forster Handbook of Fire Protection.

FIG. 1. FIRES DUE TO IMPROPER INSTALLATION OF HEATING DEVICES. TO MANY ANY OF THESE SIX INSTALLATIONS WOULD HAVE APPEARED PERFECTLY SAFE

should be provided for irons, and proper air space should be maintained about all heating units.

Fuses are the safety valves of the electrical system and should be installed at the point where the wires enter the building and on each branch circuit. Open link fuses are still used in some of the old schools, and frequently cases are found where janitors or teachers have replaced blown fuses with copper wire, nails or any other conducting material that happened to be handy. Such conditions subject the entire circuit to possible overloading have caused many fires.



WATCHING THE WATER DISTRIBUTION

THE START OF THE FIRE



WITHIN A VERY BRIEF PERIOD AFTER THE IGNITION OF THE FIRE THE SPRINKLERS AUTOMATICALLY COMMENCE TO DISTRIBUTE THE WATER, AS HERE SHOWN.



FIRE EXTINGUISHED WITHOUT ANY HUMAN AID



HOW A SPRINKLER LOOKS IN OPERATION

ILLUSTRATIONS OF SPRINKLER OPERATION IN A CLEVELAND SCHOOL

on the ground or on absolutely incombustible construction; never on wood, even if protected.

Where stoves must be placed on combustible construction, they should be raised on legs or supporting beams at least 6 inches and preferably 12 inches from the floor, ventilation being thus afforded.

Floors should be protected over a liberal area with metal on asbestos.

Proper clearance overhead where floor above is of wood will vary with the heating device, but should not be less than 2 feet with a furnace and 3 feet with a boiler. For stovepipes the minimum clearance is generally placed at 12 inches, although 18 inches is better. Ample clearance from wooden walls and partitions is as important as adequate headroom.

In addition to the usual heating devices, schools are likely to have in them hot plates used in domestic science courses, glue heaters in woodworking shops, forges, annealing furnaces, and blow torches in blacksmith and machine shops, stoves, mangles and irons in laundries, and gas heaters at lunch counters. In connection with all of these there are fire hazards which must be guarded against.

*Steam Pipes.*—The possibility of fire occurring through contact of hot steam pipes with woodwork is questioned by many, but the danger has been definitely established. In the case of the Collinwood School fire, the official verdict was that a steam pipe passed through a closet near the foot of the stairs and was undoubtedly the cause of the fire which destroyed 175 lives. Proper insulation or air space should be provided about all steam pipes where they pass through floors or partitions.

## Fire Extinguishing

IT is startling to see how little provision is made for fire fighting in the average school. It is even more startling to observe the poor upkeep of equipment and the ignorance of the janitors and the faculty as to its use.

For isolated country schools, especially of college type, good water supplies, fire mains, hydrants, hose, ladders and other equipment are essential for property protection purposes, but the features of such a protection system will not be discussed here, as that is an intricate engineering problem, varying greatly with the conditions. This article will be confined to the fire-fighting equipment which may go into the school building proper.

*Automatic Sprinklers.*—Some school boards and principals either have not understood the value of sprinklers or have been prejudiced against them. but in many of the older schools automatic sprin-

klers are the logical answer to the problem of securing greater life safety. Unfortunately, in many cities conditions are such that the best proposition by no means goes through, as witnessed by the notorious case of a certain city which suffered a serious loss in its schools and which invested funds, sufficient to provide adequate sprinkler protection, in an installation of stamped metal ceilings.

While the school buildings should be equipped with hand extinguishing apparatus, the ordinary school over one story high, if of combustible construction, needs automatic sprinklers, and needs them badly.

Frequently an installation of sprinklers will furnish a sufficient degree of protection to render unnecessary expensive structural changes that would otherwise be imperative in the interests of safety.

The sprinkler, if properly maintained, is on duty day and night, goes into action as soon as the fire reaches modest proportions, is not affected by smoke as are human fire fighters, and can be arranged to give an alarm the moment water flows from the sprinkler system. (See illustration on page 291.)

Sprinkler heads are made with a special solder which melts at about 160° F., which is less than the boiling point of water. The sprinkler has a ½-inch orifice or nozzle and a deflector, and under usual pressure will discharge 15 to 20 gallons of water per minute in the form of a drenching spray over an area of perhaps 15 feet in diameter. As the sprinklers are seldom placed over 10 feet apart, these spray circles overlap and a fire has little chance to burn or spread.

It is gratifying to know that a considerable number of sprinkler equipments have been installed in schools.

In cities where it is impracticable for financial reasons to install the full equipment considered desirable, the following procedure may be adopted:

(a) All school buildings which are under the jurisdiction of the board which is considering sprinkler protection should be listed in the order of their relative danger to life, taking into account construction, exits, operations carried on therein, and any other essential factors.

(b) Sprinklers should be provided in the basements of school buildings in the order of their standing on the relative hazard scale.

(c) These sprinkler systems should all be arranged so that they can later be extended to upper floors of the buildings.

(d) After basements of all buildings, except the very finest, modern, incombustible



ones, have been equipped, the installations should be extended upward, again beginning with the more hazardous on the list.

(e) In this manner a given amount of money will be used most effectively, and ultimately all combustible schools can be fully protected.

The reason for this proposal will be evident upon reflection. Fires above people seldom jeopardize

colleges, especially where these are without public protection, there is generally advantage in an installation of inside hose, provided that there are trained persons to use the equipment to advantage.

In all schools a hose connection should be provided in the boiler or furnace room to wet down ashes and to use on incipient fires.

*Chemical Extinguishers.*—Approved extinguishers of the soda and acid type should be distributed



RESULT OF POOR CHIMNEY CONSTRUCTION. FLOOR ATTACHED TO CHIMNEY HAVING ONLY 4-INCH WALLS AND NO LINING. FIRE DESTROYED BUILDING

their lives. If there are two ways out of a given room, a fire on the same floor is not a very serious matter, assuming that all rooms are occupied, fire promptly discovered and alarm given. On the other hand, fires below persons, and particularly fires in the basement where rapid spread has unfortunately been the general rule, are most to be feared. Practically all persons are above a basement fire, and fires spread upward far more rapidly than horizontally or downward. The Collinwood and Peabody life loss resulted from basement fires.

*Inside House Prevention.*—In high schools and

throughout all school buildings. From any point in any school corridor at least two fire extinguishers of this type should be plainly visible, and they should be located not more than 100 feet apart. At least one extinguisher should be placed in each laboratory, woodworking shop, basement, or other place where there is any special hazard.

Special liquid extinguishers may be valuable in special locations for fires in oils, grease or electric equipment, as they function chiefly by the generation of a gas blanket which excludes oxygen from the flames.

(To be continued)

## Foundations, Their Selection, Design and Construction

Announcing a Series of Articles

**I**N presenting in this department to the readers of THE AMERICAN ARCHITECT a series of articles on Foundations, their proper selection and design, it may be well to set down as preface some facts that it would appear should be taken into consideration with reference to the architects' attitude toward a certain part of his building that of late years has not always received the same careful consideration as has been given to the design and plan of the structure above the ground level.

Engineers have complained, and perhaps with some justification, that in the selection and placing of foundations—even of buildings of importance—architects have in so many instances so slighted this phase of the work as to throw the real-responsibility for the stability of the structure, as far as its foundation is concerned, entirely upon other related professions.

It is necessary, if the architect is to assume his vocation as a "master builder," that he should be thoroughly conversant with every detail of his structure from the lowest part of its foundation to the part farthest above ground and that in preparing such plans and specifications as are necessary, the foundations should receive the same thoroughness of treatment as every other part of the building. Failing in this and permitting this duty to devolve wholly upon the engineer is in a measure shirking a very direct responsibility.

It is assumed that in every architectural office engaged on work of any magnitude there will be a department of architectural engineering whose duties it will be carefully to design and plan not only the foundation but many of the other architectural engineering features that develop in the structure of the modern building.

To reiterate a contention often made in these columns: the architect is the master builder of the work and he should be able either through his own knowledge or that of those employed by him in his organization to present in his final plans an accurate and well developed scheme for the foundation as for every other part of the structure. Unfortunately there are many instances in which this essential condition does not exist. It is with the purpose of presenting to the architect and architectural engineer certain elements as to Foundations that are not only vital, and therefore essential, but are really a part of the architect's duties and may not with honesty be shirked by the architect or assumed by the engineer or the contractor.

We hear much at this time of the correct inter-

professional relation that should exist between the professions of architects and engineers, and it is believed that nothing would more aggravate a condition of dissatisfaction between these two professions than the fact that either one or the other was side-stepping a duty for which it was paid to perform.

It will be the endeavor of the writer of these articles, whose experience is one gained by actual practice with foundation work, to direct attention to such things as it has been his experience to observe, and to point out just what the architect should do and just what he should know and put into active practice in every building where the foundation becomes of importance. There will be presented actual descriptions of various foundation operations, the elements controlling their design, and the necessities of the building as arbitrarily commanding their planning. The first of these articles, which will appear shortly, will deal with preliminary sub-soil investigations.

## Construction Division U. S. A. Still Active

The job of the Construction Division, U. S. A., is not yet over. The cantonments which were constructed were of a temporary nature and character and will not provide proper housing facilities for the permanent personnel of the regular army. There are in the United States housing facilities of a permanent and a usable nature for something less than 100,000 troops. To provide for the 300,000-odd men which seems to be the minimum proposed by new army legislation, it is necessary to provide housing facilities for some 200,000-odd men and officers. This, of course, does not consider the housing required for the annual drafts which will be brought in for temporary service under any universal training law.

The minimum expenditure that may be expected to be made by the Construction Division for construction of permanent quarters and for the operation of utilities was placed by General Marshall in his testimony before the Senate committee, at \$100,000,000 a year. This figure exceeds the total amount annually spent by the whole Quartermaster Corps during the period previous to 1917. The operation of the utilities throughout the cantonments is an item of great importance, as it has been estimated that the average cost of furnishing a soldier with heat, light, water and sewerage facilities is somewhere like \$144 a year, though in special cases it has dropped as low as \$100. On the basis of an army of \$300,000 men, this item alone is between \$30,000,000 and \$42,000,000.

# Bibliography of Literature on Chemical and Engineering Laboratories

By CLARENCE J. WEST

**D**URING the war industrial research in the United States was greatly stimulated and the importance of the industrial research laboratory as a factor in maintaining the supremacy of an industry was more clearly recognized than ever before. As a result of this, new laboratories will undoubtedly be built and many old ones will be reorganized that they may render more efficient service.

In order that the experience of others may be available to those who are contemplating the establishment or the reorganization of their laboratories, the following list of references has been collected. With a few exceptions, only those laboratories have been included, the description of which is accompanied by drawings, plans or photographs showing the general arrangement of the buildings or rooms. A few general references on the value of Industrial Research are also given.

## GENERAL

Clewell, C. E.—Industrial Lighting, *J. Franklin Institute*, 188, 51-90 (1919).

Engine test laboratory; special building of tractor manufacturing plant for experimental development of engines, *Automotive Ind.*, 38, 868-9 (1918).

Fleming, A. P. M.—Research organization in industrial work, *Nature*, 102, 454-7 (1919); *Electrician*, 82, 118-20 (1919). (Suggestions are given for the establishment of industrial research laboratories.)

Planning a works research organization, *American Institute E. E. J.*, 57, 153-70, 170-192, 386-406 (1919); *Elec. R.*, 54, 251 (1919); *Illum. Eng.*, 12, 9-12 (1919).

Hinman, J. J., Jr.—American water work laboratories, *J. Am. Works Assoc.*, 5, 133-41 (1918).

MacFarland, A. F.—Chemist's part in speeding up steel output, *Iron Age*, 101, 1645-8 (1918).

Mees, C. E. K.—Production of scientific knowledge, *J. Ind. Eng. Chem.*, 9, 1137-41 (1917).

Planning a research laboratory for an industry, *J. Ind. Eng. Chem.*, 10, 476-80 (1918).

Industrial research laboratory organization, *Mech. Eng.*, 41, 667-8 (1919).

Richtmyer, F. K.—Industrial Research Laboratories, I, Research and the industries, *Sibley J. Eng.* 32, 80-4 (1918).

Riley, H. M.—Baltimore Company has appliance testing laboratory, *Am. Gas Eng. J.*, 106, 583-7 (1917).

Riley, H. M., and Wilson, L. B.—Gas appliance testing laboratory, *Am. Gas Eng. J.*, 107, 369-75, 425-7, 430-3, 489-94 (1917); 108, 1-6, 77-82, 169-72, 176-9, 341-9, 561-7 (1918); 109, 217-23, 481-5 (1918); 110, 117-21 (1919).

Sharp, E. H.—Independent laboratories in the engineering industries, *J. Franklin Inst.*, 183, 221-8 (1917); *Ind. Management*, 53, 380-4; *Me. & Chem. Eng.*, 17, 167-9; *Am. Soc. M. E. J.*, 39, 650-1 (1917).

Some special problems in the lighting of laboratories and technical institutions, *Illum. Eng.*, 12, 13-16 (1919).

Traverman, C. J.—Ore testing laboratory, *Eng. Min. J.*, 103, 1142-4 (1917).

## SPECIAL LABORATORIES

### *Bethlehem Steel Company*

Bethlehem Steel Company's new chemical and physical department, *Iron Age*, 94, 710-3 (1914).

### *Carnegie Institute*

Barker, T. S.—Steel research laboratory planned for the Carnegie Institute of Technology, *Mech. Eng.*, 41, 465-8 (1919); *Iron Age*, 103, 954-5 (1919); *Iron Trade Rev.*, 64, 891 (1919).

### *Consolidation Coal Company*

Williamson, H. A.—Laboratory of the Consolidation Coal Co., *Coal Age*, 12, 235-7 (1917).

### *Fiat Works*

Testing Laboratory of the Fiat Works, *Engineer*, 125, 555-6 (1918).

### *General Electric Company*

Hosmer, Helen R.—Industrial Research Laboratories, II.—The research laboratory of the General Electric Company at Schenectady, *Sibley J. Eng.*, 32, 98-103 (1918).

### *Goldschmidt Bros.*

Smelting and refining laboratory of Goldschmidt Bros., Chicago, *Amer. Arch.*, 114, 38-39 (1918).

### *A. D. Little, Inc.*

A modern laboratory for industrial research, *Met. Chem. Eng.*, 19, 100-1 (1918).

Little, A. D., and Howe, H. E.—Organization of an industrial laboratory, *Mech. Eng.*, 41, 663-6 (1919).

Laboratory and office of A. D. Little, Inc., *Am. Arch.*, 114, 577-8 (1918).

### *Massachusetts Institute of Technology*

New Laboratory plans of the Mass. Inst. of Tech., *Eng. N.*, 74, 340-1 (1913).

Bromley, C. H.—Mass. Inst. of Tech. laboratories and power plan, *Power*, 45, 337-43 (1917).

Improved Engineering Laboratories, Mass. Inst. of Tech., *Iron Trade Rev.*, 61, 1104-5 (1917).

Russell, G. W.—Hydraulic laboratory of the Mass. Inst. of Tech., *Bost. Soc. C. E. J.*, 5, 121-30 (1918).

### *Mellon Institute*

Hamor, W. A.—Description of the new building of the Mellon Institute, *J. Ind. Eng. Chem.*, 7, 333-43 (1915).

### *Missouri School of Mines*

Forbes, C. R.—Mining laboratory of the Missouri School of Mines, *Eng. & Min. J.*, 99, 309-11 (1915).

### *New Jersey Zinc Company*

Jenkins, D.—The New Jersey Zinc Company's Franklin laboratory, *Bull. Amer. Inst. Mining Eng.*, 1917, 1181-5, *Eng. Min. J.*, 104, 425-6.

### *The Nela Research Laboratory*

Hyde, Edward P.—Industrial Research Laboratories, III—The aims, organization and work of the Nela Research Laboratory, *Sibley J. Eng.*, 32, 123-6 (1918).

### *Scoville Mfg. Co.*

New laboratory for brass, Scoville Mfg. Co., *Iron Age*, 101, 858-9 (1918).

### *Syracuse University*

Nugent, P. C.—Hydraulic laboratory at Syracuse University, *Eng. N.*, 71, 74-7 (1914).

### *U. S. Bureau of Chemistry*

Gibbs, H. D.—Color of laboratory of the Bureau of Chemistry—brief statement of the object and problems, *J. Ind. Eng. Chem.*, 10, 802-3 (1918).

*U. S. Bureau of Mines, Pittsburg*

Bureau of Mines new laboratories, *Power*, 49, 384-8 (1919).

Harris, G. W.—New Pittsburg Station of the Bureau of Mines, *Coal Age*, 15, 707-11, 749-51, 852-5, 907-11 (1919).

Pittsburg Bureau of Mines experiment station, *Eng. Min. J.*, 107, 899-902 (1919).

*U. S. Bureau of Standards*

Walén, E. D.—Bureau of Standards research laboratories, *Textile World*, 55, 1563 (1919).

*U. S. Metals Refining Co.*

Hood, B. B.—U. S. Metals Refining Co.'s new laboratory at Chrome, *N. J., Eng. Min. J.*, 105, 451-4 (1918).

*U. S. Naval Academy*

DeBaufree, W. L.—U. S. Naval Engineering experiment station at Annapolis, *Sci. Amer. S.*, 81, 72-4 (1917).

*University of California*

Randall, Merle—Gilman Hall, the research center of the chemistry group at the University of California, *J. Ind. Eng. Chem.*, 10, 634-40 (1918).

*University of Cincinnati*

Formal opening of the new chemical laboratory, University of Cincinnati, *J. Ind. Eng. Chem.*, 9, 604-12 (1917); *Met. & Chem. Eng.*, 16, 367-73 (1917).

*University of Illinois*

Stock, H. H., and Holbrook, E. A.—Mining laboratories of the University of Illinois, *W. Soc. E. J.*, 19, 459-86 (1914).

Paine, E. B.—Engineering experiment station of the University of Illinois, *Am. Inst. E. E. Pro.*, 34, 2421-7 (1915); 35, 504-5 (1918).

Hopkins, B. S.—Description of the chemical laboratory of the University of Illinois, *J. Ind. Eng. Chem.*, 8, 537-47 (1916).

New chemical laboratory at the University of Illinois, *Met. Chem. Eng.*, 14, 421-4 (1916).

Dedication of the new ceramic engineering building, University of Illinois, *J. Ind. Eng. Chem.*, 9, 84-6 (1917).

*Youngstown Sheet & Tube Company*

Notable Laboratory: Youngstown Sheet & Tube Company, *Iron Age*, 99, 1497 (1917); *Iron Trade Review*, 60, 1335-7 (1917).

FOREIGN LABORATORIES

Backer, H. J.—Oude Chemisch Werktingen en Laboratoria Van Zosimus tot Boerhaave Groningen and the Hague, 62 pp.

Chubb, I. W.—British National Physical Laboratory, *Ind. Management*, 54, 420-6 (1917).

Glazebrook, Richard T.—A national proving house and standardizing laboratory, *Engineering*, 105, 293-5.

Glazebrook, Richard T.—National industrial research laboratory, *Engineer*, 125, 180-1 (1918); *Eng. & Contr.*, 50, 423-5 (1918).

Scheme for an electric proving house, *Inst. E. E. J.*, 56, 26-7 (1918).

Engineering equipment at Hong Kong University, *Engineer*, 125, 136-8, 168-9, 199-200 (1918).

Andre Citroen laboratories, *l'Ind. Chimique*, 5, 242-4 (1918); Kuhlman laboratories, *l'Ind. Chimique*, 6, 130-3 (1919).

Guillet, L., and Godfroid, H.—The laboratories of the Andre Citroen works, *Rev. Metal*, 15, 19-64 (1918).

Haanel, Eugene—Description of the laboratories of the Mines Branch of the Department of Mines of Ottawa, Canada, Dept. of Mines, Mines Branch, *Bull.*, 13, 51 pp. (1916).

New chemical laboratories at University College, *Electrician*, 77, 16-7 (1916).

New technical chemistry laboratories of the Imperial College of Science, South Kensington, *Engineering*, 99, 551 (1915).

Queen's University Laboratory, *Can. Chem. J.*, 2, 17 (1918).

Engineering News from Europe

Reconstruction of France

There is to be a permanent exhibition at Paris (rue Louis-le-Grand), known as the "Renaissance des Cités." The aim of the promoters is to show what can be done on town-planning lines to restore the damage towns of France and embellish others. Plans of Chauny, photographs of Noyon taken from an aeroplane, and plans for extensions to Paris, are some of the exhibits already placed. There are also documents dealing with the land registry and types of workmen's houses, by Greber, architect. The text of the Town-Planning Conferences held at the "Société Française des Urbanistes" is being published in English.

Housing Problem in England

Sir Charles Tamlin Ruthen, O.B.E., Member of the Council of the Society of Architects, read a paper\* before that body in which he pointed out that even if the brick output is increased 250 per cent, it will be 15 or 20 years before the present shortage can be made good. He proposed wooden houses as a remedy, and stated that they have a life equal to that of the majority of brick houses, and that they were, of course, cheaper. He had effected a saving of about £125 on one he had built. Figures prove that more than a quarter of the population, or more than 7,000,000 persons in England, are improperly housed. He estimated that supposing the housing problem to be satisfactorily dealt with during the next five years, a total of 1,044,000 houses should be built, or considerably more than 200,000 annually. Supposing 25,000 bricks were required per house, it would mean that 5,000,000,000 bricks would be required per annum. In order to obtain this output, all other work would have to cease for the period, or the number of workmen engaged would have to equal 2½ times the number engaged in pre-war days. Even considering this, it is likely that 15 or 20 years will elapse before the shortage is remedied.

If a grave national calamity was to be averted, Sir Charles considered the following to be the five main points in house erection: Rapidity of construction, weather-proof qualities, stability, durability and cost.

The figures already stated point out the impossibility of erecting brick houses, or slow-built English types of houses. Sir Charles had studied the methods in vogue in America and Canada for some time, and had noted that many thousands of timber-built houses erected in America have lasted satisfactorily, and have had a life equal to the majority of the brick houses of Great Britain. He therefore made a demonstration of rapid-house erection near Swansea, South Wales. The houses are typical examples of American dwelling construction, adapted to English tastes. The foundations are of brick, with a bitumen damp-course, and the framework is of wood. A shield of stucco-board is secured to the framework. This consists of, first, a fibrous board on which a second material—a thick layer of asphaltic mastic—is applied, and the third consists of wooden dovetailed laths embedded under great pressure into the first two. He claims for this construction a thoroughly damp-proof, warm and vermin-proof building. The external finish is stucco, and the appearance is similar to that of an ordinary brick house with a cement stucco finish. The cost of one of the houses has been £125 less than that of a similar house of 11-in. hollow brickwork. The house was completed in 30 days.

\* "A New System of House Building."

# Safety Education in the Public Schools

By ALBERT W. WHITNEY, *Chairman, Committee on Education, National Safety Council*

THE number of deaths due to accidents in the United States is in the neighborhood of 70,000 a year and the number of serious accidents other than death about two million. In other words, we have in our factories and streets the equivalent in their effect upon our own people of two European wars going on all the time. More specifically, the casualties due to accidents in this country during the period of our participation in the war were twice as great as the casualties to our soldiers in battle. Year in and year out there is this perpetual wastage of life and limb, this agony of torn flesh and spilt blood, this tragedy of husbands and fathers torn from their families, of little children brought lifeless or bleeding to their parents' feet. This is not a sacrifice for a principle, for liberty, for democracy, for right and truth; it is only a passionless, senseless tribute to carelessness and ignorance. A wife or mother who has given her husband or her son on a French battlefield has received some return for his life in the high emotion of the struggle for a better world, but a wife who in place of her husband receives flesh torn to pieces by the gears of a lathe or a father and mother to whom is brought the form of their child crushed under the wheels of a trolley car have no such exchange; they have only the agonized cry of wanting to know what the purport of a world can be in which such meaningless things can happen.

Much has already been done to lighten this horror. Most of the industrial plants of the country have done something to reduce their accidents and in the case of many the undertaking has been thorough and effective. Many plants have been successful in reducing their accidents to a third of what they were under old conditions. Workmen's compensation laws, which lay the responsibility for accidents directly upon the employer himself, had much to do in arousing an interest in this work, but to the credit of employers be it said that this interest once aroused has gone forward because of the driving force of the appeal of humanity and efficiency. The strength of the movement can be measured by the growth of the National Safety Council. Founded in 1912, it has now a membership representing six million of the industrial workers of the country. Its activities are having a profound effect. Until recently the work has been largely industrial, and has perforce had to do with more immediate and obvious needs, such as the mechanical guarding of machinery and the organization of shop committees.

This work, however, is now so well under way that the Council can direct its efforts toward the field of public safety and toward fundamentals, and of these there is none so important as education.

The problem is at bottom a psychological one, to get people to think in terms of safety. Safety, the saving of lives and limbs, is part of the conservation movement, and conservation is a part of efficiency; engineers are thinking in terms of efficiency; they are beginning to think in terms of conservation, and this must inevitably bring with it the conservation of humanity as well as of materials and energy.

Already a number of universities have incorporated safety work in their engineering curriculum not only in connection with actual shop practice, but as a part of such courses as industrial management and machine design.

The Federal Bureau for Vocational Education has made the teaching of safety and hygiene an integral part of the work in all vocational schools. The National Safety Council, through its local councils, and the American Institute of Safety are both carrying on a most important educational work among plant inspectors and foremen.

So much, briefly, for what has been already done in the educational field outside of the public schools. It is the public school, however, that is the most fertile ground of all. If men and women are to have a regard for safety that will control their lives in an important way they must get it while they are children. The problem is therefore to introduce safety education into the schools in such a way that it shall permanently affect the child's way of thinking.

While the National Safety Council was considering how it might best attack this problem it was fortunate enough to have the problem actually solved by Dr. E. G. Payne, of Harris Teachers' College, St. Louis. What remains to be done is for the most part only to spread the news of what has been accomplished in the St. Louis schools.

The problem of introducing one more subject into an already over-crowded curriculum is something to be undertaken with respect and fear. Dr. Payne had so much respect for the feelings of teachers that he did not even attempt this. He did something different and much better; instead of introducing a new subject, safety, he introduced safety into all subjects.

May I attempt in an unprofessional way to de-

scribe the pedagogical problem? Education consists in the acquisition of certain processes, principles, and points of view that have a practical application to the business of living; it is the building up within the child of a mechanism for grasping the world. These principles cannot be taught, this mechanism cannot be built out of abstractions. The links of the mechanism must be made out of materials that are in the child's life. Principles must be pressed out of some body of experience. The more closely this body of experience approximates to the real life of the child and is in fact the real experience of the child the more effective the result will be. Not only are principles and processes thereby impressed with a vital power and meaning that they would not otherwise have, but at the same time a large body of facts and conclusions become available for application in the real business of life. In other words, the only way to learn is from life itself and the schools must be approximately a working model of life. The principles and facts of life must be got at the same time.

In primary and secondary education this principle has a respectable standing; in university education it is far from admitted, at least in general practice. There is still thought to be some virtue in pure culture, either taught in the abstract or as little contaminated as possible with practical affairs. The sooner that life is thought of as one whole and not cut up by compartments into business culture, religion, and art, the sooner we shall have a satisfactory world.

What has been done in St. Louis is to use the child's knowledge and intuition of danger and safety as a part of that body of experience out of which the educational mechanism is to be made. In this process safety takes its place only as one of a considerable number of equally important interests. Other bodies of experience which are made use of in a similar way are those arising out of the child's interest in nature, in health, in school discipline, in civic and national life, and particularly in the last two years the absorbing interests connected with the war.

The interest in safety on the part of children has probably a larger dramatic and emotional element than in the case of grown up people. We older people have many interests, such as politics, religion, art, the exigencies of making a living, that scarcely affect the child's consciousness. In our own experience life becomes so complicated by other more subtle dangers that physical danger has lost much of its poignancy. In the case of the child, however, the presence of physical danger is the cause of vivid reactions arising both out of his intuitional background and out of his reasoning.

May I, for the sake of knocking him down, erect an adversary who shall say, "The desire for safety is an ignoble motive. The very flower and savor of life is adventure. To the extent that Safety cuts adventure out of life, life becomes insipid, life is reduced to a dull monotony of material well being but of spiritual poverty."

I respect my adversary for his fine tolerance of what is merely negative; I am sorry that he has failed to see that Safety has its positive side as well as its negative side.

The confusion comes from the fact that Safety is a two-sided idea. But, like most people with two faces, it presents only one to the public. The two faces are "Safety from" and "Safety for." It is only the former idea that you are thoroughly familiar with.

Safety gets its meaning solely from the fact that life has a value. Safety has had its greatest development where life has had its greatest value. I have never known, for instance, that the safety movement has developed in India, where life is not highly valued.

If we admit that Safety has this double aspect, then we recognize that the safety movement is not a process of deprivation, but a process of substitution. It does not deprive life of adventure, but it substitutes a worthy adventure for a mean adventure.

There is no real adventure in carelessly losing one's life under car wheels or in the gears of a machine. It is a worthy adventure to lose one's life on a battlefield in France or in piloting a way through the air across the ocean.

Life is essentially the great adventure and must continue to be so, if it is to be of any spiritual value. Safety is only a method of seeing that everybody gets his chance at a real adventure.

If this is the real mission of Safety, there can be no doubt that it is a proper subject for school instruction. May I, on this natal day of our national consciousness remind you that freedom, that liberty—those words that have kindled a hotter, more sacred fire in the hearts of men than any other words are of the same kind of safety. Freedom *from* tyranny implies freedom *for* the pursuit of a happy life.

It cannot be given all of us to fight for Freedom, but the fight for Safety, the fight for the real adventure, the fight for a life that shall be the measure of a purpose instead of the marred result of purposeless chance, is within the right of us all; it should be particularly within the right of every pupil in the public schools.

298

Frontispiece to 2307

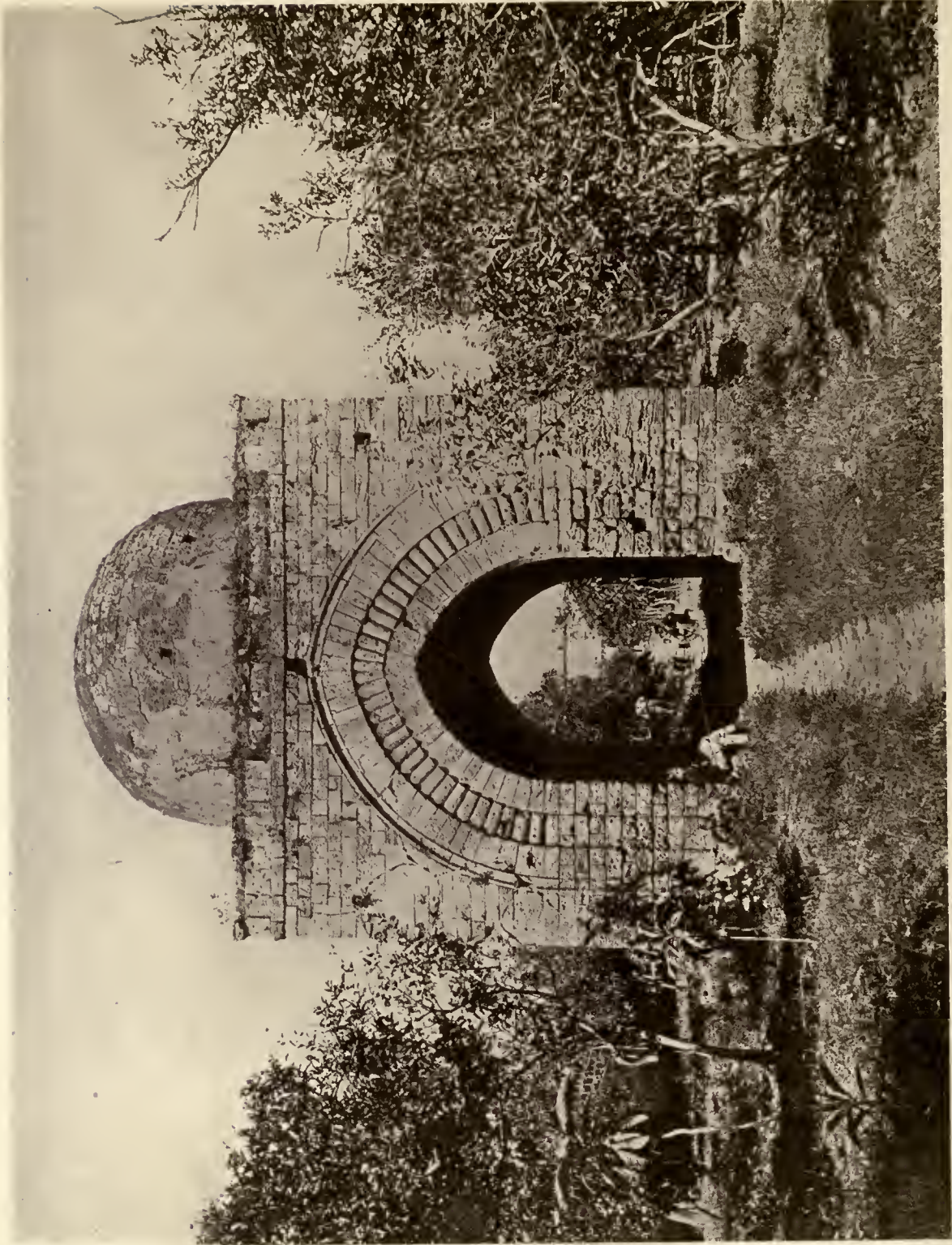

LA CUBOLA, PALERMO



# THE AMERICAN ARCHITECT

VOL. CXVII

WEDNESDAY, MARCH 10, 1920

NUMBER 2307

## The Architect and the Post-War Committee

By GLENN BROWN, F.A.I.A.

WHEN a patient shows evidence of a collapse we see hurried and excited conferences of the family and friends. Doctors are hastily called in with their assistants and nurses. There is a spirit of nerve tension and eagerness for all to lend a helping hand. In reading the last proceedings, it would appear that the family of the Institute felt that the head of the house was suffering with a serious malady, the cause unknown.

They have called in a large staff of doctors, in the Post-War Committee, to diagnose the patient from head to heel, with X-rays of his circulation and digestive organs, with the hope of diagnosing some unknown disease with which they agree the patient is bedridden.

The case must be serious as they have taken from the household reserve fund ten thousand dollars for hospital expenses, and to secure the services of efficient nurses and doctors. The patient has been isolated and removed far from home for special treatment.

This is all the more startling when we are informed that the family is very poor, only eight architects out of a hundred being called on to pay an income tax. We are impressed with this condition when we remember that the doctors and nurses represented by the secretarial and editorial staff cost for ten years only ten thousand annually, when more than 50 per cent. of the architects would have paid under the present laws an income tax. While we appreciate the fact that it costs more to bolster up and cure the sick than it does to keep a well man in fit condition, the great cost emphasizes the dangerous character of the malady. The Post-War Committee, the doctors, lacking confidence in their power to diagnose the disease, are calling loudly to their assistance the architect, building craftsman and layman. The hope is expressed that by this diversity of opinion, assorted, added and divided by the number of opinions received, a happy mean will be reached which will clearly show the character of the illness and result in the recovery of the patient.

My long experience, I feel, justifies me in examining the case as presented by the Post-War Committee, making a diagnosis and suggesting methods of treatment.

In their statement of progress for a year the Committee outlines their efforts. They have called to their assistance all the architectural societies of the world. They have sent out circulars and questionnaires to individuals and received suggestions. They have called to their aid the builders, the engineers and the laymen, as they doubt their own ability to locate the trouble. They state, and by reading the proceedings we see it to be a fact, that: "The last Convention of the American Institute of Architects was almost entirely devoted to a discussion \* \* \* of the several subjects under which the Post-War Committee divided its program." The Committee, it appears to me, are acting unwisely in calling for help so loudly to outsiders before formulating a treatment and reaching a conclusion. It may even be that some of the outsiders called in may be callous and willing for the patient to die. The Committee publishes their preliminary conclusions, with comments by the editor of the Journal and at one time Secretary of the Executive Committee.

Their tentative conclusions were: "The Institute should do less and less toward dealing with the business activities of the profession and more toward the foundation of guiding principles which are universal to the profession."

This means going back to early Constitutions of the organization and depending more on the honor, dignity and justice of the individual architect than to many rules and regulations.

This pride in the honor of the architect, a cherished and sacred thing, guiding individuals and societies to the Golden Rule, was weakened by the guidance of rules to govern the relations between the architects themselves and between the architect and the client.

One case out of many that might be mentioned will illustrate the effect of such methods. D. H.

## THE AMERICAN ARCHITECT

Burnham, as I recollect the instance, had a corporation as a client, the management of which wished him to undertake a large piece of work because they had knowledge of his capacity and were assured of satisfactory service. As often occurs, others, with a friend on the board, wished to secure the job. The management to save trouble authorized a semi-competition. Now Burnham felt that this interference was illegitimate, and determined he would enter the competition, although from his interpretation of the rules of the Institute he was barred as a member. He took the straightforward course and resigned.

Burnham had an international reputation based on the great buildings he had erected; the great work he had accomplished at the Chicago Exposition and his breadth, force and capacity in the broad principles of design shown in great city plans. Few surpassed him in his unstinting efforts for the public good. Past President of the Society, organizer with McKim and others, and patron of the American Academy in Rome, his power and force were lost to the organization. The strangest feature of the case was divulged when the Investigating Committee reported that Burnham had misinterpreted the rules and had a perfect right under the regulations to act as he did. The decision was too late, as he felt no further interest in a society bound down by rules that were not even understandable.

I feel that the Post-War Committee would be justified in recommending the abrogation of many of the rules which have been added from time to time, becoming more and more entangled as they piled up; and in the simplification of the ones which remained, and in suggesting that the time of the Conventions be not devoted as they have so often been to endless discussions on the wording and meaning of detrimental rules. The time of the Conventions should be given to objects that are of the greatest practical public service and this in the end will redound to the benefit of the profession.

The other conclusions of the Committee all have a bearing upon the changes they think fundamental in the rules.

The first considers State societies and their freedom from Institute control. The Committee takes up the matter of State societies affiliated with the Institute as if it were a new question, when in fact it has been advocated and encouraged by the national body almost from its organization. And it has been tried by two States which have more than one chapter, and is in effect in twenty-one chapters whose territory of influence is bounded by State lines. It appears that by use of these State societies which are already in existence we might secure the most effective expansion. Have these State societies, whether chapters or a combination of chap-

ters, failed in their purpose? And if so, why? I believe a careful investigation will find that it has been due largely to the rules and regulations by which they have been bound hand and foot. The earlier form of organization which allowed latitude in such societies appears to have been better. The old form was of sufficient elasticity to allow the young and inexperienced, the old and unqualified, the young draftsman and craftsman, and the layman interested in building to be members; and at the same time took in consideration local conditions, which we must acknowledge are not the same in all parts of the United States.

One of the fundamental errors of the Institute was made when it attempted to drive every member of the chapter, whether it had local or State territory, into the Institute, and bind its members with more rules and regulations, at the same time letting down the bars of Institute qualifications and driving from State organizations useful and in many cases efficient men, whom even the greatest latitude would not cover, into the national body.

Why this determined effort to lower the standards of the national body and disrupt the efficiency of the local organization? It was done to get more dues, so as to pay larger salaries and give increased traveling expenses for the officers of the Institute and the Journal.

The old way of chapters, having a membership from which it was their pride to see members advance as they became eligible to the Institute, was the better way. The pure metal in this way was brought to the top in the melting pot and made useful to the public. The practical plan would be to modify the rules for State societies or chapters, possibly making them even more liberal than they formerly were.

The next change recommended, "establishing definite permanent affiliations between all national organizations in the building industry."

Such affiliations may be advantageous or destructive. Advantageous if we secure their affiliation for useful ends, the good of the public; destructive if the affiliation is used, and there is always a tendency in that direction, for our or the affiliated society's personal advantage.

The third conclusion of "permanent relationship, with technical bodies \* \* \* a permanent league of vocations."

If such "affiliation" or "relationship" bound us to accept and abide by regulations promulgated by bodies often diametrically opposed to our aims and ideals it would be binding us hand and foot, without a moral right to resist. It would be surrendering ourselves to a supercontrol, as the League of Nations without reservations would have surrendered our country. If we cannot organize our own associa-

## THE AMERICAN ARCHITECT

tion on a sound, practical basis, do we not show our weakness when we call in others to show us the way? Are we not running the great risk of being destroyed in the process? There are several professions, like the engineers and the constructors, the new name we see applied to the builders and contractors, which have already begun the absorption of the architect; and are ready and willing, much I believe to the public detriment, to complete the process. If these "affiliations" and "relationships" are for the purpose of getting all we can for ourselves, "the public be damned," which, judging from their action, is the sole purpose of the various labor organizations, then we had better cease to exist as a profession. If these combinations are for the purpose of gaining strength for the public service in forwarding the fine arts, let us have the combinations.

If it is for educating the people in knowledge that the architect from his education and experience is the best man to plan, the best for securing grouping and arrangement for economy of space, the best for a combination of material for structural efficiency and harmony of proportion, best for design in combining buildings and landscape which add to the pleasure and culture of the community, the best to decorate the interior, to give charm and dignity to home life, and the best to obtain economical and efficient business management—if this is the intention let us have these combinations, but before binding ourselves to them let's be sure of our reservations against entangling alliances which may be our destruction and a loss to the public of our useful service.

The next conclusion is on our registration laws.

A topic ever occurring in the history of the Institute for the past forty years, based on protecting the public against unsafe and unhealthy structures. Such laws add little to the standard of the architect, although important for the public. As all who have striven and worked over these laws as I have know, they cannot prevent the jerry builder, the constructor, or the owner building his house. It should not prevent capable structural engineers and construction companies who can build safely and well. It cannot prevent vulgar and meretricious designs from marring the city streets and country landscape.

There seems no way after years of trial to make a citizen employ an architect, as I fear these laws were intended to do, simply for the reason that his structure should add to the attractiveness and credit of his neighborhood. For this reason I believe license laws giving any one the legal right to erect a structure should not be confined to an architect, but to any one who can prove his ability to construct safely and sanely. Now here is where we might use

the word constructor, be he architect, engineer, construction company or builder.

There are many grades of safe constructors.

1. Small buildings, wood, brick and stone, which include 75 per cent. of the work.

2. Reinforced concrete, skeleton steel; which covers a large percentage of business and apartment structures.

3. Massive structures that require great arches or great trusses, elaborate foundations, important but limited in number.

One man might be very capable in 1 and thoroughly unfit to undertake work in 2 and 3. Another might be capable in 2 and not be able to undertake 3, which would require the highest type of skill. To best protect the public the licenses should be for constructors in grades one, two and three. One man would be licensed to undertake a certain class of buildings, another certain other classes and so on as he had shown himself capable by an examination proving his fitness. The most capable man might be licensed for all grades. In this way the public would be assured of securing men capable from a structural standpoint of getting safe buildings. The young and inexperienced could start with the lower grade and advance as their knowledge and experience increased. The architect with the constructor's license would show the public that he could build safely. He should as he has done in previous generations prove that he can give them more than safe construction, that he can give them something that will be attractive to the stranger by enhancing the beauty of the exterior and its surroundings, a joy to his household and intimates by the charm of his interiors, both adding to money value of his property.

Again, we see a conclusion reached that might well have been passed twenty-five or thirty years ago in the statement in effect "we must have competitions for Federal and municipal buildings, but it is not advisable in the case of private owners. We consider the difficulties of the young man, but he must get his work in some other way. We deprecate offering sketch plans without remuneration." As we have had competitions certainly since the times of the Renaissance, I believe we will have them in some form or other until men as well as Nature cease to strive for the highest results. Although we deprecate them they are not an unmixed evil. An argument that appeals to many is that it gives the young man a chance—an argument which I believe would hardly be justified by facts. In looking back I can recall very few instances where the young man has secured his award by competition. The majority of competitions have been won by well equipped offices with men capable

## THE AMERICAN ARCHITECT

of planning, designing and make attractive water color drawings. The few that I know who have won out on competitions are men I believe who would have come to the front without competition.

But competitions have been the means of enthusing draftsmen and architects, a means of study and education, from the lowest to the highest in the office, in this way benefiting hundreds in addition to the one who won the commission.

Architecture is not the only profession which puts its best into the sporting effort to secure something big and great, with the prospect of receiving no pecuniary remuneration if he loses. The lawyer with his fee contingent upon winning his case; again, expending his efforts to protect the weak from the strong. The preacher giving his life to the poor and the slums. The physician expending every fibre of his brain and nerves in fighting to save life—money or no money.

We will continue to have Federal and municipal and corporation competitions because of the divided interests of the client. The architect must use his best endeavors to see that they are conducted so that the combination of a capable man and the best plan and design wins.

The young man, as he has always done in the history of the world if he has the proper business capacity, talent and energy, will come to the front; only a small percentage can reach the top, but a large majority will reach midway the ladder.

The Post-War Committee appointed sub-committees on three phases of architectural education, the use of the architect's office in continuing the instruction and education in elementary schools. On the general subject I want to say a word.

The architects throughout the country might well enter into the elementary educational scheme by giving talks to the high schools throughout the country, letting the young people know something about buildings and something about architects. We might induce the technical high schools to introduce a course of mechanical and free-hand drawing for those who wish to study architecture, so they will be familiar while young with the manipulation of drawing instruments, pencil and brush. Education has been under consideration of the Institute for the past fifty years, studied by committees, conventions and individuals. It took part in the foundation

of our early schools and has offered suggestions, many of which have been followed from that time. Personally I believe in broad culture for the architect, an equivalent to an A.B., in addition to his strictly architectural training. This, preferably taken in the school in connection with his architectural work. I believe strongly in the atelier system, under the control of a practicing architect, as exemplified in the atelier system inaugurated some years ago in Columbia University, New York, with McKim in charge of one, Hastings in charge of another and Van Pelt, I think, in charge of a third. In these ateliers we had enthusiasm, ambition, guided by the practicing architect, which I believe has not been equaled before or since.

I believe thoroughly in the boys working during the Summer in architects' offices and in the architect giving them practical problems other than tracing and drudgery. They should be taught materials and their strength and how to calculate strains and stresses. They should be made familiar with specifications and business methods. Architects in practice might well give their time to lectures before classes on the practical side of architecture. The more intimate the practicing architect becomes with the boy in the school the better for both.

The good results of personal contact are clearly shown in the men who came under the influence, first, of R. M. Hunt, like George B. Post, William R. Ware and Henry Van Brunt; second, of H. H. Richardson, with men like Charles F. McKim, Stanford White, T. W. Clark, Shepley, Rutan and Coolidge. So many were uplifted, encouraged and impressed with the highest ideals for the profession by that charming and remarkable man, William R. Ware, that I cannot attempt to name them.

To have had the merest contact with the hypnotist, Charles F. McKim, or the enthusiastic idealist, Stanford White, was an inspiration leading to higher ideals and better work. It is interesting to remember some of the men at present in practice who came under their influence, among many others Cass Gilbert, Carrere and Hastings, W. A. Boring, Henry Bacon, York and Sawyer, Trowbridge and Livingstone, Lord and Hewlett.

In the next article I propose to suggest modifications of the Institute organization which I think would be beneficial.

# Specification Clauses

By FRANCIS W. GRANT

## V—PAYMENTS

**P**ARTIAL payments shall be made to the contractor on or before the tenth day of each month during the progress of the work in amounts equal to 90 per cent of the value of the work and material actually performed and fixed in place during the preceding month, measured by the contract sum, as ascertained, computed and determined by the architect; subject to conditions named elsewhere herein relative to schedule of prices, liens, shop drawings and default of contractor:

The final payment shall be made only upon the written certificate of the architect that the structure and all appurtenances thereto are complete in accordance with the terms of this contract, and upon a satisfactory showing being made that all bills and claims of whatsoever nature incident to the performance of the contract have been fully paid; and that no lien attaches to or is obtainable against the premises. The final payment shall include the sums retained from the partial payments.

It is agreed that no payment except the final payment shall constitute or imply the acceptance of any portion of the work or material.

It is further agreed that the first partial payment hereunder shall not be due or payable, even though a certificate shall have been rendered therefor, until the contractor shall have negotiated and delivered to the architect a satisfactory surety bond as elsewhere herein provided.

Partial payments may be made (a) at stated periods of time and based upon the value of the work found by the architect to have been accomplished; (b) at times when the work shall have reached certain specified stages of advancement based upon the architect's computations as before; or (c) in stated sums at predetermined stages of advancement.

The former of these methods and the one contemplated by the above suggested clause is most generally adopted and is recommended as being most convenient and equitable.

The theory advanced for making the partial payments coincide with certain stages of the work instead of periodically is that it tends to expedite the work. As a matter of fact, however, the method of paying periodically in sums regulated by the diligence displayed by the contractor during comparatively brief periods of time tends far more to stimulate regular and continuous progress and besides has the merit above other methods of enabling the contractor to make and keep definite engagements with his creditors, whereas under either of the fixed-stage methods of payments some trifling circumstance, such as the non-delivery of a single column, may disarrange all the contractor's calcula-

tions and perhaps cast unfair reflections on his credit, and all this without compensating advantage accruing to the owner.

A further objection to the "fixed payment at fixed stage" method of making payments is the difficulty of accurately defining the several stages. A clause stating that a certain fixed amount shall be due when the walls have reached the level required for setting the first-story beams, for instance, is capable of widely differing interpretations as to what should be included. It might and it might not be ruled to include all areas, non-bearing basement partitions, underground pipes, etc.

Still another criticism applying to either of the two fixed-stage methods is that under these methods architects are very liable to expose their ignorance by fixing impracticable stages, and stages that compel an illogical sequence of operations.

It is sometimes provided that in addition to the placing of material and the performance of labor the contractor shall pay for the same before being entitled to partial payments. This could be accomplished by merely adding the words "and paid for" after the words "fixed in place" in the first paragraph of the clause above submitted. This procedure is not recommended, however, as it unnecessarily limits and defines the contractor's operations. His bond should be of such reliability as to satisfy the doubts that the showing of receipted bills is intended to overcome.

Whatever method of payment is specified must be literally observed in all its details throughout the life of the contract and never deviated from without the formal execution of supplemental contracts and the consent thereto of the sureties in each such instance if the contract is to be preserved in full force and effect. Informal changes in the method of payment are dangerous to the integrity of the contract. In some States, particularly in New York, a deviation from the exact terms of the contract as to payments renders liens for material and labor valid under circumstances which, had the terms of the contract been observed, would have been invalid.

Material merely delivered at the site and not actually incorporated in the building should under no circumstances be included in partial payments. Sometimes a concession is made in this matter out of consideration for the hardship endured by the contractor in having to wait on progress of other parts of the work while expensive material especially fabricated for a certain use has to lie idle.

## THE AMERICAN ARCHITECT

It would be safer under such circumstances to treat the idle material as collateral for a loan to the contractor (if the material is his and paid for), but safer still and more business-like to let the contractor finance his own affairs unaided by the owner.

The percentage retained from partial payments should not be excessive. Ten per cent about represents the contractor's anticipated profits and is sufficient to cover probable error in computation of partial payments. It is as much as should be retained unless it be decided to dispense with a surety bond securing the faithful performance of the contract, in which event it might be well to make no partial payments at all.

In the case of large contracts, covering a considerable period of time in their performance, the sum retained from partial payments becomes so large as to constitute an expensive burden. An intelligent contractor will of course foresee this and include the expense for interest in his proposal, thereby placing the burden on the owner, where by right it belongs. Writers on this subject in recent periodical literature have suggested that contracts provide for some means of reducing the retained sum by a sliding scale as the time for completion approaches, or for payments in full for the value of work performed monthly after the sum retained aggregates a fund sufficient to serve its purpose.

For the benefit of those who see merit in diminishing the retained sum, the following is submitted as a suitable substitution for the first part of the paragraph under this caption:

Partial payments based upon the work performed and material actually incorporated in the building up to the last day of each calendar month, measured by the contract sum, as ascertained, computed and determined by the architect, shall be made to the contractor on or before the fifth day of the next succeeding month, subject to conditions named elsewhere in this specification relative to schedule of prices, liens, samples, shop drawings and default, it being agreed that a sum equal to 10 per cent of the value of the work performed and material installed as so determined shall be deducted from the amount found due on each such partial payment period until the sum of such deductions shall equal 5 per cent of the entire contract sum. The sums retained from partial payments as herein provided shall not be deemed due and payable until completion of the contract.

It is commonly specified that partial payments shall be a certain major percentage of the value of the work performed at named periods of time. Literal observance of this method of computing the amounts due the contractor is liable, however, to result in over-payment. If the contractor bids a sum considerably less than actual cost and thereafter binds himself to performance for that sum he must give the owner the building for less than it is worth and his partial payments should be based

on values less than actual in the same ratio. The words "measured by the contract sum" are used in the above suggested clause to cover this point.

It is entirely appropriate and proper to treat the subject of payments in the specifications, but their mention in more than one place in the specifications should be avoided. If a separate formal contract is used the subject of payments should be incorporated therein and not in the specifications, thus lessening the chance for error and contradiction; in such event, however, a copy of the proposed contract form should be bound with the specifications when given out to bidders that they may be fully conversant with the terms to be imposed.

The writer has recommended in other articles on this same general subject that all the several documents preceding execution of a contract be prepared on the assumption that no separate formal contract form is to be employed. Under such method of procedure the proposal and its acceptance takes care of the contract sum in gross, and the specifications gives all necessary detail as to payments.

The architect should not so write his specifications as to constitute himself an arbitrator of business relations between the contractor and his subcontractors. The owner should be placed in a position of security against unpaid claims of subcontractors by a surety bond and a financially responsible general contractor, and the architect should, under no circumstances, meddle in the business relations of the contractor and his subcontractors and material men by furnishing data, dictating payments, selecting workmen or otherwise, for by such course he burdens himself with responsibilities altogether without necessity. Such responsibilities are of a character difficult for most architects to handle creditably and to arbitrarily assume them is deemed by the writer inequitable to the general contractor.

The uniform documents of the American Institute of Architects propose just the opposite of this course. These even go so far as to provide that the architect shall furnish to the subcontractor on request information as to the amount included for work performed by the subcontractor in the partial payment certificates issued the general contractor. It is then further provided that this sum shall be paid by the contractor to the subcontractor promptly when due, stating at the same time when it shall be deemed due. Solicitude for the poor, helpless subcontractor does not end with this, for the Code then stipulates that this payment shall be made at that time even though the payment to the general contractor himself due at the same time is not paid.

Since mechanics' liens cannot attach public property, that portion of the payment clause providing

for the withholding of payments pending the discharge of liens should be omitted from specifications for public buildings

The statutory time within which liens may attach after completion of a building varies in the different States, but is generally from sixty to ninety days. If the final payment be withheld until the expiration of such lien limit period to safeguard against liens it would work hardship on contractors in many instances. It would in any event entail an expense for interest on the money thus made idle, which would naturally be included in bids and resulting contracts. If the final payment be not withheld during that period a very careful investigation must be made by the architect into the matter of possible unpaid claims at the time of final settlement.

Liens or lienable claims overlooked at the time of final settlement with the contractor generally involve vexatious legal procedure to clear title. The surety on the contractor's bond is of course liable if everything has been regular, but small irregularities are sufficient many times to discharge sureties from responsibility. The architect is cautioned in particular not to overlook the fact that if the contract requires that the contractor shall make a satisfactory showing that everything is paid for and no such showing was demanded, the surety can present the best of evidence of irregularity and probably escape liability, leaving the contractor's personal assets as sole recourse.

An excellent practice is to demand of the contractor an affidavit that all claims are paid, taking this is a "satisfactory showing" under the contract. Overlooked claims constitute a cause for criminal action instead of civil if the contractor gives such an affidavit. Following is a form for such affidavit that has proved excellent in practice:

\* AFFIDAVIT

State of..... )  
 County of ..... )ss.

....., being duly sworn, on oath says, that he is the identical ..... under whose contract was ..... (constructed, altered or repaired).....at.....(give location) ..... for .....(give name of owner) ..... under the direction and supervision of ..... (give name of architect) .....; that all of the bills of every kind in connection with the said contract have been paid in full; that this affiant has been paid in full; that the contract has been in every manner completed, and nothing remains to be done in regard thereto.

This affidavit is made for the benefit of the owner, and the sureties on the bond of this affiant, and all others concerned.

Subscribed and sworn to before me this..... day of .....19...

.....  
 Notary Public in and for the State  
 of .....  
 residing at .....

To withhold a payment when due is an exceedingly dangerous proceeding. In the absence of some contract provision written in correct contemplation of delayed payments, the contractor may, if he so elect, treat the contract as abrogated the same day that a payment properly due is refused, and his sureties will also be released. Or the contractor may, in the case of payments specified to be made upon completion of specific portions of the work, without invalidating his contract, refuse to proceed beyond such point of completion until the payment earned has been paid. The withholding of payments for mere disciplinary effect is unbusinesslike and dangerous for the reasons set forth.

The following paragraph may be added to the payment clause to guard against abrogation of the contract in case of delayed payment:

Omission or failure on the part of the owner to make any partial payment or payments at the time due as hereinabove provided shall not be held or deemed to vitiate, abrogate or void this contract, but in such event the contractor shall be entitled to interest on any such deferred payments at the rate of 10 per cent per annum for the time that the same shall remain unpaid after becoming due.

"On or before" a certain day of the month, as expressed in the suggested clause accompanying this article, is deemed preferable to "on or about" as expressed in the A. I. A. Standard Documents. The contractor is entitled to something absolutely definite on this very important matter.

The form in which certificates should issue for partial and final payments deserves the most careful consideration. In this connection attention is invited to the fact that the term "estimates" so frequently employed in referring to these documents is a misnomer. They are certificates based upon estimates: the architect's determination of an exact sum deduced from estimates and approximations of his own or perhaps of the contractor.

The certificate should be expressed in unequivocal language, as brief as possible, and never issued in duplicate. It should bear such summary or statement of account as will render it complete in itself, obviating all necessity for reference to previous certificates or to account books, by the contractor to whom it is issued or the owner on whom it is drawn, in arriving at a full understanding of the financial status of the contract at the time of its issue.

Extras and deductions should be treated, in the issuance of certificates for partial payments, as merged in the original contract and subject to all its terms as to partial payment and sums retained unless in their negotiations supplemental agreement to the contrary is specifically entered into in writing. Certificates in form and size resembling bank checks are most convenient and appropriate.

# Art After the War

**E**VEN while the guns were demolishing villages and churning the land, men within the very sound of those guns were at work building. The whole countryside might be stricken as if with pestilence, but wherever military necessity demanded there ran through that worse than desert roads which men built under shell fire and then kept in repair. One of the inevitable results of war, visible even while war rages and inescapable as soon as war subsides, is this process of reconstruction.

After such a war as this, which is not yet technically at an end, the need of reconstruction extends beyond the region that shell fire could reach. In an interesting discussion of "Art After the War," a writer in the editorial pages of the *Outlook* states that those roads of France were symbols of men's minds. No one can read the literature produced in the trenches without realizing that just as men were busy reconstructing the highways across the devastated land, so men were busy building in their minds new paths for their thoughts to take the place of paths that had been obliterated by their war experiences. And just as the end of the war has released energy for the reconstruction of material things destroyed or displaced, so the end of the war has offered a new opportunity for the reconstruction of men's minds.

This which seems commonplace enough, and so obvious as scarcely to bear the saying of it, is, like many other obvious things, likely to be overlooked by those who are nearest to it and ought to see it most clearly. The age of reconstruction is distinctively the age of the artist. Primarily the artist is a builder, a creator. Whether the material he handles be pigment or clay or brick or imponderable sound, what he builds is ideas.

Indeed, there is nothing to-day so essential to the world as its art. Even the prophet and teacher of religion cannot avail unless he either has in him the creative power of the artist or can enlist that creative power in the service of the ideas he promulgates. The educator must be an artist, otherwise he will be simply a hearer of lessons or the keeper of a place of detention. The political leader must exercise the function of the artist if he would create new forms of law or of political action to meet the new situation. Whoever, in fact, is to have any creative part in reconstructing what the war has injured or replacing with something better what the war has destroyed, will succeed only to the degree to which he follows the laws and principles which it is the business of the artist to discover and in his product to reveal.

There still lurks in the minds of many Americans, undoubtedly, the idea that an artist is a sort of super-entertainer, and that art is a form of restful amusement. Pictures, from this point of view, exist to provide relaxation for the tired business man who has the money to buy them; music is a counter-irritant to the cares and worries of the day or a soporific for soothing overstimulated nerves. According to this view, there is no important distinction between good and bad art. If it amuses, relaxes, stimulates, or otherwise entertains and refreshes people, it is sufficiently good for its purpose.

There lurks, too, in the minds of many people who regard themselves as artists the idea that art is primarily for the self-satisfaction of the artist; that it is good to the degree that it expresses the emotion which the artist wants to express. Pictures, from this point of view, are but projections of whatever is in the soul or mind or nerves of the person who paints them. Music is the audible cry of the composer's spirit, whatever it may be. This idea of art ignores the interests of the tired business man, just as the business man's idea of art ignores the yearnings of the artist; but the two ideas have this in common—that the good or bad in art is a matter of comparative indifference. From neither point of view has the artist any need of a conscience or a standard.

In either of these senses art is a trivial thing. It is equally a silly luxury for the seeker of entertainment and for the person who imagines himself an artist because his emotions are too much for him. In a nation engaged in the serious business of finding order in the chaos that war has created and setting to rights the things that war has set askew, men with a sense of responsibility are rightly impatient with those who talk about art at such a time, if art is nothing more than a means of entertainment or a sort of emotional safety valve.

Art, however, is not a luxury; it is a necessity. It supplies to men the satisfaction of a craving as great as hunger or thirst. From time immemorial men have faced a world of chaos as we are facing it to-day. They have tried to think their way through the tangle, and those who have thought the most clearly they have hailed as their philosophers. They have groped their way to faith in an order underneath all this disorder, and those who have brought them the clearest light of faith they have hailed as their prophets. But men have not been satisfied, they never will be satisfied, with merely hearing about this order and beauty which



## THE AMERICAN ARCHITECT

they are convinced exists somewhere. They want that order and beauty made real to them. They want it in a form that they can live with; and those among them who have taken out of this chaos and disorder material out of which they have built forms of beauty and order and truth they have hailed as artists. Whether it be a cathedral or a

of men in its turn has discovered chaos and disorder for itself and has therefore wanted its own disproof of what it has seen in its own ugly present.

To the very extent to which America needs to rebuild her mind after the war, to that extent she needs a pattern according to which she can



ST. STEPHEN'S CHURCH, WORCESTER, MASS.

JNO. WM. DONOHUE, ARCHITECT

poem, whether it be a statue or a symphony, whatever creation of man embodies this conception of order in a way that gives lasting satisfaction to that craving for order, men have kept and cherished. And every epoch in history has supplied its own embodiment of this conception; for each generation

build. This is no time for men capable of being artists to devote their gifts to the service of the tired business man or to the indulgence of their own emotional appetite. It is the time for the artist to be what he may be—the leader of a people through the wilderness to a promised land.



ST. JOHN'S CHURCH, NORTHAMPTON, MASS.  
JNO. WM. DONOHUE, ARCHITECT



## Nationalization of Architectural Education

AS architecture is both a science and an art, the method of its teaching combines many and often very diverse things.

Education in any direction, to be successful, largely depends on the creation of interest in the mind of the student. This point was very carefully considered in an address by Paul Waterhouse before a recent meeting of the R. I. B. A. Mr. Waterhouse stated:

"However one defines education, one ultimately comes up against the word 'interest,' of which no definition is possible. The process of teaching is merely that of shortening the process of absorption by the pupil in two ways—first, by placing the facts to be absorbed within easy reach of the pupil; and, second, by stimulating his appetite for the facts."

How may this stimulation be best effected? That which will most stimulate interest, that will prepare the mind receptively to absorb and keep knowledge, will be the correct basis of all forms of education in architecture.

Architects in this country who have thoughtfully considered these important matters are in accord that there should be, and quickly, a radical revision of our present methods of technical education. They are equally in accord that the final decision as to what is best should be lodged with the men in active practice.

A basis of philosophy as far as it may be logically carried will assist in the formation of a basis of practicality. And it is such a basis we shall have to achieve before we can begin successfully to rear any fabric that will meet our rapidly changing conditions.

WHATEVER result there may be in the end reached will be by a correctly proportioned combination of both these elements, those whose

every decision is reached by philosophical deduction and those who practically view everything they do. It will not be possible to eliminate the pedagogic element from these things, but it will and should be possible to curb its preponderance in the solution of what should largely be a practical question. Educational methods in architecture should be so strengthened and enlarged as to be representative of all of our national interests. This is strongly urged by Professor Waterhouse. Such forms of education will even before graduation expansively lead the student to contemplation of the broader and higher things that he will confront when he goes forth into the world.

It has been stated that education confined to a specific course at the outset breeds a narrow comprehension of every other outlying question. If this is true, methods of education should, as Professor Waterhouse urges, be so nationalized as to broaden to the fullest extent the architectural student and lead him toward the sure path to a future success.

---

## Extending "Block Party" Methods

THE "Block Party," started among our alien population resident in East Side congested neighborhoods, has become developed by interested observers in more aristocratic circles, and, as embodying the essence of community relations, is being carried forward successfully in the "uptown districts." The latest of these organizations to attract attention by reason of its successful working is the "East Sixties Property Owners' Association," formed by a group of sixty or more property owners resident in blocks from Sixtieth to Sixty-second Streets, between Second and Third Avenues. The types of houses in these blocks, while less ornate than many of the more modern residences nearer Fifth Avenue, are, due to the fact that they are large occupied by their owners, as neat and at-

## THE AMERICAN ARCHITECT

tractive as any residential blocks in the city. It is to maintain these conditions, to repel the invasion of the speculative builder who has so often destroyed the domestic atmosphere of similar localities, that this association has been formed. The essence of success is, of course, a perfect and liberal spirit of co-operation among the members. In the present instance this seems to have been achieved. There are other objects to be obtained by the successful operation of these organizations. Co-operative buying of coal and staple food necessities, the employment of community watchmen specially to care for the safety and tidiness of the section, tree planting, and the appointment of plumbers, carpenters and other craftsmen to serve the members, are among these objects.

**A** PROPOSED improvement that will interest architects is the intention to relieve the neighborhood of its architectural monotony and to create a distinctive or different aspect to the façades of the houses. It is amazing what may be economically and artistically carried forward in this direction, by simple changing of cornice heights, painting, the introduction of iron grills and window boxes, and the well-considered alteration of entrances.

There are at least two sections in New York City where Mr. Alfred Sterner, architect, has executed a transformation from a sordid, commonplace city block to one of absolute artistic charm. There is no excuse for the further existence of the deadly monotonous row of brownstone houses. If these block organizations work toward the elimination of these unsightly things and create in their place locations of houses of attractive and artistic aspect, they will not only have accomplished a good work

to their own benefit, but have unselfishly added greatly to the satisfaction of every beholder.

### Walled Towns

**R**ALPH ADAMS CRAM is continuing the book *Habit*. His most recent work, *Walled Towns*, is written to offer a solution of the difficulties that have arisen as a result of the war. Familiarity with Mr. Cram's attitude toward his profession and his strongly developed leaning toward an ecclesiastical aspect, restrains us from the somewhat unreasoning and adverse criticism indulged by critics who only know the architect through the pages of this book.

It may not be contended that Mr. Cram does not know his facts. It is, however, highly probable that many of his architectural readers will not thoroughly agree with his deductions. When, for example, Mr. Cram describes, with much accuracy and a fine command of words, an ideal mediæval walled town, he fails, it appears, to consider the many practical disadvantages those towns experienced. And when he draws a contrast with some congested area in our large cities, it is highly probable that he may be in error in attributing the most satisfactory conditions to the walled town.

His picture of an early New England village is one to dwell in the memory. His suggestion as to how all the advantages of these earlier Arcadias may to-day be obtained may, to most of his readers, appear largely impractical.

However, the whole work is delightfully entertaining, and every architect will read it with a sense of satisfaction as further evidence of the scholarly and thoughtful attitude of men in the profession.



VENICE—FROM THE ORIGINAL PAINTING BY R. BELLOTTO  
(COURTESY OF M. KNOEDLER & CO.)



HOUSE OF GEORGE L. OSBORN, BROOKLINE, MASS.  
JAMES PURDON, ARCHITECT



310



HOUSE OF GEORGE L. OSBORN, BROOKLINE, MASS.  
JAMES PURDON, ARCHITECT





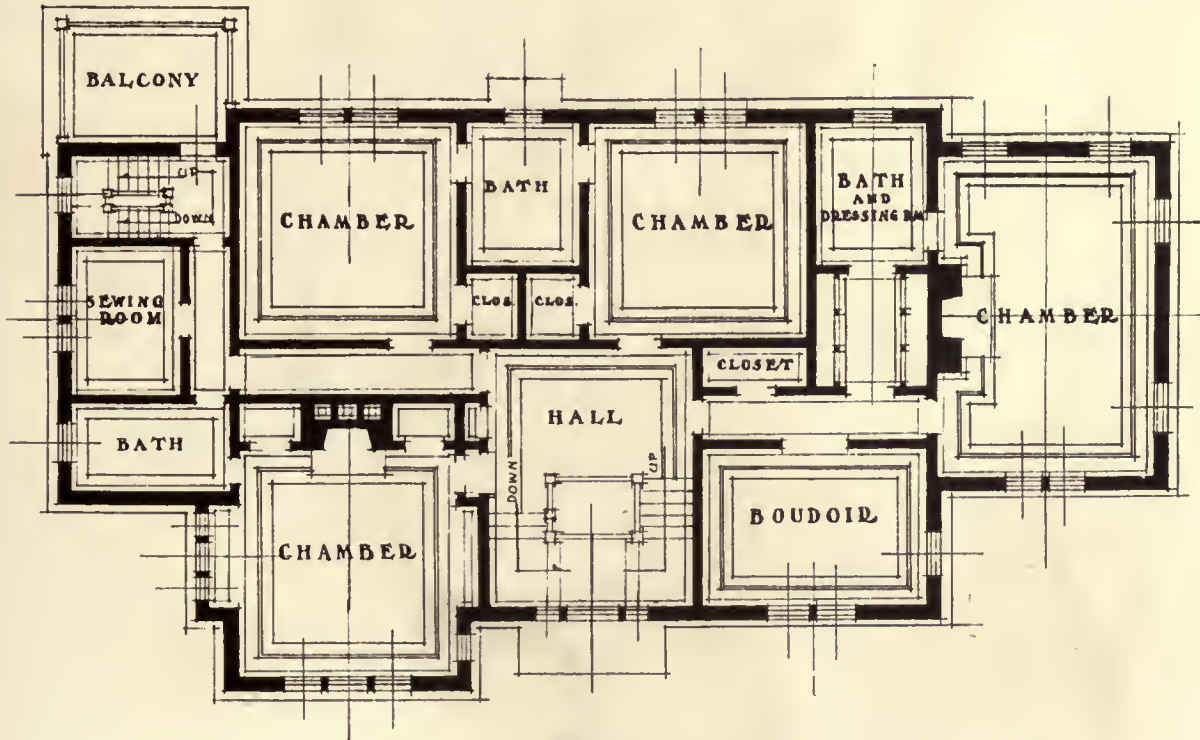
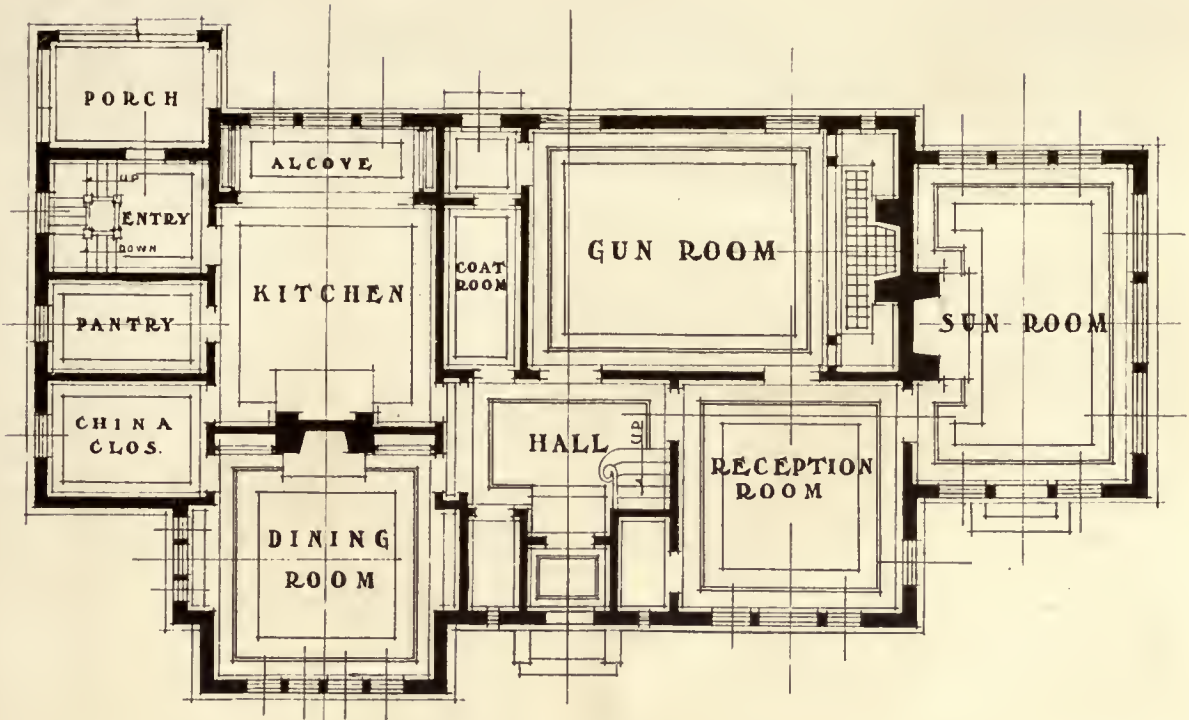

HOUSE OF GEORGE L. OSBORN, BROOKLINE, MASS.  
JAMES PURDON, ARCHITECT





HOUSE OF CHESTER S. HARDY, FITCHBURG, MASS.  
JAMES PURDON, ARCHITECT



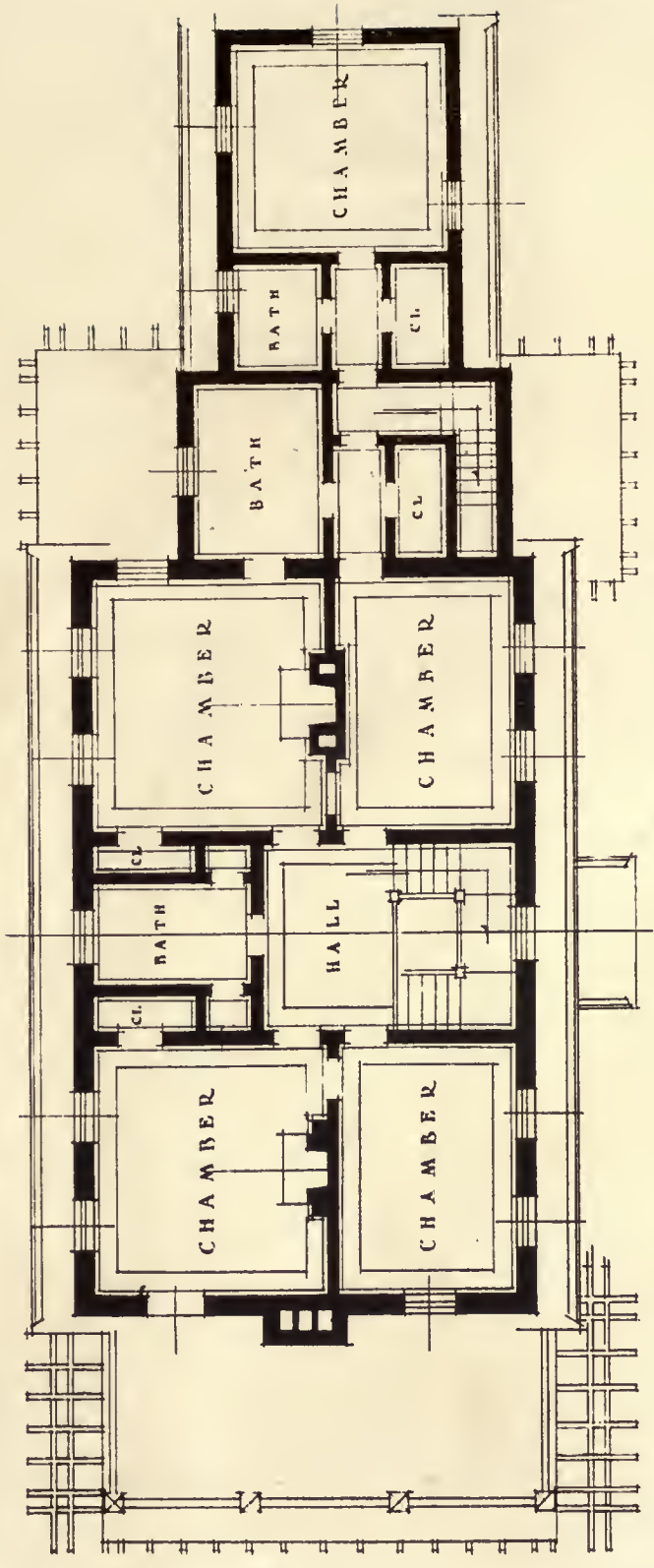
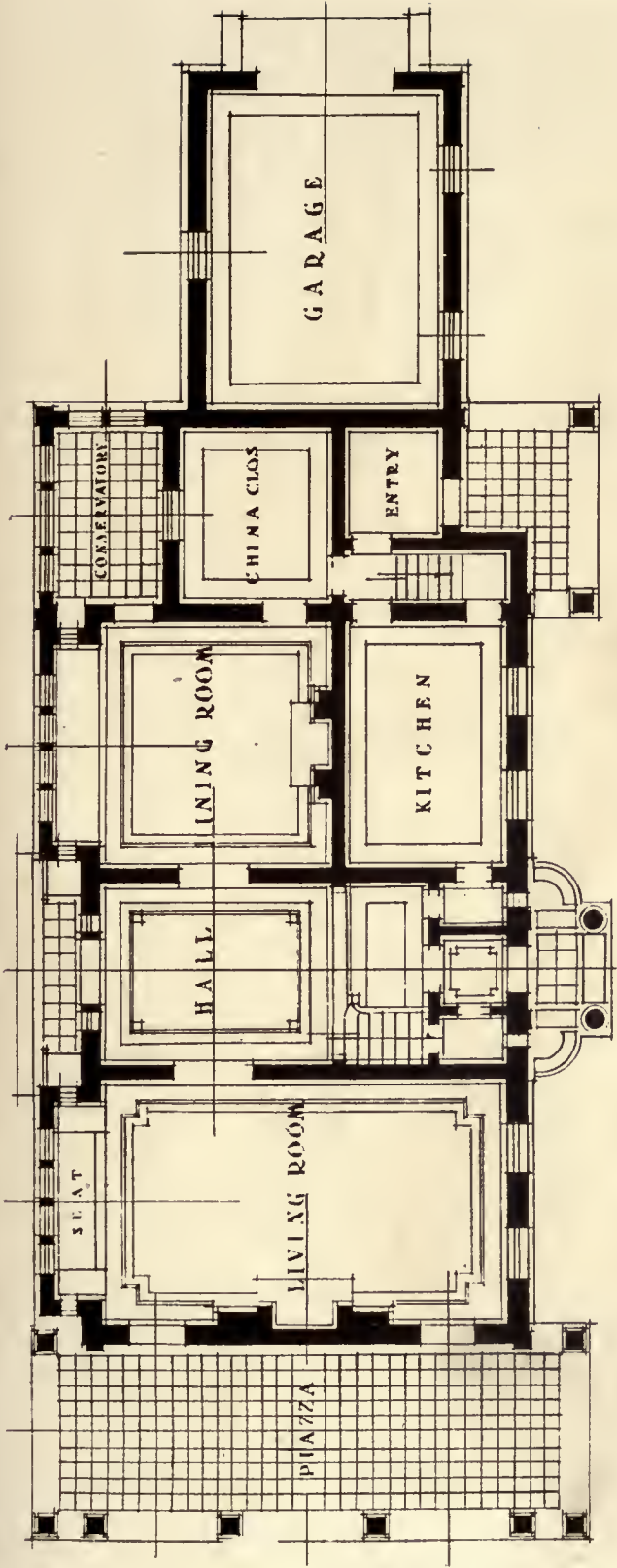

HOUSE OF C. S. HARDY, FITCHBURG, MASS.  
 JAMES PURDON, ARCHITECT



6  
310



HOUSE OF CHESTER S. HARDY, FITCHBURG, MASS.  
JAMES PURDON, ARCHITECT







HOUSE OF DR. MARTIN B. DILL, NEWTON CENTER, MASS.  
JAMES PURDON, ARCHITECT

3107





HOUSE OF DR. MARTIN B. DILL, NEWTON, MASS.  
JAMES PURDON, ARCHITECT

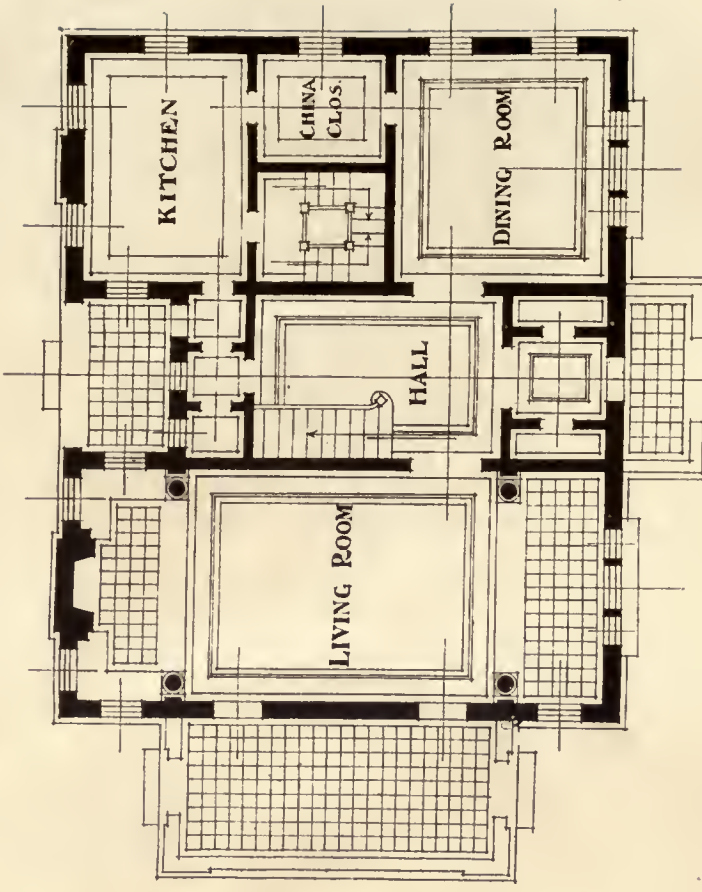
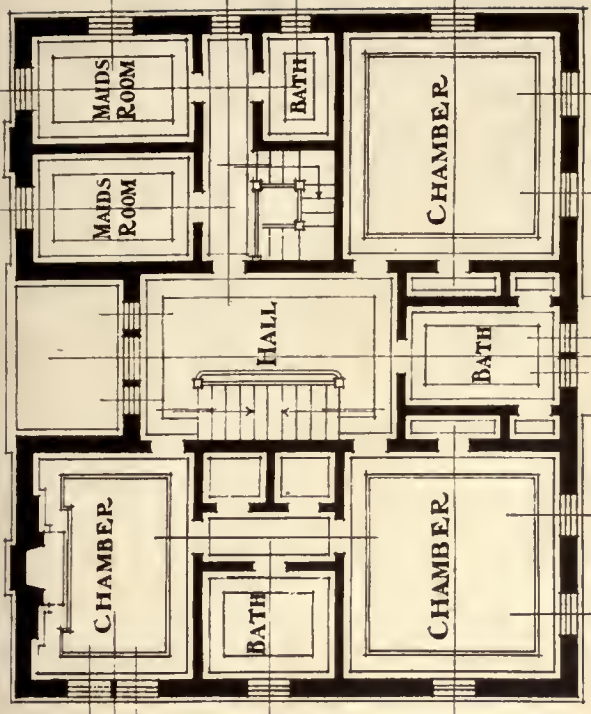

310



# Criticism and Comment

*The Editors, THE AMERICAN ARCHITECT:*

The article on Architectural Engineering by Mr. Yardley, in the Jan. 7 issue of *THE AMERICAN ARCHITECT*, has proved very interesting, and should bring to its readers among the architects a clear realization of one of the elements in the practice of the profession which needs the most careful consideration of every practicing architect. The constantly changing conditions of construction, the advance in the development of mechanical equipment, and the more complicated living and working conditions are placing before the architect of to-day problems never dreamed of by the architects of two or three generations ago.

As a profession we must either recognize these changing conditions and the corresponding responsibilities which they force upon us, and in recognizing them, meet them in an intelligent honest way, or go down before a just criticism of not being able to deliver to the public the real service which the public has a right to expect and for which we receive our compensation.

The possibilities contained in the practice of architecture must appeal differently to the various individuals practicing. To some the only appeal is in the idealistic attributes of the profession. The maintenance of a business organization and engineering departments is not only distasteful, but considered by them as unethical and therefore unprofessional.

It is, however, the overemphasis of the idealistic attributes of the profession and the belittling of the business and materialistic side that has given the public the impression, merited to a certain extent, that the architect is a dreamer, not a practical doer, and has thereby undermined the public confidence. If the architects of this country are to maintain their position as master builders, a heritage that should not be lightly given up, we must realize that as a profession we must give complete, economic service to the owner.

If the architect is to be the master mind in the development of a project of any magnitude, he must be the creative mind, the dreamer who brings into being the design, the beauty, the thing that appeals and lives in the mind of the public; he must be the analytical mind who solves the economic problems, the disposition of space, selection of materials, economy of operation, etc.; he must be the controlling factor in the engineering problems of disposition of materials, methods of construction, selection and

disposition of the mechanical features; he must administer all the financial responsibilities in a thoroughly businesslike manner. As the adviser of the owner, if the problem is one of a commercial nature, he must be able to advise on financial questions both of investment and operation. If the problem is industrial, he must be conversant with complete plant operations and efficient methods. In his own interests he must be a good salesman, not so much in selling his services to the public as in selling to his client the result of the serious honest study of the problem in hand, backed by real knowledge of the subjects involved. Without such salesmanship many a carefully studied scheme of real merit is upset by an owner's unstudied opinion and his lack of complete confidence.

The man who could embrace in himself all the foregoing qualifications would be a rare genius. Conditions indicate that the progressive office expecting to carry on a general practice cannot be a one man office, but must be an organization which is capable of rendering complete economic service to the owner. Such an organization can be worked out without the loss of the individuality which is so necessary to good work, and with a gain rather than a loss in the personal attention which it is possible to give to the client and his problem and which means so much in the way of future commissions.

In such organizations, rightly conducted, lies the hope for the young man, the future architect. The man starting in an individual practice to-day is, as soon as his practice requires engineering, faced with the necessity of either employing the services of structural, electrical, and mechanical engineers, which through lack of co-operation is often costly to the owner and disastrous to the architect; or the employment of engineering draughtsmen, which is liable to result in placing in the hands of men of comparatively little experience and immature judgment matters of great importance, involving large sums of money, and upon which the success or failure of the working out of the entire problem may depend—in the eyes of the owner. Many an architect has lost prestige through faulty ventilating systems or mechanical equipment in a building which in all other respects was almost above criticism.

Organization seems to afford the means of achieving the result desired in the surest, soundest way. By combining in one organization several architects of different temperaments and training, at least one of whom is an architectural engineer, as executive

## THE AMERICAN ARCHITECT

heads, together with engineers at the heads of engineering corps of the various branches of engineering, as well as accounting and business departments, based on modern systems, it is possible to render architectural service of the type demanded by the exigencies of the times in an efficient, honest and creditable manner. Such organizations afford a training and an opportunity to the young man which cannot be gained in small individual practice. His individuality is not lost in the larger organization, but is given a greater opportunity to become recognized. Through such organizations the architect may remain the master builder, not afraid of losing his place in the community to the big construction organizations, nor need he be afraid of not being recognized and called upon in times of public need.

By honestly performing the service generally accredited to the profession, the future is secure. If we fear to appear too practical, and handle the commissions entrusted to us in an unbusinesslike, unprogressive way, we may expect to make way for those better fitted to perform our work. If we are master builders, let the conduct of our practice be so efficient as to merit our advice being sought on all problems relating to building. Let us take our place as experts and not only as dreamers. Let us be true to our profession.

LAWRENCE S. BELLMAN,  
Mills, Rhines, Bellman & Nordhoff.  
Toledo, Ohio.

### *The Editors, THE AMERICAN ARCHITECT:*

Mr. Yardley, in *THE AMERICAN ARCHITECT* of Jan 7, brings out an article which should receive careful study by every university which teaches engineering or architecture.

Fourteen years ago the writer, while serving in the capacity of chief engineer for a structural iron concern, realized the inadequate engineering data in many architects' plans.

If this was so apparent along structural lines, which are generally conceded to be closely related to architecture, what must it be relative to the mechanical and electrical requirements of a modern building? After a thorough investigation it was evident that a so-called architectural engineer is as important in the architect's office as a general manager is to a factory. As Mr. Yardley stated, he must be a man with not only a thorough engineering knowledge, but a practical hard-headed and broad-minded business man. This is what is demanded of

a manager of a factory. He may not be an expert in any particular department. This he leaves to his department foreman, who is selected by the manager. Just so with the architectural engineer. He is not expert with the details of a heating plant, or the column connections of a 12-story building, although he naturally detects any detail which is defective. He, however, selects competent engineers just as a factory manager selects foremen, and his general engineering knowledge governs the work.

In the construction of buildings it is not necessary to take a complete course in railroad curves, or why a motor should be wound with No. 12 instead of No. 14 wire. However, a course in engineering, embracing the fundamental principles of all classes of engineering, would be far-reaching in developing an architectural engineer.

In addition, three or four years of outside superintendence would give the student the necessary practical knowledge. After that, it becomes the question of ability and continuous study of building requirements.

O. N. MUELLER,  
Vonnegut, Bohn & Mueller.

Indianapolis, Ind.

### *The Editors, THE AMERICAN ARCHITECT:*

The article of Mr. Yardley, in *THE AMERICAN ARCHITECT* of Jan. 7, proved interesting both to our engineer, Mr. E. W. Stern, and to me. Unfortunately, we are both too busy to give sufficient time to the subject to comment constructively on the matter referred to, and no other form of criticism is worth anything.

Our recent experience has clearly confirmed his view that the structural engineer should be a part of the organization of the architect's office, working together with the other designers and side by side. He should not be an individual that is called in to put the structural "guts" into a building on which the design has been completed.

As for the editorial comment on the need of special training for architectural engineers, I am inclined to think that what is needed is a larger development of the fundamentals of both engineering and architectural education. I think the engineers will have to be taught more about architecture and the architects will have to be taught more about construction.

ROBERT D. KOHN.

New York.

# Current News

## Happenings and Comment in the Fields of Architecture and the Allied Arts

### Foreign Trade Service

The first Foreign Trade Service devoting its exclusive attention to the construction industry has been organized by the National Federation of Construction Industries, and is now in active operation with general offices in the Drexel Building, Philadelphia.

The work is being carried on by the Foreign Trade Division under the direction of Dr. J. T. Duryea, President of the Pierce, Butler and Pierce Manufacturing Corporation of New York City, who is Chairman of the Federation's Foreign Trade Committee.

The list of Directors and Advisory Board of the Federation includes the names of many of the country's best known business and industrial leaders.

One of the aims of the Foreign Trade Committee is to discover where the real opportunities lie for world trade in construction materials and machinery, and to aid in determining the best means of developing them. For this purpose a special and intensive study of each branch of the industry in all parts of the world is being made, and reports are being prepared at the Federation's headquarters.

The Federation is actively co-operating with the Bureau of Foreign and Domestic Commerce at Washington, with the Chamber of Commerce of the United States, and with all Chambers of Commerce abroad and foreign Chambers of Commerce in this country. It is in touch with banks, leading export houses and shipping companies, and many other large interests both here and abroad. Through these channels, the National Federation of Construction Industries is constantly in receipt of numerous inquiries and requests for information from all parts of the world from parties interested in the purchase of American construction products or desiring to represent American construction interests abroad. These inquiries receive careful attention, and all available information regarding each is sent to members who are interested.

The Foreign Trade Committee is pushing the movement to do away with the haphazard growth of our export trade, and purposes to aid in the circularization of all information that will tend towards organization of the construction industry throughout the world on a sound economic basis and result in the interchange of construction materials, machinery and methods that natural conditions and national interests may dictate. It serves as a point of contact for many large construction interests of the United States and other countries; meets foreign visiting delegations and American business men recently returned from abroad, and obtains from them information regarding the construction industry in the fields they have just left. This information is compiled and distributed in the form of reports. The Committee aims to aid in bringing about a constantly increasing degree of co-operation between the construction interests of all parts of the world.

The Federation is at present securing figures designed to show the relative costs and time of erecting office structures and warehouses in New York City and in London. It is well known that British trade and industry are

seriously hampered for lack of proper office space and working facilities. By graphically showing at what cost American building methods may be adopted abroad, it is believed that a way may be opened to overcome this difficulty and at the same time bring about a considerable demand for the erection of American buildings and equipment.

Dr. Duryea, who was a member of the Reconstruction Supplies Committee of the International Trade Conference at Atlantic City, plans consistently to broaden the activities of the Committee and intensify the work of the Foreign Trade Division.

### Project for Making Paris Center

What is described as a project for making Paris the world's commercial center, just as it has been for centuries the artistic, literary and social center, is outlined in the *New York Herald* in an interview with M. Maurice Quentin, member of the Municipal Council from the First Arrondissement. M. Quentin says that the world market will be instituted within the next few months.

He has been one of the most persistent advocates of the idea of making Paris the center of the world's commercial transactions, and, with M. de Lavalley, a municipal councillor of the Seventh Arrondissement, has kept the matter continually before the Paris authorities. The support of numerous French producers and exporting organizations has been obtained, and, with the approval of the Municipal Council, M. Quentin believes that substantial progress can be attained and results assured which will make for a more rapid establishment of pre-war prosperity.

"We intend to commence with the development of a national market, principally for agricultural products, as France is essentially an agricultural nation," he said. "This was suggested before the war, when we found many obstacles confronting us, one of the most important being the existence of railway freight tariffs which made it cheaper to send French products direct to England than to send them to Paris for distribution. We also had to face the question of 'octroi' duties; but now these two important problems have been solved, and goods entering Paris for distribution and not for actual consumption in Paris will be subject to a refund of the 'octroi' duties.

"By reason of the peculiar divergence of French railways from Paris as a center, we shall be able to reship products from all parts of France without loss to the producer. With its present adequate commercial organizations, Paris should be able to make a strong appeal to buyers from all parts of the Continent, as well as to representatives of overseas commercial firms."

One of the first steps in the new project will be the creation of a permanent "Palais d'Agriculture," on the site of the old fortifications now being demolished at the Porte Maillot. This will consist of a series of buildings in which will be housed exhibits by leading producers of French foodstuffs, and buyers from all parts of the world, on visiting Paris, will be urged to inspect the "samples"

and to place their orders through the central marketing organization.

The original plans called for an expenditure of 20,000,000 fr., but the advance in the cost of building materials during the war will increase this outlay to nearly 60,000,000 fr., but even this outlay would be warranted, M. Quentin asserts, if France is enabled to attain the place in international commerce that the quality of her products warrants.

The idea has already been approved in the United States and it is understood that a "world market" for the benefit of American firms is to be instituted in New York next year. With the promised support of French trade generally, as well as the assured assistance of the Ministry of Commerce and the Municipal Council, it is believed that the French project will be on a substantial basis many months before the New York market.

## High Cost of Wasting Water

The Department of Water Supply of New York City has inaugurated a campaign to reduce to a minimum the enormous waste of water caused by leaking fixtures and carelessness. Hundreds of millions of gallons of water are wasted annually, all of which can be saved by a little care and attention. The department calls attention to the fact that half a million leaky fixtures are within buildings in New York City; that one hundred million gallons of water are lost every day because of leaky fixtures, and that forty thousand tons of coal are used every year to pump this wasted water.

It is incumbent on every citizen, and especially every property owner, to see that leaky faucets are repaired; that care is taken to turn off water when not in use and to stop the practice of using running water in place of ice in the summer, and of letting water run to prevent the pipes from freezing in the winter.

Wasting water is one way to increase taxes.

## Belgium Quarries During the War

Before the war the quarries of Belgium were among the largest and best equipped in all Europe, states *Stone*. Belgian marble, especially the famous "Belgian Black," has been widely used in this country, but the most important quarries were those producing granite, basalt, limestone, and cement stone. The Belgians were among the first to develop stone working machinery, and were the inventors of the wire saw. They early made use of electric power, and some of the largest plants were entirely electrified. The provinces, in the order of their importance in stone production, were Hainault, Liege, Namur, Brabant, Luxembourg and Limbourg. According to a report by M. Joseph Libert, Director-General of Mines, the value of the product of Belgian quarries dropped from more than 70,000,000 francs in 1913 to a little over 10,000,000 francs in 1917. In 1913, 34,893 workpeople were employed at quarries; this total fell to 8989 in 1915, but rose to 11,886 in the following year, to fall to 6055 in 1917.

Some of the quarries, such as those producing limestone, cement stone, paving stone and rubble, were requisitioned by the Germans and have been maintained in a productive condition. The granite quarries were practically idle, and upon their resumption is largely dependent the inception of building operations, etc. Improved transport facilities are urgently needed in this direction, many lines having been removed bodily, notably in the Condroz

and Sprimont-Poulseur districts. The reopening of the quarries in the province of Luxembourg is also dependent upon a demand for the products. The output of plastic earths in the Ardenne basin has declined greatly during the war; as machinery is not largely employed in their production, they should be working at an early date in order to supply the needs of the zinc and glass works, etc.

## Proposed Addition to New York Stock Exchange

To provide a sorely needed extension of floor space of the Stock Exchange a committee of members has acquired the Mortimer & Wilks Buildings on Wall Street, which occupy the entire frontage from Broad to New Streets. The Mortimer Building will be torn down and a twenty-story addition to the Exchange will be erected on the site at a cost of \$3,000,000.

Trowbridge & Livingstone, architects of the addition, have designed the new Building, in harmony with the Stock Exchange Building proper, with a colonnade of Corinthian columns corresponding to those on the Broad Street façade.

## Rare Works of Art Found in Unexpected Places

The recent discovery of a long-lost Raphael in an old curiosity shop in a Paris slum recalls many a story, no less dramatic, of treasure-trove in art, says *London Tit Bits*.

It is not long since a stolen canvas by Raphael of the "Holy Family" was found in the cottage of an Italian peasant, where it was serving the sordid purpose of stopping a broken window; a Correggio which had vanished from the walls of the Dresden gallery, and been lost sight of for generations, was recovered from the recesses of a Saxon hayloft; and priceless tapestries, designed by Raphael for Pope Leo X., were rescued from the hands of a Paris Jew after he had burnt two of the pieces in order to extract the gold and silver contained in their texture.

Raphael's pictures, indeed, seem to be peculiarly ill-fated. Only a few years ago his "La Belle Jardiniere" was picked up at a second hand shop in Paris for forty-four francs. His Vatican "Adam and Eve" was found flung aside in the corner of a picture dealer's shop in the Rue St. Lazare, by an artist who paid 100 francs for it, and sold it a few days later for 80,000.

For a modest fifty centimes a Parisian art amateur purchased Raphael's original design for his great picture "La Disputa del Sacramento," for which he would willingly have paid twenty thousand times as much.

More romantic still is the story of the great master's famous picture, "The Massacre of the Innocents," which recently was discovered in the cottage of a poor widow of Como. Originally owned by Cardinal Luigi d'Este, it had somehow come into the possession of a priest, who had paid the equivalent of a sovereign for it, and gave it to the Duke Alfonso d'Este more than three centuries ago. After the duke's death the canvas vanished utterly until it came so dramatically to light again in the Como cottage.

Rubens' famous masterpiece, "The Visitation," was, a few years ago, exchanged by a Paris curiosity dealer for two Louis XV. armchairs and a sixteenth century coffer.

A fortunate collector discovered among a number of canvases exhibited for sale by a secondhand dealer at



Montmartre one of Tenier's finest canvases, which he was able to purchase for thirty francs.

A portrait of Nell Gwyne by Sir Peter Lely was discovered in singular circumstances at Birmingham by a medical man. While attending a patient in a small tenement he noticed on the wall of the living room a tattered picture of the head and bust of a woman. The frame was worn eaten with age; but, despite its torn condition, the picture seemed a good one, and it was purchased by the doctor for a trifle. He took it away and ultimately sent it to be cleaned.

There was nothing on the canvas to indicate the artist's name, but the eyes of the subject bore that peculiar expression of tender languishment, blended sweetness and drowsiness attempted by no other painter than Lely.

## The Comfortable Eskimo Home

The movement to modernize the Eskimo by providing him with concrete huts in place of his picturesque snow "igloos," as suggested by an official of the United States Bureau of Fisheries, would be the death of the denizen of the icy North, in the opinion of Vilhjalmur Stefansson, the Arctic explorer. Not only is the Eskimo as devoted to his age-long habitation as the South Sea Islanders are to their traditional garb of flower garlands and fresh smiles, but he is far healthier, warmer and more comfortable in his domed mansion of snow blocks than he could be in any modern house of concrete.

The statement that the natives of the Prybiloff Islands were about to discard their snow huts for modern concrete huts, finding the gales of the Behring sea too strong for the former, upon which the story of the intended change of Eskimo habits was based, Mr. Stefansson characterized as too silly for discussion. The explorer, talking at his headquarters at the National Geographical Society Building in New York, said that the Prybiloff Islanders had never lived in snow, but in wooden, huts and that further north, where the natives do live in snow houses, it would be next to impossible to convert them to any other dwelling.

"Their igloo serves as a home for two or three weeks. Then they build a new one. Because it is new it is clean and sanitary. It is as warm and comfortable as your library. A candle gives as much illumination as three electric lights, because of the intense whiteness of the snow. The snow-house will stand under any conditions. In all, the igloo is as comfortable a home as a man could wish.

"The concrete hut, like the wooden hut, must be uncomfortable and insanitary. Wherever the natives have changed from the snow to the wooden home there has followed pneumonia and typhoid and a tremendous increase in the death rate."

## Personals

Rolland C. Buckley, architect, has established an office at 412 Essex Building, Minneapolis. Mr. Buckley, who was formerly a member of the firm of Buckley & Prins, Minneapolis, architects, spent over eighteen months in government service, being first stationed at Ft. Snelling as Director of Military Relief and later transferred to the Aviation School Bureau Camp Service. His former partner, E. Paul Prins, is now associated with the architectural firm of Brown & Fraser, 445 Security Building, Minneapolis.

Herbert Spielman, architect, formerly a member of the firm of Samuel Hannaford & Sons, Cincinnati, Ohio, announces that he has withdrawn from this organization

and is now engaged in individual practice of his profession, with offices in the Mercantile Library Building, Cincinnati. Catalogues, samples and price lists of building materials and supplies are desired..

A new firm has been established in Portland, Oregon, in the combination of Jamieson Parker, formerly with A. E. Doyle, and Folger Johnson, who before its dissolution by his entering war service was a member of the firm of Johnson & Mayer. The offices of Johnson & Parker are in the United States Bank Building, Portland.

O. L. Grimes and R. L. Jungling have opened an office for the practice of architecture and general engineering under the name of Grimes & Jungling, architects and engineers, Room 1207, Fullerton Building, St. Louis, Mo., and would like to receive catalogues and samples.

Flournoy G. Hagan has opened an office in the First National Bank Building, Paris, Ky., for the practice of architectural and structural engineering, the title of the firm to remain Wm. K. Hagan & Son. Catalogues and samples are requested.

Gordon Laidlow Smith, Cincinnati, O., recently returned from overseas service as Lieutenant of Engineers, and has opened an office for architectural practice at 341 Volunteer Building, Chattanooga, Tenn. Samples and catalogues are desired.

George R. Callis, Jr., architect, who before the war was located at 55 Knickerbocker Building, Baltimore, Md., has opened an office at 611 American Building, Baltimore. He also retains his office at Melvin avenue, Catonsville, Ind.

James E. Casale, architect, announces the removal of his office from 569 Fifth Avenue to temporary offices at 128 East Twenty-eighth Street. After May 1 Mr. Casale will be permanently located at 73 East Fifty-second Street.

Dillon, McLellan & Beadel, architects, announce that Arthur Dillon has finished his work on the Federal Division of Rehabilitation and has resumed practice at 149 Broadway, the Singer Building, New York.

Mrs. John Wallace Riddle, architect, has been retained by the Women's Roosevelt Memorial Association to prepare the plans for the restoration of Theodore Roosevelt's birthplace, 28 East Twentieth Street.

Fitch H. Haskell has retired from the firm of Godley & Sedgwick. The business will be continued as heretofore by Frederick A. Godley and Henry R. Sedgwick at 244 Madison Avenue, New York.

Guilbert & Betelle, architects, announce the removal of their offices on February 1 to new quarters in the Aldine Building, 546 Broad Street, Newark, N. J. Entrance: 2 Lombardy Street.

Wm. S. Worrall, Jr., architect, announces that he has moved his office from the Queensborough Building to 132 Fourth Street, corner of Jackson Avenue, Long Island City, L. I.

George Lawrence & Co., masons and general contractors, have moved from 9 Pleasant Place to 1412 Herkimer Street, Brooklyn.

Alfred C. Bossom announces that he has removed his architectural offices from 366 Fifth Avenue to 680 Fifth Avenue.

Louis Stone, formerly of Stone & Wright, Stockton, has opened an office in the Albany Block, Oakland, Cal.

Cass Gilbert was recently elected president of the National Institute of Arts and Letters.

# News Notes From Various Sources

The New York State Association of Architects has appointed the following Legislative Committee for the year 1920: Thomas F. Gleason, chairman, Albany; John H. Scheier, N. Y. C.; Alexander Selkirk, Albany; Robert North, Buffalo; Edward Loth, Troy; Edward S. Gordon, Rochester; Frederick H. Gouge, Ithaca; Gordon Wright, Syracuse; Harry Haskell, Elmira; Carl C. Tallman, Auburn; Harry R. Tiffany, Binghamton, and Addison F. Lansing, Watertown. A meeting of the committee has been called in the Albany Club, 102 State street, Albany, to confer with the State Board for the Registration of Architects, for the purpose of discussing the law and its proposed amendment.

Fifty thousand dollars, it was recently reported, will be the capitalization of the Housing Corporation of Harrisburg, Pa., Chamber of Commerce. The corporation will enable prospective homeseekers, who do not have the money to build or buy outright, to secure suitable homes on easy terms.

At least \$25,000 of the capital stock has already been subscribed. It has been decided that the earnings of the capital are not to exceed six per cent.

The public playground and athletic field which was presented to the City of New York by Mrs. Isaac L. Rice and family will probably be placed in Pelham Bay Park in the Bronx instead of in Central Park, as was first suggested. Herts & Robertson, architects for the Rice family, appeared before the Board of Estimate and stated that the new location was adjacent to salt water and therefore would be advantageous for swimming pools and aquatic sports.

A plan of contemplating an equal division of net profits or net losses annually between the company and its 1200 employees and containing provisions by which the workers may take over control of the business was announced today by Winship, Boit & Co., owners of the Harvard Knitting Mills, engaged in underwear manufacture at Wakefield, Mass. The employees, who in recent years have received an annual bonus of 15 per cent, agreed to accept the plan.

Stout denial that farmers of the country were in favor of the Government retaining control of the railroads was made by Oscar E. Bradfute, president of the Ohio Farm Bureau Federation, who was a member of President Wilson's first industrial conference.

Mr. Bradfute said the only farmers' organization associated with the American Federation of Labor is the Farmers' Equity Association of the Northwest.

Problems relating to increased production through shop industrial training and the questions of arbitration, conciliation and collective bargaining were discussed at the twentieth annual meeting of the National Civic Federation. That labor is opposed to compulsory arbitration and will resent any attempt to interfere with the right to strike was the view taken by Samuel Gompers.

The Harvard Corporation announces an increase of 20 per cent in salaries of all members of the teaching staff except those in the law school and the graduate school of business administration. In these two schools the salary basis is considerably higher than in other

departments of the university. The increase is retroactive to January 1 last.

Payments of \$5,100,815 to pensioners of the steel industry since 1911 are recorded in the ninth annual report of the United States Steel and Carnegie Pension Fund. The average age of pensioners is 65.6 years, their average period of service 30.32 years and the average monthly pension \$21.55. Active pensioners on January 1 were 2940.

Building of new homes to solve the house famine and the expansion of business are being retarded because the administration insists on keeping building material at the bottom of the preferred list for car accommodation, according to the Dow service daily building reports.

An important part of the proceeds of the new French loan will be applied to the retirement of paper in circulation. This will be one of the essential features of the Government's plan to improve the financial situation of France, the Associated Press is able to say.

Judge Gary announces: "The wage rates of day labor at the manufacturing plants of the Steel Corporation have been increased about 10 per cent, to become effective February 1. Other rates will be equitably adjusted."

Republican members of the House Ways and Means Committee in conference agreed informally to favor legislation authorizing the Treasury to extend additional credits of \$50,000,000 to certain European countries for food relief.

War powers of the Government have been reinvoked for the commandeering of 72,500 tons of open hearth steel rails for use by the Railroad Administration in building up steel rail stocks of the railroads.

A conference of Scandinavian Cabinet Ministers will be held early in February at Christiania.

The question of Norway, Sweden, and Denmark joining the League of Nations is to be considered.

"We are sliding down the scale on which the German mark and the Austrian crown occupy the lowest degrees, the Russian ruble being reckoned as zero," says "L'Echo de Paris."

The number of unemployed persons in Berlin at the end of the war was 62,000. The following year the total rose to 187,300, but in January of this year it fell again to 59,000.

By a vote of 75 to 24, the House appropriated \$1,000,000 to guard the liquor in the 800-odd bonded warehouses in this country, amounting to 69,000,000 gallons.

Approximately 5000 acres of public land on the Shoshone, Wyoming, irrigation project will be opened to entry March 13, Secretary Lane announced.

An extensive survey of living costs in the principal cities of the country will be started by the Department of Labor.

# Weekly Review of Construction Field

Comment on General Conditions of Economics With Reports of Special Correspondents in Prominent Regional Centers

## The Farmer's Relation to Our National Well-Being

TO get down at once to first principles, man must be supplied with food before he can indulge in the cultivation of his loftier ambitions. Without physical life, mental processes cease to exist. Without physical sustenance, the body dies and there is, as far as those of the earth now know, nothing more to build upon. In the large, therefore, and with our ever-increasing population, it is necessary that food production be proportionately augmented, and to augment food production means at the same time to increase the power and well-being of the farmer.

When one reflects on the vast extent to which we are dependent upon the good will and the good work of the farmers, it is amazing that matters pertaining to farm life should be permitted to drift in the placid stream of indifference. There has been developed an attitude among city folk that farm life is a primitive kind of existence and one so different from what industrial workers know, as to merit, apparently, apathy if not actual scorn. This is, on the face of it, absurd, and it is only through a narrow outlook and a misinterpretation of facts that such beliefs have been able to take root.

If this country is to thrive and be the sturdy, vital power that we see in our visions, it is not enough that it shall not be hungry. Its food must nourish and its resources must be conserved. This means that every possible facility and encouragement must be given to the farmer, that immense group of citizens who are at the very source of our strength and well-being as a nation.

At the present time there is a conspicuous shortage of farm labor, and a consequent diminution in food production in many of the Eastern States. Farmers state that they contemplate leaving their farms or curtailing the acreage under cultivation because of the labor scarcity in these rural districts. One farmer sees nothing for it but to "raise only what we need for our own use and let the other fellows look out for themselves." Farm help has been lured to the city by the promise of short hours, high wages and the hope of a good time.

Meantime it is reported that Chicago is filling in Lake Michigan for miles and that New York is pouring millions of tons of soil into the East River, the purpose in both instances being to provide more space for the constantly increasing population of each of these great cities. If there is reason to doubt this, it nevertheless serves to emphasize the fact that there are too many people in these and other large cities, while there are not enough in the rural sections of the United States. Throughout the country is a great acreage of untilled land the cultivation of which would feed millions of people. This land lies idle while these millions of people eke out a bare existence, and the cry is always for more foodstuffs.

The best thing to induce a general and genuine back-to-the-farm movement would be an active and continuous betterment of the farm with reference to facilities for convenience and comfort in the daily life of the farmer. There is nothing inherent in the land where farms now are to prevent the installation of such comfort-giving things as are to be found in larger communities. Those who look sneeringly upon the mental stature of the farmer may note with consternation that the farmer is giving up his homestead and moving to the city, prompted by that same mentality. Unless something is done this country may be faced with the necessity of importing foodstuffs and wasting the very power that has made for our present national strength.

One of the suggestions made will have a wider influence than would at first be apparent: The American Land Service points out that there are thousands of young men and women seasonal workers, such as teachers, students and those employed in various trades, whose vacation periods dovetail with the agricultural seasons. The busy season in the country is in Summer: in the city, Summer is the slack season, the organization points out.

It is planned to take these workers to the country in units. They will be housed in a large house or camp in the center of farming districts, and will be delivered to the various farms in the morning by motor truck. They will be gathered up the same way in the evening. The day's work will be limited to eight hours, except in case of emergency.

The organization calls attention to the fact that the efficiency of city workers on farms was demonstrated during the war. Hundreds of them learned then the advantage of a few weeks' outdoor life in the country.

The important point here is not even mentioned. The gain lies not so much in the temporary relief that these people will afford, but it does lie in the intercommunity of interests that may logically be expected to arise. There will almost inevitably result a mutual respect and understanding, and the city people will doubtless avail of the opportunity to introduce such aspects of city life as may be adaptable to farm conditions and conducive to the greater comfort of those affected.

Another idea suggests itself. It is well recognized that most of the immigrant labor entering this country stagnates in the large Eastern port cities, and, while not having any preconceived preference for one locality over another, is simply dumped by the shipping companies on an over-supplied market. It would be too Utopian to expect these companies to carry the immigrants further West, but it would undoubtedly be an interesting experiment to make it one of the conditions of citizenship to serve an apprenticeship of, say, two years, on a farm or in a district of a certain small maximum population. To do this would, however, require the close co-operation of the Government, for if it directs people where to live it should in a sense assume responsibility for providing the details. With all the ramifications that this presents, there are few things

more important to be done on a large scale such as the Government might do. There are certain things to be said for the scheme despite the obstacles suggested and despite the obloquy attaching to Government performance.

These immigrants, who congregate in overcrowded sections of large cities, are most of them from the peasant classes of Europe and would be more contented in the free out-of-doors than hampered as they now are by the limitations of the unaccustomed slum house.

With such a plan in progress the rise of anarchistic propaganda is greatly reduced. Conditions are more tolerable. Men are placed where there is demand for just the service they are qualified to give, and are eliminated from circles where their presence is ungraciously tolerated for lack of a closer analysis of the problem and action thereon. It is likely that once so settled the foreign laborer will be slow to filter into larger cities. He will more likely get his brethren on the other side to join him in his rural quarters. Then, with a manageable number of foreigners in a comfortably appointed community, the problem of Americanization will be infinitely simpler of solution than the present undistributed masses of immigrants, in their unspeakable quarters, can permit.

With the benefits of increased farm labor, the scattering of our overcrowded centers, and a closer Americanization of incoming foreigners, together with all the corollary benefits, such a procedure as that suggested is not to be despised.

The foundation of our industrial organization harks back in the last analysis to the farm and its products. If these could be adjusted, other difficulties would inevitably diminish, and if in the carrying forward of this end there could also be accomplished a scattering of overcrowded people from their present centers, benefits would be doubled all along the line.

There cannot be too much reiteration on the subject of the importance of the farmer and the necessity for making his environment as attractive as possible. A group of Middle Western architects have sponsored a movement for better farm buildings, but it is necessary for everybody to do some hard thinking on this topic. Better farm buildings mean increased production; increased production means reduced prices; reduced prices mean stability and prosperity in the ranks and files of the citizenry. Does it therefore not seem that to achieve these ends there should be a well-directed and earnest effort, a long pull and a strong pull on the part of architects?

## Increased Production Convention

Seeing in increased production a means of restoring normal business and price conditions, the Chamber of Commerce of the United States will make its eighth annual meeting, to be held at Atlantic City April 2 and 29, an "Increased Production Convention."

This subject is considered of such importance that in working out a program for the meeting every topic will be considered from this viewpoint. Lack of production is one of the chief causes of the high cost of living and costs cannot be reduced until more goods are put on the market. The present is a seller's and not a buyer's market. Prices have been forced up by competitive bidding. This in turn has made necessary unusual wage increases, with a still further rise in manufacturing and production costs.

The general subject of increased production has been divided up in the program for the convention into sub-

jects. The first to be taken up will be the Government in relation to production. Under this heading will be considered anti-trust legislation and taxation. Business of every kind is keenly interested at this time in the situation with respect to taxation, especially in the subject of excess profits taxes, against which there has been general complaint.

The second general subject to be taken up will be transportation in relation to production. This will include both land and water transportation. One of the chief causes of low production just now, as The American Architect has frequently pointed out, is the general shortage of railroad equipment. One authority estimates that the country is short at least 200,000 box cars, and all lines of industry have felt that shortage.

International finance and its relation to world production has a prominent place on the program. This subject will be discussed both from the financier's and the business man's point of view. Lack of means of financing European industries is a decided factor in retarding production in many of the countries of Europe.

One general session of the convention will be given over to agriculture in relation to production. Here will be presented for discussion the part of the Government, the farmer and the business man in agriculture.

Another important general subject will be the relation of labor to production. This will be approached from the two sides: the employe's viewpoint being presented by a representative of the American Federation of Labor and the employer's by a business man.

Besides the general sessions there will be held group meetings, divided as along the great divisions of industry. In these meetings the subject of increased production will be the main topic discussed.

Too much emphasis cannot be laid upon a subject so important to the welfare of our country.

## Credit Expansion or Production

In its review of current economic conditions, the National City Bank of New York says: "The question of credit expansion is directly related to industrial costs and to the endless cycle of wage and price advances. The cycle calls continually for more credit, and if the supply is to be provided indefinitely the 'dollar' in which wages are paid will continue to depreciate in purchasing power, and the whole industrial and financial situation will become more and more hopelessly confused. It would seem that we have gone far enough in this direction for everybody to see that there is nothing to be gained for honest industry by going farther. There is no advantage to the wage-earner in reducing the currency of the United States to mere stage money, which has no definite command over the goods he wants to buy, or in having the industrial structure lifted up on a vast pyramid of credit which will sooner or later collapse as all like pyramids have in the past.

"When this is understood it will be seen that a resolute stand must be made against increasing the volume of loans, compelling such a restriction of new undertakings and such a lowering of costs as will enable the business of the country to be done without further credit expansion. If the people will set themselves to increasing production and paying their debts the whole situation will rapidly improve, but there is no prospect for easier money except as this policy is pursued and the price level lowered."

# DEPARTMENT OF ARCHITECTURAL ENGINEERING

## The Story of Limestone

Its Transition From the Quarries in Indiana to Placement in the Completed Building

By GEORGE BANGS McGRATH

ARCHITECTS and builders as well as laymen fall into the easy habit of considering as commonplace many of the standard products employed in building construction. All too

found that man has done his part exceedingly well.

A prominent contractor who has used limestone from Indiana quarries in his building operations for a quarter of a century was asked if there was plenty



HYDRAULIC STRIPPING IN QUARRY

often they little know the story which lies behind the origin and production processes which bring the material to market. Now and then there is a touch of Nature's wonderful hand hidden in the things which the builder employs, and frequently it is also

more stone where that came from. He looked up in surprise and said:

"I am sure I don't know. I never thought of that."

And when he was told that the deposit of such



TYPICAL LIMESTONE QUARRY SCENE. QUARRY AT BEDFORD, INDIANA. STEAM CHANNELERS AT WORK

stone which has been utilized for building purposes for upward of a quarter of a century constituted a solid sheet 60 miles long, 20 miles wide and 80 feet thick, equivalent to something like eighteen billion tons, his surprise was great. Further surprise was manifested when the information was advanced that in some years 30,000 carloads had been shipped, making in the aggregate a train 250 miles long, carrying a load of two billion and forty million pounds, approximating 12,000,000 cubic feet in bulk.

The mechanical processes which produce the stone, from the solid sheets in the quarries to the regularly shaped rectangular blocks preparatory to milling, and that fabricate and fashion it ready for its place in the building, seem little known to archi-

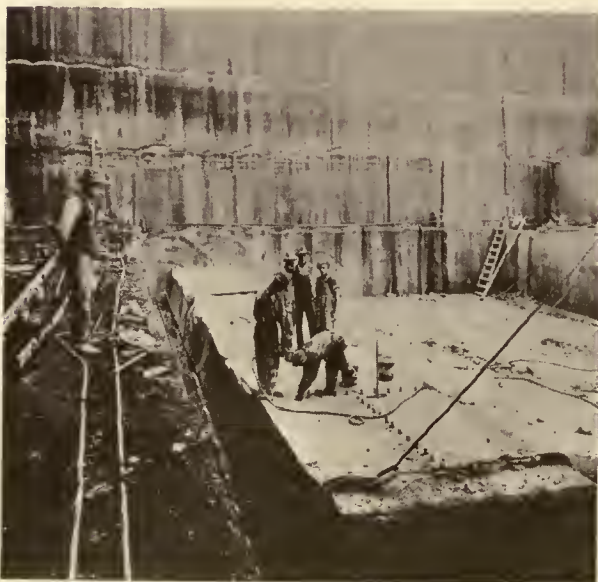

QUARRY SCENE. BREAKING OUT TWELVE-TON RECTANGULAR BLOCKS OF LIMESTONE

tecs and builders in general. That stone exists which is capable of ready response to sawing, milling and shaping operations by modern mechanical appliances is a revelation to many. Great progress has been made in mechanical methods of operation and some of these processes of production will here be briefly explained and illustrated.

Considering quarrying operations, the over-burden is removed or "stripped" by hydraulic pressure as shown in one of the illustrations. The stream of



TURNING OVER "CUT" IN QUARRY AFTER BEING CUT OR CHANNELLED BY CHOPPING OR CHANNELING MACHINE

water is directed so as to undermine the earth sections. The rock sections are drilled and lightly blasted away, steam shovels transferring the debris.

The sheet or "floor" of limestone proper is then cut or channeled into strips by power channeling or chopping machines which cut a narrow and deep channel through the stone. A "key block" is first removed on the principle of extracting a plug from a watermelon and the blocks quarried until a face is secured, when a long channeled section is turned on its side by use of steel wire cables operated from large derricks, after which movement the section is drilled and broken into mill blocks ready for rais-

ing from the quarry pit to the freight cars above, for transportation to the local mills or to the sawing and fabricating mills of the cut stone trade throughout the United States and Canada.

Some of the blocks are roughed off or "scabbled" to square them into regular shape and save freight charges to distant points on excess material. This work is done on power scabbling machines especially designed for this purpose.

At the sawing mills the blocks are sawn in various ways. The gang saws, consisting of a series of

cient piece of mechanism, standing about 6 feet 6 inches in diameter, with cutting teeth of black diamonds. This saw, traveling at an average speed of two miles per minute, actually cuts its way through the solid stone at an average rate of from 6 to 8 inches per minute.

It is in the planing, turning and milling of the stone that many unusual operations are performed considering that it is natural stone and not wood that the tool's treat.



INTERIOR OF MILL, SHOWING PLANER BATTERY

steel blades which ride an abrasive consisting of Ottawa sand and water, are probably the most popular and maintain an average cut of about six inches per hour. Wire band saws are sometimes used for sawing blocks into extra thick slabs.

The diamond drag saw is used for making fast single cuts. The cutting teeth are set with commercial black diamonds and water free of sand is used. These saws obtain a cutting speed of from 30 to 40 inches per hour.

The circular diamond saw is employed largely for end cuts or jointing and is a wonderfully effi-

ciently membered mouldings are produced on the planers, the steel cutting tools of which stand still, the stone being braced on platens which travel at the rate of from 25 to 30 feet per minute against the stone, with a reverse speed about double that. On a majority of the planers both top and side tools can be utilized simultaneously, and some of the larger machines carry two platens, producing two mouldings and using four cutting tools at the same time.

An unique invention is the circular planer devised for cutting circular mouldings.



VIEW OF STONE GANG-SAW. ON THE GRATING ABOVE IS PLACED OTTAWA SAND, USED AS AN ABRASIVE, THE SAWS NOT BEING PROVIDED WITH TEETH

Turning lathes of various sizes are employed, from the little fellow engaged in turning out small balusters to his giant brother credited with monolithic columns over 33 feet in height and of proportional girth. Column bases, balls and the like are also turned on the lathes and the bases shaped by a powerful cutting machine termed a "header," which moves against the stone to be treated.

Small circular carborundum saws are used to some extent and, while limited in size and much smaller than the circular diamond saws, still find their valuable place in the economy of the modern stone mill.

While it is possible to produce Indiana limestone from its resting place in Nature's own laboratory

and install it in the building, performing all operations by machinery, it should not be assumed that the stone cutter as an artisan and the carver as an artist have been altogether replaced by tools which mind the somewhat mysterious power of electricity and steam. Both the cutter and the carver enjoy their rightful place in the industry and both perform functions beyond the ken of any machine, although both these operatives in a majority of instances employ successfully an air-driven tool which succeeds the old hand mallet. Of late there has been something of a revival of hand-cut finishes which highly complement the economy and efficiency of the modern mechanical devices and promise here and there to add something more of "the affectionate touch



PLACING STONE IN LATHE FROM WHICH MONOLITHIC COLUMN IS TO BE TURNED



CARVING PILASTER CAPITOL. CARVER IS USING AIR-HAMMER

of the hand of man" to the nation's architecture in stone.

Stone was undoubtedly the building material furnished by Nature of which man first made use. When the various "Ages" marking man's civilization were named, we find the "Stone Age" as the earliest. And Nature has so abundantly supplied man with this durable material of construction that, although quarries have been opened and worked down through the ages, there still remains sufficient in store to supply his needs through centuries yet to come. Let us treat this ancient material with respect; let us build well with it, that the future may view our work with satisfaction.



# Fire Protection for Schools

## Part III—Means of Egress

By H. W. FORSTER

THE fatuous faith of the majority of school authorities and laymen in the life-saving power of outside fire escapes is a constant source of wonder and pain to the student of fire protection for schools. Some escapes are wide and properly railed; the stairs have an easy pitch; access to them is direct; they lead to the ground; they are located opposite blank walls or pass windows protected with metal frames and wired glass; they are a valuable means of egress if used. The large majority of fire escapes, however, are a delusion; they may prove death-traps. Narrow, steep, reached by climbing over window sills, terminating many feet from the ground, passing windows out

these facilities may be promptly and intelligently used.

Building construction, height, enclosure of stairs and provision of automatic sprinklers all have a bearing on the amount of stair capacity that a building requires. The preliminary report of the Committee on Safety to Life of the National Fire Protection Association, to be found in the 1919 Proceedings, is the forerunner of an ultimate practical plan for adjusting the egress requirements to the building with due regard to its structural and protective conditions.

*Fundamentals of Good Egress.*—It should be possible to empty a school building of ordinary height

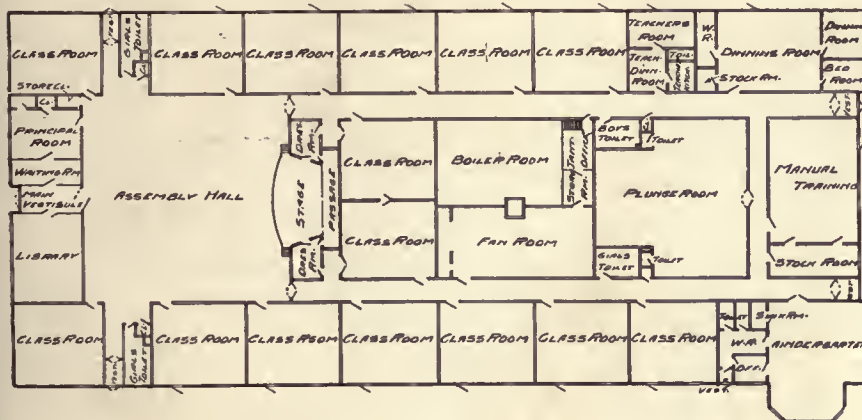

THE FEATURES OF THIS BUILDING ARE:

TWO WAYS OF EXIT FROM EVERY ROOM; IN MOST CASES DOORS OPEN DIRECTLY TO THE OUTSIDE. THERE ARE NO STAIRS TO CLIMB; NO VERTICAL FLUES TO ADD TO RAPID SPREAD OF FIRE AND NO OUTSIDE FIRE ESCAPES TO CREATE A FALSE IDEA OF SAFETY.

THIS TYPE OF SCHOOL HOUSE IS NOW GENERALLY CONCEDED TO BE THE SAFEST WHICH CAN BE ERECTED.

FIG. 4. PLAN OF A SINGLE STORY SCHOOL, ROCHESTER, NEW YORK.  
EDWIN S. GORDON, ARCHITECT TO THE SCHOOL BOARD

of which flames are likely to pour, never used at times of drill, they are a monument to the ignorance of the authorities and the selling ability of the manufacturers. An outside fire escape on a school building is generally an admission of the inadequacy of normal exit facilities.

A one-story school, such as that shown in Figure 4, has ideal egress facilities. No group life loss is possible under such conditions. The conditions in the Collinwood School, shown in Figure 5, where 175 lives were lost, were similar to the present situation in thousands of our schools. Each school problem needs careful study to the end that adequate egress facilities may be provided and that

and ordinary construction in not more than three minutes; two are preferable. Elements that need consideration are:

- (a) An alarm system for prompt notification of fire or of drill.
- (b) Proper individual room aisles to admit of quick marshaling of children.
- (c) Adequate door or doors to corridors, to inside stairs directly, to other rooms, or to outside towers or escapes.
- (d) Sufficiently wide, straight, unobstructed corridors.
- (e) Stairs ample as regards number and of proper width, handrails, preferably enclosures.

and separation to protect against smoke blocking all stairs.

(f) Direct exit from stairs to outside, without forcing pupils to enter lower halls.

(g) Special egress facilities for auditorium, gymnasiums, lecture rooms, and other points where large numbers of persons congregate.

(h) Carefully planned and frequently held egress drills.

It should be borne in mind that in many cases school houses serve the purpose of community centers and are used for public meetings.

**Alarm Systems.**—All school buildings, with the possible exception of small one-story structures, should be provided with a dependable means for giving prompt alarm at time of fire. In small buildings of more than one story a vertical rod from basement to top floor, provided with an oper-

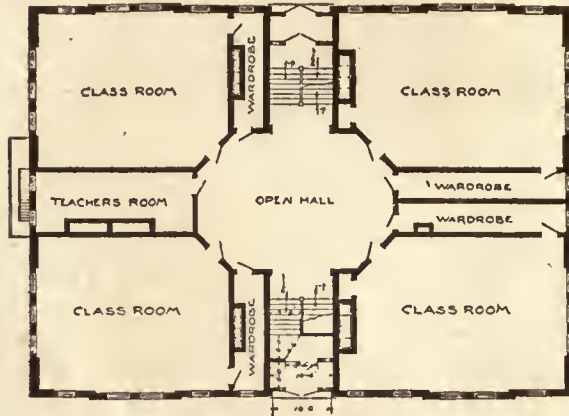

FIG. 5. LAKEVIEW SCHOOL, COLLINWOOD, OHIO. FIRST FLOOR PLAN FROM THE FRONT. COMPARE MEASUREMENTS AND ARRANGEMENT OF VESTIBULE, WHERE 173 CHILDREN PERISHED, WITH CONDITIONS IN YOUR COMMUNITY

ating handle at each floor and connected to one or more large gongs, will answer. In larger and more complicated buildings, however, it is necessary to use electrical systems. Gongs should be so located that they can be heard plainly in every portion of the building, and one signal station for every twelve rooms is a fair standard, although this will, of course, be varied according to arrangement.

**Thermostats.**—Approved thermostatic (automatic) fire alarm systems operate on a moderately rapid increase in temperature. Such systems are similar in action to an automatic sprinkler system, but lack the extinguishing feature. Probably for this reason their installation has been limited to cases where there has been a keen interest in fire

protection, but where funds were not available for the installation of automatic sprinkler systems.

**Sprinkler Alarms.**—Where automatic sprinkler systems are installed fire alarms can be automatically given by means of a water flow alarm valve connected to gongs throughout the building. This is probably the most efficient fire alarm system devised, as the starting of the fire, operation of sprinkler head to extinguish it and the sounding of alarm are almost simultaneous.

**Individual Room Exits.**—In the opinion of many good judges, all class rooms, laboratories, etc., should preferably have two exits, one leading to the corridor or to an inside stairway directly, and the other to a similar stairway, a fire tower, an

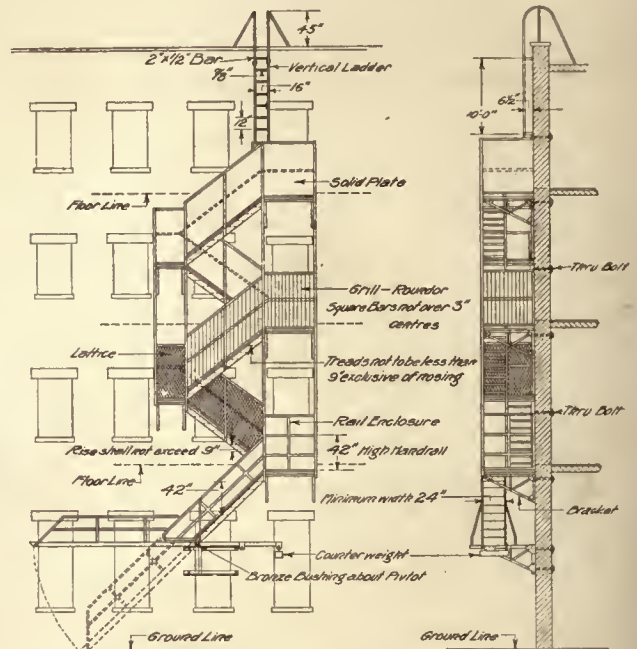

**SPECIFICATIONS**  
 Height of Building - Not recommended on buildings over six stories in height  
 Location - Stairs should preferably be against blank wall, access from all openings to stairs being by horizontal balconies. Wall openings within 10' of such stairs to be protected by approved automatic fire doors or door ways and automatic or fixed fire windows on window openings  
 Doors - Shall have minimum width of 30" and minimum clear height of 78"  
 Balcony and Stair Enclosures - Shall be at least 50" between railings on superimposed forms and at least 36" in straight run stairs.  
 Stairs - Minimum clear unobstructed width shall be 24". The pitch of stationary and of swinging stair (when down) shall not exceed 45°

FIG. 6. STANDARD OUTSIDE STAIRS AS RECOMMENDED BY NATIONAL FIRE PROTECTION ASSOCIATION

outside escape, or an adjoining room from which a second means of egress can be reached. On the other hand, some are inclined to think that the single exit in buildings of good construction has an advantage from the viewpoint of maintaining discipline in time of panic.

In many cities portable one-room school units are in use, and these frequently are provided with but one exit, which is generally used to connect them to the main building. A separate outside exit should be provided.

School basements, especially where basement rooms are used as class rooms, should have exits leading directly to the outside.

*Corridors.*—One acceptable rule regarding corridor widths is 8 feet for a building having eight

tories, wood-working rooms and other hazardous places, should be protected by wired glass in metal sash or by fire doors.

*Larger Meeting Rooms.*—The necessity of adequate means of egress from auditoriums, gymnasiums, lecture rooms, laboratories, or other places of general assembly is evident. Where not located on the ground floor, there ordinarily should be separate exits leading directly to the outside. Doors should open outward and be kept clear of chairs and other objects.

NUMBER OF STAIRWAYS

The stairway arrangement of every school, old or new, should meet the fundamental rule of at least two ways of egress being available from any class or assembly room. The arrangements should be such that there is only a remote chance of both exits being cut off by smoke or fire at the same time. The more common arrangement, of course, is to have two stairs connected with the same corridor into which, in turn, all rooms open. If two such stairs are fairly close together, they cannot be properly considered separate means of egress unless enclosed in fire-resistive or fire-retarding partitions equipped with smoke-proof doors.

Account must be taken of the possibility of one stairway at least being blocked by fire or smoke, the other or others being called on to provide adequate egress under those conditions.

It is commonly assumed that a standard 4-foot or 5-foot inside stair will pass in drill formation 120 pupils per minute, or 60 in each of the two lines. To be conservative, this figure should be reduced to about 45 per minute per file past a given point.

*Stairway Construction.* — Measured between handrails, the width of stairways should never be less than 3 feet and never more than 5 feet unless intermediate handrails are provided. In new construction the best practice is to have the stairs 4 feet wide. Stairways should preferably be incombustible, and should be kept absolutely free from obstruction.

The stairway plan should be simple, and stairs should be of uniform width throughout their length. Winding stairs should never be permitted.

*Handrails.*—Handrails should be provided at both sides of all stairways and also at intermediate points where more than one double column of pupils is to be accommodated. Ends of rails should be curved to prevent pupils running into them. Balustrades should be at least 3 feet high.

*Fire Escapes.*—Adequate exit in new buildings should preferably be secured without resorting to fire escapes. On many existing buildings, how-

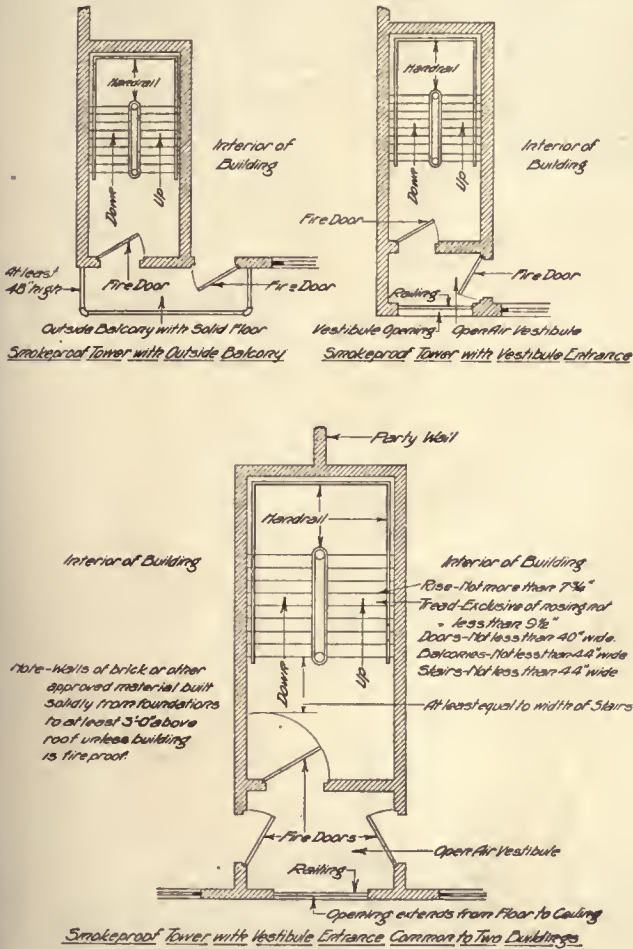

FIG. 7. SMOKEPROOF STAIR TOWERS

class rooms on a floor, and one foot more or less for every two rooms above or below this figure. The corridors should not terminate in dead ends.

Stairways should preferably be located at all turns or ends of corridors. Sloping floors or ramps should be avoided where possible and, if necessary, their pitch should not exceed one foot in eight.

All openings which subject corridors to serious exposure, such as windows overlooking combustible roofs or doors communicating with labora-



FIG. 8. BRICK AND WOOD-JOISTED SCHOOL BUILDING. SAME PLAN AND COST AS BUILDING SHOWN IN FIG. 9. INTERIOR CONSTRUCTION OF WOOD, WOODEN CORNICES AND CEILINGS OF STAMPED METAL.

ever, fire escapes are necessary because of the inadequacy of the inside stairways.

Fire escape stairways should extend to the ground. Where for any reason it is not possible to continue the stair to the ground, a counterbalanced section is necessary as shown in Fig. 6.

*Smokeproof Towers.*—The Philadelphia Fire Tower in its various modifications provides the safest means yet devised of egress from upper floors of buildings. The stairway is cut off from the building by fire walls and fire doors, making it impossible for either smoke or flames to enter the tower. (See Figure 7.)

Such towers can serve every normal stairway need in all save extremely cold climates. Scores of schools in North Carolina have only smokeproof tower stairs.

*Doors and Gates.*—Had the one bolted door of the pair of doors at the foot of the Colinwood School stairs been open, the children might have passed through to safety. All doors provided should be adequate for the number of occupants and, with the possible exception of individual classroom doors and doors on fire walls, should swing with the travel. Doors should never be bolted during school hours except by means of approved panic bolts.

Gates should be avoided wherever

possible. If absolutely necessary, they should be locked open during school hours.

*Horizontal Egress.*—In planning new school buildings of large area, these should be sub-divided by one or more approved fire walls. Even in old buildings it is occasionally advantageous to install such walls. Sometimes existing walls can be improved to serve this purpose. Where buildings are thus sub-divided the first concern at time of fire should be to get the children through the fire wall out of the section in which the fire is located and into the section which is safe.

*Signs and Lighting.*—Red and white exit signs, with letters at least 5 inches high and illuminated at night, should be placed over all stairways and doors leading directly to the outside. Exit signs should not be omitted over doors leading from roofs and basements. Secondary egress signs for classrooms, auditoriums, laboratories, etc., may be advisable in large schools.

In order to simplify instructions, all stairways and outside exit doors can be numbered and these numbers used for drill and other purposes.

The current for exit lights should preferably be obtained from a system separate from that ordinarily used for lighting purposes. It is also well to provide auxiliary gas lights for use in case the electric service is interrupted.



FIG. 9. REINFORCED CONCRETE SCHOOL BUILDING. NOTHING TO BURN IN CONSTRUCTION; MAINTENANCE COSTS AT A MINIMUM; DEPRECIATION NEGLIGIBLE

326

Manuscript No. 2308



ALTAR OF SANTA LUCIA, IN THE CATHEDRAL, AVILA

*THE AMERICAN ARCHITECT*

# THE AMERICAN ARCHITECT

VOL. CXVII

WEDNESDAY, MARCH 17, 1920

NUMBER 2308



LAWN VIEW, HOUSE OF JAMES T. McMILLAN, DETROIT, MICH.

## The Relation Between the Architect and the Landscape Architect

By WILLIAM PITKIN, JR., *Landscape Architect*

*Illustrated by photographs of landscape design by the author*

### PART I

THE value of establishing a co-operative relation with landscape architects is being recognized by architects very generally. While the landscape architect is considered a necessity on certain projects, particularly domestic work, there is still some uncertainty regarding the manner in which he shall be retained, the type of undertaking on which his employment is justified, and the exact nature of his relation with the architect.

Occasionally an architect, or more frequently a client, will consider it wise to have the grounds developed one or two years before the house is designed; another architect will consider such work unnecessary until the house is completed or nearing completion; while a third will think it best

that the architect and landscape architect collaborate from the inception of the project.

There are certain obvious objections to developing the grounds prior to designing the house—namely, that the landscape architect cannot foresee, except in the most superficial manner, the new conditions to be created by the architectural developments. His planting will have the advantage of one or two years' growth—the usual argument for such a proceeding—but it is hardly to be expected that it will occupy the happiest position in relation to future buildings, or that the drives and gardens will relate properly to them.

The frequent practice of bringing the landscape architect into the problem after the house is nearly completed is even more unsatisfactory, and it is



VIEW OF HOUSE AND GARDEN OF GEORGE B. MONTGOMERY, BUFFALO, N. Y.



TERRACE WITH FOUNTAIN, MONTGOMERY GARDEN, BUFFALO, N. Y.

exceedingly difficult to achieve an ideal ground plan in this manner.

It is highly desirable that the main elements of the landscape architect's plan be conveniently arranged, well related to each other, and pleasing in the general ensemble. This necessitates their bearing a proper relation to the floor plan of the house. If the floor plan is developed regardless of the landscape plan it is quite impossible to secure this relation on account of certain difficulties not foreseen by the architect.

The location of the house may defeat the best drive arrangement, or the grade line may be too high or too low in relation to proposed terraces and lawns. Coal bins may be conveniently located in reference to the boilers, but the coal chutes may be on the living side of the house where there is no other need for a drive, and where other-

wise a garden would have a perfect relation to living rooms and porches.

The careful planning of city lots prior to the building of the house is even more essential than on larger properties, for the mistakes which are made from lack of a proper plan are magnified by the limitations of space, and are more difficult if not impossible, to correct. Generally there is only one house site and garage location which will permit

the efficient disposition of service features and the maximum utilization of lot area for recreation and beauty, so that a very slight difference in the location of the buildings may completely destroy the possibility of achieving a good ground plan.

To avoid such mistakes and disappointments, it is desirable that the architect and landscape architect collaborate freely from start to finish, both keeping their plans flexible till the final solution is

achieved. This will afford each the opportunity to provide for all plan requirements, and to develop together a comprehensive scheme which will insure the best treatment.

There are occasions where the landscape architect should control the selection of the architect, as on large park projects, but in the case of developments, where the architecture is the dominant note of the scheme, as in most domestic pro-

jects, it is preferable to allow the architect to choose the landscape architect, or to at least pass upon his selection.

This arrangement is justified by the necessity of having the landscape setting subservient to, and in harmony with the style and spirit of the architectural design, and it is quite reasonable to expect architects to take this point of view.

In such cases, however, it is generally desirable

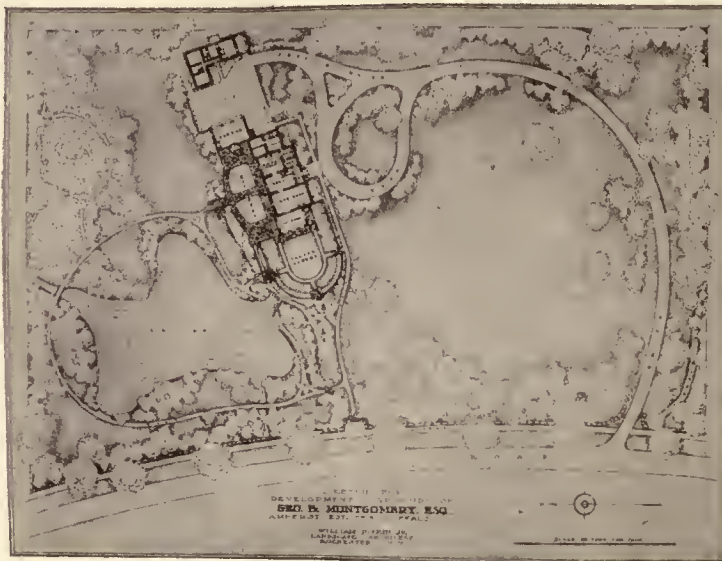

SKETCH PLAN FOR DEVELOPMENT OF GROUNDS OF GEORGE B. MONTGOMERY, BUFFALO, N. Y.



## THE AMERICAN ARCHITECT

to have the landscape architect make his agreement for services with the client, either direct or through the architect, and his compensation should be received from the client and not from the archi-



AN EFFECT OF LATTICE IN GARDEN OF GEORGE B. MONTGOMERY, BUFFALO, N. Y.

tect. The reasons for this are obvious—namely, that the relation between architect and landscape architect is thus purely one of collaboration—both working together to the same end, but each free to suggest and criticise, and to bring to the solution of the problem the best efforts of individual genius, ability and experience.

The selection of the landscape architect by the architect would necessarily imply that the former's preliminary sketches for the ground plan will be submitted to the architect and thoroughly settled upon between them as to general design and important details before they are presented to the client. The result will be a comprehensive scheme embodying the best ideas of both professional advisors, and carrying with it the weight of unified



WALL TREATMENT IN GARDEN OF GEORGE B. MONTGOMERY, BUFFALO, N. Y.

approval, which will be an important factor in securing the client's favorable consideration of its recommendations.

Though it is not advisable, as stated, to undertake the landscape development prior to the making of house plans, it is often desirable, as well as entirely

practical, to start landscape construction work considerably before the building is started, *provided* the house plan has been developed with the ground plan at least to the point of finished sketches. This has worked out very satisfactorily many times with the result that when the house was completed it fitted into a landscape more or less fully established. An example of this kind is the country place of Mr. George P. Greenhalgh at Toledo, the plan of which will appear in the succeeding article. The ground scheme was worked out in co-operation with the architect, Mr. Alfred Hopkins, and the landscape work has been carried on for several years, though the only buildings erected to date are those included in the farm group.

In contrast to this example is the method frequently followed of acquiring a comprehensive plan for the development of the property, and working it out from year to year as funds are



DETAIL IN MONTGOMERY GARDENS, BUFFALO, N. Y.

available, or as the owner enjoys undertaking the completion of one feature after another. This method is equally satisfactory as the making of the landscape plan, in conjunction with the house plans, solves the many problems in each which are inter-related, and provides for the eventual carrying out of a comprehensive scheme which will give the house the desired setting and develop the property to the best advantage.

The property of Mr. George B. Montgomery at Buffalo was developed in this manner in accordance with the general scheme shown in the sketch illustrated here, which was supplemented by complete working drawings and specifications for the owner to follow from year to year. As shown by the photographs which were taken three or four years after the house was built, the landscape treatment is gradually developing and has already made a good setting for the house, designed by Paul A. Mann, architect, in co-operation with whom the plans were worked out.

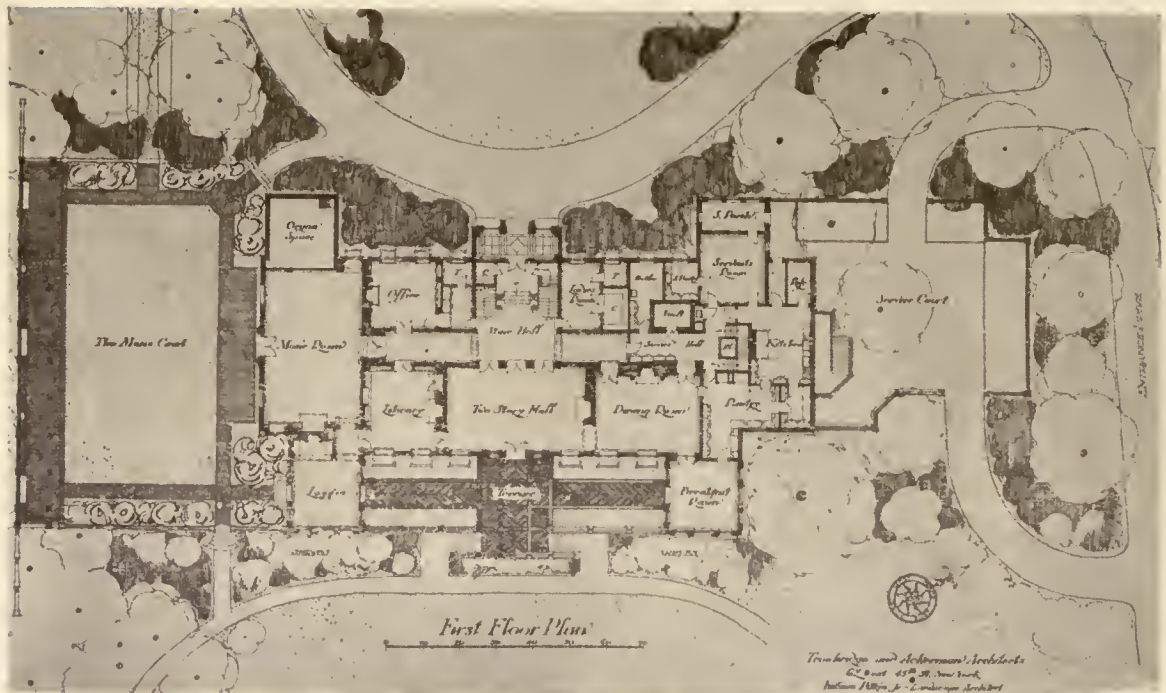

HOUSE OF JAMES H. NEWBERRY, GROSSEPOINT, MICH.  
TROWBRIDGE & ACKERMAN, ARCHITECTS  
WILLIAM PITKIN, JR., LANDSCAPE ARCHITECT



AT LEFT: A TROLLEY WAIT-  
ING STATION

CLEMENT R. NEWKIRK, *ARCHITECT*



BELOW: GARDEN VIEW ON  
PROPERTY OF J. J. GILBERT,  
LITTLE FALLS, N. Y.

WILLIAM PITKIN JR.,  
*LANDSCAPE ARCHITECT*



## THE AMERICAN ARCHITECT

The architect who recognizes the value to him, as well as to the client, of a landscape architect's co-operation, will desire to know the approximate cost to the client of such services before he can feel justified in recommending his employment.

The total expenditure on landscape work averages so little in proportion to the cost of the buildings that the landscape architect's compensation figured on a straight percentage basis will not considerably exceed the usual percentage charge of architects.

practical service to a clientele of architects desirous of securing technical assistance in the interests of their clients and themselves. Such a conference will develop the conditions and requirements of the problem, as well as the architectural program, and will let the landscape architect determine the magnitude of his work and enable him to make a definite proposition for his services.

The supervision of construction work is generally handled upon a percentage or per diem basis, depending upon the frequency of visits and the



SUCCESSFUL TREATMENT OF A ONE HUNDRED FOOT LOT AT SOUTH BEND, IND. PLANTING IS ONLY ONE YEAR OLD

Most architects, as well as the majority of clients, prefer to have the landscape architect charge a lump sum for sketches, working drawings, specifications, estimates and visits of consultation in connection with their preparation, this sum to cover both time and expenses, including traveling expenses.

Within the area in which the majority of his work is situated, a landscape architect should be willing to confer with an architect and his client, without putting either of them under any obligation or at any expense, except possibly a very moderate charge to cover actual time and expenses. This method of procedure makes it possible to give

degree of responsibility over development operations. Landscape architects are obliged to carry out much of this work through their own organizations, because of the difficulty of finding in many cities, contractors capable of doing good grading, planting and other work requiring executive ability, expert knowledge and good taste.

Accurate estimates of cost should be made before the work is started, and to a very considerable degree, a landscape architect's reputation will be based upon his success in keeping within the cost limits thus established.

The cost of developing large estates is, of course, only limited by the owner's requirements, but once a program is definitely decided upon it is possible

## THE AMERICAN ARCHITECT

to complete the work within the amount of the estimate made at that time.

On smaller properties and particularly on city lots, where the securing of a good setting for the house and an interesting development of the plot is worth a great deal to both architect and owner, the cost of landscape work is surprisingly little. The possibilities are so limited by the restricted space and the buildings themselves occupy such a large proportion of the lot area that the expenditure is proportionately limited. The average city

ideas as to planting design, and in order to perfect a co-operative relation such as outlined, the landscape architect must appreciate the value of architectural design in planting. He must realize that the horticultural interest of his material is decidedly of secondary importance, and that the primary considerations are form and color.

Form is the essential factor in the selection of the individual plant or tree, and in the arrangement of the mass planting. Planting about buildings will depend for its success almost entirely



GARDEN TERRACE, ESTATE OF WILLIAM E. BOCK, TOLEDO, O.

lot can be attractively and harmoniously developed at a cost as low as 4 per cent of the cost of the house, and will seldom exceed 10 per cent, including labor, materials and the services of the landscape architect.

While landscape architecture covers many other phases of work important to them, architects look to landscape architects primarily for assistance in connection with planting, as they do not themselves have the requisite technical knowledge of planting materials. They do have, however, very definite

upon form. It will recognize the need of a certain formality as compared with the purely naturalistic, and its composition will include material of architectural outline, grouped to harmonize with the lines of walls, piers and columns and to accent decided vertical or horizontal lines of the building. It will emphasize and reveal the excellencies of the architecture rather than bury them, and though composing well, will be softened by the character of its foliage and by the use of enough material of rounded form to blend it into the ground.

Color of foliage in planting material used about buildings is of greater importance than color of flower. It affects the composition the year around while the flower lasts for only a short season, and it offers the finest medium for obtaining interesting contrasts of light, shade and texture. The use of evergreens is almost essential not only for color in winter, but for contrast with deciduous material in all seasons. No other material can give the architectural outline or the warmth and richness to a setting for a building.

that except for certain high lights, the colors should be restrained and dependence placed upon good whites and some yellows, with pink and lilac used conservatively. Good green foliage should constitute the backbone of the planting, blue, green, or golden evergreens should be used with restraint, and variegated foliage should be entirely omitted.

The use of good-sized planting material to obtain a quick result is entirely practical and costs very little more. It includes the planting of nursery stock larger than the average size, and the



UPPER TERRACE, HOUSE OF W. E. BOCK, TOLEDO, O.  
WILLIAM PITKIN, JR., *LANDSCAPE ARCHITECT*

The consideration given the foliage of deciduous material must include not only the spring and summer color, but also the fall color, when wonderfully harmonious effects may be secured by proper combinations of planting material in composition with architectural materials. Fall and winter fruits of deciduous materials should also be very thoughtfully considered especially when used with evergreens.

Color of flower in planting about buildings must necessarily be limited by the type of building and the color of its material, but it is safe to say

transplanting of native shrubs and large trees, which can be moved with complete success if properly handled.

The plans and photographs, illustrating this article, show the result of a co-operative relation between architect and landscape architect, in which they have considered the architectural and landscape requirements, and have developed a common plan embodying the best solution of their respective problems, and satisfying the demands of good design, convenience and amenity.

*(To be continued)*

# An Indigenous Architecture

By GEORGE W. MAHER, F. A. I. A.

ONE of the pronounced indications of the new era in our broad land is the inspiring change in sentiment towards the recognition of American effort. This new-born interest in native genius has vitalized the pent up energy of a great nation whether of the shop or manufactured articles or of the artistic or creative product.

Prior to the great World War this present attitude of mind was quite the contrary. Indeed, it was thought by many that America had no ideals and it was not uncommon to hear, alas, from our own countrymen, that this country possessed but a feeble spirit in relation to things of an original or creative nature. There was also a distrust of our possessing a vital national life.

It is, therefore, most refreshing to note that this negative attitude of this great and glorious democracy, greatest in all history, was totally wrong, and that the American people possess a vitality and genius, a spirit and love of country equal to the most endowed peoples, or nations of the earth. It is for this reason that I am encouraged to present to those interested in the architectural profession, why our common art should keep apace with this new era and endeavor to express the true spirit and life that surrounds us.

Our country has possessed writers and prophets, if you please, like Theodore Roosevelt, who have told us in unmistakable language truths that are fundamental, principles that we must recognize. Mr. Roosevelt has stated that America should possess an art and architecture indigenous to this great country, that it must express our ideals and that it is the responsibility of the architects to foster this movement. I refer particularly to the paper prepared by him and read at Minneapolis in the year 1916 before the National Convention of the American Institute of Architects. This strong and wholesome address was well received by the architects at the time but unfortunately has brought forth little or no constructive action, excepting in a small degree and from the Middle West part of this country. To-day, the advice so generously given, seems forgotten and is dormant so far as any tangible national result can be sensed. Indeed, when at this moment the very air we breathe seems to permeate and vibrate with American destiny, with America's leadership in world affairs, the progress

of architectural thought has not risen to the occasion, or has not in audible or articulate tones made public its aspiration to become a part of this great movement.

We are familiar with the examples of recent work which have been published in current architectural publications. This is the crux of the situation I refer to, and an indication of the state of mind of our profession. I feel I am right in stating that the buildings illustrated are most conservative. It would seem that the architects are making a fetish of precedent—content to add replica upon replica, indicating a sterility in creative or imaginative ability. This seems particularly true of our government or general public work, where the architect seems to vie respectively with the others in an endeavor to out-Greek the Greek or the Italian, French or English schools in the buildings that are either proposed or executed. I could mention these specific buildings to illustrate the thought I have in mind, but it is hardly necessary to do so since these edifices are known and accepted as set examples of precedent following respective schools of architecture.

It is obvious that no architect should attempt to design original or creative themes unless he is well grounded in the spirit and history of the art of the great past. This preparation, however, should be a stepping stone to original effort, not a short cut toward standardization of forms for expediency and accommodation. It is not enough that the public work referred to be well composed and adheres to certain examples of good precedent. Our perspective has been all sufficient, and a public building to-day fails of its purpose if it is a plagiarized effort.

A country like America demands a vital art created from its own environments, its own people, an art that will suggest a democracy and reflect the aspirations and character of the nation. These public buildings that are being erected, from the very nature of their designs, cannot suggest the wonderful flora and animal life of America. Nature is abundant throughout this broad land, our flowers are varied and beautiful beyond compare, suggesting color and opportunity for decoration: shrubbery and vegetation meet the eye on all sides. Here is an inspiration worthy to consider by the artist—also our native birds and wild animals that inhabit our wonderful fields and forests. These incentives should be taken full advantage of so that

Reprinted from the *Monthly Bulletin* of the Illinois Society of Architects.

he who observes and is of sympathetic mind and heart, may profit thereby in his creative work—aiming to express America, the land of opportunity and of bounty.

The Illinois Society of Architects has asked me to write a series of short articles to be published in the Illinois Society Bulletin, suggesting certain ideas and impressions touching upon this subject. I shall aim to do this from the viewpoint of the Middle West. I hope I have a purpose to perform, perhaps in the inaugurating of a school of architecture in the midst of this country where the enthusiasm of the young men shall not be quenched and where full opportunity be given to encourage them to express in their work the ideals of America and the spirit of a democracy.

### American Impressions of Buenos Aires

Mr. James H. Collins, an American traveling in Buenos Aires, has recorded his impressions of that old town for the *Philadelphia Public Ledger*. He states in part:

When the Spaniards established cities throughout the region that is now Latin America they built in the Spanish style, with thick walls, fifteen-foot ceilings and narrow streets. Thick walls shut out

the heat, high ceilings give circulation of air and narrow streets shield people from the tropical sun. The Spaniard also built his house around a patio, or central courtyard, which was his flower garden and his front lawn.

For most of the Latin-American countries this was quite right, but not for Buenos Aires, which has a temperate climate. And Buenos Aires is paying heavily for this imposition of an unsuitable architectural scheme. It is paying millions of pesos to cut avenues through the narrow streets of its old Spanish town, and also paying in other ways not so obvious.

Mr. Collins believes Buenos Aires would welcome American types of buildings. The shortage of both dwelling houses and office structures, together with the climatic conditions noted above, both serve to commend tall buildings, with lower ceilings and thinner walls than have been erected in the past. There would seem to be further opportunity for American architects and builders in another direction, for the problem of housing the working classes and by means of suitable homes promoting their well-being appears not to have been given the careful consideration to which it is entitled in Buenos Aires.

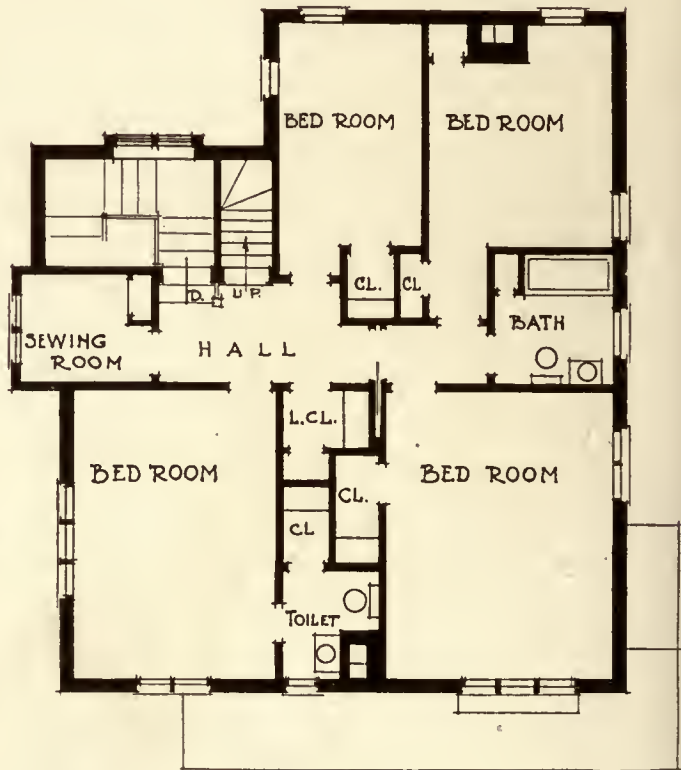
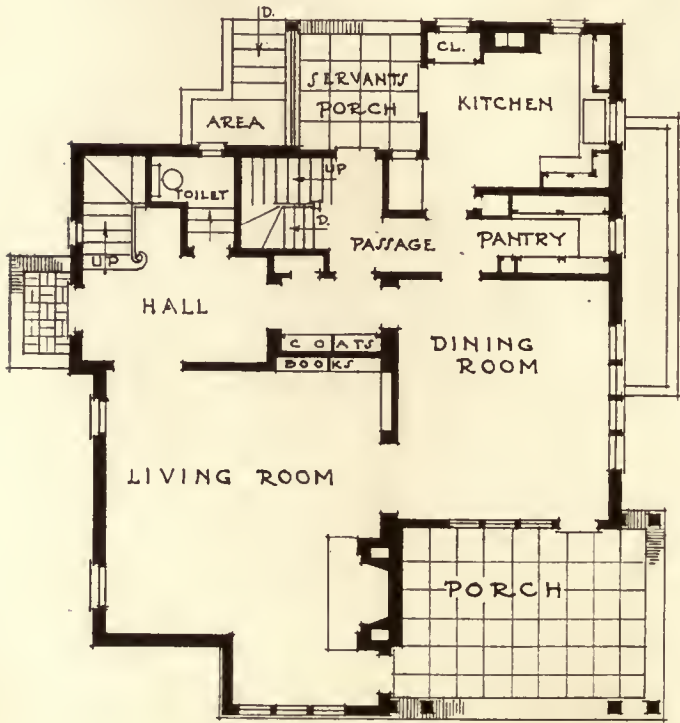

HOUSE OF W. W. NICHOLS, ROCHESTER, N. Y.

CLEMENT R. NEWKIRK, ARCHITECT

(For illustration see plate section)



# Japan's Housing Troubles Amusingly Recounted by a Visitor

## Difficulties Presented in Providing Necessary Types of Houses For the Native and the Foreigner

THE trouble with Yokohama is that it stopped expanding just at the time it began to grow, states a correspondent of the *Seattle Times*. The result is that refugees from Russia, fleeing before the blessings of Bolshevism, have telescoped at this point with refugees from the United States, fleeing before the blessings of prohibition, in a welter of seething, cursing, shelter-hunting humanity that is all fussed up and no place to stay. Otherwise, Yokohama, the gateway to the Orient, picturesque, unique and one of the most livable spots in the Far East, is all right, barring the odors, the roads, the transportation and other drawbacks over which this part of the world seems to have no control.

If you are indifferent to food and have a taste for scenery—including a fine view of the sacred mountain—if you can doze as comfortably at the side of a lotus pond as by the fireside at home, you will like Yokohama. But unless you are prepared to live in the open, on fresh air and vistas, or pay prices, at extremely second-rate hotels, tarry where you are,

As for houses, they are more to be desired and more difficult of realization than a high seat in heaven. Only through long travail or murder are they achieved. But, as a forlorn home-seeker remarked while observing the quaint pageantry of a passing Buddhist funeral procession, "They are always having funerals here, but it doesn't do any good. Nobody with a house ever dies."

The house shortage is not confined to Yokohama, but exists also in Tokyo, Kobe, Osaka, Nagasaki and indeed throughout the empire. A building campaign backed by the government is endeavoring to meet the urgent needs of the Japanese, but the foreigner must look out for himself.

Old residents blame the house shortage and excessively high rents—houses bringing from five to ten times the rental asked a few years ago—on the influx of Russians, who have flocked here in large numbers, boosting the cost of living, servant's hire, and all imported commodities. Again rumor says these Russians are of that class which profited most by the Bolshevik revolution, who have come hither with alacrity to spend ill-gotten gains.

To the sorely pressed follower in the wake of trade expansion it is a crumb of comfort to learn that profiteering landlords, who eagerly rented to Russians at top prices a year or so ago, are now

reaping their just reward, as Russian tenants, who agreed to any rental and paid several months in advance, have paid nothing since and are intrenching themselves behind the Japanese law, which forbids turning out a tenant unless a dwelling is provided for him. They neither pay nor move, but await with calmness legal procedure that is sure to extend over months, during which time anything may turn up, even a passport to America.

There are two distinct varieties of houses—Japanese and European or foreign style. The former, unsubstantially built, with its paper "shojies" and screens, with no means of heating save a "habachi" (charcoal brazier), is a cunning doll's house to look at and a delightful abode in summer, but a thing of draughts and chills in the rainy season—November to April—that sends shivers through a foreigner just to look at.

Foreign style houses are limited in number, the greater portion being in this city, which boasts a large foreign settlement. Practically no new dwellings have been built since before the war. The government seizure of German owned property—which constituted one-seventh of the foreign holdings here—has contributed to the acute congestion. When a German owned house was vacated no new tenant was accepted and many houses fell into disrepair. A foreigner cannot own land in Japan but can hold it in what is called "Perpetual Lease" under the 999 year provision.

The Japanese are making every effort to regain control of these foreign owned land tenures, which have become very valuable through improvements placed on them. Once a lease of this kind passes into the hands of a Japanese it cannot be resold to a foreigner. The government has prohibited the selling of German owned property to any but a Japanese subject.

A foreign agency, not a house renting agency, in Yokohama shows a list of twenty-seven American families that have applied within one week's time for housing facilities to this source alone. The manager attributes the house scarcity not only to Russian pressure but to the increasing number of American firms that are sending representatives to Japan. It may be well for these representatives to know, when accepting contracts, that the cost of living has advanced more in Japan than in the United States and that houses here are engaged months in advance and bring rentals that keep pace

with the profiteering rates levied upon a helpless public by the land pirates "at home."

And those thirsty souls, who look with eyes of envy upon the oasis of the Far East and figure feverishly the cost of transportation, should remem-

ber that others have had the same inspiration. It is true the bars are open but the accommodations are limited. The newcomer will find that rents run from 150 to 500 yen (\$75 to \$250)—when there is anything to be rented.

## Construction Legislation in Congress

Every prospect gives credence to the belief held by United States Treasury officials that 1920 will be a big business year for construction legislation in Congress, writes a Washington correspondent. For the first time since 1913 the national law makers will be asked to pass an omnibus building act. Present estimates indicate that the appropriations to be carried in this proposed statute will embrace any sum from \$50,000,000 to \$100,000,000.

Until Congress does act in some way to pay for the building of post-offices and other Federal structures, the office of the supervising architect in the Treasury Department will have comparatively little in the way of contracts to offer the construction and building material firms of the country. The bill passed in 1913 gave the supervising architect about \$30,000,000 for the erection of those Federal jobs which members of Congress would succeed in getting for the folks back home. Whatever operations have gone forward have been under this law, but 1920 finds the Treasury Department face to face with that amount exhausted and something like 25 sites for public buildings authorized but yet unpurchased because of the lack of money. Representative John Wesley Langley of Kentucky, Republican, is chairman of the Committee on Public Buildings and Grounds in the House of Representatives. He plans to take up the needs of the Government in construction lines in the very early future.

The effect of the passage of bills providing for a large construction program on the part of the Government would undoubtedly be toward the stabilizing of industry.

That contractors are not bidding widely on those jobs which the supervising architect is awarding now is very apparent to the Treasury Department. Unsettled conditions in labor and the higher prices on materials are regarded as reasons for the scarcity of bids and their big figures, the latter circumstance making the closing of the contracts by the Government an impossibility in some instances.

The rise in prices everywhere and in every line has been the determining factor in the unbought sites still to be acquired by the Government from the 1913 bill. Real estate values jumped so rapidly that the money set aside for them by congressional

action could not make purchases, and there was nothing to do but to wait until more money was forthcoming to make up the difference.

In addition to the regular civilian needs of expanding the Federal buildings, the Public Health Service, which is also a part of the Treasury Department, has sent a memorandum to Congress asking for \$85,000,000 to enlarge its hospital facilities to take care of the men injured from the war who will need to be hospitalized for the remainder of their lives. While the construction to be done, if this bill is passed, will be of a special nature, such as hospitals and buildings of that type, the contracts necessary to put the plan into execution will be among the largest bits of Federal business in the reconstruction period. The Bureau of War Risk Insurance, the Hospital Division of the Public Health Service and the Federal Board of Vocational Education, an independent body which reports directly to Congress, compose the three factors directly connected with the proposal to erect \$100,000,000 worth of hospitals. Administration of the bill once it is passed will fall upon Dr. W. G. Stimpson, chief of the Hospital Division of the Public Health Service, which is now running about 48 hospitals with 8000 beds throughout the country. This is an increase of more than 50 per cent over the pre-war hospital facilities.

Congress has already authorized the Treasury Department to provide hospital and sanatorium care for a number of persons, inclusive of the following: Discharged sick and disabled soldiers, sailors, and marines, Army and Navy nurses (male and female), patients of War Risk Insurance Bureau, merchant marine seamen, seamen on boats of the Mississippi River Commission, officers and enlisted men of the United States Coast Guard, officers and employees of the Public Health Service, certain keepers and assistant keepers of the United States Lighthouse Service, seamen of the Engineer Corps of the United States Army, officers and enlisted men of the United States Coast and Geodetic Survey, civilian employees entitled to treatment under the United States Employees' Compensation Act, and employees on Army transports not officers or enlisted men of the army, now entitled by law to treatment by the Public Health Service.



## Progress in American Industrial Art

**C**URIOSITIES of art education in this country have induced a mental attitude on the part of the layman that art was something to be acquired by the rich at much cost and kept behind glass cases. That art might have any conspicuous connection with the living of one's daily life was an idea toward which the public, oppressed by the high cost of so-called actual necessities, was not receptive. The fact that the development of good taste in the part of the consumer would compel a better product on the part of the manufacturer, and conversely, that the better product would also react favorably on the public taste, was a possibility toward the realization of which the general public was indifferent.

There is, however, something about beauty that enables it to get a message across, and when officially labelled and viewed by the general public, it creates a wholesome craving for the possession of similar works.

It is therefore entirely reasonable that manufacturers, alert to the lure of the dollar, should incorporate the element of beauty in the making of their wares. While this attitude on the part of the manufacturers may be due to the normal twentieth century desire to stimulate a bank balance, it is obviously true that the results of our daily environment are in no wise diminished by whatever cause motivates them.

**T**HE manufacturer may be solely concerned with the greater income he may acquire with the aid of art in his perfectly utilitarian product. But inevitably that product when employed for the purposes for which it was designed, will disseminate its influence for good and justify its existence.

The important thing is more insistently to spread the gospel of art as applied to our daily surroundings. Furniture, rugs, pottery, textiles, silver and metal work, wood products: these things and many

others with which the layman is constantly in contact, must yield that interest which alone makes life worth living.

Perhaps the most important influence working toward this end is the Metropolitan Museum of Art in New York. There is at present in progress an exhibition of America Industrial Art which very ably demonstrates the practical or trade value of an art museum, and which gives evidence of the educational use made of museum objects for the improvement of present-day design in industrial arts. Here objects and designs have been assembled, which, though made for purely commercial purposes, yet owe their conception or method of execution to the study of museum originals. Examples have been chosen in varied types of material, form, color, texture and technique generally, in widely separated lines of production, yet all destined for the open market and all showing that museum study is eminently worth while, even as to its purely financial or business aspect.

Only encouragement is needed to impress the public with the importance of its environment, and of industrial art as affecting it. The museum is exactly on the right track; the movies are trying to do their part. It remains for the schools, the libraries, the public authorities, all to co-operate with the manufacturers, to teach them what is good, and teach the layman that it makes a difference.

## To Insure a Better Americanism

**T**HERE is constantly being brought to attention the many avenues along which every branch of our national life is moving toward a better and more rapid Americanism.

The National Security League has announced that leading educators throughout the country are to be formed into committees to adopt a program of a plan for a nation wide movement. It will be endeavored to make it necessary that specific knowledge of the American form of government shall be a requirement for a college or university degree.

This program, which is divided into two parts, is as follows:

"Study and discussion of the principles and spirit of the American constitution and government through the college and university forums and debating societies.

"Advocacy of a required course on the constitution and the American form of government in all colleges and universities.

"The latter aim will be developed on the basis of the required new course on American government just added to the curriculum of the College of the City of New York."

**I**N a letter received from a correspondent in the Middle West there is given the outline of a proposed plan to teach a better Americanism which is interesting in view of the fact that it is proposed to inculcate the highest ideals of good citizenship through the influence of good and purely American architectural surroundings.

A large theological seminary under the control of a sect whose priesthood is largely foreign, proposes to acquire a tract of land on which to erect its seminary and the dependent buildings. These buildings will be entirely in our early Colonial style and largely replicas of buildings which have emphatic historic interest. The idea is one that should have the strongest encouragement. It not only perpetuates a style that is strongly American in its suggestiveness, but it will also imbue a veneration for our historical traditions and result in the development of better ideas of citizenship.

### The "Americanization" Boom

**T**HE Senate, by a vote of 36 to 14—making a total vote of fifty out of a possible ninety-six—has passed a bill appropriating \$6,500,000 for teaching aliens a knowledge of the English language and American institutions—the immediate purpose being to combat "red" influence. Senators know, and the public should understand, that this is merely an initial appropriation, certain to result in a permanent addition to the activities of the Federal Government. With \$6,500,000 an organization can be created which an earthquake could not break loose from the Treasury. It will be riveted tight.

In discussing the subject, therefore, it is essential to consider it as a fixed determination of the Federal Government to take up actual instruction, which has hitherto been considered as a strictly state function. Senators who voted against the appropriation are said to have done so on the ground that education is not a Federal function.

It is quite possible that no one in the Senate has had any such personal contact with this subject as to enable him to judge whether teaching the English language to adult aliens will have any influence in "Americanizing" them. It does not seem to have occurred to any Senator that the method may equip the bright to proselyte more effectively among Americans, of whom some are quite susceptible. As for the average alien adult, there is no reason to suppose that any facility which he may acquire at night schools in reading or speaking English will lead to the habitual use of that language or, if he can read his native language, to stop reading the papers in that language printed in this country, many of which are anarchist. As for the children, they learn English in the schools.

### Means of Americanization

**T**HE alien problem is a multitude of local problems in whose proper solution the States and the Nation are vitally interested and to which each might profitably contribute, if it were known how wisely to spend the money. There is in the country a rather large number of those who have been in actual contact with groups of foreigners in work of that kind, and if they could be assembled and all others excluded something useful might come of it. "Americanization" is just now a fad in special charge of public officials, universities and others, few of whom can speak even a word of any language of those whom they propose to Americanize, and, therefore, can have no knowledge of the feeling and trend of thought upon which building must begin. The present agitation is serving to bring home to the people the importance of the subject, and to that extent is useful.

Americanism cannot be "taught" in English or any other language. It must be subconsciously absorbed by contact. The problem is how to secure the contact when aliens are settled in colonies. With that solved the rest is easy.

# Criticism and Comment

---

*The Editors, THE AMERICAN ARCHITECT:*

The writer has read the article entitled "The Architectural Engineer," by Mr. Yardley, with much interest, and has nothing but praise for his magnificent presentation of the subject. We, as you know, have always contended that engineering is the handmaid of architecture. In other words, the two are inseparable. As one definition of architecture states it, "Architecture is the Art of Ornamental and Ornamented Construction."

It is the lack of appreciation of this fundamental of architecture that has caused the insipid and dry copies of previous examples of architecture, in which attempts have been made to simulate designs wholly out of harmony with the materials used in the construction of the building. The writer has always insisted that architecture can not be considered as pure art, as it combines three basic principles in about equal relations, namely, aesthetic, technical and phonetic, or the power to tell a story.

Mr. Ferguson in his "History of Architecture" has stated this proposition very clearly. The possibility of an individual architect himself being able to meet the demands modern construction has imposed upon him is far removed, and the engineering student mentioned in the first paragraph of Mr. Yardley's paper has, to the mind of the writer, sensed the situation properly.

We, in our experience, do not find it is possible to secure any one individual measuring up to what Mr. Yardley claims the architectural engineer should be. We have an organization of over 130 individuals, embracing the highest specialists down to the lowliest office boys, and after many years of striving to secure an architectural engineer, such as Mr. Yardley has described, we were obliged to give up the search, and so organize our staff that instead of one co-ordinating individual, who was sufficiently expert in all branches to make the final decisions in problems involving the highest engineering skill, we have specialists in each line under a co-ordinating executive who is also a technical man and might be likened to the chairman of the board of directors of a large corporation. By means of daily conferences at a fixed time, including the heads of the architectural, engineering and supervising departments, which, of course, embrace specification writing and the other branches, we are able not only to solve new problems but to keep in close touch with the work in the field which is just as important as the creation of new designs. Of course we have special conferences when necessary.

In other words, the standard Mr. Yardley has set for the architectural engineer is far too high and difficult, to expect to find a sufficient number of men to fill the amount of positions available. A man of the attainments suggested should be a member of a large architectural firm or engaged in private practice.

It is the architects themselves who have failed to measure up to the requirements that modern construction has demanded, and the cure is not to have them supplanted but to make the future architect what he was centuries ago, the chief builder. It is very refreshing to look back to the time of Michael Angelo and compare his unique position with that of our prominent architects of to-day. We all know that Angelo was not only a genius in painting, but was likewise one in sculpture, architecture, engineering both civil and military, a poet and a musician. Can one imagine Michael Angelo being employed as an architectural engineer in some big organization? Such a type is too big to be in anyone's employ. He would be, as we term it, a captain of industry.

The writer does not wish to disparage the efforts of those who have attainments such as Mr. Yardley described to secure positions as architectural engineers, but wishes to bring out the fact that a modern architect's organization gets so large that it grows beyond the ability of any one man.

EMILE G. PERROT,  
Ballinger & Perrot.

Philadelphia.

*The Editors, THE AMERICAN ARCHITECT:*

The subject of Architectural Engineering is too big to be dismissed offhand. I do not think there is any such thing as an architectural engineer. There are architects and engineers. The one includes the other, and to try and separate them is to accentuate the very troubles which, to my mind, led to the disastrous condition during the war. The sooner we refuse to admit that an architect is an architect unless he knows all that an engineer knows and then some, the sooner we will have our heritage in the work going. I claim that a properly trained architect can do better engineering than the best engineer in the world because he has not only the so-called engineering but also the architectural point of view. I claim, also, that an architect by training is better able to handle the engineering problems as such than any engineer because

## THE AMERICAN ARCHITECT

he combines the business training, the large point of view, the consideration for design and the appreciation of what constitutes good construction. So far I never have found these combined in an engineer, and have often found them combined in an architect. So I feel that THE AMERICAN ARCHITECT as representing our profession cannot too strongly insist that there is no such thing as an architectural engineer, that the attempt to create such a class has resulted first in a hybrid who can be trusted with neither one side nor the other. Next, it has meant that the public has utterly failed to appreciate the real, practical, business possibilities of our profession.

C. W. BLACKALL.

Boston.

---

### *The Editors, THE AMERICAN ARCHITECT:*

Commenting on Mr. Yardley's article on "The Architectural Engineer," which appeared in THE AMERICAN ARCHITECT of Jan 7, it covers the subject admirably. In my experience as an architectural engineer I have been confronted with exactly the problems mentioned by Mr. Yardley, and in addition I have also been called upon to take charge of estimating and superintendence. The experience of the firm of which I am now a member has given us some very definite ideas as to how engineering work can best be handled, and as to the exact duties of the architectural engineer.

The first method tried for handling engineering work was to have it done by outside firms, but this proved to be very unsatisfactory, especially on complicated work. In making the plans, co-ordination of the various parts of the work was almost impossible. The architectural designer, the structural engineer, the mechanical engineer, and the electrical engineer tried to work together, but none of them had sufficient conception of the work of the others to be able to work intelligently toward a common end. In the end each was compelled to revise his design several times, and to make sacrifices in either appearance, economy, or efficiency, in order that his work might fit in with the work of the others. In the actual construction many discrepancies were discovered which almost always

caused alterations, with additional work, and additional expense to the owner.

On account of these unfortunate experiences it was decided to establish an engineering department as a part of our organization. Although our work is not of sufficient amount to justify an organization containing specialists in every known branch of engineering, we have gotten satisfactory results with an organization which can handle the ordinary problems. We are convinced that an engineer who is well grounded in the fundamentals of the various branches of engineering can produce the necessary co-ordination of the various parts of the work, even though he does have to call in specialists to work out the details of unusual problems.

An estimating or cost department is included in our engineering department because the question of costs is a very essential factor in all engineering design. For example, economy in a structural design can only be effected by a careful study of the costs of the different designs possible under any given set of conditions. Again in the selection of a heating and ventilating system, the cost is usually one of the determining factors, but not in the same way. In this case it is not a question of which system is the cheapest, but which will give the best results for an expenditure consistent with the project in question. Inasmuch as all engineering problems involve an intimate knowledge of costs the logical thing to do was to establish an estimating department. It not only furnishes the necessary data for engineering designs, but also makes complete estimates of proposed work.

Superintendence is included in our engineering department for the reason that most of the difficulties encountered in construction are purely questions of engineering. Occasionally, decisions involving architectural design will be referred to the engineer, as head of the superintendence department, but he must have sufficient knowledge of architecture to know when to call upon the architectural designer for advice and assistance.

LYNN O. KNOWLTON, M. Am. Soc. C. E.

Bass, Knowlton & Graham.

Indianapolis.



HOUSE OF RICHARD U. SHERMAN, UTICA, N. Y.  
CLEMENT R. NEWKIRK, ARCHITECT  
WILLIAM PITKIN JR., LANDSCAPE ARCHITECT

342

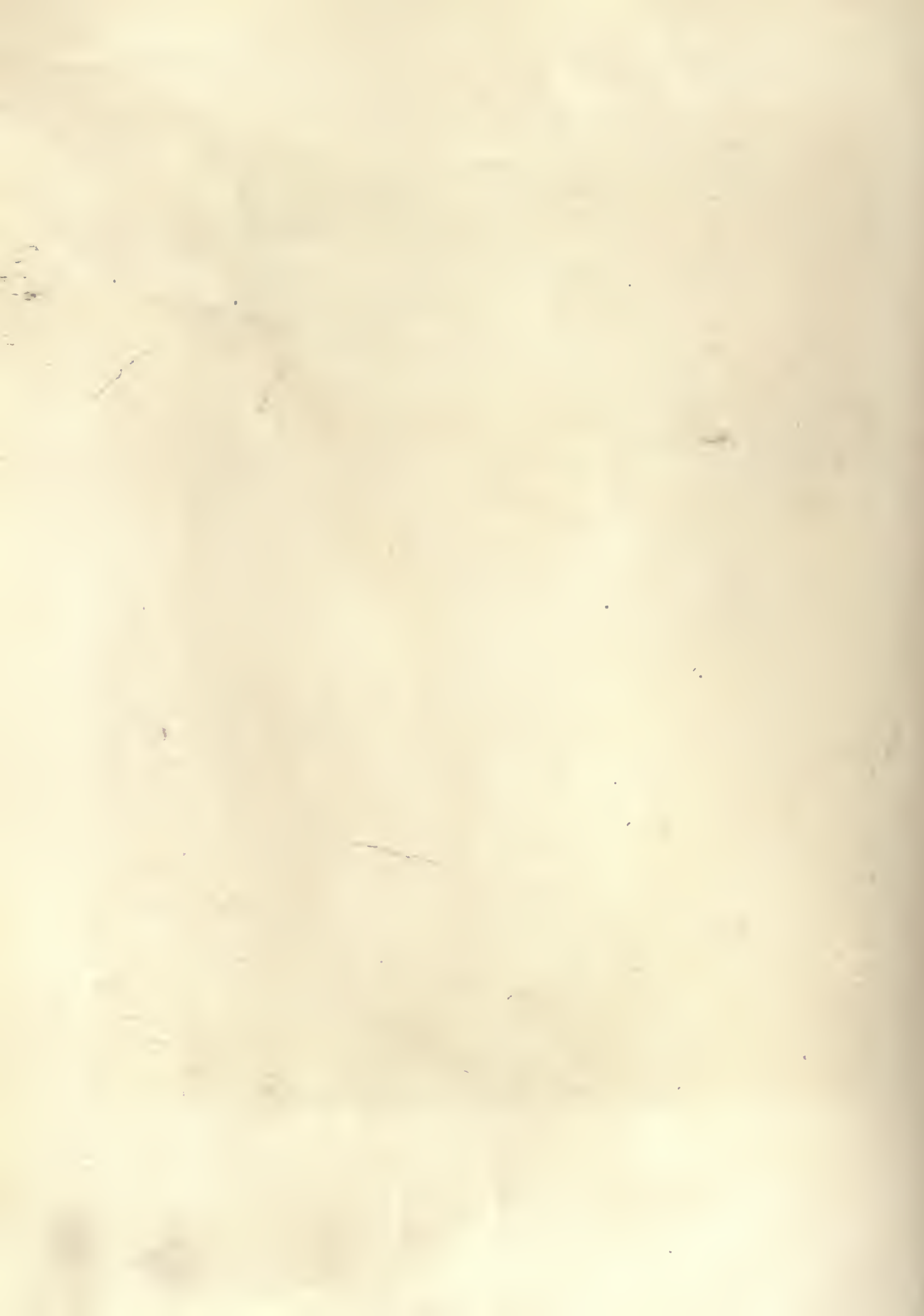



5422



HOUSE OF RICHARD U. SHERMAN, UTICA, N. Y.

CLEMENT R. NEWKIRK, ARCHITECT

WILLIAM PITKIN JR., LANDSCAPE ARCHITECT



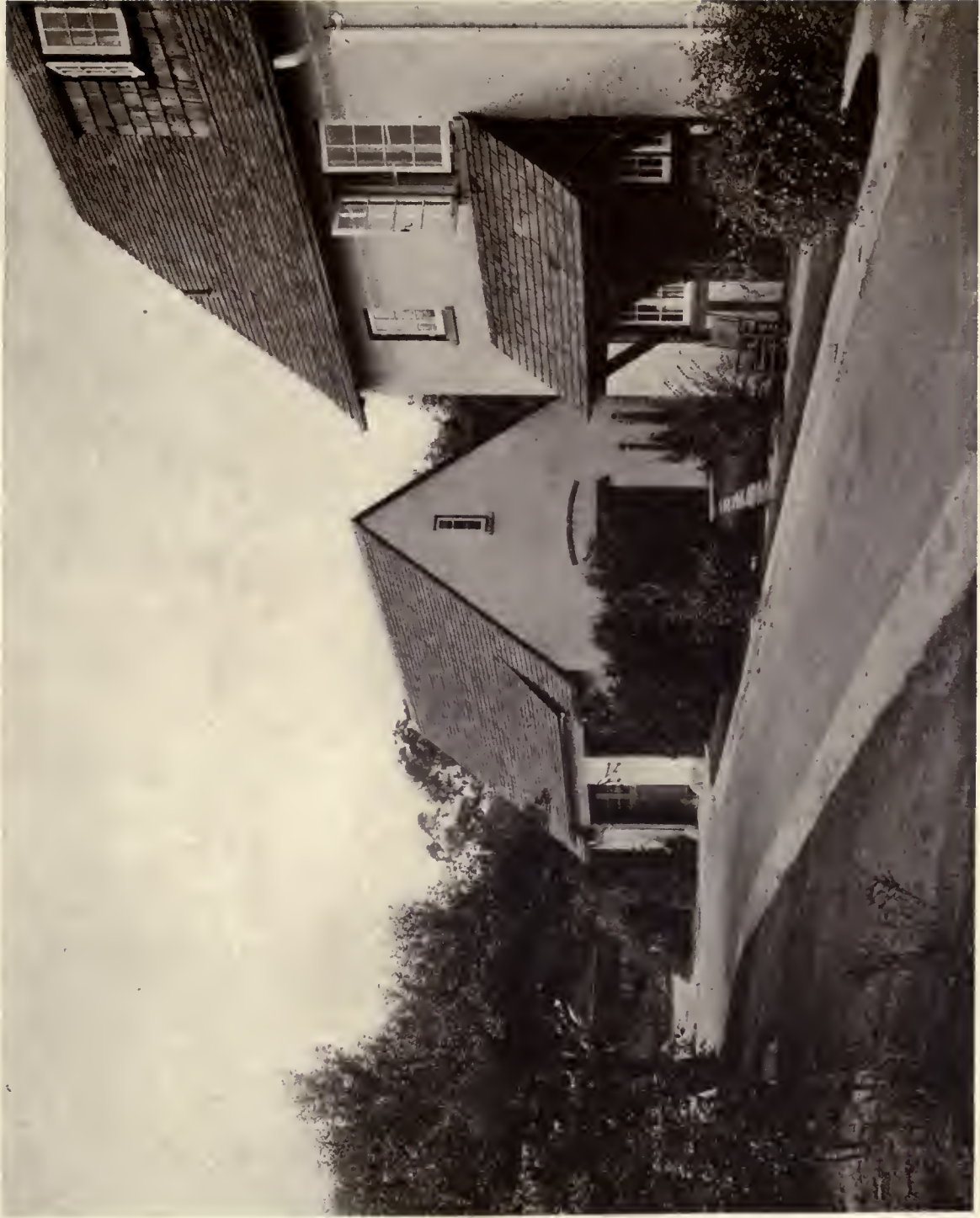

SERVICE ENTRANCE AND GARAGE  
HOUSE OF RICHARD U. SHERMAN, UTICA, N. Y.  
CLEMENT R. NEWKIRK, ARCHITECT  
WILLIAM PITKIN JR., LANDSCAPE ARCHITECT

3428





ENTRANCE DETAIL

HOUSE OF RICHARD U. SHERMAN, UTICA, N. Y.

CLEMENT R. NEWKIRK, ARCHITECT



HALLWAY

HOUSE OF W. W. NICHOLS, ROCHESTER, N. Y.

3425





HOUSE OF W. W. NICHOLS, ROCHESTER, N. Y.

CLEMENT R. NEWKIRK, ARCHITECT

WILLIAM PUTKIN JR., LANDSCAPE ARCHITECT

3425

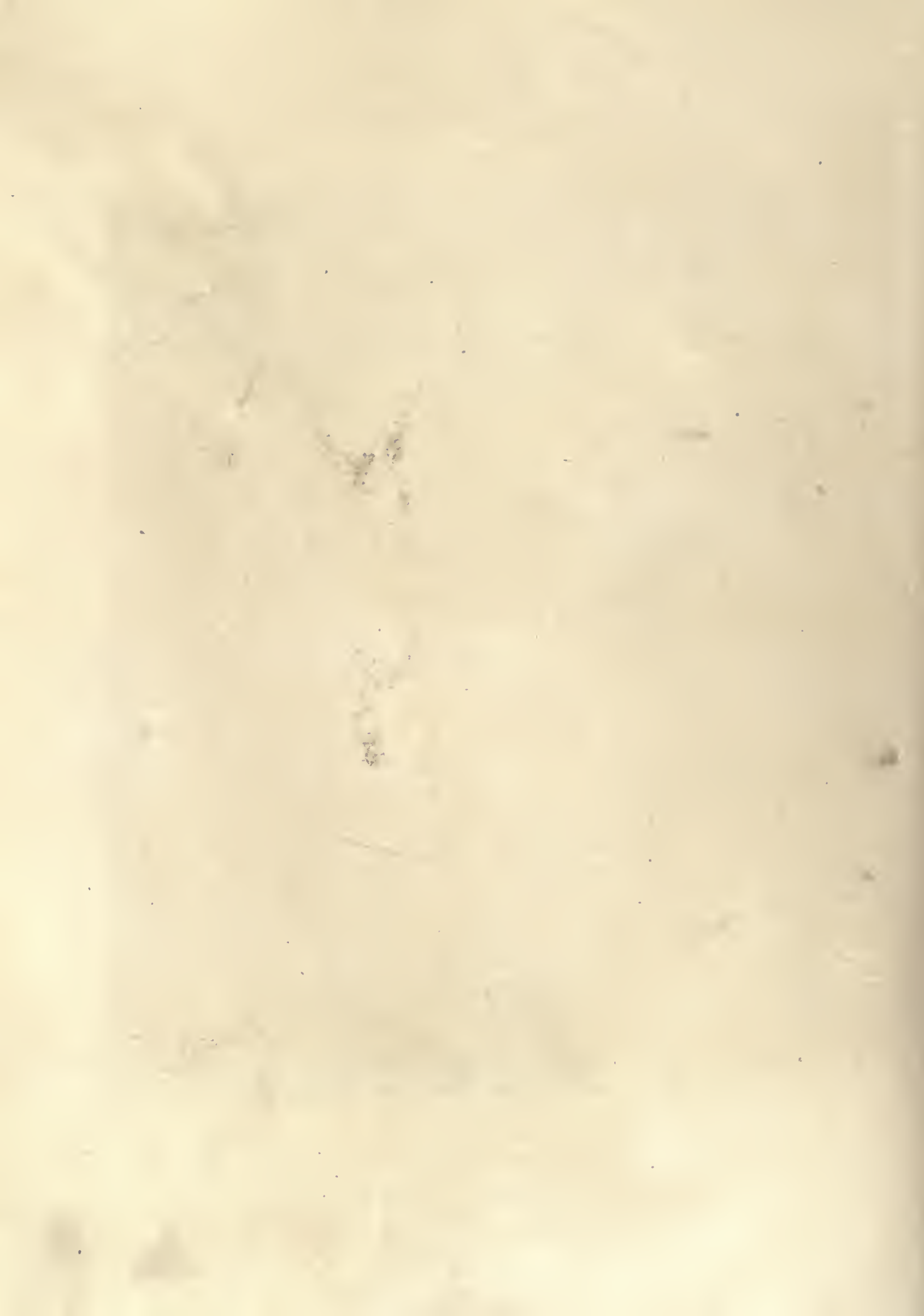



3426



HOUSE OF W. W. NICHOLS, ROCHESTER, N. Y.  
CLEMENT R. NEWKIRK, ARCHITECT  
WILLIAM PITKIN JR., LANDSCAPE ARCHITECT  
(See page 336 for floor plans)



3427



HOUSE OF W. W. NICHOLS, ROCHESTER, N. Y.  
CLEMENT R. NEWKIRK, ARCHITECT  
WILLIAM PITKIN JR., LANDSCAPE ARCHITECT



342 8



LIVING ROOM



FIRST FLOOR PLAN  
SCALE 1/8" = 1' IN FEET

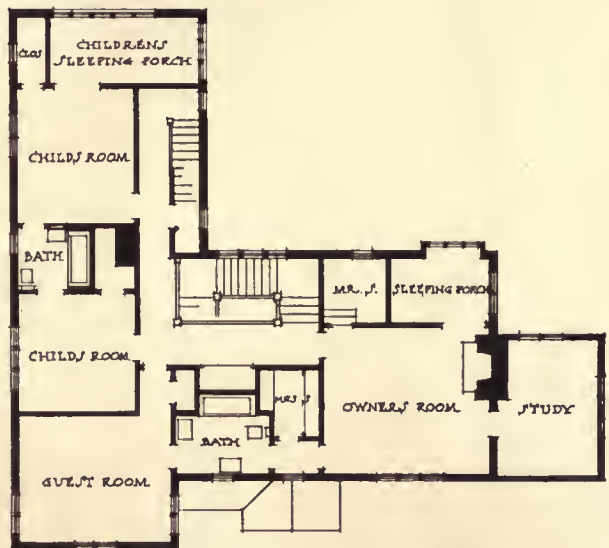

SECOND FLOOR PLAN  
SCALE 1/8" = 1' IN FEET

HOUSE OF RICHARD U. SHERMAN, UTICA, N. Y.  
CLEMENT R. NEWKIRK, ARCHITECT



# Housing Corporation Replies to Senatorial Criticism

FOLLOWING the results of the recent investigation by the Senate Committee on Public Buildings and Grounds, dated December 16, the United States Housing Corporation before its dissolution gave a reply which makes interesting reading. It is as follows:

"The United States Housing Corporation in a recent report of the Senate Committee on Public Buildings and Grounds is severely criticized for the policy of constructing a fairly permanent type of attractive, modern house. The committee calls attention to the fact that certain types of small 'ready-cut houses' had been constructed for about \$2,000. The report of the committee states: 'We do not pretend to be experts in industrial housing.' Housing did not call for better housing, or even just as good housing, but merely called for housing that would be sufficient. True, they must last during the war; but this was also required of cantonments. No one in the army complained of the lack of tile bathrooms, or in the navy of the lack of individual sleeping compartments, on the theory that the war might be long.

"The question raised is a fundamental one; it is of special interest to-day on account of the housing shortage, which has compelled attention to the subject of economical housing throughout the country. During the war period houses were built by several agencies of the Government. Besides the six thousand houses built by the United States Housing Corporation, houses were built by the Housing Corporation of the Shipping Board and by the Ordnance Department. All of the houses built by these agencies for industrial war workers were of a permanent construction and modern type, excepting certain smaller, cheaper and temporary types of frame housing and barracks which were built for locations remote from cities and which would obviously be of service only until activities terminated with the ending of the war.

"England went into the construction of war housing to an extent many times greater than did this country. The type of housing which the English Government built was of even a more permanent type than the houses built here. Several private housing corporations, notably the Bridgeport Housing Company, of Bridgeport, Conn., just prior to the time when this country entered the war built for the industrial workers of their crowded city a number of houses and apartments similar to those later on erected in Bridgeport by the United States

Housing Corporation. All this permanent type of housing is subject to the severe criticism and sarcasm of the Senate committee's report.

"The question now arises: 'Was the policy of the Housing Corporation, and incidentally the policy of the Emergency Fleet Housing Corporation, in the construction of modern, permanent housing wrong, and should these houses have been short-lived, temporary shacks or barracks to serve only the war emergency?' That question was carefully considered. The war loss to the Government in dollars and cents will probably be about the same in the case of the permanent and temporary housing. In the case of the permanent housing, there is a material salvage loss by virtue of having to sell a large number of houses in a very short time and at a material increase over previous housing costs. The temporary housing has less salvage value, but this loss is met in part by the lesser first cost of construction. But, granted that the financial loss to the Government is just as great with the salvage of the permanent house as it is with the temporary house, the Government has secured without extra expense the incidental salvage of having created a decent American home. Of all assets which the country has to-day, none is greater, none is needed more, than good housing, and the individual ownership of homes, which create loyal and useful citizenship. There was nothing to warrant the United States Housing Corporation to a procedure of filling up some of the best towns in the United States with a lot of cheap hovels which would have degenerated into slums and which would have been a disgrace to many cities now provided with decent Government housing.

"Industrial housing built by the United States Housing Corporation and by the Emergency Fleet Corporation was not designed nor intended for the alien or the common laborer. It was designed for the skilled mechanic, for the average American. The type of the house built was the type demanded and ready to be paid for by this skilled worker. He is doing it. All of the first-class houses built by the Housing Corporation were filled up as fast as they were constructed, and they have been bringing an income to the Government at the rate of over two million dollars per annum. The last houses in demand by the tenants or by the prospective house owners have been the cheap, temporary houses recommended in the Senate committee's report."

# Peking, the Violet City

## The Impression of Color as Presented by the Varying Aspects and Lighting of a Great City, Interestingly Set Forth

ONE does not usually think of a city as a color or even in connection with color, writes *Arts and Decoration*. We speak of it as being clear or otherwise; as being sunny, cloudy or foggy; but with the exception of the fogs of London and the brilliant skies of New York, who but a few remember the lovely opalescent mist that enshrouds Paris half the year, or the flaming reflections of Venice.

It has remained for Will Thompson in the September, 1919, issue of *Asia Magazine* to tell Occidentals of the exquisite hues of old Peking in paragraphs so charming as to make them interesting to everyone who has not seen this capital of ancient civilization. Mr. Thompson says in part:

"Late afternoon; on the wall of the Imperial City. Had I been asked to write an essay on the apotheosis of Peking, I assuredly would have written this one. Dreams of a golden dusk spent in the old garden of Prince Ching, last and greatest of the ultra-Manchus, have left their indelible impress deep in my inner consciousness. From such a place, at such a time, in company with such a personage, should an apotheosis be written. Alas, unhappily for me, it has not been done; and this remissness in my duties can never, I fear, be remedied. Past closed palaces and blood-colored walls of crumbling temples, accosted and dazzled by the late October sunshine, streaked as with fingers winy-red, I have come on a mission through the labyrinthine streets of the Imperial City. The chrysanthemums were blooming in the old garden of Prince Ching; and my eyes were fairly dazzled by the light on the tiles of the ancient palace. On my way back I shall purchase a bouquet of the aromatic beauties to adorn the large vase of *cloisonné* on the inlay table in my ancestral hall. Peking and her chrysanthemums, and the walls and roofs of the Forbidden City! Yonder they lie, forbidden now as always, those gleaming tiles of pure yellow, those soaring roofs carved in the images of beasts and birds rising before me, clad in a purple diaphanous veil which hides their lower parts.

"The Violet City permit me to call the widow of Peking; and Peking is bereft of her ancient Emperors. Whether or not an Imperial head shall

ever again sit in those magical corridors renowned since the Tartar conquest remains a matter of doubt. The Great Pure Manchu dynasty of Tsing, now at an end, enjoyed the unique distinction of being the last, perhaps, to sit on the Dragon throne; and though there are claimants aplenty to come forward and state their claims, not only of the Manchus themselves, but presumed descendants and 'shadow emperors' of the ancient Mings, China has decided to try out her fortunes under presidential guidance for a while. Which is all well and good; but China—the China we have always read and dreamed about—without an Emperor! The idea seems at first a little incongruous, until we get used to it. Slowly the beams have faded from the little paved courtyard where for a brief moment they held their dance. In complete shadow now, the Violet City goes through its nightly transformation, as so many times before; yet no life stirs within those grim portals, grown suddenly cold and terrible under the spell of approaching night; no light gleams from those darkened windows. It is as if the shadow of death had passed suddenly upon the scenes of life, once bright and gay as a flower-garden, leaving in its wake wreck and ruin and a nameless impressive silence. Gone is all lightness and gaiety from the porticoes which I have been admiring; and everything is merged together in a solid mass of impenetrable violet, as if some gorgeous creation in lead had been dropped into the fire, then brought forth and allowed to cool. Again, as I look at the curious phantasmagoria before me, the outline of Coal Hill and the farthest palace-roof appears cut out of purple cardboard, perfectly flat against a copper sky. Night descends, the stars thrill out expectantly; and still I sit, motionless, entranced by the magical dance of vapors in the cauldron-brew of night. The Violet City appears to rise, to grow taller, as by one supreme effort, then to fade, to melt slowly into the azure sky of which it forms a part. The copper glows linger, reluctantly, then turn to rose, like footprints of a departing Empress in the pasque-flower sky. And then I rise and turn back from the wall, saying softly to myself 'The Violet City is the widow of autumn—the apotheosis of Peking!'"



# Current News

---

## Happenings and Comment in the Fields of Architecture and the Allied Arts

### Meeting of New York Society of Architects

Two speakers contributed to the interest of the regular monthly meeting of the New York Society of Architects on Feb. 18. These were Mr. G. Osgood Andrews, who discussed the origin, composition and manufacture of glass, and Mr. Henry B. Hertz, of the architectural firm of Hertz & Robertson, who discussed the memorial building, Victory Hall, which he is designing for New York. The meeting, which was well attended, was presided over by J. Riely Gordon, chairman.

### Illinois Society Meets

The regular monthly meeting of the Illinois Society of Architects at the Art Institute, Feb. 23, was featured by a talk by F. T. Miller, president of the F. W. Dodge Company, and by an illustrated talk on "From the Texas Trail to the Table," by Mr. R. D. Hebb, representing Swift & Company.

Mr. Miller pointed out the great problems of construction brought about by long deference of projects during war times due to allocation of labor and capital to war's needs, and later to the manufacturing of luxuries. As one specific example he cited how the automobile industry has been buying up big plate glass manufacturing plants and sheet steel projects.

Mr. Miller made it clear to his audience that whatever happens, the great demand exists and will exist for construction. "Remember," he said, "that construction has had its lean year."

The difficulties in financing and in transportation were dwelt upon shortly by the speaker, and inasmuch as these problems combined with labor shortage, all have to be met, Mr. Miller urged upon the architects the necessity for standardization in the building profession. The National Federation of Construction Industries, which convenes in Chicago March 24-25, is active in taking up the problems affecting standards, and has been promised co-operation by the United States Bureau of Standards.

Upon a motion put by Henry K. Holsman the society voted that letters be sent to the proper recipients in Washington to show the society on record as favoring the passage of legislation to stimulate construction, especially the bills to encourage the building of homes by providing for the exemption from taxation of the income from mortgages under the limits as prescribed by H. R. 8080 and S. 2094.

### Art in the New Russia

A graduate of the Petrograd Conservatoire, Mr. Paul Dukes, who escaped from Russia last September, writes in the London *Daily Telegraph* that "Bolshevik art naturally favors the extreme modern, and is entirely in the

hands of the futurists. They have had the management of the decorations on all public holidays and festivities. The population wandered about, staring at the futurist extravaganzas with which the walls were decorated and wondered what on earth they could possibly be intended to represent. The futurist mania became at last too much even for the Bolsheviki, and when the question of decorations for May Day were being discussed a resolution was passed 'on no account to entrust the decorating of the city to the futurists of the art department of the commissariat of education.' The result was that there were no decorations at all.

"Numerous statues have been erected to prominent Socialist leaders, mostly foreign. Of these, Karl Marx is naturally the most favored. I am sorry to say many of these form futuristic eyesores in various prominent positions both in Moscow and Petrograd. The Bolsheviki also made a very grave mistake in allowing their enthusiasm to drive them into the erection of temporary monuments of plaster of paris which very soon wore away under the action of wind and rain and now form the veriest travesties of statues. A tolerable piece of sculpture, though sadly out of place, is the obelisk erected to commemorate the anniversary of the Bolshevik revolution and placed in the soviet square at Moscow.

"A feature of the exhibition held last summer in the Winter Palace was that anyone, artist or no artist, who cared to put pencil or brush to paper could have his productions exhibited. The exhibition was announced to be the biggest the world had ever seen—I have no doubt it was. Nearly all the pictures bore the stamp of advanced modernity, but there were also others to be found in remote corners of the palace."

### Durability of Green Timber

That there is practically no difference in the relative durability of green timber and seasoned timber when untreated and exposed to the weather and in contact with the ground, has been established by recent experiments conducted by the Forest Products Laboratory in connection with the manufacture of poles, posts or ties. In the case of ties laid by the laboratory in co-operation with the Northern Pacific Railway, the average life of seasoned ties was only one-tenth of a year longer than that of green ties and measurements on poles made by the laboratory in co-operation with the American Telephone and Telegraph Company, show that the rate of decay in green poles is a trifle less than in seasoned poles. The fact that green and seasoned timber have the same durability when used in exposed places is due to the fact that both soon reach the same moisture content, and this is the principal factor in determining the rate of decay of a stick of timber.

Wood for interior construction, however, should be thoroughly seasoned; otherwise it is likely not only to shrink to a serious extent, but to decay before it seasons.

## Educating Through Play

Some time ago there was held in Gunsaulus Hall, Chicago, an exhibition of toys made in America, the potential influence of which it is interesting to consider. The idea in presenting these things was to bring forward that element of beauty which students of childhood have learned to recognize as a vital force in the education of young people.

By repeated experiments of this kind, the manufacturer, it is hoped, may be convinced that beauty costs no more than ugliness, and that largely upon the care that he may exercise in this particular will the taste of future citizens depend. That he may then bring to his work the exhilaration of one who wields a power for good, and may raise its standards out of the class of the indifferently commercial into that of a constructive force in the community would seem the logical development.

## Swedish Housing Scheme—Iron and Building Trades Interested

According to the American Chamber of Commerce in London, an important housing scheme, which should be of great interest to all suppliers of iron construction and building material, has been instituted in Sweden, with a view to relieving the shortage of housing accommodation in that country.

The American Chamber is informed that this housing scheme entails the building of not less than 28,000 fire-places during the next three years, involving a total expenditure of 140,000,000 crowns, and it is proposed that the state should assist private builders by granting loans on favorable conditions from a fund of 80,000,000 crowns.

The German trust which formerly dominated the Swedish market in foundry and forged tubes by affiliating Swedish firms is reported to have ceased partially to exist, leaving the market more free for competition.

## Boston Plans Memorial

A memorial building to be erected on an artificial island which would be placed in the Charles River basin, at Harvard Bridge, is proposed as Boston's memorial to the veterans of the World War, in a report to Mayor Peters made by a special committee. The building would cost \$1,000,000 and the cost of laying out the island would amount to a like sum.

## Approve "South Park" Improvements for Chicago

The so-called "South Park" plan of Chicago, which calls for improvements eventually leading to a great park system to take the place of the now unsightly and decidedly sooty right-of-way of the Illinois Central, has been indorsed by Chicago voters, and bond issues duly authorized.

It is expected that work will start at an early date and contracts will be let for breakwaters behind which the outer parkway will be built. An inner breakwater will extend from Thirty-eighth to Thirty-fifth streets, and the outer constructions from Fiftieth Street to Jackson Park and from Grant Park to Thirty-fifth Street.

Contracts will be awarded at once for the grading and completion of Grant Park at a cost of \$3,700,000.

## Painter's Art to Exploit New Orleans' Beauty

An artistic movement to familiarize the country with the unique beauties of New Orleans is contemplated by Harry B. Lachman, landscape painter, who is exhibiting his work at the Delgado. Mr. Lachman has received the indorsement of the Association of Commerce and plans to begin activities as soon as he returns from exhibiting in Paris and London.

When Mr. Lachman returns from France he will bring with him several American artists. They will study the great range of subjects in New Orleans and after a period of work here by these and local artists a large exhibition of their work will be sent throughout the United States, perhaps under the auspices of the Association of Commerce.

Mr. Lachman desires to form a school in New Orleans, the French Quarter of which he believes very suitable for studios. Prominent New Orleans men have approved this purpose.

"This exhibition would be the means of making known to the art-loving public of the United States the unique beauties of New Orleans and would undoubtedly prove a great attraction to the traveling public," he says.

"New Orleans is practically unknown to the painters of our own country. I have found here the greatest range of subjects of any city in the new world. I might say there are few cities in Europe that can compare with New Orleans."

## British Railway Men's Leader Warns His People

James Henry Thomas, general secretary of the National Union of Railwaymen, said to-day that the state of the world was such that unless something were done speedily a crash would come in which nobody would suffer more than the workers.

Mr. Thomas declared that the British workmen must work a quarter harder than before the war, the French twice harder and the Germans eighteen times harder. He added that the labor party's difficulties arose, not through the cleverness of the other parties, but through jealousies in its own ranks.

## Spurns \$5,000,000 Offer

Sir William Orpen, the distinguished artist, has refused an offer of £1,000,000 (normally \$5,000,000) for painting 300 portraits, which is said to have been made him by an American.

"It is quite true the offer of £1,000,000 to paint portraits came to me from America," Sir William said to-day in confirming the report, according to the *Daily Mirror*. "To complete such a contract, however, would take far more than the ordinary lifetime—it might take as long as 300 years."

Sir William will go to America this fall on business.

## Why It Costs to Build

Building costs have risen from 84 to 240 per cent since 1913, according to Franklin T. Miller, New York publisher. He attributed this advance to the demand for automobiles and other luxuries, asserting these had drawn labor from the building industry and raised the cost of labor so much that rentals had gone up in sympathy.

## Tradition Again Yields to Progress —French Windmills to Be Removed

PARIS, March 3.—The world-famous Moulin Redet, one of the two remaining windmills which for centuries have crowned the Montmartre, is to be removed to make room for the construction of new houses. As this inevitably will ruin the picturesque spot from the artists' point of view, the painters are in despair, and lovers of old Paris are endeavoring to get the authorities to consent to the mill being moved to another site instead of being pulled down.

In the seventeenth century the hillside and top of Montmartre were covered with windmills. The number finally dwindled to two, Moulin de la Galette and Moulin Redet. For many generations the artists of all countries have sought out the Montmartre for the purpose of reproducing these mills on canvas. The section was a favorite one with American tourists and artists.

## Historic Home of Dr. Priestley Is Honored

The original home and laboratory of Dr. Joseph Priestley, the famous chemist who discovered oxygen in 1774, which is located on the banks of the Susquehanna River at Northumberland, Pa., was purchased recently by graduate chemists of the Pennsylvania State College, who plan to move it to the campus there and make it a lasting memorial to the great scientist.

Expert architects from the college will at once make the necessary surveys preparatory to the work of moving the Priestley home to the campus at State College. The house is of frame structure and a great deal of care will have to be taken in its removal. So far as possible, every bit of material now in the house will be used in its reconstruction. This will be a very difficult matter, for the house is now 123 years old, and the nails used are of the old-fashioned "hammered" type. Generous painting has kept the woodwork in a remarkable state of preservation, and it may be possible to rebuild the greater part of the structure from the present lumber. Immense pine timbers used in the frame work are as good as new, and the old-fashioned interior decorations—arched doorways, fireplaces and stairway—are in such condition that they can be removed and replaced with comparative ease.

The reconstruction on the college campus will be along the old architectural lines, but modernized and adapted to some suitable use by the School of Natural Science, according to present plans. The house is an old landmark in Northumberland County, and can be seen on the outskirts of the town from trains on the Pennsylvania Railroad passing Northumberland. It is a two-story structure, with capacious attic space. It is about 45 x 50 feet, with a projection at each end about 25 feet square. One of these was the kitchen and the other the workshop, or laboratory, in which Priestley pursued his scientific study and experiments. It is known in the neighborhood as the "office end." Professor A. L. Kocher, expert in architectural history and design at the college, has long been interested in the house for its historic importance among the old homes of Pennsylvania and has taken many exterior and interior photographs there.

Dr. Priestley's career as a scientist in the last half of the eighteenth century was one that has put him down as one of the greatest in history. He is credited with the discovery of oxygen and many of its properties in his laboratory in England in 1774. About the same time he

discovered ammonia and hydrochloric acid, and a year later, 1775, he was credited with the discovery of sulphurous acid gas. Within another year he found nitrous oxide (laughing gas). His discovery of nitric oxide dates from 1772. A large amount of his experimental work was conducted in Birmingham after 1780, where he considered his stay as the happiest event of his life.

He was a noted dissenter in religious views and was persecuted in England for his Unitarian teachings and activity. His house in Birmingham was mobbed and all of his chemical and physical apparatus destroyed. He was made uncomfortable in London, and not being sure of his life, he came to America in 1794. His sons had preceded him. He settled at once at Northumberland and built the Priestley mansion there. He continued his experiments there until his death in 1804. He was buried at Northumberland and the house and grave have been visited by interested persons from all parts of the world.

In 1874 a large number of chemists gathered there to celebrate the 100th anniversary of the discovery of oxygen. These chemists formed the nucleus of what is now the American Chemical Society. One speaker on that occasion said: "Of the most important gases known at present we owe nearly three-fourths to Priestley."

Dr. Priestley was a prolific writer, quite as much on religious subjects as on scientific ones. He was a vigorous and incisive teacher and preacher. His political principles found no favor with the Adams administration, and it is said that at one time he was threatened with expulsion from the country. However, he was a very ardent supporter of Jefferson, and was offered the position of Congressional chaplain, which he refused. His discoveries in chemistry would have established the fame of half a dozen ordinary workers, yet in his own opinion most of his results were accidental.

## Tense Situation in Albany's Building Shortage

According to reports Albany faces a critical housing problem and with no immediate plans for relief in sight, real estate dealers, builders and architects are wondering where hundreds of families will be housed. At the present time, the demand for homes is greater than the supply and builders are not contemplating putting up any new structures.

Building supplies are at a maximum price and several architects and builders do not look for any decrease within the next five years. With a prospect of additional labor costs in the spring, builders are inclined to be slow in making any plans for the erection of new homes until a more settled condition is obtained. Building in Albany is considered to be at a standstill with the exception of several large projects which are under way.

## Building in Milan

Consul Winship reports from Milan, Italy, that in order to relieve the housing situation in that city plans for the construction of about 1,000 concrete tenement houses in addition to those under construction have been prepared. These will be built on a cottage type in separate buildings, accommodating four families each, in all about 5,000 persons, and occupying an area of about 400,000 square meters.

## Movies Teach Process of Home Owning

The National Graphic Publicity Service of New York has in preparation a motion picture play entitled "The Home Builders," which is to be shown several times a day in the exhibition hall of the Grand Central Palace during the second "Own Your Home" Exposition from May 1 to 8.

The picture tells the story of a young couple desirous of building their own home. It takes them through the necessary steps to the achievement of this purpose, beginning with the real estate agent's office and a visit to the property to select a home site, insuring the title, securing the mortgage, consulting the architect and the contractor and the actual building and furnishing of the home.

There are so many thousands of people to-day who are anxious for information as to just how to go about building a place that will be all their own, but who lack the knowledge of how to proceed, that it is expected that this entertaining picture will give them in a pleasing form the information they require.

## New York Will Open Two New East River Tunnels

It is announced by the Transit Construction Commissioner that two new tunnels under the East River, New York, would be ready for traffic next month.

One of these is the tunnel from Whitehall Street, Manhattan, to Montague Street, Brooklyn, and the other extends from Sixtieth Street, Manhattan.

The reconstructed Brighton Beach and Culver lines can be routed through the tube from Montague Street so as to carry passengers from outlying sections of Brooklyn under Broadway, Manhattan, and as far north in that borough as Sixtieth Street.

Practically all of the track work in the Broadway-Fourth Avenue tunnel from Sixtieth Street, Manhattan, to Queensboro Plaza, Long Island City, has been finished and will be ready for train service about April 15.

Cars of the New York Municipal Railway Corporation are already in operation under Sixtieth Street as far east as Lexington Avenue, and as soon as the special track work at Queensboro Plaza is completed, under-river service can be instituted.

New Yorkers whom the housing shortage has driven to these districts will, it is hoped, have the compensation of good service in getting to and from the city proper.

## News from Various Sources

Delivery has just been made to the Finnish Government of fifteen American locomotives.

\* \* \*

The appropriation for the building of the twelve piers at Staten Island, originally \$14,500,000, has been increased by \$3,500,000.

\* \* \*

Soldiers in the Bolshevik army must submit to compulsory labor, according to advices received by the State Department at Washington.

\* \* \*

It is proposed to establish a club house on Bemini Cay, a small island of the Bahama group and a British possession, located about seventy miles east of Miami, Fla.

Figures compiled by the Foreign Trade Department of the National City Bank show that the total exports from Europe will result in an aggregate more than double that of 1918.

\* \* \*

The scarcity of housing accommodation in Switzerland is so serious that the Berne authorities have decreed that no foreigner may rent a house, flat or private rooms, but must live in hotels or pensions.

\* \* \*

The cement works at Concrete and Portland, in Fremont County, Colorado, have been compelled to shut down on account of shortage of railway cars, it has been announced to the Colorado Utilities Commission.

\* \* \*

Ten acres of land have been set aside by the Western Electric Company to be used as an athletic field for its thousands of employees and as a memorial to the thirty of their fellow workers who lost their lives in the war.

\* \* \*

Operation of the railroads, Pullman lines, express companies and waterways, unified under Federal control, has cost the nation approximately \$700,000,000, according to official calculation, since they were taken over two years ago.

\* \* \*

Negotiations for leasing Warwick Castle as a hotel for American visitors have fallen through as it was found that only thirty people could be accommodated at a time and the necessary alterations in the building would cost \$100,000.

\* \* \*

News has reached London that the British dump at Gallipoli, composed of Turkish booty, has been raided. Eighty thousand rifles, half a million rounds of ammunition and thirty-three machine guns were removed, probably to the Asiatic side.

\* \* \*

Abnormal costs of labor and materials will halt road building in the Mississippi Valley for several years, was the opinion of delegates to the conference of the Mississippi Valley State Highway departments. Nine States are represented.

\* \* \*

The De Forest laboratories of Highbridge announce that wireless telephone conversations have been carried on between Ossining and Chicago, with the use of a small aerial, a low wave length, and power of only one-third of one kilowatt.

\* \* \*

Positive assertion that the British Government does not plan to seek further loans in the United States, but, on the contrary, is desirous of reducing the obligations it has already incurred in this country, is included in a statement from London transmitted to Secretary Glass through R. C. Lindsay, British Chargé d'Affaires.

\* \* \*

The Dominion financial statement for January shows Canada with a net debt of \$1,900,000,000. The current revenue for ten months of the fiscal year was \$288,230,911, being \$17,000,000 more than ordinary expenditure. For the ten months the war expenditure was \$298,815,088. At the present rate the revenue for the fiscal year ending with March should be nearly \$350,000,000, the largest in the history of the Dominion.

# Weekly Review of the Construction Field

## Comment on General Condition of Economics with Reports of Special Correspondents in Prominent Regional Centers

The same page of a New York daily carries two articles which give contrasting points of view upon the building construction problem. The circumstances which have given them rise are of New York City, but the conditions are much the same as elsewhere and the same comparative forces will work out the situation's solution.

On the one hand is the warning from the City Comptroller that the \$15,000,000 school building program may not be completed within three years. Great concern is therefore expressed over the possibility of the schools being compelled to expand their half-time schedules in order to accommodate 100,000 pupils for whom there are as yet no accommodations. Contractors have written to the Board of Education asking to be relieved of contracts on account of the difficulty in finishing the work within the time limit and at the increased prices. If they lived up to the terms of their contracts it would mean financial ruin.

On the other hand is a suggestion from the City Chamberlain that the city utilize 7000 lots which it already owns as sites for bungalows to be erected by the city and leased to tenants at a nominal rental.

Between the two is the expression from labor upon high rents which offers two alternatives: a rent strike or a general infraction of trade agreements for the purpose of obtaining higher wages to meet the increased rentals, action being held in abeyance until the State Legislature has had time to act.

This looks like an impasse.

### THE CONTRACTORS

It was not argued by the contractors that the carrying through of their contracts was impossible, but that it spelt for them financial ruin. It would not be sane to urge these men to work to their own loss; for them to be willing to do so would be to carry public spirit a bit too far toward public detriment. It is not likely that the 7000 bungalows would be built more cheaply by the municipality than by a development corporation, nor that the municipality could acquire its materials more cheaply and easily than a contractor, nor that the result would be economically any more beneficial, or that the rents, provided they were just, would be lower. Municipalities cannot provide housing by edict and with no other expense than the bill which passes from the board of aldermen to the mayor. There is actual money involved and the money is collected in taxes and the taxes are paid by the owners of other houses and eventually by the tenants. The only people who could escape would be the occupants of the 7000 lots, who might have cheap rents at the expense of the rest of the city's population.

It does not seem like a short cut to cheaper rents. It is improbable that the usurpation by the municipality of the work of men who are specialists in building could make for the straightening out of a problem. Surely there is enough common sense in our population to effectively protest against such a mixing up of responsibilities and dumping them upon the State. It must be plain to every business man that experienced architects and builders are the only people qualified to work upon such a complicated problem. A failure to accomplish work three years in arrears through one year of thorough-going disorganization is no adequate reason why such men should be re-

lieved of the trust. Their failure to carry on work as they expected to be able to do before materials became difficult to procure and prices were so radically advanced offers no reason why they should not be made responsible for continuing the work with such expedition as they are able and as economically as the changed circumstances permit. One may believe implicitly in the teachings of radical economists and yet realize that now is not the moment for putting new theories into effect, or agents into the saddle. The middle of the stream is no place to swap horses.

### MUNICIPAL HOUSING

There are announcements from all over this country and Europe of dwelling projects being undertaken by governments and municipalities. They have a political aspect. Possibly many of such projects have been actuated by a feeling of insecurity among those in power and their belief that it is incumbent upon them to still the social unrest by giving heed to whichever shout is loudest. It may be that during the war governments were allotted extraordinary powers which they now are slow in abdicating. It is most likely that our growing appetite for propaganda which advises group movement and its economy of judgment leads us to say "housing" just as we say "production" and "Americanize," and as we used to say "hyphenate." Out of saying the word the population gets its satisfaction and the politician gets carte blanche.

By some the State ownership of houses may be thought desirable. The State as a competitor of private enterprise may seem to some to stimulate effort and indirectly to enforce justice. It seems that some people look upon their government, municipal or federal, as being capable of quickly supplying their every need; as being, in fact, run for that purpose. But everyone who believes in this country's past or future will know that such people do not make its strength nor its influence; they only make a lot of noise.

It is a splendid thing for people to co-operate in community building projects. It is wise and far-seeing for any locality to make building cheap and easy for its home-seekers. But it is quite another thing for office-holders to embark their constituents upon mammoth building projects for cottages to be rented at nominal sums. There was a time in Rome when they distributed corn; once in New York they used to give away coal; but to give out houses is carrying it too far. The constituents won't stand for it. And there need be no fear that this kind of competition will develop and normal building operations be stifled by it.

### THE IMPASSE

There is a shortage of housing and rents are high. There is a shortage of labor and wages are high. At this point labor, which has the power to make or mar, sits back and demands that wages be advanced or living expenses reduced.

It should be apparent to anyone that prices of rent as of food, and again of labor, are dependent upon the supply. To labor is attributed a policy of demanding "what the traffic will bear." The landlords are accused of heartlessly getting what they can. It would seem that the obvious means for labor to get back at the landlords

## THE AMERICAN ARCHITECT

would be not to strike and further deplete our stores of goods needed for consumption, but to get busy and reduce the shortages. When there is more space for housing than is actually needed it will be rather difficult to profiteer.

### THE OUTCOME

Upon inquiry it was found that the realty people have available between fifty and a hundred million dollars which is awaiting investment in new building provided there is assurance that contractors, dealers and building material manufacturers, and also labor, will not make advances in price within a stated period. Thereupon the mayor announces that it is his plan to bring these men together upon an agreement concerning a big building plan. He says with his customary wisdom: "I haven't the slightest doubt that the labor men will do everything to relieve the housing congestion by going to work with a will. Their loyalty to a good cause is never found wanting. Aside from that they will be helping themselves." So we are just about where we were before except that we have the mayor for an interlocutor. At this particular stage everything seems to have simplified; but there are a few actualities to be taken into consideration. Not only are steady prices needed, but enormous quantities of building material. Not only the labor of the building trades must be "loyal to a good cause" but the labor for the production and transportation of the materials. As the Governor of Pennsylvania says: "It is time to stop talking and get to work."

(By Special Correspondence to THE AMERICAN ARCHITECT)

**S**EATTLE.—Eastern steel manufacturers are standing firm this week against engaging any new commitments except on the basis of June or July delivery at the prices then in operation. Some of the larger jobbers have a supply of finished steel building essentials.

Corner bead is up from \$30 to \$35 per 1,000 feet. Jobbers were notified officially this week that the Youngstown Pressed Steel Corporation had withdrawn all quotations on metal lath. Jobbers are unable to get a sufficient supply of moulding plaster. Great Western leads in the scarcity. Jobbers in vigorous efforts to get 100-ton lots are advised that the manufacturers cannot load in less than two to three weeks. Brick and tile are plentiful, as the Puget Sound production is ample, and the market is unchanged.

Pipe-fitting and plumbing supply jobbers are unable to fill contracts for delivery of valves and fixtures, although there is a brisk demand.

The shortage of steel essentials is now being keenly felt. Many building projects in the business district are in great need of these materials, and while some have an assured supply through previous contracts the car shortage is preventing delivery.

In all quarters, however, the demand that building projects proceed is coming in for recognition. Architects are of the opinion that building activity in the North Coast territory has never before been exceeded, and it is noted that the higher grades of materials are being called for almost without exception. Few of these projects are the result of rebuilding as the result of fires, as the fire loss in this territory during the past year has been remarkably small. The climate permits outdoor building operations through the winter and there has been no lay-off season.

The fir lumber market, however, has begun to slip. Manufacturers and wholesalers who during the past ninety days have been selling cars of lumber placed in transit, as fast as they arrived at eastern destination, report that the demand has suddenly receded. The auction

market that has been conducted by reason of eastern buyers who bid against each other for flooring, ceiling and drop siding is disappearing. Eastern buyers who placed their orders as long ago as last May and are still unable to get them are vigorously pointing out that orders placed on the high market of this winter are being filled. The market since last May and June has advanced \$50 to \$60 on all finishing lumber.

(By Special Correspondence to THE AMERICAN ARCHITECT)

**C**HICAGO.—A record building boom in Chicago hangs on the wage dispute between the building trades council and local builders and contractors. Lumber and building material men are seeking to stabilize prices, cut down the cost of building homes and settle the question of housing and high rents. However, the building trades craft are insisting that a 25 per cent increase in wages is vital.

Labor leaders says that in normal times prior to the war there were 89,000 men in the building trade organization, which now has dwindled to 45,000. They claim that higher wages in other cities have drawn labor away from Chicago. This is particularly true of structural iron workers. Such a condition, however, is denied by building contractors, who say an increase in wages in Chicago will necessarily mean an increase in cost of building, thus continuing the "vicious circle."

Building operations in Chicago during January and February have increased about three and one-half times in volume over the same period in any preceding year, while the amount of money spent is probably five times as great. Contractors say that nothing can stop the building program but lack of money, and there will be plenty of that if the banks do not become timid because of a general rise in prices.

The investigation by the city council of "rent profiteers" so far has produced little results. Chicago is really paying the price of the costly building strike of last year. Lack of labor and adequate transportation has played a part in putting up the cost of sand to \$5 a yard, in the scarcity of cement and the shortage of brick. Common maple flooring is now selling at \$165 per thousand and structural timber has advanced about 250 per cent in the last two years. Reinforced steel and window glass are scarce.

The following are some of the proposals now pending before the Constitutional Convention now in session at Springfield, Ill.:

Legislature may authorize cities, towns and villages to regulate the intensity of the use of lot areas, to classify buildings, trades and industries with respect to location and regulation and to create residential, industrial, commercial and other districts.

Municipalities, upon payment of compensation, shall have power, in carrying out a general city and district plan, "to place restrictions against the use of land or lands needed in future for public use."

Subject to regulations prescribed by law municipalities shall have power to establish a city or district plan and to exercise control over the use of all land embraced within such plan.

Upon adoption by referendum, municipalities, or any other political division of the State, may issue bonds to encourage building of small homes or apartments, or building of homes for owner in fee of any land; under same general plans now in force with building and loan associations.

Zoning proposal, empowering legislature to permit cities to limit buildings and structures to specified districts, upon basis of their use or construction.

# DEPARTMENT OF ARCHITECTURAL ENGINEERING

## Economical Temporary Roofs for Fire-proof Buildings. Double Stairways for Factories

**I**T is a matter of common occurrence to construct a building of several stories in height with foundations and columns designed to carry several stories to be added in the future. Under these conditions a regular floor is constructed above the upper story to serve as a future floor and as a base for the temporary roof. These tem-

When the temporary wood construction is used a loss results in the short lengths and the breakage that attends such operations. In any event there is a dead loss of the labor of construction and removal as well as the material destroyed or rendered useless. To offset these costs the protection and use of a roof has been provided.



THE OAKES COMPANY BUILDING, INDIANAPOLIS  
VONNEGUT, BOHN & MUELLER, ARCHITECTS.  
INTERIOR VIEW SHOWING THE TEMPORARY DRAINS FROM THE ROOF.

porary roofs are usually constructed with wooden rafters and sheathing supported on short studs or by placing a cinder fill covered with a few inches of cinder concrete, pitched to drainage points and both serving as a base for the composition roof covering. Such temporary roof constructions involve the use of materials and labor and when the future stories are constructed the roof covering is a total loss, the cinder fill a rubbish to be removed.

To avoid such a waste of labor and material a different method was employed in the construction of the Oakes Company building in Indianapolis. This building is of the flat slab reinforced concrete type of construction. When the lower stories were constructed they were covered with a regular floor, made as level as possible and finished for future use. This floor was constructed exactly as those in the stories below, the top surface finish having

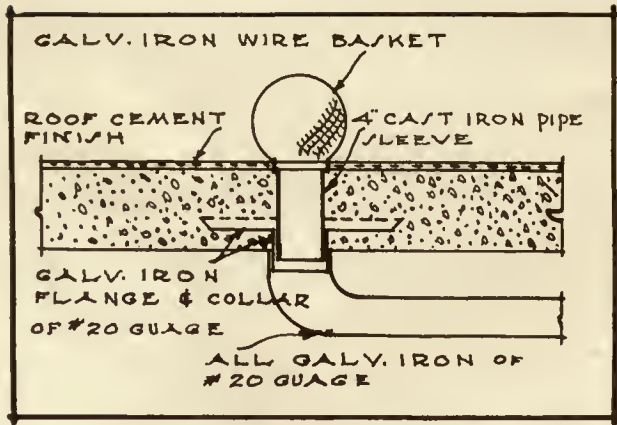

DETAIL OF TEMPORARY DRAIN CONNECTION

a metallic hardner incorporated in it. It was simply a first class job of floor construction. Instead of constructing a temporary roof as described above, the finished floor was exposed to the weather as a roof. Although the floor was made as near a horizontal plane surface as possible there was no noticeable amount of water left on the roof after a rain storm. And such water as did remain due to the slight depressions in the plane of the roof, soon disappeared through evaporation. It will be noted by inspecting the plan of this temporary roof that downspout openings were provided adjacent to

each interior column and were connected by 4 in. and 4½ in. galvanized iron pipes to the permanent 4½ in. wrought iron downspouts placed at the side wall. A 4 in. cast iron pipe sleeve was provided at each roof opening, which extended through the roof slab. A galvanized iron flange and collar of No. 20 gauge was built in the concrete slab as shown by the detail. To these were connected the 4 in. No. 20 gauge galvanized iron pipe placed below the roof slab and leading to the permanent downspouts. Each of these openings in the roof were provided with a galvanized wire basket in the usual manner.

This floor served as a roof for several years and gave entire satisfaction. When the future stories were added, it was only necessary to protect the finished floor surface during construction, remove the wire baskets and horizontal conductor pipes and fill the holes with concrete. The only possible loss was in the labor of removing these things, filling up the holes, less such salvage as might obtain. It is plainly apparent that a real saving of labor and material was effected. The plan, detail and photograph showing the interior of the upper story and the ceiling, adequately illustrates this method here described.

There is no doubt that this method might be duplicated to advantage in many structures.

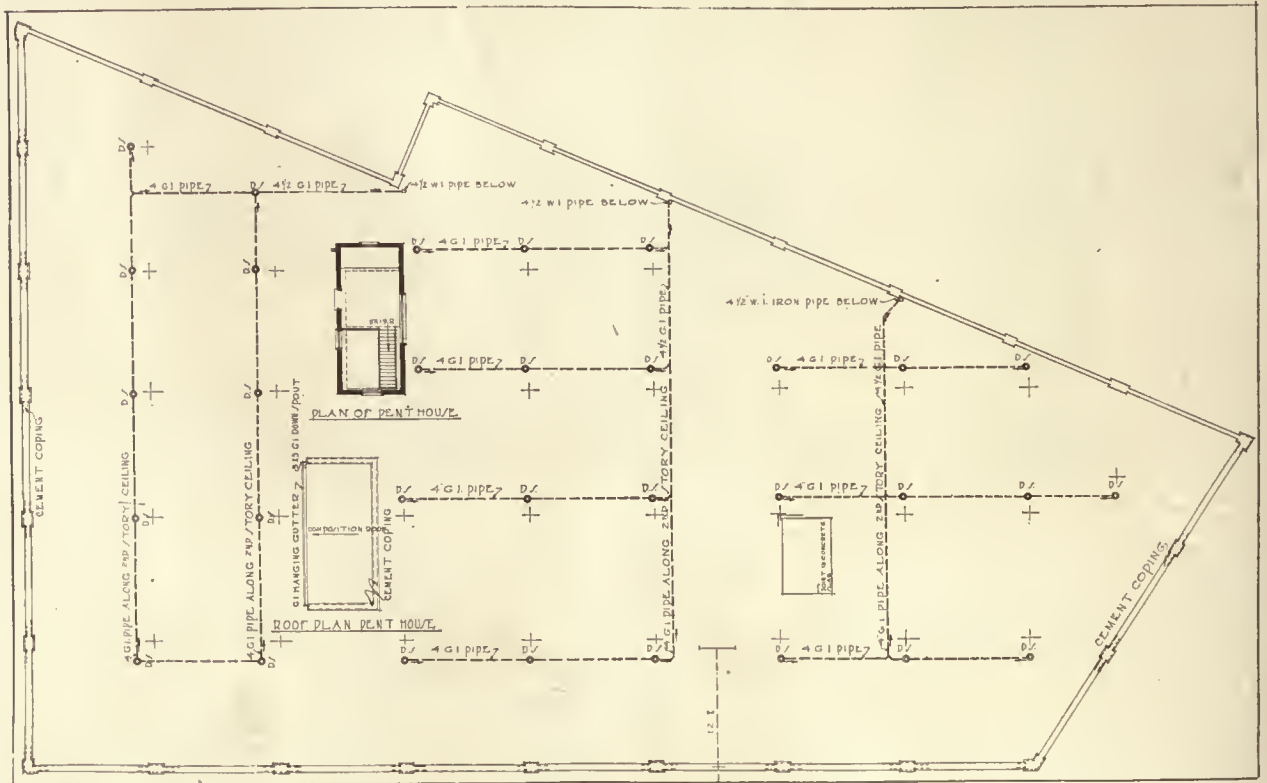

ROOF PLAN, THE OAKES COMPANY BUILDING.  
LAYOUT OF TEMPORARY DRAINS SHOWN DOTTED





KAHN TAILORING COMPANY BUILDING, INDIANAPOLIS. VONNEGUT, BOHN & MUELLER, ARCHITECTS  
DOUBLE STAIR EXIT SHOWN ON SIDE ELEVATION

**I**N the building for the Kahn Tailoring Company, Indianapolis, here illustrated, the so-called "double stairway" was used. This type of construction is described in *THE AMERICAN ARCHITECT* of April 16, 1919, page 557. This building is 200 ft. x 200 ft. in size with a large interior court. This interior court is connected with the street by a wide driveway extending through the first story. There are two sets of these stairs in the outside walls and two sets in the interior court. This in effect provides eight stairways, using a floor area equal to that which is usually provided for four ordinary stairways. Thus a double duty or service is secured without loss of floor area. The advantage of this arrangement, as a protection to life in case of fire, is readily understood.

In this building the height from top to top of floors is 14 ft. With a 6 in. thick platform this would give a clear headroom of 6 ft. 6 in. under the platforms. The story height is governed by the thickness of the platform construction and the allowed headroom. It is possible to construct such platforms as thin as 4 in. or less when made of reinforced concrete or metal plates. A study of the details shown in the article above mentioned will

clearly show the possibilities of this form of stair construction.

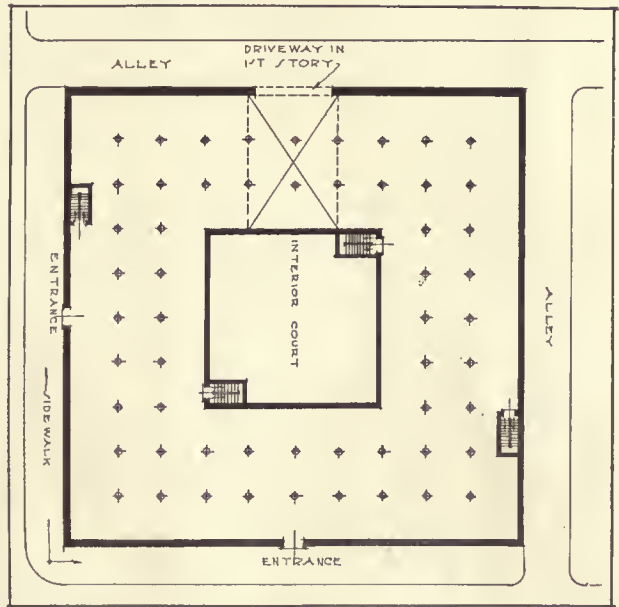

GROUND FLOOR PLAN, KAHN TAILORING COMPANY BUILDING. NOTE EXCELLENT DISTRIBUTION OF EXITS



KAHN TAILORING COMPANY BUILDING, INDIANAPOLIS.  
A DOUBLE STAIRWAY EXIT ON STREET FRONT

In the case of the stairs used on the building for the Kahn Tailoring Company, they are open on one side, the other three sides are inclosed in metal sash and wire glass. The fourth side is inclosed in the first story, where two exit doors are provided. The construction is clearly shown in the photographs and the locations shown in the sketch plan well indicate the very ample means of egress provided in this building.

The interior views show a work room and the cafeteria. In the former the natural lighting is shown to be ample. The artificial illumination is of two kinds, general and individual at the work tables. The general illumination is provided by ceiling lights and need only be of such intensity as to afford safe passage for the operatives. The table lighting will naturally be of greater intensity and adjustable to the individual needs of the workers.

The exterior of this building is of a simple and dignified character. The principal elevation with the return of three bays, is faced with brick. The balance of the exterior walls is of concrete. This building affords an excellent opportunity to compare a brick and a concrete wall. The brick piers are wider than the concrete piers, it is true, and therefore the brick faced elevation is in better proportion and slightly more ornate. It is doubtful if the concrete portion would in any degree compare with the brick portion even if constructed after the same detail. There is yet much to be done in developing concrete walls so as to produce a result that is in even a slight degree as pleasing as the walls finished in brick, terra cotta or stone. Even with the introduction of color and various kinds of surface treatment, it is doubtful if a concrete



TYPICAL INTERIOR VIEW, KAHN TAILORING COMPANY BUILDING, INDIANAPOLIS. IN WORKSHOP GENERAL ARTIFICIAL ILLUMINATION IS PROVIDED, SUPPLEMENTED BY INDIVIDUAL ILLUMINATION AT THE WORK.

surface can ever be made as pleasing in appearance as a wall of well made brick. The introduction of the stone bases under four of the piers in the principal elevation would have been an improvement in the design.

## THE AMERICAN ARCHITECT



THE CAFETERIA  
KAHN TAILORING COMPANY BUILDING, INDIANAPOLIS.

THE building of the Hibben Hollweg Company, Indianapolis, illustrated here, is a good example of simple and direct designing. The purpose of the building is clearly expressed in the design. The details of the ornaments are of such a kind and scale as to comport with the apparent stability and durability of the structure. It is an excellent example of a modern commercial building.

These buildings were designed and their construction supervised by Vonnegut, Bohn & Mueller, architects.



HIBBEN HOLLWEG COMPANY BUILDING, INDIANAPOLIS. VONNEGUT, BOHN & MUELLER. ARCHITECTS.

## Schoolhouse Construction and Its Relation to the Spread of Fire an Important Consideration

WITH the present generally poor structural conditions and lack of fire extinguishing facilities in many of the existing schools, the need for fire drills is evident, and in most states monthly fire drills are required by law or by school regulations.

The almost lightning-like speed with which many fires spread is generally due to a combination of combustible construction, large unbroken areas, open stairways, and various floor openings. Many of the older wooden interior schools, with central open and wooden stairs, and frequently without even the basement stairway cut off, are ideally designed for a quick-spreading fire that would cut off escape of the occupants. The studding, furthermore, is often unstopped from the basement to the attic, and a few minutes after a basement fire got under way the attic would be a mass of flames and the building doomed.

In contrast to such a school is the modern fire-resistive structure in which the amount of combustible material is reduced to a minimum, the fire areas are moderate, each room is capable of confining within its limits a fire of considerable intensity, egress stairs and other shafts are enclosed and there are two ways out from each important point.

*New Buildings.*—There is no excuse for anything but the best construction for new schools. The difference in cost between the best construction and distinctly dangerous construction is never enough to warrant exposing our children. Occasionally the better building is the cheaper. The literature of the National Board of Fire Underwriters, the National Fire Protection Association and the National Education Association is particularly valuable to the architect called upon to design a new school.

One-story schools need not be of fire-resistive construction to secure adequate life safety if they have individual room exits.

Two-story schools seldom need be of fire-resistive construction if areas are moderate and if adequately protected exits are provided.

Three-story and higher schools should be fire-resistive in the best sense of the word, with stairs and other vertical openings protected.

It is particularly important that where additions are built to existing buildings the new construction be modern from a fire standpoint and not a duplicate of the old, and that there be a definite fire cut-off between these two sections.

## Suggested Method of Checking Up Details and Superintending Building Construction

THE architect is not only called upon to provide drawings which graphically illustrate his conception of the building he has been called upon to design, and specifications which describe it, but he must also supervise its construction and see that the work is carried out to the minutest detail in accordance with that design.

Unless some careful system is worked out for accomplishing this detailed inspection, some things may easily be overlooked in checking up the details and this is particularly true when work is almost finished or when the owner has taken partial occupancy. In such cases there may be a myriad of items yet to be cared for which require some means of following up other than inspection and memory.

In this connection, methods used by building contractors might prove helpful. On the opposite page a form for checking used by Well Brothers Construction Co., and one which permits quick analysis of progress is reproduced. This check sheet is one which was used on work of the National Cloak & Suit Co., at Kansas City, the particular job being an eleven-story warehouse of 690,000 square feet floor area. Due to conditions now becoming quite familiar it was necessary to occupy the building with a full force on January 26, while considerable work still remained to be finished. The owners desired the quickest possible speeding up in order to avoid constant interference to efficient operation of their business.

While the check sheet reproduced covers only the item of toilets which always require considerable watching, similar checking sheets can be made up for each sub-division of the work.

It will be noted that in the column at the left are itemized details and across the top are column headings, 11-A, 10-A, 9-A, etc., which represent floors in "A" and "B" building while "N" and "S" refer to the north and south toilets respectively.

The heavy vertical lines shown in the various columns indicate that the work has been completed, while the check mark means absence of that detail in that particular toilet. A blank space denotes that the work has yet to be done.

One of the advantages in using a system such as here described, is that nothing is left to memory. A careful inspection of all check sheets will quickly indicate what work is still to be done. Different colors are often used in such work, and colored pencils may be used to advantage to show what

# THE AMERICAN ARCHITECT

progress has been made. For instance black for the initial week of the record and a different color for each succeeding week. This of course would only be satisfactory if the period of time required for such work was relatively short. It might be added that this system parallels to some extent the construction records kept on railroad work for

excavating, back fill and other items. This is made up day by day, on cross section paper, thus giving at the end of the job a chronological record of the progress.

Such progress charts are also kept on record in all large construction work and are found indispensable.

## Checking Sheet Used on National Cloak & Suit Company's Building, Kansas City

	Toilets										2-29-20					
	11A	10A	9A	8A	7A	6A	5A	5B	4A	4B	3A	2A	2B	1A	1B	
	NI	NI	NI	NI	NI	NI	NI	NI	NI	NI	NI	NI	NI	NI	NI	
ROUGHING IN																
STOOL SET																
BARRY ..																
SOAP BOXES SET																
PAPER RACKS ..																
RADIATORS ..																
TILE WALL																
.. FURRING																
VERT SCREENS																
MARBLE SET																
.. STUOL																
STALL HINGES																
.. DOOR STRINGER																
VESTIBULE HINGES	✓	✓	✓	✓	✓	✓	✓	✓	✓	✓	✓	✓	✓	✓	✓	
BROWN COAT																
WRITE ..																
PATCHING																
BACK PUTTY	✓	✓	✓	✓	✓	✓	✓	✓	✓	✓	✓	✓	✓	✓	✓	
OUTER DOOR HUNG																
.. .. TRIM																
.. .. CHECK																
STALL .. HUNG																
.. .. BOLTS																
.. .. BUMPS																
VEST. .. HUNG	✓	✓	✓	✓	✓	✓	✓	✓	✓	✓	✓	✓	✓	✓	✓	
COAT RAIL																
MIRROR																
PIPES COVERED																
5 DOORS HUNG	✓	✓	✓	✓	✓	✓	✓	✓	✓	✓	✓	✓	✓	✓	✓	
WOOD DOORS PAINTED																
WALLS FURRED																
.. 1ST COAT																
.. 2ND COAT																
RADIATORS PAINTED																
JOINTS PAINTED																
PLASTER ..																
1 DOOR ..	✓	✓	✓	✓	✓	✓	✓	✓	✓	✓	✓	✓	✓	✓	✓	

HEAVY VERTICAL LINES INDICATE COMPLETED WORK; A CHECK MARK MEANS ABSENCE OF THAT DETAIL IN THAT PARTICULAR TOILET; A BLANK SPACE DENOTES THAT THE WORK IS STILL TO BE DONE

## A Simple Support for the Skyscraper's Flagpole

THE use of the flagpole is coming into more and more favor for topping out the tall building. Unless one carefully observes such a flagpole during a high wind storm it is difficult to realize the extent of the pressure, and the strain to which it is subjected at such times. The necessity of providing an adequate, yet simple support is apparent.

by 4 in. cross channels. At the center two 6 in. cross channels spaced  $10\frac{1}{2}$  in. apart were framed into the longitudinal beams and a steel flagpole base connected as shown in Section B-B and Plan C-C. This base consists of a  $14 \times 14 \times \frac{1}{2}$  in. plate and four  $3 \times 3 \times \frac{1}{4}$  in. angles.

A circular collar, made of  $2\frac{1}{2} \times \frac{3}{8}$  in. flat steel is placed about five feet above the base, this being

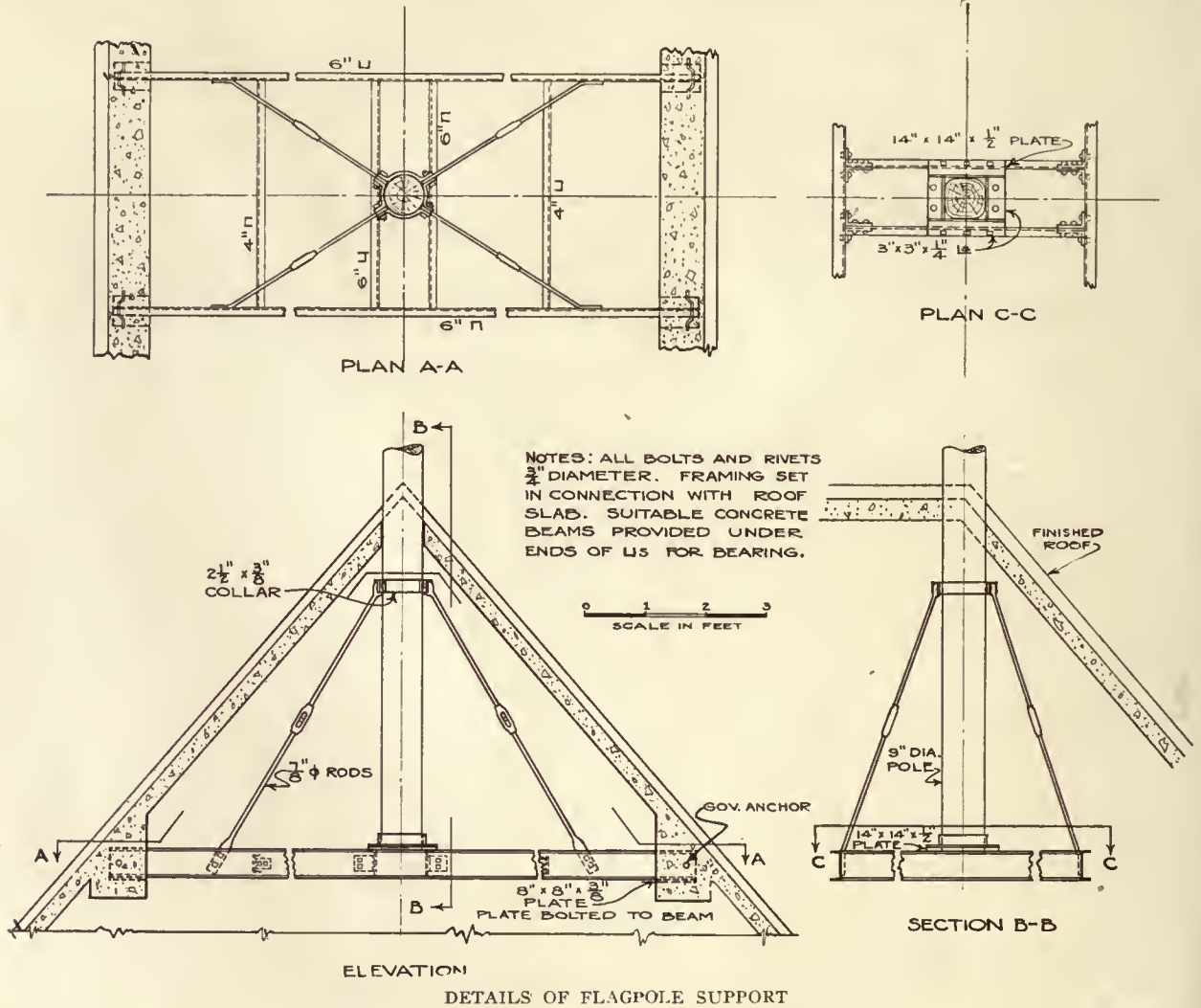

The accompanying detail shows the construction in a tall building recently erected in Philadelphia. The structural framework of this building is of reinforced concrete, including the sloping roof.

Two six-inch channels approximately 4 ft. apart were well anchored at their ends into the reinforced concrete roof beams, and stiffened laterally

made in four sections as shown in Plan A-A, so as to provide a simple top connection for the four stay rods, which are connected by two bolts apiece at their lower ends to the 6 in. channels. These rods are  $\frac{7}{8}$  in. diameter and are provided with turn buckles to take up any slack.

This construction forms a simple yet satisfactory support for the flagpole.

358

frontis piece to No 2309



A PATIO IN CORDOBA

THE AMERICAN ARCHITECT



# THE AMERICAN ARCHITECT

VOL. CXVII

WEDNESDAY, MARCH 24, 1920

NUMBER 2309

## Architects and the Public

Do the Client and the Public Understand Architecture or What  
an Architect Is?

By FRANCIS S. SWALES, *Architect*

WHETHER architecture comes within the province of the "highbrow," or a commercial calling, presents a question which seems to puzzle alike for an answer the general public and those who assume, adopt or are "authorized" to use the title of architect.

Just why a self-denominated, supposedly intelligent person should be in doubt as to what it is that he claims to be is not very apparent. Why an association of such persons should be found asking "Where am I at?" and answering themselves, "God knows!" is still more difficult to comprehend.

But, "What is an architect?" asks a little pamphlet received from the publishers of *The Journal of the American Institute of Architects*. It answers itself, as might be expected of a politic servant of any such body as the Institute, containing, as it does, so many men of so many different minds. Its answer is: "There are many definitions." Correct! The "dictionary definition" is that the architect is the chief builder. But of buildings—there are also many definitions.

Mr. F. P. Dunne, who through his character "Mr. Dooley—the keeper of a little liquor store in the outskirts of Chicago"—has given us many literary capsules containing the essence of popular judgment and opinion, answered the question some years ago by the example: "Mike Angelo's an architect, and so's McKim."

His definition is clear, leading everybody to infer that the dome of St. Peter's at Rome, Columbia University's Library, The University Club of New York, Harvard University Gates, etc., may be regarded as examples of architecture—models of the kind of work which an architect is popularly supposed, provided he finds the opportunity, to produce. It implies that had "Dooley" given more names, and at a later date, he might have men-

tioned McGinnis and Walsh, Casey and Dillon, Sullivan, O'Connor and Murphy and Dana; and allowed us to gather that the names and work of Cass Gilbert, Pierce, Anderson, Pope, Hastings, Barber, Swartwout, Sawyer, Platt, Goodhue, and a lot of others—if it will not be invidious to mention a few and not the others!—are well-known in sundry places that we, within the profession, wot not of. But is anybody interested in definitions of an architect? Is an architect an enigma? The interest which the world takes in architects is regulated by the quality of architecture the architects can produce. And the quality of architecture that the architects can produce is in its turn regulated by the character of client for whom it is primarily designed.

Why, during the past few years especially, has the question so often been raised in our technical press as to whether an architect is an artist, a professional man or a business man? Is it because the profession is divided into three groups—one insisting that the producer, the draughtsman, engineer and designer; the second, that the adviser, the man with experience and knowledge of costs, operations, and the law connected therewith; and the third, that the merchant, or he who knows how to sell the architect's product—his experience and power of accomplishment—is the only really valuable factor in "architectural service to the client"? Does it seek an answer to the question whether the client demands a "business man" when he calls upon an architect for the performance of certain work, or is looking for that which the public understands as an artist: a picture-maker, scenery-producer, illustrator or painter? These are all in the day's work of the architect, but none, nor all of them, is the whole of it.

What does the client usually state that he wants, the first time he meets the architect? Does not

his expression almost invariably contain the words "I want a *design*," or "I want *plans* for," etc.

The client is, usually, "a business man": a manufacturer, trader or executive in some business concern, or "a professional man" himself. He is the possessor of better than average intelligence. He does not need to be told that every architect cannot be a Michael Angelo, nor a McKim, but if he feels the work justifies it he will seek such ability. He hopes "his architect" will produce something he can take pride in owning. He may have definite or very indefinite ideas as to what he wants in plan or appearance, but he knows quite well that he depends upon the architect for the design. And upon the design will depend very much the price at which he can dispose of the building if occasion arises to compel him to do so, or if such is his ultimate object. No observant real estate dealer of to-day needs to be informed that space in a well-designed office building or apartment building will rent at higher rates than in one that is not so well-designed, or that a house "designed by an architect" of reputation will command a high premium over another of equal size and accommodation "built by a builder." He knows as well as the architect that appearance inside and out is, next to location, the greatest commercial asset a building can possess. Few clients are unfamiliar with the wisdom of the real estate man. Figuratively the design as shown by drawings is the seed from which the building grows. It contains the life of the building. If the seed is unhealthy, the building will be unhealthy. As with plant life, the ordinary human can form some judgment as to the worth of the grown plant, so he can form his judgment of the completed building—or design in execution. But it requires some special learning to distinguish between seeds and also between designs as shown by drawings; especially to determine that which will probably result from them; and the client does not, usually, possess a sufficient understanding of drawings to bring his imagination to a visualization of the result in execution. A good set of drawings of a poor design or a poor set of drawings of a good design may easily deceive him.

Good appearance—that which enjoys permanent popular appreciation—is understood in the *result* but seldom in the drawings. Which is the case, also, with effective, intelligent planning, upon which not only appearance but efficient use depend. The plans and the elevations—the drawings of the "arrangement" and "appearance"—for the various parts of the work constitute the seed—the design in the embryonic state. The great mass of technical detail, all of the ordinary sciences employed, may be likened to fertilizer of the plant. It con-

tributes to its strength and development if it is the right kind; and knowledge as to that which is the right kind is obviously essential to the architect.

As to the advice which an architect as a professional man supplies, it may be taken for granted that like advice received from a doctor or lawyer or anybody else presumed, or presuming, to be able to advise on the strength of his experience and knowledge, the client may act upon some of it; but in the average case will conclude that his own judgment is more often best. Only the exceptionally well-balanced and best-educated clients may be expected to assume that acceptance in full of the professional judgment as represented by untrammelled plans and specifications is better for his interests than following his own preconceived opinions. On the other hand, the weaker, the more ignorant the client, the more he will insist upon instructing and advising the architect in matters often so elementary that the professional man has ceased to regard them as "knowledge," except as that common to every school-boy.

Yet many things very obvious to the architect in matters of building are so obscure to many a highly intelligent layman that he is often inclined to regard any advice from the architect, if volunteered, as an impertinence or unwarranted assumption of knowledge superior to his own "common sense."

But, what a very *uncommon* thing that "common sense" is! It is seldom to be found in the proud person, especially if his pride is in his position or wealth; never in the vain one. And pride and vanity are the commonest of human traits. The commoner the client the more they will be displayed in his judgment—and reflected in the architecture of his building. But the finer qualities of the finer personalities are equally sure of interpretation; for such clients possess the instinct which leads them to the best advice and leads them also to accept and use it fully to their own advantage and to that of the public at large. Such clientele is growing in great numbers in the United States to-day. Do we not find the proof of this in the fact that the best of our architects have such large practices that they are compelled to organize their offices to the most perfect state of business system and productive efficiency, in order that every possible minute of the designer's time may be spent upon design?

The architect as a designer is not simply an artist dealing solely with appearance—form and color—as is the case with the decorator, nor with "drawings" only, but is one working in practical arrangement and construction, which in true economy must be decorative. His work is limited only to

such constructions as "it pays" to give at least a measure of beauty. It differs essentially from the work of the civil engineer in that it does not include works which do not require consideration of appearance or in which appearance is of but minor importance, such as the design of reservoirs, tunnels, dry-docks, canals, sewers, water conduits, dams, roads, embankments and other earthworks; the design of machines, such as boilers, engines, pumps, dynamos and motors or the calculation of sizes of conduits of various kinds connected therewith. The field of engineering as applied to buildings, however, belongs to the architect, as it affects and is affected by arrangement and appearance, and must be absolutely controlled by him, as his is the only profession competent to control and coordinate its many special branches, also to decide upon their relative importance to a particular building; and to determine the fitness of "specialist" engineers when and if required. To the architect, however, engineering is a means to an end—not the end itself. He must hold to the theory of Euclid—that the whole is equal to all of its parts taken together.

The *design* of the dome of St. Peter's is not only its beautiful form, or the decorative treatment of its exterior and interior; or its wonderfully inventive qualities or originality of construction; but of all of them taken together with the suitability to the purpose for which it was built. It was the work of no mere structural engineer whose knowledge is limited to the *science* of construction, but of a mighty architect with the understanding of the art of building, who, while not called upon to deal with equipment involving hydraulics, steam and electricity as is an architect of to-day, was, in addition to being an architect, one of the greatest sculptors and painters the world has seen.

The client is clearly the important problem in the practice of architecture. He equates all the other factors. He is equal to the completed building which is the whole work of the architect. He can make a good or a great thing possible, or he can ruin it by an effort to dominate in the designing. The measure of his understanding is taken and the quality of his knowledge is proclaimed by the kind of architecture or building that results. Upon the kind of client which the architect obtains, will depend to a great degree the architect's reputation; which raises the question: Has the architect any power of selection of his clients? I shall contend that he has. That it is within his power, also, to educate his client and to develop his best traits.

The client which every architect worth the title desires is the kind which only those of the highest attainments secure. They, as the articles by Mr.

Glenn Brown, recently published in *THE AMERICAN ARCHITECT*, show the late President Roosevelt to have been, are people of such broad culture, understanding and keen observation that their judgment of the completed work of the architect is as comprehensive as that of the best students of the subject. Such client is an aristocrat—a word which, like the word architect, has "many definitions," but only one meaning, *of the best*. And the requirement of such clients is:—*of the best*—not the excessive demand of "the man with money and nothing else," for "the best on earth" and all there is of it; but the reasonable demand for the best obtainable—enough to meet their needs. With the aristocrat as a client it becomes a question solely of the architect's abilities whether architecture equal to that of Michelangelo or McKim will result. Clients of this kind are obtained as prizes resulting from previous best endeavors. They will come to the architect not merely *trusting* to his ability but with the knowledge of it. They *may* come for a Columbia Library or the dome of a vast cathedral, but, at first, they are likely to come for a house of moderate size, a small hospital building, bank, church or school, and they may come for a commercial or industrial building. The greater things—the monumental buildings—come when a satisfactory answer can be given to the Napoleonic question: "What has he done?" Does it seem that I am contending that the calling of the architect is that of the "highbrow"? And what is a "highbrow"?

Its origin and definition are given by Professor Stephen Leacock of McGill University, Montreal, in his "Essays and Literary Studies," in which he states his views of the American reading public as follows: "The great mass of the American people, such as live in frame dwellings in the country, or exist in city boarding houses, ride in the Subway, attend a ten-twenty-thirty vaudeville show in preference to an Ibsen drama, and read a one-cent newspaper because it is intellectually easier than a two. This is the real public. It is not, of course, ignorant in the balder sense. A large part of it is, technically, highly educated and absorbs the greater mass of the fifty thousand college degrees granted in America each year. But it has an instinctive horror of 'learning,' such as a cat feels toward running water. It has invented for itself the ominous word 'highbrow' as a sign of warning placed over things to be avoided.

"The word to the American mind conveys much the same 'taboo' as haunts 'the tomb of a Polynesian warrior, or the sacred horror that enveloped in ancient days the daró pine grove of a sylvan deity.'

"For the ordinary American this word 'highbrow' has been pieced together out of the recollections of a college professor in a black tail coat and straw hat destroying the peace of an Adirondack boarding-house; out of the unforgotten dullness of a Chautauqua lecture course, or the expiring agonies of a Browning Society. To such a mind the word 'highbrow' sweeps a comprehensive area with the red flag of warning. It covers, for example, the whole of history, or, at least, the part of it antecedent to the last two presidential elections. All foreign literature and all reference to it are 'highbrow.' Shakespeare, except as revived at twenty-five cents a seat with proper alterations in the text, is 'highbrow.' The works of Milton, the theory of evolution and, in fact, all science other than 'Christian Science' is 'highbrow.' A man may only read and discuss such things at his peril. If he does so, he falls forthwith into the class of the Chautauqua lecturer and vacation professor; he loses all claim to mingle in the main stream of life by taking a hand at ten-cent poker, or giving his views on the outcome of the elections."

Now Professor Leacock as a Canadian observes the American public from the advantageous standpoint of an onlooker with the particular advantage which the Briton himself admits of the superior British intelligence and judgment. He regards the "great mass of the American people—the real public" from above, and, so regarded, it bears this resemblance to that beverage of history known as the gin-fizz, it appears as a circle of froth, but below is a substance homogeneous, made up of a number of good ingredients with the power and the tendency to add to the joy of living of those who understand its strength and nature and that it may not be taken as a "stream." His view of the public is the mistaken one of those "architects" who claim that "the public don't know and don't care."

It is by no means disposed to 'taboo' the intellectual pleasures of life. The average American, with as much as a public school education, has read something of Shakespeare, and, perhaps, also of Milton; but he declines to *recite* it or to listen without some expression of mechanical humor to anybody else attempting to recite it; nor will he discuss it if the object of the discussion appears to be a competitive display of knowledge. Yet he may be interested in the subject in a general and casual way, but it is not his principal or one of his principal interests. That, I think, is his attitude toward architecture.

The training and education of architects and their theories of art, the sciences on which their knowledge of construction, mechanical equipment, materials and methods of doing business are found-

ed and their professional ethics are uninteresting until he is compelled by some cause to pay attention to them. He does not doubt that architects, like other business and professional men, are possessed of a great deal of special knowledge relating to their work, but it is something beyond any necessity on his part to understand, and that which does not interest him and which he does not care to understand is "highbrow." Much of the special knowledge, as of the laws bearing upon the relations between architect, builder and owner; all of the elementary academic science acquired in a university course, knowledge of by-laws relating to building construction and sanitation; organization of the architect's office, conduct of operations, etc., are commonplace, paralleled in his own affairs but along another line. If his interest can be aroused by the work of the architect it will be as regards its phases that are not commonplace. It will be in the creative work, expressing ideas, effects, impressions. If he finds the building convenient, appropriate and beautiful he will almost certainly comment upon it, at least while it is new. In a word, it is the *architecture* that interests him.

The "ten-twenty-thirty vaudeville" is given in a modern, attractive building by a modern showman who understands "the house is part of the show." The "Ibsen drama," being for people interested only in Ibsen, is almost certain to be given in the least attractive, cheapest theatre available, on the old assumption that "the play is the thing, and nothing else counts." The young American woman knows that she looks better in her furs than in her calico wrapper; likewise, that it is to her advantage to be placed in a setting of beautiful surroundings. Entertainments which cause her to smile are also to her advantage, enhancing her attractiveness. She prefers "shows" at which she is not exclusively an onlooker. Such are the undercurrents which spell success for the "ten-twenty-thirty vaudeville" and failure for the Ibsen drama with the "mass of the American people."

Our people are not dull to pleasure of the intellect. The immense sales of gramophone records of the finest musical compositions and of reproductions of such pictures as Whistler's "Mother," Sargent's "Carmencita" and frieze of "The Prophets," the decorative prints of the work of Maxfield Parrish and Jules Guerin, are positive proof of popular appreciation of the best that is being done about us. But as to "Old Masters," genuine as well as fakes, they are for the student of "highbrow" but of not much interest to the masses. American interest in antiques and their copies is affected or fictitious except when, as is often the case with furniture and rugs, the old is more pleasing to the eye

(Continued on Page 372)



ENTRANCE DRIVEWAY, ESTATE OF WILLIAM S. WALBRIDGE, TOLEDO O.

## The Relation Between the Architect and the Landscape Architect—Part II

By WILLIAM PITKIN, JR., *Landscape Architect*

Illustrated by examples of work by the Author

THE estates of D. M. Ferry, Jr., and Senator Truman H. Newberry, at Grosse Pointe, Mich., developed in association with Messrs. Trowbridge & Ackerman, architects, are excellent examples of the difficulties encountered on the long, narrow lake shore lots typical of that section. They show the possibility of attaining through co-operative effort a harmonious house plan and landscape plan.

The Ferry house, though built entirely above the ground level, and having practically a full basement story, has been given the feeling of standing down on the ground by an arrangement of terraces on the lake side, and by raising the forecourt several feet above the lawn grade, which difference in grades is disguised by the forecourt walk and planting. This has required the minimum amount of

grading and has added much to the attractiveness and interest of both the architectural and landscape treatments.

As will be noted in the plan, the solution is also unusual in that the lake façade centers on the broad lawn, while the street façade is off center in order to bring the entrance on axis with a fine double row of trees which form the setting for the approach drive.

The Newberry plan recognizes the desirability of leaving the lake view unobstructed and the broad lawn unbroken. To accomplish this the drive is brought to the rear, and the service entrance concealed by a wall and planting at the end of the house. The plan further ties the garden scheme into the house plan by placing a semi-formal music court adjacent to the large music



"STONECROFT," ESTATE OF WILLIAM S. WALBRIDGE, TOLEDO, O.

room, so that it seems to be merely an outdoor portion of that room. The visitor is thus introduced into the first of a succession of gardens which form a delightful stroll about the estate.

"Heithock," the residence of Mr. C. G. Edgar, Grosse Pointe, Mich., of which Mr. Albert Kahn is the architect, was placed within fifty feet of the lake to fit the topography and the existing tree growth. The abrupt slope required a careful study of the grade problem, which has been solved by the terrace treatment shown in the photograph.

This makes the house appear to stand firmly on the lower level, and produces a nice relation between the first floor of the house and the lower lawn which has been so developed as to emphasize its extreme length. The plan shows the garden properly related to the important living rooms.

The landscape plan took advantage of a beautiful river view in determining the location of the residence of Mr. W. E. Bock of Toledo, of which Mr. George Rheinfrank is the architect. It utilizes the river bank for a series of terraces, of which



SERVICE COURT ON ESTATE OF WILLIAM S. WALBRIDGE, TOLEDO, O.

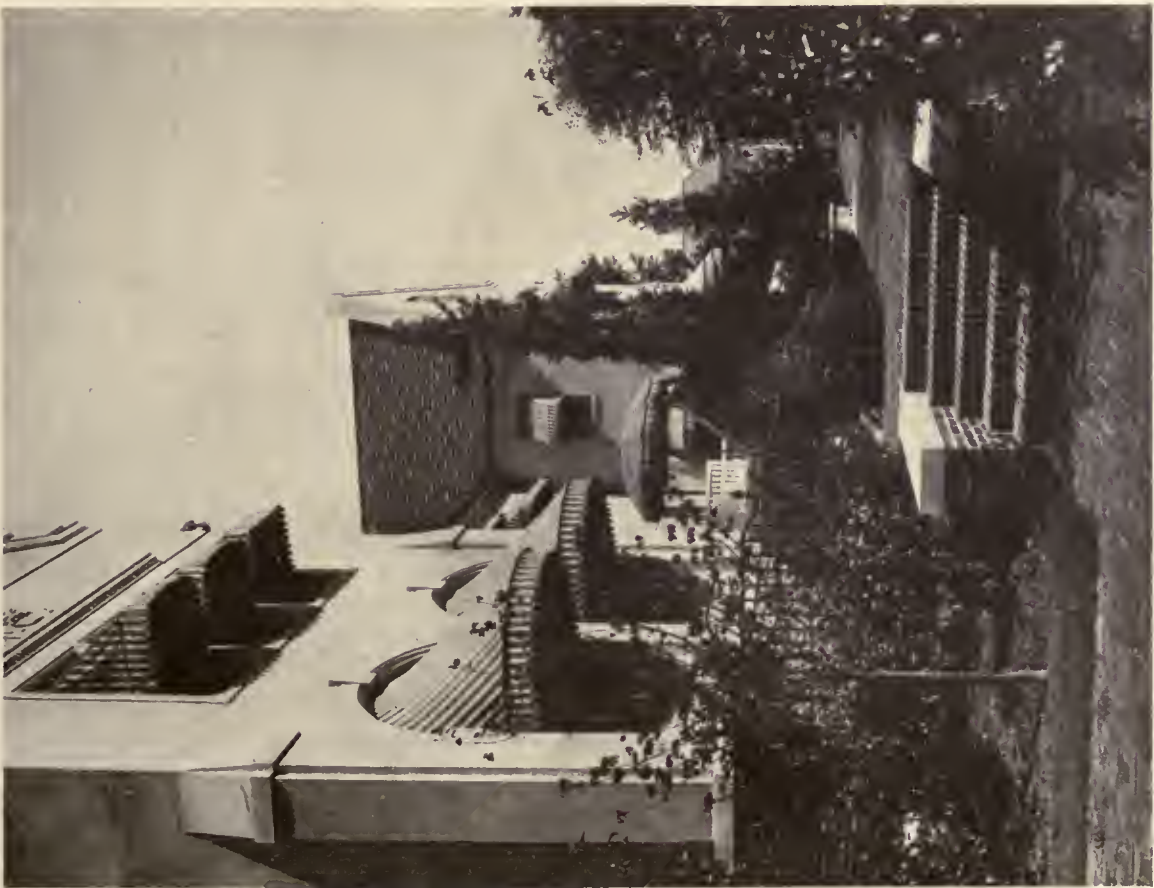

THE TERRACE

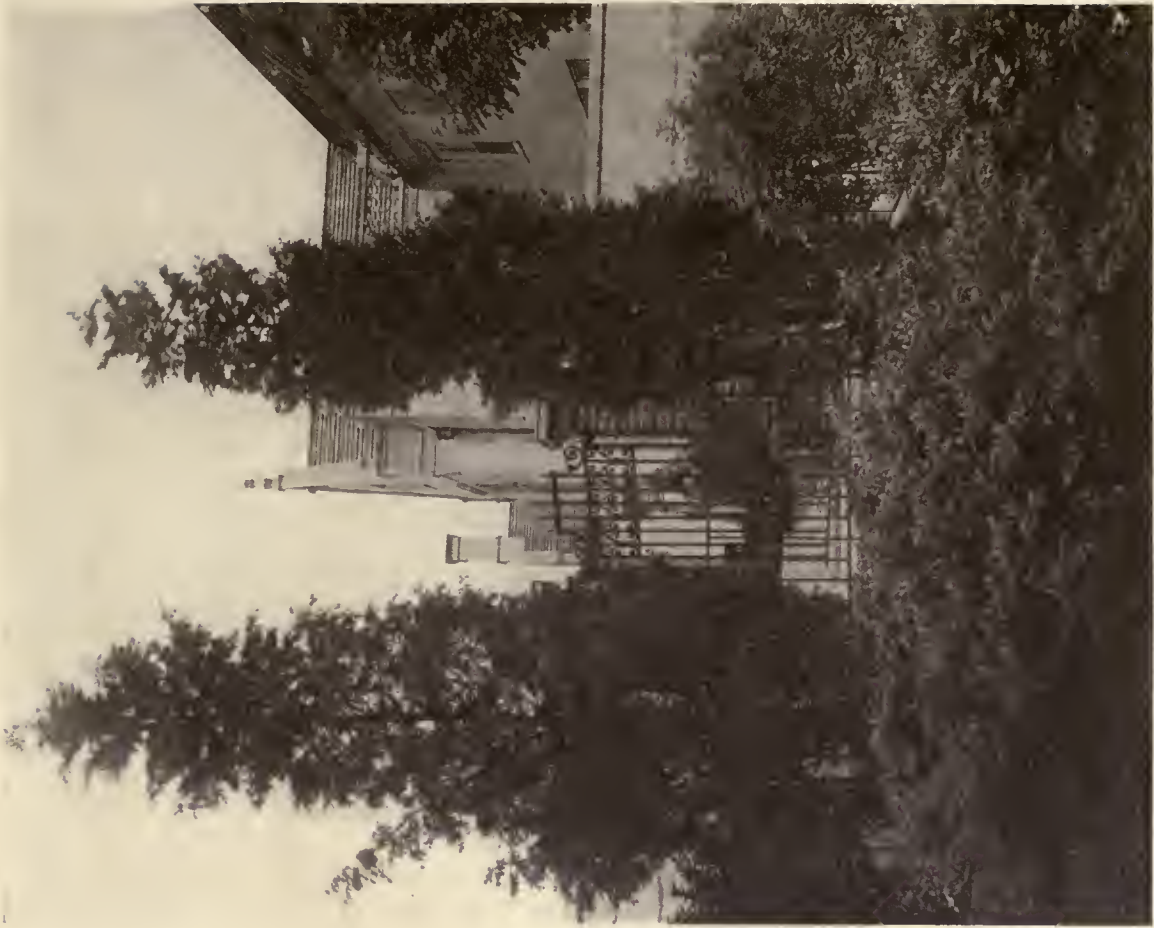

PLANTING DETAIL

ESTATE OF D. M. FERRY, GROSSE POINTE, MICH.  
WILLIAM PITKIN, JR., LANDSCAPE ARCHITECT

the upper one is paved as a sitting out place, and is framed by shrubs and trees. The second terrace is given warmth and color by a border of flowering perennials which reveal the balustrade enclosing it. Steps lead down the bank to an intermediate smaller terrace, and from there to a promenade just above the water level, which is terminated by the boat house and dock at one end and an overlook at the other.

The residence of Mr. J. J. Gilbert, Little Falls, N. Y., of which Mr. Linn Kinne is the architect, is an excellent example of the proper development of the city lot in combination with the house plan. The landscape plan shows the garden intimately related to the living room and porch, while the terrace overlooks the rear lawn, which is naturalistically planted and graded. The tennis court enclosure is worthy of study on account of its architectural character and its contrast to the usual unsightly iron pipe affair.

The drive arrangement utilizes the least possible amount of ground while adequately serving both main and service entrances, and with the walks affords proper circulation about the property.

The charm of the landscape treatment is due to the division of the lot into several quite distinct parts, as garden, informal lawn, tennis court, service yard and vegetable garden. Each feature is complete in itself, and though interestingly connected one with the other, together have much of the feeling of a series of outdoor rooms, and give the property a sense of spaciousness quite unexpected in so small a property.

Another treatment of the smaller city lot is shown in the photograph of the residence of Mr. F. A. Bryan, South Bend, Ind. The drive is held to the boundary to retain a broad, open lawn in front of the house, and the entrance walk follows it until nearly opposite the front entrance to which it leads through shrub planting separating

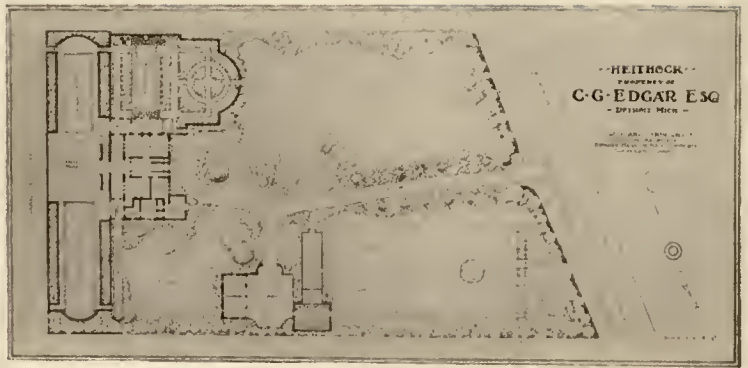

it from the lawn. The garage is attached to the house for economy of space, and a simple but charming little garden is located at the rear, adjacent to the living room and porch.

The James T. McMillan residence at Detroit, Chittenden & Kotting, architects, shows another solution of the narrow lake front property—the lot being only 200 feet wide and 1500 feet deep.

The house had to be built entirely on top of the ground, so the basement story has been filled around by material pumped from the lake, and a terrace treatment developed to blend this new grade into the average grade of the lot.

The drive is raised to an intermediate grade in front of the house, and encloses a central panel, which is sunken at the end near the house and which is framed by planting, including large masses of perennials.

The lake front slopes gradually to the lawn level, which is kept open in the center but is heavily planted along the borders to keep the views within the property and to frame the lake view.

The planting and the treatment of grades have kept the house from appearing to stand too high above the ground, and the broad, central lawns have added much to the apparent width of the property.

"Stonecroft," the estate of Mr. William S. Walbridge, was an unusual problem to both architect and landscape architect, on account of the diffi-

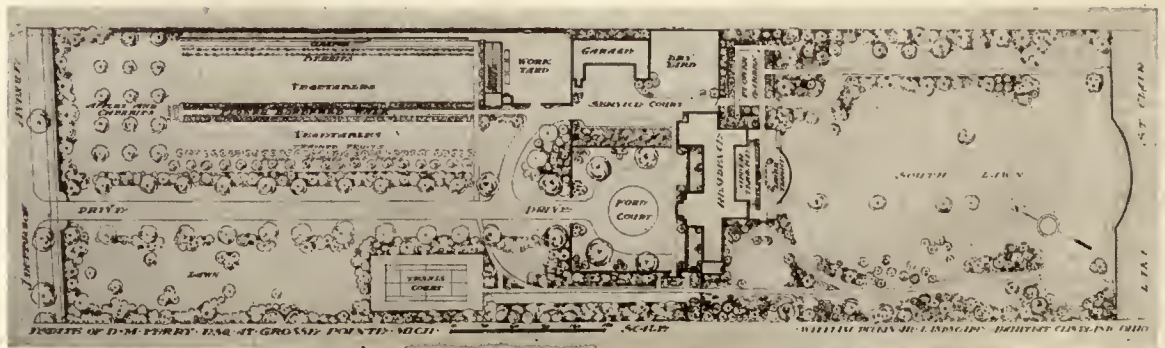

ESTATE OF D. M. FERRY, GROSSE POINTE, MICH.



## THE AMERICAN ARCHITECT

cult topography and the splendid existing tree growth.

The property is cut by two deep ravines heavily wooded and these left a narrow promontory, very limited in area, overlooking the Maumee River, which is a mile wide at this point. The architect, Mr. R. B. Taylor, has fitted the house to this unique



TERRACE OF HOUSE OF GEORGE B. MONTGOMERY,  
BUFFALO, NEW YORK  
WILLIAM PITKIN, JR., *LANDSCAPE ARCHITECT*

location, and the landscape plan has made the most of the unusual conditions.

The drive reaches the house by a bridge across

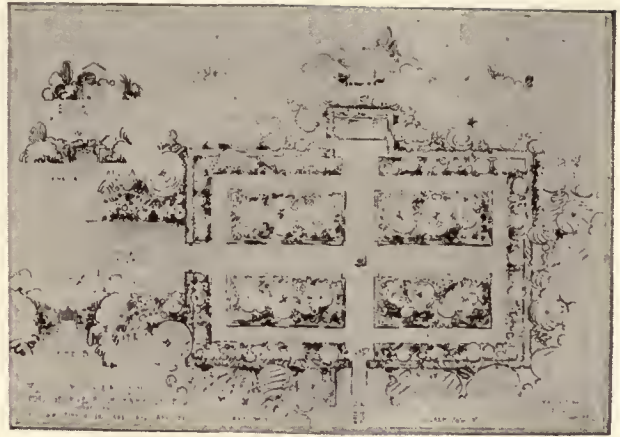

FLOWER GARDEN FOR GEORGE F. GREENBALGH, PERRYS-  
BURG, O.

the ravine and widens out into a forecourt supported by a retaining wall which extends 35 feet down into the ravine. Foot bridges connect the house and lawns with the gardens, while inter-

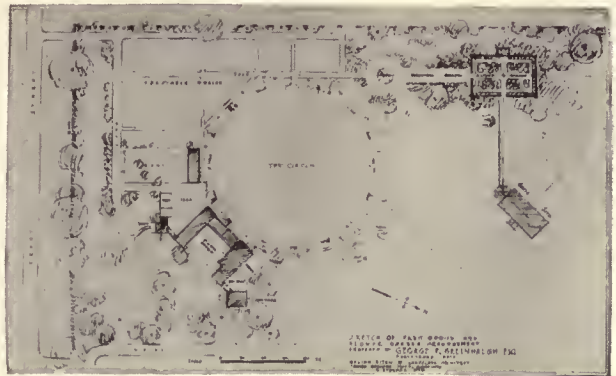

FARM GROUP AND FLOWER GARDEN ARRANGEMENT,  
ESTATE OF GEORGE P. GREENBALGH, PROVIDENCE, R. I.

esting trails have been carried through the ravines.

The river front of the property is developed into a series of narrow terraces with steps connecting them with the upper house terrace and intimate house lawn. The service yard shown in the photograph is an unusually interesting feature, and provides a sitting out place, having the river view and breezes, without intruding on the living portion of the grounds.

# American Fabrics for Home Decoration

**T**APESTRIES for the walls, velvets for curtains and rich silks for upholsteries in olden days were for kings, queens and noblemen only, states *The Touchstone*. To-day, however, thanks to the scientific skill of American weavers, the rich color and beautiful texture that completed the beauty of old castles and manor-houses are now to be enjoyed by almost everyone. Decorators, whether professionals of great experience or the woman of good taste who furnishes her house according to her own ideas, hail the coming of American-made silks, satins, velvets and tapestries with delight.

American resourcefulness has been put to the test along many lines during the last few years and, being driven to the wall, as it were, has accomplished almost superhuman results. With materials for dyes and cloths cut off by the war, manufacturers for a time were in trouble, but they have risen triumphantly above all obstacles, so that we may now boast of textiles for house furnishings marvelously dyed and skillfully woven.

After the house has left the hands of the architect and the builders, then come the decorators to bring it to its completed beauty. Upon the judgment of the decorators, therefore, depends, to a serious extent, the harmony of the house. It is in their power to increase or to ruin the good work of the architect. Some decorators "key" their rooms to some choice rug; others choose the brocade tapestry or paper for the walls first of all, and with it as a model select the furniture and color of woodwork.

Fortunate, indeed, is the person who can wander through the old world and bring back choice products of the loom with which to furnish his house, but everyone is not so happily situated; for them, however, are myriads of lovely things "made in America" from which to choose. It is not always the most expensive fabric that is the most beautiful or most suitable. Better to have a well-woven cotton material in good color than a rich silk of jarring tone. There is on the market a large selection of cotton materials suitable for walls, hangings, pillows, couch and chair coverings and window curtains of rare beauty. It is impossible to mention them all, but there is scarcely a shop in the whole country that does not hold in stock denim (plain or striped), cotton taffeta, cotton broché, plain rep, monk's cloth, basket weave cloth, crash, voile, étamine, Jaspé cloth, cotton velours, madras, ging-

ham or even burlap. If these cannot be had locally, there are always the mail order houses which will gladly send samples.

When it comes to the matter of brocades and damasks, however, the stock is not so universally accessible. It is not always possible to send samples of the most expensive weaves, yet certain well-established houses do consent, so that women far from the big markets can still have the most modern of material left at their door with which to make their home more beautiful.

These American-made silks in many cases reproduce almost exactly historical tapestries and brocades from France, Italy, Spain and China. In color and texture they can scarcely be told from the priceless originals now resting in the museums, for decorative uses they answer every purpose. American manufacturers reproduce with amazing skill Byzantine Roman patterns, Sassanid Persian patterns, and give us new designs based upon Coptic symbols. They have borrowed primitive symbols found among our own American Indians, from the Aztecs in Mexico, as well as the ancient lands of China, Italy and Egypt. They give us velvet brocade copied from ancient grey chateaux of sunny Provence, silks from the King's Court at Fontainebleau, sumptuous tapestries from the Middle Ages, fabrics designed in France showing the Chinese influence, rugs and carpets from Persia and China.

With such a wealth of tasteful and harmonious material from which to choose, American houses may now enjoy that rich, luxurious comfort formerly associated only with the richest rulers of the world. We may have rugs for our floors, brocades for our walls, velvets or shimmering transparent silks for the windows, subtly-colored and well-designed silken materials for pillows and lamps. Those who wish to reproduce the subdued mellowness of time-worn fabrics find little difficulty, for there are many reproductions from which they may select. Those who wish the brilliant, barbaric, almost luminous colors so much in vogue to-day will find more spread out on counters than even their vivid dreams lead them to suspect.

In short, there are "Made-in-America" silks for every need of every American home, from modest cottages to most stately country homes or city residences.

## France Evolves National Planning Scheme

France has ordained that every city of 10,000 inhabitants and every village of 5000 inhabitants which in any five years is increased by 500 souls, and every health or vacation resort, every grouping of buildings of a historic or picturesque character, is required to have within three years a "scheme of arrangement, beautification and extension." Any city or town of whatever size, partly or entirely destroyed by war, fire or earthquake, is to have, within three months, an outline of such a scheme. The scheme is divided into three parts:

First, the plan showing the highway system, the parks, playgrounds and the land to be held in reserve.

Second, the program dealing with archaeological and aesthetic values, with building heights and water and sewage systems.

Third. "The regulations of the method of application of measures provided for by the plan and the program."

Commissions in each prefecture and one national committee will oversee the execution of the plans.

It is especially to be noted that each town plan must be accompanied by a statement of the financial consideration involved. This important detail too often has been omitted in town planning projects in the United States.

No nation ever has embarked on such a far-reaching program. Not only cities and towns, but even villages that show any signs of growth are compelled to conform henceforth to a predetermined road map.

There is something very heroic about all this. A country that but lately has emerged from a war in which more than half its young men were lost; in which it has seen the major part of its industrial cities laid waste; a war by which it has been saddled with a debt that cannot be even materially reduced in many years—this country could well be excused if it confined its efforts to satisfying only its most urgent needs. It would not have been reasonable to expect anything else, and yet France, evidently realizing the waste in lives and treasure inseparable from uncontrolled urban development, has resolved, cost what it may, that henceforth all of her towns, great or small, shall be able to govern their lives and growth in accordance with a carefully considered "scheme of arrangement, beautification and extension."

## New York's Large Need for Hotels

A striking indication of the demand for high-class residential accommodations in New York and the steady increase in prices being paid for space of this nature is revealed in a statement made by the management of the new Ambassador Hotel, now under construction at Park Avenue, between 51st and 52d Streets.

Although the hotel will not open before Oct. 1, the management announces that enough applications already have been received for residential accommodations to more than fill the amount of space that will be leased to permanent guests. No reservations, however, have as yet been allotted. Five-room apartments are listed at \$20,000 to \$30,000 a year. Some of these suites include maid's room, boudoir, foyers and private halls. Three-room apartments will rent from \$12,000 to \$18,000 per year. While some of the apartments will be listed at the rate of \$3,500 per room a year, the average annual rental will be from \$4,000 to \$6,000 per room.

While these prices probably represent a higher figure than those charged by any other hotel in the United States, investigation among the first-class hotels of New York would reveal a sharp advance in the prices asked for permanent suites as a result of the strong demand for living quarters of this description. The shortage of servant labor is among the chief contributing causes of these conditions. With regard to the situation an official of the Ambassador Hotel made this statement:

"It is really amazing to note the rush New Yorkers are making to secure permanent quarters in hotels. Although only about 300 of the Ambassador's rooms will be devoted to the use of permanent guests, we are being overwhelmed with applications for space of this kind. At our temporary offices, 11 West 46th Street, every mail is bringing applications for reservations and we take this as an indication that there are many more people in New York who want to live in hotels than there are hotels to take care of them.

"No doubt an investigation would show that all the better class of hotels are being compelled to turn away many persons who desire to become permanent guests. If this is the case, it may be expected that the next few years will witness the construction of a large number of new hotels and apartment houses in this city."



## Stabilization of Labor and Materials

**M**AYOR HYLAN of New York, in an interview printed in the daily papers, made a somewhat cryptic statement in which he leads to the conclusion that the present almost total paralysis of building as relating to housing in New York is due to the instability of labor. Mr. Hylan is reported as stating:

"I am satisfied that there are seven or eight men in this city who have it within their power to say the word that will launch a building boom which will be the greatest in the history of the world. If these seven or eight men would give and take—would put aside old feelings and get away from the arbitrary attitude they have taken—bricklayers would be back to work to-morrow and other mechanics in the building trades would follow and complete the job they have begun."

It is true beyond question that the sources of evil in building construction at the present time are the instability of labor and material prices. Basically labor is the root of the trouble. Excessively high wages combined with strikes and other pronounced and controlling factors of labor unrest and poor guidance of course combine to create instability of prices. Labor is the major cost of materials, and inability accurately to forecast this labor cost creates the present unstable conditions in building material markets. It is unfortunate in many ways that those who seek to guide the course of organized labor cannot be brought to see clearly and broadly just what are the real elements in these unsettled conditions and how largely they are further unsettled by poor judgment and a lack of broad vision.

After the armistice was signed these same groups of men loudly proclaimed to the bulk of labor that so blindly follows them that the only sure method to maintain a high wage scale was by limiting production. The best trained economic thought in this country was strongly in

opposition to such a theory, and after more than a year of labor strikes lockouts and other methods to retard production, organized labor is beginning to learn at some cost that it has committed a serious error.

These same tactics, followed to-day, are those Mr. Hylan so strongly censures, and are the real elements of danger to our construction interests. There are small hopes for any free offering of loaning capital for building operations as long as present methods are pursued by those who seek to control and direct labor. The very efforts of labor to maintain a high scale of wages may become futile through their own actions. If present conditions are long continued and building construction retarded, the small demand for labor will react in a reversal to ante-war wage scales and labor will have accomplished its own undoing.

---

## Temporary Beauty

**T**HE subtle influence of environment is difficult to estimate, but its far-reaching effect cannot be denied. From time to time the municipality comes out in all its glory of adornment and is aglow with color. Her people are stimulated with a certain pride. They walk with heads high and a sense of well-being. Then the purpose for which the decoration was put forth comes to an end. The banners are down, the people relapse to their week-before-last gait, and everything is again sober and dull.

Is there not a mental twist somewhere? In our personal relations, the effort is always to appear at one's best. But in municipal history, one only appears at one's best on occasions, perhaps once or twice a year.

In the years before the war the rather commonplace character of the decorative treatment of New York's streets on special occasions has not been sufficiently good to warrant its serious consideration as to permanency. But the patriotic impulse

stimulated by our war work in this country has caused the best of our architects and painters to lend their time and skill to the design and execution of decorative features that would have, if in permanent form, been dignified and appropriate elements in our city's artistic development.

All of which is apropos of the fact that the Fifth Avenue Association of New York proposes an annual festival to be called Fifth Avenue Week, and to be celebrated during the week starting on April 5.

In its main aspects, the spectacle will consist of special exhibitions of the fine and applied arts in the show-windows of merchants, and their illumination at night. The Board of Education will co-operate in a series of lectures demonstrating the "relationship of commerce to art and to civic ideals." Competent architects and artists are planning the decorations. Art societies and art dealers are at work.

If the spectacle comes up to expectations, it will be too good to be so transient. While the element of cost enters into the protraction of such display, it is believed that the results in the artistic education of the public will more than compensate.

Undoubtedly there will be many well-developed features of this gala week that could advantageously be made permanent. It might be well to start right here in the proper artistic development of this city out of doors. It is suggested that whatever is of sufficient merit be seriously considered as a permanent part of the future development of Fifth Avenue.

---

### High Rents as Affecting the Building Situation in New York

**N**EW YORK CITY has set out to find, if it can, a solution of its now acute housing problems and a means to combat the profiteering in rent that has reached a point where the public are becoming uneasy as to what they regard as the excessive demands of landlords.

Many factors that have helped to increase rents have been aggravated by speculative buying. The remedy in this direction is not difficult, as it is possible to prevent speculation up to the degree that it now has reached.

The important problem, that of the creation of new homes, will, if energetically attacked, immediately act as a further stay upon speculation, and in addition will be the most effective way of meeting the present and future needs of New York's growing population.

Mayor Hylan proposes a plan of effective co-operation between labor and real estate interests as well as co-operation on the part of the different departments in the city. This plan, among other features, contemplates the suspension of income tax on first mortgages up to \$40,000, and the creation by the city of a loan department for real estate similar to the farm loan board.

The opinion on this program as expressed among the real estate men and other related interests is a willingness to try out the matter in the belief that it will be a reasonably effective method for early relief. The present high rents in New York and probably in other large cities all over the country have no real justification. They are a flagrant disregard of the long established and customary rights of tenants and while it is true that during the war the real estate and building interests had lean years, it is unreasonable to hope to recompense these interests for these years by an advance in rents not based on any reasonable attitude.

A remedy, of course, must be found, and in seeking this remedy common sense dictates against making the cure worse than the disease. No one will deny the right of the landlords to make a fair profit and any public action that will seek to deprive them of this will, of course, seriously affect new building activities. It therefore becomes necessary in dealing with what is a matter of the utmost economic importance, to proceed with caution and make sure that in resenting what it is believed is an excessive demand on the part of some landlords there shall not be created a condition that will tend to retard our already long delayed building activities.

## Architects and the Public

*(Continued from Page 362)*

than the modern designs which are so generally the product of the "factory" designer. Ours is a people disposed to "let the dead past bury the dead" and to be cognizant of the fact that "The lad that died o' yesterday is just as dead—ho! ho! as the scurvy knave men laid away a thousand year ago."

This same people has a remarkable appreciation of decorative architecture. Ask any commercial traveler who knows New York and the Pacific Coast what he thinks of the Woolworth Building, New York, and of another building at the coast almost as high and roughly the same shape. I have tried it many times. The Woolworth Building is described with superlatives, the Seattle Building with expletives. The difference is all in the impression caused by the architecture. Challenge the American traveling in Europe for business or pleasure with the statement that "There is, of course, no fine architecture in America," and note among the examples that will be given, in reply, the buildings that such travelers know. If from New York they may mention a few of the high buildings, but they feel they are on surer ground when they list the Public Library, The Customs House, the Pennsylvania Station, the new Post Office, Madison Square Garden, the Metropolitan Museum, the Guaranty Trust Building, and St. Thomas' Church. Chicago people may be specific as to their office buildings, but they usually think of the Field Museum. The Bostonian knows the Boston Library, State House and Trinity Church. Only once, that I recall, I asked a Philadelphian. He claimed the Philadelphia City Hall to be "a greater and costlier building than St. Paul's" (London), "but," he explained, "it isn't so pretty because it isn't so old." He was of the types of humanity that have eyes but see not, or whose vision is obscured by local pride. The average American of no particular locality, especially if a lady, mentions the Capitol and the "White House." Quite a surprising number display conviction that the Pan-American Building and Temple of Scottish Rite at Washington are "as good as anything in Europe." Of course there is always some patriotic bias in such replies.

Another important experiment to the student seeking to learn whether genuine interest in architecture is manifested by the public at large is offered by the great International Expositions. In its main purpose the exposition is an institution of higher education. Its daytime visitors attend principally to obtain information from exhibits regarding their particular interests in life or business. The greatest number of visitors is invariably to the Fine

Arts building. Yet of the daytime visitors, not one-half enter any one building. And by checking the turnstiles of the art building with those of the exposition entrance gates it is found that not more than one in fifty visitors to the grounds enters any one building. By similar checking it is found that not more than one in ten visits the "midway" and not even one per cent pay admission to any one "side-show." The people who take seats about the bandstands are fewer than two per cent. It might appear that the expression is, therefore, not worth while to the exhibitor. Yet that is far from the case. One pavilion at the Brussels Exposition, which, with the installation of exhibits included, cost ten thousand dollars, received more than fifty thousand dollars return in gratuitous "advertising space" in popular and art magazines, by virtue of "write-ups" due principally to its architecture and decorations. It also proved its fascination to visitors by the fact that an average of upward of seventy thousand visitors, taking away with them approximately one hundred thousand pieces of advertising literature, passed through its entrance *each week* during the entire season—a larger number than visited any of the "side-show" attractions! Yet its visitors were fewer than two per cent of those entering the grounds. Another evidence that it is the architecture, buildings and gardens, and the decorations and sculpture, that are the main interest to the public can be proved by an experiment which I have tried at practically all the expositions since the Chicago World's Fair, which was to inquire of the official photographers and publishers of souvenirs and prints sold individually, such as post-cards, which of the views had been his "best seller." Without exception I have found popular judgment, in great majority, as shown by its cash outlay for photographs and picture post-cards, to be in full accord with that of architects. Inquiries of one of the exposition publishers brought forth the statement "Nobody has ever asked that question"—and it was several weeks before he could supply a correct statement of the number of sales of each of the views. This simple means of discovery of the advertising value and popular appreciation of architecture had been overlooked by all the thousands of business houses exhibiting. Still another point worth noting in this connection is that advertising signs on a building prevent the sale of post-card or photographic views of the building, while "trees or water in the picture" assist the sales.

Why, then, is it necessary to make a selection of clients—why desirable to decline any of the work obtainable? If our public possesses good judgment in architecture why is it, relatively, so little in evidence? Why are the streets of our large cities and

## THE AMERICAN ARCHITECT

our small towns lined with deadly uninteresting or monstrosously overwrought façades, while only at intervals, widely apart except in the wealthiest and newest or very oldest districts, are good examples of architecture to be found.

The last question may be answered by a note of history. Coincident with the development of the steam-engine in its various practical applications to pumping, locomotives, steamboats, etc., and the rapid development of mechanical engineering as a profession, we find architecture which had been, prior to about 1830, a subject of general knowledge among the educated classes, quickly ceasing to exist. It is doubtful whether a dozen architects of real ability practiced in the United States during the fifty years between 1830 and 1880. Machinery, railroad and steamship development called upon all available inventive talent and scientific mechanical knowledge. Practically, there were no architects and no architecture. Building was left to mechanics to design and their ignorance made our streets hideous. In time our people realized the fact. How quickly they recognized the works of Hunt, Richardson and McKim as something different and more desirable than all the others! As soon as good design was supplied the demand was for all that could be obtained. But three or four good architects could not design all the buildings erected in this country during the eighties, and three or four hundred cannot design all the buildings required to-day. During the past thirty years perhaps nothing in American progress has been quite so notable and worthy as its architecture, and the architectural educational system therewith, but we still lack architects in sufficient numbers to perform the work in the available field. Are not the buildings which Hunt, Richardson and McKim have left us evidence of selection of clients? When all about them were erecting the poorest contraptions in the form of building that the world has ever seen, those architects built many of the buildings that may find a place in the histories of architecture yet to be written, and are among the bright intervals in dull streets. Richardson's rock-faced and rather rowdy architecture appealed to the mass of the public of his time and Richardson sought the public for his client. Hunt's and McKim's architecture appealed to the more refined minds they selected from the clients requiring private and educational buildings. The Herald Building, New York, and the nearby Hotel Imperial by Stanford White were early demonstrations that design is superior to material in producing good commercial buildings which hold their own in public esteem. In the immediate neighborhood of Herald Square are newer buildings, built with prodigal ex-

penditure upon enormous masses of carved and worked stone, one pier of such building costing more and occupying many more square feet of valuable ground space than a whole row of the light, beautiful columns in the arcade of the "Herald" Building. But while this little building never goes unnoticed by the visitor in New York for the first time, what other building in the vicinity can he name? It is evident that far more work is to be done than there are architects to do it. Consequently the field is still good commercially for the "practical architect," or builder's draftsman; for the "decorative architect"—copyist of antiques, poseur and employee of those firms that "adorn" but do not "decorate" our buildings; "licensed architect"—"licensed" by the Board of Superior School-Teachers to place "R. A." after his name (to all educated Europeans these initials stand for membership in the Royal Academy of England)—such may yet have to reckon with a Prohibition Amendment; the "Architect & Engineer"—"engineer" when within ear-shot of an architect, "architect" when among engineers; "artistic architect"—maker of poster-picture houses with freaky-leaky roofs, with bedrooms at one side of which a cat must lie down like the Goddess of Hadrian's design for a temple, "because its head would go through the roof if standing." All this "architectural" riffraff is but the survival of the days when the public was forced to obtain help in the design and execution of buildings from any mechanic or picture-maker with an elementary knowledge of drawing. Consequently many a good mason's foreman and many a good magazine-illustrator have been lost, economically, in the making of a worthless architect. Of course these people recognize the first law of nature, which is self-preservation, and the first principle of business, which is private gain. Their whole attitude is opposed to good architecture and to the interests of the best architects. In spreading the gospel of their own interests, false "efficiency," by which speedy production is meant, and false "economy," which is synonymous for cheapness, drivel about "sentiment" and "taste" are the grounds on which attempts are made to fool and confound the public. It is from within "the profession" that public judgment is browbeaten and perverted. From such sources come the false rumors of ridiculous mistakes, foolish business methods, overcharges, excessive cost of work, insane personal conduct attributed to eminent architects: things which in truth never occur. The layman too often accepts that which he believes is authoritative opinion from "a practical man" or "a genius" owing to his inability to distinguish the character of architecture while in the stage of "drawings." The client whose mind has

## THE AMERICAN ARCHITECT

thus been poisoned is often beyond hope of enlightenment or development. His work is best dispensed with, as in result it will damn its architect. But enough real architecture has been produced to enable the public to form its own conclusions from results, and a sufficient number of good architectural training courses exist in this country to guarantee the growth in number and ability among architects.

The average client comes to the architect prepared to listen to reason and to learn. He becomes interested in the discovery that the designer of the beautiful building is possessed of all the training in theory and practice and knowledge of the structural, sanitary, mechanical and electrical engineer, as far as such knowledge applies to any type or part of a building. It is at once an education and surprise to find the man whom he had regarded as "a sort of artist and inventor" more accurate and reliable in his knowledge of costs, proper organization for orderly sequence, rapid continuous construction and resource in "getting by" contingencies as the work progresses than he finds his "practical contractor." Gradually it dawns upon him that the builder is only an agent for certain limited purposes, carrying out the instructions of the architect. It comes almost as a shock to the client to find that the "practical man" he has found the architect to be designs and if necessary executes with the help of "ordinary mechanics" the finest decorations, furniture, stained glass, curtains, electric fixtures, painted decorations and modeled ornament. He finds his architect well

informed of the rules and equity in the game of business-life, with the perception to observe and sense of justice to combat either the contractor or client in any effort to "trim" or "put one over on" the other. He may not like but will respect the architect with the necessary moral courage to tell him firmly "where he gets off."

His interest in the architect as well as in architecture grows and he becomes the friend of the fraternity of architects as well as of "his architect." The game of educating the client—of giving up more time than the architect sometimes thinks he can financially afford—is a game that is worth the candle. Once sufficiently interested he joins that growing mass of the "real public" which in this country, especially, and at the present time, particularly, is insisting upon the old copy-book headings: "From everyone according to his ability to everyone according to his needs," "The tools to those who can use them," "The battle to the strong," "The survival of the fittest," "America first."

The architect with faith in his capacity; with the courage to train, and keep in training, in all branches of his subject; with the developed knowledge of his ability, demonstrated to his own, true satisfaction in his work, has little cause to worry as to definitions of his sphere. His objective is the completed building, his scope everything that contributes to any visible structure, his workshop is under his hat, his field is the whole civilized world, and his future one of almost infinite opportunities.



TRUTH AND FORTITUDE  
PANEL IN GESSO-DURO AND PAINT FOR AN OVER-MANTEL  
MACK JENNEY & TYLER, DESIGNERS





HOUSE OF ROBERT CUSHMAN, BROOKLINE, MASS.  
JAMES PURDON, ARCHITECT



374 2



LIVING ROOM

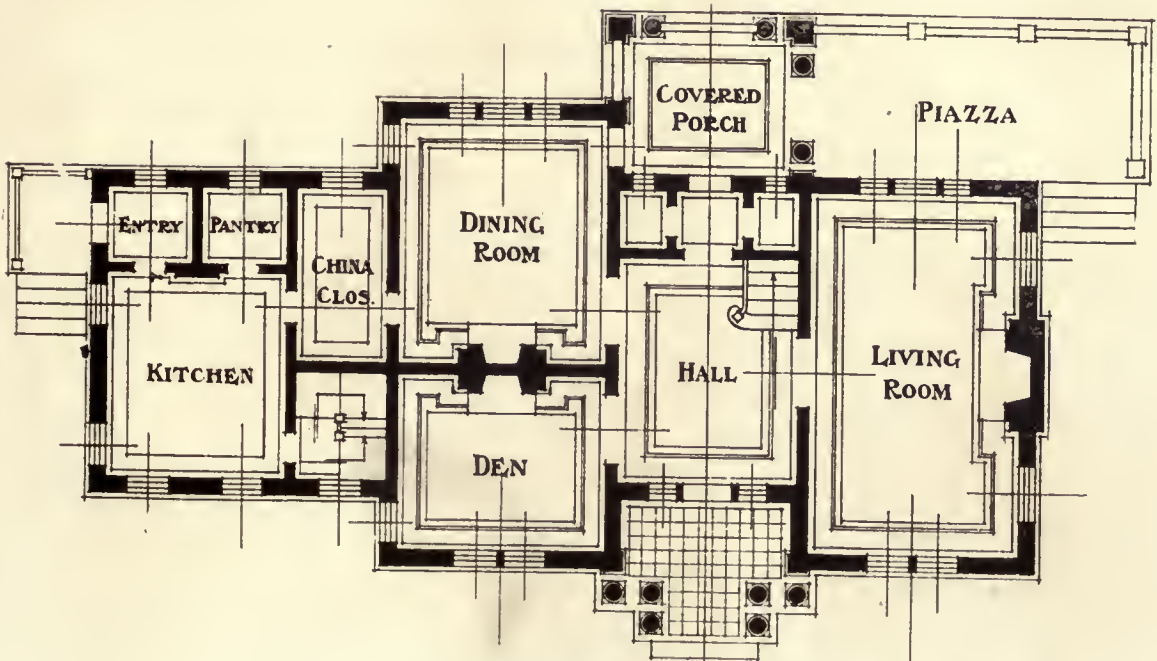

HOUSE OF ROBERT CUSHMAN, BROOKLINE, MASS.  
JAMES PURDON, ARCHITECT



374

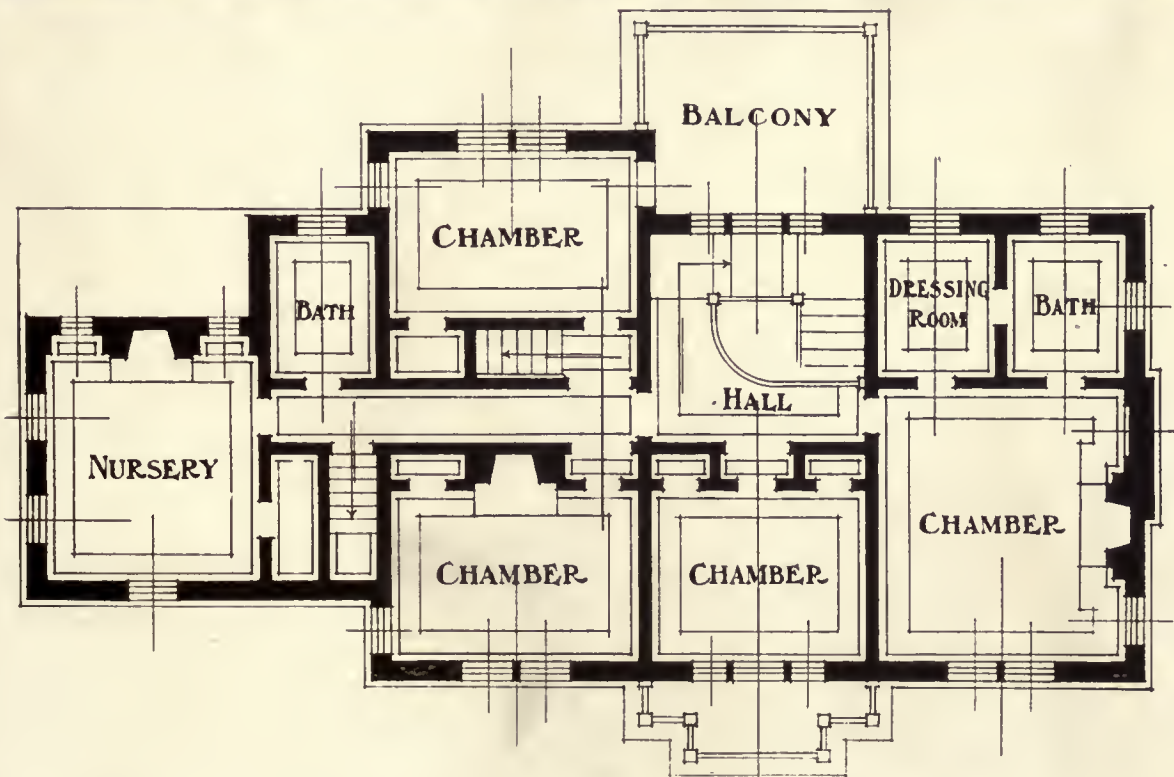

DINING ROOM AND SECOND FLOOR PLAN  
 HOUSE OF ROBERT CUSHMAN, BROOKLINE, MASS.  
 JAMES PURDON, ARCHITECT





HOUSE OF GIFFORD L. SIMONDS, FITCHBURG, MASS.  
JAMES PURDON, ARCHITECT

3749





5'  
374



DETAIL OF PRINCIPAL ENTRANCE  
HOUSE OF GIFFORD L. SIMONDS, FITCHBURG, MASS.  
JAMES PURDON, ARCHITECT



374<sup>6</sup>

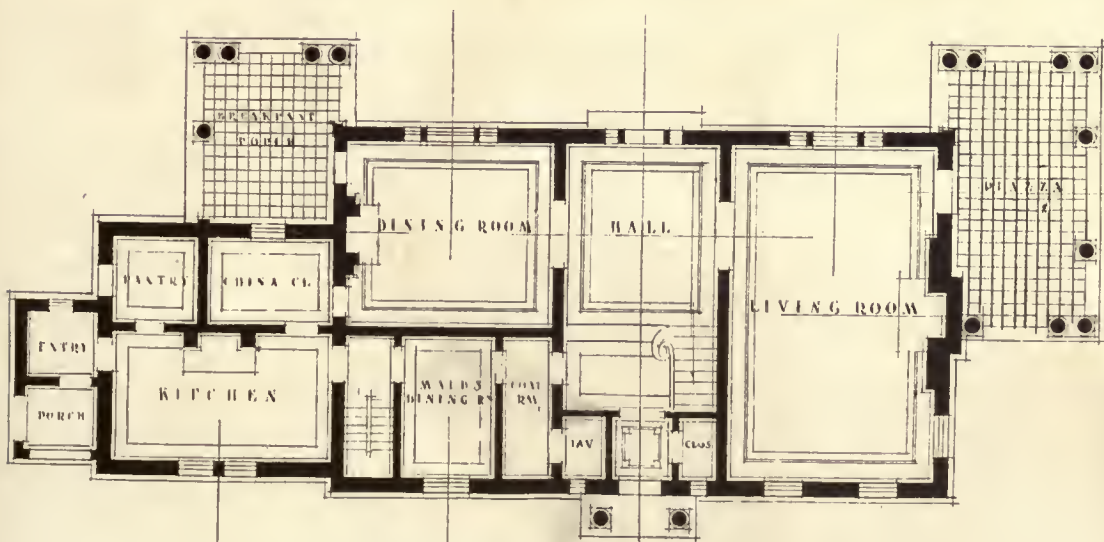

HOUSE OF GIFFORD L. SIMONDS, FITCHBURG, MASS.  
JAMES PURDON, ARCHITECT



374<sup>1</sup>

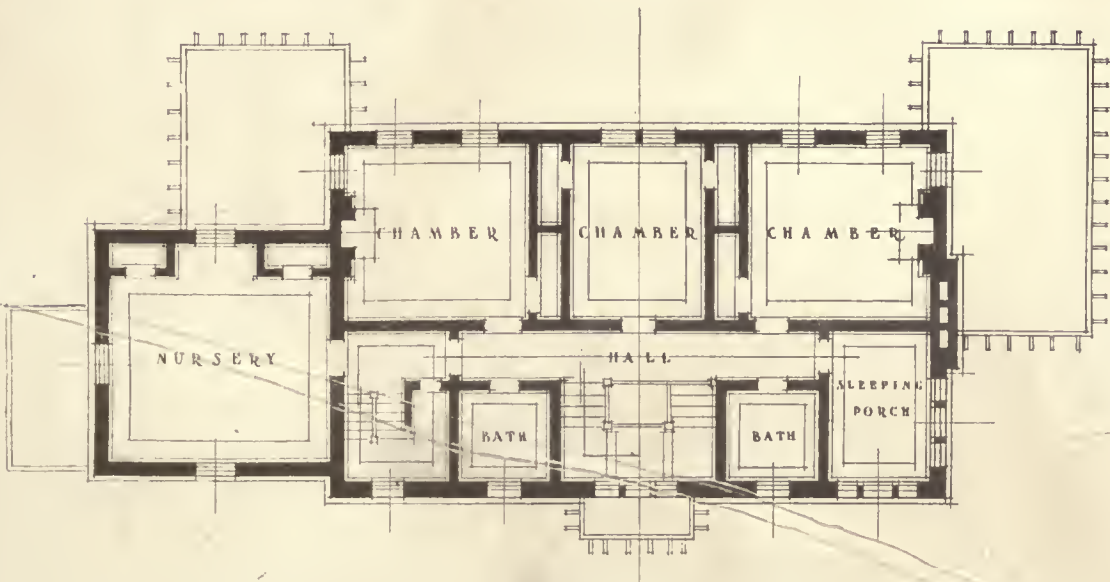

HOUSE OF GIFFORD L. SIMONDS, FITCHBURG, MASS.  
JAMES PURDON, ARCHITECT



# Criticism and Comment

## The Architectural Engineer

*The Editors, THE AMERICAN ARCHITECT:*

I have carefully read the article by Mr. Yardley entitled "The Architectural Engineer," published in *THE AMERICAN ARCHITECT* of January 7, and I would say that the writer has very high ideals as to the qualifications of an architectural engineer. I heartily agree with him that such a trained man would be a great asset in architectural practice, but I sometimes wonder whether a man with the qualifications stated can be found. I personally believe that an architectural engineer should be well grounded in both design and construction, so that he can carry out the structural work necessary and also appreciate the requirements of design, and harmonize the two elements so as to produce a satisfactory result. Such a man must have not only an excellent technical training in architecture and structural engineering, but must also be well trained in the field of practical experience.

ALLEN HOLMES KIMBALL.

Ames, Iowa.

*The Editors, THE AMERICAN ARCHITECT:*

It is easy to string out a series of assertions, but it is difficult to be convincing. I can understand what Mr. Yardley meant in his article entitled "The Architectural Engineer," in outlining the qualifications of an architectural engineer, but I do not believe that the discussions of such subjects are properly appreciated by laymen. There should not be any separation of structural from architectural design, and there cannot be in well co-ordinated work.

WILLIS POLK.

San Francisco.

*The Editors, THE AMERICAN ARCHITECT:*

It seems to me that the requirements stated by Mr. Yardley in his article entitled "The Architectural Engineer," for an architectural engineer are very ideal, but almost impossible of attainment. Such a man would be a superman, and the engineering and architectural fraternities are shy on these. There is too much knocking of "the average architect." In regard to the course in Architectural Engineering in the University of Pennsylvania, I might say that we *are* able to interest a reasonable percentage of our students.

The architectural engineer must know architectural engineering from the architectural point of view and not from the engineer's point of view. The author of the article in question speaks of "the

too common discrepancies between architectural design and construction." I would like to know just what are these discrepancies. I must say that I don't see many of them in the designs from the offices of good architects.

When the "architect is ignored by his client in favor of the engineer," then architecture will have ceased to exist, and mere building will have taken its place. I am not at all sure that the whole world is not tending in this general direction in all things—in all phases of human thought and action. If the world ever gets there it will be a dull world to live in; but, of course, it will be nice and clean and "efficient"—one great big, well-ordered machine-shop, with just the proper factor of safety, no money wasted, and all accurately checked by slide-rules.

THOMAS NOLAN, F. A. I. A.

Philadelphia.

## Designing the Low Cost House

*The Editors, THE AMERICAN ARCHITECT*

There is no question in my mind that architectural service is worth while for every building project, even the humblest. If it does not pay the architect without charging an exorbitant fee there is something wrong in our way of taking care of this branch of our service. It is all wrong to leave the field open to mail order houses, the lumber companies and the contractor. A proper solution will undoubtedly be worked out and I believe it will be along the lines of chapter departments. Such a department might be the means of eliminating to a great extent the ordinary dues. It could be profitable at least to the extent of making the architectural societies self-supporting. It would relieve the individual architect of handling low cost units under a high overhead, and would relieve the builder of a modest home from the abuses current as matters are now conducted.

In this connection there is a chance to co-ordinate the actual practice of the work of our architectural schools and colleges, which is sadly in need of lining up with the real conditions which practicing architects have to meet. We do not want to turn out half-baked architects any faster than they are being turned out. What we need is a better understanding on the part of the young man as to what being an architect really means and the enlisting of his efforts in an enthusiastic apprenticeship until he is thoroughly qualified.

Sioux City, Iowa.

WILLIAM L. STEELE.

## Modernist Movement in Art is Analyzed

The Russian Futurist sculptor, Archipenko, one of the leading exponents of the modernist movement in Paris, has given out a remarkable account of art development under the Bolsheviki. He said:

"One of the results of the revolution was a great stimulus to painting and sculpture, especially of Futurist tendencies. There were three reasons for this. Firstly, every untrained youngster who felt the spur of artistic impulse seemed to think that futurism meant nothing but splashing a lot of brilliant color together on canvas—or any other available surface. Self-expression along these lines was easy, and friends of mine who were in Russia during the first year of the revolution say that some towns were a regular riot of vivid decoration. Walls, doors, roofs, palings and even trees rivaled the rainbow with their variegated blaze of color.

"The second reason was psychological. Many artists who formerly abhorred futurism were caught by the wave of change and novelty that the revolution brought in its train and set themselves to rival the Futurists in wild and startling compositions.

"The third reason was a practical one. During the early days it was not certain whether artists would be considered workers or bourgeoisie, and many well-known members of the old school of court-painters and so on were harshly treated or imprisoned. Accordingly, to be a Futurist became a sort of guarantee of good revolutionary standing and old-fashioned painting was at a discount.

"Later there came a change for a rather simple reason. The Bolsheviki wanted to have portraits

of their best-known leaders hung everywhere, even in small villages, to replace pictures of the Czar and royal family. Much as I admire futurism, I must admit that a futuristic portrait of Lenine or Trotzky would hardly be recognized as such by the average Moujik. So there was a sudden eager scouring of the country for painters whose pictures would resemble the subject.

"From dungeons, hovels and concentration camps old-school artists were summoned to the Kremlin and set to work. It was a veritable triumph for them. And since then they have been treated on an equality with the moderns and an allowance of food and painting materials has been given to them.

"Art is greatly encouraged by the Bolsheviki. There are frequent exhibitions, each containing about 1,000 pictures. Therefrom 300 of the best are selected and bought by the State at a handsome price for distribution throughout the country. The rest are burnt—an effective but somewhat drastic method to discourage mediocrity. At least that was the original practice, but recently, owing to the shortage of canvas, etc., I am informed that painters of rejected pictures now get them back with orders to scrape off their wretched daub and try to accomplish something better next time.

"A sign of the changed times is the great interest taken by the masses in art. One of my friends wrote that literally hundreds of people crowded round him while he was painting a futuristic picture of the market in Moscow. One Philistine, who declared the artist was making fools of them because the picture resembled nothing on earth, was ducked in a nearby horse-trough. Evidently futurism has come to stay in Russia."



VENETIAN COMMERCE  
GEORGE DAVIDSON, PAINTER, THE AMERICAN ACADEMY IN ROME



# Current News

---

## Happenings and Comment in the Fields of Architecture and the Allied Arts

### London Forced to Erect Skyscrapers

The old question of whether London is to have skyscrapers is being revived because of the high price of property in the business section and the lack of space in office buildings.

The government buildings in Whitehall are four stories high, but it has been found necessary to add a story to the war office to meet the demands of the department. One well-known architect in touch with the government's plans expressed the opinion that unless the new and the old ministries were content to do their work outside of the area devoted to governmental activities, skyscrapers were inevitable in Whitehall.

Generally speaking, however, London does not like tall buildings. Percy Tubbs, past president of the Society of Architects, declared that if the skyscraper was to come it would be necessary to widen the streets.

"But space in London is not so scarce as it is in New York, which is an island," he said. "I think the traffic problem will not become so unwieldy that we shall be afraid to let London expand any further outward, and we will be compelled to expand it upward. Personally, I always feel that where skyscrapers abound the man in the street moves in the bottom of a well."

American architects who are here erecting a huge department store have repeatedly asked for permission to extend the main building high enough to accommodate not only the present business of the concern, but to provide for the future, and have met with no encouragement whatever.

---

### First Flats in America

The notion of multiple housing facilities was being advocated in this country 50 years ago, as a means of solving the problem of city living. The apartment house, already established abroad, was just coming into existence here, as the *Washington Star* of August 18, 1869, thus sets forth:

The heavy and constantly increasing expense of house-keeping in most American cities is forcing attention to the subject of reform in that direction, and hence we hear of co-operative movements and various other plans for cutting down prices. High rents are being constantly complained of, and various remedies are discussed, and some few adopted, the only one which has so far amounted to anything being the erection of suburban cottages, but for active business men in cities the disadvantages of a residence in the country, even near a city, and on a line of railroad, are manifold. Overburdened New York is casting about, therefore, for other measures of relief, and there, where the evils are greatest, we may expect to see the most effectual remedies applied.

It is now proposed to build a new house in Eighteenth Street near Irving place, in that city, to be constructed on the European plan, with suites of apartments entirely

independent of each other. As the rents are to vary from \$900 to \$1,200 a year, the dwellings will be handsome and expensively decorated.

An equally interesting experiment for persons of smaller means has already been made in Brooklyn. The building has a front of 130 feet on Duffield street, with two wings, running 65 feet back of it at right angles. A court is inclosed between the wings, 65 feet square, which is entered from the front by an iron barred gate leading through a covered archway. The houses have handsome street doors. The first two floors of each house comprise one tenement of seven rooms, with closets, kitchens and a bathroom complete, and rent for \$600 a year.

The two upper floors of the houses rent for \$23 a month each, and contain, respectively, four rooms. The ground floors of the wings are divided into apartment suites, each of four rooms and open upon the court, which is floored with asphaltum and ornamented in the center with a bed of flowers. These apartments are rented for \$25 a month, and those of the three upper stories, opening upon balconies, rent severally for \$23, \$21 and \$18 a month. All these tenements are neat, well finished and inhabited by respectable persons. Each family has a separate storeroom in the basement for coal or provisions, and a defined space upon the roof for drying clothes.

A janitor regulates the whole establishment. He directs visitors to the apartments sought, keeps the court and staircases in order and restrains the children from becoming noisy and from injuring the furnaces. The buildings are of brick. The number of apartment suites is 42. The cost of the whole was \$140,000. It is said that other establishments of the kind might be erected for far less money. The rent of the different apartment suites now brings \$11,700 a year, or about 8½ per cent on \$140,000.

---

### Restoring of St. Gervais

The work of restoring the Church of St. Gervais, Paris, which was struck by a "Big Bertha" shell on Good Friday, 1918, killing fifty-four persons, began on March 1.

It is expected that the restoration will be completed by October, in time to celebrate the five-hundredth anniversary of the consecration of the edifice in 1420.

---

### Wisconsin's Housing Plan

Wisconsin has what is probably the first specific co-operative housing law passed by any State in the Union. The law makes it possible for any municipality or counties to engage in housing or for interested individuals to organize themselves to form co-operative housing companies.

Under this law a corporation formed under its provisions is given power to acquire land and to prepare it for residential use upon approval of any public land commis-

sion of the locality where the property of such corporation is located. It also provides that if the land is located within any city or within a radius of three miles from the boundary of the city, approval must be had from the health department for the development of the land.

No single dwellings may be erected by such company the cost of which exceeds \$5,000. Enough ground space must be provided to furnish sufficient air and light.

A clause of the act directs that no land shall be sold by the corporation except in case of winding up the affairs of the corporation or in foreclosing mortgages or liens, or for disposing of land not needed by the corporation. Two further provisions further indicate the truly co-operative character of the corporation, namely that no lease may be made for land or property of the corporation except to a stockholder in it and for the use of such stockholder. Exception is made in the case of American soldiers, sailors or marines in the war between Germany and the Entente, who need not be stockholders. No tenant may hold stock in the corporation beyond the value of the premises used by him. All stock must be issued in consideration of money, labor or property estimated at its true money value. No dividends may be declared until a fund equal to 2 per cent of the authorized capital of the corporation has been created and no dividend exceeding 5 per cent of the par value of the stock may be paid to any holder. The preferred stock of the corporation must be retired as soon as possible. For this purpose 10 per cent of the annual profits is set aside each year.

By providing that the Common Council of any city and the Board of Supervisors of any county may subscribe for preferred stock of the corporation in question, opportunity is offered for those governmental units to engage in the housing of wage earners. The directors of the co-operative housing corporation do not receive any compensation for their services until a surplus fund of 2 per cent of the capital has been set aside and until dividends on preferred stock have been paid. At no time is the compensation of the board of directors to exceed \$500 per annum.

## All England Gripped by House Shortage

Not only London, but practically all the larger cities and towns of England and Wales, are facing a shortage of dwellings, rivaling, if not surpassing, the one prevailing in Greater New York, according to reports made at a conference on housing finance held recently in London. Representatives of fifty of the leading local governing bodies in Britain were present, as were Premier Lloyd George and several members of his Cabinet.

After the Chancellor of the Exchequer had explained the practical impossibility of the Government raising a loan of about £1,000,000,000 to finance the new building, as suggested by the municipal representatives, and had pointed out that the Government would probably have to expend nearly £60,000,000 before next September in fulfilling its promise to help finance building operations in towns having less than £200,000 assessed valuation, it was decided to start drives in all the larger municipalities for the necessary funds, and a committee was named to co-operate with the Minister of Health in this campaign.

In addressing the meeting, Premier Lloyd George laid great stress upon the necessity of doing something to enable the youth of England to found homes and thus to allay the rising spirit of discontent. The Premier, in urging the co-operation of the municipalities and the labor organizations for the purpose of solving the housing problem, said:

"There is nothing that is contributing more to the unrest than the great shortage of houses, and that is inevitable when you come to think what the effect is upon the populace of conditions of that kind—overcrowding, the discomfort that comes from it, the disturbance of family life, the failure to get houses. We hear from every part of the country of young people anxious to get married. Family life is a great guarantee for the security of the State, and if you get hundreds of thousands of young people anxious to settle down who cannot do it because there are no habitations for them it is a great peril and danger to society, and it is in order to avert that that we have summoned you here to-day."

Speaking at a session of an international housing conference arranged by the International Garden Cities and Town Planning Association, which opened in London February 16, with delegates present from twenty-two countries, including the United States, Sir Charles Ruthen, a leading London architect and Government official dealing with the housing situation, said he was sure that the timber-frame house would be extensively adopted in the British Isles before many months and would play a big part in solving the housing problem. He pointed out that at the end of 1919 there was a shortage of near 750,000 houses in England and Wales and that the number needed annually to meet normal requirements was 100,000, so that even if material and labor were available to build 200,000 houses by the end of 1920 the shortage would still be 650,000. He asserted that more than 3,000,000 persons in England and Wales were improperly housed and said this was sufficient answer to the prejudiced mind that preferred, for other people, the slum or the gutter to comfortable timber-frame houses.

Bernard Holland, chairman of the Housing Committee of the London County Council, remarked that the County Council had undertaken in the next five years to clear many insanitary areas in London and to erect 30,000 houses, if the labor and material could be had. In the East End the council was building 24,000 houses, which would constitute a model town.

In the meantime the Ministry of Health and the local authorities of several of the large cities are facing the problem of deciding whether to accept offers by local guilds of building trades workers to construct dwellings directly for the municipalities at rates lower than those asked by private contractors. This movement originated in Manchester, but can only be made effective if the necessary credit is advanced by the various governmental bodies.

## Beaux Arts Post Established

A charter has been granted by the American Legion to a post in Chicago, which will be shown as the Beaux Arts post.

The post's membership is formed of architects, artists, musicians and dramatists, and promises to be a big success.

All followers of the allied arts are invited to the meetings, which are held at 6 p. m. at the Art Institute on every second Wednesday. The next meeting will be held on April 7.

## Has Novel Lighting Idea

A novel idea for securing odd and beautiful lighting effects has been worked out by a New York artist, who utilizes painted parchments and paper to this end. The idea is said to be only partly new, since parchment lamp shades have been on the market for some time. But this

artist has carried out the idea a little farther in devising simple geometric forms of portable lamps and ceiling fixtures.

The development of this form of decorative illumination is believed to be still in its infancy. And the person who has a little native ingenuity and taste can work out the idea effectively while at the same time giving expression to the creative impulse.

---

### Exchange Rates and Material Prices

The importance of exchange rates as a factor in our export trade has been brought home to the American public very forcibly during recent months, writes the *American Contractor*. That cancellations of European business would mean the piling up of American products at or on the way to tidewater and that if the unequal rate of exchange continues American products at their present prices will be undersold in their home market by European manufacturers should be of interest to consumers generally. If high prices of lumber at home are the result of a scarcity due partly to large exports a break in the export tide would be likely to lower these prices. Lumber markets of the country have been very active for over a month and reports have it that trade has been limited only by the car facilities offered for shipment. On the Northern Pacific Coast 20,000 carloads of lumber were reported ordered but unshipped for lack of transportation—a condition paralleled in a less acute degree at the steel mills, where it is estimated that half a million tons of finished and unfinished steel are awaiting shipment. Mr. J. E. Rhodes, secretary-manager of the Southern Pine Association, in a communication addressed to the Northwestern Lumbermen's Association, states that he is unable to offer any suggestions which might assure the members of this association of a more stable lumber market for the next six months at least. He says that in addition to the domestic consumption there has been an increasing call for lumber for export, the volume of which has been regulated only by the ability of exporters to secure ships.

---

### American Lumber Association Formed

What is declared to be the greatest lumber organization in the world, in scope, capital and business represented, is the association just formed in Chicago. L. Germain, of Pittsburgh, is president, and L. R. Putnam, of New Orleans, manager. Both men have been important figures in the industry. The membership of the new organization embraces wholesale lumber dealers in all important American cities with selling connections the world over.

In the official announcement the purposes of the association are stated to be to standardize the buying and distribution of the enormous volume of wholesale lumber business; to enforce a rigid code of business ethics among lumber wholesalers; to systematize distribution so that no part of the market shall be crying vainly for lumber while other parts of the market are glutted, and to devise means for eliminating the present enormous wastage in the lumber business.

In addition to standardizing and systematizing of buying and distribution of America's lumber for the world's trade, the association already has mapped out a program of conservation of the nation's lumber resources. Under the present system only 37 per cent of the tree is marketed.

The remaining 63 per cent rots in the forest as stumps, limbs and tops. The association will conduct a series of scientific investigations for utilization of this wasted material in close co-operation with the United States Government. Also the association will seek use of the Forest Products Laboratory at Madison, Wis., and the bureau of testing materials at Washington.

---

### School Ventilation in Chicago

Chicago has advanced a step in the science of school ventilation. In two new schools—the Faulkner and the Orr—a special type of ventilation has been installed which has eliminated many defects of the old system.

John Howatt, chief engineer, is responsible for the type. It provides a concrete tunnel eight feet square passing under the main corridor the length of the building. From this tunnel, in which the air is warmed, washed and humidified, vertical ducts pass to the rooms above. Dirt is unable to cling to the vertical ducts and the concrete tunnel is washed out daily.

---

### Baruch Sees Drop in Prices at Hand

High prices of necessities are ending with the approach of the peak in world production in every line of industry, asserted Bernard M. Baruch, former chairman of the War Industries Board, in testifying last week before the House War Expenditures Committee.

"The profiteers and hoarders," said Mr. Baruch, "will soon run to cover, with the markets returning to normal. Only a cataclysm, an act of God or some development such as the overthrow of the Government can prevent this. When the hoarders and profiteers see that this greatly increased production is in sight, and they will be the very first to see it, they will unload and run to cover. With the restoration of normal transportation on the sea and on land, and with the world back at work, reduction of the cost of living is an absolute certainty.

"When the war broke out in 1914 it took 25,000,000 men from production to destruction. It took five men and women to care for the wants of each of these fighting men. This made the enormous total of 125,000,000 persons withdrawn from their normal pursuits. Factories were changed to produce agents of destruction in unlimited numbers.

"This went on for the war period. But with the armistice the world began to get back to work. We in the United States are now about back to normal. True, some—yes, a great many—have not yet resumed the job at top speed, but they are getting back. The great forces that of necessity had to be dedicated to destruction now are about to aid construction with all of their ability. Production will reach the maximum and the result will be that prices will go back to normal and all of the people will benefit. Because of my belief in this fact I am opposed to any price fixing by Congress in peace times. The law of supply and demand can be depended on to take care of this."

---

### England's Disabled Service Men

Almost 10,000 firms in the United Kingdom have enrolled in the British Government's scheme for the employment of disabled service men and have guaranteed positions for 97,000 men, according to information received by the Bankers Trust Company from its London

representative. The figures indicate that British employers who have signed up are doing better in percentage of disabled men employed than their agreements require.

Enrollment under the Government plan calls for employment of a number of disabled men equal to 5 per cent of the total number of employes by each enrolled establishment. The firms now co-operating with the Government have total staffs of about 1,650,000 men, which on the 5 per cent basis would require the absorption of about 82,000 disabled men, whereas the total number for whom employment has been found is 97,000.

Originally the scheme was intended to apply to firms with ten or more employes, but it is now open for the enrollment of every employer. According to recent reports, about 40,000 disabled men, exclusive of those still in hospitals, are awaiting employment. Figures furnished by Premier Lloyd George to the National Federation of Discharged and Demobilized Soldiers and Sailors show that civil departments of the Government service have employed disabled men up to 8 per cent of their personnel.

The Premier's report indicates that Government training schemes for disabled men will cost about \$100,000,000, including allowances, the average allowance to men under training being £3 5s. (nominally \$16). Out of approximately 4,500,000 service men demobilized less than 8 per cent were on out-of-work donation at the end of 1919, according to the Premier's figures. It has been suggested that unemployed ex-service men be made available for trades in which there is labor shortage.

## A Garden of Inspiration

Willis Polk, of San Francisco, has had transformed a conglomeration of bricks, rags, sticks and miscellaneous trash outside his office windows into a "garden of inspiration"—carefully labeled to avoid mistake. He is occupying temporarily a vacant lot upon which is a large atelier to accommodate some of the overrun from his plans and drawings in the Hobart Building. Logical, as always, he will have it known that his men are striving for beauty. If they have to look out on carload lots of dead cats and old bricks and other rubbish, it must get on their nerves and irritate them and diminish the extent to which they are able to concentrate on perfection.

## Chicago Loop District Hopes to Revise Building Code

Chicago, the home of the skyscraper, is chafing under the restrictions of its building code, which limits the height of office buildings in the Loop district to two hundred feet. This limit was fixed in 1911 with the idea that it would bring about an expansion of office building outside the Loop and thus tend to relieve congestion in the central business area. In this, however, the proponents of the plan were disappointed.

To-day the city council is considering an amendment to the building code, restoring the old 260-foot height for Loop buildings as a relief to congestion. Building Commissioner Bostrom, who has taken an active interest in the proposed system for Chicago, favors leaving the question open until the recently appointed zoning commission has made its report.

Among the arguments advanced in favor of the 260-foot height are:

It will solve the office rent problem by providing more space.

It will mean greater income for the city through an increase in assessed valuation.

The 200-foot limit since its adoption in 1911 has curbed building activities, as promoters will not build 200-foot buildings, which cannot compete with the 260-foot buildings erected before 1911.

The cost of operating a sixteen-story building in Chicago is so great that it does not yield any profit to the owner, while the four additional stories which this will permit only yield a fair return.

Ivan O. Ackley, president of the Chicago Real Estate Board, is of the opinion that Chicago is going to have its greatest opposition to zoning in the business district.

"Values in the business district," he says, "have been created which are fictitious, owing to the intensive use of lots in the downtown district, and when we come to limit the height that a man may build a building in the downtown district it is going to depreciate the value of all the other unoccupied land very materially, and those property owners are going to put up a desperate struggle to prevent anything of that kind happening, because it will mean a destruction of values."

## Why House Building Must Increase

The stability of the building industry is based, like every other industry, upon supply and demand. The increasing population demands more dwellings, and building will, unquestionably, continue. With this conviction the following evidence has been set down by the Associated Metal Lath Manufacturers, of Chicago:

The year 1918 saw only 20,000 new houses built. There should have been twenty times that many.

In 1919 it was a bit better, with 70,000 dwellings completed, according to the estimates by the U. S. Housing Corporation. But still the increase in population is far outstripping the building program for new houses. While in 1890 an average of 110.5 families occupied each 100 homes, to-day that figure has mounted to 121 families for every 100 dwellings. Hence the present acute congestion.

With a conservative estimate of 27,900,000 families in 1925, the great housing shortage will continue unless building in all parts of the country increases to an extent unparalleled in the history of the construction business.

If only the current number of homes are constructed each year for the next five years 409,500 homes must be built, and the congestion will reach 129.6 families per hundred homes, or 2 families in every fourth house.

Merely to keep up with the increasing number of families and in no way alleviate the present congestion 2,139,000 homes have to be constructed before 1926, while a return to the pre-war conditions of 115 families per 100 homes means the building of 3,340,000 dwellings in that period. When it is considered that in a town of 25,000 this construction program means 475 and 750 homes in five years, respectively, the stability of the building industry becomes apparent.

## The New York Hotel as an Industrial City

The large hotels to-day are industrial cities. Besides doing the work of a big bakery and kitchen they do their own plumbing, steamfitting and silverplating, make their own butter fresh every day, have their own farms and

engage the output of many farmers, do their own preserving and make all their own ice. They own the motor-trucks they use and do their own hacking service and buy theatre and opera tickets for their guests. Thousands of pieces are handled every day in the big steam and electric laundries, for the hotel itself and for its guests. A quick service is operated for the guests and they can get their pieces returned the same day.

There are men to look after the fluctuation in the number of guests, what part of the country they come from; who deal with the wage rate in 300 occupations; look after the advertising in the newspapers, home and foreign magazines and theatre programs. They run their own printing shop in many cases. One turns out its menus and letter-heads in its own printery.

The New York City hosteleries furnish the most luxurious apartments and service of any in the world to meet the demands of the most plethoric pocketbook. A floor of one of the hotels is occupied by one man who pays at the rate of \$50,000 per year. It is no uncommon thing for suites to be taken in first-class New York hotels at from \$15,000 to \$30,000 a year. A party of women took a suite at another at \$180 per night.

## The Culmination of Greek Architecture in the Age of Pericles

Five Lectures at Metropolitan Museum, New York

Mr. William B. Dinsmoor, the librarian of the Avery Library of Columbia University, who is to give the course, has recently returned from Greece where he devoted ten years largely to the study of the Periclean monuments. The first lecture will be delivered on March 25; the succeeding ones on April 1, 8, 15 and 22. Mr. Dinsmoor was the fourth of the fellows in architecture sent out to the American School of Classical Studies at Athens (1908), and after four years in this capacity he served for six years on the faculty of the school as its architect; he spent an eleventh year at Athens as assistant military attaché with the American Legation. The architectural fellowship at Athens was instituted with the purpose of securing for architects and archaeologists, before the unavoidable concealment of evidence and the placing of details in inaccessible positions had made it too late, accurate measured drawings and descriptions of the monuments now in course of restoration. For the Greek Archaeological Society, and subsequently the Greek Government, had undertaken the mechanical work of mending, hoisting, and laying in their original positions, as far as possible, the disturbed or fallen blocks belonging to the masterpieces of the ancient Athenian architects, but they were not primarily interested in the matter of publication. The American School at Athens therefore took over the literary and scientific investigation of two of the structures recently rebuilt, the Erechtheum and the Propylaea of the Acropolis and for the work on the Erechtheum (1903-1905) summoned Mr. Gorham Phillips Stevens, now director of the American Academy at Rome; the restoration of the Propylaea was carried out during Mr. Dinsmoor's residence in Athens, and was terminated, for the present, on account of the active participation of Greece in the war. These two monuments will be published in detail under the auspices of the American School, which, during fifteen years of uninterrupted activity, acquired an enviable reputation and practically a monopoly in this field of the architectural investigation of the Acropolis.

This period is chosen, because it has been so frequently discussed that the Parthenon and the Erechtheum, the Propylaea and the temple of Athena Nike (Wingless Vic-

tory), have become familiar to all. The audience will therefore be in a better position to discern just how far the picture, somewhat loosely presented in the various histories of architecture, has been filled in and connected by the latest scientific researches. During the first two lectures the viewpoint will be historical. A preliminary survey of the rise of Athenian architecture, which was a late and sudden development as compared with the pure Ionic and Doric styles of the East and the West, will show how the two distinct styles were gradually welded into a harmonious unit by the eclectic architects of Athens. Next will be discussed the careers and works of the Periclean architects, both those sufficiently famous to have been mentioned in ancient literature, and one, anonymous but prolific, known only from his temples; with these will be noted briefly the decorative sculptors and one city-planner. The third and fourth lectures will show the ancient architect and his subordinates at work, the creation of the designs, preliminary schemes and final results, constructive problems and how they were solved, methods of erection and the accounting for the cost. In the last lecture the subject will be considered from another viewpoint, that of the preservation of the monuments, the propriety of "restoration," the methods of rebuilding and the results attained. Throughout the course an attempt will be made to take the audience behind the scenes, so to speak, and to indicate the processes by which unknown facts are discovered and inferences are drawn, and it is hoped that this feature will not only be of general interest, but will have some value for the few who may in the future be thrown into actual contact with Greek monuments.

## Britain to Utilize Mooring Towers for Dirigibles

It is learned from the American Chamber of Commerce in London that the steel towers now in course of construction at the Barrow works of Messrs. Vickers will enable airships moored to them to be supplied with fuel, water, gas and goods, while the crew and passengers will also go aboard from the tower.

When completed, says the American Chamber, the structure will be about 150 feet high and will consist of steel lattice work. The Vickers' design is furnished with a revolving head, to which the airship will be closely moored, bow on, and float clear of the ground. The vessel will thus swing to the direction of the wind, protection from which is provided by the stream-line shape of the body. A winch and cable will bring the airship to the tower head and an elevator inside the tower will carry crew, passengers, fuel, cargo, etc., to the vessel. At the top of the tower a small compartment serves as an ante-room to the airship, which will be connected to it by a flexible enclosed gangway.

When an airship is making for the tower it will announce its intention by wireless and an ingenious system has been devised for bringing it safely to its landing place. The automatic mechanism for releasing the vessel from the tower will be controlled by one man, and not more than three men altogether will be required to bring a dirigible to port and send it out again.

The American Chamber in London understands that a number of these towers are expected to be ready shortly and British aerodromes will be immediately supplied with them. A further point of considerable interest to the public is the reported intention to build mooring mast waiting rooms at the foot of the tower, which might be easily developed into hotels.

Personals

Edward H. Wigham and J. Elder Blackledge, architects, have opened offices in the Indiana Pythian Building, Indianapolis, Ind. Samples and catalogues are desired.

Geo. W. Eldridge has reopened an office for the practice of architecture in suite 621-626 Exchange Building, Third and Hill streets, Los Angeles. Mr. Eldridge desires samples and catalogues of building materials.

Louis Svarz, architect, who has been stationed at Camp Taylor, Kentucky, with the U. S. field artillery for the past year, has returned to Seattle and opened offices at 24 Seattle National Bank Building.

George H. Keith, architect, announces his return from service in France. He has reopened his office at 612 Hut-ton Building, Spokane, for the practice of architecture.

John P. Krempel and Walter E. Erkes, architects and engineers, are now occupying their new offices in the Bradbury Building, Los Angeles.

Earl Scott has opened an office in the Albany block, Oakland, Cal.

Alfred F. Priest has moved his offices to 618-619 Fay Building, Los Angeles.

John Parkinson of Los Angeles was elected president of the California State Board of Architecture at joint meeting of the newly-appointed members of the northern and southern districts, held in Santa Barbara. Clarence R. Ward, of San Francisco, was elected vice-president.

Both the northern and southern boards completed their organization, officers being chosen as follows:

Southern District—John Parkinson, president, and A. M. Edelman, secretary and treasurer.

Northern District—Clarence R. Ward, president, and S. Schnaittacher, secretary and treasurer.

Vance W. Torbet, architect, 200 Fifth avenue, New York, has been released from service with the Construction Division of the army and has resumed practice at the above address.

Architect Lorentz Schmidt, 121 North Market street, Wichita, Kan., announces that the firm will hereafter be known as Lorentz Schmidt & Co., with offices at the same location.

Glen Thomas, architect, 119 North Market street, Wichita, Kan., has moved to the Caldwell-Murdock Building, Wichita, Kan.

The architectural firm of A. A. Ritcher and H. I. Eiler, Assoc., Reading, Pa., and William H. Lee, Philadelphia, Pa., have associated and will hereafter practice under the name of Ritcher-Lee Company, with offices at 32 South Seventeenth street, Philadelphia, and Sixth and Court streets, Reading, Pa.

Architect Donald C. Bollard has opened offices in the McCague Building, Fifteenth and Dodge streets, Omaha, Neb. Mr. Bollard was formerly with the Bankers' Realty Investment Co.

Edgar and Verra Cook Salomonsky have opened offices for architectural practice at 368 Lexington avenue, New York.

News Notes from Various Sources

German Government has chosen a new coat of arms for the Republic, consisting of black eagle on gold and yellow background, without other ornamentation.

\* \* \*

A. A. Ossendoffsky, Chief of Intelligence Department of All-Russian Government, Omsk, estimates that World War, Bolshevism, Civil War, starvation and disease, has cost Russia a total of 35,000,000 lives. He places cost of Bolshevism at 12,280,000 lives.

\* \* \*

On December 27, approximately 8,000 immigrants arrived in port within 48 hours, and on that date 1,168 were detained at Ellis Island for further examinations as to their fitness for admission to United States.

\* \* \*

Senate Military Committee, January 26, approved provisions providing for compulsory military training for youths between 18 and 21 years, inclusive, and ordered a favorable report upon Army Reorganization bill.

\* \* \*

Cablegram from Warsaw to Department, January 10, states that a large emigration movement from Poland to the United States awaits adequate steamship facilities. About 20,000 persons are now awaiting transportation.

\* \* \*

"One Year of British Reconstruction," by Arthur Gleason, is title of article in *The Survey*, February, 1920.

\* \* \*

Individual contractors, building firms and associations are asked to join in the nation-wide fight to secure from government bureaus recognition of the "absolute necessity" of lifting war-time restrictions on the movement of building materials by rail. Reports gathered in all parts of the country show there is plenty of building material, but it cannot be shipped for lack of cars.

\* \* \*

More than half of Canada's world trade in 1919 was with the United States, according to official figures made public here. Canada imported goods from the United States to the value of \$740,580,225 and exported in return \$454,686,294, the adverse balance against Canada being \$285,893,931.

\* \* \*

"Automatic Regulation of Humidity in Factories" is the subject of a 4-page illustrated pamphlet reprinted from the *Scientific American Monthly*. Describes apparatus developed at the Forest Products Laboratory for automatic control of moisture content in wood products during manufacture. May be obtained from Director, Forest Products Laboratory, Madison, Wis.

\* \* \*

The American Farm Bureau Federation was organized at a recent meeting of representatives from 28 State Farmers' Bureaus. Objects of Federation are to correlate and strengthen individual State Farm Bureau and similar State organizations in a national body, to promote, protect and represent business, economic, social and educational interests of farmers and to develop agriculture. Membership of Federation was placed at 700,000.

\* \* \*

National Foreign Trade Council holds its Seventh National Foreign Trade Convention at San Francisco on May 12-15, 1920. The theme of the Convention is "The Effect of Being a Creditor Nation."

# Weekly Review of Construction Field

Comment on General Conditions of Economics With Reports of Special Correspondents in Prominent Regional Centers

If there is one thing more than any other which is hampering building at the present time, it is the lack of co-operation. The point of view of contractors upon a joint conference plan is therefore timely and the following remarks, taken from the address of Mr. A. P. Greensfelder given before the Building Contractors' Division of the National Conference on Construction, state the case:

"In discussing Joint Conference Plans with labor," said Mr. Greensfelder, we are not discussing any proposition which involves a non-union shop, a closed shop or any kind of shop, but we are discussing a question of co-operation with our employes, no matter what their affiliation, and no matter what our affiliation.

"In the Railroad Bill there is an article referring to the question of labor, and a joint conference is provided. The same plan is being adopted rapidly in many countries and in many industries, and I think it is high time, as employers, that we consider some means that is satisfactory in joint conference with our employes.

"One of the things which is bothering the country and the world at large, is the shortage of labor. We heard talk this morning of efficiency and of the elimination of waste, and I am sure that appealed more closely to the Labor Platform than anything else we have had. Any movement which eliminates waste is forward movement and one that the country can afford to support.

"Now in order to make these things practical, I am just going to give a few suggestions for what in labor circles, if it had a name, might be called "Joint Cards." For instance, why not let the trowel man help along on brick work, on plastering and on marble setting? Why must you call for some bricklayer, and then call in the plasterer, and then go to the marble setter, and so on along the line? At the same time you might, no matter what his card is at the time, let a capable man cover wood-work and a dozen other things. We know that is actually done. We find carpenters and workers, and we put them to work making something out of their line. We know that one head cannot attend to more than a certain number of things, so why not eliminate a lot of that card friction?

ANOTHER thing is the question of weekly wage and monthly wage. I am sure that what families of the workingman want is a full pay envelope each week, and anything that will accomplish that is a measure of the man's earning power. I believe in certain views of the building laborer. We can enlarge on the particular line with new ties between the larger organizations. The railroad men have a great many of what they call "full time men," and naturally the yearly earning power of such a man is comparatively high.

THE next thing I have in mind is a standard of qualification. We believe that there should be a certain measure of qualification which is quite a fair and equitable matter; that a man should be requested to qualify and demonstrate his ability to perform work.

"Apprenticeships and technical training are perhaps

propositions that require consideration. The situation as it is should be overcome, and every contractor should look around for boys who are at hand, who are willing and faithful, and should educate them. We should encourage the attendance of these boys at trade schools and we should encourage and govern this national state, city, and local question of vocational training.

MACHINERY is becoming more and more universally used, and we should use our best influence on labor so that they will see that the increased use of machinery is not fatal nor injurious, because the more fruits produced the more production and wealth. And if a single carpenter can use twice as much lumber as he could by old methods, his practical use is twice as much, and his value is made twice as much both to the community as a whole and to himself.

"Safety and welfare measures are matters which co-operation with the National Safety Council has brought about, and which are worthy of every contractor's attention. If you can eliminate the expense which comes through increased insurance you will prevent suffering and you will eliminate a cost which, I think, has been placed in some trades at about one month's salary for each man in a year's time. We should as an association co-operate with the National Safety Council.

"Increased production is another thing that we hear much about, and not only in the industrial plant. It is best to devise some means pertaining to the bonuses that will recognize increased production of an individual and the Association is at work studying this problem.

"The question of overtime should be studied. What does the man's definite working day consist of? I do not think we can state it as a whole. It is a thing which varies with the different parts of the country and with different kinds of labor.

"In order that you may realize that these questions are receiving the attention of men of all classes in all walks of life, watch the great number of articles appearing in periodicals of every kind all over the country. If you will realize the amount of attention these subjects are receiving, you will see the absolute necessity of co-operating with every organization that is trying to do something in straightening them. When you do not do it, you are adding to the high labor unrest.

THE work done by the British Building Trades Parliament, as described in the January 24th issue of The Nation, is the biggest project that I have ever had brought to my attention, barring none, and it is worthy of intense study. If we can emulate it, I say we should do so.

"Now, it is very important in dealing with labor problems that we should learn the truth about both sides. An article published in 'Concrete' reads as follows: 'A group of Cleveland manufacturers in whose territory there had been a good deal of labor difficulty, banded themselves together for the purpose of putting nothing but facts before their employes. They didn't cull the agitators from among their ranks; rather, they invited them into their employ and gave them a hall in which to agitate. The

more radical they were the more they were sought. Free speech was encouraged, the freer the better. There was but one stipulation—at every meeting a plant manager or owner, somebody with facts from the other side was present. He was on hand to speak with authority, and let no over-statement, no mis-statement, go without stout proof of the contrary. And while this group of manufacturers has been in the thick of strikes, it is said that not one of their plants has had a strike of its own.

"There is tendency in all of us to hear one side of a case—to see the injustice in it and without waiting to hear anything further, decide immediately to fight. But let us bring all sides of the dispute, while it is still an embryonic dispute, together in the spotlight of publicity. Let us make sure that each side gets every shading of the other side's point of view.

ONE of the things which is affecting employment, of course, is the trend of wages and the corresponding cost of living. It is gradually rising and labor is gradually getting its rising share of the better living conditions and good things of life. When I stop to think that we are all laboring men, and that we all want a better share as conditions make that possible, I know the only difference between the employe and the employer is but in the name.

"Strikes and lock-outs are another cause of labor trouble, and cannot, perhaps, be entirely eliminated, but they should be used only in extreme cases after mediation, arbitration and publicity, and I think the conferences have worked along that very line of thought.

"We should have a Standing Conference with labor between the Association of General Contractors and the American Federation of Labor. You may think that the A. F. of L. represents only union men as against employers, but they are representatives of labor and at their conferences all subjects of mutual interest may be presented with an intention toward the development of understanding and mutual confidence.

"The mere willingness of the employer to meet the employes who have a grievance is not sufficient. There should be a definite arrangement, satisfactory to both employers and employes, whereby employes can collectively take up disputes or matters of common interest with the employers. Non-union labor is entitled to consideration, and it behooves us to so organize non-union labor that they also can get representation. When you have accomplished that you have accomplished a vital thing, for you should force men to join a union in order to secure representation."

THE American Federationist carries an article by Samuel Gompers, which states various political planks as having the sanction of labor, viz.: "Problems arising from production, transportation and distribution to be solved by applying the methods of co-operation; elimination of unnecessary middlemen, who exact a tax from the community without rendering any useful service, this reform to include farmers."

Another reads: "Ownership of homes, free from the grasp of exploitative and speculative interests; inauguration of a plan to build model homes and to establish a system of credits whereby workers may borrow money at a low rate of interest and under favorable terms to build their own homes."

And a third, which also seems to touch upon the building field: "Legislation placing a graduated tax upon all usable lands above the acreage which is cultivated by the owner."

(By Special Correspondence to THE AMERICAN ARCHITECT)

San Francisco:—The recent agreement between the San Francisco Building Trades Council and the Building In-

dustries Association of San Francisco looks very much as if San Francisco is insured against strikes and lockouts for all time. Under the terms of an agreement which becomes effective April 1, 1920, all controversies between employers and employees will be settled through arbitration and mediation without the cessation of work. A wage increase of 50 cents per day will become effective upon that date also, which provides for a number of the lower paid crafts in the building industry. Under the new agreement it is set forth that all contracts must be finished under the conditions and wage scale obtaining at the time such contracts were entered into. It has been decided further that in case living conditions justify a revision of wages, either upward or downward, necessary changes will be made by mutual consent of both organizations above mentioned, after a thorough investigation of existing conditions is made and after proof has been submitted to the satisfaction of all concerned.

A permanent Joint Conference Committee has been appointed by the Building Trades Council, representing artisans, mechanics, and laborers, and the Building Industries Association, representing various contractors and employers in all departments of the building and construction industry. This committee will devote its activities toward the stabilization of the industry and will be the means of the establishment of definite and harmonious relations between the two bodies.

An investigation of the building program contemplated by San Francisco has already been made, including the costs of both materials and living, in order that any revision in wage scales or material prices may be made with fairness to all branches of the building industry.

(By Special Correspondence to THE AMERICAN ARCHITECT)

Seattle:—The outstanding feature of the building trade here this week is the decline in fir lumber and the sharp falling off, apparently in concert or by agreement, of orders for the East. The mills are more or less fearful that when the market rebounds it will not go back to the former levels. So complete a cessation of buying from the East in so short a time has never before been known in the West Coast fir trade.

Transit, or consigned and unsold cars of lumber, have been accumulating at an alarming rate in the East, and before the market can right itself these cars must be moved. The announcement of a general cut in price by one of the "string" yard manufacturers of from 10 to 30 per cent has convinced builders that a series of breaks is at hand, and there has been silence from all buyers.

Immediately after the railways took back their properties they began soliciting loads from the Eastern territory, believing that if loads can be brought West the car situation will be relieved.

There is no  $\frac{3}{4}$  or  $1\frac{1}{2}$  inch Carnegie hot rolled channel iron on the Pacific Coast. Jobbers who have been forced to make the search are empty handed. The earliest delivery that Eastern manufacturers will promise is October 1, and even at that date they will not quote. Sherron cold rolled formed channel will take its place. Cultivator steel is quoted so high as to be prohibitive, and due to the car shortage it is almost impossible to get more. There are ample stocks of steam and hot water radiation and the market is firm and unchanged.

Plaster in sacks has advanced, but the market is due to the advance in bags rather than in plaster. No quotations are \$2 per ton higher.

Roofing is strong at 20 cents per roll higher. Scarcity of paper is drawing the plaster supply more closely to the ration plan. Jobbers have already begun to ration the building trade.



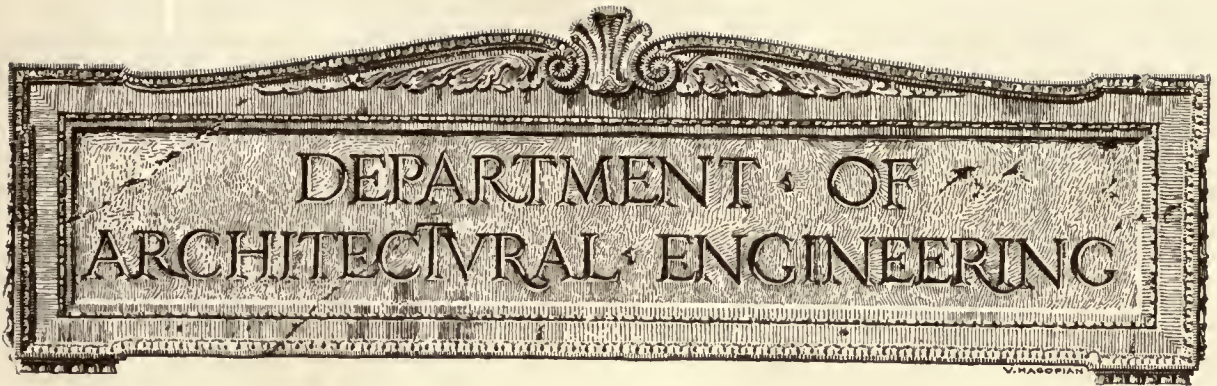

## Annual Convention of the American Concrete Institute

THE 1920 annual meeting of the American Concrete Institute, held at the Auditorium Hotel, Chicago, was arranged at the same time as the National Conference on Concrete House Construction, thus permitting the holding of joint sessions on matters of mutual interest. Due to the fact that the last convention was held in June, the Institute thus changing back to a winter convention schedule, only a little more than half a year elapsed between the two conventions, and as a result the amount of new material presented was less voluminous than would have been the case had a full year elapsed. Interesting matter, however, was not wanting.

The report of the Committee on the Treatment of Concrete Surfaces was presented by J. C. Pearson, chairman. This report is accompanied by a number of notes containing explanations relative to the various recommendations, and drawings illustrating several details of construction. In general the recommendations are the same as contained in the report submitted last year.

One of the subjects of interest at the previous convention was the variation of strength of concrete with the variation in water content. This theory has been tried out in many practical ways during the ensuing period, and an interesting paper entitled "Examples of Application of Abrams Water Ratio to Proportioning Concrete," was presented by Stanton Walker.

The report of the Committee on Concrete Building Block and Cement Products took the form of a recommendation asking for the Committee the authority of the Institute to co-operate with other agencies in having a systematic series of fire tests of concrete building units made in conformity with the Institute standard practice so as to give standing

to products made in that way, and avoid interminable questions and doubts in every local community, by underwriters and others, as to the fireproof qualities of concrete building units.

Recently many concrete tanks for the storage of fuel oil have been erected. Due to difficulties in obtaining coal, rise in price, etc., fuel oil has been made use of to an increasingly greater extent. The construction of the tanks in which such fuel oil is stored, as well as its action upon the material of which such tank is constructed, is of importance. One of the reports presented dealt with this subject. This was the report of the Committee on Concrete Storage Tanks and contained Recommendations Governing the Construction of Reinforced Concrete Fuel Oil Tanks. H. B. Andrews, of Andrews, Tower & La Valle, Springfield, Mass., is chairman of this committee. Data on the construction of such tanks will appear at a later date.

The report of the Committee on Reinforced Concrete and Building Laws was in the nature of a progress report containing the regulations as revised by the committee October, 1919. Matters relating to the formation of a Joint Committee and also standardization of specifications for steel bars for concrete reinforcement have already been made mention of in THE AMERICAN ARCHITECT, issue of February 18th.

The special committee on Different Types of Concrete Floor Finish did not present a report, due to the short time in which this special committee had to work and because of the complicated nature of the investigation. There was, however, a very lively discussion on the floor of the convention of different expedients in getting good floor finish and considerable prominence was given in that discussion to commercial methods of hardening floor surfaces, notably those materials which have calcium chloride

as the basis. This important feature of building construction will be presented more fully in these columns in a subsequent issue.

Walter A. Hull, U. S. Bureau of Standards, chairman of the Committee on Fireproofing, reported further on the tests being conducted by the Bureau of Standards. The results of previous tests were presented in *THE AMERICAN ARCHITECT*, issues of October 29th and November 5th, 1919.

J. C. Pearson and J. J. Early presented a paper on New Developments in Surface Treated Concrete

and Stucco, printed in full in this issue.

There was a registration of 274 at the convention. At a business session of the Institute the election of the following officers and directors was announced:

President, H. C. Turner, New York City; vice-president, Charles R. Gow, Boston, Mass.; treasurer (re-elected), Robert W. Lesley, Philadelphia. Members of the Board of Directors: Edward A. Tucker, Boston; E. D. Boyer, New York; Arthur Bent, Los Angeles.



FIG. 1. PRECAST CONCRETE WORK AT MERIDIAN HILL PARK

## Successful Building in Stucco

### New Developments in Surface Treated Concrete and Stucco<sup>1</sup>

By J. C. PEARSON<sup>2</sup> and J. J. EARLEY<sup>3</sup>

[AUTHOR'S NOTE.—The joint authors of this paper have been closely associated by their membership on the Advisory Committee of the Bureau of Standards Stucco Investigation, and on the Committee on Treatment of Concrete Surfaces of the American Concrete Institute. Both residing in Washington, they have had an unusual opportunity to study and discuss together the results obtained from the experimental work of the Bureau in concrete and stucco, as well as those from Mr. Earley's work in connection with his contracting business. These discussions often led to the consideration of possibilities somewhat beyond the range of established practice, and, in fact, beyond the limitations of established theories relating to the gradation and proportioning of the ingredients of mortar and concrete. It was therefore natural that ideas were conceived which were too visionary to be of use to

any committee, but nevertheless deemed worthy of further investigation on the writers' own account. If these ideas proved to have no value, no one would be the loser; if they did amount to anything, the results would be a contribution to our knowledge of stucco and concrete.

Hence it is a matter of some gratification to the authors to be able to describe these new developments in the treatment of concrete surfaces, the success of which is due largely to scientific studies of the behavior of combinations of various sized particles, and the development of a technique adequate for the molding of these combinations of particles in any desired form and place.]

**S**TUDIES of the experimental stucco panels at the Bureau of Standards led to the general conclusion that by adherence to well established practice, structurally sound and durable

(1) Paper presented at the 1920 annual meeting of the American Concrete Institute.

(2) United States Bureau of Standards, Washington, D. C.

(3) Sculptor, Washington, D. C.

stucco could be secured, but that a great deal could be, or ought to be, done to improve its appearance. Crazing and map cracking are common to most stuccos, and are especially objectionable on surfaces of fine texture; the monotony of the cold grey



FIG. 2. A CLOSE-UP VIEW OF CONCRETE SURFACES BY EARLEY-PEARSON METHODS

cement color is objectionable, and is only partly relieved by the use of white cement and mortar colors; and finally the muddy appearance (due to cement, or cement and pigment, being too much in evidence) is objectionable from an artistic standpoint. Consideration of these matters suggested at once the use of less cement, and it became evident that by efforts in this direction improvement in appearance might be obtained. The apparently insurmountable obstacle to this departure from usual practice was, of course, the lack of plasticity in the leaner mixtures. Various methods of overcoming this difficulty were considered, and some experiments were made which indicated that a real improvement might be obtained by substituting fine inert material for a portion of the cement. The easiest way to accomplish this result seemed to be by using blended cements, that is, normal cements ground with a certain percentage of sand, stone-screenings or other suitable materials. These experiments were never carried very far, however, for it did not seem possible that any method which might be devised for retaining plasticity could bring about the desired result, viz., the elimination of all objectionable features mentioned above.

Serious as was this lack of plasticity in the lean stucco mixtures, it was, after all, something that

could be overcome by *work*. This was demonstrated by the fact that mixtures as lean as one part cement to six parts of stone screenings were applied on some of the Bureau of Standards panels with excellent results. But the improvement in these panels as compared with some of the easier working combinations did not seem great enough to justify the increased cost of application. The question finally arose whether by careful attention to gradation of the aggregates this improvement in appearance might not be so enhanced that the cost would be a secondary consideration.

This idea came from the fact that Mr. Earley had succeeded in making complicated casts of concrete from specially graded aggregates in such manner that a very large percentage of the area of the treated surface (first wire brushed and then washed) was aggregate, and a very small percentage cement. Possibly due in part to the higher reflecting power of the surfaces of the exposed aggregates, the color of the concrete surfaces thus produced was determined almost wholly by the color of the aggregates, and only very slightly affected by the cement itself. A most convincing demonstration of this fact was obtained by constructing two concrete slabs containing exactly the same proportions of specially graded aggregate, the one be-

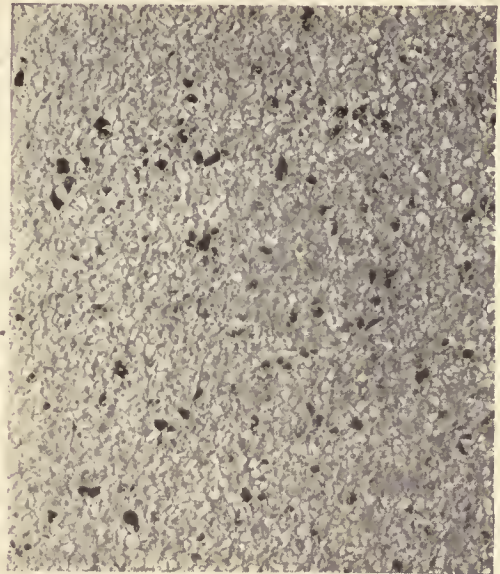

FIG. 3. ANOTHER CLOSE-UP VIEW OF CONCRETE SURFACES BY EARLEY-PEARSON METHODS

ing mixed with gray cement, the other with white cement. After the surface treatment of brushing and washing had been applied, only an expert could have determined which slab contained the grey cement and which the white.

To digress still further for a moment, this method of obtaining permanent and very pleasing colors in concrete surfaces is such an important item in the development of the processes here described that it is worthy of fuller explanation. Before color in concrete surfaces can be under artistic control a technique must be developed which has for its medium the elements of the concrete itself. Although in problems involving appearance, aggregate is by reason of its greater bulk the major

and manipulated as to deposit in the surface the greatest possible amount of aggregate. Any great degree of success can hardly be expected in coloring concrete through the cement. The choice of colors is restricted by chemical reaction with the cement, which causes them to fade or change; depth of color is restricted by strength requirements of the concrete, which limit very closely the amount of pigment which may be added to the cement. Therefore with the choice of color limited by one re-



FIG. 4. ENTRANCE TO MERIDIAN HILL PARK, WASHINGTON, D. C., SHOWING EXPOSED AGGREGATE SURFACES

element and cement the minor, it is, nevertheless, the color of the cement which is the natural color of normal concrete. The reason for this is that the cement is finely ground and deposits itself, paint-like, over the surfaces of the aggregates and colors the whole mass. If, therefore, concrete is to receive its color from the cement paste, variation must be obtained by the addition of pigments to the cement, following the well established practice of mixing paints; but if the aggregate is to be the source of color, the concrete must be so designed

and the depth of color by another, the cement itself must remain dominant. On the other hand, in coloring concrete through the aggregate all such restrictions are removed, and colors may be obtained from white to black through all the range of possible aggregates. An examination of drawings done in hard pastels and of paintings of the impressionist school suggests a technique in coloring which is peculiarly adaptable to the coloring of concrete by means of the aggregate. In the pastel tones are produced by hatching and cross-hatching

with lines of pure color without blending on the surface of the drawing; in the paintings by spotting with pure colors one beside the other, and without blending. In both cases the tones are effected by the blending of the light rays reflected from the picture to the observer. Wonderful depth and clarity of tone are characteristics of this school of coloring, and in it are to be found a great deal of exact knowledge and valuable precedent. When this knowledge is translated in terms of concrete

The laboratory program was fairly simple. The plan consisted simply in working first with concrete mixes in miniature, in which the sizes of cement particles, sand particles and coarse aggregates particles were reduced from the normal sizes in the ratio of about 1:10, this being taken as the approximate ratio of the size of particles passing a No. 8 sieve to pebbles one inch in diameter. It was assumed that the density of such mixes would depend mainly on relative sizes of the component



FIG. 5. DETAIL VIEW OF ENTRANCE TO MERIDIAN HILL PARK, WASHINGTON, D. C., SHOWING EXPOSED AGGREGATE SURFACES

aggregates, it is obvious that, if the aggregates are carefully selected and carefully placed, all the elements are present for the successful coloring of concrete surfaces. The results obtained in practice bear out the theory given above, and there is every reason to believe that the aggregate is the proper source of color for concrete.

Hence it was a most important conception that a similar result might be obtained with stucco. The success of this depended, first, upon securing a suitable gradation of the stucco aggregate, and, second, upon being able to apply such a mixture, once it were satisfactorily compounded. It was known at the outset that these mixtures would be harsh, therefore plasticity no longer played any part in the calculations.

particles, with due allowance for the water content. If these mixes appeared to be satisfactory for the purpose, it was assumed that any reduction within the 1:10 ratio would also be satisfactory, and the actual reduction to be employed in compounding any given stucco mixture of this type would be as slight as the requirements of texture and the difficulties of application would permit. To make a long story short these experiments in the laboratory with the miniature concretes were very successful. Not the least important part of the laboratory work was the microscopic examination of the structures of these little concretes, which yielded many valuable suggestions for the gradation in size of particles, and for the proper proportions of the various sizes to yield the desired effects in the treated sur-

faces. The first attempt to apply the new product to a vertical wall was not wholly discouraging. Small areas were treated successfully, and eventually a terra cotta tile penthouse on one of the new labora-



FIG. 6. DETAIL OF VESTIBULE OF PRIVATE RESIDENCE—COLOR ALMOST WHITE, WITH OCCASIONAL SPOT OF BROWN

tories of the Bureau of Standards was coated with the exposed aggregate stucco. This example was the forerunner of the work illustrated in this paper, and while it is not as free from imperfections as the more recent work, it has attracted most favorable notice. Fortunately, the mechanics who were selected for this work developed a real interest in the new type of finish, and subsequently a pride in the results of their work, which made for very rapid progress in the development of the methods of application and treatment. New requirements in thoroughness of mixing, consistency, and control of the absorption of the undercoats were met, and other improvements in the general process were gradually introduced as essential parts of the routine. Not all of the problems have been solved, but there has been very gratifying progress in the comparatively short time that the new stucco has been applied commercially.

The illustrations accompanying this paper have been selected as typical of Mr. Earley's work in the vicinity of Washington, D. C. They are ar-

ranged in nearly chronological order and show the gradual improvement that is being made as experience accumulates.

Figs. 1, 4 and 5 are views of the concrete work at Meridian Hill Park, Washington, D. C. Fig. 4 is a general view of one of the main entrances, the construction of which was described in the Proceedings of the American Concrete Institute, in 1918. Fig. 5 is a detail of the surface. Fig. 1 is a view of the upper level of the entrance shown in Fig. 4. The balustrade seat and planting box are of precast concrete, containing Potomac River gravel as coarse aggregate; the concrete tile are fabricated from black trap rock. The detail of the entrance shown in Fig. 1 illustrates the use of different textures for architectural scale, but with no variation in color. The aggregate is Potomac River gravel without additions or modification of any sort.

Fig. 7 is a view of the gate posts at the entrance to the grounds of the U. S. Naval Hospital. The aggregate is Potomac River gravel, but slightly modified to obtain a color harmonizing with that of the buildings in the background.

Fig. 8 is an interior view of the Café St. Mark's,



FIG. 7. GATE POSTS AT ENTRANCE TO UNITED STATES NAVAL HOSPITAL, WASHINGTON—AGGREGATE POTOMAC RIVER GRAVEL

Washington. The architectural treatment is such as to give one the impression that he is lunching in a formal garden, whence the café is sometimes referred to as the "Outside Inn." The walls are of

## THE AMERICAN ARCHITECT

exposed aggregate stucco, on metal lath, the color and texture matching that of the precast concrete urns. This is notable as the first commercial application of this type of stucco.

Fig. 2 shows the surface of the Potomac Park Field House, Washington. The work was done with Potomac River gravel. The surface treatment is applied to the undercuts as well as to the more exposed portions. Attention is called to the close disposition of the larger pieces of aggregate, and the evenness of the texture.

is a very interesting combination of precast work, monolithic concrete and stucco. The color is nearly white, with an occasional spot of brown, the texture is characteristic of concrete and not of stone, and both color and texture are uniform throughout.

The writers believe that the work here described shows progress in the development of concrete and stucco as materials worthy of a place in the highest type of buildings or structures. It is to be noted especially that none of this work is an imitation of



FIG. 8. INTERIOR VIEW OF CAFE ST. MARK'S, WASHINGTON

Fig. 3 is a view of the concrete work at Fort Lincoln Cemetery, as yet uncompleted. The color of the aggregate is such that from a moderate distance the structure resembles cut granite, but it is in no sense an imitation of granite. It is interesting in showing the remarkable proximity of the stucco aggregate. In comparison with Fig. 6, this detail shows improvement in control and workmanship.

Fig. 6 is a detail view of the vestibule of a private residence. This has recently been completed, and

stone. Close inspection shows at a glance that it is concrete, with textures that vary widely, but always characteristic of concrete. Furthermore, the material may be cast in any form the architect may desire, with all details complete; no cutting, tooling or dressing is required other than the prescribed treatment of cleanly exposing the aggregate. Finally the material provides a medium for the expression of color in infinitely greater variety than that which obtains in the natural building stones.

In conclusion the writers would add a word about stucco. The new type of exposed aggregate finish can not fail to arouse new interest in stucco, as a product, regardless of the nature and treatment of the finishing coat. The product should be more widely used; and the reason it is not more widely used is that it has too often been applied by contractors or mechanics who consider it only as an outside plaster. This paper has attempted to convey the impression that cement stucco is more like concrete than plaster, and that plasticity is not essential. The point the writers wish to emphasize is that the art of applying durable stucco is very different from the art of plastering, and, in their opinion, stucco will take the place it deserves among building products only when this fact is generally recognized.

### Book Reviews

STRUCTURAL DRAFTING AND THE DESIGN OF DETAILS: BY CARLTON THOMAS BISHOP. CLOTH 8X10—PP. 338, ILLUSTRATED. JOHN WILEY AND SONS, INC.

**W**HILE this book has been prepared primarily to meet the needs of the engineering student and structural draftsman, it contains much valuable data for those of more mature experience. Part I, consisting of four chapters, contains a description of the organization of structural steel company and the manufacture and fabrication of steel. Part II, which is the main portion of the book, contains 25 chapters and treats very thoroughly of structural drafting, from an elementary description of the drawing, then leading up to complicated detailed drawings of structural members for both bridges and buildings, and ending with a description of the method of checking such drawings. Not alone actual drafting, but such allied subjects as the making out of material order bills, shop bills, etc., are also described. This section of the book is replete with illustrations, the plates covering practically all classes of work which the structural draftsman is called upon to do. Part III, containing 15 chapters, deals with the design of details. Engineering designing data, taking up in order simple beams, tension and compression members, plate girders and grillages, comprises this section. Numerous tables of structural shapes and other useful data are contained at the back of the book.

This volume covers in an excellent way the scope of work performed by the structural draftsman.

ESTIMATING CONCRETE BUILDINGS: BY CLAYTON W. MAYERS. 6X9 STIFF CARDBOARD COVER—PP. 51, ILLUSTRATED. ABERTHIAN CONSTRUCTION CO.

This small volume describes briefly and in logical order the succession of steps in estimating the quantities and costs of concrete buildings. The methods described are sufficiently illustrated to clearly demonstrate their application. While a much larger and more comprehensive volume might have been written on this subject, the book will be found to contain much of value to those engaged in concrete construction.

ELECTRIC LIGHTING: BY OLIVE JEROME FERGUSON. B.S. IN EE., M.E.E. CLOTH 6X9—PP. 238, ILLUSTRATED. MCGRAW-HILL BOOK CO., INC.

At the present time many books dealing with the subject of electric lighting are published, but improvements in this field are rapidly developing which tend to render parts of the older books obsolete, and the books themselves incomplete. Mr. Ferguson's work seeks to cover the entire field of electric wiring and illumination. To the uninitiated the book will seem ultra-technical. It is to be regretted that a more simple treatment of the subject was not used in the opening chapters, giving adequate explanations of the terms used.

The first four chapters deal with the subject of electric wiring, and are followed by three which are descriptive of the several types of electric illuminating units. The subject of illumination is treated in subsequent chapters, nine of which are devoted to lighting of various classes of structures such as residences, factories, schools, etc. One chapter is devoted to color. An appendix contains tables for use in connection with illumination calculation.

ARCHITECTURAL DRAWING PLATES: BY FRANKLIN G. ELWOOD. PAPER COVER 7 $\frac{3}{4}$ X8 $\frac{3}{4}$ —PP. 15. THE MANUAL ARTS PRESS.

This little book is designed for the student and also as a practical handbook for the architectural draftsman. It contains 15 plates in all, illustrating details of doors, windows, mouldings, cornices, porches, etc., as well as several single line sketches showing the method employed in making preliminary plan studies. It should prove a useful addition to the draftsman's library.



u  
392

Jeant's piece x 9310



THE LEANING TOWER OF SARAGOSA

# THE AMERICAN ARCHITECT

VOL. CXVII

WEDNESDAY, MARCH 31, 1920

NUMBER 2310

## The Architect and Organization

By GLENN BROWN, F. A. I. A.

IT is a fallacy to believe that an organization through rules and card indices will successfully run itself.

The vital factor is the character of its members and the initiative and common sense of the official staff. The character of membership is of little importance if they place incompetent managers in office. I have heard it stated by men who should have known better that it was their ambition to organize the Institute office to a plane where the machine would operate itself, so that the character and force of the men in charge would be of little importance. An impracticable, visionary idea; the history of the world has shown that the individual man at the head is the life-giving force.

It behooves the society to get the man who represents the highest elements of the profession for its head. A man known to the world for his accomplishments, ideas and ideals. Such a man immediately secures public confidence which is the foundation for successful results. Men of this character are not seeking office, in fact they often wish to avoid it. A rule was adopted some years ago requiring the acceptance of a nominee before his name could be presented for office at a convention, on the plea that the Institute should not be placed in the position of electing a man president and have him refuse. My belief has always been to elect the man considered best for the position, without his knowledge or consent, irrespective of geographical or other considerations. Before this rule was adopted it was often done with successful results. A notable instance of this was the election of Charles F. McKim. A body of us at the Buffalo Convention had no doubt that McKim represented the ideals most highly prized by the majority of the profession and determined to put his name on the ballot. A large number of members, whom we might call pessimists, insisted that McKim would not serve if elected and demanded that we should nominate some one active on the

393

floor of the conventions, who did much talking on rules and regulations. We persisted and McKim was elected. It was my duty as Secretary to notify McKim of his election and I must confess that the reiteration of the statement, "You will never get McKim to serve," made me nervous. After due thought I determined to notify McKim personally instead of writing him a letter of notification, as I feared a prompt declination.

After running the usual gauntlet of New York offices I reached the sanctuary of McKim, where after some preliminary words on Washington and the Park Commission, McKim was notified that he had been elected President at the Buffalo Convention. Apprehension and astonishment was expressed on his face as he said:

"You can't be in earnest, you must be joking."

"We are very much in earnest, Mr. President," I replied. "The convention was unanimous in selecting you as the man best representing the Institute and the one who can make its work of the greatest public service."

"I could never preside over a convention," he said, "I know few of its members and don't feel that I am fitted for the office, so I must decline."

He was told that we needed a man of his character in the campaign for better government architecture, the development of Washington, the education of the public, and impressed upon him the great public service he could render in the position. Wm. R. Mead backed these arguments and McKim finally accepted. This was a notable example of the office seeking the man and not the man seeking the office.

McKim was enthusiastic in making the Institute an instrument of public service. It is hardly necessary to say that when his enthusiasm was aroused it meant work, unceasing work for himself, his staff and his friends of high and low degree. He gave the Institute a prestige in official and civil life it had never approached before.

## THE AMERICAN ARCHITECT

If he had been asked to accept before his nomination he would have declined. He was commandeered for service and accepted.

The evil effect of this rule is shown in another instance. Before the convention in New Orleans, a majority of the chapters expressed their desire to have Wm. R. Mead as President; it was a time when a sane and safe head was much needed by the organization. The rule made it necessary to get his acceptance before his name could be presented to the convention and he declined. If he had been elected without his knowledge, I feel confident he would have accepted. With the failure to secure Mead the society began to lose the public confidence. A vice-president should be selected with the same care, as he at any time may become the head of the association. I have little patience with the custom of selecting men for geographical reasons instead of individuality and character.

In selecting the president and other officers of the society avoid those seeking place, and commandeer those who best represent the common sense and ideals of the members.

When the officers have been selected let them control; do not delegate authority to this and that committee, to this and that individual. The best results will be attained by the central staff unhampered by numerous rules and instructions. The organization of the general staff is a matter of vital importance.

The Secretary should be the executive officer of the Institute to "carry on" instructions from the President and Board of Directors, and to conduct the ordinary routine of the office. He should be capable of answering questions relating to architecture, whether history, construction, business or legal. He should be in touch with movements in this country and the countries of the world, like city planning, housing for communities, education and other broad efforts in the public service. He should have a knowledge of the allied fine arts and of the movements of engineers, builders and labor. He should be posted on legislation proposed or enacted, where it relates to the fine arts or construction. He should be diplomatic, and when occasion arises, pugnacious in dealing with Government and State legislators and officials. He should be patient but persistent. He should be able to write clearly and speak to the point when presenting a case for the society. He should have his reference library at hand and know how to use other available libraries when needed.

He should be familiar with social amenities and functions. He should, subject only to the President, Directors and Executive Committee, be directly in charge of:

1. Routine business.
2. The organization of conventions.
3. The editor-in-chief of the Journal Proceedings and other Institute publications.
4. Should have charge of propaganda for the welfare of the profession and for the public good.
5. Should carry on all negotiations and conferences with legislators, executives, foreign societies and outside organizations.
6. He should give his whole time to the Institute and be located in Washington.
7. He should have a chief clerk or office manager for office routine.
8. A bookkeeper to keep accounts, collect money, audit bills and transfer money to treasurer for deposit; and accounts payable approved for payment.
9. An assistant editor for ordinary make-up, proofreading, and such other work as may be delegated to him by the secretary.
10. An elastic corps of typewriters and stenographers, and filing clerks according to the work in hand.

Given these assistants under the direction of the President and Directors, do not hamper him with rules binding him hand and foot; or give various committees power to interfere with this or that function of his office, as exemplified in the present publications committee.

The Treasurer, all will agree, should be a man with a knowledge of finances. He should receive through the Secretary's office, the funds of the Institute, disburse on the indorsement of the President and Secretary and invest surplus, when any, subject to the approval of the Executive Committee.

The men who join the organization should be admitted for capacity in plan and design, knowledge of construction, efficiency in business and reputation for upright standing in the community. At one time it was too common to base the candidate's entrance on his capacity in design; now there appears to be a tendency to force in all who will pay their dues. I believe quality is far more important than numbers. One member of the Institute whose standing and character is a light to the country is of more value than a dozen men who are unknown or not favorably known.

Let us weigh the different elements in his work and if he has a fair average and is not markedly deficient in some one of the elements, admit him.

Do away with local chapters and have as branches only state associations. Allow these state associations considerable latitude as to the character of membership. The few limitations, I

## THE AMERICAN ARCHITECT

would make, would be a stated number of Institute members before giving the title of state association of the American Institute of Architects, with the right to delegates in proportion to their Institute membership in conventions of the national body, and restricting the vote to Institute members on national questions. They could encourage state members who would be candidates for Institute membership; junior members, students and draftsmen who would be candidates for state membership. They could institute means for encouraging interesting and educating the associates looking to state membership.

They could have associate membership of allied building trades and crafts, and encourage intercourse, discussion and instruction on all subjects of a common interest. The state associations might have branches in cities where they thought it desirable for local reasons. The local branches need not be supervised by the national body, but by the state body.

Get every state to organize such a body, starting with the chapters which have a state for their territory as well as the state organizations already in existence. Let all who would be eligible for a license to practice architecture in a state be eligible to the state association. Make it a distinction for the practitioners doing the best work in the state to be yearly recommended as members of the national body. Let it be known throughout their state when men were recommended and admitted to the Institute. This advance for merit would give a worthy object to seek; it would constitute an honor conferred upon the individual that which would be reflected upon the state and the people would appreciate the fact.

The distinction would, in time, be the same as an election to the National Academy.

Make it more a distinction for a member of the Institute to be elected a Fellow, only conferring this honor for notable achievement in design, construction, education or public service. Only members should be eligible for this grade.

Simplify the code of competitions, guarding against favoritism and leading to the best design and the most capable man getting the work.

Get rid of the canon of ethics and depend upon the knowledge of the members as to what is right and what is wrong and upon their honor to uphold the justice and dignity of the profession.

Do not let us enter entangling alliances with other professions or other societies. Let us be ever ready to assist them or seek their assistance in specific cases when we can be of public service in advancing the fine arts, for this, as Saint Gaudens says, "Makes for the nobility and elevation of

life"; in securing safe construction as it insures the public against accident; in obtaining thorough business management, as that prevents waste.

The question of business methods and fees is important in the relations of client and individual, and as the customs and necessities are so dissimilar in the East, South, Middle West and Pacific Coast, I feel that it should be left largely to the state societies and not make an effort at control which has proved unsatisfactory.

I believe if the architect is to prove his worth as a public servant, and exercise the privileges and perform the work for which his experience and education best fit him, he must not delegate very important branches of his authority to others. He must take the position given in the title, Architect, (Master Builder). He must be in complete control of plan, design, construction, landscape and interior decoration, and business management. When he delegates any one of these functions to others he is doing himself, his brother architects, his client and the public a serious injury. The sooner the individual assumes and bears the full responsibilities of the title he has adopted, the better for all. This means work and possibly more work, but it means a greater output, a more effective output. Continuous and more efficient work and greater production is what the country needs at the present time. This is a fact for the architect as well as for the mechanic and the laborer.

The letting of work, either in the lump sum according to the usual custom in this country or by the cost plus a percentage, have both decided drawbacks. The first often becomes a gamble between competitors as to an interpretation of the drawings and specifications, based on the accuracy of their computing staff, their knowledge of the capacity and character of the work required by the architect, the possibilities of breaking the contract and making up on extras and gain or loss by the rise or fall of wages.

I have felt for years that a fair solution of the contract might be found in a guaranteed bill of quantities to which the contractor would fix a price for each item, with a rate for deductions or additions. This would make the uncertain quantity only the output of labor, on which he would have to make his guess. He could secure himself against the advance in materials by making his contracts when the work was awarded.

In these troublous and uncertain times, the bill of quantities might contain a clause stating that the prices in various branches are based on labor at so much a day. If labor increased or decreased a certain rate the prices would be so much less or

so much more. The lump sum contract is a temptation to save even by slurring the character of the work, as the less it costs the greater the profit.

The cost plus percentage contract is a temptation to reckless extravagance; in outlay for materials, wages to clerks and mechanics, an excess of labor for the output work, carelessness as to the production of labor, as the greater the cost the greater the profit. The unreasonable cost of this form of contract has been clearly demonstrated during the war period and I feel that the engineers, the practical men, to whom this work was almost entirely delegated, must assume the blame. Of course it is claimed that these extravagances were due to the necessities of the war; but I believe our troubles now are due largely to this cost plus system, which encouraged a reckless increase and yet more increase in the cost of labor and material. It might be asked, what should have been done? The architects were the profession to manage such operations; thousands of them offered their services, competent men who would have taken hold at a salary less than the mechanic is now paid. He would have organized forces, employed labor, bought material, and executed the work more quickly than under the system followed. Architects and builders would have accepted salaries. Construction company superintendents could have been commandeered if they would not accept a salary, just as other things were commandeered.

I have seen a hundred carpenters in each other's way sheathing a roof, where twenty would have been much more efficient. I have seen bricklayers at ten dollars per diem laying 400 brick a day, when a few years ago we considered 1200 a moderate day's work when wages were four or five dollars per diem. I have seen laborers by the score, receiving four and five dollars a day, ditching slowly, take out a half shovel of earth, slowly raise it from the ditch, slowly deposit it on the bank, slowly dump it, rest, talk, then slowly repeat the operation. Quadruple the time for half the material and wages double what they were a few years ago. We must attribute this enormous waste and cost due to reduction of production to the cost plus a percentage contract. Under no other form of contract or management would this waste and excessive cost have been tolerated.

I heard a soldier back from France make a comment which had considerable weight, I thought. He, in effect, said:

"Yes, you mechanics were grumbling when you were getting ten dollars a day for eight hours work, safe and well housed, while I was in the trenches, risking my body and life for thirty dollars a month and food. The Government should have fed

you and made you work for thirty dollars a month. If they could draft me to fight why couldn't they draft you to work for the good of the nation."

I believe it is a mistake for the architect to employ in his own office the cost-plus system, either with contractors or for his own remuneration. In 90 out of a hundred cases it is of vital importance for the owner to know how much he will have to spend. I believe this will be best assured by a contract based on a bill of quantities, on which the architect is to receive a stipulated commission.

The society should initiate and persistently pursue measures for the public good. Two important campaigns were started years ago, one in town planning, for which the architect is best fitted to reach a satisfactory solution. This by lack of interest and persistence has been allowed to pass to more public spirited associations. Then at the New Orleans Convention a carefully prepared scheme for a Bureau of Public Works was presented, a bill which Senator F. G. Newlands, who initiated and carried through the Irrigation and Reclamation Schemes, was ready to push before Congress. This measure was side-tracked because the Convention devoted its time to the discussion of rules and regulations. Now it is being pushed under the initiative of the Engineers, with the Engineers the dominant factor; and it should be very carefully studied by the Architects lest the securing of a good plan and design, so important in the public interest, be not guarded.

There is one measure now for which the Institute may work. A National Gallery of Art in which they may be of public use. Will they do it, or will they continue the discussions of rules and regulations among themselves, among all professions?

I will briefly recapitulate:

Annul the binding rule of acceptance before nomination and elect the man representing the highest standards of the professions for President.

Make the Secretary the executive officer, and make all affairs of the Institute go through his office; whether it be office routine, dealing with officials, reports of committees, propaganda, or publications. Give this Secretary an ample staff for efficient work, with power to select his assistants; a chief clerk for office routine, an assistant editor for publications, a bookkeeper for accounts and a stenographic force, expanding and contracting according as emergencies may arise. Make him the executive officer in fact, subject only to the control of the President and Board of Directors. He must for the sake of the society be an architect of standing, known to the people by his work; a man of culture in the fine arts, a man of affairs

and common sense, a man imbued with high ideals but practical in their application, a man not afraid of losing personally in fighting for the right.

Do not delegate independent power to committees.

Make State Societies the federated branches, and allow them liberal independent action; this is preferable to the independent organizations to which there is a strong tendency.

Maintain the architect's right as securing the best results for the public to control, plan, design, in construction, landscape and decoration.

Initiate and persistently pursue movements that will foster and advance the fine arts.

Organized in the way suggested I feel certain that the Institute will again secure the public confidence and will be alive, and grow as an instrument of public service.

---

## The Robert L. Bacon, Jr., House

JOHN RUSSELL POPE, *Architect*

**A**FTER all, there is good reason why architects should insist that theirs is an art as well as a business.

The mental attitude of the architect and the artist painter toward the materials they employ are certainly very similar. For example, some painters load their palettes with a great many "spots." They are insistent that they can only successfully work when they have many varieties of red, of yellow and of blues. Again they will need the cadmiums and cobalts, and all those other expensive pigments, insistently declaring that they can only achieve a worth-while result with many and most costly colors.

Many architects work along this line. They so impress a client with the necessity for the most costly materials that the client becomes affrighted when he contemplates the cost and abandons the project, or gets another architect.

Undoubtedly, the old masters of painting worked with an exceedingly simple palette, and undoubtedly no sane person would question the merit of their work or its enduring qualities. It is equally true that the master builders of centuries ago created the buildings that have become classics of architecture out of the simple materials that abounded in the immediate neighborhood. And it is doubtful if they could be made alive and set to work to-day with all the complex and numerous materials with which the present-day architects work out their designs, if they would excel the efforts of their earlier incarnations.

If it is correct, as has been many times stated, that a true mission of art is the refinement of the commonplace, it would be equally a fact that a result of the highest achievement of excellence secured by the use of commonplace materials is the best exposition of art and the work of an artistic genius.

An instance of these things is afforded by the house of Robert L. Bacon, Jr., designed by John Russell Pope and illustrated in this issue. Fortunately for the architect and the success of his efforts, he had for a client a man who was able to appreciate the value of an artistic effect without an inflated idea of the value of the materials employed.

The insignificant cost of the stretcher and the canvas on which a masterpiece is painted in no manner affects its value as a work of art, and if, as in this instance, the architect can assemble by use of commonplace materials a result that in its ensemble is so worthy of artistic admiration, he is certainly blazing the way and setting a good example to architects everywhere.

In the Bacon house the architect was undoubtedly able to visualize the possibility of the artistic interpretation of the humble materials he determined to employ.

Having decided that he would construct the shell of the house of common red brick, and having in mind, no doubt, the effect of similar construction observed in many of the roadside buildings when he had traveled in Italy, he has adopted for the motive of the design an early Renaissance type; and over the common brick has spread coats of whitewash, varying in number to produce the effect of weathering so wonderfully colorful in the Italian examples. Photographs with their absence of color cannot adequately convey the successful outcome of this method of handling cheap material, but those whose good fortune it has been to study the effect attained are unanimous in approval.

Certainly a successful architect must needs be a many-sided man. He must not only be a true artist, an executive and master builder in the truest sense, but he must be a diplomat. Not of the amateur school with precedent founded on the work of other men, but, if he may carry conviction to his



HOUSE OF ROBERT L. BACON, JR., AT WESTBURY, L. I.  
JOHN RUSSELL POPE, ARCHITECT



## THE AMERICAN ARCHITECT

client, he must of necessity prove by concrete example that he knows what he is talking about, that he can successfully carry forward the economical but artistic result he is urging. It might, and probably would, be difficult to prove that while a half million dollar house had been erected with most satisfactory and economical results, one that was to cost perhaps less than a tenth of that sum could be proportionately economically carried forward.

It is just exactly this sort of thing that was accomplished in the Bacon house.

We only occasionally hear in these days of the bad taste of the rich. The reason perhaps is that the rich have been "shown" by architects, and that they have had pointed out to them the right and the wrong way to buy architecture, and just how it becomes a good or a bad commercial asset as it is well or poorly interpreted.

What we need to-day more than anything else in our domestic architecture is the sort of supervision that has made the Bacon house a successful example of a country house. It is the getting away from the standardized straight lines of the rule and T square and a "painting of the fabric," as it were, by the daily supervision and changing to effect a certain predetermined result that exists only in the mind of the architect, and cannot by any possible means be reduced to a statement of drawn plans or specification.

Slowly but surely suburban United States is taking on, in its domestic architecture, a certain dignity of aspect that before very long will be as universally commented on and approved as is rural architecture in England. Undoubtedly we in this country are searching for and attaining better ideals in art than ever before. It is only the pessimistic ones, who are

so "utterly artistic" that they lose the real significance of art, who fail to appreciate this.

Such advancement as has been made is of course due to education, but the education is not confined to school courses. It is at all times carried forward through the influence of well-designed houses. Those who dwell in them are always learning, and



it will be the architects who are the real teachers and who will have made this great advancement possible.

Every house that has received the carefully considered attention of a competent architect, preaches the propaganda of correct living and makes for that mental and social uplift we are told is so absolutely necessary for our correct advancement as a nation. This being true, it would seem that there are far reaching influences for good in the advancement of architecture to its highest development.



# Proposed Victory Square and Civic Center, Bloomington, Illinois

Edward H. Bennett and William E. Parsons, Consulting Architects

By ARTHUR T. NORTH

THE pioneer instinct of the New Englander caused him successively to settle northern New York, the Western Reserve, northern Indiana, Illinois, Iowa, Nebraska—as well as furnish a large proportion of the '49ers who had such a great influence in molding the destiny of the Pacific States. Wherever they settled we find to this day the instincts of thrift, progress and an inherent respect and desire for education and refined surroundings. In their descendents, their ideas and policies in political, educational and religious matters still prevail.

In the Corn Belt of Illinois and Iowa they developed an agricultural section which is probably as prosperous as any in the world. With this increasing prosperity, due to industry and the natural advantages of soil and climate, they established educational institutions in great number. They may not be famous for size or impressive buildings and equipment, but they served as no other institutions could under the conditions to make for a general education and culture that is reflected in many ways.

One indication of the superior make-up of the inhabitants of this territory is the great interest shown in civic and community activities. This is illustrated by the example of the City of Bloomington, Illinois. This city, with a population of 35,000, is one of the important communities of the Corn Belt, possessing exceptional educational institutions, library, hospitals, newspapers and other facilities that attend a prosperous city. Its largest commercial interest is as a jobbing rather than as a manufacturing center.

The Bloomington Association of Commerce, in 1919, appointed a City Planning Committee to study and prepare a plan for a Civic Center and a Memorial Building. This committee retained Edward H. Bennett and William E. Parsons, consulting architects, to make a survey and prepare a report. The report was submitted in mid-summer 1919, and outlined here in part.

The various civic and community activities of most cities are usually housed in a region near the center of the city. In most cases they are scattered and unrelated; often being placed where they do not serve well the public convenience or where they

obstruct the normal growth of commerce. Generally there is an assortment of styles of architecture with varied and inharmonious colors and materials.

The purpose of this plan must be understood as an effort to establish a general location and orderly grouping for several public and semi-public buildings which will be required in Bloomington during the course of the next decade or two; also to suggest a consistent style suitable for public architecture. None of the buildings proposed can be considered as unnecessary or purely ornamental in themselves, nor are the building areas proposed in excess of the city's expected needs of the coming generation.

The plan submitted is for the Center only, the heart and life of community activities. Nevertheless it is only a part of the whole city. Therefore, before recommendations were submitted a survey of the entire city was made in order to ascertain the facts which might form the basis of a sound plan. The survey was of two-fold nature; to establish the location of the Center with regard to the existing city and with regard to the probable areas of expansion and the needs of the future.

Relatively low property values prevail in the building sites proposed as compared with values of business property adjacent to the north, south and west of the Court House Square. Existing public and semi-public buildings forming the nucleus of the Center are the McLean County Court House, Wither's Library, The Bloomington Club, Masonic Temple, Y. M. C. A. Building, three theatres and several churches.

The proposed new buildings required in the near future are a new Post Office, a County Memorial Building, a City Hall, a Municipal Auditorium, a Y. W. C. A. Building, a Municipal Arts Building and others of a community or public nature. These are to be grouped about a new square or plaza formed by the widening of Prairie Street through one-block, to be named Victory Square and to be embellished with appropriate monuments, sculpture and lighting standards. Two fountains and pools in which the façades of the surrounding buildings may be reflected are suggested. The County Memorial Building should occupy the most prominent

## THE AMERICAN ARCHITECT

frontage on Victory Square, preferably that on the east side.

It may be confidently expected that a Civic Center developed along the lines of the plan submitted will be accomplished without any immediate extraordinary expenditure of public money. The

buildings proposed will be required in any event and adequate sites must be purchased for them wherever they may be located. No appreciably larger sums would be required for the development of this scheme than would be required if these same buildings were scattered at random.

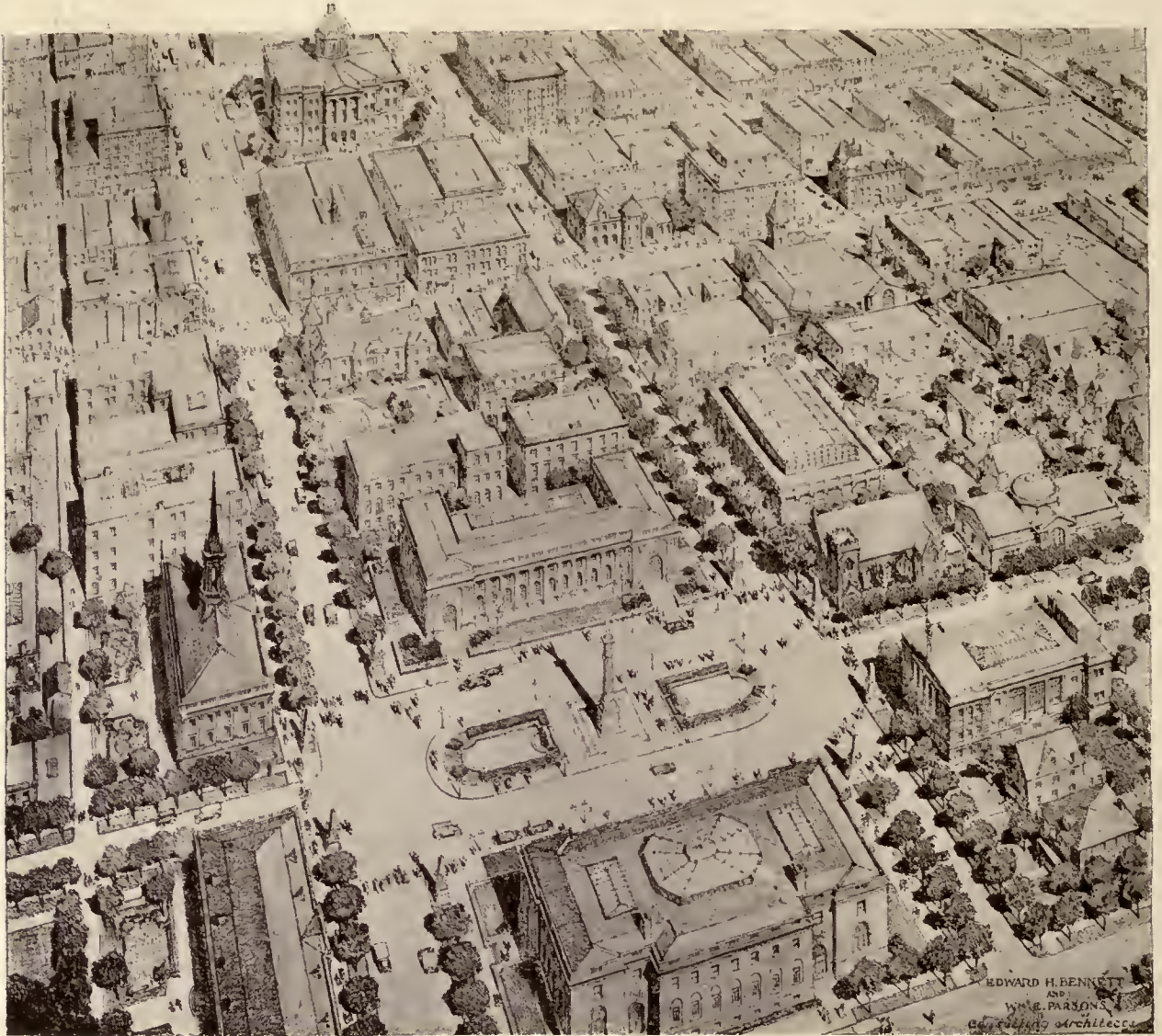

BIRD'S-EYE VIEW OF BLOOMINGTON CIVIC CENTER  
EDWARD H. BENNETT AND WM. E. PARSONS, CONSULTING ARCHITECTS

# Teach School Children to Appreciate Housing

## The Problem of Educating Future Citizens in Proper Care of the House

The problem of teaching tenants to live properly in their homes, to know the value of light and air, to have proper regard for the owner's property, to understand how to utilize and not abuse sanitary conveniences, and to take care of public parts of buildings used in common by several families, is one of the most perplexing confronting the housing worker. Much has been done in several cities by the visiting housekeepers who go into the homes to teach mothers the essentials of good housekeeping. That plan has worked successfully. There is no doubt, however, that the greatest hope of teaching proper housekeeping methods lies in reaching the children through the public schools. Their minds are more plastic. They are constantly imbibing American habits and American standards of living.

The Cincinnati Better Housing League has, with the cordial support of the Superintendent of Public Schools, put into effect a plan for teaching children the essentials of good housing. It gives promise of being entirely successful. For the present the plan is being used only in the schools in the tenement districts, for it is felt that the greatest need is there. The plan, as reported in *The American City*, is as follows:

The Secretary gives a talk to a general assembly of the pupils of the sixth, seventh and eighth grades. The talk is brief and snappy, touching only on the simple principles that the children can grasp, urging each one to constitute himself a junior sanitary police officer to watch over the cleanliness of the house he lives in, and emphasizing the essentials of the right kind of home. The talks are made lively and interesting by asking the children questions and getting them to tell how they think they can help to keep their homes right, to prevent fires, and the like.

In one school at the end of the Secretary's lecture, the children did the questioning. They showed that they had received intelligent instruction from their teachers by asking questions so pertinent that one might well expect to hear them at a housing conference.

At the first civic lesson following the talk in the school, the eighth grade devotes the entire lesson to a study of the League's educational pamphlet, "Health, Home and Happiness." The teacher then asks the pupils to write essays on "The Proper Care of the Home." The best five essays are selected by the teacher and sent to the Better Housing League, which awards for the best essay a certificate reading as follows:

"This is to certify that ..... submitted the best and most original essay on 'The Proper Care of The Home' in an essay competition among the members of the Civic and Vocational League Club of the ..... School.

"Awarded by the Better Housing League..... date."

The first essay on which the certificate was awarded showed a remarkably clear understanding of the subject, considering that it was written by an eighth grade pupil. "Looking back," said the little girl, "we find that the more civilized and educated the people are, the better the housing conditions. Therefore, we, the people of the United States, should have sanitary and clean homes, especially if we wish to rank as a leading nation. . . . For it is the same with the human body as with a plant. Put it in a light, airy and clean place and it thrives, but put it in a dark, musty place and you soon have a drooping, sickly specimen. If a plant is worthy of care and attention, how much more so is the growing child that will be the future citizen?"



SMALL CONSOLES FROM PARIS BUILDINGS (LOUIS XVI PERIOD)  
(FROM THE ARCHITECTURAL JOURNAL)

## Two Recent French Planning Reports

Two Reports by "La Renaissance des Cites" Upon Reconstruction of War Regions and the Housing Needs of Paris

THE planning problems at present confronting France are the planning of new cities and parts of cities and the replanning incident to it, writes F. B. Williams, in *The American City*. These problems have been greatly intensified by the war. Much of northern France has been destroyed and must be planned anew. Vast regions have been so completely devastated that all property lines have been obliterated, while the ownership remains as before. It would be not only better for the property owners, and the municipalities as well, to replot and replan these areas, but also easier and cheaper. Before the war, however, planning and replanning in France, as well as in other countries, were needed. Legislation to cope with these problems had long before the war been passed in many European countries and again and again proposed in France without result. At present, French city planners are endeavoring to make progress in these matters, while still handicapped by the lack of laws they have so long needed.

One of two recent valuable reports is that of the legal section of "La Renaissance des Cités," a society founded in August, 1916, to study and diffuse information with regard to the principles which should be followed in the reconstruction of French cities destroyed during the war. With this society George B. Ford, formerly consultant in city planning of the city of New York, but more recently with the American Red Cross in France, is co-operating. The report is a brave attempt to obtain by voluntary action what can only be adequately done under government auspices. The ruined cities are urged to adopt city plans, although French law does not make these plans binding on property owners; the property owners are urged to unite in restoring their lands and buildings, in order not only that expense may be saved, but also that lot lines may be changed, to the advantage of all, since no method of replanning and replotting by government authority exists.

The second of these two reports is that of the "Government Bureau for Low-Priced Housing for the Department of the Seine," or Greater Paris. The questions considered are, first, means of obtaining an increased supply of cheap houses, and

secondly, city planning as a necessary part of such housing. Here again the problems are those of the pre-war period, intensified. The cost of houses, too great for low-priced labor before the war, has now more than doubled; the standards for such houses, too low before the war, must, more than ever, be raised. Paris, terribly congested before the war, is now worse than ever.

In the endeavor to relieve the situation, the French Government has given the bureau 10,000,000 francs and has instructed it not only to increase the supply of adequate low-priced houses, but to relieve congestion, and to proceed along garden city lines. As a first step in these directions—and all it can do with such a comparatively small amount—the bureau has used the entire sum in the purchase of land outside the city. It announces that it will proceed in accordance with (among others) the following principles:

1. It will create, not garden cities, but garden suburbs.
2. Its operations, both as to land purchase and development and as to housing construction will be on a large scale.
3. Severe regulations to secure a sufficient supply of light and air, the proper amenities and pleasing esthetic effects, so dear to all Frenchmen, will be imposed.
4. Speculation, not only before but for all time after construction, must be entirely eliminated.

In the search for methods of preventing speculation, the French report, apparently with an entire absence of bias or prejudice, analyzes and discusses the German attempts to accomplish this result, apparently favoring the German "hereditary building right" as a substitute for ownership of the fee, and the German "right of repurchase" as a limitation on ownership, or the retention of that ownership by the city or state, as often practised in Germany. The report also earnestly urges the French Government to make itself responsible for the difference between present costs and the costs as they will be ten years hence, much as is proposed in England; declaring that only thus can a sufficient supply of suitable houses be seasonably obtained.



## Glenn Brown on "The Architect and Organization"

**G**LENN BROWN'S suggestions for the reorganization of the Institute as set forth in his article, "The Architect and Organization," printed in this issue, are particularly timely. With the annual convention of the Institute to be held in Washington less than six weeks from this writing, there is none too much time for serious consideration of these important matters. Important they are, in the strictest sense, and it will serve no good purpose to postpone for another year the consideration of a proposed policy and of means for its vigorous development.

The things Mr. Brown advises are exactly the vital elements of the Institute's present problems. Mr. Brown's recommendations must be seriously considered. They are those of a man who has had long experience and who has always shown a thoughtful and eminently practical attitude towards the Institute.

It is a source of satisfaction to note that the matters of reorganization urged in this article are on identical lines with the opinions that have been editorially expressed by THE AMERICAN ARCHITECT.

Mr. Brown strongly urges the appointment of an executive secretary. His specifications of qualification call for a man of high position in the profession and one who shall combine the best executive ability with the further ability to edit and control the *Journal's* publications and their policy. This is not a new suggestion. It was very strongly urged before the Nashville Convention, and in view of the sentiment of approval among delegates, it was believed would receive serious consideration. For some reason, one purely conjectural, no action was taken at Nashville on this very important matter. It will be interesting to learn in case the forthcoming Washington Convention fails to act, if such failure can be attributed to the same influences that have been so insidiously in evidence in the past.

Comment has been made many times that the

Committee reports read at Conventions and the well developed sentiment that has become part of the official records, never get beyond adjournment, that the work of months by various groups of men who have spent valuable hours in investigating important matters and in the drawing up of carefully considered reports, is simply so much wasted time. Rarely are these things developed into practical form, and the failure so to develop them is the failure of the Institute to keep the profession prominently before the public eye.

With a competent executive secretary in charge, these reports would be carried forward to some measure of conclusion, and the Institute would at once assume before the general public its proper position as the ruling organization of the profession, a power to be reckoned with and an educational factor of the first importance.

A joint resolution passed by the Illinois Chapter and the Illinois State Society, very clearly stating the need for an executive secretary and defining his duties, was presented to the Board of Directors of the Institute at the Nashville Convention. It was referred to the Post-War Committee. Almost a year has elapsed without any word from the Committee on this important matter.

The resolution stated:—

"Be It Hereby Resolved, in view of the pressing needs of the Institute brought about by the ever changing conditions confronting the profession, that for the best interest of the profession, and in order that the Institute may be an ever increasing benefit to society:

"The secretary of the Institute shall devote his entire time to the duties of the Institute, with headquarters at The Octagon. He shall be editor-in-chief of *The Journal* of the American Institute of Architects, and the president shall be and is hereby directed to appoint the secretary a member ex-officio of the Committee on Publications.

"It shall further be the duty of the secretary to act as business manager of the Institute, to visit the various Chapters throughout the country, to promote closer relations between the Chapters and the profession at large, as well as with various technical or professional organizations and other organized bodies relating to the building industry.

"His activities shall also include any other duties incident to the proper performance of all matters outlined in the conventions of the Institute."

MR. BROWN writes, "Do away with local Chapters and have as branches only State Associations." This idea cannot be too strongly recommended, and fortunately its desirability can be shown by actual example. Can any of the various Chapters of the Institute show greater efficiency or more constructive effort than the State Societies of Illinois and New York, for example? This comparison is no disparagement of the Institute, as State Societies are largely composed of Institute and Chapter members. It does prove that better work is done under State Society organization than under the directly controlled Institute Chapters.

Allowing, as is urged, the State Societies to exercise considerable latitude in the character of its members, would be largely to extend the Institute control of the profession and to relieve it of the present justified criticism that it does not represent a majority of the profession.

The sifting out process that men would have to experience before they could become full Institute members would practically answer the objections that have been advanced as to the necessity for safeguarding the character of Institute membership.

"Get every state," writes Mr. Brown, "to organize such a body, starting with the Chapters which have a state for their territory as well as the state organizations already in existence. Let all who would be eligible for a license to practice architecture in a state be eligible to the state association. Make it a distinction for the practitioners doing the best work in the state to be yearly recommended as

members of the national body. Let it be known throughout their state when men were recommended and admitted to the Institute. This advance for merit would give a worthy object to seek; it would constitute an honor conferred upon the individual which would be reflected upon the state and the people would appreciate the fact. The distinction would, in time, be the same as an election to the National Academy.

"Make it more a distinction for a member of the Institute to be elected a Fellow, only conferring this honor for notable achievement in design, construction, education or public service. Only members should be eligible for this grade."

THEREIN lies the gist of the entire matter. A great retardant to progress in Institute matters and a handicap to its efficiency has largely been due to the lack of proper professional relation. There has been self assumption of certain rank that has not always been concurred in. Under an arrangement of State Societies such as herein advocated, these conditions would no longer exist. Every man would know his place, because it was not self assigned, but accorded to him by his fellows. He need waste no time in insistently maintaining it, the patent of his position in the profession could not be assailed. And further, there need be no limitation to the ambition of even the lowliest member. If, as Napoleon said, "every French soldier carried a Marshal's baton in his knapsack," so every architect could declare that his chances to the highest rank in his profession were only limited by his ability to attain it.





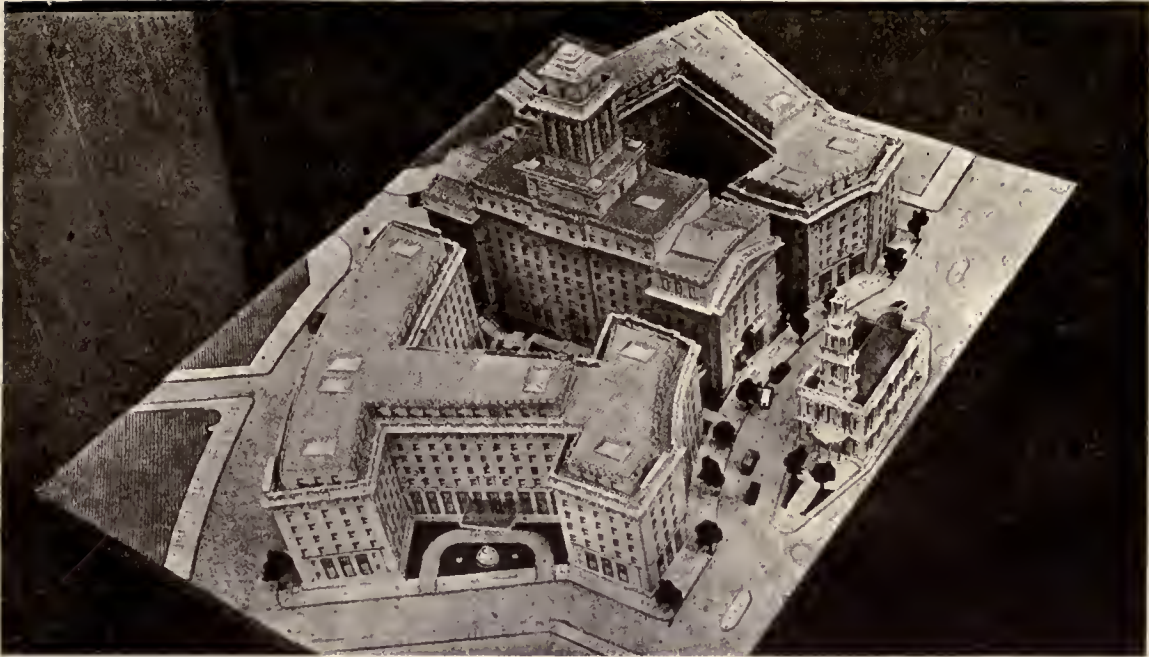

MODEL OF THE BUSH TERMINAL BUILDING, TO BE ERECTED ON THE STRAND-ALDWYCH ISLAND SITE

## The Bush Terminal Building in London

HELMLE & CORBETT, OF NEW YORK, *Architects*

THE most recent and most important instance of the entry of American architects into architectural work in England is that of the projected Bush Terminal Building to be erected on the Strand-Aldwych island in London.

The English architectural magazines are devoting large space to both illustrations and descriptions of this structure. It is the largest built in London in modern times.

Mr. Corbett, now in England as the representative of his firm, is the subject of an extended article in a recent issue of *The Architect's Journal*.

Praise for the design and encouragement for the successful outcome of the work is unstintedly given, proving that our English professional brethren are good sports, and regard the art of architecture as of no nationality but as something to be warmly commended when efficiently done, no matter where it shall originate.

After frankly stating that if the promise of the preliminary design is realized the building will be one of the finest architecturally in London, the article congratulates Mr. Corbett on the splendid results of a close and careful study of the problem,

and is sure that every advantage has been taken of the magnificent opportunities for architectural effect provided. Continuing, the article further states in describing the major details of the work:

His building takes the form of three distinct blocks, the central one facing and continuing the lines of Kingsway through to the Strand. For the time being this part of the work is all that will be proceeded with, the cost being estimated at £300,000. Later on the wings will be added, with their curved fronts to Aldwych, their side elevations to Marconi House and Australian House respectively, and frontages to the Strand. In passing, it may be mentioned that Mr. Corbett has been at great pains to compose his Strand elevations in sympathy with Gibbs's beautiful little church of St. Mary-le-Strand—that architectural jewel casket," as he enthusiastically described it to a representative of this Journal, who had the pleasure of a chat with him a few days ago. In the model, of which a reproduction is given, the scale relationship of the church to the new building is clearly shown, and it will be seen that, although the former is naturally slight and fragile in comparison with the latter, it is by no means overpowered by it. Rather does the greater building

enhance the appearance of the smaller, providing it with a restrained architectural background that throws its delicate beauties into stronger relief.

Mr. Corbett is a great believer in models. He regards a model as an essential preliminary to the preparation of designs, particularly when a building has to conform to a special environment. The great value of a model, he holds, is that it enables an architect to gain a good idea of the appearance of his building in three dimensions before he has irretrievably committed himself to bricks and stone. The general use of the model before the preparation of finished drawings should at least prevent the perpetration of some of the more obvious defects in proportion and composition that everywhere thrust themselves upon our notice. Mr. Corbett holds that the intensive cultivation of draughtsmanship, so characteristic a feature of modern architectural training, is primarily responsible for the dullness of much modern English and American architecture. We must, he urges, get back to thinking in three dimensions, as the old architects had to do before H. B. pencils and cartridge paper conspired to confine men's thoughts to a plane surface.

A good illustration of the real value of the model is afforded in the case of the new Bush Terminal building. The dominating feature of the central block is a tower, which, of course, will fill in the vista of Kingsway. In order to discover the best vertical proportions for this tower Mr. Corbett had that feature prepared on telescopic lines. Thus it was possible in the model to adjust to any level the component stages as well as to vary the total height. Mr. Corbett is still experimenting with this tower (a round one has even been suggested as an alternative), so it must not be assumed that the proportions shown in the illustrations are necessarily final.

The plans of the building are now before the L.C.C., and it is expected that sanction to begin building operations will shortly be given. Mr. Corbett assures us that the work will be carried out entirely by British contractors.

With regard to the internal arrangements of the building, there will be, as the plans show, an ample elevator service, no fewer than eight lifts running to all floors. Toilet facilities will be provided on every floor.

Heating is by direct radiators under the windows, and good ventilation will be secured by withdrawing vitiated air. It is probable that an artesian well will be sunk, so that the building may have its own water supply, and a power plant will be installed for heating, lighting, and ventilating. The big open spaces within the building will be divided up as required by tenants.

## Presumption and Proof

### An English Point of View of the Matter of Preparedness

Many of our difficulties arise out of a habit of taking presumption for proof; and, as our presumptions are usually swayed by our hopes, the results obtained prove to be disappointing, if not dangerous, editorially states *The Architect* of London. Naturally, we cannot in the ordinary affairs of life expect the mathematical proof that we look for in science, but we can, and ought to, base our actions and policy on something firmer than hopeful and optimistic presumption. How many lives might have been saved had our politicians—it is an aspersion of statesmanship to call them statesmen—acted on the plain fact that Germany was straining every nerve to prepare herself for waging a successful war—instead of on the presumption that Europe was too civilized to think of a great war? How much trouble and future anxiety might we not be saved if we realized the fact that India never was, and probably never will be, a nation, but is the geographical expression for a tract of land which has only found peace under British rule?—because it, and it alone, can maintain peace between rival races and rival religions. Instead of which we attempt to apply a crude democratic theory to the East—a theory which we can hardly say has been triumphantly vindicated in Europe. What is democracy, and what are its fruits? Democracy seems to be based on the dogma on which the French Revolution was founded—the equality of all men, a presumption which the most elementary thought shows us to rest on foundations of sand. Men may, under wise government, have equal protection under the law, but human progress has only been made possible by the fact that some individuals are kinglike in ability, energy, and other characteristics, among their fellows. The immutable law of the world is that to him that hath shall be given, and we only promote chaos and disorder by trying to force on the community an unworkable theory. The law that we should recognize is that to attempt to artificially level up is bound to fail, while the most that can be secured to mankind is to free them from conditions which are inherently unjust and based on the interests of individual sections whether employers or workers.

We have no proof that it is possible to arrive at the millennium, but the whole of the history of mankind proves that when we have made progress we have done so through channels first constructed by the efforts of individuals driven by the fundamental instinct to do better for themselves.

478



HOUSE OF ROBERT L. BACON, JR., AT WESTBURY, L. I.  
JOHN RUSSELL POPE, ARCHITECT



408 2



HOUSE OF ROBERT L. BACON, JR., AT WESTBURY, L. I.  
JOHN RUSSELL POPE, ARCHITECT



9  
408



HOUSE OF ROBERT L. BACON, JR., AT WESTBURY, L. I.

JOHN RUSSELL POPE, ARCHITECT

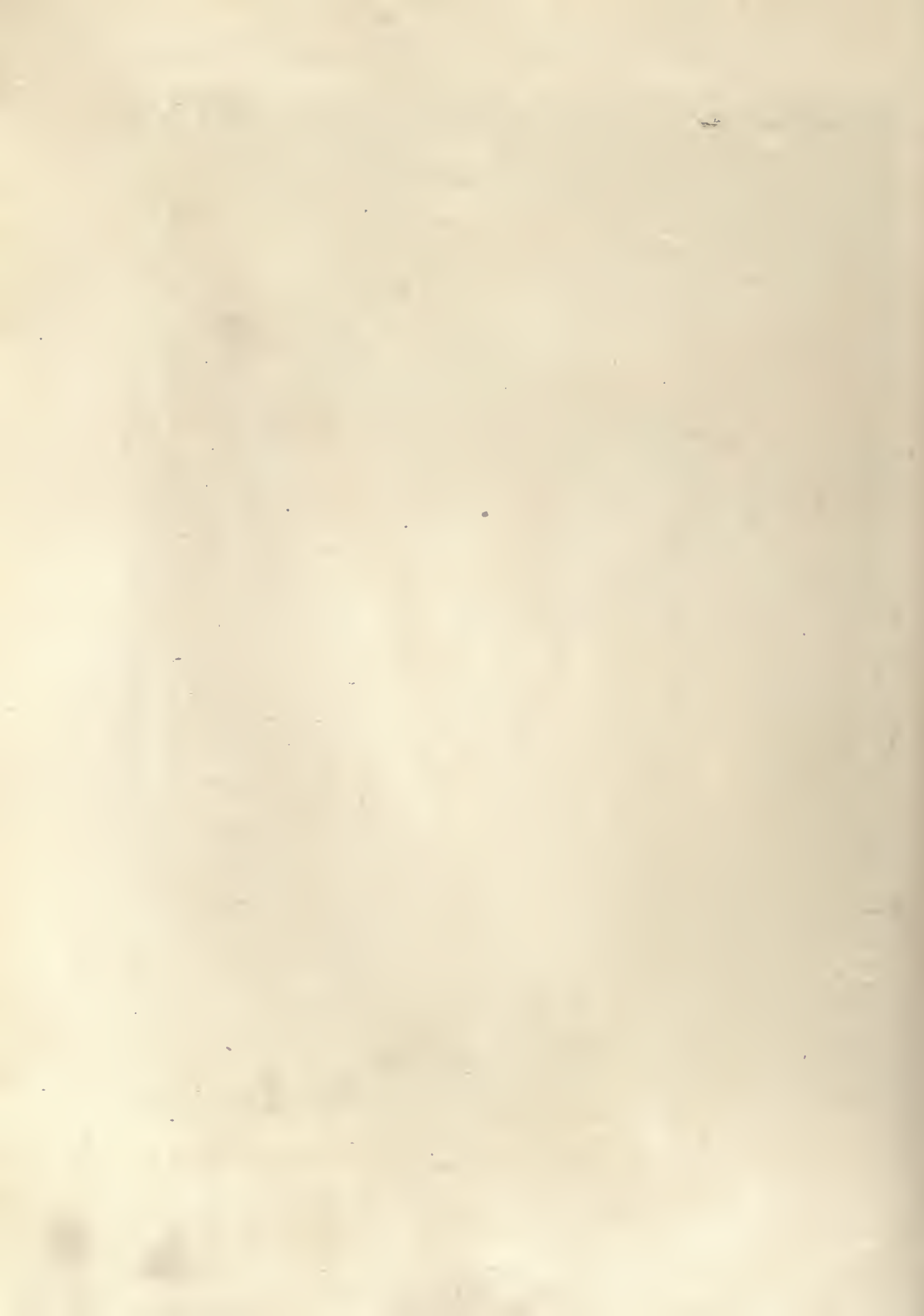



408



HOUSE OF ROBERT L. BACON, JR., AT WESTBURY, L. I.  
JOHN RUSSELL POPE, ARCHITECT



408  
b  
r



HOUSE OF ROBERT L. BACON, JR., AT WESTBURY, L. I.  
JOHN RUSSELL POPE, ARCHITECT



408 b



HOUSE OF ROBERT L. BACON, JR., AT WESTBURY, L. I.  
JOHN RUSSELL POPE, ARCHITECT



7AC  
20



HOUSE OF ROBERT L. BACON, JR., AT WESTBURY, L. I.  
JOHN RUSSELL POPE, ARCHITECT

4087





# Current News

## Happenings and Comment in the Fields of Architecture and the Allied Arts

### Chicago Architects Prepare for Annual Exhibit

The thirty-third annual Chicago Architectural Exhibition, given jointly by the Chicago Architectural Club, the Illinois Society of Architects, the Illinois Chapter, American Institute of Architects, with the co-operation of the Art Institute of Chicago, will be held in the Galleries of the Art Institute of Chicago from April 6 to May 5, 1920.

The exhibition will be illustrative of architecture and the allied arts, and may include drawings and models of proposed or executed work, academic drawings, examples of rendering, sketches, examples of decorative painting, sculpture, and the allied arts and crafts, photographs and other features, specially arranged with the exhibition committee. Owing to limited amount of gallery space, academic exhibitions will limit to ten exhibitions from any one institution. Drawings must be framed or mounted and the omission of glass is requested in frames larger than 2 x 3 ft. It is suggested, whenever possible, when rendered drawings are exhibited, that photographs of the completed work are exhibited with them.

Exhibits otherwise desirable will not be rejected for the reason that they have been shown before.

The exhibition will be held in the fireproof galleries of the Art Institute, Michigan Boulevard, Chicago, opening Tuesday afternoon, April 6, and closing Wednesday, May 5.

### Exhibition of Old World Art at Boston Museum

A loan exhibit of all the beautiful things that can be secured representing the culture and art of the different countries whose sons and daughters have come to live in Massachusetts is in progress at the Museum of Fine Arts until April 15. It is called an "Exhibition of the Handicrafts of the Old World," and will be open to the public during the regular museum hours.

This event, unique in the art history of Massachusetts, is the result of joint effort of representatives of the twenty-six countries now represented among the inhabitants of this State. All may look with special pride as they walk through this exhibit upon contributions of their own ancestral races. Each nationality, flowing into the main channel of American life, has brought divers gifts and characteristics which, blended, make our national character. So, too, all have brought contributions of art and culture that are now shared by all the citizens of Massachusetts.

The art and culture of Italy, of England, of France and all the other countries which are represented here are the building stones of American culture and art, and it will be of keen interest to those who appreciate art to view the treasures assembled from this angle. Everything to be shown has been made in the Old World, and has been approved by a committee representing the museum.

### Brooklyn Chapter Meets

Brooklyn architects are considering the advisability of having all the draughtsmen in the various local offices associated with the Brooklyn Chapter of the American Institute of Architects. The matter was discussed at a meeting of the Chapter at the Crescent Club.

Among the architects present at the meeting were T. E. Snook, Jr., Alexander Mackintosh, Herbert Dunning, Charles Saunders, Charles Wagner, Arthur R. Koch, John B. Slee, Frank H. Quinby, T. E. Snook, Sr., Fred Monckmeyer, W. J. Dilthey, Stephen W. Dodge, L. V. Swezey, Charles Kreinbrink, W. A. Parfitt, G. F. Kiess, Charles Winkleman, J. Sarsfield Kennedy.

It was the consensus of opinion that the monthly meetings of the Chapter can be made instructive to all the younger men of the profession. Since the war many of the draughtsmen have been scattered in different parts of the country, and have been employed on industrial enterprises. An effort is being made by the labor unions to "unionize" draughtsmen and which does not appear to meet with their approval, as they desire to remain independent and seek employment under such terms and conditions for which they are fitted.

The building situation was considered in various phases. It was suggested that an effort should be made by various financial interests to stimulate production. "Many of the brickyards are practically idle or operating in limited capacities, which has caused common brick to rise in price during the past year to \$30 per thousand, when this brick could be selling at a profit of not more than \$10 per thousand," remarked one of the architects. There is nothing on earth cheaper than clay, and with some financial co-operation home industries all along the line should be stimulated which would have the tendency to lower excessive rents. The housing situation is very acute. Bankers do not desire to loan funds in view of the high cost of material. It is believed that manufacturers of various interests should make every effort to rehabilitate the plants of production in building trades.

### Architects Warned to Be Registered

The State Board of Examiners of Architects have just issued a circular of information for the registration of architects in the commonwealth of Pennsylvania. The act requires that any person residing in or having a place of business in this State who on July 12, 1918, was not engaged in the practice of architecture in the State of Pennsylvania, under the title of "architect," shall before engaging in the practice or being styled or known as an architect secure from the State Board of Examiners of Architects a certificate of his or her qualifications to practice under the title of "architect," and be duly registered.

The circular gives detailed information regarding necessary qualifications for registration, examinations, rights of certificate holders, etc. Application blanks may be obtained from the "State Board of Examiners of Architects," Harrisburg, Pa.

## London's Housing and Building Problems      Important Improvement in Westminster

A new solution for London's housing problem has been brought forward by Sir Martin Conway, who is spoken of by the newspapers as an authority on this subject, who has advocated the pulling down of large numbers of antiquated houses in the slum and congested areas and the erection on their sites of commodious, modern high buildings with anywhere from ten to thirty floors, and who has given his views on this subject to the *Evening Standard* as follows:

"It is a mistake to suppose that I advocate skyscrapers similar to those of New York. What I have in mind is a communal dwelling—a very tall building, certainly, but even wider than it is tall. If the building were 300 yards square it would do.

"If we were to erect such dwellings in London we could house all classes in each one. There would be no trouble then about the servant problem, for the servants would live in the same building. If you were to knock down ten little houses and build them one on top of the other, what would you get? You would get a big open space out of the combined backyards, for the building would occupy only a quarter of the old site. If you could knock down the East End of London and accommodate the same number of people on a quarter of the area, you would have huge open spaces.

"To live on such a co-operative system would solve all our town dwelling troubles and do away with a lot of transport difficulties. There need be no limit to the size of such communal dwellings, and health would certainly not suffer. You would simply be extending the flat idea in a huge way. Those who lived at the top of the high building would get out of the London gloom. They would be above the worst of the fogs, above the noise, the damp and the dust. They would breathe the pure air and get fine views.

"In the lower part of each building there would be plenty of room for a club, a school, canteens, recreation rooms, libraries, a crèche, playing rooms for children, smoking rooms, a cinema, shops, co-operative stores and the like. The working woman with a family could send her baby to the crèche and the others to the playing garden or the school. There would be no necessity to play in the streets, with the commodious garden that each building would have. Each building, of course, would be centrally heated, with hot and cold water for each bedroom, and shilling-in-the-slot meters for gas and electric light. There would also be a laundry. Lifts, naturally, would be numerous.

"It may be said by politicians that such a scheme would be unpopular. Of course it would be if we were to contemplate an extension of the old tenement-house idea. But nothing of the kind is suggested. The new buildings would have the most modern comforts and conveniences and not be like the horrible, ill-equipped old tenements."

Another authority, Mr. C. Giles, of Henley-on-Thames, who built the first new house in South Oxfordshire, after the signing of the armistice, has patented an invention in solid core concrete construction. It is claimed that this reduces the cost of the average dwelling house by at least one-third, and a house which would ordinarily cost £750 can be built for under £500, or, allowing for the Government subsidy, £350. No bricks are required, and the work of building can be done without the employment of skilled labor. Building experts who have tested the invention speak highly of it.

It is reported in the daily papers that Parliament is expected early in the new session to give consideration to an important improvement in Westminster which will open up a large area for much-needed roads and buildings. The district covers 250,000 acres of old houses and narrow ways between Victoria Street and Millbank. The scheme provides for the building of a new "city" as an adjunct to the governing center of Westminster. It is intended as an Empire War Memorial.

For some months the London Traffic Board and a Cabinet committee have been considering the scheme. Sir Eric Geddes, Minister of Transport, has expressed a favorable opinion of the new main thoroughfare which it is proposed to run from Victoria Station along the line of Horseferry Road over a new Lambeth Bridge and through Lambeth to London Bridge. On the cleared area it is proposed to erect a Shakespeare theatre, new buildings for the University of London, a Gothic memorial chapel by Westminster Abbey and industrial institutes.

A prominent architect, when interviewed on this subject, stated: "This district has been more or less lying waste, and it is badly needed for the erection of commercial buildings. It will be part of the scheme to erect large groups of offices for which there is great demand."

## Labor Shortage and Economic Rents in England

Sir Kingsley Wood, who is parliamentary private secretary to Dr. Addison, and chairman of the London Housing Board, in a special interview with a representative of the *Evening Standard*, gave his views on labor and rents.

"I think under the municipal scheme we shall have 100,000 houses in course of erection by May, and this, in my judgment, will not be a bad result. No one can question that there is a serious shortage of labor to-day in the building trade. I do not think it is any exaggeration to say some 200,000 men have left the trade. So far as the Government housing scheme is concerned, I do not hesitate to say that when it is in full swing, as it will be during the approaching spring months, there will be a grave shortage of labor unless some step is taken. Practically 75 per cent of the building trade to-day is engaged on reconstruction work, factory work, and that other work which has been postponed for so many years, namely, housing repairs.

"I know the great thing in the minds of a large number of the workers is the fear of unemployment. In my judgment, however, there is enough work to be done by the building trade to keep it in full swing for many years to come. What we really desire is the full co-operation of all employers and employees in the building trade. If we can get the support of the private builders of the country we shall have taken a very long step toward obtaining the 750,000 houses that we at least require to-day.

"The worst thing we could do would be to inaugurate charity rents. What every worker ought to receive is a wage sufficient to pay a proper rent. Obviously, under present-day conditions the State will have to make a contribution to rents under our scheme. One-third of the cost of the ordinary house is being wiped out and regarded as a war loss. We are notifying the authorities to base their rents on this deduction with a view, within a period of years, say seven, to having rents fixed at their proper economic value."

## Revival of Industrial Construction in the South

From every source of available information comes evidence that the dawn of the day of great industrial construction has come in the Southern districts of the United States. Good roads, electric power plants, water power developments and huge industrial establishments are all being provided for on a scale of millions, proving beyond doubt that the day of small and parochial considerations has passed, never to return, it is hoped. Discussing this, the *American Contractor* states there is a general awakening to the importance of the proper utilization of the sources of power that are available in the many rapid streams of the higher lands. North Carolina has made the most pronounced progress in this matter and her State Highway Commission, working in concert with a department of the State university, is making a complete survey of the numerous waterfalls that can furnish power and light for the greater part of the State, after the manner of the development in the Watauga River, where nearly 400 farms get light and power from one fall, said to be representative of thousands that may be similarly utilized.

In addition to its other commitments, North Carolina is preparing to take advantage of the Federal Government's aid for road building and will do its part to meet the terms on which it may receive the whole of the \$6,000,000 that has been set apart as the share of the State.

A veritable boom for good roads has spread over the whole region, every part contributing its quota to the force that is making for better means of communication. Alabama leads with an appropriation of \$25,000,000 to be raised by the sale of bonds; in Tennessee various counties are named as appropriating from \$1,000,000 to \$3,000,000 for roadway improvements, while a single city in Texas, Fort Worth, is to spend \$2,500,000 on the paving of its streets.

The demand for new railroads is promised to be met by the rehabilitation of old lines and the construction of new ones. In Texas the new railroad development is most likely to first manifest itself. Ten years ago railroad officials declared that at that time not less than 10,000 miles of new road were needed for the trade of the western part of the State alone. There has been very little done to supply this old demand and no attempt has been made to keep up with the increased demand which rapid settlement of the country has created.

In strictly industrial enterprises one may read of the many millions that are to be expended in buildings and plants. An English combination of capitalists will put \$1,000,000 into Florida phosphate plants; the Mobile, Ala., Shipbuilding Company is to enlarge its fabricating plant at Birmingham at an expense of \$10,000,000; while the number of smaller enterprises that are mentioned amount to more than 1200, the sums to be invested in each running from \$100,000 to \$10,000,000.

## Have to Buy Homes or Move

More than 60,000 Pittsburgh families bought their homes in the last year, not because they were particularly anxious to own their own homes, but, according to real estate men, they had to buy or move. This is continuing at the same rate thus far this year.

Rents have increased in proportion, small houses and apartments showing the highest percentage. Fifty per cent raises for the coming year are said to be common, and in some instances 100 per cent has been asked and paid.

## Competition for Milwaukee County General Hospital

A program has been issued for a competition for the proposed Milwaukee County General Hospital.

The architectural adviser is Alfred C. Clas, A. I. A., and participation is limited to such architects as shall have made application on or before April 7, 1920. Copies of the program may be obtained by application to Board of Supervisors, Milwaukee County, Milwaukee, Wis.

## Historic New Orleans Building Is for Sale

The Gem Café, famous in New Orleans history as the rendezvous where the rescue of Napoleon from Saint Helena was plotted, where the first mardi gras parade was planned, where the State Legislature met and worked out a campaign against the carpet-bag rule, where the exclusive Pickwick Club was formed and where governors of Louisiana for years have held their discussions over coffee cups and wine glasses, is for sale.

Originally the home of a Spanish nobleman, the landmark of Rue Royal, which was a coffee house just across Rue Royale in the days when the "Senate," America's Monte Carlo, was running, is said to antedate the old "Absinthe House," which has been a mecca for New Orleans tourists. In late years despite the development of modern restaurants, the Gem Café has been the political eating house of leaders in State affairs and has been visited by every governor since Louisiana has been a State.

## Housing Plans In Paterson, N. J.

To spend approximately \$1,500,000 in building homes in order to relieve congested conditions is the decision of the committee appointed by the Mayor of Paterson, N. J., on Feb. 7. Two hundred new homes will be erected and Paterson will become a municipal landlord as soon as work can be started. The houses will be of frame, say advices from that city, of the standard two-family type, with five rooms and bath on each floor and two rooms in the attic. They will be rented at a fair figure, the rental charge to apply on the purchase price. The houses will cost about \$6,000 each.

## Architects' Work More Pressing Than Jury Duty

In his difficulty to secure talesmen, for only two were willing to serve out of a hundred men called, Judge Rosalsky of the General Sessions in New York, asked the men who brought excuses to decide among themselves who should serve. "Let each man who wants to be excused give his reason," he said, "and let the others be the judges. I will abide by your decision."

The first to give his reason was an architect, who said he was engaged in the building of twenty-six houses. Jury duty meant that he could not concentrate on the trials because his interest was in seeing the houses properly and speedily finished. His fellow jurymen consulted.

"Your honor," said one of the talesmen, "we have decided to let him go. We need houses."

The eloquent pleas from others that they would lose money met with no sympathy. They would all lose money. At the end only one, the architect, was permitted to leave because of the pressure of his business.

# THE AMERICAN ARCHITECT

## Personals

Edward Demar, architect, has opened an office at 509 Water Street, Port Huron, Mich.

Claude Shepherd Ashworth has opened offices at 8-9 Farrar Building, Provo, Utah, and desires catalogs.

Harold Laurence Young, 253 West Forty-second Street, New York, has resumed the practice of architecture.

Arthur Jacobs, architect, has removed his office from 128 North La Salle Street to suite 36, 138 North La Salle Street.

Kemper Nomland, 312 Southwest National Bank Building, Oklahoma City, desires catalogs and manufacturers' samples.

William H. Sayler & Co., architects, of Kansas City, Mo., announce the removal of their offices to 306 Mutual Building.

Graham, Anderson, Probst & White, architects, of Chicago, have opened an office at 205 R. A. Long Building, Kansas City, Mo.

Donald C. Bollard and James R. Webster have opened an office at 303 McCague Building, Omaha, Neb., and desire catalogs and samples.

Wallace W. Donaldson, architect, has opened an office at 69 Ruggery Building, 20 East Gay Street, Columbus, Ohio. Catalogs are desired.

Charles R. Wait, formerly of Wakefield, Mass., has become a member of the firm of E. M. Parsons & Co., architects, 1 Beacon Street, Boston.

J. L. Theo. Tillack has opened an office in the McFadden Building, Hackensack, N. J., and desires samples and catalogs of architectural interest.

Balinger & Perrot, architects and engineers, will be located at their new offices at 329 South Broad Street, Philadelphia, on and after Feb. 20.

John R. Gieske, Huntington, W. Va., is preparing plans for the McClintock-Field Company, wholesale dry goods, Greenup Avenue, Ashland, Ky., to cost \$60,000.

William G. Herbst and Edwin O. Kuenzli announce their partnership for the practice of architecture and will have offices at 721 and 722 Caswell Block, Milwaukee.

A. L. Groce Company, engineers and architects, are now located at 47 West Forty-second Street, New York City, and will be glad to receive manufacturers' catalogs.

Edmund H. Poggi, 450 Miners Bank Building, Wilkes-Barre, Pa., formerly of Sturdevant & Poggi, architects, has resumed the practice of architecture at the above mentioned address.

W. B. Dinsmoor, of the School of Architecture of Columbia University, has been appointed librarian of the Avery Architectural Library. This is the largest library of the kind in America and is one of the three largest in the world.

Webb M. Siemens and Ray C. Arnhold, formerly with Walter Boschen, architect, of St. Joseph, Mo., have formed a partnership of Siemens & Arnhold, architects, and have opened an office at 303-4 Bartlett Building, St. Joseph, Mo. They desire complete catalogs and samples.

## News from Various Sources

A decrease of \$204,057,387 in the public debt was effected in February, leaving the total debt \$25,404,331,717.

\* \* \*

The membership of the American Association of Engineers at the end of February was 13,081. On that date 5635 applications for membership were pending.

\* \* \*

Secretary Lane, Feb. 25, ordered opening to homestead entry of over 360,000 acres of land in western Oregon, formerly embraced in Oregon and California railroad grant.

\* \* \*

The London Housing Board has inspected 2000 houses that may be converted into flats. Of these 1000 have been approved and work is to commence immediately. Work has also been begun on 8000 houses.

\* \* \*

House of Representatives adopted a rule referring all bills dealing with soldiers' bonuses to Ways and Means Committee with instructions to report a comprehensive measure for monetary and land bonuses to soldiers of the World War.

\* \* \*

Attendance at the Metropolitan Museum of Art in New York in 1919 was 880,043, an increase of 227,886 over 1918. These figures were only exceeded in the years of the Hudson-Fulton celebration and during the J. Pierpont Morgan and Altman collection exhibitions.

\* \* \*

New York City's steadily mounting tax burden is shown by a comparison of the rate and valuation of taxable property in 1913 and the same factors in 1920. In the earlier year the rate was \$1.844 on a valuation of \$7,006,647,861, while for the present year the rate is \$2.512 on a valuation of \$8,626,121,707.

\* \* \*

Office of Chief of Staff announces that the department is steadily adding to its corps of reserve officers, but has decided not to call reserve corps officers for training this summer without their consent. Commissions in the Reserve Corps are available to qualified discharged officers who have not yet applied and applications are requested.

\* \* \*

Department of Agriculture announces that conference began Feb. 24 in offices of the Bureau of Public Roads by which confusion and other difficulties that have come from use in different States of varying tests for materials used in road construction are expected to be eliminated. Highway testing engineers representing most of the States are attending. From their suggestions a system of standardized tests is to be evolved.

\* \* \*

Sixth annual report of Federal Reserve Board issued states that the board is prepared to exert its full power to regulate and control the credit situation, which is held to be the vital factor in reconstruction. Its effort will be to check expansion and to induce healthy liquidation. It states that there need be no apprehension as to the nation's ability to effect transition from war-time to peace-time conditions if reasonable safeguards against abuse of credit are respected.

# Weekly Review of the Construction Field

TO meet the housing shortage in New Zealand, a country which has long been remarkable for the success which has attended the government's relations with labor, a bill has been passed by parliament which provides for substantial loans to workers on a 5 per cent basis with ½ per cent rebate for prompt payment, for thirty years in the case of wooden houses and thirty-six and one-half years for those built of other materials.

On the other hand, in the cities of Europe and America there are violent altercations between landlords and tenants over the increases in rentals which has led many of the apartment houses dwellers to combine in purchasing the buildings in which they live. Several new apartments are being built in New York financed by the future tenants. This seems to be the direct way toward eliminating dishonest or profiteering landlords.

The rent problem, however, does not become an active factor in the construction field except insofar as radical legislation in the way of rent fixing becomes ominous and restrains investment. The factor which leads all others in importance is, of course, the questions which at the present time surround labor. The doubts and uncertainties of what labor will demand and how much it will demand and the methods it will use in insisting upon the satisfaction of its demands, to say nothing of the quality of work which it will give, are matters of uncertainty though not of apprehension.

THE bricklayers and plasterers of Trenton, N. J., having been granted an increase in wages several months ago, have presented another demand for more money. An increase of 35 cents an hour, which would make the scale \$1.35 an hour, is asked for. The hod-carriers also want an increase which will bring their scale to \$1 an hour, an increase of 30 cents on the present rate. It is said that the employers are willing to grant the raise but with conditions which the bricklayers say they cannot accept. The demand is to become effective April 1.

The building trades in Chicago are better paid on the average than artisans in similar lines in most of the Middle Western cities, it has been announced by the Chicago *Daily News* after a telegraphic survey of seventeen of the principal cities in that section of the country. Chicago building trades workers are receiving \$1 an hour. Seven of the seventeen cities are paying the same scale for bricklayers and nine are paying a higher rate. Carpenters receive \$1 an hour in Chicago, but are getting higher wages in two other cities: Gary and Omaha, while in twelve cities they are paid less. Plasterers, structural steel workers, plumbers, gas and steamfitters, roofers and painters are receiving higher wages in Chicago than in other cities. Peoria and Detroit are paying bonuses to secure men. The scales at Gary are based on Chicago, although premiums are being paid there for workmen. Carpenters at Cincinnati are striking to receive \$1 an hour immediately and \$1.25 on May 1; Toledo has a new scale effective April 1 with 25 per cent increase; Omaha, which now pays carpenters, bricklayers and plumbers \$1.12½, has an increased scale going into effect June 1.

A number of cities state that they have no labor shortage in the building trade, but expect one when building commences in earnest within the next few weeks. Exceptions are Grand Rapids and Toledo, where it is said that there is a scarcity in all trades and it is difficult to employ men. Grand Rapids pays carpenters 90 cents and

bricklayers \$1.10. The figures accumulated by the *Daily News* are all based upon an eight-hour day.

It is quite generally true throughout the country that the wages and price demands have gone up. It is not only the coal men and railway employees but all workers everywhere. Therefore the general opinion seems now to be that prices of labor and commodities must stay at their present levels, and more than likely, still further advance.

THE industrial relations principles published by the Cleveland Chamber of Commerce are attracting wide attention. The Minnesota State Federation of Labor has begun a study of them. The Standard Oil Co., The Government Arsenal at Watertown, Mass., Governor Gardner of Missouri and various educational institutions throughout the country are all expressing great interest.

Criticism of these principles by a labor newspaper are interesting, as follows: "They are a long step in advance of the position heretofore held by large employing interests and will merit fair consideration at the hands of organized labor.

"On the general principle of desiring industrial peace, there is no difference of opinion in the ranks of organized labor—ninety-nine workers in a hundred would rather be steadily employed than tramping the streets."

The chief feature of this declaration of principles, as has already been stated in *THE AMERICAN ARCHITECT*, is the recognition of the predominant interest of the public in problems affecting the matter of production. Compulsion by either employer or employee to maintain an open or closed shop is opposed. Negotiations between employers and workers through groups of elected employees are advocated, and the advisability is recognized of employees being aided in such negotiations by outside advisors of their own choosing. It is stated that the cost of living is the main point considered in establishing wages, also living, production, initiative, skill and steadiness of employment. The eight-hour day and Saturday half holiday are recognized as desirable and the overtime work is discouraged.

The chief point, however, is the entrance of the public into the controversies which have hitherto been carried on with the public speechless, uninformed and the worst sufferer. The ridiculous waste of strikes would be avoided by the continuance of work during periods of arbitration and the placement of full facts in the light of day makes dependence upon the justice of public opinion. Undoubtedly there will be a lack of agreement with such a practical arrangement from the extra-radical group which is in favor of nothing but the overthrow of the "present System," lock, stock and barrel; the expropriation of capital and the management of the world in general by syndicates or soviets or guilds. This Cleveland expression of principles bases its point of view upon the rights of the consumer rather than of the producer, where most of the radicals have begun their arguments and unfortunately many of them get no farther.

THE low position occupied by the cost of shelter in the statistics published by the National Industrial Conference Board is gratifying. The increase in the cost of five major items in the family budget since July, 1914, was as follows: Food, 92 per cent; clothing, 136 per cent;

## THE AMERICAN ARCHITECT

sundries, 75 per cent; fuel, heat and light, 48 per cent, and shelter, 36 per cent.

**I**N a review of the building situation, Mr. S. W. Straus says.

"Actual building operations throughout the country have shown a marked gain since the beginning of the year. The total for January will show approximately \$325,000,000 or a gain of \$50,000,000 over December and an increase of \$100,000,000 over November. There are many indications that gains in volume of new construction will continue and that, unless conditions undergo a radical change, the approaching spring will witness an unprecedented amount of building work throughout the United States.

"The demand for accommodations of all descriptions is stronger than it has been at any time in the past, due to the long period of underproduction in the industry and the country's growth in population and business. The labor situation in the industry is more stabilized than has been the case for several months. While supplies of building materials are limited at present, improved labor conditions are expected to greatly stimulate production in these lines and make it more readily possible for builders to proceed with their work.

"Building costs are moving toward higher levels and there is no immediate indication that these tendencies will be changed. The labor supply is sufficiently limited and the demand for building is strong enough to create underlying conditions that will exert continued pressure toward higher price levels.

"General conditions through the industry are in a wholesome condition. This is reflected in a strong demand for capital with which to further building enterprises. The enormous demand for space and the steady marking up of rents has brought about a considerable amount of new building of the larger types of construction, such as office structures, manufacturing plants, hotels and apartment houses in the leading cities of the country.

"While the demand for buildings of all kinds will continue strong for an indefinite period, there is no likelihood of a runaway market or of boom conditions, as the shortage of labor and building materials will prevent such conditions and there seems to be every indication that the industry will gain added momentum along thoroughly substantial lines."

*(By Special Correspondence to The American Architect)*

**SAN FRANCISCO.**—Although building costs are still in the ascendancy, construction work seems to be gaining impetus in San Francisco as spring opens up. The weather is still a little uncertain, even more so than in normal years on account of the rainy season starting in very late and continuing later than usual. Nevertheless much work is getting under way and the local architects' offices are well filled with assignments. The situation is particularly bright as far as prospects for the erection of many large new structures in the downtown business district of the city. Much work of this nature, which was held up during the war and has since been postponed for one reason and another, is now scheduled to proceed without further interruption. This makes more volume to the business now being handled by the leading architects than has been noted in a long time.

In addition to the new buildings for the Federal Re-

serve Bank, the Wells Fargo Bank, the First National Bank, the Mercantile Trust Co. and the Anglo-California Bank, which is a notable showing in the way of new banking and financial institutions, plans are being prepared for various other large buildings, including a \$1,500,000 theatre to be erected at Market and Taylor Streets; a new theatre for the Orpheum Company, a \$250,000 reinforced concrete warehouse to be erected at the southwest corner of Bryant and Rincon Streets and a store building in Geary Street, between Powell and Mason.

Architects, in common with the bankers and brokers of the city, are inclined to predict that the tremendous development of the business district of the city, which is now under way and will receive an astonishing momentum before the end of this year, will continue for a long period.

*(By Special Correspondence to The American Architect)*

**SEATTLE.**—Difficulty of securing steel products of the finer grade of workmanship is now interfering with building projects in this territory. Vitroware is scarce and the eastern mills will not offer any guarantees as to either prices or date of loading. Tubular mills are refusing to accept contracts and the pipe companies declare they can give jobbers no satisfaction as to when business can be resumed. Jobbers are able to get staples, but china lavatories and bath tubs easily fall under the prohibitive list. Manufacturers of brassware state that without accepting any more contracts they can continue in full operation for nearly two years.

North Pacific coast jobbers, advised that large buildings, completed excepting as to the plumbing fixtures, are standing idle in the East, are not able to take comfort from the situation. The complaint of the manufacturers to their local jobbing clients is that they cannot get raw materials.

On the other hand, it has been intimated to jobbers that while no new business can be accepted, it might assist in delivery if premiums over the market were offered.

Nails are very scarce, particularly as regards five and eight penny stock, and jobbers continue their rationing plan in order to appease insistent patrons. Building hardware is easier. Pipe of sizes  $\frac{3}{8}$ ,  $\frac{1}{2}$ ,  $\frac{3}{4}$ , 1, and  $1\frac{1}{4}$  inches is almost unobtainable. So great is the emergency that Seattle jobbers this week opened negotiations with British Columbia shipbuilders, whose plants have been closed down since the end of the war for pipe of this size in stock when the plants were shut down. The jobbing trade is about 50-50 as to whether there will be an improvement before fall. The claim that there can be no improvement is based on the demonstrated fact, if this section is a criterion, that the mills are booked up solid until October. This is also indicated in telegrams and correspondence regarding the firming of future contracts.

Cement is steady intrinsically, but the rising cost of bags in pushing the market upward. Metal lath is plentiful and the market stationary. Despairing of getting a supply of cultivator steel, jobbers are using channel iron, which seems to be plentiful. Brick is plentiful.

Fir lumber is dull, eastern buyers apparently having left the market in a body in the hope of lower prices. The lumber market generally is \$2 to \$5 lower on common assortments and \$8 to \$10 lower on finishing sizes. There is no buying whatever, but the mills claim that the market will react.

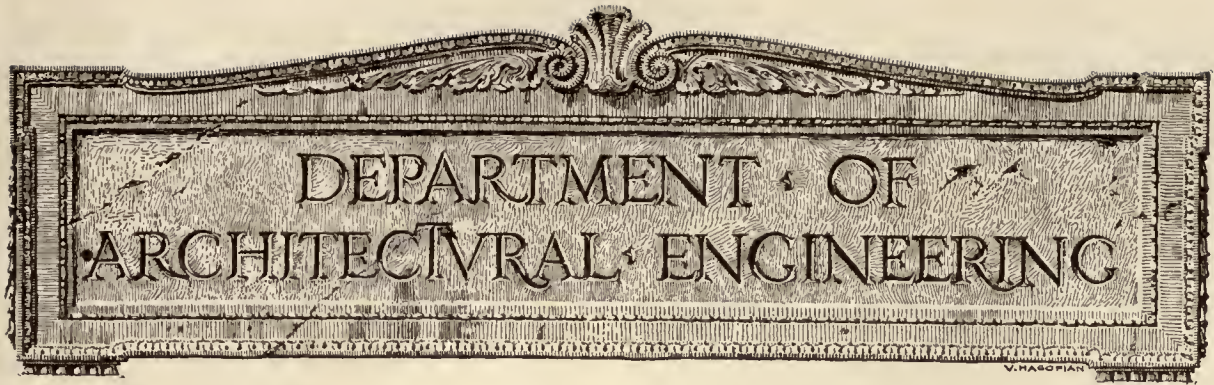

## A Unique Institutional Building

### The Elevator Storehouse, Blackwells Island, New York City

By BENJAMIN W. LEVITAN, *Architect*

BY the uninitiated, the architect is often thought to be one whose entire time is taken up with tee square and triangle and thus they fail to comprehend his infinitely greater task of planning. Often the architect is given a problem to solve, which in its difficulties presents a close parallel to that of perpetual motion, but be it said to the credit of the profession, these problems are almost always solved in a satisfactory way, as is testified to by the many notable structures erected in accordance with their designs, and under their direction. The architect gets the job because he is capable of working out the problem.

Back in 1915, the then Commissioner of Charities of New York City, burdened with a problem which was not only troublesome to his administration, but which had proved so to preceding ones, in an endeavor to dispose of a persistent and willing architect, suggested that he present its solution. Now this problem was in large part really one of engineering, but, in the broader sense the architect is also an engineer.

To make clear the difficulties at that time confronting this department let me briefly describe some physical conditions existant in New York City, and with which many may be unfamiliar.

Located in the East River, approximately midway between the Manhattan and Queensboro shores, and included within the boundaries of Greater New York, there lies a long, narrow and rocky island known as Blackwells Island.

It forms one of a group of several such islands which made navigation difficult in this part of the East River, from below this point out through Hellgate.

Originally, being accessible only by vessel and therefore of slight value for either residential or commercial purposes, it was utilized by the municipal authorities for the housing of various of the City's institutional buildings.

The area of the island is approximately 250 acres, and it is divided into five sections, as follows: The northerly end is occupied by the Metropolitan Hospital; the next section south by the Work House, under the supervision of the Department of Correc-



BRONZE TABLET IN MAIN ENTRANCE HALL, GROUND FLOOR

## THE AMERICAN ARCHITECT

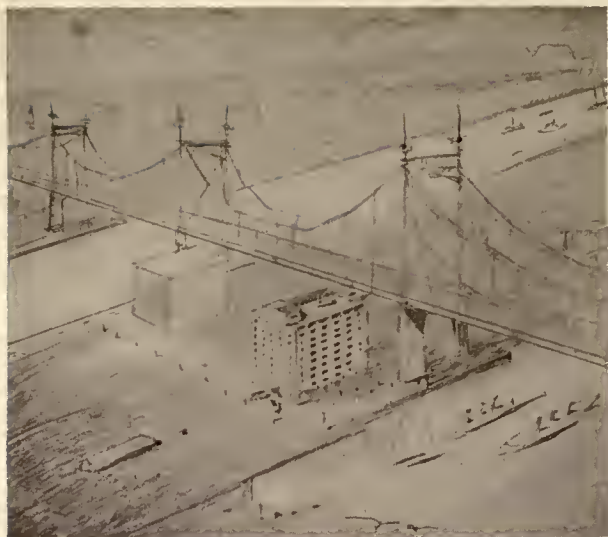

ARCHITECT'S PRELIMINARY SKETCH ILLUSTRATING SUGGESTED METHOD OF SOLVING TRAFFIC PROBLEM

tions; the next section south by the City Home, under the direction of the Department of Charities; the next section south by the Penitentiary, Department of Corrections, and the southerly end by the City Hospital. The area of the island is divided almost equally between the two departments, i.e., the Department of Corrections and the Department of Charities, the institutions under the jurisdiction of each occupying approximately 125 acres.

The island has a population of from eight to ten thousand persons, and the daily tonnage of material necessary for the use of this population is therefore considerable.

In 1908, the Queensboro Bridge, spanning the East River on a line with 59th Street, Manhattan, was completed. This structure passes over Blackwells Island, the two center piers being located on the island. The Department of Charities at that time maintained fifteen steamboats to provide a means of communication with the various institutions under its control thus transporting both persons and supplies by steamboat.

This method of transportation had proven decidedly unsatisfactory as well as entailing a great expense to the city. It will be realized that it was necessary to first transport all supplies to the city docks, where they waited to be loaded on the boats. The loss in transit and handling which occurred at this point was an item that kept several city officials busy.

The problem presented to me by the Commissioner was this: "How could transportation be best improved and this method of water transport eliminated?"

Let me explain, that in an attempt to present a

satisfactory solution and prior to my injection into the matter, the Bridge Department of the City of New York had already presented several schemes, worked out by its engineering staff. The first of these contemplated erecting an elevator shaft in the center of the Queensboro Bridge roadway, where the bridge spans Blackwells Island. All deliveries would be made by motor truck, the elevator taking these to and from the island level. The main objection to this plan was that it would almost certainly block traffic on the roadway, and several trucks waiting for the elevator at one time would cause serious congestion. A later plan suggested was to build two passenger elevator shafts, one on each side of the most westerly of the two bridge piers located on the island. This was evidently suggested by one of the features of the original bridge design which included a passenger elevator at the Queens end (see illustration). Inasmuch as it is a considerable distance from the Queensboro shore line to the plaza where the bridge roadway reaches the street level, it will be noted that one of the towers of the Queens approach was so constructed as to include an elevator shaft. Thus at this point persons can be transported to the ground level without traversing the



TOWER CONTAINING PASSENGER ELEVATOR AT BRIDGE PIER OF QUEENS APPROACH. ONE PLAN CONTEMPLATED THE ERECTION OF SIMILAR TOWERS AT THE BLACKWELLS ISLAND PIERS



bridge to the plaza and retracing this path on the ground below.

This plan for placing such elevators on the island was originally accepted and an appropriation of \$104,000 made to carry it out. However, due to the insufficiency of such a plan to take care of freight traffic the scheme, after further study, was abandoned before any construction work had been started.

After making a careful study of all the conditions, I accepted the Commissioner's challenge and drew a sketch showing the possibilities of economically and efficiently handling the traffic

diately side-tracking all traffic bound for Blackwells Island, as would be the case in turning off a main avenue into a side street, from which point trucks could be taken to their ultimate destination without in any way blocking or otherwise interfering with the bridge traffic on the main level of travel.

For several reasons, chiefly from the fire hazard standpoint, it was deemed advisable to keep the face of the building back some distance from the bridge. Thus in case of a fire in the building, the heat would not be sufficient to weaken the main structural members of the bridge.

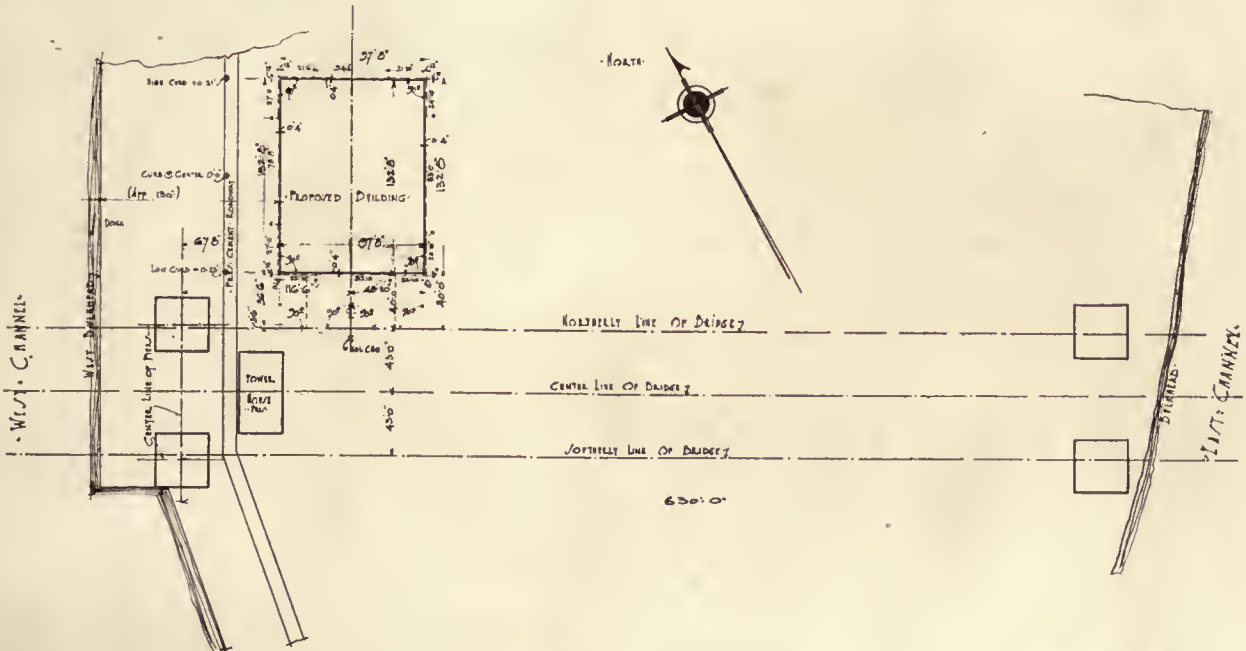

DIAGRAM SHOWING LOCATION OF ELEVATOR STOREHOUSE BUILDING, BLACKWELLS ISLAND, NEW YORK CITY

problem, insofar as it related to the City's institutions on Blackwells Island.

Having made a study of the needs of the various institutions housed on the island, I realized that these could and should be met by the erection of a large building to accommodate the different required activities such as bakery, meat storehouse, drug dispensary, etc. By sketching out this scheme, illustrating how the elevators could be incorporated into such a building I convinced the Commissioner of Charities of the logic and real economy of this plan. It will be noted from the sketch that the original intention was to erect two buildings, but only the one shown in the foreground has been erected.

This plan provided for a building whose roof should be level with the bridge, thus forming a traffic concourse not less than 100 ft. by 150 ft. in area. Its carrying out would permit of imme-

While the original intention was to safeguard the building with an automatic sprinkler system, it has happened that due to a lack of appropriation this intention has not yet been carried out. It is hoped that at some later date this will be provided, as it seems an essential feature.

To continue with the story of my relations with the city authorities, I might say that the plan was presented to the Mayor (John Purroy Mitchell), a progressive official, who viewed it with favor. Numerous conferences were then held with the heads of the several city departments interested, resulting in their endorsement of the plan and its submission to the Board of Estimate and Apportionment, who adopted it and appropriated the necessary funds for carrying it out.

In order to save time and effect an economy, the excavation was not included in the general contract but was let before the completion of the



SITE OF STOREHOUSE BUILDING SHOWING COMMENCEMENT OF WORK

plans. The steel work was also separately sublet. Five months from the date of laying foundations the building was enclosed and the roof was on. Unfortunately after the work had progressed thus far further construction was considerably delayed by conditions brought about by the war, and the building has but recently been completed. A view of the Queensboro Bridge from about the center of the Manhattan span to the Queens approach shows part of Blackwells Island, the site of the building and the two bridge piers located on the Island. An inspection of the location diagram will show the relative positions of the building and bridge as well as the location of the piers.

The distance from the ground level of the Island to the crown of the roadway on Queensboro Bridge is 135 feet. The basement floor of the building is located approximately four feet below the ground level, and in the height from basement to bridge



CANTILEVER TRUSSES SUPPORTING CONNECTING ROADWAY, HANGING BRIDGE BELOW TRACKS ALSO VISIBLE

roadway nine stories in addition to the basement were worked out. The story height of the basement is 12 ft. 2 in.; of the first story 14 ft. 2 in., and of all the upper stories 13 ft. 8 in. The building is of the skeleton steel type and exterior walls are of brick. Face brick is used on the entire exterior of the building as well as on the exposed



VIEW OF QUEENSBORO BRIDGE FROM MANHATTAN SIDE. THE TWO CENTER BRIDGE PIERS ON BLACKWELLS ISLAND ARE 630 FEET APART

## THE AMERICAN ARCHITECT



VIEW LOOKING FROM TRAFFIC CONCOURSE ON ROOF OF STOREHOUSE BUILDING TOWARDS BRIDGE. GUARDHOUSE SEEN IN CENTER

brick work facing the traffic concourse, also the roof structures, etc., including elevator inclosure, garage, and parapet walls. The face brick work is laid in Dutch and Flemish bond with  $\frac{3}{8}$  in. joints. Terra cotta trim is used throughout. The floor arches are of reinforced concrete. Except in a few cases the finished floors are of cement.

As will be noted from the location diagram the southerly face of the building is distant 40 ft. from the northerly line of the bridge, and about 60 ft. from the bridge's main structural members. One of the interesting features of the construction is the cantilever trusses extending from the building to the bridge line and carrying the connecting roadway. No mechanical connection is made between the bridge and the building and there is a space of several inches between these two structures, which is covered over by a steel apron plate, thus permitting expansion and contraction without developing any strains in the structures. It will be noted from the cross section of the building that the anchor arms of the cantilever trusses supporting the connecting roadway extend back into the structural framework of the building, these members being shown dotted and so arranged as not to interfere with several large openings in the interior partitions of the top story shown on the floor plan.

Two freight elevators approximately 11 ft. by 26 ft. are provided at the northerly end of the building and provision is made for a third elevator of similar type. A smaller freight elevator and lowerator are also provided adjacent to the large freight elevators, and provision is made for a future freight elevator of this type and also an additional lowerator. Two passenger elevators are provided at the southeast corner

of the building and provision is made for two additional passenger elevators.

The roadway connecting the bridge and the building is 56 ft. wide, in the center of which is located a stairway leading from the level of the bridge roadway to the ninth floor of the building. Just north of this stairway is constructed a booth 6 ft. by 20 ft. for housing the necessary guards who control all vehicular traffic to and from the storehouse building.

On the east side and extending above the main roof or traffic concourse level is a garage approximately

20 ft. by 36 ft. As will be noted from an inspection of the floor plans there are two stairways in the building placed remote from each other, and extending from basement to roof.

The floors are designed for the following live loads: First floor, 150 lb. per square foot; second floor, 120 lb.; third floor, 150 lb.; fourth floor, 120 lb.; fifth floor, 150 lb., and sixth to ninth floors, 120 lb. The roof is designed to carry a uniform load of 150 lb. per square foot, or a five-ton concentration at any point. The building is provided with a refrigerating plant and is to be occupied as follows: First floor: Storage, distributing office, restaurant and kitchen; Second floor: Cold storage for fresh fruits and vegetables, poultry and ham, bacon, lard, fat, milk, cream, cheese, eggs, etc., also butchery; Third floor: Cold storage; Fourth floor: Bakery; Fifth floor: Coffee roasting and storage; Sixth floor: Storage; Seventh floor: Drug store; Eighth floor: Drug manufacturing; Ninth floor: Dispensary and offices. The roof forms the traffic concourse.

The refrigerating plant is designed to maintain a temperature of 20 degrees in rooms used for storage of meats and fish, 30 degrees where butter,



VIEW OF MAIN ROOF FORMING ENTRANCE TO STOREHOUSE BUILDING FROM BRIDGE. PASSENGER ELEVATOR BULKHEAD AND GARAGE TO RIGHT. FREIGHT ELEVATOR BULKHEAD TO THE REAR

# THE AMERICAN ARCHITECT

eggs, milk, cheese etc. are stored, and 40 degrees for the storage of vegetables.

The erection of the Storehouse Building on Blackwells Island now permits direct delivery by motor truck of all materials for the use of all institutions located on the Island. In addition, all visitors and other persons having business on the Island can come by trolley on the Queensboro

as it permits a passenger on the southerly or east bound track to alight at this point and cross the bridge directly to the storage building, instead of continuing entirely across the bridge and coming back to the building via the west bound track.

Considering the matter of economy it is safe to say that the carrying out of this plan has resulted in a saving of \$2,000 daily, or \$700,000 per annum.

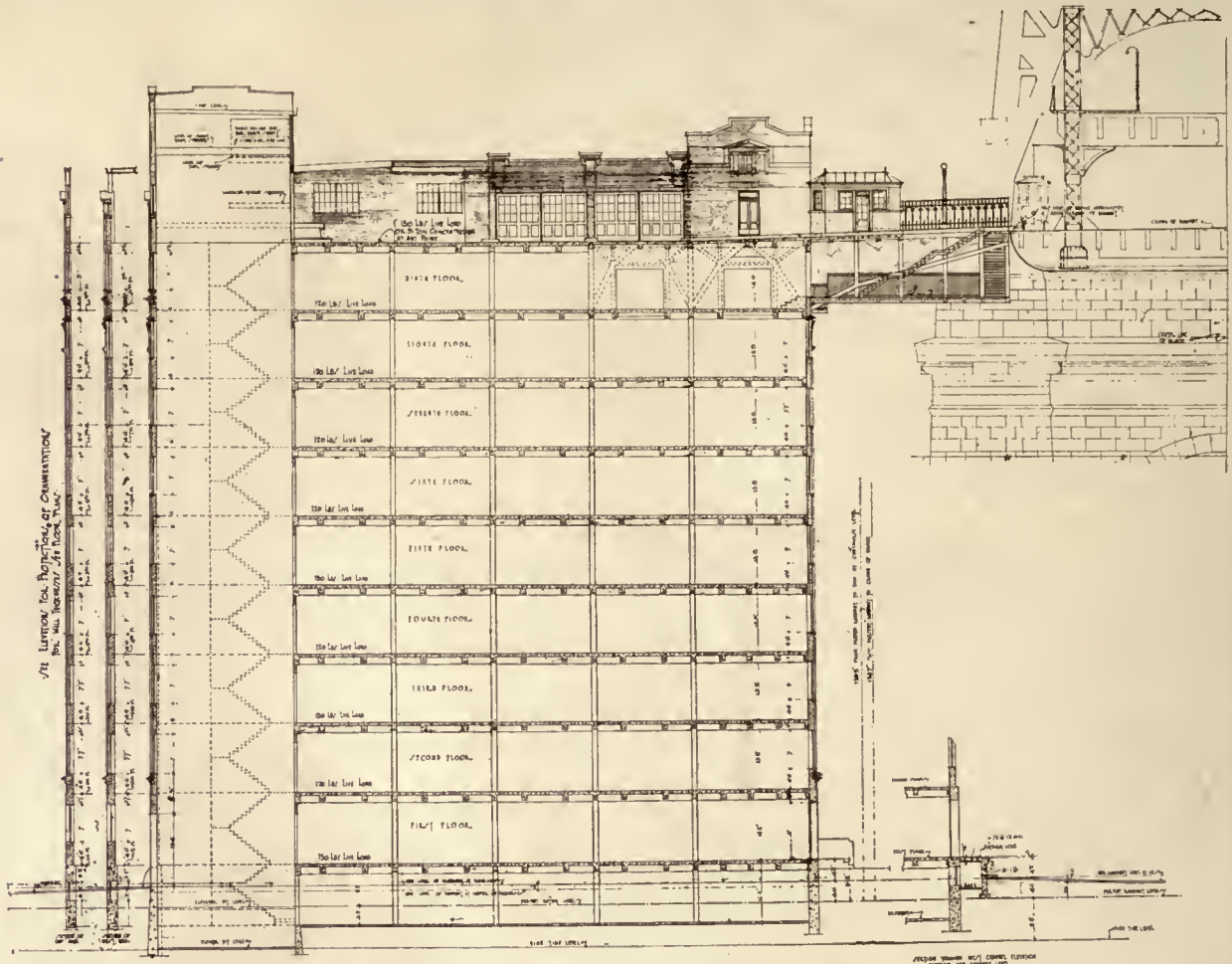

LONGITUDINAL SECTION. NOTE DOUBLE DECK CONNECTING BRIDGE SUPPORTED BY CANTILEVER TRUSSES, ANCHORED BACK INTO STEEL FRAMEWORK OF BUILDING

Bridge, and by passenger elevator from the roof of the building to the Island, much quicker and with more comfort and at less expense than was formerly possible by boat.

Stairways have just been completed on the northerly and southerly sides of the Queensboro Bridge, at the point of the Storage Building, extending from the track level to the Promenade level, and to a transverse bridge below the track level, thus permitting the crossing of the bridge at this point from the east bound to the west bound tracks. This feature is a great convenience for persons visiting or having business on the Island,

This may seem an extravagant claim, but investigation will prove its accuracy. This saving is made up of a reduction in the cost of transportation over former methods, the income now available from renting city docks for private use, which were formerly necessary for the city ferry boats, the elimination of these ferry boats, the lower prices on contracts for meats and perishables owing to direct transportation thus eliminating the spoilage factor. Due to the difficulty of getting to and from the Island, some thousand or more employees in the various institutions were formerly provided with maintenance on the Island. Since this former

# THE AMERICAN ARCHITECT

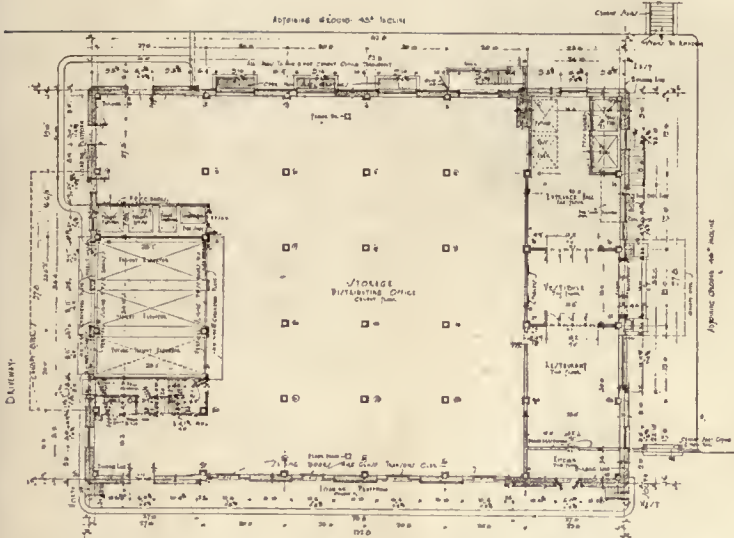

FIRST FLOOR PLAN—MAIN ENTRANCE AT RIGHT

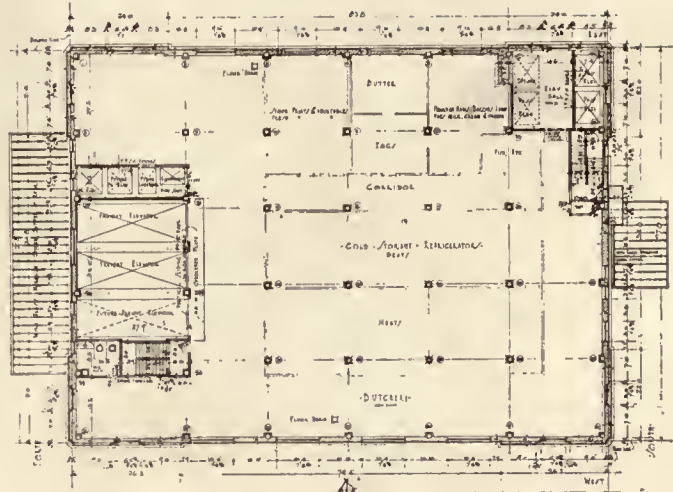

SECOND FLOOR PLAN

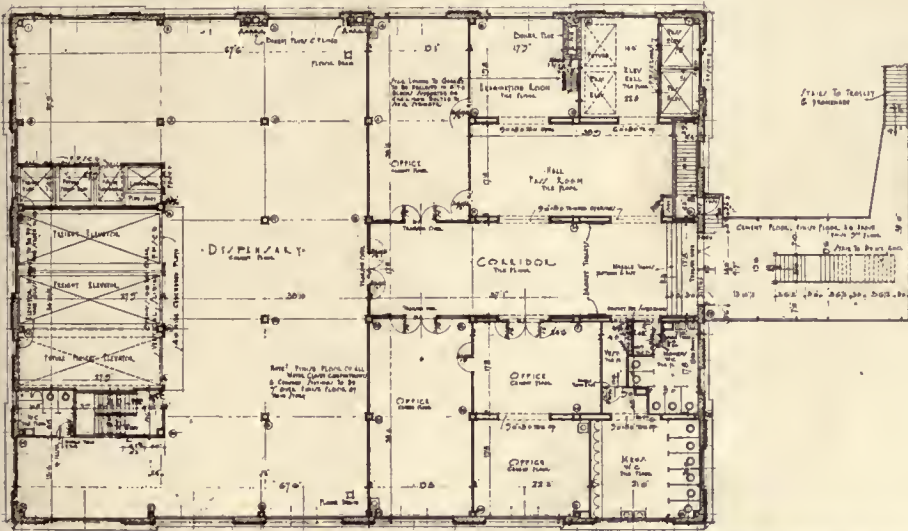

NINTH FLOOR PLAN. LOWER PLATFORM OF CONNECTING BRIDGE SHOWN TO THE RIGHT. ALL PASSENGER COMMUNICATION BETWEEN BRIDGE AND BUILDING IS THROUGH TURNSTILES IN PASSROOM. THIS FLOOR IS USED LARGELY FOR A DISPENSARY AND CAREFUL CONTROL OF ALL DRUGS IS ESSENTIAL.

PLAN OF MAIN ROOF, TRAFFIC CONCOURSE AND CONNECTING BRIDGE. ALL VEHICULAR TRAFFIC TO AND FROM THE BUILDING IS UNDER THE CONTROL OF GUARDS. THE GUARD HOUSE IS LOCATED AT THE CENTER OF THE CONNECTING ROADWAY. NOTE THE GARAGE FOR HOUSING CITY OWNED AUTOMOBILES.

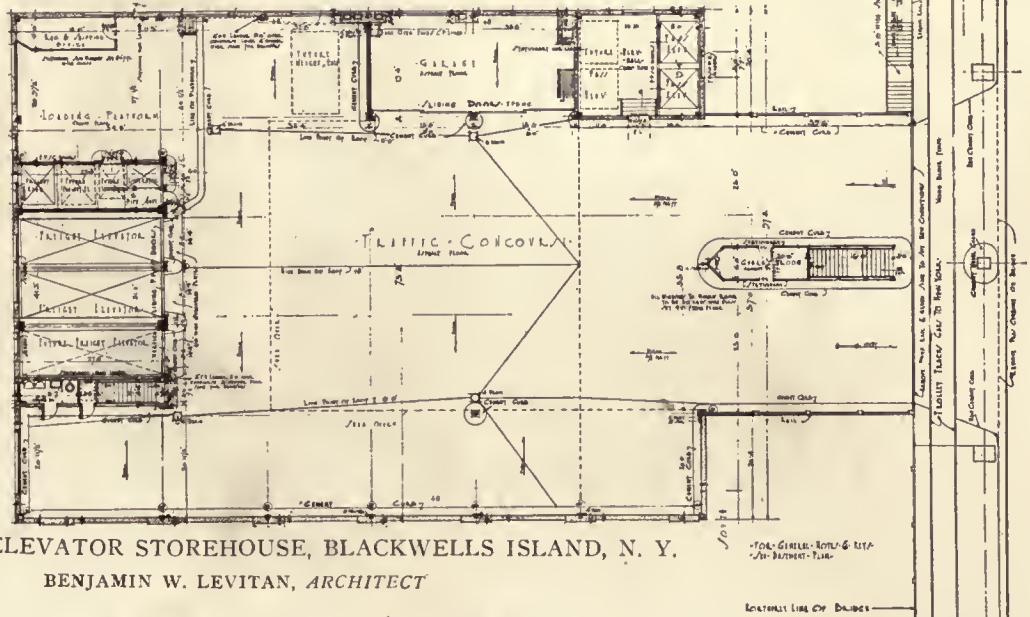

FLOOR PLANS, ELEVATOR STOREHOUSE, BLACKWELLS ISLAND, N. Y.  
BENJAMIN W. LEVITAN, ARCHITECT



THE STOREHOUSE BUILDING NEARING COMPLETION. SUBWAY TUNNEL RUNS DIRECTLY UNDERNEATH BUILDING AND 125 FEET BELOW LEVEL OF BASEMENT FLOOR. OPERATION OF THIS SUBWAY IS SCHEDULED TO START APRIL 1

Island, thus avoiding serious delays, formerly quite common, but which may prove fatal in serious cases. I might also add that when communication was by boat there was some difficulty in obtaining the services of eminent but extremely busy physicians, due to the time it took to visit the city hospitals. Since this difficulty no longer exists, adequate medical talent has become available.

Perhaps one of the most important benefits is the direct communication provided for fire fighting apparatus. While fire boats are of great help if the structure afire is near the water's edge, it is not possible to efficiently fight fire by this means should the building be located inshore which many are.

Thus, not only does this improvement make possible considerable financial saving, but it

isolation of their place of employment is a thing of the past, they travel to and from their place of residence daily, thus relieving the city of the expense of their maintenance.

From another angle, i.e., the saving of life, this direct connection is of great value. Ambulances have a direct route to the city hospitals on the

really has brought to the Island the same facilities as are enjoyed by institutions located in Manhattan itself. Transportation is the solution of many problems. Vacant lands of little value soon become bustling and prosperous communities when brought into communication with the rest of the country by adequate transportation facilities. In this con-



NORTHERLY STAIRWAY FROM TRAFFIC CONCOURSE LEVEL TO BRIDGE PROMENADE. TO CROSS BRIDGE IT IS NECESSARY TO DESCEND TO HANGING BRIDGE BELOW



STAIRWAY ON SOUTHERLY SIDE FROM PROMENADE LEVEL, AND CONNECTING WITH HANGING BRIDGE BELOW TRACK LEVEL, BY WHICH ACCESS TO BUILDING IS HAD

nection, it is interesting to note that directly under the Elevator Storehouse Building, and 125 feet below the basement floor level, a new subway has been constructed to increase the transit facilities to the rapidly growing Borough of Queens.

The building when completed and equipped will represent an investment of \$1,300,000. Altogether the Municipal authorities having jurisdiction over Blackwells Island feel that a wise investment has been made in the erection of this building and one that provides a logical means of communication between the mainland and the Island. The problem which for so long puzzled former administrations has now been satisfactorily solved.

### Suggested Building Code Issued by Lumber Organization

A suggested building ordinance has been issued by the Architectural and Building Code Service, National Lumber Manufacturers' Association, Chicago, Ill. It is intended to serve as a reasonable regulation of ordinary building construction where congestion is not abnormal, but does not constitute a building code in the general sense of the word. In the small town it should prove a reliable guide for safe construction pending the natural growth of the community. Data of an educational and explanatory nature appears in the appendix.

### Westinghouse Opportunities For Technical Graduates

Westinghouse opportunities for technical graduates are very thoroughly explained in an illustrated pamphlet bearing that title, recently issued by the Westinghouse Electric & Manufacturing Company.

Copies of the booklet will be sent to anyone interested on application to the Educational Department of the company at East Pittsburgh.

### British Housing Schemes on Town Planning Lines

Some of these housing schemes are rather ambitious. A few are quoted as follows: Swansea's (South Wales) scheme of 3000 houses on the corporation's estate, which is valued at £2,000,000. The cost of the first installment of houses is £800 each; Ebbw Vale (South Wales), in connection with which sanction has been given for the erection of 3000 houses, the cost of which will



NORTH ELEVATION OF COMPLETED ELEVATOR STOREHOUSE BUILDING, BLACKWELLS ISLAND, N. Y.

exceed £2,500,000. This scheme involves the rebuilding of the slum areas. Port Glasgow has a £3,000,000 scheme, also a block-dwelling scheme of thirteen blocks. Walthamstow (North East London), the most important urban district in England, has a scheme embracing more than 1500 houses, which will cost with sewers, roads, etc., about £2,000,000. The designs for "layouts" on town-planning lines, and for house plans, are being made in the Engineering Department. Edmonton, near London, has a £2,000,000 scheme on town-planning lines which is being prepared by its engineer department.

### A New Power Plant at Niagara Falls

Work on the new hydro-electric development at Niagara Falls, which the Hydro-Electric Power Commission of Ontario started in 1918, is progressing at an expected rate of speed. A long canal is being built to carry water around the falls and through the power plant. Some little difficulty has been met in holding the slope in the deep cuts in the earth overburden, but this has not caused serious retardation and the prospect is now that the power will be available in 1921.

United States Civil Service Examinations

The United States Civil Service Commission announces an open competitive examination for the following positions:

(1) April 6, 1920—Assistant Fuel Engineer:

A vacancy in the Bureau of Mines, Department of the Interior, at Pittsburgh, Pa., at \$4,200 a year, and vacancies in positions requiring similar qualifications, at this or higher or lower salaries, will be filled from this examination, unless it is found in the interest of the service to fill any vacancy by reinstatement, transfer, or promotion.

Both men and women, if qualified, may enter this examination, but appointing officers have the legal right to specify the sex desired in requesting certification of eligibles. For this position in the Bureau of Mines male eligibles are desired.

Appointees whose services are satisfactory may be allowed the temporary increase granted by Congress of \$20 a month.

The duties will be to assist in tests of boiler and other furnaces, of auxiliary equipment affecting efficiency in the use of fuels, investigation of fuel-burning methods and machinery, inspecting and sampling fuel, and the compilation of data and making reports.

Competitors will not be required to report for examination at any place, but will be rated on the following subjects, which will have the relative weights indicated, on a scale of 100: (1) Physical ability, 10; (2) essay on testing of fuels, with sketches, to be filed with the application, 25; (3) education, training and experience, 65.

Under the third subject competitors will be rated upon the sworn statements in their applications and upon corroborative evidence.

(2) April 13, 1920.—Assistant Specification Engineer:

Vacancies in the Office of the Chief Signal Officer, War Department, Washington, D. C., at \$1,200 to \$2,000 a year, and vacancies in positions requiring similar qualifications, at these or higher or lower salaries, will be filled from this examination, unless it is found in the interest of the service to fill any vacancy by reinstatement, transfer, or promotion.

The entrance salary, within the range stated, will depend upon the qualifications of the appointee as shown in the examination. Appointees whose services are satisfactory may be allowed the temporary increase granted by Congress of \$20 a month.

Both men and women, if qualified, may enter this examination, but appointing officers have the legal right to specify the sex desired in requesting certification of eligibles. For this position in the Office of the Chief Signal Officer male eligibles are desired.

The duties of the position will consist of the preparation of complete detailed manufacturing specifications for all radio signaling apparatus used by the Signal Corps.

Competitors will not be required to report for examination at any place, but will be rated on the following subjects, which will have the relative weights indicated:

<i>Subjects.</i>	<i>Weights.</i>
1. Education, experience and fitness.....	60
2. Thesis, to be filed with application.....	40
	—
Total .....	100

Under the first subject competitors will be rated upon the sworn statements in their applications and upon corroborative evidence.

(3) April 13, 1920.—Fuel Research Assistant:

Vacancies in the Bureau of Mines, Department of the Interior, throughout the United States, at \$1,200 to \$1,800 a year, and in positions requiring similar qualifications, at these or higher or lower salaries, will be filled from this examination, unless it is found in the interest of the service to fill any vacancy by reinstatement, transfer, or promotion.

The entrance salary within the range stated will depend upon the qualifications of the appointee and the duty to which assigned. Appointees whose services are satisfactory may be allowed the temporary increase granted by Congress of \$20 a month.

Both men and women, if qualified, may enter this examination, but appointing officers have the legal right to specify the sex desired in requesting certification of eligibles. For this position in the Bureau of Mines male eligibles are desired.

The duties of appointees will be to assist in and to direct the preparation of reports of tests relating to fuels, and the compilation of data pertaining thereto.

Competitors will not be required to report for examination at any place, but will be rated on the following subjects, which will have the relative weights indicated:

<i>Subjects.</i>	<i>Weights.</i>
1. Physical ability.....	10
2. Education, training and experience.....	70
3. Essay, thesis or report on a fuel engineering subject, with necessary sketches (to be filed with application).....	20
	—
Total .....	100

Under the second subject competitors will be rated upon the sworn statements in their applications and upon corroborative evidence.

(4) April 13, 1920.—Junior Mechanical Engineer:

A vacancy at the National Advisory Committee for Aeronautics, Langley Field, Va., at \$1,800 a year, and vacancies in positions requiring similar qualifications, at this or higher or lower salaries, will be filled from this examination, unless it is found in the interest of the service to fill any vacancy by reinstatement, transfer or promotion.

Appointees whose services are satisfactory may be allowed the temporary increase granted by Congress of \$20 a month.

Both men and women, if qualified, may enter this examination, but appointing officers have the legal right to specify the sex desired in requesting certification of eligibles.

The duties of the position will be to assist in the conduct of experimental and research tests, perform calculations, design apparatus, compile reports, or otherwise assist in the work of a research laboratory devoted to the study of aeronautic power-plant problems.

Competitors will not be required to report for examination at any place, but will be rated on the following subjects, which will have the relative weights indicated:

<i>Subjects.</i>	<i>Weights.</i>
1. Physical ability .....	10
2. Education, training and experience.....	90
	—
Total.....	100

Competitors will be rated upon the sworn statements in their applications and upon corroborative evidence.



424 ~

Jan 23/11



INTERIOR OF ST. MARK'S, VENICE

# THE AMERICAN ARCHITECT

VOL. CXVII

WEDNESDAY, APRIL 7, 1920

NUMBER 2311



CHURCH AT GRASMERE

## The English Parish Church

By ALBERT C. PHELPS, *College of Architecture, Cornell University*

NOTWITHSTANDING the merits of the English cathedral and monastic architecture, the parish church is England's finest and most characteristic contribution to mediæval art. Fortunately she possesses a vast multitude of parish churches that reflect the manners, customs and aspirations of mediæval Christians and that have been changed far less by modern alterations and restorations than the more monumental buildings.

There are three chief influences seen in the planning of early mediæval churches in England. The early British Church of the Roman occupation had fled in great part to Ireland as the Saxons overran England. Christianity was brought back to Eng-

land in the 6th century by Irish missionaries who proselytized every county except, perhaps, Kent. Then Augustine and his followers came, settling at Canterbury, bringing Christianity directly from Rome. And in the later Saxon times Norman influence brought in the traditions of the monastic architecture of Western Europe.

So there can be traced in the early churches three elements: first, the tradition of the oblong chamber of the ancient Irish type; second, the Roman basilican type of Imperial Christianity; and third, the cross plan of the later monastic development grafted upon both of the earlier types.

Bradford-on-Avon in Wiltshire is one of the



CHURCH AT COCKINGTON, ENGLAND

finest examples of the Celtic type, with a high narrow nave and narrow square-ended sanctuary. Porches projected on one or both sides and sometimes at the west end, and a strong square western tower was not unusual. This was evidently a stronghold to insure safety from foray, just as the Irish circular towers were.

The basilican church may have existed in England during the Roman occupation, as apparently revealed in the plan of a church at Silchester. However, the basilican type with its semicircular apse was certainly introduced by Augustine, and the plan of St. Pancras at Canterbury is a simple form of this type.

The monastic influence is seen in the cross-shaped plan with the central tower.

Western towers were often added to churches originally provided with central ones that were removed on account of decay or that had tumbled down. The tradition of the single tower at the west end, however, seems to be earlier than that of the central tower.

English churches reveal a tendency to adhere to the square east end of the Celtic tradition in both large and small structures and display great ingenuity in introducing necessary or desirable features as conditions changed. Transepts, a western tower, one or more side aisles, guild and chantry chapels were added without interrupting the service, till the original plan is frequently hardly to be determined. This gradual transformation, reflecting directly and clearly the prevailing customs and architectural fashions of the times, makes thousands

of English parish churches most intensely interesting as human documents.

Parish churches, especially those of country districts, were centers not only of religious devotions, but of community life in its various aspects. They served the purposes now cared for by the clubhouse and the church institute, and were looked upon with pride and affection by all classes of the community.

The mediæval English parish church was a peculiarly democratic institution. The parish and consequently the parish church was entirely independent of the power or authority of the lord of the manor or of any state officials. If the lord's steward held court in the nave of the church or if the court rolls were stored there, it was only by permission of

the parish. The parish was organized for church purposes, subject only to the church authority. Within its area every resident was a parishioner, and the wardens were their chosen representatives, elected by the whole people of both sexes, not by the parson, nor by any select vestry, still less by the squire.

The contrast between a manor court and a parish meeting is set forth in numerous extant records. Manor court rolls show the condition of the community as divided into sharply defined classes: the lord of the soil and his tenants, the tenants themselves into bond and free, and the villeins again, according to the size of their holdings. On the contrary, all such distinctions vanished when the parishioners assembled in the church to pass the wardens' accounts, to elect their successors, to listen to the annual roll of gifts and bequests, or to



CHURCH AT STREATLEY, ENGLAND

## THE AMERICAN ARCHITECT

learn the details of the collections made by the young men and women, by the wives and the husbandmen, or of the profits of the church ales, the plays or the games. In the eyes of the church all were on an equal footing at the parish meeting, as they were when they knelt before the altar—lord, tenant, villein or serf.

In the later pre-Reformation days the church-house became a usual adjunct of the parish church and served for church ales and similar entertainments, but through much of Elizabeth's reign the parish churches continued to serve for a variety of

the west end, it was usual to find a plough. This was kept there ready for use on Plough Monday, the Monday after the Epiphany, which was the season when ploughing and other rustic toil began. In olden days the church made this the occasion for blessing the tilling of the fields, the plough being solemnly blessed before the procession started. In many country parishes the laborers maintained a Plough Light burning before the patron saint.

In troubled times, or when fires occurred, the



INTERIOR OF CHURCH AT GRASMERE



CHURCH OF ST. JOHN IN THE WILDERNESS,  
ERMOUTH

uses that seem curious and inappropriate at the present time. Prominent among those that were difficult to eradicate were the mystery plays which continued to be occasionally acted in the churches to the very end of the sixteenth century.

In the large parishes the holding of fairs or the sale of merchandise within or around the churchyards occasionally encroached upon the porches or other parts of the actual church building; but such proceedings were always regarded as illicit and duly prohibited by the ecclesiastical authorities.

Dancing undoubtedly took place in the naves of certain churches at festival seasons; the wardens' accounts of St. Edmund's, Salisbury, testify to the children dancing around a may-pole in the fifteenth century.

Within the village church, under the tower or at



CHURCH AT GOWER, WALES

parishioners were allowed to store wool or grain, or chests containing valuables, or household goods inside the church, paying for the privilege to the wardens' common fund.

Deeds, too, that had no concern with church lands, but that related to leases or transfers within the parish, were not infrequently permitted to be placed in the parish chest for safe keeping. Such

covenants were often signed in the church porch, and, if they related to the church building or to the parish generally, on the very altar itself.

If a dead body was found in the parish, or if a parishioner died a violent or mysterious death, the corpse was placed in the church porch and there the coroner held his inquest.

These are but a few of the almost numberless uses for which the old parish churches of mediæval England served without any thought of irreverence.

## THE AMERICAN ARCHITECT

It is true that the church was strongly safeguarded from anything savoring of actual profanity or violence by heavy penalties and penances imposed by the ecclesiastical authorities not only upon the delinquents themselves, but in a certain general way upon the parish at large.



VIEW ACROSS CHANCEL, PARISH CHURCH  
AT CIRENCESTER

For in such cases the church was placed under an interdict, and the priest dared not exercise any of the religious ministrations until it had been purified, by the process of formal "reconciliation," at the hands of the bishop or his representa-

tive, the expense being borne by the whole parish.

"Nor should it be forgotten," says Dr. J. Charles Cox in his book on *The English Parish Church*, "that in the fierce days when limbs were lopped and lives taken for comparatively trivial offenses by a cruelly severe state, the church, on the contrary, bore perpetual witness to the spirit of mercy by insisting on all her consecrated churches and churchyards being regarded as safe sanctuaries, under strictly defined limits, for all wrongdoers. There was probably not a single parish church in the length and breadth of England that had not exercised, at some time or other, its privilege of sheltering a fugitive, and eventually substituting banishment from the realm for loss of life or limb."

The affection of the townfolk of England for their parish churches, so far as boroughs were concerned, usually centered in a particular municipal church. Within its walls not only were mayors, bailiffs and other officials elected, but the actual assemblies for the making and carrying out of by-laws were constantly held.

The old civic buildings of England were very few in number, and of a meager character where they did exist. Such splendid old municipal buildings as are found in practically all the cities of Belgium, and less frequently in Italy and France, were unknown in mediæval England.



# The National Board of Jurisdictional Awards

By E. J. RUSSELL, *Chairman, National Board of Jurisdictional Awards, A.I.A.\**

ACTIVE interest in the National Board of Jurisdictional Awards, so far as the American Institute of Architects is concerned, came about through the war. We realized immediately that the building industry, and we considered ourselves a part of the building industry, was not getting ahead very fast and was not given the recognition that we thought was its due. We felt that this lagging behind was presumably due to the lack of organization. We could not effect a building organization in a day, or in a year, and so instead of attempting to do anything of that sort immediately we decided to see what could be done to eliminate the most of the troubles that beset us in our daily practice.

Jurisdictional disputes and strikes seemed to do more harm, or so the general public thought, than almost any other phase of the business. In order to see what could be done to remedy matters, the American Institute of Architects appointed a committee to appear before the Building Trades Department of the American Federation of Labor to state that they were interested in this, and to ask whether there was any way in which they could help solve the problem.

Officials of the Building Trades Department replied that they had realized the gravity of the situation some three or four months ago, and had borrowed from the Department of Labor a man who had been asked to bring in a report showing whether anything could be done to help.

This man was John B. Lennon. Mr. Lennon is not a building trades man, but he has been connected for the past eight years of his life with the labor unions and with the Department of Labor since it has been organized. We told the labor officials that as long as they were taking such steps to bring about a reform we did not have a word to say. We stated that if we could in any way be of assistance, we stood ready.

The answer was that we could, and representatives of the Institute of Architects were notified to appear before them; they had their executive council meeting in Boston, I think, in February of last year. At that time there was a big New York strike on, and so a few of the members of the Executive Council and a few of the local labor leaders of

Boston got together and we outlined to them what we had in mind, which was simply an elimination of the strikes.

At that time we had no definite program, but said simply that we thought the war had introduced a great deal of harm into the industry. We cited cases such as arose in St. Louis where there were two large buildings on which there was a great deal of trouble, a great deal of time lost by the men, and consequently a great many delays caused by strikes, seventy-five per cent of which were jurisdictional strikes. The situation had so affected the men who had financed these buildings that they said they never again would invest in building, but would invest their money in other ways.

We expressed our belief that a great deal of good could be done by eliminating jurisdictional disputes and that we were absolutely disinterested. They replied that they were greatly surprised at our coming before them, and said, "You have come at least ten years before we expected you to." When the Boston meeting was adjourned we went to New York and there met not only the groups of the Executive Council, but also the presidents of all or nearly all of the industrial unions. The result was that each president pledged himself to support any plan that would be equitable and that would be submitted to a joint committee.

They asked us to call for a joint conference, and we suggested that labor should be represented; that employers of labor should be represented; that engineers or officers of building operations should be represented, and that architects came in the same category. They accepted that suggestion.

The first meeting after that was held in Cleveland, at which time we had representatives of the A. G. C., the National Association of Builders Exchanges, the New York Builders Exchange Association, and the National Association of Building Trades Employers. We were told that the last-named organization had not as yet been created, but that it would be created within a few months. We took the position that there should be a representative of that association added to the Board on the theory that the representation of employers should be as wide as possible.

At the Cleveland conference a plan was formulated which was submitted to the organizations represented and was approved by all of them. A sec-

\*Address given before the Building Contractors' Division of the National Conference on Construction of the A. G. C.

ond meeting was held at Indianapolis, at which time advantage was taken of the various suggestions that had been made, and the plan was finally approved by the conference. The organizations represented at the conferences were then asked to approve formally of the proposed Board of Awards. The plan provided that there should be three representatives of labor, three representatives of employers, and representatives of architects and engineers who in a measure stand between the employers and employees.

That plan was submitted to the organizations. It was considered and approved in writing by the American Institute of Architects in its convention in Nashville last April; it was approved by Engineering Council, by the Associated General Contractors, and by the American Federation of Labor at its 1919 convention in Atlantic City. It was not approved by the National Association of Building Trades Employers, nor by the National Association of Builders Exchanges, although their representatives were with us from start to finish in the work of drafting the plan. I have never yet heard why they have not given their approval. When the call was sent out for the Board of Awards to meet in

Washington November last, we found that they had not yet approved, so we called their attention to the fact that they were not members.

Matters have dragged along since that time, and the members of the Board have asked that two additional members from the Associated General Contractors of America be appointed. I understand that the other two organizations are desirous of considering the matter again, as a request was made that the call for the next meeting of the Board be delayed. I thought that if they were reconsidering I would not call a meeting of the Board, provided we heard from them definitely one way or the other by the first of March. I understand that no definite decision was reached at the conference held yesterday between representatives of the Association of Building Trades Employers, the Association of Builders Exchanges, and the A. G. C., as to the first two organizations' participation in the future work of the Board.

The future of the National Board of Jurisdictional Awards is of course hard to predict, but I feel that it offers great possibilities for good in the building industry. Many matters of importance await its consideration, and we hope to begin constructive work shortly.

---

## On Monastic Art

“**M**ONASTIC art considered as a whole had a religious intention. It was to no selfish end that the monks practiced art, for they had all taken the vow of poverty—it was for the sake of embellishing everything which served in the community, church, cloister, library, hymn, prayer.”

From the foregoing words Professor Maurice De Wulf developed this theme, “The Monks as Artists,” in the closing lecture of his recent Lowell Institute course on “Monastic Life in the Heart of the Middle Ages.”

Though the most ancient manifestations of artistic life in the cloisters appear, as Professor De Wulf had pointed out, in the transcription of manuscripts, in miniature painting and illumination, from the eleventh century architecture attracted the monks—Romanesque architecture, which was a great artistic innovation, and which formed a new standard of beauty.

“It was a form,” the lecturer said, “or a collection of forms, which were quite new, in which the rational and logical character of the church and its functions shines forth with great clearness. For the first time was seen two towers serving as a

frame for façade, large doorways, choirs with their surrounding ambulatories and radiating chapels, high walls ornamented within, a cruciform ground plan, and, above all, a barrel vault in stone, instead of wooden vaults of ceilings. These new forms appeared at about the same time in five or six parts of France corresponding with the feudal frontiers of the eleventh century. While we cannot say that the Benedictine monks were the inventors of the Romanesque, it is an incontestable fact that they were its most zealous propagators.”

But the Benedictines did not adopt a uniform Romanesque style. They took over and developed the architecture of the region wherein they happened to be. Even now France has many of their abbatial churches. And it was worth noting that the Romanesque style seemed very appropriate to the monastic life. Barrel-vaults being lower than pointed vaults were more conducive to contemplation; round arched windows transmitted but a quiet, sifted light, suitable for prayer and meditation.

Fresco, sculpture and stained glass were called to the service of architecture. From the end of

*(Continued on page 435)*



# Modernizing Church Design

IT is with a feeling of astonishment that we read the leading editorial in a recent issue of our conservative contemporary, *The Architects' Journal* of London, a sharp criticism of existing standards of church design in England and the suggestion of changes that will undoubtedly be stoutly criticized by the clergy and a number of the architectural laity. This editorial will be read with mixed feelings. One will wonder if the cause for the plaintive cry of church men who deplore the constantly diminishing attendance may not perhaps be due to the very conditions that are set forth in this editorial. And one may also doubt if methods of church designing and planning as are suggested, would accomplish the popularization of religious services.

Further, many will claim that thus ruthlessly to ignore long venerated traditions of church architecture would be to strike at the very root of religious belief, that thus to modernize the forms of religious observance would so weaken the influence of religious teaching as to lessen its power for good.

Many very important matters are involved, and as the editorial referred to so bluntly discusses these things, it is regarded as of sufficient interest to print in full. It states:—

JUDGING from such church papers as come our way, and from passing references in the secular press, it would appear that the clergy of all denominations are deeply concerned at a falling away, on the part of the general public, from attendance at Divine worship, for picture-house and music-hall, however, do not show, so far as we are aware, any parallel loss of support.

Now to what degree the churches can hope, or even desire, to rival these cheerfully pagan institutions in popularity is a theme outside the range of an architect; it calls for the wisdom of an archangel rather, or, at least, of an archdeacon; but an architect may be forgiven for wondering whether, if such rivalry can be supposed to exist, the churches do not avoidably handicap themselves in the race, and whether architects may not be in some measure to blame as accessories before the fact.

Not overlooking for one moment the very different motive which does or should prompt attendance at these diverse places of assembly, let us consider, for example, a modern music-hall, for it will be understood that the architect's business is not with shibboleths but with more material issues. The music-hall is well lighted, and attention is paid

to heating and ventilation without draught. Every sitting commands a full and unobstructed view of whatever is going on, and each sitter has a separate and comfortably upholstered seat. Cloak-rooms and lavatories, in the extended modern meaning of the term, are commodiously to hand. The music is the work of trained executants and those who say or sing have necessarily been at the pains to learn how to make themselves heard and understood, and how to make their points with certainty and precision. *Mutatis mutandis*, the same observations apply to the picture-house and the visitor can spend an hour or two in either, his body at ease and himself, therefore, free to relish whatever of intellectual or other nourishment is put before him.

Contrast the prevailing type of church; the floor obstructed by piers: lighting, heating, and ventilation imperfect, and draughts mightily prevailing; for seating either a rock-bound bench or an unstable and inadequate chair; kneeling a difficulty—we even know a cathedral in which it is all but impossible; no provision for the requirements of body or raiment, amateur music insufficiently rehearsed; and last, but not least, the officiant untrained in voice articulation or pointed speech. What wonder, then, that a public, accustomed to lavish consideration in such matters elsewhere, votes church-going an uninviting business.

There are many reasons for this state of affairs, but the chief is, in the opinion of the present writer, a false mediævalism. It is easy to understand that when in the nineteenth century the Church of England rose in revolt against smug conventionality, and looked back for inspiration to the Middle Ages, the mediæval type of church was studied with enthusiasm and closely imitated; so much so that it remains to this day the standard, despite the attempts, happy or otherwise, of a handful of hardy innovators. But it was forgotten that in old times the church fabric was not only the most lovingly elaborated building in the parish but also the most luxurious. An oak bench, though it might present a sharp molding to the shoulder blades, gave delicious ease to a man used perhaps to sit with dogs on a dirty floor and to whom a sound roof and glazed windows were the last words in solid comfort; while lack of lavatory accommodation troubled our ancestors little or not at all. Indeed, though mortification of the flesh might be undertaken under special direction for special ends, discomfort was no part of mediæval piety; and the

lurking and not uncommon fear that comfort is sinful is really rank heathenry. The mediæval builder was, above all things, up-to-date and progressive, and hastened to adopt improved construction methods and novel fittings as they became known. The dead hand in art did not exist for him.

In the modern church, then, no less care must be bestowed on lighting, heating, and ventilation than in any other public building. As for piers, they are a clumsy device for reducing roof-spans and in these times, when any reasonable span can be roofed without difficulty, they have no justification. There is no reason but prejudice why the sittings should not be, as in other buildings, arm-chair stalls with cushioned tie-up seats, the invention, by the way, we believe, of the old monks or canons. A vacuum cleaner is a simple necessity. Then there must be cloak-rooms; no one can pray in a constant fuss over hat or umbrella. One or two water-closets must be found in some handy place; the lack of this elementary provision makes church-going impossible or a painful anxiety to many old people and invalids; and it may be remarked that, by an odd paradox, the knowledge that such things are at hand takes away largely the wish to use them.

As regards kneeling, we admit ourselves beaten; no satisfactory appliance is known to us. It was all very well for the saintly Herbert to say "Kneeling ne'er spoiled silk stocking"; but the section of the race which now affects silk stockings as yet hardly shows the knee, while kneeling on any arrangement we have come across does play the deuce and all with a pair of Sabbath continuations.

Except in places where they really do sing, a choir is, in the writer's opinion, a nuisance, and would best be relegated to a gallery at the west, together with the organ, if organ there must be. The cost of an organ would often go a long way toward providing a little band; and if this were too risky, a good gramophone would set the tunes and chants far better than an indifferently-played organ, and at a comparatively negligible cost. If there were no obtrusive choir the need for a long chancel would disappear with it; the officiating ministers would be placed on a platform, so as to be well seen and heard; no pulpit would be wanted. Eastward of the clergy there need be a sanctuary only, with space enough for communicants, and the Holy Table would thus be brought forward, and become, as it should be, the visible focus of the building. There might be a screen which could be lowered in front of the sanctuary for use with a lantern—

a thing of the highest value, as those who have tried it know. Towers and bells, except in special cases, are anachronisms; people can find their way to other resorts without these reminders; though the late Fulham Theatre used, if memory serve, to boast a ring of tubes; other theatres have not found it essential to follow the lead, for which we cannot be too thankful.

There are many other points in relation to rational church-planning on which we might touch; we may say, however, in conclusion, that if we have had in mind chiefly Anglican church buildings it is because the revival of church architecture in England has been mainly an Anglican movement; the Roman Catholics have followed generally the same lines; and it is interesting to notice how more and more the Nonconformists seem to be inclining toward the Anglican model in the design of their churches.

---

### Duluth Architects Aid Low Cost Housing

To meet a shortage of houses in Duluth that is estimated at three thousand, the Architects' Association and the Builders' Exchange will join forces and arrange for extensive construction. The two organizations, believing that houses can be built more economically than is the practice, have completed arrangements for building three houses at the lowest possible cost. Each architect has promised to submit at least three complete plans and specifications for houses costing between \$4,500 and \$6,000. Any architect who has more than three houses which he believes would be satisfactory may submit plans for them. Eventually there will be fifty or more plans submitted. The Builders' Exchange will then have these plans figured for material, mill work, by general contractors. In other words, more than 100 of the leading Duluth firms will submit estimates for this work. The lowest estimate is the one that will be used—the same plan to be operated in connection with the electrical, plumbing and heating work. Lowest bids for the general contract, plumbing, heating and electricity will be shown on the plan in order that the prospective builder will know exactly what the house will cost before the contract is signed.

The Exchange will not finance any of these houses, but one company has already offered to loan several hundred thousand dollars to start this work and other real estate and investment companies have offered their co-operation.



## Retarding the Development of American Craftsmanship

THE Yale & Towne Manufacturing Co. have announced in a circular dated February, 1920, their decision to withdraw from direct solicitation from architects and contractors of "Contract Business." Further, that they will not continue to provide facilities for the scheduling of builders' hardware from architects' plans and specifications.

In announcing this radical change of policy, it is stated:

"In earlier years, all builders' hardware was sold in the form of 'stock goods' by the manufacturer to the dealer, and by the dealer to the contractor or builder. If 'scheduling' were needed, it was done by the dealer or contractor. The styles were few and simple, the dealers' orders on the manufacturer were in case lots, and the manufacturer's product was made in large quantities for stock. With the development of 'contract business' these early and sound conditions have been greatly modified; the varieties of builders' hardware (in articles, designs, metals and finishes) have multiplied far beyond the reasonable requirements, with the result that the dealer, while carrying staple goods in stock, has drifted into the practice of transmitting his 'contract' or schedule orders to the manufacturer for execution, instead of maintaining a stock from which to execute them himself. But the proper handling of contract business can only be done," the statement says, "by experts, preferably located near the building, and therefore who can best be provided by the local distributor, not by the manufacturer.

"Unfortunately, the latter has drifted into this field, and frequently has become a competitor of the distributor, even to the extent of usurping his market in certain important localities. In our judgment the manufacturer should now withdraw from this field, and leave all of the work of distribution in the hands of the dealer, where it properly belongs, thereby resuming his proper function as a producer, and enabling him to give better service to his customers."

Probably the most important incentive to the development of craftsmanship in this country has been a policy on the part of manufacturers exactly similar to that this company has abandoned.

This company's announced new method sets an example, which if followed by manufacturers generally, will seriously handicap architects in carry-

ing forward in verity of style, the work designed. Under such a policy architects must needs take what they can get. All original design would become smothered under a deluge of standardization, and by constant repetition would reduce the craftsman's art to the dead level of the commonplace. It is therefore improbable that architects will quietly rest under such conditions, or willingly forego the many artistic advantages attendant on the execution of their original designs.

They undoubtedly will encourage the efforts of those manufacturers who co-operate with them, and thus give valuable assistance in the development of craftsmanship in this country.

## Gold Medal of Honor of the Architectural League

THROUGH the courtesy of the architects, Delano & Aldrich, we are enabled to present in this issue a selected lot of reproductions from their exhibit at the 1920 exhibition of the Architectural League of New York. This exhibit was awarded the Gold Medal of Honor for Architecture. As hung on the walls of the Vanderbilt Galleries of the Fine Arts Building, Delano & Aldrich's exhibit was an important and attractive feature of a most dignified collection of architecture. It was all completely destroyed by the fire that occurred at almost the moment of opening.

The Gold Medal of Honor was established by the Architectural League in 1915 to encourage the submission of works of architectural merit. Owing to the war there was no award in 1918. The medal has been awarded to a list of distinguished architects and its establishment by the League has tended to encourage dignified presentations that have served to increase the artistic value of these exhibitions.

The Gold Medal of Honor is the only award which is made by the Architectural League of New York at its exhibitions. While this policy of limitation adds lustre by its concentrated attention, it

is unfortunate that the League has decided upon no means of recognizing much work of great merit. In the eyes of the judges there are, no doubt, many exhibits which are of such high degree of excellence as to be entitled to honorable mention.

### Service As a Contributing Factor to High Costs

THERE are certain definite increases in our material prices and wage scales as compared with those of before the war, but these are not the pith of the situation. It is in the indefinite expenses which originate in the degradation of the ideal of service that the interference with progress and prosperity may be found.

If a manufactory should fail to support the quality of its output as a matter of the first importance, if it delivered imperfect material feeling safe in the assurance that because of the emergency of the need there must be acceptance—if not dumb, at least acceptance—and the profit forthcoming; it would do harm and injustice to that factory's character, to the materials with which it worked and to the prosperity of the nation. But progressive manufacturers know they must develop, and build, and work in a serious, two-fisted way.

When a factory employe, or a worker in the

building trades so far demeans himself as to loiter on the job or to carelessly turn out work which he knows is not the best he could do, his doing so penalizes the capital which pays him and he also degrades the standard of service which makes for his character, and just so far (and much farther by influence) does he depreciate the quality of activity in his trade and in the nation. The loss is indefinite and vague, but, in its effect, cumulative.

The old men can remember days when workmen were paid once a year and then not often in money but in credit. Labor was not organized into a dictating force, it was a "down-trodden" labor so far as wages were concerned. But its menial position was dignified by a certain quality of loyalty and workmanship which unfortunately seems less universal to-day. There is now no need to pay men in notes instead of cash. They are not left to suffer a depreciated currency as are teachers, clerks and college professors. But every employer of labor knows how often errors are made which are due solely to a lack of proper service. He knows it to be an indefinite loss which he must bear, that the errors must be corrected at his expense and not passed on to the consumer. With the wisdom of experience or of training, he knows that the emergency of the demand will never permit the delivering of poor material. It is full time that the worker accepted a share in the responsibility.



## On Monastic Art

*(Continued from page 430)*

the eleventh century the bare pillars became full of life, their capitals were covered with a flowering of stone, the portals were peopled with statues, though there was something rude and ingenuous in the most antique figures. The abbots, who were building churches, put all the wealth of the abbeys at the disposition of sculptors who traveled from studio to studio, allowing their own models to be used and in turn deriving inspiration by the work of others.

Following sculpture came painting. To this day, in the abbatial church of St. Savin, near Poitiers, one may find for his admiration, the speaker said, some extraordinary mural specimens, little known to tourists. Fashioned in the eleventh century—the most ancient in date—they prove that the monks had discovered processes of art that had been lost, and these the Italians were to bring to perfection. These great compositions successfully concealed the cold nakedness of the stone, and vaults and walls were vivified.

About the middle of the twelfth century the monks also learned how to paint on glass and they at once conceived the idea of putting it in the windows of their sanctuaries. "From this point of view, the reconstruction of the Abbey of St. Denys near Paris marks an epoch," the speaker said. "The Abbot Auger called together, for the purpose of building and ornamenting this magnificent edifice, the most famous architects, sculptors and painters, and according to M. Male, "Gothic architecture and the great monumental architecture were born at St. Denys.'"

Mention was made of the fact that St. Bernard struggled against this sudden wealth of beauty, dreaming of more simple artistic formulæ. The church which he built at Clairveaux is almost naked in the coldness of the walls, and the Cistercian churches erected under St. Bernard's influence, as the speaker said, were characterized by the greatest soberness. The Cistercians, as was natural, were drawn into the current and they were called upon to play a considerable part in a new form of art

—the Gothic. At the end of the twelfth century there arose a wonderful growth of cathedrals in France, and extending to England and Spain. The White Monks of Citeaux built remarkable Gothic monasteries, and in swarming over Europe they carried their new form of art with them. In England the Cistercian Abbeys of Fountains, Kirkstall and Furness must, to judge by their ruins, have been among the fairest jewels of English Gothic art, the speaker said.

For a moment Professor De Wulf considered a type of sacred literature, which developed at the same time as architecture and sculpture, and which he called no less original expression of the artistic mentality of the cloisters. It consisted of a number of Latin hymns of unquestionable beauty, Latin having become more flexible under the influence of the studies of grammar and rhetoric.

Passing to the thirteenth century, which formed a new period in monastic art, Professor De Wulf remarked that it would require months to set forth the influence of the mendicant orders in literature, painting, sculpture and architecture. He admitted that their churches and methods of construction had been greatly criticized and they themselves accused of a betrayal of holy poverty. "The truth of the matter is," the professor said, "that all the Franciscan and Dominican churches of this period were built in the most crowded and democratic quarters of the cities, and that in them everything was sacrificed to the requirements of preaching to enormous congregations; they are simple and bare and vast, planned so that everything should converge upon the pulpit and altar, and show but scant regard for the rigid rules which made a great cathedral a system. But is this a betrayal of Gothic, or is it not rather another art manifesting a new type of beauty? Some of these buildings give us a thrill, notably the basilica of Assisi which Brother Elias built in memory of Francis immediately after his death, and which for a century served as a type of all mendicant churches.

"The fact that painting came to fruition under the protection of the Franciscans and Dominicans is sufficient to immortalize the artistic work of the mendicant Orders."

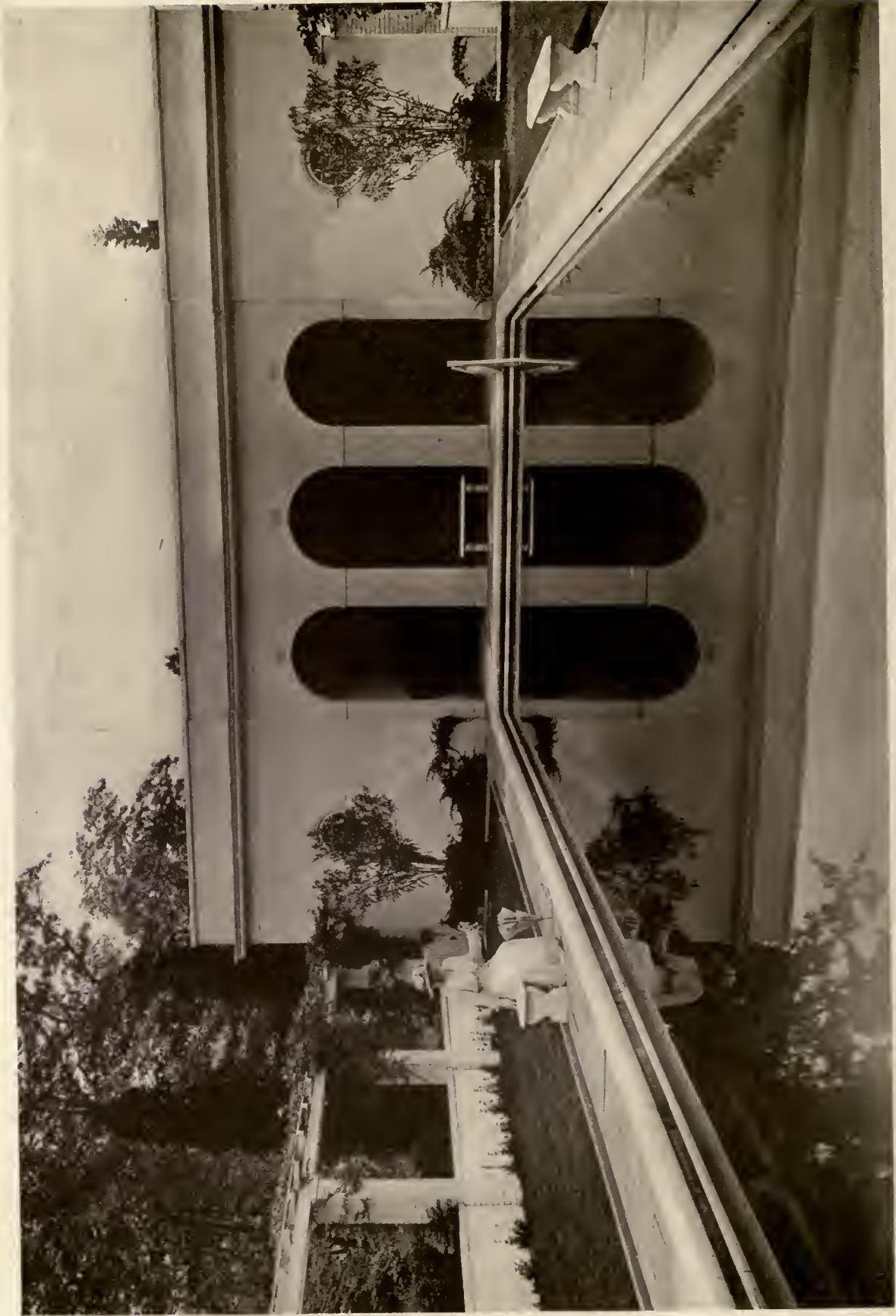

SWIMMING POOL AT MT. KISCO, N. Y.

DELANO & ALDRICH, ARCHITECTS

Part of Exhibit Awarded Gold Medal of Honor, 1920 Exhibition, Architectural League of New York

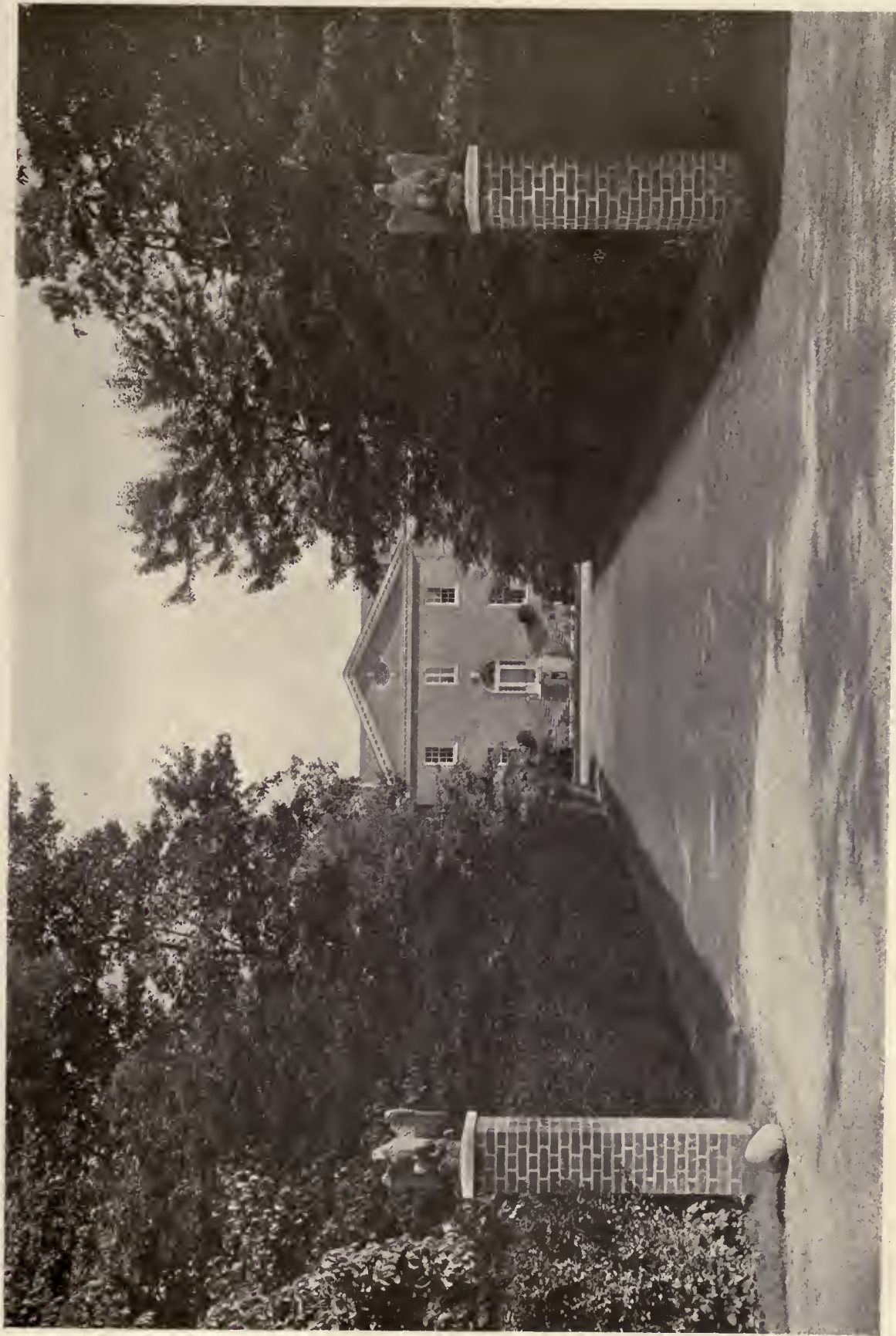

GATEWAY AND AVENUE OF APPROACH TO HOUSE AT SYOSSET, L. I., N. Y.

DELANO & ALDRICH, ARCHITECTS

Part of Exhibit Awarded Gold Medal of Honor, 1920 Exhibition, Architectural League of New York

436





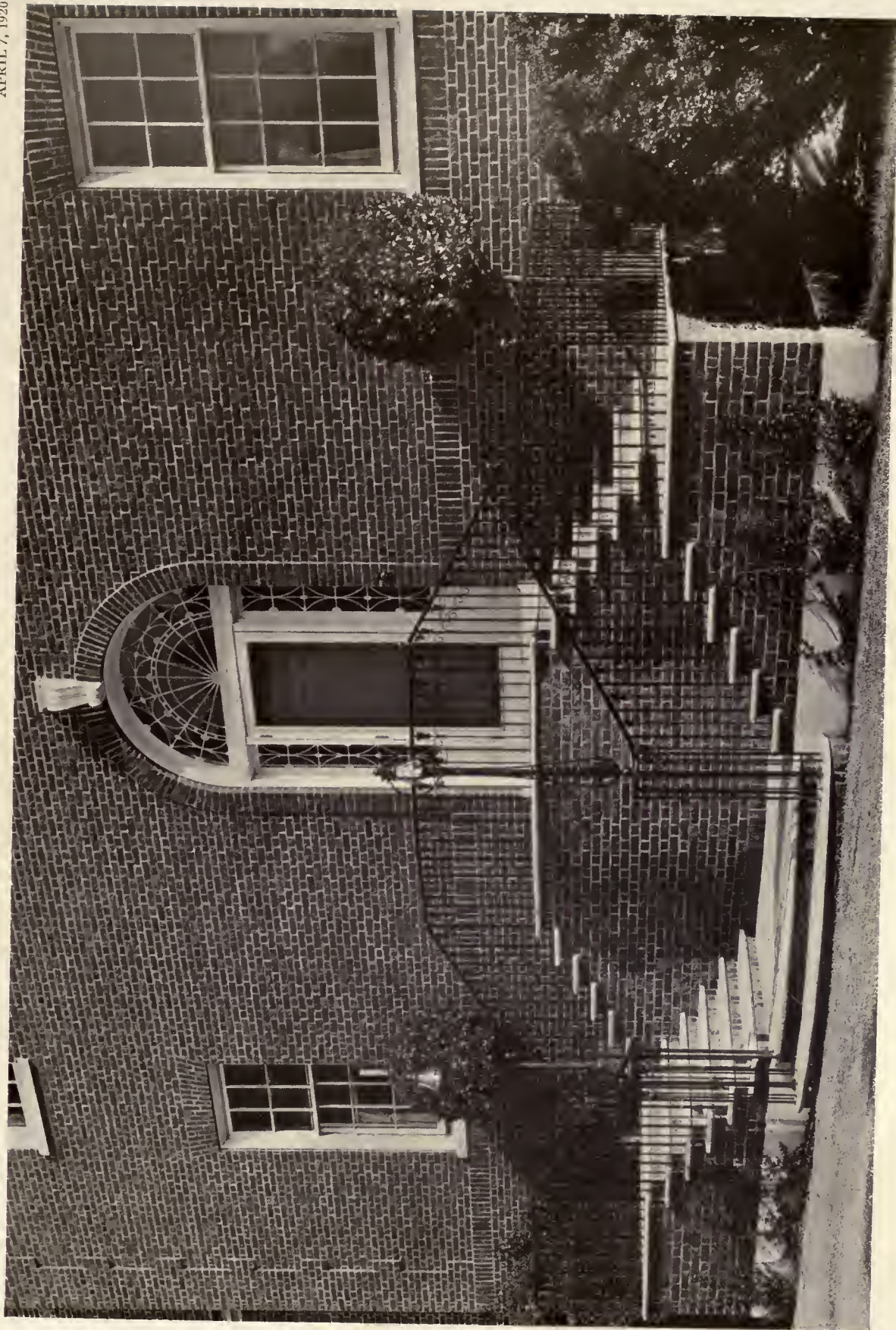

ENTRANCE DETAIL

HOUSE AT SYOSSET, LONG ISLAND, NEW YORK

DELANO & ALDRICH, ARCHITECTS

Part of Exhibit Awarded Gold Medal of Honor, 1920 Exhibition, Architectural League of New York

436 2



3  
436



HOUSE AT SYOSSET, L. I., N. Y.  
DELANO & ALDRICH, ARCHITECTS

Part of Exhibit Awarded Gold Medal of Honor, 1920 Exhibition, Architectural League of New York





HOUSE AT OYSTER BAY, L. I., N. Y.  
DELANO & ALDRICH, ARCHITECTS  
Part of Exhibit Awarded Gold Medal of Honor, 1920 Exhibition, Architectural League of New York

436



436  
6

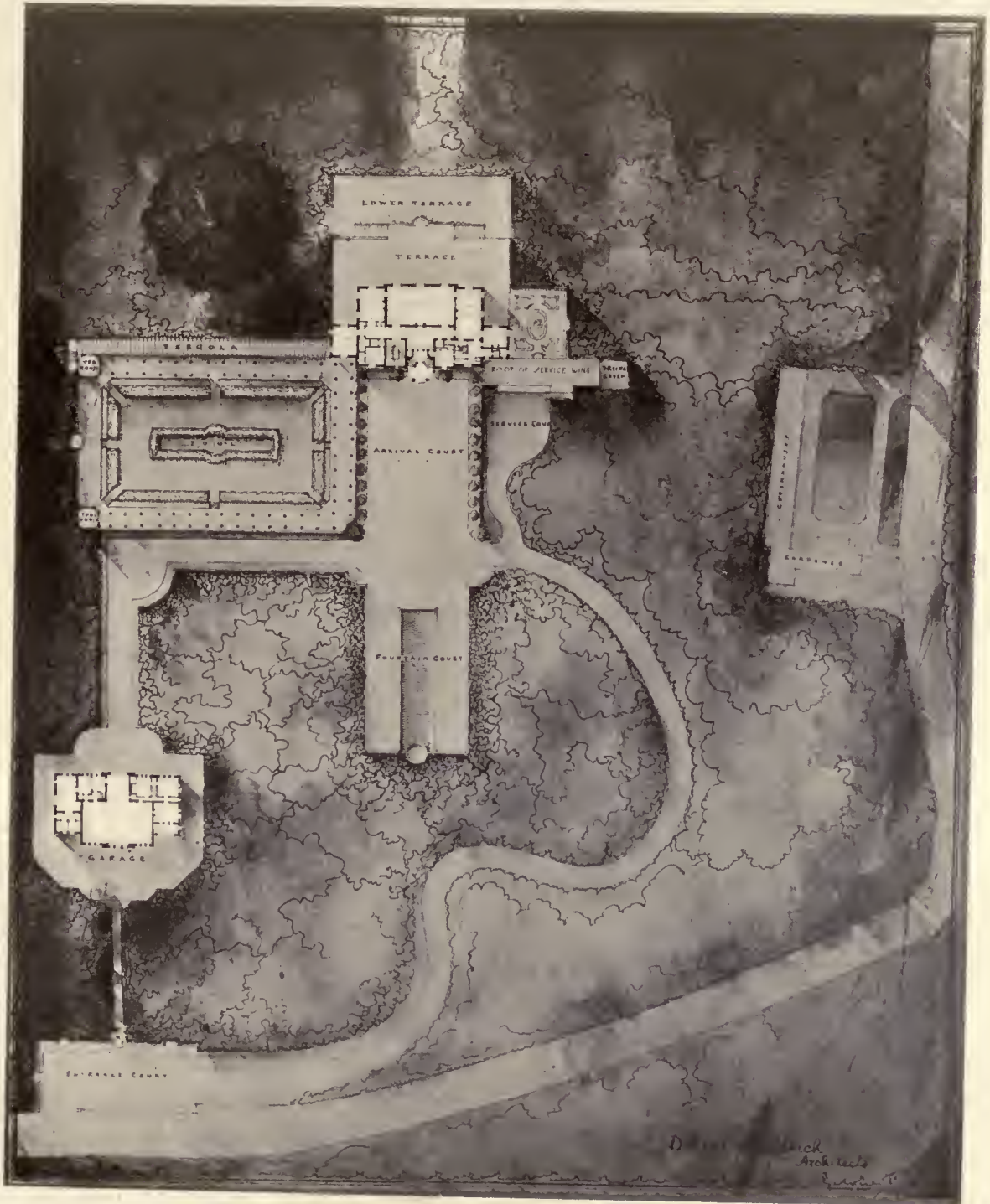

PLOT PLAN

HOUSE AT OYSTER BAY, L. I., N. Y.

DELANO & ALDRICH, ARCHITECTS

Part of Exhibit Awarded Gold Medal of Honor, 1920 Exhibition, Architectural League of New York







HOUSE AT OYSTER BAY, L. I., N. Y.

DELANO & ALDRICH, ARCHITECTS

Part of Exhibit Awarded Gold Medal of Honor, 1920 Exhibition, Architectural League of New York

4366



436



DETAIL OF MAIN ENTRANCE  
HOUSE AT OYSTER BAY, L. I., N. Y.  
DELANO & ALDRICH, ARCHITECTS

Part of Exhibit Awarded Gold Medal of Honor, 1920 Exhibition, Architectural League of New York



436



STAIR HALL  
HOUSE AT OYSTER BAY, L. I., N. Y.  
DELANO & ALDRICH, ARCHITECTS

Part of Exhibit Awarded Gold Medal of Honor, 1920 Exhibition, Architectural League of New York





GARDEN POOL

HOUSE AT OYSTER BAY, LONG ISLAND, NEW YORK

DELANO & ALDRICH, ARCHITECTS

Part of Exhibit Awarded Gold Medal of Honor, 1920 Exhibition, Architectural League of New York

236 a

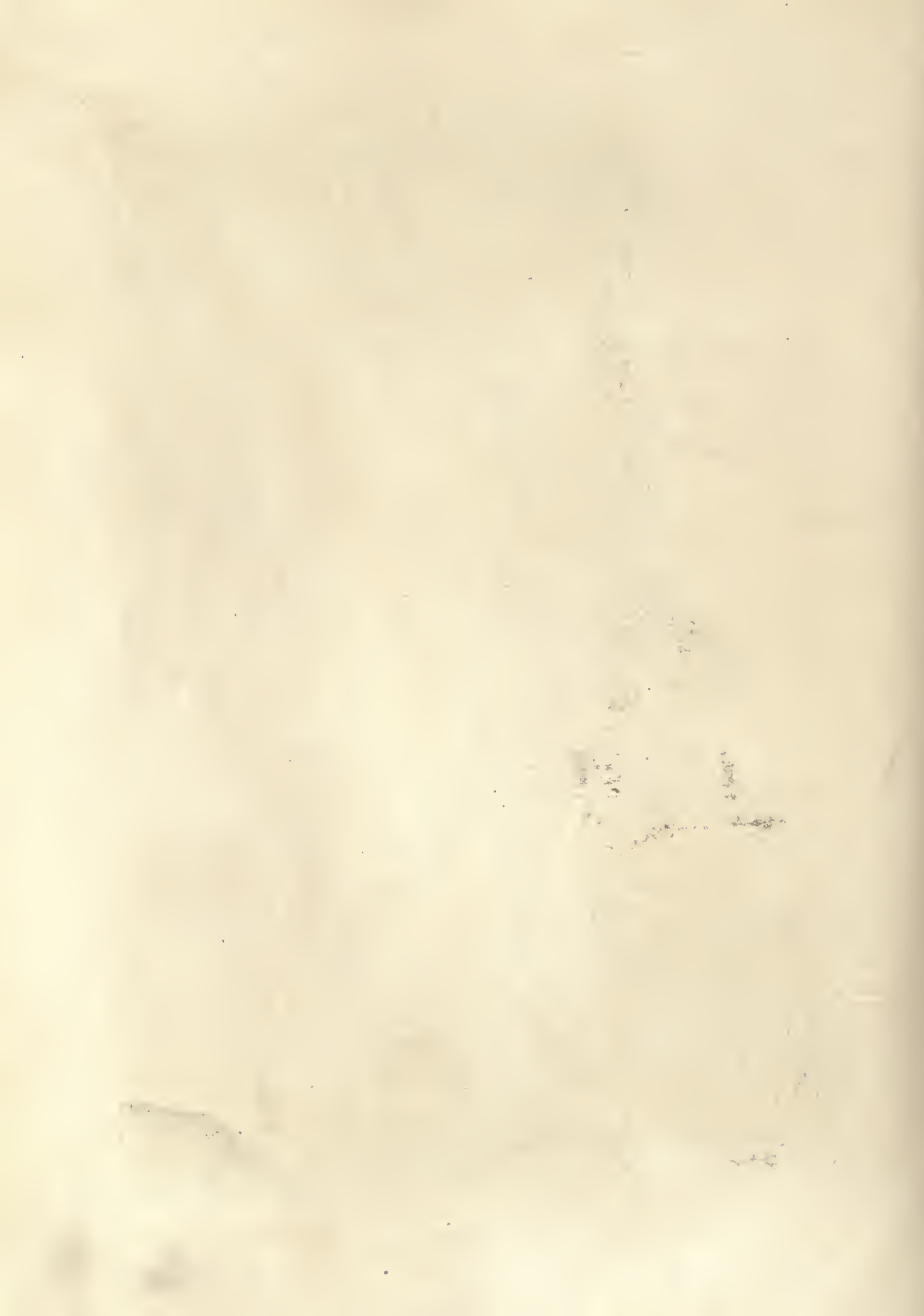



436



DETAIL OF DOORWAY IN HALL  
GREENWICH HOUSE, BARROW STREET, NEW YORK  
DELANO & ALDRICH, ARCHITECTS

Part of Exhibit Awarded Gold Medal of Honor, 1920 Exhibition, Architectural League of New York



# Current News

---

## Happenings and Comment in the Fields of Architecture and the Allied Arts

### Beaux-Arts Architects' Pageant

The Society of Beaux-Arts Architects has staged "A Pageant of Ancient France" at the Hotel Astor in New York. It was, it is claimed, the most beautiful and successful from every point of view of any previously held.

Lloyd Warren was the chairman, James Monroe Hewlett designed and executed the scenery, and Henry Davenport staged the production, assisted by George S. Chappell and Howard Greenley. Their combined efforts were so perfectly interwoven that they might have been the result of the genius of one man, and fitting into the artistic mosaic was the music arranged by Kenneth M. Murchison, which began with "Les Pompiers," sung by the students in the Latin Quarter of Paris for the last 100 years.

---

### Awards in Brick Design Competition

A competition arranged by the Chicago Brick Exchange and announced in a previous issue has just been decided. The object of the competition was to produce a design which when built will result in a worthy display of Dearborn brick.

Dearborn brick is a new type of Chicago common brick just developed, a brick with great artistic possibilities, and of remarkable hardness and durability.

The first prize, \$150, was won by Fred M. Hodgdon, of Coolidge & Hodgdon, 134 South La Salle Street. The second prize, \$100, was won by George Loyd Barnum, 4846 Hutchinson Street. The third prize, \$50, was won by Willard G. Searles, Rapinia, Ill.

The judges were: Charles S. Frost, Emery B. Jackson, I. K. Pond and Howard Shaw.

---

### Independent Art Exhibit

The cubists, the futurists, and all the other ultra-modernists in art are liberally represented in the fourth annual exhibition of the Society of Independent Artists now in progress on the roof garden of the Waldorf-Astoria, New York. All may contribute without the fear of approval by jury or without the stimulation of a prize, provided they have the necessary \$10 fee.

The result is that everyone is on a par and the public is left to judge of the merits of the works placed on view. Even the Red Men have broken into this display of art, and the work done by the young Indians of New Mexico and Arizona forms one of the most interesting entries of the exhibition.

It was estimated that there were 3000 visitors at the opening of the exhibition.

In the foreword to the catalog is the statement that the exhibits of the society have consisted of works of artists who believe that there should be a great annual showing of art in which every tendency can be represented, and that no attempt has been or can be made to keep out

exhibits considered bad by one person or by many persons. All artists shall have an equal opportunity.

The result is that a visitor to the exhibit finds the entries listed alphabetically, and he has to make the round of the galleries in search of what he may consider worth while. Each exhibitor is entitled by his fee of \$10 to have two pictures included in the exhibition, and nearly 600 are represented in the present collection.

---

### American-Made Tapestries

Though there is a movement on foot to make tapestry weaving a part of the re-educational work among soldiers, women are the best masters in the art of restoring and preserving old tapestries, says *Arts and Decoration*.

Americans have heretofore been dependent on other countries for their tapestries, but the American homemaker and art patron alike are beginning, with patriotic fervor, to aspire and reach out for the product in this as in the other fine and industrial arts.

From Fifth Avenue, where the finest examples of ancient tapestries are exhibited, in the Metropolitan Museum, and in the shops of famous importers, to the Kleiser-Edge-water Looms, where some of the finest American tapestries are made, is perhaps less than an hour's journey, while the Herter Looms, located within the busiest district of New York City, continue to create and supply the demands made upon them by decorators, architects and art patrons.

A visit to any of these looms is of untold interest. Here we do not find the throb and haste of the power-propelled factory. Each studio, in turn, seems more like a great, quiet school, where tasks are being accomplished in peaceful silence. One is impressed with the seriousness and earnestness with which the work is being accomplished, through patient years of apprenticeship, before the student becomes a talented and gifted worker, taught by imported experts, old in the art. As a reward there are few instances to be found in modern work of more perfect or exact adaptations of the ancient examples than are found right here, but admittedly lacking in charm and color which only age has given to the ancient examples extant.

---

### Duluth Art Association Active

To educate its members to an appreciation of art as an expression of social conditions, individual tastes and of convention and tradition, and in its relation to architecture, sculpture, mural decorations, or such handicraft as goldsmith's work, enameling, pottery, and wood-carving, is the aim of the Duluth Art Association.

As a means to this end there is being given a series of valuable exhibits, extending over a period of several months.

The pictures on exhibition are loaned by Duluth people from their private collections. Many of the paintings are

the work of American artists, a fact which emphasizes the fact that the local art association will do its part in bringing the works of American artists into prominence.

The March program called for an exhibition of interior decoration schemes, furniture and the sort of work that can be done by any person in making his own home more attractive.

In April there will be an exhibition of objects of art in the possession of Duluth people which they have purchased abroad. This will not only be an interesting collection from the standpoint of the art objects themselves, but will be an interesting reflection of the personalities of the people making the purchases.

The public schools of Duluth will furnish the program for May in the form of an exhibition of school work.

In conjunction with these exhibitions there will also be lectures each month which will deal with the practical application of art to the home and life of the average individual.

## Home Loan Banks and Tax Exemption to Aid Building

Senator Calder has introduced in Congress a bill for the establishment of a system of home loan banks, something similar in general plan to the Federal Farm Loan Banks. This proposal also includes a tax exemption feature.

Still another bill proposes to make more liquid the assets of building loan associations by authorizing them to issue bonds secured by deposits of their real estate mortgages.

The encouraging feature of all these proposals lies in the fact that professional builders, real estate men and the public are awake as to the situation which exists and there are many minds operating in the tremendous task which faces the nation in overcoming the acute shortage.

There is no sign that this shortage can be relieved for a long time to come, but it seems certain now that 1920 will be probably the greatest year in all our history in the building trade.

Anything less than unprecedented activity will fall very far short of meeting even the most imminent and pressing of the demands for housing accommodations throughout the country.

## Jade

Jade, though little used by Europeans, is still prized by the Chinese and other Asiatics, and is especially notable for its extensive use in every continent in prehistoric times. Ornaments and utensils of this stone are found among the lake dwellers of Switzerland, the ancient peoples of France, Mexico, Central America, Greece, Egypt and Asia Minor. The name has been loosely applied to various green stones, but is now recognized as belonging to only two species—nephrite, a form of amphibole and the more common, and jadeite, a form of pyroxene. Jade has been of great interest to archaeologists, as jade objects so universally distributed, often far from known sources of the material, have seemed to indicate great prehistoric migration. The chief present locality of jadeite is in Upper Burmah, and here the Chinese obtain material for cutting into many forms. Bauer mentions having seen a piece of the stone containing less than three cubic feet that was valued at \$50,000. Nephrite is found chiefly in Turkestan, but occurs also in Eastern Siberia, New Zealand, Alaska and Silesia. It may be of sombre interest

to recall that tombs made before the war for the late Czar and Czarina of Russia had a canopy of Siberian nephrite thirteen feet in height.

## Architectural Aspects of Bridge Building

In a letter to the *Philadelphia Ledger*, Clarence W. Brazer, of the State Board of Examiners of Architects, and himself a practitioner, discusses the proposed Delaware River Bridge and its effect upon the whole metropolitan district of Philadelphia and a similar area on the New Jersey side.

Such a great bridge, he states, will rise to a considerable height and with its towers and abutments become a landmark visible for many miles. Even in New York, in the midst of the highest buildings in the world, the great bridges spanning the East River are not in the least overshadowed. An awkward or ungraceful structure would be a great blot on the landscape. This bridge is, therefore, an important problem in city planning and architecture, as well as of engineering stresses. In important civic and esthetic problems in which engineering is involved there should undoubtedly be an association of a town-planning architect with a structural engineer. The most successful great bridges have been so designed. Let us not forget that the skyscrapers, such as the Woolworth Building, which have made America famous, were designed by architects who engaged structural engineers to determine the stresses and economy of structure required by the form determined upon.

There have been many conflicting suggestions for the location and design of this bridge, and possibly some of the best solutions may not have been published. A matter of such magnitude so vitally affecting the whole metropolitan district on both sides of the river should not be decided without carefully weighing the merits of all suggestions obtainable.

One of the best ways to obtain and consider such plans is by an impartial and open competition conducted on a well-established and equitable program which would furnish each competitor with full information as to the requirements and as to all the terrain within the extremes considered available for location. With the plans submitted in such a competition weighed by a jury on which are both engineers and architects of town-planning experience, good judgment and broad vision, the best design should be selected. This, he states, would automatically determine whether an engineer or an architect should control the design.

## City Planning in a Nutshell

One of the clearest, most comprehensive yet concise statements of the essence and value of city planning has been set forth in a leaflet prepared by the Citizens' Committee on City Plan of Pittsburgh. It is as follows:

*Purpose.*—The creation and promotion of comprehensive plans for the development of Pittsburgh.

*Effects.*—(1) More and better business. (2) Better homes and fewer slums. (3) Order, system and economy in public works. (4) Protection and extension of homes and industries. (5) Stabilization of real estate values. (6) A more convenient and practical city. (7) A safer and more healthful city. (8) A more attractive city.

*Why Necessary.*—Complete plans for a residence or industrial plant assure the correctness and relative adjust-

ment of individual rooms or parts of the plant. Similarly, comprehensive plans for the city (elastic and not too rigid) will make more certain the correctness of detailed public works and private development. Such plans will eliminate present haphazard growth. Without comprehensive plans no stable order or system can be established and desirable social and economic improvement cannot be made.

*Scope.*—The city plan to be prepared will include physical plans for an adequate street and boulevard system, increased and co-ordinated steam, railway and water transportation with advantageous terminals, necessary playgrounds, parks and public buildings, better water supply and sewage disposal systems, proper utilization of our water fronts, together with studied and definite proposals to secure more economical food distribution, increased industrial development, satisfactory housing conditions, and the conservation and enhancement of property values.

*Program.*—To plan wisely it is first of all necessary to know what the present city is. All existing plans and information must be examined. Present conditions and the tendencies of the city's growth must be ascertained. Then will follow the study and development of plans. All existing, well planned projects will, it is hoped, be incorporated into the general plans, each item falling into its proper subordinate place. Detailed projects will not as a rule be initiated by this committee, but good projects initiated by others will probably be supported. There will therefore be no conflict with the work of the municipal or county departments.

---

## A Plea for a Labor Board for New York State

In a message from Governor Smith of New York urging an appropriation for the continuing of the governor's labor board, the governor is reported to have urged the need of a flexible board of mediation, representing employers, employees and the public, serving voluntarily and able to act in various parts of the State.

After reviewing the history of the labor board, created as the result of a conference on industrial problems called by him in August, 1919, the governor said:

"During the present disturbed conditions and until our people find themselves, I consider it essential to be able to continue the work of this board and to utilize for adding to its personnel, as special members, from time to time, local representatives of the industries involved. For this I have asked the mayors of cities to supply me with names of citizens willing to act in such capacity. This board is by no means a permanent institution. It has been called into being to meet an emergency and will be discontinued when that emergency has passed.

"The experience of the board has demonstrated the value of dealing with industrial unrest before it ripens into a strike. In this way loss of production and wages and a general demoralization of the community through a strike or lockout are avoided."

---

## Insurance Given to Westinghouse Employees

An insurance policy for the sum of \$500 will be given entirely without cost to every employee of the Westinghouse Electric & Manufacturing Company who has been in the service of the company for a period of six months or more, according to a statement made by one of the

officials of the company. The plan is retroactive to March 1.

In addition, the employees may increase the value of their policies to amounts varying from \$1,000 to \$2,000, depending upon their length of service and continuity of savings, by depositing 2 per cent of their wages with the company, on which they receive the usual savings bank interest.

After an employee has maintained the required deposits for a period of five years he may discontinue or withdraw his deposits from the savings fund without in any way affecting the value of his insurance policy.

In order to provide for cases where employees need some money and do not wish to disturb their savings and thus affect the value of their insurance policy, loans will be made by the company to the extent of 90 per cent of the amount to the credit of the employee in the savings fund. This insurance will affect approximately 50,000 people.

---

## Artist Rejects \$200,000

Devotion to church art work in New York, to which he consecrated himself eleven years ago, has caused Theodore E. Tsavalas to turn down an offer of \$200,000 to return to his native country, Greece, and paint a series of pictures for St. John's Church in Marathon.

Tsavalas has been painting the great murals and frescoes in the Greek Church of the Holy Trinity on Seventy-second Street for eleven years, receiving no salary. Occasionally the congregation is asked for a contribution for the artist, and it is always generous.

Tsavalas vowed to the bishop of the cathedral in Sparta, Greece, eleven years ago, that he would never return to Greece until he had completed the paintings in the New York church. The work was then expected to take twelve years. It will take three years more than was first estimated.

---

## Urge Art Board to Judge Buildings

Cleveland may have a city art commission to pass upon the plans for all public monuments and such other structures of a public character as pavilions, shelter houses, drinking fountains and the like.

Under the plan, which already has the approval of the city plan commission and the Cleveland Engineering Society, the commission would be composed of five members, the director of the art museum, a painter designer, an architect, an engineer and a sculptor.

The commission would be provided for in an amendment to the building code, restraining the building commissioner from granting permits until the plans had been approved from an artistic standpoint.

---

## Midget Furniture for Museums

The home furnishings of Mrs. Lavina W. Magri (Mrs. Tom Thumb), who died recently, will be placed in museums by the terms of her will which has been filed here. Her collection is said to include the smallest practical furniture in use. Two miniature sewing machines and a piano are among the pieces mentioned by the will. Several of the articles were gifts from European royalty before whom she performed. The remainder of her property is divided among her husband, Count Magri, also a midget, and two nephews.

## What Do You Think of This?

Recently the journeyman plumbers of Chicago passed a resolution that no members of their organization would be permitted to work on any building where the entire drainage system from the building line was not laid with iron pipe. It is reported that the master plumbers have not agreed to this suggestion, but if the recent successes of other unions who have made equally drastic demands are indicative as to the probable result, the cost of plumbing is going to enhance enormously, and when the scarcity of iron pipe is taken into account many buildings will be without drainage for months to come.

How long will it be before contractors, architects and owners will unite and insist that they should at least be consulted as to how they should spend their own money?

It would appear to an architect that recent history in Chicago would justify the suggestion that the City Council, Association of Commerce, Chicago Real Estate Board, Chicago Clearing House Association, Building Construction Employers' Association of Chicago, the Illinois Society of Architects and all other associations should adjourn and let the Chicago Building Trades Council run their affairs.

When the protest of a business agent of the Illinois Federation of Labor has more weight with the City Council of Chicago (as was evidenced in connection with the consideration of the Daylight Saving Ordinance) than the Chicago Association of Commerce and all other civic bodies, as well, the thoughtful citizen may well ask, "What are we coming to?" and when architects are compelled to design their buildings to comply with the demands of the labor unions, and owners are compelled to pay enormously enhanced costs not for something that is better, but to satisfy the whims of some labor business agent, the question may well be asked, "Why shouldn't we all turn over our affairs to the business agents and thus be relieved of all responsibility, except paying the cost without protest?"

To some extent, no doubt, some of the contractors' associations in their working rules are as guilty of questionable practices as those of any labor union. As for example, the rules of the Cut Stone Association, the schedule of estimating work by the Steam Fitters and Master Plumbers' Association; the rules for estimating marble and tile work, sprinkler equipment, etc. The question naturally will be asked, "What can we do about it?"

*From the Monthly Bulletin of the Illinois Society of Architects.*

## Real City Planning

Where city planning in America has too frequently been limited to ambitious projects for the grouping of monumental public buildings "the city beautiful" rather than the city wholesome, it has remained for London to consider rather than the nobler project of making the city "a better place to live in."

It was Sir Martin Conway who presented the idea at a meeting of the London Society. He wished, he said, it were possible to "knock the East End of London flat and set it up on end," to tear down and wipe out the slum regions with their narrow tortuous streets and alleys, and acres upon acres of pitiful two- and three-story habitations, and replace them with great buildings going up in the air as far as they could be carried, fitted with modern sanitary comforts, and surrounded with wide streets and open park spaces that would be available when

the teeming population of the East End lived in the air instead of burrowing in the mews and byways as now. He ridiculed the idea of skyscrapers on narrow present-day streets as merely multiplying the problems of traffic, whereas his plan to replace the slum population in the air with wide streets and parks would afford room and breathing space in the heart of the city itself.

Questions of cost were, of course, obtruded and were answered with the theory that the city should be empowered to assume ownership of the air above the present building height restrictions. It would then be in position to grant permits to skyscrapers at a stipulated rate and the revenue from the air would provide funds for the demolition of the present slums and the acquisition of property for wider streets and park purposes. The remarkable feature is that the project was soberly received and seriously considered by the conservative London audience which a few years ago would have been the first to ridicule any proposal of introducing any kind of skyscraper into the British metropolis.

## Ruins of an Ancient Pueblo Uncovered

Three years ago Earl H. Morris, representing the American Museum of Natural History, undertook the excavation of an ancient Pueblo ruin in Aztec, N. M. The work was begun at the public-spirited suggestion and through the courtesy of H. D. Abrams, the owner of the property, and is being financed from the Archer M. Huntington fund for surveying Southwestern United States. Mr. Morris' early finds aroused considerable public interest and the "Aztec ruin" became widely known as the first American apartment house.

During the last month the museum party has uncovered a new section of the ruin, revealing several rooms filled with sand and fallen debris. These rooms were in perfect condition, just as left by the last occupants. The ceilings were standing and the objects left by the inhabitants were scattered about on the floor. Nothing had disturbed them except the fine layer of dust sifted over all. One of the rooms had been filled to the ceiling and was found to be a burial room. Mr. Morris wrote briefly to Dr. Clark Wissler, curator of the department of anthropology at the American Museum, concerning his most recent findings.

"In two second-story chambers there was a large accumulation of dry refuse," he says. "One of these yielded some excellent specimens of textiles and a body with wrappings in a very good state of preservation. Above the refuse in the other room there were upon the fallen third floor a surprising number of stone implements, several bone tools; some beautifully worked wooden boards, seven coiled basket plaques (three well preserved) and a digging implement with handle of wood and blade of mountain sheep horn. In the refuse beneath this layer we have to date found the remains of five children (three with wrappings perfectly preserved), four baskets in excellent shape, a wooden dipper, some beads and various odds and ends.

"Three-fourths of the deposit is still to be gone over. The outer covering of the wrapped bodies is particularly interesting. Each body was placed upon a rush mat. Then the sides were folded inward and one doubled upward. The whole was then tied into a long package with cord or yucca strips. As yet I have not opened any of the

bundles, so do not know what the interiors may contain besides the bones. These finds certainly are important. They are different from anything we have previously uncovered."

In contrast to the tiny cliff house of the park, the great Pueblo ruin, with its 300 square feet of area and its 400 odd rooms, is wonderfully impressive. The greater part of the remains is now uncovered, and visitors may walk over the tops of the massive walls, gazing down into the many chambers. Very interesting are these walls—approximately three feet thick, and built of dressed sandstone, carried piece by piece by the tireless builders from the quarries, of which the nearest lies two and a half miles from the ruin. For this prehistoric people had no beasts of burden. The cedar logs, from eight to twelve inches in diameter, which support the floors and ceilings of all the rooms, were also conveyed from a distance, for no such trees grow in the vicinity of Aztec, nor are there any indications that they have ever grown there. But if one follows the course of the Animas River toward its source in the mountains he will, after a journey of 100 to 150 miles, reach an ancient forest where great cedars grow. This river passes within a few rods of the ruin.

It is safe to infer that the ancient builders of the present ruin journeyed to the forests above, cut these huge logs and rafted them down the stream. As they lived in a stone age and had no tools of metal, these logs were worked with stone axes. Their ends are cut smooth and square, and one can still see on their surfaces the marks of the stone tools.

## Maintenance Men

The need of a central organization, composed of every interest having to do with buildings, was never more urgent than now. At present, any owner completing any structure that requires temporary heat, is compelled to employ hoisting engineers, steam fitters, licensed engineers as well as firemen, three shifts, paying overtime for night work, Saturday afternoons and Sundays, and the average cost per week to maintain such a "gang," without fuel or supplies, is approximately \$1,100.

Can any thoughtful man advance any reasons why any owner should be compelled to submit to this holdup?

The policy of the labor unions to-day seems to be "Get all you can while the getting is good." The above practice is only one of many which have grown out of the divided responsibility in dealing with the labor unions. The practice above complained of has never been approved by the Building Construction Employers' Association of Chicago, nor, the editor is advised, has it ever been approved by the association that put it into effect, that is, the "Masons and Builders."

It appears that about one year ago a demand was made on certain general contractors who were doing work on a cost plus percentage basis, to put hoisting engineers in charge of the heating plants where temporary heat was being maintained, the hoisting engineers being put on the pay roll in addition to the licensed engineers required by law, and, as every one knows, a licensed engineer requires a fireman to do the work. The steamfitters also insisted that their men must be kept on and of course, the more the job cost, the more the contractor made, therefore the hoisting engineers were employed. The practice was thus started, and has been allowed to continue without official action of the contracting associations.

The problem of the relationship between contractors and the labor unions is in need of a most searching investigation and radical readjustment, and the investigation should be conducted by representatives of all of the various associations directly interested in buildings. Owners are interested because they must pay the bills. Architects are interested because they should know definitely how to plan their work and how to estimate its cost. Contractors are interested as they are the ones who deal directly with the unions, and contractors' associations have a duty to the building public not to needlessly permit such holdups which add to building costs. Money so paid is nothing but a holdup and is an indirect method of levying graft.

How long will the building public of Chicago tolerate such practices?

*From the Monthly Bulletin of the Illinois Society of Architects.*

## New York Lists City-Owned Land Available for Housing

The first step toward municipal housing has been taken in New York. The Board of Aldermen has called upon the Board of Estimate, in a resolution, to prepare a list of city-owned lands, so that "in the event of a housing crisis" the city might construct dwellings to be rented at a fair price. The resolution follows:

*Resolved,* That we, the Board of Aldermen of the City of New York, do hereby request the Board of Estimate and Apportionment of this city

To cause to be prepared a list of all city-owned lands available for building purposes;

To secure from reputable builders and architects plans and estimates for the construction of temporary and substantial buildings so that they may be made speedily available for occupancy in the event of a crisis arising as a result of the existing housing problem;

To provide for the construction of such buildings if, in their judgment, a situation arises which warrants such action; and in that event

To authorize the Controller of this city to rent such buildings to citizens of this city during such crisis and for such period of time and at such fair rental value as they, the said Board of Estimate and Apportionment, may determine.

## Advocate State Aid for Home Building

A State-aid plan for salaried workers in Minnesota who wish to build homes and pay for them by installment is advocated by Senator Leonard Lord.

He suggests that the State raise a fund by issuing 4 per cent certificates of indebtedness or bonds for public subscription. The fund would be available at 5 per cent interest to prospective home builders through a local housing commission which would be responsible for investigating, as does a federal land bank when a man wishes to buy a farm, and would make certain of the individual's credit and character and that the home proposed was of standard design and economical.

The buyer would repay the housing association in 20 years at 5 per cent, the association repaying the State treasury. The extra 1 per cent would apply largely as against insurance losses. The plan, Senator Lord says, by eliminating the element of profit, would stimulate home building and ownership by salaried men.

# News from Various Sources

Geological Survey issues report on Portland cement in 1919.

\* \* \*

The House Military Affairs Committee adopted a policy of universal military training, to become effective July 1, 1922.

\* \* \*

The Navy Appropriation Bill for 1921 passed the House March 23, carrying \$425,000,000—\$104,000,000 is to carry on the navy's construction program.

\* \* \*

It is announced from Brussels that negotiations are under way with Great Britain for a loan of £5,000,000, and that money will be used for reconstruction of devastated districts of Belgium.

\* \* \*

Senator Fletcher introduced a bill authorizing reclamation of unused lands in the West and South through a series of bond issues, operating similar to the Federal Farm Loan System.

\* \* \*

Continuance of the longshoremen's strike will interfere with the building program. Virtually all of the lumber from the South comes by water. The Clyde Line handles 100,000,000 feet a year, the Mallory Line half that amount.

\* \* \*

It is reported that the Banco Industrial Americano is about to erect in Rio de Janeiro 10,000 North American style wooden houses, to be sold at prices of \$400, \$600 and \$1,000 each, according to size, the payments to be made by installments.

\* \* \*

Plans for an extensive building campaign among student organizations at the University of Pennsylvania are announced by Recorder Nitzsche, following closely the announcement by university trustees of the campus expansion and the erection of several new department and dormitory structures.

\* \* \*

The National Executive Committee of the American Legion announces a membership of over a million distributed through 8475 posts. New York leads with 891 posts, Illinois has 553, Pennsylvania 511, Iowa 462, Minnesota 448, Ohio 382, Missouri 291, Michigan 271, Indiana 270, and Massachusetts 252.

\* \* \*

Cuba plans to replace its present inadequate National Library at a cost of \$200,000. A new city jail is to be built on the outskirts of Havana, at a cost of \$1,000,000. A monument to the memory of the American battleship *Maine*, involving \$150,000, and the national capitol building, for which \$2,500,000 are also to be erected.

\* \* \*

*Wall Street Journal* states that building permit figures for 1919 indicate that the country is still \$2,000,000,000 or more in arrears in its program. In spite of record-breaking figures of about \$1,312,000,000 last year, slackening in building activity during 1917 and 1918 put the United States so far behind that it will probably take some years to catch up.

\* \* \*

American Farm Bureau Federation was organized March 5 at a meeting of representatives from twenty-eight State Farmers' Bureaus. The objects of the Federation are to correlate and strengthen individual State farm bureaus and similar State organizations in a national body,

to promote, protect and represent business, economic, social and educational interests of farmers and to develop agriculture. Membership of the Federation was placed at 700,000.

\* \* \*

Chamber of Commerce announces appointment of Chauncey D. Snow, former commercial attaché at Paris, as head of its new department of foreign trade. The new department of the Chamber is one of several that are being organized as a means of dividing the work of the Chamber up along lines of the great divisions of industry. The other departments to be created include industrial production, domestic distribution, transportation and communication, finance, insurance and civic development.

\* \* \*

Prof. E. B. Matthews, National Research Council, and M. O. Leighton, National Service Representative on Engineering Council, have been authorized by the recently created Board of Survey and Maps, to organize an advisory council to said board, consisting of representatives of engineering, geographic and other organizations, which shall represent the public and the professions in the presentation and discussion of unofficial demands and needs in connection with the mapping work of the United States.

\* \* \*

In an effort to solve the rent problem in New York City, Mayor Hylan recently sent out a call for a conference of real estate men, building contractors, dealers in building material, labor leaders and men and firms associated with the building industry to be held March 15. In announcing the call the Mayor said he had been assured by an official of the Real Estate Board that realty men in that city are prepared to invest between \$50,000,000 and \$100,000,000 in new building if they are assured that building companies, dealers in building materials and labor will not make advances in prices within a stated period.

\* \* \*

In an address on International Parcel Post, by Otto Praeger, Second Assistant Postmaster General, before the Foreign Trade Section of the Cleveland Chamber of Commerce, he stated that the international parcel post has developed into a most important and most formidable function of the world's greatest transportation medium, the postal service. He stated that the United States mail carries more separately handled units of commodity than any other single transportation system. The domestic parcel post alone, he said, has long since passed the billion mark in yearly shipments, while the letters and periodicals, each separately handled through half a dozen processes, run into staggering figures.

\* \* \*

Department of Interior received plan of proposed organization of the Division of Research and Statistics of the American Petroleum Institute, by Van. H. Manning, chairman of Committee on Improvements and Methods and Chief of Bureau of Mines. In this report Dr. Manning outlines a program for Government co-operation with the oil industry designed to increase efficiency and decrease costs. A committee is being formed to take up this question, representatives being appointed by the Bureau of Mines, Geological Survey, Society of Automotive Engineers, National Automobile Chamber of Commerce, American Institute of Mining Engineers and the American Society for Testing Materials.



# Weekly Review of Construction Field

Comment on General Conditions of Economics With Reports of Special Correspondents in Prominent Regional Centers

WHILE the statistics of the past several months have shown the building of factories to be the first point of attack in the building program and to show the largest number of contracts let, the building of small homes promises to be the second and immediately following activity.

Each day brings news of some new development scheme which proposes to erect houses of six to eight rooms. On March 28 eight building and loan charters were issued at Harrisburg, Pa.; seven of them for \$1,000,000 and one for \$2,000,000. One of the sensations of the week was the organization of a \$15,000,000 corporation in Chicago which proposes to finance the individual construction of homes.

The Tinkham bill, now under consideration in the House of Representatives, is designed to offer further Federal assistance in the solution of the housing problem.

Governor Sproul of Pennsylvania, in speaking before the New England Street Railway Club, favored public credits to encourage home building and home owning. "No better public investment could be made," he says, "than the creation of a greater number of home-owners in America. The ownership of property helps to make a substantial and self-respecting citizenry. Even an altruist of exalted vision ought to find inspiration in helping to bring about such a blessing as this."

It is true that these activities are not only most propitious for the solution of the housing difficulties, but for the future welfare of our country. If out of our housing shortage we should become a nation of home-owners, certainly the cloud has a silver lining.

There is no way by which we may dispose of our extravagant living and extravagant politics so quickly as by each getting down to our own little patch of earth and setting about perfecting a home upon it. Most of the ugliness and squalor of our manufacturing towns are directly traceable to the transitory character of tenants who misuse cottages and allow the accumulation of dirt because it may be so easily left behind them. The irresponsibility is easily adopted as a habit of mind. It is then displayed in the careless quality of work as well as in the litter of the public parks and streets; for there is always another job as well as another house. It is easy to start over again with everything fresh.

In Pittsburgh, last year, 60,000 families bought their own homes. The real estate men say that the same tendency continues this year. Many apartment-house dwellers in New York have combined to purchase the building in which they live and the Spring and Fall moving, so wasteful in its universality, will be reduced.

UNDER an emergency message from the Governor, the Legislature has passed a group of eleven housing bills designed to curb profiteering landlords and furnish all possible relief to tenants. There was a twelfth bill in the group which provided the exemption from State income tax of the incomes on mortgages up to \$40,000. But this bill was not reported out of committee and it is believed it will be killed.

These laws are the product of much heated controversy, but that they offer any means of relief it is impossible to believe. Probably their chief effect will be to further discourage investment.

THERE seems more hope in the project of Mayor Hylan to bring together the varying interests of the building situation in New York City. It is true that nothing has yet been accomplished in solving the difficulties of the structural ironworkers, but the masons are again at work.

The *New York Times*, in commenting upon the situation editorially, recognizes the important question of materials. "In all lines," it says, "the market is thoroughly disorganized, and the difficulty centers not only in matters of supply and prices, but in railway rates and a sufficiency of cars. Until the entire world of industry is more stable than it is to-day building of any sort will continue to be a highly speculative enterprise. At any time difficulties with a labor union or with the supply of some form of material may bring waste and delay."

The activities of European labor are alarming and there is always the possibility that this country may suffer an infection. The factory soviets of Italy have so grown in power that they have seized the plants and attempted to run them in defiance of the proprietors. In some such cases the action of the Government has been to requisition the factory and put in its representatives, who have given the workers practically everything they asked. Germany, France and England offer less extreme examples but the tendency toward bolshevism is only too apparent.

In this country there seems to be a strong movement which may eliminate that danger and that is the endeavor which originated at Cleveland to organize in the relations of labor and capital a machinery of arbitration which shall encourage good will and mutual trust and also a realization that they are combined to serve the public. There are, on the other hand, various compulsory arbitration bills pending in many States. It is well known that one may catch more flies with molasses than with vinegar; a fact which the New York landlords, to their misfortune, forgot when they vigorously demanded to be upheld in the right to all the rent they could get.

(By Special Correspondence to *THE AMERICAN ARCHITECT*)

CHICAGO:—Prices of building materials are close to the top in Chicago and wages where changed are rising. Prices (and everything is included in the movement) have been advancing for some weeks until it is now believed that the top has been reached. The quoted market on call loans for practically all classes is  $6\frac{1}{2}$  per cent, while commercial paper is quoted from  $6\frac{3}{4}$  to 7 per cent.

The high price and high wage situation have affected the city governmental affairs and Chicago is now trying to borrow \$4,000,000 with which to meet running expenses, while several millions of dollars worth of bonds recently voted for public improvements have yet to be sold. The city council has approved a plan to submit to the voters on April 13 another bond issue of \$34,200,000 for improve-

ments in the city electric light system, for small parks and playgrounds, for a combination memorial and convention hall and for the completion of the city's bridge building program.

An inquiry into the general business conditions in Chicago reveals that many rich and influential people are being attracted to Chicago for business and other reasons. They are coming not only from the East, but from the interior and the Pacific Coast. Real estate dealers and builders report a greater inquiry for homes along the North Shore than for many years.

Results of the action of the city council in changing the building limit back from 200 to 260 feet have already begun to materialize in building operations in the Loop, both among new projects and with the adding of 60 feet to the present 200-foot structures.

Among the new structures to be rushed to completion will be the bank building to house the consolidated Merchants Loan & Trust, the Illinois Trust and Savings and the Corn Exchange National Bank, which is to occupy the site of the Illinois Trust and Savings and the old Grand Pacific Hotel properties. It will be pushed up to the limit of twenty stories.

It is also understood that the new Blackstone Hotel annex has been held back awaiting the change in the ordinance, as have plans for the new hotel structure on the old Stratford Hotel site.

The Wrigley Building, now under construction at the river and Michigan Boulevard, is to be a twenty-story structure, including the tower.

(By Special Correspondence to THE AMERICAN ARCHITECT)

SAN FRANCISCO:—Prices on building material have shown practically no change during the past week. Most all lines of materials are still scarce and the architects and contractors report that building is being retarded to a certain extent on this account. It is encouraging to note, however, that improvement is expected in this respect in the near future on some lines at least. For instance, the contractors look forward to a better supply of lumber as soon as the mills, which have to close down during the Winter months, start their Spring operations, and many of them are now making preparations to resume cutting and shipping. Every effort is being made to increase the output of brick and tile. The plants in this vicinity supplying the local market are all in operation and the supply of brick is more nearly adequate now than for some time.

Meanwhile, the need for more buildings in San Francisco is steadily increasing, and there is the largest demand for building supplies that has been known since the rebuilding of the city after the great fire of 1906. Large contracts are being let for churches, schools, office buildings, municipal buildings and private homes all around the Bay region.

The call for more and better homes has opened up a large field for a great many private contracts. A large number of apartment houses and private residences are now under construction, while a large number of plans are ready for the contractors who are not in position to undertake them at the present time on account of the difficulty in getting materials and the uncertainty of the weather.

(By Special Correspondence to THE AMERICAN ARCHITECT)

SEATTLE:—Jobbers are in their fourth week of rationing building steel essentials to the various jobs. They report a strong and ascending market and increased difficulty in getting delivery. This situation is beginning to reflect in the building projects of the North Pacific Coast territory in suspension of commitments which gave every

promise of consummation during the late Winter months. In this way builders are now beginning to realize that the steel strike was not an abstract but a concrete calamity.

Shingle nails probably head the list in difficulty of delivery. In place of carloads, the larger jobbers who are handling the minimum of a car a day under normal conditions have received during the past week lots of twenty-five to thirty kegs. The eight-penny stock is equally scarce. Small pipe essentials in completion of plumbing and heating work is almost unobtainable. Eastern manufacturers declare they can give no forecast as to when relief may come, and will not contract as to price or date before the end of September.

Aside from steel, all other building materials are plentiful excepting plaster board, and the market is stationary. Local manufacture explains this. There is plenty of brick and cement and quotations are steady with a decreased demand compared with thirty days ago. Roofing is steady to firm. Plaster board is getting scarce, due to the shortage of paper, and local manufacturers have notified jobbers that they will advance quotations \$10 per 1,000 square feet within a few days.

The fir lumber market is stationary, but with a stronger undertone. The outstanding feature of the week was the fact that all the larger mills have begun to cut into their order files and orders placed for Eastern building commitments as long ago as last September and October have been filled this week. This indicates to wholesalers that the mills are again looking for business. All the larger mills that left the market in January due to an accumulation of back orders are now in the market. The future will depend largely on when Eastern builders, though the retail buyers, are willing to view the market as strong, as there is never any fir lumber buying when the market is weak.

Lath have broken badly. Quotations a month ago were firm at \$15. Wholesalers say lath are a drug on the market at \$10, and jobbers have been quoted under the market at \$9.50.

There are many homes for sale, although on the basis of last year's cost, and the transfers are light. There are now no important building projects in the city which have passed the promotion stage. Seattle is behind other coast cities in business building construction. For fifteen years prior to the war the city was able to absorb two new office buildings per year. No new buildings have been constructed during the past three years and as matters now stand the city is several buildings behind actual needs. Suites of offices are so scarce that the railways, in returning to private ownership, have been obliged to take their quarters in antiquated buildings with single elevator service, paper walls and scaling ceilings that are thinly glossed over with new paint and paper. There is a large waiting list for all modern structures in the city.

Building owners declare that new construction is now attractive owing to the low rentals. A minimum of \$3 per square foot is demanded by these owners.

## The Financing of Home Building in Chicago

(By Special Correspondence to THE AMERICAN ARCHITECT)

CHICAGO:—A \$15,000,000 corporation has been financed under the laws of the State of Illinois to finance the individual construction of homes in Chicago. This has been launched by the Chicago Title & Trust Co., aided by several of the city's banks and industrial firms in an effort to overcome the housing shortage. The cost of the homes to be built by the new corporation is not to exceed \$6,000 each. A bond issue will be floated to obtain funds.

# DEPARTMENT OF ARCHITECTURAL ENGINEERING

## Clocks, Historically and Architecturally Considered

### Part I—Early Developments

**T**HE passing of time is made known to us through the senses of hearing or seeing. The bell, the chime or whistle acquaints those within hearing of the specific time. The

marked the hour of matins and that of vespers. The muezzin, whose wailing cry was heard from the lofty balcony on the spire-like minaret summoned the faithful to Mohammed to their rig-



CLOCK TOWER, PALAZZO DEL CAPITANO, PADUA

sun dial, hour glass, clock or watch conveys the same message to those who look.

In the earlier times and in different countries, each hour of the day was apportioned to conform to a liturgical observance. The bell and chimes

orous daily observance of devotion and prayer.

While the horologe or clock might silently record the passage of time it was necessary in early days to provide some audible means of marking the hours and to remind those who might slight



ALSTADT RATHAUS, BRANDENBURG

the forms of worship that were inexorable laws of their religious duties. The striking clock is but a survival of an early custom.

It is apparent that these means of indicating time varied in regularity, depending on the person who controlled them, the sun dial alone excepted. As the life of each community had no close contact or dependence on other communities this irregularity in indicating time was of no particular importance and caused no inconvenience.

Time then was the common property of all, from the autocrat to the slave and few in number were there who had the individual time pieces of sun dials and hour glasses. With the development of the individual clock and watch these earlier means of measuring time were discarded. The means of measuring time during the dark ages were adequate for the needs of the people.

It was the advent of commerce and industry that made necessary the measuring of time with accuracy. During the early days the means of communication between communities was slow and uncertain and was an individual undertaking. Such communication was carried on without particular

reference to time. The establishment of regular caravans, post roads and posts did not require that the indicated time in one community should have any particular relation to that in another community, be it either near or distant.

The advent of regular transportation, the greatest factor in modern civilization, made necessary the establishment of regulated time in all communities. Telegraphic and telephonic communication made this even more necessary. The measuring of time to conform to religious liturgies is now subordinated to the requirements of modern industry and commerce. The whistle, clock, watch and time table now divide the day for the vast majority of persons according to the demands of industry and transportation. In order that transportation and industry may be carried on without loss, a standard uniform time for certain specified zones of longitude has been adopted in this country. This time is based on observations made by the Weather Bureau at Washington and transmitted by wireless or telegraph throughout the country, the corrections being made in each zone. Commerce, transportation and manufacturing are such tremendous factors in modern life that accurate



FRAUENTOR, AUGSBURG



ST. PAUL'S CATHEDRAL, LONDON



CATHEDRAL OF NOTRE DAME DE CHARTRES.  
CLOCK TOWER, NORTH SIDE

and dependable measuring of time is a necessity. Suitable means for accomplishing this have developed apace with the demand.

The clock motion of wheel-work actuated by springs and weights was known in the days of Archimedes, 287-212 B.C. In order to make a clock it was necessary to connect the wheel-works to a hand which rotated before a dial and to regulate the speed of the mechanism. It is not definitely known when the first clock was invented. In Cordova, Spain, there was a pendulum clock about 1000 A.D., to which it is believed that a student of the Saracenic University, who afterwards became Pope Sylvester II, added the escapement. In London a clock was installed in the palace yard in 1288 A.D., and soon thereafter they became common in the towers of cathedrals, churches and municipal buildings. The ringing of bells in these clock towers made time manifest to both the senses of seeing and hearing.

Until recently clocks were all individual mechanisms which operated without reference to each other. The most early examples of English clocks have but one hand which traverses the dial circle in twelve hours. On these dials each hour is sub-

divided into four to mark the quarter hours. Intervals of less than a quarter of an hour had to be estimated by the position of the hand. Very close readings can be made even on clocks of this kind. The advent of the long English grandfather clock occurred about 1655 and it held its place as a favorite until about 1850. This clock had a long case resting on the floor with a dial at a height convenient for inspection. Such a case permitted the use of the long pendulum, which was made possible in the limited width of the case by what is called the anchor escapement. This long sixty beat per minute pendulum resulted in the use of a subsidiary dial on which a hand rotated once each minute, divided into sixty divisions or seconds.

In the early days of clock making it was customary to accept the noon indication of sun dials as a standard. As a solar noon varies from clock time on nearly every day, attempts were made early in the eighteenth century to regulate the motion of the clock to conform to the sun dial. To do this, the pendulum was lengthened or shortened automatically or an arrangement was devised which would draw the hand backward or forward to the required amount. Such clocks, called Equation clocks, were more popular in France than in



GROSSE HORLOGE, TOUR DE LA ROUEN

England. In the latter country they more readily accepted the average or mean time shown by the clock as that most convenient to go by.

The building of the early English clocks was quite an art. The dials were often elaborated with an arch in which was shown a seconds indicator, a register of the days and months and the changing phases of the moon. Some Dutch clockmakers introduced dancing marionettes, ships and other movable objects. Such embellishments were not popular with the English. In England, the early clocks had very elaborately engraved dials of brass, but these later gave way to more plain dials while the ornamentation was confined to the four corner spandrels surrounding the circular dial plate. On these spandrels the designs often were shown in colors or low-relief sculpture. The early clockmakers made exquisite and elaborately ornamented hands in comparison with which the modern hands seem severely plain and uninteresting.

The early clock cases were often set on a paneled base for the purpose of increasing the height of the clock. The oak cases were later veneered with walnut or ebony. From an inspection of specimens of early English clocks it is noted that the decorations are confined mainly to the front of the clock, the sides of the case being often veneered with pieces of fancy wood of rectangular shape, arranged in geometrical patterns similar to marquetry. In some instances the entire case was so treated. Another form of veneering consisted of pieces cut across the grain of the wood and showing the annular rings, all of which was surrounded by a suitable border of artistic design.



CATHEDRAL OF NOTRE DAME DE CHARTRES. INTERIOR VIEW SHOWING CHOIR SCREEN

Marquetry as a finish for clock cases lost its popularity early in the XVIII Century and the use of lacquer finishes became the fashion. Some of these specimens are very attractive in appearance.

The most early specimens were sent to China in merchant ships to be finished by the application of several coatings of lacquer, a process that consumed a year or so. Later, time was gained by processes devised by Dutch and English decorators who practiced a more expeditious process, and one wanting in the high quality of the Chinese workmanship.

This manner of finishing clock cases went out of vogue soon after the introduction of mahogany in England about 1720. The beauty of this wood and the readiness with which it can be moulded and carved made its use very popular, a popularity which exists until the present time. At this time the design of clock cases was made to conform to the style of the furniture and the finish of the room. Some of the early cases were evidently



CHIMNEY PIECE AND BRONZE CLOCK. INTERIOR, SALON OVALE, HOTEL DE SOUBISE, PARIS

## THE AMERICAN ARCHITECT

made before the advent of the Chippendale period, but many excellent examples still exist of cases in the Chippendale, Hepplewhite and Sheraton periods.

Thomas Tompion is considered to be the father of English clock making. He was born in 1638, the son of a blacksmith, and became a clock-maker in London at an early age. His work is an epoch in English clock making. He became associated with the leading mathematicians and scientists of this time. His prompt acceptance of the theories of Dr. Hooke and Rev. Edward Barlow, the greatest English horologists, caused them to become universally accepted without great delay.

The greatest advance in clock making occurred when clocks were electrically operated with the resulting synchronizing of a number of clocks. This is a European idea and of the foreign clocks the Swiss movement predominates. Clocks operated in this way have been developed to a high state of perfection in this country and their use in various ways is increasing rapidly.

The illustrations of foreign subjects have been reproduced from photographs in the collection of the Metropolitan Museum of Art, to whom we are indebted for this courtesy.

*(To be continued)*

### Book Reviews

MODERN FARM BUILDINGS. BY ALFRED HOPKINS, A.A. I.A. CLOTH 7X10—PP. 237, ILLUSTRATED. ROBERT M. McBRIDE & CO.

This is a new and revised edition of Mr. Hopkins' work containing considerable added material. One of the additional chapters discusses the choice of materials for farm buildings, as well as the farmer's cottage. The book is replete with illustrations and contains valuable suggestions for constructing the numerous buildings incidental to the operation of the modern farm. It illustrates the architectural possibilities in this class of structure. The book should do much to advance the cause of better farm buildings.

HENDRICKS' COMMERCIAL REGISTER OF THE UNITED STATES. ANNUAL EDITION, 1919-1920. S. S. HENDRICKS, CO., INC.

The 28th Annual Edition of "Hendricks' Commercial Register of the United States for Buyers and Sellers for 1920" has just been published, having been delayed by the printers' strike in New York. The new edition contains several improvements, the most noticeable being the new method of indexing by coloring the front edges red, white and blue to indicate the different main sections of the book. First is blue on which is stamped the words "Trades Index." This is a section of 162 pages in which every product listed in the book is

indexed and cross indexed for ready reference. The red section is the main classified trades list. It contains 1813 pages listing over 18,000 different products. In the present edition there are over 1200 new headings, including many headings completely covering the chemical industry. The third section of the book as indicated by the white edges contains 216 pages, listing the trade names under which products are manufactured, with the name and address of the manufacturer. The second blue section is the alphabetical section of 487 pages containing all the names in the book in one alphabetical list with addresses, and their main line of business. This is followed by the index to advertisers of 20 pages, containing a full list of branch and foreign offices following each name. The whole book makes a volume of 2703 pages.

### Engineering Council

Engineering Council was organized by the American Societies of Civil Mining, Metallurgical, Mechanical and Electrical Engineers to represent the profession in all matters of common interest, especially relationships of engineers to the public and to governments. Council is one result of a wide movement to enlarge the activities of engineers for patriotic, social and personal welfare. It is broadening the functions of its member societies beyond the scientific and technical limitations of their original foundations. Performance of Council's work requires much more money than the treasuries of its member societies can supply for the coming year. Increased cost of services and printing are absorbing society incomes and causing deficits. For the calendar year 1919 Council's member societies have been able to provide \$25,000. Including the cost of the National Service Committee's headquarters in Washington, Council needs not less than \$50,000 for the calendar year 1920. The only way in sight to raise this sum is by direct appeal to the engineers of the country for personal contributions. Aside from the possible appropriations of the member societies, not less than \$30,000 will be needed.

The engineer's responsibility as a citizen, obligation to deal with welfare problems, and duty to serve the public are accepted as a matter of course by engineering societies throughout the country.

### Small Cold Storage Rooms

Under the above title the Armstrong Cork & Insulation Co., Pittsburgh, Pa., have published an interesting 36-page booklet, dealing with a subject daily receiving increasing attention by the architect. The booklet goes briefly into the principles involved in the design of such rooms, and treats very fully on the subject of insulation. Copies may be had upon request.



# The One-Story Schoolhouse\*

By FRANK IRVING COOPER

*Chairman, National Education Association's Committee on Schoolhouse Planning*

STAIRWAYS are a menace to the life of all school children, and climbing schoolhouse stairs is a menace to the health of every school girl. Records of school fires will prove the first statement and school physicians will attest to the correctness of the second.

Corridors and stairways form a marvellous network of flues which distribute burning gases, thus making the entire school building get afire with the greatest possible rapidity.

Fortunately, a safer type of schoolhouse has been developed. One of the buildings of this new type, by Edwin S. Gordon, Architect to the School Board of Rochester, New York, is illustrated in Part III of Mr. H. W. Forster's article, *Fire Protection for Schools* published in the March 10th issue of *THE AMERICAN ARCHITECT*. There are no stairs to climb in this schoolhouse; no vertical flues to cause strong draughts of air in the corridors; no outside fire escapes to cause a false idea of security; no tower fire escape placed in an out-of-the-way corner for emergency exit and open to serious objections because it is an unusual mode of egress. On the contrary, every corridor opens directly to the outside yard; every school room has its own outside door; every forty pupils have their own independent means of safe and efficient egress.

This is a school house of the one-story type, the only schoolhouse type that can guarantee absolutely the safety of school compelled childhood so far as the building is concerned.

There are other reasons for building schoolhouses of the one-story type, money may be saved in construction and put into play space instead of into the erection of the many-story schoolhouse, with its heavy masonry construction; the schoolhouse set in pitiful "zones of silence," with "safety first" pupil squads required to police school play; with damage suits brought against city finances on account of crippled or killed children.

The one-story building may be set on or near the parks. Chicago is about to try placing a schoolhouse of the one-story type in one of its small parks, in an endeavor to prove that saved-up land beauty is of less worth to a city than are the children who are growing up to be its merchants and its mothers. Green grassy acres and great trees will not make for a city's greatness so much as will the type of

citizens that every city needs and is trying to produce in its public schools for its future citizens.

A one-story school building with surrounding grounds is in little danger from exposure hazards if the building itself is built either as a fire-resisting structure or as a structure of the second class. It may be considered safe for children if its construction is of wood thoroughly fire-stopped; if it has individual room exits; if it has no basement; if it has its boiler rooms in a separate building or built of strictly incombustible material; if it has fire hose and other hand-extinguishing equipment; and if it be equipped with automatic sprinklers for all store-rooms, store closets, passageways, and other places with exposure hazards.

There are many types of the larger one-story schoolhouse, notable examples of which are the Rochester type by Gordon, before mentioned, with its school rooms grouped around an assembly hall, its extended interior corridors with class rooms on the exterior sides; the type of which Perkins of Chicago is architect; the Pacific Coast type by Naramore, Architect of the Seattle Board of Education, with its connecting outdoor corridors and its open glass-covered play spaces; the California or Mission type, with its open arched passageways, its patio and its open-air assembly; the type with its recreation corridors now being worked out by McCornack, Architect to Cleveland's School Board; the group type as worked out at Tulsa, with its two and four-room school buildings connected by covered passageways all surrounding an interior playground; and the grouped cottage type at Colorado Springs, where Superintendent Roscoe C. Hill is carrying out an interesting experiment that should come to the attention of all school men.

To sum up: The one-story type of school, in addition to its safety from the usual fire hazards, has the following points worthy of mention: It does away with stairways and fire escapes; it gives an outside entrance to each room; it gives greater freedom in planning, as the school room unit can be varied without reference to walls or flues of units above or below; the building may be constructed with great rapidity; the school rooms may be lighted by windows in the usual way, or they may be lighted by overhead ceiling lights and skylights which, when rightly planned, will give an evenly distributed light over each desk; and it also gives opportunity for the building of additional rooms, when required, without destroying the plan of the building.

\* Extracts from a paper, included with H. W. Forster's article, *Fire Protection for Schools*, prepared and printed for the Department of the Interior Bureau of Education, by The National Fire Protective Association, an abstract of which (in three parts) was published in *THE AMERICAN ARCHITECT* issues of February 25, March 3 and 10, 1920.

# Safety Education for Engineers

## Plans Discussed by Engineers, Educators and National Safety Council Officers

**A**T the conference recently held, arranged by the National Safety Council, men prominent in the engineering and educational world but not as yet interested in the safety movement, discussed what legitimate claim, if any, exists for safety education in engineering colleges. There were present at this conference many members of the Executive Committee of the Council and of the Engineering Section and the president, secretary, or some other prominent member of each of the great national engineering societies including at least two educators of national prominence.

In opening the conference Mr. Whitney said that while engineers, like other men, are more or less interested in humanitarian matters, our claim for attention on the part of engineering colleges must be based primarily on a definite relationship between safety and engineering efficiency. Mr. Whitney then called on three men to discuss briefly the relationship between safety and efficiency from different standpoints.

Dr. L. W. Chaney, United States Bureau of Labor Statistics, the first speaker, quoted from reports of the bureau which indicate that, in the steel industry, the prevention of serious accidents has been accomplished mainly by engineering revision, to which he said, we must also look for further progress in this direction. Statistics gathered by the bureau show a startling relationship between increase in production efficiency and decrease in accidents. Plants in which the output per man per day remained practically constant, show also a practically constant accident severity rate. Other plants which have introduced improved engineering equipment and operating methods have increased the output per man.

Sidney J. Williams, secretary and chief engineer of the National Safety Council, then presented an analysis of the fundamental relation between safety and efficiency.

C. P. Tolman of the National Lead Company, a member of the Executive Committee of the Council, described some interesting individual cases illustrating these principles.

A very interesting discussion took place on the part of several of the eminent engineers who were present. Frank Sprague mentioned some improvements in railroad operation which resulted in increased safety and increased capacity. Dean M. E. Cooley of the College of Engineering, Univer-

sity of Michigan, president of the American Society of Mechanical Engineers, expressed his conviction that engineering education must be liberalized and that one of the factors in this is to give the student engineer a better understanding of the human factors with which he must deal.

Professor C. A. Adams, Engineering College, Harvard University, past president of the American Institute of Electrical Engineers, and chairman of the American Engineering Standards Committee, emphasized the need of better training in fundamentals for the engineering student. We should aim to teach him not so much the specific application of safety methods, as a separate study, but rather to think of all his work in terms of safety. This will result in higher efficiency.

Agreement with Professor Adams' stand was expressed by G. K. Parsons, who suggested that the essential principles of accident prevention should be formulated in the simplest possible way, leaving the detailed application of these principles to the engineer; and by C. A. Rausch, who said that the principles of safety should be taught to the engineer as one of the fundamental elements of his profession. Doctor E. B. Rosa, United States Bureau of Standards, pointed out the need of enlisting the engineer's assistance in solving the many difficult problems encountered in safety work.

A different note was struck by R. M. Little, who made an eloquent appeal for presenting safety to the young engineer as an altruistic ideal, not solely as a matter of efficiency. The great need of our country is for leaders, he said, and in training engineering students for leadership, we must train them to recognize human values—to look upon the workman as a human being and not simply as an instrument of production. This sentiment was echoed by Mr. L. A. DeBois; he had found that the most prominent men of Wilmington, when plans for a public safety campaign were presented to them, became deeply interested at once because of the opportunity for saving human life, but were not interested in the economic argument.

B. F. Tillson described the effective work which has been done, in teaching safety to mining engineering students, the educators in this field having been interested in safety for several years. The conference closed with a statement by Professor G. F. Blessing, Swarthmore College, of his success in interesting his students in safety.

452<sup>w</sup>

Journal piece to 76-3212.

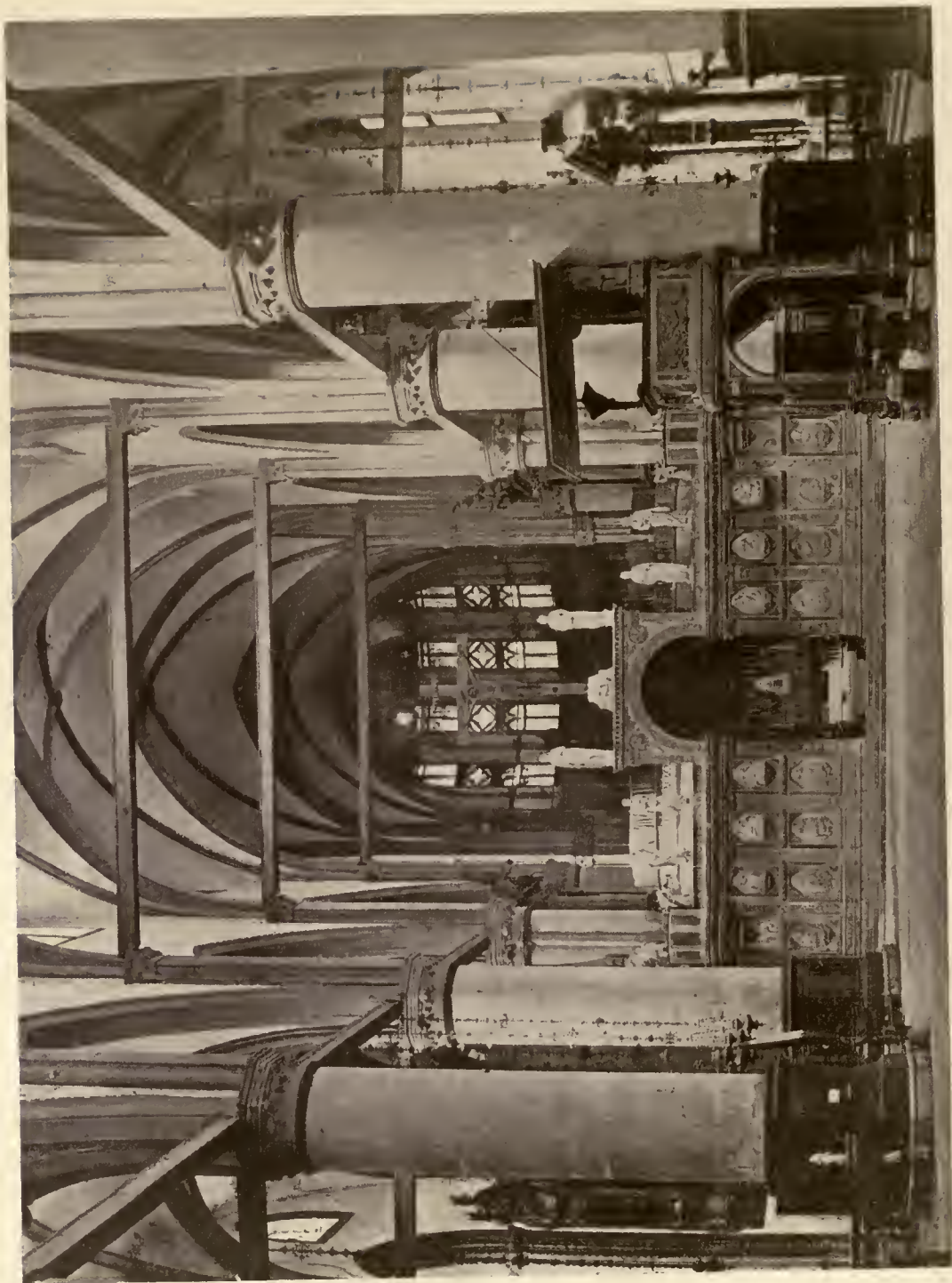

CHURCH OF S. MARIA DEI FRARI, VENICE

THE AMERICAN ARCHITECT

# THE AMERICAN ARCHITECT

VOL. CXVII

WEDNESDAY, APRIL 14, 1920

NUMBER 2312



A FRENCH FAMILY LEAVING THEIR RUINED HOME

## Notes from London

(By *Special Correspondence* to THE AMERICAN ARCHITECT)

**I**N a recent article I mentioned that I proposed in the present notice to give particular attention to the work of reconstruction in France. First, in this immense and most pressing task I will here give some account of the "Renaissance des Cités," which has its "siège administratif" at 23 Rue Louis-le-Grand, Paris.

The aim of this excellent organization, which they very properly describe as an "Oeuvre d'action," rather than an "Oeuvre de pure doctrine," has been

recently stated by the promoters of the "Renaissance des Cités" in the following terms. "To study the problem of reconstruction from the social, judicial and architectural points of view. To consider this problem always in its ensemble and not in a specialized form. To endeavor in any concrete case to apply the remedy. To bring together into this work personalities with the most different conceptions and experiences, in order, by the exchange and often by the shock of ideas, to strike out the

conception which is nearest to the truth. To sow this conception, and often to see it flower into life. To take this social renewal at its base—that of education. To accustom benevolent capacities to work in common to the discipline of a sustained effort.



LE CATELET

All preconceived theory to be put aside in the choice of the men called to this work: the result alone of realized labor to be the ground for the choice of collaborators. A social work—they add—“lies before us full of living interest, with often un hoped-for results; but a work in the shadows beneath, of patience, of faith in the aim to be attained.”

This work of the “Renaissance des Cités” has been divided under different commissions—Commission Technique, Commission Sociale, Commission Juridique, Commission Artistique, Comité Archéologique—with, at the head of the Comité de Propagande, as its President, Princess Jacques de Broglie.

One of the first fruits of this united effort was the exhibition organized and now being held, at the Union Centrale des Arts Décoratifs under the title of “Exposition pour le Renaissance des Cités,” which was formally inaugurated by M. Albert Lebrun, Minister of the Liberated Regions. The Mayor of Chauny, M. Descambres, whose coura-

geous attitude during the German occupation has been since followed by the most devoted and consistent zeal for the reconstruction of his city, over which the tide of war had flowed and ebbed till it became little more than a heap of ruins, spoke of his satisfaction in the successful Concours de Chauny, which he described as of the happiest augury for the future. He was followed by the Minister, M. Lebrun, who complimented the “Renaissance des Cités” on the difficulties which had been already conquered, and the precious re-



A “PILL BOX” BUILT THREE FEET THICK



MEUSE: PANORAMIC VIEW OF A WOOD

sults obtained. He offered himself “with all his heart,” as well as all his “chefs de service” to the realization of the work, believing that the union of so many men of good will would show to the world that France has not only known how to keep a glorious place in the field of battle, but that now with peace the solid qualities of her children will permit her to restore the North and East, which have suffered so cruelly.

The program traced out by the “Renaissance des Cités” is a large and serious one. On its active side

## THE AMERICAN ARCHITECT

its scope includes the revision of hygienic regulations, already adopted by the Conseil Supérieur d'Hygiène Publique; plans for the arranging and extension of Albert (Somme) and its region, of Tracy-le-Val and Ollencourt (Somme), of Courneuve (Seine) and of Chauny and its district (Aisne)—these plans appearing in the Concours of the Union Centrale. Besides the above there are studies on Coucy-le-Chateau and various Communes; plans of rural reconstruction, of children's education, of agricultural co-operation, social centers, sport and recreation. It is thus not merely a work of reparation for the losses of war, but of real reconstruction among these recovered and re-created cities and communes in their social, hygienic

imperishable witness of the vandalism of our vanquished enemies, and of the economic and administrative necessity of reconstituting this "chef-lieu," whose very name has become a symbol of patriotism.

Thus while in England we are wasting our energies and splendid national resources in useless and misdirected trade disputes, in France the work of reconstruction is being approached in a serious spirit of united effort; and I turn now to the very important town-planning competition for Paris, to which I alluded briefly in my last letter, which was opened in August and continued until January 31, 1920.

Paris is a city surrounded with ancient fortifica-



RUINS OF HOUSES IN A VILLAGE OF THE MARNE

and industrial life, with as its aim the evolution of the "Cité Nouvelle" of the future—"l'espérance d'améliorer la Cité nouvelle."

An interesting special problem is here, the reconstruction of Coucy-le-Chateau, organized by its Mayor and the "Renaissance des Cités," under the presidency of M. Lefevre-Pontalie. Their report states that the situation specially caused to this "chef-lieu" of the canton by the total and deliberate destruction by the Germans of a magnificent specimen of medieval military art has been examined from the double point of view of safeguarding the tragic ruins, which remain to give to the future an

tions, which are now to be demolished and the ground they cover with their basal zones to be handed over to the city of Paris for building and planning. This will necessarily affect the whole relation of the city and its suburbs, which badly need improved transport, having been hitherto largely dependent on what is known as the "Grande Ceinture," that primæval railway which it has been my misfortune to crawl around on more than one occasion, with considerable weariness and waste of time. What is now proposed is, put briefly, to transfer as far as possible the homes of the working classes to the outer districts, where a small house

## THE AMERICAN ARCHITECT

with its garden may be a practicable ideal, to extend the Metropolitan Railway beyond the old inner fortifications, and to turn the outer ring of forts, which extend from five to ten miles beyond the city, into parks and garden cities. The program set forth by the municipality of Paris for this competition desires expressly that projects should aim at "bigness of ideas" rather than at elaborated detail and should be in the nature of a sketch ("esquisse"). There are five premiums offered in this section, varying from 5,000 to 30,000 francs, while an addi-



HOUSE BUILT FROM TRENCH DEBRIS

tional 10,000 francs is placed at the jury's discretion.

Apart from this comes the second question of the improvement and beautifying of the existing city, of eliminating slums, the population being transferred to the new outer zones, the building of new streets and boulevards, and the protection of the lower city against recurrent floods. In this second section four premiums are offered, varying from 4,000 to 7,000 francs, with 6,000 francs at the discretion of the jury. Section III deals with the laying out of the fortification zones—that is, the inner line, as distinct from the outer forts, mentioned under Section I as destined for garden cities, and in many cases commanding splendid views; and Section IV deals with Housing, Hygiene, Traffic Development, the premiums here being 6,000, 4,500 and 3,000 francs, with a further 6,000 at the disposal of the jury. It is to be noted that this competition is open to citizens of all the allied nations, the entrance fee being 100 francs, in return for which each competitor will receive twelve different plans of Paris and its district, besides documents giving very full information as to regulations, etc. Competitors may supplement their plans as required, which are generally two for the section, by additional water colors and drawings; all accepted projects are the absolute property of the city of Paris. The jury will consist of ten architects, to be nominated by the competitors.

Since 1870 Paris has been under a cloud, never, indeed, openly expressed, but always to be felt in the background. She is now once more emerging to take her true and secular place as a world center of taste and culture, as the "semeuse d'idées."



LE CATELET

the "Ville Lumière"—and her municipality is wisely looking to the future.

I come next, in treating reconstruction in France, to a work of the highest value to humanity, and one which cannot be sufficiently praised. I refer to that undertaken in France by the War Victims Committee of the Society of Friends. Already in 1914 this work was taken in hand; and I have before me a copy of the letter, dated October 16, 1914, in which the Minister of War accepted the offer made by the Society of Friends to the French Government of doctors, nurses and men volunteers to help the sorely tried noncombatant population. Most of all was this help needed in the Department of the Marne; and, though the Government made a grant to refugees from the invaded territories, "we found," says the 1914 Report of the Society, "that this barely covers food and lodging . . . that they had escaped with nothing but their summer clothes, and that thousands in Chalons and the surrounding country were in the face of the approaching win-



A SHELL-SWEPT VILLAGE



ter destitute of blankets, clothing and the necessities of life."

The first party sent out consisted of five persons, and the first center of work was at Esterney, which had suffered terribly from the fierce fighting at the time of the battle of the Marne. The need was great at this time, both for relief and the construction of shelters and houses, which has formed throughout a most important part of the work accomplished. In five or six of the villages building work was at once undertaken both for shelters and repair. "The character of the work," says the report, "varied, but in most cases is governed by the fact that substantial walls have often been left after fire and bombardment"—though it may be noted that Sermaize, in their field of work, a prosperous little town of about 4,000 inhabitants, was left "hardly more than a heap of broken bricks and twisted iron," with the fountain in its center by some chance surviving. "Sometimes a one-storied dwelling can be made by roofing in and adapting existing walls, adding, perhaps, an inner partition; in other cases a lean-to building can be erected against a large, strong outer wall; in others demolition and rebuilding are both necessary;" and here the wooden houses, two-roomed or four-roomed, as the case might be, were of prompt and precious assistance. "It takes six men about twenty hours to erect a two-roomed house, and as the French authorities provide all the materials, the cost to the Commune is only about £5;" and my illustrations will give an idea of one of the workshops at Ornans, where these were prepared.

Hygiene was no less important than housing, for the sanitary conditions were frequently very bad and threatened an epidemic; but what one feels was perhaps the greatest achievement of all was the presence of human sympathy, of Christian love to these distracted and desperate beings. For the worst danger of all was the moral collapse of people attached to their homes and land, left destitute and idle, without work in the present, without hope for the future. "The hopeless boredom of life without aim and almost without hope, seems a real danger for these women and girls accustomed to the many activities of farm life . . . the great desire of all is to get back to their own neighborhood, even though they know they will find nothing but ruin awaiting them." To these men and women the helping hand and voice, the kind word, the chance of some fresh start, however humble, meant everything. Their words of gratitude are from the heart, and are touching in their sincerity. "Le Société des Amis a droit a la reconnaissance de la population toute entière. Son départ va causer un grand vide dans le pays"; or again from another

sufferer, "Je n'oublierai pas la sympathie dont vous nous avez entourée."

Take the story of little Antoinette as a typical one. "Her father was away, ill and dispirited at Verdun, and would sanction no schemes involving expenditure, while her mother was almost too downhearted to make any effort. Only Antoinette, of about eight years old, had pluck and hope for the whole family, and an immense determination to possess a new home. "Ah," said the grand-mère, "she's the one that's got the brains. She says she has half a franc in her purse, and she will pay for the wood." . . . Antoinette was not to be discouraged; she knew, she said, all about the cost, for the notice was posted up in the village, and at last the mother was persuaded to allow her to come to interview "Monsieur l'architecte" Antoinette needed no prompting. "Monsieur, je demande pour Maman le prix d'un abri de deux pièces, une cuisine et une chambre a coucher" as if one ordered houses every day.

Most pathetic of all are the old people's tales of suffering; for "it is hard to begin life over again, and in some cases it would seem almost impossible." One old couple, with a still older aunt, escaped from their farm with just twenty francs, and spent two months in fields and woods, sleeping under hedges, and stumbling one very dark night into the German lines, from which they were chased after suffering agonies of fright from the rifles leveled at them. Another old lady at Noyers, saved with her husband by her own horse and cart, refused obstinately to kill or sell her old mare—"my friend and savior." She knew the Germans were following and she trotted without stopping day and night, just snatching at a bite by the wayside. The work that had commenced with a little party of five had in these four years of war spread into a vast network of organized and splendid effort. Medical work, building, agriculture were now in full swing; already in 1915 some 310 wooden houses had been erected, and the problem of furnishing them had become a pressing one.

In Sermaize, which had now risen from its ashes, the Prefecture and Society of Friends between them gave one double bed and mattress to every household which had been burnt out. "This scheme gave the very greatest satisfaction, for the French people are immensely careful and particular about their beds and bedding, and nothing hurts their self-respect more than the miserable sleeping arrangements to which for more than a year they have been condemned."

Of immense importance was the work of saving the children, and one of my illustrations gives a little flock of these babies in an open-air crèche at Samoens; that at Chalons was "the admiration of

French visitors, an object lesson to the mothers in the value of fresh air." Agricultural machinery and tools were slowly coming in, the building of huts (one of my plates shows a machine shop at Ornans) being thoroughly organized; and in 1917, under the aegis of the American Red Cross, welcome help had come from America, and the American Red Cross in Europe had made a first grant to the Society of about £20,000 while a hundred workers from the American Friends' Service Committee had come across. What matter if yet later the tide of this terrible war was to sweep back and blot out much of this creative effort: the spirit of Christian help and life was there, established, unconquerable, ready to begin again the struggle for life against the forces of destruction, and to one whose family has been connected for generations, most directly on the American side, with the Society of Friends it is a privilege to record a work

of loving-kindness in which the very Spirit of Christ was most surely present.

### Devonshire House

Now that Devonshire House is announced as actually sold our interest naturally turns to the great house which has now stood for some two hundred years in Piccadilly, and might at one time have been considered as the home of the great Whig party. The site on which it stands was originally occupied by the Hay Hill Farm, whose name still survives in Hay Hill; but soon after the Restoration Lord Berkeley of Stratton built Berkeley House, which was acquired in 1696 by the then Duke of Devonshire.

When this house was burnt down in 1733 the third Duke entrusted its rebuilding to the fashionable architect of his day, William Kent, who received one thousand pounds as his honorarium, though the building cost twenty times that amount.



MEMORIAL ALTAR, ROEDEAN CHAPEL

J. W. SIMPSON, P.R.I.B.A. AND MAXWELL AYRTON, A.R.I.B.A., ARCHITECTS

William Kent's career is remarkable. A poor Yorkshire boy, he commenced as a coachmaker's apprentice, but ran away to London. He now began portrait painting, though his work in this direction is severely criticized by Horace Walpole; but he was taken by a patron to Rome, where he had the luck to meet the famous Earl of Burlington. From that moment Kent's good star was in the ascendant. The Earl carried him back to London, gave him apartments in Burlington House, which he occupied till his death, and gave him, too, just the start he needed. Kent's talents were universal in art creation. Besides his work in architecture, in which he has the Horse Guards to his credit and his masterpiece of Holkham, he was, as we have seen, a painter of history as well as portraits, a sculptor, designer of furniture, and landscape gardener. He became the "arbiter elegantiarum" of his day; and we even hear of two great ladies who appealed to him to design their "birthday dresses." Kent was fully equal to even this commission: one seems to have a "creation" in bronze and gold, the other introduced in the petticoat "the five orders of architecture." This was surely Palladianism à l'outrance" and makes us feel it was time for the Baroque—or even the Gothic revival. Hogarth,

in fact, attacked him bitterly as a charlatan, a Jack of all trades; but his furniture has dignity and design, and his architecture is not without merit. The entrance of Devonshire House is heavy in design, but we have to remember here that the external flight of steps has been now removed; and in the interior Mr. Beresford Chancellor has pointed out that the architect "was able to give play to his love of the rococo." Especially fine was the furniture, which included some rich designs by Kent himself, examples of which I hope to illustrate, and of the great French artificers of that day. The great wrought iron gates, with the Cavendish motto, "Cavendo tutus," were brought from Chiswick house in 1897. When some assertive modern hotel has seized its place we may perhaps regret the severe and plain mansion which William Kent had designed.

### War Memorials in England

The present War Memorials Exhibition, opened this month within the walls of the Royal Academy, is in a sense the necessary complement of that which preceded it, and which I have already noticed in these columns when it was opened at the

(Continued on page 463)

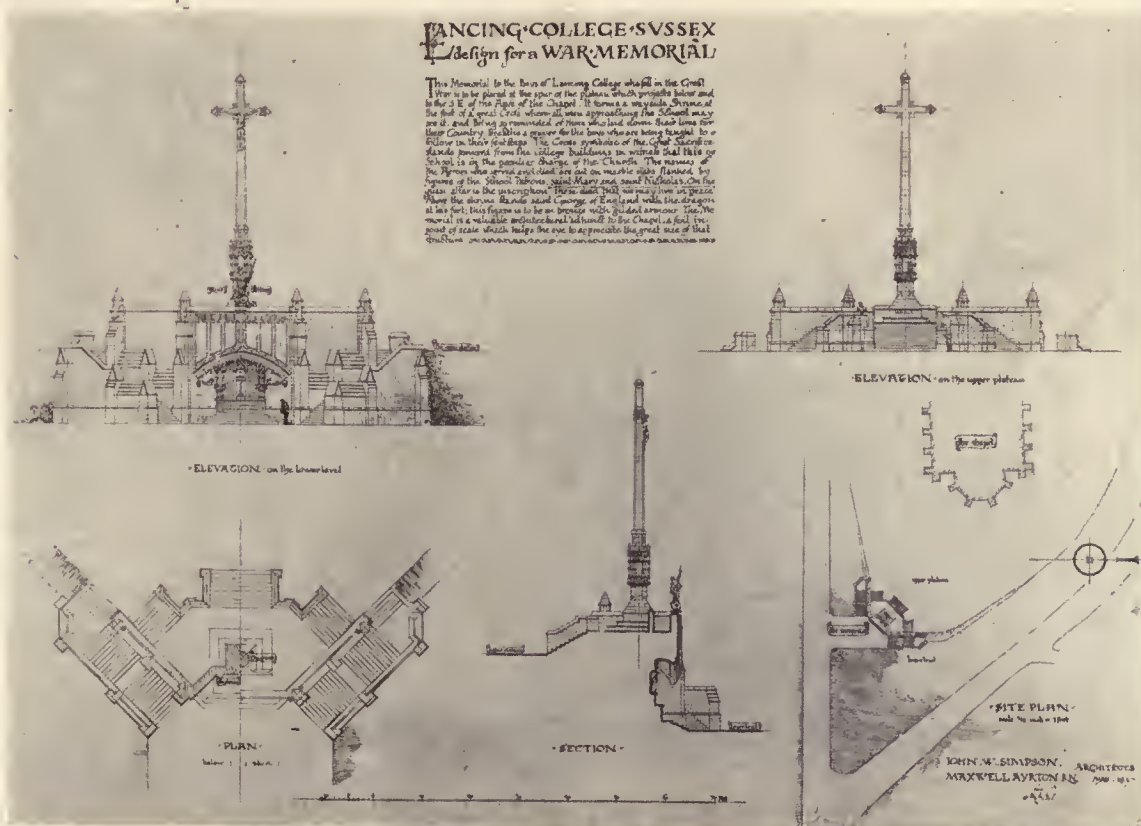

J. W. SIMPSON, P.R.I.B.A. AND MAXWELL AYRTON, A.R.I.B.A., ARCHITECTS

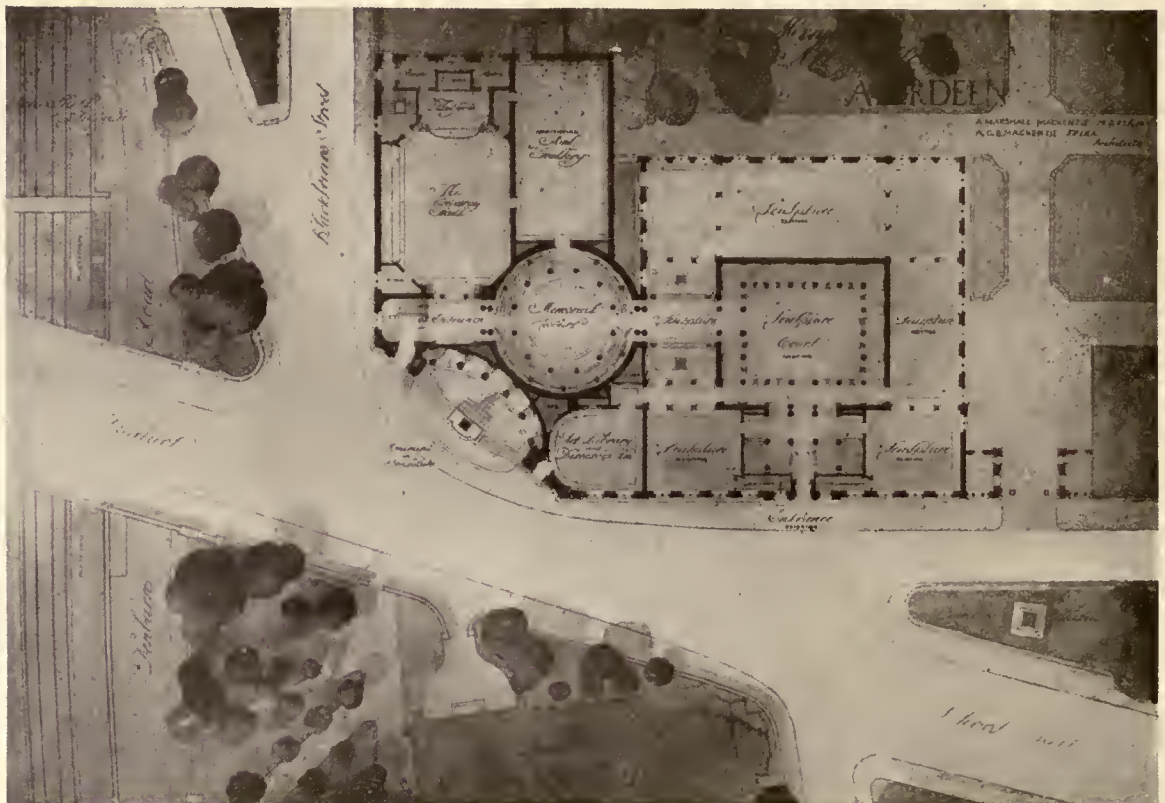

WAR MEMORIAL ART GALLERY, ABERDEEN  
MESSRS. A. MARSHALL MACKENZIE AND A. G. R. MACKENZIE, ARCHITECTS



## On Seeing Things

**T**HE ARCHITECT of London laments, in a long editorial in a recent issue, that Englishmen, and particularly those who went to the war, lack to a great extent the faculty of close observation. It cites an instance where an aviator who made a successful flight to Australia, and who during the flight was obliged by fog to land at Pisa, pathetically described his situation as with "nothing to do but see the sights." It further remarks that many people have made long trips to reach Pisa and view the "sights" that this officer-aviator regards as part of an uneventful voyage.

Perhaps *The Architect* is unduly harsh with its countrymen as lacking the ability intelligently to appreciate their environment. The power of well-trained observation is born in few men. The fault lies in our methods of education that fail to impress the value of seeing things and seeing them intelligently.

Someone has said that painters and sculptors are not really born as such, that their proficiency in their arts is the result of early and correctly trained powers of observation. It is further claimed that anyone of average intelligence can learn to draw or model, if he is early taught to see things correctly. It is this one thing,—the power correctly to analyze the things one sees—that is the basis of all education.

It was an Englishman, it is said, who on being asked if he could play the piano, replied that he did not know as he had never tried to. It is absolutely true that there are many things we could do if we would only try to do them. The easiest of these is to see things as they are.

Most of us go through life in a state of introspection. We do not sufficiently observe with a seeing eye. The mental vision is too often turned inward.

A lecturer urged an audience of young people to "stand on their hind legs and look out of their eyes." This provoked a laugh, as something amusing. But it is a word of advice that everyone might

follow with profit, and none more than the architectural student.

The new and improved methods of architectural education will certainly teach men to a greater extent the value of trained and accurate seeing of things. Most men will claim that they possess an ability to observe intelligently. Perhaps they have that ability, but there is a difference between so-called intelligent observation and the accuracy that is essential to every student of architecture. We may intelligently view a thing and feel that it is good, but not everyone may be able accurately to state why it is good and give the reasons for that conclusion.

It is this practical element in education in any of the arts that is an actual essential. If it were more generally taught we would not see so dreary a copying of precedent, but an originality based on accurate observation combined with the personal element of the observer.

## Good Architecture a Commercial Asset

**O**NE of the greatest educational results achieved by architects in this country is that they have been able to satisfactorily show to their clients the value of good architecture as a commercial asset. We do not sufficiently appreciate how large are the results achieved, as we are, so to speak, too close to the actual field and have not noticed as keenly as we might a very decided development.

It is when an intelligent observer from another country visits us for the purpose of studying our methods in specific fields, that we awake to the fact that many things we regard as "matters of course" are of sufficient moment to evoke very warm expressions of approval from a foreign visitor.

An instance in point is found in an address made by Mr. Herbert Austen Hall, architect, before a recent meeting of the Royal Institute of British Architects. Mr. Hall had but recently returned from a visit to the United States. He came here to study our department stores. The paper read shows

that he certainly possessed a highly trained power of accurate observation. The address was very favorably received by the distinguished gathering on the occasion of this meeting.

As the result of observation in this country the speaker was of opinion that American architects had two great advantages. One was that there was an immense appreciation of fine architecture in the United States, the other that business men consider their building as an investment,—something more than a mere advertisement.

In the debate which followed the reading of this paper, one of the speakers stated that in this country "good architecture was as necessary as daylight"—and that we had come to look upon a fine building as almost a necessary accompaniment of a fine business.

---

## The Report of the Housing Commission of the State of New York

**I**T is gratifying to note the practical and business-like methods pursued by the joint legislative Committee on Housing and the Reconstruction Commission of the State of New York. In a report to Governor Smith, dated March 26, this committee outlines the underlying causes that have created the great lack of proper housing and suggests certain measures that it is believed will speedily and effectively correct these things.

The personnel of the Commission is one to inspire respect for any report it may make. Its members are representative men, from the fields of finance, real estate, building, architecture and various departments of City and State governments.

A program of an architectural competition for the remodeling of a New York City tenement block, to be held under the auspices of this Commission, has been issued. A summary appears on a following page.

For more than a year the housing situation in New York and other large cities has been particularly grave. These conditions are, if possible, rapidly becoming worse.

In its report the Commission states that it has reached the conclusion that no temporary solution should be attempted. That whatever is done should be carried forward with a view to the permanent

adjustment of these conditions on a basis of exact stability. "If," states this report, "all the money available in the New York market and throughout the State were put forward tomorrow, it would be impossible to build, even in a year, utilizing every bit of man-power or material available, houses enough to take care of the shortage."

Realizing this statement as one of fact, the Commission in its report sets forth a constructive program, which as the work of a group of practical and competent men, should be taken with the utmost seriousness and carried forward promptly and without interference.

Unfortunately, building operations have been of late years regarded purely as speculative investments. To secure the greatest return from the money invested has been the all-absorbing motive.

It now becomes very certain that if our working population is to be properly housed, this speculative element will need to become minimized. Certain legislative action as regards rent raising is the first step towards relieving this speculative control.

**I**F the investing public can be made to understand that speculative building is a very serious menace to our economic welfare, such an understanding will mitigate the emergency and eventually develop a correct policy.

Now that we have experienced the conditions arising from the war, and have been able to learn the effects of a protracted stoppage of building to supply housing needs, we can with accuracy measure the importance of the steadily carried forward program of building during the times of peace.

The more apparent and easily traceable causes of the present housing shortage are the lack of materials, labor troubles, and the difficulty of securing sufficient loaning capital. But these are not really the fundamental things that have brought us face to face with the economic menace of an acute housing shortage.

The present crisis is really the result, or culmination of the result, of past tendencies. The conditions arising from the war have merely accentuated these tendencies.

We must evolve a new and well formed program of correction. The essentials of such a program are, it is believed, to be found in this well considered report.

## Notes from London

*(Continued from page 459)*

Victoria and Albert Museum. The present exhibition—we are informed by the Royal Academy War Memorials Committee—has been selected and arranged for the purpose of assisting the promoters of War Memorials and others interested, by providing them with a useful survey of modern work by competent artists, and suggesting various forms which Memorials may suitably take.

As my readers may possibly remember my critical verdict on the preceding exhibition at South Kensington was not enthusiastic, and it cannot be said that the present exhibition, though very much better in every way, reaches the level of its subject, which is no less than the adequate recognition in terms of plastic art of the heroic sacrifices which carried us through the dark days of the recent world conflict, and brought us at last to light and safety.

At the same time it represents a serious effort to grapple with a very difficult and interesting problem; and in this sense has much to be commended, even when it fails to attain the full spiritual significance of the subject. One reflection, which here comes clearly before us, is the intimate, the inherent connection between architecture and the highest forms of the sculptor's art,—a connection which has been often overlooked, at any rate in late years, in this country, but which runs through all the great art of the past, from the Parthenon, through the rich entablatures of the Roman period, the sculptured groups of Gothic work, in perfect harmony with the lines of shaft or moulding, and later in the Italian Renaissance. We find this law fully recognized in modern American sculpture, notably in the recent work of Daniel Chester French, and illustrated more or less directly in this exhibition in the designs of several leading British architects,—of Sir Reginald Blomfield, Sir Edwin Lutyens, Mr. Robert S. Weir and Sir Ernest George.

Sir Edwin Lutyens, in his small model of the "Cenotaph," which I described in connection with the Peace Celebrations, in the impressive and almost overpowering simplicity of the Great War Stone, which is being erected in British and Dominion War Cemeteries abroad, and still more his delightful design of a War Memorial at Spalding—in which the porticoed colonnade with its four great cypresses guarding a central memorial seems reminiscent of the famous Campo Santo of Pisa—shows throughout those qualities of balance and style, that fine sense of proportion which, in my judgment, insured the success of his much-discussed Westminster Cenotaph.

Mr. Robert Weir, in his ambitious "Pantheon of the Five Dominions," in which he is assisted in the sculpture by Mr. Gilbert Bayes and in the design by Mr. H. Wilson, is emphatic rather than impressive. His scheme is that of a circular building with a dome like that of Santa Sophia, a fine Romanesque porch, and an encircling gallery which seems, however, overpowered by the immense dome.

The Lancing College War Memorial, of which I give an illustration, is by Mr. J. W. Simpson, P. R. I. B. A., assisted by Mr. Maxwell Ayrton, and shows a great cross finely proportioned and placed over the Chapel; designed by the same architects is the Chapel altar and altarpiece of Roedean School, a new and prospering women's college near Brighton, which is about the same distance from my Sussex home on the east as is Lancing Boys' College on the west.

As a Worcestershire man two other memorials have a special interest for me in the proposed War Memorial for Malvern College, designed by Mr. Maurice Webb, F. R. I. B. A. and Mr. Walter Gilbert, and the Cenotaph, which is already "in situ"—in its temporary form—within the precincts and under the shadow of our Worcester Cathedral. We in Worcestershire are immensely and justifiably proud of our county regiment, which has a great tradition and was highly prized by Wellington in his Peninsular campaign; it went clean through the late war in all the hottest fighting, lost terribly, but won immortal glory, one among its many achievements being that of hurling back the Prussian Guard at Ypres in the most critical moment of the whole campaign. The present monument, designed by Messrs. H. Rowe and Sons of Worcester, bears only the words—THE GLORIOUS DEAD.

Mr. Adrian Jones has a brilliantly clever War Memorial for cavalry, which shows Saint George with brandished lance over the prostrate dragon, saluted by British and Colonial cavalry who ride below. Mr. Adrian Jones is a master of the horse in movement, and his composition here is good; but the design has been not unfairly criticized as being too pictorial. It possesses vigour and movement, but certainly no repose; and these two qualities in the best work are not surely incompatible.

The stained glass designs show very strongly the influence of the late Sir Edward Burne Jones, markedly in such designs as Edward Woore's cartoon of "Saint George" and in C. W. Whall's designs for stained glass windows, and yet again where these two artists collaborate in eleven cartoons for stained glass in Gallery VI. Burne Jones himself was an artist of imagination and exquisite beauty of line; but we do not want his

wonderful type to become a convention in this branch of art creation. Most attractive are the rolls of honour; and here Jessie Bayes excels in

two designs,—that of a personal memorial and a Communion Service book, written and decorated in black, red and gold.

# City of Birmingham, England, Housing Competition.

## Report on Prize Winning Designs

MESSRS. INGALL, BRIDGWATER & PORTER, *Architects.*  
Birmingham, England.

THE general lay-out has been planned to suit the existing levels of the site and so as to avoid unnecessary expense in levelling and in deep foundations, while at the same time securing all the requirements of modern housing, and in particular the maximum amount of sunlight in the rooms. The houses are grouped round three sides of two squares each with a short drive and turning space. The 4 houses with 4 bedrooms occupy the most prominent positions at the ends of the blocks and nearest to the road. Each house has a good and sufficient garden both front and back.

The accommodation asked for has been provided in each case, 12 houses having 3 bedrooms and 4 houses having 4 bedrooms. The living rooms are of the size required; 12 of them have windows facing south, and the other 4 have each two windows facing east and west, respectively; in all, 14 of the living rooms have two windows giving cross ventilation.

The sculleries are fitted with range, gas cooker, copper sink and draining board and table, with space for mangle. In two houses the copper and mangle are in the covered way. Storage rooms for prams or cycles is provided under the stairs.

Oversight of the garden is obtained from the living room and scullery windows. All larders are on, and have windows facing the north, except two, which face the east. In every house the prin-

cipal bedroom contains not less than 160 sq. ft. of floor area. In 8 of the houses considerable economy has been exercised by reducing the area of the first floor, while still providing the necessary bedroom accommodation.

The walls to be built of bricks. The general facings to be in local red facing bricks, with black country facing bricks to plinth, quoins, oversailing to eaves and chimney heads.

The internal walls are  $4\frac{1}{2}$ " thick with breeze concrete slab partitions between first floor rooms, where not over ground floor walls. The roof to be of deal purlins and rafters, covered with sand faced tiles.

The floors to living rooms, parlors and bedrooms, etc., to be of deal joists and boarding. Sculleries, larders, water closets and covered ways to have 9" red quarry floors. Coal places to have blue brick floors.

The joiner's work and fittings are standardized throughout.

The total cubical contents of the 16 houses measured from bottom of footings to half way up roof, and including all chimneys above roof line is 222,970 cu. ft.

The estimated cost at 1/1d per cu. ft. is £12,077.10.10. This is an average of £754.16.11 per house.



CITY OF BIRMINGHAM HOUSING COMPETITION  
SELLY OAK ROAD SITE

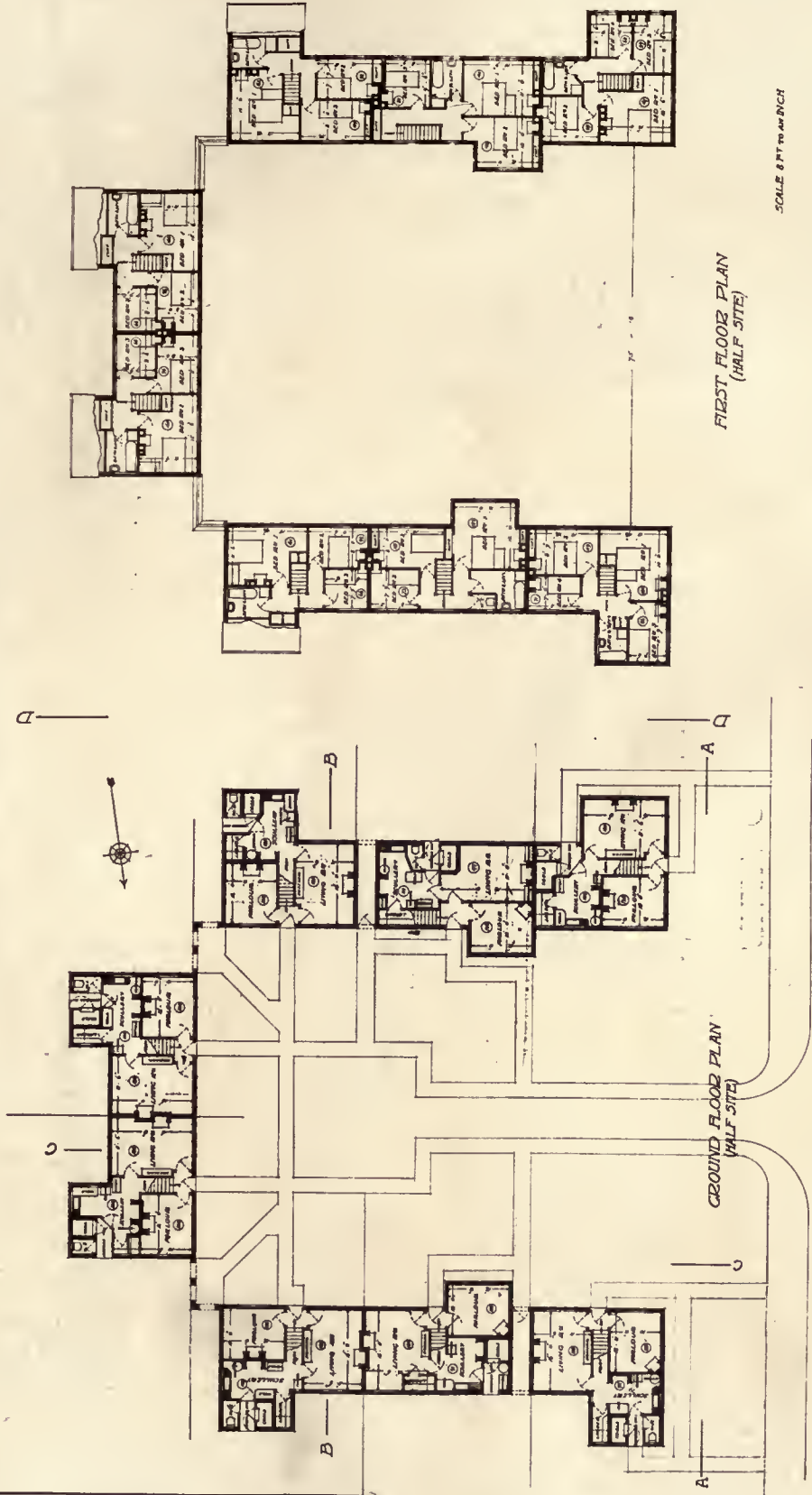

INGALL, BRIDGWATER & PORTER, BIRMINGHAM, ENGLAND, ARCHITECTS

CITY OF BIRMINGHAM HOUSING COMPETITION  
SELLY OAK ROAD SITE

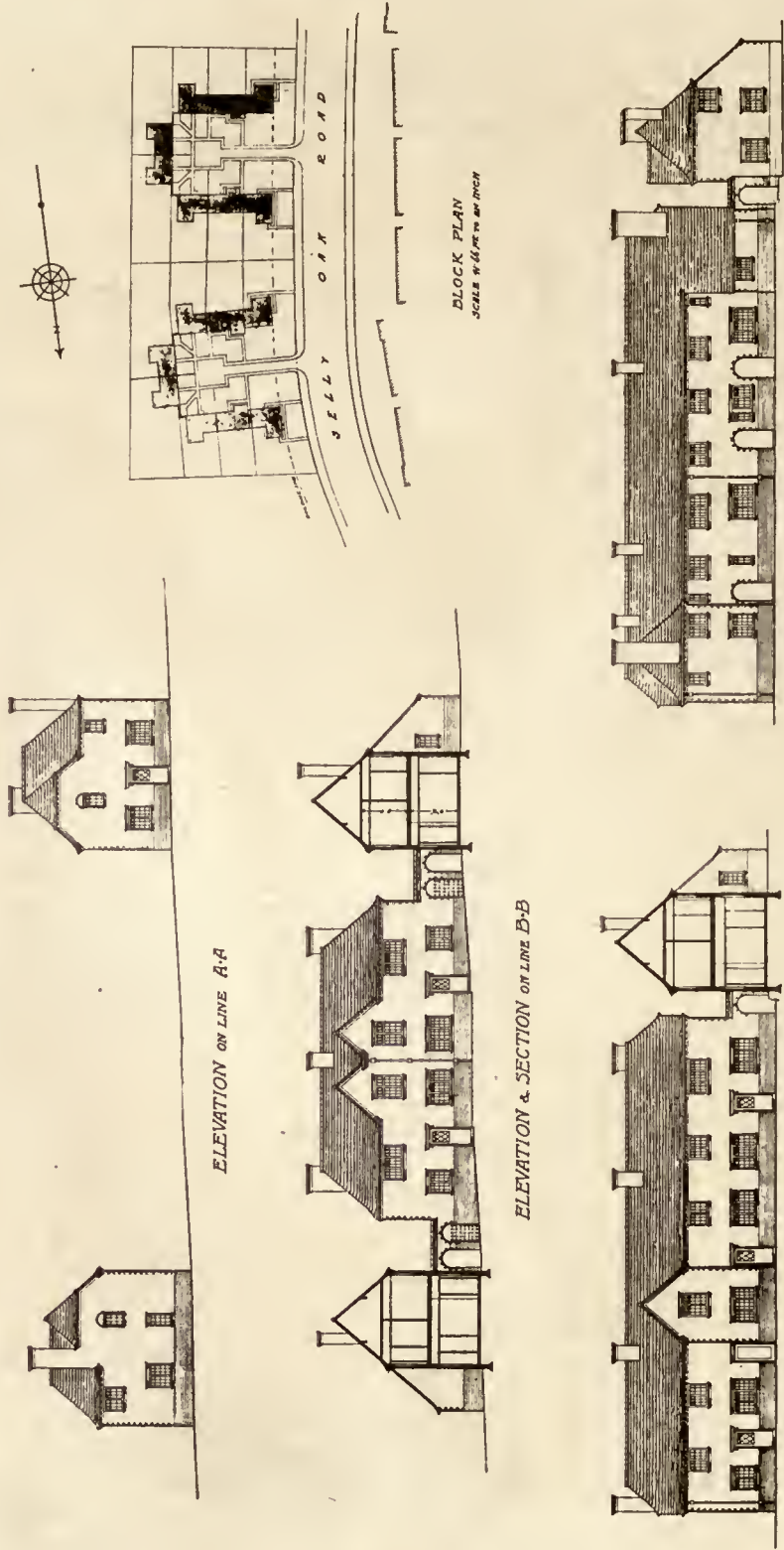

SCALE 1/8" = 10'

INGALL, BRIDGWATER & PORTER, BIRMINGHAM, ENGLAND, ARCHITECTS

# The Housing Problem and Earth Masonry

By THOMAS CRANE YOUNG

WHAT has blocked the progress of every housing project in this country, as well as in Europe, is the hard fact that under present prices of labor and commonly used materials it has proved utterly impossible to build even the smallest and most modest six-room cottage for a sum which, with the cost of the necessary land, would make the total investment for a home economically possible for the ordinary workman or moderately salaried individual. Houses which five years ago could easily be built for \$4,000 or \$5,000 will now cost \$8,000 or \$10,000.

A Congressional committee, reporting on the housing activities of the United States Housing Corporation, states: "Single houses in Bridgeport, Conn., cost \$7,263. The average for all houses was \$5,673.78."

It is not stated whether these prices represent a complete house or whether such necessary items as weather-stripping, electric fixtures, sidewalks, etc., were omitted. Probably no profit for the contractor nor cost of architectural service were included in these figures. And since the time these houses were constructed the cost of building has advanced possibly as much as 25 per cent. If one takes the average quoted price of

\$5,263.78 plus 25% = \$7,093.00 cost of house,

Add average price of

40 ft. lot at \$30. . . . 1,200.00 cost of lot,

\$8,293.00 cost of house and lot.

It can readily be seen that to pay rent or to own this home the occupant should have an income of at least \$3,500 per year. At \$1 per hour and working eight hours a day for 300 days a year, one could earn only \$2,400, which is inadequate income for above basis of cost for rent.

So far as one can learn, every new housing project yet planned or constructed, either in this country or in Europe, has been based upon some form of tenement or the traditional story and a half cottage, usually containing five or six rooms and constructed in the customary way of either brick, hollow clay tile, or wood. It would seem, therefore, if it is possible to beat the building game, it will be necessary to evolve an entirely new type of house or find some cheaper material as a substitute. It might be possible to evolve the former if architects and builders could rid themselves of tradition and study the matter as though isolated in a country

without the usual facilities of civilization and depend more upon their ingenuity and the materials which nature locally provides. In this way the Eskimo invented a cheap and comfortable dwelling built of ice; so did the early settlers in this country, who built of logs; and the early Spaniards and Indians of our Western States, who built of unbaked clay or adobe. There are abundant examples of these earth dwellings in our own country which compare favorably with the usual forms of construction for durability, looks and comfort. The Mission buildings of California are often constructed of this material, as well as many dwellings still in use after more than a century of wear. In this connection, one wonders why no one thought to construct our war cantonments and barracks of adobe instead of the unsightly, uncomfortable and costly wooden shacks universally used.

Adobe is a Spanish word from *adobar* (to plaster). It is nothing but air-dried brick of larger size than usual which may be weatherproofed with plaster, and any traveler in Mexico or California knows that these buildings are as beautiful as any we produce in the same class.

Many excellent plans for small cottages of the conventional American type have been developed by the U. S. Shipping Board and also by private architects, but as all of these have proved too costly to build, at least from a commercial standpoint, some new type of home will have to be devised in which every superfluous square inch of area and any unnecessary feature must be eliminated. Other possible economies may yet be found in new processes or materials as substitutes for present methods. Some years ago Mr. Edison led us to hope for much from his concrete house, but so far all forms of concrete have proved as costly at least as other forms of masonry.

A recent number of the London *Sphere* calls attention to an old form of masonry called "pisé" or "cob," the use of which in housing projects is now being considered in England and might be equally well applied in this country as an emergency substitute.

Sturgis' Dictionary of Architecture and Building describes it thus: "A cheap masonry of compressed earth. The most suitable solid for the purpose is clayey, somewhat sandy, loam and vegetable earth. It is mixed with straw or hay to prevent it from cracking when it dries. The wall is built in sections by means of a movable frame about

three feet high and ten feet long, the two sides of which are of boards kept apart the thickness of the wall. This frame is placed on the wall and between the sides the earth is rammed or beaten in four-inch layers. When this sort of box is full it is taken apart and set up in another place—in some parts of France houses of two or three stories are built of "pisé."

The *Sphere* states: The earth hardens to an astonishing extent in the process of drying off; so much so that it is sometimes difficult to bore into it with an auger. . . . The outer surface of the pisé wall can be color-washed or treated in various ways. Spraying with hot liquid tar has been tried successfully. The natural wall weathers in course of time to a very attractive color, and the outer surface itself withstands ordinary rain action and bad weather.

When properly waterproofed, there is no reason why these earthen buildings should not stand one climate as well as another, and certainly our variety is not more severe than that of the British Islands or of France.

Of course, there is no data extant as to the cost of earthen masonry, but in the present housing emergency it would seem worth while to make an experiment in constructing a real building with earth walls.

Since writing the above, I am able to present the results of some tentative experiments made by F. A. Winter, of Robert W. Hunt & Co., testing engineers, at my suggestion. The clay was ordinary clay taken from a local excavation. The loam was top soil taken from a vacant St. Louis lot. The mixture was dry and tamped into the form by hand.

COMPRESSION TESTS.

No.	MIX.	SPECIMEN SIZE.	AGE.	LBS. PER SQ. IN.
1.	2 parts clay—1 loam.....	9 x 6"	6 days	125
2.	2 parts clay—1 loam, mixed with straw and small amount of gypsum around the outside....	9 x 6"	6 "	156
Average weight—90 lbs. per cu. ft.				

No.		POUNDS PER SQ. IN.	
		6 days.	16 days.
1.	Plain clay.....	93	130
2.	5 parts clay—1 cement.....	78	125
3.	5 parts clay—1 gypsum.....	195	235
4.	5 parts clay—1 lime.....	0	20
5.	2 parts clay—1 loam.....	80	125

Another experiment was made to ascertain the natural surface left by the forms and possible methods of waterproofing. Earth consisting of two parts clay and one part loam, with a slight addition of dry gypsum, was mixed with a little straw cut into lengths of about four inches. This was tamped by hand into a wooden box about 12 inches square by 3 inches deep. The resulting block when taken from the form after seasoning for six days could be handled like a stone. The surface in contact with the wood form was more perfect than is usually obtained with concrete and was of agreeable color. The block was plastered on one side with ordinary house plaster which, of course, could as well have been of the waterproof variety. A part of one side was painted with ordinary house paint, and other parts were treated with liquid cement and with creosote for waterproofing. It appears that either of these materials could be successfully used and no doubt others not at hand at the time.

These experiments are by no means exhaustive and, therefore, one should be cautious about drawing too hasty conclusions, but the indications are that if a proper technique were developed this material might prove very valuable for small structures not requiring great strength and might be of particular value for housing projects or farm buildings because of requiring the use of nothing more than homemade apparatus and untrained labor.

I believe the subject would justify a really scientific investigation by our universities or, perhaps, by the Federal Government itself. For, if the results of such an investigation were satisfactory the information could be spread throughout the country by existing channels as the Government now does in regard to road building, or other matters relating to agricultural subjects, forestry, etc.

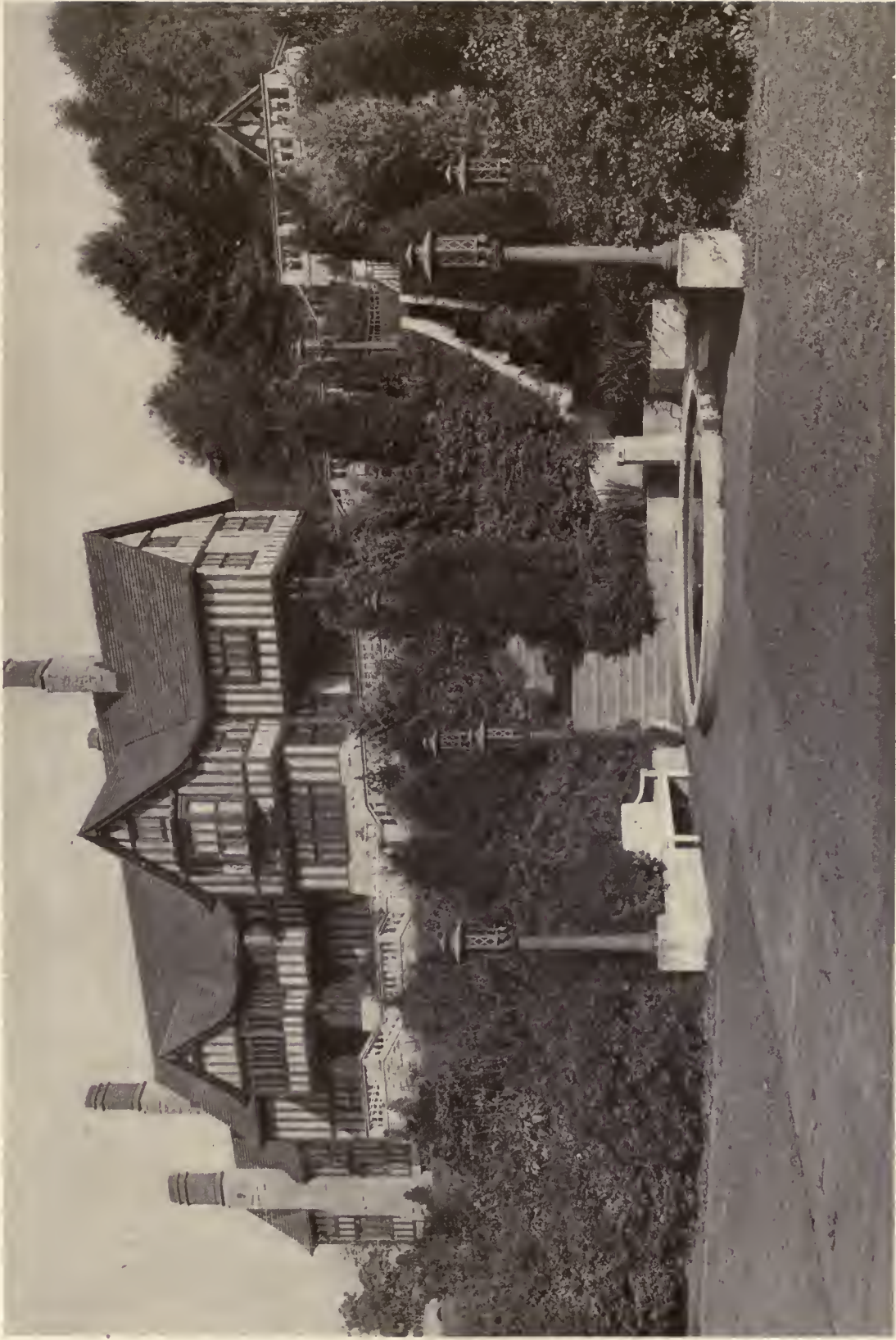

HOUSE OF GEORGE W. OLMSTEAD, LUDLOW, PA.  
ALBERT JOSEPH BODKER, ARCHITECT

1  
f68



4682



HOUSE OF GEORGE W. OLMSTEAD, LUDLOW, PA.  
ALBERT JOSEPH BODKER, ARCHITECT





3  
468



GARDEN  
HOUSE OF GEORGE W. OLMSTEAD, LUDLOW, PA.  
ALBERT JOSEPH BODKER, ARCHITECT





HOUSE OF GEORGE W. OLMSTEAD, LUDLOW, PA.  
ALBERT JOSEPH BODKER, ARCHITECT

4684



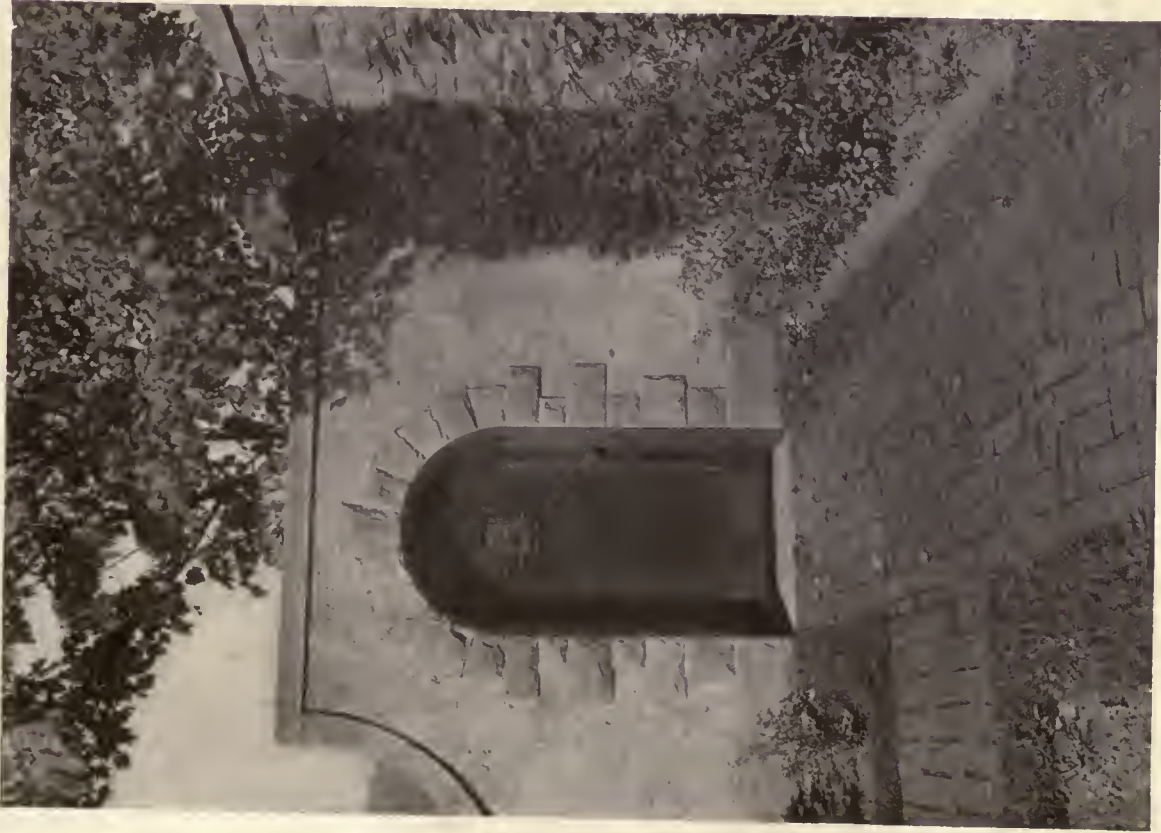

A GATEWAY



HALL

HOUSE OF GEORGE W. OLMSTEAD, LUDLOW, PA.

ALBERT JOSEPH RODKER, ARCHITECT

468  
51



4686



GARDEN

HOUSE OF GEORGE W. OLMSTEAD, LUDLOW, PA.

ALBERT JOSEPH BODKER, ARCHITECT







HOUSE OF E. M. RICHARDS, WEST NEWTON, MASS.  
JAMES FURDON, ARCHITECT

468 1



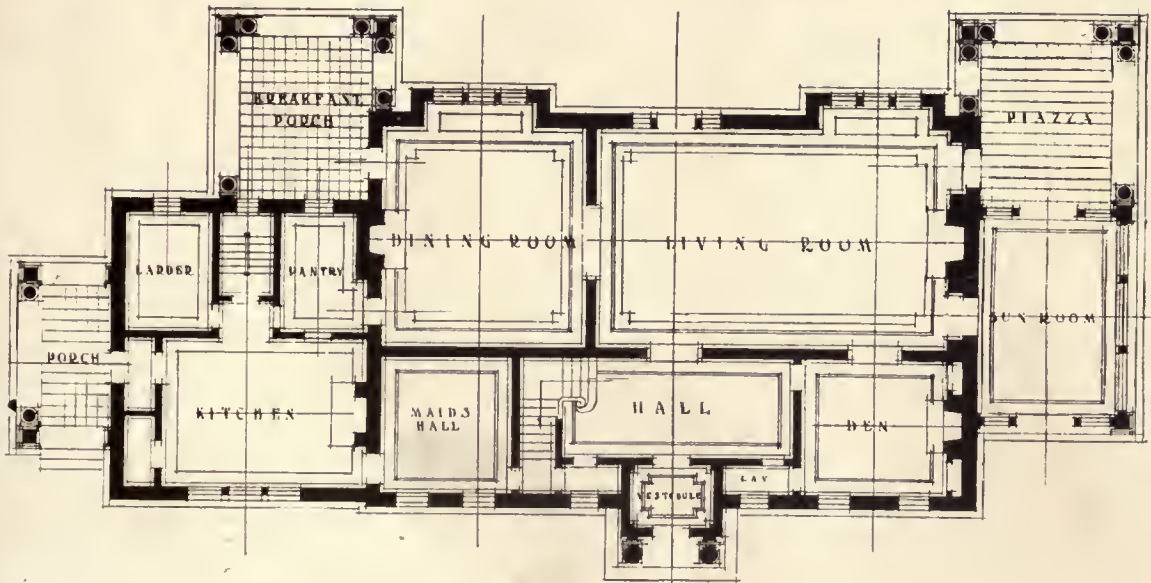

HOUSE OF E. M. RICHARDS, NEWTON, MASS.

JAMES PURDON, ARCHITECT



468



LIVING ROOM

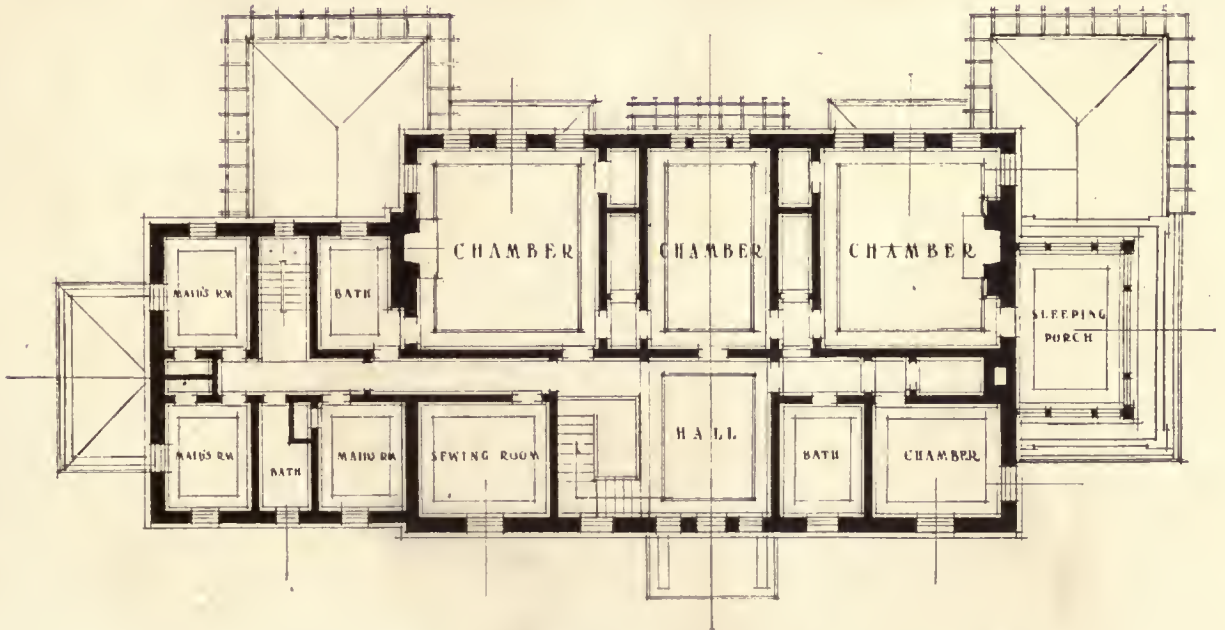

HOUSE OF E. M. RICHARDS, NEWTON, MASS.  
JAMES PURDON, ARCHITECT



# Current News

---

## Happenings and Comment in the Fields of Architecture and the Allied Arts

### Beaux Arts Post

The Beaux Arts Post of the American Legion, Chicago, met at the Art Institute, held its first meeting with 150 former service men and many guests in attendance. A good dinner and several rousing speeches, interspersed with musical selections, made a hit with everyone. Mr. Andrew Rebori spoke on the wonderful opportunity opening up before this post through the union of architecture, sculpture, painting and other arts, with particular reference to the possibility of bringing them together into harmony. Mr. Wick gave an extremely illuminating and authoritative discussion of socialism, communism and syndicalism.

All ex-service men who are interested in architecture or any of the fine arts are urged to attend these meetings either as guests or prospective members. Permanent officers will be elected in the near future, and if the enthusiasm evidenced at the last meeting is any criterion, this is bound to be one of the most active and progressive posts in the city.

### Roads in the National Forests

Thirty thousand miles of road, estimated to cost not less than \$150,000,000, will be needed for the proper protection and development of the national forests, according to comprehensive road plans which have been prepared, says a recent news letter of the Department of Agriculture. The Secretary of Agriculture has already approved the construction of 5,152 miles, estimated to cost \$26,463,000, contingent upon Federal and co-operative funds becoming available. Government expenditures of \$15,740,000 have been authorized for this purpose.

The roads comprised in the comprehensive road plans form the basis of the ultimate national forest road system. They are used as main highways, either in connection with through routes or to serve important local needs. The construction of feeder roads is being largely postponed until the primary road system of the national forests is completed.

### New Zealand Housing Conditions

Owing to the labor shortage and the building boom in New Zealand and Australia, New Zealand lumber mills are unable to meet the demand, says the Bureau of Foreign and Domestic Commerce in its consular reports. It is therefore expected that New Zealand's importations of American oak and Douglas fir will break all records for last year, as these lumbers are in great demand for the interior furnishing of homes. There is also a marked shortage of Oregon pine.

There seems to be plenty of money for loans for building homes in New Zealand, continues this consular report, which will enable the vast number of homes already planned to be constructed. In fact, the new housing bill

passed by Parliament during October provided for substantial loans to workers on a 5 per cent basis with one-half of 1 per cent rebate for prompt payment, for thirty years in the case of wooden houses and 36½ for those of some other materials. The New Zealand Government recently added 1,800,000 acres of provincial forest to the forest reserve, making a total of 10,500,000 acres, but of this the total area of milling value is only 1,371,000 acres.

### Building Trades Wages in Middle West

Chicago, Ill.—Building trades workmen in Chicago are better paid on the average than artisans in similar lines in most middle western American cities, concludes the Chicago Daily News after making a telegraphic survey of seventeen of the principal cities in its section of the country. Chicago building trades workers are receiving \$1 an hour. Nine of the seventeen cities are paying more for bricklayers and seven are paying a like amount. Carpenters receive \$1 an hour in Chicago and are getting higher wages in two other cities, Gary and Omaha, while in twelve cities they are paid less. Plasterers, structural steel workers, plumbers, gas and steam fitters, roofers and painters as a rule are receiving higher wages in Chicago than in other cities. Peoria and Detroit are paying bonuses to secure men. Gary scales are based on Chicago scales, although premiums are being paid there for workmen. Carpenters at Cincinnati are striking now for \$1 and \$1.25 on May 1; Toledo has a new scale effective April 1 with 25 per cent increase; Omaha which now pays carpenters, bricklayers and plumbers \$1.12½ has an increased scale effective June 1.

A number of the cities state that they have no labor shortage now in these trades but expect one when big building commences in the next few weeks. Exceptions are Grand Rapids, Mich., and Toledo, Ohio, where it is said that there is a scarcity in all trades and it is difficult to employ men. Grand Rapids pays carpenters 90 cents, and bricklayers \$1.10. The Daily News bases all its figures upon the eight-hour day, and presumably started its investigation because of the assertion of the Building Trades Council that the building trades workers in Chicago have been going to other cities to secure higher wages.

### Forest Engineers for India to Make Tour in This Country

A representative of the British Government visited the Forest Products Laboratory at Madison last week to arrange for a later visit of twelve forest engineers whom England is sending to India to establish a forest policy there and to solve problems of reforestation, wood utilization, etc., in that richly forested country. They will make a

tour of the United States in the Summer and will spend some time at the Forest Products Laboratory studying methods, tests, etc.

## Keep the Cement Sacks at Work

One empty sack at the cement mill is worth any number of them lying idle in dealers' or users' hands all over the country in so far as shipment of cement is concerned, states the Portland Cement Association in urging conservation of these utilities. Like many other kinds of cotton goods cement sacks are scarce. If every idle cement sack in the country were returned to the plant which sent it out, there would be considerable relief of the present shortage both of cement and sacks.

Besides, cement sacks cost money—money which is not working as long as these sacks are kept idle.

This condition is simply another one of those seemingly trifling items of neglect, which in its own way is contributing to keeping the wheels of industry from moving as regularly and as smoothly as is desired.

If a cement plant ships 1,000,000 barrels of cement a year in sacks, 4,000,000 sacks are necessary to take care of this shipment. Under actual conditions when shipments are made every day, the cement plant at the end of a year would find itself short of a very large number of sacks because dealers or cement users have not returned all they received. The following year it would, therefore, be necessary to supplement the stock of sacks by purchasing new ones. Sooner or later some sacks are certain to be lost through neglect or because put to improper use and thereby permanently kept from being again used as cement containers. No one knows exactly what becomes of them, but it means money lost to the careless user.

Many building and highway contractors have shown commendable enterprise in purchasing and storing during the past Winter large quantities of cement in anticipation of immediate need when the construction season opens. Naturally this has temporarily prevented the circulation of many cloth sacks. Nevertheless, there are enough empty sacks in users' and dealers' possession throughout the country, which, if returned to the cement mills, would make the number held out of circulation through storage of cement relatively insignificant.

Cloth cement sacks represent an outlay of money by the user until he has returned them for credit, and if they are not returned promptly the cement manufacturer must provide for new containers. This represents an unnecessary waste because far more containers must be manufactured and used than would actually be necessary if every cement sack were kept at work.

## Finishing Attic Rooms to Relieve Housing Congestion

Housing congestion is so acute in Chicago that the finishing of attic rooms is receiving the attention of building authorities in that city. It is estimated that there are in Chicago about 180,000 attic rooms which can be finished and made livable, accommodating 200,000 lodgers. If these rooms are finished and made attractive at an average cost of \$600 each and rented for an average of \$10 per month, the gross return would represent 20 per cent on the investment, the total investment being \$108,000,000.

While housing laws do not permit the cooking or living quarters in the third story of frame buildings, in which most of these rooms would exist, they might permit of

sleeping quarters and the rental would be very modest. The rooms could be properly finished and insulated so that they may not be too hot in Summer or too cold in Winter and halfway measures in remodeling them will not be profitable in the long run. If adequately done, they will assist the permanent resident in meeting higher rent problems and will help relieve the present congestion. The question of finishing attic rooms may be profitably considered by other cities.

## By Airplane to San Francisco

Delegates desiring to travel by airplane or dirigible, instead of by special train to the Seventh National Foreign Trade Convention which will be held at San Francisco May 12 to 15, are requested to send in their applications at an early date to O. K. Davis, Secretary of the National Foreign Trade Council, 1 Hanover Square, New York City.

Offer to transport any delegate by means of airplane or dirigible, "from his domicile, place of business or habitation, to San Francisco," is contained in a letter just received from Byron B. Smith, Foreign Manager of the United States Fidelity and Guaranty Company of Chicago, one of the active members of the Aero Squadron Training Corps, Inc., Ill. Mr. Smith has arranged to furnish upon request the exact cost of transportation, pilots' expense, etc.

At the Sixth National Foreign Trade Convention held in Chicago last year, there was a final declaration in favor of promoting commercial aviation and commercial aviation is also expected to play an important part in the program of the coming convention at San Francisco.

## Housing Condition in New York

That rent profiteering should be regulated without hampering the ownership of property is the attitude taken by the Real Estate Board in New York, according to advices from the State capital. The legislative representative of this board is quoted as saying, "The housing situation in New York City and in every city in the United States is acute. The high wages forced by organized labor has drawn heavily upon the country workers and has overcrowded the cities. In New York State alone there are over 25,000 vacant farm houses as a result of the drift toward the cities, whereas, in contrast, in New York City 200,000 apartments are needed to meet the demand." Crowded conditions necessitated the construction of 50,000 apartments in 1919 and 1920 in New York City, yet last year only 1,183 new apartments were built. In 1915 there were 934,822 apartments in Greater New York; in 1919 there were 982,015, an increase of only about 48,000 in five years.

## Male and Female Shade Trees

This is the time of year when the planting of shade trees is being considered. But care is needed in the species selected, and any city where cottonwoods are used for shade trees must be careful, if danger is to be averted, to plant only male trees, according to the New York State College of Forestry at Syracuse, which has prepared special bulletins on shade tree planting.

The cottonwood is not the only tree which proves the old adage about the deadliness of the female of the species, for the ginkgo is dangerous in a more serious degree than the cottonwood.



The female of the cottonwood is under the ban of many cities, because of its distribution of cotton, which clings to screens, making them unsightly and generally litters up the locality. In Albuquerque, N. M., for instance, there is a new city regulation providing for the destruction within ten years of hundreds of female cottonwoods and their replacement with male trees.

The female of the ginkgo species, however, is really dangerous, for its fruits form a slippery and dangerous substance, which is actually dangerous to pedestrians when thickly strewn upon a walk, and to some people the fruit is actually dangerous to the touch. This is so generally recognized that only the male of this species is planted in New York State

### Fuel Value of Wood

Two pounds of dry wood of any non-resinous species have about as much heating value as a pound of good coal. Speaking in tons and cords, a ton of coal may be taken as the equivalent in heating value of one cord of heavy wood, one and one-half cords of medium-weight wood, or two cords of light wood.

The following table, resulting from research of the Forest Products Laboratory, Madison, Wis., is an approximation of the number of cords of seasoned wood of various kinds needed to give the same amount of heat as a ton of coal, on the basis of 80 cubic feet of wood, with a moisture content of 15-20 per cent. to the cord:

1 cord	<table border="0"> <tr><td>hickory</td><td>ash</td></tr> <tr><td>oak</td><td>elm</td></tr> <tr><td>beechn</td><td>locust</td></tr> <tr><td>birch</td><td>longleaf pine</td></tr> <tr><td>hard maple</td><td>cherry</td></tr> </table>	hickory	ash	oak	elm	beechn	locust	birch	longleaf pine	hard maple	cherry	} = 1 ton coal
hickory	ash											
oak	elm											
beechn	locust											
birch	longleaf pine											
hard maple	cherry											
1½ cords	<table border="0"> <tr><td>shortleaf pine</td><td>Douglas fir</td></tr> <tr><td>western hemlock</td><td>sycamore</td></tr> <tr><td>red gum</td><td>soft maple</td></tr> </table>	shortleaf pine	Douglas fir	western hemlock	sycamore	red gum	soft maple	} = 1 ton coal				
shortleaf pine	Douglas fir											
western hemlock	sycamore											
red gum	soft maple											
2 cords	<table border="0"> <tr><td>cedar</td><td>cypress</td></tr> <tr><td>redwood</td><td>basswood</td></tr> <tr><td>poplar</td><td>spruce</td></tr> <tr><td>catalpa</td><td>white pine</td></tr> </table>	cedar	cypress	redwood	basswood	poplar	spruce	catalpa	white pine	} = 1 ton coal		
cedar	cypress											
redwood	basswood											
poplar	spruce											
catalpa	white pine											

Resin gives twice as much heat as wood, weight for weight. Hence such woods as the pines and firs have more heating power per ton than non-resinous woods. The resinous woods in the table are considered as having an average amount of resin (15 per cent).

The fuel value of wood depends in many cases not alone upon its heating power, but also upon such qualities as easy ignition, rapid burning, freedom from smoke, and uniform heat. As a rule soft woods burn more readily than hard woods, and light woods more readily than heavy woods. The pines give a quicker, hotter fire and are consumed in a shorter time than birch; whereas birch gives a more intense flame than oak. On the other hand, oak gives a very steady heat.

### Town of Biltmore Sold

Sale of Biltmore, near Asheville, N. C., built nearly a quarter of a century ago by the late George W. Vanderbilt as a model town, was announced. The amount for the town adjoining Mrs. George W. Vanderbilt's Summer home of the same name was not announced. The Southern Railway is said to have plans for a \$2,000,000 passenger station for Asheville on the Biltmore site.

### Business "Art" Criticized

Joseph Pennell spoke at a recent luncheon of the Poor Richard Club on "Art and the Business Man." When he had finished his attack on billboards, posters, newspaper comics, advertising and magazines, he was answered by Karl Bloomingdale, vice-president of the club, who said Mr. Pennell's speech was like mince pie—he liked it immensely but it did not agree with him.

"The billboard is the curse of America," Mr. Pennell said. "The United States has been grabbed by a gang of thieves and robbers, who have robbed it of its beauty. It is as much a crime to steal beauty as it is to steal a man's pocketbook."

### Making Use of the Landscape

Automobiles get people out into the landscape, writes Frank A. Vaughn in *Civic Comment*. That is one of their greatest services to society. Here are a few figures to show the extent of such recreation. They are taken from a private letter from one of the national forests officials in California. He says:

"My entire Summer was devoted to recreation work in the field. California had the greatest Summer recreation crowd ever known. Every resort and camp was full to overflowing. We estimate that one million people visited the forests of California the past season. About 90 per cent of the forest travel was by auto; the remaining 10 per cent by train, horse vehicles or on foot. The auto parties averaged about four persons per machine, and about 85 per cent of the forest travelers were campers. and the other 15 percent stopped at resorts and hotels. To give you an idea of the travel on special occasions, the auto visitors to Lake Tahoe on July 3 and 4 may be cited. By actual count, 10,000 automobiles went to the lake on the Lincoln Highway on the above dates. This is some travel for mountain roads that reach elevations of 8,000 feet. Our camp grounds were entirely inadequate to handle the crowds, and we are now developing more camps as rapidly as funds will permit."

From which report many important inferences may be drawn, such as: The public like a good landscape when they can get in a combination of good public reservation and good roads works most satisfactorily; the work of public foresters in providing good safe camp grounds meets a large need.

### Illinois Chapter, A. I. A., Meeting

The March meeting of the Illinois Chapter, A.I.A., was well attended, the special business for the evening being the election of delegates to the annual convention of the institute at Washington, D. C., May 4, 5 and 6 next.

Delegates chosen are: I. K. Pond, past president, ex officio; Richard E. Schmidt, director, ex officio; Henry K. Holzman, chapter president, ex officio; Albert Moore Saxe, chapter secretary, ex officio; N. Max Dunning, F. E. Davidson, Herbert Foltz, Charles Herrick Hammond, Emery Stanford Hall, Elmo C. Lowe, George W. Maher, Victor A. Matteson, George C. Nimmons, Dwight H. Perkins, Frederick W. Perkins. Alternates in the order of their election John A. Armstrong, John Reed Fugard.

The meeting passed a resolution asking that the City Council take no action on the proposed height of buildings ordinance until the proposed zoning commission had reported.

The business session was followed by an illustrated lecture on "Egyptian Art and Architecture," by Dr. Thomas D. Allen, of the University of Chicago.

## New York Society of Architects

The March meeting of the New York Society of Architects was held on the evening of the 16th.

Among the matters discussed was the Dodge-Leninger bill now before the New York Legislature conferring on the Board of Appeals the power to reverse orders of the Tenement House Commissioner. The Tenement House Committee of the society was ordered to take up the question of the creation of a Board of Appeals from decisions of the Tenement House Commissioner.

Attention was called to the bills now pending at Albany providing for increased interest rates on mortgages. It was the sense of the meeting that this would be most unfortunate, as it would raise rents still higher. The society will have a representative at the hearing to speak against this bill.

A nominating committee was appointed to select candidates for office for the coming election at the annual conference in May.

## New York to Take Possession of Niagara Gorge

A bill providing for the resumption by the State of the water power of the Niagara gorge has been prepared under the auspices of the Conservation Commission and will be pressed to passage.

The bill provides for a bond issue of \$15,000,000, which will necessitate a referendum. If the bond issue is authorized, it will enable the State to proceed with the development of one of the most economical and largest water power projects in this country. One hundred and sixty-five thousand horsepower will be generated, which will overcome the acute shortage of power in all of the western part of the State, and will insure an adequate return to the State treasury from this great natural resource.

The proposed legislation corrects the mistakes of the legislatures of 1890, 1893, 1894 and 1902, which gave away absolutely free the most valuable water power rights of the country, and thus is similar in its results to the cancellation of the diversion rights in the Long Sault of the St. Lawrence.

Unless the State can regain control of the waters of the Niagara gorge, the companies chartered years ago, but unproductive for a quarter of a century, will remain in complete possession of their unearned privileges, and, if these companies can obtain permits from the Federal Government they will reap returns which ought rightfully to go to the people of the State.

The program provides that the State sell the power to the highest bidders, preference being given to municipalities. The State would thus not enter upon the complicated experiment of distribution, leaving that to private enterprise or municipalities, and confining its own work to the comparatively simple operation of the power plant.

## Annual Convention of the American Civic Association

The sixteenth annual convention of the American Civic Association will be held in Amherst, Mass., October 13, 14 and 15, 1920. The meeting will be held as a part of the fiftieth anniversary celebration of the Massachusetts Agricultural College.

Because the village of to-day will be the town of tomorrow, important attention will be given to the subject

of country and village planning. Massachusetts and the neighboring New England States afford splendid examples of the ideal village. Interesting and instructive automobile trips will be planned for the delegates and historic towns in the neighborhood of Amherst will be visited. The character of the program, emphasizing, as it will, rural and village improvement, will be in interesting contrast to the program of the fifteenth annual convention, which dealt almost exclusively with the question of the big city. The program committee has recently been appointed, with Dr. John Nolen, of Cambridge, Mass., as chairman. Dr. Nolen will be very glad to receive suggestions for special features of the program. The tentative program will be issued early in the Summer.

## Personals

C. E. Richardson, formerly of McKim, Mead & White, and later with Bliss & Faville, of San Francisco, has accepted a position with Messrs. Temple & Burrows, architects, of Davenport, Iowa.

William J. Todd and Harry T. Miller have formed a partnership as architects and engineers, with offices in the Masonic Building, Phoenix, Ariz. They desire to receive trade literature and manufacturers' catalogs, samples, etc.

Erle J. Osborne, 2026 Jackson street, San Francisco, has opened offices at 821 Balboa Building, San Francisco, for the practice of architecture.

James H. Hoose, formerly of Bakersfield, is now practicing architecture in Modesto. His address is 818 Thirteenth street.

Ralph Wyckoff, of Salinas and Watsonville, Cal., and Hugh C. White, formerly with Lewis P. Hobart, have formed a partnership for the practice of architecture, with offices in Salinas, Cal.

Charles Howatt Biggar has resumed the practice of architecture in Bakersfield, Cal., after serving Uncle Sam for a period of two years as an officer in the Engineers' Corps. Mr. Biggar would like to receive catalogues and other trade literature from manufacturers of building materials.

Charles F. Masten and William W. Hurd have formed a partnership for the practice of architecture, and have taken offices on the sixth floor of the Foxcroft Building, San Francisco.

Koch & Wagner, architects, have moved from 26 Court street to the Chamber of Commerce Building, 32 Court street, Brooklyn, N. Y.

Wm. H. Mersereau, architect, has moved from 32 Broadway, New York, to Oakwood Heights, Staten Island, New York, where catalogues are desired.

George Awsumb, Chicago architect, has become associated with Charles O. Pfeil, 1403 Union & Planters Bank Building, Memphis, Tenn., under the firm name Charles O. Pfeil, architect, George Awsumb, associate. Catalogues are requested.

Warren W. Day has returned from overseas with Les Foyers du Soldat of the French Army and has reopened offices at 527 Main street, Peoria, Ill.

# Weekly Review of Construction Field

## Comment on General Conditions of Economics With Reports of Special Correspondents in Prominent Regional Centers

THERE is no doubt but that the method of financing home construction which is known as "The Detroit Plan" is proving to be the most practical and influential yet conceived. It is a plan not conceived upon philanthropic grounds, but within strictly business lines. It is not an emergency measure for a temporary good, but the plan of an institution which is to be of permanent value to the community and which expects to pay a reasonable profit to the investors. To everyone it has been only too apparent that there is a sentimentality in the minds of many who discuss the building problem. The movers of the Detroit Plan, however, have steered an even course between this danger and the fault of the hard and fast system already in existence in the American cities. They have recognized that there is but one possible way to provide houses for a certain number of the people in a large industrial center and that is to build them and give them to such people on some rent paying basis.

The corporation, which has a capital of three million, has twenty-seven directors representative of the manufacturing, industrial and banking interests of the city—meeting monthly. There is an executive committee of six which revolves out of the directorate, two every four months—meeting weekly. The officers are a President and General Manager, Vice-President and Treasurer, Vice-President and Secretary, the President and Treasurer being continuously active in the business.

Subscriptions to the capital stock were secured at a series of luncheon meetings to which a selected list of business men and financiers were invited. The method of apportioning the subscriptions has been that the manufacturer or business man has subscribed on the basis of the number of men and women employed in his office, store or shop:

For the first 500 or any part, at	\$25.00 per employee
For the next 501 to 1000 at	20.00 per employee
For the next 1001 to 5000 at	15.00 per employee
For the next 5001 to 20,000 at	12.50 per employee
For over 20,000 at	10.00 per employee

There are two general divisions of the business: the Financial Division and the Division of Plans and Contracts. Under these divisions are several sub-sections such as an Application and Developing Department to receive and investigate applications as to credit, employment, lot engineering and lot appraisal; a Legal Department for passing upon and making all necessary papers; a Clearance Committee; a Loan Committee and a Securities Department for the handling of securities used in revolving the funds. In the Plans and Construction Division there is a section for making plans and specifications, one for contracts and estimates and one for building and inspection.

The plan does not finance the completion of houses already in the course of construction and grants no loans unless the corporation controls and supervises the building operations. For the present loans are confined to an amount not in excess of \$6,000 for a single house. All interest charges are at the rate of 6 per cent.

THERE are three general classes of business: The Banking Plan, the Operation Plan, and the Contractors' Financing Plan. The Banking Plan is for those

applicants who either own lots or who wish to purchase a lot in some specific locality. Such applicants are not restricted in the use of building plans; they must, however, submit bids from recognized contractors that will establish the fact that the desired house is to be built at a price covered by such amount of money as is authorized as a loan. If there is uncertainty as to the ability of the contractor, the corporation's estimator secures competitive bids. If the bid is higher than the authorized loan, no attempt is made to alter the applicant's plans so that the price may be reduced, but the corporation presents one of its own plans for a building which can be erected within the allotted amount.

The corporation loans up to 80 per cent of the total amount involved in the transaction as represented by the combined appraised value of the lot and cost of the home. The applicant deeds his lot to the corporation, loan is then made and contract of sale is made between the applicant and the corporation for an amount covering both the value of the lot and the building to be placed on it, the applicant being credited with the appraised value of his lot and any additional cash that he may have paid.

The houses are built as a rule under standardized plans, and it has been found that the savings in some cases have amounted from twelve to fifteen hundred dollars on a six thousand dollar operation.

It is thought that the payment for the home should be accomplished in ten to twelve years. The client also pays the expenses of the transaction, which are figured to amount to \$67.50, within the first year; if paid in cash at the time of signing the contract a cash discount of 5 per cent is allowed.

**The Operation Plan:** In order to get houses erected more quickly, the corporation purchases vacant lots and erects groups of houses simultaneously which are disposed of to applicants at prices from \$3,500 to \$4,500 under the same general provisions as in the Banking Plan.

**The Contractors' Financing Plan:** The savings banks and trust companies are unable to fully meet the extraordinary demand for first mortgage loans, therefore the corporation is prepared to finance contractors on new operations by advancing cash to them. The building plans must be acceptable and the operation subject to general examination and inspection. Loans are not considered where the price of a single house is in excess of \$6,000 and the basis of all loans is upon the appraisal by the corporation considered in connection with the cost figures to which is added a profit of approximately 15 per cent, this total constituting the sale price of the property.

Loans are made on contractors' collateral notes for periods not exceeding three years at 6 per cent per year, payable semi-annually:

- 65 per cent on the sale price of the property when 10 to 15 per cent down payments are made;
- 70 per cent on the sale price of the property when 15 to 20 per cent down payments are made;
- 75 per cent on the sale price of the property when 20 to 25 per cent down payments are made.

Deed and land contract covering the sale of property is to be assigned and deposited with the corporation as col-

lateral for the loan. Monthly payments of not less than 1 per cent of the sale price, less the down-payment, are required. At the time of closing the transaction the contractor pays all legal department charges.

Contractors buy their own lots, building the type of house with which they are most familiar and provide their own market for its disposal. It is necessary, however, for the contract to have the approval of the corporation as to location and type of house and to show a home owner as purchaser and not a prospective speculator.

ON September 20th, 16 houses were contracted and 10 under construction; on December 20th, 550 houses had been contracted, 300 were under construction and 91 were completed.

The report of the President of the House Financing Corporation to the stockholders says: "Our organization, as now operating, can project its activities in an almost unlimited manner, thus making it possible to fully meet the housing requirements. The whole effort is limited only by the amount of capital that is available. Such capital can find the safest kind of investment through this enterprise, backed by a type of collateral that is beyond question and on which it can earn at least 6 per cent per annum from the date of investment. It is difficult to imagine how capital could be invested in a safer way, and could, under any circumstances, accomplish greater good for the city as a whole and many individual house builders in particular."

*(By Special Correspondence to THE AMERICAN ARCHITECT)*

CHICAGO:—Strikes of stockyard employes, railroad switchmen, and city hall employes; increase in wages to members of the building trades unions of from \$1 to \$1.25 an hour; steady increase in lumber prices; a boost in money rates to the legal state limit of 7 per cent; and a suggestion from local economists that voters should decline to approve additional municipal issues for public works do not furnish a very rosy outlook to the general situation in Chicago this week.

And yet last week's real estate transfers broke all previous records, totaling more than 2,000 with an aggregate consideration of \$6,000,000, or \$3,000,000 above last year.

Not the least interesting feature of the whole situation is the undoubted fact that the shortage of labor is primarily a result of the shortening of the working day and the decreased efficiency of labor. Leading contractors say that no reduction in the cost of construction may be expected for a long time. The continued shortage of cars, high wages, and limited production have caused many to urge those contemplating building to build now. Nevertheless, it is generally known that promoters of many large projects are seriously considering abandonment of their plans.

The "vicious circle" of high prices and high wages continues. People are spending as never before, apparently under the impression that the present level will be maintained indefinitely. That there is a shortage of labor is generally admitted, as is the fact that production falls far short of the demand. It is safe to say that conditions are not growing any better. It should also be added that there is evidence of growing unrest here during the last week. Incidentally, in the clothing trade, pocket makers are now threatening a strike unless given an increase in pay.

Chicago, with its enormous alien population, reflects the labor situation more nearly than any other large city in the country and is the first to feel the effect of the steady emigration to Europe.

*(By Special Correspondence to THE AMERICAN ARCHITECT)*

SAN FRANCISCO:—The "own your home" movement seems to be gaining impetus here. Whether this is due substantially or even indirectly to the vigorous campaign which has been waging in San Francisco for the past few weeks against alleged rent profiteering, particularly on the part of downtown apartment houses and hotels cannot be ascertained, but this reflection on downtown housing facilities is held responsible by some of the building interests for the marked interest shown in residential properties in the outlying districts.

Several large building projects have been announced during the past week for extensive development work in desirable residential sections of the city. Prominent among them may be mentioned the plans for the erection of one hundred and fifty new homes in the Sea Cliff district. Over \$90,000 is being expended in paving the streets and the building of sidewalks and curbs in conjunction with this development project. Plans have been completed for some of the new homes, and others are in the hands of the architects, prices ranging from \$20,000 to \$30,000 on many of them. It is announced that the materials entering into the construction of the higher class residences will be of exceptional quality. Instead of the customary white pine, Southern gum, and other woods used in low-priced houses mahogany will be employed in many cases.

While the situation is easing up a little, as far as getting supplies of certain materials is concerned, this feature of the building program here is still causing more or less uneasiness. Steel deliveries are slow, the lumber supply is low, and the brick and tile plants in the vicinity, on which the local market is dependent for supplies, report a rush of business which makes it difficult to keep up on deliveries.

*(By Special Correspondence to THE AMERICAN ARCHITECT)*

SEATTLE:—Weakness in the fir lumber market, firmness in steel products, particularly as to small essentials; refusal of the mills to accept new orders preceding the third quarter of the year and a slowing down of the business and home construction demand, were the outstanding events of the week in the construction life of the North Pacific Coast territory.

Prices generally have remained rigid without perceptible fluctuations in costs, although the difficulty of getting delivery has not softened. Jobbers report a slowing up in the inquiry for brick, cement, plaster board and tile. Labor is plentiful, and there are today no perplexing industrial problems for the employer. Bank clearings locally indicate a reduction in unnecessary expenditures, and, while financial men regard the symptom as a healthy one, they realize that it is not ultimately conducive to great construction work.

The most baffling problem of all for the jobber of building essentials is that of all kinds of nails, particularly the smaller sizes. Eastern mills, pressed for their attitude, state that they are not eager for orders for finer grades when they can move capacity production in the larger materials.

Jobbers who have perennially led and who have taken their profits on the volume basis are receiving a carload of nails every two weeks, but this delivery is made from the warehouses on emergency and business is not being accepted for shipment on arrival. It is necessary to distribute the pittances to many jobs. Similar conditions prevail as to the pipe trade, although it has become difficult now to secure both large and small sizes. Steel bars are slow in arriving, and must go under the ration plan. Nails advanced 50 cents per cwt. this week.

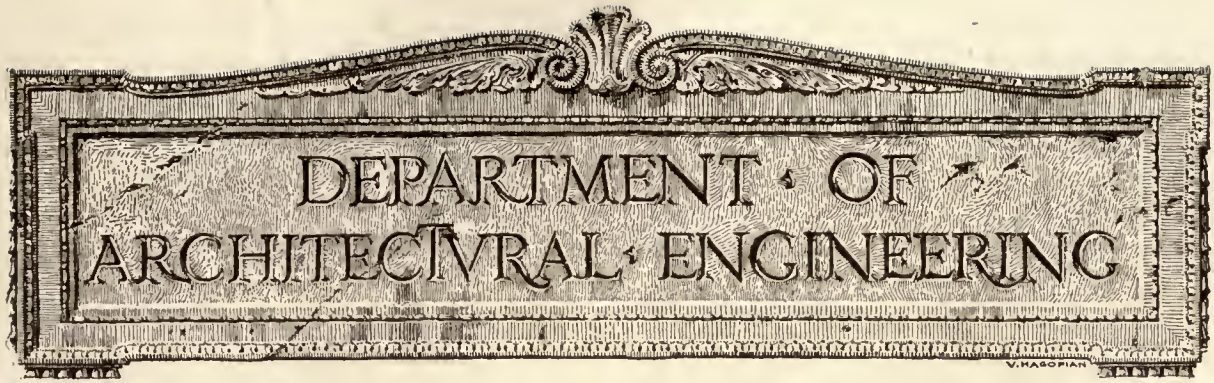

## The Expense of Estimating\*

Present Methods of Duplication of Effort in Estimating Involve Tremendous Waste—Quantity Survey Should Be Furnished by Owner With Plans and Specifications—Would Eliminate Needless Expense and Insure Uniform Basis for Bidding

By HENRY K. HOLSMAN, PRESIDENT, ILLINOIS CHAPTER OF THE A. I. A. CHICAGO

**Y**OUR chairman has asked me to talk to you about the architect's attitude toward the "Expense of Estimating." I need not say to you as a body of contractors that the architects as a class are bound to be conservative when it comes to adopting some new way of doing things. There is always apprehension that any change is urged for the advantage of somebody else. For a good length of time a proposal may be questioned to see whether there is really anything in it that is of general good, or that would not be of some particular advantage to those who make the proposition.

The architect's attitude in general toward innovations might be likened to the attitude that is generally considered characteristic of the people of Italy. A number of years ago when I superintended a building here in Chicago, I had reason to come in contact with workmen of this nationality, and my own observations were borne out by those of my superior who had had a great deal of experience. When one Italian sees two other Italians talking or discussing something, he immediately imagines that they are hatching some conspiracy against him.

There are many of us who have been for a long time trying to break down some of the prejudices in the minds of the architects opposed to co-operating with the builders, and also opposed to meeting and co-operating with the laborers and helpers.

\*Address given before the Building Contractors' Division of the recent National Conference on Construction of the Associated General Contractors of America.

### TREMENDOUS WASTE IN ESTIMATING

**A**RCHITECTS have realized for a long time that there is a tremendous amount of waste in the present method of making up estimates. The burden is said to be borne by the contractors, but as a matter of fact the contractors as a whole must pass it on to the community, and the architect is justified in co-operating with you in an effort to eliminate that waste as soon as possible, on the ground that it would eliminate an unnecessary charge against the community. When the architect fails to take off the quantities for a job before giving out the plans to ten different contractors and asking for bids, the estimating that must be done on that one job is ten times more estimating than would have been necessary, so far as quantity is concerned, if the architect had given the contractors a survey of the materials that would be required to be left in place in the building when the building is finished.

Now, the cost of estimating, or expense of estimating, in our judgment cannot be entirely eliminated from the contractors' expense. The cost of selling your product, your experience, your ability, must be borne by your trade much the same in contracting as in selling any article of merchandise.

The situation of the buyer in the building field may be summed up as follows: Presumably the owner has gone to the architect and has had the architect make plans and specifications for approximately the kinds of materials he wants to get. He then hands these plans and specifications to the contractor for his experience in estimating and for putting together a structure so that it can

be used efficiently. In that case the owner has set down the kinds of material that he wants, and has presumably paid for that much of the cost of selling as distinguished from the prices ordinarily employed in the commercial world.

But he still falls a little short in our estimation. He gives the contractor plans and specifications laid out in the general way, but he might have gone into the estimating end of the matter and given the general contractor a quantity survey of the plans and specifications, which would make it much easier and less hazardous for the seller to price the commodities.

#### CONCLUSIONS OF JOINT CONFERENCE

IT is with that thought that the Joint Conference on Payment for Estimating Construction Work, which is composed of a committee of your organization, one from the American Institute of Architects, and one from Engineering Council, formulated the resolutions that I shall now take up. Two meetings were held by the Conference, at which the subject of the expense of estimating was discussed at great length. The resolutions adopted are as follows:

WHEREAS, there is great economic waste in the present usual methods of individual estimating of the same quantities by several different bidders on the same project, therefore

*Be it resolved*, that the following are the conclusions of this conference:

First, That any system of duplication of effort in estimating, wherein each bidder separately estimates the quantities, should be condemned.

There are many reasons, which you know better than I, why such methods of estimating should be condemned. But what comes to my mind just now as most important is that the largest part of the great variation in bids on a structure is not due to the difference in prices that contractors place on materials, but is due to the variation in the estimates of the quantity of material and labor that would be necessary to carry out the plans and specifications. The commonest complaint is: "I got that contract because I made a mistake—I left out the floor." That alone is enough to show that the system should be condemned—that it is an economic waste.

Then, if there is an average of ten bidders on one job, or if every contractor on the average must bid on ten jobs to get one, manifestly there is ten times as much effort expended as is necessary. It is also manifest from our point of view that if the quantities for the job were taken off in a systematic manner according to a system universally adopted by the contractors, and if the quantities were taken off under the supervision of the architect who makes the drawings and the specifications, the quantities then would be more apt to correspond

with what is expected by the architect than if they were taken off by some individual who never saw the tracings and specifications before.

If it is specified that all contractors shall bid on this bill of quantities, or on this quantity survey and none other, they have at least one common thing fixed. Under the present method, each bidder may submit a proposal on a different schedule, based upon the way his estimators have interpreted the plans and specifications, and upon the care taken to include everything called for.

#### RECOMMEND FURNISHING SCHEDULE OF QUANTITIES

THE second section of the resolutions is as follows:

All competitive bids should be based upon a detailed schedule of quantities prepared from a survey of the plans and specifications, and submitted therewith, the costs of the preparation of such survey of quantities to be borne by the owner.

The only comment I have to make on this is that we all agree that if the buyer, the owner, is going to go to the trouble of having the plans and specifications prepared, it is logical that he should go further and get a comprehensive bill of material of quantity survey that could be easily priced.

In considering the value of a quantity survey, we realize that it will be necessary gradually to work out a standard practice. Quantities must be so listed that the bidder, when he uses them in preparing his bid, along with the plans and specifications, can understand just what will be needed, and can judge accurately as to the labor cost of the work.

The third part of the resolution bears upon payment for pricing the work and states:

While the owner should furnish a quantity survey as the basis of bids and contracts, and should submit them with the plans and specifications, and should pay for the same amounts to the bidder, the bidder should make no charge to the owner for submitting proposals based on said plans, specifications and quantity survey.

While the owner should furnish a quantity survey to contractors as a basis of bids, we do not feel that, in addition to this, he should pay each contractor for pricing the quantities and for the various items of overhead that bidding on projects entails.

There is undoubtedly an economic gain resulting from the preparation of a quantity survey by only one individual or institution instead of by five or ten as the case may be, provided these quantities are guaranteed to be correct enough for bidding purposes. Even if the quantity survey says that there is less material required by the plans and specifications than will be necessary, so long as it affords an equitable basis for bidding, it has served its purpose in a large measure. Adjustment of the

contract price may be made to correct errors to correspond to actual conditions, either before the contract is signed or as the work proceeds.

But when the owner and buyer has gone that far, he says, "This will do for the basis of bidding; here is something that you can give us your prices on. But we feel we ought not to go further as buyer, and so we will not pay you for putting prices on these quantities."

In other words, if we were to say that the owner should pay a contractor for his trouble in figuring up his prices and bidding, we would be going too far. The accepted principle in commercialism is that the cost of selling a product be added to the price charged the buyer, but only in case he does actually buy. Our first step is to say, then, that bidders should make no charge to the owner for submitting prices on his building project, provided the quantities are furnished.

#### WITHOUT QUANTITIES, PAY EACH BIDDER

**I**N the last section of the resolutions, an alternative is proposed whereby each contractor would receive pay for his estimate if he had to prepare his own quantities.

In general, competitive bids should not be invited nor submitted on projects, the plans and specifications for which are not accompanied by a quantity survey, unless the owner agrees to pay a predetermined fee to each bidder for preparing the quantities and submitting an estimate.

This clause, I think, was finally determined upon as a suggestion of co-operation between the builders and architects by way of helping to get the thing established.

Now, you see, if we could agree upon these principles, and have it recognized that they are just and fair to the contractor and the architect, and have them widely known, we could accustom those interested to the idea that unless the plans and specifications are complete, and include a quantity survey, they are not yet ready for bids. This would mean a long step toward reducing some of the errors in bidding and the estimating expense under the present method of bidding.

In conclusion, I want to point out that there were three architects, two engineers and three contractors in this Conference, and particular pains were taken that our conclusions should be unanimous. I think all these resolutions were adopted unanimously by the Joint Conference.

The following resolution was that submitted by the committee on Resolutions and adopted by the National Conference:

*Resolved*, That the progress report of the joint conference of the American Institute of Architects, Engineering Council and the A. G. C., on payment for estimating construction work as submitted to the annual meeting by the Committee on Methods, be adopted.

## Recommendations of Joint Conference on Payment for Estimating

**T**HE complete progress report as approved at the second meeting of the Joint Conference follows:

Place—Old Colony Club, Hotel La Salle, Chicago, Ill. Feb. 16, 1920, 2:30 p. m

Present—Representing the American Institute of Architects: Messrs. F. W. Perkins, Henry K. Holsman and Richard E. Smith. Representing Engineering Council: Messrs. T. L. Condron and Samuel G. Neiler. Representing the Associated General Contractors of America: Messrs. A. P. Greensfelder, H. L. Wells and W. E. Hanson.

This meeting followed a preliminary meeting of the conference held on November 16 and adjourned to this day

The following statement of the purposes of the conference was presented by the chairman, A. P. Greensfelder:

#### PURPOSE OF CONFERENCE

"(1) The present cost of estimating construction, including unnecessary duplication of effort in taking off quantities, a large amount of useless estimating on projects which do not go ahead, and the losses sustained by contractors due to inaccurate estimates, is too great and should be reduced. With proper action on the part of architects, engineers and contractors it is estimated that at least two-thirds of this cost could be saved.

"(2) Inefficient methods and inequitable distribution of the cost in making estimates and in securing bids are largely responsible for the waste that exists in estimating.

"(3) The needless confusion and questionable practices that have recently developed in local bidding methods in an attempt to solve the problem may be eliminated by a mutual national understanding; and finally

"(4) Due to the increasing demand from many localities for the elimination of unnecessary expense in submitting estimates and a better allocation of said expenses, this subject calls for immediate consideration.

"The following statement of methods in vogue at present is submitted:

#### METHODS NOW IN VOGUE

"(1) To solve these difficulties, many contractors, in supplying their own quantities and estimates are now combining to include the cost of such combined estimates in the bids submitted, either with or without the knowledge of the architect or engineer.

"While this plan reimburses the contractor for the cost of estimating and partially allocates same to each project, it does not reduce the duplication of effort or expense, but rather adds to it due to the necessity of a broker or agent as collector. It does not, however, allocate the cost of jobs which do not proceed or wherein all bidders are not members of the collection bureau or co-operating therewith. Furthermore, this system in the hands of unscrupulous men is open to abuse in that it may be operated secretly without the knowledge of either architect, engineer or owner, and thus made a method for charging whatever 'the traffic will bear,' and unduly increasing the number of bidders, some of whom bid only for the payment thus received. Both of these conditions may tend to cause an unfair assessment to the owner.

"(2) A second solution which is less commonly used at present is that whereby the several bidders secure their

quantities from a central survey bureau and supply estimates in return for a fixed charge which is included in their bids. This plan reduces the actual cost of estimating by concentrating the work of estimating, by providing a uniform quantity basis for estimating, and by partially allocating the expense of estimating on those jobs which proceed. It is not in general favor because, since contractors must be responsible for the survey quantities, they most frequently prefer to furnish their own estimates either in entirety or as a check on the quantities submitted by the central agency. The result is that each contractor more frequently supplies his own estimate, reverting to Method I above, or the present inefficient method of taking care of cost of estimating by charging it entirely to the general overhead.

"(3) A third plan which has proved highly successful provides that the owner shall furnish quantities as the basis for the bid and contract and that the owner shall pay the contractor the cost of estimating labor, pricing the quantities and performing other professional services in connection with submitting the bid. This plan reduces the cost of estimating to the owner in direct proportion to the number of bidders and further reduces it by forcing jobs which do not go ahead to bear their proper charge for estimating. Instead of charging the cost of estimating from 10 to 20 jobs which do not proceed to those which do, as overhead, this method allocates the cost of each project where it belongs. It provides also a uniform quantity basis for comparing bids, although not a uniform measure of quality, service, skill, honesty or responsibility. It insures greater accuracy on the part of the contractor in bidding and enables the architect or engineer to render better service to the owner. It gives the architect or engineer a proper share and control in the selection of the contractors who bid and in the whole process of estimating. It is a plan applicable to public work."

Following a discussion of these statements, these resolutions were adopted:

#### RESOLUTIONS

WHEREAS, there is great economic waste in the present usual methods of individual estimating of the same quantities by several different bidders on the same project; therefore, be it

*Resolved*, That the following are the conclusions of this conference:

(1) That any system of duplication of effort in estimating wherein each bidder separately estimates the quantities should be condemned.

(2) That all competitive bids should be based upon a detailed schedule of quantities prepared from a survey of the plans and specifications and submitted therewith, the cost of the preparation of such survey of quantities to be borne by the owner.

(3) That while the owner should furnish a quantity survey as the basis of bids and contracts, and should submit them with the plans and specifications, and should pay for the same, the bidders should make no charge to the owner for submitting proposals, based on said plans, specifications and quantity survey.

(4) That in general competitive bids should not be invited nor submitted on projects, the plans and specifications for which are not accompanied by a quantity survey,

unless the owner agrees to pay a predetermined fee to each bidder for preparing the quantities and submitting an estimate

#### RECOMMENDED PRACTICE

This conference proposes to prepare and present at a later date an outline of recommended practice in conformity with the above resolutions.

#### PHILADELPHIA CHAPTER ACTS

At the meeting of the Philadelphia Chapter, A.I.A., held March 8, 1920, Mr. D. K. Boyd presented a motion, seconded by Dr. Laird, that the resolution adopted in Special Conference assembled at the invitation of the Associated General Contractors of America, and in which conference were represented the American Institute of Architects and the Engineering Council, be adopted by the Philadelphia Chapter, and same be referred to the Committee on Public Information to be forwarded to the Secretaries of all Institute Chapters. This motion was carried.

### Engineering Council Bulletin

Super-Power Investigation, as proposed by the Secretary of Interior, was urged before the House Committee on Appropriations March 16 by Engineering Council's Committee, composed of W. S. Muray, A. I. E. E.; L. P. Breckenridge, A. S. M. E.; D. C. Jackson, A. I. E. E., and M. O. Leighton, A. S. C. E. Details of the advantages to the Boston-Washington industrial district through the use of hydroelectric, tidewater steam and mouth of mines steam power were emphasized—especially the fact that at least \$300,000,000 could be saved each year. The House Committee showed unusual interest in this plan.

Topographic mapping appropriation, to the extent of \$600,000, was urged in the hearing given M. O. Leighton, A. S. Baldwin and others, who appeared in behalf of the engineers. This is the appropriation that engineers from all sections of the country have been urging. It contemplates a complete topographic map in twelve years. The program for the use of this appropriation has the sanction of the Board of Surveys and Maps.

Army Reorganization Bill passed the House March 19, providing for continuation of Chemical Warfare Service and a strong Signal Corps. Amendment to maintain separate Construction Corps, which had been passed March 12 by vote of 135 to 74, was reversed by vote of 168 to 158. Present status of bill will retain Construction Corps and Motor Transport Corps in Quartermaster Corps.

Navy Appropriation Bill reported recommending \$425,000,000 against \$550,000,000 estimated. Navy "Bureau of Steam Engineering" was changed to "Bureau of Engineering," having charge of practically every class of navy engineering work

Coal Production and Distribution has been covered by three bills introduced by Senator Frelinghuysen, designed to remove existing evils of inequality and instability in producing and distributing coal

Reclassification and Compensation of Federal Employees covered by complete report submitted to Congress by Keating Commission, March 12.

National Screw Thread Commission has been extended for a period of two years. This was assured when the Senate passed H. J. Res. 299 on March 18, following similar action by the House.



# The Fundamental Principles of Illuminating Design

## II. Light Distribution

**E**XPERIENCE has shown that the bare lamp is not the most effective method of utilizing light. It has two major objections.

*First:* The intensity of the light source is detrimental to vision; and *Second:* A large quantity of the light produced is not directed where illumination is desired. The first objection may be neglected when the lamp is so placed as to be out of the ordinary line of vision, but the bare lamp will still represent an economic waste.



FIG. 1. REFLECTION. THE ANGLE OF INCIDENCE AND OF REFLECTION ARE EQUAL.

Therefore, in order better to utilize the light produced by a source, various accessories, in the nature of reflectors and enclosing glassware, are resorted to, their purpose being not only to redirect such rays of light as would otherwise be ineffective, but also to modify the brilliancy of the light source, diffusing the light in such a way as to produce a soft and restful effect.

Three distinct systems of illumination are now in common use, termed direct, indirect and semi-indirect lighting. In some cases these are modified by employing enclosing glassware for diffusion. In the direct system, the fixture employed directs all light downward; in the indirect the reverse method is employed, the fixture sending all light rays upward on the ceiling from which they are reflected to all parts of the room, as well as being well diffused. In the semi-indirect, part of the light is reflected on the ceiling while some passes directly into the room through the bowl of the fixture, which also diffuses it.

In studying the subject of distribution of light it is well to bear in mind a few of the underlying principles of light. A ray of light will travel in a straight line, to infinity, unless meeting interference. The imposition of interference may change the direction of the light, or it may change its nature. For instance, when a ray of light strikes

a mirrored surface it is reflected, whereas if it impinges on a black surface it is absorbed, but in this process heat is produced, so that although no actual loss is suffered, the form of energy is changed. A third form of interference is termed refraction. This occurs when light passes from one media into another of different density, in which case the light ray is bent. This is well illustrated by the apparent bending of a fishline where it enters the water. A fourth form of interference is known as diffusion, and consists of breaking up the beams of light and spreading the rays in all directions. By the correct control of these four forms of interference, viz.; reflection, absorption, refraction and diffusion—it is possible to produce any desired light effects. Figures 1 to 5 illustrate these forms of interference.

### CO-EFFICIENT OF UTILIZATION

In the preceding article a problem was worked out to determine the size of lamp required for a given light intensity. It was stated, however, that

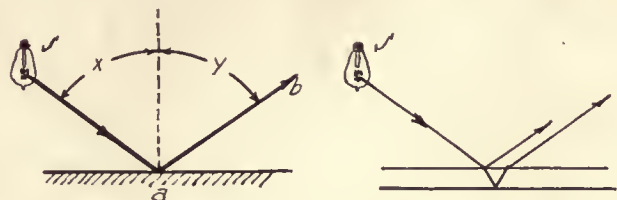

FIG. 2. AT LEFT: REFLECTION FROM POLISHED SURFACE. AT RIGHT: REFLECTION FROM MIRRORING SURFACE.

This method of calculation must be modified due to certain physical factors which tend to reduce the efficiency of the illuminating system.

First it might be mentioned that irrespective of the type of illuminating system selected, most rays of light ultimately reach the plane of action on which illumination is desired through reflection. It will be noted that in the indirect system in which the fixtures contain reflectors directing all rays to the ceiling, it is the ceiling acting as a reflector which sends the light downward upon the working plane. The advantage of this system is due largely to the excellent diffusion of light thus produced, which eliminates glare and masks the source of light so that no eye strain is produced.

It is impossible to obtain 100 per cent reflection of light by the use of any material, even from a mirrored surface. It is therefore, of course, impossible to eliminate losses. The absorption of light and consequent reduction in quantity varies greatly, depending on the nature of the reflecting surface, both as to color and texture.

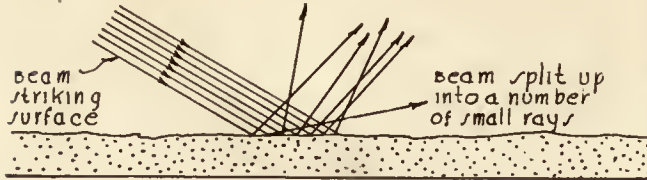

FIG. 3. DIFFUSION. RAYS OF LIGHT SENT IN ALL DIRECTIONS. THIS IS A FORM OF REFLECTION

Table I gives the percentage of light reflected by various surfaces, the highest 90 per cent, being obtained by the use of polished silver plate, and the lowest 54 per cent by new aluminum bronze. The percentage of light reflected from ceilings is taken as varying from 70 per cent for a light ceiling to 30 per cent for a dark ceiling, and for walls from 50 per cent for light walls to 20 per cent for dark walls. It will be seen that in indirect lighting successive reductions occur, which lessen the actual amount of light ultimately received at the desired location. For instance, assume that a reflector which directs light from an indirect fixture to the ceiling is provided with a corrugated mirrored surface. According to Table I only 80 per cent of the light produced at the source would be reflected. The ceiling would absorb 30 per cent of this quantity, reflecting 70 per cent of what it received or 56 per cent of the initial quantity given out. If the room is wide in proportion to the ceiling height,



FIG. 4. AT LEFT: REFLECTION FROM SEMI-MAT SURFACE. AT RIGHT: REFLECTION FROM ROUGH MAT SURFACE

this will be the quantity of light given to the working plane, but if the room is narrow with relation to the ceiling height, a large quantity of the rays of light reflected from the ceiling will strike the walls and must be redirected by them to the working plane. The walls will only reflect 50 per cent of the amount of light striking them or 28 per cent of the total light produced by the source.

TABLE I  
PER CENT REFLECTED, OPAQUE MATERIAL: LIGHT INCIDENT AT 20 DEGREES

Material	Per Cent Reflection
New Aluminum Bronze (Unprotected).....	54
Corrugated Mirror .....	80
Polished Brass .....	60
Polished Nickel Plate.....	64
Polished Aluminum .....	67
Baked White Enamel (Paint).....	72
High Gloss Porcelain Enamel.....	78
Mat Surface Porcelain Enamel, Sample No. 1.....	79
Polished Silver Plate.....	90
Mat Surface Porcelain Enamel, Sample No. 2.....	76
Regular Surface Porcelain Enamel, Sample No. 1....	73
Regular Surface Porcelain Enamel, Sample No. 2....	75
*Silvered Mirror .....	83
*Uranium Glass Silvered Mirror.....	79

\* Mirrors supplied by C. A. Matisse.

This illustrates the necessity of introducing modifications over the conditions which would obtain were perfect reflection possible. Now the percentage of reflection given in Table I only applies to material in the best condition. It will of course be realized that lighting fixtures are not kept in perfect condition, becoming dusty, tarnished, etc.,

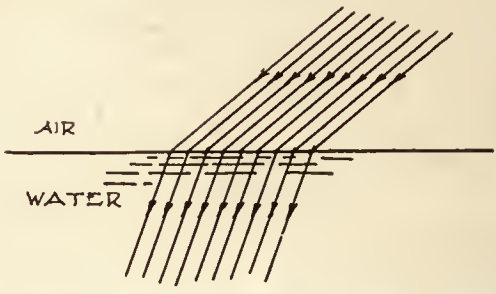

FIG. 5. REFRACTION. RAYS PASSING FROM ONE MEDIA TO ANOTHER OF DIFFERENT DENSITY ARE BENT

and therefore the amount of light projected by them decreases with use. This is also true of the source of light. Incandescent lamps become dusty and in addition depreciate from use so that the rating of a lamp in lumens would only hold for a new and clean lamp and further reduction must be made on this account.

In order to simplify calculations, instead of making a number of individual deductions for each of the causes which reduce the quantity of light it is customary to use what is termed a "co-efficient of utilization." This factor, for various conditions, is given in Table II. Let us now reconsider the calculations made in solving the problem given in the previous article. It was found that a total of 500 lumens were necessary to obtain the desired

intensity. If an indirect lighting system were selected and both ceiling and walls of the room were of a light color the co-efficient of utilization will be 22 (Table II) when the ratio of room width to

which gives 2275 lumens as that to be emitted by the source in order to obtain the desired intensity of illumination at the working plane.

A Mazda C, 150 watt lamp is rated as giving 2050 lumens, and a 200 watt lamp, 2920. The former would probably prove sufficient. This data is taken from Table III, which gives technical data on Mazda lamps. It will be noted that although nearly five times as great a quantity of light must be produced than would be the case if ideal conditions existed, yet, due to the greater efficiency of the higher powered lamp, the amount of current required is only two and one-half times as much.

A study of Table III will illustrate this point. Under "Lumens per Watt," fourth column, it will be seen that this value varies from 7.52 for the 10 Watt Mazda B lamp to 17.95 for the 1000 Watt Mazda C lamp. The latter is 2.4 times as efficient as the former.

In the next article the different types of illumination will be described in detail as well as the occupancies for which they are best suited.

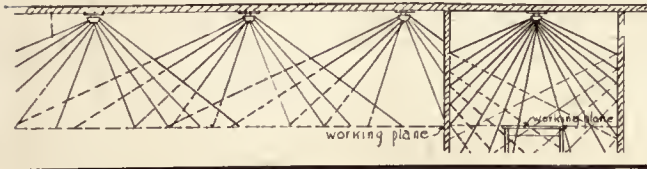

FIG. 6. WHERE RATIO OF ROOM WIDTH TO CEILING HEIGHT IS LARGE ALL RAYS REACH WORKING PLANE DIRECT, BUT WHERE THE RATIO IS SMALL THE RAYS MUST BE REFLECTED BY THE WALLS WITH CONSEQUENT LOSS

ceiling height is 1, which would be the case for this example. Therefore, of the total output of the source of light, only 22 per cent would actually reach the working plane. We must now multiply the 500 lumens by 4.55 (the reciprocal of 22),

TABLE II

COEFFICIENTS OF UTILIZATION									
This table applies to installations in square rooms having sufficient lighting units symmetrically arranged to produce reasonably uniform illumination. To obtain the coefficient for any rectangular room, find the value for a square room of the narrow dimension and add one-third of the difference between this value and the coefficient for a square room of the long dimension.									
Reflector Type	Light Output	Ratio = Room Width Ceiling Height	Light 70%			Medium 50%		Dark 20%	
			Light 50%	Medium 35%	Dark 20%	Medium 35%	Dark 20%	Dark 20%	
Prismatic Glass	90° to 180°-32%	1	.42	.38	.35	.36	.34	.33	
Bowl-Frosted Lamp	0° to 90°-45%	1 1/2	.50	.46	.43	.44	.42	.41	
		2	.56	.52	.49	.50	.47	.45	
		3	.63	.59	.55	.56	.53	.51	
Light Opal	90° to 180°-35%	1	.37	.27	.24	.24	.21	.18	
		1 1/2	.43	.39	.35	.34	.31	.27	
		2	.49	.45	.41	.39	.36	.31	
Bowl-Frosted Lamp	0° to 90°-50%	1	.56	.52	.48	.45	.42	.36	
		1 1/2	.60	.56	.52	.51	.47	.43	
		2	.67	.63	.59	.58	.54	.49	
Dense Opal	90° to 180°-20%	1	.41	.37	.34	.35	.33	.32	
		1 1/2	.49	.45	.42	.43	.41	.39	
		2	.54	.50	.47	.48	.46	.44	
Bowl-Frosted Lamp	0° to 90°-60%	1	.60	.56	.53	.53	.51	.49	
		1 1/2	.67	.63	.59	.59	.57	.54	
		2	.74	.70	.66	.66	.64	.61	
Steel Bowl	90° to 180°-8%	1	.38	.36	.34	.35	.33	.33	
		1 1/2	.45	.43	.41	.42	.40	.40	
		2	.49	.47	.45	.46	.44	.44	
Porcelain Enamelled	0° to 90°-45%	1	.54	.52	.50	.51	.49	.49	
		1 1/2	.59	.57	.55	.56	.54	.54	
		2	.64	.62	.60	.61	.59	.59	
Steel Dome	90° to 180°-9%	1	.43	.40	.38	.39	.37	.37	
		1 1/2	.52	.49	.47	.48	.46	.46	
		2	.57	.54	.52	.53	.51	.51	
Porcelain Enamelled	0° to 90°-60%	1	.63	.60	.58	.59	.57	.57	
		1 1/2	.69	.66	.64	.65	.63	.63	
		2	.74	.71	.69	.70	.68	.68	
Indirect	90° to 180°-60%	1	.22	.19	.17	.14	.12	.07	
		1 1/2	.27	.24	.22	.17	.15	.09	
		2	.31	.28	.26	.20	.18	.11	
Mirrored Glass	0° to 90°-8%	1	.36	.33	.31	.24	.22	.13	
		1 1/2	.42	.39	.37	.28	.26	.16	
		2	.47	.44	.42	.32	.30	.19	
Semi-Indirect	90° to 180°-40%	1	.27	.24	.21	.20	.17	.14	
		1 1/2	.34	.30	.27	.25	.22	.18	
		2	.39	.35	.32	.29	.26	.21	
Light Opal	0° to 90°-25%	1	.45	.41	.38	.34	.31	.25	
		1 1/2	.51	.47	.44	.40	.37	.29	
		2	.56	.52	.49	.45	.42	.34	
Semi-Indirect	90° to 180°-70%	1	.24	.21	.19	.16	.14	.10	
		1 1/2	.30	.27	.24	.20	.18	.13	
		2	.34	.31	.28	.23	.21	.15	
Dense Opal	0° to 90°-10%	1	.39	.36	.33	.33	.27	.18	
		1 1/2	.45	.42	.39	.32	.30	.21	
		2	.50	.47	.44	.37	.35	.24	
Enclosing	90° to 180°-15%	1	.23	.20	.17	.18	.16	.14	
		1 1/2	.30	.26	.23	.24	.21	.19	
		2	.35	.31	.28	.28	.25	.22	
Light Opal	0° to 90°-40%	1	.41	.37	.34	.33	.30	.26	
		1 1/2	.48	.44	.41	.39	.36	.31	
		2	.53	.49	.46	.43	.40	.34	
Semi-Enclosing	90° to 180°-30%	1	.32	.28	.26	.27	.25	.23	
		1 1/2	.40	.36	.33	.34	.32	.30	
		2	.45	.41	.38	.39	.37	.35	
Opal Bowl	0° to 90°-60%	1	.52	.47	.44	.45	.42	.40	
		1 1/2	.59	.54	.51	.51	.48	.46	
		2	.64	.60	.57	.57	.54	.52	

TABLE III

TECHNICAL DATA ON 110-125 VOLT MAZDA LAMPS

Watts	Total Lumens	Watts Per Spherical Candle	Lumens Per Watt	Bulb			
				Type	Diam. in Inches	Maximum Over-All Length, inches	Light Center Length, inches
STRAIGHT-SIDE MAZDA B LAMPS							
10	75	1.67	7.52	S-17	2 1/8	4 3/8	2 7/8
15	128	1.47	8.55	S-17	2 1/8	4 3/8	2 7/8
25	230	1.37	9.17	S-19	2 3/8	5 1/4	3 1/4
40	378	1.33	9.45	S-19	2 3/8	5 1/4	3 1/4
50	476	1.32	9.52	S-19	2 3/8	5 1/4	3 1/4
60	585	1.29	9.74	S-21	2 3/8	5 1/4	3 1/4
100	1010	1.24	10.13	S-30	3 3/4	7 7/8	5 3/8
PEAR-SHAPE MAZDA C LAMPS							
75	865	1.09	11.53	PS-22	2 3/4	6 1/8	4 5/16
100	1260	1.00	12.57	PS-25	3 1/8	7 1/8	5 1/16
150	2050	0.92	13.66	PS-25	3 1/8	7 1/8	5 1/16
200	2920	0.86	14.61	PS-30	3 3/4	8 3/8	6
300	4850	0.78	16.11	PS-35	4 3/8	9 3/4	7
400	6150	0.82	15.32	PS-40	5	10	7
500	8050	0.78	16.11	PS-40	5	10	7
750	12800	0.74	16.98	PS-52	6 1/2	13 3/8	9 1/2
1000	18000	0.70	17.95	PS-52	6 1/2	13 3/8	9 1/2
PEAR-SHAPE MAZDA C-2 LAMPS							
75	600	1.58	8.0	PS-22	2 3/4	6 1/8	4 5/16
100	870	1.44	8.7	PS-25	3 1/8	7 1/8	5 1/16
150	1400	1.33	9.4	PS-25	3 1/8	7 1/8	5 1/16
200	2000	1.2	10.1	PS-30	3 3/4	8 3/8	6
300	3350	1.12	11.2	PS-35	4 3/8	9 3/4	7
500	5600	1.12	11.2	PS-40	5	10	7
ROUND-BULB MAZDA B LAMPS							
15	123	1.53	8.21	G-18 1/2	2 5/8	3 3/4	2 1/4
15	132	1.43	8.79	G-25	3 1/8	4 3/8	2 3/8
25	222	1.5	8.67	G-1 1/2	2 1/8	3 1/4	2 1/4
25	24	1.35	9.31	G-25	3 1/8	4 3/8	2 3/8
40	386	1.33	9.45	G-25	3 1/8	4 3/8	2 3/8
60	630	1.23	10.22	G-30	3 1/2	5 1/2	3 1/4
100	1100	1.18	10.65	G-35	4 3/8	7 1/4	4 1/2

# Public Works vs. Public Waste

## The Object of the National Public Works Department Association

By M. O. LEIGHTON

SHIPS always leak. The finest vessel afloat must occasionally operate its bilge pumps. Water is always coming into the ship while it is afloat, and causes no alarm; but let that leak increase in volume beyond a certain rate and those aware of it are greatly concerned.

In like manner all ships of State leak. Money for which there is no adequate return weeps through the seams, even if it does not run out through open ports. No one takes a thought so long as this leakage is slow and well distributed. But, as in the case of the ship at sea, there comes a time when the leakage becomes so great that the taxpayer begins to investigate and protest.

Our Government has always been wasteful in the conduct of its business. This has not been the result of any wrongful intent. Throughout a long period of years it has been accepted by the majority without much thought. This was particularly true with respect to Government expenditures when we lived under an indirect system of taxation. But now our system of taxation is direct. Every individual of more than nominal earning capacity is presented by the Internal Revenue Office with a bill for his share. And when our annual peacetime budget runs up to \$5,000,000,000 as presented by the Secretary of the Treasury a few days since, we begin to think about that leakage. We begin to look for open ports.

That five billion dollar estimate will be pruned—severely pruned. That means that we must go without some things that wise and prudent men think we need. Are we then so poor as all that? The answer is that we are paying too much for what we get.

The appropriations committees in Congress will spend the greater part of their time for the next three or four months in pruning those estimates—a laudable and necessary thing to do under the circumstances; but those hard-working men are saving at the spigot and wasting at the bung-hole.

We are asking them to do the obvious thing. Give the Government a business-like organization. Co-ordinate the functions so that the processes of Government business shall dovetail. Cut out the

wastes and duplications. Abolish the rivalry between departments. We advocate a Department of Public Works for the purpose of closing some of those open ports.

When we started this movement at Chicago last April none of us had an adequate idea of its scope. We saw loose and inefficient management of our national public works. As technical men, we knew how wasteful that was. Of the necessity for a co-ordinated structure, by which the technical and semi-technical bureaus of the Government could be rendered efficient and business-like we were profoundly impressed.

But that our effort, our legislative bill would become the cornerstone of a structure to establish efficiency in all departments of the Government we could hardly foresee.

As an organization our effort is still focused on a Department of Public Works and that alone. But we realize that with that example set, reform in other fields of Government business activity will occur by the mere logic of events.

This is the reason why our project for a Federal Department of Public Works appeals so forcibly to the business man, the manufacturer, the contractor, the merchant. The technical men who met at Chicago last April to set up this organization built better than they knew. While the project retains all the virtues that appealed to us when it was launched—of technical excellence, of rational Government organization, of economy and efficiency, we now see that it reaches to National and to business prosperity.

Individual initiative in America will not continue to be that spontaneous thing it has been in the past if part of its earnings must be diverted to the support of a chaotic Government business organization. The burdens of every business organization in the country are magnified by Government business inefficiency. In mild and respectful suggestion let us remind the political party leaders of the country that the voter who goes to the polls in the future will be thinking more about the size of that annual bill from the Internal Revenue Office and of what the country is getting for it than he will of almost any other National issue:

482<sup>a</sup>

fractio piece to 2013.

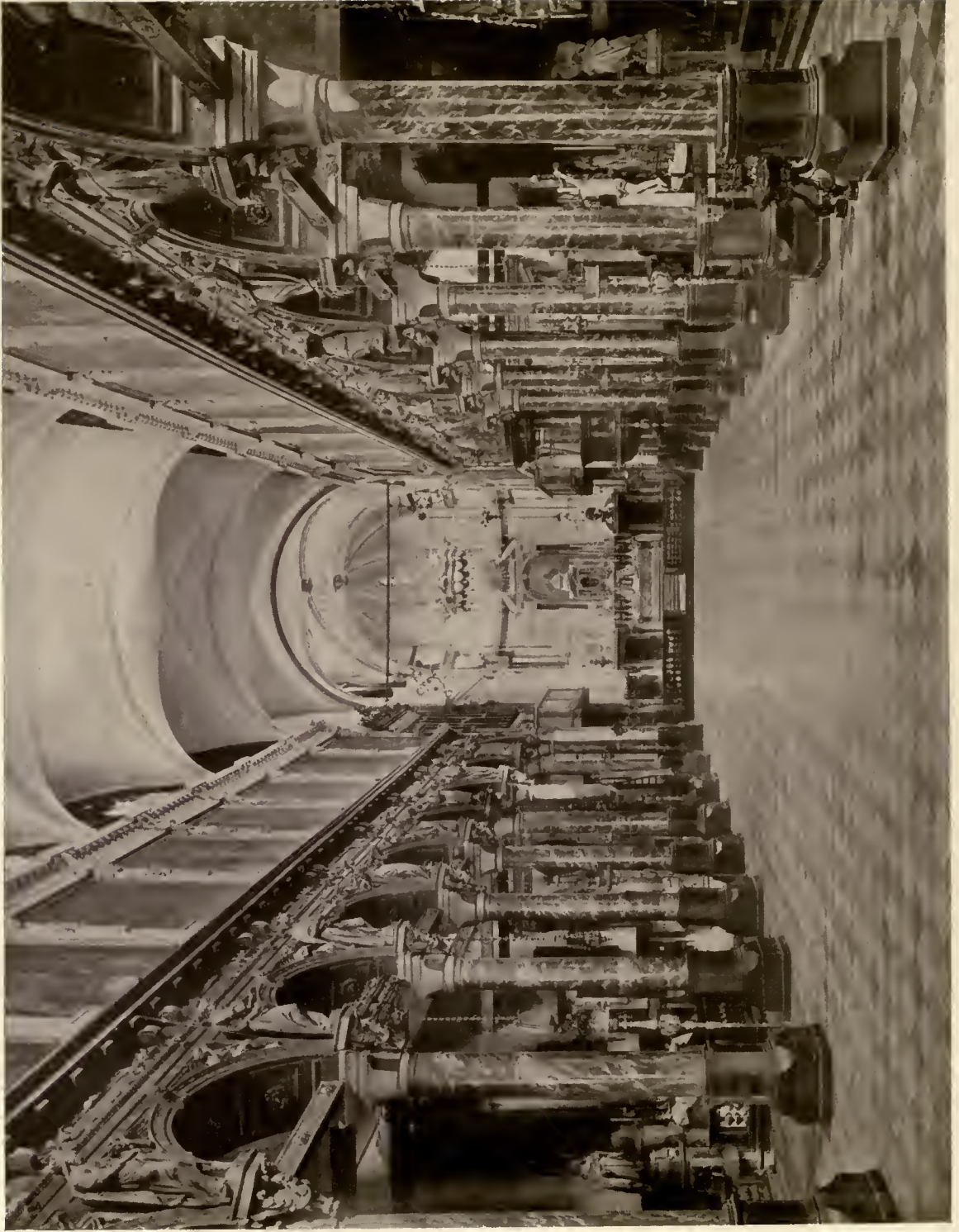

NAVE OF THE CARMELITE CHURCH, VENICE

# THE AMERICAN ARCHITECT

VOL. CXVII

WEDNESDAY, APRIL 21, 1920

NUMBER 2313

## Trimstone and Building Ornaments

An Address by Adolf Schilling Before the National Conference on Concrete Housing

FIFTEEN years ago, when I started to make concrete attractive and pleasing to the eye, I accepted as definitely settled concrete's claim for strength and endurance, demonstrated by the engineers in their work of that time and by the examples of ancient concrete work still in existence, some of it dating back 2000 years.

My researches and experiments have been devoted entirely to giving concrete the attractive and artistic qualities which would make it interesting to the architect and decorator as a medium for embellishment and actual construction in their work. If, for this reason, my remarks are of less technical interest to engineers and contractors for monolithic concrete construction, I ask their indulgence, to consider concrete for a few minutes more from the esthetic than solely from the standpoint of utility.

Twenty years of practical experience among the natural stones used in monumental and building work enabled me to realize the conditions that must be met, to give concrete a place alongside of the limestones, marbles, granites and clay products in which the architects had expressed their thoughts almost exclusively.

In the making of concrete, after once thoroughly understanding the qualities of cement as a binder or matrix, one can learn to adopt many mineral and metal resources as readily as we employ the better known sand, gravel and crushed stone for aggregates.

### BUILDING TRIM

After proving to my own satisfaction that cast stone could be made successfully, it required considerable missionary work to convince the architect of its merits and advantages for use in building construction and enrichment of design, so far claimed by terra cotta, natural stones, faience, etc. The many examples of cast stone executed during recent years give ample proof that the confidence of the early pioneers in the possibilities of high-grade concrete products was well founded.

Cut cast stone has been specified by progressive architects for high-grade buildings in many locali-



CAST STONE TERMINAL BEING RETOUCED WITH PNEUMATIC TOOL

ties. The field has been opened and it now rests with the individual and joint effort of everybody producing concrete units for building purposes to convince the architect, engineer and contractor that standard concrete products are what they want and



PERGOLA—CAST STONE WITH ROUGH AXED AND BARK COVERED WOOD AND LOCAL QUARRY STONE WALLS. ROSEMONT, PENNA.

can get, no matter if it is for the foundation or for the richly ornamented entrance of the work in hand. It must be our purpose to establish co-operation that offers dependable concrete products *to meet the requirements* of the building trade in quality and quantity.

To cover the methods of manufacture in detail would exceed the limit of this report. We have successfully used plaster, glue, wood, sand, cement and steel molds. More general information regarding the use of same will be made available by me to anybody interested.

A kind of mold extensively used in our plant is made of channel irons, in sizes from 2 in. to 18 in. wide, and in lengths from 4 ft. to 8 ft. If set on level tables or benches, the main part of a mold is provided that offers great flexibility in its use; the channel irons are held together by different length rods at the ends; wood or plaster inserts, plain or molded, determine the width, length and design of the unit to be cast. The work is poured with finished face down and can be solid or hollow, surfaced with special material on any one side or all four sides, if the volume of the stone makes it more



COPING OF CIRCULAR WATER BASIN AND BALUSTRADE OF CAST STONE; WALLS OF LOCAL QUARRY STONE. ROSEMONT, PENNA.

economical to use a core of less valuable aggregates.

Some excellent work has been done modeling directly with cement mortar by artists who have attained their efficiency in this method abroad; the most important work of this kind, to my knowledge, is a group of the Crucifixion of heroic size, at Lynn, Mass.



ENTRANCE OF Y. W. C. A. BUILDING, CHESTER, PENNA.

The artist builds up his design with permanent skeleton frame work, similar to modeling in clay. Around this skeleton he forms a rough outline of the design in wire cloth or expanded metal, and on this is placed a scratch coat of cement mortar on which when set he begins to model the final outline of his design. The artist is enabled, by using mixtures of quick and slow setting cement mortars to



regulate his medium. In this way he can give the work the same freedom and spirit as if he modeled in clay, producing any texture desired; color effects can be obtained at random by using colored cement of various shades; for instance, a garland of flowers can be modeled in their natural colors. There



DETAIL OF ENEDRA SEAT OF CAST STONE, ROSEMONT, PENNA.

is no difficulty in producing in cement the well-known Della Robbia effects, the same as is done in faience and colored marble. This method is particularly of interest and value where only one piece of a large ornamental design is to be used, thus avoiding the expense of molds and setting the cast in place. It also prevents unauthorized replicas of original designs, so annoying to the artist when he finds his conception misused.



CORNER IN A GARDEN. CAST STONE ORNAMENTS AND LOCAL QUARRY STONE WALLS. ROSEMONT, PENNA.

For treating of surfaces we use electric rubbing wheels to produce a smooth finish, acid for grain texture finish, and any of the tools used in the natural stone trade for cut finishes, according to the effect desired in the cast stone; any one or all treatments may be used on one piece. We have transportable rubbing and tooling machines to surface the extra heavy casting, and stationary machines for the smaller units. A cutting plant for natural stone is an ideal foundation to start an up-to-date cut cast stone business, even to the use of its rubbing beds and gang saws.

Concrete of proper age can be treated just like any natural stone, using the same tools and machinery to dress its surfaces, or to saw cast blocks of large size into slabs and strips. It is my strong conviction that the success of concrete stone for building purposes rests in a close affiliation of the stone caster and the stone cutter. Only in this way will we be able to give concrete proper texture and the necessary qualities of dimension stone, so essential to the architect and builder for durable and attractive construction.

The addition to every concrete products plant of



CAST STONE SCREEN AND ORNAMENTS WITH LOCAL QUARRY STONE WALLS. TEXTURE AND COLOR OF SCREEN MADE TO HARMONIZE WITH QUARRY STONE



EXEDRA SEAT, 25-FOOT RADIUS "FOUR SEASONS" SUPPORTS IN CAST STONE. ROSEMONT, PENNA.

skilled stone cutters would be a source of profit and also result in better work. The stone cutter is trained to have dimension stone true to size and shape. The average worker in cement or concrete does not appreciate this essential point, but it is all-important with the architect and general contractor. The services of a stone setter will enable the concrete products plant to set its own work, which is very desirable for the best results. We found the brick or natural stone mason did not give composition stone the required care when setting same, for reasons of trade jealousy, but once this fraternity understood that concrete stone gave extensive employment to stone cutters and setters, their antagonism vanished as they realized their own benefit in the broader use of cast stone. Whenever the opportunity presents itself, I strongly recommend closer affiliation of the composite and natural stone trades. The enormous increase in all building operations of whatever class and the constant effort for betterment in the moderate-priced home, give abundant field for both trades in a more permanent class of work and at more satisfactory profits.



ROSE TRELLIS SUPPORTS—CAST STONE TREATED WITH SULPHATE OF COPPER TO PRODUCE COLOR EFFECT. STATUE BRONZE, TRELLIS WOOD STAINED BROWN, STEPS LOCAL QUARRY STONE. ROSEMONT, PENNA.

It has taken many years to bring the craft of dressing natural stone to its present efficiency. The progressive concrete products man should study these methods and benefit by the experience of the trade whose product he must equal or better to meet approval by the architect.

To the manufacturer or worker of concrete products I further recommend the adoption of such



TEMPLE OF LOVE, CAST STONE. DOME IS MADE MONOLITHIC BY SETTING EIGHT RIBS AND PANELS AGAINST CROWN AND FORMING REINFORCED CONCRETE COVERING. ROSEMONT, PENNA.

methods as are employed successfully in other lines of manufacture in treating the surfaces of their product. In many cases instead of applying paint with brush, the article is immersed in the paint. This method can be adapted to acid washing of the concrete products, to remove the surface film and expose the aggregates. Tanks of sufficient size are not a hard matter to construct in the concrete shop, and the immersion of concrete products in acid solution will not only prove a great saving of acid

and labor, but produce a class of work that cannot be obtained with the scrubbing brush. We use two rectangular tanks 4 by 4 by 16 built of cement slabs, grooved and bolted together, and six circular wood tanks 7 ft. diameter and from 2 to 4 ft. deep. Concrete should be from two to three weeks old before treating in acid bath; duration of bath depends on age of the stone, and if rough or fine texture is desired, the time being from one to ten hours. A solution from 1 to 20 up to 1 to 10 is recommended, and after the article is put in the tank the solution does the rest. This style treatment preserves the edges and details of the design and makes the surface uniform. Any of the hard spots not sufficiently affected by the acid bath can be treated separately after the article has been flushed with clean water. Care must be taken that the aggregates of the surface are nearly uniform in hardness, or the acid will destroy the soft portion before the harder particles have been cleaned of the cement coating. I have had some very fine work spoiled where, to obtain a certain effect, I mixed black marble (a limestone) and crushed granite. The acid bath left only the holes where the black marble had been, while the granite showed a very fine texture and natural color. Judicious handling of this effect can produce desired results in texture, like Travertine stone, etc.

To produce color effects we may use gray or white Portland cements, separate or mixed in certain proportions, adding to this suitable pigments, but in such cases the natural colored aggregates, sand, silica, pebble grits, marble and granite, will give excellent and more uniform results. It requires great skill and care to properly mix cement and color pigments without reducing the strength of the cement and still obtain good color effects.

The importance of mixing the pigment thoroughly with the cement; before adding the aggregates, should be understood before attempting to make concrete in colors successfully on a large scale.

As a very simple method to test the proper amalgamation of the pigment with the cement, take a handful of the dry mixture and press it under a sheet of stiff paper; this will produce an even surface of the material, and when this surface does not show absolute uniformity in color the mixing is incomplete. If small specks of color show under this test, these same specks of unassimilated pigment will appear in the finished concrete. So far a very important factor that can be utilized for coloring concrete or cement has been given little or no attention; while very simple in its primary action, the successful application requires thorough understanding of the principle and medium employed.

This refers to the absorptive qualities of concrete during its stage of curing and seasoning, which offer opportunities for coloring concrete products by capillary action. By this method the color is deposited into the pores of the surface, amalgamating with the concrete into a permanent unit. The possibilities of this treatment are unlimited if based on knowledge of coloring values and good judgment not to impair the strength requirements of concrete. Coloring solution can be made to penetrate the surface of concrete 6 in. or more, if the object is immersed while in a very green state, but it is rarely necessary to penetrate more than  $1/32$  to  $1/8$  of an inch; this thoroughly fills all pores, gives the desired color effects and is less expensive. Every atom of coloring absorbed by the concrete reduces the strength of the solution; and as some of the coloring matter used is quite expensive, good judgment to allow only the necessary absorption of coloring matter is advisable from an economic standpoint. The sulphates of copper and iron are the most suitable to make solutions to color concrete by the capillary method.

Concrete can be so treated after it is a week old. When used in construction and carrying loads it should not be subjected to the coloring bath until the concrete has attained its required strength, as the filling of the pores in the concrete retards the action of hardening. Coloring by absorption is effective on concrete after it comes out of the mold or after being treated with tools. Surfaces that have been colored by absorbing mineral or metallic colors become more weatherproof and the action of the weather on the metallic colors increasing the beauty of coloring by the usual oxidation noticed on bronze and copper. Concrete treated by this method becomes so hard and dense that it will take a polish. I have treated its surfaces in the same manner as marble, granite and metal under polishing or buffing machines.

Wet cast concrete products, such as flower pots, vases and boxes, will hold water after the second day of casting and become so hard that when struck with a hammer they ring like a metal bell; waterproofing compound helps, but is not essential to obtain this result. I consider that the thorough mixing of the proper amount of cement and water with graded aggregates is all-important. Extensive tests made during the past three years with commercial waterproof paints produced excellent results. Common concrete can be made very attractive by one or two coats, and applied in stipple fashion, it will not impair the grain or texture, avoiding the undesirable appearance of brush-painted stone. This method is especially to be recommended for dry or semi-dry tamped concrete work, the porous surface readily absorbs the waterproof liquid and thereby

allows the pigment particles to fill the pores.

By using spraying machine the color effect is obtained most economically. It gives a uniform color or can be varied to give the richness and depth of shading that results from this treatment in experienced hands. It can be applied where immersion is not practicable. I have obtained two and three color effects by painting certain parts of an object before subjecting same to the coloring bath. The parts so colored would not be affected by the color in the bath, the absorptive quality having been neutralized.

The artistic possibilities of such treatment are only limited by the color sense and taste of the craftsman. Using certain non-absorptive aggregates their natural color can be retained, while the absorptive parts, especially the cement mortar will assume the desired color. Precaution must be taken in the use of acid washing before immersion in the color bath as the chemical action of the acids is liable to counteract the color values of the bath. Acid should not be employed after concrete is treated with colors.

Long practice and tests will give the full benefit of this process.

In the matter of surface finishes, considerable headway has been made and most of the methods are well known to the progressive concrete man. Many are so simple and inexpensive that concrete need not remain unattractive to the architect.

Most of our trim stone and ornamental work is wet cast, it is required to stay in the mold from 24 to 48 hours, and we use a 4 per cent solution of calcium chloride for our mixing water; during cold weather our shops are steam heated and kept at a temperature of 70 degrees.

We do not use curing rooms, but for quick hardening use high pressure steam cylinders 6 feet in diameter and 70 feet long. We have commercially verified the tests made some years ago by the U. S. Bureau of Standards and reported in Technologic Paper No. 5.

While these tests did not exceed 80 pounds pressure, we have hardened concrete with 150 pounds steam pressure, obtaining results so that concrete

2 days old could be tooled under rapidly revolving carborundum wheels, cutting flint aggregates without pulling out or fraying the edges. The mixtures used were from 1 to 10 to 1 to 5. Compression tests showed over 4,000 pounds in two days and absorption less than 5 per cent. The higher the steam pressure the less time it requires to harden. With 150 pounds we reduced the time to 4 hours, besides the two to three hours it requires to bring the pressure up to 150 pounds. Concrete so hardened has been subjected to weathering for several years, proving equal to naturally hardened concrete.

No Portland cement concrete product should be subjected to high pressure steam curing until it has its initial set. The steam hardening should start preferably the day following the casting.

Tamped concrete should be kept moist until it goes into the cylinder. As the expense of equipment and operating is considerably higher than curing rooms, only units that lend themselves to completely filling the cylinder space, can be hardened economically, like brick, tile or blocks; at present prices it costs about \$20.00 to harden a volume equal to 900 cubic feet or 20,000 brick. The cost of a cylinder of above size is \$6,000 installed. They should be used in pairs to allow the utilizing of steam blow off, from one cylinder to the other, after the curing is finished.

In conclusion I maintain that with honest concrete we can interest the architect, engineer and builder in its general use and while not assuming to instruct them in their choice of material, we can advocate the most extensive adoption of our products if made on the principles of concrete for quality and permanence.

Crushed marble and granite with Portland cement as a binder produces a reconstructed stone of natural components which can be dressed and finished like natural stone without being an *imitation* stone or a misuse of *concrete*. It gives us a staple building material, combining the beauty in color and texture of the natural stones with the strength and economy of concrete.

# Protective and Operative Features of the Emergency Contract

By MAJOR RALPH H. CASE, CHIEF OF CONTRACTS DIVISION, CONSTRUCTION DIVISION OF THE ARMY

SHOULD any citizen now visit official Washington, and, meeting a stranger, desire to know his political affiliations, a simple method is to flash in his face a cost plus contract. In nine cases out of ten the result will be that the stranger either will fall into a semi-comatose and wholly inarticulate condition or will leap upon you and rend the cost plus contract into shreds, gnash his teeth and wail about the "wanton, wanton waste of public money." The first is the condition of an administration supporter. The second an administration opponent. On the cost plus contract the great general division is between those who have nothing to say about it and those who have everything to say about it, *and say it!*

Mark Hanna, at the cost of boundless ridicule, epitomized the trusts by saying: "There are good trusts and bad trusts." Time and the United States Supreme Court in the Steel Case has proved Hanna was right and his epigram can be applied by saying: "There are good and bad cost plus contracts." The bad ones are being abundantly taken care of by their critics but the good ones have been neglected. The best of all the war contracts is the Emergency Contract, cost plus fixed fee used by the Construction Division of the Army on a billion dollars' worth of construction work during the war.

This contract was drawn to permit operation free from the old, red tape methods of Government practice and at the same time to protect the interests of the Government. The protective features of the Emergency Contract stand out in 14 points. Why 14 and only 14 is not so impressive as the fact that the protective points stand at the magic number. Each and all of these points are in sharp contrast to the provisions of the old lump sum Government contract, let on bids after advertisement and on plans and specifications prepared in advance.

First. The contractor is required to purchase material from such firms and at such prices as the Government may direct. This protects the Government from excessive charges for material, allows material to be purchased in quantity and allocated to different projects, allows checking by the Government as to qualities and grade and permits no payments except on written acceptance by the Government. By this provision the whole question of

purchase and allocation of materials was absolutely controlled.

Second. All wages paid for labor are determined by the Government and no deviations allowed without prior consent of the Government. This protects the Government from excessive wages and competitive bidding for labor. It permits the handling of the labor question as a unit, precluding speculation and competition made for uniformity of wages and made it impossible for contractor to enhance the cost of any project by increasing wages.

Third. Contractor's equipment is brought on to the job only with the consent of the Government and is under control of the Government and may be laid off at any time. Rates of rentals are stipulated in the contract and this rental applies on the purchase of the equipment if the Government elects to take it over. This protects the Government absolutely from over charges for rental equipments and makes it impossible that more than the appraised value of the equipment be paid as rental.

Fourth. The contractor is required to carry his own main office overhead and the contractor is paid no fee on losses and expenses, the cost of reconstructing and replacing of any work destroyed or damaged. The United States is thus protected from charges for salaries not coming directly under its control and pays no fee on work restored or replaced. This protective item disposes of any possibility of the contractor permitting the destruction of any portion of the work and then being paid a fee for its reconstruction.

Fifth. The general contractor's fee is limited on all work done under subcontracts to 2½%, regardless of the extent of the subcontractor's work. This protects the United States from paying double fees for construction work and deters the general contractor from subletting his contract.

Sixth. The contractor is required to turn into the Government rebates, refunds and net revenues from operations of commissaries and these sums are applied in reduction of the cost of the work. This protective item is twofold. It reduces the cost of the work on which the contractor's fee is computed and it makes certain that no commissary will be operated by a contractor for his own benefit and profit. This insures a high grade of commissary service to the laborers on the job, good

food and plenty of it, being always an inducement to men to say where they can be so served.

Seventh. The United States has the right at all times of free access to the records of the contractor. The United States is thus protected from padded or built records and from fictitious charges.

Eighth. All subcontracts are required to be approved by the contracting officer and all are bound by the terms of the principal contract. This gives protection against inefficient subcontractors and against improper subcontracts or those not conforming to the spirit and intent of the general contract.

Ninth. The United States had the right to terminate the general contract and all subcontracts. This right protected the United States from almost endless suits. By its exercise, construction work was stopped on the signing of the Armistice. Settlement was made for the work done, pay being figured on the amount of work accomplished. Under a lump sum contract there is no such provision and the contract can only be terminated on default of the contractor. Had this provision not been included, contractors would have been in position to bring suit for their anticipated profits. The losses caused by stopping the work would have been staggering in amount.

Tenth. The Secretary of War is made final on all matters of dispute between the contractor and the contracting officer. This protective item compelled the contractor to submit to the decision of the Secretary of War all questions, but at the same time afforded him an appeal from the decision of the contracting officer. Without this protective item a great amount of litigation would have ensued.

Eleventh. Throughout the contract the contracting officer has the right of approval or disapproval of expense for bonds and insurance, for freight and equipment being hauled more than 500 miles and all permit fees, royalties and all other similar items of expense. The United States was thus protected against increased cost and sundry items of expense by the approval or disapproval of each separate item as it arose.

Twelfth. The contractor is not allowed any interest on his working capital. This was a very important protective item as every contractor was required to carry disbursements running up into large amounts and it was necessary that he have a substantial working capital in order to prosecute the work. This item, however, made it impossible for the contractor to ever claim interest on the capital he employed. The saving in this item alone runs into the hundreds of thousands of dollars.

Thirteenth. The maximum amount payable to

the contractor as fee is fixed by the terms of the contract and it is provided that in no event shall he be paid more than a certain stipulated sum. This item actually took the entire contract out of the so called cost plus percentage class and made it a cost plus fixed fee contract. Regardless of the amount of work the contractor was ordered to do, his fee was not enhanced unless in certain instances the amount of work performed was grossly out of proportion to the fixed fee in which event, a Supplemental Agreement could be made allowing a minimum fee on the additional work.

Fourteenth. The most important protective feature of the entire contract lay in the fixing of the amount of the maximum fee to be paid the contractor. The real advantage of the fixed fee lies in the manner in which the fee is arrived at. These fees were necessarily based upon estimates of the amounts of work to be performed. In all cases the fixed fee was based upon the minimum estimate and not upon either an intermediate or maximum estimate of the amount of work. The fixing of the fees in this manner absolutely protected the United States from padding of the cost of the work and took from the contractor all inducement to enhance the cost of the work. From the time the contractor went onto the work he knew that he would reach the maximum fee fixed in the contract and therefore, it was not to his advantage to permit or allow the cost of the work to be increased. This item effectually prevented voluntary or permissive enhancement of the cost of the work by the contractor or a subcontractor. It alone saved millions of dollars to the Government. How many millions cannot be stated as there is no telling to what length costs would have run without this fourteenth protective item.

These are the great protective features of the Emergency Contract, yet they alone do not show the difference in operation between this Emergency Contract and the old lump sum contract. Protection of the Government's interests is highly important, yet it alone is not sufficient. Far greater in importance is the positive feature of operation. A course of action may be eminently safe but wholly worthless in operation in that it fails to accomplish the desired result. "By their works ye shall know them," and the final judgment on the Emergency Contract must be made on the record of accomplishment made by the Construction Division of the Army through the use of the Emergency Contract.

When the Emergency Contract first went into use the war was on, the National Guard had been called to the colors and the machinery for selective service was under way.

*(To Be Concluded)*



## Simplification

IN architecture, as in any of the fine arts, simplicity is the fundamental excellence. It is interesting in considering any of the things that affect one of the arts to trace how equally they affect all of the others. The writer who sits down in quietness and seclusion to place his thoughts on paper is but securing the same freedom from interruption to the play of his mind as the painter or architectural designer will find equally necessary. And when the writer, the painter, the sculptor or designer reviews his work, he will at once learn that in the exuberance of his mental attitude he has overclothed his subject. If he has the genius necessary to the creation of a worth-while thing, he will at once set about divesting what he has done of verbiage, of overfloridness, and will strive to express the idea to be conveyed in the simplest form he can devise.

The greatest works in any of the arts are those that can be appreciated by the largest numbers. To create a common language in art it therefore becomes necessary to express the thought in the simplest form. The idea is well expressed by a quotation from *Punch*. Giles, the gardener, on being asked by his lordship how he liked the new minister, replied "he might be all right but not so very clever" as he could understand every word he said. The point of this lies undoubtedly in the fact that the minister must have been undoubtedly clever to have clothed some great thought expounding a vital problem in words so simple that even Giles, the gardener, could comprehend.

Much of our art, and particularly of our architecture, is vulgar by reason of a pedantic use of motives that spectacularly and in an ill-bred way present a problem. Things created on such a basis are past reform. No amount of additional and even well-chosen ornament can redeem them. False in its basic elements it is false all the way through. But given the simple, correctly done thing, and its very excellence of proportion accents its merit. No added ornament can improve it.

Most of the fault lies in a tendency to stress the minor facts and to overlook the correct interrelation of large masses. In the painter's art there are many men who can paint a most creditable small picture, but are utterly incapable of producing a large one. The reason for this is that they have not their facts of nature sufficiently well learned to execute them on a large scale. Certain designers in architecture have the same limitations. They can successfully handle applied ornament but not all the elements of the entire design. So then, it becomes a matter of knowledge, of simplification based on the actual ability as the result of education. It would therefore appear that simplification in the highest form is the surest indication of knowledge and that only the vulgar and uneducated will be misled by floridity or a rococo-like presentation.

## The Dilution of Labor

That conditions of service as rendered by organized labor have fallen below a necessary standard would seem to be as true in England as in this country. This deterioration of efficiency *The Architects' Journal* of London describes as "the dilution of labor." In every country engaged in the war, military service demanded that men in all ranks of skilled labor take immediate service. Likewise, the very necessity of skilled labor to meet the urgency of war needs was largely accentuated. It became necessary to call on every non-combatant, male and female.

Writing of these conditions *The Architects' Journal* well sums up conditions as follows:

"Fingers that had driven a pen or handled a pick now found themselves closing round a rifle. New movements, new duties had to be rapidly learned and undertaken. Courses of training in the past spread over years were now telescoped within the period of a few weeks. Intensive application of the very latest ideas and methods produced the soldier in a period unthinkable to those upon whom it fell to train the army before the war.

"What was true of this great combatant force

was also true of the still larger auxiliary army of workers which at home was required to supply the army in the field with the munitions of war. Factories devoted to the production of objects desired in peace were now diverted to the manufacture of arms and ammunition. The call for labor was as strident and insistent as the call for recruits. All who were working, all who had worked, all who were not working, all who never dreamed they would ever work, were pressed into request in the frantic effort to keep pace with the demands which modern warfare made. Factories were reconstructed, new ones were built, old plant was scrapped, new plant installed."

THE war's close brought all the complex problems of a return to peace. Men who had contentedly toiled in certain trades were on their return unwilling to go back to them. Their experience in service had given them other and oftentimes higher ideals. Thousands never returned. Meanwhile the various trades and crafts were beginning once more to assume a peace-time basis, and in many important industries in place of the skilled labor that at one time did the work, the factories were filled with those whose experience was limited to the comparatively brief period of the war's duration. What has accented this condition of the dilution of labor is the failure of the trades unions to recognize a situation that every large employer of labor keenly appreciates. There is not considered the very large difference in skill or capability between this hastily and imperfectly educated labor and that which through long years of service has gained high efficiency.

These things have affected the character of service as rendered by labor until a point has been reached where one cannot calculate the exact difference in the scale of wages as now paid and that of ante-war times. Then labor was almost standardized as to efficiency. Today the character of service is often so poor as to largely augment the cost of production and very materially increase the high cost of everything we buy. Labor has succeeded in forcing compliance with its demands to a point that the most optimistic leader never dared dream of. There should now be shown by those who lead labor a desire to maintain all the early traditions of good craftsmanship. A good way to show such a disposition would be to discipline every member of a union who might be convicted of inefficiency or the rendering of a poor quality of service. When labor adopts this attitude toward its members, those who pay the high wages demanded will receive something more nearly a just return.

## On Framing Pictures

FOR years it has been an accepted rule that all pictures in oil or water-color shown at exhibitions should be framed in gold. This uniformity has served to "cut in" each picture from those surrounding, and it has been generally conceded that the neutral quality of a gold frame was exactly the proper one correctly to show the painted canvas.

The Royal Academy has recently announced that at its forthcoming Summer Exhibition, and until further notice, frames other than gold will be admissible. Those who advocate this change in framing base their contention for a wider latitude of selection—that it is not correct to infer that a gold frame is suitable for all pictures and they state that what is right for one picture may not be at all suitable for another. All of which is quite true, as it is also true that a wooden frame, painted, stained or gilded that might admirably suit a given picture would absolutely kill the color values of its neighbors.

This same objection could never be urged against the gold frame. Most of the difficulties as to appropriateness in framing in gold lie in the fact that the frames are used custom-made and seldom with reference to the character of mouldings or the color of the gold suitable to a given picture. Artists as a rule have certain adopted color schemes and methods of technique. With these canvases there is a distinct type of moulding suitable. It may be ornate and full of high lights to accent a sombre picture or it may be plain (the Whistler frame for example) and absolutely flat in its effect of contrast. The color of the gold will range from the warm bronze colors clear through to the grey tones. There will be some one of these many possible combinations that will fit any color of picture ever painted and it is certainly true that it will not fight its neighbor or be so assertive as to mar the appearance of the entire wall on which it is hung.

It is safe to predict that the Royal Academy will soon tire of an exhibition where such latitude as to the selection of the color and material of frames is allowed. Undoubtedly the result will be a series of walls of such strong assertiveness as to frames that the value of the pictures will when thus grouped become very seriously marred.

Certain latitude in these matters is allowable in architectural exhibitions where there is a wide range of pictures on a great variety of media. But to allow this same latitude as to framing at one of our Academy exhibitions would, it is quite certain, create a result that would not meet the general approval of artists.





HART HOUSE, UNIVERSITY OF TORONTO, CANADA  
SPRATT & RALPH, ARCHITECTS

The building contains assembly and dining rooms, libraries, gymnasias and a theater

492 1





GREAT HALL, HART HOUSE, UNIVERSITY OF TORONTO, CANADA  
SPRATT & RALPH, ARCHITECTS

Perpendicular Gothic with arched roof of solid oak hammer beam trussed. The mullion windows, 11 feet high, show the arms of the universities of Great Britain and her colonies. The room is lit by bronzed chandeliers

4922



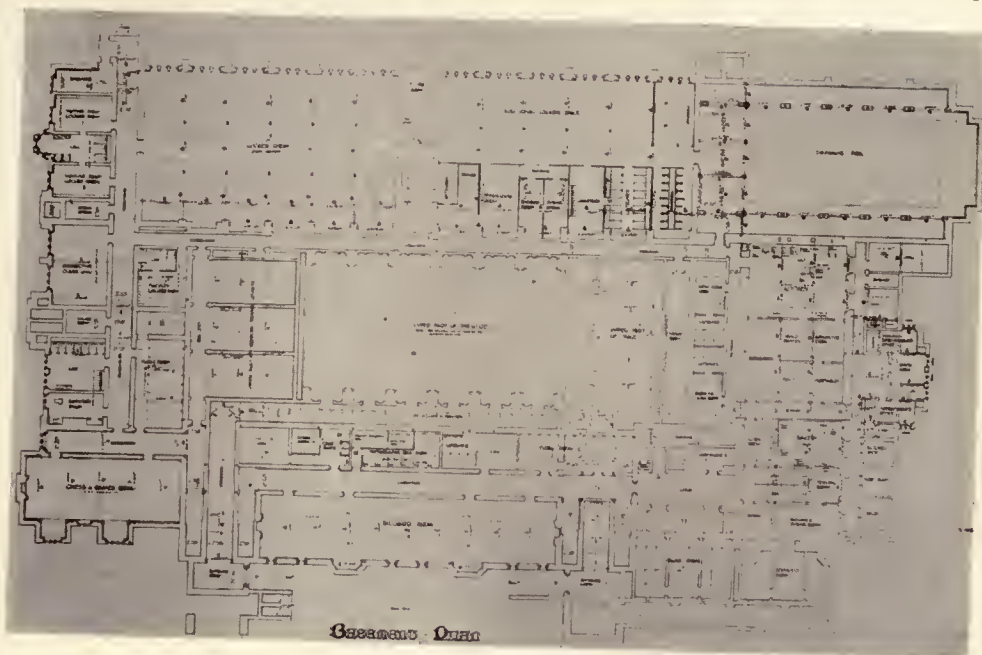

BASEMENT PLAN



FOYER OF THE THEATER  
HART HOUSE, UNIVERSITY OF TORONTO, CANADA  
SPRATT & RALPH, ARCHITECTS



4924

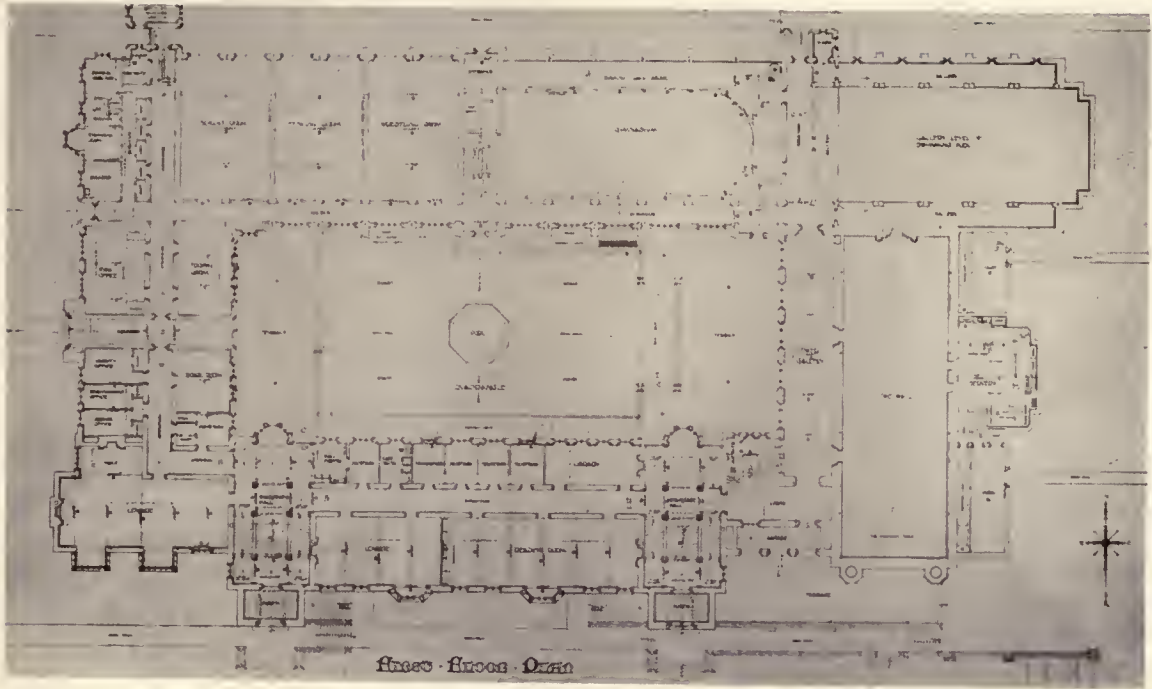

FIRST FLOOR PLAN

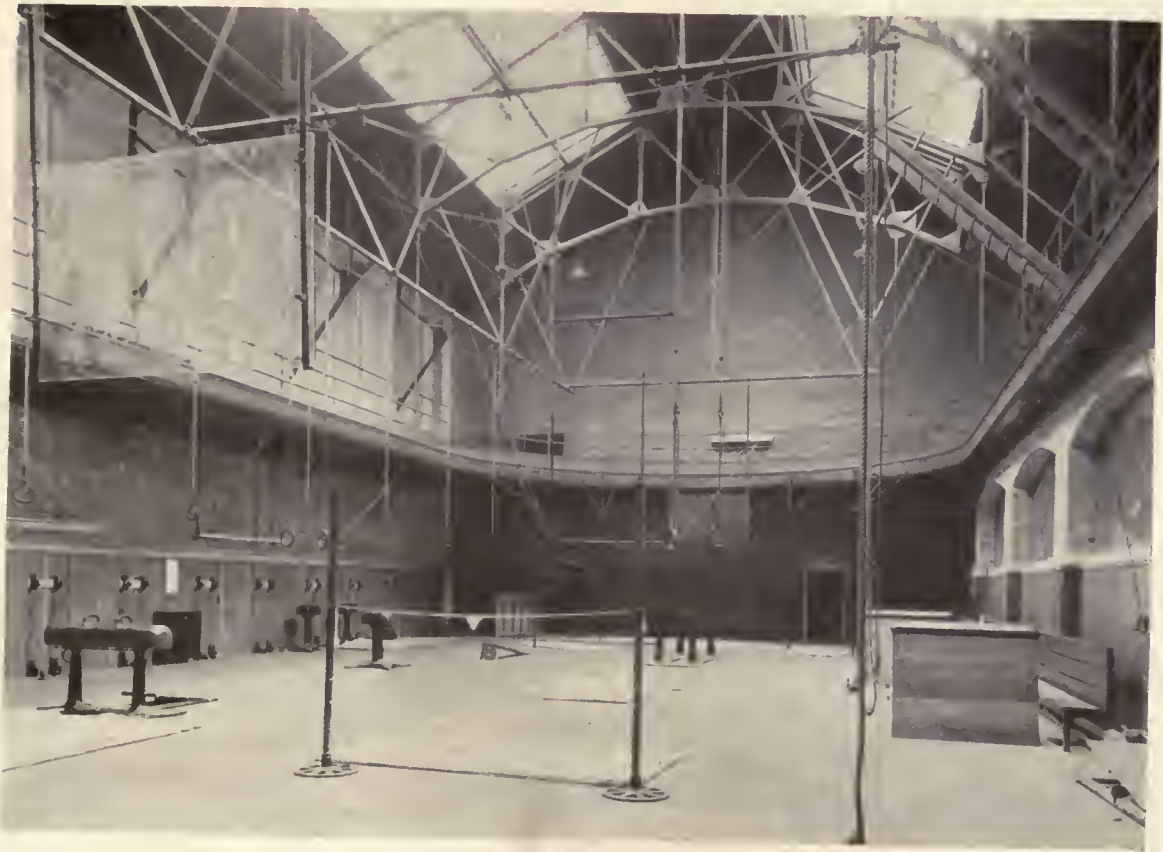

GYMNASIUM  
HART HOUSE, UNIVERSITY OF TORONTO, CANADA  
SPRATT & RALPH, ARCHITECTS





492

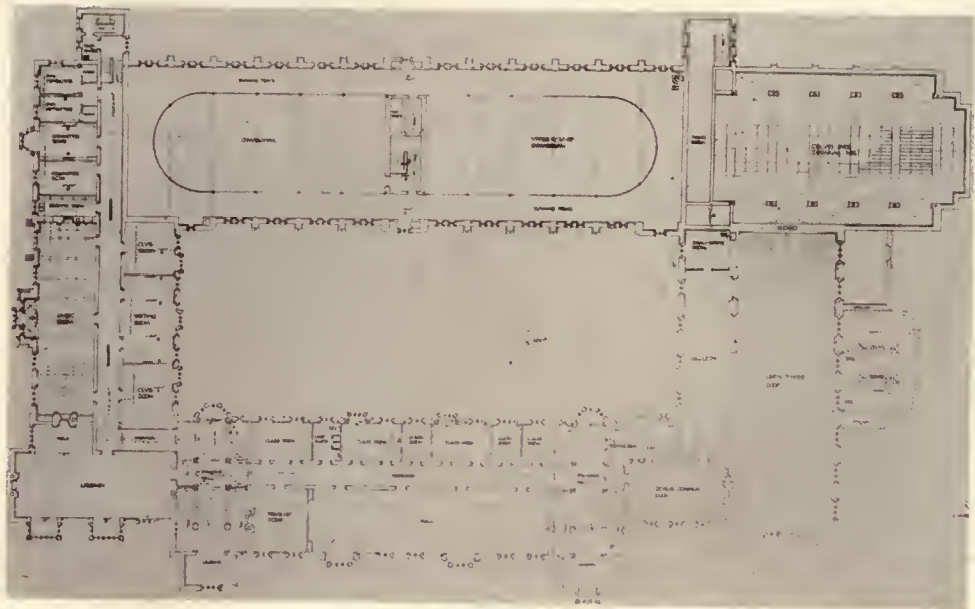

SECOND FLOOR PLAN



THE GALLERY  
UNIVERSITY OF TORONTO, CANADA  
SPRATT & RALPH, ARCHITECTS



4926

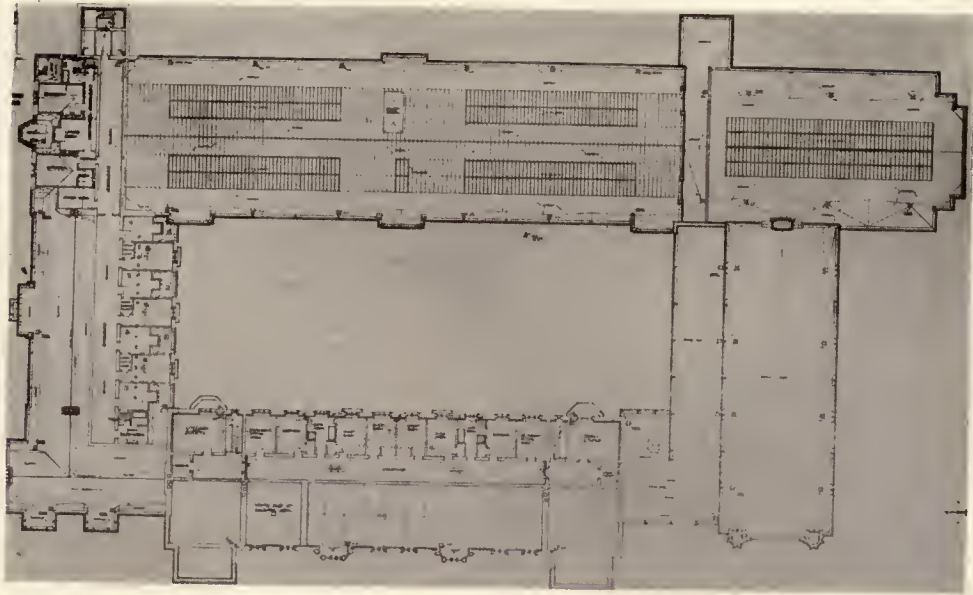

THIRD FLOOR PLAN



FACULTY COUNCIL ROOM  
HART HOUSE, UNIVERSITY OF TORONTO, CANADA  
SPRATT & RALPH, ARCHITECTS



492



QUADRANGLE



LIBRARY

HART HOUSE, UNIVERSITY OF TORONTO, CANADA  
SPRATT & RALPH, ARCHITECTS





HIGH SCHOOL, DURANGO, COLORADO  
CHARLES E. THOMAS, ARCHITECT





492 a



ENTRANCE DETAIL  
HIGH SCHOOL, DURANGO, COLORADO  
CHARLES E. THOMAS, ARCHITECT



49



AUDITORIUM



HIGH SCHOOL, DURANGO, COLORADO  
CHARLES E. THOMAS, ARCHITECT



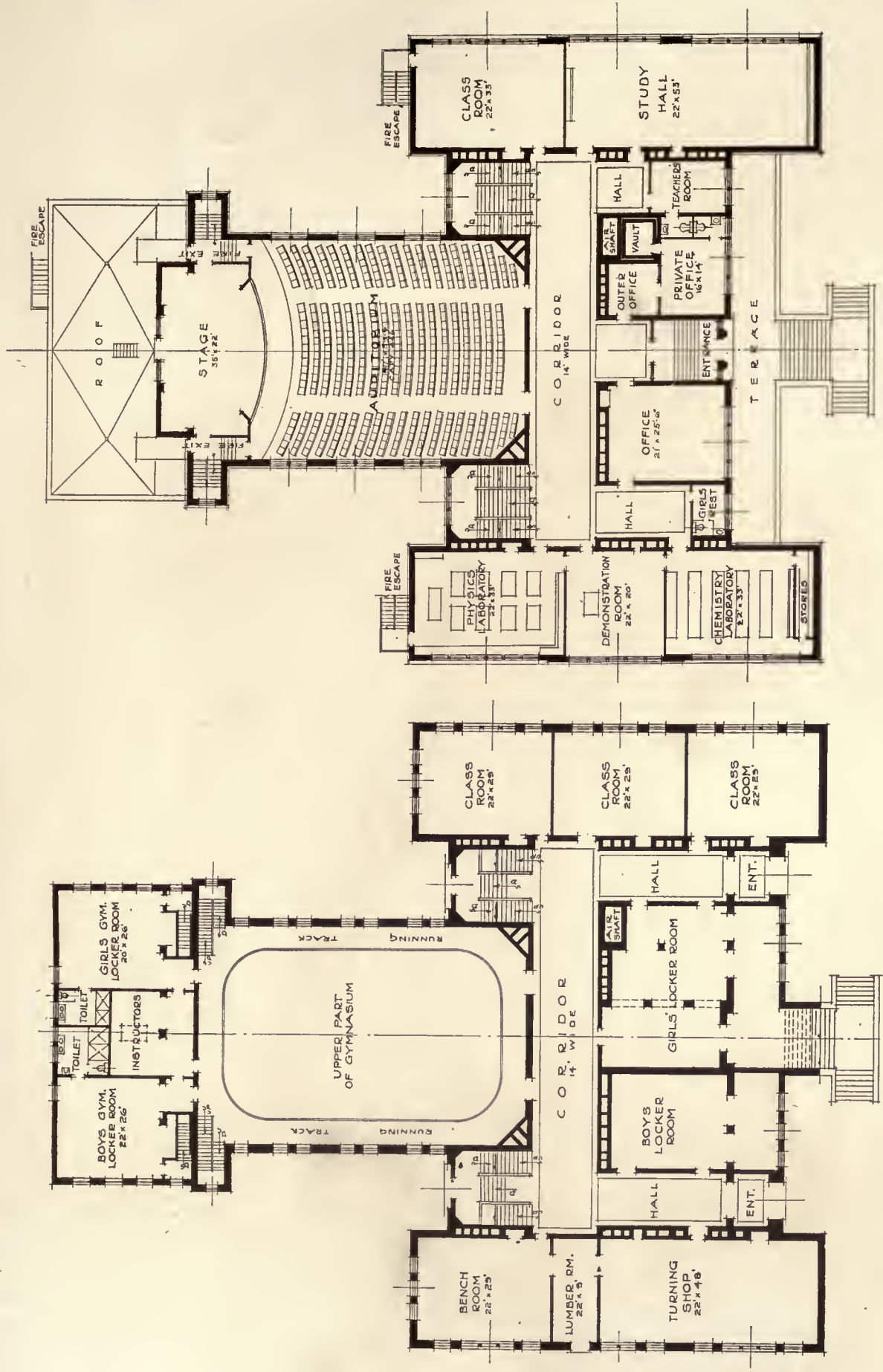

FIRST FLOOR PLAN

GROUND FLOOR PLAN

HIGH SCHOOL, DURANGO, COLORADO  
CHARLES E. THOMAS, ARCHITECT



Several years ago the School Board of Durango authorized a survey of the school system to relieve existing congestion. Although Durango is a community of less than 5,000, it is the most important city in southwestern Colorado, a section which is isolated from the rest of the State by high mountain ranges, and reached only by a narrow gauge railroad.

Situated at the head of a large and fertile valley, Durango is an important distributing center for both the valley and the rich mining district immediately above it. These facts led to the recommendation of the erection of a first-class High School, which would not only serve the need of Durango, but establish an educational center for the entire district. The lack of a theater or any adequate assembly hall in the community led naturally to the recommendation that the building be planned to afford social center service.

The contract for the building was let in 1916, and the structure completed in 1917 at an approximate cost of \$165,000, without equipment.

The plan of the building is the usual H shape, to which is added a rear wing containing gymnasium, plunge, and locker rooms, and auditorium, all of which are used by the community as well as by the school. For this reason the auditorium is treated as a theater rather than as a school assembly room. The other portions of the building are devoted to class rooms, study hall, laboratories, shops, and commercial and domestic science departments.

A complete system of heating and ventilating, with automatic regulation of humidity and temperature, is installed. The equipment of the building is in harmony with the structure.

The two years in which the building has been occupied have demonstrated the wisdom of the program, the attendance having already reached the limit of capacity, and the social center feature proven to be of greatest value to the community.

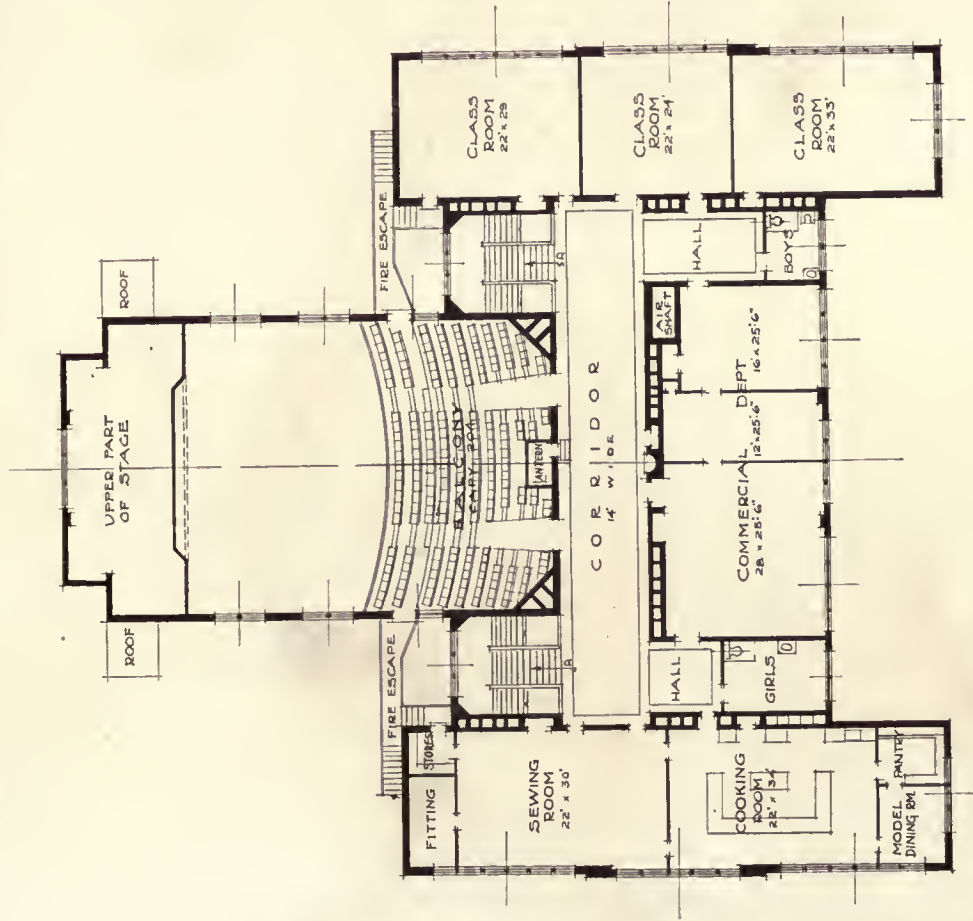

SECOND FLOOR PLAN  
HIGH SCHOOL, DURANGO, COLORADO  
CHARLES E. THOMAS, ARCHITECT





# Current News

---

## Happenings and Comment in the Fields of Architecture and the Allied Arts

### Denmark Offers Prizes for Bridge Designs

According to an issue of *Politiken*, the municipal council of Aalborg, Denmark, will in the near future deal with a proposal concerning a new bridge across the Limfjord, to replace the present old pontoon bridge. The design for this bridge, to be the largest in Denmark, will be chosen by international competition. The competitors will be given free range in order to procure as many different solutions as possible. Thus any system, whether a pontoon bridge, an ordinary bridge, or a tunnel, may be considered. Prizes of 10,000, 6,000 and 4,000 crowns, respectively, will be offered for the three best designs.

---

### England's Building Program Provides Work for 1,000,000 Men

In addition to the handicaps of high prices and scarcity of building material, England's efforts to catch up to the demand for dwelling houses are being seriously retarded by a shortage of some 200,000 workers in the building trades, due to the results of the World War. Talking to London newspaper men recently Sir Kingsley Wood, Parliamentary Private Secretary to the Minister of Health, pointed out that 60,000 of the 840,000 men engaged in building houses before the war had been killed, many thousands had been disabled and a host of others had gone into other trades.

Sir Kingsley went on to say that, including the 500,000 houses that the Government building program called for, there must be at least 1,630,000 dwellings put up during the next ten years in order to house the people at all adequately, and that there would be more than enough work for 1,000,000 men during that period. He said there was a shortage of 15,000 bricklayers in sight if the requisite number of houses were to be got under way this year, and that there was no prospect of any unemployment in the building trades, even if the workers now in the army were all to return to their old places.

Since the Government mapped out its building program the Ministry of Health has approved nearly 120,000 plans for new houses embraced in some 4,500 "schemes," covering about 37,000 acres of land in the leading cities of England. On February 20 Dr. Addison, the Minister of Health, laid the first brick in the Hayes building "scheme," the largest one under way in the Metropolitan district, which aims at constructing 2,000 dwellings. In his speech Dr. Addison defended the Ministry's policy in allowing adequate rents to be charged and pointed out that this was the proper way to avoid similar housing shortages in the future. The Minister opined that working folk ought to get wages enough to enable them to pay proper rents.

In the meantime the London papers are urging that Parliament hasten the drawing up and enactment of some kind of a rent act to take the place of the present one, which

is due to expire on July 1, as otherwise tenants will have only their common law rights and may be ejected on due notice as in pre-war days. The present rent act, which was enacted last December as a substitute for the preceding measures which prevented landlords from ejecting tenants paying \$350 or less a year rent, provides that no ejections from such premises may be made unless there is alternative accommodations available.

---

### Would Bar American Architects

With a view to putting an end to American architects practicing in British Columbia, the architects of the province, states *Contract Record*, have a bill before the Legislature which provides incorporation for an architectural institute, and also protects Canadian architects. The clause which debar American architects from practicing is as follows: "An architect seeking admission under this act, who is a citizen of a foreign country or state, shall be admitted to practice architecture in this province on passing such an examination as may be prescribed by the council; provided that such foreign country or state of which he is a citizen recognize the standards of qualification set out herein on an equal footing with their own, and admit the members of this institute equally with their own citizens."

---

### An Artists' Guild In Paris

There has recently been inaugurated in Paris the Syndicate of Graphic and Plastic Arts, organized for the defense of the legal and moral rights of artists, and for laboratory and research work. This has awakened American artists to the necessity of an American Guild based upon the same ideals.

According to word from Paris, the French Guild is at present agitating the granting of authors' rights for artists; that is, the right to a continuing interest in the sale of works in order that there shall be no speculation in works of art bought at reduced figures on forced sales.

---

### Remodeling in New York

The suggestion that New York City could find a solution of her housing difficulty in the remodeling of 33,000 apartments and houses now unfit for or unadapted to habitation ought to be received with reservations, retorts the *Globe* editorially.

The remodeling of buildings can be done properly or improperly. Experience dictates the casting of a decided vote against the method which ends with the installation of plumbing facilities, a few coats of paint or varnish, and the inevitable partition. On the other hand, to remodel properly requires time and money. It is estimated that the "improvement" of a block in Greenwich village, assessed at \$530,000, will cost \$500,000 and will

take until September 1. It is this sort of remodeling that New York buildings, now unfit for dwellings, will probably require.

The city may find the improvement of old buildings a part of its building program. It should not imagine, however, that the conversion of these into modern apartments will be a quick or inexpensive process. What the *Globe* believes is really necessary, as is indicated by Representative Amos's proposal for legislative action on the matter, is for the city to become a landlord on a large scale and at considerable expenditure of money in order to put through this entirely feasible but rather sizable undertaking.

---

## When Lithographers Differ

An incident, not heretofore publicly recorded, of the recent "Joe" Pennell "quarrel evening," as it has been called, at the National Arts Club, when during a discussion on lithography and the graphic arts in general, in which Pennell outpoured his usual torrent of abuse on all craftsmen who differed with him, was the retort of George Bellows. Pennell remarked that Bellows should have drawn his noted illustration of the "Murder of Edith Cavell" directly from the scene on paper, and then transferred the sketch to stone. Bellows drily retorted, "I didn't have a ticket to that affair—neither did Rembrandt to the Crucifixion."

---

## House Shortage Drives People from New York

The result of New York's failure to undertake and follow to a conclusion an adequate building program may be noted in the report of the Long Island Railroad. This road carried 34,000 commuters in February, more by 10,000 than the February of a year ago.

February is the month, comments the *Brooklyn Eagle*, in which every town worker who can find any sort of a place to live in town does so to escape the uncertainties of disarranged train schedules and the discomfort of tramping through snowdrifts. This year those uncertainties and discomforts were greater than within the memory of the present generation, yet the commutation figures on one railroad were 10,000 heavier than it had ever before known. It is estimated that something like 100,000 persons must be living permanently outside of New York City who would prefer to live there if they could find quarters.

The inconvenience to these Winter commuters is a serious burden, but that is not the worst of it. Taxes on the houses that they live in are paid outside of New York City, at a time when the burden of taxation there is staggering and when additions to its assessment rolls are needed as seldom before. A good part of their supplies are bought in their home towns, thus cutting down the volume of retail business done in New York. This depletion of the city's resources will go on increasing until means are found of building apartments on a large scale. If haste is not made, the families which now dwell out of the city on compulsion may have acquired the habit of country living and decline to come back. If that happens, New York will have exiled the goose which lays the golden eggs.

## Aeronautical Research in England

The establishment of an Aeronautical Research Committee in the British Air Ministry and an Industrial Research Association for the aeronautical industry are recommended in the official report of a special committee on education and research in aeronautics, details of which have been received by the Bankers' Trust Company from its London correspondent.

Among the duties defined for these organizations are:

Advising the Air Ministry on scientific and technical problems relating to the construction and navigation of aircraft.

Assisting the aeronautical industry by scientific advice and research.

Preparing for approval of the Air Council a scheme of work and estimate of expenditure for the year.

Aeronautical education is considered, by the special committee, higher education which can only be given in institutions of university work. A department of aeronautics at Imperial College is suggested for the training of those who are to direct aeronautical research and the design and construction of aircraft.

---

## Aircraft Fusion in Great Britain

Commercial interest in Great Britain has been considerably aroused, says the American Chamber of Commerce in London, by the announcement of the amalgamation of the Aircraft Manufacturing Company with the Birmingham Small Arms Company, Ltd.

There is a tendency to regard this fusion as indicating what is likely to happen in the British aeroplane industry generally in the near future, unless there is some immediate change in the situation. Aeroplane manufacturers are compelled, through lack of support, either to cease business altogether or to produce aeroplanes merely as a side line.

Commercial aviation in its present form does not offer strong inducements to business men. To make it an attractive proposition it must be greatly expanded. The relation between overhead and running charges is still disproportionately great.

War machines converted for commercial flying, the American Chamber points out, can at present carry passengers from London to Paris at 100 miles an hour at the rate of about 1/3d. a mile, while for goods transport the rate of 2/6d. per pound for a small parcel can be reduced to 1/6d. for a consignment of 75 pounds and over. Owing to the speed, the time saved is enormous. A passenger picked up in London at 11 a. m. should reach Paris before 4 o'clock. Parcels are delivered by air express well within a single day, and express letters travel between the two cities from door to door in about five hours. American business men on quick trips of investigation of British and continental markets have been heavy users of this service, which is a great time-saver for them.

---

## Extended Interest in Highway Construction

The extent to which the people of the United States are committing themselves to a definite policy of highway development is shown by reports reaching the Federal Highway Council from all sections of the country.

## THE AMERICAN ARCHITECT

In the face of high cost for both materials and labor, and the fact that in some states construction programs must be altered somewhat to meet existing labor and material conditions, there is no tendency upon the part of the people to slow down in their plans to place the nation's highways upon a higher plane in the country's transportation system. Tersely stated, "They are sold to the heels" on the proposition to construct highways that will release rather than restrict traffic, and they are dismissing labor and material problems with curt instructions to their official servants that it is up to them to deliver the roads.

A curious fact in connection with construction problems at the present moment is that the building of roads is seriously hindered by the same evil which they are designed to remove—lack of transportation. According to authoritative information, production is halted to a greater degree by inadequate transportation facilities than by labor shortage. At least this is true, it is claimed, in the production of materials for road building.

Highway officials—State and county, as well as national—are facing their duties with patience and tact, and out of a maze of trying situations, construction is going ahead at a fairly satisfactory rate.

### Stonehenge to Be Protected

Stonehenge, now a national monument of the British people, is undergoing preservative treatment so that the gigantic stones may not topple over. In making a concrete foundation for one of the columns, no fewer than 125 rude implements of stone used in the original work of dressing the boulders came to light, together with a "pick" ingeniously fashioned from the antler of the red deer. Astronomical calculations give the date of erection of this great prehistoric work as 1680 B. C.

### Cities Prepare for Future Air Traffic

About thirty cities have work in progress on the development of public landing fields for aircraft. The adaptability of the airplane to peace-time needs has demonstrated to men of vision that the airplane will in the future be used to the extent that landing facilities are available.

To be adequate, a municipal landing field must bear some relation to the main aerial routes. It must be so located that it will not later be shut in by tall buildings. It should be about 600 acres in size, and should be capable of expansion. It should be located close enough to other transportation facilities and to water-supply to permit any future development found necessary. It is not necessary that such a field be within the city limits.

Some of the cities already active include Albany, N. Y.; Scranton, Pa.; Flatonia, Tex.; Syracuse, N. Y.; Raleigh, N. C.; Jackson, Mich.; Bristol, Tenn.; Evansville, Ind.; San Antonio, Tex.; New Orleans, La.; Binghamton, N. Y.; Atlanta, Ga.; Kansas City, Mo.; Daytona, Fla.; Macon, Ga.; Cleveland, O.; Tucson, Ariz.; Montgomery, Ala.; Rochester, N. Y.; Baltimore, Md.; Detroit, Mich.

### To Revive Industrial Art

The Society for the International Revival of Industrial Art, with advisory committees in London, Paris, Rome and elsewhere, has been formed under the leadership of Mrs. William Alexander for the purpose of encouraging and

preserving the highest type of industrial art at home and abroad, and of bringing together the producers and those most interested in their works. The organization hopes to foster and preserve work of the best quality. "The society does not propose to act as sales agent for the actual buying and selling of industrial art," says its announcement, "but will establish in New York, and eventually other cities, offices, exhibition rooms and bureaus of information for the benefit of the lovers and buyers of art products."

Mrs. Alexander is president of the New York Committee; Mrs. Nina L. Duryca, vice-president; the Equitable Trust Company, treasurer, and F. Burrell Hoffman, secretary. The English Committee includes the Lady William Cecil, chairman; the Hon. Margaret Amherst, secretary; the Hon. Mrs. Walter Long and the Countess of Minto. Many members of the nobility are included among its patrons. The Belgian Committee is made up of Baron de Vink, Baron Kingud Littinkovo, and M. H. Dommertin. An exhibition, principally of fabrics and rugs from Morocco, has just been opened at 4 East Fifty-sixth street, where it is to continue for a short while.

### The Discussion of Immigration Policies

At a meeting in New York of the Inter-Racial Council the various phases of the immigrant were discussed: his immigration, education and assimilation, and his naturalization.

Without much discussion the need of a constructive policy became apparent. Coleman Dupont, chairman of the board, said that we have actual need for the immigrant for the attaining a full development of our industries. Later a gentleman speaking for the farmers remarked the movement from the farms to the factories and the vacuum it had created in the production of food. It was further pointed out that there had been no organized encouragement of desirable immigrants, and when they arrived here they were treated in the most haphazard fashion; peasants of the land became factory operatives and mechanics became laborers.

Several gentlemen, some of foreign birth, were plain in the denunciation of the attitude of Americans toward foreigners as toward inferior beings, saying that the first point of attack in the Americanization of foreigners might be the instruction of Americans in their treatment of foreigners. A defense was made for the foreign language press on the ground that it is necessary to speak to people in the words which they understand, that there were many things in a strange country which needed to be explained.

Laws for the safeguarding of immigrants' savings were urged by Paul M. Warburg.

The numerous bills for the selection of immigrants were discussed by Louis Marshall, who approved of the exclusion of the mentally, morally and physically unfit, but questioned the advisability of selecting immigrants upon the basis of nationality or upon the matter of literacy.

There are always coat-room speakers. The representative of THE AMERICAN ARCHITECT was an audience of one to a Canadian journalist. "In my country," he said, "we encourage Anglo-Saxon immigration and we get on very well, but here one hears all languages spoken, and it is going to get you people into trouble. The speaking of anything but English should not be permitted, and as for bringing in more peasants from Europe—that would be a fatality."

News from Various Sources

The audience said: "Do you think so?" and he went on: "Of course, it is only a personal opinion, and I speak from the Canadian standpoint, but I have spent the past four years on the Continent (in service) and I know the sort of people you will get."

Many, no doubt, will share this Anglo-Saxon attitude of superiority and be sure in their belief that the Pole or Lithuanian or Swede who has "made good" in this country didn't have common sense until he learned English; or, at most, that he had a feeling of superiority over his race which led him to learn English.

Mr. Hambidge's Measurements

Intensely interesting though it undoubtedly was, Mr. Hambidge's paper, read at the Royal Institute of Architects recently, did not, one may imagine, make many converts to his theories, states the *Architects' Journal* of London. His facts, however, are indisputable. He has been at great pains to gather them, and they prove his uncommon power of patient research, even if they fail to show that the proportions he has found to prevail in beautiful buildings were designed deliberately and mathematically, instead of being coincident and spontaneous expressions of the sense of beauty.

Personals

Ralph Mornington Weinrichter, F.A.S.L.A., landscape architect of Rochester, New York, announces the opening of a New York office at 10 East Forty-third street.

The withdrawal of G. Evans Mitchell from the firm of Frank, Wagner & Mitchell is announced. The business will be continued under the name of Frank & Wagner, at 46 South Broadway, Akron, Ohio, associate architects with George B. Post & Sons, New York.

National Lumber Manufacturers' Association announces the removal of its general offices from 925 Lumber Exchange to Suite 750 McCormick Building, 332 South Michigan avenue, Chicago.

Samuel P. Hall, architect, late of the Construction Division, U. S. Q. M. C., and Harold M. Bush, mechanical engineer, late Colonel of Field Artillery, A. E. F., have formed a partnership for general architectural practice, with special reference to factories and industrial plants. They have established connections with Henry V. Hubbard, professor of landscape architecture. Offices are at 16 South Third street, Columbus, Ohio.

Edward C. Van Leyen and Edward A. Schilling, architects, and Henry J. Keough and Robert A. Reynolds, engineers, have associated under the name of Van Leyen, Schilling, Keough & Reynolds for supplying complete service in architecture, engineering and supervision, and announce their removal from the Union Trust Building to 556 Cass avenue, Detroit, Mich.

H. B. Mulliken, architect, announces that he has moved his office from 103 Park avenue to 609 West Forty-eighth street, New York.

The new Calistoga High School, Napa County, Cal., will be heated by natural hot water from one of the big Calistoga hot water wells. The water will then be cooled for drinking and irrigation purposes. Considerable expense will be saved, as the water rises in the well about twenty feet above the surface of the ground and will flow throughout the building by gravity.

\* \* \*

The Free City, by Bouck White, has been published by Moffat, Yard & Co., New York, advocating the City Republic, the Community State and filling in the picture of this ideal with epigrammatic description.

\* \* \*

Housing and Housing Problems are discussed by Carol Aronovici, Ph.D., director of housing, California State Commission of Immigration and Housing. The social and economic principles involved in providing facilities for the highest possible standard within the reach of the largest proportion of people are presented.

\* \* \*

The results of an investigation covering substitutes for the saloon have been prepared by Raymond Calkins, with a valuable introduction by Francis G. Peabody.

\* \* \*

George B. Ford has published a book, "Out of the Ruins," describing his observations in the Red Cross service in France. Recent laws affecting reconstruction are made clear.

\* \* \*

A treatise on Education in Accident Prevention was prepared by E. George Payne, Ph.D., at the request and with the approval of the National Safety Council. Gives practical methods of teaching safety in the regular courses already given, without the addition of a new one.

\* \* \*

Preliminary plan for a housing project was issued by War Civics Housing Committee to interest the industries and citizens of East St. Louis in the housing problems of the city. Address the committee, 331 Federal Building, East St. Louis, Ill.

\* \* \*

A pamphlet of thirty-two pages is presented by the National Works Department Association, telling why the Government should have a Department of Public Works which would organize the many and varied public works functions of the Federal Government, now scattered through nine separate departments and thirty-nine bureaus and services. This association urges the passage of the Jones-Reavis bill to create such a department. Address the Association at 502 McLachlen Building, Washington, D. C.

\* \* \*

An illustrated bulletin (No. 816 of the U. S. Department of Agriculture, January 19, 1920), of fifty-eight pages, prepared by F. L. Mulford, horticulturist of the Office of Horticultural and Pomological Investigation, shows the kinds of trees suitable for city streets, their planting, culture and care. Apply to the Government Printing Office.

\* \* \*

Bulletin No. 5 of the series "Community Buildings as War Memorials," published by the Bureau of Memorial Buildings, War Camp Community Service, 124 East Twenty-eighth Street, New York, N. Y., 1919, thirty-nine pages. Illustrated descriptions of auditoriums in a number of cities. Address the bureau, as above.

# Summary of Program of Architectural Competition for the Remodeling of a New York City Tenement Block

The Joint Legislative Committee on Housing and the Reconstruction Commission of the State of New York present the problem of remodeling a characteristic old tenement block in New York City. The object is twofold: to find the best method of improving living conditions in the old-law tenements without destroying the buildings and to find a plan for remodeling that will encourage such alterations by the demonstration of its economic wisdom. The relation of costs to results will be a predominating factor in the judgment. The purpose of the competition is to find solutions that will be applicable not only to the block which is the subject of study but also to similar blocks throughout the city.

Competitors may decide what size units, what type and size of tenement, apartments, rooms, courts and yards will give the proper environment for decent living and the most practical result as to plan, management and financing. For the study the block bounded by Rutgers, Madison, Jefferson and Monroe Streets, Manhattan, has been chosen. Two plans of the block are supplied to competitors; one of the ground floor and the other of a characteristic floor of the apartments; also the elevations of the four street fronts. The following two drawings are required: A plan of the first floor and a plan of a characteristic floor and only one other drawing may be submitted which shall consist of a bird's eye view of the whole or part of the development.

In addition to the drawing each competitor is required to submit a description. It should contain the following: (1) An explanation of the advantages of his solution from the point of view of the tenants, owners, the community and the State. (2) The proposed methods of carrying out the alteration; in small or large units, by individual owners, groups of owners, assistance of the local community, city or State. (3) A brief description of materials, type of lighting, plumbing, heating to be used in alteration. (4) Any proposed scheme of management. This includes care of houses, heating, lighting, rentals, as well as any common facilities for the use of more than one family or one house. (5) Comparisons of existing and altered block: (a) Number of apartments. (b) Number of rooms. (c) Conveniences. (d) Sanitation and ventilation. (e) Rental values.

The drawings and description are to be marked with an emblem, the description placed in a sealed envelope, marked on the outside with the same emblem. These shall be accompanied by a sealed opaque envelope containing a card on which shall be the name and address of the competitor. All drawings and descriptions must be delivered at Room 302, Hall of Records, New York, on or before 1 o'clock June 15, 1920. The competition is open to any person.

There are prizes offered, two of \$1,000 each, four of \$500 each, and four of \$250 each. The jury holds the right of publishing or exhibiting any drawing or description that may be submitted.

The judges of the competition will be: Mr. Allan Robin-

son, Mr. Alfred E. Marling, Mr. Edgar A. Levy, Hon. Frank Mann, Mr. Clarence S. Stein, Senator Charles C. Lockwood, Senator John J. Dunnigan, Mr. Andrew J. Thomas, Mr. Burt Fenner, Mr. Robert D. Kohn, Miss Lillian Wald, Mr. Alexander M. Bing.

Until April 15th questions will be answered if sent to Clarence S. Stein, Secretary of the Housing Committee, Reconstruction Commission of the State of New York, Room 302, Hall of Records, New York City.

Two methods have been suggested as a practical means of refurbishing the old tenement districts; one is to tear down the present structures and replace them with new buildings, the second is to alter the existing structures to make them wholesome places to live in. With the present costs of building, it is impracticable to attempt the first method on a large scale if the same end can be attained by remodeling the old buildings. In March, 1919, of the total of 982,926 individual apartments in New York, 587,851 were in old law tenements; that is to say that they may be expected to be detrimental to the health of the community and a poor financial investment. The process of their destruction is slow. In ten years up to March, 1919, 58,552 apartments were destroyed. At this rate it would take 100 years for them to disappear.

Most of the owners of the old houses have had slight if any return from the money invested. Rentals are low and the tenants constantly moving. There are a large number of vacant apartments; in March last 19,110 old law apartments were vacant and they were with few exceptions unfit for human habitation.

Most of the defects of the old tenements are due to poor planning. Their more obvious faults are: (1) The lack of sufficient air and light—a large part of the rooms have no direct opening on the outer air. They are lighted and ventilated by opening into adjoining rooms. Others have windows on small shafts or narrow interior courts. Many of the families still live below the level of the sidewalk. (2) The toilet facilities are without proper light and ventilation and used in common by more than one family. (3) There are bad odors resulting from the ventilation of toilets on courts, shafts or corridors on which living or bedrooms open, and from the use of the courts as a receptacle for garbage. (4) Dumbwaiters, where they exist, are always nailed closed, and food and coal (each apartment is heated individually, excepting in the new houses) must be hauled up four or five flights. The garbage and ashes when not thrown down the shaft must be carried down to the ground floor. There are not enough sinks or wash tubs. There are practically no bath tubs in the poorer parts of the city. (5) The lack of privacy endangers both decency and health. This is due to bad planning and is accentuated by overcrowding. (6) The neglect and decay into which the houses have fallen are due to age and lack of proper care of the house. (7) There is absence of adequate play or recreational space which gives a dreary, unwholesome environment for the homes. (8) There is a lack of proper protection against fire.

# Weekly Review of Construction Field

Comment on General Conditions of Economics With Reports of Special Correspondents in Prominent Regional Centers

THE event of greatest moment in the past week is the so-called "outlaw" strike in the transportation system. Just what force such a strike will have in the development or clarification of the labor situation is a subject for speculation; but this is a speculation which doesn't get one very far.

The most disturbing feature of the manifestation is the closing of factories. After a survey of the large industrial plants of Detroit, the Employers' Association of that city announced that 110,000 men are forced out of work. In Pittsburgh 200,000 men were idle—mostly in the steel and coal industries. Three coal companies of Scranton and the mines of Carbon County, Utah, were compelled to close for want of cars. Because of a coal shortage 100,000 men are reported out of work at Columbus. There can be no section of the country which does not suffer the unfortunate effects of this strike.

And with these men out of work, even though it last but a few days, our backward production is still further held up. The costs and complicated losses accumulate like an avalanche with a waste which at this time is horrible to contemplate.

Liberal opinion has stood out for the right to strike, saying that without such right labor gives over its only weapon. This may or may not be true; it is barely possible that we have still in this country a sense for justice or for general well being which in the long run will prove to be more powerful than the detailed attacks made upon it, however organized or forceful, whether of labor or of capital. The point of view of liberal opinion seems rather narrow in its perspective of the forces at work.

On the other hand, the Poindexter bill is under consideration by the Senate Interstate Commerce Committee. It is a bill which would impose heavy fines and imprisonment on persons persuading railroad employes to quit work when by so doing they would tie up transportation. The Edge bill, also in the Senate, makes it a misdemeanor for a railroad employe to quit singly or in combination with a substantial number of his fellow employes for the purpose of obtaining more favorable working conditions. There is a third bill presented by Senator Freylinghuysen which embodies the anti-strike provisions that were stricken from the Cummins Railroad Bill.

OF a more helpful nature is the appointment of the Railroad Labor Board, which is not merely to act upon the particular occasion of dispute now to the fore, but is in control for years. It is a court of appeal in which is represented all three parties of interest: the employes, the managers and the public. And it is well that the decision now desired should not be arrived at hastily through a balance of powers, but by a legitimate decision of the merits of the case. The factors at issue are complicated and far-reaching and the solution should be, by its justice, of value in solving the other labor controversies and disagreements which are involved with the same or similar questions.

A statement from the employes says: "In determining the justness and reasonableness of such salaries so far as applicable we have taken into consideration, among other relevant circumstances, the following: (1) The scale of

wages paid for similar work in other industries. (2) The relation between wages and the cost of living. (3) The hazard of employment. (4) Training and skill required. (5) The degree of responsibility. (6) The character and regularity of employment. (7) Inequalities of increase in wages or of treatment, the result of previous wage orders of adjustment." Certainly, the Railroad Labor Board assumes a difficult responsibility.

A few months ago the American Federation of Labor expressed its interest as an organization in politics. Its wishes were not very definitely expressed except that it would support such legislators as looked out for its interest. It is now announced that the National Association of Manufacturers will enter the national political campaign with a "platform for American industry," to be submitted to both the Republican and Democratic conventions. A committee of three representative manufacturers from each State will meet in New York to draft a definite platform for industry which is to be voted on at the twenty-fifth annual convention of the association May 18th.

The effort is made to select manufacturers which reflect not only the sentiment of their particular industry, but the industry of the individual States. A letter sent to the various State organizations says: "It is now the duty of productive industry to present to the country a sound, economic program. Never before have associations like ours had the opportunity to prepare jointly such a program."

It is indeed time that industry explained its position and its needs. The assumption that manufacturing is wholly to the benefit of the owner should be corrected. The industries may be privately owned, but they are all engaged in producing for common consumption and their development and improvement benefits the great body of consumers.

France has long furnished State aid in the construction of cheap dwellings and the acquisition of small holdings of land. The interest of such money is 2 per cent, or if the buildings or land is to be rented out, the interest is 2½ per cent. The provinces and communes are authorized to purchase and resell lands for this purpose which are subdivided into lots not exceeding a quarter acre. The price of such a homestead must not exceed 10,000 francs. Such funds may also be drawn on to complete buildings already in the course of construction.

Property so acquired cannot be transferred for ten years and if purchased for a home it cannot be used for any other purpose. The purchaser must engage to cultivate the land either by himself or with the help of members of his family. When lands have been purchased by the province and divided into lots, plans are placed in the office of the prefecture and the branch offices of the province and are open to the public for two months. The price of each lot is given. In awarding the lots, consideration is given to the morality of the applicant and the number of children in the family and preference is given to those who have arranged for long term loans.

# DEPARTMENT OF ARCHITECTURAL ENGINEERING

## Clocks, Historically and Architecturally Considered

### Part Two—Modern Developments

**M**ODERN business conditions make it absolutely essential that synchronized time be in common use. Even at this time one can traverse a street in any city and find clocks varying to a very marked degree. This variation in the time indicated by clocks is the source of annoyance and often is the cause of loss in business transactions. Naturally there is a general

quality and design of the clock mechanism. The increasing use of clocks and the cost of time installations is making it necessary for architects to inform themselves as to all of the factors involved in this particular branch of building equipment. With the improvement in the design of clocks more uses for them develop and it is very probable that the item of clocks will receive the same atten-



CARRIAGE FACTORY, C. P. KIMBALL CO., CHICAGO. GEO. C. NIMMONS CO., ARCHITECTS

feeling of uncertainty when accurate time is involved and this can only be overcome by a more general use of time pieces of precision.

Clocks have, in most instances, been classed as furniture and the planning for their use and their selection has been neglected by architects. In many cases their selection is made with too little consideration of the service to be rendered and the

tion as that given to lighting, vacuum cleaning, ventilating and other mechanical apparatus and devices. The ease with which clocks are installed, their dependability and moderate cost, is causing them to be considered indispensable in many places where they were formerly considered not even necessary or desirable.

The modern electric clock system service in-



CLOSE-UP VIEW OF CLOCK TOWER, CARRIAGE FACTORY, C. P. KIMBALL & CO., CHICAGO.  
GEO. C. NIMMONS & CO., ARCHITECTS

cludes the clock, programs and alarm service, time recorders and time stamps. All of these are controlled by a master clock with which they synchronize. The secondary clocks are placed in any position desired and are in movable cases or built in the walls with only the glass face and its enclosing case projecting from the wall surface. Free-standing desk or mantel clocks can be placed where desired by providing the proper electric connections. By the use of program clocks any desired system of alarms, by means of bells, gongs, buzzers, lights or whistles can be operated and at any stated time desired. The number of programs is not limited and the service is very flexible, easily modified and controlled.

Exterior clocks in towers, pediments and projecting cases are also controlled by means of master clocks when desired. There is no limit to the number of places where such clocks are used and they are often important features of the architectural design. In fact, the clock can be made an important element in any design, whether interior or exterior. Time recorders are a secondary clock so arranged that the time when the recording apparatus is operated is indicated on a card or ticket. Their use is generally for the purpose of registering the time at which persons enter or leave a place of employment. They are usually reliable in cor-

rectly indicating time, but many possess decided advantages in the difficulty of operating them fraudulently. This is an important feature as fraudulent operation is the source of great loss in wages paid for services not rendered.

A time stamp is a device which indicates on a paper the time at which the apparatus is operated. These are used to record the time at which documents, letters, telegrams or memoranda are received or dispatched. Their use is of importance as a means of establishing the time at which events or transactions take place.

The clock is used on places of residence, places of business, public institutions, governmental buildings, schools and many other situations.

Residential use is not common as yet and this is due evidently to a lack of knowledge of the service to be secured. When the dwelling is thought of, it is not usually accompanied by the idea of clocks as a necessity. This is not as much a necessity as it is a convenience. In the detached house of large size with several service buildings, it can be made a very important feature in the routine of its operation and use. The master clock, of the astronomical regular type, is easily made a "grandfather" clock, placed in the hall, living room or library. The case of this clock should be designed to conform to the style of the interior finish and decorations, in fact designed as a part of the room and not as a movable fixture. The secondary clocks,



CLOSE-UP VIEW OF CLOCK TOWER, SEARS ROEBUCK & CO. WAREHOUSE, SEATTLE.  
GEO. C. NIMMONS & CO., ARCHITECTS



THE AMERICAN ARCHITECT



VIEW SHOWING THE METROPOLITAN TOWER, MADISON SQUARE, NEW YORK CITY

MESSERS. N. LE BRUN & SONS, ARCHITECTS

located with reference to the architectural treatment of the room, are an admirable fixture in the living room, library or dining room. When the mechanism is housed within the wall structure, the dial can be designed as the center of an ornamental treatment surrounding it and with a distinct

quarters smaller and more plain clocks are desirable; these may advantageously be equipped with a program or alarm service. This alarm service is identical in effect to that furnished with the ordinary alarm clock. The main bedroom clocks can also be supplied with the alarm service and in addition have the hands and numerals coated with a radium compound which makes the reading of the time easily accomplished in the dark. These bedroom clocks especially, as well as the other secondary clocks, should be absolutely noiseless in operation. A suitable clock service can be extended to the garage, gardener's house and other service buildings. As a convenience, such a system of clocks is comparable to a complete telephone installation. Other residential buildings such as apartment houses, clubs and hotels can be equipped in like manner. The club and hotel require the use of the time recorder for the employees and the use of time stamps to be used on letters, telegrams, memoranda of telephone calls and of all other matters in which a record of the exact time of receipt or sending out is of importance.

In addition to this, the modern hotel is being equipped with a noiseless secondary clock in each guest room, this clock being equipped with the alarm attachment and radium compound coated hands and numerals. It is customary to operate the clocks on each floor through a secondary master clock located on each floor. By this arrangement, systems with as many as a thousand clocks have no more effect on the master clock than a system of a dozen secondary clocks directly connected with it. There is scarcely a feature of hotel service that is better appreciated than a clock service as described and the demand for it by hotel patrons is extending the use of such service very rapidly. This same condition is applicable to the better class of apartment buildings. In this type of building, the clock system is but an added feature of service which followed, very naturally, the now common services of lighting fixture and light, heat, window shades, refrigerators or refrigeration, vacuum cleaning service, gas stoves, laundry equipment, telephones, elevators and all the other things that competition forced into use. The clock system is but a logical extension of service.

In office buildings where there are tenants who acquire time stamps and time recorders in the conduct of their business, the secondary wall and desk clock is also a necessity. Where office buildings are equipped to supply this service a rental charge is made which yields a handsome return on the investment.

The leading school authorities recommend the installation of clock systems in school buildings.



WAREHOUSE, SEARS ROEBUCK & CO., SEATTLE, WASH.

GEO. C. NIMMONS & CO., ARCHITECTS

relation to the general design of the room. In the library, which is often used in a manner comparable to an office, a desk clock can be installed on the library work table or mantel. A smaller and more ornate desk clock would be a suitable part of the boudoir equipment. In the kitchen and servants'



TWO CHICAGO CLOCK TOWERS

WHOLESALE GROCERY HOUSE, REID, MURDOCK & CO.,  
CHICAGO. GEO. C. NIMMONS & CO., ARCHITECTS

THE TOWER BUILDING, CENTRAL MANUFACTURING DISTRICT, CHICAGO. S. SCOTT JOY, ARCHITECT. This building serves primarily to house the tanks which supply the sprinkler systems in the adjoining buildings. The offices of the architectural, engineering and construction departments and the local offices of the Central Manufacturing District are also located in this building

## THE AMERICAN ARCHITECT

This accustoms the pupils to observe time and be guided by it and has a tendency to develop the habits of promptness and regularity. The use of the program clock insures a regularity and uniformity of operation that can be secured by no other means. Other buildings of public nature,



JOHN MAGNUS & CO. BUILDING, CENTRAL  
MANUFACTURING DISTRICT, CHICAGO.  
S. SCOTT JOY, ARCHITECT

such as city halls, court houses, eleemosynary and penal institutions find clock systems, and often programs, a necessary adjunct to their operation. The modern hospital also requires a dependable system of clocks throughout and in some places special

service, as in the operating room, where the clock has a full attachment which strikes each fifteen seconds when desired. This service is to aid the attendant accurately to count the pulse of the patient during the operation. In the rooms and wards a noiseless clock is necessary.

The modern factory has a complete time system installed in all the buildings, consisting of secondary clocks, time stamps and time recorders, which are controlled by one master clock. All big modern machinery is equipped with a counter which records the number of operations as well as the elapsed time. The printing press and the binding machine thus record the number of papers printed or books bound and also the time during which the work was executed and the operations of other kinds of machines are recorded to show the number of operations occurring during the day. These recorders and regulators are connected with the electrically driven system.

In banks the clock system, and especially the time stamps, have long been recognized as a necessary safeguard to the operation of the business.

On approaching a railroad station, the majority of people are concerned with the time. For that reason large tower and other exterior clocks are seen from all avenues of approach. In the interior, secondary clocks are placed in all rooms and in all corridors and passageways. Time recorders and time stamps form a necessary part of the equipment.

The exterior clock, either in the tower or attached to the wall of a building, may not bring a direct benefit to the owners through any influence on the occupants. It does have a certain value because the building is looked to by persons who pass and this gives the occupant and the building a certain publicity that it would not otherwise attain. It is usual in these times to enclose the water tanks and other utilities within a tower, thus adding to the architectural importance of the building. These towers afford a splendid opportunity for the installation of clocks, and clock towers are becoming more common in manufacturing and mercantile buildings than any other class of structures.

The art of clock-making has been carried on in America from the early days of its settlement. American clock makers have kept apace in all the developments of the art and are probably paying more attention to the perfection of the mechanism than to the artistic designing of the cases and dials. Ever since the advent of the electrically operated and synchronized clock much attention has been given to their improvement and in extending the field of their service.

The firm manufacturing the oldest American

## THE AMERICAN ARCHITECT

made clock has specialized on tower clock movements and has also developed a master and secondary clock of the most excellent workmanship and materials. The makers of another clock, the product of about ninety years' experience, produce a master clock which is a very high class astronomical regulator and controls the secondary clock system.

The self-winding clock is one of the most modern of the electrically driven clocks. It was formerly operated by air pressure but this system was abandoned for the more satisfactory system of electric control. The secondary movement is of a high class and was the only noiseless movement up to 1919. It is used largely in connection with the Western Union Service.

The latest synchronized clock system to be perfected and placed on the market is controlled by a master clock that is practically an astronomical regulator, and is the only one that runs on ball bearings. The secondary clock is the smallest and of the most simple construction, having no springs but being driven by a self-cleaning interlocking worm gear movement. This is accurate and noiseless and a single mechanism is so constructed that when placed in a partition, a dial can be operated on each side of the wall, this effecting a considerable saving in the cost of installation and in maintenance and operation.

Architects are beginning to realize the importance of clock systems. It is yet the custom, to a large extent, to install the clock system after the building is completed. This cannot give the best service and is more expensive in installation.

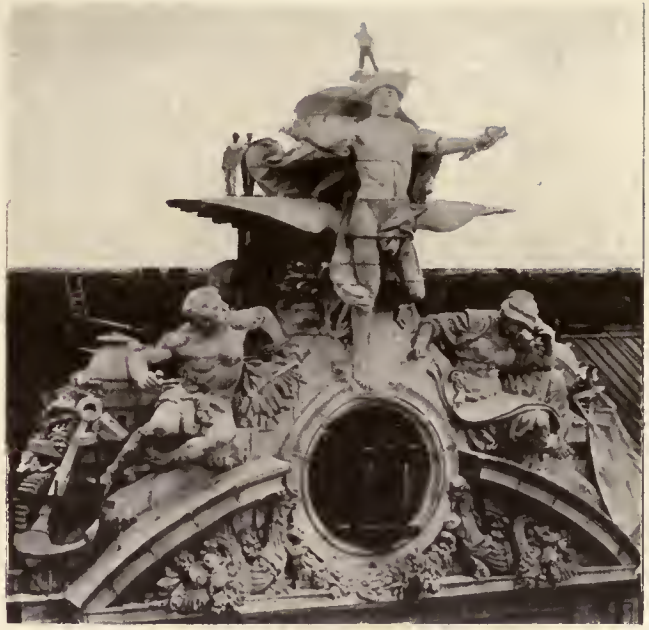

CLOCK TOWER GROUP, ASSEMBLED, GRAND CENTRAL STATION TERMINAL, NEW YORK CITY.

WARREN & WETMORE, ARCHITECTS

There is no reason why the outlets and wiring for a complete clock system should not be planned and installed in exactly the same manner that lighting, telephone, vacuum and other systems are now taken care of. At this time no one would consider the omission of providing for these utilities and to accord the same treatment to the electric clock system is well worth the architect's consideration.



BUILDING FOR THE CONTINENTAL CAN CO., CENTRAL MANUFACTURING DISTRICT, CHICAGO.  
S. SCOTT JOY, ARCHITECT

# The Future of the Construction Division, U. S. Army

## Shall It Become Part of the Proposed Department of Public Works?

**I**N May, 1917, the Construction and Repair Division of the Quartermaster General's Office was separated from the jurisdiction of the Quartermaster General, except in certain minor details, and to all intents and purposes became a separate corps. This was occasioned by the pressing necessity of providing housing facilities for the new armies which were rapidly being drafted and sent to training camps, as well as the necessity of construction of shops, factories, storage and terminal facilities to meet the transportation and overseas shipment requirements of the army.

The Construction Division was composed of never more than three regular army officers and of the very pick of the engineering and constructional civilian brains of the country. These men came in to help in this immense work and built up an organization at the head of which was Brig.-Gen. R. C. Marshall, and which conducted simultaneously 581 separate building operations and employed more than 400,000 men at one time in their construction. Not only did this organization construct cantonments with all their utilities, storage warehouses and depots, but it also built many ammunition and chemical manufacturing plants, as well as factories and factory additions for the manufacture of motors, tanks and ordnance.

In October, 1917, the operation of the cantonment utilities was also placed on the shoulders of this division, as it was found impracticable to keep the construction of cantonments and the operation of their utilities separate.

The operation of utilities is a skilled and highly technical business. It requires the services of men with much experience in this work if effective operation is to be had. The Construction Division has in its employ many skilled utility operators and managers. And so the work of the Construction Division is not finished. It is safe to assume that there is a hundred million dollars' worth a year for it to do for an indefinite period.

There are at present three plans being considered for the future of the Construction Division. The first one suggested has been to transfer it to the Corps of Engineers. This has been rejected, because the Corps of Engineers is not qualified by training or by experience to operate such a division. They have no men who are trained in building construction or in the operation of utilities. No work which the Corps of Engineers does or has done has fitted them for such a job as this. The Engineer

Corps has never in the history of the country had to do with the construction work of the army or with the operation of its utilities. The proposal to transfer this division to the Engineer Corps would then be to put civilian work totaling a hundred million dollars a year into the hands of men with no training and experience along these lines. The absurdity of this proposal has been finally realized and it is not now actively before Congress.

The second proposal is to transfer this division back to the Quartermaster Corps. There are serious objections to this. In the first place, it is a civilian corps made up of civilian engineers who are specialists in their line. These men are not willing to go into the Quartermaster Corps as reserves and run the risk of being assigned to work for which they are not qualified, but they would continue to be immediately available if the Construction Division is given an independent status. The Quartermaster General's Office was a large and important one before the war and yet its expenditures, including the pay of the army, were less than \$100,000,000, which is a conservative estimate for the amount of work the Construction Division will be called upon annually to do. The work of the Construction Division is highly specialized and had no particularly intimate relation to the other work of the Quartermaster Corps. In order that such a division may function effectively it must have an independent status. If it were transferred back to the Quartermaster Corps and made a sub-division of a sub-division it would be seriously handicapped, for if effective decisions are to be made, the responsible executive must have immediate access to the officer exercising the final authority, who in this case is the Secretary of War or his representative on the General Staff.

The Construction Division, then, should be given an independent status, should maintain its wonderful organization and "esprit de corps" intact. It should finally be transferred bodily from the War Department to the proposed Department of Public Works. It is work of a strictly non-combatant nature. Army methods and army experience are absolutely unnecessary to its proper functioning and its personnel is made up of trained civilian engineers and constructors. This division would be thoroughly at home in the Department of Public Works and it is the earnest desire of the architectural and engineering profession that it be eventually included in such a department.

506

Proctor's piece No. 2214

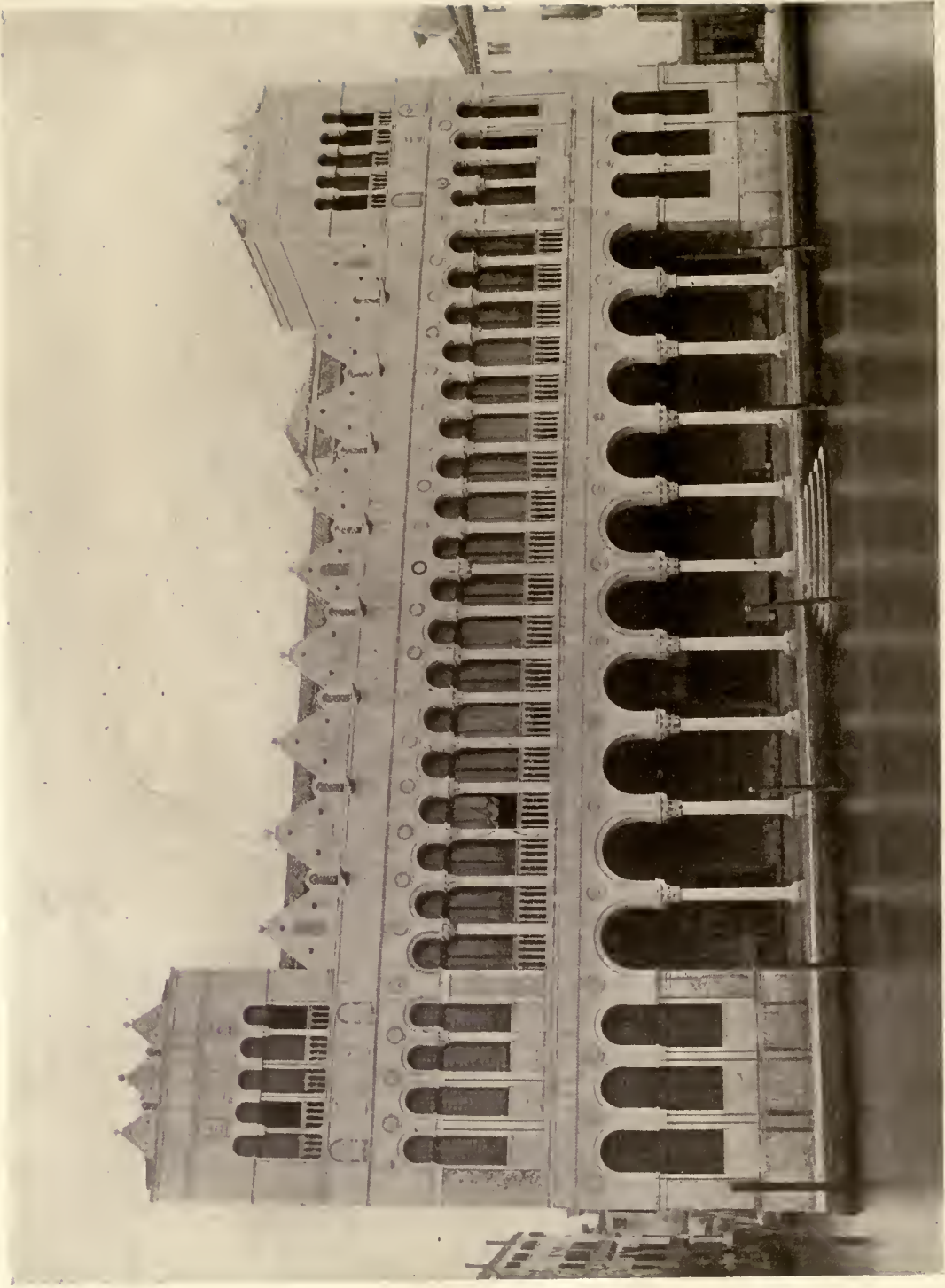

MUSEO CIVICO, VENICE, ORIGINALLY THE RESIDENCE OF THE PESARO FAMILY

THE AMERICAN ARCHITECT



# THE AMERICAN ARCHITECT

VOL. CXVII

WEDNESDAY, APRIL 28, 1920

NUMBER 2314



RICHELIEU'S THEATRE, PARIS

OCCUPIED BY MOLIERE'S COMPANY FROM 1661 TO 1673. NOTE THE PAINTED PERSPECTIVE. MANY STAGES IN CONTEMPORARY AMERICAN SCHOOLS AND SOCIAL CENTERS ARE LESS MODERN THAN THIS ONE

## Stage Design in Communal Buildings

By GEORGE M. P. BAIRD

### I THE PROBLEM

IF THE reader will imagine himself suddenly deprived of modern draughting-room appliances and forced to execute important commissions with the primitive equipment of the elder Upjohn or Inigo Jones, he will have some conception of the plight of the dramatic craftsman who attempts to produce a play or pageant upon the kind of stage usually found in American school buildings, community centers, town halls and parish houses. The

term *stage* is used by courtesy in this relation, for to apply it seriously to those open platforms, shallow, low-ceiled alcoves, and cramped half-domes, with their array of curse-provoking inconveniences—aprons, roll-curtains, hardwood floors, lamp-brackets, windows and impossible entrances—is to handle the truth very carelessly indeed. Judging empirically, the auditoria and stages in our communal institutions are either particularly disingenuous and disingenuous afterthoughts (which have been added by way of luxury and not until every

## THE AMERICAN ARCHITECT

other requirement of the structure has been satisfied); or weird devices to provide for widely dissimilar activities such as drama and basket-ball. The curious but not infrequent combination of stage and gymnasium, stage and class-room, or stage and studio, seems to be dictated by some mystical theory of economy, incomprehensible to ordinary mortals but highly favored by building committees and by architects of the "Yankee Inventor" school. Like the instrument which combines a tooth-brush, corn-

shall be made to contribute to personal and social progress. It has demonstrated the inadequacy of the old pedagogy and the old theology which made penal institutions of schools and torture chambers of churches and which failed utterly to secure that community consciousness and expression without which democracy is a sad and futile abstraction. It is learning to humanize and vitalize instruction—academic, religious, and civic—by a pragmatic adjustment of intellectual and artistic forces to the



DRURY LANE THEATRE, LONDON, 1778

SHALLOW STAGE AND DEEP APRON, THE TYPE STILL FOLLOWED IN MANY COMMUNAL BUILDINGS.  
VERILY, WE ARE A CONSERVATIVE FOLK AND LOVE THE ANTIQUE!

razor and blacking dauber, it is novel and compact but quite use'less. In striving to serve many purposes, it serves none satisfactorily.

In older, darker, Puritan-ridden days, when drama and deviltry were considered synonymous, and when accommodation for the lyceum lecturer, the graduating class or the Sunday school chorus was the sole desideratum, an elevated floor at one end of a room and a slight specialization in wall treatment about it were, perhaps, sufficient. Those days, happily, are no more. A younger generation with new ideals and more liberal ideas has arisen to demand that *all* the resources of art and science

actual mental and emotional processes of the individual and of the group. It is reclassifying values on a basis of social utility; and is discovering that many things once looked upon as mere ornaments, are fundamental necessities, while some things fondly cherished as essential, are worthless or even dangerous.

The auditorium with its vital point of focus, the stage, is no longer a luxury with only infrequent usage to excuse its existence. It has become the very heart and center of the building, the common meeting-place of the people, the crucible in which the materials of a new society are being fused and

## THE AMERICAN ARCHITECT

mingled. The stage is the community hearth where are enshrined the *lares et penates* of the folk. Before it, the group spirit is warmed to life and made socially coherent and articulate through response to the stimuli of thought and beauty experienced in common. Drama and its sister arts, music and the dance, have ceased to be mere entertainment and have become intellectual and spiritual dynamics for the re-creation of the mind and soul of man.

Unfortunately, the physical development of the

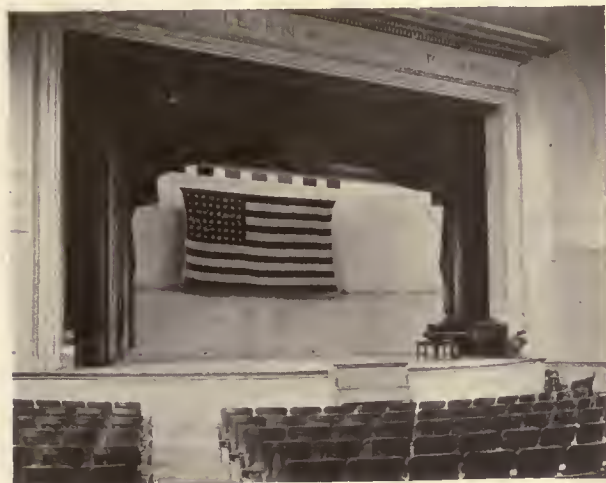

"THERE ARE CRIMES AND CRIMES"

This shallow alcove is the so-called stage of an otherwise ultra modern high school building recently erected at a cost of more than one million dollars.

Almost one-third of the floor area extends beyond the proscenium in the form of an apron, but there are no flies or wings. This stage is utterly useless for the type of dramatic work which is rapidly becoming so important a factor in secondary education.

communal stage has not kept pace with the evolution of social and pedagogical technique. The new methods are hampered or thwarted by blind traditionalism and stupid inertia in plant design. For this condition two factors are responsible. The first is the cock-sure ignorance of trustees, governing boards and building committees. The second factor is the careless architect who fails to grasp the real problem, neglects to confer with the people who are to use his work, copies features from other buildings without ascertaining their practical worth, or too readily accepts the committee's assertion that it knows exactly what it wants.

The true architect is never too busy to study his work thoroughly and never too proud to seek advice upon matters in which no one expects him to be a specialist. When he is commissioned to plan a building in which a stage is a feature, he will consult all available data and secure expert opinion before beginning his design. It is with the hope of being helpful to such a one that these articles are written. They make no pretense to com-

pleteness or final authority. Their only purpose is to point out some of the problems of the modern communal stage and to suggest means looking toward their solution. Where there is much darkness, even a tiny light is blessed.

The fundamental prerequisite to the proper design of an auditorium and art-stage for a church, school or other community building is an intelligent and sympathetic appreciation of the needs and objective of the dramatic craftsman who is to use the plant. To achieve this, the architect must understand something of modern art-stage theory and practice, and he may get his information partly from books and partly from some competent dramatic technician of the new school. Books on the subject of stage design *per se* are few in number and deal, for the most part, with obsolete types or with problems of commercial-stage construction. To be sure, there is a formidable literature of the art-theatre available, and treatises such as those of Hiram Kelly Moderwell, Sheldon Cheney and Irving Pichel, offer ex-



A HORRIBLE EXAMPLE

The "stage" in a large, well endowed memorial Settlement House. It has neither flies nor wings, but the worthless apron with its band of exposed foot-lights has not been forgotten. The draperies are a pathetic attempt to make up for architectural blunders. Behind them (rear wall) are four windows and two radiators. The stage floor is maple, laid over reinforced concrete, and is raised five feet above the auditorium level so that chairs may be stored under it.

cellent approaches to the subject; but there is as yet no single authoritative text which treats of its purely technical phases in comprehensive fashion.<sup>1</sup>

The Art-theatre Movement originated as a gesture of protest against the æsthetic squalor, intellectual degradation and economic philistinism of the commercial stage. Its travail of becoming was a slow and painful one, for it had to combat the inertia and fear of change which opposed it from

<sup>1</sup> See Bibliography, appended to Article No. 3 of this Series.

without and, at the same time, to free itself from the incubi of vague theory and dilettantism which attach themselves to every new enterprise in the world of art. It had to evolve a philosophy, create a technique, and invent the physical tools for the attainment of its ends. The equivocal sanctions, outworn conventions and unplastic machinery of the old theatre were utterly inadequate to accomplish the new ambition for dynamic beauty, intellectual honesty and free artistic expression. The



THE TYPICAL "DRESSING ROOM"

Another view of the Horrible Example. Through the doorway may be seen a portion of an alleged dressing room. An iron spiral stair leads to a similar room above. The stage can be reached only through the auditorium and the lower room. This is not an extreme example of bad design in school and community buildings.

barbarous unrealities of two-dimension trees arranged in false perspective to simulate a forest; the painted *drop* across whose rigid clouds and constant-colored mountains the shadows of actors

moved like the wraiths of gods and jötuns; the pink rococo ball-room with its painted mouldings, *center fancy*, *grand stairway*, *conservatory backing*, *rag borders* and doors of cloth; the garish frame of garland-daubed *tormenters* (highly appropriate term), and sham drape; the picture curtain—perhaps with a chaste border of advertising—upon which the scenic artist had been encouraged to do his efficient worst; the hideous glare of foot-lights, abetted by gallery *calciums* and star-pursuing *spots*; all the tawdry rubbish of the Nineteenth Century stage had to be cast out and supplanted. Nor could the art-theatre tolerate the equally idiotic, *naturalistic school* (falsely styled *realistic*) of which Mr. Belasco is high priest and prophet; since in its fanatical insistence upon truth in the minutiae of detail it has succeeded in producing only a grotesque ensemble which is a monstrous inartistic lie.

The art-theatre endeavors to be realistic in the psychological sense; that is, to give the work of play-maker and actor a setting which shall neither distract nor obtrude, but which shall enhance the mood and enforce the message of the drama. Its business is to quicken a purposeful emotion by the aesthetic presentation of truth; and this it achieves through the medium of a pan-technique in which the old arts of poet, actor, musician, choreographer, artist and electrician are integrated and co-ordinated to form a new art. This insistence upon synthetic creation, unity of emotional appeal, totality of effect and economic simplicity of means, differentiate it sharply from the traditional stage with its intellectual dishonesty, ugliness, lack of balance, meaningless extravagance and dollar damnation. It asks for but little in construction and equipment, but it demands that that little shall be appropriate to its needs. Its plant must be adequate, adjustable, economical to build and to maintain, and simple enough to require a minimum of operative personnel. It requires little more space than do the useless make-shifts so popular with builders and need not exceed them in cost. The art-theatre has come to stay, and the designer of communal buildings, scholastic, ecclesiastical or social, will profit by making it his serious study.

# The Preble County Court House, Eaton, Ohio

H. H. HIESTAND AND RICHARDS, McCARTY & BULFORD, *Associated Architects*

COUNTY court houses in this country can be divided into two distinct groups, those erected before and after the Civil War. Those erected in the earlier periods are largely of the Colonial style of architecture. Even in the pioneer days when the counties were limited in means, almost to the degree of nothing, there is evidence of careful designing and an honest effort to produce the best architectural effect possible. Many of these buildings were constructed, in the Central States at least, without the supervision of an architect—an architect as understood to-day—but by that man who was architect, contractor and craftsman combined. That man has now been displaced and with him, apparently, the ability to construct those simple and dignified buildings that please even when located in proximity to pretentious modern buildings.

Court houses erected in the newly developed territories immediately after the Civil War, and in replacing the old buildings in the older communities, seem to display a rare exuberance, a quality which has obtained almost until this day. This was due to the rapidly increasing wealth of the country, the disappearance of the old-time craftsman-builder, the appearance of the architect of that day, political conditions and an unbounded faith in the future. These architectural monstrosities are yet in plentiful and painful evidence. They are of that architectural genius which is identified by the imposing, in size only, colonnades and pediments executed in one of the "orders," ill shaped and useless pavilions and unspeakable domes topped off with a galvanized iron statue of justice, blindfolded and holding a pair of scales and a

sword. Rivalry between the counties did not tend to improve the architectural mediocrity of that period. After a passing dash of Romanesque, architectural sanity began to develop.

The court house of to-day may be said to comprise everything the old one did not include. The plan is based on service rather than an attempt to achieve a grandiose effect; permanence and durability are secured through the methods of construction employed; mechanical and sanitary appliances and conveniences are adequate to all demands; the

architectural design is in keeping with and comparable to the best efforts of the day. The selection of the architect is made on a basis of competence rather than skill in political manipulation; competitions are more often based on the recommended practice of the American Institute of Architects; juries of award are usually competent and carefully selected.

Of the new type of court house is that one recently erected at Eaton, Ohio, and Preble County may well congratulate itself in the possession of it. It is carefully planned, well constructed and its exterior and interior appearance satisfies the most critical demands.

The building is 79 ft. by 147 ft. in size and is placed 70 ft. from the lot line. The construction is of the best fire-resisting type; the heating, ventilating, lighting and plumbing systems are adequate; the exterior is of buff Bedford stone, the interior marble, wainscoting and stairs are of pink Tennessee marble and the floors of public places are of gray Tennessee marble, other floors generally of terrazzo; such wood finish as is used is of American walnut.

The basement is used for storage purposes, me-



VIEW FROM NORTHWEST



GROUND FLOOR LOBBY, LOOKING SOUTHWEST



VIEW OF VESTIBULE FROM GROUND FLOOR LOBBY, LOOKING NORTHEAST  
PREBLE COUNTY COURT HOUSE, EATON, OHIO  
H. H. HIESTAND AND RICHARDS, McCARTY & BULFORD, ASSOCIATED ARCHITECTS

## THE AMERICAN ARCHITECT

chanical equipment and has a women's comfort station accessible by an exterior stairway. The principal room on the ground floor is an assembly hall 32 ft. by 71 ft. in size, equipped with a large platform and fixed opera chairs 298 in number. The main office of the County Superintendent of Schools can be opened into this hall and affords extra seating capacity. At the east end of the build-

ings and Red Cross quarters occupy the balance of this floor.

On the first floor are located those offices which are most commonly used by the public, consisting of the Probate Court, County Surveyor, County Commissioners, Auditor, Treasurer and Recorder. These departments are supplied with the necessary private offices and toilets.

On the second floor is located the Court of Common Pleas, judges' chambers, jury and witness rooms, Prosecutor's, Sheriff's and Court Clerk's offices. There is also a law library and reading room located on this floor.

On the roof is located the county jail, which is not seen from the streets. The Sheriff's quarters, consisting of five rooms, are located along the south wall and have a fine outlook. The men's jail consists of eight cells and the women's jail of two



WEST ELEVATION

ing is located the G. A. R. room, which is nearly one-half the size of the assembly hall. A women's lounging or rest-room with adjoining toilet room are also provided. Such rooms are commonly provided in such buildings of recent design. This same service to women is now common in the country banks erected in recent years and is a development of community service. A few minor



NORTH CORRIDOR, SECOND FLOOR

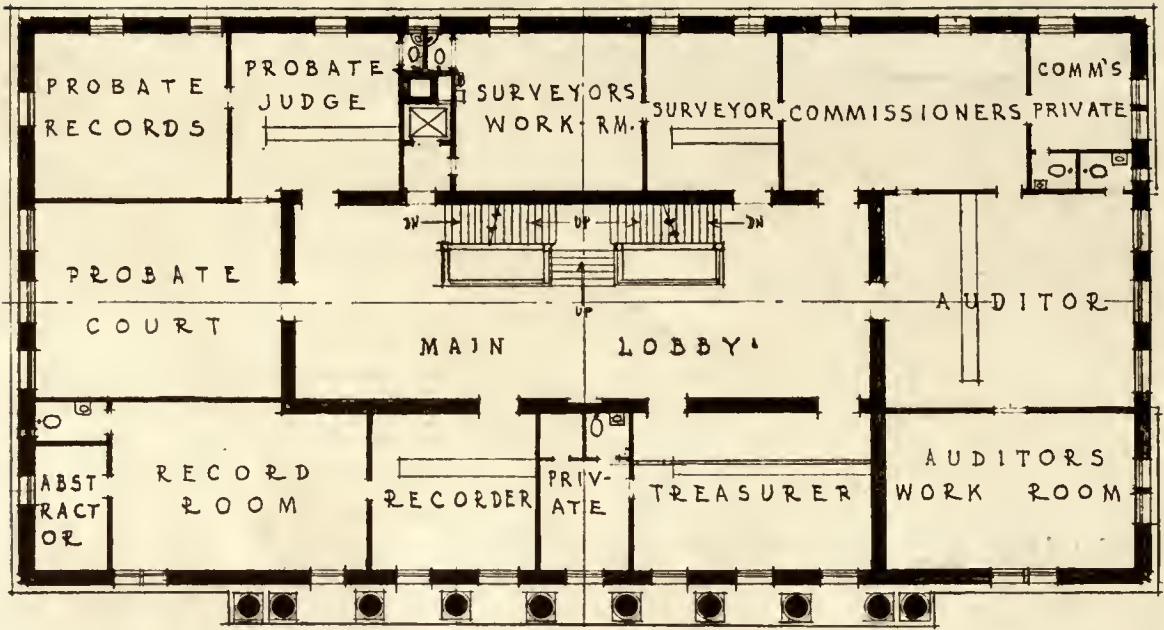

FIRST FLOOR PLAN

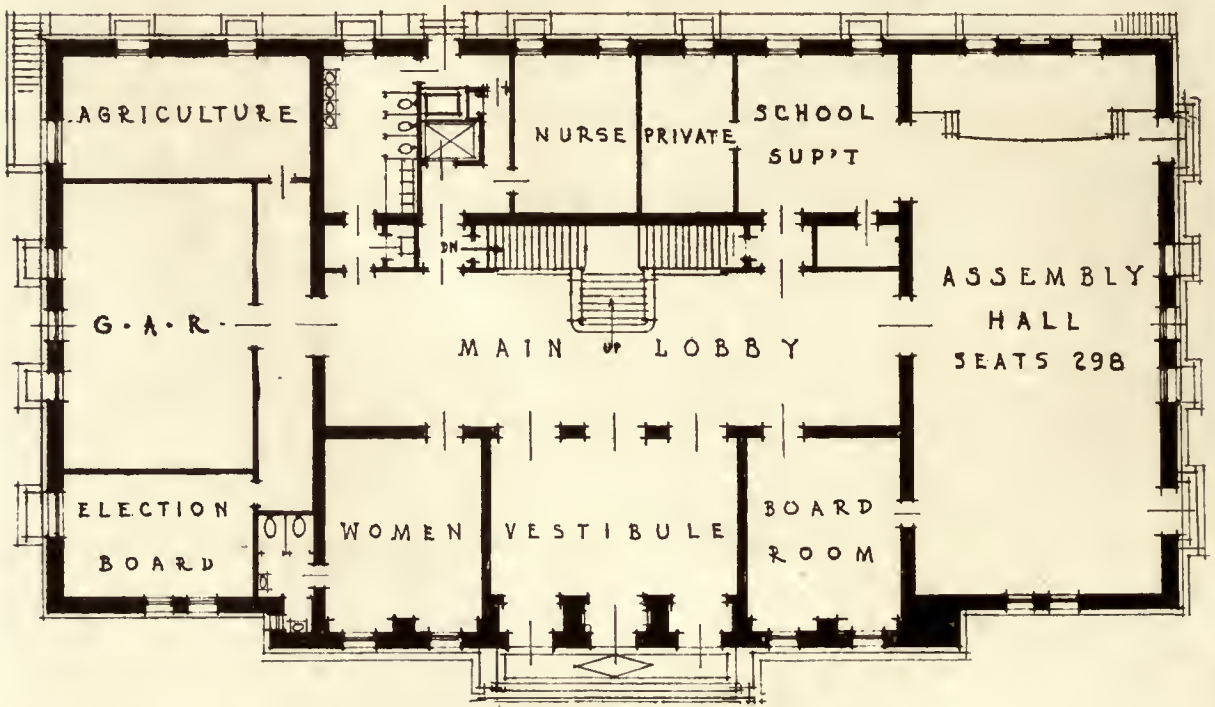

GROUND FLOOR PLAN

PREBLE COUNTY COURT HOUSE, EATON, OHIO  
 H. H. HIESTAND AND RICHARDS, McCARTY & BULFORD, ASSOCIATED ARCHITECTS



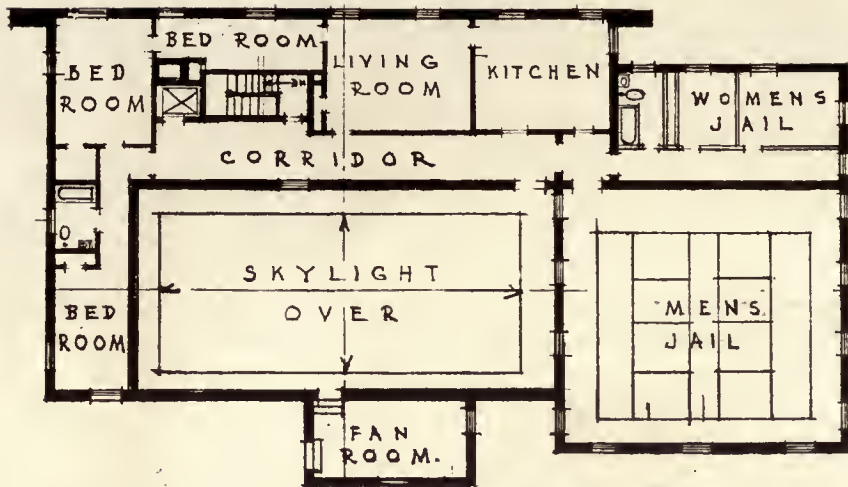

THIRD FLOOR PLAN

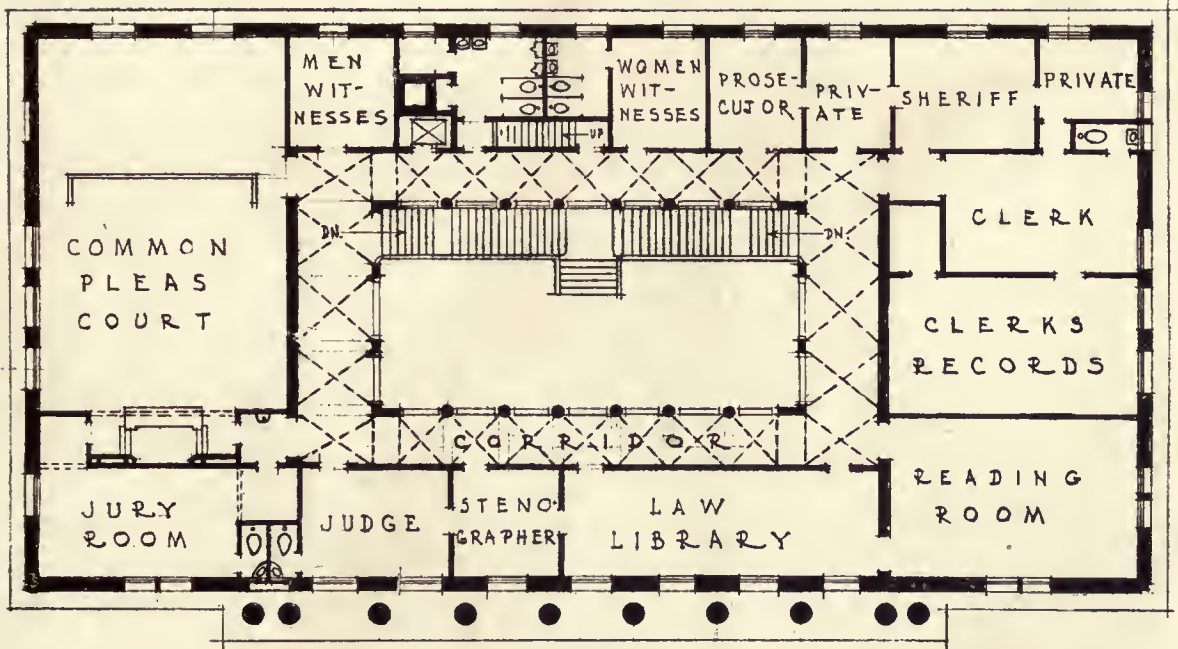

SECOND FLOOR PLAN

PREBLE COUNTY COURT HOUSE, EATON, OHIO

H. H. HIESTAND AND RICHARDS, McCARTY & BULFORD, ASSOCIATED ARCHITECTS

cells. Access is had to the jail through a door on the rear or south side and by means of an elevator and the main stairs. This scheme of combining the court house and jail results in considerable saving in operating and maintenance expense and is entirely satisfactory in rural communities where prison requirements are very limited.

The exterior of the building is designed with extreme simplicity; the general proportions, the openings, the colonnade, balustrades, cornice and

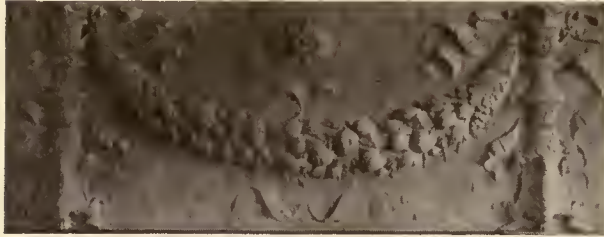

DETAIL OF FRIEZE  
SECOND-STORY MAIN LOBBY

parapet give evidence of very careful study and the effect is entirely satisfactory. The main elevation is to the north and has a colonnade of ten Ionic columns extending through the first and second stories, resting on the massive masonry wall of the ground-floor story. The paved approach and terrace with its stone balustrade complete the setting of this very pleasing elevation.

The other elevations are comparatively plain but equally as well designed, the west elevation being accented by the use of a balcony at the first-floor level. Three carved spandrels at the second-floor level complete the extra ornamentation of this elevation.

The entrance vestibule and main lobby of the ground floor are very simple in design. The wall surfaces are plain, the ornamentation very limited and the satisfactory results are secured by the proportions of the rooms, the arched openings, the ornamental panels at each end of the vestibule and the lower portion of the main stairs. The main lobby on the first floor extends through the second story and is lighted by a large skylight. On the second floor is an open corridor on the four sides of the lobby. This corridor has a grained ceiling and the arcade separating the corridor from the lobby consists of round or square columns resting on the second floor with sections of detached balustrade between them. The main lobby is so proportioned and designed as to give an impression of a much greater size than it really possesses.

This building, with its simple and chaste details, its substantialness and quiet dignity, must ultimately make its influence noticeable in the community. Fortunate is any rural community which can be in daily association with a structure of this kind. The resulting appreciation for the good in architecture must eventually exert a beneficent influence on many buildings of various kinds that will later be constructed throughout the adjoining country.

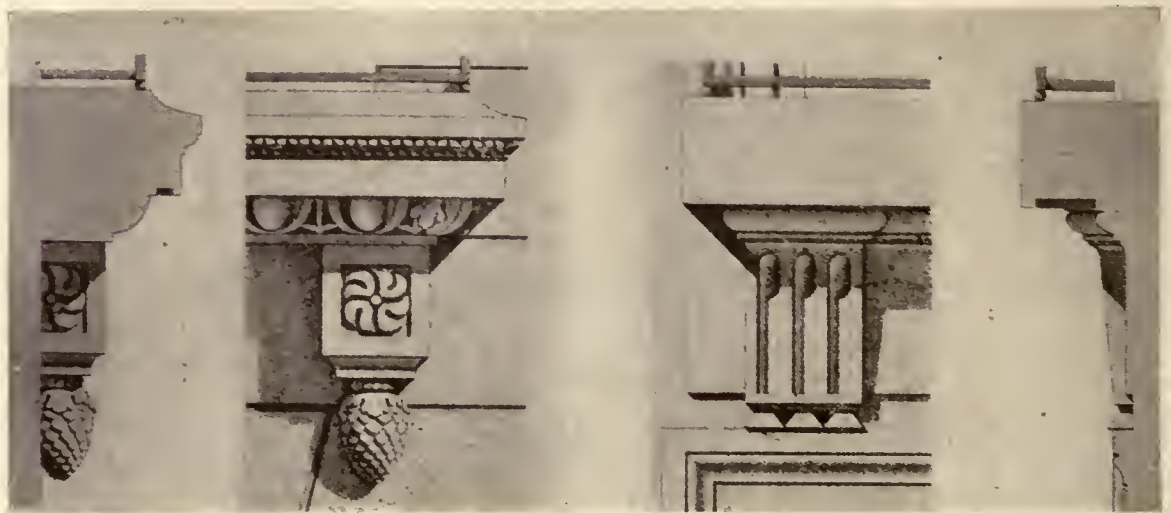

SMALL CONSOLES FROM PARIS BUILDING (LOUIS XVI)

(From *The Architectural Journal*)



LOBBY, LOOKING WEST AT SECOND FLOOR LEVEL.

PREBLE COUNTY COURT HOUSE, EATON, OHIO

H. H. HIESTAND AND RICHARDS, McCARTY & BULFORD, ASSOCIATED ARCHITECTS



EAST CORRIDOR, SECOND FLOOR, LOOKING SOUTH



COMMON PLEAS COURT



VIEW OF GROUND FLOOR LOBBY FROM THE VESTIBULE  
PREBLE COUNTY COURT HOUSE, EATON, OHIO  
H. H. HIESTAND AND RICHARDS, McCARTY & BULFORD, ASSOCIATED ARCHITECTS



## Wisconsin Sets a Good Example

THE action of the Wisconsin Chapter of the A. I. A. in unanimously instructing its Executive Committee to call a convention of registered architects of the State to consider the formation of a State Society is strongly to be commended. The example might be followed with the best results by Chapters in every State where State Societies do not now exist.

The most laborious work incident to the organization of a State Society was practically eliminated by the Committee on State Societies of the Post-War Committee when it framed and made available a model constitution and by-laws. This well constructed document can safely be accepted by all the newly organized State Societies. It has everything in its favor. But the greatest thing of all is that its general adoption would serve coherently to organize these important bodies and relieve them of the conflicting and often directly opposite interpretations which now so seriously affect the smooth working of the various State licensing laws. The more carefully this question of State Societies is considered, the more important it becomes.

The Institute as at present organized, with the addition of State Societies in every State, all under the control of the Institute, would bring the entire profession into a completely organized body. The Institute would then assume its proper relation to the profession, for it would become in the truest sense a representative organization.

Just what will be the attitude of the forthcoming convention toward this important matter cannot be foretold.

That State Society organization is of first importance needs no demonstration of proof.

## "Kidding" Themselves

THE purist of English will insist that there is vulgarity in the use of the vernacular. This may, or may not, be true, but we learn from a recent statement in a public address by Lord Reading that

the vernacular as used in the United States afforded a very decided emphasis to the use of words and, as he said, gave them a "punch."

There is a growing tendency to "kid" ourselves. This tendency exists in domestic life where the forming of a good resolution is seemingly the important thing, its carrying forward to a final result not so important. In business it takes the form of "conferences," those time-wasting deliberations where men, gathered around a long table, emulate the "three tailors of Tooley Street," and pass no end of well-framed resolutions or pronouncements, which rarely get beyond the minute book of the recording secretary.

Organizations "kid" themselves in the same way. Take the Institute for example. How hopefully everyone who was present at Nashville returned to his home. How generally did each delegate and those who were directly interested in the upbuilding of organized architecture "kid" themselves. Dozens of well-considered resolutions were passed, any one of which if carried forward to a successful end would have made a record for accomplishment.

Consider the resolution favoring the better architectural development of farm buildings. For more than a year previous to the Nashville Convention THE AMERICAN ARCHITECT had been trying to set afoot a movement that would accomplish a necessary reform in the architectural expression of our rural communities. When the Convention passed a resolution favoring all the things this journal had advocated, and in fact incorporated into the resolution that the method of procedure was to be along the lines as urged by THE AMERICAN ARCHITECT; the editors returned "kidding" themselves with the fond hope that at last something was to be done. Hope is seriously deferred. The resolution sleeps on the pages of the minutes of the Convention. A year has elapsed and nothing has been accomplished.

Is it better to travel hopefully than to arrive? Some optimistic individual has said it is. We should, at least, travel.

## Report of National Commission of the Fine Arts

THE Eighth Report of the National Commission of the Fine Arts, covering the eighteen months from January 1, 1918, to July 1, 1919, has been issued. Architects will find a compelling interest in this admirably prepared public document. Three of the eight members of the Commission that prepared this report are of the profession of architecture. They are Charles A. Platt, William M. Kendall and John Russell Pope.

There is a further reason for satisfaction to architects in the commendable work of this Commission. It is undoubtedly through their accurate knowledge of conditions as affecting the future development of Washington that the L'Enfant Plan has been preserved in its essence and carried forward as far as possible to its execution.

We have it on the authority of Glenn Brown, as set forth in his article on Roosevelt and the Fine Arts printed in THE AMERICAN ARCHITECT'S issues of December 10 and 17, that the creation of this Commission some eleven years ago was due to the efforts and influence of The American Institute of Architects. It was not difficult for that body of representative and influential men who were then at the head of the Institute to secure the warm cooperation of President Roosevelt and through his vigorous influence the creation of a Fine Arts Commission.

The wisdom of such a course has been many times demonstrated. The conservation of good art and the elimination of that which was bad has been the work of this Commission. The work has been carried on in the most thorough and satisfactory way.

Prominence in the report has been given to the plans for the future development of Washington. The preservation of the L'Enfant Plan has called for all the power that this Commission could command. Every embryonic statesman who has lacked some vital issue to keep him on the front page of the

daily papers has tried his 'prentice hand in an effort to amend or change this plan. Real estate interests have sought to distort the zoning instructions and gain permission to erect structures that would have been ruinous in their effect. Even Government officials, many in high office and who should have known better, have approved the erection of buildings on space set apart as park areas. The emergencies of the war when buildings were erected in Washington on all available land showed in the most emphatic way just what would happen to the correct working out of the plan if its basic principles were ignored.

Through all these onslaughts the Fine Arts Commission has quietly but firmly exerted its authority with the result that whatever is saved to-day toward a future logical development of the capital of the Nation is due to the Commission's work.

THE history of the inception and growth of the Lincoln Memorial and a description and illustration of the architectural design and decorative treatment of this splendid tribute forms an important part of the report. Here again we learn that it was through the efforts of the architectural profession that this monument was secured and that it was by reason of the well directed influence of the Institute that the scheme was not abandoned for another and less satisfactory method of commemorating the greatness of Lincoln.

In fact, throughout the entire report there can easily be traced the very strong influence that architects have exerted in the correct development of good art in this country. In many cases the influence has been a direct result of purely individual action and not through the medium of the organized body. A revival of the spirit which made the weight of the Institute's influence something to be reckoned with is a development to be desired and worked for. It is equally desirable that the next convention should take a long step in advance to prove that it has awakened from the lethargy of the past few years.

# Towers of Babel

EVER since New York began to realize that it was a metropolis its architecture has been of two highly divergent types, one of which perhaps deserves to be called the leisure class. Churches, private houses and governmental buildings could as a rule take whatever form seemed good to their designers, so we have a sort of architectural museum with samples of styles from every country and every age. Some of them, most notably specimens of the classic type, such as the Columbia University Library and the Pennsylvania Station, specifies the *New York Times*, look as if they belong here; others, which it would be invidious to specify, certainly do not belong here, and a good many of them do not belong anywhere. But buildings of a more practical character had to be governed by other considerations, and so came our one domestic type, the skyscraper. Sometimes it tried to be Gothic or Romanesque or Renaissance when it had lifted itself above its neighbors, like a self-made man going in for culture late in life, but for all this belated conformity it remained native and peculiar.

Yet presently it was discovered that a city of skyscrapers would not be particularly healthful for those who had to live and work in it, who never saw the sun and rarely breathed fresh air unless it were loaded with street dust. So the building regulations, lately adopted as we know, prescribed that above a certain height building fronts must be set well back from the street, and higher up there must be still another recession. Thus light and air are guaranteed in some measure for those who live in the lower stories; and New Yorkers who have seen the first buildings of the new type approach completion have been surprised to find that our native architecture has reproduced exactly one more ancient and foreign type—the Babylonian ziggurat, or temple tower of stages. And this is not merely another addition to our historical museum; as economic pressure compels the building of more and more modified skyscrapers New York will become a city of ziggurats.

The archaeologists tell us that these towers on the plan of Babylonia offer clear proof that the earliest civilized settlers must have come from the mountains. They brought with them their tribal gods who had been worshipped on the mountain top, at a shrine reached by the windings of a mountain road. There were no mountains in Babylonia,

so pious newcomers invented the ziggurat as a sort of artificial mountain, with the footway leading up over the roofs of the successive stages to the shrine at the top as the successor to the spiral trail of the mountain country whence they came. The Scriptural explanation is simpler: the ziggurats were put up as a sort of defiance of nature and God, a proof of men's capacity which was promptly punished by a jealous deity.

Early tradition is usually wrong, and even archaeologists are sometimes wrong, but man insists on drawing inferences from whatever evidence is at hand. So let us look ahead two or three thousand years, and imagine the traveler from New Zealand stopping in the Hudson Valley on his way home after sketching the ruins of St. Paul's from a broken arch of London Bridge. From his inn at Piermont or South Norwalk, or whatever may be the urban center of the neighborhood by that time, he will sally forth with a digging party of Appalachian peasants and amuse himself by working in the ruins of the ziggurats which are to be found in such numbers on what was once Manhattan Island, before the harbor was silted up by the discharge from the city sewers after six weeks of snow-storms.

How will the New Zealander explain them? He may hit upon the right explanation, of course, but he may not; for all we know, there were building regulations in Sumer and Akkad. He may regard them as symbolic of an aspiration toward heaven, like a Gothic spire; but the lamentable lack of evidence of any such feeling in the surviving fragments of the literature of the period will compel him, or at any rate will compel his professional colleagues, to reject that theory. Obscure texts provisionally dated 1920 may contain such dark passages as "wet wave gathers strength," and a whole school of excavators will dispute whether a succession of tidal waves overwhelmed the city and compelled its residents to take refuge on the higher stages of their temple towers, or a gradual subsidence of the surface of the island—a view supported by allusions of ancient writers to "billions sunk in subway"—compelled its inhabitants to make this frantic effort to lift themselves out of reach of the Atlantic. For all we know, the future may see such a development of social equality that our New Zealander will understand by "upper classes" only those who lived in the upper stories.

Even a theological interpretation is possible; the name "skyscraper" may be construed as indicating a dissatisfaction with the management of the universe, an aspiration toward the overthrow of ancient divinities and the enthronement of a man. The New Zealander may live in a more pious age than ours, and see in the decline and fall of Manhattan some such divine judgment as the author of Genesis laid upon the builders of Babel. We can only guess and guess badly; Naram-Sin and Lugal-Zaggisi would have been sadly disappointed if they could have foreseen how little our time was to know of their splendors. But a contemplation of the 'disputes' which will certainly distract the archæological circles of New Zealand in the fortieth century should be edifying and corrective to those followers of lost causes who appeal with such sublime assurance from present defeat to the verdict of history.

## Protective and Operative Features of the Emergency Contract

By MAJOR RALPH H. CASE, U.S.A.

(Concluded from issue April 21)

Had the old lump sum contract been used, before the plans and specifications could have been drawn, the National Guard would have been sleeping in the mud, with death and disease rampant in its ranks, and the great selective service army would have been beating upon doors yet unhung and crowding under roofs unswung. Our great war program would have received at its inception an irreparable blow, a fatal delay. No sane contractor would have made a lump sum bid on a job running into several millions in those troubled days. No sane Government would have considered such a bid if made. Contractors, who stay in business, figure not less than 10 per cent profit on lump sum work. What was the actual per cent of profit paid to contractors of the 32nd National Army and National Guard Camps? The actual figure is 4 per cent, which is a clear saving in operation of at least 6 per cent on the total cost, produced solely by the Emergency Contract.

But by virtue of the Emergency Contract the camps were built, and this contract is the vehicle through which success was attained. Before the men could reach the camps the camps were ready to receive the men. In ninety days from a cold start housing was provided which accommodated more than three and one-half million men. Not only housing but every convenience and facility, and every detail of sanitation and protection.

The cost of the camps—16th National Army, 16th National Guard and special Camps, built under this contract—when placed alongside the service by them rendered, was so low that it stands as the least expensive of the major items of the war. The actual per capita cost for men housed in the camps was \$69.81. This is not quite \$10 more per man than the discharge bonus of \$60 per man and that bonus was a gift which by many is regarded as inadequate.

But the Camps have not been given away. Seventeen of them have during the war become the property of the United States through the Construction Division of the Army. Fourteen of the National Army Camps (Cantonments, properly) have been bought by the Construction Division out of money saved from funds allotted for the construction of the Cantonments themselves. A large sum of money was saved in construction and in reducing construction work. This money could not have been saved under a lump sum form of contract as the latter obligates the definite amount for definite work. The millions saved were available for the purchase of the Cantonment Sites, were withdrawn from the field and reallocated for the purchase of the land. The fact is the Fourteen National Army Cantonment Sites, costing nearly Nine Million Dollars, are the gift of the Construction Division of the Army to the people of the United States, and this was made possible by the Emergency Contract. These Cantonments alone represent an investment of \$155,000,000, and are worth today as a salvage proposition at least Fifty Millions of Dollars, 98 per cent of which would have been dissipated had those Cantonments been demolished and the lands returned to their former owners. These Cantonments remain an asset to the diminished army. They will house the new army, and they are the centers of whatever kind or degree of training may finally be decided upon. These, then, are the things done through the Emergency Contract, in addition to furnishing the wealth of protection set out in the Fourteen Points:

The Camps were built in time.

The per capita cost was the lowest.

The profits to the Contractors were less than half of normal.

The Fourteen National Army Camps were given to the Government.

This is a record both in protection and in accomplishment which will stand as one of the brilliant achievements of the Great War, an achievement recently characterized by the Secretary of War as second only in effect to the ferrying of two million men to France through the submarine zone.



522



THE CHAPEL, HOTCHKISS SCHOOL, LAKEVILLE, CONNECTICUT  
CASS GILBERT, ARCHITECT



0-222



MEMORIAL TOWER, HOTCHKISS SCHOOL, LAKEVILLE, CONNECTICUT  
CASS GILBERT, ARCHITECT





THEOLOGICAL SEMINARY, OBERLIN COLLEGE, OBERLIN, OHIO  
CASS GILBERT, ARCHITECT

522 2









5-2251



BUILDING OF THE ATLANTIC REFINING CO., PHILADELPHIA, PENNA.  
CASS GILBERT, ARCHITECT





VIEW FROM NORTHWEST

PREBLE COUNTY COURT HOUSE, EATON, OHIO

H. H. HIESTAND AND RICHARDS, McCARTY & BULFORD, ASSOCIATED ARCHITECTS

6226

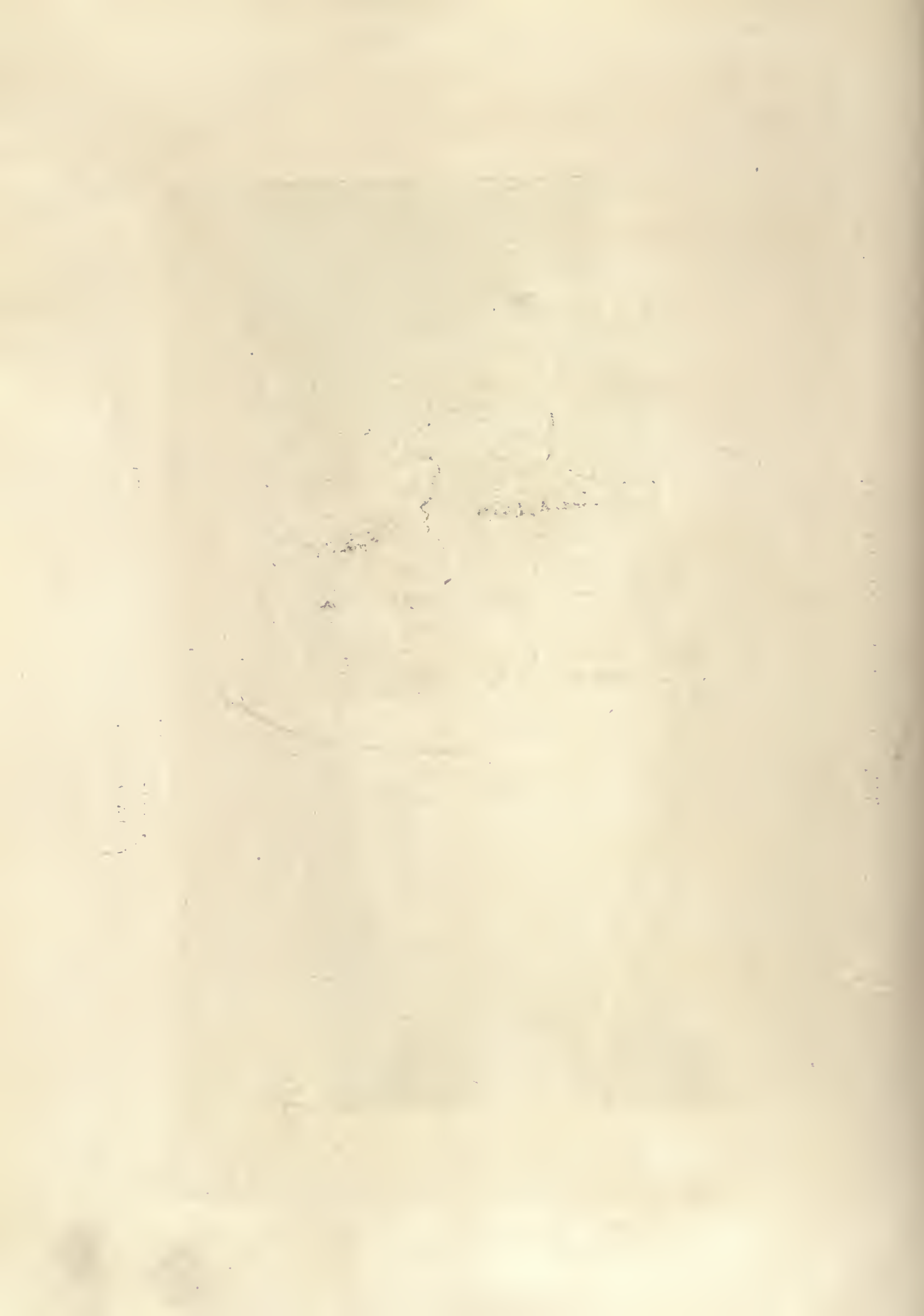



CLOSE-UP OF NORTHWEST CORNER  
PREBLE COUNTY COURT HOUSE, EATON, OHIO  
H. H. HIESTAND AND RICHARDS, McCARTY & BULFORD, ASSOCIATED ARCHITECTS

5227



5228



A MAIN ENTRANCE, NORTH ELEVATION  
PREBLE COUNTY COURT HOUSE, EATON, OHIO  
H. H. HIESTAND AND RICHARDS, McCARTY & BULFORD, ASSOCIATED ARCHITECTS





6  
522



FIRST AND SECOND STORY LOBBY, LOOKING SOUTHWEST  
PREBLE COUNTY COURT HOUSE, EATON, OHIO  
H. H. HIESTAND AND RICHARDS, McCARTY & BULFORD, ASSOCIATED ARCHITECTS



# Current News

## Happenings and Comments in the Fields of Architecture and the Allied Arts

### Minneapolis Architects Form Society

Members of the architectural profession in Minneapolis have long believed that both the profession and the city would be served and benefited by the existence of a society comprised of Minneapolis architects, architectural draftsmen and architectural engineers.

As the result of the energetic work of several architects this belief has finally crystallized in the formation of the Architectural Society of Minneapolis.

The new organization already has a membership of about sixty. Not only is it the purpose of the society to encourage closer professional and social association among the Minneapolis members of the profession, but to devote time and thought to the study and solution of those civic problems for which their training and experience fit them, and also to co-operate with the master builders of Minneapolis in the mutual study of problems of the day affecting various phases of the building industry.

An atelier will be organized for the study of architectural design under the direction of Mr. Leon Arnal. The methods of the Beaux-Arts School of Paris, of which Mr. Arnal is a graduate, will be followed. Since September Mr. Arnal has been in charge of instruction in architectural design at the University of Minnesota. He is a veteran of the Great War, with a record of full four years' service in the French army.

Following are the officers of the society: President—Jefferson Hamilton. Vice President—R. V. L. Haxby. Secretary—A. O. Larson. Treasurer—Floyd Brown. Directors—James Forsythe, Harry Downs, George F. Poulsen.

The society meets at present at the Lincoln Club, but will have permanent quarters in the Hewitt & Brown Building, now under construction at Twelfth street and Second avenue South.

### Artistic Designs in Industry

Who is to blame for bad design in our manufactures? asks the *Architects' Journal* of London. The manufacturer says the public are at fault. They prefer bad designs, and the manufacturer must meet the demand. On the other hand, there is a very considerable section of the public that prefers good design, but cannot get it. What, then, is to be done? In the course of a discussion of the subject at a conference of manufacturers and distributors of house fittings convened by the Society of Arts, Mr. C. Tennyson, deputy director of the Federation of British Industries, threw out the very practical suggestion that the manufacturer should "get in touch with an artist of good standing, originality, and common sense, and give him a good position in his factory as a sort of art director." That is very sound advice, and would secure good results provided it were adopted in the right spirit. It is to be feared, however, that in many instances the manufacturer would want to "boss" the artist, who, if he were worth his salt, would not endure the process; while

the man weak enough to stand it would simply obey misguided orders. What is the matter with British manufacturers of the old school is their headstrong obstinacy. This the Royal Society of Arts is making an earnest endeavor to overcome; while the British Institute of Industrial Art is giving every possible assistance in the campaign against the bad art which, if it continue, will tarnish the nation's industrial reputation. Britain cannot afford to let this happen, as it will, unless manufacturers become more sensitive to the commercial value of the art that they seem to despise. They have not yet realized what Ruskin dinned into the ears of their fathers forty years ago—that beauty has a high commercial as well as a moral and an ethical value.

This attitude is one that our American institutions should more thoroughly share. It is always productive of good results to enter into friendly competition in things of this sort. England is waking up to the importance of certain truths. Will America sleep on?

### Burnham Library Open at Art Institute

One of the happiest events in the history of the year at the Art Institute is the opening of the new Daniel H. Burnham library in the space just south of the Ryerson library. Describing this in the *Chicago Evening Post*, L. M. McCauley states that this handsome reference and reading room for architects seems to have been conjured from the limited area of a corridor which has the effect of being enlarged in the transformation. Under the direction of Howard Shaw, the architect, as well as trustee of the Art Institute, the introduction of barrel vaulting and lofty arches give the apartment a stately appearance. Long, narrow windows with leaded glass admit daylight and specially contrived indirect lighting from alabaster bowls hung from the ceiling afford a pleasant illumination.

Midway in the south wall a panel has been reserved for hanging the portrait of Mr. Burnham, painted by Anders Zorn. It is a realistic presentment, illustrating the vigorous interpretation peculiar to the Swedish artist. The canvas was painted when Zorn was in Chicago and Mr. Burnham in the prime of life. A second portrait of the celebrated architect, in a sympathetic mood, painted by Oliver Dennett Grover, is prized by his fellow architects in their collection of portraits hanging in their clubroom at the Art Institute.

A valuable library of books, prints and all sorts of publications relating to architecture given by the late Mr. Burnham to the Art Institute is the nucleus of the collection installed in the new library shelves. Other acquisitions of the same character have been assembled here with comfortable reading desks and tables for the use of students of the architectural school and all others who are interested in this subject.

The Daniel H. Burnham library catalogs 2,400 volumes on architecture. As a man of creative genius and vision Mr. Burnham labored for and saw the Chicago of the

future. Through his efforts and under the inspiration of his enthusiasm the present wide movement of a city beautiful was put under way. Mr. Burnham had the gift of drawing other men to him and of imparting to them his dreams. In the bequest of the records of architecture something of his presence seems to linger and to hallow the atmosphere. His personal service to the arts of the city, his encouragement to young artists and his undying faith that the noble and the beautiful would survive preserve his memory as a living force among those with whom he labored and to whom he wished to pass on the torch of tradition.

West of the reading-room of the Burnham library the corridor has been rebuilt for the use of the photograph department of the Art Institute, which lists over 36,000 prints and 19,427 slides, including many of architecture. Here, too, are the beautiful Arundel and Medici prints for the use of those who are studying the arts of the past. Both photographs and lantern slides are available for loans.

## "Bungalow" is Bengalese

We get our word "bungalow" from the Hindu word "bangla," which really means Bengalese, but which refers to a Bengalese thatched hut, states the *Oregon Journal*. The British officers in India, being unable in out-of-the-way stations to secure lumber, frequently built their houses of bamboo. The original form of the bangla or bungalow consisted of a large and lofty room with double walls of bamboo, with canvas partitions to form the bathroom, storeroom and bedroom and having a wide porch surrounding the bangla. We have modified the bungalow in this country until its Bengalese ancestor, the one-storied, single-roomed, porch-surrounded bangla would not recognize its American descendant.

## Competition for Library Building

A competition for a new branch library building to cost \$100,000 will be held by the Board of Trustees of the Free Public Library of Jersey City, N. J., the secretary of which may be addressed for further details. The competition will be open until August 16.

## In Memory of Stanford White

The trustees of New York University, whose library building was designed by the late Stanford White, long ago conferred upon him an honorary degree. More recently, it is learned from the *New York Tribune*, they have accepted the offer of a group of his friends to erect in his memory a pair of bronze doors at the entrance to the structure, which remains one of the finest products of his art. The plans for the development of this tribute were decided upon at a meeting held at the Century Club on December 1, 1919. They recognized a peculiar appropriateness in the form of memorial presented in these doors to be placed on University Heights. The architect's father, Richard Grant White, the distinguished Shakespearean scholar, was a graduate of the university. The design for the doors was made by his son, Lawrence Grant White, now a partner in the old firm of McKim, Meade & White. No more felicitous manner could have been chosen for the perpetuation of the architect's name and fame. He will be commemorated, too, by just such a collaborative process as he loved. Throughout his career, White was wont to call in the services of sculptors and painters. He had for them, indeed, the sympathy of a

man initiated into the spirit of their mediums. John La Farge once told how White in his youth had come to him with the aspirations of a painter. He urged him instead to devote himself to architecture. The advice, as we know, was justified, but White never lost his gusto for the other arts. When he was building the great baldachino in the Church of the Paulist Fathers he had MacMonnies model the three angels and entrusted the sanctuary lamp to Philip Martiny. The famous portal for St. Bartholomew is another of many instances of this policy of his. Hence it is fitting that the same policy should govern in the building of the new university doors. Eight of the panels in them will contain seated figures in relief, typifying the arts and sciences, and they will be modeled by sculptors formerly associated with White. Two will be done by Andrew O'Connor, two by Herbert Adams, two by Philip Martiny and two by A. A. Weinman. The scheme to be thus carried out was inaugurated by a committee embracing the following names: James Barnes, James L. Breese, Winthrop Chanler, Thomas B. Clarke, Royal Cortissoz, Devereux Emmet, Allen W. Evarts, Henry W. De Forest, Robert W. De Forest, C. Dana Gibson, Cass Gilbert, F. L. V. Hoppin, Charles B. MacDonald, Clarence B. Mackay, William R. Mead, Willard L. Metcalf, De Lancey Nicoll, Charles A. Platt, Frank K. Sturgis, Lloyd Warren, Whitney Warren and Arthur Weekes. The smaller executive committee is composed of the architect, Thomas Hastings, who is chairman; the sculptor, Frederick MacMonnies; the painter, Thomas W. Dewing, and W. Franklyn Paris, secretary. The funds for the memorial are being raised through private subscription.

## Chicago's Building Plan

To enable 5,000 tenants to build permanent two-flat buildings through a Civic Loan Association is the plan launched last week at a meeting of the Chicago Real Estate Board's Committee of Fifteen. Public-spirited citizens will subscribe \$15,000,000 to the corporation and loans equalling 80 per cent of the value of building and lot, with \$6,000 as the maximum figure, will be made to prospective home builders. It was announced at the meeting that \$2,000,000 has been subscribed to the fund without solicitation.

The interest rate will be uniformly 6 per cent and real estate board commissions will be charged. The borrower will pay the loan at the rate of \$10 per thousand per month, including interest. The term of the loan will not exceed five years, but at the expiration of the five-year term the company will agree to extend further the term of any loan in good standing.

Under the committee's plan the board of directors will employ a head architect, head builder, head appraiser and a general sales manager of the loan department. It is proposed to devise 400 to 500 sets of plans for these buildings, and it is believed that the restoration of the people's confidence in building will be greater under this plan than any other.

## Art and Science in Engineering

The parts that art and science play in the various branches of engineering was briefly put by Arthur Surveyer in a discussion on engineering education before the recent annual meeting of the Engineering Institute of Canada, printed in the *Engineering News-Record*. Mr. Surveyer, who, in addition to his consulting practice, is a member of the board of directors of the Ecole Polytech-

nique de Montreal, called attention to the fact also that the Ecole is the only engineering school in North America where tuition is given in French. He thus states the case of art and science in the various branches of engineering:

"Engineers can be divided into two great classes, according to the relative importance of the part played by art and science in the exercise of their profession. The building engineers and administrators of certain classes of utilities constitute the first group. This class includes the architectural engineer, the structural engineer, the public works engineer and the engineer builder or operator of canals, harbors, railways and tramways. These technicians apply, in their practice, some of the principles of science, but they also—and this probably to a greater extent—apply empirical rules based upon the experience of others and constituting the art of the preceding generations.

"The second group is composed of the industrial or manufacturing engineers. Their field of action is very wide; it includes the fabrication of all engines and machinery, all the applications of chemistry, such as metallurgy, electro-chemistry, electro-metallurgy and the series of industries dealing with the transformation of materials, such as dye works, pulp and paper manufactures, tanneries, sugar refineries, glass works, potteries, gas plants, etc. It also embraces all the applications of physics to the compressed-gas, cold and liquid-air industries and the ever-increasing number of applications of electricity to the construction of electrical machinery and wireless telegraphy. This group of engineers utilizes science to a greater extent than art, and their formation requires more laboratory work and less *ex cathedra* teaching."

## Calls Rebuilt Dwellings "Birth Control Houses"

Thousands of old-fashioned dwellings in Greenwich village, Washington Square and the Chelsea and Gramercy Park sections of New York, which have been remodeled into bachelor, studio and non-housekeeping apartments, are "fire traps, converted in violation of law, and are detrimental to good citizenship and the improvement of the human race," Frank Mann, tenement house commissioner, declared in a statement.

"They may at least be termed birth control houses, since no one brings a family into them or tries to raise one," the commissioner said.

The commissioner declared legal action would be taken as soon as the housing shortage is relieved.

## Mud Huts in Berlin

Reversion to the primitive types of dress and habitation in vogue during the Dark Ages is taking place in Berlin, according to a report in the *Literary Digest*. No new dwelling houses, except mud and board shanties, have been built there since the war broke out, we are told. Yet the population has increased to such an extent that four million people are now jammed together in the city where there is not room enough for three million. As a result, communities of ill-clad and sandal-shod folk are said to be living on the edges of the city in thatched-roofed houses of uncooked clay like the adobe huts in uncivilized parts of Mexico and Central America. So great has the demand for these mud habitations become that technical instruction as to how they should be built has been made available throughout Germany.

## American Institute's Fifty-third Annual Convention

The fifty-third annual convention of the American Institute of Architects is scheduled for May 5, 6 and 7 in Washington, D. C. Convention headquarters have not yet been given out. William Stanley Parker, secretary, the Octagon, Washington.

## Public Buildings

A foreigner who admires America and Americans very much but who is, at the same time, not blind to a few national faults and weaknesses, commented recently on the fact that public and public buildings are so far apart. He believes that there are many beautiful buildings in America. But the people for whom those buildings were erected take very little real pleasure or satisfaction in them. They use the buildings when necessary, but rarely pause to enjoy the architecture or to feel a sense of pride and possession.

Whether it be bank, post office, church or museum, the building itself nearly always fails to become a vital part of the public's wealth. During the period of the building's erection the public is carefully kept outside. When the workmen are through for the day the doors are boarded up and ugly signs are posted announcing "No Admittance" or "Trespassers Will Be Prosecuted" or "Closed" or "Keep Out." Frequently a high board fence is erected to defy even the casual glance of interested passersby.

When the building is completed the public is coldly indifferent. It has acquired the habit of letting the place alone, and goes in only hurriedly to transact the legitimate business of the place.

Of course, it is frequently necessary to protect the laborer's daily accomplishment from souvenir-hunting hands or from the accidental damage which might result from the unrestricted explorings of large numbers of curious citizens. Still there is much truth in the foreigner's criticism. The public should care more about its buildings while they are under construction and should feel more at home in them when they are done. If it is not wise to open up a half-built building for public inspection, at least there could be pictures of its various parts and daily reports of its progress and explanations of its finest features. Then it would become in fact as well as in name, a public building.

## Chicago Art Institute Extends Work

People formerly went to the State Fair to see the raw products of the farm. This year they will see the finished product of the best in art, architecture and home decoration.

They will see masterpieces by the greatest living American artists; they will see photographs, designs and plans of houses drawn by the best American architects.

They will be taught how to build a house; how to furnish and decorate a home; how to landscape the home grounds, and how to dress.

The Extension Department of the Art Institute of Chicago has found a new way to educate the people in art through a new kind of State Fair.

Three years ago the Art Institute undertook the job of teaching Americans both in and out of Chicago what art really is and what it is good for. During that time the institute has sent out "art missionaries" carrying an

equipment of painting, furnishings and interiors to seventy-five cities in the United States.

Through the medium of lectures, exhibitions and interior decorating demonstrations the dweller in the smaller cities and towns has been given a new understanding and appreciation of art. These exhibitions and lectures often last five or six days. Sometimes they are given under the auspices of the Chamber of Commerce or Civic Association, again it may be the Own Your Own Home Association that fathers the show. The new feature at State Fairs is the latest development of the plan to carry the Art Institute to the doors of the people.

## Model Farmhouse Buildings

On the campus of the Nebraska College of Agriculture there is a miniature farm modeled, designed and laid out to satisfy local conditions. The buildings were designed and constructed by the Agricultural Engineering Department of the college. They include a comfortable, attractive farmhouse, set on a concrete foundation and equipped with modern conveniences; an up-to-date dairy barn with a solid wall concrete silo; a hay shed for alfalfa; a horse barn, a hob house; a tool shed and shop; a poultry house and a machinery shed.

All the buildings are well made. They are ideally located in a well shaded and ornamental yard bordered by a small fruit orchard and garden, and the outlying fields are fenced and laid out as you would find them on a real farm.

The buildings on this farm are built to one-quarter scale. The material from which the buildings were constructed were cut to one-quarter scale in the woodwork shop. The buildings were all constructed on the floor of the wood-working laboratory and later were moved out of doors to their present location. The construction was all done by students in the woodworking classes of the college, under the direction of the professor in charge.

The problem of the well-constructed farmhouse and other buildings necessary for efficient work on the farm, is attracting more and more attention. It is one of the most important phases of the reconstruction of rural life now in progress throughout the country. It is a natural indication of agricultural prosperity and it means that the farmer no longer is contented with the old methods of construction that involved drudgery for the housewife and hardship and discomfort for all the members of the farmer's household. It is a hopeful sign.

## Argentina's Building Program

There is a large field for the sale of American construction materials in Argentina, according to a report just made public by the Bureau of Foreign and Domestic Commerce, Department of Commerce, and the investment of American capital in Argentine enterprises is an important factor in securing contracts.

Buenos Aires is in great need of first-class office buildings. Several departments of the Government are being crowded out of their old quarters for lack of space, and modern hotels and apartment houses of the American type are needed. With the return of normal conditions, many model homes for workmen will also be erected in the suburbs of Buenos Aires. Notices appear in the newspapers of the capital from time to time inviting bids on various public construction enterprises. The time limit for these is usually short; but if American firms were represented in Buenos Aires they could secure many such contracts.

The National Council of Education has adopted a large building program for public schools. The plans to be

completed in the next few years call for an expenditure of about \$8,500,000. The needs of various cities in the province of Buenos Aires will call for the installation of sewerage and water systems in the near future at a total cost of about \$2,300,000.

The various provinces of Argentina have building programs independent of those of the Central Government, says the report, but also receive Federal aid in the execution of many public works. Definite projects in which the Central Government plans to aid the provincial governments in the immediate future call for an expenditure of \$10,000,000 for sewerage and water systems alone.

Argentina has always been an excellent market for iron and steel products for construction purposes. Formerly the imports of cement were considerable, but a large cement plant is now in operation about 200 miles from Buenos Aires, owned by American interests. Lime of unsurpassed quality is found in many parts of Argentina, and the plaster of paris used is produced chiefly in the country. Clay roofing tiles and roofing slate and glazed wall and vitrified floor tiles are imported in considerable quantities. Some years ago advertising campaigns were instituted to popularize felt roofing materials, but with only partial success. The chief competitor of this kind of roofing for industrial purposes is galvanized-iron sheeting, for which there is good demand. In the past ten years many skeleton-steel structures have been erected. Architects believe that reinforced concrete will be a strong competitor with this type in the future.

The report, which also discusses the market for construction materials in Bolivia, is the result of a first-hand investigation by Trade Commissioner W. W. Ewing. It is known as Special Agent Series No. 188, "Construction Materials and Machinery in Argentina and Bolivia," and can be obtained at 20 cents a copy from the Superintendent of Documents, Government Printing Office, Washington, D. C., or from any of the district and co-operative offices of the Bureau of Foreign and Domestic Commerce.

## Importance of Ample Electric Wiring

Architects are advising their clients to wire new residences and apartment houses for all possible electric uses and future developments, but they have to contend with the same objections that were presented when modern plumbing was recognized as a necessity. The prospective builder is not fully informed as to the present-day use of electrical appliances nor of the reasons why they will become absolute necessities as the cost of portable fuel advances, and he is apt to tell his architect to cut down on the wiring estimates, not appreciating the fact that he is giving instructions for an incomplete job, which will certainly have to be finished at some future time if the house is to be habitable for himself or a salable piece of property.

The time is long past when wiring for lighting purposes will satisfy. The man or woman who is looking for a home is learning to give as close scrutiny to the wiring as to the plumbing.

There must be wire capacity enough to provide for an electric range and hot water heater in the kitchen, and there must be outlets in the dining-room, parlor, library and bedrooms to provide for the use of the smaller electrical devices, such as heater, chafing dishes, hot pads, fans, piano lamps and other movable lighting fixtures. The question is no longer how cheaply can a house be wired, but how well.

# Weekly Review of Construction Field

Comment on General Conditions of Economics With Reports of Special Correspondents in Prominent Regional Centers

THE construction of buildings, the production of basic materials and the transportation of such materials from the manufacturer to the dealers and from the dealers to the job are all involved or likely to become involved in the controversies which arise from the demand for more wages. In the larger cities there seems to be no limit to the extravagance to which such demands may be carried.

Four months have passed since the stabilizing agreement in the New York City building trades by which skilled craftsmen were placed at \$8 per day. Now the unskilled laborers are setting forth demands for \$1 an hour minimum and some of them are scheduled to go on strike. The bricklayer's laborer at \$1 an hour is able to work in all kinds of weather. The bricklayer is unable to work on rainy days. This makes it easily possible for the unskilled laborer to earn more than the skilled, which invites more trouble.

The railroad strike has of course tied up the transportation of building materials and the reduced supplies in the yards are practically exhausted. It is commendable that in this situation there was no skyrocketing of prices. The hold-up in railroad transportation seems now to be at an end, but the reparation of the damages brought about by its delays cannot be immediate. The immediate outlook for construction is not encouraging.

IT seems most likely, however, that the public—if there is still a public—will be well aware of the cause of the delays in building by which it is being so seriously inconvenienced. The case is quite plain. The more serious the inconvenience the plainer the case. If one has a comfortable place to live at a reasonable rent, or if one owns one's own home, it is easy to look upon strikes in the building trades with a degree of equanimity. There is getting to be, however, a large proportion of our population which (not knowing where it is going to live) feels vitally interested.

The current issue of *The Nation* carries an article which analyzes the situation of those who are in need of houses and arrives at the conclusion that the necessity of business to make profits and the demand of the workers for profits will shortly bring "a time when business men will frankly come to the community and say they cannot operate the business system, because there are no profits in it. That day has arrived in the British coal mines and railways. It has apparently arrived in housing both in England and the United States. The house of today, as it tries to get itself built, is weighed down by an overlay of golden charges—taxes, profits, interest, every item of material, every stroke of labor."

Undoubtedly the facts are as Mr. Gleason states, but whether the conclusion of the business man which he infers is inevitable is to be questioned. The difficulty with carrying forward a building program is not the high wages, but the undependability of the workers. Should they make an agreement and stick to it, could they be depended upon to work instead of strike, much might be assured of accomplishment which now seems

doubtful and a dangerous experiment. It really does not seem necessary or desirable to overturn the whole social system, and it isn't likely that business men are going to throw up the sponge.

AN organization of a building loan association is contemplated in New York with a capitalization of \$30,000,000 which shall construct the modest type of house needed by the small salaried class. Of the purchase price—which would be about \$2,500—the purchaser would be required to pay 6 per cent annually, in monthly installments; he would also buy stock in the corporation upon the installment plan. His total monthly payments would amount to about \$25 and at the end of twelve years he would own the house.

This scheme carries many of the commendable features of "the Detroit Plan" and seems to offer a solution not only in the housing of a population, but toward the settlement of many of the social problems of the day. No one can look upon the accomplishments of this country and say that the principles upon which it has worked are faulty. It is quite as true and must be admitted that the tendency through recent years toward a submergence of individuals into cogs of an industrial system and nothing else lessens their value as citizens. However large their pay or short the hours of work, there is sure to be discontent at such a fate. A job and fat pay envelope, and rented tenement, however sanitary, and a picture show, however exciting, do not make a stable, well-rounded life. The good citizenship is missing. And if from the present crisis we can stabilize not only our markets and wages but our manhood it will have been worth going through. If the tendency to become nomadic is succeeded by the satisfaction of settling down—and this seems a not unnatural reaction—we shall be able to talk of socialism or syndicalism or bolshevism with an expectation of arriving somewhere. After our workers know what it is to have permanent homes they will doubtless find that they have a new perspective upon their place in society.

THE Savings Division of the U. S. Treasury Department states that there are heavy inquiries for the small denomination Liberty Bonds throughout the country. This is believed to indicate that the people who, by thrift, are able to buy these securities have stopped their extravagance and are looking about for sound investment. The demand has become so large that the supply of the "popular" sizes had been reduced and the Treasury Department has issued instructions to the Federal Reserve Banks for the exchange of bonds of larger denominations for those of smaller units.

Lumber statistics from the Northwest show that production for the week was only 1.06 per cent below normal. It is said that an inadequate car supply was keeping shipments below production and preventing the mills from accepting all the business offered to them.

In the steel trade the production for March was considerably in excess of expectations and showed that the

mills had fully gotten into their stride after the setback suffered from the earlier steel and coal strikes.

*(By Special Correspondence to THE AMERICAN ARCHITECT)*

CHICAGO:—Prior to the calling of the railroad switchmen strike in Chicago ten days ago there had been a decided improvement in transportation, particularly noticeable in increased steel shipment.

Industry had come back after months of coal shortage and transportation difficulties; goods which had been held in warehouses for long periods were moving, and delivery and payment of these helped to relieve the credit situation.

There was a promise of easier conditions for both producer and consumer, and with the increase of supply came indications of lower prices.

But the strike which has spread all over the country has changed this. It has tied up traffic, forced thousands of workers in other industries out of employment, again crippled industry and seriously disturbed the money market.

The housing situation will be rendered more acute as the result of the slowing up in the construction industry.

Though there has been a big increase in building, most of it is being done by industrial concerns. Building awards for Chicago for March, 1920, were \$103,267,770, which is over \$40,000,000 more than any month in the city's history, but only 19 per cent of this sum was for residence construction.

Home builders cannot afford to pay the increased costs of labor and material which are showing a gain in cost of 100 per cent over those of March a year ago.

Those who are building in suburban districts show a preference for brick or concrete as a building material where formerly nine out of ten buildings were frame.

Permits issued in Chicago in March for 480 buildings involved a total cost of \$10,000,000, as against 497 buildings and \$5,501,850 for the same month a year ago. During the first quarter of the year 1,084 permits, aggregating \$28,699,800, were issued. Last year there were 793 aggregating \$8,486,750.

Along with the high cost of construction goes the high cost of borrowing. More than \$100,000,000 worth of improvements contemplated by public utilities companies throughout Illinois will be given up because of excessive interest rates. Rates in Chicago are on a 6½ per cent to 7 per cent basis with the banks disposed to limit accommodation wherever this can be done without working a hardship.

The shortage of railroad equipment and extensive labor difficulties continue to hamper.

Chicago is now the nation's greatest army supply sta-

tion and will continue to be the food center of the American army. With the recent completion of Unit C of the trio of gigantic army supply depots on the south side of 39th between Ashland avenue and Roby street, Chicago will have 1,890,000 square feet of permanent floor space for storing Government supplies. All the meats for the entire army will come to these warehouses.

This permanent depot project, costing approximately \$10,000,000 and said to be the largest in the world, grew out of an off-hand suggestion of an army officer that there should be such a depot in Chicago.

Building contracts in the Central West in March amounted to \$89,727,000. There has been a steady increase in this district since the beginning of the year, January having shown a total of \$61,423,000 and February \$78,082,000. The total for the quarter is about double the amount for the same period last year. Of the quarterly total 32 per cent was for industrial buildings, 21 per cent for public works and utilities, 19 per cent for buildings and 18 per cent for residential buildings.

*(By Special Correspondence to THE AMERICAN ARCHITECT)*

SAN FRANCISCO:

THE present uncertainty as to the price of lumber in the future is somewhat retarding the supply. The lumber yards, awaiting price developments, are at present inclined to delay stocking up. Although the price of lumber remains about the same, there is a question as to whether or not it will be continued. The majority of the San Francisco lumber dealers think that those who expect a drop in the present price of lumber are going to be disappointed. The demand for all the timber products so far exceeds the supply that it is very doubtful if the opening of the Pacific Coast saw mills will affect the price of lumber in the least.

The brick shortage in San Francisco and the Bay Region is forcing the construction men to await their turn for their supply. Many more buildings of concrete construction are being erected than otherwise would be if brick could be obtained in sufficient time to erect them.

Reinforcing material is showing an upward tendency, owing to the large demands that are being made on it.

Construction men and California architects say that they see no slowing up of the demand for more buildings and homes for some time to come.

The supply of labor is as short if not shorter than the supply of materials. However, much of the supply of material is due, so the producers say, to the shortage of sufficiently trained laborers. The construction men are still much in need of more trained men to help them fulfill their contracts on time.



# DEPARTMENT OF ARCHITECTURAL ENGINEERING

## The Isolated Sewage Disposal System

A Type Adaptable to the Country Residence

By WILLIAM C. TUCKER

SOME of the choicest residential sites are located in sections unprovided with municipal sewers and, therefore, it is generally necessary for the architect planning such a country home to make provision for a satisfactory method of sewage dis-

posal no longer countenanced and these methods cannot be too strongly condemned, nor their attendant dangers overemphasized.

The underlying principles to produce complete bacterial reaction are quiescence, sedimentation and



COUNTRY ESTATE OF THE LATE CAPTAIN DE LAMAR AT GLEN COVE, LONG ISLAND, N. Y.

C. P. H. GILBERT, ARCHITECT

Plans for the Sewage Disposal System Are Reproduced on Page 530

posal. Fortunately scientific investigation has resulted in evolving a plan both simple in construction and efficient in operation.

Former methods of draining household waste material either into a cesspool or a nearby stream are

the delivery of the material for treatment in as dense a form as is expedient, with sufficient fluid only to hold the solids in suspension so that they may be moved in the sewer with celerity and freedom. To produce these results the sewage must

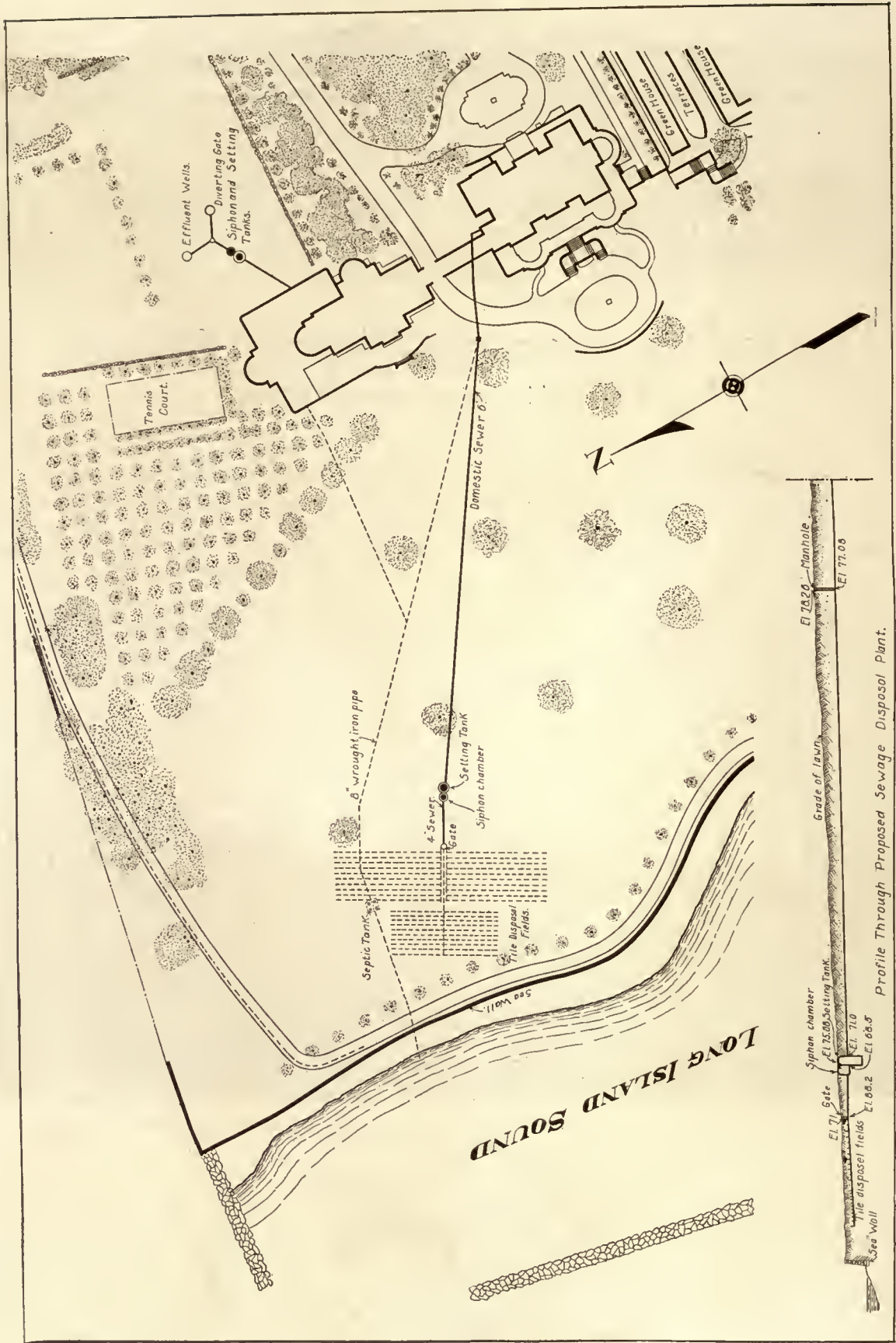

ESTATE OF THE LATE CAPTAIN DE LAMAR AT GLEN COVE, LONG ISLAND, N. Y. THE SEWAGE DISPOSAL SYSTEM SHOWN HERE HAS BEEN IN SATISFACTORY OPERATION FOR SEVERAL YEARS

be delivered to a water-tight masonry chamber of sufficient capacity to retain the accumulation of two days' supply. The receiving basin must be so constructed that the movement of the sewage during its passage to final disposal may be leisurely.

To obtain this condition a short masonry wall two feet high is usually built across the bottom of the receiving tank, located at the center, to act as a baffle plate and assist in producing a sluggish and retarded flow. Thus fermentation and sedimentation will be most thorough, accompanied by complete bacterial activity. This action changes the solids into insoluble and mineral components

ing basin may be circular in form for smaller units, including those of 600 gallons capacity; if larger, the rectangular form will be found more advantageous. The determination of the water consumption within the house is somewhat difficult and is dependent upon its availability, whether there be running water or not. In the former instance, 60 gallons per head per day may be assumed as a fair allowance. No animal stall or wash table drainage should enter the sewage disposal system, since that from the former contains finely masticated food of the animals, which fails to settle in the receiving basin, causing clogging and seri-

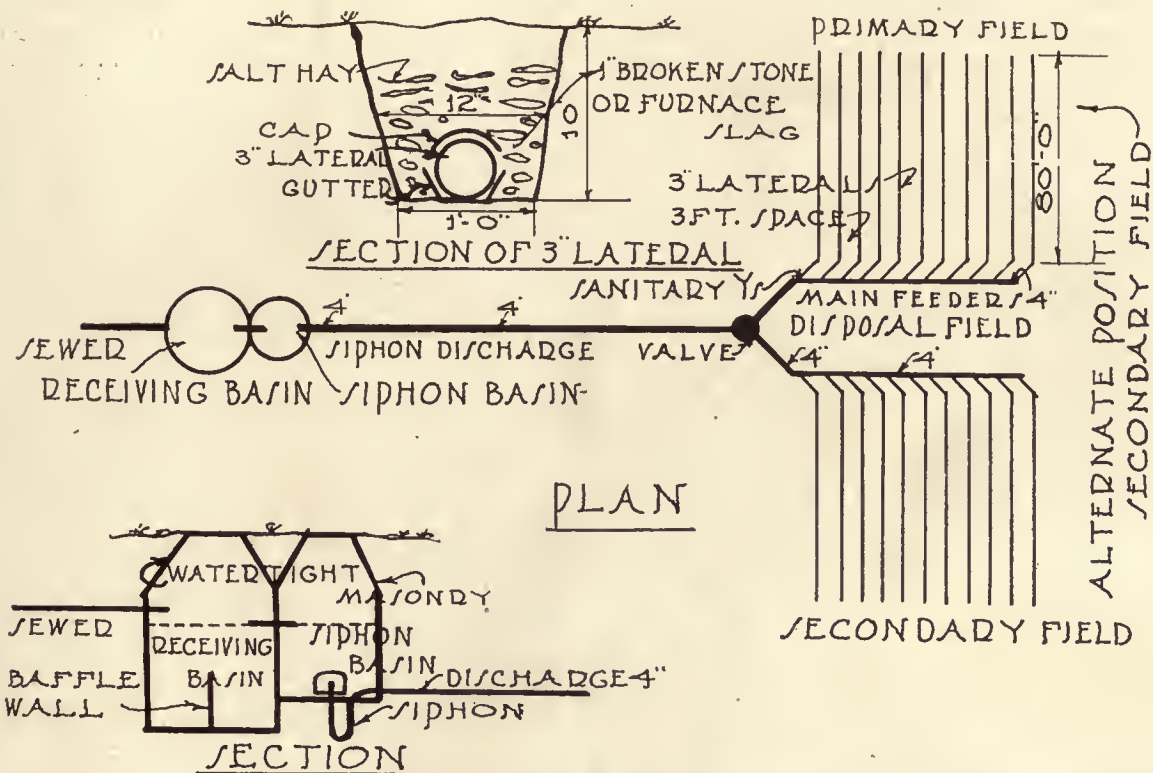

FIG. 1. THE TYPE OF ISOLATED SEWAGE DISPOSAL SYSTEM ABOVE ILLUSTRATED FOLLOWS THE MOST ADVANCED METHODS YET DEVELOPED

which settle to the bottom in the form of a thick black viscous sludge into which bacterial activity continues, as well as the formation of gases which escape to the outer air. The resulting effluent should be free of suspended matter, and is generally of grayish color, with slight sweetish odor, and retains much heat.

The receiving basin must be of the correct size. This cannot be determined until the daily water consumption within the house is known. The depth of sewage should, if possible, not be over 4 ft. 6 in., which has been generally accepted as correct from numerous scientific experiments. The receiv-

ous interference with the proper action of the filtering media. The road material carried by the drainage from wash tables quickly settles in the sewers, causing interruption of flow and final stoppage.

The location and character of the surrounding material, for final disposition, for whatever mode may be employed, is most important and cannot be selected with indifference. The location should be upon gradual, sloping, unshaded ground exposed to the sun and at considerable distance from growing shrubbery or trees whose root tendrils may seek the nitrogen in the effluent, enter the sewer pipe and interfere with the free absorption by the earth.

The surrounding material must be of gravel or sand; loam and hardpan should be avoided as much as possible on account of their non-absorbent qualities. When this is impracticable the means of disposal must be considerably increased or the unit subdivided. An area of generous proportions is necessary for final disposal, situated at some rather remote and protected point and should not be used for general farming purposes, nor traversed by the farm implements. It should be placed at as great a distance from the source of the water supply as is practical to avoid contamination.

The scientific method of sewage disposal is most elementary and mechanical in its application, and consists of consigning the effluent to the earth in such quantities and manner that it may be readily and continuously absorbed. This may be accomplished in a number of ways which differ radically from each other in form and cost, but the underlying principle is the same.

The most advanced method of sewage disposal



FIG. 2. THE STEPPED UP ARRANGEMENT OF THE MAIN FEEDERS HERE SHOWN IS NECESSARY WHEN THESE ARE LAID ON STEEPLY SLOPING GROUND

and one of highest scientific attainment is shown in Fig. 1. A chamber is provided containing a siphon which acts automatically when the sewage has reached a predetermined height and discharges the entire contents at point of disposal in one operation. The siphon is manufactured in one piece, is most simple in construction, has no moving parts and can be readily installed. From the siphon chamber the effluent is discharged into disposal fields, primary and secondary, one of which is always in use, generally for a period of two weeks, while the other is at rest, recuperating, as demanded by good practice. The valve shown on the siphon discharge directs the flow to either field as desired.

These disposal fields consist of lateral lines of drainage tile laid a short distance below the surface of the ground. The laterals, a cross section of which is shown in Fig. 1, consist of 3-inch tile laid with open joints, protected against falling material by caps, laid 10 to 12 inches below the surface of the ground and surrounded on top and sides with a 4-inch layer of 1-inch broken stone or furnace slag which is protected by a thick layer of salt hay against the filling entering the inter-

sices. These lines are taken from 4-inch sanitary right and left Y's with 3-inch branches, are spaced 3 to 4 feet apart, as shown in Fig. 1, are laid very flat, with a fall of but 6 inches in their entire length, and are approximately 80 feet long. This length has been scientifically determined as correct, so that each siphon discharge completely fills all lines, allowing the contents slowly to seep into the surrounding media through the open joints.

It often develops that a hillside is the only available space upon which to locate the disposal field, which necessitates special forms for the main feeders, so that the onrush at each siphon discharge may not burst through to the surface at the end, and not completely fill each lateral. To obviate this and reduce the velocity of flow to a normal rate, the main feeders are installed in a series of steps, as shown in Fig. 2, with the horizontal space between each step laid flat, so that the rate of flow is greatly reduced.

The country estate of the late Captain De Lamar at Glen Cove, L. I., is here shown and the sewage disposal system installed is clearly indicated. This estate was fully illustrated in our issue of September 17, 1919

## A New Development in Liquid Fuel

There has appeared on the fuel market a new source of energy—that is, a new combination of old sources in the form of a colloidal suspension of coal particles in fuel oil. This furnishes a readier and cheaper fuel and makes possible the use of the poorer coal veins for the coal content. It can be sealed against combustion, has a greater heat content per unit weight than either coal or oil, handles as simply and easily, is self-quenching in water, burns without ash, yet is capable of throwing up the densest of smoke screens by the proper manipulation of the air registers on the furnaces. This feature is of use in naval warfare.

It was developed by the Submarine Defense Association, a private concern, with the assistance of the United States Navy and the British Admiralty to combat the scarcity of fuel during the war.

Many failures had come from attempts of a similar nature for the same reason that lemon seeds fall to the bottom of a glass of lemonade—gravity. But Linden W. Bates by first pulverizing the coal to nearly molecular fineness and perfecting a suspending ingredient—a fixateur—was able to overcome gravity and keep the coal in suspension in a sort of colloidal form. It was tested just before the signing of the armistice and is now ready for commercial use. The fuel will flow in pipes under pressure and will atomize readily in old equipment.

# Foundations, Their Selection, Design and Construction

## Preliminary Investigation of Subsoil Necessary for Intelligent Design

PRACTICALLY every architect realizes the importance of foundations, therefore it would seem unnecessary to stress this phase of the subject, but there are so many factors necessary to the proper selection and design of a foundation that although the seriousness of the problem may be realized, yet for some unexplained reason the careful and necessary preliminary work demanded to arrive at the right solution is often neg-

in all seriousness that the foundations may be completed while the plans for the rest of the building are being worked out. A more fallacious claim was never made, for the plans of the entire structure must be well developed before the foundations can be even properly designed, let alone constructed. Some preliminary work such as the excavation is, of course, possible and often desirable.

Not only must the plans be well developed, so



TESTING THE SOIL

The subsoil on which the above test was conducted consisted of fine, dry, compact sand slightly mixed with loam. The Building Department would have allowed 3 tons per sq. ft. After a successful test for 6 tons, during which a 50 per cent overload was placed, this higher loading was allowed, permitting a substantial saving in cost of foundations. The leg of the platform extends 16 ft. below the curb level

lected. In this article I will attempt to point out the reasons for and methods of such preliminary work in subsoil investigation.

It has frequently been stated in advocacy of the "cost plus" method of letting contracts (the merits or defects of which will not be entered into here) that one of the major advantages of this plan is the speed of construction possible under its provisions, and in support of this contention it is stated

that a fairly approximate estimate of the loads to be supported may be made, but a knowledge of the nature of the material on which such foundations will rest is absolutely essential before intelligent work on the design can be commenced.

Three general conditions of a building site exist prior to the commencement of the work: (1) The site may be wholly or partially occupied by existing structures; (2) It may consist of vacant prop-

erty at or above the curb level; or (3) It may consist of vacant property the surface of which is at approximately the basement level of the proposed structure.

In either case it is necessary to determine the nature of the subsoil at the assumed foundation

TABLE 1. SAFE LOADS ON FOUNDATION SOIL IN TONS PER SQ. FT.

NATURE OF SOIL	NEW YORK	PHILADELPHIA	DETROIT	DENVER	SAN FRANCISCO	MERRIMAN/ANY BOOK	FAIRBANKS/ANY VALUE
SOFT CLAY OR SOFT WET SAND	1			1	1	1 to 2	1 to 1½
SAND & CLAY MIXED	2		2	2	2		2
FIRM CLAY	2			2	3	4-6	2-3
LOAM OR FINE DRY SAND	3		3	3	3		3
HARD DRY CLAY	4	3½	4	4	4	6-8	4
COMPACT SAND	4	3½	4		4	4-6	4
COARSE GRAVEL	6	6	4		6		6
HARD PAN OR SAND & GRAVEL CEMENTED	10			8		8-10	8 to 10
SOFT ROCK	8					5-10	8
SHALE ROCK				8			8
MEDIUM ROCK	15					15-20	15
HARD ROCK	40				20	25-200	30 UPWARD

WHEN NO SOIL BEARING VALUE IS SPECIFIED BY THE LOCAL BUILDING DEPARTMENT AND NO SOIL TEST IS HELD, THE FIGURES GIVEN IN THE RIGHT HAND COLUMN WILL GIVE SATISFACTORY RESULTS

level—usually a few feet below the basement floor.

When conditions are as described in Case 1, the basement or cellar level of the existing buildings is often at approximately the level of that of the proposed structure. In this case it is only necessary to open up several pits 3 ft. to 4 ft. square, and carried to the proposed level of the new foundations in order to determine the nature of the soil at such level. In sections where the subsoil is known to be uniform, one such pit will be adequate. However, in many localities the nature of the subsoil varies to such an extent that it would not be safe to depend on one such opening. For buildings up to 100 ft. square, a test pit near each of the four corners and one in the center will prove sufficient, unless the soil excavated from these locations varies radically, in which case a closer analysis will be necessary.

When conditions are as described in Case 2, it is frequently possible to determine the nature of the soil without great difficulty. In such cases rock will often be encountered, cropping out on the sur-

face, and a little investigation should determine whether it is safe to assume that the entire foundations will rest on rock. When, however, rock crops out at one corner of the lot, and dips down sharply, the strata making an angle of 60 degrees or less with the vertical, it is likely that rock in the other portions of the lot will be encountered only at great depth. In such a case a foundation resting partially on rock and partially on soil may necessarily be selected. This is one of the most difficult of foundations to design. If, however, the top soil consists of filled-in ground, or is of such nature that no close approximation of the underlying strata can be made, test pits should be dug as already described, or if the foundations are to be at any great depth, it will be better to have borings made. When conditions are as described for Case 3, the opening of several test pits will usually be sufficient.

By following the foregoing suggestions, the nature of the soil at the assumed foundation level will be made evident. This, however, may not end the preliminary investigation.

Suppose the proposed structure is to be 16 stories, with column spacing of 20 ft. in each direction, to be occupied as a factory with a live load of 200 lbs. per sq. ft. The dead load will be assumed at 75 lbs. per sq. ft. Then the load brought to the column footing will be:

Roof—40 lbs. dead+60 lbs. live=100 lbs. per sq. ft.  
 16 floors at 75 lbs. dead+200 lbs. live each=16x275 or 4,400 lbs. per sq. ft.

The total loading for roof and 16 floors will be 4,500 lbs. Since each column supports 20'x20' or 400 sq. ft. of floor area the load on the footing will be 400x4,500=1,800,000 lbs. or 900 tons.

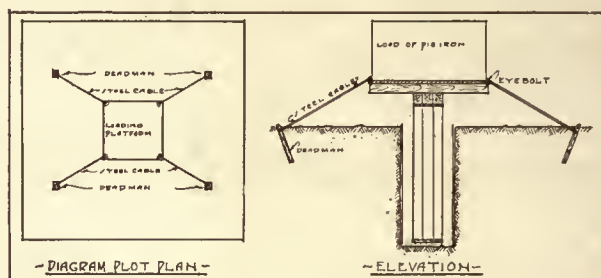

DIAGRAM SHOWING METHOD OF BRACING SOIL TESTING PLATFORM WITH STEEL CABLES OR WIRE GUYS TO PREVENT TILTING

Assume that upon investigation of the soil, this is found to be sand and clay mixed, on which according to the regulations of the local building bureau an allowable loading of 2 tons per sq. ft. is permitted. If spread footings at this level were used, each column footing would have to have an area of spread of four hundred and fifty square feet, since

900

— = 450 sq. ft. This is plainly impossible, since  
 2  
 the entire area available per column is only 400 sq. ft. (cols. being spaced 20 ft. centers). Plainly spread footing would be out of the question on a two-ton loading.

Some other type must be chosen or an actual

compact sand is encountered. The building inspector will not permit the work to proceed, and the entire foundation must be redesigned with all the attendant delay and contract difficulties.

A good compact stratum will often be encountered underlying a soft top soil. When soil of small bearing value is found at or a little below the basement level, it will usually pay to dig deeper.

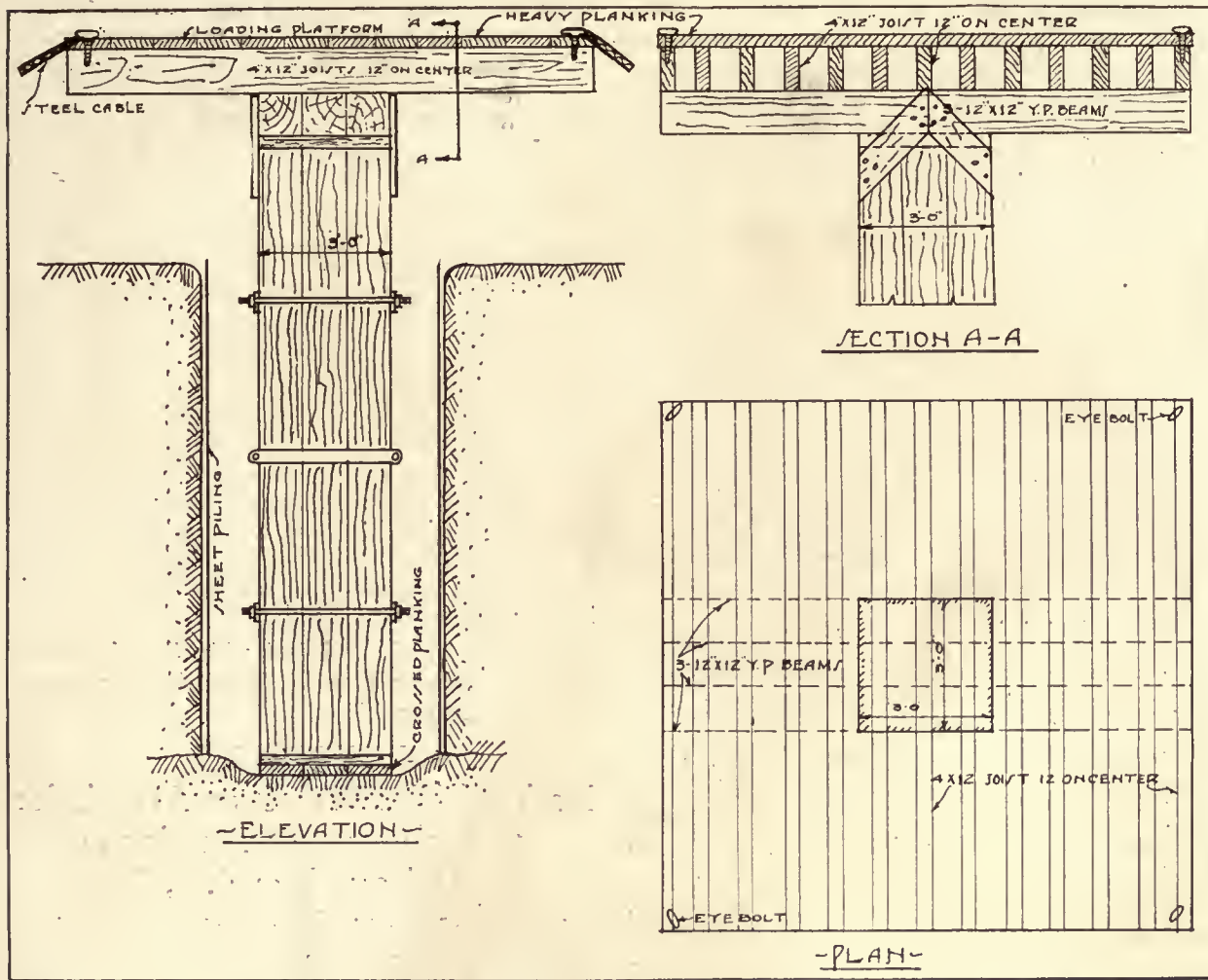

TESTING PLATFORMS CONSTRUCTED AS SHOWN BY THE ABOVE DRAWING HAVE GIVEN SATISFACTORY SERVICE WHEN SECURELY BRACED AS SHOWN IN THE DIAGRAM ON THE OPPOSITE PAGE

test on the soil made to determine if a higher bearing value is safe. To indicate the value of a preliminary investigation, let us suppose that in this instance none had been made, and because of data obtained from the excavation made for a building a hundred feet distant, compact sand was pre-supposed, on which a safe loading would be 4 tons per sq. ft. On this basis spread footings have been designed, contracts let, and work commenced. When the excavation reaches the footing level no

The nature of the soil at a lower level may be determined by open test pits or by borings. The latter are not used to as great an extent as they should be. Such borings can often be made by an ordinary wood auger. Wash borings are probably the most common type employed, are not expensive and can be made rapidly. By careful inspection of the material brought up, the depth at which firmer soil exists can be judged quite accurately by a person experienced in such work.

This information will show whether it is best to use spread footings at the basement level; to go deeper with open excavation; to adopt a pile foundation or to use pneumatic caissons.

In Table 1 the safe loads on different foundation soils as permitted by various building codes and other authorities are given. These figures have been arrived at through experience, and are conservative. For instance, on compact sand, if dry and confined, a loading of 8 tons could often be safely allowed. By inspection it is not possible to determine whether such a value would be safe and so a lesser value is fixed to cover average conditions. This applies in a more or less degree to other soils. The only method of determining the maximum safe bearing value is by actual test. Practically every building code, besides specifying allowable loads on soils, contains some clause such as the following:

"The Building Department shall have the power to demand that tests be made of the bearing capacity of the soil whenever the department may deem it advisable. All such required tests shall be made under the direction of and to the entire satisfaction of the department and at the owner's expense."

The New York City code also contains this provision preceding the table of allowable safe loads:

"In the absence of a satisfactory test of the sustaining power of the soil, different soils, excluding mud, shall be deemed to safely sustain the following loads. . . ."

In many instances, an actual test on the soil will reveal that it is capable of sustaining a greater load than specified by the local building code. Where there is any doubt, therefore, such a test should be conducted, and its cost will, in the majority of cases, be more than compensated for by the reduction in cost of the foundations. Having conducted a large number of such tests, I feel justified in making this statement.

In an effort to economize in the cost of the test, an area of only one square foot was frequently suggested and sometimes used. A fair test is impossible on such a limited area, and the results cannot be taken as applying to large areas. The minimum that should be used is 2 ft. x 2 ft. and better results are obtained by loading an area 3 ft. x 3 ft. As difficulty has been encountered in some instances when conducting these tests, due to improper construction of the test structure, a sketch showing a satisfactory type of structure is here given. Most of the trouble occurred by the test platform assuming a lopsided position during loading, and frequently breaking away from the bracing and toppling over before the test was completed. This tendency is more prevalent when the area loaded is small.

It is important that the loading material be evenly applied to the platform to reduce this tendency. Pig iron is the material most frequently used in such tests. Cast iron elevator weights have also been used, but these require the use of a derrick for placement. When the load is not great a box for sand will be found satisfactory. Bricks are also sometimes used. In one test a large rivetted steel tank was up ended on the loading platform and filled with water. This tank had to be exceedingly well braced, and while it proved satisfactory in this instance, I would not recommend the general adoption of this plan. Pig iron has proved the most satisfactory loading material.

Before conducting the soil test, the desired loading is fixed by the architect. The soil should then be first loaded to this amount, readings being taken as the loading progresses to note the settlement. This load should be left in place for 24 hours and a reading taken at the end of this period, after which a 50 per cent excess loading should be placed, and the settlement noted during its application. The total load should be kept in place for six days and readings taken daily. If the settlement is progressive, the desired loading should not be permitted. If, however, it slackens daily and reduces to practically zero after the third or fourth day, the proposed loading is safe. The maximum settlement during the entire test should not exceed 2 in. In many cases (on compact sand or gravel) it has not exceeded  $\frac{1}{2}$  inch.

The next article will deal with the selection of the most suitable type of foundation for several sets of given conditions.

---

## National Fire Protection Association to Hold Annual Meeting at Chicago May 4, 5, 6

In connection with the annual meeting of the National Fire Protection Association, it is urged that all those who contemplate attending this meeting make hotel reservations at once due to the congested conditions of the Chicago hotels.

Some of the features on the program include a visit to Underwriters' Laboratories on the afternoon of the second day, May 5; a noon luncheon for May 5 planned by the Chicago Chapter N. F. P. A.; an outline of the fire prevention work of the Fire Prevention Bureau of the Pacific by Jay W. Stevens of San Francisco, Manager of the Bureau. The new three-reel fire prevention motion picture, "America's Greatest Crime," will be shown at the meeting.



participate 2315



VENICE

FROM A WATER-COLOR SKETCH BY JOSEPH MCGINNISS

# THE AMERICAN ARCHITECT

VOL. CXVII.

WEDNESDAY, MAY 5, 1920

NUMBER 2315

## The Rotch Traveling Scholarship

Some Notes as to What It Means and What It Is With a Biographical Sketch of the Late Joseph McGinniss and Illustration of His Work

**T**HOUGH the Rotch Traveling Scholarship has been in existence so long, it is not generally known just what it is and what it means to the holder. The scholarship was the first prize established in this country for architectural students. It was endowed by the family of Benjamin S. Rotch, a wealthy Boston merchant, whose son, Mr. Arthur Rotch, was a prominent Boston architect, a Beaux Arts man and one whose interest was ever manifested in public affairs. The first award of the scholarship was made in 1884 and every year since that period a man has been selected and sent abroad, except for the two years which have just ended, when, owing to the conditions in Europe, traveling scholarships were out of question. The man who will receive the prize this year will, therefore, be the thirty-fifth holder of the scholarship. The fund originally was \$50,000 and the allowance to each student was \$1000 a year for two years, but due to the careful business management, especially of Mr. William Rotch, the present treasurer of the fund, the amount available has steadily increased until now there is available each year \$1500 which the student receives to be expended in study and travel abroad under the direction of the Rotch Traveling Scholarship Committee. This committee is appointed by the Boston Society of Architects and has entire charge of the scholarship, making the award and directing the studies of the students abroad, always subject to the approval of the trustees. A great deal of liberty is allowed the students in the determination of their lines of study. There have been some who have spent all their time in the Ecole des Beaux-Arts. There are very few who have not given at least some time to this sort of study, and of late years most of the men have put in a good deal of time at the American Academy at Rome, where the Rotch scholars are admitted on the same terms as the holders of the Roman scholarship. Several of the scholars have extended their travels as far as Egypt and Greece. One of them made a tour of the world, including in his studies the work in India, China and Japan, sending back

some extremely interesting work. This was Mr. Edward T. Foulkes, now a practising architect in San Francisco. Most of the holders, however, have limited their travels to England, France, Italy and



A DOORWAY, OXFORD  
FROM A PENCIL SKETCH BY JOSEPH MCGINNISS

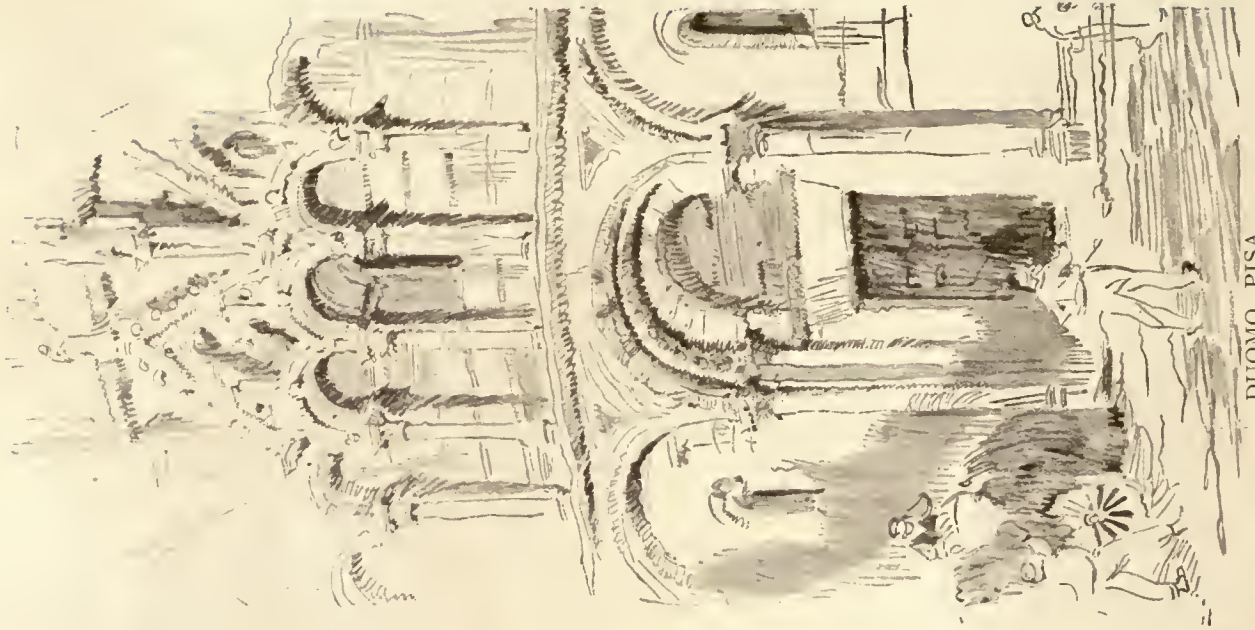

DUOMO, PISA

FROM PENCIL SKETCHES BY JOSEPH MCGINNISS

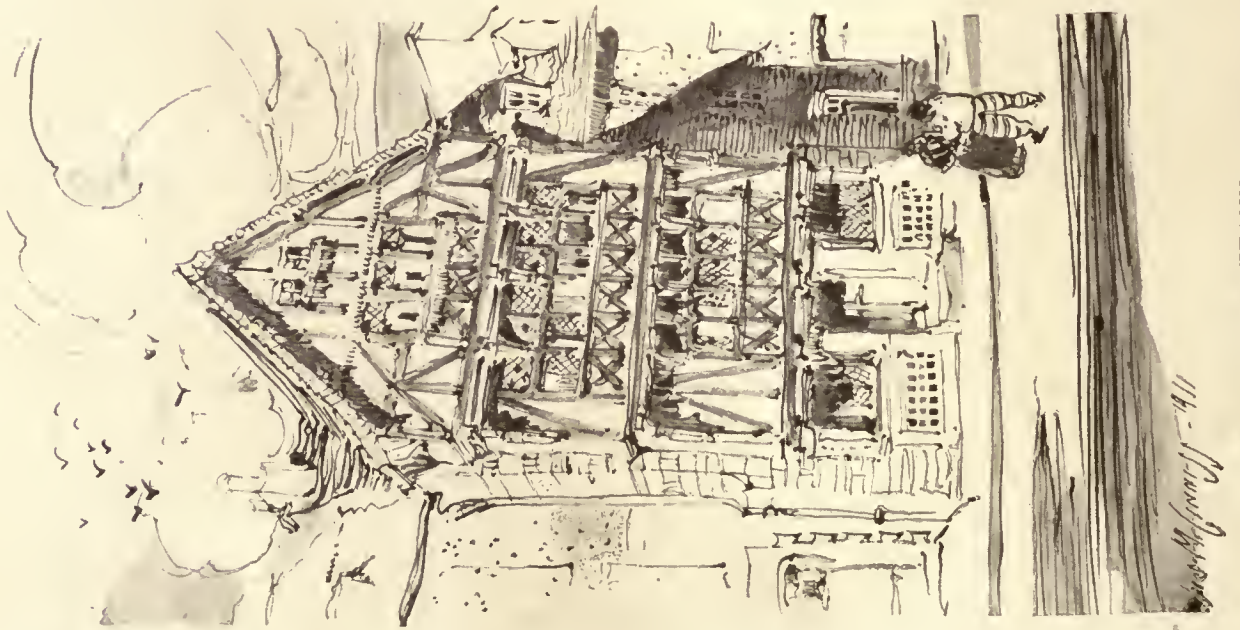

MORLAIX, BRITTANY

Spain, and in the majority of cases France and Italy together have taken up about three-fourths of the time of the students. The men are left practically free to choose their own line of work, but the committee endeavors to help them in every reasonable way, simply requiring monthly reports and the return three times a year of all drawings made.

THE men are selected partly on their records and partly on the examinations. The graduates of certain recognized technical schools are admitted to the Competition in Design, but all other applicants are called upon to pass examinations in French, History of Architecture, Construction and Drawing. The award of the scholarship is on the Competition in Design, and to help the committee, the drawings submitted are judged by a jury which usually includes one past holder of the scholarship from the vicinity of Boston and two practising architects from other cities. The judges this year include Mr. Benno Janssen, of Pittsburgh, Pa.; Mr. Charles Zeller Klauder, of Philadelphia, and Mr. J. Lovell Little, of Boston. It is rather interesting to notice the uniformity of the standards which seem to have been accepted by the judges. During the thirty odd years of the scholarship there have been naturally a great variety in architectural character of the men who have helped. Some architects have served on the jury who were pronounced modernists of the Louis Sullivan school, and on the other hand there have been many of the most rigid academic type. The problems, too, have varied from those of a light, imaginative character to the most severely classic problems, but almost without exception the awards have been made first on the basis of the plan, and second, on the academic composition, mere draughtsmanship really counting for very little. It is considered, on the whole, an encouraging

sign that decisions are arrived at in this manner, for it implies a recognition by the profession as a whole of the fundamental principles of design which have been worked out better by the Ecole des Beaux-Arts than by any other one school, and while the designs have not been limited to the Beaux-Arts designs, the principles of design which have attained so much favor in Paris have seemed to dominate the choice here.

THE scholarship is limited to men under 30 who have worked during two years in the Massachusetts office of an architect residing in Massachusetts. This necessarily limits the choice. It also means that while the men come from other places to study in Boston for the scholarship, they do not necessarily settle in Boston on their return. As a matter of fact, more than one-half of the former holders are now settled in and about New York City, and out of the total number only a little more than one-third are located in Massachusetts, consequently the profession in other cities is profiting quite as much as Boston by the work of these men. The average of attainment by the Rotch men has been such as seems to justify the establishment of the scholarship. Among the practising architects who have held the scholarship may be mentioned Mr. Henry Bacon, Mr. H. VanBuren Magonigle, Mr. A. W. Lord and Mr. F. C. Hiron of New York; Mr. H. B. Pennell, Mr. George F. Newton, Mr. S. W. Mead, Mr. C. H. Blackall, Mr. Walter H. Kilham, Mr. L. C. Newhall, Mr. W. L. Mowll, Mr. James Ford Clapp and Mr. Israel P. Lord of Boston; Mr. William D. Crowell of St. Louis; Mr. Horace G. Simpson and Mr. Edward T. Foulkes of San Francisco; Mr. Wm. L. Welton of Birmingham, Ala., and Mr. R. C. Spencer, Jr., of Chicago.

The traveling scholarship was the first of its kind and is still one of the very few scholarships which is not directly connected



FROM A DRAWING BY JOSEPH MCGINNISS

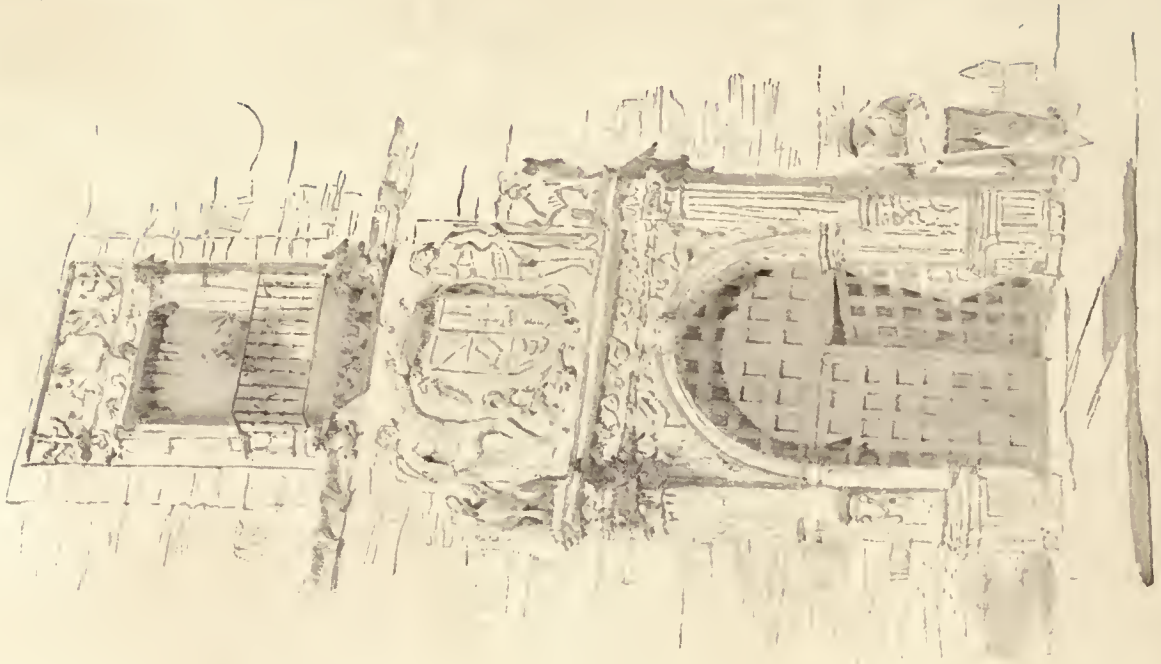

CASA DE ANGULO, BURGOS  
FROM PENCIL SKETCHES BY JOSEPH MCGINNISS

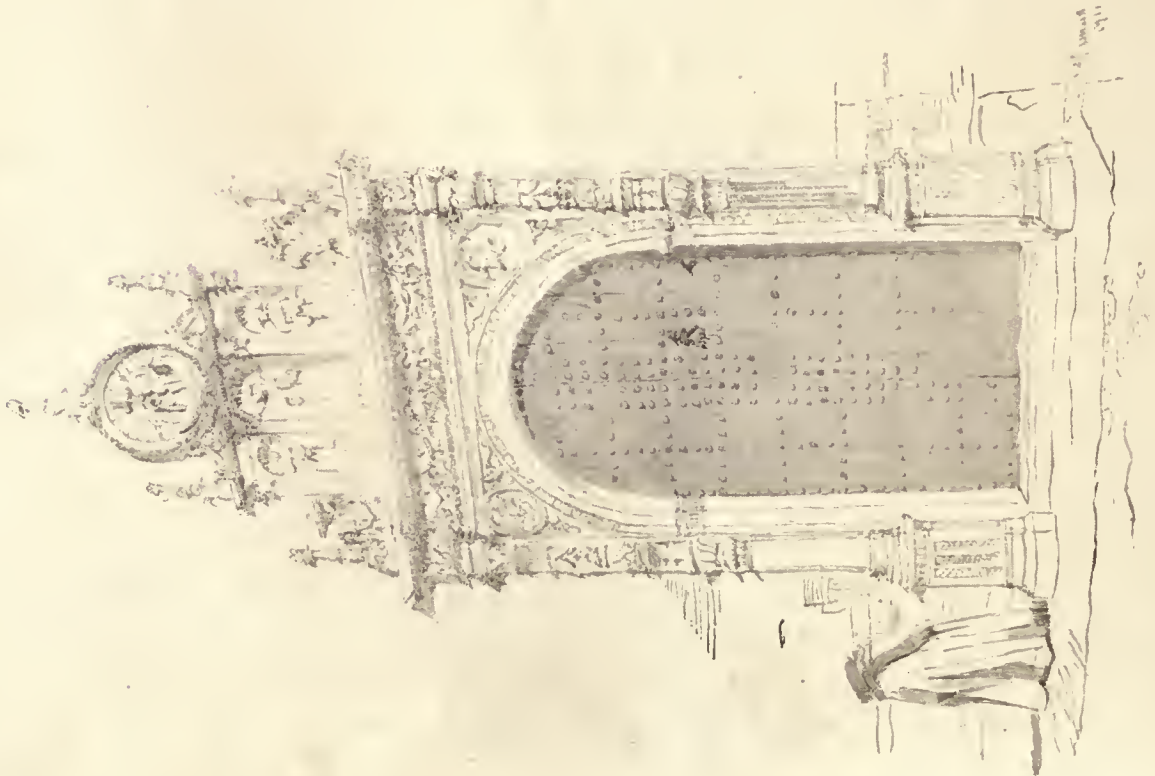

CONVENT OF SAN CLEMENTE, TOLEDO  
FROM PENCIL SKETCHES BY JOSEPH MCGINNISS

University, Columbus, has been collecting a large number of photographs representing the best work in this field, and has examples from the most successful architects and landscape architects in this country.

Prof. Elwood desires to increase this collection as far as possible to include all the desirable work



ARCH OF TITUS, ROME

with some educational institution, but there are many which are attached to the architectural schools, so that whereas thirty-six years ago the student had only one choice, there are now thirty or forty throughout the country, and yet the Rotch scholarship still holds its attractiveness and every year there is a choice and select body of young men who earnestly compete for this prize. The scholarship can fairly be called one of the most important educational factors in the professional life of this country.



PALAZZO DAVANZATI, FLORENCE

### Volume on Landscape Architecture in Preparation

Prof. Elwood of Ohio State University Seeks Co-operation of the Profession

For many years there has been a decided need for a rather elaborate pictorial representation of the best work that has been done and is being done in the United States along landscape architectural lines. With this in mind, Philip H. Elwood, Jr., professor in landscape architecture at Ohio State

complete or still in progress. Such photographs as are eligible are to be published in the proposed volume by the Architectural Book Publishing Co. of New York.

The work will cover a field that is now very inadequately photographed. No publication is available up to date that groups the illustrations in a professional way and gives full credit to the designer as will in every case be done in the forthcoming book. Communications may be addressed to Prof. Elwood.

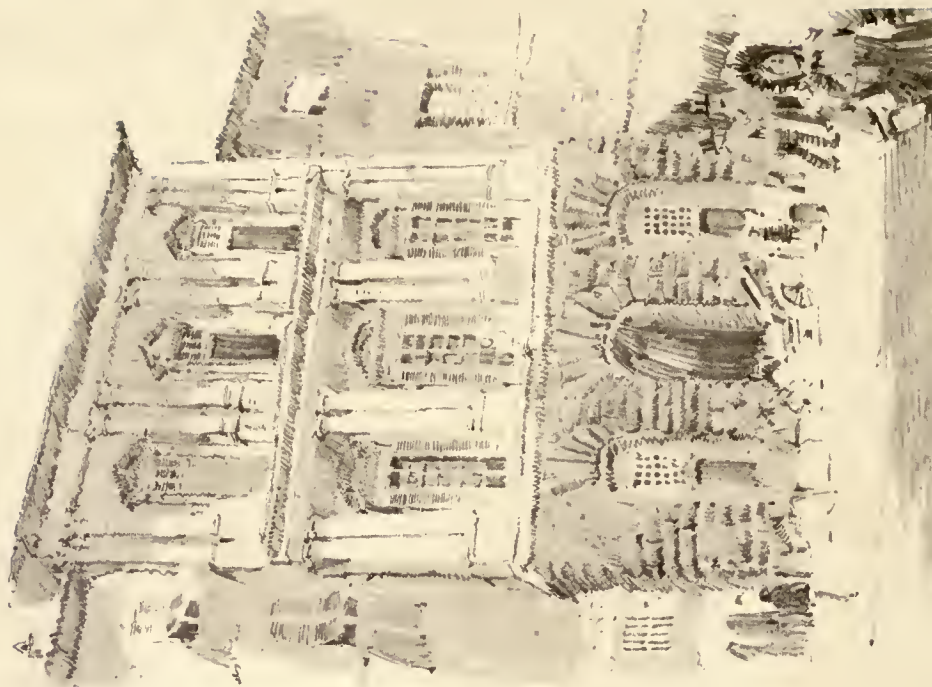

PALAZZO UGUCCIONI, FLORENCE  
FROM PENCIL SKETCHES BY JOSEPH MCGINNIS

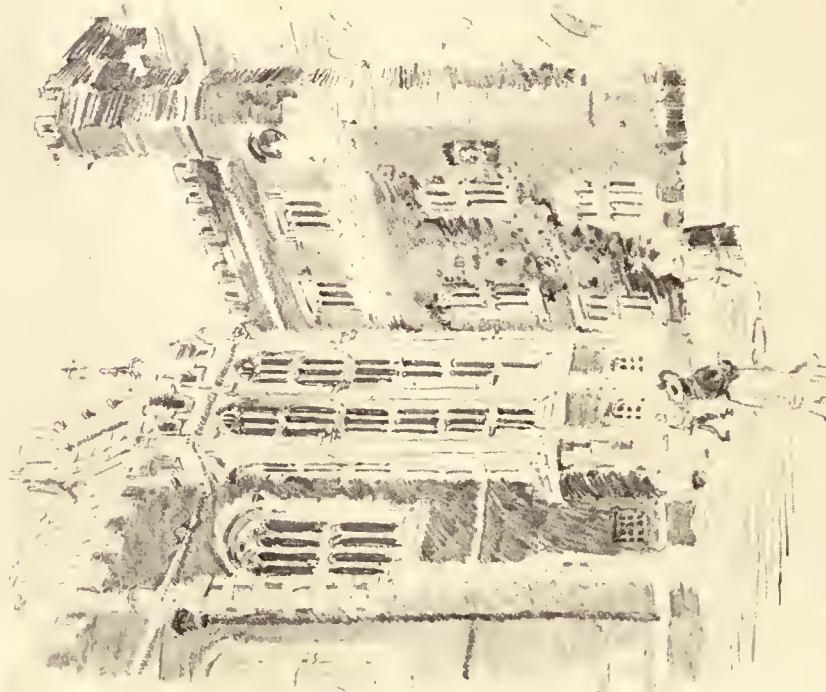

A QUADRANGLE, OXFORD



# Joseph McGinniss—1882-1919

## A Biographical Sketch

By C. H. BLACKALL, *F.A.I.A.*

**J**OSEPH MCGINNISS was born in Boston in 1882, studied at the Rice Training School, graduated at the English High School and studied architecture for three years at the Institute of Technology. He then took special problems at the Boston Architectural Club atelier, being employed meantime in the offices of Coolidge & Carlson, Codman & Despradelle, E. B. Stratton and Wheelwright & Haven. He entered the competition for the Rotch Traveling Scholarship in 1910 and won the prize with a most brilliant design for a Midway Station of the Boston Railroad Tunnel.

He went abroad and immediately began to send back some most interesting drawings which rank among the best the scholarship has ever received. He returned to Boston in 1912 and very shortly after that opened an office and was able immediately to command a very interesting and high practice. He built for the City of Boston an addition to the City Hospital, a number of infirmary buildings at Long Island and five different engine houses. He also built two of the city's schools, one in Dorchester and one in the North End, and he was called upon to build at different times four Catholic



CHURCH OF MADRE DE DIOS, BURGOS  
FROM A PENCIL SKETCH BY JOSEPH MCGINNISS

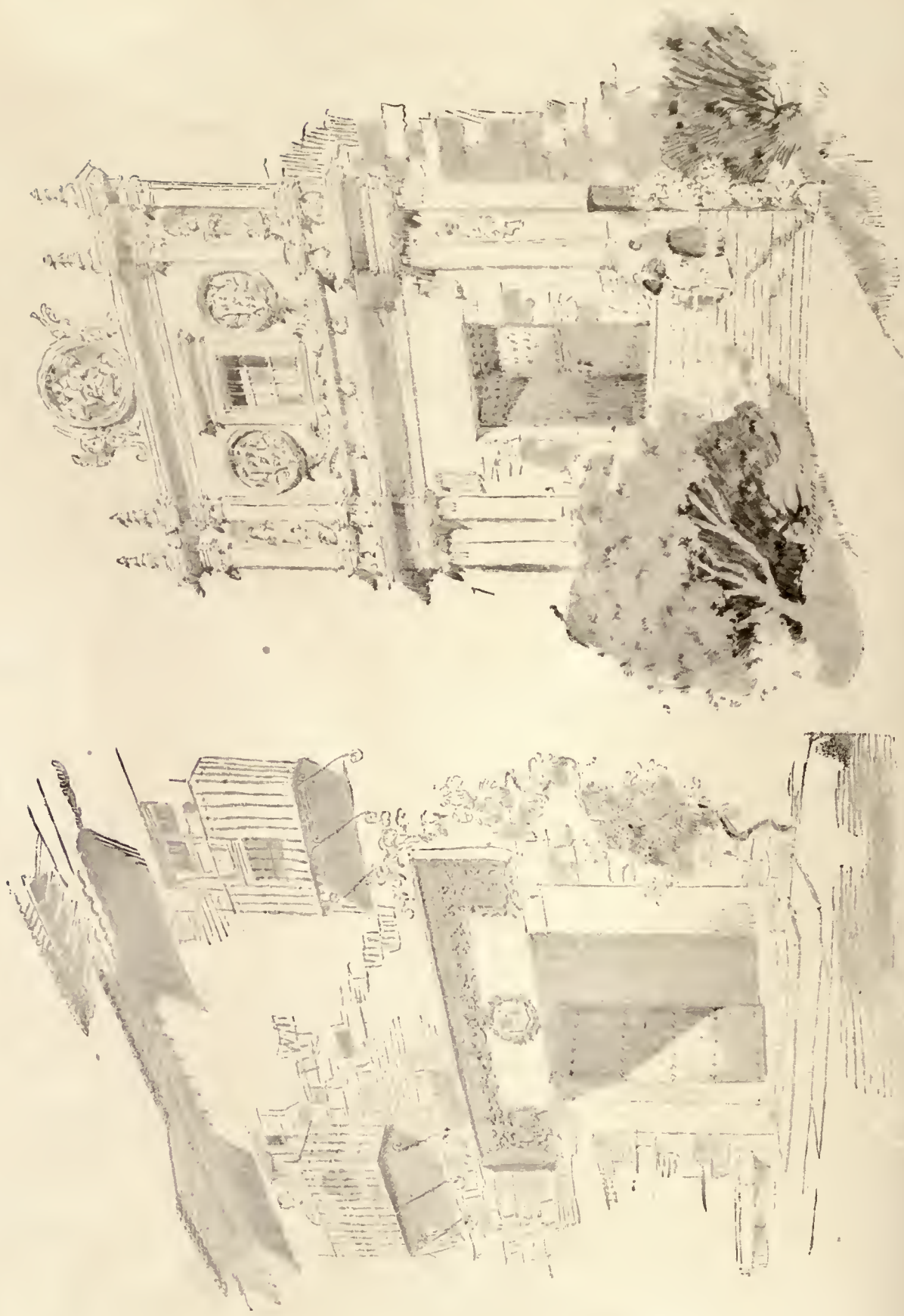

ARCHBISHOP'S PALACE, SALAMANCA  
FROM PENCIL SKETCHES BY JOSEPH MCGINNISS

AVILA

churches, one at Hull, one at East Milton, one at Wellesley and one at Cambridge, all of which came out very well and established his reputation as one of the brightest young architects in the city. His last and most prominent work was the Codman Square Theatre in Dorchester, which was begun in 1918. In the fall of that year he was attacked with the influenza, which rapidly developed into pneumonia, and both he, his wife and his very small child died within a few days of each other. He was buried in the church which he had designed and built in Wellesley, September 23, 1918.

**D**URING the nearly forty years of the Rotch Traveling Scholarship only two deaths have occurred. The first was Mr. Louis W. Pulsifer, who died very soon after his return and before he had demonstrated his business capacity. The second was Mr. McGinniss, who in a space of less than six years had built up a business of high character and had shown himself to be possessed of many of the essential qualities which go to make up the successful architect. His work is characterized throughout by most sincere, conscientious, faithful study. He gave everything his personal attention and most of his drawings were made with his own hand. He gave himself up so wholly to his profession that he had little time for associa-



tion with other architects, though he was known and his work admired by many and his death was a great loss to the profession in Boston.

The reproductions of the work he did while holder of the scholarship, which are presented in this issue of *THE AMERICAN ARCHITECT*, cannot wholly catch the spirit of the original drawings. The delicacy of touch in his pencil work, the sense of pictorial mass which he showed in his water colors, and his appreciative rendering of Spanish and Italian detail are most sympathetic and supply the imaginative quality which is so apt to be absent in our modern work. Of his more serious large drawings the reproductions can do but faint justice. The Giralda Tower of Seville is a drawing measuring several feet in height, drawn to a scale of  $\frac{1}{4}$ -inch equals a foot, and rendered in very full color with a brilliant sky, all of the Moorish details being very carefully and appropriately indicated. The interior of the church of San Clemente likewise can give but a slight idea of the elaboration of the original drawing. It is to a large scale and all of the elaborate and extremely interesting mosaics are shown in full color. In the house at Viterbo he

presented a lighter subject, but he showed his appreciation of the subject by the accessories, the two little perspectives in one corner, and the charmingly indicated medieval figures which give scale to the drawing. This is a  $\frac{1}{2}$ " scale drawing. Mr. McGinniss was very much impressed with the Spanish work and his drawings are most elaborate in their presentation, always in full color, and with an ever-recurrent evidence of his interest in the subject of the architecture. Note, for instance, the cavalier drawn in the corner of the pavilion of the Palace of Monterey at Salamanca, most interestingly indicated and just the right touch to show how thoroughly he enjoyed the Spanish spirit. But his work was by no means all chosen from this debatable field. The doorway from St. Peter's and the façade of the Palace of Versailles indicate how wideawake he was to the possibilities of combining expression and imagination with his envois. It should be explained that the regulations of the scholarship require each holder to send back three serious drawings every year of measured work of subjects approved by the committee, but the utmost liberty is allowed each man and he virtually made his own choice of subjects, so that whatever merit there is in the choice of drawings which Mr. McGinniss presented is wholly his.

FOUR examples are given of his water colors. Mr. McGinniss thought in color even when in monotone and these reproductions, while wholly failing to give any real color, certainly suggest most rich and lavish tones. How essentially Roman is the drawing of the Temple of Vesta with the ancient tower in the distance, and how full in color the whole composition seems to be; and in the charming sketch of the Porto Romano at Siena the sim-

plicity of the medium of the treatment lends itself to the delightful sense of color both of the wall and foreground and the bit of landscape through the open door. The original water color is a vivid contrast of rich burnt sienna and brilliant blues. His water colors were a joy to all who knew them intimately and one could not see them without envying the opportunities which Mr. McGinniss knew so well how to improve. Even the black and white reproduction of the Venice water color makes one feel the rich yellows and browns of the wall,

dark green of the foliage and the delicate blues and greens of the water.

His pencil sketches are no less a delight to the artist. It is interesting to consider that he had had very little experience in sketching or in the use of pencil before he went abroad and he developed his style almost at once, these charming bits of crisp, picturesque black and white, including samples from his first as well as from his last year; and that he should so cleverly catch the spirit of the half timber work in Normandy, or the delicate elaboration of the Spanish work, or the massive qualities of the Florentine and Roman palaces, is pretty good evidence how thoroughly he knew just what he wanted to find and managed to put it on

paper. We in the profession to-day are far too prone to include the pictorial side of architecture. Photographs and photographic reproductions have cut out a very considerable portion of the imaginative element from design, and it is well for the busy practitioner sometimes to study work just like this of Mr. McGinniss' and see how effectively he draws, how appreciatively he masses his lights and shadows and what a keen sense he has of the picturesque. His death was untimely. Had he lived there is reason to feel that he would have won the highest position in the profession.



SAN CLEMENTE, ROME  
FROM A DRAWING BY JOSEPH McGINNISS



## The Old Order Changeth

MANY architects in England are fearful that the proposed high buildings which will soon rear their bulk in London will so dwarf the many beautiful Christopher Wren churches as to decrease their artistic effect through the inevitable loss of scale. As one man writes, "there is no more beautiful sight in the world than to sail up London's river and behold these beautiful spires dominated by the dome of St. Paul's."

It is difficult to advance an argument that would find listening ears, urging a reconsideration of the building of tall structures. Trade and commerce must first be served in these practical days. Speculative building must needs have its way. The golden guinea has greater allurements than the gilded spires of Sir Christopher Wren. So then, these "finger posts that point the road to heaven," will soon be hidden from the general view. Where once in all their stately beauty they dominated their locations, they soon will by their towering neighbors be shrunken to pigmy proportions. The pity of it. In view of the world-mad attitude toward money and its acquisition, no man will be able to protest to a degree that will earn him a patient hearing.

MEN born in New York, or whose residence in the city dates from the early 70's, will recall when the district south of Canal Street presented a comparatively even cornice line of what would now be considered low buildings. In its quaint enclosure, where now is reared the Equitable Building, stood the old meeting house where during the Revolutionary War the British Dragoons stabled their horses and defiled a sanctuary. At the head of Wall Street stood and yet stands Trinity Church, and but a few short blocks north, the venerable St. Paul's.

In those days of forty years and more ago, the spires of these churches afforded points of observation to which the city man conducted his country cousins, for a wide and comprehensive view of Manhattan Island and its environs. It was a sight once seen, never to be forgotten, when on a bright Summer's day one might view from Trinity's spire

the long stretch of the Hudson River front, now the Riverside Drive, clothed in great masses of green foliage, or the shorter expanse of the East River and the "Sound," with its blue waters sparkling in the sun. Central Park then, did not as now, show a parallelogram of green on a dreary expanse of brick and mortar. The actual detection of its boundaries became difficult as it was merged in the foliage of trees that lined the city streets or that large area, now crowded thick with apartment houses, where tall trees of large girth and great age formed groves through which the New York man and his family walked on Sundays and holidays. All these things could be seen from Trinity's or St. Paul's tall spires. All this is now changed.

Trinity, like the truth it typifies, lies at the bottom of a well of brick and mortar. It is only that its spacious churchyard acts as a barrier to further encroachment, that it has not been completely submerged. Does anyone doubt that eventually this fine old church and perhaps its chapel of St. Paul's will meet an end by removal or rebuilding on a less restricted site? We shall be told it is sentiment to indulge in such regrets as the passing of the isolated dignity of these noble structures. Viewed in the light of modern opinion it may be. But to the man born in New York who venerates its traditions and in whom respect for these old churches is a part of his creed, all the thrills he may feel when as returning from abroad he views the towering masses of lower Manhattan, will not compensate for the passing of the dignity of location that once was Trinity's and St. Paul's and other venerated and good architectural churches.

So then, it is possible to read with fine understanding the expression of regret by the Londoner when he regards the possibility of a similar fate overtaking that wonderful group of churches, each a masterpiece, by Sir Christopher Wren.

"Old fogeyism," we shall be told. "Blocking the path of progress" and other reproaches will be made. Perhaps it is so, but sometimes it is wished that we could be spared the spectacle of such degradation and that it might be postponed until after we were

gone. Selfish—it may be. What's the use? "The old order changeth," but some of us do not.

### Labor Plays at Cross Purposes

**A**N anomalous, if not an amusing, condition is created by the announced intention of the New York Building Trades Employers' Association to grant, effective as on May 1, a wage increase of one dollar per day. This makes the new scale \$9 per day for blacksmiths, boiler-makers, carpenters, framers, cement and concrete masons, and many other departments of the building trade. It does not, however, apply on the wage scale of bricklayers, now receiving \$10 per day.

The amusing and contradictory feature is to be found in the fact that on the day this raise was made public (April 24) a parade of New Yorkers, attired in overalls and old clothes as a protest against the ever-mounting cost of clothing, was being held. Of the 115,000 mechanics whose daily wages were augmented by this increase, there were undoubtedly a large number who took part in this parade. On May 1 there was started a tenants' strike against the landlords as protest against unreasonable advance in rents. Probably a goodly proportion of these "wage-boosted building mechanics" were also active in this movement. Further, the ever-restless and always grasping clothing trades employes have presented a demand to the manufacturers asking for increased wages and decreased production.

Contemplation of these conditions excite the risibilities at the same time they provoke the most just adverse criticism. Could anyone imagine a situation more filled with inconsistencies?

It is but a few months ago since it was announced that by a special agreement between labor and the employers, there was insured peace in the building trades for the next two years at least. A provision in this agreement called for an advance in wages if

the cost of living could be demonstrated to have advanced. This demonstration has been so very easy that the employers carefully standing by their agreement have announced the one dollar per day increase.

At the outset of this agreement a flat rate of \$8 per day was fixed in all branches of the trade. To this rate the bricklayers refused to agree, claiming their occupation was one where working days were controlled by weather conditions and they—the bricklayers—refused to join with the Building Trades Council in its agreement with the Building Trades Employers' Association. Here there was created an impasse. With the bricklayers refusing to work for \$8 a day, the entire building trade was for a considerable period tied up. Finally a committee headed by the Mayor, acting as arbitrator, effected an agreement and the bricklayers went back to work on a \$10 a day basis.

One might feel reasonably sure that the way had been made clear for a peaceful resumption of long-delayed building operations. But hope seems futile, as now it is learned that lesser paid mechanics are claiming discrimination. They are threatening trouble. Could anything be more unreasonable? It even arrives at the point of becoming ludicrous.

In these squabbles and in their final adjustment, the ultimate consumer—the building owner—as usual bears the burden. Work of major importance is to-day conducted on the basis of cost-plus contracts. This extra \$1 per day conservatively figured as representing a total of \$700,000 a week must be paid by the client, or owner. Unless there is a fixed fee arrangement it will represent an added profit to the contractor.

Does labor see the inconsistency of its objections to high rents, high cost of daily living, and all the "high" ills that now affect us, in its attitude toward its daily wage? It would not appear that it did.



SCENE FROM SHERIDAN'S "THE RIVALS"

PRODUCED BY THE DRAMA DEPARTMENT, SCHOOL OF APPLIED ARTS, CARNEGIE INSTITUTE OF TECHNOLOGY. DESIGN BY WOODMAN THOMPSON. NOTE THE PORTABLE FOOTLIGHT TROUGH AND ABSENCE OF APRON. THIS PHOTOGRAPH WAS NOT TAKEN BY NORMAL STAGE LIGHTING, HENCE THE LATERAL SHADOWS

## Stage Design in Communal Buildings

By GEORGE M. P. BAIRD

### II

#### CONSTRUCTION AND EQUIPMENT

THE scope of these papers is too limited to permit discussion of auditoria in communal buildings except in so far as they directly contribute to or modify the dramatic craftsman's work on stage. The technology of optics, acoustics, ventilation, heating and safety in the region outside the proscenium wall are fully covered in easily procured texts and need no exposition here. It goes without saying that the audience must have a feeling of comfort and security if it is to enjoy the performance on the stage, and that no pains should be spared to insure this result.

The auditorium must be planned so that the words of the actors may be heard and that a good view of the stage may be had from any seat. This is the only imperative limitation of size. The unfortunate association of the word "little" with the art-theatre has led to many a stupid blunder and unnecessary reduction in capacity. The littleness of the pioneer art-theatres was dictated by economic and legal considerations and not by any ambition to be tiny. They succeeded not because they were small, but in spite of that misfortune. It is folly to perpetuate limitations when a reason for them no longer obtains. Intimacy there must be, but intimacy does not mean constriction. It is

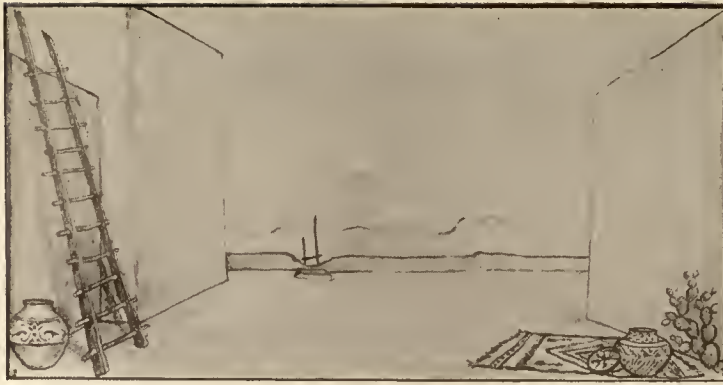

SIMPLICITY IN MODERN STAGE SETTING

Sketch of setting for author's production of "Mirage" at the University of Pittsburgh. Scene—roof of Hopi pueblo. Materials—blue horizon, adobe-colored screens and floor-cloth and characteristic properties. The illusion of distance and the atmospheric effects in a desert country were secured by the magic of manipulated lighting

achieved by design and internal proportion, calculated decoration and effective illumination, rather than by cramping. The ideal auditorium is one in which the maximum number of people can be comfortably accommodated and in which no individual is deprived of his right to see and hear all that transpires within the frame of the proscenium arch.

Decoration should be as chaste and simple as possible and innocent of the wedding-cake or stove-front atrocities in design so dear to the heart of the commercial theatre. The color scheme should be restful and harmonious; the illumination ample but diffused and free from hard points of light. Ornate mouldings and elaborate orders should not be used to define the proscenium opening. It should have just sufficient differentiation to mark it as the focus of interest and to arouse a pleasant feeling of anticipation and curiosity in the mind of the audience pending the rise of the curtain. The curtain may be made the dominant color note of the room, but it should be devoid of the pseudo-murals, and painted draperies all too frequently displayed. Let the architect and the decorator bear in mind that the auditorium is the servant and the hand-maid of the stage, and that she must wear no garment and make no boast which will detract from the interest and beauty of her regal mistress.

The Stage

To most people, the term *stage* means that part of the theatre which is visible to them through the proscenium arch and upon which the action of the play takes place. This is an unfortunate misconception and is responsible, no

doubt, for much of the prevalent bad design. The true stage is from four to five times larger than the central, visible portion or *playing stage*, and includes, in addition to it, the unseen *wings* to right and left and the invisible *flies* above. Roughly the *wings*, taken together, are equal to the central playing stage, while the *flies*, which extend over the central portion and the *wings*, rise above them for a distance equal to twice the height of the proscenium arch plus an amount sufficient to permit idle scenery to be raised beyond the view of spectators seated in the front row of the auditorium. Since, in general, the dimensions of the stage are fixed in relation to those of the proscenium opening, the determination of the latter is the first point to be considered in any plan.

Mr. Claude B. Hage, construction engineer for the Century Theatre of New York City, has evolved a scheme of relative dimensions based upon the number *seven* and its multiples. The following tabular presentation of his idea is abstracted from a recent article by Mr. Irving Pichel.<sup>2</sup>

Proscenium height	7 feet less than width	
Proscenium width	28	35 421
Height of Loft	56	63 79 to 84
Width of Stage	42	56 70
Depth of Stage	21	28 35 to 42

This is fairly representative of commercial theatre practice, but requires modification to fit the needs of an art-stage. Thirty-five feet<sup>3</sup> is an excellent width for the stage of a communal building

<sup>2</sup> Theatre Arts Magazine, Jan. 1920, page 36.

<sup>3</sup> An opening less than 20 (wide) x 14 (high) will throw the human figure out of scale.



REALISM BY SUGGESTION ON THE ART STAGE

Sketch of setting for author's production of "The Terrible Meek" by Charles Rann Kennedy, at the University of Pittsburgh. Rock-work and crosses modeled in the round



550



FROM A DRAWING BY JOSEPH MCGINNISS

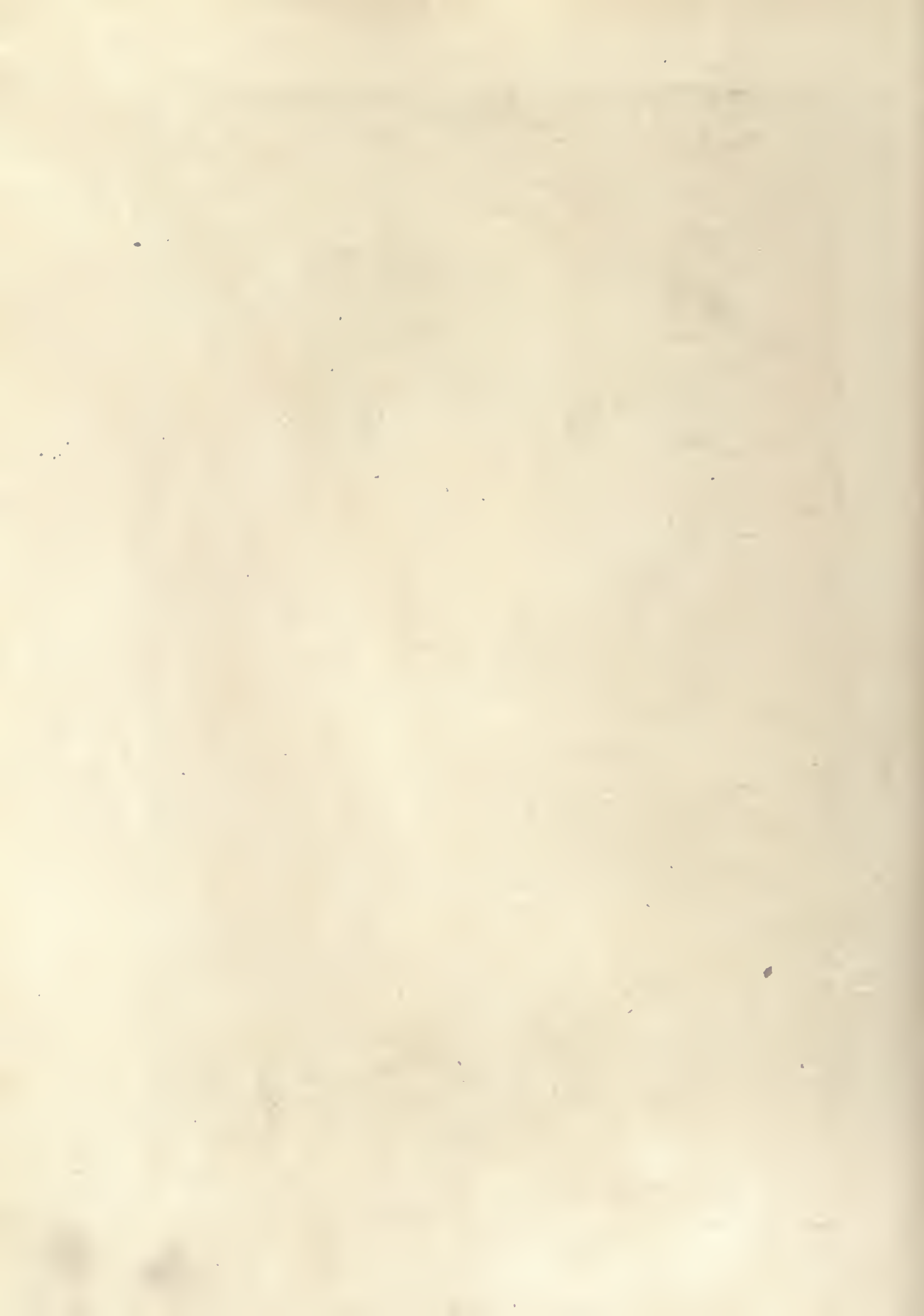

350<sup>2</sup>



BOBOLI GARDENS, FLORENCE  
FROM A WATER-COLOR BY JOSEPH MCGINNISS



230



TEMPLE OF VESTA, ROME  
FROM A WATER-COLOR BY JOSEPH McGINNISS



5504



PORTA ROMANA, SIENA  
FROM A WATER-COLOR BY JOSEPH MCGINNISS





53-05



*Joseph McGinniss*  
ENVOI OF THE ROTON TRAVELLING SCHOLARSHIP.

FROM A DRAWING BY JOSEPH MCGINNISS



550



FROM A DRAWING BY JOSEPH MCGINNISS



550



FROM A DRAWING BY JOSEPH MCGINNISS





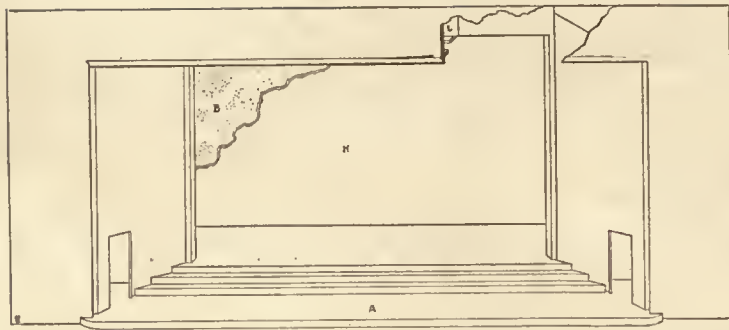

STAGE—FIGURE 3

a. Fore-stage; b. Fire curtain; h. Horizontal; l. Proscenium hood.

sheet metal over a steel or iron frame), suspended from steel cables, and moving in snug metal *smoke-grooves* which are set not less than eighteen inches to right and left of the arch. The curtain may be counter-weighted and operated by means of a hand-line, but the use of an electric winch is to be preferred.<sup>4</sup> Radiators, pipe lines, etc., should be bracketed high enough on the side walls to permit the stacking of scenery.

*Floor*

The stage floor is level and of pine or other soft wood; the *screw-pegs* required to fasten scenery and *stage-braces* can not be used in maple or oak. It is a good plan to build the floor in easily handled, movable sections to provide for the use of *traps* called for in the action of certain plays.<sup>5</sup> Where space for the storage of scenery, properties and portable equipment is not available on the stage level, the floor girders can be located to permit such materials to be lowered into the cellarage. Metal stairs to the stage cellar should be placed at the extreme right and left and as near the front as is practicable.

The stage floor should be about three feet above that of the auditorium floor, but may be somewhat higher when the latter has no pitch. The stage should not extend beyond the proscenium wall to form an *apron*. This construction is an unnecessary relic of the past.

A *light-pit* should be provided close to and parallel with the rear wall. It is a kind of trench, 3 to 4 feet wide, 3 feet deep and slightly longer than the width of the central *playing stage*.<sup>6</sup>

<sup>4</sup> For detailed specifications, see "Theatres & Picture Houses"—Melay, p. 31.

<sup>5</sup> Examples—Hamlet, Act V, Scene I, Strindberg's "Kronbruden," 6th Scene. Kamban's "Hadda Padda," Act IV.

<sup>6</sup> Purpose of light pit is explained under "illumination."

*Flies & Loft*

The *rigging loft* or *gridiron* is a skeletal platform located above the stage floor at a height equal to twice the height of the proscenium arch plus from 5 to 8 feet. There should be sufficient head-room between it and the stage roof to permit adjustment of its blocks and sheaves over which pass the lines from which scenery is hung. In commercial theatres and in the more pretentious art-theatres, the power arms of these lines are lashed to *pin-rails* situated on the *fly-galleries* which run along the side walls. The

modest stage of the school or community building does not need these galleries and may have its pin-rails bolted to the side walls at a convenient height.

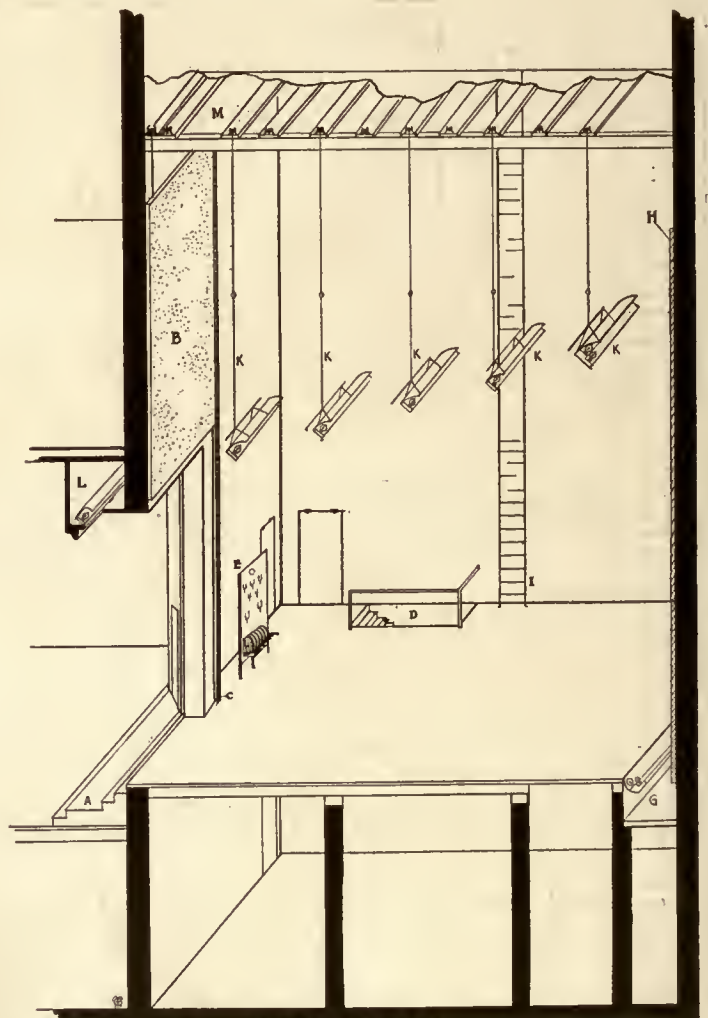

STAGE—FIGURE 2.

SECTION OF COMMUNAL STAGE

a. Fore-stage; b. Fire curtain; c. Smoke groove; d. Stairs to cellar; e. Switchboard and dimmers; g. Light pit; h. Horizontal; i. Ladder to gridiron; k. Border lights; l. Proscenium hood; m. Rigging loft (gridiron).



The roof should be provided with sky-lights, ventilators and automatic sprinkler system.<sup>7</sup> A steel ladder rises from the stage floor to the gridiron.

*Auxiliary Rooms.*

Special dressing-rooms, baths, wardrobe and property rooms, paint and carpenter shops are out of the question in the majority of communal buildings, but at least one room for the storage of scenery, properties, costumes and electrical supplies should be provided near or under the stage. The players can use the gymnasium, bath house, class rooms etc. as temporary dressing-rooms, provided that they do not have to traverse a main public corridor or

scenery in the round, screens, hangings etc., arranged with nice attention to composition, design and chiaroscuro) it succeeds in creating an illusion which contents and convinces. With a few yards of fabric, a stick or two, a flat blue *drop*, and a few colored lamps *in resistance*<sup>8</sup>, art-stage craftsmen like Maurice Browne or Sam Hume will make you a stage picture infinitely more interesting, veracious and soul-satisfying than the most costly spectacle of Sir Herbert Beerbohm Tree or the most extravagant production of the meticulous Belasco. Of all the mechanical forces at the producer's command, lighting is easily the most important, and it is the business of the architect to provide the stages which

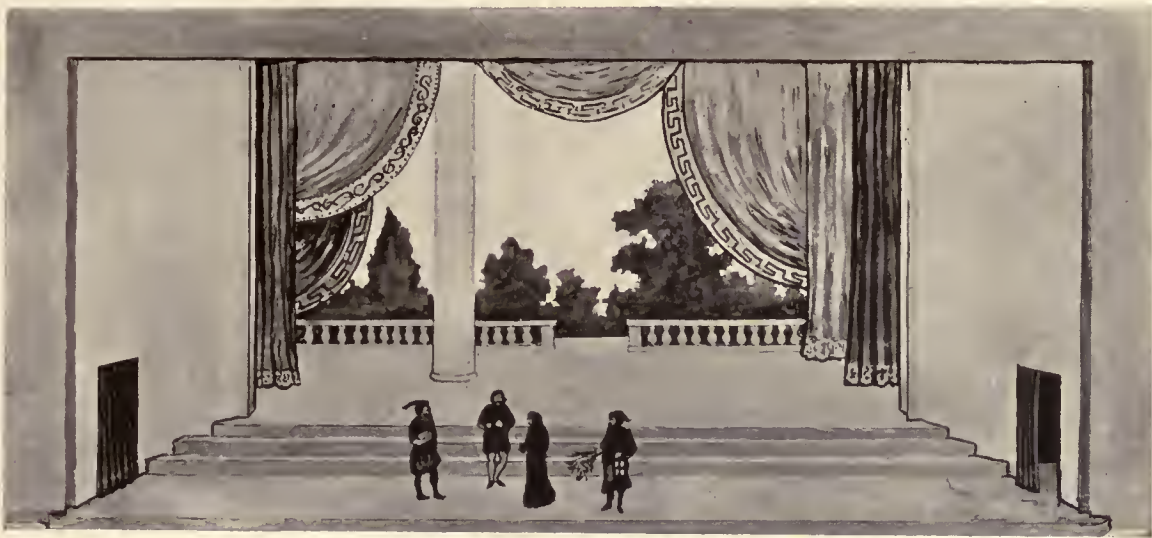

STAGE—FIGURE 3 A.  
FORE-STAGE AS USED FOR PROLOGUE

the auditorium in order to gain the stage. In schools or settlements which have manual training departments, the matter of a workshop is not a problem, and in other buildings the basement may be used for the construction of scenery and props. Painting is usually done on the stage proper.

*Illumination*

THE traditional theatre got its effects by the use of elaborately built and painted scenery which was either palpably artificial or too physically naturalistic to be psychologically and artistically true. The art-stage avoids such costly trappings and creates in their stead an *inscenerung* which is economical, plastic, appropriate and, in the best sense, realistic. By the carefully studied application of light to planes and solids (simple

he designs with the equipment essential to an efficient use of this most facile and subtle instrument. The equipment should include: *borders, pit-trough, floor pockets, proscenium hood* and, if desired, *foot lights*, all controlled from a central switch-board and furnished with proper *resistance*<sup>8</sup>.

*Borders* are galvanized iron troughs, suspended from the gridiron in adjustable cradles and provided with lamps (wired in three circuits<sup>9</sup>) and trained to cast light downward and backward upon the stage. They are hung parallel to the curtain line at intervals of 7 feet and are somewhat longer than the width of the proscenium arch. The border trough nearest to the rear wall should have a double row of lamps. A duplicate of this member (trained to cast light upward and backward) is placed in the

<sup>8</sup> Dimmers, which see.

<sup>9</sup> For 3 colors, white, amber and blue. Lamps, 60 watt tungsten, set 4 to running foot in single row border.

<sup>7</sup> For details, see Rules of Nat'l Board of Fire Underwriters.

light pit, the two being used to produce the illusion of *plein air* and distance by the reflection of their light from a tightly stretched cloth of white or blue<sup>30</sup> which is hung against the rear wall.

The *proscenium hood* is a double border (or a row of unit lamps), trained to light the front of the stage, and concealed from the audience by an architectural feature, located at the top of the proscenium opening and on the auditorium side of the proscenium wall.

Foot lights are largely *passé* on the art stage, but if desired, they should be of the disappearing type. A portable trough (molded to harmonize with the trim of the arch) which may be laid upon the stage when needed, is more serviceable and less costly to maintain than a permanent installation.

Floor pockets of approved design should be placed off-stage to right and left. Portable lighting equipment (such as flood and baby spot lights) and the lines required in the setting of a scene (fires, table lamps, etc.) are plugged into these pockets as required. There is no need for arc pockets as the powerful nitrogen bulb can be used in *spots* instead of the old-time arc lamp.

A switch-board of dead face type is situated off-stage right, parallel with and about three feet from the proscenium wall. All circuits of the stage and auditorium except emergency ones (i. e., exit and safety lights) are controlled by a master-switch and sub switches arranged in gangs on this board. Close at hand is the *dimmer bank* made up of a series of resistance plates actuated by individual levers and a master lever. Without dimmers good stage lighting is utterly impossible, since the adjustment of intensities and the mixing of colors depends upon them. Each dimmer plate must have 80 or more steps (gradations of resistance); a smaller number causes the lights to "jump" unpleasantly and prevents the gradual realistic progression from darkness to day or the reverse. There should be at least one dimmer plate for each of the three colors used, one or two for portable lights, and one for the auditorium.

#### Scenery.

While scenery is hardly within the province of the architect, it may be that he will find himself compelled to provide or suggest it in sheer self-defense, since the whole effect of his labors may be ruined by the gaudy stage dress provided by the unrestrained genius of the local scenic studio. In such event he will, of course, consult with a competent art-stage technician and be guided by his suggestions. A *multiple* or *permanent* setting, such as that designed by Sam Hume for the Arts and Crafts

<sup>30</sup>. This cloth is variously known as sky-sheet, cyclorama, horizon, back-drop, etc. See Moderwell's "Theatre of Today", Chap. VI.

Theatre of Detroit might prove to be one useful solution of the problem. In any event, the architect should see that the large *horizont* or back-drop is properly installed and that one or two sets of draperies are provided for backgrounds in non-dramatic performances such as lectures and concerts. He should also arrange for the proper mechanical fixtures on the fabric curtain (*act drop*) which hangs just inside the proscenium (fire) curtain.

The writer regrets the necessarily fragmentary and sketchy character of these papers, but trusts that they may be of some little service to architects and others interested in the design of communal buildings. A brief bibliography of useful and suggestive books and articles upon the subject is appended to this article.

#### BIBLIOGRAPHY

- Some books of value to designers of communal stages.
- Adler, Hazel H. *The New Interior*. Century Co. N. Y., 1917. *Suggestive discussion of auditoria for art-theatres.*
- Anonymous. *The Truth About the Theatre*. Stewart & Kidd, Cincinnati, 1918. *Indictment of commercial theatre in America.*
- Atkinson, Frank H. *Scene Painting*. F. J. Drake & Co., Chicago, 1916. "*Commercial*" *Use with great caution.*
- Bakshy, Alexander. *The Path of the Modern Russian Stage*. Cecil, Palmer & Hayward, London.
- Beegle & Crawford. *Community Drama & Pageantry*. Yale Press, 1916.
- Bragdon, Claude. *Projective Ornament*. Manas Press, Rochester, 1917. *Lighting in stage decoration.*
- Burleigh, Louise. *The Community Theatre*. Little, Brown & Co. Boston, 1917.
- Carter, Huntley. *The Theatre of Max Reinhardt*. Mitchell Kennerley, N. Y., 1917. *Much valuable information on structure and equipment of European Theatres.*
- Clark, Barrett H. *How to Produce Amateur Plays*. Little, Brown & Co., Boston, 1917. *Excellent elementary treatise.*
- Craig, Gordon. *On the Art of the Theatre Toward a New Theatre*. The Theatre Advancing. Little, Brown & Co. Boston. *Craig is the great pioneer of the art-theatre.*

- Cheney, Sheldon. The New Movement in the Theatre. *Mitchell Kennerly*, 1914.  
The Art Theatre, *Knopf, N. Y.*, 1917.  
*Very good. Second only to Moderwell's "Theatre of Today"*.
- Chubb, Percival. Festivals & Plays. *Harper & Bros., N. Y.*, 1912.
- Eaton, Walter P. Acting and the New Stagecraft. *Theatre Arts Magazine*, pp. 9-12, Nov., 1916.
- Hunt, Elizabeth R. The Play of Today. *John Lane Co., N. Y.*, 1913.
- Kinsila, Edw. B. Modern Theatre Construction. *Moving Picture World Co. N. Y. Equipment & Lighting. Use with caution.*
- Krows, Arthur E. Play Producing in America. *Henry Holt & Co.*, 1916. *Much useful information badly arranged.*
- Matthews, Brander. A Book About the Theatre. *Chas. Scribner's Sons, N. Y.*, 1916. *Historical, curious, euphoric.*
- Meloy, Arthur S. Theatres & Picture Houses. *Architects' Supply & Pub. Co.*, 1916. *"Commercial" Use with caution.*
- \*\*Moderwell, Hiram Kelly. The Theatre of Today. *John Lane Co., N. Y.*, 1914. *Easily the best work in English covering the whole field of modern drama and its technique of presentation.*
- Pichel, Irving. Stage Construction for Small Theatres. *Theatre Arts Mag.*, pp. 24-40, Jan., 1920. *This article should be in the files of all architects of communal buildings. Up-to-date and practical.*
- Rolland, Romain. The People's Theatre. *Henry Holt, N. Y.*, 1918.
- Sabine, Wallace C. Theatre Acoustics. *American Architect*, Dec. 31, 1913.
- Taylor, Emerson. Practical Stage Directing for Amateurs. *E. P. Dutton, N. Y.*, 1916.
- Withington, Robert. English Pageantry. *Harvard Press, Cambridge*, 1916.

## An Indigenous Architecture

By GEORGE W. MAHER, F.A.I.A.

THE articles that have appeared in the Illinois Society Monthly Bulletin have suggested that no movement of any permanent importance can evolve and properly mature unless founded upon certain fundamental principles related to environment surrounding life and progress.

"The Chicago School" or "Movement," as well as other distinct Chicago achievements, received its original impetus from the adventurous spirit of the early pioneer. The "I will" spirit of this great metropolis of the west is indigenous; it is a Chicago product of energy inherited from the early struggle for existence, a power that is generally known and given full recognition.

The upbuilding of Chicago after the great fire was one of the first evidences of this indomitable spirit. Although the heart of the city was stricken and complete cessation of business life was occasioned, yet a new and greater city arose from the ashes of the old with remarkable rapidity and of permanent character so that in a very short space of time the city was normal in its life. These evidences of vital, unconquerable will challenged the admiration of the entire country and the world. As another evidence of the "I will" spirit of this great metropolis attention may be directed to perhaps the greatest effort that has ever been performed by any city in the world embodying the complete powers of

visualization, organization, construction and art, weaving them together in a masterly manner into the greatest exposition that has been erected by man.

The World's Columbian Exposition was the artistic triumph of the age and has been given due recognition. It is not my purpose to call special attention to these accomplishments but to endeavor to bring to the mind the force of the statement that I have suggested in regard to this progressive creative spirit of Chicago which dates from its birth.

"THE CHICAGO SCHOOL" of building was first expressed in a noteworthy way at the World's Columbian Exposition. This effort was the creation of the Transportation Building by Louis H. Sullivan, the architect. Here was an expression in art and architecture entirely new. The attention and interest of the traveler from abroad in viewing this art product of the great Fair was immediately challenged; here was evidence of progress in architecture.

This building was, perhaps, the most remarkable in the splendid group of edifices. It not only expressed in plan, design and ornament the purpose for which it was constructed, but also brought to the minds of those who visited the great Fair a new vision of the possibilities of the use of materials,

## THE AMERICAN ARCHITECT

construction, art and architecture blended together in an original creation.

This building was prompted by the spirit of the west, and therefore indigenous, being related by inception and execution to this locality.

This splendid conception should be resurrected and replaced again in all of its original glory of design, of color and art for the purpose of accommodating great national gatherings and impressing them with the possibilities of American creative genius.

"The Chicago School" in design was, therefore, as auspicious in its beginning as that of any art movement in any country and no doubt was the inspiration that encouraged other minds to seek a new expression in their work. It, therefore, can be stated that "The Chicago School" dates its outward expression of note in the year 1893. It has progressed consistently from this time, ever growing in importance as recruits of independent minds have added their interest and influence to the movement. The work of this widening group of men has not been of an organized nature, nor do the examples of the work of each correspond in general theme. There have not been as yet any text books written or any art or architectural schools or lecture courses instituted to stimulate the interest of the student in this particular creative work. There are few professors as yet who are qualified to crystallize into practice this expression of an indigenous art. It is recognized by the men who constitute this group that no one should presume to design in creative work who is not well grounded in the theory of precedent architecture, also a knowledge of the historic art of the great past, since no art movement of forward tendency can be adequately evolved that is not founded upon the spirit of past achievement.

It is, however, very evident in the work of this group of architects that progress must not be hindered by precedent no matter what the sacrifice may entail. That environment and the life of a people must be considered first in all of its phases of development and that this inspiration be given full expression.

"The Chicago School" as one of its principles recognizes the engineering features of building as being of importance and that the great themes of

modern construction be emphasized in all of their daring, soaring grandeur not concealed or camouflaged by conventional methods of design of another age but that the masonry, steel or concrete be properly clothed and embellished with original features and ornament inspired by a knowledge of the needs of the situation. Bountiful nature is drawn upon to beautify and ennoble the varied structural forms thus taking inspiration directly from that which springs from the soil.

THE special room at the Annual Exhibition of the Chicago Architectural Exhibit held at the Art Institute of Chicago April 6th to May 5th, 1920, displays the work of this school and the extent of its wide and varied influence. This exhibit includes all types of work from the smallest hamlet to the great modern public building; homes, office buildings, bank buildings, gymnasiums, pavilions, theatres and college buildings, churches, town planning, landscape work, sculpture, modeling, stained glass, decorations and general designs.

This exhibit perhaps displays a broader range of effort in plan and design than any exhibit held in Chicago or elsewhere. In studying the exhibit it is interesting to note the openness and freedom of mind that seems to prevail and possess the respective architect in the solution of his problem and the directness with which he meets the situation, whether it be a residence, bank, theatre or great public building. The respective groups are as individual and free as the term indigenous implies, each architect working out his particular problem without fear or the thought of praise or blame, ever influenced by the spirit of right, pride of country and the reverence for our common art. No greater educational propaganda could be suggested than that this entire exhibit be forwarded to various parts of the country where it may be viewed and explained to the general public.

The principles underlying this work are akin to the ideals of America and represent in a tangible way the spirit of a democracy, working through the minds of the men who have created this work.

These examples are indigenous since they spring from the soil and the people.

# Current News

---

## Happenings and Comment in the Fields of Architecture and the Allied Arts

### Building Material Still Remains a Non-Essential

(By Special Correspondence to THE AMERICAN ARCHITECT)

CHICAGO:—The National Federation of Construction Industries, including material men, contractors, architects, engineers, bankers and representatives of all lines of construction work, at the first annual meeting held at the Hotel Sherman, adopted resolutions calling upon the railroads of the country to remove the "non-essential" classification from building material and allow the nation to overcome the present housing shortage.

Speakers at the meeting pointed out that the shortage in homes as well as in commercial structures is due to a large extent to transportation restrictions and inability of builders to get materials moved over the railways. The demand was voiced that building materials be placed on the preferred list for transportation, the same as food products. It was explained that a crisis in building faces the nation.

### Building Conditions in Salvador

Not only school buildings but cheap houses for workmen are much needed in Salvador. Public-spirited men of wealth are putting up improved dwellings for the working classes and the Government plans to co-operate in work of this character and to repair the more important buildings damaged by the earthquake.

Studies and experiments in the construction of earthquake-proof buildings have naturally resulted from the not-infrequent damage or destruction of Salvadorean cities and villages by the eruption of volcanoes. An architect in San Salvador supplies the following observations on this subject:

"San Salvador, like all Latin American cities, was originally constructed after the Spanish colonial type, the buildings having heavy stone walls formed of stones and clay taken from river beds and other stony places. Lime was little used on account of the difficulty of procuring it from the only deposits, near Metapan in the Department of Santa Ana.

"In March, 1893, repeated earthquakes almost destroyed the capital, leaving only a few structures standing, among these the cathedral, a bank building, the national palace, and a few small buildings in which lime had been used in the walls. Many of the residents of the capital rebuilt their homes on higher ground, and this resulted in the growth of the suburb of New San Salvador or Santa Tecla. However, many other inhabitants remained in the capital, rebuilding their homes according to a construction system called the "bajareque," which has proved to be practically earthquake proof. This system consists of a framework of hardwood (of which there is an abundance in the country), plastered with mud or clay; most of the buildings are one story."

In November, 1899, the national palace was completely destroyed by fire, and five years later a new palace was

begun, which was finished in 1914. Its framework of iron and steel filled in with brick masonry was made in Belgium, and technical contractors from Europe came to direct the construction. It is now the finest building in the country. The national theatre was rebuilt a few years ago of reinforced cement, the building being artistic and satisfactory in every way.

An Italian architect introduced in Salvador a system of metal framework of beams and columns, filled in with hollow cement blocks. The School of Medicine is built on this plan, as are several other structures. Many buildings are of reinforced or trussed concrete construction, the materials having been imported chiefly from the United States. There is not a large market for lumber in Salvador as local timber fills most needs and is moderately priced. The lumber principally in demand is roof timber, heavy posts and flooring, the latter generally of cedar or other hardwood.

### Housing Problem Acute in Berlin

The territory which Germany has surrendered to Poland under the terms of the Versailles treaty is dumping thousands of homeless fugitives into already overcrowded Berlin, according to Dr. W. Laporte, municipal housing commissioner.

"Investigation has shown that in a single house seventy-nine persons were fugitives from Polish Germany. There are approximately 32,000 families seeking homes in Berlin. We have today only 320 apartments at our disposal," said Dr. Laporte.

The Berlin housing commission has proposed the immediate construction of 5,000 two-room apartments or huts to accommodate the families who are now exposed to disease, sleeping in cellars.

### Glasgow Foresaw Housing Shortage and Planned Ahead

The city of Glasgow tackled the housing problem long before it was made acute in Great Britain, America and France as a result of the war.

In fact, Glasgow started fifty years ago to tear down the old rookeries, put up new buildings and construct wider and better streets at a total cost of \$8,500,000.

A beginning was made by the erection of two model tenements and seven model lodging houses, six for men and one for women. The city put up stone buildings of from three to five stories in height. In each there is a large dining hall and abundant kitchen facilities. There is in each a big recreation room.

The seven lodging places can accommodate 2,235 persons. The charges vary from 8 to 12 cents a night.

An innovation was the erection of a "family home" in which rooms are let to workmen with motherless children. Servants look after the children while the father is away at work and see that those of school age go to school. The children are boarded for about 45 cents a

week. The room for the man and his family costs \$1.10 per week. Children beyond the number of three are given beds in the dormitory at an extra cost of 16 cents a week. The last reports showed that 122 men and 146 children were living in this home.

In all, the city has provided homes for 2,199 families. Apartments are rented by the city from \$25 to \$75 per annum to workingmen.

The city's manager for this property is W. C. Menzies, who in his younger days emigrated to America and worked for a time on public buildings in Cleveland. Later he worked on suburban residences in Cincinnati and Covington and later still in Chicago.

## Difficulties Encountered by Chicago Contractors

That the lack of transportation facilities and service are strangling building activities in many of the larger cities is typified in the experience of Chicago. The following quotation from the monthly *Bulletin* of The Illinois Society of Architects suggests some of the handicaps confronting the construction industry in the metropolis on Lake Michigan:

"Unless some way is speedily found to induce the railroads to handle construction materials building work will shortly cease.

"For several weeks Chicago contractors completing time jobs have been compelled to rely on auto truck deliveries almost exclusively, hauling cement from Gary, brick from Rogers Park, cement and sand from anywhere, paying in some cases as much as \$5 per yard for sand, \$3.50 for stone and \$3.45 for cement.

"Material dealers are refusing contracts for future deliveries. Contractors, therefore, do not know at the time of signing a contract what they may be compelled to later pay for some of the basic building materials. This state of affairs is reflected in recent contractors' bids which architects are noting are considerably higher than they were even thirty or sixty days ago.

"The uncertainty of the labor market is another factor causing careful bidders to play safe. The prospects are that in order to secure labor contractors will soon be paying a bonus to all branches of building trades. The factor, when added to the fact of the inevitable increase in the cost of materials which will come from a demand many times that of supply, will very soon make the completion of any project one of uncertainty, and the architect who will be able to secure the completion of any important structure within a time limit of three times that of pre-war conditions, or at apparently 300 per cent of pre-war costs, will be considered an organization genius. Building costs are advancing and will continue to advance for at least two or three years more."

## Germany Compelled to Refuse \$5,000,000 for Art

An offer of \$5,000,000 has been made by an American to the German Government for sections of the famous altar piece painted by Jan and Hubert Van Eyck, formerly in the Cathedral of St. Bavon, Ghent, and now in the Berlin Museum, says the *Tageblatt*.

It is said the Government cannot accept the offer, as the treasure must be returned to Belgium, under the terms of the Versailles treaty.

Germany, however, must pay the Hohenzollern family for this work of art as a part of the settlement for the taking over of royal holdings, the newspaper says.

## Texas to Have State-wide Campaign for Civic Beauty

A State-wide campaign for civic beauty has been started by Mrs. A. H. Abernathy, State chairman of civic art of the State Federation of Women's Clubs. She has issued the following proclamation:

"All club women and all others who really love Texas and care for its best development," she says, "are urged so to make their plans that they can help in an intensified campaign during the month of May to wake up every town in the State to the need of beautifying the community.

"In our national unity of purpose toward the true Americanization of all our people we find civic art taking its own place. National, State and city governments are coming to realize more keenly the value of beautiful communities. The more progressive towns of any size foster one or more civic improvement associations, each founded in the belief that restlessness and depression of spirit are aggravated by unpleasant surroundings, while beautiful cities make for happy, hopeful, ambitious and active citizens."

To every club or organization which consents to take part in the campaign is to be sent a plan of work as follows:

"Personnel of the director and co-workers of the campaign. It is important that the director and her chairmen of committees shall have a clear vision of what should be done; shall have patience, tact and a sense of humor; shall be willing to work, and shall be willing to subordinate personal opinions for the general good.

"Selection or appointment of a director in each town, and the appointment of the following committees:

"1. An ordinance prohibiting disfiguring signs and billboards, and its enforcement.

"2. Shade tree and shrub commission.

"3. Commission for general beautification of the community.

"4. Publicity, slogans, posters and other attractive means of getting the spirit of the campaign before the public.

"5. To devise ways and means for one or more trained speakers during the month of May.

"6. To conduct lantern slides exhibiting examples of civic beauty and public eyesores.

"7. To conduct an essay competition among high school pupils, the best one published.

"8. The most beautiful home and grounds contest.

"9. The most useful and orderly backyard contest.

"10. Parks and recreation facilities.

"11. Public buildings.

"12. Streets and highways.

"13. To stimulate the discussion of the following civic art needs in Texas, to further information about them and to work toward their ultimate accomplishment: A State art commission, a commission for civic art beautification in every community where there is a federated club, school civic art leagues, and the postponement of the erection of memorials until there are art commissions in Texas.

"14. To get reports from each committee of the plans for work, and send to the district chairman of civic art by May 10, and to make to the district chairman by June 10 a full report of all work accomplished in the campaign

"Understanding of the primary objective and of the ultimate objective.

"Study of methods to be used in campaign.

"Importance of follow-up work of the director.

"May we not in such work heed Ruskin's warning that it is not beauty which is expensive but ugliness which costs?"

## Profitable Use of Farm Woodlands

The forest lands held by farmers in the Southern States constitute a total of about 124,000,000 acres, which is more than one-third of all the farm lands in that section, says a recent *Farmer's Bulletin* of the Department of Agriculture. "It may surprise some to know that farm woodlands represent more than one-half of the entire forest land in the Southern States, including the great holdings of the lumber companies, and yield annually about \$94,000,000 worth of timber products. Of this amount nearly one-half is sold in the form of logs, other cut products, and as standing timber. The remainder is used on the farm."

To make farming pay better by showing the way to the more profitable marketing of farm timber is one of the principal objects of farm forestry. Some owners use timber that ought to be sold, while others sell timber that ought to be used on the farm. The foremost purpose of woodlands is to supply firewood, posts, rails, poles and rough building lumber for the maintenance and improvement of the farm. Millions of young pines which have been shaded out and have gone to waste in old field stands would have made fence posts and given ten to twenty years of service if they had been properly treated with creosote; on the other hand, choice white-oak butts have been seen being made into fence posts because they "worked easily," notwithstanding the fact that less than a mile away there was a sawmill which wanted such logs for quarter sawing at \$40 per 1,000 feet.

Small-sized trees are being cut for ties, poles and cordwood which should be left for additional growth and entire woodlands which contain considerable choice timber, much more valuable for lumber, have been cut clean for nothing but ties.

High grade logs of white oak, yellow poplar, red gum, ash, cherry, black walnut, etc., says this bulletin, can in most cases be sold in carload lots direct to the manufacturing plants, even though these are located considerable distances away.

Steep slopes, poor soil, rocky land, unused corners, gullied land and wet land afford places for growing timber profitably, these various classes of so-called waste land being as a rule better adapted for forest production than for any other use. Tree planting over gullies checks erosion and not only results in profit from the foresting, but protects valuable farm land.

## A Health Cabinet

West Virginia has formed a health cabinet for the State, including the commissioner of health, the superintendent of schools, the sanitary engineer, the director of nursing service, the supervisor of rural schools, the director of the farm bureaus and a representative of the Red Cross. The cabinet has decided to focus its attention on one county in the State at a time, and to make a demonstration in it over a period of three months. Representatives of different kinds of social work—ten or twenty of them—will be sent into the county. An attempt will be made to examine every school child and most of the adults, to hold nutrition clinics, and so on.

## Housing Plans in Chicago

(By Special Correspondence to THE AMERICAN ARCHITECT)

CHICAGO:—Various civic and commercial organizations of Chicago are hard at work on plans to speedily reduce the city's shortage of 50,000 homes. Of these the Chicago Housing Association announced through its leaders, Benjamin J. Rosenthal and Herman H. Hettler, that 8,000 houses to cost in the neighborhood of \$2,500 each would be constructed this Spring and Summer.

It is planned to allow tenants to pay for the new homes at the rate of \$19 a month for twelve years. For outlays said to be less than the cheapest rent, 8,000 Chicagoans will have five-room standardized frame houses with modern conveniences and yards large enough for gardening.

This is the first formulated and unconditional promise made by a Chicago civic body to help solve the city's shortage of homes.

The Chicago Realty Board has appointed a committee of experts and business men to decide what type of dwelling will give the quickest relief. After a report by the committee the building program of the organization will be definitely determined.

The speeding up of construction, however, is not the only phase of home building to be considered by Chicago organizations in the opinion of Julius Rosenwald, president of Sears, Roebuck & Co. Mr. Rosenwald declared it to be the duty of the city's industrial and commercial leaders to get together for the formation of a syndicate to finance workers desirous of building homes.

"Conditions are appalling," said Mr. Rosenwald. "Of this there can be no doubt. One of our civic organizations or some of our leaders adapted to this work should rise to the occasion and make a campaign for the required amount of money. It should not be difficult to get finances for a project like this whether the amount be \$1,000,000 or \$5,000,000, or more."

Mr. Rosenwald advocated the adoption in many of its elements of the Detroit plan. Just as the plan is in Detroit, Mr. Rosenwald would have his proposed financing syndicate lend the prospective home owner enough money to finance building a home, without being required to pay exorbitant rates for a second mortgage or for a loan made on a note. To start building the owner must have approximately 20 per cent of the cost of the home.

## Stanford White's House Bought by Y. W. C. A.

The former residence of Stanford White on Lexington Avenue and Twenty-first Street, New York, has been sold to the Young Women's Christian Association.

It consists of a five-story structure, with a two-story addition, occupying a plot with a frontage of 58 feet on Twenty-first Street and 131 feet on Lexington Avenue. After Stanford White's occupancy the building was extensively altered, and it became the home of the Princeton Club, which later gave it up and took quarters in the Yale Club.

In the rear of the property just sold is the building which houses the activities of the Russell Sage Foundation, which covers the balance of the block on Lexington Avenue.

It is understood that the association is to use the present buildings, which are connected, for the International Institute for Young Women. The building has a roof garden and a large auditorium, besides a large number of dormitories.

Personals

M. E. Boyer, Jr., has opened an office for architectural practice at 505 Trust Building, Charlotte, N. C., and desires catalogues and samples.

Ralph Mornington Weinrichter, F. A. S. L. A., landscape architect, of Rochester, N. Y., announces the establishment of a New York office at 10 East 43d street.

Kirby T. Snyder, architect, formerly at 933 Plymouth Building, Minneapolis, has moved his offices to larger quarters at 738 and 739 Plymouth Building. He desires new catalogues and samples from material firms.

Kemper Nomland, formerly of New York and Los Angeles, has opened offices at No. 312 Southwest National Bank Building, Oklahoma City, Okla., for the general practice of architecture and desires catalogues and samples.

Architect Edwin H. Clark of Otis & Clark, 6 North Michigan avenue, Chicago, is to sever his connection with his partner on May 1 and will move across the river and occupy quarters in the remodeled residence at 8 East Huron street.

Fulton & Taylor and Paul T. Cahill desire to announce the formation of a new partnership, Fulton, Taylor & Cahill, architects, and the removal of their office after April 1, 1920, from 631 Hippodrome Building to 8120 Euclid avenue, Cleveland.

J. A. Lindstrand, for the past five years architect for the Bureau of Valuation, Interstate Commerce Commission, announces that he has severed his connection with the United States Government and has opened offices for the general practice of his profession at 800 North Clark street, Chicago, Ill.

Rayburn S. Webb, formerly of the firm of Parlow & Webb, architects, Capt Girardeau, Mo., announces the opening of an office for the general practice of architecture at Room 519, Himmelberger-Harrison Building, Cape Girardeau, Mo. Manufacturers' catalogues and samples are requested.

News From Various Sources

The British State-aid schemes have produced during the past fifteen months 246 houses. There is need for 500,000.

\* \* \*

The members of the French labor unions are planning to tax themselves one franc each for the relief of their Austrian comrades.

\* \* \*

Statistics Branch, General Staff, War Department, issues statement on the 1,200 landing fields for aircraft listed in United States.

\* \* \*

The note circulation of the United States was \$1,056,000,000 in June, 1914; \$3,643,000,000 in November, 1918, and \$4,051,000,000 in December, 1919.

\* \* \*

According to the *Automobile Trade Journal*, more than 7,623,551 automobiles were registered in the United States last year. Of these 87.14 per cent were passenger cars.

The number of motor vehicles registered in New York State in 1919 was 571,662, an increase of 107,904 over 1918. They yielded the State approximately \$6,000,000 in fees.

\* \* \*

The immigration through the Port of New York in 1919 reached a total of 168,025, of whom 47,034 came from Mediterranean ports. The immigration in 1918 was only 71,751.

\* \* \*

The Legislature of New York has passed a bill, which has been approved by the city, changing the title of the Department of Public Charities to the Department of Public Welfare.

\* \* \*

Second Annual Hotel Men's Show will be held at the Coliseum, Chicago, the week of May 10. Displays of the most up-to-date furnishings, equipment and labor-saving devices will be shown.

\* \* \*

The 141 savings banks of New York State had resources of \$2,456,993,719 on January 1, which was a gain of \$225,531,791 during the year, and deposits of \$2,267,395,799, an increase of \$225,384,695.

\* \* \*

The Department of Agriculture in Washington reports that the number of people engaged in farming in New York State decreased 3 per cent last year and that the number of farm laborers decreased more than 17 per cent.

\* \* \*

Senate March 29 adopted committee amendment to post office appropriation bill providing for a transcontinental air mail route between New York and San Francisco by way of Chicago and Omaha and passed bill carrying total of \$462,000,000.

\* \* \*

Park Commissioner Francis D. Gallatin, of Manhattan, has announced that he will open two Municipal Flower Markets, one near the Maine Monument at Columbus Circle, and the other in Union Square, where florists may sell directly to the consumer.

\* \* \*

Suggestions for utilizing the wooden-hulled ships, now lying idle in the Delaware River, and others expected later to relieve the housing congestion, are being discussed among Philadelphia real estate men, according to a recent news note of the Atlantic Coast Shipbuilders' Association.

\* \* \*

Statistics recently compiled show building construction contracts let for first three months of 1920 in territory east of Missouri and north of Ohio rivers were \$780,408,000, compared with \$275,555,000 for first quarter of 1919. Normally first three months of year account of 20 per cent of year's total of work started.

\* \* \*

U. S. National Museum at Washington issues statement calling attention to the fact that it contains many collections and exhibitions rich in interest and value for the designer working in textiles, costumes, arts and crafts, and in other phases of decorative art. States that economic value of museums in this respect is coming to be realized more and more by designs as demand increases for unique and unusual designs. In National Museum forms of decorative art shown cover geographically every part of globe, and in point of time from crude prehistoric beginnings of art down to present.



# Weekly Review of Construction Field

Comment on General Conditions of Economics With Reports of Special Correspondents in Prominent Regional Centers

At the annual meeting of the United States Steel Corporation, April 19, Judge Gary, chairman of the board, discussed business and labor conditions. "It seems to us," he says, "the problem of high cost of living is of convincing importance. Therefore, it should be the effort of all to establish and maintain a reasonable basis of prices; certainly to prevent further increases, otherwise the Government, from the standpoint of protection of a part of the public, must interfere. Moreover, it is believed that in view of all the conditions prevailing the selling prices of most of the diversified products of the corporation, for the present at least, are high enough, though it is pertinent to say that when the actual value of the properties and volume of business of the corporation are considered the net return is at least moderate."

Referring to the large surplus of the corporation, he recalled the panic of 1907, when as a means of preventing further demoralization in financial circles the seventy-five or eighty million dollars which the corporation then had in cash, did valuable service. "We are not called upon to maintain cash for those purposes," he continued, "but in accordance with the principles of good management we should keep ourselves in a condition that will enable us to do all the business offered that we can handle, promptly and properly, without borrowing a dollar."

"We know pretty well what has happened in the past, we know what is happening now; but we cannot make an accurate prognosis for the future. Consequently we must be prepared so far as we can. There is now more or less social disturbance in this country. There has been a bold, deliberate, underhanded movement instituted by people who are not loyal to the principles of our Government. But they will not succeed, because 97 per cent of the people of this country are loyal. We are going to get through this because of conservatism, because of prudent management and the desire to economize. There is no excuse for lack of economy at the present time. There is no excuse for spending six and three-quarter billions of dollars a year for the management of the affairs of this Government."

"The people of the United States never had so good an opportunity for progress and prosperity as they have at the present time. In that respect conditions have been improving for the last year or more. We may take and maintain the leading position, industrially, financially, commercial, of all the nations of the world; we have the resources, which are natural and permanent, to occupy and maintain the position."

In speaking of labor conditions, Judge Gary opposed the "one big union" idea. He stated their position: "We acknowledge the natural right of labor to organize, but we insist that a labor organization should be subjected to governmental control and regulation like other organizations. Discrimination by law in favor of or against any particular class is detrimental to the interests of the community." He also does not accept the "shop committee plan" as being "no better or more satisfactory to the employes than our own"—but he adds that "a studious, thoughtful, fair-minded, intelligent general public is at present considering these vital questions."

A compilation of the resources of the national banks has shown a shrinkage of almost a billion dollars in the two months of January and February of this year. The total resources on February 28th were \$21,862,540,000, which were, as compared with March 1st, 1919, an increase of \$1,665,000,000. The chief cause of the reduction since January 1st has been the withdrawal of governmental deposits, which declined from \$448,000,000 to \$67,000,000. The distribution over the country of this reduction in deposits is \$688,000,000 from New York, \$12,000,000 from Chicago, \$20,000,000 from St. Louis; Philadelphia, \$72,000,000; San Francisco, \$44,000,000; Boston, \$33,000,000; Dallas, \$30,000,000; Baltimore, \$27,000,000, and Pittsburgh, \$22,000,000.

Of the reserve cities, 24 showed increases in deposits and 31 showed decreases not exceeding \$10,000,000 each way. The country national banks have shown a net increase in deposits during this period of shrinkage amounting to over \$89,000,000.

The ratio of loans to deposits on February 28th, 1920, was 70.70 per cent, as compared with 65.97 per cent on December 31st, and 63.35 per cent on March 4, 1919.

In all business circles nowadays there is an undercurrent of talk of "panic" or "depression" or "shake-out" or "readjustment." The terms seem to be synonymous. Every now and then the stock exchanges think the moment has arrived, but the situation results in their finding out that some group has made a haul.

The Federal Reserve system is generally held to be an almost certain preventive of a money panic. Further, it is apparent to anyone that there is a large amount of work to be done. If there is a discovery of overproduction it will be at some remote time. We have not too much money tied up in empty dwelling houses, nor in railroad development.

Prices and wage schedules are high, compared with the past averages they are very high; but there is a question whether they will be reduced. Some leading economists say they will not. There is no reason for believing the buying power of a dollar in 1914 to be a criterion any more than its buying power in 1714.

At present the demand for goods and for labor is far in excess of the supply; it is natural to expect that when the balance is reduced there may naturally be some reduction in prices. Some wisecracks are sitting around patiently waiting for that time. Some others are increasing their makings while the making is good. Although it is only a minority, it is unfortunate that these men have so little confidence in the future and cannot see through their apprehension. Their practical advantage is to stabilize the present market by the production and delivery of actual goods.

(By Special Correspondence to THE AMERICAN ARCHITECT)

Chicago.—The arrest of the strike leaders by the Federal Government practically ended the railroad strike in the Chicago district, and a substantial increase in the movement of freight shows a situation rapidly becoming more nearly normal.

The steel industry was the hardest hit by the virtual

## THE AMERICAN ARCHITECT

suspension of traffic, more than half of the steel mills in the district being shut down as a result of the strike.

While the steel situation continues depressing, the outlook of the construction industry is more promising, owing to the increased movement in building material. Recent reports by the railroads indicate a big tonnage of lumber and building material moved during the strike period. Lumber shipments show an increase of 26 per cent over those of the corresponding time a year ago.

The increased transportation of building material should tend to lighten the load carried by the construction industry, which continues to be hampered by labor and credit difficulties. The high interest rate of 7 per cent is generally in force. Banks are reported to be refusing loans on construction work—a tightening up of credit due to an already over-loaned condition, labor shortage and uncertainties. This attitude on the part of the banks appears to be coincident with the stand taken by many contractors, who are refusing bids on work that cannot be completed within a few weeks because of the uncertainty of labor after that time.

Building permits, however, continue to exceed all previous records, both in number and the cost of projected structures, but local economists assert that many permits have been taken out which will not be used for the present because of cost and uncertainty of completion.

Bond issues totalling \$34,500,000 intended for better street lighting, building of bridges, improvement of parks, playgrounds and bathing beaches and a municipal convention hall were defeated by Chicago voters recently. It is believed that the thought of increased taxation, unprecedented construction costs and the diverting of labor and material from more pressing needs have influenced the voters in defeating the bonds.

*(By Special Correspondence to THE AMERICAN ARCHITECT)*

It is a question how much longer the prices of material will be able to hold up actual construction in San Francisco. The scarcity of desirable office space is daily becoming acute and a large number of buildings of this type is planned. Montgomery street is being especially favored in this respect. Insurance companies are advertising the immediate erection of two large buildings, one on the corner of Pine and the other on Busk street. Across the street from the latter the Crocker Estate has announced a fifteen-story building. Less than two blocks away the First National Bank is beginning the erection of a large addition to its building on the corner, and across the street the Wells-Fargo Nevada National Bank has bought the property adjoining its building, with the announced intention of building an addition. These buildings are assured and a number of others are projected upon which architects are making plans and estimates. The next five years will witness the complete remodeling of the sky line for the first four or five blocks along Montgomery.

So far as prices of materials are concerned, but few changes have occurred during the week. Reinforcing bars are in somewhat serious condition. The local mills depend entirely upon scrap as their raw material for steel bars, and steel scrap is made almost exclusively in the shipyards. This is becoming scarce and is held at higher prices, which in turn boosts the price of bars. It is noted

that none of the changes in prices of material show a downward tendency.

While quotations are given on spruce, hemlock and yellow pine lath, it must be noted that these figures are purely nominal, as not enough of these varieties come to San Francisco to establish a market. Practically all the lath used here is of fir or white pine.

In the structural steel quotations for beams and channels the prices are "out of stock" figures in the case of these materials, the first figure being for beams and the second for channels.

*(By Special Correspondence to THE AMERICAN ARCHITECT)*

Seattle.—The railroad strike which compelled Eastern buyers who have fir lumber to resell, because of inability to get cars switched or unloaded was a weakening factor in the tone of the fir lumber market this week, although quotations remained unchanged. Nails, steel pipe and plumbing fittings have advanced and Eastern mills report inability to cope with the situation. United States Steel mills are attempting to hold prices in line, but have little stock to offer, and purchases by North Coast jobbers from outside mills are at higher prices. Staple earthenware plumbing essentials are in fair supply, but brass goods are up 10 per cent and pedestal and wall-hanging bowls are almost unobtainable.

Cement advanced 25 cents per barrel to \$4.50, with a rebate of 80 cents for bags. The lath market is weak and No. 1 standard lath are being delivered on the job at \$10. Brick and plaster are steady. Plaster board is unchanged. There is no channel iron in the market and architects will be urged by jobbers and building contractors to find a substitute in North Coast building operations. Sidewalk lights are in brisk demand. More of these have been used in Seattle than ever before. Fire brick from British Columbia and face brick from other points of Western Canada is plentiful. Face brick is \$65 delivered on the job.

Jobbers report an easing off in the demand for building materials. Under the conditions of delivery and price there is considerable discussion among contractors as to the cost plus basis of taking contracts, although this has not yet assumed definite form.

Jobbers began quoting nails 50 cents higher this week, in conformity with an advance to them by the mills, but even this gives no assurance of the approximate time when delivery conditions will improve. The Steel Corporation has not changed its quotations, but cannot satisfy jobbers as to the quantity they can supply, and when relief is sought with outside mills jobbers go into a higher market. There is no stable market in either nails or tubing. Steel bars are at a \$4.25 base to jobbers, but neither the Pacific Coast nor Colorado mills can meet the demand. The local market is 25 cents higher. A horizontal advance of \$5 to \$10 on all building steel is being inaugurated here by the jobbing interests. Pipe is up two points under similar conditions to those of nails. The National Tube Corporation has refused to advance its prices, but is unable to deliver stock.

Fir lumber mills have assumed an independent attitude toward wholesale buyers and will not accept at bids offered. Reports from the East indicate that the Spring lumber demand is over and that there will be no buying from that direction until Fall.

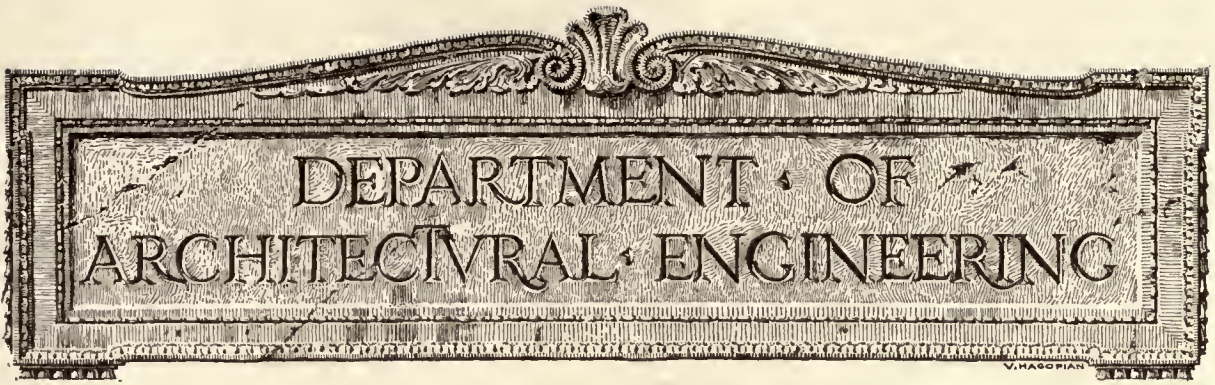

## Valuable Information on Building Materials Made Available Through Work of Trade Associations\*

By WHARTON CLAY, M. W. S. E.

*Commissioner. Associated Metal Lath Manufacturers*

A TRADE ASSOCIATION is a voluntary organization of competitors such as manufacturers, jobbers or dealers, in the same general line of business. These competing interests join for material benefit. They are sometimes associations of men in the same line in different cities, as central stations, street railway operators, and others who manifestly are not in direct competition, but always commercial interests that have the same general problems of manufacture, development or sale to face. This type of association, however, does not include the usual Chamber of Commerce of a city, which would be made up of firms in varying lines of business, nor does it include professional or public societies, for instance, the American Society of Civil Engineers, the National Fire Protection Association or others whose membership is individual in nature.

Four hundred and fifty such associations were listed by the U. S. Bureau of Commerce in 1917, and hundreds more have developed within the past few years. Many industries in which no organization was in existence found themselves so widely divergent in types, styles and products that it was impossible for the United States Government to deal with them when war came upon us. In fact, the Government fostered the organization of competitors into trade associations; which, having now discharged their war duties, are continuing because they fill an economic need not only within the ranks of the industries themselves, but also in

service to the general public. They will, henceforth, always be prepared to serve the country in times of peace or in times of war, insuring a speedier mobilization of industry than would be possible without them. They are able to co-operatively develop foreign markets or economically promote domestic consumption.

\* \* \* \*

The United States Bureau of Standards has prepared a report on standardization work in 102 trade associations co-operating with the Bureau, which has been made available, and a list of over 600 trade associations has been canvassed in the preparation of this paper. Information has been received from several score more than it will be possible, in the time allotted, to fully acknowledge. It is, therefore, with regret that the accomplishments of only a small number of associations which have done admirable work in engineering, can be described this evening.†

So great has the importance of association work in general become that the first building to be built after the war in New York City was the twenty-story National Association Building, especially designed to accommodate the many association headquarters centered in New York City.

The public at large, and even the engineers who deal more particularly in materials, may not realize the broadmindedness of the manufacturers of the

[† Editor's Note: While Mr. Clay in his address described the work of 73 Trade Associations, only the activities of those connected with the building industry are here set forth.]

\* Abstract of paper read before the Western Society of Engineers.

United States. Many do not know that the members of these associations will send their own factory experts to the brother manufacturer's plant to assist in the better production of a competing material. They do not realize that through these associations, the improvements made by one manufacturer are immediately available for all other manufacturers.

At first it would seem absurd to expect a manufacturer who has learned to prevent efflorescence, let us say, in a certain product, to give this secret to his competitors, and it did take broadmindedness to see the personal advantage in so doing, although it would be immediately granted, that the advantage to the general public is great.

One reason why such acts are frequent, is because the manufacturer who becomes imbued with the association spirit, discovers that the best thing he can do for the sale of his own product, is to have the general public realize that the material is one not subject to drawbacks when manufactured by anyone, and is a safe and proper material to specify. He realizes that he cannot get one hundred per cent of the business, and it is better for both the public and himself to take his chances in getting a smaller percentage of a larger industry which is not held back because of poor manufacturers.

Double dependence can be placed upon the products of Association members—the seller has his own reputation at stake, and all his competitors will see to it that their product is in no wise discredited by inferior workmanship or materials sold by others.

This world is a small place to live in and the advantage and friendly spirit generated by co-operation react to the benefit of all concerned.

\* \* \* \*

*The Paint Manufacturers' Association* at Philadelphia has developed an educational bureau which has been brought by successive steps from the bureau of promotional development and from the advertising committee.

From time to time the paint industry has been menaced by a shortage in the flax crop. Whenever this condition recurs, legitimate and intelligent as well as illegitimate attempts actuated by ignorant cupidity have been made to utilize or substitute other vehicles. The facts are at once a promise and a menace to the trade in the hands of the unscrupulous "Oil Doper." They become a menace when even the price of linseed oil rises. In the hands of the conscientious paint technologist they promise both a reserve for emergencies and in the raw materials for new paint specialties.

The idea that the paint and varnish industries

might do something to prevent the threatened abandonment or destruction of the American flax crop originated with the Educational Bureau, in 1907, when the menace of the then-existing situation was brought sharply to the attention of the trade by a failure of the crop.

No more effective work has ever been accomplished (not even by the German government), in behalf of any industry than this work for the paint industry of the United States. The committee has wisely contented itself with selecting the men who understand the subject and supplying them with the necessary funds for educational work among the flax growers. The result is an achievement that cannot be minimized, and is a credit to agricultural engineering.

*The Association of American Steel Manufacturers*, Pittsburgh, was pioneer in the adoption of standard specifications for structural and boiler steels and for concrete reinforcement bars rolled from billets, and these specifications were the basis of the specifications later adopted by the American Society for Testing Materials.

In September, 1916, an arrangement was entered into for co-operation between the Portland Cement Association and the Lewis Institute, Chicago, under the direction of Professor Duff A. Abrams in developing new information on concrete. The research work was carried on at the Institute but the financial support came from the Association, the whole being in charge of an advisory committee. Under this union 70 very important series of tests on concrete and aggregate have been conducted. In addition to these there are a great many physical tests in concrete materials which were carried out in connection with these series, and are incidental to their correct development.

The results of the tests on the work in these series have been combined and described in several printed papers and reports.

*The National Association of Sand and Gravel Producers*, Indianapolis, Ind., has started the work of the Engineering Department by conducting a series of tests, which they expect to use as a basis for drawing proper specifications for the use of sand and gravel. Heretofore, specifications for sand and gravel concrete have been adopted largely from specifications covering the use of crushed stone, which is an essentially different product.

The department will also undertake to develop new uses for sand and gravel, especially in the way of utilizing certain grades of material, particularly the smaller sizes, which, in many sections of the country, are now waste products.

By standardizing the diameters of shafts and heads of column forms for round concrete columns

the Metal Form Association, Cleveland, Ohio, have enabled member companies to carry on business with one-half of the stock of forms formerly used which, of course, has enabled them to reduce the price to the contractor and insured a quicker delivery.

The shafts of the column forms are now made in diameters starting from twelve inches in even two-inch multiples up to fifty-four inches in diameter, and the heads are made from forty-two inches in even six-inch multiples up to seventy-two inches. Before this standardization took place, architects designed in odd inches and with heads of varying diameters.

Early during 1919 the *Gypsum Industries Association*, Chicago, organized a division of engineering. This division has prepared specifications in conformity with present accepted standards of engineering and architectural practice which cover the following:

Gypsum, raw and calcined, for structural and commercial purposes.

Gypsum plasters of all kinds.

Gypsum partition tile for the construction of non-bearing, fireproof partitions, enclosures, furring, and the fireproofing of steel columns.

Gypsum plaster board for incombustible lathing purposes, soffit ceilings, vent ducts, etc.

Gypsum wall board as an interior surface for the walls and ceilings of ordinary joisted constructions.

Reinforced structural gypsum for the construction of fireproof roof decks, fireproofing unit shapes, and similar purposes.

The Association has recently created a fellowship in the United States Bureau of Standards. It is intended that the Association's representative will continue scientific investigations upon gypsum products which were started by the Bureau of Standards some time ago. These investigations will include extended possibilities in the use of gypsum for structural and decorative purposes.

A standing committee of the American Society for Testing Materials known as "Committee C-II on Gypsum" is divided into five sub-committees whose duties involve research work and the adoption of specifications on the following:

Gypsum for various uses, gypsum plasters, structural gypsum, testing methods (for gypsum), nomenclature.

The *Lime Association*, Washington, D. C., in 1910 adopted standard specifications for lime drawn up by its Committee on Standard Specifications for Lime and assisted in securing the adoption of the standard lime barrel law. It was instrumental in securing the formation of Committee C-7 of the American Society for Testing Materials.

*The Associated Metal Lath Manufacturers*, Chi-

cago, have made a thorough engineering study of their material and its relation to other building materials, particularly plaster and cement. Fire tests have been conducted in various parts of the country and at the Underwriters' Laboratories. In this field very definite study is being made to develop better methods of protecting lumber and in this way to aid conservation of the resources of the country.

The so-called fireproof building has received much consideration in the past but the small house has been neglected. Metal lath is being especially studied with a view toward the best service it can render in concrete as well as wooden houses. The same engineering idea that dictates the greater protection of the most vulnerable parts of a battleship is being applied to the dwelling house construction with a view toward obtaining the maximum amount of fire protection with the minimum of expenditure.

The effect of painting metal lath has been studied through weather tests in several parts of the country and the processes of all the competing companies has been made available. This project will now be given a protective coating far superior to that which has been known in the past.

The subject of sound insulation in commercial partitions has been developed through experiments at the University of Illinois, bringing out some radical departures from previous accepted ideas on this subject. An exhaustive test on thermal conductivity of exterior walls has been made by professors at Armour Institute of Technology with a view to improving the heat insulation of small houses.

All of this data is made available to the public and the building profession by bulletins.

In the common brick industry, there has recently been a conservation development of considerable importance. Occasionally a million bricks will be discolored from the ordinary run, due to longer burning or accident. It has been discovered that these bricks, which the contractors used to throw away, are harder and can be laid up in a very attractive manner and will break the monotony of a common brick wall. Already architectural campaigns are being conducted to familiarize localities with the stability and beauty of this formerly wasted product and a housing development of 175 homes is under way in Chicago, using this material. *The Common Brick Association* is studying the standardization which will affect 250 manufacturers producing 3,000,000,000 common brick per year.

*The Hollow Building Tile Association*, Chicago, has been instrumental in the creation of standards so that the manufacturers themselves know of the standards to work to in producing the right kind of tile.

The engineering department has prepared and is ready to submit to the various building commissions a Standard Building Code, which protects the users of tile in any community from poor tile construction. It has prepared and has issued to the building public a handbook on hollow tile construction especially for architects and engineers. It also has prepared and issued a builders' manual, being especially prepared for the small contractors. The engineering department is prepared to become consulting engineers as to the proper use of building tile to the architectural and contracting professions.

*The Steel Sash Manufacturers' Association*, New York, has effected a standardization of 23 types for stock sizes, which have been adopted by all the member companies and are now carried in stock throughout the United States, insuring prompt delivery and enabling the architect to design standard openings and still obtain competition from several companies. A year ago there was no standardization and at the present time 60 per cent to 70 per cent of steel sash is standardized, effecting an economy to the general public and widening the market for the manufacturers.

According to the *West Coast Lumbermen's Association*:

"The lumber industry has not given so much attention to the technical matters as the other chief structural materials manufacturers—cement and steel; largely because of the fact that these two materials are in themselves manufactured products in the making of which the producers have depended largely on chemists and engineers. Wood being already a finished product in its raw state did not require this technical help in the same way, and lumbering, being a widely distributed and pioneer industry, was developed largely from a practical standpoint."

Twenty-five years ago the practice in the lumber industry was to cut logs into whatever grades and sizes they would produce, keeping in mind at all times the idea of getting the largest possible volume of product. The lumber thus produced was usually sold "mill run" to wholesalers or jobbers who undertook to sort it for quality and sizes and to find a market for it. The development of lumber manufacturing associations has completely changed this practice.

Lumber is now graded at the back end of the saw mill plant and is put in the pile or shed in accordance with such grading according to quality and dimension. The manufacturer no longer operates his plant solely with the view to producing the largest possible quantity of material, but, on the contrary, he now knows the grades and sizes which are in demand, and he is able, therefore, to operate

his mill in such way as to produce a larger proportion of those particular kinds of lumber which are needed by the consumer.

The quality of the product in the aggregate has been materially raised by the establishing of standard grades. This may be made clear by an illustration. Take a 16-foot yellow pine board which contains a large defect 18 inches from one end. Under conditions prior to the establishment of standard grades, this board would have gone on the market as a 16-foot piece, but to-day the manufacturer knows that by cutting it to 14 feet, thereby eliminating the defect, he can raise it to a higher grade which will bring a higher price, and which will meet the requirements of some consumer who has no use for the lower grade. In consequence, he manipulates the product in the mill to produce those particular grades which consumers are demanding and to eliminate, as far as possible, those grades for which there is not an active market. The result is a larger production of the kinds of lumber most needed and larger production of the better grades of lumber, and a proportionate lowering of prices on the entire output of the plant, because of its increased merchantability.

*The Southern Pine Association*, New Orleans, Research Department has conducted investigations or has initiated investigations which were designed to develop facts relative to the strength of timber for structural purposes. Also various investigations relative to the better means of utilizing wood for purposes where it is now used in the manner not most economically and also in the better preparation of timber material for the use it is particularly applicable. Investigations have also been conducted with a view of further utilization of the waste products incident to the manufacture of lumber and to extending knowledge of the utility of by-products as the result of utilization of wood waste. Particular attention has been given to the various properties of treated lumber and values of various methods of treatment and the proper place for utilizing wood of various types of preservation.

*The American Wood Preserving Association* has a membership of over 300 and since its organization in 1905 has assisted in developing wood preserving industry in this country. From 30 wood preserving plants in operation in 1905 the Association's propaganda has resulted in a growth in the number of plants to 125 in 1920. The wood treated by these plants now amounts to approximately 135,000,000 cubic feet of which nearly 75 per cent represents cross ties. The annual consumption of wood cross ties is about 115,000,000 in number and of this quantity about one-third, or 35,000,000 are chemically treated to more than double their life in track. In 1905 when the Association was organ-

## THE AMERICAN ARCHITECT

ized, the cross ties treated amounted to 14,800,000; in 1919 approximately 35,000,000, indicating an increase of 140 per cent in the period of 15 years.

To encourage the development of the wood preserving industry, the American Wood Preservers' Association holds periodical meetings for its members and the public and publishes the experiences of those engaged in the wood preserving industry and those who use treated wood; also formulates specifications for wood preservatives and standardizes the methods of treating material. Investigations are made by special committees appointed by the Association to record the developments in the various branches of the wood preserving industry. These committee reports are published in the Association's annual proceedings for general distribution.

The primary aim of the American Wood Preservers' Association is to promote knowledge of wood preservation with the view of conserving our forest resources.

*The National Association of Electrical Contractors and Dealers*, New York, has prepared, in co-operation with American Institute of Architects, certain standard symbols for use on drawings and helped prepare the standard conduit sizes for certain sizes of wire which were embodied in the Electrical Safety Code. There are Committees on Standardization, National Electrical Code, House Wiring Central Stations, Architects, and Engineers. There is also a Committee on the Standardization of Attachment Plugs and Receptacles.

The Elevator Industry was one characterized by complete lack of harmony before the war. Personal rivalry and sharp practices in business existed. At a meeting called by the Chamber of Commerce, the entire industry was represented by some 50 men, in a large part owners of the various businesses. The result of this meeting, fostered by the Chamber of Commerce and in connection with the War Industries Board, was that decided improvements were made in the construction of elevators, and at the present time they are engaged in a program of standardization, which is supported by the *Elevator Manufacturers' Association of the United States*, The American Institute of Architects and The American Society of Mechanical Engineers, and a definite accomplishment is the preparation of the elevator code covering all classes of elevator work, which will be sanctioned by the architects and engineers and Bureau of Standards. It has taken some three years to prepare this, and they expect to issue it this Spring as a publication of the Elevator Manufacturers' Association of the United States, for guidance of architects, municipalities, state boards, etc. It naturally represents the ideas of the

entire industry in such a way that any of the manufacturers can operate, and the desirable feature is that it advocates betterment of conditions. On account of the importance of elevators, they feel that it will be of great value to the public.

*The American Association of Refrigeration*, Chicago, has the following commissions which are engaged in standardization or research work: (1) Commission on Gases and Units, which deals with the physics and chemistry of refrigeration, (2) Commission on Testing Refrigerating Machinery and Insulating Materials, which concerns itself with matters of the design, construction, operation and methods of testing refrigerating machinery and materials, (3) Commission on Industrial Refrigeration, which takes up the use of refrigerating apparatus in the industrial arts, (4) Commission on Railway and Steamship Refrigeration, which considers all matters pertaining to car icing, pre-cooling, car construction, insulation and uniform regulation.

The Association has co-operated with the Bureau of Standards for a number of years in investigations of the physical properties of refrigerants.

And at the other extremity we have *The National Warm Air Heating and Ventilating Association*, Columbus, Ohio, which has a Committee on Engineering and an Advisory Committee on Warm Air Furnace Research, which supervises the research looking to increasing the efficiency of warm air furnaces which is being conducted at the University of Illinois.

Some standardization of products was accomplished during the war through the Association's War Service Committee, and Formula and Rules for Installation of Warm Air Heating have been published by the Association.

*The Magnesite Association of America*, Philadelphia, was formed about 3 years ago to carefully investigate the subject of heat insulations and to give publicity to the value of 85 per cent magnesite for such work.

A Technical Committee, consisting of two engineers in the employ of two Member Companies, was created, and a Fellowship in the Mellon Institute of Industrial Research, University of Pittsburgh, was secured. The Technical Committee and the Mellon Institute work in very close harmony and the results of their efforts are being given publicity by the Association in the form of advertising in trade and technical magazines, booklets, specifications, etc.

These investigations from an engineering standpoint have been especially interesting in that when the work was commenced it was quickly realized that all previous experimentation had been based

on one certain type of condition, whereas, in practice, there are so many different conditions under which high pressure steam is employed that it has been necessary to do a very great deal of pioneer work in basic experimentation with bare pipes and boiler surfaces before the actual work of testing insulating efficiencies could be begun.

The function of the Mellon Institute and the Technical Committee, in addition to the above, is to standardize methods and processes of production of magnesia, and a great deal of work has been done, and is under way, along this line.

*The Asbestos Textile Manufacturers' Association* also maintains a Fellowship in the Mellon Institute, designed to test and endeavor to standardize weights, qualities and uses of products made in that branch of the asbestos industry.

\* \* \* \*

Engineering education is based upon properties of materials, analysis of cause and effect, and investigation. These are three principles on which the Trade Association justifies its position without the question of a doubt. Engineering implies impartiality in the measure of products through the cold glasses of scientific observation. It teaches the basic principles upon which to depend. It has studied the unfolding of science and invention, and realizes that articles of commerce are subject to constant developments—that new ideas, however small they may seem at first, must be given full consideration, as a small idea with the basis of fact has, and again may, revolutionize a big industry. Engineering knows what is best today, may not be best tomorrow; not from the standpoint of style or popularity, for these are matters for sales managers to predict, but from the standpoint of the usefulness or economy of the product itself; and it is constantly seeking material improvement.

As so ably expressed by Mr. Herbert C. Hoover when he accepted the Honor Award of the Western Society of Engineers recently, for engineering the distribution of the world's food supply:

"I could not accept it for myself because in those organizations where I have had the honor to preside there has been a large preponderance of engineers, volunteers from our own American profession. First in the Belgian Relief, then the Food Administration, then again in the Supreme Economic Council I have had associated with me first and last over 1,000 American engineers. It has been the ability of these men, their capacity and constructive thought, that quality of engineers which leads them to quantitative thought and not qualitative thought, is the basis upon which organization in emergency can and must succeed."

The Engineering education frequently neglects

human relations—a most important element in the Trade Associations. Publicity, Psychology, Economics, Law and other similar studies are not generally covered in engineering courses.

Such considerations as these are of great importance in this work for it is clearly up to the association manager, not only to develop new methods and ideas, but also to "sell" them to the association members and the public. In this work the engineer cannot stop at the rendering of his report, but must see that the results of his determinations are accepted commercially for the good of his industry and the public. The commercial side is as important as the technical.

The public is apt to think that the "bookworm" or "grind" is the typical engineering student because the public knows that hard application is necessary to graduate. But there are as many hand clasps among engineers as among any other men. Students who take part in fraternal and undergraduate activities have an unusual opportunity for social contact with their fellows, and to develop a great appreciation of the fact that this world is full of people as well as materials.

The Greek and Latin courses were not used in order to fluently read Plato or Cicero but as a "means" of education. The Engineer has been justly proud of his training, but he has considered it as an "end" instead of a "means" of education. He has been slow to branch out of purely technical work and the public considered that as his limitation.

But this is rapidly changing. The Engineering education is selected more and more by those who wish to cope with the great problems of the modern material world. The Engineering education is being recognized and many corporations have adopted a policy of employing only engineers on their sales forces. Bankers and business men are now educating their sons to follow their footsteps in commercial life through a course in an Engineering College.

Where can we turn for a scheme of education than can more profitably be used to the benefit of competing industry?

We cannot expect perfection in anything, but must look for the best we can find, hoping to develop the courses and the human product where they can be of as great service to commercial life as they have proven themselves in the more purely professional fields. On the other hand, the development of the Trade Associations may develop the need of a new Profession of Industrial Engineering with its own course. This will attract students who will fill the double requirement of commercial and technical tendencies.



# Double Concrete Walls Used in Construction of Ohio Grain Elevator

THE relative merits of single and double walled construction have received much attention from those connected with the building industry for many years. The double wall possesses an indisputable advantage, so far as maintaining a more even temperature within the space enclosed by it is concerned, in preventing the passage of moisture through the wall and in practically eliminating condensation on the interior. The main drawback to such a type of wall has been from the constructional standpoint. Double brick walls tied together by wites proved not altogether satisfactory, and moisture found its way through at these connecting wites. Hollow building blocks do not provide a continuous air space due to the connecting cell walls and mortar joints, although

a double mold, without bottom or ends is employed. The footings are placed as for any other type of masonry construction, the double wall starting above the footings. In commencing the wall this mold is



DOUBLE WALLS BUILT IN SUCCESSIVE TIERS

the production of such blocks is a development in the right direction.

If there is no physical connection between the outer and inner wall sections or shells, the construction will naturally provide more efficient insulation. Walls of concrete so constructed seem to have been developed which are structurally safe, and can be erected without serious construction difficulties.

There are many types of buildings in which a type of insulated wall can be used to advantage. In the accompanying illustrations, construction views of the Powers Grain Elevator at Genoa, Ohio, are shown. This structure was designed by Robert L. J. Wagar of the firm of Homberger and Wagar, Engineers, Sandusky, Ohio.

The walls were constructed in accordance with what is known as the Van Guilder system, in which



WALLS NEARING COMPLETION. NOTE HORIZONTAL LINES SHOWING PROGRESSIVE TIERS

placed on the footings, the two sides filled with a stiffly mixed concrete and well tamped. The mold is immediately released and pushed ahead, ready for re-filling to form the next section. This process is repeated until a complete circuit is made. Each such operation completes a tier of wall nine inches high. By the time one tier is completed, the concrete at the starting point has set sufficiently to permit the starting of the next tier on top of it. The outer and inner shells of each tier are tied together by galvanized metal ties and the concrete reinforced laterally. The exterior surface is stuccoed. The lines of the progressive tiers are clearly defined on



STUCCO WORK PRACTICALLY COMPLETED. LIGHT SCAFFOLD USED BEING TAKEN DOWN



VIEW LOOKING DOWN. DOUBLE WALL CONSTRUCTION CAN BE CLEARLY SEEN

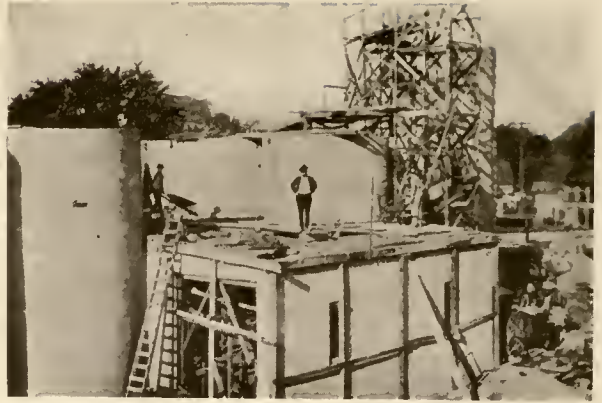

EXTERIOR STUCCO WORK IN PROGRESS

the work prior to the exterior surfacing. In applying this it was necessary to erect a light scaffolding, which can be seen in one of the photographs.

The concrete was mixed and conveyed to the required level by the hoist shown, and thence transported by wheelbarrows to the location needed. Plank decking was used where necessary as the structure progressed in height. The walls were constructed by the Sandusky Double Wall Company.

In connection with the construction of such buildings, where the contents bring lateral pressure on the walls, the intensity of this pressure increasing from top to bottom, it is important that the reinforcement be carefully computed, and properly placed, to prevent failure after the structure is filled to capacity.

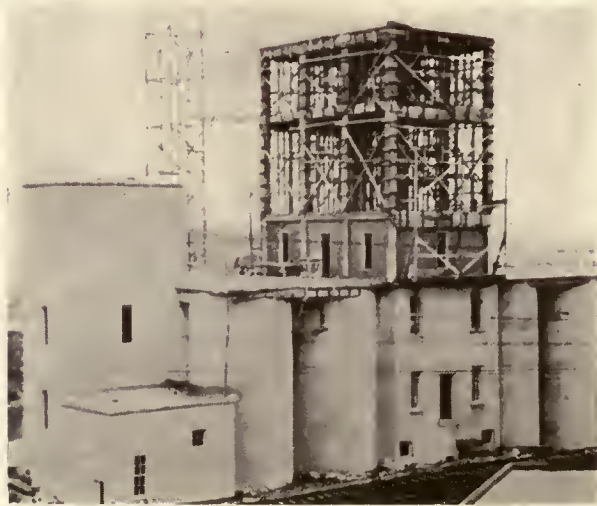

POWERS GRAIN ELEVATOR, GENOA, OHIO  
L. G. Wagar, *Designing Engineer*

## Book Review

RETAINING WALLS—THEIR DESIGN AND CONSTRUCTION:  
BY GEORGE PAASWELL, C. E. CLOTH 6x9—PP. 269, ILLUSTRATED. MCGRAW-HILL BOOK COMPANY, INC.

While the subject of retaining walls is not one of major engineering importance, yet the improper design or construction of these would invalidate many important engineering structures of which they form a link. The correct method of determining the forces to be resisted by a retaining wall has always been, and still is, a debatable one among modern engineers. As stated in Chapter I, no trace of any theoretical basis for the design of retaining walls can be found prior to 1687. Undoubtedly sound empirical rules were in use by the ancients, as their works testify. In the book, of which Mr. Paaswell is the author, a review and study of various theories and rules bearing on the subject are made, and a recommended form of procedure given for determining the exterior forces. The author seeks to place emphasis on the importance of correctly designing the wall, and to this end the problems of design of various types of walls as well as their construction are entered into fully. Considerable space is devoted to concrete walls. The importance of the construction plant and various methods of construction are described in the latter part of the book.

HOW TO USE CEMENT FOR CONCRETE CONSTRUCTION:  
BY H. COLIN CAMPBELL, C. E. CLOTH 5x7½—PP. 380, ILLUSTRATED. STANTON AND VAN VLIET COMPANY.

This book deals largely with methods of construction for various buildings and structures commonly associated with farm life. While not strictly speaking a technical work, it contains much valuable data for the farm owner or builder not regularly engaged in concrete construction work. The message of the book is to urge the construction of a more permanent type of building for these uses, and points out the economy thus attained due to the elimination of endless repairs.

gentle piece to 76.25/6 .

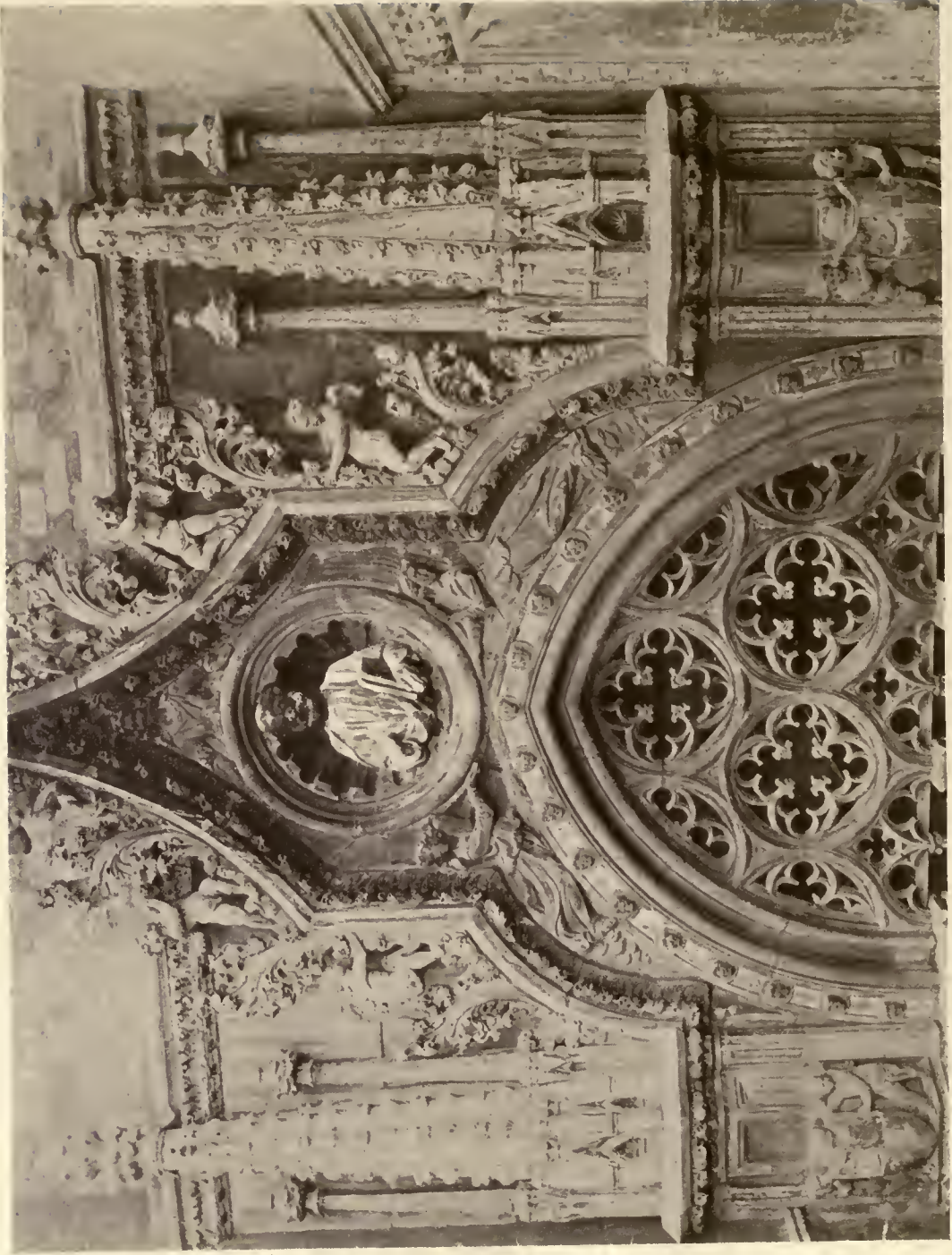

DETAIL OF WINDOW AND GABLE, VENICE

THE AMERICAN ARCHITECT

# THE AMERICAN ARCHITECT

VOL. CXVII

WEDNESDAY, MAY 12, 1920

NUMBER 2316



A VARIANT OF THE TYPE S HOUSE  
MOTT B. SCHMIDT, ARCHITECT

## The Artistic Development of the Standardized House

THESE has been a steady improvement in the quality of design displayed in the larger and more expensive houses, but the small dwelling seems not to have been given the attention by architects which it merits. The design of a low-cost house is quite as serious and as difficult a problem as the laying out of a big estate, for if the cottage is to have distinction it must be simple and without useless ornament. The limitations of space demand a fine and sure æsthetic feeling. Only by an experienced and well-balanced mind can there be attained the discreet taste which brings such a

simple problem to perfection. For quality of simplicity and style do not drop from heaven.

The limitations of money enforce an extreme practicality. The occupant would like to have in his house every convenience that appears in a house costing twice the money. From every inch of space must be pinched full use. The economy of material and labor must be always in mind.

No doubt half the women in the country think they could draw such a house with a lead pencil. But serious problems are involved which deserve the best attention the architects can give. Indus-

## THE AMERICAN ARCHITECT

trial communities were so rapidly expanded during the war that the housing developments gave opportunity for the best men to attack this problem. It is a pity that the findings of their experience are not more widely distributed.

In one of those fits of economy that occasionally overtake our Government, even the admirable report of the Housing Board, which would be of incalculable value, was issued in such a limited edition as to be practically unobtainable. But the point of attack has been shown. The economy of group construction has been instilled into the popular mind and in all large cities it has been, or is being, adopted as a part of some plan for relieving the present housing shortage.

Most of these efforts are to satisfy the needs of those who are able or willing to pay from three to six thousand dollars for their home. But in a suburb of New York on Long Island a building development is under way which utilizes the advantages of standardization but avoids the monotony and lack of artistry of the commonplace, stereotyped building project. Three architects,

Messrs. Mott B. Schmidt, George Gilbert and Aymar Embury II, have been retained by the development corporation. They have each furnished plans which will be used in the erection of one hundred houses adapted to the needs of suburbanites. The first installment of twenty-five houses is now under way; several of them are nearing completion. These houses are being constructed to sell at from ten to fifteen thousand dollars.

There are illustrated in this issue four types of floor plans for the houses and ten perspective exteriors. Upon the varied combinations of these plans the present construction is based. Varying orientation and the use of different outside finishes: stucco, stepped shingles, plain shingles, clapboard, paint, stain, and weathered finishes succeed in giving to each house its individuality and a variety is secured for the colony which is heretofore rare in such developments. For the interiors, individuality is similarly achieved in the choice of floor plans, of interior finishes, mantels, balusters, tiles and other architectural features—all of uniform types but never uniformly applied.



VARIATION OF THE TYPE G, SIX-ROOM HOUSE  
GEORGE GILBERT, ARCHITECT



TWO VARIATIONS TO TYPE E HOUSE  
AYMAK EMBURY II, ARCHITECT

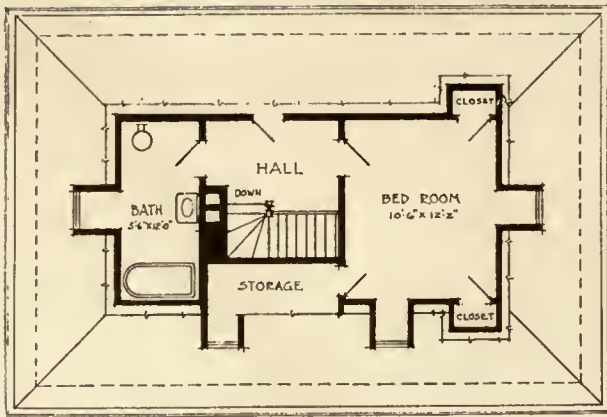

THIRD FLOOR PLAN, TYPE S

The origin of the idea seems to be with that valuable experience which this country gained in the development of its housing to suit the urgent demands of munitions employees and by an adaptation of that experience to the consideration that an American family wants its home to be as much unlike the other houses in the street as is consistent with economy.

By uniformity in the building of small houses, a construction system may be developed which

greatly shortens the time needed by the workmen. A fireplace built in one house may be more quickly executed in a second, if the same men move on to a third with the experience gained—the quickest and easiest way of building this unit is soon discovered. In war-time building the element of time saved was most vital, but it became also apparent that this meant a saving of money. What might otherwise go to payment for the men's time may be spent for superior materials and for those refinements such as laundry chutes or cedar closets which they could not afford to include in a ten or fifteen thousand dollar house built singly. It is upon such an economy that these houses base their claim to interest.

The man who builds a house of moderate cost for his home mistakenly fears that he cannot afford the services of an architect. His plans therefore, are developed by the local carpenter or builder whose taste and knowledge of proportion is far subservient to the enthusiasm with which he applies decoration. The results have been evident in all middle-class suburbs.

And when, by another alternative, the houses of such a community are all built by a realty company, they are ordinarily from stock plans with every—



A ONE-CAR GARAGE  
AYMAR EMBURY II, ARCHITECT



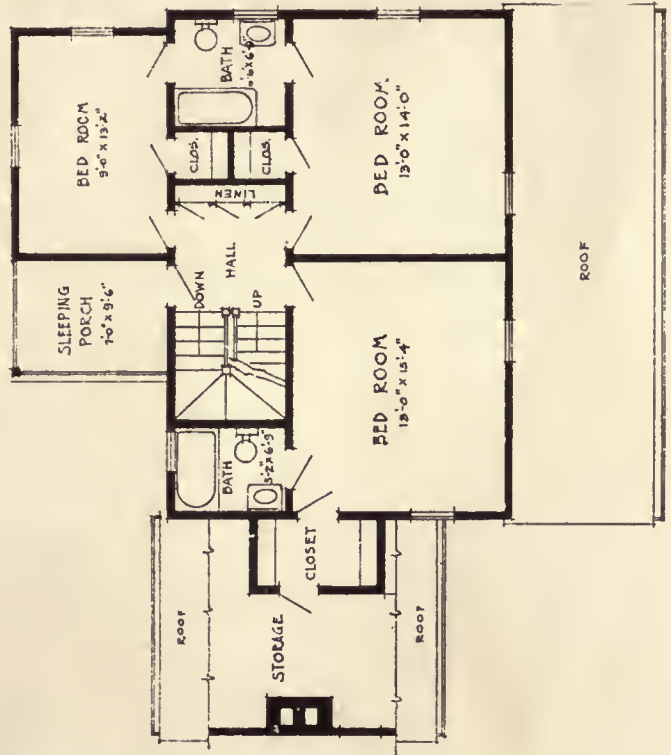
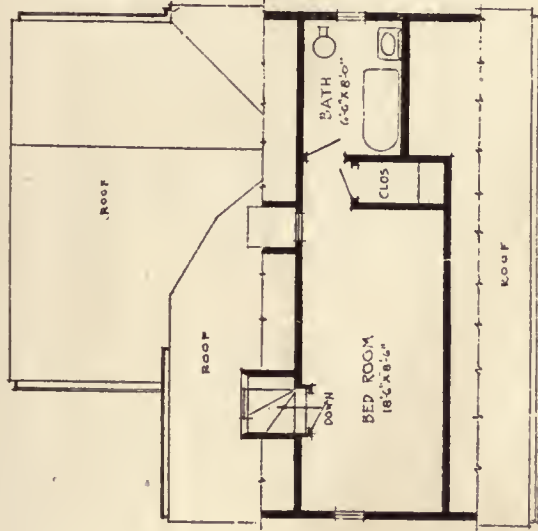
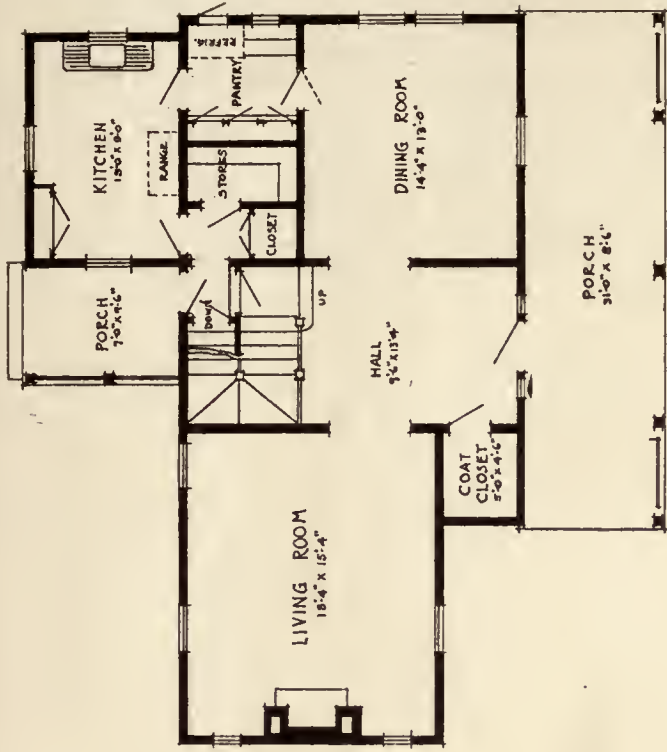

FLOOR PLANS OF HOUSES, TYPE E  
 AYMAR EMBURY II, ARCHITECT

or with every other house alike in long but uniform rows. However well proportioned such a unit may be, it does not satisfy the developing public taste. Or, if the public has no taste, these serrated rows certainly do not aim to develop one.

The way between this Scylla and Charybdis is shown in the housing now illustrated. By a more active working relation between the architects and the investment corporation and by a willingness on the part of those financing the property to admit the commercial value of beauty and to spend money

The next step with this theory of building group houses will be to educate the manufacturers so that with the retention of certain essential standards the finish and fittings shall be varied in some obvious aspect which shall adapt them for carrying out the style or feeling of the house in which they are used.

A man need not be so very old nor so widely traveled to recall the days when large numbers of laboring people at manufacturing plants and even suburban dwellers were housed in rows of

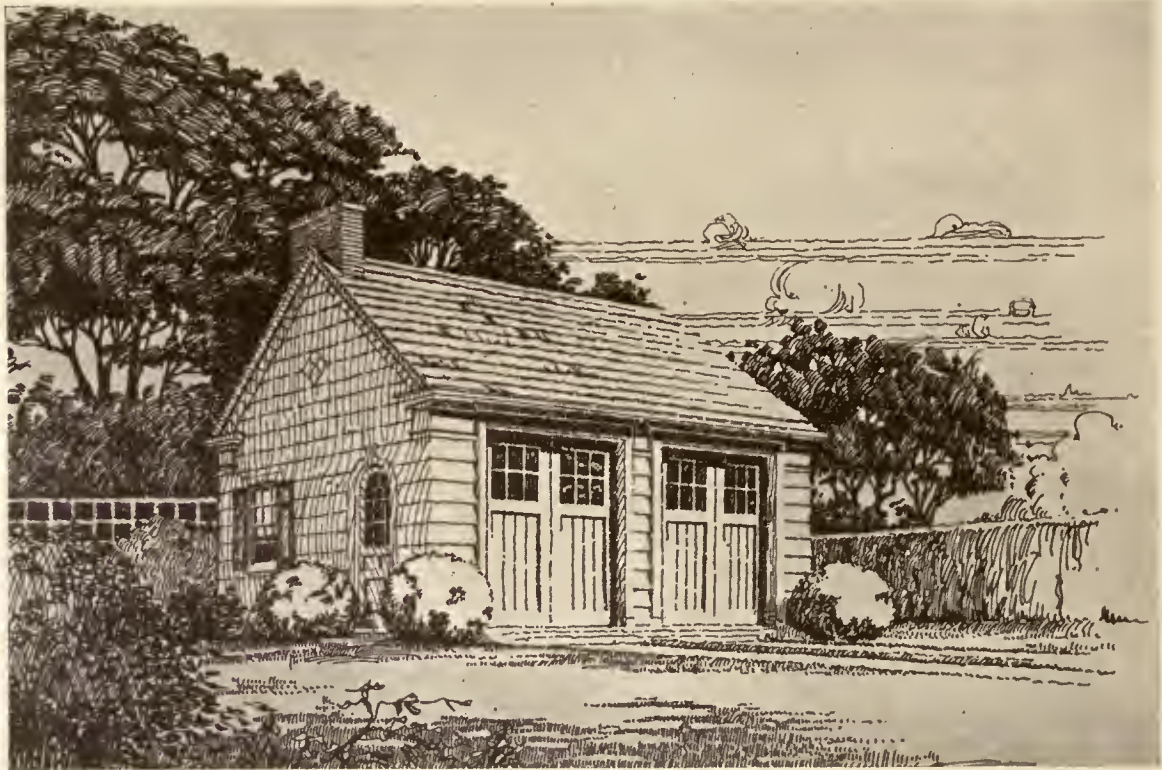

A TWO-CAR GARAGE  
MOTT B. SCHMIDT, ARCHITECT

for it, a community is growing which may make some just pretense to be an environment for modest and refined homes. The architects have been permitted to provide several types of houses instead of the one which might be stamped out *ad nauseam*. In providing these several designs the architects on their part have adapted the plans to group construction. They have provided in some cases interchangeable floor plans, in others that either of two sides of a house may face the street, as well as that doors, mantels, kitchen sinks, bathroom fittings, heaters, etc., may be bought in quantities.

so-called "villas," the monotony of whose exterior killed every last spark of individuality. While our war experience helped greatly to effect reforms in the designing of the low-cost house, it would not be just to groups of architects all over the United States to claim that it was war's emergencies solely that have brought about this very desirable improvement.

For a decade or more the town-planning movement has been steadily coming to the front, and the intricate problems that this movement has developed have received the thoughtful care of many highly trained and exceedingly competent architects.



TWO VARIATIONS OF TYPE E HOUSE  
AYMAR EMBURY II, ARCHITECT

It was through the influence of such men that those who ruled large commercial operations were brought to a realizing sense of the value as a commercial asset of good architecture. The development of manufacturing building design created a pride of occupancy of those who worked in these buildings and the desire to have equally attractive homes was a natural result.

This movement has now, fortunately, spread in every State, so that today there is a certain development of the low-cost house which indicates in

the most emphatic manner the using of a higher level of our standards of domestic life. Naturally those who promote suburban building operations in a speculative way desire to combine every element of business thrift in the furthering of their schemes. Standardization of plans, when the plans have been as thoughtfully developed as in the present instance, will present but few objections and these will be thoroughly overcome when the exteriors show such wide and artistically diversified elements as these architects have skillfully worked out.

---

## Standardization and the A. I. A.

**W**ASTE of abundance is deplorable. But waste of that which is not sufficient to supply demand is criminal. All crime is against public policy.

The American Institute of Architects advises its members that their duty toward the public takes precedence even over their duty toward their clients.

Article 18 of the Institute's statements of "Principles for professional practice" states in part, speaking of the architect: "He should not, even under his client's instructions, engage in or encourage any practices contrary to law or hostile to the public interest; for as he is not obliged to accept a given piece of work, he cannot, by urging that he has but followed his client's instructions, escape the condemnation attaching to his acts."

Having admitted that waste is against public policy and that the American Institute of Architects stands unequivocally for the best interest of the public, it may be concluded, without the formal action of a convention of the Institute, that the Institute is for standardization, if standardization is in the interest of the public.

There can be no question but that the Institute believes that standardization is desirable in certain particulars; always the Institute has lent its co-operation to worthy national movements, which have been working toward standardization. Note their early co-operation with the old National Builders' Association in the preparation of a uniform contract between contractors and owners.

For more than fifteen years committees of the Institute and its various chapters have been working for standardization of catalogs. The Institute has co-operated with the American Society for Testing Materials in its work to secure standard specifications, notably of steel and cement, but also of many other materials.

The Institute has co-operated with the National Fire Prevention Bureau, the Underwriters' Association and various organizations looking toward the perfecting of right standards with reference to fire protection.

For more than ten years the committees of the Institute have been working on standard forms of specifications, bonds, forms of proposals, etc.

There has been no question as to the advisability of securing uniform practice in the foregoing matters. The question now seems to arise as to whether it is not possible, without encroaching on aesthetics, to greatly extend the field of standardization. For surely it must be conceded as a premise to any discussion of matters pertaining to building, that the Institute stands unequivocally committed to the principle that the public interest demands that there must be individuality in design and arrangement.

Building is not architecture unless it gives vent to individual expression. So long as the function of architecture is the housing of human beings, so long must architecture lend itself to the ideals, the ends, the aims and the purposes of different people.

The wisdom of the Creator in making men different is not to be questioned. The outstanding fact is that they *are* different.

Since it is the function of the architect to take cognizance of facts and harmonize them into a logical, economical arrangement, to do this in such a way as to secure comfort and safeguard the life and health of the occupants of a building, to inclose the plan with a covering which is an orderly, consistent expression of the purpose of that plan, it is likewise the architect's duty so to shape this inclosure so as to make it personally pleasing and harmonious. Therefore all true architecture must of necessity take on individual characteristics peculiar to individual occupancy.

The human form is more beautiful than any

other creation of God, because shining through that form is the human soul, but since the soul is individual in character, the expression of every human being, although similar in form and structure, is yet different in line. Likewise, since architecture is the expression of human need, true architecture must be different as well as pleasing and harmonious.

Public duty forces the American Institute of Architects to take firm stand against extremes in standardization, extremes which would tend to take the personal element out of design, extremes which would build our cities with monotonous rows of meaningless mediocrity, illustrated by the abominable aggregations of the ambitious speculator. Fit hatcheries of Bolshevik bunk—destroyers of ambition, monotonous leveling. Surely such living conditions cannot be expected to incubate high ideals.

Forewarned against extremes of standardization, it may be observed that not more than 25 per cent of building make-up can be classed as essential to the spiritual expression of occupancy. The remaining portion of all buildings is practically common in function to most structures.

It is to this portion of building make-up that the American Institute of Architects can be depended upon to lend its complete co-operation in the matter of standardization.

Even in the realm of standardization, however, emphasis must be laid upon the importance of complying with the rules of good taste in design. It costs no more to make stock moldings in accordance with established rules of good design than it does to make them atrocious combinations of the compass-produced curves. All it requires is that the manufacturers of these standard materials shall call to their assistance expert designers.

Witness the transformation that has come over the product of the commercial tailor in the last twenty-five years. Ask any successful clothing manufacturer if he would go back to the old system, or rather, lack of system, in design. Have they employed standardization methods? Certainly they have, but the designing departments of all of the leaders in this line are manned by masters in the realm of art.

Correctly proportioned garments are no less warm because they commit no offense against good taste and certainly they contribute much toward the upward look and confident step of their wearers. Hark back to the farm. Remember the warm, substantial mother-made trousers of a schoolmate of boyhood days? Did they not serve every practical function? Were they not interchangeable, forward acting and back acting? Were not the behind and the before exactly alike? Certainly they complied with all the rules of standardization, except good taste, but to that poor lad they meant shame,

mortification, disgust—conditions of mind not conducive to noble thoughts.

Brick should be standardized as to size, but face brick never as to color or texture. The human eye demands restful change.

Lumber should be universally standardized as to size and grading rules.

Manufactured moldings, both in wood, metal and composition, should be standardized as to size and outline, but the greatest skill should be exercised in their design. Stock moldings should consist of the elements of good moldings so skillfully selected as to make possible innumerable pleasing combinations out of limited stock. This is practical, and at the same time would decrease cost of production and distribution. Properly designed molding elements would be used by architects as well as speculative builders. Speculative building would be less offensive against good taste and specially designed buildings would be reduced in cost by using stock materials. All that is needful to bring this about is for national associations to employ competent designers and issue standard templates and for all manufacturers to co-operate.

Mortar is a medium for uniting masonry parts. There is no reason why it, together with all materials entering into its composition, should not be standardized. Why should we have Haverscamp and Preservemysore wire? Why not have a national association prescribe, say, three grades of wire insulation, and let all manufacturers standardize on same and let the consumer purchase from the nearest source and thus save freight and useless confusion?

Why have different roughing-in measurements for the same type of plumbing fixtures? All that is needed to eliminate enormous waste in this line is national agreement as to standards.

Why 7000 brands of waterproofing with high-sounding names and pestilential salesmen who swoop down on architects' and engineers' offices like the barbarian hordes of the North which consumed Rome? They toil not, neither do they spin, neither do they know chemistry, yet a peculiar secret formula is their plea.

The fundamentals of waterproofing can be summed up in a half a dozen well understood formulae. Why all this waste of gas?

Why 990 different locks when twenty would cover the whole field and leave something for the distinctive design of exposed knobs and escutcheons?

Why five to twenty different quantity surveys for estimates on one building? One carefully prepared survey would insure better and more accurate results, and if the practice was followed throughout the nation, would conserve man power and save millions on millions of dollars of expense.

Why innumerable cost accounting systems leading to endless confusion and waste? It would seem as though two or three well-thought-out systems would be sufficient to cover the whole field.

Why not have standard times and seasons for making statements, issuing certificates, for payment and receiving payment?

All of these whys will lose their force when national associations have completed their investigations, have issued their pronouncements and local co-operation has put them into practice. Then and only then will the present enormous waste of resources be eliminated and the public interest adequately served by the construction industry.

## Berne—City of Mediæval Fountain Statues

**B**ERNE, the capital of Switzerland, occupying a truly ideal situation on a rocky peninsula formed by the river Aar, in full view of the snow-crowned glistening chain of the Bernese Oberland Alps, proves a constant delight to all lovers of well-preserved mediæval architecture. It is a city of cosy arcades, ancient gates and towers, and notably of handsome fountain statues. A reporter for the International Syndicate describes these at length in the following words:

These fountains, he says, are the special pride of the Bernese and a particular object of admiration on the part of all visitors. The constant merry babbling of a spring brings life into the greatest solitude and the sweet monotony of the flowing water seems to soften any harsh and irritating noises caused by the every-day traffic. In biblical times already we find the fountains mentioned as a meeting place and while they are not used to the same extent in these modern days, yet we perceive that they are frequently patronized. Horses and cattle are watered here and the children take a particular delight in making a fountain the center of their playground. Yea, some old-fashioned women could not imagine the possibility of a successful washday if they were not able to avail themselves of the abundant water supply of some fountain; and so it often happens that one can enjoy the most picturesque and animated scenes at the foot of one of those fascinating, silent fountain statues.

These fountain figures, which are mainly emblems of the various trade corporations or guilds, are the most precious reminders of Renaissance art in Berne, and, as they have in recent years been restored in their original gray colors, their unique beauty can again be seen to full advantage.

On our stroll through the Spitalgasse, we perceive, first of all, the comical Bagpiper Fountain—put up by the fraternity of this joyous profession, which also included the wandering musicians. The

statue represents a handsome young man blowing the ancient instrument of his guild; a monkey behind his back seconds him in his performance, and a goose at his feet plays the attentive listener. His garb is typical of the unconcerned life of wandering minstrels. His shoes permit of an ample display of the toes, and the only bright features of his upper garments are the gilt fringes which adorn it.

Two interesting fountains stand in the adjoining Marktasse. One statue commemorates Mrs. Anna Seiler, the founder of the Seiler Hospital, which, in later years, developed into the now famous Insel Hospital. The figure shows a graceful, handsomely dressed woman pouring water into a basin. The other statue, which was erected by the fraternity of the sharpshooters right in front of their guild house, represents a warrior in uniform ready to take part in some friendly military tournament. In his right hand he is holding the banner of the sharpshooters, and a small bear seated at his feet points his rifle in a protectory manner toward the entrance door of the guild house.

Further on, in the Kramgasse, we find the Zahringer Fountain, erected by the city in honor of Berthold V, of Zahringen, the founder of Berne. The figure consists of a bear in full armor carrying the banner and coat-of-arms of the house of Zahringen—a golden lion on a red background. A cub nestles comfortably at his feet, and feeling perfectly safe in such protection, it gracefully devours some grapes.

In the Kramgasse too is the curious Samson Fountain, representing the fight of that hero of the Old Testament with the lion. The Bernese were fond of pointing to Samson as a typification of old Bernese courage and the original report about the battle of Laupen in 1339, where the Bernese under Rudolph von Erlach gained a victory over the army of Fribourg and its confederates,

*(Continued on page 583)*



## Remodeling London

AT a recent meeting of the Royal Institute of British Architects Mr. Delissa Joseph read a paper on "Higher Buildings for London." The present limit of height is 80 feet. Mr. Joseph advocates that buildings 200 feet high be permitted facing parks and the river and that in the case of thoroughfares more than 80 feet wide buildings be carried up to a height equal to the width of the thoroughfare.

Two hundred feet, compared with the buildings of downtown New York, is not very high, but it would make a distinct effect upon London's skyline. It might belittle the effect of the exquisite spires of London churches. And it would most certainly augment the demands upon the transportation systems. These are dangers which might with wisdom be counteracted.

Some of the objections offered are quite amusing to the American mind. One gentleman asks, if children are living sixteen to seventeen stories up, how are they to get out to play. He foresees the elevator getting out of order and old ladies climbing 400 steps. He imagines a fire and no means of fighting it, no means of escape and an appalling loss of life.

The very interesting proposal that areas of 50 acres be taken at a time, the old low buildings torn down and new ones erected with open spaces between was said to be impractical because the workmen who were to live in them wanted, not so much hot water and central heating, but a plot of ground where they could raise cabbages and potatoes. A London workingman does raise a surprising amount of truck in his little garden—but inasmuch as the higher buildings would occupy less land than the old ones, it is hard to see the force of the argument. The effect of these groups of high buildings surrounded by parks, playgrounds and truck gardens might be most attractive. There is no reason why care should not be taken (as we have not done) to protect the dignity of church spires, old

palaces or public buildings from the immediate proximity of the skyscrapers.

THERE is no reason why æsthetes should view with alarm "beetling heights, towers of Babel and concrete cliffs." Such beauty as there is to London is not in the monotonous sea of two-story cottages which stretches endlessly from Peckham Rye to Hampstead. But in this sea there lie little green islands—charming little islands—so unexpected, so inviting, so quiet that after one pauses and goes in one feels that at last he has found a home. The past and the future drop away before the impressive peace and calm of the immediate present.

London in May! Think of it! Flowering shrubs and lawns, tulips and hyacinths—and outside somewhere the beating pressure of the great city. Could it ever become a Downtown New York or a Loop District? God forbid. But for the addition of another Lincoln Inns Fields, a Finsbury Circus or a Bunhill Fields, and for a few more "Greens" and "Commons" here and there, who would not sacrifice the endless dismalness of cottages and accept in their stead groups of apartment houses.

## "Americanism"

IN a forceful editorial on Americanism, the *Newark News* seeks to safeguard our constitutional rights by calling an abrupt halt on the misuse of the word "Americanism." This is a subject that cannot be too insistently reiterated. As the *News* very rightly claims, Americanism does not mean what some people are trying to make it mean. Its connotation must be kept clean and clear. Then, representing as it should, all that is sacred to the natives of this land, it would not be conjured with by men unscrupulously using the very force it bears. It should not be used to further ulterior motives instead of the idealism and progressiveness for which it actually stands. Americanism is not a code of conduct; it is a state of mind.

To apply the word for a special individualistic or class purpose is not only deceitful treason, but socially dangerous. "If Americanism means that," a man may say, referring to some improper application, "I don't want Americanism."

Some social and industrial reforms are attacked as "un-American." Even criticism of existing conditions, no matter how sincere or just, often bears the same stamp. It has become, in the minds of some, un-American to protest, to present grievances, despite the fact that "the right of people to assemble and present just grievances" is one of the corner-stones of the American Constitution.

Americanism is not a cloak behind which to hide. It is not an eternal negative to all proposed changes. It is not worship of what has been. Neither is it the opposite. It may be one or the other, depending upon the circumstances involved.

Unless the word is to have a false or perverted connotation, its loose use must end and people, in using it, must search their souls deeply lest they desecrate a beautiful and lofty word-conception.

---

### Profiteering in Labor

THE present unsettled conditions in the field of labor are responsible for the development of abnormalities that seriously affect an early return to static conditions. Further, in the case of shortage of labor, supply methods are being pursued that are reprehensible from the standpoint of business integrity. Competition is the life of trade, but only competition that is honorable and straightforward. Any other methods are simply business dishonesty.

There are certain ways of handling labor on construction. A builder may join a local group of con-

tractors and work in co-operation in supporting the local existing agreements. He may learn all the factors as affecting the local building situation and either work with the other builders or independently as he may elect. Or he may enter the field of labor, over-bid existing scales and by specious allurements win labor from his building competitors. The first is the method pursued by honorable men, the second stalks very near the rim of reprehensible methods, the last is a badge of business obliquity.

It is learned that in some sections builders with large contracts who have entered local fields have raised rates and otherwise upset existing agreements. Inasmuch as owing to the lack of stability both as to labor and materials, the majority of building contracts are today proceeding under a cost-plus agreement, such irregularities largely augment the cost of construction and place a burden on the owner that he should not be compelled to assume. And if any argument was needed further to prove the vicious principle that underlies the cost-plus contract it could certainly find its main contention in conditions where contractors over-bid an already abnormally high scale of wages.

As a form of profiteering in the building industry, dangling a bait of high wages based on an advance over agreed scales is as truly profiteering as any form that is now being carefully investigated by the Government and has thus far led to a large number of well-merited convictions.

Further, this action in over-bidding agreed wage scales is utterly selfish. A contractor, having entered a local market, thoroughly unsettling its labor conditions by angling with high wages for labor, retires with his profits and leaves the local contractor to suffer from an unsettled condition for which he is in no way responsible.



## Berne

*(Continued from page 580)*

mentions that the men from Berne met the enemy after the style of Samson, bold and unafraid.

From the Kramgasse we emerge into the Gerechtigkeitsgasse, in the middle of which we perceive the fountain of the same name, i. e., the Fountain of Justice. The statue shows a blind-folded woman with a pair of scales in her left hand. At her feet are four small figures—Pope, King, Sultan and Burgomaster—the representatives of the different kinds of state legislation. All listen earnestly and with closed eyes to Justice, admitting her sovereignty in each and every land.

The most curious of Berne's fountains is, however, the Ogre Fountain, representing a Jew in

the act of devouring a child, while several other infants are held in readiness in his pockets. The sight of this statue has still an awe-inspiring effect on all youngsters, and the name of it alone frequently suffices to change a naughty behavior into a docile one. The figure is said to have been erected in memory of a ritual murder wrongly attributed to the Jews. On the lower portion of the column a procession of armed bears appears to be bravely marching to battle.

While Berne is not the only Swiss city which can pride itself with such truly artistic ornaments, the fountain statues of the capital are particularly noteworthy for the remarkably uniform execution of the characteristic figures and the regular and unique distribution over the town.

---

## Pompeian Wall-Painting

The interest in period rooms, or rooms finished in a definite style, is not an essentially modern characteristic. Just as we today endeavor to adorn our homes with harmonious decorations, so the ancient-Italians strove to beautify their dwellings. And these decorations, because of the nature of their buildings, and because of the desire of the people themselves to emulate palaces of the nobility, took the form of wall-paintings, or frescoes. The best examples of these ancient decorations, which, paradoxical as it may seem, were preserved only in their destruction, are to be found in and around Pompeii. Because of this fact, according to *Arts and Decorations*, all ancient Italian frescoes are classified as Pompeian in style.

They are found, as has been said, upon the walls of the houses. The Italian house was built, as is true even now, of stucco, a sort of plaster finish over a foundation of brick. But we should not confuse ancient plaster with our knowledge of the crumbly plaster of today. The process of its application is more complex. Upon the rough foundation, *trullissatio*, are laid in succession, evenly and smoothly, three coats of lime and sand. Then follow three coats of lime and marble dust, "at first coarse, then finer, and in the uppermost coat of all the finest powder." The wall may now be finished either with a high polish, which may "attain such a brilliancy," says Vitruvius, "that one can see his face mirrored in its surface, or with a coat of color applied in the fresco technique."

Although the circumstances of the original discovery of the process of fresco painting, *udo illinere*—"to paint upon the wet"—as Pliny calls it, are

unknown, yet the method was a matter of common every-day knowledge to the ancient Italian. Stated in simplest terms, fresco painting is painting with a wash of liquid pigment over the freshly laid surface of plaster, thus becoming incorporated with it when it is dry. The explanation of this process is a chemical one. When the limestone is burnt into lime all the carbonic acid is driven out of it. When this lime is slaked by being drenched by water it drinks this in greedily and the resultant paste becomes saturated with an aqueous solution of the hydrate of lime which rises to the surface of the plaster. As the wet pigment is applied to this liquid hydrate of lime, it diffuses into the paint, soaks the plaster through and through and gradually takes up carbonic acid from the air, thus producing carbonate of lime, which acts as the binding material, forming a sort of crystalline skin and gives the colors a peculiar lustre.

Fresco technique is essentially a color finish to plaster. The pigments are mixed with nothing but pure water and palette of the artist is limited practically to only the earth colors, such as the ochres, even white having to be made from lime. White lead, vegetable and metallic pigments, Vasari tells us, do not hold their colors so well and are as a rule avoided.

Pompeian wall-paintings can be grouped under four general classes depending upon the period of their origin. Pompeii was essentially the home of rich traders, who possessed sufficient means to want if not to afford elaborate dwellings. In order to obtain the grandeur of marble palaces there was devised a plan of painting in imitation of marble slabs

in relief. This is known as the incrustation style and dates from pre-Roman times.

Developing from this style of incrustation, and contemporary with the Roman Republic, arose the device of imitating both the marbles and the panelled reliefs by painting. Moulded cornices were employed somewhat, but their projections became very slight.

The third style, of about the same period as the Roman emperors, was the least faulty and the most refined of the four styles. Here the human figure assumed greater importance and we find nymphs floating in diaphanous drapery against solid backgrounds of deep color. Fauns and bacchantes dance endless sarabands under light porticoes in the friezes.

It is this architectural feature which the fourth period developed to a pompous and theatrical extreme, with its spindlelike columns and its all too slender caryatids. This style dates from the year 63 A. D., the time of the earthquake, when the city was severely shaken and many of its important houses were destroyed, to be rebuilt optimistically, to the year 79 A. D. This was the date of the final destruction, when the gleaming sword which had hung so many years over its head fell, and the city was buried under a rain of ashes vomited forth by Vesuvius.

Nor were these decorations confined exclusively to the rich, for even as we employ workmen to paint our houses, so the Pompeian commissioned the decorating of his walls. Nevertheless these paintings possess to a surprising degree a charm and a grace that belie their artisan origin.

The School of Design has recently acquired a piece of Pompeian wall-painting, which is an excellent example of the third period, and characterized by the careful modelling of the features and by the background of deep color. Here we have pictured a woman, seated, three-quarters front, holding a lyre in the crook of her left arm to which she points with the right hand. The gesture indicates that the instrument is thought of as an attribute, and the evident feminine characteristics of the figure lead us to suppose that the muse of music is intended, despite the fact of the popularity at that time of the feminine type of Apollo. The symbolic pose of the figure is paralleled in the Apollo in a fresco at

Pompeii depicting the Marsyas and Apollo legend. Nor is this idea unusual or unique, for we find a similar composition even in the works of Greece, notably in a relief on the marble base from Martineia, now at the National Museum, Athens. The simple hairdress, the restrained features of the face, the dignified folds of the garments, all bear out the conception that the figure is an abstraction rather than a concrete portrait. She wears a tunic, twisted on the left shoulder and draped loosely over the right, revealing a neck delicately tinted in flesh tones. Over all is thrown a flowing outergarment of violet contrasting sharply with the brilliant red background. She is seated upon a highly ornamented chair—or is it a sort of architectural parapet—and as such conceivably a part of a larger design. At the base of the stool is a portion of a wing. Can this be the wing of a sphinx? Such a figure would work into a larger decorative scheme. Parallels of the sphinx motives are innumerable.

The seated figure in Pompeian painting is common, but usually in profile or full front positions, the intermediary pose only rarely. The closest parallel to our muse is found among the Boscoreale frescoes in the Metropolitan Museum of Art. I refer particularly to the painting of the Woman Playing the Lyre from the grand triclinium. Here we have pictured, seated upon an elaborately decorated chair and richly decked with jewels, a woman playing a lyre. Behind her stands a girl, an interested listener to the music. The same grace and charm are displayed in this group as is evinced in the School of Design painting. The facial types are similar, the hair-dress is identical and the shoulders are turned at the same angle, but the position of the feet differs. Both wear white and violet robes which are juxtaposed against a brilliant red background. The striking difference is that in one we evidently have a portrait, but in the other an allegorical figure.

The allegorical tendency of Pompeian paintings is more nearly typical of that Greek culture which they mirrored. Their importance lies not so much in giving us a conception of the Hellenistic character of Roman life, as in preserving for us an inkling of their prototypes, the Greek paintings themselves.

584

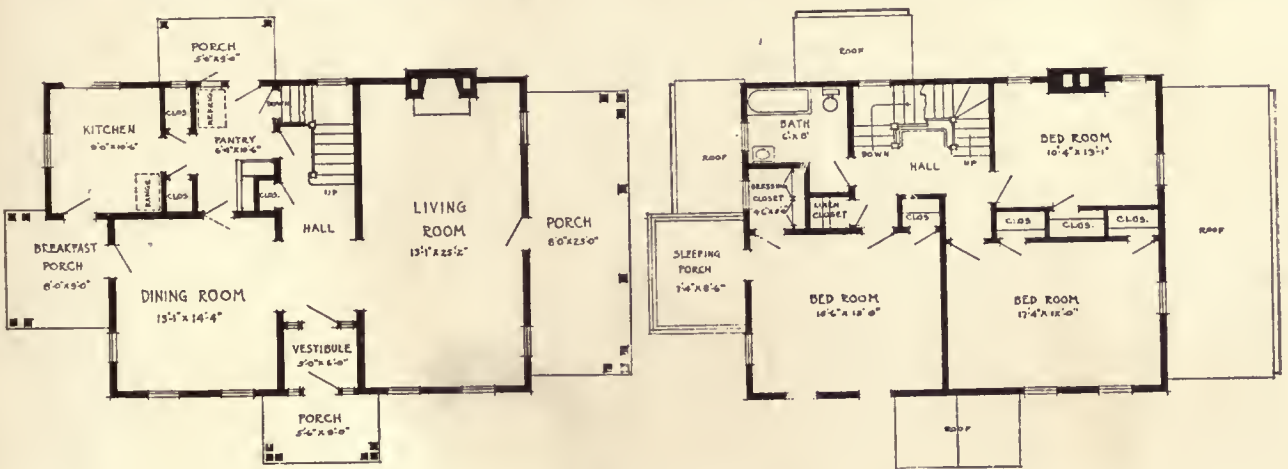

SIX-ROOM HOUSE—TYPE G  
GEORGE GILBERT, ARCHITECT



584<sup>2</sup>

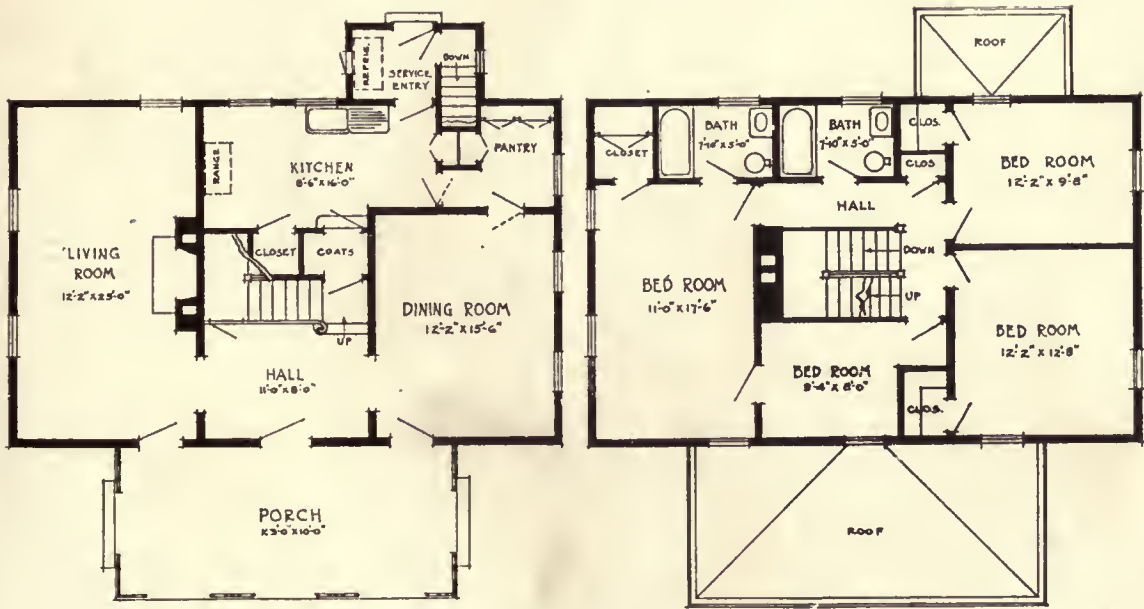

SEVEN-ROOM HOUSE—TYPE S-1  
MOTT B. SCHMIDT, ARCHITECT



584

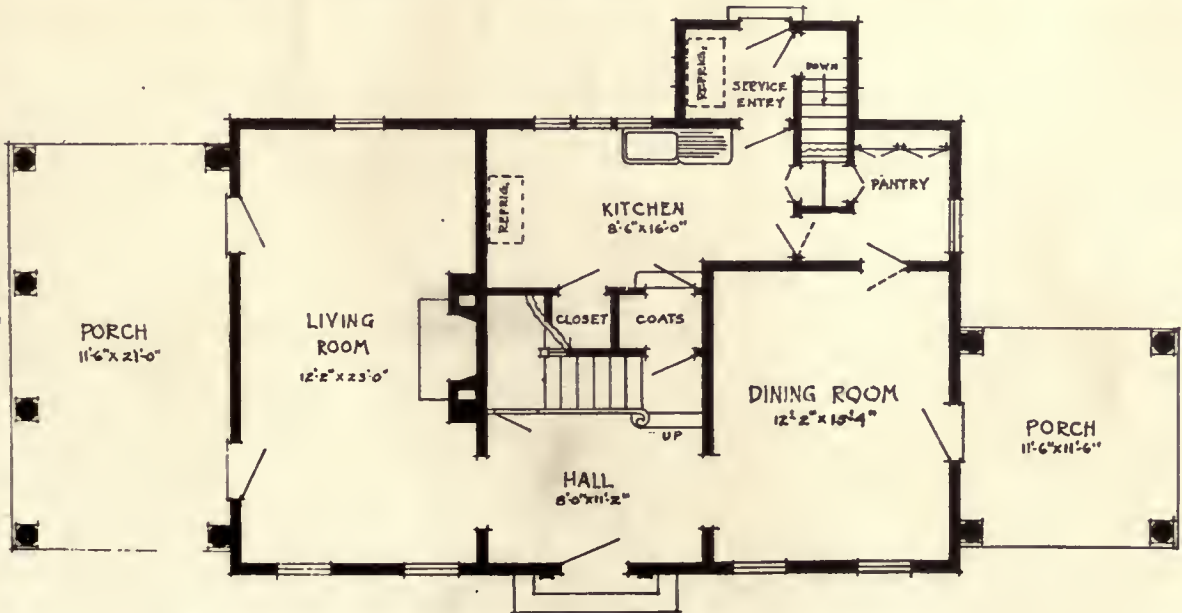
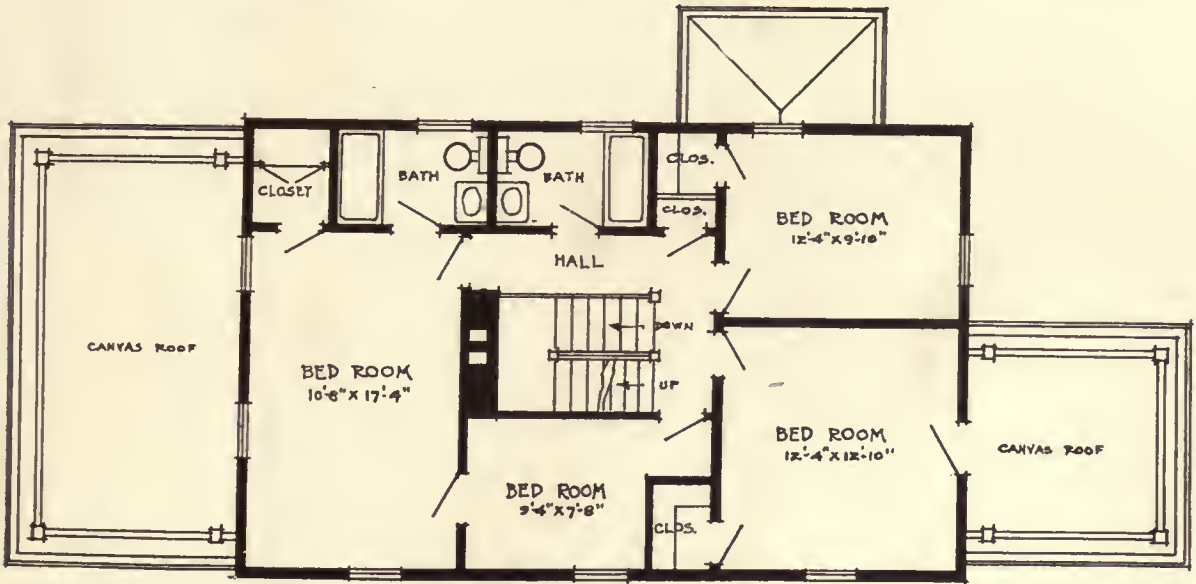
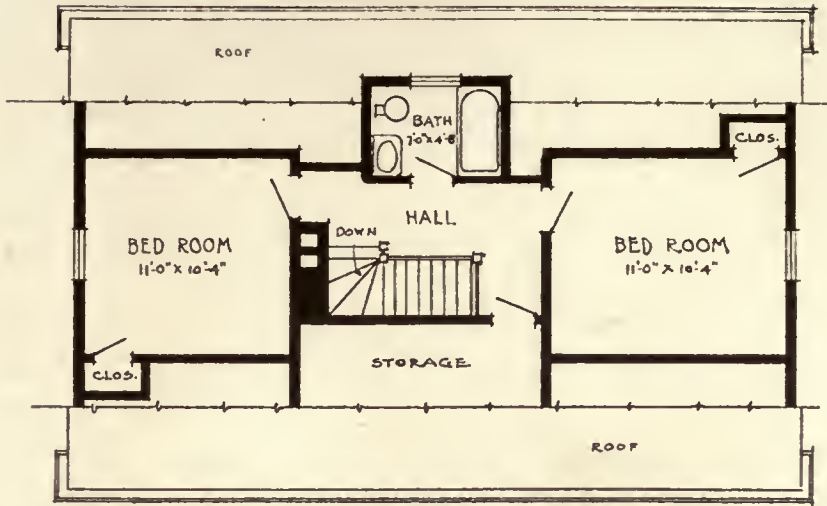

FLOOR PLANS, TYPES S 2 AND 3  
MOTT B. SCHMIDT, ARCHITECT





4  
5-8A



TWO VARIATIONS OF TYPE S  
MOTT B. SCHMIDT, ARCHITECT



VARIATION OF THE TYPE G, SIX-ROOM HOUSE  
GEORGE GILBERT, ARCHITECT



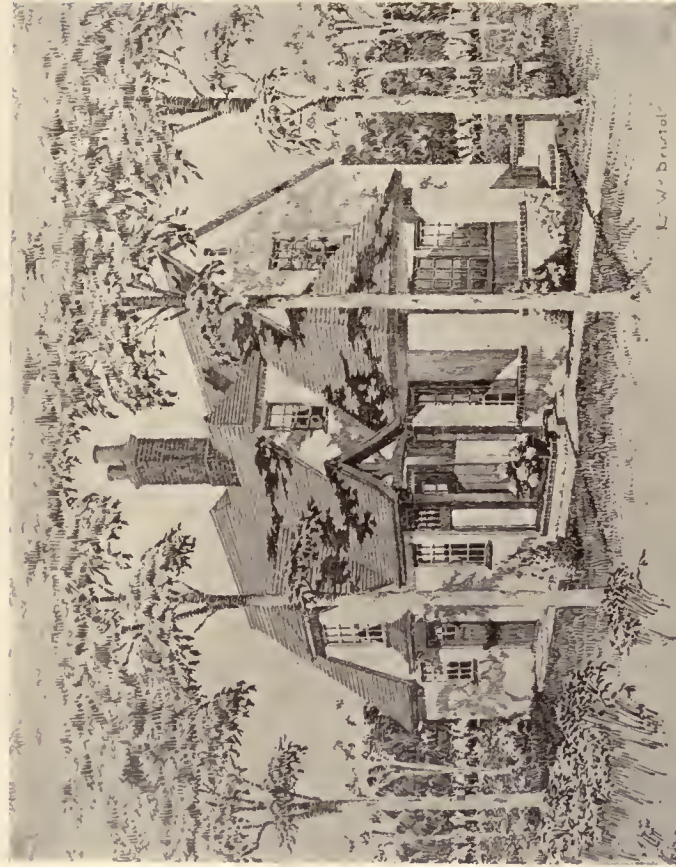
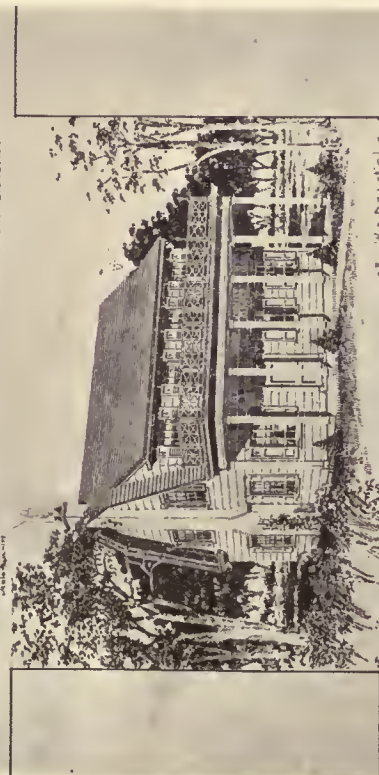

TYPES OF HOUSES AT GARDEN CITY, LONG ISLAND, N. Y.  
R. W. BRISTOL, ARCHITECT



5-84  
6

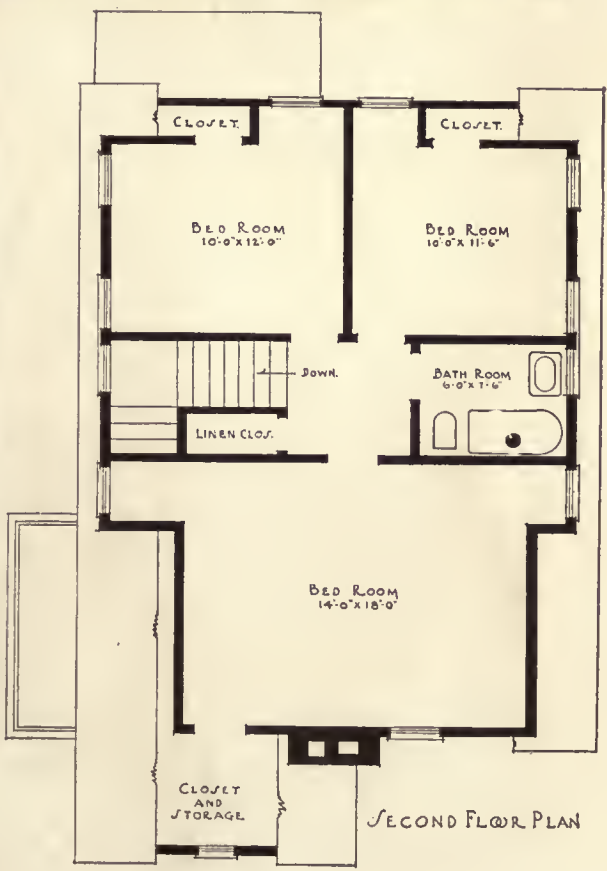
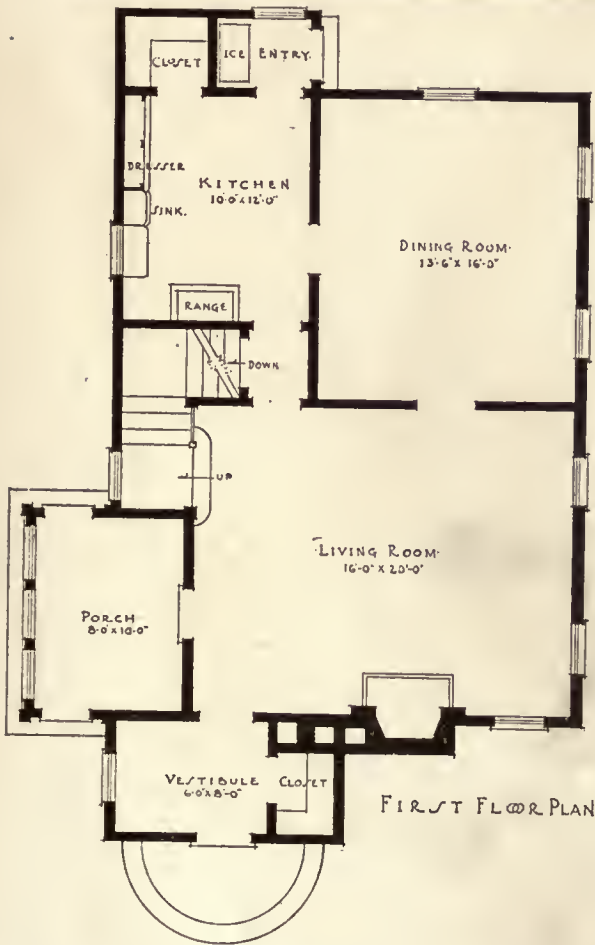

A SIX-ROOM TYPE OF HOUSE AT GARDEN CITY, LONG ISLAND, N. Y.





JAMES H. BROWN BUILDING, DENVER, COLORADO  
J. B. BENEDICT, ARCHITECT

584  
7







FIRST FLOOR PLAN



TYPICAL FLOOR PLAN

JAMES H. BROWN BUILDING, DENVER, COLORADO  
J. B. BENEDICT, ARCHITECT

584  
8



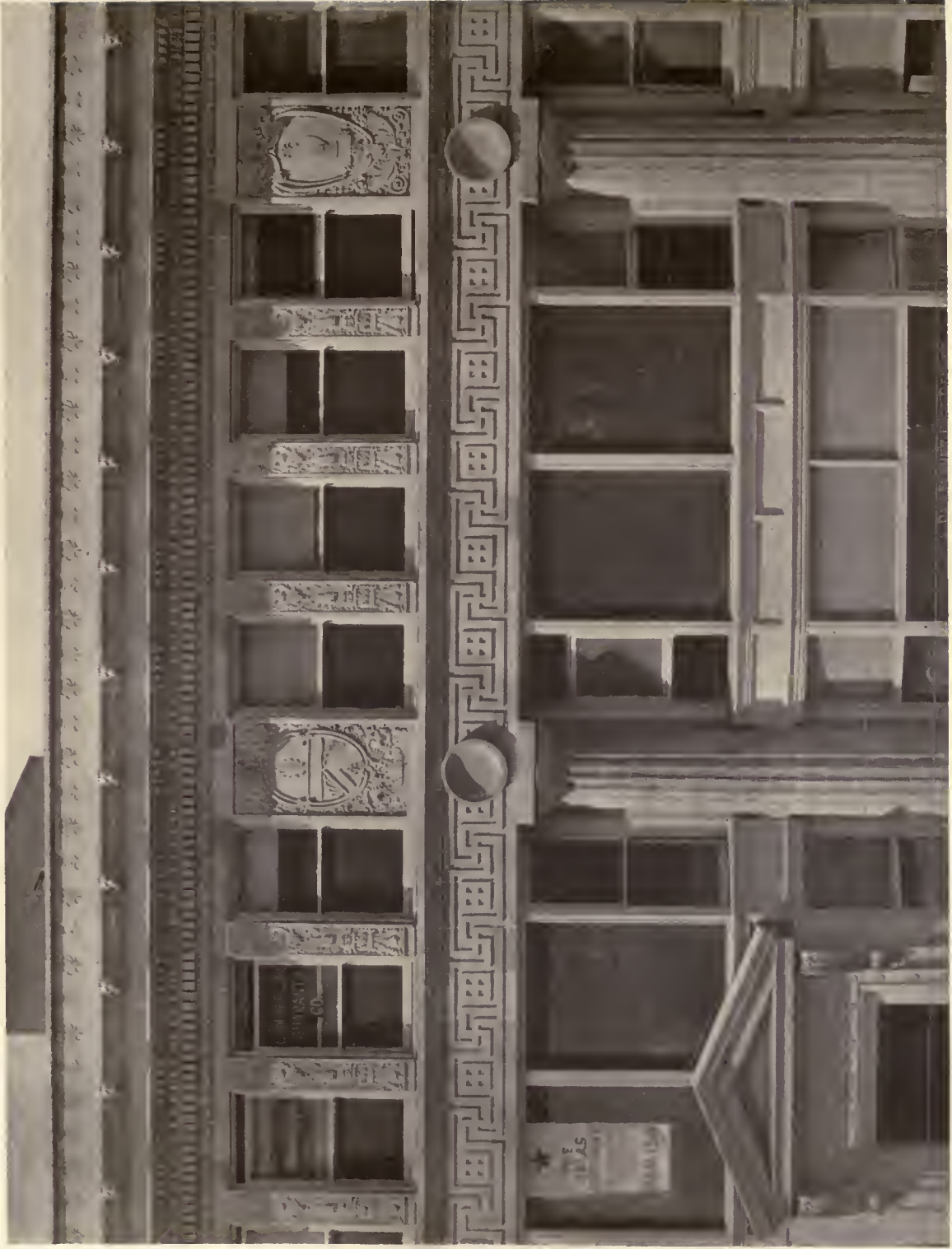

DETAIL OF UPPER STORIES OF JAMES H. BROWN BUILDING, DENVER, COLORADO  
J. B. BENEDICT, ARCHITECT

584  
a



# Current News

---

## Happenings and Comments in the Fields of Architecture and the Allied Arts

### New York Society of Architects

An important and numerous attended meeting of the New York Society of Architects was held at the Society's headquarters, the Engineering Societies' Building, West 39th street, President James Reilly Gordon in the chair, on April 21.

Revision of the Architects' Registration Law was discussed at length, attention being called to the proposed change abolishing the title of Registered Architect and substituting for it that of plain Architect. Also the requirement of an affidavit from an applicant for a certificate, claiming that he had been in practice prior to the passage of the act.

Much interest was shown in the matter of proposed Junior League affiliated with the Society.

As bearing upon this question, Mr. McCarthy referred in strong terms to the practice of some so-called architects—stigmatized by the speaker as "pikers"—who, rather than stand for a legitimate price for their work, are willing to accept a merely nominal fee, regardless of professional dignity or ethical obligation. He coupled with these men certain officials of the Building Bureau, who act as intermediaries between speculators and practitioners of the class referred to. Mr. Henry Holder was appointed the Society's delegate to the Brooklyn Superintendent of Buildings to make inquiry into this matter.

Secretary Frederick Zobel gave utterance to strong feeling—which was largely shared by members present—as to the numerous bills before the Legislature tending to restrict building operations, and urged the importance of sending a protest to the Governor, asking him to veto all such measures.

---

### England's Unemployment Insurance Bill

The Bankers' Trust Company has received from its London correspondent complete details of the new Government Unemployment Insurance Bill, by which it is proposed to give out-of-work protection to almost the entire employed population of the United Kingdom between the ages of 16 and 70 years.

The new bill is to supplant the present British unemployment insurance plan which applies to about one-quarter of the workers (3,500,000 persons) and pays out-of-work benefits of 11s. a week. Under the plan now before Parliament the benefits are to be increased to 15s. a week to men and 12s. to women. Workers between 16 and 18 years of age will receive less than adult persons in case of unemployment.

More than 11,700,000 workers will be immediately eligible to insurance under the proposed plan. Agricultural and domestic services are excepted employments and in Ireland only workers insured under the present plan are to be eligible. But means are to be provided whereby the Min-

ister of Labor may bring excepted industries under the new plan.

The bill provides the following method of financing the insurance: Male workers will each contribute 3d. per week and their employers will contribute 3d. per week for each man employed. The rate paid by female workers will be 2½d. per week and an equal amount from employers. Lower rates will be collected for workers between 16 and 18 years of age. The Government will contribute a sum equal to one-third the total amount collected from workers and employers.

It is estimated that the Government's contribution will be about \$15,000,000 a year. The cost to the Government of the present insurance has been about \$6,250,000 a year. This Government assistance and the collections from workers and employers accumulated a reserve under the old plan which permitted of the benefits being recently increased from 7s. to 11s. pr week.

Industries will be permitted to set up special schemes of their own provided they give equal or superior advantages to the new Government plan, and a state grant will be made to these special plans. But it will not be in excess of one-tenth the estimated amount of the total contributions which would be paid by these employers and employees under the general scheme. It is calculated that about 3,800,000 workers, or about one-third of the total number insurable, may place their insurance in special schemes of the various industries.

Principal conditions that will apply to the payment of benefits are:

Benefits not payable until at least twelve contributions have been paid and until at least six months have elapsed since first contribution was paid.

Amount of benefits that may be drawn limited to one week's benefits for every six contributions paid.

Applicants must be capable of, and available for, work but unable to obtain suitable employment, and must give proof of unemployment by daily attendance at appropriate reporting places.

---

### Times Square

To many good Americans the hundred blocks or so bounded by Twenty-eighth and Forty-eighth Streets, and by Eighth and Park Avenues, in New York, form the center of the universe, declares the *Survey*. For, this is the center of theatreland and, incidentally, also the hotel center of the metropolis. A survey undertaken by the metropolitan area committee of the Interchurch World Movement brought out the fact that every minute three temporary dwellers enter and leave this area, accommodated in ninety hotels, seventeen clubs and 493 boarding and rooming houses. Only some 5,000 families live in the area; but its forty-five theatres and ten moving picture houses hold 78,000 persons and have an average weekly attendance of nearly a million.

## The World's Most Perfect Carillon

The world's most perfect carillon is claimed by the Roman Catholic Cathedral of St. Colman, at Queenstown, Ireland, of which Pugin & Ashlin were the architects. It has just been dedicated. A special feature of the ceremonies of dedication was the inauguration of the carillon, on which recitals were given by M. Nauwelaerts, the city carillonneur of Bruges. The carillon of 42 bells, with clavier, compass  $3\frac{1}{2}$  octaves chromatic, is considered to be the largest and finest in the United Kingdom, and the most perfect set of bells in the world tuned to equal temperament. The founders are Messrs. John and Denison Taylor of Loughborough. The carillon was designed by and erected under the supervision of Mr. W. W. Starmer, the expert in bells. The great bell weighs 6,775 pounds, and the smallest only thirteen pounds, the total weight of the 42 bells being seventeen tons.

## Archæologists Excavate Palace of Edward the Confessor

Not in many years has any discovery so interested English antiquarians as the recent finds in Windsor Park during excavations made by Captain Vaughan Williams to try to locate a palace supposed to have been built there by King Edward the Confessor. American antiquarians also are evincing much interest in the discoveries.

Just before the war Captain Williams got permission to excavate. Following the trail of an old Roman road he had located, he came to the park wall, near Bear's Rail. There he found the outlines of two moats of distinctly Roman character. Later he found bits of Roman tiles scratched up by rabbits. The war ended his work.

This past summer he resumed it and his digging has resulted in one of the most remarkable antiquarian discoveries ever made in Great Britain. He had hardly scratched the surface before he brought to light stones similar to those of Windsor Castle, but uncut, rougher and much older.

King George visited the excavations. Then the Berkshire Archaeological Society did so and money was raised to continue the work.

At the present time the excavation has revealed two square moats (outer and inner) inclosing buildings, the whole covering two acres. A complete Saxon kitchen of perfect descriptions, with two hearths thirteen feet square and central passage about eighteen inches wide, were unearthed. These hearths were used for basting two oxen. Both are in a fine state of preservation.

The kitchen adjoined a large H-shaped building thought to have been the palace of Edward the Confessor, which covered most of the ground within the two-acre inclosure. On the right was a buttery and a small porch at the back and a large porch leading on to the courtyard.

A little chapel was then discovered, inside which is an altar eight feet by two.

Here was another most interesting find—a hearth with a channel, evidently ancient Saxon. Many eminent antiquarians believe this to be a pagan sacrificial altar. In the same chapel was found a Christian altar. In Bede's "Chronicles" reference is made to King Redwald of the East Saxons having two altars, one pagan and the other Christian.

While there is yet no direct proof that Edward the Confessor occupied a palace in Windsor Park, Captain Williams believes that he chose the place because it is 400

yards from a hot sulphur spring and that the Confessor's healing miracles probably were connected with the curative properties of the sulphur springs.

Interest in Captain Williams' excavations has been heightened by the discovery that Edward the Confessor's palace is above a building of the Roman era. He has obtained pieces of Roman terra cotta tiles during the digging.

## Tyrannical Unionism and Industrial Arts

The industrial arts, cherished so sincerely by our forefathers, have faded from existence, or so states the *Seattle Star*. The tradesman no longer injects touches of art into his handicraft. He turns out goods that are practical, but absolutely void of imagination, and which are undistinguishable from the thousands of others that his fellow worker turns out. This prevalent condition, according to a number of critics, is due to the many inventions which take the place of men in factories, also to the world's cry for practicability in its heedless race to forge ahead.

It is very true that the installation of machines in factories has obviated hand-work in manufacturing articles, and that the necessity for speed tends to kill industrial art, but these things alone cannot be blamed for the decay and downfall of the industrial arts. The worker who manufactures an article with the use of a machine has practically as great an opportunity, if not more, to use his imagination and skill as the man who fashioned the same article centuries ago with a knife or some other crude instrument. He can add touches to it that would brand it as his own and in some cases increase the value considerably, but—does he do it? No.

Tyrannical unionism has killed the last spark of ambition in the worker of today. Unions have slowly built around themselves a barricade of laws which govern not only the laborer but also the employer. They dictate in such a manner that the man employed in a union shop has nothing to fear from his employer as long as he does some work and is in good standing with his local. They hire a man with the understanding that he must conform with the laws of the organization and that he must not scab on another craftsman by doing any of his work or using his tools. Not only that, they regulate wages and a thousand and one other things. Naturally the laborer has no occasion to please any one except his union officials. His initiative is destroyed and in this there is no greater enemy to industrial arts than tyrannical unionism.

## The Indian as an Artist

The bureau of American ethnology has just issued a fully illustrated article, entitled "Designs on Prehistoric Hopi Pottery," by J. Walter Fewkes. The book is intended as an aid or rather incentive to the study of aboriginal art, and an appreciation of the American Indian as an artist. Although primarily for art schools where decorative motives are studied, it might likewise be of value in public schools or wherever attention is given to designs that are purely American in origin. Our moccasin-dressed Americans have a wealth of suggestions to make to those of us who have long lived under a higher civilization.

There is an ever-increasing demand for a distinctive American art which is being met in various ways by our museums. Many decorative motives are found in the

rich symbolism found on prehistoric Indian pottery, before it was modified by white influence. Some of these designs still survive among the living Indians, but a much greater and less adulterated form persists in prehistoric bowls and vases brought to light by the spade of the archeologist.

Probably the most famous of all the survivals of a prehistoric religion among the aborigines of the United States is the celebrated snake dance performed biannually among the Indians called the Hopi, who live some seventy miles east of the Grand Canyon of the Colorado. In this ceremony the participants in the dance carry live reptiles; but this startling ceremony is only one of the interesting things about these people.

They are wonderful potters; and the schools or wherever attention is given particular interest about this pottery is its complicated symbolism connected with their religious ceremonies. An analysis of this symbolism shows that the favorite natural object represented in it is the bird and the feather. In the many modifications that exist of this symbol, the majority are so far removed from realistic representations that it is extremely difficult to detect and interpret the figures. This could only be done by one who is as familiar with the subject as the author, who has spent many years in studying the surviving rites of this interesting people. So far as geometric decoration goes, with the exception of the egg and dart pattern, there is no design known to Greek or classic nations which was not independently discovered in America and used by this people. We find also the sun and earth also depicted with various animals, one of the most important of which is the mythic serpent with plumes. The specimens considered in this article are on exhibit in the United States National Museum and would well repay an examination by all students of American symbolism.

## Dearth of Office Buildings in London

Owing in part to the commandeering by the British Government during the war of numerous buildings previously occupied by business firms for the purpose of accommodating war staffs, and still more to the total cessation of building operations, there is now an acute dearth of office accommodation in London, states Alfred Nutting of the American Consulate General, London.

Buildings which were in course of erection in 1914 and 1915 were completely abandoned, derricks, cranes and other machinery dismantled, and the partly built edifices left untouched.

Since the armistice operations have been resumed on these buildings, but the accommodation provided therein had been leased long ago in anticipation of early completion, and consequently the fact that such offices have become available has not tended to ease the incessant demand. With the active resumption of trade, foreign and domestic, and its ever-widening extension, new firms and corporations find an almost insurmountable difficulty in securing location in which business can be transacted.

Recently it was stated that a proposal had been considered to extend the boundaries of the "city" of London on its northern side so as to take in some of the open spaces or unused land for the purpose of providing office buildings, but whether or not this suggestion will develop into accomplishment is for the future to answer.

Meantime, temporary wooden huts and buildings erected by the Government in squares and other open spaces in and near the "city" during the war are reported to be eagerly leased by business men and firms at rentals of

£220 (\$1,070) per annum, a sum that formerly was sufficient to secure conveniently fitted accommodations of a more or less commodious character in substantial stone and brick buildings.

## Memorial Trees to Be Planted on Arbor Day

That every school in New York State plant on Arbor Day of 1920 a memorial tree for every former student who died in army service is the Arbor Day suggestion of the New York State College of Forestry at Syracuse.

In order to assist in this living memorial, the College of Forestry will give assistance and advice, and will also secure for each such tree a properly marked metal tablet in the form of a shield from the American Forestry Association, which will register the memorial and add the tree to its honor roll of the nation's soldier dead.

One method of celebrating Arbor Day would be the planting, if there are enough soldiers to be thus remembered, of a row of memorial trees to make a memorial roadway from the school building to the street, or to make a shaded street in front of the building.

The New York State College of Forestry, while it trains students for the forestry profession, also has another mission, and that is to take to the State assistance in developing forest areas, and particularly in inspiring children with the idea of the value of the tree to the State. For school ground development it has on its extension staff a landscape forester as a specialist in such work.

The college believes that public schools should be beautified with proper shade trees, just as the farmer should be assisted to get a tree crop, and a future income from land not adapted to farm crops, and the Arbor Day suggestion is to foster the idea of growing trees as well as to provide a real living memorial for the soldier dead.

The college itself plans the same memorial to its soldier dead, for it lost twelve men in action, after sending 300 of its boys to front line trenches or training camps.

## Children and Apartment Houses

The owners of apartment houses in San Francisco, as the result of a month's campaign directed against them by several civic organizations, have changed their ruling with regard to children. During the campaign the accusation was made that the average apartment house owner would not, under any circumstances or conditions, permit small children to live in their apartments. To meet this condition, a special meeting of the civic organizations and the apartment house owners was held, at which the apartment house owners agreed to take in children, provided that persons who have children sign an agreement to pay for any damage inflicted to the furniture, furnishings and general equipment of the apartment by their children during their tenancy.

Such a contract system might be followed by apartment house owners in other cities, where a similar campaign has been started by ministers, judges and others to give the apartment house business a bad name as a destroyer of family life. The apartment house owner should adapt himself to present conditions, and as houses are now scarce, he will have no trouble in filling apartments left vacant by those who object to children.

## Important "Home Building" Bill in Congress

The provisions of the Calder Bill (No. 2492 in the Senate and No. 7597 in the House of Representatives), which is now pending in Congress, bear much the same relation to the owning and building of homes that the Federal Farm Loan act bears to the financing of farming operations. The support of home building programs in cities and towns is considered of equally vital importance. It is an Americanization issue to develop a larger home owning class among the workers of the country and to strengthen loyal citizenship thereby. Its aim is fundamentally sound and of great importance. Its collateral advantage in aiding the building industry for a long term of years is likewise of much importance.

## To Supply Books for All

Extension of library service to 60,000,000 persons in the United States who have inadequate opportunities of obtaining good reading matter, is the principal aim of the "Books for Everybody" movement of the American Library Association now under way in every State in the Union.

Encouragement of technical libraries in industries, of more books for the blind in the standard Braille type, and the expansion of the country library system, are other phases of the movement on which stress is laid. Greater and more flexible service to the merchant marine coast guard stations and lighthouses; translation of the best books about America into foreign tongues for the benefit of 15,000,000 new Americans, financing of libraries and service to ex-soldiers, sailors and marines in hospitals of the United States Public Health Service—these are projects put under way by the association in its broad program.

Opportunities for self-instruction in all lines of human endeavor and a broader general knowledge through reading and study courses to be prepared under the direction of skilled librarians are available under the "Books for Everybody" movement. It is a program of better citizenship through universal adult education. To carry out the work of the association for the next three years a fund of \$2,000,000 will be obtained, not through an intensive drive, but by individual efforts of librarians, library trustees and friends of libraries.

## Chicago Women Urge Federal Bureau of Housing

"We favor the creation of a Federal Bureau of Housing and Living Conditions with sufficient funds to enable it to investigate housing and living conditions throughout the country and to conduct research and experimentation with a view to the inauguration of a constructive housing program," is one of the "planks" put into writing by the public-spirited and influential Woman's City Club of Chicago and advocated in connection with the coming presidential campaign. They contend that the United States has spent large sums of money in the promotion of scientific farming, the care of cattle, sheep and bees, in the development of commerce and manufacturing, but except for the housing of shipbuilders and munition workers during the war, the United States Government has taken no

cognizance of the problem of housing its citizens. The United States Housing Corporation and the Transportation and Housing Division of the Emergency Fleet Corporation investigated the housing and living conditions of more than 200 cities and towns and invested more than \$110,000,000 in housing projects. The designing, constructing, operating and disposing of these houses should set new standards for the nation, these patriotic women contend, adding that this work represents our greatest salvage from the war.

## Permanent Exposition Building for Furniture Trade

The first permanent exhibition building for furniture manufacturers east of the Mississippi will soon be erected in New York near the Pennsylvania Station, according to a statement by R. Braun, president of the New York Furniture Exchange Association, Inc. The building, said Mr. Braun, will be twelve stories high and have 150,000 square feet of exhibition floor space. It will cost approximately \$900,000 and will occupy a plot 150 by 100 feet. It will be of interest to architects to know that they may see the representative work of manufacturers throughout the country assembled within one building where they are conveniently grouped.

## Holland Buys Art

Holland, immune during five years of warfare from the expenses which devolved on the belligerent nations, has been amassing wealth such as she never knew before. Her people are regarded by *Arts and Decoration* as very close competitors of ours in the matter of obtaining art treasures. She has awakened to the fact that a remarkably good investment would very likely be represented by the repurchase of her own art works, even at the high prices now placed upon them. So Dutch buyers, it is said, thronged English salesrooms during the whole of the war. Whether they have been acquired in order to keep their treasures, or to pass them along to other continental collectors has not yet been learned.

According to *The Star*, as many as 10,000 pictures have left Britain for Holland, some bought by Dutch dealers and others taken over to Holland by our own firms, and sold for sums largely in excess of those fetched here. As a rule, the Hollander does not give high prices; he buys thriftily, not sensationally. Knowing the points in his own school of painting, he buys with discernment, but his steady acquisition of pictures has had the effect of sending prices up. It may be that before long we shall be buying back the same works at greatly enhanced figures.

## Museum of Art Treasures Discovered in Poor House

A veritable museum of art treasures has been discovered among old furniture in a home for the poor in Seville, Spain. Valuable paintings and sculptures of the most celebrated artists of the sixteenth century, including paintings by Zurbaran, Roclas and Pacheco are among the treasures unearthed. There is one picture four meters high signed by Guido Rein and another by Valdeslaeal, and a piece of sculpture by Ramos. The picture of Guido Reni alone is valued at more than 2,000,000 pesetas. It develops that the Valdeslaeal painting was bought some twenty-five years ago for five pesetas, its owner believing it of no value.



## Impressions of Sweden

Stockholm, as everybody knows, is one of the cleanest and brightest of capitals. So is Helsingfors, just across the Gulf in Finland. Helsingfors might give lessons in the municipal amenities to almost any American city, although it is tucked away in the north, in a bare little land of rock and lakes and birch trees, in the latitude of the southern end of Greenland. Describing conditions in Sweden, Arthur Ruhl, in the *Outlook*, states:

I do not happen to know of any American city so consistently clean and well built. They post no bills in Helsingfors. They tie them around posts with strings, and when they have served their purpose they disappear, strings and all. Every morning there is a market on the broad quay at the end of the Esplanade; fish, flowers, meat and vegetables—even Oregon apples, which contrive, in spite of distance and almost prohibitive rates of exchange, to cross the sixtieth parallel. A few minutes after noon you would never know a market had been there. Stalls fold up, rubbish disappears, street cleaners turn on the hose and presently the quay is as clean as a tennis court.

The Helsingfors gas tanks are not the dismal contraptions that disfigure most of our water-fronts. The tank itself may be the same, but they build a neat brick house for it—a sort of monumental roundhouse, with stone wreaths around the top by way of frieze, quite in place among buildings intended for politer uses, and not without some suggestion of the Castle of St. Angelo in Rome.

The Swedes, like most northern peoples, are inclined to be hard drinkers. That is to say, they consume a good deal of alcohol, and their favorite drinks are "hard" drinks—brandy, schnapps, arrack punch—rather than the wine of south or the beer of middle Europe. I had heard "alcohol," "drink," and the "saloon" spoken of as if they were interchangeable terms, and people talk of doing away with the saloon (the Swedes did away with it years ago) as if the only way to do away with it were to do away with alcohol. I was accustomed to more or less vituperative remarks on one side or the other, but not to a calm and, as it were, scientific consideration of the subject, as if it were something quite respectable and worth the careful study of the same sort of citizens as those who plan park systems or build model tenements.

## The Clothing Workers' House in New York

The first home of the New York Historical Society is to be torn down to make room for the first home of the New York branch of the Amalgamated Clothing Workers of America, reports the *Survey*. The Historical Society building was erected in 1855 at the corner of Second Avenue and Eleventh Street, Manhattan, which was then the centre of fashionable life in the city. The ground is peculiarly associated with Knickerbocker tradition. It was part of the farm which Governor Peter Stuyvesant purchased in 1647, and which later became a Dutch village called Stuyvesant or Bowery Village. Just across the street is the church, St. Mark's-in-the-Bouwerie, where Governor Stuyvesant is buried. The Historical Society itself is closely associated with illustrious names of old New York, for among its founders and early presidents were Peter Gerard Stuyvesant, DeWitt Clinton, Gouverneur Morris and Albert Gallatin.

Now the genteel days of Second Avenue are forever past. The tenements have closed in upon it. Stately old

residences are replaced by moving picture houses, and throngs of working people fill the walls where fashionable promenaders took the air. And across from historic St. Mark's is to rise a building which, instead of housing the archives of the past, will be devoted to the use and enjoyment of the workers who have made this district their own. The men associated with the new enterprise—such men as Sidney Hillman and Joseph Schlossberg of the Amalgamated Clothing Workers—are likely to mean as much to the New York of the future as did the founders of the Historical Society to the New York of the past.

The new Amalgamated Temple will be unique among labor buildings. It is intended to be the centre, not only of the business activities of the union, but of recreation and education for New York's 50,000 workers in the men's clothing industry. It will contain the offices of business agents, trade managers and other union officials, and a large room for executive board meetings. The financial department, where the members pay their dues, will take up a large part of one floor. Another floor will be devoted mostly to shop meeting rooms. There will be an assembly hall seating 2,500. In the basement there will be a large recreation room and gymnasium and a restaurant. The top floor will be a sun parlor of glass and steel, which will seat almost as many people as the assembly hall. On every floor a considerable amount of space, in a wing, is devoted to class rooms, of which there will be twenty in all, and there will be a library for the use of the students. Educational work is considered by the builders to be the most important of the uses to which the building will be put.

The temple will cost \$600,000. The money is being raised by levies of one day's pay upon the New York clothing workers. The architects are G. A. and H. Boehm.

## House Boats and High Rents

A writer in a recent issue of *Outlook* wants to know "Why not build you a houseboat and laugh at high rents?"

In the Orient, he says, hundreds of thousands of people live on boats. They are born, live and die afloat. Spend an afternoon on the bridges spanning Tokyo's many canals, and you will find whole families living on the clumsy cargo boats or less unwieldy sampans which are poled up and down the odoriferous waterways of Japan's capital. Cruise along the Inland Sea, and then go up and down the China coast. In both places you will find clumsy-looking but seaworthy junks which are the lifetime abode of the men, women and children who manage them. With the human beings dogs and cats—yes, and ducks and chickens—live in complete contentment.

Necessity is the mother of invention and the father of imitation. Under the pressure of high rents may not Americans imitate Orientals and build their homes on the sea, or at least on bays and rivers? Why not? It is already being done. In New York City, where the demands of landlords have been especially exorbitant of late, a small colony of houseboat dwellers has grown up on the Harlem River. Some of these craft are surrounded by water only at high tide and have small gardens adjacent to their front doors (if landlubber phraseology may be applied to such an almost amphibious institution as a houseboat). Others are afloat all the time. Many of them have such conveniences as electric light, running water, tiled baths, etc. And with the help of a small skiff or a long gangplank they are within a few minutes' walk of subway or trolley. Yet the rent of this sort of home, we are told, is but five or ten dollars a month.

Why not build you a houseboat and laugh at high rents?

## Character of Immigration To-day

Quoting a statement sent out by the Inter-Racial Council, the bulletin of the Guarantee Trust Company of New York declares that there is nothing of hope for the general industries of the country in the character of the immigrants now coming into the country. It is stated that "the majority of immigrants coming in now are women and children, mostly coming to join husbands and fathers, and that there are practically no immigrants coming in from whom we can recruit unskilled labor. The races that predominate are Greeks, Syrians, Italians and Spaniards. Most of the men coming in have lived here before. The women who come in are not of the domestic servant class. If they engage in work at all, it will be in canneries, boot and textile factories. Those who have come in express no predilection for domestic service. In announcing a conference of representatives of industry, finance and agriculture on the immigration problem an officer of the Council said:

"Immigration before the war and after the war are two entirely different propositions. They are so different that America is 4,000,000 men short as a result of the dwindling of immigration. Thousands of immigrants are going back."

## Melted Snow Harms Roads

Highway authorities state that even though there were no traffic to use the highways of America during the winter months, the clearance of snow from the roadbeds would more than be justified. In the movement now country wide, to keep the roads clear of snow, and thus make them available for the great amount of hauling by motor trucks, every effort is being made to interest States, counties, cities and towns, and the farmers, in the work. Melted snow softens the roadbed. The base under the wearing surface is loosened. Much damage is done. Every driver of a motor truck or passenger car has noted the effects of winter on the highways. Traffic will break its way through on the uncleared road. The movement now on to bring about the clearance of the roadways so as not to impede motor truck hauling, will aid in conserving roads as nothing else could do. When this is brought home to the authorities and to farmers, their assistance to the great movement will be given willingly. On roads made soft by melting snow ruts form, and results are disastrous. Much of the larger percentage of road repair work is due to winter traffic through neglect of highways during snow time. Demands of the times are such that clearance of the roadways will be more general now than formerly, for the country needs the work of every available truck.

## Book Note

"LANDSCAPE ARCHITECTURE: A COMPREHENSIVE CLASSIFICATION SCHEME FOR BOOKS, PLANS, PHOTOGRAPHS, NOTES AND OTHER COLLECTED MATERIAL." BY PROFESSOR HENRY VINCENT HUBBARD, OF HARVARD UNIVERSITY, AND MISS THEODORA KIMBALL, LIBRARIAN OF THE SCHOOL OF LANDSCAPE ARCHITECTURE OF HARVARD UNIVERSITY. PUBLISHED BY THE HARVARD UNIVERSITY PRESS, CAMBRIDGE, MASSACHUSETTS.

This pamphlet is of the same size and organized in the same general way as the City Planning classification published by Professor J. S. Pray and Miss Kimball in 1913. There are enough libraries and practitioners in the field of landscape architecture to make this present classification

most valuable, and it is fortunate that the experience of the School of Landscape Architecture at Harvard is thus put at the disposal of the public.

Such a comprehensively planned and carefully developed outline of the landscape architect's field should be of serviceable interest to those in the adjoining profession who are meeting the difficult problem of developing a scheme for the arrangement of the complicated material which must needs be readily available in all architects' offices.

## News From Various Sources

The first results of the 1920 census give Cincinnati a population of 401,158, an increase of 37,567, or 10.3 per cent over 1910, and Washington 437,414, an increase of 106,345, or 32.1 per cent over 1910.

\* \* \*

In the year preceding the war (1913), our exportation of manufactures amounted to \$1,117,000,000, and in 1919, the first full peace year following the war, \$3,486,000,000, or three times as much in value in 1919 as in 1913.

\* \* \*

The Federal Trade Commission is to be given authority to accept and administer inventions and patent-rights developed by Government employes without charge to them. A bill with these provisions has passed the Senate and been referred to the House Committee on Patents.

\* \* \*

The Senate adopted a committee amendment to the Post-office Appropriation Bill providing for a transcontinental air mail route between New York and San Francisco by way of Chicago and Omaha and passed the bill, carrying a total of \$462,000,000.

\* \* \*

The record of testimony before the Senate Committee on Public Lands in the support of the Jones-Reavis bill to establish a National Department of Public Works has been printed and a limited number is available for distribution. Applications for copies may conveniently be sent to the Washington office of Engineering Council, address as above.

\* \* \*

In 1918 there were 379,438,072 passengers on the London tubes and underground railroads, 652,562,327 on the omnibuses, and 198,334,499 on the street cars, a total of 1,230,334,898. Including Sundays this works out at an average of 3,370,780 passengers a day. It is expected the 1919 totals will be considerably higher.

\* \* \*

The Bureau of American Ethnology of the Smithsonian Institute announces issuance of a fully illustrated article entitled, "Designs on Prehistoric Hopi Pottery," by J. Walter Fewkes. The book is intended as an aid to study of aboriginal art, and the Institution considers it might be of value in public schools, or wherever attention is given to designs that are purely American in origin.

\* \* \*

The draft boards in the United States enrolled the names of nearly 24,000,000 men. When the armistice was signed, November 11, 1918, there were about three and one-half million men in the military service of the United States, of whom 2,758,542 were furnished by the selective draft. Had the war continued, Class 1 alone would have contributed an additional 3,630,106 from the registrations qualified for general military service.

# Weekly Review of Construction Field

Comment on General Conditions of Economics With Reports of Special Correspondents in Prominent Regional Centers

PRODUCTION is improving slightly, if at all. The railroad tie-up has been so wide in its effect, so cumulative of disadvantages to all industry, that its full cost cannot yet be felt or foreseen. "It is heart-rending," said one manufacturer. "Our railroad sidings are full of material waiting to be moved and the builders are without the supplies. When it will be moved no one knows." It is discouraging, there is no doubt about it.

"The proverbial impracticability of making bricks without straw is not a whit less feasible than constructing buildings without cement, lime or steel," says the New York Sun in a review of the local building conditions. "Just as the termination of the bricklayers' strike and the advent of spring weather had given promise that something like a beginning might be made toward solving the problem of new construction, scores of building enterprises have come to a dead halt and the whole structure of the building industry is menaced."

The secretary of the Building Trades Employers' Association says: "It is impossible to get anything like adequate quantities of the first essentials of building operations and we cannot get any definite assurances from the railroads concerning the prospect of better conditions. All kinds of materials are scarce because of the freight embargoes imposed in consequence of the strike tie-up. Some builders have been drawing upon limited quantities of material by bringing it in by means of motor trucks, but that is expensive and the supplies are meager."

One of the largest contractors says that out of 1400 men he has just laid off 1200. He has thirty-two jobs under way, but is without cement, and his steel and lumber are held up somewhere on the road.

The Guaranty Trust Company looks upon the results of the railroad strike as an evidence of the small margin on which the business of the country is being done. It estimates that a million men were thrown out of work. "The significant fact," it says, "is that there were apparently no reserves on hand which would have enabled production enterprises to bridge over the interval of disturbance." And in this situation it finds "another illustration of the primary obligations resting upon the country to produce more of the essential things." Protests are appearing with greater frequency against the continuance of those enterprises which minister to the comparatively small proportion of the population whom the war has enabled to indulge themselves in reckless expenditures and in favor of those which will put the country's business on something better than a hand-to-mouth basis.

From Chicago we hear of another deterrent to building in the increase of wages in some twenty crafts of from \$1 to \$1.25 an hour. These increases in pay, it is said, have reduced the building activities in Chicago by at least one-half.

In New York all building trades craftsmen have been granted an increase of one dollar a day, effective May 1. Unfortunately, because of the shortage of materials induced by the railroad strike, many of these men are being laid off and the increase will not get them very far just at present.

The railroads of the East have presented a statement of their case to the Interstate Commerce Commission which asks for increase of rates to an average of about 28 per cent. It is claimed by them that their increase in revenues since 1916 has been 36 per cent, while the increase in costs has been 99 per cent.

It is everywhere the same story. And always the demands for more money arouse a sympathetic interest. We all have experienced the cheapening of the dollar. We all know that the expense of living has gone up, and continually goes up. We know that the railroads need much more money to "carry on" and that their "carrying on" is essential to our commercial development. It is undoubtedly essential to our general welfare that they should have it.

We all of us sympathize with all the people who want more money to meet their living expenses. We are sorry for them. But the people who have our admiration are those who keep straight at work. There are contractors who have completed contracts and lost money by it. There are manufacturers that have not advanced prices and yet push their plants to the utmost to meet demands. There are dealers who are not profiteering but sharing in the absorption of increases. These are the people who are going to pull us through. And in all the discouraging phases of the present time the dynamic qualities of such businessmen stand out. It may be that they will get their reward in heaven; but the general opinion seems to be that they won't have to wait that long. Certainly their attitude will inspire loyalty in all their clients and their brave stability will be one rallying point for all that is disorganized in industry.

(By Special Correspondence to THE AMERICAN ARCHITECT)

CHICAGO:—Chicago is facing a possible complete cessation of building activities in the near future, as the result of the shutting off of building loans by the banks.

The tightening of credit to the building industry has been noted for the past six weeks and has recently culminated in the refusal of further real estate or building loans. Tightness of money, inflation of real estate values and an already over-loaned condition were contributing factors in the decision, according to the banks.

Building has dropped off 30 per cent this month and every day the decline is more noticeable. Builders say that, with bank loans shut off, building in Chicago will soon be at a standstill.

The only building projects under way are those already financed, but even the man with sufficient funds to build is continually hampered by the lack of building materials. Crushed stone, lime, gravel, cement and many other materials are now very difficult to get. Some of the cement companies have established truck service from towns in Indiana to supply trade that cannot be served through rail transportation.

Shortages of raw material and labor continue to hinder in all lines. Railroads claim a 90 per cent resumption of freight traffic, but manufacturers declare it to be almost impossible to secure raw material, and as a consequence

## THE AMERICAN ARCHITECT

many factories are closing and industries already closed give no sign of resuming operation.

In many instances the curtailment of shipping and manufacture has caused advance in price, but there has been shown a disposition on the part of some of the industries, especially in the construction field, to allow prices to remain at the present level, preferring to absorb the added cost of operating, rather than pass it on to the "ultimate consumer."

The sincerity of the movement to curb high prices of building materials is indicated in the action taken recently by the lumber interests in the district around Chicago. Lumbermen, it is reported, have agreed to absorb the 25 per cent increase in wages granted to some of the construction trades after May 1, rather than have the contractor add it to the cost of construction.

Leading construction men of the country who were called here in conference by the Associated General Contractors of America, for the purpose of "getting to the bottom" of prevailing conditions, have appointed a committee to investigate the high cost of construction material and—if conditions warrant—to request the aid of the Federal Trade Commission. W. A. Rogers, of Chicago, president of the Associated General Contractors of America, said: "the leading construction firms of the country have come to the conclusion that the contractors should no longer 'pass the buck' to the consumer, and therefore must take determined action."

*(By Special Correspondence to THE AMERICAN ARCHITECT)*

SEATTLE:—Almost without exception jobbers of building material in this territory report that small building projects have been abandoned as a result of increasing difficulties of getting inside essentials from the East—including nails, pipe, fittings, vitroware, and metal parts.

Jobbers are showing unconvinced architects and contractors their private telegrams and correspondence from eastern mills to the effect that no more business can be firmed at this time or any in the future so far as they can report at present and prices offered seem to carry no inducement. Orders placed by Seattle jobbers as long ago as September for vitroware have not yet been loaded. After repeated telegrams orders placed 120 days ago are now being loaded at eastern mills. Quotations have remained stationary.

Wall radiation has advanced. Three column 38-inch water radiation is quoted at \$47.80 at the warehouse. Jobbers have abandoned all efforts at getting nails from the East and are being supplied with 50 per cent of their requirements from Colorado mills.

Fiscal conditions in Japan are bearish. Large interests there have not paid for steel materials on the docks for some time. Should these conditions prevail it is regarded here as possible that the export demand will ease the domestic situation in time for later summer building projects.

Claybourne, B. C., fire brick has advanced \$10 to \$77.50, which brings it into direct competition with Troy, Idaho, brick, which jobbers are delivering on the job at \$70.

Plaster board is out of market, but the supply of wall board is plentiful. Cement is steady at \$4.60 per barrel with 80 cents rebate for bags.

Channel iron is unobtainable even for incompleting business buildings and architects have been urged by jobbers to provide a substitute. Experiments are being made with quarter-inch corrugated steel. Metal lath is steady.

Medusa white cement is being used almost exclusively in supplying Seattle, Tacoma, Olympia and Bellingham.

The firm lumber market is \$5 lower on upper sizes

and \$3 down on common, although the mills do not concede any weakness in general tone. They have been advised by wire that transit or unsold cars in the East have been cleaned up as a result of the railroad strike and expect a quick rush for market within the next thirty days. Should the car supply improve, however, to 60 or 80 per cent of normal the market would break.

*(By Special Correspondence to THE AMERICAN ARCHITECT)*

SAN FRANCISCO:—Deliveries of materials which have been held up by the strike are beginning to be made again, but it may take a month to bring deliveries to a normal condition.

The brick manufacturers are contemplating a raise in prices, but whether this will come immediately or after the inevitable increase in railroad rates is a matter not yet decided. The brick men are trying to avoid two increases in rapid succession and may decide to wait railroad action before advancing prices.

Lime was advanced in price this week and further advances are looked for in this material. In the main there were few changes during the week. One of the most important structures planned for San Francisco is the new Furniture Exchange, on which work will begin as soon as the architect, Kenneth MacDonald, Jr., completes the plans. The building is to be an eight-story concrete structure covering an entire block—bounded by Natoma, New Montgomery and Howard streets—and will cost \$700,000.

After a strike of about two months the mill men about the Bay have returned to work. A good many interiors were held up by the strike.

By a decision given recently by Assistant City Superintendent of Buildings Fowler of Seattle, the building code of that city permits the construction of certain classes of buildings in areas outside the second building district which might be termed dangerous structures. If these same buildings were placed in the down-town district they would be regarded as "fire traps," but Mr. Fowler says it is perfectly legal to build them outside the restricted district mentioned.

*(By Special Correspondence to THE AMERICAN ARCHITECT)*

BIRMINGHAM:—Building operations in Birmingham are showing indications of increasing activity as spring advances, being retarded somewhat by the uncertainty of price schedules covering materials.

In many lines there seems to be a stiffening of prices rather than a decline. Iron pipe is in heavy demand with some producers refusing to quote for close deliveries, and others out of the market until they are caught up with present commitments.

The continued bad weather has curtailed lumber production and delayed shipments over a wide territory. Many mills are shut down or running on half-time.

The general apathy permeating all farm labor does not argue for increased activity. Until the country's individual production is intensified and brought to a higher standard in all lines, the strain upon the sources of supply will not be lessened and the great economic problems facing the nation will still remain unsolved.

The housing problem is one which at the moment is presenting unusual difficulties in Birmingham as elsewhere. Much interest is felt in the census report, the announcement of which is daily expected from Washington. It is believed that a substantial increase in population over 1910 will be shown and as a result of the exhibit a more pronounced determination to build necessary houses to take care of the people will develop.

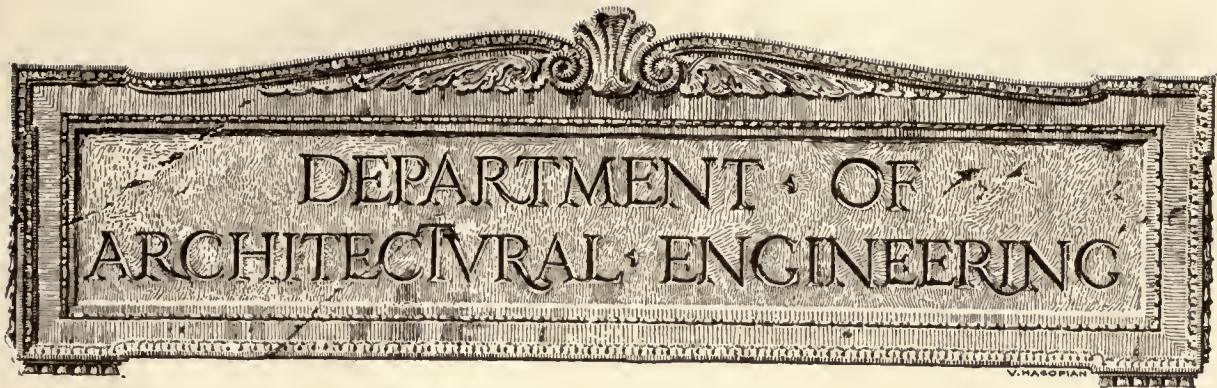

## Successful Building in Stucco

### VI—Stucco on Concrete Block Walls

THE adaptability of concrete block as a base for stucco is evident. It is true that in many places this material has been tried and later rejected, due to blocks of poor quality, improperly manufactured, having been supplied.

A large number of manufacturers of such products are now using every endeavor to maintain a proper standard of excellence for this material, so that if secured from a reputable manufacturer, blocks of the proper quality can be obtained. At the recent Chicago meeting of such manufacturers the various phases of this subject were discussed to the end that the quality of their product might be improved.

The requirements for, and proper methods of, building with concrete block were fully outlined in the reports presented at the National Conference on Concrete House Construction by the committee and various sub-committees dealing with concrete block houses, and much of the information and recommendations contained in this article is taken from these reports.

Concrete block and tile laid in Portland cement mortar are particularly well adapted to serve as a backing for Portland cement stucco because they are composed of the same class of material as the stucco itself and afford an excellent bonding surface. For Portland cement stucco finish the block or tile should be rough and of coarse texture, but not weak or friable.

In applying stucco to block or tile the joints should be raked out or cut back at least even with the face of the wall; no projections should be left. The wall should be brushed free from all loose particles and wet down and should be moist at the time the stucco is applied; if dry, the moisture is absorbed from the stucco and a weak finish is the

result; if too wet, a film of water prevents a proper bond.

Naturally good walls are impossible unless the blocks on which the stucco surface is placed are of proper quality and strength. The standard adopted by the American Concrete Institute is an excellent guide by which to go and is here presented insofar as it relates to the subject of this article.

#### EXTRACTS FROM AMERICAN CONCRETE INSTITUTE STANDARD No. 10

*Ultimate Compressive Strength.*—(a) Solid concrete stone, building block and brick. In the case of solid stone, block and brick, the ultimate compressive strength at 28 days must average not less than fifteen hundred (1,500) lb. per sq. in. of gross cross-sectional area of the stone as used in the wall and must not fall below one thousand (1,000) lb. per sq. in. in any test.

(b) Hollow and two-piece building block. The ultimate compressive strength of hollow and two-piece building block at 28 days must average one thousand (1,000) lb. per sq. in. of gross cross-sectional area of the block as used in the wall, and must not fall below seven hundred (700) lb. per sq. in. in any test.

*Gross Cross-Sectional Areas.*—(a) Solid concrete stone, block and brick. The cross-sectional area shall be considered as the minimum area in compression.

(b) Hollow building block. In the case of hollow building block, the gross cross-sectional area shall be considered as the product of the length by the width of the block. No allowance shall be made for the air space of the block.

(c) Two-piece building block. In the case of two-piece building block, if only one block is tested



A WALL BEING CONSTRUCTED OF THE USUAL TYPE OF CONCRETE BLOCK

at a time, the gross cross-sectional area shall be regarded as the product of the length of the block by one-half of the width of the wall for which the block is intended. If two blocks are tested together, then the gross cross-sectional area shall be regarded as the product of the length of the block by the full width of the wall for which the block is intended.

*Absorption.*—The absorption at 28 days (being the weight of the water absorbed divided by the weight of the dry sample) must not exceed ten (10) per cent when tested as hereinafter specified.

*Limit of Loading.*—(a) Hollow walls of concrete building block. The load on any hollow walls of concrete block, including the superimposed weight of the wall, shall not exceed one hundred and sixty-seven (167) lbs. per sq. in. of gross area. If the floor loads are carried on girders or joists resting on cement pilasters filled in place with slush concrete mixed in proportion of one (1) part cement, not to exceed two (2) parts of sand and four (4) parts of gravel or crushed stone, said pilasters may be loaded not to exceed three hundred (300) lb. per sq. in. of gross cross-sectional area.

(b) Solid walls built of architectural stone, block or brick and laid in Portland cement mortar or hollow block walls filled with concrete shall not be loaded to exceed three hundred (300) lb. per sq. in. of gross cross-sectional area.

*Girders and Joists.* — Wherever girders or joists rest upon walls in such a manner as to cause concentrated loads of over four thousand (4,000) lb. the block supporting the girders or joists must be made solid for at least eight inches from the inside face of the wall except where

a suitable bearing plate is provided to distribute the load over a sufficient area to reduce the stress so it will conform to the requirements stated under "Limit of Loading."

When the combined live and dead floor loads exceed sixty (60) lb. per sq. ft., the floor joists shall rest on a steel plate not less than three-eighths ( $\frac{3}{8}$ ) of an inch thick and of a width one-half to one inch less than the wall thickness. In lieu of said steel plate the joists may rest on a solid block which may be three or four inches less in wall thickness than the building wall, except in instances where the wall is eight (8) in. thick, in which cases the solid block shall be the same thickness as the building wall.

*Thickness of Walls.*—(a) Thickness of bearing walls shall be such as will conform to the limit of loading given under "Limit of Loading." In no instance shall bearing walls be less than eight inches thick. Hollow walls eight inches thick shall not be over sixteen feet high for one story or more than a total of twenty-four feet for two stories.

(b) Walls of residences and buildings commonly known as apartment buildings not exceeding four stories in height, in which the dead floor load does not exceed sixty (60) lb. or the live load sixty (60) lb. per sq. ft., shall have a minimum thickness in inches as shown in the following table.

THICKNESS IN INCHES FOR CONCRETE BLOCK WALLS					
No. of Stories	Basement	First Story	Second Story	Third Story	Fourth Story
1.....	8	8	..	..	..
2.....	10	8	8	..	..
3.....	12	12	10	8	..
4.....	16	12	12	10	8

*Variation in Thickness of Walls.*—(a) Wherever walls are decreased in thickness the top course of



AN ATTRACTIVE HOUSE CONSTRUCTED WITH WALLS OF CONCRETE BLOCK AND STUCCO FINISH

the thicker wall shall afford a solid bearing for the webs or walls of the course of the concrete block above.

MORTARS

UNLESS carefully made, mortar joints are likely to be the weakest portions of a concrete block or tile wall. The essentials of a good mortar

5. It must possess good working qualities.
6. It should look satisfactory.
7. It should endure permanently.

Portland cement mortar meets these requirements and should be specified for concrete block and tile wall construction.

*Ingredients of Portland Cement Mortar.*—The

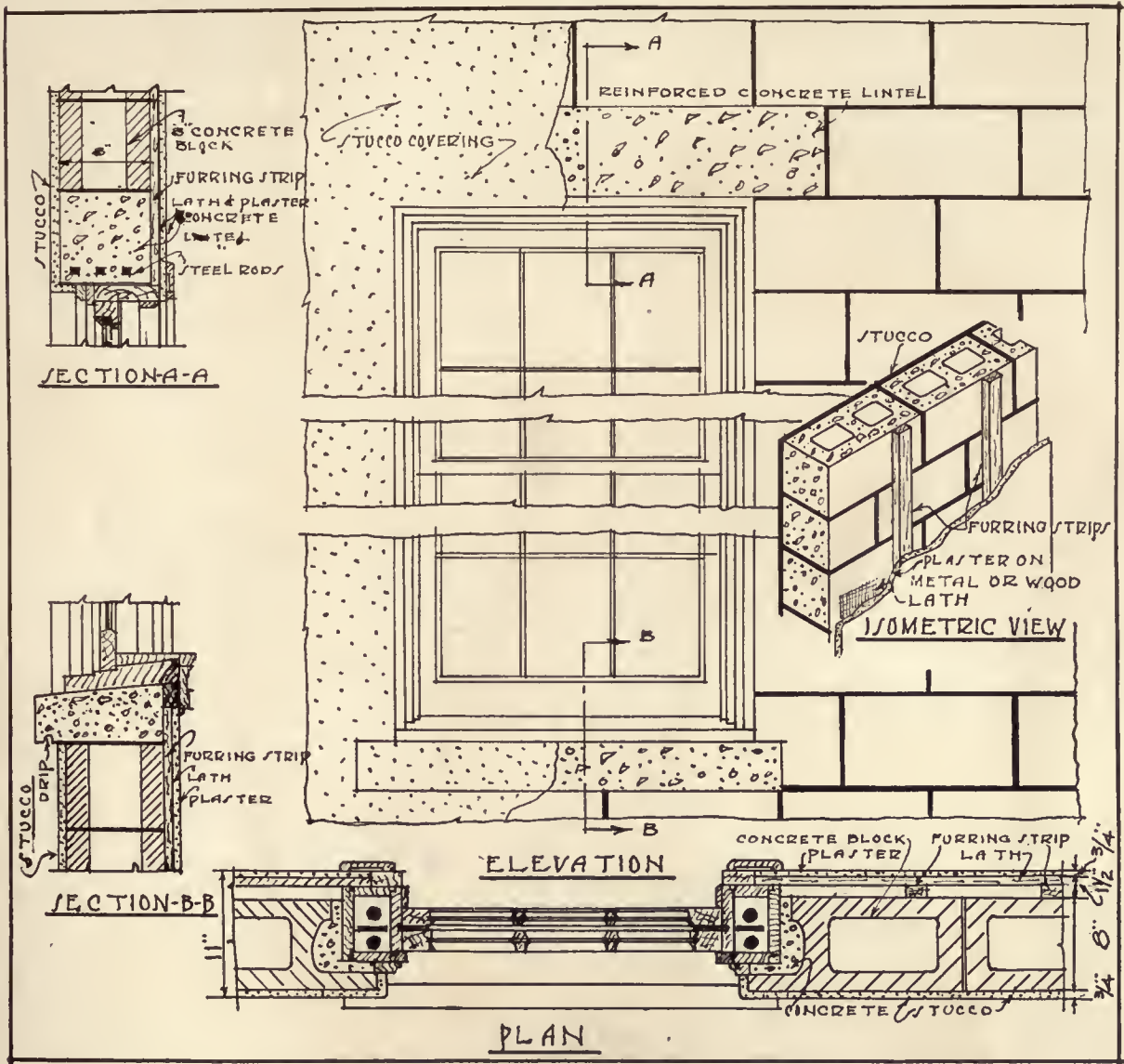

DETAILS OF CONSTRUCTION—STUCCO ON COMMON TYPE OF CONCRETE BLOCK

joint are:

1. It should be dense and non-absorbent.
2. It must have a sufficient compressive strength to withstand pressure in the wall without crushing.
3. It must attain strength rapidly.
4. It must be reasonable in cost and easily obtainable.

ingredients of Portland cement mortar are Portland cement, sand and water. Usually a limited amount of hydrated or well-slaked lime is included.

*Sand.*—Sand used for mortar should be hard, clean, free from vegetable matter and contain not to exceed seven (7) per cent by volume of clay or loam. The particles should be well-graded and



WALLS BEING CONSTRUCTED OF THE INTERLOCKING TYPE OF CONCRETE BLOCK

range in size from fine up to those which will just pass through a screen having 4 meshes to the lineal inch. Most masons prefer that the coarse particles predominate, claiming that coarse sand produces a more workable mortar. Sand which is not clean should be washed before using.

**Cement.**—Any standard brand of Portland cement may be used which meets the specifications for Portland cement adopted by the American Society for Testing Materials. Cement should be kept in a dry place until used. Cement which contains lumps which cannot be crushed with the fingers should not be used.

**Water.**—Water should be clean, free from acids and alkali. In general it can be stated that water



UNLESS THE AIR SPACE IN THE WALL CONSTRUCTION IS CONTINUOUS, INTERIOR PLASTERING SHOULD BE ON LATH FURRED OUT FROM THE FACE OF THE WALL AS SHOWN ABOVE

which is fit for drinking is satisfactory for cement mortar.

**Lime.**—Only well-slaked or hydrated lime should be used. Lime is added to the mortar to impart to it better working qualities, thereby reducing the cost of labor in laying a given section of wall. Care should be observed not to add more lime than specified in the paragraph under "Proportions," otherwise the strength of the mortar may be materially diminished.

**Proportions.**—Among masons there is a wide variation in the ratio of cement and sand used in making mortar; some prefer as rich a mixture as equal parts of cement and sand, while others use a mortar containing three times as much sand as cement. A proportion of 1 sack of cement to 2 cubic feet of sand will be found satisfactory under most conditions.

A mixture containing in excess of 3 cubic feet of sand for each sack of cement is not recommended. Hydrated or slaked lime may be added to

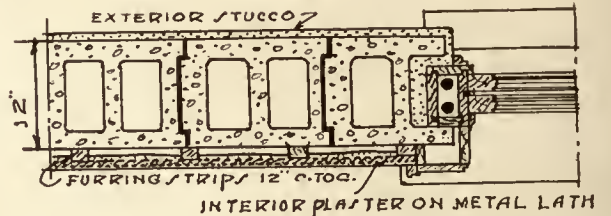

DETAIL OF WINDOW JAMB CONSTRUCTION FOR TWELVE-INCH BLOCK

the mortar in an amount not to exceed 25 per cent. by volume of the amount of cement in the mixture.

**Mixing.**—The usual method is to mix the cement and sand dry until the resulting mixture is uniform in color and of like character throughout. Hydrated lime may be incorporated in the mixture simultaneously with the cement and sand. When lime putty (slaked lime) is used it is customary to dissolve the putty to a creamy consistency in water and then use this lime water when mixing the mortar. The mortar may be either mixed by hand or by mechanical means. In most cases hand mixing is practiced, as the workmen can readily tell when the mass has acquired the proper consistency to obtain the best working qualities. Only as much water should be added as will, after thorough mixing, produce a mixture of such plasticity as will work to best advantage.



It is best to mix only a small batch of mortar at a time (say enough for 30 minutes' work). Mortar which has stiffened must not be remixed with water to impart to it workable qualities again. This process is commonly referred to as "retempering". It should not be permitted.

*Application.*—A good bond between the mortar and the block is essential. To accomplish this end, mortar should be applied with force. For best re-

The simplest method of waterproofing is to paint the wall with hot pitch or asphalt. When this method is adopted the precaution must be taken to have the wall dry, as these materials will not adhere to a moist surface. Lines of drain tile should be laid around both the outside and inside of the wall footings and at least 6 inches below them to carry off excess water. These tile should be connected to a suitable outlet drain.

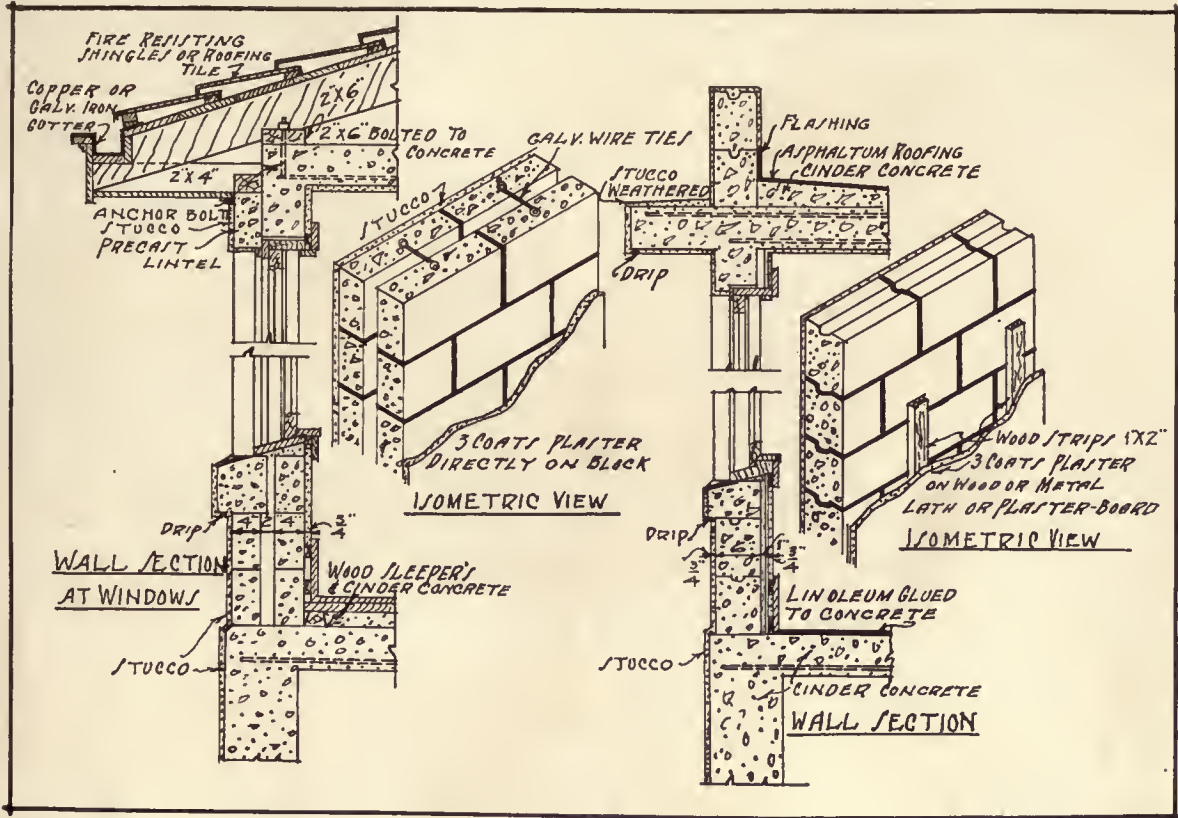

DETAILS OF CONSTRUCTION—STUCCO ON CONCRETE BLOCK

At Left—Double Walled Type. Inner and Outer Shells Connected by Metal Ties Only.  
At Right—Solid Block of "Book Tile" Type. Interior Furring Necessary.

sults both ends of the block should be buttered. The horizontal or supporting section of the block should be entirely covered with mortar.

WATERPROOFING THE FOUNDATION

A DRY basement is one of the requirements of good construction. When the side on which the house is to be located does not have good natural drainage it is best to waterproof the outsides of the walls below grade. No matter how much care is exercised in making concrete block or placing them in the wall it is not always possible to obtain absolutely watertight construction.

SILLS AND LINTELS

To make sure that no moisture penetrates the walls at the sills, lintels, sill courses, lintel courses and joint courses and to prevent condensation on the inside walls at these places, all building trim should be of two-piece construction so as to provide an air space between the inner and outer sections. The space between the inner and outer sections need not be greater than 1/4 inch; a continuous air space is all that is required. Each division of lintel should be reinforced according to standard methods to carry the superimposed load.



THE DOUBLE WALLED BUNGALOW READY FOR STUCCO FINISH

### INTERIOR PLASTERING

SOME concrete block enthusiasts have recommended that plaster be applied directly to the block surface. These recommendations have been made despite the fact that it is customary to furr out the plaster for all kinds of masonry houses. Furring and lathing cost only slightly more when considering the total cost of the house and they assure a warmer wall. The better insulation thus provided effects a considerable saving in the winter coal bills and provides a house which is cool in summer. In no case should plaster be applied directly on the concrete surface unless the house is constructed according to the following specifications:

The wall shall be constructed of two-piece block, providing a continuous air space from the footing to the eaves and entirely around the building. All sills and lintels shall be of the two-piece type and the inner and outer sections shall be separated so as to provide a clear air space between them. The



STUCCO WORK COMPLETED

outside of the foundation below grade shall be waterproofed as hereinbefore described.

### SIZE OF BLOCKS \*

A TABULATION of sizes of block and tile, as now manufactured, is shown in Table I. The name of the manufacturer is followed by the width, height and length of unit, the actual size of the block or tile being given. For instance, a block listed as 8" wide,  $7\frac{3}{4}$ " high, and  $15\frac{3}{4}$ " long, is ordinarily referred to in practice as an 8" x 8" x 16" block. These units are purposely made smaller to allow for the mortar joint which, when added to length and



CONSTRUCTING A DOUBLE WALL WITH CONCRETE BLOCKS. IN THIS CASE THE AIR SPACE IS CONTINUOUS AND FURRING THE INTERIOR IS UNNECESSARY

height, produces a unit of full length and height.

As a help to the designer in determining the most desirable distance horizontally between doors and windows to corners, and also the most desirable widths of door and window opening, Table II. has been prepared. Lengths of wall sections and door and window openings, should be, as far as possible, multiples of quarter blocks.

Table II. gives the length of wall sections of from one to eighteen units by  $\frac{1}{4}$  units. Your committee believes that a quarter length is as small a fraction of a unit as is necessary or desirable and that manufacturers of molds should adapt their machines and furnish suitable division plates for making  $\frac{1}{4}$ ,  $\frac{1}{2}$ , and  $\frac{3}{4}$  length blocks. By careful design it is often possible to get along with two sizes of units—the full length and the half length units.

\*From report of Sub-committee B, National Conference on Concrete House Construction.



THIS TYPE OF STUCCO HOUSE WITH TILE ROOF MAKES A PLEASING COMBINATION

TABLE I  
STANDARD CONCRETE BLOCK AND TILE SIZE

Manufacture of Mold	Height, Inches	Width, Inches	Length, Inches
Anchor Concrete Machinery Co..... Rock Rapids, Iowa	7½	8-9-10-11-12	15½ & 23½
Bradstad Concrete Machinery Co..... Canton, So. Dak.	7¾	10	23¾
The Brandell Co. .... Cincinnati, Ohio	7¾	4-6-8-10-12	15¾
Ideal Concrete Machinery Co..... Cincinnati, Ohio	7¾	4-6-8-10-12	15¾-23¾
The Hamilton Concrete Machinery Co.. Cleveland, Ohio	5	4-6-8-12	8-10-12
The Anchor Conc. Mach. Co., (Hobbs) Columbus, Ohio	3 to 12 ins.	3 to 12 ins.	3 to 24 ins.
The Besser Manufacturing Co..... Alpena, Mich.	7¾	7¾-9¾-11¾	15¾
Flexo Concrete Mold Co..... Cedar Rapids, Iowa	5¾-7¾	8-10-12	15¾-23¾
Zagelmeyer Cast. Stone Block..... Mach. Co., Bay City, Mich.	7½	8-10-12	15½-23½
The Federal Cement Prod. Co..... Cleveland, Ohio	5	8½-12½-16½	12
The Ferguson Synstone Co..... Denver, Colo.	11¾	8-12	23¾
The Helm Brick Machine Co..... Cadillac, Mich.	7¾	10	23¾
Hydro Stone Co. .... Chicago, Ill.	8¾-11¾	4½ to 17	23¾
The Multiplex Concrete Mach. Co..... Elmore, Ohio	3¾-5¾-7¾	8-10-12	19¾
Peters Eastman Greer Co..... Indianapolis, Ind.	3 to 6 by ins.	7-10	20
Century Cement Machine Co..... Rochester, N. Y.	4 to 16 by ins.	4 to 20 by ins.	4 in. to 6 ft.
W. E. Dunn Mfg. Co..... Holland, Mich.	7¾	8-10-12	15¾
Francis Concrete Machinery Co..... St. Louis, Mo.	7¾	8-10-12	15¾-23¾
The Hayden Auto Block Mach. Co.... Columbus, Ohio	7¾	4-6-8-10-12	15¾-19¾-23¾
Northwestern Steel & Iron Works..... Eau Claire, Wis.	7¾	9-12	23¾
The Pettyjohn Co. .... Terre Haute, Ind.	7¾	7¾	15¾-19¾-23¾
The Republic Iron Works..... Tecumseh, Mich.	7¾	2-4-8-10-12	15¾
Stewart Mfg. Co..... Waterloo, Iowa	7¾	8-10	15¾

The purpose of Table III. is similar to that of Table II. It is intended to help the designer determine the most suitable height for door and window openings and other vertical wall heights.

To explain the use of Tables II. and III. a drawing (Figure 1.) of a house elevation is presented. The distance "A" corresponds to the wall lengths shown in Table II. and the distance "B" to heights specified in Table III. The purpose of both tables is to assist the designer in laying out the house so as to require no cutting of block, which is costly.

Corner block, joist blocks, sills, lintels, and other special shapes should be furnished by the concrete products manufacturer so as to make possible for the constructor to erect the building complete. Nothing detracts more from the appearance of a structure than poorly made and improperly fitted building

# THE AMERICAN ARCHITECT

trim. It has been suggested that jamb block be used next to all doors and windows in places of the block with an ordinary end.

The question has arisen as to the best method for designating sizes of block, and it is recommended that the height, width and length be specified.

The accompanying photographs and details illustrate the construction of various types of concrete block walls as a base for stucco finish.

*The next article will treat of magnesite stucco.*



ELEVATION OF HOUSE ILLUSTRATING SETTING OF CONCRETE BLOCK.

FIG. I—ILLUSTRATING APPLICATION OF TABLES II AND III

TABLE II

TABLE SHOWING RELATION BETWEEN NUMBER OF COURSES OF CONCRETE BLOCK AND TILE AND THE HEIGHT OF WALL FORMED BY UNITS OF DIFFERENT SIZES

NUMBER OF COURSES	HEIGHT OF WALL SECTIONS FORMED							
	3 In. Block Ft. In. 0 3	4 In. Block Ft. In. 0 4	5 In. Block Ft. In. 0 5	6 In. Block Ft. In. 0 6	8 In. Block Ft. In. 0 8	9 In. Block Ft. In. 0 9	10 In. Block Ft. In. 0 10	12 In. Block Ft. In. 1 0
1								
2	0 6	0 8	0 10	1 0	1 4	1 6	1 8	2 0
3	0 9	1 0	1 3	1 6	2 0	2 3	2 6	3 0
4	1 0	1 4	1 8	2 0	2 8	3 0	3 4	4 0
5	1 3	1 8	2 1	2 6	3 4	3 9	4 2	5 0
6	1 6	2 0	2 6	3 0	4 0	4 6	5 0	6 0
7	1 9	2 4	2 11	3 6	4 8	5 3	5 10	7 0
8	2 0	2 8	3 4	4 0	5 4	6 0	6 8	8 0
9	2 3	3 0	3 9	4 6	6 0	6 9	7 6	9 0
10	2 6	3 4	4 2	5 0	6 8	7 6	8 4	10 0
11	2 9	3 8	4 7	5 6	7 4	8 3	9 2	11 0
12	3 0	4 0	5 0	6 0	8 0	9 0	10 0	12 0
13	3 3	4 4	5 5	6 6	8 8	9 9	10 10	13 0
14	3 6	4 8	5 10	7 0	9 4	10 6	11 8	14 0
15	3 9	5 0	6 3	7 6	10 0	11 3	12 6	15 0
16	4 0	5 4	6 8	8 0	10 8	12 0	13 4	16 0
17	4 3	5 8	7 1	8 6	11 4	12 9	14 2	17 0
18	4 6	6 0	7 6	9 0	12 0	13 6	15 0	18 0
19	4 9	6 4	7 11	9 6	12 8	14 3	15 10	19 0
20	5 0	6 8	8 4	10 0	13 4	15 0	16 8	20 0
21	5 3	7 0	8 9	10 6	14 0	15 9	17 6	21 0
22	5 6	7 4	9 2	11 0	14 8	16 6	18 4	22 0
23	5 9	7 8	9 7	11 6	15 4	17 3	19 2	23 0
24	6 0	8 0	10 0	12 0	16 0	18 0	20 0	24 0
25	6 3	8 4	10 5	12 6	16 8	18 9	20 10	25 0
26	6 6	8 8	10 10	13 0	17 4	19 6	21 8	26 0
27	6 9	9 0	11 3	13 6	18 0	20 3	22 6	27 0
28	7 0	9 4	11 8	14 0	18 8	21 0	23 4	28 0
29	7 3	9 8	12 1	14 6	19 4	21 9	24 2	29 0
30	7 6	10 0	12 6	15 0	20 0	22 6	25 0	30 0
31	7 9	10 4	12 11	15 6	20 8	23 3	25 10	31 0
32	8 0	10 8	13 4	16 0	21 4	24 0	26 8	32 0

TABLE III

TABLE SHOWING NUMBER OF BLOCK REQUIRED FOR WALL SECTION OF VARIOUS LENGTHS

Number of Block and Fraction of Block	LENGTH OF WALL SECTIONS							
	12-INCH BLOCK		16-INCH BLOCK		20-INCH BLOCK		24-INCH BLOCK	
	Feet	Inches	Feet	Inches	Feet	Inches	Feet	Inches
1	1	0	1	4	1	8	2	0
1½			1	8	2	1	2	6
1¾	1	6	2	0	2	6	3	0
2			2	4	2	11	3	6
2½	2	0	2	8	3	4	4	0
2¾			3	0	3	9	4	6
3	2	6	3	4	4	2	5	0
3¼			3	8	4	7	5	6
3½	3	0	4	0	5	0	6	0
3¾			4	4	5	5	6	6
4	3	6	4	8	5	10	7	0
4¼			5	0	6	3	7	6
4½	4	0	5	4	6	8	8	0
4¾			5	8	7	1	8	6
5	4	6	6	0	7	6	9	0
5¼			6	4	7	11	9	6
5½	5	0	6	8	8	4	10	0
5¾			7	0	8	9	10	6
6	5	6	7	4	9	2	11	0
6¼			7	8	9	7	11	6
6½	6	0	8	0	10	0	12	0
6¾			8	4	10	5	12	6
7	6	6	8	8	10	10	13	0
7¼			9	0	11	3	13	6
7½	7	0	9	4	11	8	14	0
7¾			9	8	12	1	14	6
8	7	6	10	0	12	6	15	0
8¼			10	4	12	11	15	6
8½	8	0	10	8	13	4	16	0
8¾			11	0	13	9	16	6
9	8	6	11	4	14	2	17	0
9¼			11	8	14	7	17	6
9½	9	0	12	0	15	0	18	0
9¾	9	3	12	4	15	5	18	6
10	9	6	12	8	15	10	19	0
10¼	9	9	13	0	16	3	19	6
10½	10	0	13	4	16	8	20	0
10¾	10	3	13	8	17	1	20	6
11	10	6	14	0	17	6	21	0
11¼	10	9	14	4	17	11	21	6
11½	11	0	14	8	18	4	22	0
11¾	11	3	15	0	18	9	22	6
12	11	6	15	4	19	2	23	0
12¼	11	9	15	8	19	7	23	6
12½	12	0	16	0	20	0	24	0
12¾	12	3	16	4	20	5	24	6
13	12	6	16	8	20	10	25	0
13¼	12	9	17	0	21	3	25	6
13½	13	0	17	4	21	8	26	0
13¾	13	3	17	8	22	1	26	6
14	13	6	18	0	22	6	27	0
14¼	13	9	18	4	22	11	27	6
14½	14	0	18	8	23	4	28	0
14¾	14	3	19	0	23	9	28	6
15	14	6	19	4	24	2	29	0
15¼	14	9	19	8	24	7	29	6
15½	15	0	20	0	25	0	30	0
15¾	15	3	20	4	25	5	30	6
16	15	6	20	8	25	10	31	0
16¼	15	9	21	0	26	3	31	6
16½	16	0	21	4	26	8	32	0
16¾	16	3	21	8	27	1	32	6
17	16	6	22	0	27	6	33	0
17¼	16	9	22	4	27	11	33	6
17½	17	0	22	8	28	4	34	0
17¾	17	3	23	0	28	9	34	6
18	17	6	23	4	29	2	35	0
18¼	17	9	23	8	29	7	35	6
18½	18	0	24	0	30	0	36	0

Protophila to No. 2317



THE LIBRARY, VENICE

# THE AMERICAN ARCHITECT

VOL. CXVII.

WEDNESDAY, MAY 19, 1920

NUMBER 2317

## Fifty-third Annual Convention—The American Institute of Architects, Washington, D. C.

### First Day's Proceedings

**M**ORE delegates than for many years past assembled in the Hemicycle of the Corcoran Galleries of Art at the opening of the fifty-third annual convention. Even the large attendance at Nashville last year was exceeded. And with this large attendance there was also a well defined attitude of seriousness, and it was evident at the outset that the Institute was determined to put its house in order. Reference to President Kimball's admirable address will show exactly what the general disposition was toward the problems that were to be discussed.

President Kimball accurately diagnosed the ills that now affect the Institute, and it was the general opinion that the treatment he prescribed would largely aid in placing the profession of architecture on the exact and proper plane where it belongs.

Reserving a more extensive review and discussion of this address for a future occasion, it is pertinent to refer to the fact that architects when assembled as a deliberative body present as a composite picture an entirely different personality than they do when individually expressing themselves. It is interesting to note that even the most pronounced of malcontents seem to find in close contact with their professional brethren something that overcomes the grouches and dissatisfaction that so often mark the ante-convention attitude.

When one goes to these conventions with the memory very keen of all sorts of unrest and promises to "wake things up" and notes in place of what was logically to be expected, a most pacific attitude, the thought arises that there is "much cry and little wool" and that, after all, things are not so very out of joint. To be sure, as this is written, this gathering is but one day old, but long years of experience lends encouragement to the belief that all is, or will be, well with the architectural world.

Cloudless skies and a southerly wind created ideal weather and for this reason there were in addition to the large number of delegates many women as guests, and a large number of Washington men who showed a lively interest in the proceedings.

Contrary to the usual custom, there was no opening address of welcome by some local official. The convention at once, at the tap of President Kimball's gavel, got seriously down to business. Also contrary to the opening day's routine of previous conventions, there was practically little if any debate until but a short while before adjournment.

The President's address, that of the Board of Directors, and also the report of the Post-War Committee, were longer than usual and their reading absorbed most of the time given to the first day's sessions. All these important documents will be found in this issue. Their very careful perusal is earnestly suggested to every man in the profession. In fact with special reference to the very complete report of the Post-War Committee, it is believed that every man in every profession or activity that joins with architecture will find it worth while to study this report. It sets forth just what to do and how to do it. The pity of it is that a movement so well planned and so efficiently set on its way should be allowed to languish from the combined disadvantages of insufficient funds and the lukewarm attitude of those whom this committee has so unselfishly sought to serve.

The lean years that President Kimball referred to in his opening address have now to be made fat ones, and the spirit of every man for himself is probably no more strongly developed in architects than in other professions. The condition will have to be taken as it is found. But certainly it is a pity that the Post-War Committee should for the reasons set forth seek to turn back to the Institute the

## THE AMERICAN ARCHITECT

powers it so well exerted and for which exertion it is feared it has been but poorly required.

A feature inaugurated at this convention which should not be overlooked or slightly regarded is the First National Exhibition of Architecture, opened under the most auspicious surroundings on the evening of the first day. This exhibition of architecture, grouped under different states, had been gathered and selected by the various Chapters and sent to Washington. It was arranged to cover almost the entire wall space of the upper galleries and probably was the largest and most complete showing of architecture that has ever been given in this country. With each state carefully and proudly selecting its representative material, it is easy to comprehend that what was hung in this fine collection was the very cream of recent architectural accomplishment.

Occasion was taken a number of years ago to comment in *THE AMERICAN ARCHITECT* on the splendid way in which a collection of architectural exhibits was hung by the T-Square Club in Philadelphia in connection with an exhibition of the painter's and sculptor's arts. One collection so admirably supplemented the other that there was a beautiful and harmonious ensemble. The collection in the Corcoran Galleries even more insistently accents this unity of arts. Many times larger than any other architectural exhibitions, it is surrounded by many galleries of paintings and sculpture, the masterpieces of the world. One loses nothing by contact with the other. We shall have patience with the enthusiast on such an occasion who insists that architecture is all an art, and shall not chide him for the moment if he fails to realize that it is also a very important business.

A splendid exhibition such as this is good to hold, for it promotes in architects themselves a higher respect, a deeper reverence for their profession, and it also teaches the public to appreciate all those high aims for which architects always strive.

One thing that will impress the thoughtful observer when he views these regional groups of exhibits is that if the name of the state that marks them were removed, he would find it difficult to

determine whether the location were north, south, east or west.

The design of large buildings in this country has become so standardized, particularly the "skyscraper" office building, that we may look in vain through this vast exhibition even in details of design, for any positive indication of a regional location. All these buildings have been, of course, carefully planned to meet their various purposes, but why so accurately follow precedent in choice of material and general treatment of design as to rob them of a distinctiveness as representing the cities in which they are located? If we are going to evolve a regional type of architecture, we shall have to reform these things.

The physical difficulties attendant on the assembling of these exhibits were very great. The committee of local Washington men, of which Waddy B. Wood was chairman, were at one time threatened with absolute failure. Erratic and much disturbed railroad transportation conditions had prevented the delivery of many of the contributions of distant states until almost the very hour of opening. But where there is the will there is always the way. The early arrivals on this opening evening could hear the sound of many hammers driving the nails to hang exhibits that had only a few minutes before been received. Even the catalogues were fresh from the printers' hands and the forms from which they were printed had been locked and sent to press almost while the vast number who were present were reaching the galleries.

This is the spirit that wins, and it is the spirit of dogged determination that seems to be present in every delegate to this convention to place the profession so correctly before all the world that it may never again be misguided.

At the outset, it was the intention in setting down these things to write, as in years before, "the first day's proceedings." But this year things are different. There were no "proceedings" in the sense of flowery oratory and fervid speech. Just a quiet, serious getting down to business, with the relaxation, to complete the day, to be found in this very fine National Exhibition of Architecture.



# Address of President Kimball at the Opening of the Fifty-third Annual Convention of the American Institute of Architects

I KNOW I owe it to you to say something restful, consoling, encouraging, even hopeful; certainly no section of mankind has a better right to hear and see and feel itself fairly valued and reasonably appreciated than have the architects, as one small division of that great army to whose skill and patriotism, self-sacrifice and public devotion all men owe this, their latest survival—and our million, more or less, millionaires their war made millions. Surely nothing would better satisfy the yearning within me than to be able to say these things that are due to be said, and to so say them that they might be heard of all men.

To commerce, well organized and keenly alive to its opportunity, a golden harvest has been returned—returned in figures that are almost unbelievable. “Scandalous” is the word used by a merchant of my acquaintance, to characterize the tidal wave of ever increasing profit that has poured in upon him among others whose lives chanced to be cast in the moulds of barter and trade.

Of the host whose offering was service, war-needs have brought to those engaged in so-called “useful pursuits” a bounty hardly less profligate; while to the architect and many of his brother professionals, without whose technical skill and far-reaching vision neither commerce nor labor could have passed beyond the first line defences—to him and to them the fickle hand of fate has offered little beyond the chance to show the material of which he and they are made, and to furnish examples of that finest of all God’s creations—“a good loser.” All of which intensifies my regret that I may not cry the facts from the house-tops to the farthest corners of the land, and so loud that none should fail to hear.

Much as I honor the game spirit that prompts it, the ever present smile behind which we architects seek to hide the unhappy truth, is becoming little short of sickening. Can it be that that threadbare word “camouflage” is to be our one legacy from the war? Must we go on displaying this brand of deceit—human pewter masquerading under a silver hallmark—that we may laugh with the rest of the world? Is it right, is it fair to keep up the smile for the sake of an exploded idea? Isn’t it time to discard *deception* and try the *truth*? Why should we punish the profiteer when profiteering

is the teaching and example and pride of our people, and during our generation at least, always has been? If we are to condemn the “added talent” of scripture, why encourage a great central Chamber of Commerce lobby headquarters here in Washington? Why continue to invite the charge of maintaining a local architectural lobby, for that matter? Why a percentage (a profiteer’s) basis for professional service? Why call ourselves a National Society on hardly a 10 per cent. representation? Why attempt a comprehensive program with a Country Club organization? Why nation-wide laws when our problems are local? Why continue to smile and pretend to be happy after seven years of privation and in the face of seven more of uncertainty? Why keep on trying to legislate against the laws of Nature; and finally, why such topics and questions here and now?

The last is, perhaps, the only pertinent question in the list. The seven lean years through which we have lived, with the prospect of seven others before us that may be even more trying, should have convinced us that something is wrong, and that whatever it is, it is no mere detail. Two years of purposeful, though none too well appreciated effort by the Post-War Committee have helped me, at least, to the conclusion that in this self-centered age the professions (so-called) are marching in the vanguard of the army of selfishness, carrying a banner of deception bearing the motto, “Do unto others as you would be done by.”

Our Institute is run by a Board of Directors—always wisely chosen and always functioning beyond criticism. It has been officered, during this administration at least, by a group whose only strife has been a contending to share each others’ loads. A masterly report by our Secretary will shortly lay before you in detail the record of Institute activity—all of which is my excuse for transferring the President’s address to a field of generalization and speculation rather than of detail and record.

I know of no organization whose possibilities are greater—possibilities for service to society, I mean. And I take it that to so serve to the limit of its capacity is what justifies any professional organization, this one not excepted. Two years of close observation, sharpened by the responsibility they imposed and kept at high tension by reason of

## THE AMERICAN ARCHITECT

unusual and rapidly changing conditions—two years in which an indulgent constituency and a willing, efficient instrument have given me most generous help, provide my excuse for assuming to parade before you, as worthy of attention, a group of ideas that reduced to lowest terms are neither more nor less than your retiring President's personal opinions.

FOR the sake of argument let us keep in mind the fact that while the American Institute of Architects is still far from being numerically representative of the profession, it has from its birth furnished to the profession the ideals and examples after which the architectural practice of this country has been patterned, and has always been the court of last resort before whose bar all its serious and most important questions have been decided. Wherefore, in assuming for the Institute the credit of such leadership, we are debarred from disclaiming our share of the blame, where blame exists, for conditions that are not consistent with what should be present-day architectural heritage. During the sixty-three years of the life of the American Institute, profound changes have taken place in almost everything but the Institute itself; possibly out of love for its traditions, possibly largely the result of habit, those responsible for the A. I. A. have not seemed to take into account that its work has grown out of all proportion to its membership and machinery. The official instrument to adequately represent and make the most of a great public servant, such as is our profession, should count as members approximately one-half of those who legitimately practice that profession, which means we owe it to our pretenses to promptly secure a membership of at least 3,000; which in turn means better than doubling our present list. To do this, and do it fairly, changes are essential, membership must be made both more attractive and more easily attained. I place representation, adequate representation, as one of possibly three essential fundamentals in which the American Institute is not quite filling the bill.

A second important item, in which we must assume for the Institute full responsibility, is the example set to all architects as well as to all professions, of valuing professional service upon a percentage basis. To the baneful effects of this one *faux pas* I ascribe most of our really serious troubles. Certainly failure to hold, in a higher degree, the confidence of the public and of the client is traceable directly to this fallacious and mischievous source of suspicion which we have erected into a barrier between ourselves and our clients and society. Until architects as a class realize this and better understand the nature and extent of the harm done, I feel perfectly sure they will

never enjoy that position of trust in the community to which their qualifications should entitle them, nor will they achieve that degree of usefulness which the public has a right to expect of them; and until the American Institute has set the example of changing this, to me, perfectly indefensible system, to one which by its nature removes the cause of suspicion, I feel the Institute will continue to occupy a position of not quite "filling the bill." This item of a right basis for professional charges is, to my mind, one of those three fundamentals in which we are not quite measuring up, and for which I earnestly bespeak a cure.

MY third complaint is a more domestic matter, and has to do with one of our intimate peculiarities. Does it require argument to commend the very best form of organization? Is our work less in need of the elements that make commercial organizations succeed? If leadership is the keynote to success, is there any good reason why we should disregard those conditions that foster just that element in practically every form of organization that goes forth to do a man's work. The executive found in municipal, county, state and national organizations has always some element of power which, like the White House veto, provides the trading basis whereby the executive may to some extent enforce the consideration of his policies. Throughout industrial and commercial life, the same control of power that places an executive in office provides him with the kick he needs to make leadership worth exercising. In most social clubs and in professional associations the executive means little more than nominal leadership—and its functioning seldom even justifies that. There is indicated for this association, however, a tremendous opportunity and one that should justify clearing the way for the highest type of executive leadership. I can offer no suggestion fraught with more promising possibilities than that our future presidents should be provided with an instrument more effective than the opportunity to persuade and the right to vote in case of a tie.

Certainly no member of the Institute could undervalue the honor attendant on executive preferment at the hands of its membership; but it is conceivable that in the light of possible achievement some very desirable candidate might seriously weigh his chances of rendering a service—under present conditions—that would warrant the sacrifices involved in the two years of concentrated thought that will more and more be demanded as we more and more fully accept for the A. I. A. its obligations to architecture and to society. Let those who would have the Institute more fully measure up to its ever-increasing opportunities for

## THE AMERICAN ARCHITECT

Leadership in service to the public consider well this thought. Now just a word of the satisfactions and regrets that mark this passing administration. For the thousand added memberships for which I made my futile appeal of a year ago I have not quite a thousand regrets, but unhappily nearly so; comparison with the progress made by other professional groups shows the Institute in its usual position—at the foot. While a net gain of 83 in 1919 is said to be almost the banner performance of our history, it compares but feebly with 1,232 for the same time, as an average result, in the case of five engineering societies; or with one particular technical society, fifty years of age, which in one week added to a membership 1,200, just 2,000 new members—illustrating what may be done with tools, even though in our case we might not care to use the same tools. As a step toward a real result in the membership campaign that is in the air, let me suggest tinkering a bit with that time-honored canon that forbids competition in price. Let us open the door (by abolishing this canon) to all those boys who have been too honest to accept a law they felt it dishonest to abide by; and to all those other beginners who through modesty have hesitated to assume equality of performance with the leaders of the profession—which only could justify equally high fees. I believe that alone would enfranchise the whole balance of the thousand, for which I am recording a regret.

UNDOUBTEDLY, the most unusual activity of the present administration, and I believe it the most unusual in the history of the Institute, is the work of the Post-War Committee. For me, it sets the high-water mark of satisfaction. The liberality and courage with which the Institute supported its President in this entirely unselfish, as well as unusual activity, will go far, I think, to answer the critics whose complaint has been that we are a close corporation with only our own interests at heart. I know of no parallel, no case where a professional body has generously financed an effort in which its members were no more interested than were all the rest of the profession; and in this case, too, it has not been only the profession of architecture, but every profession that has come in for its share of attention, and will certainly reap part of the reward. The way in which the Post-War Committee and its Executive Council have devoted time and energy when those two essentials were, perhaps, at their highest market price, is a matter of the greatest gratification to me, and should be a source of pride to every member of the Institute and every architect in this land. My regrets in this connection have to do with conditions beyond our control. It would be para-

doxical to include the ending of the war among things to be deplored, yet there is no denying that the signing of the armistice brought to a sudden close a period of great mental activity and promise; particularly is this true among those workers who had been forced to make the greatest sacrifice as a consequence of the war. Depleted larders and colossal obligations were not to be ignored, and it is *regret*, not *criticism*, that expresses my feeling for those who, at that time, dropped completely all occupations, physical and mental, that had not to do with recuperation. It is to this occurrence and condition that I wish to direct the attention of all those who may fancy that the Post-War Committee's effort has in any sense been lost. Nature's finest growths are from slow-germinating seed, and I have no hesitancy in prophesying that the seed sown by the Post-War Committee will yield a perennial crop, and of exceptional value, as long as architects shall practice and their works endure.

In the one item of interprofessional relationship the Post-War Committee has sown a seed the fruits of which will, I believe, be of incalculable and immediate value to every one whose contribution is service. It may well be that in this one suggestion there may have been started that new social instrument for which we have all been waiting, and the need of which is so eloquently expressed in every phase of the ever-increasing struggle between the hosts of progress and of inertia which marks beyond all other things the age in which we live.

I should be recreant to my sense of duty were I to omit recording a protest against such a wide difference as exists in the Institute between the workers and the others. We can hardly hope for great Institute achievement while it is left to so few to serve so many. In this thought I voice the personal contribution of our Secretary in his ever-recurring plea that the Chapters may come to recognize that they are the Institute, and as such may begin to assume its responsibilities and duties.

For those among us—I may not say how large or small the group—whose evident pleasure it has been to destroy and obstruct, I have only the wish that they may come to see the error of their ways before it is too late to perform some useful service in extenuation. Perhaps in no particular has unfriendly manifestation been more fruitful of misfortune and more costly to the Institute than in the continued opposition on the part of certain individuals and groups to the success and growth of the *Journal*, the continued high character of which is certainly one of the greatest satisfactions that I have to record.

Among the contributions to Institute welfare and success that we should not fail to recognize is the

creation of *The Architectural Press*, and we must render to our Treasurer, Mr. Waid, a tribute of appreciation for his part in it, worthy of the example he has set, in going outside of his implied responsibilities to offer a splendid service to the Institute, and at a cost to himself in time, patience, and money sacrificed, that it is hard to overestimate.

In connection with certain occurrences during this administration for which some may feel sorrow, I should be inconsistent, preaching to a text of "truth in place of deception," if I were to express regrets for any circumstances resulting from the placing by anyone of any individual personality at a higher value than the best interests and welfare of our beloved Institute. I, therefore, intentionally omit from this address the recording in such cases of the usual expression of regret. Before closing, I wish to record my deep appreciation of all who have worked with me in the service of

the Institute during the past two years, many of whom are of those who not only hide their light under a bushel, but who do their praying in secret as well. Certainly no Executive of the Institute has ever had more loyal support, and I believe none has more highly valued such support.

Let me close with a plea for a larger view of things architectural, that we may not fail to correctly interpret the messages meant for us in the readjustment taking place in the world today. If in the physical *impasse* that threatens to stop all building, regardless of cost, there are signs of the ultimate return of money to its legitimate place as a scale of measurement; and if in the new significance that has been given to the word "*denationalize*" we may rightly discern a first step toward the universal brotherhood of man, then I say there is that in our future to justify all and everybody that has been sacrificed, and our abiding faith in the wisdom and justice of all things.

---

## Report of the Post-War Committee on Architectural Practice to the Fifty-third Annual Convention of the American Institute of Architects

**A** REPORT of the Post-War Committee presented to the Fifty-second Annual Convention of the American Institute of Architects at Nashville detailed the activities of this committee for the years 1918-1919; outlined the form of organization which the Post-War Committee should take and recommended that, because of a rapid movement in business conditions since the armistice, the lines of investigation having to do with problems of a business nature be given a secondary place in the activities of the Post-War Committee for the current year and that the larger and more fundamental problems of relationship become subjects for study and investigation.

The report of the Chairman was accepted and the continuation of the Post-War Committee approved by the Convention. The plan of organization and the scope of work was approved at a special joint meeting of the Executive Council and the Post-War Committee held during the Convention period.

Pursuant to this action, a plan of organization was worked out and National Chairmen were appointed to direct a specific study of the following subjects:

1. Education—Mr. Frederick L. Ackerman, New York City.

2. State Societies—Mr. Frank E. Davidson, Chicago, Ill.
3. Registration—Mr. William P. Bannister, New York City.
4. External Relations—Mr. Ernest J. Russell, St. Louis, Mo.
5. Improvement of Service—Mr. Morris G. Holmes, Chicago, Ill.
6. Professions—Mr. Thomas R. Kimball, Omaha, Neb.

During the year it was found desirable in order to expedite the work of the Executive Council to move the Executive offices to Chicago and bring the Chairman and Secretary in closer touch with one another. At this time the Executive Council was increased by the appointment of Mr. Frederick L. Ackerman and Mr. Charles H. Whitaker, as members of the Executive Council and by the appointment of Mr. Henry K. Holsman of Chicago, as Secretary of the Executive Council.

The Post-War Committee was created by the Board for the purpose of setting up a committee which could function entirely independent of the Institute so that representatives of the entire profession including all Architectural Organizations might be invited to participate.

The object of the Post-War Committee has been

## THE AMERICAN ARCHITECT

to encourage a more comprehensive organization of the entire Profession and clear the atmosphere of uncertainty and misunderstanding as to what the term "Architect" implies and what responsibilities attach to the practice of the Profession; to recognize that the problems of the Profession are largely social problems affected sympathetically by rapidly changing social and economic conditions; to impress upon Architects their obligations, as professional men to society, and to bring about a clearer understanding of the relationships that should or do exist between the Architect and those whom he may serve; those with whom he collaborates and all others who render a professional service.

The original questionnaires sent out in two separate issues to all listed Architects in the United States provoked wide-spread discussion and constructive criticism. Replies were received from individuals and organizations throughout the United States, many Institute Chapters, and other organizations of Architects, having devoted meetings—and in some cases series of meetings—to a serious discussion of the hypothetical statements contained in these questionnaires.

Following the Nashville Convention, a "Report of Progress" containing a digest of discussions bearing on Post-War subjects at the Nashville Convention was sent to each practicing Architect in the United States. Each Post-War Committeeman, secretaries and presidents of all listed Architectural organizations were furnished with an organization diagram of the Post-War Committee, and a reprint of a diagram prepared by the Special Post-War Committee of the Washington State Chapter outlining, graphically, a method of procedure in directing a study and investigation of topics affecting Architectural practice. Accompanying these diagrams was sent a written brief prepared by the Executive Council outlining the Post-War Committee's activities; its objects and hopes for accomplishment, and explaining in detail the character of the Post-War Committee Organization and the manner in which it was to function.

These more formal documents have been supplemented from time to time by explanatory letters issued by the Secretary and by bulletins issued by the Chairmen of the National Committees.

As a result of the propaganda issued by the Post-War Committee, voluminous replies have been received from which may be deduced a list of topics bearing upon Architectural practice and professional relationship that would seem to be worthy of continued study by Institute Committees. A list of these subjects is appended.

The scope of the Post-War Committee's Investigation has been so great and the ramifications of the Organization itself, so extended that it will take

years before the value of the results obtained can be properly appraised. Replies coming directly to the Executive Council, however,—not only from the United States but from foreign countries—indicate that the effort of the Post-War Committee has received wide attention. Current editorial comment in papers now appearing and discussions of controversial questions now being carried on in the architectural, engineering and building press seem to indicate that thought along these lines has been stimulated by the investigation initiated by the Post-War Committee. Interviews with Architects and groups of Architects throughout the United States seem further to indicate that individual Architects, inside and outside of the Institute, are doing more coherent thinking along better directed lines and are showing a clearer conception of the real problems of the Profession and of their own obligation to society.

The Post-War Committee has probably performed its primary function in having brought about serious discussion and thought on a wide range of subjects, which, otherwise, probably would not have been brought so directly and immediately to the attention of the Profession.

The whole subject of the Organization of the entire Profession has thus been advanced to a very active stage. The relation of the Architectural Profession to other professions and to society is probably better understood and out of this understanding should grow a clearer recognition of real values in human life.

Specific lines of investigation and action have been carried on by National Chairmen as follows:

### REGISTRATION:

The National Chairman, Mr. William P. Bannister, has prepared and issued a bulletin to all Post-War Committeemen, setting forth the desirability of State Registration Laws; stating the fundamental essentials of such laws and advising as to the preparation of bills to be presented to Legislatures for the enactment of such laws and for the creation of Examining Boards. This Committee has made available for States contemplating the enactment of Registration Laws, the benefits to be derived from the experience of other States wherein such laws have been enacted and are now in force. A copy of the bulletin issued by the National Committee on Registration and a report of that Committee is appended.

In connection with the policy of encouraging the enactment of Registration Laws, it seems to be obvious that there should be some recognized standard for the Architect on behalf of the community itself, just as there are standards for the lawyer and doctor. Further than this, these standards should be uniform. All Registration Laws

## THE AMERICAN ARCHITECT

should be so drawn as to give consideration to and to advance, first of all, the interest and welfare of the public. Until it is possible to classify Architects with the degree of accuracy which a legal definition of the use of the term Architect would provide, it will always be impossible to properly organize the Architectural Profession or to combat the misunderstandings that now seem so generally to exist as to what an Architect is and as to what service is expected from him.

### STATE SOCIETIES:

The National Chairman, Mr. Frank E. Davidson, has prepared and issued to Post-War Committeemen a bulletin setting forth the desirability of organizing State Societies in each State, and has placed in the hands of each Post-War Committeeman a tentative form of Model Constitution and By-Laws patterned after those now existing in Illinois, Michigan, Indiana, and other States. This form of Constitution and By-Laws has been issued as a tangible basis for criticism and constructive action, and with the idea of placing in the hands of groups of Architects interested in organizing State Societies, a document which would furnish them a definite basis upon which to initiate their efforts. The issuance of this document has called forth criticism from a few individuals and seems to be out of harmony with the ideas of the Committee of the Institute on State Societies. The policy, however, of encouraging the organization of State Societies was approved by the Nashville Convention. The exact form and terminology of any Constitution and By-Laws adopted by a newly organized State Society would, almost unquestionably, be given careful thought and consideration by the Society itself which would probably not accept in toto any document prepared by a central organization. Criticism provoked by this document has greatly stimulated a discussion of the subject of the Organization of the Profession. Like all other work of the Post-War Committee it is too early to appraise the results of this investigation.

A copy of the bulletin and the form of Constitution and By-Laws, together with the report of the Chairman of this Committee are hereto appended.

On the general subject of State Societies, it is believed that in order to speak with authority for the Architectural Profession the entire Profession must be more fully organized. At present approximately 20 per cent. of the Architects of the United States belong to the Institute and its Chapters, and the other 80 per cent. of the Architects are not reached or influenced by any organization. Among this unorganized 80 per cent. are many Architects of high standing, men of influence who regard their profession with the

highest respect, but who, for one reason or another, have not joined the Institute. It was the belief at the Nashville Convention that the Organization of State Societies would take in a large part of these Architects, and by developing a relationship between these State Societies and the American Institute of Architects, by representation at the Convention as suggested by the Board or otherwise as may be worked out, that the unorganized Architects would become acquainted with the personnel, the traditions and the ideals of the Institute to the great advantage of the entire profession. That further, these State Societies would become a fertile recruiting ground for Institute Membership; it has further been suggested that when the value of such a relationship as above described has been demonstrated the State Societies might, in some degree, become supporting members of the Institute, which in the opinion of the Post-War Committee should always remain the guiding National organization.

While it is impossible at this time to state conclusions the replies to the questionnaires seem to indicate a preponderance of opinion favorable to the organization of State Societies.

### CO-OPERATION WITH RELATED INTERESTS:

The National Chairman, Mr. Ernest J. Russell, has been a man of many activities under this broad title. While the work of this National Committee was to a large extent initiated and in the early stages financed by the Post-War Committee, the appointment of sub-committees of this National Committee have been ratified by the Institute and now stand as Institute Committees, thereby lending force and authority to their action. The work of the National Committee on Related Interests is broadly sub-divided under the following heads:

(a) Labor Organizations; Contractors' Organizations; (b) Engineering Societies; (c) and (d) Draftsmen's Organizations. Bulletins issued by the Chairman of this Committee and a report of progress are appended hereto.

(a) The organization of the National Board of Jurisdictional Awards in the Building Industry is one of the most progressive steps ever taken toward a better understanding between employer and employe in the building industry. Settling amicably in conference, between representatives of labor organizations, contracting organizations, engineers and architects, the question of jurisdiction among trades will eliminate one of the most fruitful sources of strikes that has ever existed;—the proportion of jurisdictional strikes far outnumbering strikes from any other cause.

The fact that Mr. Ernest J. Russell was chosen as Permanent Chairman of this National Board for

## THE AMERICAN ARCHITECT

Jurisdictional Awards should be most gratifying to the Architectural Profession, and particularly so to Mr. Russell himself. The American Institute of Architects has joined with the other organizations in a mandate to enforce among its members the findings of the Board.

### (b) CONTRACTORS' ORGANIZATIONS:

A committee of Architects under the Chairmanship of Mr. Russell was appointed to attend the Convention of the National Federation of Construction Industries recently held in Chicago and took an active interest in the discussions and committee work of this Convention. It seems apparent that there is a great need for direct affiliation between Architects and all of the factors entering into the production of buildings. The organization of the National Federation of Construction Industries seems to provide the machinery through which such an affiliation can be brought about. A letter ballot from the Members of the Committee who attended this Convention—all of whom are Members of the American Institute of Architects—was unanimous in recommending that the American Institute of Architects should affiliate itself with the National Federation of Construction Industries.

### (c) ENGINEERING SOCIETIES:

The American Institute of Architects asked the Engineering Council to join with it in appointing a committee to co-operate in the solution of problems mutually affecting the two societies. Mr. Russell, as Chairman of the Committee on External Relations, and Mr. Richard E. Schmidt were appointed as representatives of the Post-War Committee and of the Institute. All State Chairmen of the Post-War Committee have been asked to cause similar local joint committees to be formed. The beneficial results to be obtained from such co-operation are very far-reaching, the question of joint or separate registration of Architects and Engineers being one of the subjects which can be most equitably handled by this method.

### (d) DRAFTSMEN:

It has been suggested to local Post-War Committeemen that Architects should get in close touch with Architectural Clubs (or to encourage the organization of such clubs where none exist), to talk over the respective viewpoints of the Architect and the draftsman in relation to common problems. Architects should assist the draftsmen in their studies and classes and co-operate with them in their organization. This sub-committee has been unable to carry forward to any conclusion the question of draftsmen's Unions, but it is recommended that this study be carried on as the work of an Institute Committee, realizing that this will make for the improve-

ment of the entire architectural Profession.

### IMPROVEMENT OF SERVICE:

Mr. Morris G. Holmes, National Chairman, after a thorough study of a digest of correspondence received in response to Post-War issues, has prepared a bulletin bearing on the question of office organization; co-operative offices; co-operation with outside technical specialists; compensation; competitions and other problems of practice. Because of limited financial resources and for other reasons that will be dwelt upon later, this bulletin has never been sent out but is appended herewith.

### PROFESSIONS:

The National Committee on Professional Relations, Mr. Thomas R. Kimball, Chairman, has directed its efforts to the task of organizing the Inter-Professional Conference held at Detroit, November 28th and 29th, 1919. Mr. Robert D. Kohn had charge of the organization of this Conference, was its temporary Chairman and was elected by the Conference as its Permanent Chairman.

At this Conference fourteen Professions were represented and a National Organization was formed which bids fair to develop means whereby through co-operation between the Professions the service of each for the Public Good will be improved and their combined efforts may have a more effective and beneficial influence on Public affairs.

One striking effect of this organization is that four representatives of other Professions will appear before this convention and speak on the subject: "What can be gained for the Public Good by co-operation between the Professions?"

The National Organization has already developed local organizations in several cities.

### EDUCATION:

In the opinion of the Post-War Committee, Architectural Education will never be what it should be until the period of school study is recognized as being only the beginning of a process of education which must continue through the period of draftsmanship in the office and tend toward the growth of the Architect himself in the knowledge of new methods and practices throughout his entire professional career.

### SPECIAL COMMITTEES:

From time to time during the past year conferences or conventions of particular interest to the Architectural Profession have taken place, and where possible the Executive Council have appointed Special Committees to sit in these conferences.

This has been true in the case of conference held in Chicago under the auspices of the Associated General Contractors of America to discuss the perplexing problems of "Expense of Estimating." A

## THE AMERICAN ARCHITECT

Committee of Architects was appointed to act with a similar Committee appointed by the Engineering Council and by the Associated General Contractors of America. The Committee appointed consisted of:

Mr. Richard E. Schmidt, Mr. George C. Nimmons, Mr. Frederick W. Perkins and Mr. Henry K. Holsman, all of Chicago.

Through action by President Kimball, this Committee became an Institute Committee. Two meetings have been held at which methods of estimating have been discussed as follows:

- (a) The Quantity Survey System.
- (b) Organization of Estimating Bureaus by various trade associations.
- (c) The utilization of estimating organizations to furnish estimates to contractors on a prorated basis, charging the entire estimating cost to the Contractor awarded the work.

This series of conferences has not been concluded, but a progress report has been made and is attached hereto.

### COMMITTEE ON WAR MEMORIALS:

A Committee to deal with the important question of War Memorials was appointed, Mr. Horace Wells Sellers, Chairman. This Committee was taken over by the Institute and a report has been made to the Board.

### SUMMARY:

What may be called definite accomplishments of the Post-War Committee may be summarized as follows:

- (a) Have received and tabulated under subject headings, a mass of opinion, suggestion and criticism from individuals and societies bearing on various phases of the problems confronting the Architectural Profession. Lack of funds has prevented the general distribution of a digest of this material.
- (b) Have established a point of contact and machinery for co-operation between the Architects and Engineering Council.
- (c) Have established a definite basis for co-operation between Organized Labor, Building Contractors and Engineers. This probably being the opening wedge to a broader co-operation and more sympathetic understanding between these great elements in the Building Industry.
- (d) Have laid the foundation for a closer association with the Building Industry through participation in the Conference of the National Federation of Construction Industries.
- (e) Have placed an argument for Registration of Architects, together with practical data on Registration Laws—mode of procedure to secure such

laws, etc.—in the hands of individuals and organizations in practically every State in the Union.

(f) Have placed the question of the organization of State Societies, together with an outline of the experiences of States having such Societies, and also a form of Constitution and By-Laws in practically every State in the Union, through the membership of the Post-War Committee.

(g) Have probably started a larger body of Architects thinking concurrently along formulated lines of study than ever before.

(h) Have developed a form of organization that has many features to recommend it as a workable machine for carrying on educational effort of national scope. A chart is attached hereto.

(i) Have developed through the effort of the special Post-War Committee of the Washington State Chapter a chart indicating desirable fields for investigation in the study of problems effecting the profession of Architecture. The chart is attached hereto.

(j) Have laid the basis for an international professional relationship, by correspondence and interchange of documents and information. This relationship has taken an active form through the creation of the Institute Committee on Foreign Cooperation, and the Post-War Committee hopes that this work may be prosecuted with vigor as a part of the basis of a new and more tolerant relationship among all nations.

(k) Have established relationship between the various Professions through the formation of the Inter-Professional Conference.

### CONCLUSIONS:

The labors of the Post-War Committee on Architectural Practice were commenced at a time when normal industry in the United States was still paralyzed and when employment in all of the pursuits of peace was still at a very low ebb. Architects throughout the country were largely unemployed and the future was fraught with many uncertainties. The appeal of the Post-War Committee, therefore, calling attention to some of the more patent professional ills, brought an immediate and general response.

Instead of serious depression in business and general unemployment, however, that many anticipated, business increased by leaps and bounds until by the fall of 1919 the business problems of Architects became such as to require their entire attention.

Just in the ratio that these problems increased, the interest as expressed by the activity of the local Post-War Committeemen increased, until during the past few months the work of the Executive Council has been greatly handicapped.

*(Concluded on page 613)*





## The Convention and State Societies

“WHY,” enquired President Kimball in his opening address, “call ourselves a National Society on barely a ten per cent. registration?” Is the answer, “because”? Or is it, that a certain minority of the ten per cent. which is and has been in power will not so act in a matter of reorganization as to encourage every architect to affiliate with the Institute.

President Kimball no doubt received a most illuminating answer to his query while listening to the debate on State Societies during the afternoon session of the second day. The essence of that important conference will be found in our next issue.

The fact stands out clearly that it is the desire of the majority of the profession now unrepresented to accept any well considered plan or organization that will give them the benefit of an association with the Institute. At no time during the debate could anything be detected as showing a disposition to question the right of the Institute to assume an attitude of absolute control. This acknowledgment of the authority of the Institute was not from delegates from the chapters or from members of the Institute, but from officers and members of the various State Societies who were in attendance in response to a special invitation of the Board of Directors.

President Kimball is right when he states that there is no organization whose possibilities are greater than those of the Institute. Will it avail of these possibilities or will it continue to endeavor to represent the profession on a basis of but ten per cent. of a possible membership.

UNDOUBTEDLY the solution of this problem lies in an organization of the entire profession through State Societies to be controlled by the Institute, and to form the organizations through which all men must pass before becoming finally advanced to Institute membership. When the profession at large can be made to understand that affiliation with a State Society does not mean the

joining of a reorganization that is not in accord with the Institute, but on the contrary is very directly associated with it, these State Societies will grow and flourish and build the Institute into a representative organization.

In this connection of reorganization to effect a more complete representation, it is interesting to note the views of many of the delegates as expressed in conversation. A group of men, high in the profession, regularly delegates to these annual meetings were discussing a plan of reorganization. Just why this plan was not put forward on the convention floor it is difficult to imagine, but its novelty and absolute practicability should recommend it to every thoughtful observer of the profession. This plan of reorganization could be summarized as follows:

They took, for example, the National Academy. Its highest honor of membership—a full academican—is limited to a certain number. Its associate rank, while not limited, is carefully recruited by the votes of the academicians. The National Academy has shown a broad and appreciative spirit in going outside of its immediate field of the painters' art in its election to the honors of both Academicians and Associates. It has chosen many architects of distinction, sculptors, mural painters and others in the field of the allied arts. The position of the National Academy is absolutely unassailable. The National Sculpture Society is organized on very similar lines. Both are representative bodies.

WHY not, then, a National Academy of Architecture? Why should not the American Institute of Architects elect from its membership a group of, say, one hundred men who would become the founders of the National Academy of Architecture. Then, why not reorganize the Institute as The Institute of American Architects with a governing body composed of a council of one member from each State. A president could be elected from this group to preside over the Institute. The Chap-

## THE AMERICAN ARCHITECT

ters as Chapters to be reorganized as the nuclei of State Societies.

Every registered architect in the country would be eligible to the Institute, his term of membership contingent on his good standing; his dismissal for cause from the Institute to act as revocation of his registration.

Commenting on this plan, it might be added that democratization can be carried to too great an extent. It may be true that all men are "born free and equal," but it is not similarly true that they grow up as equals. In anything we attempt there must be some incentive of success. There must be some goal or honor. The men who faced almost certain death when they went over the top have just pride in the badge of honor that a grateful government pins to their tunics. There must be an objective, a goal. Travelling hopefully is all very well, but even the stoutest heart will falter if there is no reward in sight upon arrival.

So then, why not award with recognition and all the proper dignities the men who have made architecture famous in this country? Why not let them from the high position of academicians of architecture rest on the laurels they have won and leave all the details, cares and work of organization to those men whose very daily activities in their profession have so well qualified them to take up the details of organization management.

ARCHITECTS who stoutly maintain that architecture is wholly an art, and nothing else, have succeeded up to the present time in retaining in the American Institute of Architects every feature in support of that contention. This group of men are today firmly in control. Meantime the Institute daily shows evidence that it is not in the truest sense a representative organization, inasmuch as it does not bring under its jurisdiction the entire profession and, to quote Mr. Charles St. John Chubb in the *May Journal*, "as long as the Institute remains a body of the aristocracy of the profession, there is room for another kind of architectural organization."

No one will for a moment contend that these men who are so insistent on the acceptance of their contentions are not representative men in the profession. They certainly are. As a rule their names are firmly identified with our best architectural development. But, giving to them the great honors they have so justly won, acknowledging our debt to them as creators of the best buildings in the country, does not necessarily compel acknowledgment that they are the best fitted to guide the Institute in its details of organization. A point of view that belongs with high position often becomes intolerant of that in those who have not thus arrived. Why not give to these men as other art organizations have done recognition for high accomplishment.





HOUSE OF H. R. REA, SEWICKLEY, PA.  
HISS & WEEKES, ARCHITECTS

612



622



HOUSE OF H. R. REA, SEWICKLEY, PA.  
HISS & WEEKES, ARCHITECTS



612<sup>3</sup>



HOUSE OF H. R. REA, SEWICKLEY, PA.  
HISS & WEEKES, ARCHITECTS





6124



HOUSE OF H. R. REA, SEWICKLEY, PA.  
HISS & WEEKES, ARCHITECTS



612



HOUSE OF H. R. REA, SEWICKLEY, PA.  
HISS & WEEKES, ARCHITECTS





ALTERATIONS TO HOUSE OF EDWARD M. HALE, PASSAIC, N. J.  
JOHN F. JACKSON, ARCHITECT

612





ALTERATIONS TO HOUSE OF EDWARD M. HALE, PASSAIC, N. J.  
JOHN F. JACKSON, ARCHITECT







HOUSE OF GEORGE CROMPTON, POCASSET, MASS.  
JAMES FURDON, ARCHITECT





HOUSE OF GEORGE CROMPTON, POCASSET, MASS.  
JAMES PURDON, ARCHITECT

612



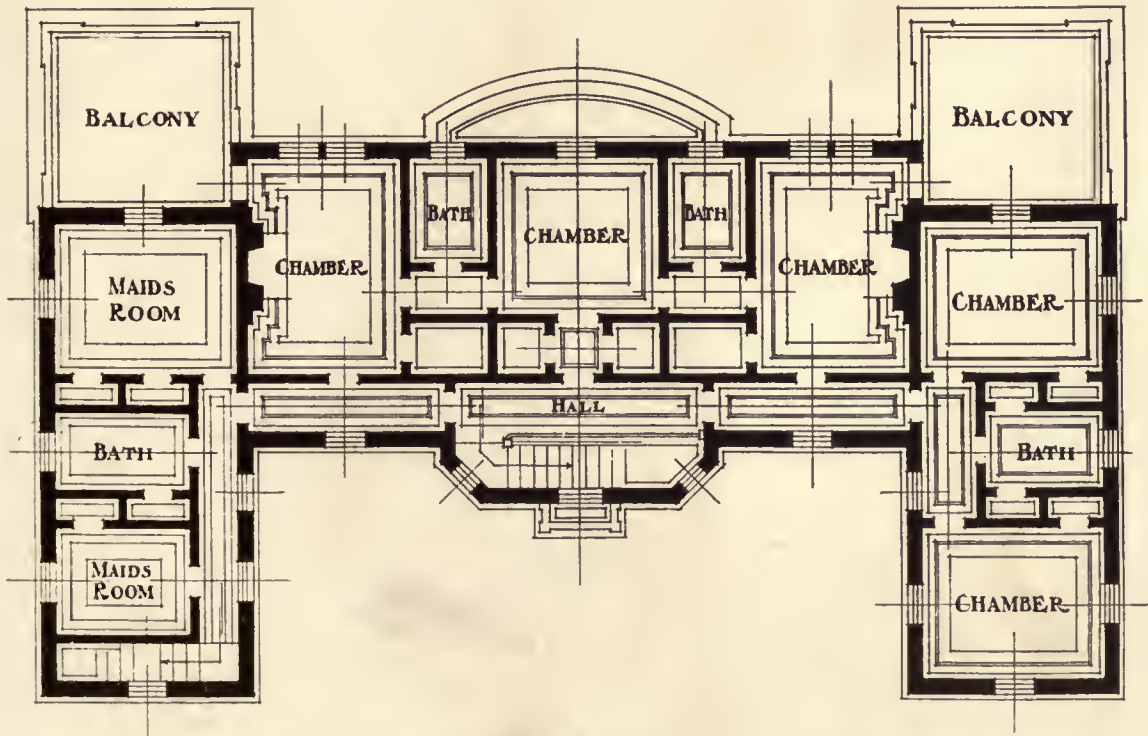
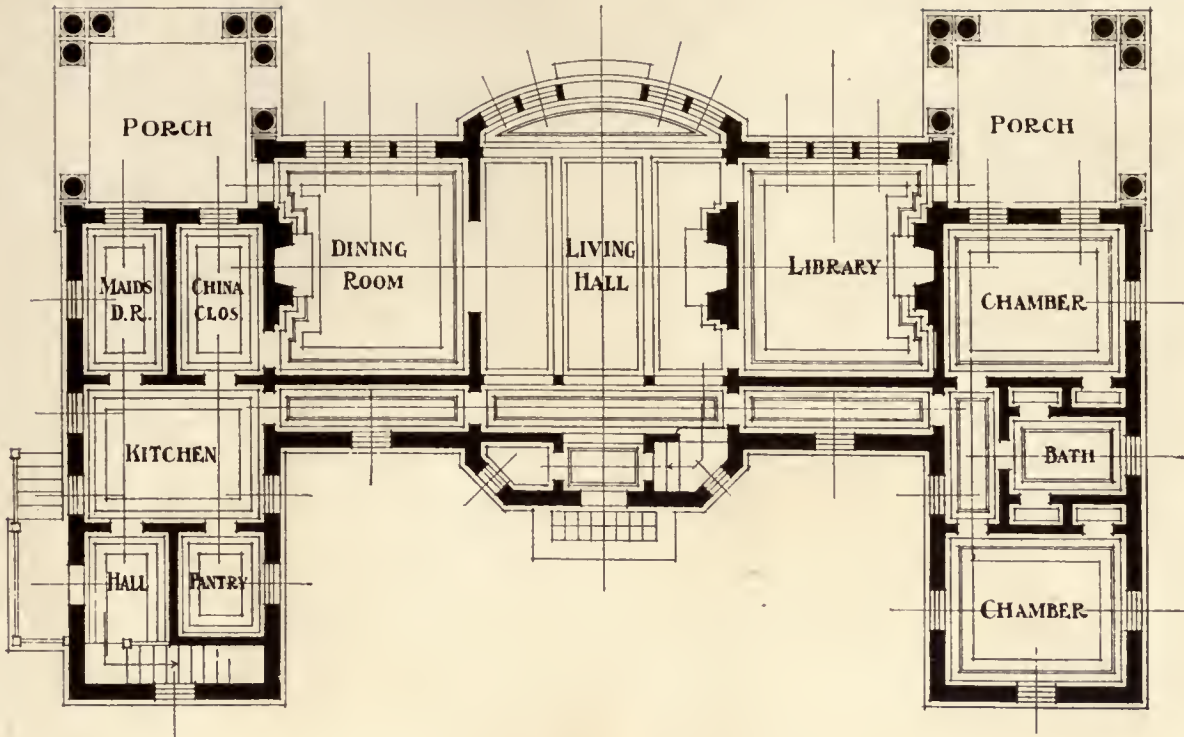

HOUSE OF GEORGE CROMPTON, POCASSET, MASS.  
JAMES PURDON, ARCHITECT



## Report of Post-War Committee

(Continued from page 610)

In this connection the Committee is regrettably led to the conclusion that Architects do not actively interest themselves in the problems concerning their profession except in times of depression. Then they turn to their organization for help and suggestions through which they may meet the problems incident to depression, only to find that they themselves have neglected to help their own organizations in the task of preparing for just such emergencies.

The funds so generously appropriated by the American Institute of Architects for carrying on the work were becoming rapidly exhausted and many of the activities of the Executive Council, such as distributing the report of the Committee on "Improvement of Service"; disseminating excerpts from the replies received from our various bulletins; putting into effect a "follow-up" system among our National Chairmen and Post-War Committeemen, were curtailed or abandoned, and it was found impracticable, because of the cost, to call any meetings of the full Post-War Committee.

The Executive Council believes that the time is not propitious for a further expenditure of funds by the Institute for Post-War Committee work, but feels that its work has now been brought to a point where it can better be carried on by properly constituted Institute Committees.

Subjects worthy of further study as suggested by a preponderance of criticism in the replies received from Post-War Issues:

1. What should be the function of the American Institute of Architects?

(a) A National Organization of the Profession and a direct factor in economic and social life; or,

(b) A dignified Academy attainable only by a few, and dealing only with the internal Ethics of the Profession?

2. What should be understood by the term Architect?

The public should know the circumscribed field of the Architect's legitimate activity, just as the public knows that of the Doctor and the Lawyer.

3. The desirability of giving Local Chapters of the Institute greater authority in formulating Rules of Practice for the guidance of their Members, more in conformity with established custom in a locality.

4. As related to creating sentiment in favor of Registration Laws. To set up a standard of what a man should know and be competent in before he enters into practice as a Principal.

5. Parliament of Building Industries.

6. The entire subject of relationship between Architects and draftsmen.

7. Methods of organization of an Architect's Office to render complete service.

8. The value of dignified Publicity after a definite policy and a definite meaning of terms have been established.

9. Remuneration for Architect's Service:

(a) The Percentage System.

(b) Cost—Plus a Fixed Fee.

(c) Other methods.

10. Expense of Estimating:

(a) Quantity Survey.

(b) Contractors' Bureaus.

(c) Commercial Bureaus for Member Contractors.

11. Schedule of Charges, to provide for complete Service omitting reference to employment of Specialists, Clerk of Works, and data to be furnished by the Owner.

12. The executive council believes that the work of the following Committees should be continued:

(a) Inter-Professional Conference.

(b) Registration.

(c) State Societies.

(d) Related Interests.

(e) Improvement of Service.

# Synopsis of Committee Reports

## Fifty-third Annual Convention of the American Institute of Architects

### COMMITTEE ON FIRE PREVENTION

F. E. DAVIDSON, *Chairman*

STATING at the outset that a "fireproof" building does not exist, the report refers to the fact that architects have learned the lesson of experience, and as a result will undoubtedly give their attention more largely to matters of fire prevention rather than to systems of fireproofing. Continuing the report states:

Notwithstanding all the propaganda of the best thought on the subject, the annual fire loss of the Nation is constantly increasing. If during normal times a dozen good reasons were given for preventing fires, a hundred may now be advanced. Our housing conditions are deplorable. The world is demanding all the food, all the clothing and all the structures that our bounteous Nation can produce, and when the surplus which may be spared for foreign nations is reduced by an annual fire loss of \$270,000,000 the loss falls not only upon our own industries, but must be paid by all the nations of the earth.

How, then, may the architectural profession perform its full duty to society in connection with the great problem of reducing the fire loss? Obviously, as an organization, we can do but little, but if every architect would interest himself in the local work of the National Fire Protection Association much might be accomplished.

Your Committee recommends that architects, as individuals, join this National Association, and assist in the movement recently started whereby it is proposed that every fire chief surround himself with a cabinet of advisers, composed of architects, engineers, real estate brokers, bankers and others whose every interest lies in preventing their own city from being destroyed by fire, and its good name from the calumny of fire waste and carelessness; and who will stand back of the chief in the enforcement of his fire prevention orders. With such a body of citizens back of them fire department heads will have little fear of interference with their plans for fire prevention.

Another reason why architects should affiliate with the National Fire Protection Association is that by so doing they will regularly receive the publications of the Association which are worth many times the small cost of membership.

It is valuable to learn from this report that the Underwriters' Laboratories will shortly publish the result of the tests of 105 different types of columns commonly used in building construction in conjunction with the various systems of fireproofing.

This report it is learned will soon be available and may be had by architects on request.

### COMMITTEE ON WAR MEMORIALS

HORACE WILLS SELLERS, *Chairman*

Since the signing of the armistice this committee has been performing a valuable service in the giv-

ing of sound professional advice on the subject of war memorials.

The idea has been from the outset to create a better understanding of what memorials should be to worthily express the patriotic spirit which inspires them.

The result and effectiveness of the committee's efforts in response to requests for advice in regard to memorial projects can be conjectured only. In but a few instances have these projects contemplated any form of monument to be set up solely as a reminder of events or deeds to be commemorated. In almost every case the inquiries refer to so-called community houses or some utilitarian structure for which there is a local need apart from the purpose to create a war memorial, and in turning to the Institute for guidance the general request has been for typical plans or designs to use in promoting the project and in some cases it has been assumed that the Institute is prepared to furnish complete working drawings.

In conclusion this report states:

Reviewing the general situation in the light of the committee's experience since its appointment to undertake the Institute's activities in this field, it would recall the concerted movement on the part of various allied associations interested in the arts relative to this subject as encouraging evidence of the widespread desire to counteract the influence of the manufacturers of monuments of stereotyped design and the helpless acquiescence of the public in accepting such works with which we have been only too familiar in the past.

As already pointed out by others who realize the present situation, there is a new danger in the wide appeal that the community house idea makes to the popular fancy insofar as it threatens to create an endless repetition of more or less stereotyped designs and especially under existing conditions which suggest avoiding the expense of competent architectural service as well as the cheapening of materials of construction, both detrimental to the quality in design and permanency that a memorial structure should possess. How the Institute can be of service in dealing with the situation is a subject to which your committee is giving careful consideration and in this connection it commends the suggestion that examples of war memorials here and abroad would be of value in educating the public and helpful to architects and sculptors if they could be illustrated in the Journal and possibly included afterward in a brochure or reprint devoted to the subject.

### COMMITTEE ON SMALL HOUSES

EDWIN H. BROWN, *Chairman*

This is a very complete summing up of an important development on housing problems since the close of the war.

The committee strongly favors the organization



## THE AMERICAN ARCHITECT

of the architects of the country on the basis of an Architect's Small House Service Bureau.

A national body, properly incorporated, the Board of Directors of which shall be identical with the Board of Directors of the A. I. A. If possible, this should be a corporation without capital or stock, or anything to do with the handling of money, its sole object being to act as the guiding and controlling factor of the policies and actions of the various local Small House Service Bureaus. Proper Articles of Incorporation and By-Laws should be drawn up by Institute counsel to enable it to carry on its work.

This body should have an organ to carry on its work and this should be run as a department or branch of the *Journal*. Since the Minnesota Bureau has already started such an organ your chairman suggests that this ultimately be taken over by the *Journal* and that it be continued as a department of the *Journal* under the direct management of Mr. Flagg.

This is the soul of the whole idea, says the report.

Each section of the country should have its individual Service Bureau properly incorporated under the Articles and By-Laws as submitted by the central body. Attached to this report, as exhibits A & B, are copies of a complete working and workable Articles of Incorporation and By-Laws for the district or sectional or Chapter Bureaus.

With the exception of that article referring to the central body they are identical with those adopted by the Architects' Small House Service Bureau, Incorporated, of Minnesota. That bureau is ready, so soon as the matter is adopted by the Institute, to at once adopt the article omitted and so tie itself irrevocably to the national idea.

### REPORT OF COMMITTEE ON PRESERVATION OF HISTORIC MONUMENTS AND SCENIC BEAUTY

HORACE WELLS SELLERS, *Chairman*

The report sets forth in part that:

During the past year the activities of your committee have been largely confined to a general survey of the situation with view to outlining a course that may lead to widening the influences of the Institute in this field. As touched upon in its last report, war, and incidentally building conditions, have been unfavorable to public as well as individual effort to secure the restoration of buildings of historic or architectural interest. Although the destruction of such monuments in other lands caused by the war brought home to us a wider appreciation, perhaps, of the value of our own historic buildings and the necessity for safeguarding them, and it is expected that the fruits of this awakened interest will be realized with the return of more normal peace conditions.

Thus far your committee has been unable to formulate a procedure whereby the Institute may lead in the preparation of a survey and record of our early American architecture pursuant to the action of the fifty-first convention, but has the matter under careful consideration. There is evidence of local accomplishment in this direction that may lead to the concerted action proposed, as for example the purpose of the California Historical Commission to prepare a physical survey of all of the ancient mission buildings in its territory, a movement which your committee has taken

occasion to commend and to which one of its members is giving valuable service.

The sacrifice of our forests to meet the demand for lumber during the war, and regardless of waste, which is only too apparent at all times, has directed attention to the scenic as well as the economic losses sustained which is especially deplorable where forests of ancient growth, and practically unreplaceable, are concerned.

Your committee has had recent occasion to call upon its members and other organizations to interest themselves in opposition to the passage without further investigation of a bill before Congress known as H. R. 12466 and now on the Unanimous Consent Calendar, "authorizing the granting of certain irrigation easements in the Yellowstone National Park and for other purposes." The discussion on this bill in Congress and the opinion of competent authorities on the subject not only questions the necessity for this invasion of the park, but discloses the grave consequences that such an easement and development might lead to in opening the way for still further and more disastrous encroachments upon this reservation.

### COMMITTEE ON PUBLIC WORKS CHARLES A. FAVROT, *Chairman*

This report states that its activities during the past year have been confined to cooperative assistance rather than individual initiative in furthering the purposes for which it was appointed.

It is manifest that individual initiative may have been the cause of embarrassment to the activity of a much larger group of technical men, now organized and known as the National Public Works Department Association.

This association is composed of practically the entire engineering, architectural and constructing profession in this nation, and is actively supporting the Jones-Reavis bill introduced in both the Senate and House of Representatives in last June.

The purpose of this bill is to reorganize the Interior Department and change its name to the Department of Public Works and thereby substitute sound business methods for wasteful and extravagant ones in the conduct of our National Public Works.

The bill above referred to is endorsed by practically the entire technical profession, and meets with the approval of the present Secretary of the Interior.

A convention of the association above referred to was held in Washington on January 13th and 14th last.

It was the sense of this convention that there should be eliminated any suspicions of class movement in endorsing this measure, and that business men and business groups should be invited to participate in the direction of the campaign to the fullest extent.

At the suggestion of the committee the following resolution was passed by the convention:

WHEREAS, The National Public Works Department Association, as a federation of technical construction and business societies, for the purpose of supporting the Jones-Reavis bill, known as Senate Bill 2232, and as House Bill 6649, has enthusiastically entered this field of work during the past year; and

WHEREAS, There can be no disagreement as to the sameness and disinterestedness of the objects sought which is in keeping with the best practice of every other great nation; and

WHEREAS, The object to be accomplished by this legislation is to substitute sound business methods for wasteful and extravagant ones in the conduct of National Public Works; therefore,

## THE AMERICAN ARCHITECT

BE IT RESOLVED, That the American Institute of Architects in convention assembled, receive with enthusiasm the report of progress made by this association during the past year, and it endorses the support given to the movement by its board of directors; and,

BE IT FURTHER RESOLVED, That the Institute urges its members to participate to the fullest extent in the campaign looking to the passage of the Jones-Reavis bill, or other similar legislation receiving the endorsement of the National Public Works Department Association.

### BUILDING COMMITTEE

WM. MITCHELL KENDALL, *Chairman*

This committee has in charge the case of Octagon House. It is learned this year as it was last that the proper preservation of this historic structure is hampered by a shortage of the necessary fund adequately to do the work that is necessary. Referring to some details of repair it is interesting to learn the floor of the entrance has been repaired with boards taken from Woodlawn Mansion at Accotink, Va., which was designed and built contemporaneously with the Octagon by Dr. Wm. Thornton.

The drawing room was loaned to the American Federation of Arts for its work in the interest of war memorials. A directory for the benefit of the visiting public was placed in the vestibule.

Before the war a fund was established by several Chapters for providing the drawing room with furniture of the period, thus making the room suitable as a writing room or conference room for Institute members when in Washington. That fund amounts to \$203.54. The estimated cost of the furniture, designed by Mr. Bacon in 1916, was from \$2,500 to \$3,000, and, of course, would be much more expensive now.

### COMMITTEE ON STRUCTURAL SERVICE

SULLIVAN W. JONES, *Chairman*

By the nature and scope of the work with which it is charged, the Committee on Structural Service is confronted with perplexing problems of organization and finance. The committee has two functions to perform to the end that public interest may be served through a progressively more intelligent and enlightened practice of the architectural profession.

The first is to initiate efforts, when considered advantageous, directed toward establishing standards in the interest of wise economy or better building, or to promote improved practices relating to any or all phases of construction; and to establish and maintain dynamic contacts with other bodies engaged in the work of standardization or endeavoring to effect changes in practice when their activities may involve the interests of the architectural profession as a servant to society.

The second function is that of collecting, correlat-

ing, and compiling statistics and data relating to construction, and disseminating the information; recording and reporting the results of research and investigations which contribute to knowledge applicable to construction; and making the product of the committee's own work, and its work with other bodies available for the guidance of every one engaged in the building industry. Without performance of this second function, the first would be a sterile effort and, indeed, were better left undone.

The report states in detail:

The American Engineering Standards Committee originally founded by the American Society of Mechanical Engineers, the American Institute of Electrical Engineers, the American Society of Civil Engineers, the American Society for Testing Materials, and American Institute of Mining Engineers underwent reorganization the latter part of 1919, and now organizations other than the five founders are eligible to membership, subject, of course, to certain restrictions designed to exclude organizations of a purely commercial character. The member organizations may be represented on the committee by one, two, or three, committee members, for each of whom the annual fee is Five Hundred Dollars (\$500).

Briefly, the procedure for the adoption of national standards provided by the American Engineering Standards committee is this:

Any organization or any number of organizations interested in the establishment of certain standards may singly or jointly notify the Standards Committee of the need for the proposed standards and the intention to formulate them. The Standards Committee gives its consideration to the statement of need for the standards, and, if satisfied, endeavors to select all organizations interested. The interested organizations are appointed "sponsors" and they create a joint "Sectional Committee" charged with the work of formulating the standards desired. The standards thus formulated are reported back to the sponsors and when there is unanimous acceptance by the sponsors, the standards are reported to the Standards Committee, which authorizes their publication as "National Standards."

It will be observed that under this procedure the Standards Committee will ultimately become the medium for co-ordinating all activities in the field of standardization.

The committee is fully persuaded that the Institute should become a member of the Standards Committee not only because the Standards Committee should have the earnest support and co-operation of the architectural profession, but also because the Institute can thus keep up with the rapid march of events and be certain of its appointment as one of the sponsors for standards which relate to materials and methods in which the architect is directly interested and thereby introduce the architect's needs and experience as factors in shaping conclusions that otherwise might fail of universal sanction. By seating its members on the Engineering Standards Committee the Institute's problem of covering the field of standardization activities is greatly simplified. The Institute's voice will be heard in connection with all procedures of interest to the architectural profession, and the Institute and the Committee on Structural Service may be spared unjust criticism for not making feverish and futile attempts to keep pace and effect contracts around the whole perimeter of an almost boundless field of activities.

The Committee on Structural Service recommends that

the Institute apply for membership in the American Engineering Standards Committee and appoint the chairman and one other member of the Committee on Structural Service as its two representatives to sit on the committee.

*Co-operation* with other bodies demands provision in the committee personnel for representation and co-operative work. This requirement gathers importance if the Institute acts favorably upon the committee's recommendation that it become a member of the American Engineering Standards Committee. Through this membership there will be offered opportunities for co-operative study and creative work which are now shut off by reason of the committee's inability to keep itself informed on the activities of other organizations. As an example of the enlarged field of opportunity thus offered, reference is made to the drafting of an elevator safety code undertaken jointly three years ago by the American Society of Mechanical Engineers, the Elevator Manufacturers' Association, and the United States Bureau of Standards. The elevator safety code and, indeed, all matters relating to elevator equipments are of direct and deep interest to the architect, yet the Institute had no official knowledge of the work on the safety code until January of this year. As the result of the committee's activities in connection with the Conference on National Safety Code, this tentative elevator code is now being studied by the committee and the Institute will be one of the sponsors for the code when completed. Had the Engineering Standards Committee, with the Institute a member, been in existence when this work was undertaken the Institute would certainly have been one of the original sponsors. Doubtless there are a large number of current efforts equally important to the architectural profession with which the Institute has had no opportunity to become connected, and with which, in the future, through membership in the Standards Committee, the Institute may and should become actively connected.

The only feasible, though not fully satisfactory, means of meeting this requirement of adequate representation is to enlarge the Structural Service Committee by adding to it members selected because of especial equipment of knowledge and experience with structural problems, who should be scattered throughout the principal cities where conventions, meetings, and conferences are customarily held, as well as those cities which are considered as centers of construction activity for certain regions.

## COMMITTEE ON CONTRACTS

W. M. STANLEY PARKER, *Chairman*

The work of this committee is of particular value and its recommendations will be studied with interest by every member of the profession. There is no more thought compelling subject before the profession of architecture today than that of contracts.

The report states in part:

In regard to the cost plus fee agreement form, the fourth tentative draft, as submitted with last year's report, has been widely distributed to various individuals and organizations: only a few comments have been received, and no fundamental criticism has been received which the committee believes should be followed. In presenting the agreement form, the committee has always endeavored to make clear the fact that it was not a definite form available for use intact, although conceivably it might occasionally be so used, but that it was a form intended to serve as a guide in the drafting of such forms of agreement. The committee recommends that the "Circular of Information Relative to the Cost Plus Fee System of Contracting for

Building Construction" and the "Form of Agreement between Contractor and Owner" for use with such a system in the forms known as the "Fourth Tentative Draft" be adopted by the Institute, and printed for sale as an Institute Document with the following two changes in the text of the Agreement:—

Article 5, Paragraph (3) to read as follows:—Salaries of Contractor's Employes stationed at the field office, in whatever capacity employed. Employes engaged, at shops or on the road, in expediting the production of transportation of material, shall be considered as stationed at the field office and their salaries paid for such part of their time as is employed on this work."

Article 13, omit the word "signed" in the fifth line, and substitute for the last six words of the first paragraph the words "all receipted bills," so that the first paragraph shall read "The Contractor shall, between the first and seventh of each month, deliver to the Architect a statement, sworn to if required, showing in detail and as completely as possible all moneys paid out by him on account of the cost of the work during the previous month for which he is to be reimbursed under Article 5 hereof, with original pay rolls for labor, checked and approved by a person satisfactory to the Architect, and all receipted bills."

Two other matters have come to the attention of the committee, one being a request of the Institute of Lighting Fixture Manufacturers urging that contracts for lighting fixtures be settled at the time the general contracts for the buildings are settled in order to prevent delay which will make difficult the proper execution of the fixtures. The committee does not believe that any general pronouncement on this matter can be made; that, of necessity, many such contracts must be settled at a date later than the date of the general contracts. It is needless to say that the problem of lighting fixtures is involved in the layout of the electric work for the building, and in many types of buildings must be, to a very considerable extent, definitely determined when the original layout is made, and it goes without saying that the contracts should be settled in time to give adequate time for execution of the work. Further than this, it does not seem possible to go in attempting to standardize handling fixture contracts.

A further matter is the question of issuing a standard clause for lump sum contracts providing for the adjustment of the lump sum to cover increases in current rates of labor in order to protect the contractor against loss on this account. The matter was briefly discussed at the board meeting in November, and there was a general agreement that some such clause was desirable. The matter was referred to the committee with authority to issue such clause as they might approve. A canvass of the committee developed both approval and strong disapproval of such action. The committee believes that no such clause should be issued by the Institute until the demand for it is clear, and substantial agreement reached on its form. The committee, therefore, recommends that no such clause be issued at this time.

## COMMITTEE ON COMPETITIONS

RICHARD F. SCHMIDT, *Chairman*

It is claimed that there is a definite type of client who has an indefinite problem which he desires to study with a number of different minds, in order not only to develop his problem, but to develop the personal equation.

To these men and this type of problem the Competition Code is not suited as it prevents the owner

coming into contact with the competitors and limits the judgment of an indefinite problem to a jury unfamiliar with the controlling factors of the problem.

It is further claimed that these men have been prevented by the Code from carrying out what seems to many a perfectly legitimate business undertaking and architects and the profession have been placed in the position of telling the business man that while they admit that it was a perfectly good business proposition their professional code would not permit them to co-operate.

Apparently this has been detrimental to the profession and to a general adoption of the code.

The Institution recognizes the right of an owner to purchase unlimited professional service on a basis of adequate remuneration where no competition exists.

The report suggests that the convention consider the drafting of a clause which will state that it shall be held: that no competition exists where two or more Architects prepare sketches at the same time for the same project, if each Architect so employed be informed as to all the others and the remuneration for the preliminary service so rendered be uniform for all and be agreed upon by the owner and all of the Architects so employed as satisfactory and adequate. Such a clause should be modified by the statement that it is not desirable that such an exception should be applied to buildings of considerable size or importance, or when the problem is definite the solutions can be compared solely on the basis of drawings submitted.

It is applicable only to cases where the elements of the problem are uncertain, and where the personal opinion of the owner is a controlling factor.

The convention may deem it advisable to insist on the employment of a professional adviser whose duty it shall be to see that each Architect employed be informed as to all the others and the remuneration for the preliminary service so rendered be uniform for all and agreed upon by the owner, and to all the Architects so employed as satisfactory and adequate; also to see that all drawings requested of the Architects be on the same basis and be presented in the same manner and that he shall act in an advisory capacity only, the owner not being obliged to accept the recommendation of the adviser or of a jury in making the final selection.

Nothing in such a clause is to be construed as modifying the Institute's condemnation of any arrangement by which a disguised competition is conducted under cover of payment that is either nominal or inadequate compensation to participants of the service performed, whether or not further employment on the project follows.

It appears to your committee that the reasons for establishing the fundamental principles of the program which have been discussed at almost every convention, are not understood or known to the profession in general and that it is apparent that convention reports and the Circular of Advice are not read, or digested, if read, by the whole membership. Chapters could well afford to devote at least one hour of each evening of each season to the subject and your committee recommends further that the discussions and committee reports of several years past be published in pamphlet form, including a list and data of competitions which have been satisfactorily conducted under the Institute Code.

COMMITTEE ON COMMUNITY PLANNING

JOHN IRWIN BRIGHT, *Chairman*

The report of this committee has been unusually well prepared. It is a careful analysis of the many and intricate matters that architects will have to consider when engaged in community planning. It states at the outset:

An intelligent direction is necessary in any housing enterprise. In the case of the Government, it produced houses whose main characteristics are quality, usefulness, and beauty. If the same degree of intelligent direction had been exercised by speculative interests it would have resulted in a subordination of all desirable features to the necessity of earning a profit on the investment. It is significant that we speak of the "necessity" of a profit and the "desirability" of good living conditions, because that state of mind is responsible for the indifference with which we view the disappearance, one by one, of all the desirable features of the home. When all is lost but private profit, we refuse to build for that is the one thing which we cannot bring ourselves to surrender.

The Government, however, was able to do this, but the elimination of gain was, after all, a negative virtue and taken alone teaches but half the story. The positive virtue is the development of the community plan in which the welfare of all was considered before the supposed rights of any one individual. Housing produced by private enterprise, working primarily for a profit, cannot regard the social advantages of its customers as of equal value to the financial return on capital and it is therefore plain that if people wish to live under such admirable conditions as exist in most of these villages, the speculative builder must be barred out.

The physical arrangement of the houses is a distinct advance over the usual pre-war type. This was only to be expected, as never before was the national effort so concentrated on this problem, enlisting the best minds of the country in the effort to design and erect pleasing houses. Generally speaking, the houses were but two rooms deep and when the detached house was not possible, the rows were short and architecturally pleasing. It is to be hoped that these object lessons will exercise a stimulating influence on our future domestic architecture.

Unfortunately, these efforts have taught us nothing on the questions of land, finance, and management for the very good reason that the face of the government has been set against any study of these questions. As far as can now be seen, the houses will be sold to individuals and the values created by the community itself will ultimately revert to the individual or the speculator.

The general findings of the committee are set forth as follows:

The general tenor seems to demonstrate that there is as yet no general public realization of the issues at stake. This can only be corrected by a campaign of education and in order to make a commencement on this line, a lecture tour has been undertaken. The committee hopes that the Institute will appropriate a sufficient sum of money for its continuance. The committee recommends that in presenting to the public the idea of community planning, a certain definite theory should be expounded. It is not enough to show pictures of charming houses. It should be taught that to obtain the result, certain changes connected with our ideas on finance and social rights must be effected. Not until industry is organized to produce socially useful goods

can there be a real answer to the building problem, but without expressing itself on this question the Institute could perform a great public service in concentrating attention on immediate evils. The public expects its architects to advise it rightly on problems connected with plan and building and while rendering this service, we should fit ourselves to discuss the whole question. In this category, the protection of the value created by the community itself

should receive the first consideration. This has been called inaccurately the unearned increment and the faulty definition has largely been the reason why its significance has not been generally comprehended. Increment is not unearned. It is earned, but, to use a bookkeeping expression, we have not credited the asset to the proper account. The neglect to balance it against its creative forces has permitted the impression that it is spontaneous in its origin.

---

## Convention Notes

The large room in the Corcoran Galleries to the left of the main staircase, commonly used for loans, was occupied by a comprehensive showing of Washington plans, lent by the Federal Art Commission, and formed part of the First National Exhibition of Architecture.

It was the Park Commission's plan for the development of Washington made some twenty years ago under authority of the United States Senate that gave fresh impetus to city planning in all parts of the world. In a single large frame on the east wall of this gallery are shown L'Enfant's original plan for Washington drawn up in 1791, the plan as revised in 1800, the plan as reverted to in 1900, and enlarged and developed, and the plan of Washington as so far put into execution.

\* \* \*

There was a general disposition on the part of everyone who was present at the reception at the opening of the exhibition in the evening adversely to criticize the action of the Government in permitting the encroachment of War and Navy buildings in Potomac Park. The large plans showing this encroachment were carefully studied.

\* \* \*

There was a brilliant assemblage of interested guests at the opening reception of the First National Exhibition of Architecture. All ranks of the military service were represented in uniform, from the private to a major-general. The great success attending this exhibition will doubtless encourage the Institute to extend its scope and character in future years.

\* \* \*

After adjournment on the afternoon of the first day, the officers of the Arts Club of Washington tendered a reception to the delegates. Mrs. George Julian Zolnay, wife of the president; Mrs. K. H. Bush-Brown, Mrs. Charles Fairfax and Mrs. L. M. Leisenring presided over the tea tables.

The Arts Club house is a fine example of our best Georgian Colonial period. It was built in 1802, served for a brief period in 1817 as the Executive Mansion, and has been, in turn, the legation of Great Britain, Austria and Belgium.

\* \* \*

There were many interesting reunions during the convention between delegates who had last greeted one another while in active service in Europe during the war. Many wore the stars of citation and other decorations gained in service.

\* \* \*

The visit after adjournment on the second day to the Lincoln Memorial was a fine feature of convention days. This stately structure lacks but little of completion, and when the grading and landscape effects are completed, will be a central point of interest to visitors to Washington.

Its location is superb and the general effect, the correctness of every architectural detail, creates a memorial in which every architect, particularly those of the Institute, may take a very just pride.

\* \* \*

Looking from the Lincoln Memorial toward the Monument and Capitol an opportunity was afforded to judge the effect of the placing of the War and Navy buildings. One of the things the Institute will certainly have to accomplish is the removal of these unsightly structures.

\* \* \*

Ideal weather marked the convention days in Washington. Yet, as one member put it, "We all know Washington, and that's why Nashville was so enjoyable, by reason of novelty."

\* \* \*

The second day's proceedings were much enlivened by the speeches of the various representatives of the State Societies, while the report of the committee was being considered. These will be found fully reported in our next issue, May 26.

# Current News

---

## Happenings and Comment in the Fields of Architecture and the Allied Arts

### Architects Propose World Legislation to Stop Hideous Urban Deformity

World-wide legislation to stop the "hideous deformity" of streets, parks, gardens and plazas and to beautify all cities was advocated at the first Congress of Architects at its sessions in Montevideo, Uruguay.

Representatives were present from all South American countries as well as from the United States. The congress in proposing legislation for adoption of regular plans and location of public buildings and monuments, recommended continuation of the system of uniform squares.

Classes in "urbanization" in universities and special schools of architecture were also proposed as indispensable for culture of the people.

Emphasis was laid on need of construction with government aid of cheap and hygienic homes for laborers in industrial sections. The congress urged establishment in each country of a "national bank for the construction of economic houses" with funds contributed by employers and capitalists.

---

### Building Operations in 1919

Reports received by the United States Geological Survey, Department of the Interior, from the building officials of 114 of the larger cities in the country show that building operations in 1919 greatly exceeded those in 1918, both in number and cost. The number of permits issued or buildings erected in these 114 cities in 1919 was 309,551, as compared with 173,635 in 1918, an increase of 135,916 or 78 per cent. The cost of the operations in 1919 was \$1,130,817,591 as compared with \$369,252,315 in 1918, an increase of \$761,565,276 or 206 per cent. If the operations in the remaining cities from which the Geological Survey usually receives statistics of building operations show a proportionate increase the number of permits issued or buildings erected in 1919 was about 377,000, which would cost about \$1,300,000,000, so that the record for 1919 was the highest yet reached in the building industries in these cities in both the number and the cost of operations. The year of the next highest record was 1916, when 347,761 operations were reported, which cost \$1,046,276,549. The average cost per operation in the cities which have so far reported for 1919 was \$2127 in 1918 and \$3653 in 1919.

---

### War Memorial Plans Crude

None of the sixty-seven proposals submitted in the competition of ideas for a permanent war memorial to be erected by the City of New York was found sufficiently meritorious to recommend its adoption to the general committee, the jury of artists which inspected the plans submitted, has reported.

The jury expressed the opinion that the competition has

served to show that the memorial should be in the form of an arch, a cenotaph, a statue or sculptural group. Opinion disapproves of any project mainly utilitarian in scope. The jury urges the consideration of all available sites in the City of New York and particularly the northern portion of Manhattan. New York City desires a war memorial worthy of the cause that it commemorates and worthy of itself. This desire is attainable if the proper steps are taken. The first step has not been taken. A competition of ideas was attempted in a casual way by the Mayor's Committee, without giving due notice and invitation, without a program and without the direction of a representative committee. The results of this attempt, as shown in the recent exhibition at the City Hall, speak for themselves as in fact carrying the project but little farther than its starting point.

While there may be several ways of going about this rather difficult problem, the direct and simple procedure which has been urged upon the Mayor's Committee is in effect this:—

To hold a competition, perhaps country-wide, of proposals of schemes under direction of a representative committee whose personnel shall give adequate assurance of its serious purpose and responsibility. This committee to evaluate the results of the competition as to site and schemes, whether monument, bridge, memorial hall, or any combination of these, upon a definite place, and to settle the question of both scheme and site within such limits as to make possible an architectural solution.

To delegate this solution to a sub-committee of professional men who shall institute, conduct and judge a competition in the approved way for the scheme and place selected and make an award of the work to the winner in this final competition.

---

### Bungalows

In their effort to arrive at the lowest cost of building homes for working-class families, English architects and housing reformers have made a number of discoveries. Mention has already been made here of new ideas on material and method of construction, and lay-outs that minimize the cost of street-making. The *Survey* refers to the latest contribution which comes from Barry Parker, the well-known architect. Retained by the Joseph Rowntree Village Trust to investigate the latest experiments in cottage construction, he found, first, that in the particular locality where houses were to be built, brick was still the cheapest material—because it can be handled more quickly than others—that much cost could be saved by standardizing every part to the utmost extent (he calls it building on the Ford car plan), and that at the present cost of labor and timber, bungalows are cheaper to build than two-story houses. He says in a recent issue of *Housing*:

"We decided on bungalows, because we weighed the relative cost of labor, and the difficulty of getting labor, against the increased amount of material which there is in

a bungalow over a two-story cottage giving the same accommodation.

"Our view was that by eliminating the staircase we reduced considerably the labor needed; and by practically eliminating scaffolding we further reduced the labor needed, avoiding as this did almost all running up and down of ladders, as well as the labor entailed in erecting scaffolding, and, in addition, one laborer could attend on more bricklayers working on the ground level than he could working on the first floor and roof level of a two-story cottage."

He further mentions the advantage of more rapid roofing and the amount of time gained thereby during which the men can work under cover. The chief difficulty, however, was to design a floor plan permitting the greatest possible uniformity, yet permitting different location or rooms and windows so as to get the best light for each house, whatever its aspect. This was so successfully solved that with four of the bungalows arranged in a square, only one bedroom is sunless and all ladders have north exposure. One of several structural innovations is a kitchen range which can be heated from the open fire in the living room or alternately from its own grate.

The idea that the taller house is cheaper because of saving in land, has long been exploded in England, where investigations have proved that the price of land invariably follows the type of development and absorbs the intended saving.

## Housing Shortage and Fire Hazard

### Adequate Protection Is Essential to Conserve Existing Supply of Home Space

A housing shortage so acute that the very social fabric of a country may be threatened, is the great present-day problem confronting us. So states Wharton Clay, architectural engineer, in the *New York Times*. With the necessity for building increased a hundredfold, in order to catch up with the rise in population, conservation of the national resources is likewise a paramount issue. So necessary is the permanence of every item in building work that protection from fire of every inch of combustible material that goes into the construction of a home must be effected, if living conditions are to be made more enduring and the cost of housing reduced.

Only 20,000 new houses were built in 1918. There should have been twenty times that many.

A bit better was 1919, with 70,000 dwellings completed, according to the estimates by the United States Housing Corporation. But still the increase in population is far outstripping the building program for new houses. While in 1890 an average of 110.5 families occupied each 100 homes, to-day that figure has mounted to 121 families for every 100 dwellings. Hence, the present acute congestion.

With a conservative estimate of 27,900,000 families in 1925, the great housing shortage will continue unless building in all parts of the country increases to an extent unparalleled in the history of the construction business.

If only the current number of homes are constructed each year for the next five years, 409,500 dwellings must be built, and the congestion will reach 129.6 families per hundred homes, or two families in every fourth house.

Merely to keep up with the increasing number of families and in no way alleviate the present congestion, 2,139,000

homes have to be constructed before 1926, while a return to the pre-war conditions of 115 families per 100 homes means the building of 3,340,000 dwellings in that period.

These figures become all the more startling when it is considered that they include the building work necessary for increase in population only. They do not include the construction necessary to cope with the enormous yearly residential fire losses, which are the equivalent of 13,000 homes, valued at \$5000 each, totally destroyed. Nor do they include the large number of homes abandoned or demolished to make way for new building work.

In a town of 25,000 the construction program necessary means at least 500 and 800 homes in five years, respectively, and the stability of the building industry becomes apparent.

Materials must be used to protect the combustible structural members of all the houses we build in the future. One fire loss is worse than a building project abandoned.

## Quotations on Office Space in Many Cities

Building managers in most cities have been busy in recent months deciding what is the right rental basis, and in some cases schedules have been changed several times. It is generally conceded that buildings are entitled to 6 per cent. net earning, after a deduction of 2 per cent. of cost of improvements for depreciation. Reports received from various cities by *Record and Guide* indicate that the following is the asking price per square foot for desirable office space:

New York .....	\$3.00 to \$5.00
Philadelphia .....	3.00 to 3.50
Boston .....	3.00 to 4.00
Chicago .....	2.50 to 3.50
Cleveland .....	2.50 to 3.50
Cincinnati .....	2.00 to 3.00
Buffalo .....	2.00 to 3.00
Toledo .....	1.25 to 1.75
Dayton .....	1.00 to 1.50
Peoria .....	1.25 to 1.75
St. Louis.....	1.75 to 2.75
Atlanta .....	1.25 to 2.50
New Orleans .....	1.40 to 1.75
Louisville .....	1.50 to 2.00
Omaha .....	1.50 to 2.50
Spokane .....	1.30 to 2.00
Seattle .....	1.75 to 2.50
Portland .....	1.50 to 1.75
Los Angeles .....	1.50 to 2.00

## Madrid to Be Improved

Plans were approved by the municipal council for making Madrid one of the finest cities in Europe. It is intended to provide accommodations for a permanent population of 1,000,000.

At the suggestion of King Alfonso, a commission of members of the Academy of Fine Arts has been studying for a long time the possibilities of developing city plants to conform with the general plan for improving the city.

More than 1000 houses now building will be made to conform with the scheme. The height and structure of the many buildings under construction will be controlled by the new plans.

Personals

Ellory K. Taylor, architect, has opened an office at 1627 Sansom street, Philadelphia.

Holmes & Winslow, architects, have moved to 134 East Forty-fourth street, New York.

William Douden, architect, has removed from Millersburgh, Pa., to the Nicholson Bank Building, Union, S. C.

Irving Brooks, architect, has moved from 215 Montague street to larger quarters at 26 Court street, Brooklyn, N. Y.

Charles M. Spindler, architect, has moved his offices from 215 Montague street to 26 Court street, Brooklyn, N. Y.

Brook & Sackheim, architects, recently moved their offices from 215 Montague street to 26 Court street, Brooklyn, N. Y.

William J. Provost and William E. Butler have associated to practice architecture at 292 Main street, Stamford, Conn.

Max Hirsch, architect, announces the removal of his office from 215 Montague street to 26 Court street, Brooklyn, N. Y.

Oliver M. Wiard has opened an office for architectural practice at 101 Park avenue, New York, and desires manufacturers' samples and catalogues.

Bart Tourison, architect, formerly of Philadelphia, has moved to New York City and has established offices in the Hudson Terminal Building, 50 Church street.

Ralph G. Macy recently resigned as chief engineer of the Walter Kidde Co. to join the engineering staff of the Engineering & Appraisal Co., New York City.

H. P. Knowles, architect, announces the removal of his offices from the Vanderbilt Concourse Building, 52 Vanderbilt avenue, to 21 West Forty-ninth street, New York.

Roy A. Benjamin and Harry M. Prince have established offices for architectural practice at 2003½ Main street, Dallas, Tex., under the name of Benjamin & Prince.

Brentwood S. Tolan has reopened an office for architectural practice in the Farmers' Trust Co. Building, Ft. Wayne, Ind., and catalogues, samples, etc., are requested.

Bannister & Schell, architects, for a number of years located at 67 Wall street, Manhattan, announce that they have moved their offices to 246 Fulton street, Brooklyn, N. Y.

Richard Williams and J. Frederick Kelly have formed the architectural firm of Williams & Kelly and have opened offices in the Chamber of Commerce Building, New Haven, Conn.

Clifton Lee, Jr., and Merrill C. Lee have opened an office for the practice of architecture and engineering at 918½ East Main street, Richmond, Va., and desire samples and catalogues.

National headquarters of the National Builders' Supply Association are now at 708 Merchants' Bank Building, Indianapolis, Ind., instead of in the Odd Fellows' Building in that city.

Lubroth & Lubroth, architects, announce the dissolution of the partnership heretofore existing, and in future Jacob

Lubroth will practice his profession in the old offices at 44 Court street, Brooklyn.

Frank H. Day and Harry E. Bolton announce the opening of an office for the practice of architecture at 24 North Main street, Gloversville, N. Y. Manufacturers' catalogues and samples are requested.

Grimes & Jungling, architects and engineers, have moved from their location at 1207 Fullerton Building to 513 Odd Fellows' Building, St. Louis, Mo., on account of increasing the size of their quarters. Catalogues and samples are desired.

News From Various Sources

A subway is to be constructed in Tokyo, Japan.

\* \* \*

New York City had 9000 saloons when prohibition came.

\* \* \*

Farm horses of the United States are valued at \$1,993,000,000.

\* \* \*

In Buenos Aires poison gas has been used to kill rats found in buildings.

\* \* \*

The United States has doubled its consumption of petroleum since 1911.

\* \* \*

In only twelve States of the forty-eight is the largest city also the capital.

\* \* \*

West Virginia has just finished paying to Virginia its share of the old State debt.

\* \* \*

It is estimated that it will take this country about six years to get absolutely dry.

\* \* \*

There are more geysers in Yellowstone National Park than in all the rest of the world.

\* \* \*

During 1919 more ships were built in the United States than in all the rest of the world.

\* \* \*

The average salary for teachers is \$400 a year more in New Zealand than the United States.

\* \* \*

Ninety million barrels of oil were used for fuel and other military purposes in the European war zone.

\* \* \*

Motor car builders predict that there will be at least 10,000,000 motor vehicles in use in the United States during 1920.

\* \* \*

The United States Forest Service reports that in Florida is the largest stand of yellow pine anywhere in the Southern States, the amount being estimated at 50,000,000,000 feet.

\* \* \*

The United States Bureau of Standards, after 150 days of testing, has decided that the 1:2:4 concrete mixture used in the construction of water storage tanks is sufficiently waterproof for the purpose. Although the head was 35 feet and there was a small loss of water due to penetration, the exteriors of the tank remained dust dry.



# Weekly Review of Construction Field

Comment on General Conditions of Economics With Reports of Special Correspondents in Prominent Regional Centers

With the lifting of railroad embargoes it is expected that building construction will be relieved of the most difficult obstacle which stands in the path of the season's program. Much of the stalled freight is already getting under way and the railroad officials believe that the next three weeks will see the clearing of the rails and the movement of all freight now blocked in transit. After this has been accomplished and the natural relations between supply and demand are re-established the speculative tendencies will disappear from the prices of building material and though this does not imply a reduction, it is doubtful if there will be any further advances for the present. All the weight of conservative business men is with the effort to stabilize prices and supply.

The National Association of Building Trades Employers proposes for all lump sum contracts the following clause: "The above proposition is based upon the cost of labor and materials as of this date. If increase or decrease in the cost of labor or materials occurs on this work, the owner will be charged or credited with such increase over or under the prices which existed at the date of contract."

This association has also expressed its disapproval of overtime work as detrimental to the best interests of the building industry.

There has been a great deal of uncertainty as to the efficiency of the shorter day. Some of the labor delegates to the International Labor Conference hesitated to urge its adoption on a basis of greater productivity. A report has now been published by the U. S. Public Health Service which shows a comparison made under the direction of Professor Frederic S. Lee, of Columbia. It is found that the eight hour system is more efficient than the ten, as the ten hour is more efficient than the twelve.

The outstanding feature of the eight hour system is a steady maintenance of output. In the ten hour day the maximum is reached in the fourth hour but declines in the fifth and stays at a low level the remainder of the day. The eight hour day begins and ends approximately on schedule and lost time is reduced to a minimum.

In the absence of fatigue, accidents vary directly with the speed of production owing to increased exposure to risk; but the breaking up of the regular variation by fatigue is indicated by (1) the rise of accidents with the fall of output and (2) the disproportionate rise of accidents with the rise of output and the absence of a proportionate fall of accidents with the fall of output in the final hours of the day.

It is also stated in this report that labor turnover has been found to be directly associated with distasteful working conditions and is lowered by systematic effort to improve conditions; that the turnover is highest among new employees.

There is satisfaction in the knowledge that these matters are having careful scientific research. Much more remains to be done in the way of analyzing and adapting the human element in industry. As the report says in explanation of its purpose "That complexities of maladjustment exist, that all the ingenuities of human invention must be expended upon them, need no longer be contended. The new era opening for social and economic progress is now

to bring to bear upon these intricate problems the finest powers of science, focusing upon the several elements, among which health is of first importance, integrating them and relating them to a large view of society. To humanizing working conditions, to reassert the value of the individual, to study all ways of releasing in work the best energies of the worker instead of as now prodigally wasting them, this should be the practical role of science in industry. And it is as a contribution to this era of intensive study devoted to large ends that the report has been aimed."

The announcement of unfilled orders by the United States Steel Corporation shows a gain of 467,672 in the month of April, reaching a total of 10,359,747 tons. This is more work than could be turned out in the eight months up to the end of the year. The amount of unfinished business is larger now than at any time since August, 1917. The record figure in 1917, however, was in April, amounting to 12,183,083.

To a slight extent this figure has been influenced by the railroad strike, which has interfered with shipments and production, but it is chiefly an increase accountable to the demands of business.

The scarcity of capital seems to be world wide. During the past month the Bank of England raised its discount rate from 6 to 7 per cent, the Bank of France from 5 to 6 per cent, the Bank of Sweden from 6 to 7, the Bank of Finland from 7 to 8 per cent, the Bombay rate from 7 to 9 per cent. Such advances are made, of course, for the purpose of holding in check the demands for credit, which the shortage of capital makes necessary.

The demands for all kinds of goods are in excess of the supply and the world has not regained the normal production which existed previous to the war. The people wish to buy more goods than yet exist. They would make credit take the place of capital. Inflation therefore exists as it did during the war; exists and spreads in spite of the advancing bank rates. The situation is intensified by the large amounts of commodities in transit.

*(By Special Correspondence to THE AMERICAN ARCHITECT)*

CHICAGO:—The aristocrats of the building trades, with \$10 a day wage, may find themselves facing a scarcity of "jobs" if the slump continues in the building industry in Chicago.

The tremendous reduction in building activities is bound to result in a slack employment season for many of the highly paid craft, say the contractors. Already the labor shortage has ceased to exist in the construction field and builders report little difficulty in securing men.

This is a decided contrast to conditions of last year when men in building trades in Chicago dropped from 72,000 to 42,000 with the bonus system, overtime and wage increase offers made by contractors in outbidding one another to get men. The present wage scale for some twenty of the craft is an outcome of that mad scramble to secure labor last year.

Trades including carpenters, bricklayers, plumbers, lathers, glaziers, plasterers, steamfitters and structural iron workers now get \$1.25 an hour instead of \$1.00. Common

## THE AMERICAN ARCHITECT

building labor has been increased 43 per cent since May 1st—an increase from \$5.60 to \$8 a day. Plasterers' laborers now receive \$8.50 and caisson diggers \$10 per eight hour day.

That some of the trades feel slighted in the general wage increases is shown by two new strikes, which constitute a fresh "menace to the construction industry." A section of the iron moulders' union walked out demanding a minimum of \$10 per day. The flat wage for moulders recently was \$6.40 for eight hours. It was later increased \$2 per day, which was accepted by 90 per cent of the moulders in the Chicago district.

Four thousand striking carpenters employed in sash, door and woodworking mills of Chicago threaten to tie up the industry if their demands are not met. The men were drawing 85 cents an hour and were to get \$1.10 an hour beginning June 1st, according to members of the employers' strike committee.

With skilled labor at \$10 per day and common labor at \$8, brick at \$16 per thousand, lime at \$2 per barrel, laths at \$22 per thousand and lumber, which cost \$35 to \$40 four years ago, today at \$65 and \$80—construction has become almost prohibitive. In the opinion of the trade, the public cannot or will not build until construction costs drop.

The contractors claim they are hampered in building operations by the attitude of the banks toward building loans, while the banker justifies the tightening of credit accommodation to the builder by citing the low rate of interest on building loans.

In the meantime the individual has been forced into a "blind alley," facing an indefinite prolongation of high rents and inadequate housing facilities.

*(By Special Correspondence to THE AMERICAN ARCHITECT)*

SEATTLE:—Architects and jobbers are able to report this week a more active interest in large building contracts, although the work has not proceeded beyond the figuring stage. Due to the fact that such interest has been quiet since early spring the indication is regarded as pointing to more extensive building in the late summer. It is the history in the North Coast country that the largest building commitments are seldom undertaken until the rainy season sets in in the fall, and it is expected that more business building work will develop. Small homes, dwellings and residences now under way will be completed, but beyond this, home building for the year is believed to be at an end due to inability to get essential finishing materials.

Price changes this week reach only to radiation, vitroware and boilers for steam and hot water heating, which have advanced 5 per cent. Steel and plumbing supply jobbers bear out the assertion that there is considerable figuring on large work but agree that fulfillment is wanting.

Jobbers report inability to get delivery for the present quarter in pipe and fittings, but there has been no advance to them in primary costs.

There is plenty of fire, face, and common brick—due to adequate local production. Jobbers are delivering on the job at stationary prices. Metal lath is steady. Fir lath is plentiful and the market weak at \$10.50 on the job. Roofing is steady and featureless.

Red cedar shingles are weak at \$5.80 to \$6 for clears and \$4.60 for stars, per 1,000 basis, or 12 per cent less for squares at the mill. Inability of manufacturers and wholesalers to get shipments past the embargoed points in the East is given as the reason for the weakness in the shingle market.

Fir lumber is stationary. A few orders have come in from Eastern builders through yard buyers and these being

for urgent delivery indicate to the mills that there is shortly to be a return to the West Coast of Eastern buying in volume. Tendency toward concessions in prices is slowly vanishing, although mills that would not quote wholesale buyers ninety days ago are now soliciting their business. It looks as though accumulated back orders were cleaning up. The car supply is wholly inadequate to meet the situation, but transcontinental line officials state that they will within thirty days be able to deliver a fair volume of system cars which, if the ratio is to 70 to 80 per cent of requirements, will weaken the market.

*(By Special Correspondence to THE AMERICAN ARCHITECT)*

SAN FRANCISCO:—Deliveries of freight are showing little if any improvement and building is being delayed in various quarters by the impossibility of getting necessary materials.

Common brick advanced \$2 per thousand this week and lime and plaster and cement also sought a higher level on May 1. Notwithstanding the high prices of material, the city is planning to erect a group of war memorial buildings on Van Ness avenue, adjoining the Civic Center—to cost \$2,500,000. Bliss & Faville, architects, have prepared plans for an addition to the building of the Women's Athletic Club, on Post street; this will enlarge the dining room, library and several other rooms as well as provide sixty additional sleeping rooms.

Architect George W. Kelham is completing plans for a four-story concrete addition to Holbrook, Merrill & Stetson's stove manufacturing plant in this city. The addition is 137x275 feet and will cost approximately \$500,000.

From plans prepared by Architect W. H. Weeks, a contract has been let for the erection of a concrete and terra cotta Court House for Inyo County, Calif., for \$158,700. Mr. Weeks has also been commissioned to prepare plans for a fireproof high school building to be erected in Piedmont, Calif. Bonds for \$250,000 have been voted for the construction of the building.

The Builders' Exchange, the General Contractors' Association of San Francisco and the Building and Industries Association of San Francisco have voted to consolidate and will henceforth go under the name of the Builders' Exchange.

*(By Special Correspondence to THE AMERICAN ARCHITECT)*

BOSTON:—Thirty-three new Massachusetts corporations were chartered this past week with total capitalization of \$10,260,000.

Crowded conditions in Boston schools, of which so much has been written during the last few years and which now force 8,000 children to be accommodated in 160 portable buildings or hired quarters, have led the school committee to advance an ambitious building program covering three years for which \$2,000,000 additional each year will be required. The new program takes care of 48 new school buildings.

Contracts awarded in New England from January 1 to April 29 amounted to \$108,932,000 as against \$37,519,000 for a corresponding period in 1919; \$47,124,000 in 1918, and \$58,472,000 in 1917.

*(By Special Correspondence to THE AMERICAN ARCHITECT)*

BIRMINGHAM:—The city's building inspector has issued permits during the month of April for 34 new structures which are to be rushed to early completion in view of the present need for more houses.

The strike of union plumbers for \$12 per day of eight hours has tended to discourage a certain amount of work for which local architects have been preparing plans.

Prices of building material remain practically unchanged.

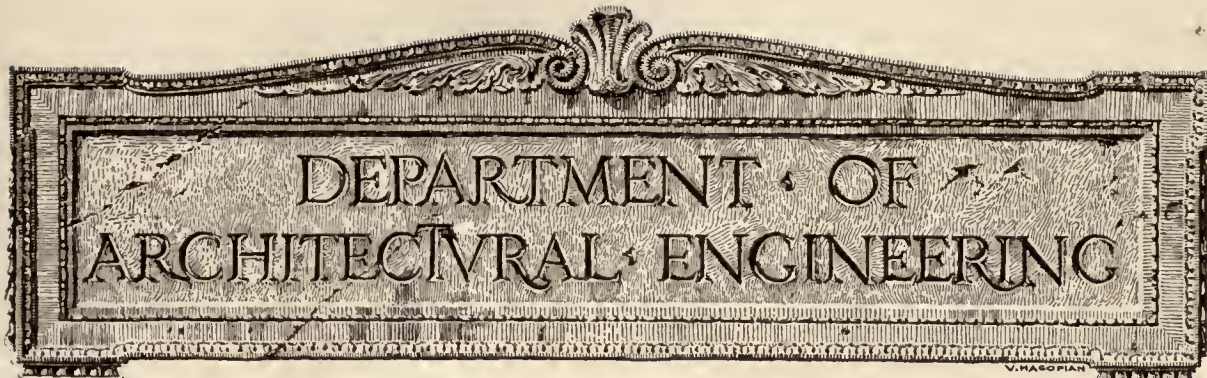

## Designing the Automatic Sprinkler System for Hot Water Heating

**A**FTER the tremendous wastage of war, more than ever before is economy in all things essential. The architect who designs a structure both substantial and artistic at minimum cost is not only serving his client but also performing a public service by making construction work possible in these days of high costs. The farmer has been urged to study methods of improved cultivation that he might make two blades grow where but one grew before. Might it not be possible to conserve material and labor in the building industry, by obtaining double service where possible from material entering into the construction? It would seem that the automatic sprinkler system offers a splendid opportunity along this line. Practically every industrial building erected today is equipped with such a fire extinguishing system, the installation of which in certain types of structures is made compulsory by law in many states. Whether required by law or not, hard-headed business men have been able to realize the beneficial results accruing from the installation of such a system in their buildings. Lower insurance rates is but one item.

But these same buildings must also be heated. Present systems of heating vary greatly according to physical conditions. To design the sprinkler system that it will also function as a hot water heating system, and cost less than the combined cost of a separate heating system and the usual type of automatic sprinkler installation is a desirable achievement. Such a system may be designed as either a gravity or forced hot water system. Local conditions will naturally govern the choice. However, this combined system should not be decided upon until after a careful study of its adaptability to the particular structure in question has been made. It is obvious that a heating system consisting of

bare pipes spread over the entire ceiling area is more efficient where the floor area is large in proportion to the wall and window area. The radiating surface of the sprinkler piping if not equal to the total required to make up the heat losses should at least be large in proportion to it. For a narrow building with large window surface, this would not be the case.

In contemplating innovations, the conservative person is skeptical. The question "Will it work?" is often asked in a manner presupposing that it will *not* work.

Results obtained from a number of systems of this type installed and in use over a period of from one to eight years, coupled with the fact that the Underwriters' Laboratories under the direction of the National Board of Fire Underwriters have approved its use, should be sufficient to prove its practicability and would indicate that this system is destined to come into quite general use for those certain classes of buildings to which it is adapted.

It is reported that as long as 25 or 30 years ago the idea of utilizing the same pipes for heating and for fire protection was tried out, but it was not until 1910 that the first automatic sprinkler equipment of standard design was combined with a forced hot water heating system, and the piping of the sprinkler system thus utilized as heating surface. The idea originated, no doubt, purely from a desire to make a saving in first cost of installation, and while this is still the primary reason for the combination, it has been found that there are also some lesser advantages, while no apparent disadvantages have been found.

The rules of the National Board of Fire Underwriters prescribe a *maximum* outgoing water temperature of 212 degrees. The average temperature

of the water throughout the pipes will be somewhat less than this, but still considerably above the 155 degrees at which the sprinkler heads open. The most serious problem to be solved was that of insulating the sprinkler head, so that while the water

were taken, each set of readings being taken from one to four days apart.

The grand average temperature of all outlets was 88 degrees with an average temperature of water in the line of 190 degrees, which would indicate that the installation of standard automatic heads, fusible at 155 degrees, will be entirely satisfactory, and this has been proven by experience with actual installations.

Inasmuch as it is impossible to drain the so-called insulators without turning them, the question of freezing is also of importance. A rigid test of this phase was also conducted by the Underwriters' Laboratories, four insulators being equipped with automatic sprinklers, and filled with their normal amount of water, and subjected to temperatures varying from + 2 deg. to - 5 deg. for a period of

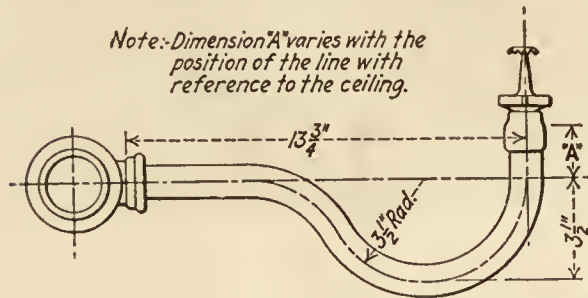

FIG 1. DETAIL OF INSULATING ARM

in the main pipes was high, that at the head will be below its fusing point.

Figure 1 illustrates an insulating arm by which this object has been satisfactorily accomplished. This consists of a 3/4 inch pipe bent into a trap form, and the efficiency of this insulation is clearly shown by the records of a test conducted by the Underwriters' Laboratories. A small combined automatic sprinkler and heating system was constructed, with a standard size sprinkler line having eight outlets. Insulators of the dimension shown in Figure 1 were installed and thermometers were placed in the end of each, instead of the sprinkler heads. This sprinkler line was then connected by supply and return connections to a gas heater.

Thermometers were also placed in the main supply and return connections. This system was operated for a period of 155 days, and 57 sets of readings

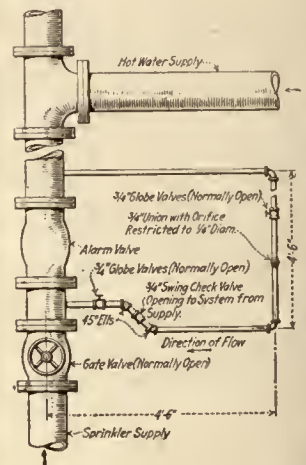
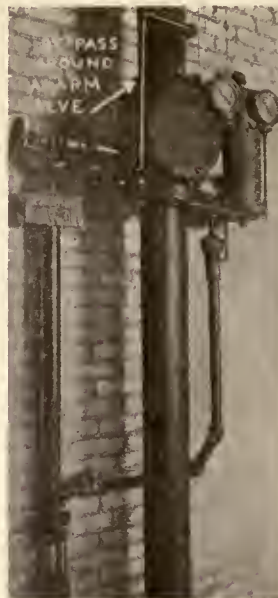

FIG 3. THE ARRANGEMENT OF VALVE HERE SHOWN IS IDENTICAL WITH REGULAR SYSTEM EXCEPT FOR THE BY-PASS.



GENERAL VIEW OF SPRINKLER LINES. INSULATING ARMS AND EXPANSION JOINT CAN BE SEEN

three days. Neither the insulator nor sprinkler head showed any injury at the end of this period.

This major problem of insulating the heads having been overcome, the only other alterations made necessary to the standard design consisted of providing a complete system of return piping, connecting to all lines. Inasmuch as all of the sprinkler piping up to the last head must be of regular sizes used for sprinkler systems, it is in the design of the return piping where the equalization in flow of hot water must be taken care of. Very good results have been obtained by the use of an additional valve used as a throttle in the return from each series of lines; but the plan of equalizing the flow by means

of variations in the size of these connections is favored by several authorities on the subject. This method can be employed more easily if the returns are planned on the basis of "first supply—last return," in which case the connection to each series of lines can be figured as should ordinarily be done for one pipe coil.

The elimination of air from the system can be

The  $\frac{3}{4}$  inch by-pass is illustrated by Figure 3, and it will be noted that a union with bushing having a  $\frac{1}{4}$  inch orifice is installed in this. Two spring-loaded type water-relief valves are installed at the heater or boiler, one set at 10 pounds above the highest pressure at source of water supply, and the other at 15 pounds above the same pressure.

The supply main from the heater should be

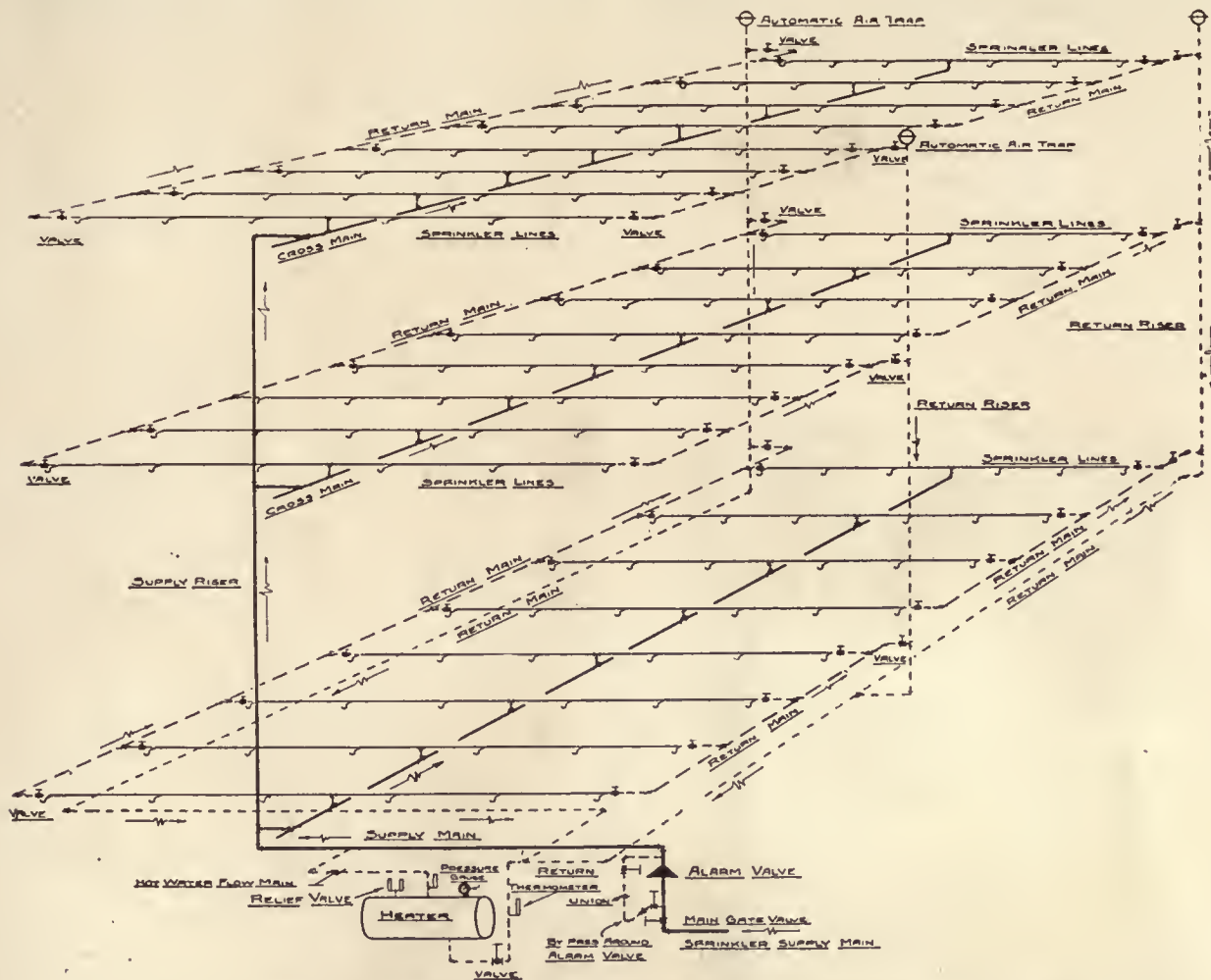

FIG 2. TYPICAL LAYOUT OF COMBINED HEATING AND SPRINKLER SYSTEM. FULL LINES SHOW STANDARD PIPING. BROKEN LINES SHOW ADDITIONAL PIPING NECESSARY TO CONVERT ORDINARY SYSTEM INTO COMBINED TYPE.

accomplished by means of the installation of automatic air traps on the return lines as illustrated in Figure 2, which is a diagrammatic sketch showing a typical combination installation.

The expansion and contraction of the water in the system is taken care of, under the Underwriters' rules, by means of a  $\frac{3}{4}$  inch line at the source of the water supply, installed as a by-pass around the alarm or check valve, and by water relief valve.

connected inside of the alarm or check valve and should be equipped with a valve so that the heater may be shut off from the sprinkler system should occasion demand. Where auxiliary radiating surface is required, the connections for this should be taken separately from a point on the heater side of the main shut-off valve.

The heat produced by the sprinkler piping is calculated the same as for overhead pipe coils.



DETAIL OF RETURN AND FLOW MAINS OUTSIDE HEATER ROOM

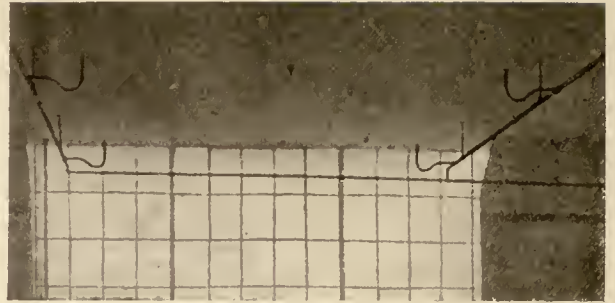

ILLUSTRATION SHOWS METHOD OF TYING SPRINKLER LINES INTO RETURN PIPING

except that a slightly higher value can be allowed due to the more efficient air circulation around the pipes.

Such calculations will often show that but slight auxiliary radiating surface is necessary; in such a case it is more economical to increase the smaller sized piping to make up the difference, than to provide radiators. In accomplishing this the lateral

Acknowledgment is made to Mr. A. W. Moulder from whose paper on the subject, presented before the American Society of Heating and Ventilating Engineers, much of the information and illustrations contained herein are taken.

### Construction and Fire Protection of Cotton Warehouses

Under the above title the United States Department of Agriculture has issued a 79-page paper by J. M. Workman, covering the subject in a very thorough manner. The book is profusely illustrated, so as to make quite clear all phases of construction recommended for various sizes and types of buildings. A number of plates of standard warehouse plans are included at the back of the book. These are given as a basis of warehouse planning, and do not form complete working drawings.

Copies may be had upon application to the Superintendent of Documents, Government Printing Office, Washington, D. C., the price being 50 cents.



GENERAL VIEW OF HEATER ROOM. NOTE SIMPLICITY OF ARRANGEMENT

branches may be increased to 2 inches throughout.

In the event of any heads on such a combined system going into operation, it is not believed that the emission of the hot water would cause scalding, since the water is atomized into a fine spray by the deflector on the sprinkler head, and it would thus be cooled somewhat by the surrounding air.

### A New Method of Sewage Disposal

The National Lime Association has just issued Bulletin No. 200 bearing the above title, prepared by Sidney P. Armsby. The bulletin is in the nature of a progress report, and contains data relative to what is termed "The Direct Oxidation Process" of treating sewage.

The treatment is electro-chemical, but differs from the earlier electro-chemical process in that lime is introduced. The relative advantages of this method and the practical application of the fundamental principles are described.

The National Lime Association is in no way financially interested in the process as such, and presents the results obtained to date for careful consideration to those interested in the subject.

Copies of the bulletin may be had on application to the Association at Washington, D. C.

# The Balance

**M**EMBERS of the American Institute of Architects, speaking at the recent Washington convention, stressed the importance of organization. The late war, more than any other recent event, demonstrated clearly the need for organization. In fact, are not disorganization and failure synonymous?

The successful development of architecture depends not alone upon the organization of individuals, but also upon individual organization. To conduct his business successfully, every practising architect must organize his forces, be they large or small, to secure a proper balance.

The office of the architect of to-day, from which designs for many and diversified types of buildings proceed, is far different from what it was years ago. Modern life has passed from the simple to the complex, and the change has been reflected in art, science and industry. Consider the modern building. Complex to a major degree! From foundation to cornice, it stands a wonder of skill and ingenuity. Held in place by engineering knowledge, clothed and draped by the artist's talent, designed for commercial needs, maintained at an even temperature the four seasons round, illuminated electrically, so that it knows no night, while its utmost heights are reached swiftly, silently and without effort by means of the modern elevator. And these structures are the product of the master builder, the architect. His organization is for the sole purpose of interpreting his conception of them into language understandable to the contractor, who carries the design into execution—blueprints, specifications, a schedule of quantities, so many tons of steel, so many brick, so many yards of concrete and the like.

**T**HE very complexity of the work produces a serious problem. Shall the architect include within his own organization those competent to carry out completely his design or shall he retain outside organizations when needed, such as the structural and mechanical engineer and the quantity surveyor? It may be that sizes of beams and columns, types of foundations, systems of heating, sizes of plumbing pipes, location and capacity of electric outlets are but details, yet these are the details largely responsible for the modern building. Unless studied and carefully developed in sympathy with the project as a whole, the building will not properly function. Inadequate elevator service will paralyze the modern office building. And the architect is alone responsible. The well-designed exterior is not all, neither

is structural safety sufficient to make the structure of to-day successful.

In this complex structure two professions are intimately linked together. Neither is sufficient alone, and thus co-operation is essential to successful work. Architect and engineer must work hand in hand. And why is this sometimes difficult? Is the engineer an outsider, only called upon in case of trouble? Does he lessen the architect's importance? Does the architect feel that the engineer is becoming too prominent in the realm of building? Somehow it seems difficult entirely to reconcile the artist to the cold, hard, calculating and mathematically correct point of view of the engineer, and it is equally hard for the engineer without strong glasses even to hazily catch the artist's vision. The architectural engineer as yet seems rare. Colleges are graduating architects and engineers, and the characteristics of the individual causing him originally to choose his life work, often crystallize as the years go by.

Michael Angelo and Leonardi da Vinci, who achieved notable success as artists, architects and engineers, are the exception, not the rule.

**W**HAT is now needed is a truer and clearer understanding between members of the two professions, to the end that a proper appreciation of the importance and value of the work of each other may be arrived at.

The recent action by a large municipality in retaining a firm of architects to design an important bridge brought a storm of protest from the engineers. Yet no one doubted that engineers would design the structural features of the bridge. Why, then, the hub-bub? Had the work of the architect been adjudged the more important? And during the war when engineers seemed to be called by the government in greater numbers than architects on building design and construction, the latter were the protestants.

What, then, is the solution? Does it not lie in an alliance, or rather many individual alliances between members of the two professions? During recent years the tendency of the architectural organization to include an engineer as a member of the firm has increased. Such engineers, of necessity, are in sympathy with and come to a keener appreciation of the work performed by the architect, and likewise the architect, having the engineer constantly associated with him, realizes the importance and value of his engineering knowledge when applied to building construction. The modern structure presents a large enough problem for both to

labor on, without either attempting that phase of the work for which he is neither by education nor inclination qualified to perform. Thus we have not only an organization, but one with balance, and that very factor will be evident in the type of structure designed, be it bridge or skyscraper.

### Available Sizes of Reinforcing Bars

AS was recently announced, many of the sizes of steel reinforcing bars formerly manufactured have been discontinued, in accordance with the recommendations of the Special Committee on

the right the diameters. It will be noted that up to the 1-inch bar, all bars are round in section, with the exception of the 1/2-inch size which is manufactured in both round and square shapes. This is true also of the 1-inch section, but above this size square sections only are available.

The scale on the vertical line corresponds to the bar areas. It will be seen that for the smaller bars the variations in area are also small. From the 1-inch round bar the areas of available sizes increase by approximately one-quarter square inch.

This diagram will be found helpful for reference purposes to those engaged in designing reinforced concrete work of any description.

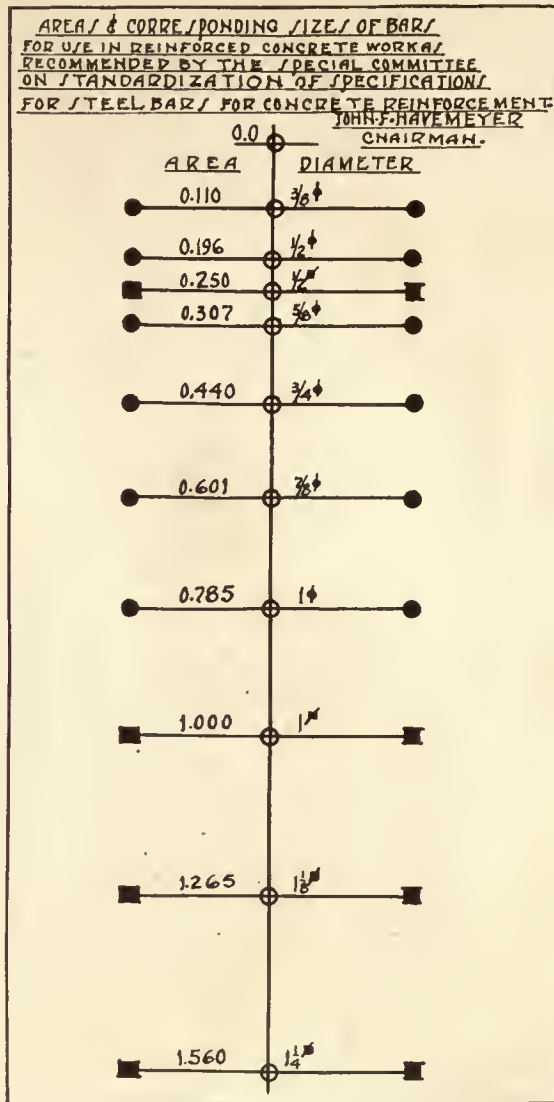

Standardization of Specifications for Steel Bars for Concrete Reinforcement. The sizes now available are shown in the accompanying diagram. To the left of the vertical line the areas are given and to

### U. S. Department of Commerce Publishes Information on Markets for Construction Materials and Machinery in Uruguay

UNDER the title, "Construction Materials and Machinery in Uruguay," the United States Department of Commerce has just issued a 59-page booklet, attractively illustrated, and setting forth in a very thorough manner the conditions of the building material markets in that country. It also describes the general physical characteristics of the country, its resources, manufacturing facilities, transit lines, water supply, labor conditions, architecture and construction. Many proposed construction activities are mentioned, from which some idea of future requirements can be had.

In this connection the following quotations, taken from this publication, are interesting:

The Oriental Republic of Uruguay is the smallest country in South America. It is situated in the South Temperate Zone. The River Plate on the south gives the country, together with Argentina, great commercial advantage, both countries being located in the gateway of one of the greatest systems of inland waterways in the world. Uruguay has an area of 72,153 square miles, being somewhat larger than the New England States. Politically, it is divided into 19 departments. It is the ninth nation in South America in population, its inhabitants, according to an estimate made December 31, 1916, numbering 1,378,808.

\* \* \*

The wages paid range from 12 to 15 cents an hour for common labor and from 20 to 40 cents for skilled labor. Gang bosses and foremen receive \$50 to \$95 per month.

There is a very complete and stringent eight-hour law, and it is rigidly enforced. No man can work longer than 5 hours without rest, nor more than 8 hours in 24, nor more than 48 hours in one week. The penalties for violation of this law are applied both to the employed and the employer. The usual working hours are from 8 to 12 a. m. and from 2 to 6 p. m., although during the Summer months in the interior of the country the hours are in some cases 7 to 11 a. m. and 3 to 7 p. m.



## THE AMERICAN ARCHITECT

The style of architecture of Uruguay during the colonial period was similar to that which predominated in Spain at the same time. But the type was modified, whereas in other nations, such as Peru, Chile and Bolivia, the pure Spanish style predominated, as may be seen in the old buildings constructed in the style called "Plateresco." This style is unknown in Uruguay. The colonial style found in Uruguay contains the classical elements of architecture adapted to the styles that dominated the Spanish art.

The Spanish influence is less noted in the decoration than in the arrangement and the general plan of the buildings. The houses of the colonial period had low roofs as in the cities of Spain, and their interior arrangement was also copied from the buildings of Spain.

Architecture slowly improved, due chiefly to the coming of French, Italian, and other foreign architects. Classical styles prevailed, with occasional types of Louis XIV and Louis XV, and Gothic was used for a number of buildings.

After the schools began to teach architecture the influence of the graduates was notable, especially in introducing the details of European architecture. Methods of construction were perfected and the buildings gave the city its modern and attractive aspect. In styles the Neo-

There is a strong sentiment in this country favoring a large extension of business in South American markets. There is no logical reason why goods made in the United States should not be largely used in these countries. Relative to the subject of becoming commercially established, the following advice is pertinent:



BRIDGE OF REINFORCED CONCRETE, CONSTRUCTED BY THE DIVISION OF HIGHWAYS



PRIVATE HOUSE IN MONTEVIDEO

Greek was followed by the art nouveau, as in Europe, but for this the Louis XVI style was almost immediately substituted, and it predominates today. The plan of construction is that of the "maison de rapport" and the "petit hotel" found in the residences of the rich. Thus fine houses have been constructed whose interiors are decorated with boiseries, turrets and all classes of elements proceeding from the manufacturers of Europe.

The architects of Montevideo say there is need for a large number of workmen's houses, in which at least \$3,000,000 might be invested. There is also need for 10 commercial buildings at \$300,000 each; slaughter houses and cold-storage buildings, costing approximately \$4,000,000; electric light and power houses and factories, \$1,000,000; a considerable number of small houses to rent, in which some \$6,000,000 might be invested; hotels, \$1,000,000, and opera house, \$1,000,000.

In addition to the private buildings the Government requires the following modern buildings: Governor's Palace, estimated cost, \$8,000,000; Palace of Justice, \$3,000,000; postal and telegraph building, \$1,000,000; municipal palace, \$3,000,000; police headquarters, \$1,000,000; hospitals and clinics, \$2,000,000; asylums and places of refuge, \$1,000,000; schools, \$2,000,000; barracks for infantry, \$1,000,000, and for artillery, \$1,000,000.

Exportation from the United States to Uruguay has been largely in the hands of a small number of commission firms of high standing, which have a strong hold on this class of business. This is undoubtedly the most appropriate medium to use in starting a current of business, but it is not the most effective for establishing definite and lasting connections, at least in a country like Uruguay, which has always been considered by Europe as one of its best customers and which is accustomed to receive the greatest consideration. Importers are often averse to dealing through agencies and prefer direct relations with the manufacturers and producers, so that they can always be sure of the sources of the goods.

Not a great deal can be accomplished in the Uruguayan markets merely through catalogues and correspondence, except in answering requests, and the best way of introducing goods is to send a personal representative, who can study the markets and get in touch with prospective customers. This was the method used by our European competitors before the war and they will undoubtedly return to it when conditions are normal.



CONSTRUCTION OF CONCRETE BRIDGE

A few of the illustrations are here reproduced from this booklet, copies of which can be obtained for 15 cents from the Superintendent of Documents, Government Printing Office, Washington, D. C.

# Engineering Notes of Interest

## Data on Slate

The Structural Service Bureau, Philadelphia, of which D. Knickerbacker Boyd, F. A. I. A., is Architectural Adviser, has just issued two pamphlets dealing with slate, one treating on natural slate for blackboards and the other forming Chapter I of a series on structural slate. Methods of quarrying and milling, as well as the several grades and finishes, are described and illustrated. The relative costs are also given for the various grades of structural slate.

\* \* \*

## New Development in Glass Manufacture Produces Burglar-Proof Variety

When one considers the value of jewelry annually stolen by the simple process of breaking the jeweler's show window and making a quick get-away, one wonders why some special construction for such locations has not been resorted to. It is, therefore, of interest to note that there is being manufactured at present (in this country) a new type of glass known as "safety glass" and, while primarily produced for automobile windshields, it is also suitable for window use.

In the process of manufacture instead of turning out a single sheet of ordinary plateglass, the method is to use two sheets of fine glass welded together by a pyroxlyin plastic sheet between them. Thus there are three layers—glass, transparent sheeting and glass—welded to form a single unit, resilient, impenetrable, non-shattering.

Even when struck a heavy blow, as with a hammer for instance, the resilient central sheet remains practically intact and holds the glass on either side of it firmly. The glass cracks but no hole is made through which a burglar could extend his hand and rob the display.

By continued hammering, the windows could be pounded to pieces, but it would take so long to do it, that daylight robbers could not operate successfully.

Mechanical difficulties in manufacture make it impractical at present to make safety glass in panes larger than 20 inches by 50 inches. However, a show window made up of panels of that size would not be impracticable, and with proper artistic treatment the smaller panes would not impair the attractiveness of the display in the window; neither would the almost imperceptible color tint in the glass.

Its introduction for show window use where valuables are on display seems certain.

## Effect of Fineness of Cement

Under the above title the Lewis Institute of Chicago has issued Bulletin 4, prepared by Prof. Duff A. Abrams, in charge of the Structural Materials Research Laboratory.

The results of a large number of tests are given and the important features brought out thereby discussed.

An examination of the tables and figures indicates that in general the strength of concrete increases with the fineness of cement. There are notable exceptions to this rule in the case of some of the cements having residues less than about 10 per cent on the No. 200 sieve.

The tests show that the lean mixtures are increased in strength relatively more than the rich ones for a given change in the fineness of the cement. They also show that the beneficial effect of fine grinding tends to disappear with the age of the concrete.

For copies of this bulletin address Structural Research Laboratory, Lewis Institute, Chicago.

\* \* \*

## Experiments on Corrosion

An investigation is now under way in the laboratory of the National Lime Association to determine the effects of various materials including lime, plasters and concrete mixtures containing lime upon the corrosion of steel used as a reinforcement.

Several series of test slabs embracing a number of mixtures in common use are under observation. Results of this investigation will be available to those who may be interested in about three months' time.

\* \* \*

## Government Reorganization

The engineers', architects' and constructors' plan for a National Department of Public Works has been accepted with so much favor by the leaders in Congress that the principle has been extended to all other lines of Federal activity. The so-called "Smoot-Reavis" joint resolution recently introduced into Congress provides for a Congressional commission of six members to survey the administration work of the Government and submit bills to cover a plan of reorganization. This resolution was participated in by the National Public Works Department Association and has its support.

Forsterpiece to 23/8.



PALAZZO UGUCCIONI, FLORENCE

# THE AMERICAN ARCHITECT

VOL. CXVII.

WEDNESDAY, MAY 26, 1920

NUMBER 2318

## Fifty-third Annual Convention—The American Institute of Architects, Washington, D. C.

### Second Day's Proceedings

**I**N addition to the printed committee reports, liberally supplied to delegates and the press, the chairmen of the various committees were in each instance called upon when their respective reports came up for action, to briefly supplement them by oral statements. This afforded opportunity for questions which were freely asked and as freely answered.

The first report to come up for consideration during the morning session of the second day was that of the Committee on Small Houses, of which Mr. Edwin H. Brown, of Minneapolis, was chairman.

Mr. Brown stated:

#### REPORT OF COMMITTEE ON SMALL HOUSES

The Committee on Small Houses felt that the thing for it to do was not to make a survey of the small house question and get a number of very valuable records and data and all that sort of thing, but it felt, after looking the situation over, that it was very distinctly up to the Institute and up to the profession of architecture to provide some help in getting out reasonably good plans for small houses; and so it started in to see if it could not construct a machine that could actually do this. It was very fortunately placed, in that the general conditions of the work in Minnesota and the Northwest had brought to the profession in that part of the world the vital necessity of doing something to meet this particular case. Some of the lumber-yards were establishing large drafting rooms and getting out plans for small houses, one that I know of employing from fifty to seventy-five draftsmen, getting out plans quickly for small houses which were presented free to anyone who bought the materials for their houses from this particular lumber-yard. The various material associations throughout the country found it necessary in securing sales of their particular goods that they should be able to give free plans

to the people who wanted to build small houses. How could we meet the situation?

Minnesota architects thought they could meet it; and so they got together at the beginning twelve architects, all of whom happened to be members of the Institute, and they formed a small organization, duly incorporated, and each firm took out a membership in this corporation and paid cash for a certificate of stock, and incorporated themselves as The Architects' Service Bureau of Minnesota. This had such possibilities, and met with such favor, that the committee felt it was the proper idea to be put into execution by the profession in general.

The next question was, "How about the local touch?" Minnesota architects could not make a very great success in designing buildings for Southern California, or for Florida, or for Louisiana, because as we build a house in Minnesota, it would be a waste of money to try to build it that way in those parts of the world. So that meant that this organization must extend throughout the country; and thus was evolved the scheme as laid down in this report.

Then, "How could that be controlled?" The logical head of all things in the profession is the American Institute of Architects. (Applause.) Why not, then, have the American Institute of Architects deliberately take charge of all this work, and manage it? We have a Board of Directors that we consider a very wise board. If we could get them to take charge of it, we felt the thing was assured. And so we laid out the plan submitted to you in this report.

Briefly, that plan means a National Service Bureau. Now came the question: A great many architects, members of the Institute and others, out in the West, the Southwest, and the South, are doing a great deal of small house work. Many of

## THE AMERICAN ARCHITECT

them, in fact, do nothing but residence work, and as we get out into those parts of the country the residence work is not big. A twenty-thousand-dollar house is a pretty good proposition. A man with six, eight or ten of those during the year is earning his livelihood very nicely. It might have been dangerous for the Institute to put in something that would hurt his practice. It would not be fair. And so we decided that the proper name would be "The Architects' Small House Service Bureau."

The next thing was, How should this be handled throughout the country? That meant the Architects' Small House Service Bureau of the United States, and that should be a corporation without stock, without any capital, the board of directors of which should be the Board of Directors of the American Institute of Architects, so that they could control the whole thing.

Then the committee felt that they should get out standard articles of incorporation and by-laws, so that those different parts of the country that were interested in this proposition could incorporate in different districts, whether by chapter or regionally, depending upon the conditions of the country, and on the same basis start a bureau, a service bureau; and this, please, is the proper use of the word "service." It means service to the people in general from the professional standpoint, to be spread all over the country. Then anybody in any part of the country desiring a plan—let us take a common happening in Minnesota: Many people move to California, or to the South, and desire to build, and they do not know anything about conditions in those parts of the country. They frequently come to architects and say: "Please let me take plans for a house out to the Coast and build it." This would mean that some of these people going there would be at once referred to the Architects' Small House Service Bureau of Southern California, we will say, who would then take the matter over and handle it for them.

So we laid out these various small bureaus which are directly tied into the Architects' Small House Bureau of the United States. If the thing travels on, it means ultimately that we will have perhaps five or six hundred architects, mayhap more, giving direct attention to the question of the small house. By "small house" we mean houses of three, four, five and six rooms. We thought that thirty-five hundred or five thousand dollars would cover it when we began; but conditions have changed, and it probably means seven or eight thousand, or maybe more, as the limit now.

In regard to the architect who is doing small-house work, this does not infringe upon his particular branch of the profession, because all he has to do is to become a member of this Small House Bureau.

and he can take just as active a part in it as he wishes—the more active, the better—and he has then at his disposal not only his own ability in that line but the ability of ten or fifteen other men in his vicinity who are working with him, and he is reasonably remunerated for his work.

This has possibilities of developing into the most wonderful profit-making scheme that you can consider. This could be built up into a great commercial enterprise, and reap enormous profits; but the Institute could not touch it under those circumstances, and so you will note that it has been tied down. It is a limited dividend proposition. To make the men work who go into it (it seems a strange thing, but people who do not put up any money for anything are not very much interested in it, and something for nothing is of very little value) we have laid down that each man going into this should pay \$100 for his certificate of stock, and then he is tied up to a certain amount of work which he is to give, for which he will be repaid at the usual rates for architectural service. He cannot make more than 8 per cent upon his investment. If he takes a share of stock and puts \$100 in it he gets \$8 a year profit. The thing must be run as a strictly commercial enterprise.

A number of the national organizations of the country, such as the National Lumber Manufacturers' Association, the American Face Brick Association, and organizations of that type and size, have expressed the utmost interest in this movement. They have made trips to Minneapolis to discuss the possibilities, and they are back of it, I am sure, from the beginning to end. They appreciate the point that the logical people to make drawings, designs, and carry out the building of small houses are the men that were trained for that particular profession, and therefore they will be glad, undoubtedly, as time goes on and we show them that we can do the work—which is to be doubted, at present, reasonably. The architect's profession will then be the principal designers of the small houses in the United States, as they should be. (Applause.)

I want to call your attention merely to the two important points—that it is not a profit-making enterprise; that it is designed so to spread its activities over the country that any person in any part of the country desiring a small house can get a plan that is designed to suit his community. It will be more or less of a limited service of love to take the plans as laid down and build from those. You will note that the Service Bureau insists upon its ownership and proprietorship of the plans. It speaks of them as instruments of service only. If the owner of a house desires to keep one special set of plans to look over he may have them, but he must return any others that he gets, and nobody can build from

them without express permission of the Service Bureau. We hope to be able to control the situation so that we will not have block after block of exactly the same houses. We may spread them over a few square miles, and have a number of the same in the same city, but they will at least be spread about enough so that there will be variety.

Then came the question of the trade-mark: What should we use for a trade-mark? Trade-marks are necessary now when you are conducting an experiment, a business enterprise; and we sat down and worked one out. It is rather small. You can see it very easily when you get the magazine. As you get it, it is a small house. It was originally the original small shelter of a house, with the initials, "A.S.H.S.B." across the middle, making the letter "A", standing for "Architecture." In it is the letter of the particular "M" at this point, meaning "Minnesota." When Nebraska starts her Service Bureau, that will be changed to "N," and "Nebraska" will be written under it, and for such as come from the national headquarters it will be "U.S.A." They will all be tied together. They will all be gotten up on the same general plan, as we see it, so that these plans, these magazines, will go all over the country, and every plan will be stamped with this trade-mark until it is thoroughly understood that architects are back of this thing.

The Architects' Small House Service Bureau, Inc., of Minnesota is a corporation formed by a number of practicing architects to supply professional service, well studied and carefully prepared plans, specifications, details, all necessary information—at minimum cost—for the erection of 3, 4, 5 and 6-room homes of safe investment. This service is ready-to-use and limited to houses of six rooms. For larger homes employ an individual architect and pay him a reasonable fee. The Architects' Small House Service Bureau, Inc., of Minnesota, can be considered a non-profit-making enterprise because it is formed with a very small capital and is a limited dividend corporation.

The names of the members are given, and their offices—Minneapolis, St. Paul, Duluth and Grand Forks. We are starting advertising, gentlemen. We are advertising in competition with the other people, and we are doing it because it is not advertising any particular architect. It is advertising the professional service, and what it is, and we have got to put it before the people of this country so they will understand it, and so we are doing. (Applause.)

There ensued a long and interesting discussion on the features of this report. Two very pronounced opinions were expressed. One, that a general extension of the Minneapolis idea would result in depriving the young architect of the value of the experience he now gains in securing and executing

this class of work on low-cost houses. Fear was expressed that all the many experiences that go to build the young architect's qualification for larger work would be taken away. Another opinion was that those who participated in these schemes would soon have supplied series of plans and designs which could be with slight variation many times repeated. Thus there would be no further use for their services as there would be no demand for further designs.

On the part of those who more strongly favored the adoption of the committee report, these objections were regarded as not based on the actual experience of the Minneapolis Chapter, whose work in this direction was believed to have successfully solved the question of designing low-cost houses, and to have created an example that might be successfully followed by Chapters everywhere.

#### STATE SOCIETIES

The important question of State Societies, and the definition of the exact attitude of the Institute toward those organizations, was next in order.

Mr. Robert D. Kohn, chairman of the Committee on State Societies, read the report of his committee, as follows:

At the meeting of the Board of Directors held in New York in December, 1919, the President was authorized to appoint a Committee of the Board to investigate and report on the problems of relationship between the Institute and State Societies. The Committee appointed by the President consisted of Messrs. Parker, Waid and Kohn, the last named being Chairman. The field of work assigned to this Committee may perhaps best be indicated by a statement prepared by the Board previous to the appointment of the Committee, which subjects extensively were assigned to the Committee for consideration. These subjects include:

- (1) A form of invitation to be issued to State Societies inviting them to send representatives to the next Convention;
- (2) a protest from one Chapter against the invitation being sent to a State Society in its territory;
- (3) general consideration of work of different kinds that can be accomplished by State Societies, different from and more extended than can be done by Chapters of the Institute;
- (4) the difficulty faced by the Institute Committee on Increase of Membership in enlisting men who found it more to their advantage to join one of the State Societies;
- (5) the desire of the Post-War Committee to encourage the formation of State Societies intended to have a much broader scope as to membership than have Chapters of the Institute;
- (6) the whole question of relationship of State Societies to the Institute. On one hand, the suggestion that they be organized or reorganized under the auspices of the Institute, and on the other hand, the idea that they may best be kept separate, but should co-operate with and be helped by the Institute;
- (7) the suggestion that the Institute itself should change its requirements of membership so as to include every one that is now eligible for the most liberal type of State Association.

In addition to this the Committee was instructed to prepare a program for the consideration of the Board at its pre-Convention meeting indicating a desirable form of Con-

## THE AMERICAN ARCHITECT

stitution and By-laws for State Societies and suggestions of any relative changes that might become necessary in the Institute Constitution and By-laws in case it were deemed desirable that the relationship between the State Societies and the Institute be recognized in the Institute Constitution.

In carrying out the instructions of the Board your special Committee has assumed the position that it was not *directed* to prepare a Constitution and By-laws for State Societies, but was the medium through which suggestions for such drafts might be considered. One such draft was submitted by one of the sub-Committees of the Post-War Committee, was criticized by the Chairman of your Committee and was printed in amended form and distributed to members of the Post-War Committee throughout the country by that Committee. On the recommendation of your special Committee the Executive Committee of the Board had already notified the membership of the Institute that this draft sent out by the Post-War Committee did not have the approval of the Board, nor were the recommendations accompanying the draft in line with the Board's general policy.

Since the meeting of the Nashville Convention a number of matters affecting this problem of State Societies have developed. A new State Society has been formed in New York, to which all registered architects are eligible to membership and all draftsmen employed in the offices of architects eligible for registration. New Jersey has formed a State Society under the wings of the New Jersey Chapter of the Institute, to which all registered architects are eligible, the plan being similar to that of the Boston Society of Architects, if your Committee understands that plan (of which some of its members are uncertain). The Pennsylvania State Association decided at its meeting of April 20 not to change their State Association into the same form as that of the New York, but to remain an Association of the Institute. We believe that Ohio is still undecided on this point. Some of the Pennsylvania Chapters have developed an admirable plan for redistricting the State and the Southern Pennsylvania Chapter has volunteered to try to form two additional Chapters in the State to take care of the men remote from the centers of the present Chapters, the idea being that these additional Chapters would remove the necessity for another type of State Association.

After considering the merit of these moves and the communications relating to them from various parts of the country, having studied a lengthy analysis of the effect of State Societies prepared by the Secretary of the Ohio State Association, Mr. Chubb, realizing also that the whole question is very much involved in that of regional Associations and the powers delegation of the Institute to regional Committees, your Committee of the Board recommends a report to the Convention as follows:

That the Convention authorize the appointment of a Committee on State Societies which shall

(a) Consider the varying conditions that exist in different parts of the country, which probably make it unwise to adopt any single country-wide policy on this subject.

(b) To consider conditions in each State or each section of the country and try to discover what type of Association would serve best for that region; whether or not Chapters of the Institute can be made to serve the purpose or new State Societies should be formed; or again, whether the Institute Societies now in existence can be extended in powers to take care of the situation.

(c) Study the problem of the formation of State Societies where there is no State Registration Law and report on whether or not the test of registration is not the

only test that should be applied to State Societies.

(d) Consider any drafts of State Society Constitutions that may be submitted and prepare an opinion for the consideration of the Board on this subject.

(e) Consider whether or not the Institute should make any changes in its By-laws in so far as they affect State Societies of the Institute formed by Chapters in order to give them broader powers and permit of their affiliation with groups of draftsmen and architects outside the Institute, etc.

(f) Consider by what means the Institute can increase the number of Chapters and the desirability of a State Society of the Institute to be formed in every State where there is more than one Chapter.

(g) Consider whether the Institute itself should broaden the field of its influence by including either in the Institute or within State Societies or in affiliated bodies every competent practicing architect and draftsman in the country.

(h) Consider and report on the effect upon these problems of the creation of regional Conventions or a reorganization of the Institute so as to make its Conventions representative of four or five regional Conventions to be held in different parts of the country. (Note: This paragraph has not received the approval of Messrs. Parker and Waid.)

Continuing, Mr. Kohn stated:

Those of us who have been in touch with the reactions in various parts of the country toward the policy adopted by Nashville are quite certain that a thing that is desirable in one State may not be desirable in another. I think that all the members of that committee felt strongly that they wished to encourage any plan which would include these organizations of architects affiliating in some way, cooperating in some wise, with the Institute itself, the whole body of architects in the country, and not only a group of architects, or perhaps the most distinguished practitioners. It is an attempt quite favorable to the movement that was made at Nashville, that is, an attempt to increase the democracy of this movement by including a larger body of practitioners, and not an attempt to kill a move for that kind of democratization, and I hope it will have the support of the convention. It is practically a request that the Board be permitted to study this subject for another year and make definite recommendations to the next convention. (Applause.)

Mr. Waid. Mr. President: the convention is pleased to know that fifteen gentlemen representing ten different State Associations have responded to the invitation to be present at this convention.

I move you at this point, before our own delegates discuss the subject, that we invite them to take the floor and speak upon the subject of State Associations.

Mr. Kohn. If that motion carries I should like to introduce the gentlemen representing each of these societies who have expressed a willingness to express their point of view.

Mr. Hammond. Mr. President, I am a member of the Illinois Chapter and also President of the



## THE AMERICAN ARCHITECT

Illinois Society of Architects, and I feel that all the State Societies should be in favor of this resolution of the board, but I think that the wording of the last sentence is unfortunate, and I would like to have that changed if Mr. Kohn is willing to do so, so there will not be any appearance of reconsidering anything that was done at the other convention, which might psychologically affect some of those men who are not here. We do not want to give the impression that we do not want to encourage the State Societies, and in stating that you want to reconsider that action I think you would give that impression.

Mr. Kohn. I would be very glad to reword my resolution if I have been unfortunate in the remark, so as to withdraw the word "reconsideration" and simply state that it is the policy of the Institute to do so-and-so, and I will so reword it.

The Chairman. If that is agreeable, the Chair will so order.

Are you ready for the question?

(The motion, duly seconded, was carried.)

The Chairman. Will Mr. Kohn kindly read it again?

Mr. Kohn. I have here five State Societies. There may be others that were represented at a little luncheon given by the Directors to-day to the delegates present from State Societies who are not members of the Institute, and I should like to introduce these gentlemen, not in the order of their importance, but just as I happen to have them written on this slip of paper before me, and I should like to call, first, on one of the representatives from the Montana State Society, Mr. Wilson, and ask him to express his views on relationship to the Institute.

The Chairman. Mr. Wilson, of Montana. (Applause.)

Mr. Wilson. Mr. Chairman, Members of the Institute: I would like to take advantage of this opportunity to first thank the Institute for the very great privilege, as we consider it, to have representation here, which is the first meeting in the history of Montana where, I believe, there has been a representative of a State Society at the Institute Convention. We certainly appreciate this and consider it a great privilege.

To begin with, the profession in Montana is really a baby profession. We have not been in existence very long. Architecture is considered much more of a luxury than a necessity and, therefore, it is a continual battle amongst us to get work. The people do not want us. They much prefer to go to the lumber-yard, as you heard Mr. Brown mention this morning, where they have their draftsmen and where they give their plans for nothing. They go to them for the school houses, and our State Board of Health, even, in the State Government, will give

plans for the school houses, and they are passed upon by the State's Board of Health, which knows nothing at all about construction or architecture. We have one continual scrap along that line. Therefore, as a profession and as our mothers and fathers went to the West in the early days and blazed the trail for future civilization of the West, we feel we are blazing the trail for the upbuilding of the architect's profession. (Applause.)

About 1900 there was a State Society organized in Montana, but there were not enough architects to keep it alive and it died a natural death. About 1910 or 1911, when a few more of us came into the field, we were able to reorganize that. It has been going now for about ten years. Every meeting we have is a little bit better than the other.

At the beginning we were all greeting each other with a six-shooter in one pocket and a knife in the hand. Now there is a much better feeling among us and it is getting better right along. We have one or two meetings a year. There are about thirty-five to forty architects in the State. We have about thirty in our State Society.

They are not all the best architects in the world, but we feel that we would rather have them with us than "agin" us. (Applause.) In that way we are taking the novice or the carpenter that thinks he is an architect, who has been able to get a certificate due to the recent law that we passed, and we are trying to educate him.

Now we look to the American Institute of Architects as the guiding star for all our deliberations. Most of us abide by the ethics of the Institution. At least, we try to. Most of us abide by your charges, or try to get them, and some of us lose jobs by it. In fact, since I came to this meeting I have lost a job (Laughter). I kept to your percentage and the other fellows went below me.

Therefore, it looks to me as though, if we can have representation—or perhaps the regional system would be better, where we can get together and talk these things over—that we will do more toward educating the public and making better architecture known and appreciated in Montana than in any other method or system that I know of. Therefore, we will appreciate anything as an association that the Institute might send us or in any way might direct us, and I assure you we are very, very glad to follow your dictates. (Applause.)

Mr. Kohn. I should now like to introduce one of the representatives from the Michigan State Society, Mr. Malcolmson. (Applause.)

Mr. Malcolmson. Mr. Chairman, Gentlemen of the Convention: Perhaps I may be able to give you some information regarding the work of the Michigan Society of Architects which may form a measurable basis for your conclusions as regards the

general issue and as to the desired relationship, if any, between societies and the American Institute of Architects.

When this message came to our Society we did not feel that there was very much that we could contribute to the matter, but we thought it wise to have someone come here to listen and consult with you in regard to it. But the general feeling was somewhat as might be described by the man who has received a black-hand letter which called for a donation on his part of \$10,000 or a threat to kidnap his wife. By appointment he met the two black-handers and he stated to them, "I haven't got the \$10,000 but I am in sympathy with your movement." (Laughter and applause.)

My own personal position in connection with this matter might be described in the reply of the maiden lady of uncertain years who, when reprimanded because she had not entered the field of matrimony, stated that she held herself in a condition of receptivity for all sublime chances. (Laughter.)

Consequently, you understand I am here to learn as well as perhaps to impart some little measure of information.

There is no friction between the Michigan Society of Architects and the Michigan Chapter of the American Institute—none whatever. We are working together in absolute co-operation, the effect of the activity of the Society from the time of its organization on its present basis, in which organization Mr. Stanford Hall, of Chicago, a prominent Institute member, co-operated. From that time the Michigan Chapter of the Institute, as shown by this chart in the Journal which was received in the convention here to-day—this graphic chart shows that the Chapter increased from the time of the inauguration of our society to the present day just 100 per cent. This will give you some conception of the effect of society organization upon chapter activities as manifested, at least, in the State of Michigan. Instead of being a detriment it has been an advantage. Of course, in this process the biblical idea of the lion and the lamb lying down together was, I might say, exemplified, but, of course, at its conclusion the lamb was inside the lion, which, of course, was no detriment. (Laughter.)

I noticed in the hotel, as illustrating this principle, a little couplet by James Russell Lowell:

"As one lamp lights another, nor grows less,  
So nobleness enkindleth nobleness."

And the Chapter has not grown less, it has grown more, and the Society in the realm of this mutual swelling has not grown less.

Now to an intelligent organization of this kind it is unnecessary to illustrate the value of organization, and yet we must all appreciate the value of organization, and co-operation. I do not think we

can too highly appreciate it. It is illustrated in a very simple and brief story which perhaps might not be too full of levity for an august body of this kind.

A colored driver taking his master through a country path, and being very expert with the black-snake whip, was nipping off the butterflies and bumblebees and bugs, etc., from the trees and flowers, and they came along by a hornets' nest hanging within nice reach of the whip—that is, in the mind of the master. He says: "Sambo, take off that hornets' nest." He says: "No, sir, not on your life. Them's organized." (Laughter.)

Now, in conclusion, regarding the matter of organization as affecting legislation, you may go before the legislators and you can tell them all about the Renaissance, you can tell them all about the different styles of architecture, you can tell them all about the advantages of city planning and municipal planning, and all this, one way and another, and they may listen to you and they may not. They may give you some attention or they may give you no attention. It is something they do not understand technically or in any other way. And more than that, they do not care to understand. But, gentlemen, there is one thing that legislators, large or small, in important national bodies or in the bodies in connection with the most minute municipality—there is one thing they do understand; they certainly do understand votes. (Laughter.)

Now, gentlemen, you will all realize that in a profession which has to deal so frequently with practical issues and with legislators of various kinds, from boards of education up through city councilors and even national legislation, it is no special detriment to have presented to these people the value that there is in an organization back of the requests that you make and of the arguments you have to offer. They are much more effective when the individuals to whom you offer them realize that there may be some possible danger, or detriment in neglecting to give you some attention. Otherwise you would be as helpless as the minister who was all ready to make the most magnificent drive of his life in the game of golf, and the caddie, innocently perhaps, but in some way, disconcerted him just enough to destroy the drive, and he turned and says: "You naughty—naughty—you—you—you—you naughty caddie!" (Laughter.)

There is another question with regard to this, and the broader, it seems to me, you can get this propaganda of architectural training and culture and refinement and education, the more individuals you can introduce it to, the greater will be your scope, and you are reaching out into fields perhaps, under society auspices, that you cannot normally reach by the limits of this body of the American Institute.

Now as regards the respect for votes, I cannot re-

frain from telling you another anecdote, because Emerson says: "Don't argue, illustrate." (Laughter.) This was another colored gentleman whose name was Rastus. He went out hunting bear with his master with a number of Northern visitors, and they tracked a bear to a den, a dark-looking hole. They all came up there and stood around the den with their rifles ready for action, and the master got impatient and said: "Rastus, go in there." Rastus looked around, his face changed in its hue as much as could be expected from a gentleman of his color, he backed up and trembled. The master said again: "Rastus, go in there." Rastus looked around again. Finally he took one look at the Colonel and he dodged into the den. He was not in there but a fraction of a second when he came out with his clothes disarranged and somewhat disturbed in appearance. After him came the bear. The bear was disposed of by the surrounding gunners who were ready for him, and finally one of the Northern visitors came over to Rastus and said: "Did you know that bear was in the hole?" "Yes, sir." "Well, why did you go in that hole?" "Well, sir, you see it was like dis: I never had no pussonel acquaintance with dat dar bear; I didn't know dat bear; I had nebah seed that bear before, but, my Gawd, I knows the Cunnel!" (Laughter.)

Gentlemen, it is not a matter of introducing some new thing. The State Societies are with us and they have some advantages. Perhaps districts may differ, but with us they have a benevolent work and they are doing it. I may say that the Michigan Chapter yields to nobody in its regard for the American Institute of Architects; we look upon this body as being the central body for the propagation of architectural truth, so to speak. We look upon it, with its traditions and its history, to be something more than revered, to be followed and treasured, and we would like to come to you and get your counsel and your advice and your instructions, if you please. We come here not in a spirit of combat, but in a spirit of service (Applause). We feel that we can go out under your instructions and we will suppose, for instance, in a practical way that something of a legislative character is desired to be carried out. Now instead of coming and negotiating with a mass of Congressmen or a bureaucracy or in some way attempting to affect these individuals as they are in their organization, supposing by the ramifications of a State Society, embracing all sections of the country and all calibers of the men in the profession, that we are able to see these legislators in their homes, in connection with their family life and their business associations, and show them that it is in the interest of their constituents that certain measures which we realize to be of general benefit should be followed, can we not readily show them the advan-

tages. And so then we say, as the Michigan Society, let us come in and co-operate with you, let us endeavor by some means or another, by every means in our power, to arise from the condition of recognized measurable stagnation which now oppresses the profession and come into one of co-operation, federation or any other way by which we may work together for the benefit of the profession. Let's go. Thank you. (Applause.)

(Mr. Kohn in the chair.)

The Chairman. New York has a young State association formed in June of last year which is represented by two non-Institute members of that association at this convention, Mr. Riley Gordon and Mr. Loth, of Troy. I believe Mr. Loth has agreed to say a word for that association—Mr. Loth.

Mr. Loth. Mr. President and Gentlemen of the Association: There was a darky minister—(Laughter)—this is a true story now—who was summoned to a congregation, or, called, as it was called, to preach a sample sermon, and he had by an unfortunate or, rather, a fortunate circumstance brought one of his old-time efforts, the title page and the last page, and he forgot all of the middle, and it is needless to say that he got the job (Laughter).

Now the last two gentlemen who have spoken have certainly covered the ground, and, therefore, it is perhaps for me, figuratively speaking, to say that I have forgotten not only the middle but also my title page and my peroration.

I do consider it a great honor to stand here as a representative of the New York State Association of Architects. I presume it is the largest or, in fact, New York State contains the greatest number of architects of any State in the Union. This new association has, in my opinion, not grown to the expectations that I had looked forward to, and I will admit that I am just a little bit depressed over the result. There is nothing to be gained by kidding one's self. It is better to look the devil squarely in the face and, of course, if we can, lick him, all right.

Now the American Institute of Architects since 1858 has been a standard for everyone practicing architecture in the country and looked up to, but it has been difficult to get the great majority of practitioners into the Institute. I can remember way back many years when several men like myself, then young, discussed the question as to whether we should go into the Institute or not, and we decided we would not. I think now, of course, I made a mistake at that time. Now how can the great mass of practitioners be elevated just one little peg higher up? How can it be done? I believe that it is through the medium of the State associations.

Now I have talked with young men of to-day about joining the New York State Association and

most everyone of them has said to me: Why, what good will it do me? Now that is a lamentable attitude, but it is a fact. That is the way they look at it. Now," I have said to those young men: "You should not ask me what good this association is going to do to you; you should say to yourself, I will join this association and I will give all my time, my talent and my money to elevate my co-workers and the body politic. (Applause.) It is the nature of the service, the thought, that dominates all through this country to-day in almost every profession to an extent the like of which has never been realized in this country before, at least, probably not in the memory of those that are here now.

It is up to someone to show us how in the State of New York, and I limit my view to that, because I know absolutely nothing about the conditions in other States—it is up to someone to show us how to bring about a change for the better.

Now I apprehend that we have probably 50 architects of the State in the State Association. There are no doubt 1,000 practitioners in the State of New York that belong to no association whatever.

Now just to illustrate, we have in the City of Albany an organization of architects and consulting engineers, I think of about twenty-five members, and I do not think there are four members of that association that are members of the State Association, and somehow or other we do not seem to be able to get them in. Now why? I will admit that I do not know. I have tried, I have made personal solicitation, I have written letters. The reason that they do not come in is perhaps because I am not able to present to them the advantages of joining the association in such a way—it probably needs somebody more capable. Now whatever the reason is I do not know, but I do hope that this Institute will be able to build up strong State organizations that will be working hand in glove with the Institute. The Institute will be the national clearing house and each State will be permitted to solve the problems peculiar to itself. You all know the motto, "Do it now." Now I will admit, brethren, when I say I am somewhat distressed and disappointed over the result that we have not got our thousand members together in a year, that perhaps I am rather ambitious of results, but that motto, "Do it now," is very forceful, and I should like to see the thing accomplished in a moment. I would like to see all these 1,500 practitioners in the State of New York rubbing elbows one with the other and learning that each one is just as good as he himself and there are some who are better, and every man would be better if he came in contact with the man who is just a little bit above himself.

Now, as I say, I should like to see us do it now, but that, of course, is impossible, but I would like

to have the Institute say to us just how we can do it. (Applause.)

The Chairman: The Illinois Society of Architects is represented by three visiting delegates to this convention. I am going to ask Mr. Ralph C. Harris to speak for that society—Mr. Harris.

Mr. Harris. Mr. Chairman, Gentlemen: In the first place, I am a rotten story teller, so I am not going to tell you any stories, but I would like to just say a word in regard to the condition we have in Illinois. We have not the number of architects they have in the State of New York. However, for some reason or other we have been far more successful in gathering the architects together and we feel that the State Societies have a place.

Now I imagine there are somewhere around 600 practising architects in the State of Illinois. In the Illinois Society we have very nearly 400 of that 600. Why it is I am not prepared to say exactly. One of our reasons for doing it is that we believe that every architect should belong to an association.

As soon as a man is licensed in the State, as soon as the results of the licensing examination are published, he is entitled to join the Illinois Society of Architects. Our only requisite for membership is a license to practice and honorably practice, and in that way we catch the men just as they start their professional work, when they are very much interested in the thing as a profession, and we do not find a great difficulty in getting them to join. Our dues are very low. They are something like \$8 a year. So the financial obligation is not great. We get the men together.

Now we believe that the State Society is a sort of a training ground, if you will, for the Chapter of the Institute, and we try to make it such. All the things we do for the betterment of the profession are done in absolute accordance with the ideals of the Institution and we work in absolute harmony with the Illinois Chapter. I am not going to take any more of your time. I realize that the convention has a great deal of work to do.

I would like to bring just one more point to your attention, and that is in a very great measure, at least in our case, the State associations are governed and guided by your own members. If I am not mistaken with two exceptions all the officers and every director of the Illinois Society is a member of the Illinois Chapter of the American Institute of Architects. So you can see there must be close harmony and that the two organizations work closely together.

I would like to express my appreciation and the appreciation of the society for the privilege of being here and we wish to thank the Institute for its consideration of us. (Applause.)

The Chairman. The North Dakota Society of

## THE AMERICAN ARCHITECT

Architects is represented by Mr. Hancock. Will Mr. Hancock, if he is present, say a word—Mr. W. B. Hancock.

Mr. Hancock. Mr. Chairman, Gentlemen: I feel considerable embarrassment in attempting to talk to this august body, because I did not expect to make a speech and I am very little of a speech-maker anyway, and nothing whatever of a story teller. We have had some quite entertaining stories. I wish I could tell you some equally good.

I think perhaps the situation as stated by Mr. Wilson, of Montana, fits North Dakota quite admirably. I think the situation is just about parallel.

I presume you know that North Dakota has a registration law in effect which was found quite inadequate, and when it came up to the test of the Supreme Court it was declared unconstitutional. That, however, has subsequently been cured. At a special session of the Legislature late in the fall of 1919 the defect in the law was remedied and we now think we have a fairly good operating law.

Mr. Waid. May I ask Mr. Hancock what the status of eligibility is? Is it registration?

Mr. Hancock. Registration and approval by the State Board of Architects, which is composed of three men in the profession within the State. And we are just now in the beginning of things there and there are many improvements we would like to make, and we hope to make, as time advances.

I had expected that one of the members of our State Board would be here, but unfortunately he could not come. Therefore, I am the sole representative, and in the talking end of the thing I am rather a poor one.

Our State Society, the North Dakota Association of Architects is the style of it, was organized three

years ago and with about twenty members. I think we have about thirty practitioners within the State, and they are of every kind and degree, the same as Mr. Wilson stated of Montana. We do not bar anybody and there is considerable discretion left with the State Board under the law, but so far they have been administering the thing quite satisfactorily, I believe, to all the resident architects, and I think without any hardship to outside architects who have been practicing within the State, some of whom are present, and if they have any complaint to make against the North Dakota law I would like to hear from them.

On the call for nominations for officers, there were four nominations for the presidency, as follows: Henry H. Kendall, of Boston; Robert D. Kohn, of New York; Milton B. Midam, Jr., of Philadelphia, and Ernest J. Russell, of St. Louis. The nominations for first vice-president went to Charles A. Farrot, of New Orleans, and for second vice-president to William B. Faville, of San Francisco. William Stanley Parker, of Boston, was nominated to succeed himself as secretary, as was also D. Everett Waid, of New York, as treasurer. The nominations for three to serve on the Board of Directors for three years were Charles H. Alden, John C. Austin, N. Max Dunning and Abram Garfield.

The evening session was a conference on Inter-Professional Relations, presided over by Mr. Robert D. Kohn.

There was a very interesting exchange of views on this important question and some addresses of moment. It is expected that a synopsis of these addresses will be printed in a later issue.

# Extracts From the Report of the Board of Directors of The American Institute of Architects

Presented at the Fifty-third Annual Convention, Washington, May 5-7, 1920

NO special subject can be referred to as the principal topic of the convention. The many matters to be touched upon in this report cover the whole range of Institute activities, and in many cases involve action of great importance and corresponding burden. They all, however, have a common aim, the larger accomplishment of the Institute's purpose, and this is fundamentally service, to society and to the profession. This, as always, is the real subject before the convention, and, as always, it has two sides to be considered, one—what the Institute collectively can do for the profession as a whole, and for the individuals that compose it; the other, which should be assigned no lesser place, what the individual can do for the Institute and the profession, for without this accumulation of active individual support the Institute, as a body, can accomplish little.

\* \* \*

The total membership of the Institute on May 1, 1920, was 1580 (as against a total on April 15, 1919, of 1499) and is made up as follows:

Fellows .....	287
Members .....	1178
Honorary Members .....	81
Honorary Corresponding Members.....	34

Since the last report of the board there have been:

Advanced to Fellows.....	8
Elected Members .....	130
Reinstated .....	5
Elected Honorary Corresponding Members..	1

There have been the following resignations and removals:

Fellows .....	4
Members .....	26

There have been the following deaths:

Fellows .....	9
Members .....	12
Honorary Members .....	2
Honorary Corresponding Members.....	2

The total of new active members elected has been .....

135	
The total of new Active Members elected has and deaths of Active Members has been...	51
Leaving a net gain in Active Members of:...	84

## Membership

While the board is glad to note that the number of new members elected is the second largest ever recorded, and shows an increase of 100 per cent. over last year, electing 135 new active members, it is convinced that it is far below what should be the normal increase, and far below what could be secured by the development of a consistent effort to that end. The convention last year decided not to reduce dues, and the membership campaign was denied this impulse. The board hoped, however, that the committee it appointed would be able to develop an activity among the Chapters that would secure a large increase in members even without this inducement, and possibly its one

circular letter to the Chapters is responsible for the increase reported. If so, it shows how easily it can be done, and lends added hope for the success of a consistent campaign.

The board believes that this can be accomplished best under the direct supervision of the Executive Secretary, as a regular Octagon activity, in consultation with a local Committee Chairman. Actions by this convention doubtless will effect the procedure that will prove desirable and the results that can be secured. In any event the board intends to inaugurate a campaign through the Octagon, and is confident that it can and will be carried through effectively, if the Chapters will appoint interested and energetic local committees to co-operate with the Executive Secretary.

## Education

The report of the Committee on Education is recognized by the board as an important report of progress. No report on education could well be conclusive. It can only be a record of a step in an endless progress. The report, however, indicates the wisdom of the reorganization put into effect last year and shows definite progress in the study of the problems specifically assigned to the committee.

The board commends for consideration the definition of the preparation requisite to the practice of the profession and the analysis of the work of the architectural schools, faced with the problem of trying to do more than they have time to do with pupils inadequately prepared.

The board indorses and presents to the convention the following resolution of the committee:

"WHEREAS, The schools of architecture generally are so organized as to condense their period of study to four years, and

"WHEREAS, A consideration of the courses given shows that they are generally good but hampered by a too great condensation, and

"WHEREAS, It is the conviction of the convention that more courses, more thoroughly given, are requisite; therefore, be it

"Resolved, That the American Institute of Architects does hereby recommend to all schools to lengthen their course in architecture to a period to exceed four years in order to make it possible to include such necessary studies as have been left out of the curriculum, and to give more time for the more complete assimilation of the subjects taught."

The board also is glad to present for adoption the following further resolution of the committee, regarding the issuance by the Institute of a document for use in connection with the standard registration law, indicating a standard of professional competency for those admitted to practice under the name of architect, and a method of determining its fulfillment in individual cases:

"WHEREAS, The American Institute of Architects has

(Continued on page 645)



## Report of Committee on Education

AS in former years, the report of the Committee on Education is a scholarly discussion of one of the most important subjects that can receive the attention of the Institute. It has been generally conceded that most of the ills that now beset the practice of architecture are due to the fact that the practical elements of architectural education have not kept pace with the practical developments of architectural practice.

The report presented at Washington exhaustively analyzes all the various matters of education that have for the past few years been subjected to criticism. It points out the good and bad elements of this criticism and it makes recommendations that deserve a better fate than burial in the Institute archives. Not alone do these carefully prepared reports on Education drift along to non-accomplishment, but other equally well-studied efforts of important committees share a similar fate.

The trouble is that when once permitted there is no force, no impetus, to keep them moving steadily forward. When a convention has adjourned the constructive character of the Institute practically ceases. This is not written in a harshly critical manner. It is simply to state a fact.

In the first place it is remarkable that groups of men who find the exactions of their professional work so time consuming should be physically able to give the time necessary to the investigations of facts and the preparation of these admirable documents. It would only be possible by relinquishment of practice to continue the forwarding of these matters during the twelve months and sometimes more between conventions. Anyone who has studied these reports and knows their valuable and practical nature will regret that so much good has, in a sense, gone to waste.

What is needed now, more than ever before, is a reorganization of the executive departments of the Institute as centered at Washington. There should be an executive secretary and a competent staff to take up and continue these things. The suggestion that such a man be selected from the ranks of the

profession and placed in charge is a good one. He could in one year so fruitfully work that the American Institute of Architects would be known throughout the land better than it now is and the influence of organized architecture would be something to be respectfully considered. "Well begun" is today not even "half done." The world moves so quickly that important matters are absolutely but nine days' wonders. If they are to be kept fresh in the minds of people they must be constantly kept before them.

The manufacture of power and projectiles is an all-important feature in a preparation for war. It, however, is in their efficient use in accomplishing their purpose that they become valuable. The Institute has accumulated an arsenal of good, reliable ammunition. Most of the extremely valuable is still in storage and with no well-skilled element to bring it into action.

To give these things their utmost momentum requires not only a constantly functioning executive body but it is necessary that such an executive body should have behind it sufficient power to give whatever it tries to do such a proper momentum. This momentum may properly and even necessarily come from a membership sufficiently large in proportion to the entire number of the profession as to constitute a representative body.

The matter of State Societies, like Banquo's ghost, will not down. With these organizations in every State, an Institute of American Architects, and an Academy of Architecture—a condition would be attained that would make the profession a group of Master Builders that would dominate construction and all that is allied to it.

## The Second Day's Proceedings

Outstanding as among the most important features of the Fifty-third Convention were the reports of the Committees on Small Houses and on State Societies. It is with much satisfaction and with due acknowledgment to the efficient Convention Press Committee that we are enabled to present to our

readers what is practically a complete report of this second morning's meeting.

These debates are worthy of the careful attention of every architect, irrespective of Institute affiliation. The Committee on Small Housing has presented a plan which possesses the unusual advantage of a practical test. It will be interesting to observe to what extent other Chapters will follow the example set by Minneapolis.

The debate on State Societies very clearly presents the views of those who favor such organization. As a record of opinion this issue will be valuable and will serve to permit quiet and thoughtful consideration on a matter perhaps more important than any that is now before the architectural profession.

In the May issue of the Journal, Charles St. John Chubb discusses with much detail the matter of State Societies. He insists that in all matters referring to the Institute the Journal should be the only forum, and that no member should air his opinions in the architectural press.

It is possible that many men with minds of their own will resent this restriction on freedom of speech or as to the vehicle through which it may be conveyed. Further, Mr. Chubb remarks, "as long as the Institute sticks to its present standards and remains a body of the aristocracy of the profession, there is room for another kind of architectural society." Which would appear to justify the query, is there not room for another kind of architectural journal, where speech is free and unrestricted, and with standards more democratic?

### Advertising Methods as Used for Religious Propaganda

DELEGATES journeying to Washington for the recent Convention will have noticed along the roadway a number of signboards proclaiming religious texts and urging early repentance for false ways of living. These are frankly stated to be under the direction of a large group seeking to advance a certain nationwide movement organized by the churches of this country.

Perhaps no class of men are more opposed than architects to a marring of our public highways by blatant and vulgar signboards, and they will deplore the fact that a movement in which all right-thinking men participate has descended to such base usage.

It is difficult to understand why a custom so generally condemned by those who have the best artistic interests of the country at heart should be indulged in by the churches, where the aesthetic proprieties might reasonably be looked for in their highest development. The best traditions of the church seem disregarded in this act. Art received all its early encouragement under the guidance of the church. The monks and friars of mediæval days practiced it in all its phases, and clothed it with a sacredness and dignity that succeeding years have not surpassed.

Tradition must give way to progress. This is not a plea for continued conservatism in the conduct of the church. Modern conditions must be met with modern solutions. The church has adapted itself to these conditions, and religion is more and more practiced on all seven days a week instead of only on the seventh, and practiced, moreover, with definite relation to the normal activities of a man's life.

Interest is therefore transferred from the purely artistic point of view represented by the billboard incident to the psychological result of the new attitude. The enjoyment of the scenic beauty of the countryside is not enhanced by rounding a curve and seeing beside a picturesque brook or mountain slope the rather searching and indelicate queries regarding the reader's past and future that now adorn not only the signboards but the cliffs and tree trunks as well. The silent lessons of primeval nature need no help from such obvious daubings, and the passer-by is conscious of resentment in place of the peaceful tranquillity of the preceding moment. So that, quite apart from the artistic aspect, the idea is hardly one to be effective.

Religion cannot successfully be advertised without losing its whole essence. The true way to advertise religion is by service,—by doing the best thing one can in the best way one can, and by revealing at the same time the capacity of others to do so. If we do less than this we retard the highest development of humanity. For humanity moves in each of us like the current of a stream. Let us keep an unclogged bed for it. Let us in our art and architecture, as well as in our religion, do these things with the same sacredness and selflessness of intent that did the monks and friars, that the modern day may continue its material progress without decreasing its spiritual.



## Board of Directors' Report

(Continued from page 642)

previously and does now encourage the adoption of laws for the registration of architects by all States, and have to this end prepared a typical law for the guidance of such legislation, and

"WHEREAS, The efficacy of such laws can be greatly enhanced by the adoption of proper standards of professional competency and equitable methods for their determination; therefore, be it

"Resolved, That the American Institute of Architects, while convinced that many States will wish to set up higher standards, recommend as a minimum standard of academic and technical and practical education, and of professional competency and methods for its determination, the best standards adopted and the methods now employed by the States of Illinois and New York."

The appendix of the committee's report indicates interesting progress in the preparation of the book on the Fine Arts suggested by the last convention. The board believes the work will prove to be one of the most valuable and broadly effective efforts ever undertaken by the Institute and offers the subcommittees having it in hand its appreciation and cordial support.

### *Small Houses*

The report of the Committee on Small Houses presents activities for which the board has the keenest interest. It has been said with some justice that the profession has served merely the moneyed classes of the community and done nothing for the poor. Here is an opportunity to serve effectively that very large section of the public that wants to live in small inexpensive houses and that cannot afford normal architectural service.

When the proposal for a Small House Service Bureau was presented to the board in November it recorded its interest, but could not see its way clear to assume the financial burden involved at a time when the organization of the Institute Press was still uncompleted and the bond issue, then in process, fully involved in the development of the existing activities of the Journal.

The board records its admiration for the energy, devotion and unselfishness of the committee and the members of the Minnesota Chapter in promptly deciding that the time was ripe and assuming the burden of initiating the work in such a way that it can become a part of a bigger national movement when the Institute can see its way clear to undertake it.

### *Committee on Contracts*

The board notes with satisfaction the probability of early publication of the Handbook of Architectural Practice. The board is also glad to report that acting under authority of the fifty-first convention it has approved the Cost Plus Fee documents as reported by the Committee on Contracts, and has authorized their issuance as Institute documents. These documents are suggestive only, and serve not as a fixed standard document to be bought and used intact, but merely as a guide to those desiring to draft a contract on a cost basis.

The increased revenue from the Standard Documents is noted with satisfaction as an index not only of the constant use of the documents, but also of a return of the profession to a more nearly normal activity.

The fifty-second convention referred to the Committee on Contracts a suggested revision of the Schedule of Charges. Recently a further suggestion has been presented for the consideration of the delegates at this convention.

The board believes all such suggestions should receive

careful consideration. The Schedule of Charges, however, is one of the most important standard documents of the Institute and should only be changed to accord with a strong majority sentiment.

The board believes that both the suggestions should be fully discussed and the arguments of the proponents developed for the information of the convention, and that they be then referred to each Chapter for discussion during the coming year with a view to report by the board to the fifty-fourth convention. The board also believes that the question of the remuneration of the architect as compared to that of other professions and activities as well as to that of his draughtsmen should be investigated in the broadest way and recommends to the new board the appointment of a special committee for this purpose.

### *State Societies*

The developments since the last convention indicate clearly to the board that the action taken then in regard to State Societies was taken without a full understanding of import and that this question is very much involved by varying local conditions that make any broad uniform national policy impossible. It is also involved with the closely related problem of regional subdivisions of the Institute which comes before this convention for consideration.

There is no question in the mind of the board regarding the desirability of the closest co-operation between the Institute and existing State Societies and any new ones that may be organized, but it believes the policy and extent of new organizations should be more fully investigated in connection with new plans for the development of the Institute through new Chapters and increased membership.

For this reason the board offers the following resolution:

"Resolved, That the action of the fifty-second convention concerning State Societies be reconsidered and a special committee be appointed to study the subject fully in relation to varying local conditions to the best development of the Institute organization, and the most effective organization of the profession as a whole to meet the needs of different districts and report to the Board of Directors at its meeting just prior to the next convention."

The board urges full discussion of this matter by the convention for the instruction of such committee, and will present later for consideration a recommendation of the Minnesota Chapter.

### *Regional Representation*

The question of regional representation on the Board of Directors has long been under discussion. It now comes before you as a definite proposition for action. The amendments that have been circulated were prepared by the board with a view to making the by-law provisions as simple as possible, but with full scope for the development of the new relationships between directors and their districts.

The scheme proposed involves nine districts with one director from each. As at present, three directors would be elected each year to serve three years.

Since the amendments were distributed a further suggestion has been made that there be six districts with one director from each, three directors being elected at large.

This question involves fundamental reorganization of the Institute and the board refers it to the convention in the hope that there may be many expressions of opinion. The board, without having fully developed an opinion on many details involved, records its approval of the fundamental idea of a division of the territory of the Institute into nine districts, each one of which shall be represented

# THE AMERICAN ARCHITECT

on the Board of Directors by a director elected by the district itself.

## *Draftsmen's Organizations*

The old problems of conditions of employment, of division of the rewards of knowledge, experience and industry have acquired, during these days of reconstruction, a new interest for all people and particularly for all those engaged in professional occupations. The draughtsmen in our office are asking themselves whether the rewards of experience and ability in their chosen work are commensurate with those received by their acquaintances in other professions and industries. They are wondering whether the future of the architectural profession offers them sufficient encouragement to keep alive their interest and enthusiasm. Many have already abandoned the profession for other more remunerative or more congenial occupations.

Organizations of draughtsmen are being formed to study these questions and to seek means for bettering conditions.

In some parts of the country these organizations partake to a greater or less degree of the nature of trades unions. In other parts the union idea is repugnant, particularly to those who regard themselves as potential architects, looking forward to independent practice. In New York the draughtsmen have formed a society whose purpose as stated in its constitution is "to improve and perfect the quality of service rendered the community by the architectural profession, to organize in friendly and helpful association all those engaged in rendering this service and to promote the economic and general welfare of those engaged in the profession."

This society has sought the active interest, advice and support of the practicing architects and joint committees of architects and draughtsmen have been formed. It is already evident to the members of these committees that architects and draughtsmen have much to learn from each other and that the knowledge gained from such joint study cannot fail to improve the quality of the service rendered to the public, from which, in the last analysis, the reward, whether to principal or assistant, must come.

The board urges that such societies of draughtsmen as believe that the interests of employer and employe are not necessarily antagonistic; that the profession must continue to develop along professional as distinguished from commercial or industrial lines, that the art of architecture and the welfare of those engaged in its practice cannot be advanced by machine shop methods; in short, which regard their calling as a profession and not as a trade, are deserving of the encouragement and active help of the Chapters.

The board feels that this is not only a duty to our draughtsmen, but that it is a vitally necessary step if the profession is to continue to attract men of education and high ideals to its service.

The problem presents different aspects in different localities, and their solution must come through direct human contact and friendly discussion, leading to mutual understanding, respect and confidence. It is therefore a matter in which the initiative must be taken by the Chapters.

## *Farm Buildings*

The Committee on Farm Buildings appointed under direction of the fifty-second convention found it impossible to accomplish results without a substantial budget, which the board was unable to offer.

It suggests as the proper scope of such work a field of

effort so large that the board recognizes the impossibility of attempting to carry it out under present conditions. The board believes that preliminary study of the problem in the different districts is possible at slight, if any, expense and that out of this local effort it may later be able to develop a national policy. It, therefore, advises the reference of this matter and the suggestions of the past committee to the Chapters for such action as may in each case seem desirable.

\* \* \*

In conclusion the board wishes to record its regret at the frequent evidence that is found of a sentiment in the Chapters that they are something apart from the Institute over which the Institute holds a certain and sometimes irksome control. The board wishes to emphasize as strongly as possible its conviction that while the national officers and committees have their definite share of Institute work to accomplish the major work of promoting the objects of the Institute does and must of necessity lie with the Chapters. Policies, whether regarding the conduct of competitions, public instruction in problems of community planning, suggestions for co-operation between architects and their draughtsmen, policies, in fact, concerning action in almost all the matters before this convention for discussion, can be developed by the board and the standing or special committees, or by the conventions themselves; but their real virtue will lie in the effectiveness with which the Chapters carry forward the execution of the policies in their various territories, the energy with which they develop active contact with the public and effect public action in matters related to the arts, the friendliness and wisdom with which they approach the too long neglected problems of their draughtsmen—and the spirit of fair play and mutual consideration they develop in their relations with each other.

It is by such activities within each Chapter that the architects of the country will be united in the closest fellowship and by the great accumulation of such local activities that the Institute will best promote the aesthetic, scientific and practical efficiency of the profession, and meet most fully its great obligation of service to society.

## OFFICERS OF THE AMERICAN INSTITUTE OF ARCHITECTS, ELECTED FOR 1920-1921

President.....Henry H. Kendall, Boston  
First Vice-President.....  
.....Charles A. Favrot, New Orleans  
Second Vice-President.....  
.....Wm. B. Faville, San Francisco  
Secretary.....Wm. Stanley Parker, Boston  
Treasurer.....D. Everett Waid, New York

## BOARD OF DIRECTORS

For One Year—1920-1921

Edward W. Donn, Jr., Robert D. Kohn, Richard E. Schmidt

For Two Years—1920-1922

Edwin H. Hewitt, William B. Ittner, Ernest J. Russell

For Three Years—1920-1923

Charles H. Alden, N. Max Dunning, Abram Garfield

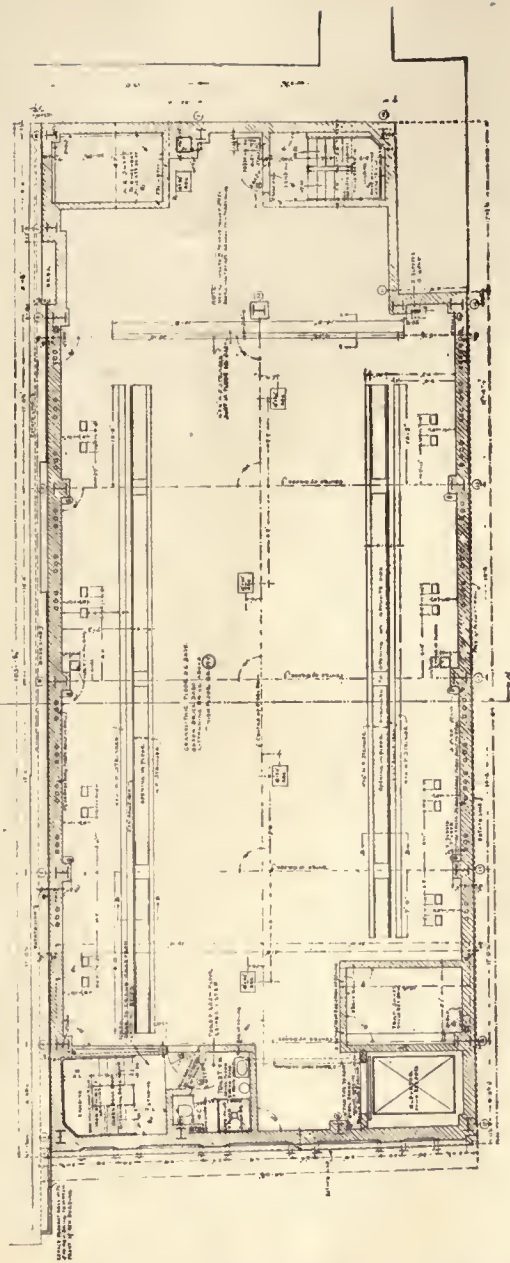
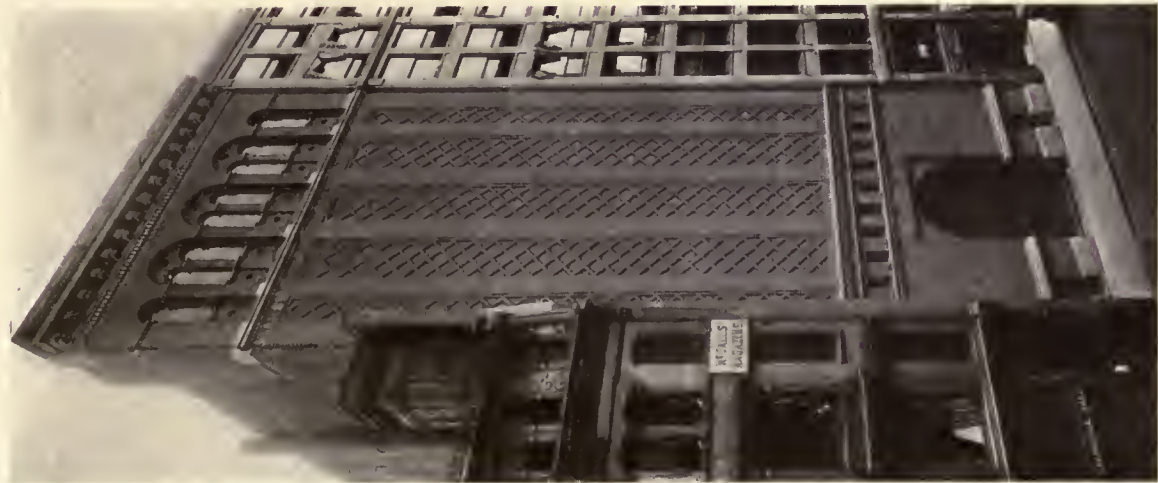

CHAUNCEY STREET STATION  
 EDISON ELECTRIC ILLUMINATING CO., BOSTON, MASS.  
 BIGELOW & WADSWORTH, ARCHITECTS

-646



646

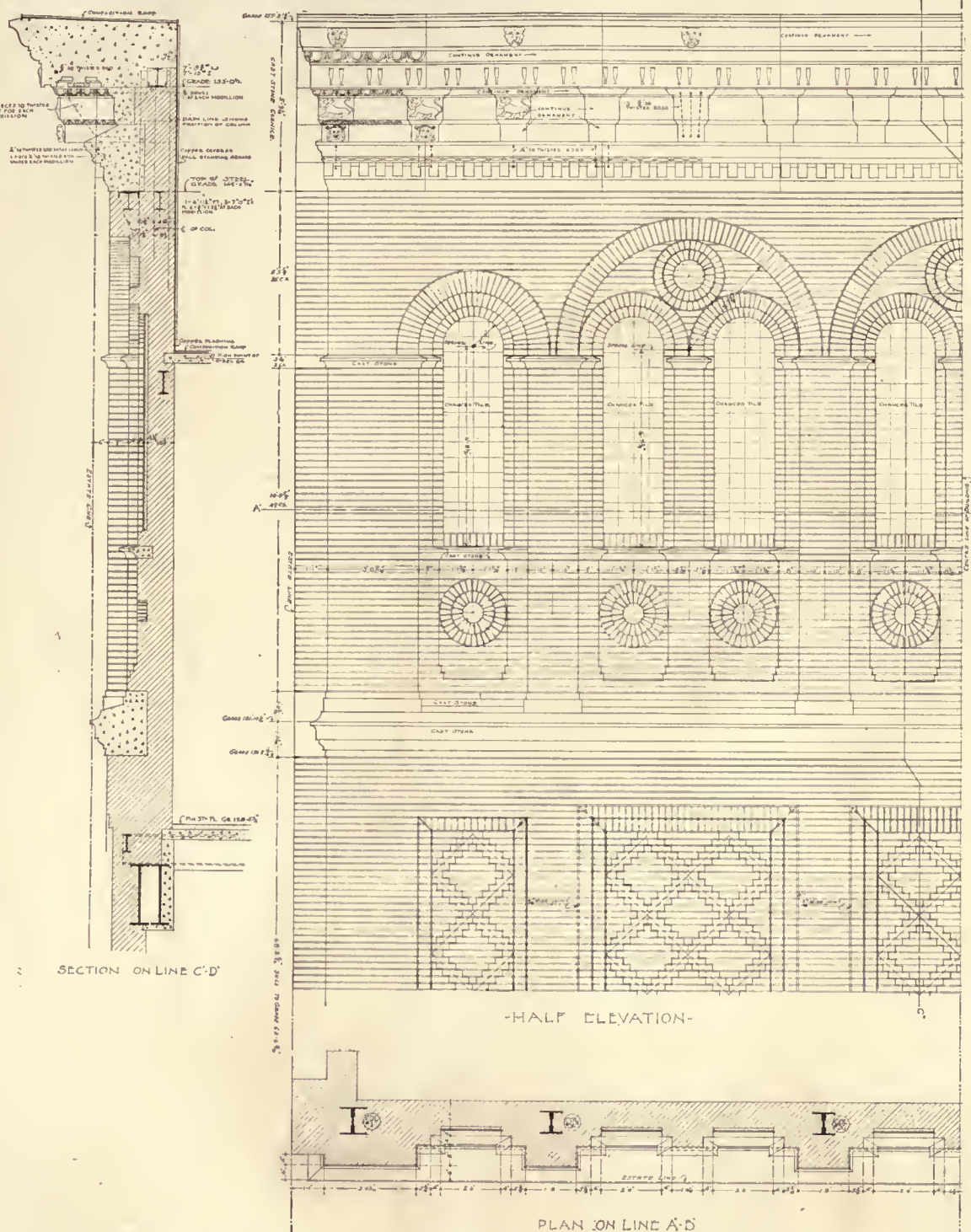

3/4 INCH SCALE DETAIL OF UPPER PART FRONT ELEVATION  
 CHAUNCY STREET [21<sup>ST</sup>] STATION BOSTON  
 FOR THE EDISON ELECTRIC ILLUMINATING COMPANY













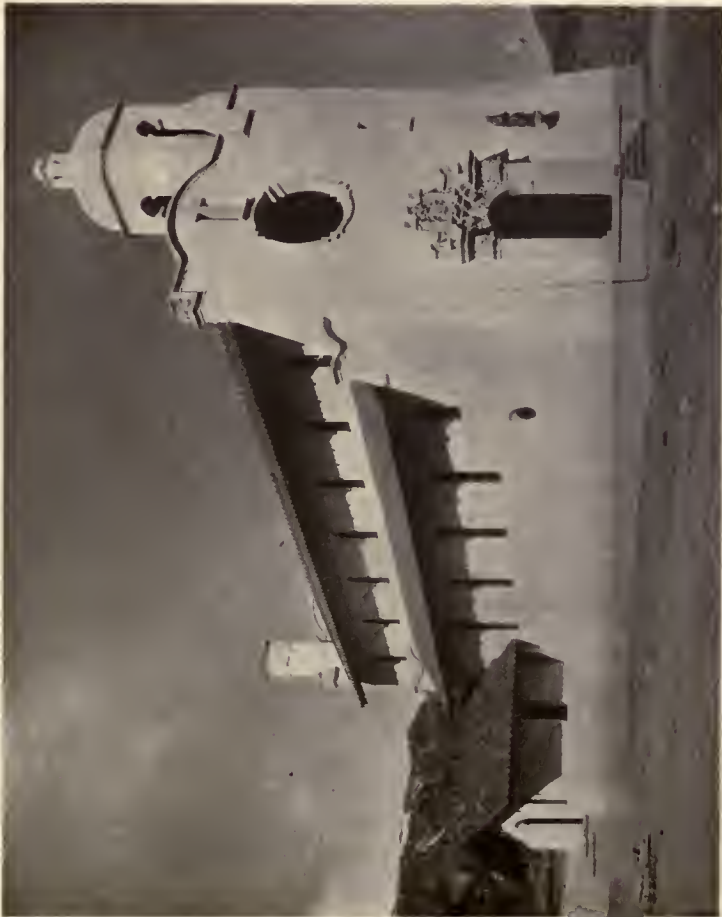

ROMAN CATHOLIC CHAPEL, COLORADO SPRINGS, COLO.

MacLAREN & HETHERINGTON, ARCHITECTS

646<sup>5</sup>





DETAIL MAIN DOORWAY  
ROMAN CATHOLIC CHAPEL, COLORADO SPRINGS, COLO.  
MacLAREN & HETHERINGTON, ARCHITECTS



5427

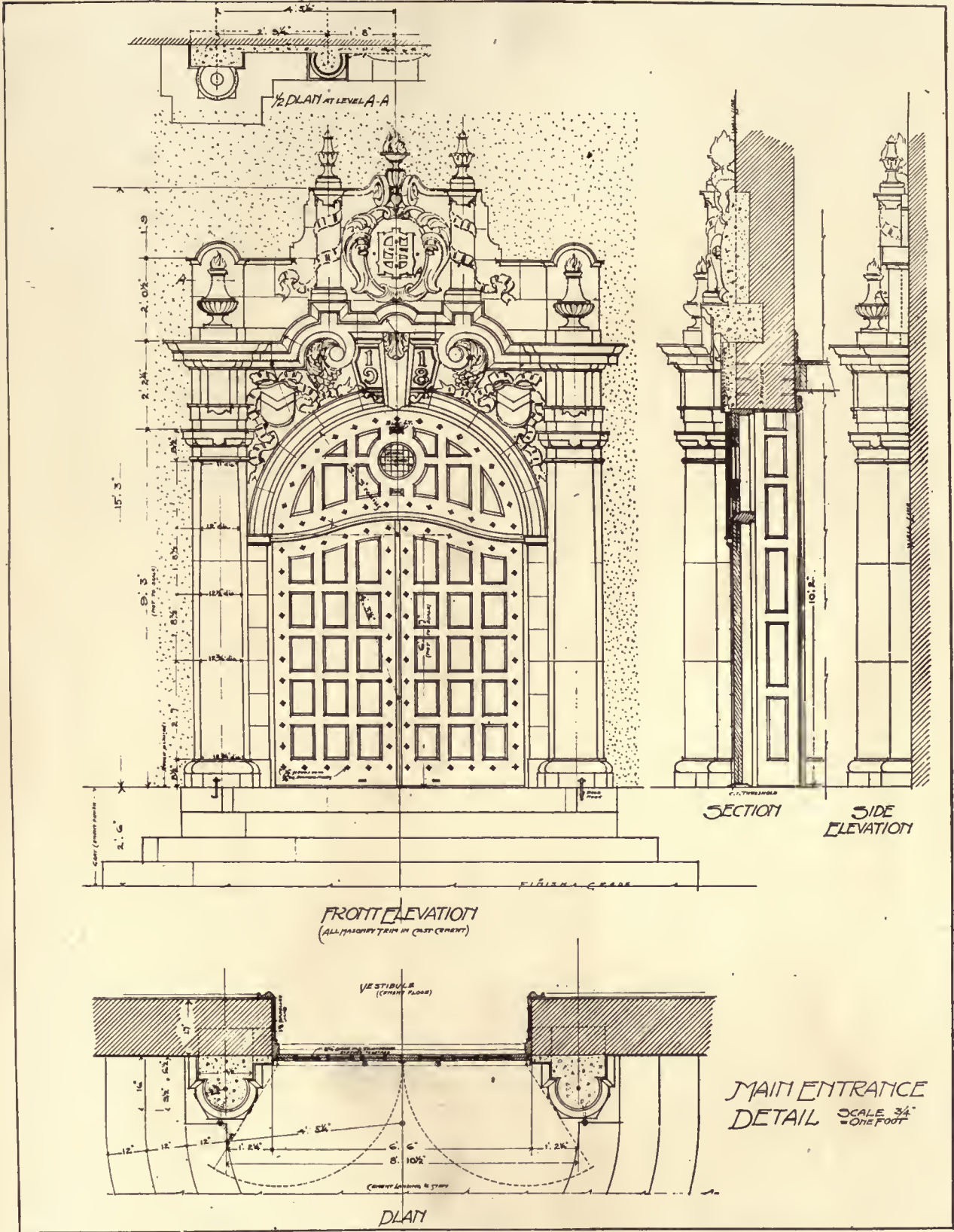

DETAILS OF MAIN DOORWAY  
 ROMAN CATHOLIC CHAPEL, COLORADO SPRINGS, COLO.  
 MACLAREN & HETHERINGTON, ARCHITECTS







J. K. SMITH

FIRST MEDAL  
A MEMORIAL BRIDGE

UNIVERSITY OF PENNSYLVANIA

## Beaux-Arts Institute of Design

DIRECTOR OF THE INSTITUTE, LLOYD WARREN

ARCHITECTURE, WILLIAM F. LAMB

SCULPTURE, JOHN GREGORY

MURAL PAINTING, ERNEST C. PEIXOTTO

INTERIOR DECORATION, ERNEST F. TYLER

### Official Notification of Awards— Judgment of January 6th, 1920

#### PROGRAM

#### CLASS "A"—II PROJET

The Committee on Architecture proposes as subject of this Competition:

#### "A MEMORIAL BRIDGE"

On either side of a river, two cities, forming however a single community, have grown up. They have recently been incorporated by an act of legislature into one city. In commemoration of this event, and to replace an old bridge which is now inadequate, it is proposed to build a Memorial Bridge.

The river at this point is 200'-0" wide, although immediately below the bridge, it widens out rapidly into a harbor for big shipping. On account of the difference in level between the upper and lower parts of the city, the total length of the bridge at the roadway level is 350'-0". A few feet above the river, on one side, is a street of the lower town, which must pass either through the abutments or under the bridge. The street crossing the bridge at the upper level, which is 150'-0" above the river, is an important business thoroughfare.

JURY OF AWARD: F. A. Godley, P. Cret, L. P. Burnham, J. C. Levi, P. A. Cusachs, H. C. Butler, F. C. Hirons, A. B. Trowbridge, M. Prevot, H. Davenport, G. A. Licht, L. Ayers, M. B. Stout, E. Gugler and W. F. Lamb.

Number of drawings submitted—46.

#### AWARDS:

FIRST MEDAL:—J. C. Janney, S. J. Laschenski and J. K. Smith, University of Pennsylvania, Philadelphia.

SECOND MEDAL:—A. C. Runzler and S. H. Brown, "T" Square Club, Philadelphia; P. F. Taylor and J. M. Hirschman, University of Pennsylvania, Philadelphia; O. Wilkins, Yale University, School of Fine Arts, New Haven.

MENTION:—R. Eastman and J. S. Whitman, Cornell University, Ithaca; A. T. Terrell, G. Roth, H. Marceau and Florence Wingate, Columbia University, New York; A. O. Ahlberg, Atelier Denver, Denver; R. B. O'Connor, Princeton University, Graduate College, Princeton; H. B. Preston and R. Walldorff, Syracuse University, Syracuse; R. Nickel, "T" Square Club, Philadelphia; G. K. Trautwein, P. Domville, C. F. Gromme, G. C. Emery, S. B. Baylinson, A. Levy, E. O. Johns, T. B. Epps, G. M. Martin and A. E. Westover, Jr., University of Pennsylvania, Philadelphia; E. Pickering, University of Illinois,

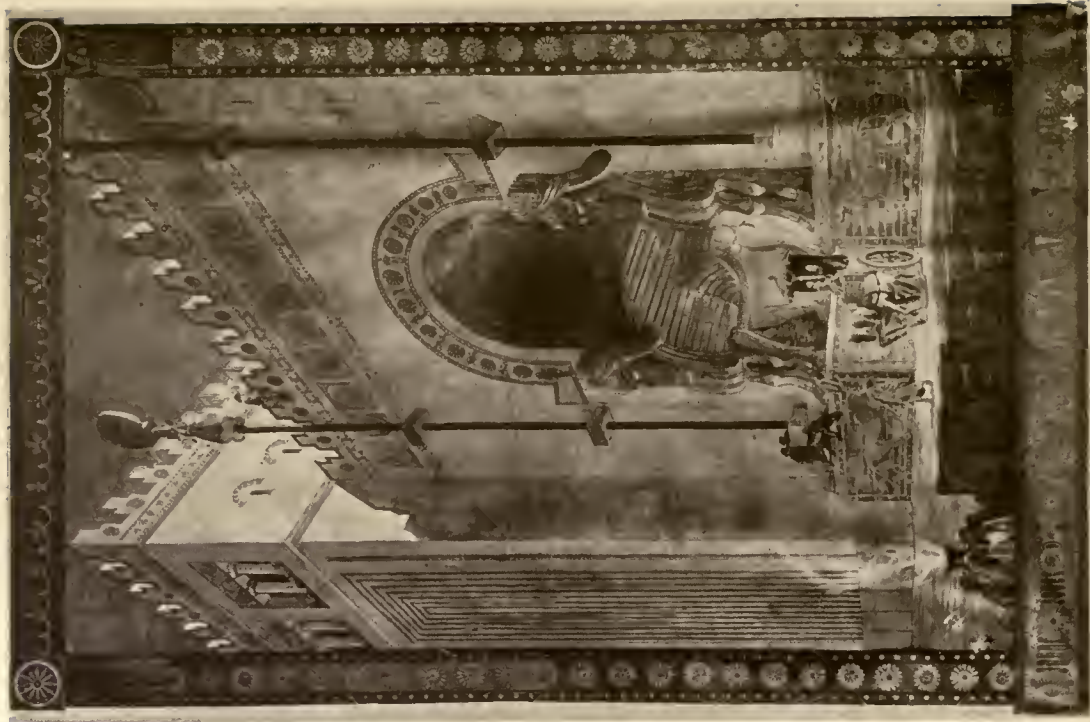

T. B. EPPS FIFTH MEDAL UNIVERSITY OF PENNSYLVANIA  
 CLASS "A" AND "B"—ARCHAEOLOGY—1 PROJET  
 THE ENTRANCE TO AN ASSYRIAN PALACE  
 STUDENT WORK—BEAUX-ARTS INSTITUTE OF DESIGN

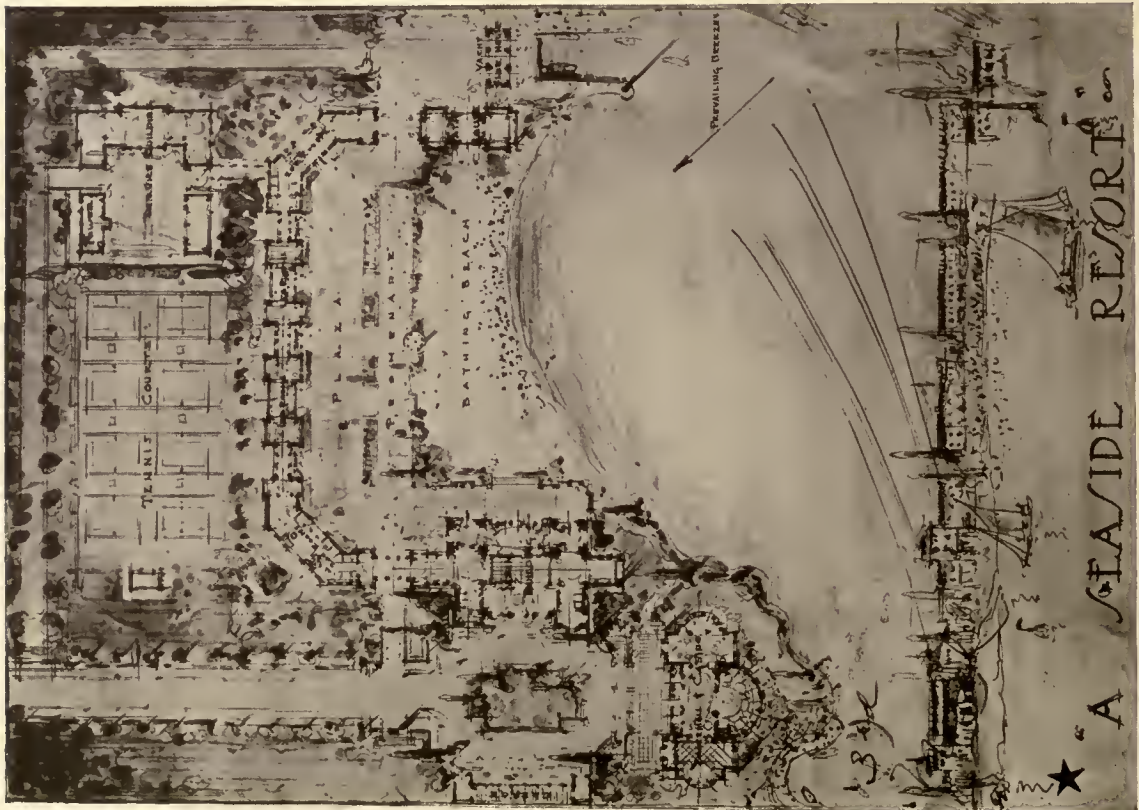

W. F. MCCAUGHEY THIRD MEDAL UNIVERSITY OF ILLINOIS  
 CLASS A "II" ESQUISSE-ESQUISSE, A SEASIDE RESORT  
 STUDENT WORK—BEAUX-ARTS INSTITUTE OF DESIGN

# THE AMERICAN ARCHITECT

Urbana; G. F. Street, University of Kansas, Lawrence; G. F. Poulsen, University of Minnesota, Minneapolis; G. S. Underwood, Yale University, School of Fine Arts, New Haven.

H. C.:—J. T. Briggs, Columbia University, New York.

## PROGRAM

### CLASS "B"—II ESQUISSE—ESQUISSE

The Committee on Architecture proposes as subject of this Competition:

#### "THE GARDEN FACADE OF A CITY HOUSE"

The garden facade of a city house, which is built between party walls, faces on an enclosed garden. The garden is 50'-0" deep and 35'-0" wide, which is the entire width of the plot. On the ground floor at approximately the level of the garden, and opening directly into it, is the living room, a room of ample proportions, occupying the full width of the house on the garden side. Above this room the facade sets back about 12'-0", forming a terrace at the second story level, which opens directly out of the bed room suite of the owner. There are three stories in all, including the ground floor. The subject of this problem is the garden facade of the house.

JURY OF AWARD: R. M. Hood, J. Wynkoop, L. Warren, H. Hornbostel, G. H. Bickley, D. J. Baum and A. Phillips.

This Jury also served as Jury of Award for Class "A"—II Esquisse-Esquisse, Class "A" and "B" Archaeology—I Projet and Class "A" and "B" Archaeology—I Measured Drawings.

Number of drawings submitted—25.

#### AWARDS:

FIRST MENTION:—H. W. Gill, Columbia University, New York; G. Chittenden and L. F. Fuller, Los Angeles A. C., Los Angeles; C. B. Lewis and W. Douglass, Yale



FIRST MENTION

C. B. LEWIS YALE UNIVERSITY  
THE GARDEN FACADE OF A CITY HOUSE

University, School of Fine Arts, New Haven.

MENTION:—R. W. Craton, Columbia University, New York; P. Goodman, Atelier Licht, New York; J. L. Feil, L. Rombotis and H. E. Hunter, Los Angeles A. C., Los Angeles; D. Murphy, A. C. Smith, L. Hamilton and H. S. Kelly, Yale University, School of Fine Arts, New Haven; W. S. Boice, Atelier Hirons, New York.



J. C. JANNEY

FIRST MEDAL  
A MEMORIAL BRIDGE

UNIVERSITY OF PENNSYLVANIA

THE AMERICAN ARCHITECT

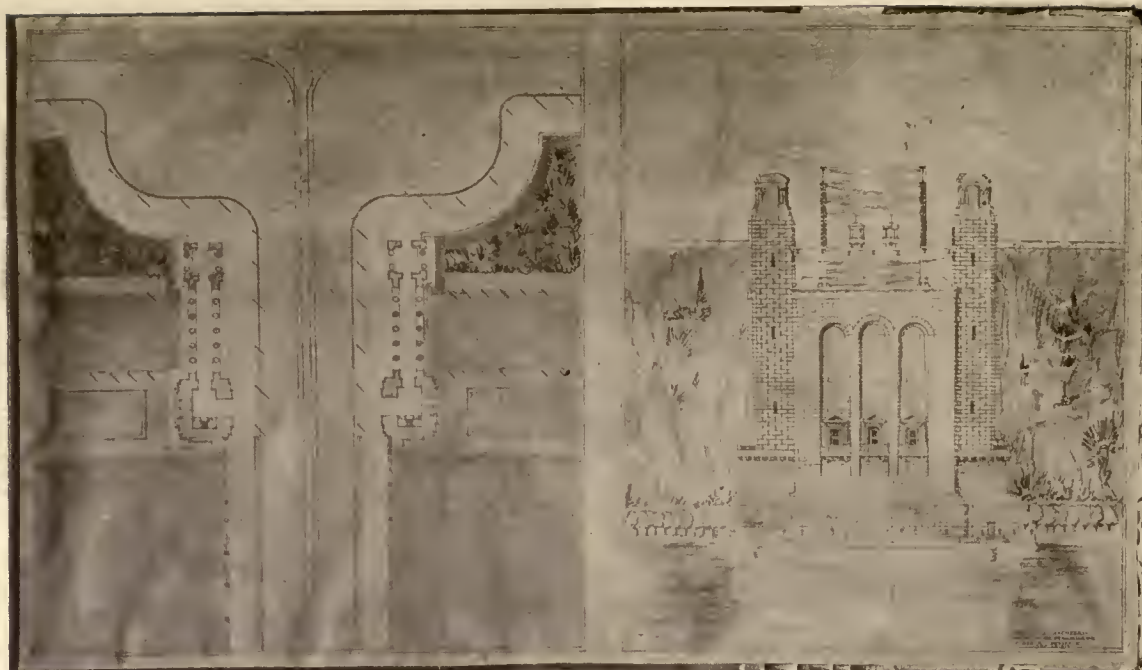

S. J. LASCHENSKI

FIRST MEDAL

UNIVERSITY OF PENNSYLVANIA

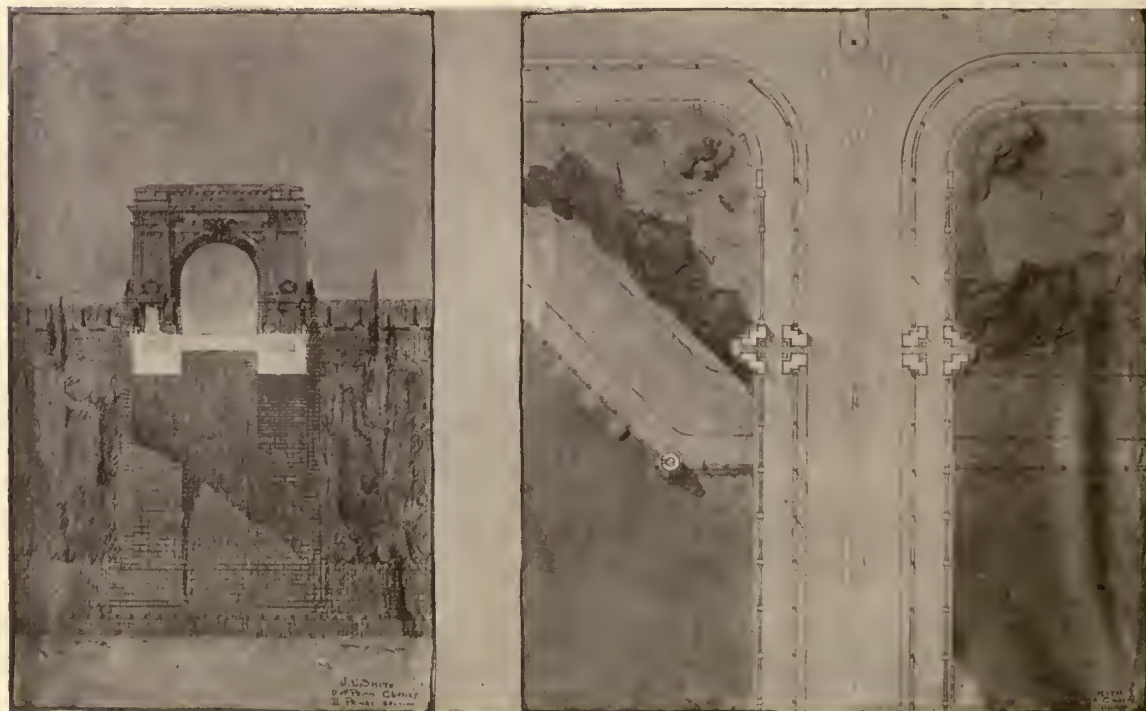

J. R. SMITH

FIRST MEDAL

UNIVERSITY OF PENNSYLVANIA

CLASS "A" II. PROJET—A MEMORIAL BRIDGE  
STUDENT WORK—BEAUX ARTS INSTITUTE OF DESIGN

# THE AMERICAN ARCHITECT

## PROGRAM

### CLASS "A"—II ESQUISSE—ESQUISSE

The Committee on Architecture proposes as subject of this Competition:

#### "A SEASIDE RESCORT"

It is proposed to erect on the shore of the Atlantic Ocean, about thirty miles distant from one of our large cities, a summer resort which will combine, within its confines, the requirements of a modern city hotel of the first class with the many attractions of the seashore. It will provide in the fullest measure for the needs and pleasures of guests assembled under its roofs by a community of summer interests. Here, if so minded, they will be able to enjoy the sports of boating and bathing, golf, tennis, etc., the pleasures of social intercourse and all the mental

A small yacht club house with pier, floats, gasoline and supply stations, and a small harbor for pleasure craft.

A garage for guests' and visitors' cars, with repair and supply departments.

A service building accommodating 250 servants three stories in height, with dormitories for male and female help, dining rooms, kitchens and living rooms.

A power plant for supplying light, heat and power to the resort.

Tennis courts with small locker house.

The golf course is without the scope of this plan.

The plan should indicate consideration of the sea view and sea breezes, and of the approach, which is by a private road connecting with the public highway.

The limit of the indicated plan shall not exceed 1,000 feet in its greatest dimension.



S. J. LASCHENSKI

FIRST MEDAL

UNIVERSITY OF PENNSYLVANIA

A MEMORIAL BRIDGE

and physical comforts of a well ordered household.

The subject of this program is the planning of this resort in such a manner as to obtain a satisfactory architectural expression and a correct correlation of its various structures and elements. In this plan the following requirements shall be indicated—

A building in as many stories as desired, containing public rooms, i. e., lounges, lobbies, dining rooms, kitchen, reading and writing rooms, library, service rooms, etc. Connected with the above building by covered galleries, three or four buildings, each three or four stories high, with a total capacity of 700 guest rooms, with baths, parlors, etc. The arrangement of the above buildings about an open plaza facing the sea shall be such as to provide a number of concessions for shops, tea rooms, etc.

A band stand, lounging and observation shelters, promenades and gardens.

A dance hall and casino.

A bathing beach and bath house with locker rooms, pool, turkish and shower baths.

Number of drawings submitted—15.

#### AWARDS:

THIRD MEDAL:—A. O. Ahlberg, Atelier Denver, Denver; T. E. Ash, "T" Square Club, Philadelphia; W. F. McCaughey, University of Illinois, Urbana.

MENTION—G. W. Trofast-Gillette, Columbia University, New York; J. S. Whitman, Cornell University, Ithaca; R. P. Vander Poel, Syracuse University, Syracuse; E. Pickering, University of Illinois, Urbana; C. H. Bruegger, Atelier St. Louis, St. Louis.

Judgment of January 6th, 1920.

#### PROGRAM

### CLASS "A" AND "B" ARCHAEOLOGY—I PROJÉT "THE ENTRANCE TO AN ASSYRIAN PALACE"

The subject of this problem is a secondary entrance to a royal palace. For defensive purposes, the gate, which was invariably arched, was small, and was flanked on either side by pylons rising above the adjoining walls: In

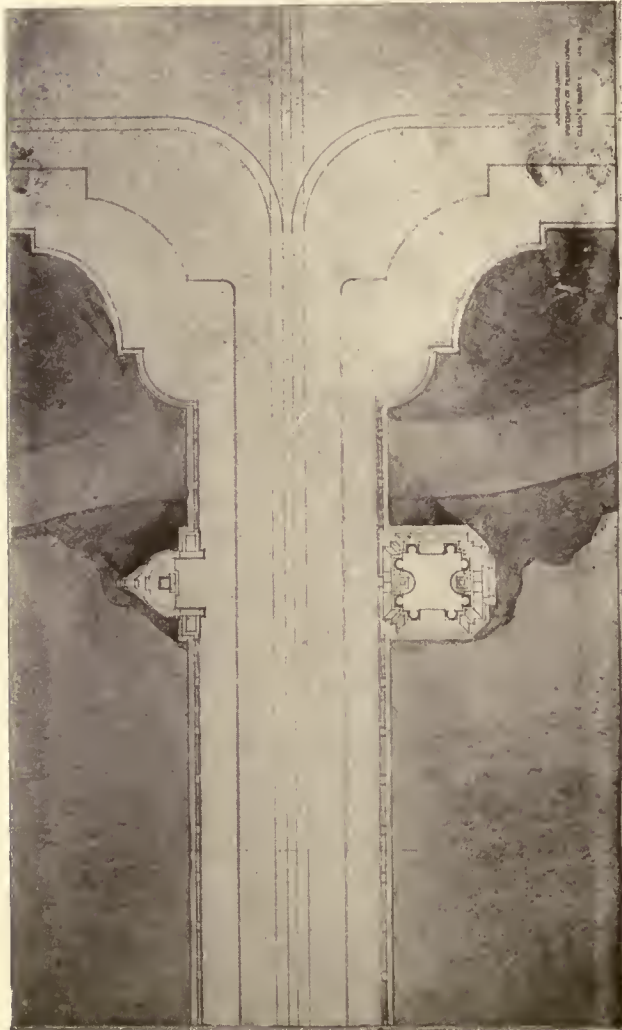
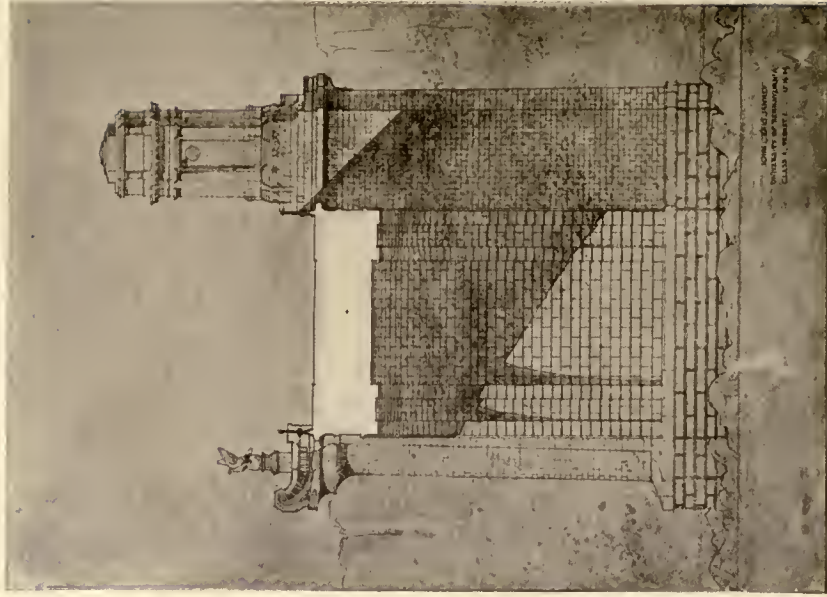

FIRST MEDAL.

UNIVERSITY OF PENNSYLVANIA.

CLASS "A" II. PROJET  
A MEMORIAL BRIDGE

STUDENT WORK—BEAUX ARTS INSTITUTE OF DESIGN

J. C. YOUNG

## THE AMERICAN ARCHITECT

this case the entire motive, including the pylons, shall not exceed 60'-0" in width.

The method of construction of the Assyrians, of huge masses of sun-baked brick, faced with alabaster, burned brick and enameled tile, precluded projecting ornamental motives, columns, etc. Flat, repetitious decorations were more characteristic of the materials and style. The chief decorative elements were low relief sculptures, colossal winged monsters with human heads being particularly notable.

Number of drawings submitted—4.

### AWARDS:

THIRD MEDAL:—T. B. Epps and P. Domville, University of Pennsylvania, Philadelphia.

MENTION:—R. A. Willson, Carnegie Institute of Technology, Pittsburgh.

Class "A" and "B" Archaeology—I Measured drawings. Number of drawings submitted—1.

SUBJECT:—Colonial Doorway, Salem, Massachusetts.

### AWARD:

THIRD MEDAL:—E. A. Lehti, "Atelier Hirons, New York.

---

# Electric Distributing Station, Boston, Mass.

BIGELOW & WADSWORTH, *Architects.*

THE building is five stories high with cable vault and boiler room in basement.

Rotary converters are installed in first story with transformers on galleries above the converters. The clear height of first story is 46 feet. Near the ceiling is installed a travelling crane with a span of about 35 feet between rails, having a lifting capacity of 50 tons for hoisting parts of machines. There are no interior columns in first story, the columns of stories above being carried on steel girders 3 feet 4 inches deep at ceiling of first story spanning the entire width of building, a distance of about 40 feet, and resting on columns in walls. Portions of first floor are framed to carry a live load of 750 pounds per square foot.

The second story is used as an operating room and contains the switchboards.

In the third story are the buss compartments.

The fourth and fifth stories contain the storage batteries. These floors are framed to carry a live load of 500 pounds per square foot and besides being fire-proof, are acid and water-proof.

The building is strictly fire-proof and is built independent of the adjoining buildings to prevent transmission of vibrations, spaces being left between walls of the Company's building and those of ad-

joining buildings. The building has no windows. Air is supplied and discharged through large shafts. At rear of building is located the intake shaft, running down from roof to ceiling of basement. The air is brought in through this shaft and discharged at basement ceiling, is then carried up through openings in first floor under rotary converters, cooling converters, into first story. The outlet shaft is located at ceiling of first story, having openings with registers into shaft on second and third stories and running through roof. The battery stories have independent shafts starting at ceilings and running up through roof for ventilation. At top of shafts above roof are pent houses with movable louvers for controlling the passage of air. Near the intake shaft at first story is located an air washer and heater, with a duct from intake shaft to washer for conveying air. After being washed and heated the air is carried through galvanized pipes to the stories above the first.

An electric push button elevator is installed for freight and passengers.

The building is equipped with a stand pipe with two steamer connections at sidewalk and fire-fighting apparatus on roof. Every precaution was taken in the construction of the building to make it as near conflagration proof as possible.

# Current News

## Happenings and Comments in the Fields of Architecture and the Allied Arts

### Rotch Traveling Scholarship

The drawings submitted in competition this year were judged by a jury consisting of Mr. Charles Zeller Klauder of Philadelphia, Mr. Benno Janssen of Pittsburgh and Mr. William Emerson of Boston. Acting upon the recommendations of this jury, the Rotch Traveling Scholarship for this year has been awarded to Mr. Robert M. Blackall and the prize of \$75.00 offered by the Boston Society of Architects has been awarded to Mr. Victor L. S. Hafner.

Mr. Blackall, the successful winner this year, will be the thirty-fifth holder of the scholarship. He was born in Cambridge in 1889, graduated from Harvard University, Class of 1912, with degree of A B; was for a few years in engineering service on the Chicago & Northwestern Railway; spent one summer in travel abroad, entered the Institute of Technology in 1916, taking the regular architectural course and supplementing it with fifth year work, during which time he won the traveling fellowship in architecture. In Harvard he was a member of the Varsity football team and the hockey team. His practical experience has been gained in the offices of McKim, Mead & White of New York, E. F. Stevens and Blackall, Clapp & Whittemore, Architects. He is the son of the first holder of the scholarship, which was awarded in 1884. He comes to the scholarship peculiarly well trained in every respect, with a thorough college education, two college degrees and several years of real, practical experience.

### Lewis F. Pilcher, New York State Architect, Receives Medal of Merit

An unusual recognition of the profession of architecture by the laity has come to the Hon. Lewis F. Pilcher of New York in the award of a Medal of Merit by the National Committee on Prisons and Prison Labor. It has heretofore been necessary for architects to organize architectural societies in order to give medals for architectural work, so that the tribute from an unrelated humanitarian group is in the nature of a precedent.

Readers of *THE AMERICAN ARCHITECT* will recall the recent and very complete illustration of Mr. Pilcher's work for the prisons of New York. It is to commemorate distinguished and signal services in the field of Prison Reform that the Gold Medal of Merit has been established. Chester Beach, the sculptor, produced the design. It is a dignified token in reward for service.

In announcing the awards, Mr. Adolph Lewisohn, chairman of the committee, said in effect that the cumulative results of medical science, ameliorative legislation, industry and architecture have brought into practical execution the most notable advance in the history of prison affairs—the development of the Classification or Psychiatric Institution at Sing Sing. Representing the first three groups, and who are also recipients of medals, are Dr. Walter B. James, known to readers of this paper as expert in mental diseases and criminology; Hon. Henry Manning Sage, State Senator, through whose enterprise the necessary ap-

propriations for prison construction and maintenance were assured, together with the enactment of helpful laws; and Mr. Hugh Frayne, of the American Federation of Labor, who has been actively engaged in securing vocational training for prison inmates, and at standard current rates instead of the contract system heretofore the rule.

The presentation was made at Columbia University on May 13th on the occasion of the annual meeting of the National Committee on Prisons and Prison Labor. Mr. Adolph Lewisohn presided. The addresses of acknowledgment were marked by the earnestness and dignity that characterizes the work of ardent and serious men of affairs. Mr. Pilcher, on receiving the medal, spoke with conspicuous modesty of his own part in the final success. He further referred to the evolution in the conception of punishment. He compared the ideals of the modern prison with those of former times. The aim today, he stated, is to prevent crime, and in cases where it has occurred to find the reason and remove the cause so that it may not be repeated. He deprecated the aggravation of these causes by cruelty and injustice during the period of incarceration. He made a plea for intelligent wardens and officers of administration, and expressed the hope that punishment, which was only legalized revenge, would eventually give way to a helpful and constructive attitude on the part of society that would result in the irreducible minimum of crime the country over.

### Housing Notes From Various Cities

In a report prepared for the Bureau of Labor Statistics by W. F. Ogburn, "Study of Rents in Various Cities," St. Louis was shown to have the largest proportion of overcrowded families, 80.1 per cent. of all the families having less than one room per person. The War Civic Housing Committee of East St. Louis evidently appreciated those conditions and is working to improve them. Their report, "Housing for East St. Louis," is a preliminary plan for a housing project. It is proposed: (1) To form a syndicate composed of the industries \* \* \* and the citizens. (2) To create a capital fund of \$250,000 by subscription from members of the syndicate. The plan will secure full protection to the investor with a return of 6 per cent. (3) To develop suitable vacant property. (4) To erect attractive and substantial houses of modern type in sufficient quantity at one operation quickly. (5) To offer and sell these houses at a price equal to actual cost, with an initial cash payment of 10 per cent. and monthly installments of 1 per cent."

Wisconsin has a new law, Chapter 402, Laws of 1919, which permits municipalities to engage in housing or for interested individuals to organize themselves to form co-operative housing companies. This "co-operative housing law is probably the first specific housing law passed by any State in the Union."

According to *Community Service*, March, 1920, the following housing corporations have been formed:

Akron, Ohio, \$5,000,000; St. Louis, Mo., \$2,000,000; Louisville, Ky., \$2,000,000; Chicago, Ill., \$3,000,000; Ke-



nosha, Wis., \$200,000; Laporte, Ind., \$100,000; Lockport, N. Y., \$500,000; Rochester, N. Y., \$2,500,000; Wilkes-Barre, Pa., \$5,000,000; Cincinnati, Ohio, \$3,500,000.

Massachusetts has not yet been able to make up for its shortage of homes and keep rents from skyrocketing. A State Commission on the Necessaries of Life is struggling with the problem and has urged the cities to form housing corporations and take over and improve tenements abandoned by workmen who have moved to better ones. The commission found that there were 3000 tenements which were unoccupied because the landlords would not remodel them so as to make them fit for occupancy.

At the suggestion of the commission a bill has been introduced into the Legislature that would limit the return from investments in dwelling houses to 8 per cent. The purpose of it is to prevent speculation in homes.

Massachusetts corporations have attempted to relieve the shortage by erecting community houses. Whole villages of attractive houses are being put up in New Bedford, Lawrence, Lowell and other mill cities, and will be rented or sold to employes on easy terms.

## Hospital and Institutional Planning

Architects will be interested to learn that the Hospital and Institutional Bureau of Consultation in New York City, of which Henry C. Wright is director, has made available information regarding all phases of hospital and institutional plans, equipment, organization and operation. The Bureau has offices at 289 Fourth avenue, New York, where copies of the prospectus and other details may be obtained.

## Steady Development Needed in Orient

The present depreciation of the American dollar in China and India is opening up great markets for American export, according to a statement by the National Foreign Trade Council. Furthermore, the native buying power has more than doubled in the last four years.

In China alone it is estimated that one hundred and fifty American firms have established offices since the war. The older established firms, both European and American, are not worrying over the possibility of increased competition. There is plenty of room for all that may wish to come; but the general belief is that the newcomers have not the necessary patience to deal with the Chinese and to wait two or three years for definite results.

In a recent interview, says the National Foreign Trade Council, Mr. Heu En-Yuan, the Chinese President of the new Sino-American Bank, declared: "Both in the Chinese Government and outside it is felt that small dependence can be placed on American business or financial policy. About once in every five years American men of business become interested in China, but this interest does not last long. Something always happens to frighten the bankers away. First it is a change in political affairs at home; then international politics are to blame; then again the business men and financial representatives sent to China become impatient at the delays and intrigues always present in Chinese affairs, grow tired of the interminable negotiations, and go home."

China, with its awakening population of over 400,000,000, is a field that the American manufacturer cannot afford to neglect. The future possibilities of its markets are so tremendous that they readily merit the study to be given them at the Seventh National Foreign Trade Convention

to be held in San Francisco, May 12-15 next. Both Chinese and American experts on Oriental trade will be on hand to supply information and advice.

## Minneapolis Architects to Have New Building

A four-story office building, of unusual style and purpose, to be used exclusively by a group of Minneapolis architects, engineers and decorators, is to be built at Second avenue south and Twelfth street. The structure is to cost \$150,000 and will be ready for occupancy next August.

The building will have a frontage of 110 feet on Twelfth street south and 69 feet on Second avenue.

The style to be followed in the construction is known as Lombard or early Italian. The exterior will be built of Bedford stone. Plans for the structure were designed by Hewitt & Brown.

One of the features of the new building is to be a professional research library, now being assembled. Here all information will be ready for use relating to architecture, landscape planning, engineering, building materials and equipment.

The fourth floor of the building is to be divided into large draughting rooms, to be flooded with north light. There will also be rooms for contractors and estimators and a blue-print room — to be shared in common. An art gallery and exhibition room will occupy the first floor.

## Production in Railroad Transportation

Railroad ton miles are an accurate index of the nation's productive activity. Freight ton miles first passed 100 billions a year in 1898; they crossed the 200 billion mark in 1906; the 300 billion mark in 1913. In 1918 they reached 400 billion. If our industry continues its expansion the railroad traffic will continue its amazing growth, for it is the capacity of the railroads to haul raw materials and finished products that determines the final productive capacity of all industry.

The railroad traffic since 1900 has increased more than three times as fast as the trackage, more than twice as fast as the equipment and more than twice as fast as the number of workers. And while it is true that these economies have been for various reasons, mostly incident to the war, carried beyond the point of efficiency, it has also been possible through the adoption of better and more powerful machinery to inaugurate really valuable economies. For example, the average freight trainload in 1900 was 270 tons and in 1918 it was 625 tons. It is because of the increase in the trainload, with all sorts of collateral economies in the handling of traffic that since 1900 the railroads have been able to increase the annual output per employe from less than 200,000 traffic units to nearly 300,000 traffic units.

This story of growth with a reduction of human effort is the story of all industry in America. It is a record of which we are all proud.

## The Biggest Bascule Bridge

One of the world's engineering marvels, a single-leaf bascule bridge measuring 260 feet from its base to its end and weighing 3500 tons, was put into operation in Chicago last December. It spans the Chicago River at Sixteenth

street and is used by a number of railroads having terminals in that vicinity.

While the new bridge is counterbalanced and operated in much the same manner as other bridges of this type, states a description in the *Independent*, it is unique in that it has two counterweights instead of the single block ordinarily employed. These counterweights, which are composed of concrete, are five feet six inches thick, sixty feet high and thirty-seven feet wide, and weigh approximately 885 tons each. In the face of each counterweight are a number of apertures which are for the purpose of adding adjustment blocks to obtain the exact weight required. As the bridge opens the counterweights move entirely outside the range of the railroad clearance, and when it is fully opened their lowest points are eight feet below the base of the rail.

Notwithstanding its tremendous weight the bridge can be opened or closed in one and a half minutes, being operated in the usual manner characteristic of this type. In addition to the usual oak bumping blocks ordinarily used, however, it is also equipped with an air buffer which comes into play when the bridge reaches a nearly open position and gradually arrests any further movement of the bridge after the power has been cut off and the motor brakes applied.

The bridge is also unique and remarkable in one other respect: it is so built that later, when the work of straightening the channel of the Chicago River at Sixteenth street is begun, it can be moved intact to another location 400 feet to the west, where it will span the new channel. It will be moved on a circular track with rollers, and to fit in the new location will have to be turned around completely.

## Sanitary Survey in Eastern Europe Proposed by Red Cross

At the first annual conference of the General Council of the League of Red Cross Societies, held at Geneva, Switzerland, March 2 to 10, 1920, Professor George C. Whipple, chief of the Department of Sanitation, a branch of the General Medical Department, and his associate, Colonel F. F. Longley, presented an outline of proposed activities. These, it is learned, include sanitary surveys in Eastern Europe to be undertaken with three principal objects: (1) To ascertain the facts as far as they are available; (2) to demonstrate the value of sanitation to the community; (3) to serve as the basis of public health measures and appropriations. It is expected that the surveys will be conducted jointly by sanitary engineers and physicians.

The sanitary surveys will be conducted in seven parts, as follows: (1) The Locality; (2) Climate; (3) People; (4) Vital Statistics; (5) Sanitation; (6) Health Administration; (7) Special Survey Information. Under sanitation there are the following twelve main subdivisions: (a) Water Supply; (b) Drainage and Sewerage; (c) Disposal of Human Excreta; (d) Use and Disposal of Animal Manure; (e) Refuse Disposal; (f) Disposal of the Dead; (g) Sanitation of Buildings; (h) Sanitation of the Air; (i) Control of Animals and Insects; (j) Food Sanitation; (k) Sanitation of Transportation Facilities; (l) Miscellaneous Sanitary Matters.

## Paris to Construct Homes for Workers

The municipality of Paris has taken in hand the housing problem there and proposes to spend 1,700,000,000 francs (nominally about \$340,000,000) to solve it. It contem-

plates building 1476 new two-room workingmen's apartments at once, with 950 more to be erected later. They will be built in the heart of Paris and near the fortifications. It was stated that probably many half-finished houses being built for wealthy persons will be requisitioned by the municipality and turned over to workmen's families.

The shortage of housing facilities in Paris has raised a cry from many quarters, and to meet the situation many miniature "skyscrapers" have been built in Montmartre, much to the disgust of the artists who live there. They have formed a parliament to discuss the question and have organized parties which take their names after the art school to which they belong. Thus there are the "Cubistes," the "Montmartrois," the "Sauvagistes," the "Dadaistes" and the "Gassieristes."

Some of the extremists are so enraged over the encroachment of the "skyscraper" builders into their district that they are urging all artists in the Montmartre to move to Marseilles.

## Municipal Stadiums

The Bureau of Municipal Research of Toronto, to promote greater definiteness in the discussion of a projected stadium for that city, has brought together information on some of the principal modern stadium and other athletic structures in the United States. Twelve universities and colleges, one high school (Tacoma) and one city (San Diego) only so far have felt the need to provide for such a structure. Nearly all of them were built in the last ten years. The permanent seating capacity ranges from six to forty-seven thousand, the cost from \$32,000 to \$1,000,000 (from \$3.55 to \$28.60 per seat). In most of the large cities, the question has never been discussed. Chicago and Minneapolis have the building of stadiums under consideration. The former was very fully illustrated in three recent issues of *THE AMERICAN ARCHITECT*.

The San Diego stadium, built by the city in 1914-15 at a cost of \$165,000, seems to be in almost constant use, with 824 practice events and 72 match events in one year, and owing to "climatic conditions such as to permit the use of the stadium 350 to 360 days in the year."

## News from Various Sources

Publications of the United States Public Health Service.—An invaluable list of the printed matter distributed by the United States Public Health Service, with information about how to secure the various periodical and special publications. Dated April, 1919. 94 pp. Miscellaneous Publication No. 12. (Apply to the Government Printing Office, Washington, D. C.)

\* \* \*

Town Planning in Bombay.—A quarto pamphlet of 64 pages, with diagrams, setting forth the results of the Bombay Town Planning Act of 1915, this being a paper read at a meeting of the Town Planning Institute, in London, on December 5, 1919, with the discussion thereon. Published by authority of the Town Planning Institute, 4, Arundel street, London, W. C., England.

\* \* \*

Police Departments in Kansas Cities.—A report on police departments in seventeen Kansas cities of the first and second class and in twenty-five out-of-State cities. A summary of the answers received to a questionnaire on the subject of police departments. Apply to Municipal Reference Bureau of the University Extension Division of the University of Kansas, Lawrence, Kan., March 1, 1920.

## THE AMERICAN ARCHITECT

Among curious inventions sanctioned by the United States Patent Office is a tornado-proof house, the invention of a New England man. It is built on a pivot so that every breeze turns it with its head to the wind.

\* \* \*

"Save the Youngest."—Seven charts on maternal and infant mortality, with explanatory comment. Published by the Children's Bureau, United States Department of Labor. Children's Year Follow-up Series No. 2; Bureau Publication No. 61.

\* \* \*

Surface Water-Supply of the United States.—Part XI of a series of fourteen reports presenting results of measurements of flow made on streams in the United States during the year ending September 30, 1916. Entitled, "Pacific Slope Basins in California." Data collected by the United States Geological Survey.

\* \* \*

Rural Community Buildings in the United States.—Bulletin No. 825 of the United States Department of Agriculture, contains 36 pages, with illustrations. Community buildings, their general character, maintenance, operation and management, and the uses to which they are put, are presented in detail, and specific examples are described and illustrated. (Apply to the United States Department of Agriculture, Washington, D. C.)

\* \* \*

Official Directory of the City of New York.—Third edition (1920) of this handy little pocket reference book, compiled by William Viertel, editor of the *City Record*, under the direction of Peter J. Brady, supervisor of the *City Record*. 164 pp. It contains a brief history of New

York City, information as to the personnel of the city, county, State and Federal offices, and the city institutions and their functions. Furnished both in paper and in leather covers. (Apply to the Supervisor of the *City Record*.)

---

### Personals

C. P. H. Gilbert, architect, who for a number of years has maintained offices in the Townsend Building, 1123 Broadway, announces that after May 1 his offices will be located in the Metropolitan Tower, 1 Madison avenue, New York.

Charles W. Deusner and Helen Dupuy Deusner announce that they have resumed the practice of landscape architecture in Southern California, under the firm name of C. W. and H. D. Deusner, with an office at 15 North Euclid avenue, Pasadena, Cal.

Frank S. Parker, architect and engineer, for some time past identified with large structural interests in Manhattan and Brooklyn, announces that he has established offices for the independent practice of his profession in the Temple Bar Building, 44 Court street, Brooklyn, N. Y.

J. Devereux York, John Cary Regan and E. J. Burke have formed a partnership to be known by the firm name of York, Regan & Burke, located at 1323 North Clark street, Chicago, Ill., as architects and engineers, embracing concrete engineering, theatre construction, buildings, bridges, concrete steel structures, industrial plants, churches and civic improvements.

---

## Weekly Review of Construction Field

Comment on General Conditions of Economics With Reports of Special Correspondents in Prominent Regional Centers

---

The affairs of the railroads are not by any means straightened out. It is stated that in the yards of one road there is an accumulation of 14,000 cars. An official of the Pennsylvania Railroad is quoted in the New York dailies as saying that little progress is being made in relieving the congestion of the New York district. The car service committee of the American Railroad Association finds the reports to show a slight improvement in the situation generally throughout the country, but with conditions very bad in some localities.

The manufacturers are suffering severely, and in answer to their complaints, the car service committee is endeavoring to allocate cars to the industries and localities most greatly in need of them.

The brotherhoods have issued a statement which, in part, says: "The country is face to face with the menace of a breakdown in transportation service. Already the efficiency and safety of the service has been seriously impaired by the action of thousands of employes who voluntarily have quit to find higher wages elsewhere. The car shortage now threatening to stop the wheels of all industry in the country is one of the first effects traceable to the failure to provide the railway workers with a living wage.

Moreover, railroad travel is becoming hazardous by reason of the reduction to almost one-third in number of track walkers, whose duty it is to guard the roads against causes of wrecks and other accidents.

"We have presented our case for a living wage for the workers. Expert opinion, predicated on incontrovertible facts, indicates the lowest figure at which a family of five can be maintained in health and reasonable comfort is \$2,500 a year. On the basis of what is accepted as the most accurate estimate of a bare subsistence level of earnings, which is \$1,700 a year, 88 per cent of the railway workers are attempting to maintain their families below a bare subsistence level. The average yearly wage paid to the entire number of railroad workers in the United States today is \$1,280.30.

"Under the conditions, it should not be surprising that officials of the various organization of railway employes should find it difficult to maintain 100 per cent discipline within their ranks. Neither should it be strange that men are leaving the railroad service and that other men cast respect for wage agreements to the winds in an effort to keep their families above a level of pauperism. Unrest in the ranks is increasing at an alarming rate.

## THE AMERICAN ARCHITECT

In the face of this situation building material is being delivered, though not in such quantity as it is needed.

Such optimism as one may find at the present time is founded on the steady advancement toward better days. It is becoming accepted as a fact that the interests of capital and labor are in common and that the controversies over wages will be settled with that fact in mind. The work of enlightenment goes on. The New York *Tribune* suggests a body of lecturers to address chambers of commerce and labor unions, preaching to both identically the same doctrine.

An organization of a building loan association is contemplated in New York with a capitalization of \$30,000,000, which shall construct the modest type of house needed by the small salaried class. The purchaser would be required to pay 6 per cent of the purchase price—which would probably be \$2,500—in monthly installments; he would also be compelled to purchase stock, paid for on the installment plan. The total monthly payments would amount to about \$25 and at the end of twelve years he would own the house.

The scheme carries many of the commendable features of "the Detroit Plan," which seem to offer a solution, not only for the housing of our population, but for many of the social problems of the day.

Builders, architects, real estate men, labor union officials, dealers in building materials and city officials of New York have formed an organization with Frank Mann, Commissioner of the Tenement House Department, as chairman. The organization has been divided into groups of bankers, architects, builders, etc., each of which is to form plans and report to the organization as a whole.

(By Special Correspondence to THE AMERICAN ARCHITECT)

CHICAGO—Estimates made in connection with the rail and other strikes are that 1,000,000 people are idle and a billion dollars' worth of raw materials and merchandise are carried by the banks as a result. Of this amount Chicago has its share, as this city has been looked upon as the center of the labor troubles of recent years. As a result, the building industry here continues to suffer. Steel plants of this district got down to nearly 50 per cent of their capacity, but have recovered of late. Rail traffic, however, is probably not more than 60 per cent normal at this time, and it will take weeks before the railroads will be back to their standard—prior to the switchmen's strike.

The demands of the striking carpenters in the sash and door mills of Chicago have been granted, and the men are returning to work at a wage increase of 25 cents, i.e., from 85 cents to \$1.10 an hour, to take effect at once instead of June 1, as originally promised by the Chicago Lumbermen's Association.

Labor has won another round in the everlasting conflict between employer and workman in the building industry, and construction costs will no doubt go up another notch to meet the increase in wages. In general, however, building operations in Chicago are nearly at a standstill because of the difficulty in getting materials.

According to Mr. E. M. Craig, secretary of the Building Construction Employers' Association, nation-wide reductions in building activities have been decided upon by the employers, who met recently in conference at Washington. Mr. Craig in commenting on the scarcity of material here said the general situation was the same everywhere.

Various causes have been given to account for the slump in building: tight credit, high interest rates—which remain at 7 per cent for collateral loans and from 7¼ to 7½ for commercial paper, labor shortage, scarcity of ma-

terial, reduced individual output and high wage scale. According to an article published recently in one of Chicago's biggest journals most of the troubles of the construction industry can be attributed to the tremendous growth of the automobile industry.

The publication points out that 700,000 people formerly engaged in other lines, notably the building industry, are now employed in the manufacture of automobiles and automobile accessories. It is claimed the automobile industry is absorbing a vast quantity of material which normally would go into the construction of buildings, such as hardwood, glass, steel, etc. A recent inquiry for 150,000 feet of hardwood lumber for the manufacture of automobiles indicates, it is claimed, why flooring is costing \$260 a thousand instead of \$40 a thousand. This condition, as the result of the expansion of the automobile industry, may continue for some years, it is predicted.

(By Special Correspondence to THE AMERICAN ARCHITECT)

SAN FRANCISCO—There are no changes in quotations of supplies this week. Building is still being held up by poor deliveries of material. The jobbers in steel and iron materials say that the few cars of materials which they are receiving go out at once on long standing orders and the stocks on hand are showing no improvement whatever.

The financial stress in Japan is apt to have its reflex action on Pacific Coast building conditions. The Japanese have been taking large quantities of finished reinforcing bars and also of scarp from which these bars are locally manufactured. As they have ceased to buy, at least for the present, the market for bars is much easier. One local mill quotes bars at \$4.25, but this is entirely for future deliveries, and the spot quotation for bars remains \$4.50 to \$4.75.

A number of new theatres are announced for San Francisco, and work on one of the largest of these will start in a short time. The latest announced is the new Castro Theater on Castro Street between Seventeenth and Eighteenth, to have 2,000 seating capacity. Architect J. R. Miller is preparing the plans.

A contract for the structural steel to be used in the erection of the Federal Reserve Bank building has been let to the American Bridge Co. The contract was awarded on a tonnage basis for approximately \$200,000.

The trustees of the Chico High School district have awarded a contract for a new high school building to James L. McLaughlin for \$360,000. The plans of the building were prepared by Architects Woollett and Lamb.

Architect Norman R. Coulter is preparing plans for a two-story reinforced concrete building to be erected by the Salvation Army at Lytton, Sonoma County. It will be known as the "Main Building" and will contain the executive offices, dining room, kitchen, rest, reading and playrooms and girls' dormitory. Its estimated cost is \$100,000.

(By Special Correspondence to THE AMERICAN ARCHITECT)

BIRMINGHAM—From some quarters in the lumber trade we hear of lower quotations where there has been accumulation of stock due to the freight congestion at some of the larger manufacturing points and the consequent cancellation of orders because of inability to obtain cars for shipment. Retail prices at local yards, however, have not responded to this influence, indicating that the retail trade regard the situation as temporary.

In other building material lines there is no inclination to reduce prices; on the other hand, higher costs are predicted.

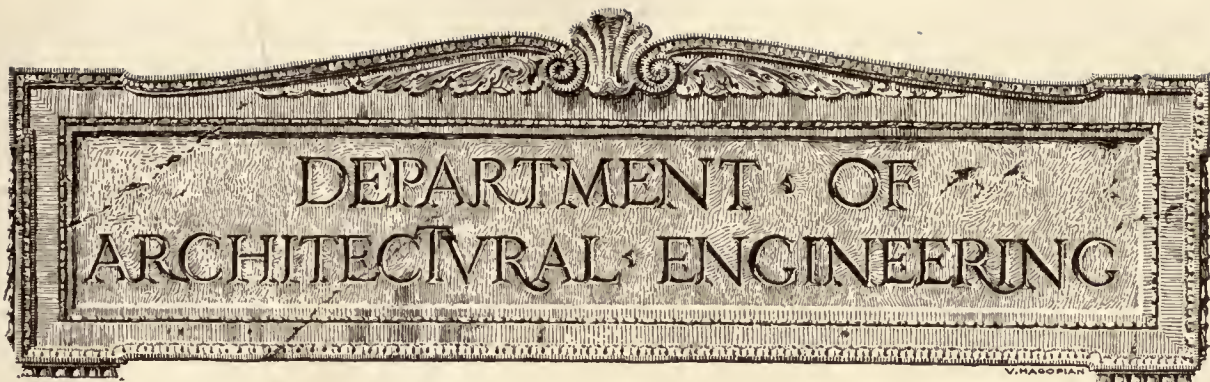

# The New Building Zone Ordinance of Portland, Oregon

By CHARLES H. CHENEY, *Consultant, City Planning Commission*

A COMPREHENSIVE Building Zone Ordinance has been adopted by the City of Portland, Oregon, (population estimated at 320,000), which it is believed will do much to foster industry, stimulate home ownership and contented home conditions for industrial workers, as well as make the city a more comfortable, orderly and convenient place for all who live and work here. This ordinance was the result of some 18 months of careful study and more than 150 meetings and conferences by the City Planning Commission and neighborhoods and property owners affected in all parts of Portland.

Complete Use of Property Maps and other data were prepared, showing the existing conditions and tendencies of growth of the city. These were carefully discussed by representative property owners committees in each neighborhood who, with the aid of the City Plan Commission, evolved a preliminary zoning plan which was ratified at a neighborhood meeting to which all property owners of the district were invited. These neighborhood plans were later pieced together to make up the general preliminary zoning plan for the city. After public hearings during a number of months, before both the City Planning Commission and the City Council, the ordinance was finally adopted in its present form on March 17th, 1920. It will be subject to a vote of the people at the General Election next November.

In its final report to the City Council, the City Planning Commission said that it was to be expected that this ordinance would benefit the city as follows:

Stabilize and protect property values and investments;

Protect the maintenance of the home and of home neighborhoods;

Offer a safe district in which industries may be located without fear of protest and with every facility to do business;

Prevent undue congestion of population;

Insure better sanitary conditions;

Simplify the problem of street traffic regulations;

Make possible a sensible and more practical street paving program for the future;

Render possible great economies in the paving of city streets through a decrease in the width of roadways, where sizes and number of buildings are limited.

Insure the permanence of character of districts when once established, permitting and encouraging orderly enlargement of business centers and industrial zones while preventing the scattering and intrusion of any inappropriate and destructive uses of buildings which deteriorate and decrease property values; and, finally,

Make Portland a more orderly, convenient and attractive place in which to live and work.

The new Portland Zone Ordinance combines the principle protective features of the Alameda, Los Angeles, St. Louis and New York Zone Ordinances. It applies to new building permits only, existing buildings and uses not being affected, even tho they fall outside the respective zones proper for them.

## THE USE OF PROPERTY REGULATIONS

IT was found necessary to establish eight kinds of classes of Use Districts. These comprise two kinds of residence classes; two kinds of business classes; two kinds of industrial districts; and two special classes of the districts.

At present it was decided that there should be no

## THE AMERICAN ARCHITECT

Class VIII (heavy industrial) districts within the city limits, a large industrial area for stock yards and similar industries already being well established outside the city limits to the north where prevailing winds will carry away offensive odors and smoke. There are therefore really only seven classes of Use Districts established at this time, which may be more particularly described as follows:

Class I Residence Districts will permit new single family dwellings, churches or schools only. Approximately 86% of all buildings in Portland today are single family dwellings, and the City Council has now set aside about two-thirds in area of the whole city for Class I districts, to protect homes, at the request of property owners.

Class II Residence Districts, permitting any kind of new dwellings, flats, hotels, or apartments, were established around the central core of the city and in numerous small districts through the outlying sections. Buildings of this type actually cover today an aggregate of about 250 blocks (200 feet square) throughout the city. The Zone ordinance established 1250 blocks in Class II, beside permitting this type of buildings in over 800 more blocks of business districts of Class III and Class V. It is estimated that this allows apartment house space enough to take care of Portland's needs in this type of buildings, until the population exceeds a million and a half.

Class III Business Districts, for all ordinary stores, trades and professions, including any kind of dwellings of Classes I and II, were established to cover the downtown retail center and a number of retail centers which desired to keep out the public garage and other businesses which interfere with the best retail store development.

Class IV Districts, for public and semi-public buildings, schools, churches, playgrounds, parks, airplane landing fields, libraries, fire houses, green houses, etc., were established to cover every existing property of such use in the city.

Class V Business Districts, permitting any kind of new retail or wholesale business, warehouses, public garages, dyeing and cleaning establishments, undertaking parlors, etc., were established surrounding the downtown retail center, and at practically all existing local business centers at cross roads, about every half mile conveniently located, practically all main traffic arteries.

Class VI Districts, for hospitals, sanitariums, clinics, day nurseries, homes for the aged or children, and other charitable institutions, were established to cover existing institutions of this type that the surrounding neighborhoods would agree should be permanently located there. In a few cases where good home neighborhoods had been invaded by such institutions, the property owners vigor-

ously protested against making them permanent, and these will either have to seek a new location or convince their neighborhoods before they can be enlarged.

Class VII Industrial Districts for all ordinary, not obnoxious, industries, warehouses and factories, including any business use but excluding new residences of any kind were established to include approximately 6000 acres within the city limits in which practically all such existing properties are today located.

No new residences are to be permitted in the industrial districts, as in Alameda, Newark, etc. The small residence owner fights improvements that industries must have in the way of wide, heavy hauling pavements, extra large sewers, unlimited spur tracks, closing of streets, etc. Plants desiring housing sites for employees adjoining their works can have that portion of their property re-classified in one of the residence zones.

### LIMITS ON HEIGHTS OF BUILDINGS ESTABLISHED

**T**O protect the city from overcrowding at a few points, and from scattered overhigh structures, limits on the height of new buildings are established in the ordinance, with appropriate regulations to meet the needs of the different Use Districts. The following height districts were established:

Two and one-half-story Height Districts, limiting new buildings to a maximum of two stories and finished attic, not to exceed 38 feet, were established to cover the outlying single family residence districts of Class I. It was found that 97.5% of all existing buildings in the city are of 2½ stories or under, and it was thought advisable to maintain this character of homes, for the best interest of both home owners and the City.

Three-story Height Districts, limiting new buildings to three stories or not more than 42 feet in height, were created to cover nearly all the small outlying business and apartment house districts.

Four-story Height Districts, limiting new buildings to four stories or not more than 60 feet in height, were made to cover the apartment house and business districts just away from the center of the city.

Six-story Height Districts, limiting new buildings to six stories or not more than 85 feet in height, were established to cover the closer in apartment and business centers, except the central downtown district.

Eight-story Height Districts were established limiting new buildings to eight stories or 105 feet in height in the industrial zones and in the wholesale districts in the center of the city.

Ten-story Height Districts, with a limit of 130 feet, were established for the central downtown

retail district only. A few buildings of fourteen and fifteen stories already existed in this district and the testimony of the Assessor and owners of property was that they were not profitable, aside from the fact that they cast a shadow cutting off light and air from their neighbors. These downtown regulations were the result of many months' study by a representative committee appointed by the Realty Board and Building Owners and Managers Association.

Towers, gables, spires, grain elevators, gas or water tanks, can exceed the height limit, provided they set back one foot for each additional foot of height above the height limit and do not cover more than 2500 square feet on the base area.

### AREA REQUIREMENTS

**I**N Business and Industrial districts rear yards are required, but only where windows necessary for light and air are opened at the back of the building. Portland already has a housing code pretty well protecting dwellings, apartments and hotels. In the Class I Single Family Dwelling Districts property owners asked to have their neighborhood kept as open as at present and accordingly Home Area regulations were established to cover all Class I Districts, requiring new dwellings to cover not more than 40% in area of the lot at grade nor more than 30% in area of the lot above a level about 16 feet above grade. It was found that practically all the homes in these districts at present cover only from 20 to 25 per cent of the lot and that therefore this regulation would not prove onerous. It is similar to the requirements of the Class E Area Districts in the New York City zone ordinance.

### FLEXIBILITY AND METHOD OF AMENDMENT

**T**HE importance of a reasonably simple method of amendment was emphasized in preliminary discussions on the zoning ordinance, and as finally passed it is arranged that any property owner, upon filing a list of all owners within 200 feet of property desired to be reclassified, can set in motion the machinery for bringing about a change. The matter is then automatically referred to the City Planning Commission for report and upon receipt of this report the Auditor shall within not less than 12 days set a hearing before the City Council, notifying all property owners within 200 feet. The action of the Council is then final, and the whole proceeding can be accomplished in a week's time if special occasion requires it. It was realized that no zone ordinance can be perfect and any such instrument must be a living and growing thing if the city is to progress. While the tendencies of city growth under zoning will undoubtedly be to maintain the business and industrial centers as established, enlargement from time to time of their boundaries

and of the apartment house or Class II zones, is to be expected to keep up with the normal increase of the city.

### IMPORTANCE OF ZONING AT THIS TIME

**T**HE importance of the adoption of a zoning plan by Portland is evident at this time, as the city is undoubtedly entering upon an era of great expansion, in addition to having to catch up for five years for lack of building during the war period. It was urgent to have some sound basis for settling where the industrial districts are to be and where the facilities for them can be concentrated. This the zone ordinance will do, as well as establish safe protected home neighborhoods near industries for the housing of industrial workers.

Competition has become an important factor between Pacific Coast cities hoping to secure new industries. It is well known that some dozen or fifteen of America's largest industries are getting ready to locate coast branches. Alameda, Berkeley and other cities have already established industrial zones where greater facilities and privileges are being concentrated than obtainable elsewhere. Seattle, Tacoma, Spokane and San Francisco all have zoning commissions at work, each trying to make ready to attract these great payrolls. Portland seems so far to be ahead of them, if certain reactionary forces within the city do not prevail.

The City's Industrial Commission, or Committee of Fifteen as it is called, has brought forward a most important plan for the improvement of the harbor at a cost of \$10,000,000, bonds for which will undoubtedly be voted in November.

The Building Trades Council and most of the leading institutions of the City urged the passage of the zone ordinance as an encouragement to building. They pointed out that many owners were now afraid to build for fear of what might locate next to them and prove a detriment. Regulated building will provide a sense of security and a solid foundation for investments to poor men and rich men alike, not heretofore possible with unregulated growth.

During the discussions on zoning before the Portland City Council the question was raised as to exact evidence on the experience of cities that had already adopted zone ordinances. It is interesting that we were able to discover no city that had abandoned zoning after once trying it out. Nearly every zoned city has found it necessary to amend and re-adjust boundaries from time to time, but this we take as an evidence of progress.

In response to inquiries by Mayor George L. Baker of Portland, replies emphasizing the beneficial effects of zoning were received from Oakland, Cal.; New York, N. Y.; Los Angeles, Cal.; St. Louis, Mo.; Alameda, Cal., and Chicago, Ill.

## Window Walls

During recent years the all-light commercial building has been largely developed. Its introduction and extended construction has been due, to a large extent, to the steel window sash. In fact, today this type of window has really replaced much wall area formerly constructed of masonry.

Under the title "Window Walls—Their Cost and Their Advantages," the Detroit Steel Products

Company has issued an interesting and instructive booklet describing the development of the "window wall" from a new angle, that is, considering this type of construction not simply as a window, but as a type of wall construction as well. Cost comparisons, carefully worked out, which can be advantageously studied, are given. Copies may be had on application to the Detroit Steel Products Co., Detroit, Mich.

# A Novel Feat Accomplished in Moving a Chicago Building

Cut in Half, Swung Around and Put Together Again, Operation Proves Good Financial Investment

**I**T'S an ill wind that blows nobody some good is an old adage, but a true one. This was recently proven in connection with the house-moving job illustrated in this article.

Not long ago it was decided to increase the size

of them. Included among these was a twelve-family apartment house. This building is three stories and basement in height and was located on the southwest corner of Jackson Boulevard and Irving Avenue. The walls which faced on these two streets are constructed with face brick, and the other walls of common brick. The floors are of wood joisted construction and the interior partitions of wood studs, lath and plaster. The buildings are heated



SECTION 2 TURNED ABOUT  $\frac{3}{4}$  OR  $67\frac{1}{2}$  DEG. AND FACING N.W. NOW IN CENTER OF IRVING AVENUE. ORIGINAL POSITION IMMEDIATELY IN FRONT OF PRESENT POSITION AND FACING JACKSON BOULEVARD WHICH IS IN THE FOREGROUND

of the Crane Technical High School in Chicago, and for this purpose the property comprising one-half a square block to the rear of the original building and facing on Jackson Boulevard was purchased. Since several existing buildings were located on this property it was necessary either to remove or demolish



SECTION 1 IN MIDDLE OF IRVING AVENUE AND FACING EAST JUST BEFORE TURNING; SECTION 2 AT RIGHT IN ORIGINAL POSITION



# THE AMERICAN ARCHITECT

by steam, contain electric lighting equipment and modern plumbing.

Estimates were received for the demolition of the various buildings and one contractor submitted a bid of \$6,000.00 for demolishing the buildings in question and removing the debris from the premises.

It was subsequently decided to sell these buildings rather than have them demolished, and a price of \$2,500 was received for them as they stood. It will thus be seen that the School Board effected a saving

boilers, new sewer connection, etc., which amounted to \$10,000.

The total cost involved may therefore be summarized as follows:

Cost of original buildings.....	\$2,500.00
Cost of new lot.....	10,000.00
Contract for moving buildings.....	12,500.00
Cost of new foundations, etc.....	10,000.00
Total.....	\$35,000.00

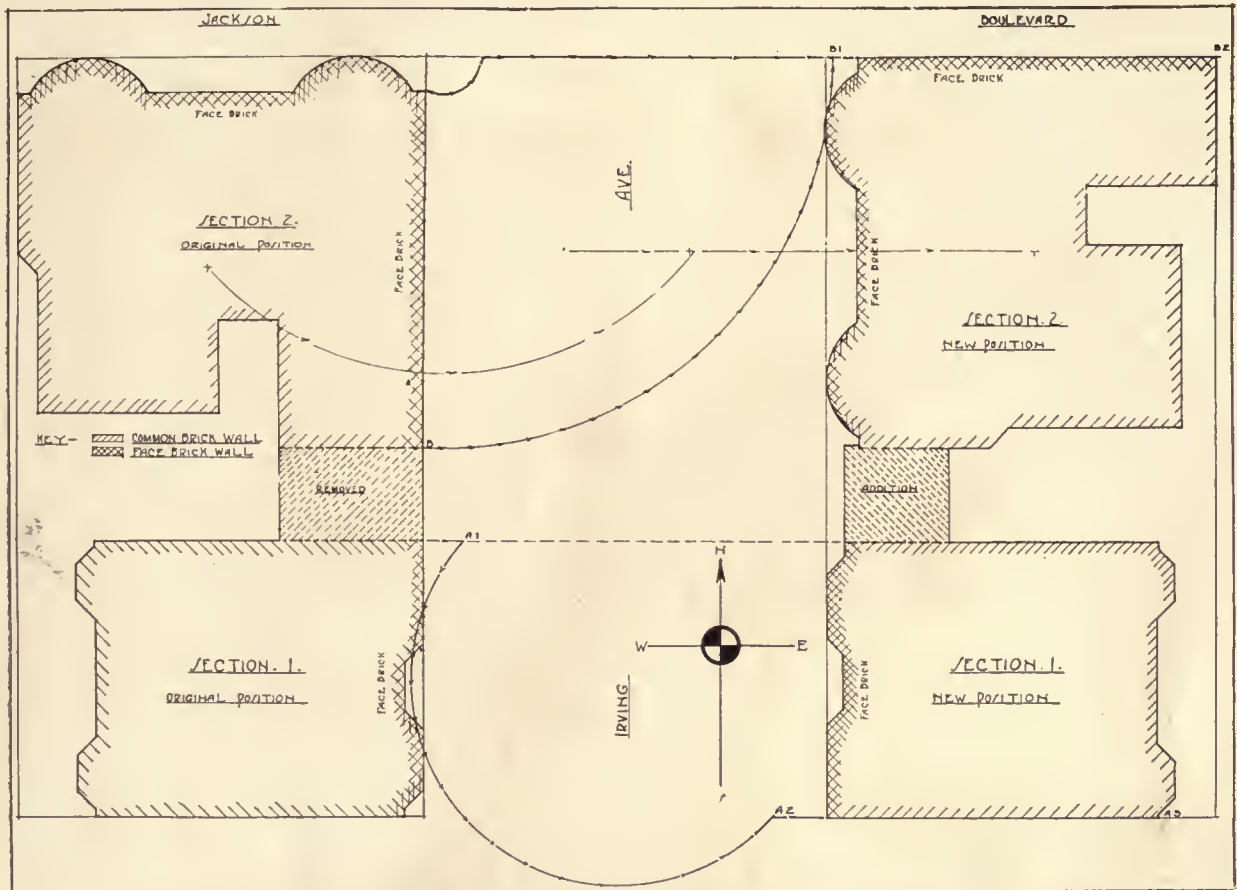

DIAGRAM SHOWING ORIGINAL AND ALTERED LOCATIONS OF BUILDING

of \$8,500, since instead of paying out \$6,000 for the demolition of the buildings, \$2,500 in cash was actually received.

The only vacant property available in the neighborhood consisted of a lot on the southeast corner of Jackson Boulevard and Irving Avenue, and the purchaser of the buildings also purchased this property for \$10,000. A contract was entered into with L. P. Friestedt Company, moving contractors, to transfer the buildings from the original location to the new site, the amount of this contract being \$12,500. The only additional expense consisted in the preparation of new foundations, the resetting of

It is estimated that the total improvement could not be duplicated at present prices (including the value of the ground) for less than \$70,000. Some 400 applications were received from persons desiring to rent the apartments and at the present rate of rentals the valuation of \$70,000 would be a fair price to fix. These figures indicate that an operation such as that described is a good financial investment and could be duplicated to advantage in many instances.

While the practice of demolishing buildings was usually resorted to before the war as the quickest method of clearing property for new improvements, it is doubtful whether this is an advisable policy to



SECTION 1 TURNED ABOUT  $\frac{3}{4}$  OR 135 DEG. AND FACING N.W. SECTION 2 AT RIGHT.

pursue when present housing accommodations fall so far short of the requirements in many localities.

Whenever it is at all possible to relocate such structures this should be done rather than having them entirely destroyed.

A more difficult job of moving could hardly have been encountered than that which confronted the contractor in the instance here described and illustrated. The photographs clearly indicate this. In the first place, as has been previously stated, the only vacant property in the vicinity was the southeast corner of Jackson Boulevard and Irving Avenue, whereas the building's original location was on the southwest corner. Furthermore, since the build-



REAR OF SECTION 1 LOOKING EAST. THE BUILDING IS MOVED INTO IRVING AVENUE AND READY TO BE TURNED 180 DEG. ON ITS CENTER. TO THE LEFT IS REAR OF SECTION 2. NOTE THE SILLS, ROLLERS AND CRIBBING.

ing did not fit the new lot purchased, it was impossible to move this in one piece, since pressed brick walls would not then have been presented on both street fronts, hence it was necessary to cut the building in two sections as is shown in one of the photographs and illustrated on the diagram.

The sections will be designated as "Section No. 1" and "Section No. 2."

Section No. 1, which originally faced east, was moved directly across the street (Irving Avenue) and then rotated 180 degrees so as to face west in the new position. The work of turning was done



CUTTING THE BUILDING INTO TWO SECTIONS, SECTION 1 AT LEFT AND SECTION 2 AT RIGHT. SECTION 1 "LOADED" ON THE FALSEWORK READY TO BE RAISED PREPARATORY TO MOVING.

in Irving Avenue, after which the building was moved to its present location.

Section No. 2 originally faced north. It was necessary to rotate this through an angle of 90 degrees before bringing it on to the new foundations. The building was moved to Irving Avenue, the turning being done on this street, and then moved to its position as shown in the photograph.

By comparing the photographs of the building in its original and present location it will be seen that the relative positions of the two sections have changed. In order to provide adequate light these two sections were kept some 12 feet apart, and a small one-story addition erected on the front of the



BUILDING IN ORIGINAL POSITION, SECTION 2 FACING JACKSON BOULEVARD, SECTION 1 IN REAR FACING IRVING AVENUE. NOTE THE CUT IN SIDE WALL DIVIDING THE TWO SECTIONS. CRANE TECHNICAL HIGH SCHOOL IN REAR.



SECTION 1 AT RIGHT, SECTION 2 AT LEFT. BOTH IN FINAL POSITION ON EAST SIDE OF IRVING AVENUE, FACING WEST. THE SECTIONS ARE NOT JOINED EXCEPT BY A ONE STORY STRUCTURE AS SHOWN.

MOVING A CHICAGO BUILDING

court so formed. In the process of moving Section No. 2, it was necessary to remove the porch and this was later rebuilt. It is of interest to note that one of the tenants in the first floor on the south side of Section No. 1 remained in the building during the entire period of moving. Water connections were



TURNING OF SECTION 2 ALMOST COMPLETED AND READY TO BE MOVED BACK INTO FINAL POSITION. SECTION 1 AT LEFT AND UNDERPINNED WITH BRICK ON NEW FOUNDATIONS. SECTION 2 STILL IN IRVING AVENUE, JACKSON BOULEVARD IN FOREGROUND.

maintained by the means of a hose, and an electric connection was also provided. It was not possible, however, to supply gas during the moving, but this was the only inconvenience suffered by this tenant.

In moving the building the sections were supported on cross sills which in turn rested on longitudinal sills under which hardwood rollers were placed. These rollers operated on track sills supported by timber cribbing in the usual way, which can be clearly seen in the photograph showing the rear of the two sections.

No damage in plastering or cracking of the brick walls occurred during the moving and both sections were found to be intact after having been reset on the new foundations.

This clearly demonstrates the feasibility of moving a building under the most critical conditions and such a procedure represents an asset to the community. Had the buildings been demolished it would have required a greater period of time to build accommodations to replace the loss, since only sixty working days were required for the work of moving. Some delay was occasioned on account of the foundations and owing to labor troubles, so that the time which elapsed from the commencement to the completion of the work covered a greater period.

## National Federation of Construction Industries Approves of Federal Department of Public Works

AT the request of the National Public Works Department Association, the National Federation of Construction Industries submitted a referendum to its membership on the proposal to create a Federal Department of Public Works.

The Federation is composed of national associations of industries which are concerned with construction work in all its phases. It is the most important body in this field. The membership of its constituent societies is composed of manufacturers of every class of material entering into construction enterprises, as well as of architects, engineers and contractors, thus making its membership a truly national body.

The two questions submitted to the Federation's membership were:

1. Shall the Federation endorse the Jones-Reavis Bill S-2232-H. R. 6649 for the creation of a Federal Department of Public Works?

2. Shall the Federation endorse the principle of a Federal Department of Public Works?

The resolution of the National Public Works Department Association, passed at its second convention, in Washington, was published with the bill. This resolution disavowed any interest of this Association in the transfer of the Bureau of Education to the Department of Labor.

The results of the ballot were as follows:

Associations	Question No. 1	Question No. 2
Yes	72.7%	100%
No	18.1%	...
Not voting	9.2%	...
	100%	100%
Individuals		
Yes	75.0%	92.8%
No	17.7%	7.2%
Not voting	7.3%	...
	100%	100%
Total	100%	100%

It will be noted that 100 per cent. of the member associations approved Question 2 and that 92.8 per cent. of the individuals approved it, a very remarkable expression of opinion and one which should have great weight with the business interests of the country.

This vote should be called to the attention of the Chambers of Commerce who are now considering this measure, for it is believed that if these Chambers of Commerce inform themselves fully on this measure, they will be as heartily in favor of it as the National Federation of Construction Industries has proven itself to be.

666<sup>3</sup>

participate to 2317.



APSE AND BELFRY OF THE CATHEDRAL OF MURANO, NEAR VENICE

# THE AMERICAN ARCHITECT

VOL. CXVII.

WEDNESDAY, JUNE 2, 1920

NUMBER 2319

667



## House at Spuyten Duyvil, New York City

TITUS DE BOBULA, *Architect*

THE site is on an abrupt slope of the hill on the east side of the Hudson River where the Harlem River joins it, within the city limits at about 225th street. The east side of the plot fronts on Palisade avenue and on the west it adjoins the New York Central Railroad right-of-way on the river. The spot was chosen for its views in three directions over the Hudson, and the glorious sunsets over the Palisades.

It was decided that the more prominent part of the house should be the west side and not the one facing the street. A one-room-deep building was desired, to serve as summer and winter residence—a combination of a city house and country home planned so that the fewest possible servants would be necessary. The slope of the ground made it possible to have two full stories below the main floor, giving sufficient room for a garage and servants' quarters, all under one roof, with the main building separated from it on different levels.

Beginning at the lowest level of the house on the west several terraces are laid out for the old-fashioned flower garden and the vegetable gardens. Below these the brush has not been disturbed. The ultimate plan calls for retaining walls, rock gardens, sunken garden and a tennis court, work that will take several years to complete. The sub-basement level is entirely above the ground on the west and contains a storage room, private office, billiard room with a fireplace and a bath. These rooms adjoin the stairs in the tower. The reinforced concrete driveway forms the ceiling. Next are the coalbins, fed from the drive above, heating-room, ironing-room and laundry. One flight of stairs connects with the kitchen, another straight run leads to the service porch and service gate.

On the basement level is the garage for three cars. It has a gravity pipe line from a 500-gallon gasoline tank located underground near the street. The concrete driveway from the garage to the street

has a uniform slope of 10 per cent. It leads through the porte cochère, is flanked by grass plots and can be closed by a pair of gates on the eastern building line. These gates and the service gate at the north-east corner give full privacy from the street.

On this level the house proper contains the carriage hall with stairs to the dining-hall above, the service dining-room, four bedrooms, a stone-vaulted wine cellar, kitchen, kitchen pantry, refrigerator-room and service porch.

On the main floor through the vestibule, which

curio-cabinet in the wall and built-in bookcases on the east wall. On the west a pair of French doors open to a small balcony and right and left from the mantel two arches lead to the sun porch, which also has an open fireplace and two balconies. Except the



DETAIL, MAIN ENTRANCE

has two coat closets, is the living-hall. By placing the stair tower in the center, an inglenook and a sunset tearoom was obtained. The stair landing has a large stained-glass window to the west and at two points French doors open to the terrace, which extends on the west beyond the dining-room and is arranged for a rose garden with a small fountain on the axis of the dining-room.

On the other side of the hall is the library with



BREAKFAST PORCH

pantry and lavatory doors the whole floor is left open, curtains and screens taking the place of doors. This gives a straight vista of seventy feet from the dining-room to the sun porch.

The second floor is divided into three suites. One with a sleeping porch, loggia, chamber with four exposures, dressing-room and bath; one with a porch, chamber, shower and toilet; and one with a porch, loggia, bath, chamber and a foyer opening to a balcony over the rose garden. Besides the necessary closets, all lined with cedar, there is also the cedar-lined linen and sewing-room on this floor.

On the third floor, besides the attic, is a chamber and bath with stairs to tower deck.

The materials employed in the construction were concrete and cyclopean masonry for the footers,





RIVER FRONT  
HOUSE AT SPUYTEN DUYVIL, NEW YORK CITY  
TITUS DE BOBULA, ARCHITECT

stone walls and hollow-tile walls. Plaster-block and hollow-tile partitions. All floor slabs and stairs concrete. Red mission tile roof. Asphalt waterproofing on all outside slabs and walls in the ground. Tile drain in front of the east foundation. Copper

not segments but straight surfaced and slightly rounded at the center and the rise. The driveway in the basement level is curved and dished both ways. On account of its slope it acts as a gutter and necessitates three six-inch drains.

The slab holding the rose garden over the garage, besides its asphalt waterproofing and one-foot layer of broken stone, has a bed of loamy soil three feet deep on top of it. It is well drained so that there is no danger of the soil turning sour.

On the inside above the basement all floors and stairs are covered with marble. All walls have a four-inch marble base. Marble wainscot to the ceiling in all bath and washrooms, with built-in accessories, white steel medicine cabinet and built-in electric heaters. The heating system is low pres-



BUILT-IN CHINA CLOSET IN DINING-ROOM

flashings, gutters and leaders. Wrought iron and bronze entrance doors, wrought iron grilles, gates, balcony and stair railings. On account of war conditions no fireproof inside doors and windows were obtainable. These are wooden casements opening to the inside and weather-stripped. Screens open to the outside and for the winter are replaced by storm sashes. No inside trim anywhere. The outside stucco is a magnesite composition with marble dash put on in freezing weather without showing a single defect or cracks. Its color is old ivory. The inside plastering is three-coat work, the last coat roughly sanded. The ceiling slabs of the first floor are beamed, but both the slabs and the beams were calculated and poured for very flat arches and vaults similar to the Tudor arch but shallower. They are



DINING-ROOM AND BREAKFAST PORCH

sure steam with low radiators to serve as seats. The hot water system is circulating from a separately heated tank. The plumbing is of the best. A vacuum cleaning system is provided with six outlets.

The electric wiring is in conduits for sufficient

THE AMERICAN ARCHITECT

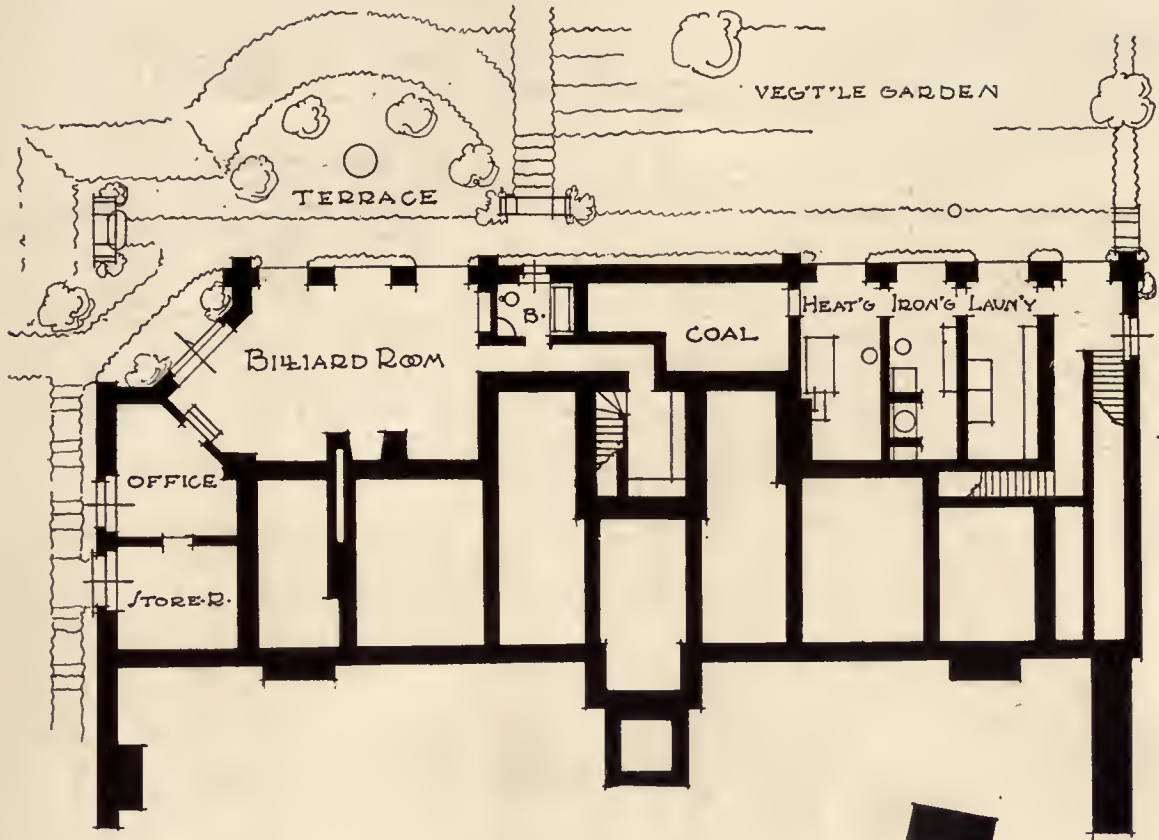

SUB-BASEMENT PLAN

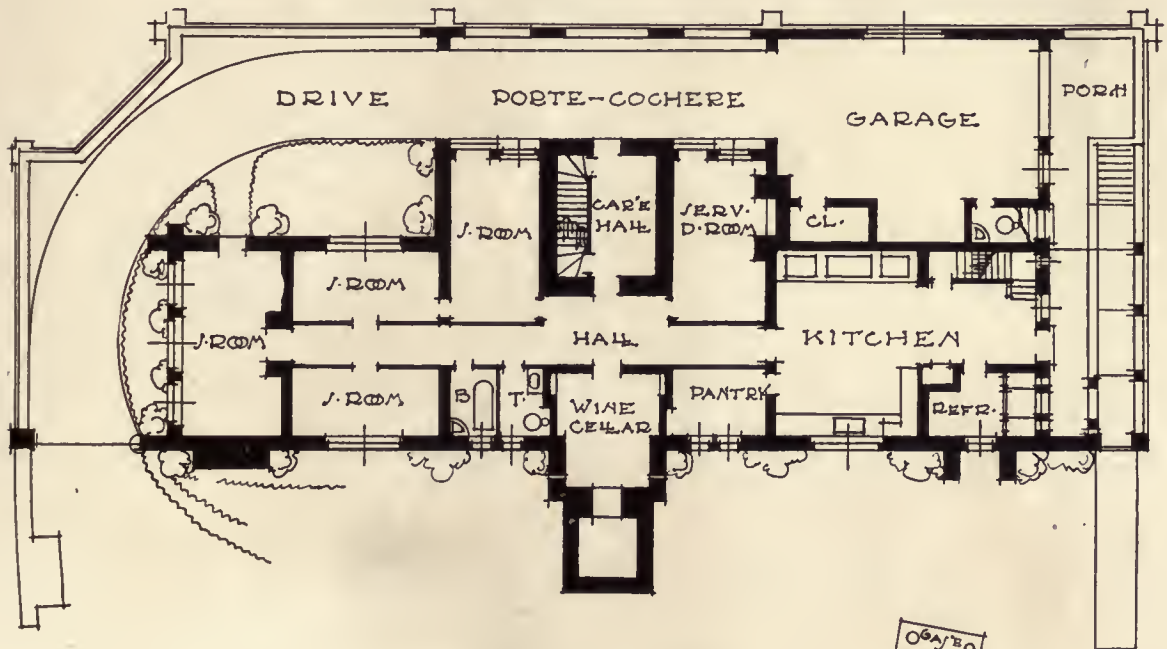

BASEMENT PLAN

HOUSE AT SPUYTEN DUYVIL, NEW YORK CITY  
TITUS DE BOBULA, ARCHITECT

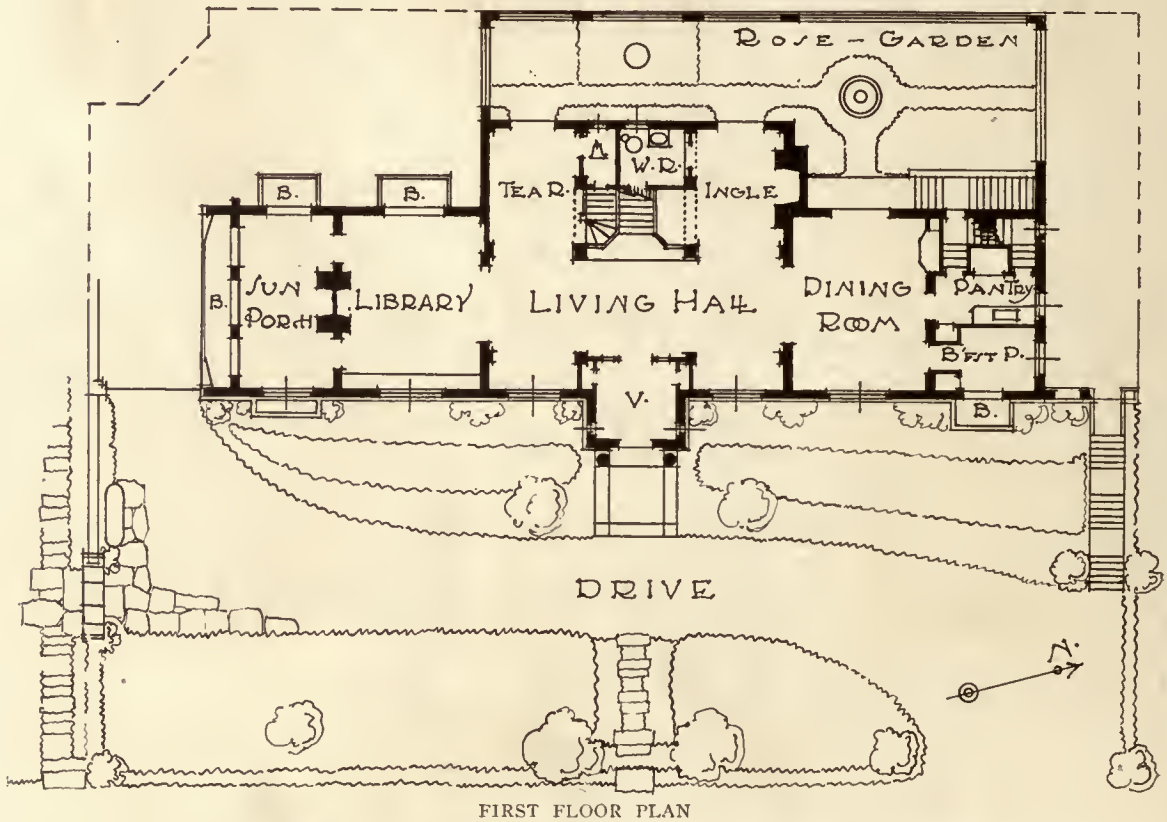
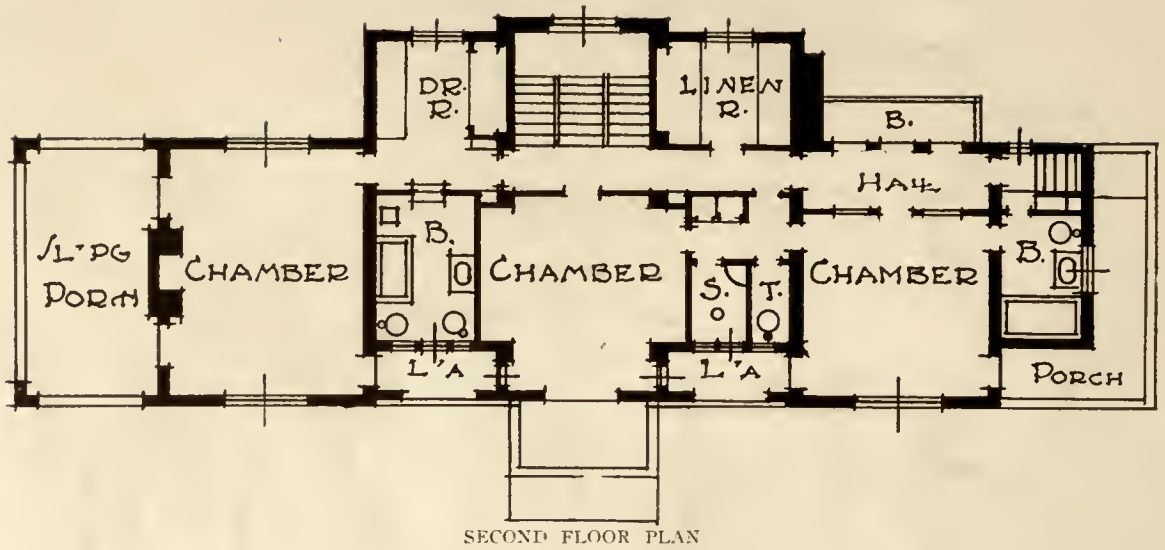

HOUSE AT SPUYTEN DUYVIL, NEW YORK CITY  
TITUS DE BOBULA, ARCHITECT

sidelights and bare receptacles in each room. Except the basement, no ceiling lights are provided anywhere. In the walls of the living-hall four 6x14-inch openings, each containing a 100-watt nitrogen lamp and closed on both sides of the wall by lead glass sash, light up the whole floor at the turn of the switch in the vestibule.

An intercommunicating telephone with nine stations is also provided, besides the long-distance system. Bell annunciators are placed both in the butler's pantry and kitchen.

The decoration of the interior walls and the painting is extremely simple, light shades being used in all rooms.

For designing the elevations no established style was used. The half-circle arch and straight lines were allowed. Simplicity was the aim. For the ironwork the quadrifoil, for the column caps and stone carving the oakleaf and acorn was the motif.

Especial luck favored the planting. On the barren sandy-clay hillside inside of six months we had all the perennials taking root. Besides the rhododendrons, hardy azaleas, lilacs, heliotrope, hollyhock, Scotch pinks, a mint patch under the breakfast

porch, dwarf junipers, asters, canterbury bells, etc., the cedar trees and arborvitae hedges and arches were the most useful and decorative. For climbers on the stone and stucco the euonymus radicans and Boston ivy proved successful. In flower boxes and terraces where a droop was desired the English ivy found its place. In the rose garden with an arbor vitae outside hedge and with dwarf box along the bluestone path 100 English standard rose trees and arches of Dorothy Perkins ramblers were in full bloom six months after the foundation was started.

On the lowest level terraces, screens of Scotch fir were planted, relieved over the paths by rambler arches.

A very satisfactory result was obtained in the speed and the planting as not one plant was lost. This is due partly to the excellence of the stock which came from a Long Island nursery, but a good deal was due to the skill of the gardeners who furnished and planted them. Seven months (which included the winter) after the survey of the plot, the greatest part of the house was ready for occupancy.



INTERIOR, METROPOLITAN MUSEUM OF ART, SHOWING A GLIMPSE OF GALLERIES AS DECORATED FOR CELEBRATION OF FIFTIETH ANNIVERSARY OF MUSEUM'S FOUNDATION

# Conference of the Interprofessional Relation

Addresses by Dr. Ebersole and Mr. Thomas R. Kimball Before the Fifty-third Annual Convention of the American Institute of Architects  
Thursday Evening, May 6th

## ADDRESS OF DR. EBERSOLE

**M**R. CHAIRMAN, ladies and gentlemen of the American Institute of Architects: I wish I had the gift of oratory to tell the story I am expected to tell upon this occasion. Unfortunately, while I make my living by using the mouth, it is not my own but the other fellow's mouth. (Laughter.)

I do not want to appear before you to-night representing the medical profession. I am here as a representative of the National Dental Association, a delegate selected to go to Detroit to meet with your people; but I do not want to talk to you as a physician or as a dentist or as a lawyer, for I read law almost two years and gave it up to study dentistry and medicine, because I came to know that dentistry, at that time the most lowly of all the professions, offered a greater opportunity to serve humanity than law or medicine. Therefore, I gave up the study of law and took up the study of dentistry. But dentistry then was a profession that was an object of ridicule. Dentistry occupied the position of the jack, that ungainly animal with ears waving; because at that time no one thought of a dentist without fear or without ridicule.

Medicine, on the other hand, stood for something, and I was not willing to hitch onto the dental profession alone because of the attitude that the people at large had for that profession. Therefore, to add dignity to that profession I felt it was necessary to become educated in the line of the mother profession, medicine. And on what, if you please, might be termed a go-between between the two professions, I am neither a physician in practice nor a dentist in practice, because I do not do all the things that any one of the two professions prescribes. I am a composite of the two, if you please. I spoke of the jack. Now for service in the animal creation when we wanted some kind of an animal that could stand hard labor and could serve better than any other, what did we do. We crossed the jack with the horse and we produced the mule, the most serviceable of animals. (Laughter.) Therefore, I come before you to-night as a cross between medicine as the mother and dentistry as the father, a service individual.

I want to talk to you now about service, and that is what I am here for; and I want to say to you,

Mr. Chairman, that I consider it a great honor to come before this group of architects. It was your group who gave birth to the Interprofessional Conference, or to the idea. You are the builders of structures, and I honor you for the high ideals you have expressed.

It is true that I went to Detroit wondering what in the name of God medicine and dentistry had in common with architects and engineers. I did not know, but I had been on the floor only a few minutes until I caught a vision, and if I only had the power to inspire you people as I was inspired upon that occasion there would be no question about a successful interprofessional organization of some sort. Now I am not afraid of the record. I have not a typewritten speech to make, but I have here simply a few memoranda to keep me from wandering too far. At the meeting in Detroit high ideals were expressed.

**W**HYY do we need an interprofessional organization? Every one here has called attention to the fact that this is the age of industrialism. I hope I am not wrong, but I have come to feel that this is no longer a government of the people, for the people and by the people. I may not get it right, but I have come to feel and I think you have come to feel that it is a government of organized interests. When I came into professional life professionalism stood for something. The professional man and the professional woman stood for something in the community. Well, they do to-day to a certain extent. But, ladies and gentlemen, you do not stand where you did twenty years ago or ten years ago. Professional life in this country has been subsidized. What is the status of affairs to-day? On the one side there is capital, industry, highly organized, at the top, struggling for the almighty dollar and getting it, too. On the other side is labor, highly organized, underneath, working for the dollar, and getting it, too. (Laughter.) What is the consequence? Those two great millstones, capital above and labor below, are grinding the grist of the common people between them, grinding out the dollars. Why is it that there is no one to-day to speak for the common people? When you call a conference, when you appoint a commission in this country, either by the national, state or municipal government, what is the first thing they consider?

## THE AMERICAN ARCHITECT

The influence of organized labor, the influence of organized capital. And well they should. But who represents the great mass of people? Bring it right to Washington. At the recent round table conference when the President appointed a commission to represent first capital, second labor, and third the public, and when he came to the people to represent the public, what did he do? What was he compelled to do. He appointed Judge Gary, the head of one of the greatest organizations in this country, to represent the great American public. He appointed John D. Rockefeller, Jr., heir to the greatest fortune known, both of them admirable men, but both of them representing dollars. Was there a professional man or a professional woman at that round table conference, a man or woman who represented high ideals in professionalism? Now why am I talking to you tonight? Things have reached a place in this country where something must be done. It cannot go on as it is. It will not go on as it is. Somebody has got to sit in and help labor and capital solve the problems, and not solve them in the interest of capital and the interest of labor alone, but solve them in the interest of mankind in general. (Applause.)

Now, Mr. Chairman, I know of no group of people better qualified to sit in and help solve these problems than the brains, the intellect of this country, the professional men and women, acting and working along the lines and along the ideals set forth by your Interprofessional Conference in Detroit. What do we stand for? As declared upon that occasion by your president, Mr. Kimball, we stand first for service to all mankind; second, for service to our clients or our patients; and third, as he expressed it, for a return to the individuals supplying that service. I wish to add another and make it third; first, service to all mankind; second, service to the client or the patient; third, service to the professions to which you belong; and fourth, a return to the individuals supplying the service. With ideals of that kind, ladies and gentlemen, with a declaration for service to all mankind, I know of no group of people anywhere on earth better qualified to sit in and work for the common good. Will they trust us? Yes, when they come to know that for which we stand.

Now, ladies and gentlemen, I do not believe in whipping the devil around the stump. I believe in just reaching over and whacking him on the head and putting him out of commission, and then going along and attending to your business. So I am going to come down to practical things.

**L**ET us see what the professions stand for in the community at the present time. I am going to talk dollars and cents, Mr. Chairman, a tabooed

question in professionalism. But let us see where we stand today. Coming down on the train I had the pleasure of the company of one of our prominent architects from Cleveland and I told him that professional people did not stand for what they did some years ago, and he took exception to what I said. Let us see. In Cleveland the non-English speaking scrubwomen are receiving more money per day for their services than 90 per cent of our school teachers, the people who are acting as the second fathers and second mothers to our boys and girls in this country. A condition has arisen in the teaching profession and the point has been reached where that profession has found it necessary to join a union in order to command a living compensation. The plumbers are earning more per day than 95 per cent of the ministers in this country and the bricklayers have more clean cold cash in their pockets at the end of the day than 70 per cent. of the lawyers. Carpenters are earning more to-day than 85 per cent. of the physicians. You do not believe that? Well let us see. What is the carpenter's overhead? When you have paid the overhead of the professional man or the professional woman, when they have paid their high office rent, when they have purchased their equipment—and do not forget that these men and women have spent from three to four or five years training their intellects for service, and in the procuring of this training they have spent money that it has taken years to earn, either before or after they have received their education. Add to this the good clothes they must wear. After this the expenses that your architects are under, and then tell me what your professionalism stands for today. What do you measure it by, their worth and their value? What are the people of this country measuring them by? By dollars and cents, because that is the only thing that they recognize—money! Where do you architects stand? I am going to try to tell you. You know I am not an architect, but I spent part of the morning and part of the afternoon circulating around among you to get your psychology. You know it is a good idea to study your audience once in a while and find out what you are up against; and if I do not state things correctly, I want you to try to correct me. But look here, what is your minimum fee or commission as established by your association here? Somebody says 6 per cent is the minimum. Now, ladies and gentlemen, what does the contractor get for his services? Do your clients object to paying 10 per cent, 15 per cent sometimes, and sometimes 20 per cent to the contractor? Do they object? But who ever heard of a client deliberately offering you more than your minimum fee without a kick? (Laughter.) Where do you stand? And whose fault is it? It is not

the fault of your clients. It is not the fault of the contractor. It is your own fault. Many of you are afraid to ask for the kind of a fee you should receive.

Now let us see the position of the two groups if you will. Who should have the fee, the architect who designs and plans and supervises the structure, or the contractor who some years ago used to supply a little capital to carry the thing over the initial stages until you got what you called the first estimate. That was years ago. Today your cost-plus proposition does not require the contractor to put up a damned dollar. (Applause.) And I say "damned" as a Presbyterian elder, that means the strongest kind of profanity. (Laughter.) More than that. The 10 per cent. that your contractor receives means more profit straight through, while your little 6 per cent means what? Every assistant and supervisor that the contractor employs, every man in any capacity is figured in on the cost-plus. (Laughter.) And the higher the salary paid to the assistant the greater the cost, and the greater the net profit to the contractor; while with you people, you pay for an office maintained with dignity. In order to do the big things worth while you must have a group of assistants who command high fees. You must have an office and equipment. You have got to have your draftsmen, your superintendents, and all of these people, and who pays them? You pay them out of your little 6 per cent or 10 per cent if you are lucky enough to get it. Now where do you stand? I am simply applying these principles to your profession, because I touch you where you live. What is true of your profession is true of my profession. It is true of all professions. We are afraid to go out and ask for that thing which is our just due. And how are we going to get it? Come to Cleveland if you will. We have I believe some fifty architects in the local chapter. What can they do, when they go to talk to the public? What can they do when they go to talk to our municipal people, the municipal government? Practically nothing alone. Now just a word and I must close. I notice the Chairman holding up his watch, and that means shut off. I am a hard fellow to shut up. I am mulish. (Laughter.) The one solution for this evil—and I got this inspiration from your post-war committee—the one solution is the getting together of all professions working first in the interest of all mankind.

**N**OW what is the first thing necessary? It is to educate the people to understand the value as well as the meaning of professionalism, of professional life. That is the first thing. Now what can you do for all mankind? If you stand for the principles set forth and stated a little while ago you

can serve mankind by making your government, whether it be national, state or municipal, understand that you represent the great American public and that you have the right to represent them, and the only way you can make them understand what you mean is to get together and say to them, "We represent the hundreds of thousands of people in this country who belong to the professional group. Do you know what the politicians understand? When you go to them seeking help or seeking the correction of some fault, there are only two things that they understand, and those things are money and voting power. I am not fighting politicians, I am not fighting labor, I am not fighting capital, nor do I want anyone to fight honest capital, honest labor, or honest politicians; but I do not care a damn whether they are politicians, capitalists, or labor, they do not understand anything except organized effort, voting power; and the solution of the present problem as I see it and as I understand it is the getting together of the professional people of this country and having the people understand what they stand for, and then saying to the various groups, whether capitalists, laborites or politicians: "Thus far shalt thou go and no farther."

Now what can you do for your clients? What is the second declaration. You can with co-operation with the various professions protect them against unjust legislation.

I suppose if I were to mention a plumber, you people might understand what might take place. Suppose you have a plumbing inspector who is a member of organized labor. They will put into their code rules and regulations which make it almost impossible for you to get by some things. What are you going to do to protect them against that? You can protect them against unjust work.

Now what can we do for the professions? We can improve our status, we can improve our view, we can improve our outlook. The gentleman who preceded me has told you about how little a lawyer knows of the architect and how little a dentist knows about the architect. I do not know much about them. I employed an architect once—only once. (Laughter.) The reason for that was that I only built once. I was only able to build once, because my patients had to do that for me. You know they had to pay for that, and it was only once that they were willing to pay for it. If you have anything to put through, bring it before the Inter-Professional group, thresh it out, and then go after it with a group of people backing you that is worthwhile.

**N**OW for the individual, and I am done. What can you do for the individual. We talk about professional, and I hope no one has higher views than I have, but you have got to recognize



## THE AMERICAN ARCHITECT

the importance of the dollar. In my profession I have got to have the latest and best instruments in order to perform the highest kind of service. We have in my profession some of the best men, some of the most capable men who ignore the dollar. One of our best men, a man known internationally, is going to have a very hard time to buy himself after he dies—if you will pardon the bull—because he has not realized the value of the dollar. Now we must recognize the dollar as an instrument of service, and you have got to get at least as much as the school teachers, as much as plumbers, if you are going to demand the respect of the people in the various communities.

Just one word more. Can an Inter-Professional organization be put over? It can. Twelve years ago next July I stood before an international conference on hygiene. Your Chairman spoke of something that has been accomplished, and I am going to use this as an illustration. At that conference some of us declared that the human mouth was responsible for most of the ills and ailments of mankind from the pathogenic standpoint. We were classed as crazy both by the medical and dental professions. We were told that we were all kinds of fools. We said to the dental profession: "If you do thus and so we will prove certain things." We had some difficulty to get them to do what we asked them to do, but they came across. The National Dental Association appointed a committee. The local organizations appointed committees and subscribed funds. To make a long story short, when that professional group showed their interest, and showed it by concerted action, then we were able to go out and finance the proposition. We went from a local organization in Cleveland to the State Dental Society Meeting at Columbus and asked them for a sum of money. They voted just what we asked for, which surprised us too. We went from Cleveland to Baltimore before the Dental Manufacturers' Club and told them what we had. We told them what we wanted, and we told them we wanted \$10,000, \$6,000 of it in equipment and \$4,000 of it in cash. They said, "You can have \$15,000." I said, "No, we want just what we have asked for. If you will give it to us we will turn the world over and bring them to know and understand the value of healthy, well cared for and properly used mouths." At that time, ladies and gentlemen, how many of you knew the value of well cared for and properly used mouths? Today there is not a man or woman within the sound of my voice but what knows the importance of a well cared for mouth, and the danger of diseased teeth in the mouth. Today we have in the schools in all the cities that are worthwhile dental clinics. We have instructions going out all over the world pointing

out the value of dental service. And what is the result? The dentists of this country are so busy they cannot serve their patients.

You want your architects, your lawyers, and everybody to work in a group that is serving humanity. If you have this proposition organized, there will be no trouble about financing it. If you will take action here tonight or tomorrow endorsing this Inter-Professional movement, if you will put yourselves on record, if you people here will sign cards for membership in that organization and put yourselves on record, then you can go out and get all the money you need. You can go before the professional organizations. They are willing to come in and work with you, but you architects, you people who gave birth to this thought have got to put yourselves on record, and the rest of us will follow you and work with you. God bless you. (Applause.)

### ADDRESS OF MR. THOMAS R. KIMBALL

**M**OST of you know something about me, some of you know nothing, and none of you know all. (Laughter.) I have lived my life apart. I have read very little, on account of weak eyes. What I have to offer is chiefly personal experience, and after all that is all any one has to offer that is very real. When I am engaged in a legitimate pursuit—I use the word "legitimate" advisedly—I am a practicing architect. When I am looking for recreation I am breeding game cocks. (Laughter.) I am doing it advisedly, because of all God's creatures there is nothing left that man has tampered with that is pure except a game cock. We have quite a lore, quite a history, connected with the raising of fighting chickens. The game cock is really a very dignified creature. (Laughter.) I know the record of one little black hen that was brought into prominence 72 years ago. She has had more than two million descendants. Most of them have died in the pit, and never one has turned tail. (Laughter and applause.)

The subject that we are talking about tonight has for me a certain significance. In the language of childhood I feel as though you were playing with my doll, and I am envying you. Nobody expresses my attitude toward it at all. I have no fears about it. I am not worried. I am not in a hurry. The thing that I want to see accomplished is not in danger of failure, not one particle of danger. There are a few human game cocks, and they are in the pit on this thing, and they are going to stay with heads in the right direction. (Applause.) My experience which has brought me into this particular relation is a curious one. I confess to a feeling akin to cannibalism when I met another professional man. (Laughter.) There are on the back of my neck cer-

## THE AMERICAN ARCHITECT

tain hairs that always stand on end when I talk to another professional man, and the desire to bite him almost gets the better of me. (Laughter.) And the more I know him the more I want to bite him. (Laughter.) Now you must not laugh at me. I never was more serious in my life. Those who know me know that there is no harm in me whatever.

I tried to think it out all alone, out in Nebraska, why it was that all my quarrels have been with professional men? Every client I have had who was in business, who was in commerce, has treated me fairly. Every client I have quarreled with has been a professional man.

**N**OW in trying to solve that problem I have come to a certain position on this question, and it is a thing that has made me anxious to see us get together and try to understand one another and try to get that common language that our distinguished guests tonight have called our attention to. Do you know why I want it? I want it so we can eavesdrop and hear something about ourselves. We do not hear anything about ourselves now—not because we do not try to eavesdrop—but because we do not understand what is being said, thought and felt about us. If we did, we would learn something. I want us to get together. I am not in a particle of a hurry. I live out in an agricultural country. Out there we never begin by what they call constructive effort. We burn the weeds off first, and get a clearing, and in that way we get a chance to work with the real seed. We prepare the garden. When I came away from the professional conference in Detroit I had some notes that I made in the discussions there to the effect that we were going away to prepare the garden. I have attended several local conferences and I do not find that the others are trying to prepare the garden. They are trying to get a result. You cannot do that until you have burned off the weeds. I want us to go slow. I do not want us to hurry. I do not want us to worry about this thing. It is so important that it cannot fail; and if it should fail what does it matter? If it fails, nothing matters to professional men. We talk about dealing with professional organizations. Do not think about it any more. It would be all right if they were professional organizations, but they are not. They are commercial. They would not exist if they were not. But in every one of them there are a few professional people. Those are the people I want to see gathered together into this new organization. Those are the people I want to have speaking a common language. Those are the people I want to have know one another and learn to realize what they have got in this world outside of their own little bailiwicks.

That is all I want in this thing. The rest will do itself. Now do not let us worry about it, do not let us be in a hurry.

**I** WENT before the Dental Association, out in Nebraska, and I find that as a class they come nearer being professional people than any other class we have. I have been before almost all of them. The dentists have set the one great professional example that has been given to the world. In the face of the danger of ruining their own practice they have started preventive dentistry. If it succeeds, they go out of business. There is the most inspiring example I have met in any professional connection. Now Dr. Ebersole represents dentistry. He has set us a beautiful example of gathering money among the dentists. The dentists are there with the money in their hands wanting to come into this thing. They are waiting their chance to come in. They have not got to have any time wasted on them at all. Every live, wideawake dentist in the United States will be a member tomorrow if you ask him. I am not worried about them. I am worried about the architects. I have been worried ever since I began to know them. (Laughter.) Are they professional? I think not. I wish I thought they were. I am taking advantage of an opportunity here tonight, because I may not get another. (Laughter.) I should like the architects to know exactly what I think about them. I love them all. There is no question about that. They do not stir up the hate in me that the other professions do. (Laughter.) I do not want to bite them, but I have very little respect for their professionalism. I believe they are good material and if we burn off the weeds we will get a crop, but I do not think we ought to be in a hurry.

Now my little experience with this thing is summed up in a word. After the Interprofessional Conference I waited for material to work with. It did not come. It was no one's fault. It could not be done. I waited for some big fine, ringing, sonorous names connected with the other professions. They did come. I could wait. I have been out among our professional people in Nebraska, and I have not been turned down, and it is only a matter of time when every professional man in the State of Nebraska who is asked to come into this thing will come in on a moment's notice, and I know the other States will. I have no worry about it. I am in no hurry; but I do not want to gather anything that is spurious. I want the professional men, I want the men who think in the way we have been talked to tonight. I want the spirit that has been described here tonight to go into the group that we gather together. I thank you. (Applause.)



## The Supreme Position of the Institute

One thing the fifty-third annual convention of the Institute demonstrated above all others, was the need for reorganization. The creation of an Institute that would be representative of the entire profession, that might claim without fear of successful challenge that it was the dominating and controlling force in every phase of building operation in the United States. To prove the presence of this sentiment and clearly to show the disposition of architects not allied with the Institute, of draftsmen and of craftsmen, one only has to quote from the stenographic reports of the three days' meetings.

For example, William J. Haggerty, a representative of the Bricklayers' Union of Philadelphia, said in the course of an interesting address during the third day's session (presented in full on another page):

"I feel sure, as some of my colleagues do, that if the American Institute of Architects would take its proper place and be the guiding hand of all the building craftsmen, from the common laborer up to the completion of the building, if the architect would take his place as the leader, which he really is, instead of apparently staying aloof and having everyone looking up to him, as we see it, greater results could be obtained, because without a guiding hand, someone to teach us, we naturally drift into a powerful organization that does not understand the rest of our fellow men and wants to run right over them. We have no desire to do that. We want to learn, and we want educated, intelligent men to be our leaders, whether they belong to our respective organizations or not."

Thus speaks organized labor. Will anyone who heard Mr. Haggerty's address doubt that he spoke with knowledge and authority?

The question of the well-defined condition of unrest in the various organizations of draftsmen, culminating in some sections of the country in a willingness to become unionized under the American Federation of Labor, was freely debated. Without exception, there could be found in the remarks of every speaker, either directly stated or implied, that the responsibility rested with the Institute.

That it had ceased to exercise the paternal attitude toward these organizations as was its right to do. Said Mr. William B. Ittner, of St. Louis:

"I have often felt more or less guilty by reason of the fact that I am myself not in closer touch with my draftsmen. I have often felt that one of the great needs of the American Institute of Architects was closer touch with their students. I have often wished that there was some method by which this body could be intimately connected with the student draftsmen, whereby this body could take under its wing, as it were, the man who is to become the future architect, watch his career, and give him every help that we could train him for the greater service which he is to render when he actually enters professional work."

As to that large majority of the profession of architecture not connected with the Institute, nor under the present organization ever likely to be, the debate on State Societies on the morning of the second day clearly indicates the willingness of these unaffiliated men to acknowledge the governing right of the Institute provided the Institute would officially acknowledge that they existed. Said Mr. Wilson, of Montana, attending the convention by invitation as a representative of the Montana State Society:

"We look to the Institute as the guiding star in all our deliberations. Most of us abide by the ethics of the Institute. \* \* \* If we can have representation, if we can get together and talk these things over, it will do more towards educating the public and making better architecture known and appreciated in Montana."

Mr. Malcolmson of the Michigan State Society, during the course of a witty speech, said:

"I may say that the Michigan Society yields to nobody in its regard for the American Institute of Architects; we look upon this body as being the central body for the propagation of architectural truth, so to speak. We look upon it, with its traditions and its history, to be something more than revered, to be followed and treasured, and we would like to come to you and get your counsel and your advice and your instructions, if you please. We come here not in a spirit of combat, but in a spirit of service."

Again quoted, and this time from the remarks of Mr. Loth of the New York State Society, we find the same willingness to acknowledge the supreme

## THE AMERICAN ARCHITECT

right to control on the part of the Institute. Mr. Loth said, in part:

"The American Institute of Architects, since 1858 has been a standard for everyone practicing architecture in the country and looked up to, but it has been difficult to get the majority of practitioners into the Institute. I can remember way back many years when several men like myself, then young, discussed the question as to whether we should go into the Institute or not, and we decided we would not. I think now, of course, I made a mistake at that time. Now how can the great mass of practitioners be elevated just one little peg higher up? How can it be done? I believe that it is through the medium of State associations."

Organized labor, draftsmen, the unaffiliated members of the profession, all willing to acknowledge the supreme right of the Institute, why should there be hesitancy in proceeding without delay in the preliminaries of such an organization. Why should the Institute defer until another year what it could with much approval from all concerned at once set afoot.

There is a certain *dolce far niente* in this lethargic, postponing policy. *Manana* may be a good expression for our Mexican neighbors as an excuse for postponing activities, but in these energetic days it means procrastination which, now, more than ever is, the thief of time.

### "Frozen Credits"

The great problem in existing conditions of financial operations is the thawing out or releasing of so-called frozen credits. Official Washington has at last awakened to the realization that scarcity of money and the attendant high interest rates are largely due to the fact that enormous sums are at present locked up in loans on hoarded stocks of merchandise. As this hoarding is to produce a fictitious condition of scarcity and high prices, it is now proposed to release this large amount of money by calling in, wherever possible, such loans as have matured.

In the past, it has been the custom in order to force the payment of loans on hoarded stocks, to sharply advance interest rates. This method has little if any effect on this to-day's large class of profiteers and such action has only served to increase costs of the commodities when finally placed on the market. Higher interest rates, as *The Sun and New York Herald*, in a recent financial article

has aptly stated, are "only one jump ahead of higher prices for these hoarded commodities and so the incentive for hoarding is augmented."

If the banks, as threatened, pursue a policy of smoking out these frozen credits, the profiteer will be compelled to turn the hoarded goods onto the market and lower prices will at once occur. Having by these very logical means relieved a condition which should have had this drastic treatment some-time ago, large and available sums of money will be released for use in directions where there is now crying need for financial aid. Legitimate enterprises, and more particularly building operations, will be able to proceed and we may with reason expect an early return to more normal conditions.

WHAT we need to make sure at this time is that the release of these frozen credits in one direction is not followed, owing to the lure of high interest rates, by the diversion of the money as loans on other hoarded commodities. The profiteer having been once smoked out and obliged to distribute his stocks, should find it impossible again to so control the necessities of life or longer to maintain abnormally higher prices.

Here is opportunity for the Federal Reserve Banks to exercise careful watch over these matters of credits. If the authorities in Washington continue to exercise the vigilance that now seems to be a part of official action, we may hope to see money more easily obtainable, cheaper in rate, and we may enjoy the resumption of many essential industries so long retarded by unscrupulous profiteers who have been aided by the tendency of banks to loan to the highest bidder irrespective of the influence of such loans upon the general good.

It is probable that the possibility of Government action has largely influenced the price-cutting that has occurred in all the large cities of the country. Cuts of up to fifty per cent have been made in order to encourage an apathetic buying public which has been waiting in the hope of a return to normal conditions. The logical method to effect a return to normal conditions would be in increased production. As long as large sums are frozen in loans on hoarded stock we shall never be able to resume production—particularly in our building operations—with an activity that will carry with it the concurrent factor of lower prices.

# The Debate on the Relations of the Architect to Client, Draftsman and Builder During the Third Day's Proceedings of the Fifty-third Annual Convention of the American Institute of Architects

FOLLOWING a most interesting meeting of the preceding evening, discussing the interprofessional relation, a detailed account of which will be found on another page, the morning session of the third day was taken up with a most interesting and very instructive debate and discussion of the relations of the architect to client, draftsman and builder.

We earnestly urge our readers to carefully study this debate. The topic is one of the most serious importance. Not alone for the reason that it vitally affects the future practice of architecture, but also because it is so interwoven with the question as affecting architectural education, the proper status of the student draftsman and the ultimate growth of the Institute to a truly representative body in numbers.

In opening the discussion Mr. Emil Lorch, of Michigan, asked to address the Convention with regard to the status of the architectural draftsman. He said:

Through an accident, I got into the building of the American Federation of Labor. They have a building here, a six or seven-story building. I was looking for the Federated Engineering Council. Now, it is my impression that the trouble with the architectural draftsmen does not begin with them so much as it does with the engineering and contractors' draftsmen. The architectural draftsmen, as a whole, are of a higher order than some other groups of draftsmen in that larger mass of which they would form probably about 5 per cent, so far as it can be roughly estimated; and I should like to suggest that the problem of the draftsman be studied again in conjunction with that of the engineering draftsman, and by reference then to the Engineering Council. I think the Engineering Council will presently be just as much concerned with what is going on among their draftsmen as we are with ours. We had an illustration of that in Detroit, where the influence of these other draftsmen led to a movement to organize a union among the architectural draftsmen. By dint of very careful handling that was deflected, and an architectural club was organized where the better draftsmen are holding the positions.

Mr. Ernest J. Russell, of St. Louis: Mr. President, I should like to make this statement, which has a bearing upon the remarks that have just been made:

The joint committee of architects and engineers took up in a tentative way this same subject at its meeting on Tuesday of this week, and decided unanimously to recommend to the Engineering Council that a committee be appointed to consider this particular subject so far as the engineers were concerned. That being the case, it might be well for the American Institute of Architects to co-operate nationally with the engineers, who are just as vitally interested in this particular subject as are the architects.

Mr. Albert Kelsey, of Philadelphia: Mr. President, this question of the relationship of the draftsman to his employer, and also more particularly, perhaps, the relationship of the students in our thirty-eight universities and colleges to their future employes, it seems to me is one of very

vital importance to the existence of the profession itself as a profession and as an art. Of course, industrial and economic conditions have forced us in this Convention to regard conditions in a post-war reconstructive manner, and we have been forced—I do not criticize at all—to regard things in the condition that we find the world at the present moment; but architecture from time immemorial has been something a little apart from these sordid bread-and-butter problems.

Now, the draftsmen, and especially the hundreds and hundreds of students who are being graduated from our thirty-eight colleges and universities where architecture is taught, sometimes start out with a little glimmer of idealism. For a moment—I am not going to digress very far—I wish to digress, and to allude to the meeting we had last night.

General Ansell, in his very forceful address, toward the end casually, superficially, and without conviction, alluded to Ruskin. It was a decorative touch, and was a graceful gesture. I do not think it was anything more; but it was that touch of idealism that I think we ought to keep in mind, and it seems to me that we ought to think now and then of the great moral leaders of the world in the past, especially in times like these, and try to keep their torch burning.

I have not seen a line of Ruskin, as far as I know, for months, certainly not within the last few weeks; but, if I can quote correctly, Ruskin said:

"Good taste is a moral quality. Tell me what a man likes, and I will tell you what he is."

Now, that is the attitude of mind of the keen student. Only a few days ago a former draftsman of mine, who has not been in my employ for two or three years, came to me and told me he was up against it. He said: "I love architecture. The only trouble with architecture is, it is too damned interesting." Then he went on, and he told me his family troubles, that he could not make enough to make both ends meet, and he thought he would have to give it up, and he was very, very sad about it. Now, it seems to me that we have reached a point where it is our duty to point out to these young men that if they are going to stick to architecture they have got a hard row to hoe, and they have got to be more or less contented with the joy of working; and it seems to me that this Convention and we as employers do not sufficiently warn the student as to what he is up against.

There are a great many who can afford to go into architecture and pour out their hearts on their work, who are not entirely dependent upon their salaries; but I do think that we ought to cease this constant economic discussion long enough to look at the other side of the problem. Somehow or other, this Convention has reminded me of something that took place at the conference at San Remo two weeks ago. I have not been in that quaint old town for over thirty years, and doubtless it has been very much improved and enlarged and modernized, but I have a feeling that it has lost some of its old sturdy character.

## THE AMERICAN ARCHITECT

Only five years ago the main street of Fiume was known as the Corso Guillermo Seconda. Then a great burst of enthusiasm and change of heart took place, and they took down the signs, and they named it the Corso Wilson; and then only the other day there was another change of heart, and they changed their same old street to the Via Fiume.

It seems to me that this volatile process is injurious, certainly to art, and that we as architects, striving to make our cities not only more practical but more of an inspiration to the people, ought now and then to hark back to the old ideals, and that the Institute itself should remember some of the very great men we have produced who, in spite of "hell and high water," stuck up for their ideals. (Great applause.)

Mr. Lorch: I forgot to say before that over in the building of the American Federation of Labor I found an office, a suite of rooms, which is the headquarters of the National Organization of Architectural and Engineering Draftsmen. I met the secretary, and he said he would like the privilege of coming before this organization. I merely want to transmit his wish to you. It would probably be worth while for some committee, before this organization leaves Washington, to investigate the situation at first hand right here in Washington.

Mr. Henry K. Holsman, of Chicago: Mr. President, referring to the report of the Post-War Committee and the work of that committee on this subject, I should like to call attention to what some of the chapters in the country are doing in the matter of the relation of architects to draftsmen. The San Francisco Architectural Club sent in an interesting report as to how the architects in San Francisco are caring for the welfare of the draftsmen. The Illinois chapter feels that it is very important that the chapters throughout the country should take an interest in the draftsmen's organizations, and I should like to hear from San Francisco about the way they are working with the draftsmen's organizations.

Mr. William B. Ittner, of St. Louis: Mr. President and Gentlemen: I think it was quite evident to those who attended the interprofessional meeting last evening that a great many of our difficulties are due to the fact that we are not acquainted with our brothers in the professions—all good professions. I think perhaps some of our difficulties, or supposed difficulties, with respect to our employes, are perhaps due to the same causes. I have often felt more or less guilty by reason of the fact that I am myself not in closer touch with my draftsmen. I have often felt that one of the great needs of the American Institute of Architects was a closer touch with their students. I have often wished that there was some method by which this body could be intimately connected with the student draftsmen, whereby this body could take under its wing, as it were, the man who is to become the future architect, watch his career, and give him every help that we could to train him for the greater service which he is to render when he actually enters professional work.

I like the suggestion of Mr. Lorch of having some one here who represents the National Federation of Labor, and I believe that we are fortunate this morning in having such a representative. Yesterday, at the Lincoln Memorial, Mr. Boyd introduced me to a representative of labor in Philadelphia who is actually co-operating with the profession for the advancement of his craft. I think Mr. Boyd has the gentleman present, and, if so, I should like very much to hear from him. (Applause.)

Mr. D. K. Boyd, of Philadelphia: Mr. President and fellow-members of the profession of architecture:

You heard in the report of the Post-War Committee about a little activity—little at the beginning—which has

been started in Philadelphia between the men who work on the buildings and certain individual architects. Unfortunately the movement is not a chapter movement. I hope that it will become a chapter movement in Philadelphia, and I am sure it will when the matter is fully understood, and that it will become a chapter movement in every State in the country, to the end that the men who initiate the designs for buildings will come in close contact with the men who actually execute those drawings.

For about four years I have been trying to get the Philadelphia chapter to organize all of the forces in the city of Philadelphia which have to do with the sheltering of humanity. For two years I have made myself unpopular with some of the officers of the Institute in trying to drive across the idea, as I saw it, that the architects were the leaders in the entire realm concerned with the sheltering of humanity. Nothing having happened in Philadelphia along those lines for all that time, I asked the Allied Building Trades Council, representing nineteen labor unions, if I could not come before them. I did what I very often do—butted right in—and I gave them a talk. I said something like this: That I thought the time had come when the men who executed the work that we architects initiate should come in closer contact with us, and that if all of the organizations of workmen, builders, and architects, officially and otherwise, would not co-operate, let us see if we could not get together individually; and speaking to them as man to man I said that I thought the time had come in the labor-union movement when the discussion of the wage-scale and of the hours should cease, and when those men owed it to themselves to consider only taking more interest in their work, improving the character of work done, and making it as effective as possible.

I will not say what else I said, but I left the meeting—that was several months ago—and immediately I began to receive letters and telephone calls, and finally a visit from a committee of the Bricklayers' Union of Philadelphia. This committee said it had been formed as a result of this little talk. They came to see if the architects were in earnest in trying to help the laboring man to take more interest in his work, to help him to do better work, and above all to interpret the ideals and aims of the architect. That so appealed to me that I asked Mr. Zantinger, chairman of the Educational Committee of the Institute, Mr. John Bright, chairman of the Committee on Community Planning; Mr. Medary, whom you all know, and who has been very active in it; Mr. Horace Wells Sellers, who was the acting regional director of the Post-War Committee, and Mr. Abell, my partner, who is not a member of the Institute, and they all went with me up to a conference with the Bricklayers that has resulted in so many things that I hope you will allow me to ask you to hear what Mr. Hagerty has to say about it. He is one of the members of the Educational Committee of the Bricklayers' Union of Philadelphia. (Applause.)

### ADDRESS OF WILLIAM J. HAGERTY

BUSINESS REPRESENTATIVE OF THE BRICKLAYERS' UNION OF PHILADELPHIA, AND REPRESENTATIVE OF THE COUNCIL OF ASSOCIATED BUILDING TRADES.

**M**R. PRESIDENT, Ladies and Gentlemen of the American Institute of Architects: I wish to extend to you greetings from the Council of Associated Building Trades of Philadelphia, and the Bricklayers in particular, expressing the hope that from your deliberations here constructive legislation will come forth to better not only your own particular profession but the man who follows along and executes your planning.

## THE AMERICAN ARCHITECT

It is true that we have been for a considerable number of years afraid of the architect. We have always seemed to think that he was something far above us, and could not be reached; but after attending your Convention for two or three days, and the little social intercourse that I have had with you, I have come to feel that you are just as democratic as the man is who meets in his little labor union, trying to solve some of his little problems. (Applause.)

Mr. Boyd, a member of your Institute, who has been very active in the city of Philadelphia in his efforts to bring about a better understanding and to present the subject in a better light to the labor unions and to the public, has done such a wonderful amount of good that it is spreading all over the city of Philadelphia. We heard Mr. Boyd speak at the Council of Associated Building Trades one night; and, being a young man who tries to be progressive and to follow the interests of the men whom I represent, I had a committee appointed to call upon Mr. Boyd to see whether he was sincere in the remarks that he had made at that meeting. Our natural conclusion at that meeting, naturally being a suspicious lot of fellows, was: "Well, here is another politician who is trying to further his own interests" (laughter); but after appointing a committee and calling upon Mr. Boyd we learned that Mr. Boyd was very sincere, and we asked Mr. Boyd for his assistance and co-operation in trying to educate our members up to a higher standard. We found, after an investigation, that 90 per cent of the bricklayers who belonged to the union—and there are approximately two thousand in Philadelphia—did not know how to read a plan, did not know one symbol from another, nor what it meant, and we immediately started a class to educate our men; and I think we gave Mr. Boyd's partner, Mr. Abell, more work than he thought he was really going to have, because we finished up with a class of two hundred. (Applause.)

After I found out what good Mr. Boyd had done, and the other architects and the other speakers whom Mr. Boyd brings to our meetings every Monday night, I immediately took three boys under my wing and educated them myself. We now give our building out to nine different unions who are teaching their members how to read plans and how to construct work more properly without being directed by one man over a considerable force which he could not handle. Our aim and object is, if I may say so, now, to have every bricklayer, and if possible every building trades craftsman in the city of Philadelphia, as good an architect as we can make him. (Laughter and applause.)

After a little experience that I may tell you about, we were always under the impression that our employers and the architects thought that the more illiterate a workingman is, the better workingman he is; but after taking two or three boys under my wing and educating them myself, sending them to school and watching over them, I find that they are four of the best men in the city of Philadelphia to-day. They are only twenty-four, twenty-five and twenty-six years of age, and they are now superintendents for contractors (applause), which goes to prove that the more opportunities a workingman has of being educated, the greater productive factor he is, and a cleaner and better citizen of the United States. (Applause.) We have come to the conclusion that the only really logical and sane course to take to kill radicalism, socialism and bolshevism is to educate the workingman. (Great applause.)

I feel sure, as some of my colleagues do, that if the American Institute of Architects would take its proper place and be the guiding hand of all the building crafts-

men, from the common laborer up to the completion of the building, if the architect would take his place as the leader, which he really is, instead of apparently staying aloof and having everyone looking up to him, as we see it, greater results could be obtained, because without a guiding hand, someone to teach us, we naturally drift into a powerful organization that does not understand the rest of our fellow men and wants to run right over them. We have no desire to do that. We want to learn, and we want educated, intelligent men to be our leaders, whether they belong to our respective organizations or not.

You can readily see that the representation of the Institute upon the Jurisdictional Board of Awards has done a wonderful amount of good in the building world. In fact, you cannot at this time conceive what an amount of good it has done. You all know that from 50 to 60 per cent of strikes are caused by jurisdictional disputes; and if we have some one to say: "You cannot do this," as this jurisdictional board has already done, it minimizes the amount of trouble in the building world; and I should like to see that continued and fathered by this Institute, so as to lessen the amount of trouble that may be. While I realize that at this time there probably cannot be any direct co-operation, unless along educational lines, for the Institute to be a father, as it were, over the building trades, I feel sure that if the local chapters or the city chapters would take an interest as the Philadelphia chapter is doing in the city of Philadelphia, great results would come forth from their activities.

Mr. Boyd, I may say, now has the absolute confidence of sixty thousand building-trades men in the city of Philadelphia. (Great applause.) He can do more, I believe, than any other man that does not belong to organized labor. He can go into their meetings and sit down and listen to their discussions. He is invited, and they are looking to him and to the local chapter to be the one guiding hand in the city of Philadelphia to teach and educate the workmen, and it is something they certainly do need. I thank you. (Great applause, the members rising.)

Mr. Frederic Biggin, of Alabama: Mr. President, for some years I have been interested in gathering the experiences of our agricultural college graduates after they have had years of training in the offices. I regret to say that frequently—in fact, in the majority of cases—it seems to be well expressed in those words of Solomon: "Vanity of vanities, all is vanity and vexation of spirit."

While serving as architect in a great construction arm of the War Department during the war, I was struck with the prevalence of this frame of mind on the part of the hundreds of draftsmen there. A very large proportion, rather to my surprise, was composed of graduates of the foremost architectural schools—Harvard, Columbia, Cornell—and the technical schools, such as Carnegie Tech and Boston Tech and our own Alabama Polytechnic; and yet in almost every instance the gist of their experience was: "I am sick of the whole business." Now that is fundamentally wrong.

Only last evening I spent the time with a former graduate of my own institution, whom I recollect as a most enthusiastic, hard-working student, and the experience he expressed was: "I hate it all. I love architecture, but I hate my experience as an architectural draftsman, a member of office forces."

Now, what is wrong? It is not so easy to tell in all details; but some things are so clear that they stand out in letters of fire.

One is that the average draftsman—and I can remember my own young draftsman days in Philadelphia—works night and day, enthusiastically, very often steadily, on the

## THE AMERICAN ARCHITECT

development of some scheme, and he never sees even the foundation stone laid or the completed building unless he makes a special expedition to it after it is done. He has no connection with it during the process of construction. It is true that wages and salaries are better now. In past days, that was a stumbling-block. The draftsman's income was not sufficient to allow him to live like a gentleman, to marry, and to do his full duty as a citizen. But there is another point that I believe we of the American Institute of Architects have neglected, and that is that the draftsman ought to feel himself in some sort a part of the great movement of architectural development, as represented by the American Institute of Architects.

In this connection, let me say that we are missing a great opportunity in that line in the colleges. Every architectural college of high grade, at least, has what is known as the architectural association, a voluntary organization of the fellows for the purposes for which we are met here—to advance themselves in the profession, to promote good fellowship—and the discussions and papers that are presented at these association meetings are frequently of a very high order. The meetings are enthusiastic. Such bodies give that esprit de corps that means so much for a course in architecture; and if you want to see how students of architecture can work, you ought to come up to our big drafting room at ten or eleven o'clock at night, when other students, perhaps, have finished their work and are just enjoying themselves. Our fellows are working and developing their designing problems, not because they have to; it is all extra time, thrown in.

At present, however, there is no way provided to bring those boys, after they graduate from college, under the influence of the Institute. At the time when they are struggling as draftsmen, perhaps, to make ends meet and acquire further training, or as young architects to get jobs and keep the wolf from the door, the most impressionable time, they are not affiliated with the Institute, nor have they any chance to be. I should like to see something done to connect the office draftsman with the Institute, and something done to affiliate with the Institute these strong architectural associations of students who are going shortly to be in practice as architects.

The electrical engineers in their institute, and the mechanical engineers in theirs, have solved this problem. They have junior chapters, as it were, at their colleges. They are not full members; they do not expect to be recognized as such; but they have connection with the parent body, and after graduation they just as naturally drift into it as our graduates at present do not. Many, I believe, the majority, of architectural graduates are now lost to the Institute, at least for a long term of years. That is all wrong. To my mind, they should come as naturally through connections established for the purpose by us, into this body of ours as a boy reaching his majority becomes a citizen and a voter. (Applause.)

The Secretary: The Secretary would like very much to call attention to what seems to him to be at least perhaps to a certain extent a misunderstanding on the part of Mr. Biggin in regard to the possibilities of the present Institute organization—not necessarily the way the present possibilities are carried out by the chapters, but the possibilities of the situation. That very thought of the need of affiliating the students with the Institute body as early as possible has been in the minds of the Board of Directors for a long while, and underlay the construction of the standard chapter by-laws, and a special provision was included to cover it. It has been felt that until a man was a full member of the Institute, with all that that implied in his standing and position in the profession, he ought not

to be privileged to use the name of the Institute, because that has been found in chapters in the past to make it easy for a man to get substantially all the benefits of the name and the association and then stay there regardless, really, of his progress in the ranks. So, with that in mind, the following clause was incorporated in the standard chapter by-laws:

After stating the details of the associateship class, in which a member may only stay for three years before becoming a full member of the Institute, it is stated that—  
“Chapters may also, for co-operation or to provide a recruiting ground, affiliate with themselves other groups or organizations of architects, draftsmen, sculptors, craftsmen, students, etc., who shall, however, have no connection with the Institute nor voice in chapter or Institute affairs, nor any right to use the name ‘American Institute of Architects.’”

In other words, they are an affiliated organization, with a definite link of interest and control and co-operation, although they have no right to use the name of the Institute; and it seems to me that operation under that clause would go very far to meet the suggestions of the last speaker.

Mr. George H. Gray, of New Haven: I should like to speak as to the practical point of carrying this into effect. As chairman of the Educational Committee of the chapter for many years I had occasion to try to work this thing out; and in a chapter of that size, which is representative of many of the chapters of the country, I found it exceedingly difficult to bring anything into the chapter which was attractive to the draftsman. What I finally did was to get the city university to organize an extension course in architecture, with an atelier and courses of lectures, so that the student should have a chance to improve himself—that is, the general draftsman—and even the graduate from the architectural school should have a chance to continue his studies of a theoretical nature after graduation, and while he was in the office. That has worked out very satisfactorily to a certain extent, but it did not bring them into the chapter, nor did it make them a part of the profession.

My feeling is that that could be carried much further, and be made a general force in the Institute, if the Institute would organize through the educational department, probably, a more or less standardized course of lectures, with copious lantern-slides, which might go around the country, and lectures be given within the chapter by chapter members and within the chapter room, so that there would be something to attract the draftsman to the chapter, something to make membership mean something to him. Merely to get him in to be an ornament to the roll of the chapter means nothing to the draftsman. He feels that he is simply being toadied to, and there is nothing to it so far as he is concerned; but if you can give him that kind of return for his membership I think it will get somewhere.

The average chapter cannot organize those courses of lectures, nor can they get together the necessary material for the lectures. It could be done through a central committee of the Institute in a far more thorough and satisfactory manner, and at comparatively little expense.

There is one other matter of which I should like to speak, and that is, the relation of the architect and the client to the contractors. I tried a little experiment just before the war began which was proving very successful. At the completion of a building I would get the client to organize a housewarming party to which all the contractors, sub-contractors and important material men were invited. (Applause.) We got them together, and they were men who



## THE AMERICAN ARCHITECT

had been fighting one another because of the difference in their interests. The roofer with his flashing and the bricklayer were constantly at odds as to who was responsible for a leak in the roof and the spoiling of the plastering, and the plasterer came in on that, and so on all the way down the line. We got those men together; we got the receiver of their finished product, the client there, and a few of the client's friends, to receive them; and it was really a most satisfactory thing. It made a finer relation between all these various sub-contractors and contractors, between the client and the contractors, and between the architect and the contractors, and everybody got together with a much better understanding and it was passed on to the next client that there was something that was working to the interest of the client through a certain office; and if the various architects would try that, I am satisfied they would find their work much smoother and pleasanter for everybody concerned. (Applause.)

Mr. William B. Ittner, of St. Louis: I believe that the machinery is already provided by the Institute for bringing about what we all seem to feel is necessary—some closer and more intimate relation between the student and the Institute. It will be remembered that at the Nashville Convention a motion was made regarding the work of our Educational Committee, that they were not only to cooperate with the schools of architecture in arriving at some definite conclusion as to the course of study, but they were to consider (I think the motion read) the relation between the British Institute and the student draftsman in England, and to investigate and report to this Convention upon some scheme whereby the student of architecture, the earnest man, could be brought into close touch with the Institute.

Mr. Parker read a provision in the chapter by-laws which he feels would bring about the closer relation locally. I do not like the wording of that by-law, because the very verbiage of it seems to set up a barrier which it would be my desire to break down. The Educational Committee, it seems, have had no time during the past year to take this matter into consideration. It would seem to me quite proper, then, for this Convention to reaffirm its action at Nashville; and while it perhaps is undesirable to direct the Board, it might be well to say to them that it is the sense of this meeting that its Educational Committee should as soon as practicable present some comprehensive plan whereby the student of architecture and the student draftsman of the country could be brought into closer relation with the Institute. I so move you. (Applause.)

Mr. Cecil F. Baker, of Kansas: I should like to say a word for the information of our friend from Philadelphia. The department of architecture which I represent, believing that we are training citizens in our architectural students as well as technically trained men, believing that we owe a service to the community and that our students must gain that sense of service in their profession, and that the service cannot be complete without a full understanding of the point of view and of the work of the men with whom they must carry on building operations, has planned for the coming winter a short course to take place during the dull season of the building trades, in which we propose to offer free to contractors and to their employes a short course of six or eight weeks in planning, estimating and some lectures explaining the architects' point of view. I grant that it is still in the embryo stage, but we believe that it is very hopeful. The contractors of Kansas are enthusiastic about it. Our students are enthusiastic about the contact which they foresee with the men who carry out the designs which they execute; and I believe it offers a possibility both of great opportunities to our architec-

tural students, to contractors and their employes, and of education and better understanding on the part of the public of both professions. (Applause.)

Mr. Don Barber, of New York: I had not thought to delay this meeting or to make any remarks on this subject, but it has been occurring to me right straight through this Convention that all these problems of the relation of the architect to the draftsman, and to the client, and to the world, and their ideals, and all these things, were somehow or other tied up in one basket, one simple idea. I do not know that I can state just what this idea is, but in my mind it is something like this:

We as a country, a democracy, are ruled by the majority. Unfortunately, the majority is always lacking in what the minority seems to have—that is, more education, more whatever you like. In other words, it is the minority that points the way, and it is the majority that destroys. We see it in our political life; we see it all the way down the line; and it seems to me that the American Institute of Architects was started through a proper impulse by men of high ideals, by men who had the profession and the practice of architecture in their minds and a desire to develop it to its highest form, and that the Institute has gone along very well in the term of its life, preaching education, trying to get together, trying to agree on certain rules of behavior, and that it has done an extraordinary work; but I think the time has not come when the Institute has got to broaden its influence. (Applause.) I think there are entirely too many art societies in the United States. (Applause.) Take the condition in the city of New York: I have forgotten how many art societies there are, so-called, all taking care of a little branch of art, and they do not get together. They are all groping toward the same ideals, they are all shooting in the right direction, but they are all shooting parallel, and the bull's-eye is too darned big. (Laughter and applause.)

Now, if I remember rightly—and I am giving impressions rather than anything else—the membership of the Institute I think represents probably not more than ten, certainly not more than twenty per cent of the number of practicing architects in the United States. We have done a work based on a solid foundation extending over a period of fifty years; and I ask you to consider what would happen if the eighty per cent decided that we were a nuisance, and wanted to put us off the map? (Laughter and applause.) It is not unlikely that they are going to do that, either, because there have been already, here and there, these little embers burning, and talking about the pride and the glory and the Sunday-school theories of the Institute. There is this rumbling, this beginning of a revolution. We find it lately in this question of draftsmen, these embryo architects, these men who should be and who have got to be in time members of this Institute and run this question of the architectural profession. I believe that the whole thing could be solved by a consensus of opinion which would be so big and so understood and so simple that when the Institute—or whatever the name of the society may be when it gets to be that big, and I hope it will still be the Institute—says something, that word will be heard all the way around the world, and there will be no comeback on it.

There is no question in my mind but that the existing unrest among the draftsmen—that is what we are talking about this morning—comes from a lack of understanding and a lack of consensus of opinion in the offices in regard to the way they handle the work and handle the draftsmen. The draftsman is thrown from one office, doing work in a certain way, to another, with a different range of salaries, different kinds of work, all sorts of things. In

## THE AMERICAN ARCHITECT

New York the other night we had a little dinner. Mr. Atterbury invited a few of us to his house to discuss this matter, and I think he invited twenty or thirty men, and nine of us showed up, as usual. (Laughter.)

We began discussing the various methods in use in our offices, and there were not any two of the nine men whose architectural practices in their offices bore any relation—I am talking now of the relation they bore to the draftsmen—that was in any way parallel. Now that the draftsman is floating from office to office, and now that we are reaching a consensus of opinion in regard to certain larger phases of the subject of architectural practice—I think you will agree that in the expression of architectural practice in the buildings that have been erected in the last ten or fifteen years more progress has been made in simplicity, character of design, fitness, in other words, than from the beginning of the history of the architectural profession in this country. If we are getting together on those academic questions, why can we not get together on the way that thing is produced, and in that way transmit a certain systematized arrangement down to these younger men on whom we are absolutely dependent?

I believe that this question of draftsmanship is the most serious thing we have got to face to-day. I think we have got to show our draftsmen that men who work in the creative arts cannot be unionized (applause); that their own future will fall of the force of that kind of organization. That they should co-operate and be organized, I fully believe. This is a day of organization, and I think they are all going to organize; I do not think we can stop it; but I think we have got to give them a run for their money. We have got to pay them enough money, as Mr. Kelsey said, to make both ends eat—I mean, meet. (Laughter.) I think this is one of the most serious matters that is before us to-day, and I believe the solution of it lies in going out now and getting a larger membership in the Institute, getting all these societies so affiliated that they speak with one voice and that we gain strength; and when we gain that strength we should, then I believe all this education, all these requirements of the code of ethics, these dear old hobby-horses of the Institute which have rocked along for years and have been perfectly delightfully cared for, groomed, painted every year, have all been crutches of education. We have analyzed the trouble of the architect, and we have provided this crutch and that crutch and the other crutch, and now we can walk pretty well on crutches, but I think it is about time that we got to a position where we could throw all our crutches away and walk out in the sunlight alone. I think we ought to get to a point where, when we look in a brother architect's face, we do not have to worry about whether he has got the code of ethics in his pocket or is using it in his office. (Applause.) I think the quicker the Institute gets to control at least 75 per cent of the architects in this country, so that they understand each other in the voice of one big, overwhelming organization, the quicker all these smaller problems will fall away of their own weight.

Mr. Kohn: I am here only as a substitute, in a way, for Mr. Fenner. Mr. Fenner made a report to the Board on the situation in New York, and I think certain elements of that report will be of value to the men attending the Convention.

I think he and I, who were working on the same committee in New York with the draftsmen, realized that the problem is quite different in different parts of the country; that is, it is absolutely different in the big cities from what it is in the small towns. In the big cities the first thing we have faced is the fact that there is a shortage of draftsmen. We are convinced that there are less than there

were before the war available. Even going up-State to the meeting of the State Association in Utica last year, I discovered there were no draftsmen available in the small towns. That may, however, not be true throughout the country.

What is the trouble? Why are the men leaving the profession, leaving the work of architectural drafting and going elsewhere, as they apparently are? Why are so few coming in? There is probably some financial background to the thing; at least, that was our first idea. We have found otherwise. We have found that that is only one element in the problem.

In New York there are two organizations formed. We were approached by the Union of Draftsmen, I shall call it that, the body to which Mr. Lorch referred, connected with the American Federation of Labor.

The Institute was approached, at the National Convention, by the American Architectural Association as it was called, an association of draftsmen formed in New York. By request the Institute Committee in New York met some of the representatives of the association, and I personally met the representative of the American Federation of Labor Unions. We are working with the association which was started by a group of a hundred and fifty or two hundred draftsmen in New York, who did not wish to be affiliated with the Federation of Labor, who wanted an organization of draftsmen so that they might stand together for beneficial purposes, any beneficial purposes, not excluding an increase in pay, if that turns out a subject for action; but, at any rate, a group of draftsmen who felt they were connected with the profession, in which they wanted to stand for certain educational things that were to improve the quality of their service as the secretary read in the report, quoting from the by-laws, and they did not think it was consistent with their purpose to be a part of the Federation of Labor.

The three architectural societies, of employers, I mean, the architectural societies of New York, appointed committees, two delegates, to meet with this group of draftsmen to see what they wanted to do, and those meetings are now going on.

I will come to the point of that thing, although this is not a report of what is actually going to take place, but I am very certain it will result in agreement to co-operate between this association of draftsmen and various architectural societies in New York, in order to better the service of both the draftsmen and the architects. (Applause.)

I want to say that in my experience with these draftsmen, sitting down with them, with these delegates from the Draftsmen's Association, I do not believe they got very much out of me, but I learned a great deal from them. Let me say, in answer to some suggestions which have been made here, that in the big cities where there are many draftsmen, it is different from what it is in the country. They do not want to belong to your association, most of them. They are not comfortable in your association. They will not say in your organization what they will say among themselves. We found that out, getting a group of them together. They feel quite differently about the whole thing. They are always employes, and we may say what we please about calling them friends. I heard somebody in the League in New York say: "My men are my friends. I am close to them," and all that sort of thing. They may feel that as intimately as you please. I feel that way about mine, the men who are working with me. But that has nothing to do with it. There is the distinction you cannot overcome, that you are paying them, and they feel it. You have the control over

## THE AMERICAN ARCHITECT

the money. It is perhaps the meanest thing in the world, but nevertheless it is true. It is just in the blood. They will say certain things when you get them together by themselves, when they are in the majority, in other words, which you cannot get any other way, and we of the committee, Mr. Fenner, some other architects, and I, with an equal number of draftsmen, six architects and six draftsmen, sitting down with this committee representing two or three hundred men, have heard things I have no doubt about ourselves, our own offices, which we had not suspected. Certainly, I say that about myself. I do not want to exclude myself from condemnation. We heard of perfectly astonishing cruelties, if you please—absurd cruelties, to the feelings of the men, from ignorance, perfectly simple things that we could all correct in our practices, as Mr. Barber has suggested, but which we do not know about until we get these men together, and we have to help them get together.

I am not going further into this subject. I would be glad to discuss it for hours, because we have been in it for weeks with these men. But my one message is this, in some districts you may be able to get them in with the Institute, but in the larger cities you have to help them form their own organizations, where they can help each other to establish certain practices, to agree on what is the practice, questions of pay and discharge. When you sit down, as we have, and hear from these men, nice fellows, who were not soreheads, these things it makes you pause. These were not fellows who needed to demand greater pay. As it happened, the Association elected as members of this committee men who could get a job anywhere any time. I do not think there was a man there who was earning less than perhaps a hundred dollars a week. So they were no soreheads, and they told us stories about discharge in some of the big offices, being bounced without notice. If you heard about one office we heard about in a certain city, which they knew about, and in which one of the men had been employed, you would be astonished. They worked these men overtime for three weeks in order to get a certain set of drawings out; they pleaded with them and begged them, and the drawings were gotten out on Friday night, and Saturday twenty-one men were discharged from the establishment.

That is not an isolated instance. We have heard the most astonishing stories. Perhaps none of us are guilty of that sort of a meanness, but little things, perfectly petty, little things you hear about, which get these men just as sore as they can be, and they say, "Why should we stay in this thing?"

Here is another point. It is not the man who is going to be an architect who really makes the trouble, the man who feels he has a chance to practice for himself. He is all right. But really we have to acknowledge that a large number of these men are going to stay draftsmen all their lives, they are bound to, and it is simply irksome to them, and they see no progress, and in a good many of the larger offices, they are just pegging along. A man is skillful at detailing, and he is kept at that, and another is skillful at another thing, and he is kept at that. There is no variety.

There is also a certain secrecy in some offices. We do not want them to learn too much about what we are doing; they might take our clients away and start up for themselves. We are all guilty of it.

What is the answer? We have to go back to our several communities and put unionism aside. We should worry about it. If you are right with your men, what is the difference what they do? Stand for anything. Help them get together. If you have anything to teach them, help them get ahead, and meet them frankly and in every way possible in their own association. Let them form their association. I am convinced that is the only way. And cordially say, "We will co-operate. Come on in when you feel like it." Have joint meetings, if you please.

I have been won over in the last three weeks to this idea, that we cannot get them in our association and really help them, but we can help them form their own association, and co-operate to the limit with them. (Applause.)

---

### CONVENTION NOTES.

The dinner, held at the Chevy Chase Club, and which marked the close of the Convention, was a most enjoyable and intimate affair. It was an entirely informal occasion and for that reason was perhaps attended by an unusually large number of delegates. More than 150 were present.

\* \* \*

The presentation on the morning of the third day, of the Institute's medal for excellence in Craftsmanship marked a pleasant occasion. Mr. Samnel Yellin, of Philadelphia, was the recipient of the medal, which was awarded for excellence in work in wrought iron.

\* \* \*

During the quieter times while the Convention was in session, many delegates took opportunity to wander through the adjacent picture galleries to view the very fine collection of pictures and sculpture. The Havermeyer made an ideal convention hall.

# Beaux-Arts Institute of Design

DIRECTOR OF THE INSTITUTE, LLOYD WARREN

ARCHITECTURE, WILLIAM F. LAMB

SCULPTURE, JOHN GREGORY

INTERIOR DECORATION, ERNEST F. TYLER

MURAL PAINTING, ERNEST C. PEIXOTTO

## Official Notification of Awards— Judgment of January 27th, 1920

### PROGRAM

#### CLASS "B" II—ANALYTIQUE

The Committee on Architecture proposes as subject of this Composition:

#### "A WALL FOUNTAIN"

At the end of a rectangular pool, in a public garden, it is proposed to erect a fountain in the form of a decorative free standing wall. The Medicis Fountain in the Luxembourg Gardens in Paris, and the Fountain of Trevi in Rome are well-known examples of this type of fountain, particularly the former, as therein the development of the crowning motive (of special importance because it is silhouetted against the sky) is clearly indicated.

The subject of this program is the treatment of the facade of the fountain which faces the pool. In composition, it shall be divided into three ways of equal or varying widths if desired, by the use of one of the orders. Niches, statuary, vases and other decorative forms may be used, and the order shall be set on a pedestal base, and may or may not be surmounted by an attic or other motive. The fountain shall not exceed 30' in width.

JURY OF AWARD: P. A. Cusachs, H. Davenport, E. A. Park, H. Hornbostel, E. Gugler, E. F. Tyler and J. F. Harbeson.

Number of drawings submitted—50.

### AWARDS:

FIRST MENTION PLACED:—E. C. Rising, John Huntington Polytechnic Institute, Cleveland; D. W. Earle, Patron-R. M. Hood, New York; H. T. Plumer and W. R. Fisher, "T" Square Club, Philadelphia.

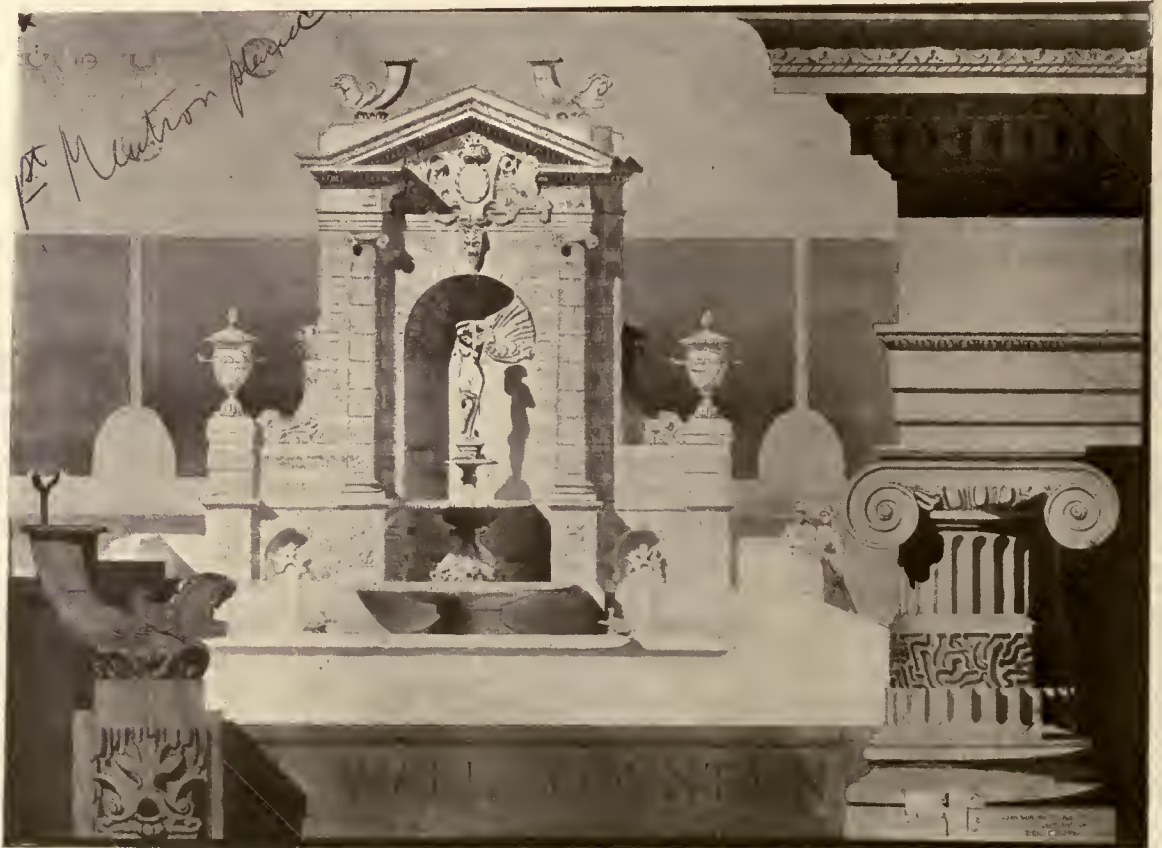

E. C. RISING

FIRST MENTION, PLACED

JOHN HUNTINGTON POLYTECHNIC INSTITUTE

CLASS "B" II—ANALYTIQUE—A WALL FOUNTAIN

# THE AMERICAN ARCHITECT

FIRST MENTION:—J. Truden and A. R. Mohr, Atelier Corbett-Gügler, New York; W. S. Boice, Atelier Hirons, New York; G. H. Brockow, Los Angeles A. C., Los Angeles; H. F. Neville, University of Kansas, Lawrence; D. P. Thomas, University of Washington, Seattle; G. B. Bengtson, Boston A. C., Boston.

MENTION:—R. W. Arnold, G. L. Newman and F. W. Crimp, Boston A. C., Boston; J. P. Bennett and G. J. Hanniken, Atelier Corbett-Gügler, New York; A. M. Taylor, C. H. Dornbusch and H. J. Hoefener, Columbia University, New York; H. B. Hays, F. J. Brince, H. Van Der Lyn, E. Olsen and W. S. Robson, Jr., Atelier Hirons, New York; W. A. Schabel John Huntington Polytechnic Institute, Cleveland; W. W. Mezger, G. S. Dudley, E. Brockow and M. Sabransky, Los Angeles A. C., Los Angeles; L. Mazurowski, Atelier North, Buffalo; E. A. Beihl, "T" Square Club, Philadelphia; R. R. Hibbs and F. R. Stuhl, University of Kansas, Lawrence; V. Carlson, A. D. Harrington and M. D. Williams, University of Minnesota, Minneapolis; D. M. Campbell, W. Douglas, D. Weinstein, H. S. Kelly, C. B. Lewis and B. S. Georges, Yale University, School of Fine Arts, New Haven; A. Wuchterl,



FIRST MENTION, PLACED

D. W. EARLE

PATRON R. M. HOOD

CLASS "B" II. ANALYTIQUE—A WALL FOUNTAIN

Atelier DeGelleke, Milwaukee; L. A. Gulling, Atelier Schadler, Reno; E. Penfield, Atelier Wynkoop, New York.

## PROGRAM

### CLASS "B"—II PROJET

The Committee on Architecture proposes as subject of this Competition:

"THE GENERAL READING ROOM OF A PUBLIC LIBRARY"

The chief conditions necessary to a successful reading room in a public library are an abundant, diffused light, quiet, and an architectural expression that is simple and dignified. It should be above all ample in its proportions, as in no better way can the quiet atmosphere so suitable to reading and reflection be obtained. The exact form is immaterial. It may be rectangular, square, round, or cruciform, or even subdivided by points of support, provided only that the arrangement is such as to permit of an adequate control by the librarian of both the reading tables and the entrance and exit. The Bibliotheque Nationale and St. Genevieve in Paris, the Library of Congress in Washington, the New York Public Library, the Columbia University Library and the Boston Public Library all show the diversity of forms and treatments that are possible.

The room that is the subject of this problem occurs on the main floor of the public library in one of our large cities. The building is so disposed that all the walls are exterior, except one which abuts the Catalogue Room, and through which is the entrance to the Reading Room. The main book stack is directly under the Reading Room, and there are no floors above, so the Reading Room may take any form desired, provided that the superficial floor area does not exceed 10,000 sq. ft. The distribution of books



PLACED FOURTH. FIRST MENTION

W. K. HARRISON

ATELIER CORBETT-GUGLER

FIRST PRELIMINARY PARIS PRIZE COMPETITION

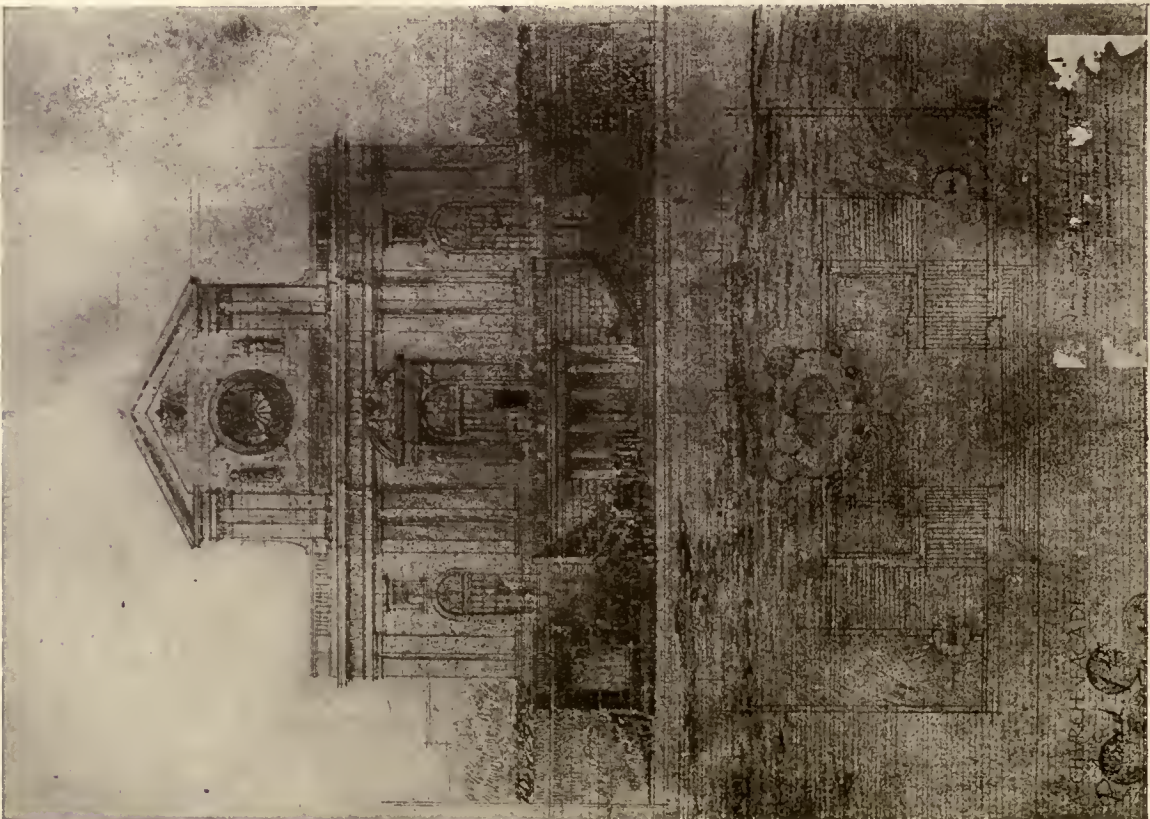

R. S. SIMPSON

PLACED FIRST, THIRD MEDAL

PITTSBURGH L. A. C.

FIRST PRELIMINARY PARIS PRIZE COMPETITION—A CHURCH FACADE

SOCIETY OF BEAUX-ARTS ARCHITECTS

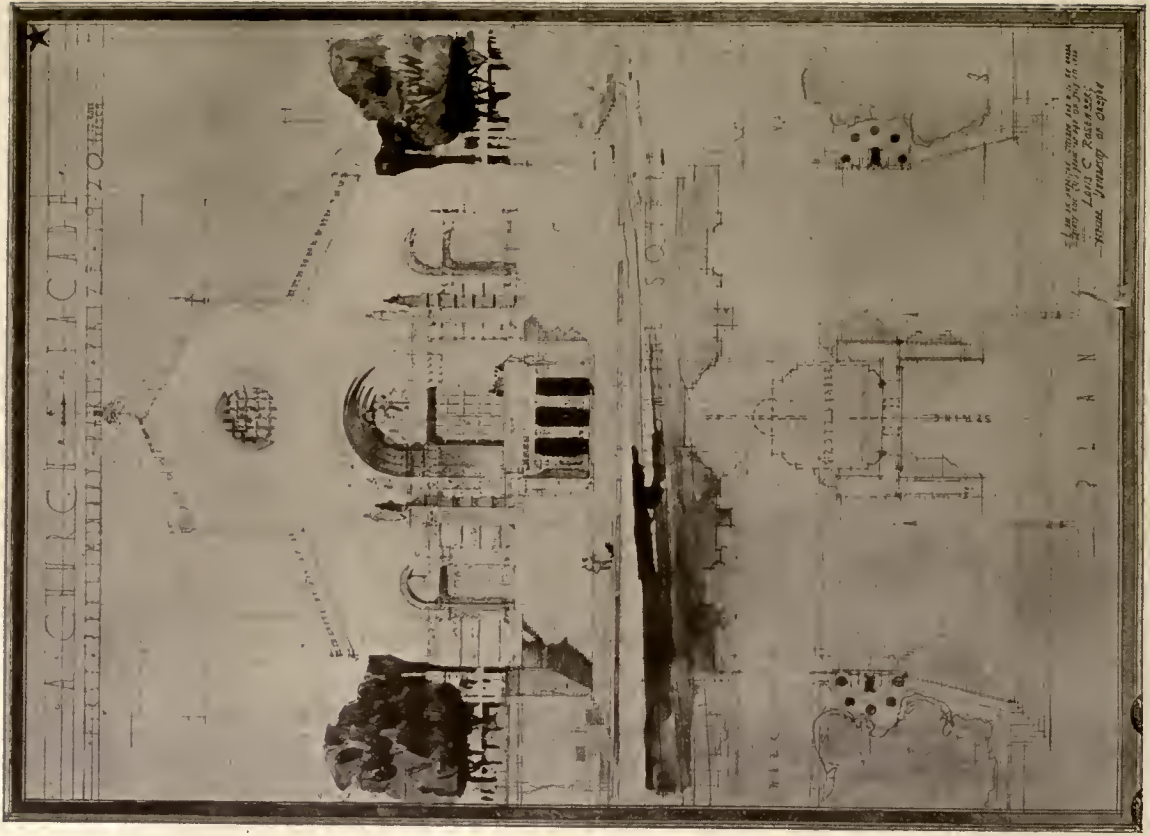

PLACED SECOND, THIRD MEDAL

L. C. ROSENBERG

UNIVERSITY OF OREGON

THE AMERICAN ARCHITECT

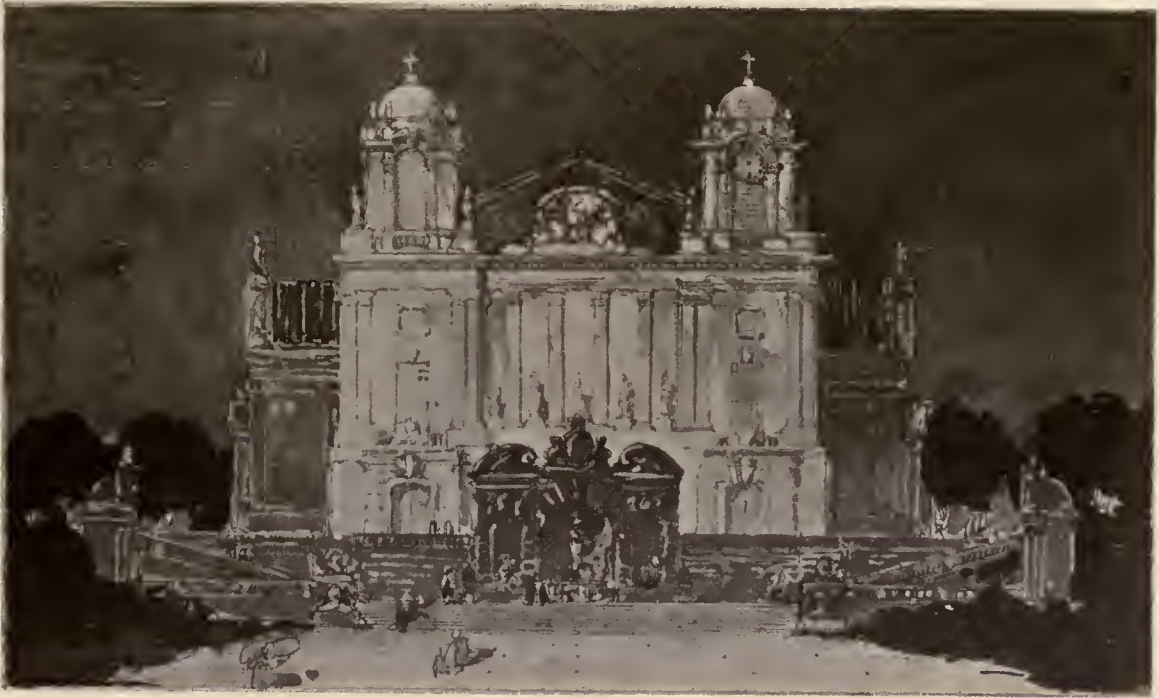

G. W. TROPAST-GILLETTE

PLACED THIRD. FIRST MENTION

COLUMBIA UNIVERSITY



L. SIMPSON

PLACED FIFTH. FIRST MENTION

WASHINGTON UNIVERSITY

FIRST PRELIMINARY PARIS PRIZE COMPETITION—A CHURCH FACADE

SOCIETY OF BEAUX-ARTS ARCHITECTS

# THE AMERICAN ARCHITECT

shall be controlled from the Librarian's desk, which shall have a direct connection with the book stack by means of lifts and elevators. Ample provision shall be made around the walls or otherwise, for reference books.

**JURY OF AWARD:** R. M. Hood, F. A. Godley, L. Warren, F. C. Hirons, S. W. Morgan, A. D. Seymour, A. M. Brown, E. V. Meeks, M. Prevot and J. W. O'Connor.

Number of drawings submitted—36.

## AWARDS:

**FIRST MENTION PLACED:**—C. F. Wright, Boston A. C., Boston; F. W. Brown, Columbia University, New York; M. Jaeger, Jr., Atelier Hirons New York; O. L. Gowman 611 West 156th street, New York; J. B. Lindquist, Chicago A. C., Chicago.

Washington, D. C.; P. Goodman, Atelier Licht, New York. H. C.:—J. Feil, Los Angeles A. C., Los Angeles. Judgment of January 27, 1920.

## Society of Beaux-Arts Architects

Official Notification of Awards—Judgment of February 23d, 1920

FIRST PRELIMINARY COMPETITION FOR THE 13TH PARIS PRIZE

OF THE SOCIETY OF BEAUX-ARTS ARCHITECTS PROGRAM

The Annual Committee on the Paris Prize proposes as subject of this Competition: "A CHURCH FACADE"

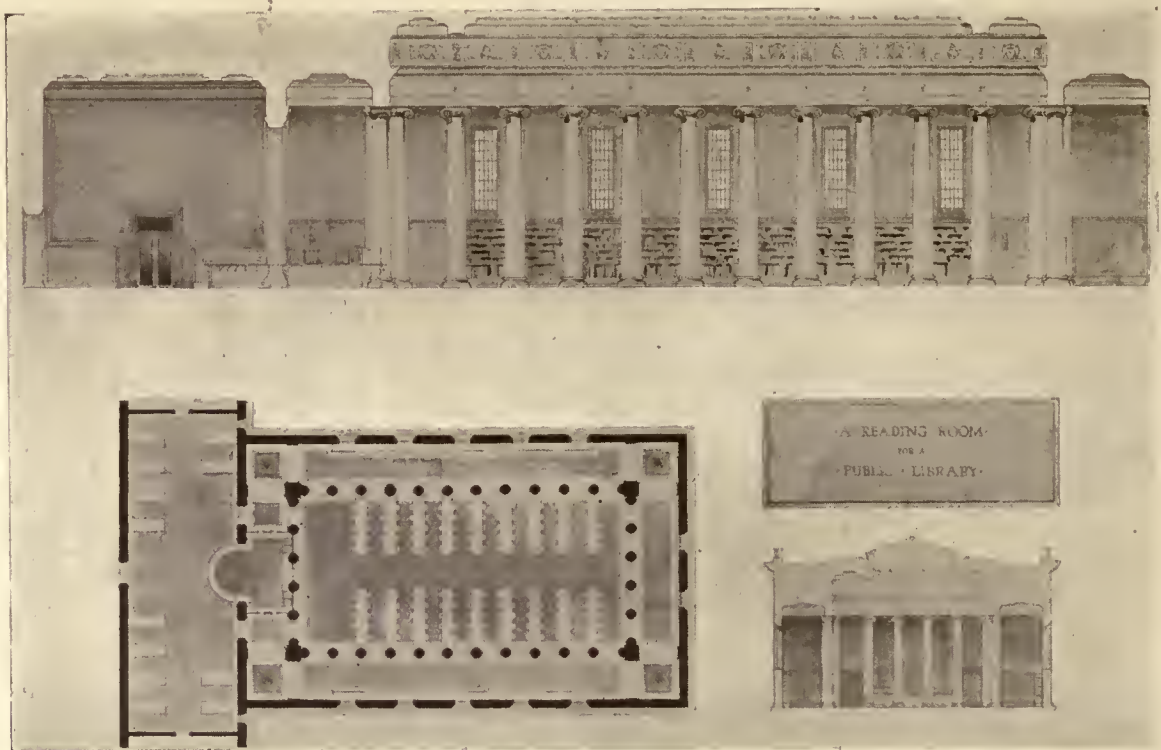

F. W. BROWN

FIRST MENTION, PLACED

COLUMBIA UNIVERSITY

CLASS "B" II, PROJET—THE GENERAL READING ROOM OF A PUBLIC LIBRARY

**FIRST MENTION:**—O. P. Morton, Boston A. C., Boston; O. Betts, Columbia University, New York; J. Lucchesi, Atelier Hirons, New York; B. F. Miller, University of Minnesota, Minneapolis; R. B. Thomas, L. Hamilton and D. W. Murphy, Yale University, School of Fine Arts, New Haven.

**MENTION:**—R. E. Hacker, W. C. Yanike, H. R. Kaplan, W. D. Moyle and J. Hill, Columbia University, New York; L. F. Fuller, G. Chittenden and L. Rombotis, Los Angeles A. C., Los Angeles; E. R. DeShaw, Syracuse University, Syracuse; J. L. Fleming, W. M. Icenhower, E. Bircsak, J. W. Dawson and D. K. Frohwerk, University of Kansas, Lawrence; G. H. Levy, Atelier Wynkoop, New York; A. C. Smith, Yale University, School of Fine Arts, New Haven; G. A. Daidy, George Washington University,

## GENERAL:

The entire facade of a Renaissance Church has been destroyed by shell fire, leaving intact the main body of the building with its center and side aisles transept, Sanctuary and Vaulting. The church stands on an elevation at one side of the principal square of a town in the south of France, so that the French, Spanish or Italian style will be appropriate. In front of the church and on its axis gushes a holy spring, which has been revered for centuries. It is proposed to rebuild the front from the funds of a great international subscription, and at the same time build new and handsome approaches with stairways, balustrades, a niche or grotto over the spring, and two shrines at either side or in front for two statues miraculously preserved during the bombardment.



# THE AMERICAN ARCHITECT

## DIMENSIONS:

The central nave is 40' wide, 75' high to the crown of the vaulting, 80' high to the ridge of the roof, with two side aisles, 25' wide and 40' high to the top of the roof over the vaulting. The church stands on a terrace 20' above the level of the square with the spring 5' above the level of the square. The distance from the church facade to the side of the square is 60'.

## REQUIREMENTS:

Elevation of the church and the approaches.

Plan of the facade of the church and approaches.

JURY OF AWARD:—R. H. Dana, Jr., L. Warren, R. M. Hood, W. Lamb, L. F. Peck, W. Van Alen and E. L. Tilton.

Number of drawings submitted—118.

PLACED FOURTH—(1st MENTION):—W. K. Harrison, Atelier Corbett-Gugler, New York.

PLACED FIFTH—(1st MENTION):—L. Simpson, Washington University, St. Louis.

PLACED SIXTH—(3rd MEDAL):—E. R. Purves, University of Pennsylvania, Philadelphia.

PLACED SEVENTH—(1st MENTION):—N. Larson, University of Minnesota, Minneapolis.

PLACED EIGHTH—(3rd MEDAL):—R. L. J. Riling, University of Pennsylvania, Philadelphia.

PLACED NINTH—FIRST ALTERNATE—(3rd MEDAL):—F. A. Chapman, San Francisco A. C., San Francisco.

PLACED TENTH—SECOND ALTERNATE—(3rd MEDAL):—E. L. Howard, Cornell University, Ithaca.

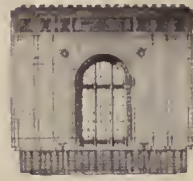
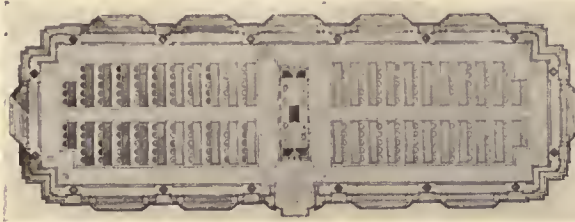

O. L. GOWMAN

FIRST MENTION, PLACED

NEW YORK

## CLASS "B" II, PROJET—THE GENERAL READING ROOM OF A PUBLIC LIBRARY

### AWARDS:

PLACED FIRST—(3rd MEDAL):—R. S. Simpson, Pittsburgh A. C., Pittsburgh.

PLACED SECOND—(3rd MEDAL):—L. C. Rosenberg, University of Oregon, Eugene.

PLACED THIRD—(1st MENTION):—G. W. Trofast-Gillette, Columbia University, New York.

MENTION:—G. N. Pauly, Carnegie Institute of Technology, Pittsburgh; G. D. Conner and T. M. Hofmeester, Jr., Chicago School of Architectural Design, Chicago; R. H. Douglas, Pittsburgh A. C., Pittsburgh; L. B. Wamnes, Atelier Rebori-Chicago A. C., Chicago; A. W. Inman, University of Pennsylvania, Philadelphia; H. J. Korslund, University of Minnesota, Minneapolis; P. N. Jensen, Atelier Wynkoop, New York.

# Report of the Standing Committee on Education, C. C. Zantzinger, Chairman, to the Fifty-third Annual Conference of the American Institute of Architects

AT the Board meeting on May 3, 1919, the Committee on Education for the term of 1919-1920 was appointed and instructed.

"The Board of Directors, in order to carry out the instructions of the Convention as to the continuing organization of the Committee on Education, as well as to further the study of the various educational problems to be considered by the Committee, creates it for the present year as follows:

"A committee of nine, three for three years, three for two years and three for one year.

"Three subdivisions of the committee, forming sub-committees of three members each on the following subjects:

"First.—Architectural Education.

"Second.—General Education.

"Third.—Public Appreciation of the Arts.

"Each sub-committee to contain a one-year, a two-year and a three-year member, so that the sub-committees will have a continuing membership from year to year, as well as the entire committee.

"The chairmen of the three sub-committees to form an executive council, one of them being general chairman of the Committee on Education."

It has been impossible for your committee to hold any full meetings during the year. There have, however, been held two well attended meetings in New York—one on July 15, 1919, and the other on November 10, 1919. The chairmen of the sub-committees have met repeatedly during the year.

The reports of the sub-committees are as follows:

## 1.—*Report of the Sub-Committee on Architectural Education.*

Two of the Board's instructions to the committee referred directly to architectural education, to wit:

A. That relative to co-operation with the Association of Collegiate Schools of Architecture, and

B. That relative to co-operation with the Committee on Registration Laws.

A. The last Convention adopted the following resolution:

"*Be it Resolved*, By the American Institute of Architects that its Committee on Education be instructed to study and, with the co-operation of the Association of Collegiate Schools of Architecture, to determine upon a definite program whose purpose shall be, first, to define the preparation requisite to professional practice, and, second, to suggest changes in prevailing school methods looking toward their improvement."

Throughout the year there has been co-operation between the chairman of this sub-committee and of the committee of the A. C. S. A. The discussion that follows is submitted in the hope that consideration of it by the Convention may lead to conclusions of a constructive nature.

The resolution above directs the committee:

"First, to define the preparation requisite to professional practice."

Primarily, this must be such as to produce the equipment necessary to the architect, as prescribed by the Institute in its Circular of Advice on Professional Practice. This may be considered to be summarized in section 19, which reads:

"The public has the right to expect that he who bears the title of architect has the knowledge and ability needed for the proper invention, illustration and supervision of all building operations which he may undertake. Such qualifications alone justify the assumption of the title architect."

No one of the human vocations makes more varied and exacting demands upon its votaries than that of architecture. Always a noble calling and in modern times recognized as one of the learned professions, the building art has become so wide in range of responsibility and so complex in its technical requirements that none but a broad and extensive preparation can fit the novice for it. The various functions of the architect call for breadth and keenness of mind, creative ability, taste and perception of beauty, knowledge of construction and materials and their behavior when assembled in structure, and business and administrative capacity. It is manifest that these qualities can only be developed through both study and practice; hence the recognized necessity for training in two stages—in the school and through apprenticeship.

We offer as a definition of the preparation requisite to practice that the architect should have equipment as follows:

1.—Intellectual. A general college education or its cultural equivalent, and a knowledge of the history of the arts, of the theory of construction and of his obligations as a citizen and a professional man.

2.—Artistic. Skill in design; a disciplined creative faculty marked by imagination, taste and a sense of beauty.

3.—Technical. A knowledge of practice, including the preparation of working drawings, specifications, contracts and preliminary estimates, the superintendence of buildings, office administration, etc., and a comprehensive insight into modern building methods.

The resolution further directs:

"And, second, to suggest changes in prevailing school methods looking toward their improvement."

The committee have informed themselves concerning these methods and also of the criticisms made of them and of the results attained by the schools.

A review of the curricula shows a successful effort on the part of the schools to so condense the essentials that graduates have had at least an introduction to the most necessary subjects. We believe that, generally speaking, no more can be done, even under the most favorable conditions, in the inadequate period of four years.

Our study convinces us that under the widely varying existing conditions, the schools have rendered good service. It is the duty of the committee, as we understand, to see to it, that the requirements of the profession are more clearly defined. We hope to bring about co-operation between the teachers and the practicing architects as an immediate benefit to the schools and an ultimate gain to the profession. We approach this task with hope of support, for none but the most blind could fail to see that of all the subjects brought before the last Convention, none awakened greater interest than did that of education.

With the reorganization of the Committee on Education as outlined above, has come the opportunity to formulate over a period of year a series of requirements and a statement of opinion which may serve as a guide to the schools of architecture in making their curricula.

## THE AMERICAN ARCHITECT

We are impressed with the great magnitude of the problem that lies before any school that attempts to offer to its students a curriculum embodying a specific preparation for all the phases of modern architectural practice. Manifestly, many of these are specialties, for which the well-rounded theoretical training of the student will fit him generally. We must, for this year, confine ourselves to a consideration of the course in architecture as usually understood.

In considering any course of study, we should bear in mind that it has been organized for the benefit of the average student in the average college, the genius will know no discipline. It is probable, and even desirable, that the schools of the far East and the far West will be far apart in the application of any theories we may develop.

The school of architecture has been well defined as "the nursery of the imagination." We believe that, while the greatest care should be exercised not to hamper the development of the genius by undue insistence upon a grinding effort to acquire knowledge, we must not forget that the *average mind* must be trained, for the unfettered flight of the untaught imagination must be discouraged.

We conceive that the first efforts of the school should be to a greater emphasis on construction, on design in three dimensions and on a realization of the materials involved. It is our thought that instruction in the interrelation of these fundamental considerations should go slowly and insistently forward hand in hand, having always in mind together, the beauty and the fitness of the design. We therefore advocate that a greater emphasis be placed on the teaching of the theory of construction, and we deplore any subdivision of the course which tends to separate design from construction.

It is with regret that we are forced to register our conviction that education in our art as now offered in some of the schools tends too often to the superficiality that is observable in higher educational methods generally in this country. In order to mitigate against this condition, we believe that the usual college standard of sixty to seventy per cent as a passing mark should be raised in all essentially technical subjects; in other words, we advocate a greater thoroughness.

With reference to the teaching of architectural design, we are convinced that this can best be done by practicing architects, and we therefore advise all who are inclined to specialize as teachers not to give up practice. On the other hand, we beg to remind the practitioners of their responsibility to the rising generation in our profession, and to suggest that they be more responsive to the opportunities for service offered them by the schools in the way of lectures and criticism.

Concerning the detailed arrangement of the courses, we believe that these should be so grouped as to afford an opportunity, first, at an early period for the sifting out of the ineligible; second, for the giving in an intermediate period of an equipment adapted to the requirements of the average man in general or ordinary practice; and, third, in the last period, for the unhampered development of the student's imagination through the medium of advanced design in contact with the most mature and developed minds available.

We suggest the probable usefulness of the moving picture for instruction in building and manufacturing methods. We believe that the course in history and design could be advantageously supplemented by travelogues given from the essentially architectural point of view with emphasis on the plan, art and architecture of the cities illustrated. And, finally, we recommend for consideration the advantage to the student of an actual sight-seeing journey in America under the guidance of an instructor.

This brief summary of our consideration of the existing methods of instruction and of our comment thereon leads us to but one conclusion. The schools have made a brave effort to do what they believe to be necessary within the period usually allotted to the college course. It is our firm conviction that the school cannot do that which is expected of it in the time allotted, and we therefore offer the following resolution:

WHEREAS, The schools of architecture generally are so organized as to condense their period of study to four years, and

WHEREAS, A consideration of the courses given shows that they are generally good but hampered by a too great condensation, and

WHEREAS, It is the conviction of the Convention that more courses, more thoroughly given, are requisite, therefore be it

*Resolved*, That the American Institute of Architects does hereby recommend to all schools to lengthen their course in architecture to a period to exceed four years in order to make it possible to include such necessary studies as have been left out of the curriculum, and to give more time for the more complete assimilation of the subjects taught.

B. The last Convention adopted the following resolution:

*Resolved*, That the Committee on Education and the Committee on Registration Laws be instructed to consider jointly, and report to the next Convention, a proper standard of professional competency for those admitted to practice under the name of Architect, and a method of determining its fulfillment in individual cases."

The chairmen of the two committees have met and considered these questions.

The Committee on Education believe that a proper standard of professional competency has been outlined above (under the first section of A). This can properly be set up as the ideal towards which to work. As a step in this direction, we recommend that in all States where registration laws are under consideration, the Chapter committees and committees of the State Association recommend the adoption of a standard at least equivalent to that now required by the State of Illinois. Whenever such laws are drafted, it is desirable, the committee believe, that provision should be made for the acceptance without examination of applicants for registration who are graduates of any school which is a member of the Association of Collegiate Schools of Architecture.

In view of the varying conditions of practice in different parts of the country, it is inadvisable to set up a hard and fast maximum requirement. On the other hand, we are convinced that a minimum requirement is essential. And the same may be said of the method of determining its fulfillment in individual cases.

We have investigated the methods of the State of Illinois and find them good. We therefore offer the following resolution:

WHEREAS, The American Institute of Architects has previously and does now encourage the adoption of laws for the registration of architects by all States, and have to this end prepared a typical law for the guidance of such legislation, and

WHEREAS, The efficacy of such laws can be greatly enhanced by the adoption of proper standards of professional competency and equitable methods for their determination, therefore be it

*Resolved*, That the American Institute of Architects, while convinced that many States will wish to set up higher standards, recommend as a minimum standard both of professional competency and methods for its determina-

## THE AMERICAN ARCHITECT

tion, the standard adopted and the methods now employed by the State of Illinois.

C. At the last Convention a report on the educational methods employed in England was requested. This is in progress, but at this writing is not to hand.

D. No report of the Committee on Education this year would be complete without reference to the admirable discussion of architectural education made before the last Convention by Mr. Thomas E. Tallmadge in behalf of the joint Committee on Reconstruction, Illinois Chapter and Illinois Society of Architects, Sub-Committee on Education. To the teachers will fall the duty of so arranging the school courses as to take advantage of the additional period of study recommended in the resolution above. Mr. Tallmadge's report should be of great value to them.

2.—*Report of the Sub-Committee on General Education.*

Owing to the broad application of modern investigation and methods made in the report of the Committee on Edu-

cation of last year, it is particularly to be regretted that, because of his ill health, the chairman of this sub-committee, Mr. Grant La Farge, has been forced to offer his resignation from the committee. The consideration of this important branch of the committee's work will have to be placed before the Convention of next year.

3.—*Report of the Sub-Committee on Public Appreciation of the Arts.*

The program to govern the writing of an essay to be used as the opening chapter or introduction of the proposed book to be published by the Committee on Education, as prepared by Mr. George C. Nimmons, chairman of this sub-committee, is submitted herewith. In it is outlined the work of the committee during the year. This program is being modified from day to day as occasion for discussion offers. It is presented to the Convention herewith [see Appendix] in its unfinished state, in the hope that discussion on the floor may lead to its final definition.



WINDOW TO THE STAIRCASE AT SUTTON COURT, NEAR CHISWICK, ENGLAND

This three-light, or Wyatt, window is typical of the delicate style of work that prevailed in the latter part of the eighteenth century. Its charm is due to admirable proportions and refined detail, the frieze being carved with rosettes, flutings, and a dentil band, and surmounted by a carved and glazed lunette.

*From The Architects & Builders Magazine (London)*



VIEW OF ADMINISTRATION AND MAIN CELL BUILDING

## Federal Prison, Atlanta, Ga.

EAMES & YOUNG, *Architects*

TOWARD the close of the second administration of President Grover Cleveland, Congress authorized the building of two Federal Prisons—one to be situated in Atlanta, Georgia, and one in Leavenworth, Kansas—and Eames & Young were appointed Architects for both Institutions by Attorney General Griggs. Instructions were given the Architects to ignore all precedent in prison architecture and to give to their design as much of the character of the usual Departmental building as possible, consistent with the purposes of the building, and expressive of the dignity of the Federal Government.

A contract was let for the minor Cell Wings, Dining Room, Assembly Room, and other utilities sufficient for the proper housing of prisoners. When this had been accomplished, it became the policy of the Department of Justice to use convict labor so far as possible in further construction. A Superintendent of Construction was engaged who had charge of all building operations under the Architects; temporary shops were built and civil foremen in each of the principal trades were placed in charge. These came to be, in effect, trade schools affording healthful occupation and opportunities for education of the men in wage earning crafts. The product

of their labor, of course, became valuable to the Government though used in the Institution buildings only. The stone cutting shop alone employed several hundred men who cut all of the Georgia granite facing used in the Main Cell Building and Administration Building shown in the photograph. Some of this was quite difficult to produce but the quality of the workmanship was fully equal to that usually obtained by civil labor. However, the work was necessarily slow owing partly to the limited annual appropriations by Congress and because of the necessity of keeping the convicts continuously em-



HOSPITAL BUILDING

## THE AMERICAN ARCHITECT

ployed. There were some disadvantages following this policy as well, as the full efficiency of the Institution could not be developed until the completion of the last cell wing early in the present year.

**T**HE Institution cannot be said to be entirely completed except so far as the present contract with the Architects is concerned, as no doubt the construction of other buildings will be required sooner or later. In fact, the original layout included sites for factory buildings, of a kind to be afterward determined, arranged symmetrically by streets around a central campus or playground.

Referring to the airplane view—the buildings shown in their order are: Administration Building, Main Cell Building, Connecting Corridor, Minor Cell Building; and on the main axis, the building containing dining room, assembly room, tailor shop, etc.; kitchen, bakery and storage buildings, and across the street the Power House. The buildings

on the left of the axis are the Laundry Building and Deputy Warden's office. On the right is the Hospital Building. To the left of the Power House are various temporary shops and in the background is a camp for tuberculosis patients. The large low building is a cotton spinning factory erected by the Government as a war measure and without the benefit of any architectural advice. Placed as it is, the original plan will have to be considerably modified if ever again considered.

The surrounding wall is of reinforced concrete sections varying from 40 to 50 feet in height. There is no patrol gallery, but guard towers are provided at the angles of the wall. Trap entrances to the grounds, or "sally-ports" as they have been designated, have been provided as shown in the airplane view—on one side to permit the entrance of railway cars and on the other for vehicles approaching by road from the direction of the City.

The buildings appearing outside the walls near



AIRPLANE VIEW, U. S. PENITENTIARY, ATLANTA, GA.

EAMES & YOUNG, ARCHITECTS

the railway gate are an incomplete group of farm buildings belonging to the Institution. Residences for the Warden and the Deputy Warden are on either side of the circular approach, but do not appear in the photograph.

No attempt has been made to complete the system of streets within the walls or to carry out the landscape and planting contemplated in the original sketch, though it may be done in the future and the temporary drive on the central axis removed.



VIEW OF ENCLOSING WALL AND SALLY-PORT

## Yellowstone Park Menaced by Commercial Purposes

FOR purposes of irrigation and general water supply, it is learned that the waters of the Yellowstone Lake Basin are to be exploited, and the world-famous region of beauty covering more than 3,000 square miles will be invaded by commercial interests. There is now before Congress a bill empowering the Secretary of the Interior to give away certain water rights in Yellowstone Park. It has already passed the Senate and is being considered in the House.

If there were only a commonplace corporation behind the scheme there would doubtless be heard the cry of "exploitation." But when a city pleads that it is athirst, as did San Francisco prior to her obtaining the Hetch Hetchy rights in the Yosemite National Park, or a group of farmers assert that food crops are being ruined for lack of large volumes of irrigating water as in the present instance, the heart even of a "nature lover" is apt to soften.

The present distress is due to the desire of irriga-

tionists in the Upper Snake River Valley in Idaho to submerge the Falls River Basin in the extreme southwest corner of the park, behind a set of dams, and force the water out upon their fields below.

It is conceded that more water may be required. There may not be room for doubt on that score. The doubt which has, however, arisen in the minds of those who are always suspicious of every attempt to confiscate a bit of national park soil for commercial use, is as to the necessity for creating their storage reservoir within the park itself. The feeling among the "antis" is that the reason dominating the selection of the proposed scene of activity lies in the fact that it is government land and cheap to acquire.

It is stated that there are at present about 300,000 acres of irrigated land in the valley of the Yellowstone River in Montana, and that without further water from the lake no extension of this area is possible. With the lake water they estimate that 700,000 acres additional can be brought under culti-

vation. Already they have arranged with the Reclamation Service for a study of the situation and a report, and once that is in hand Congress will be besieged to grant the right to use the park.

**I**F the interests of the agricultural communities of the country require the extension of irrigated lands, and this water is of fundamental importance, in the carrying out of that enterprise, it is not likely that the champions of the National Park would be disposed to quarrel with the fact. What they will want to be assured of is that there is a real economic necessity for this development of the water storage within the park; that sufficient water cannot be stored in the canyons farther down stream below the lake and outside the park; and that in any case a minimum injury shall be done to the park and its inhabitants. The viewpoint of those who take an interest in the National Parks has been expressed by the director of the Park Service, Stephen T. Mather, in his recent annual report.

Mr. Mather stated:

"There can be no utilization of the lakes of the park or of the Falls River Basin for irrigation that will not bring with it desecration of the people's playground for the benefit of a few individuals or corporations. All of the lakes in the park are in heavily timbered districts. Great forests reach down to the water's edge. In some parts of the park, level tracts of land embracing thousands of acres lie at an elevation of only a few feet above these lake shores. Raising these lakes will kill millions of feet of timber, wipe out miles of roads and trails, and create a scene of chaos and destruction that would be an eyesore for a thousand years. Is there not some place in this great nation of ours where lakes can be preserved in their natural state; where we and all generations to follow can enjoy the beauty and charm of mountain waters in the midst of primeval forests? The country is large enough to spare a few such lakes and beauty spots. The nation has wisely set apart a few national parks where a state of nature is to be preserved. If the lakes and forests of these parks cannot be spared from the hand of commercialism, what hope can we entertain for the preservation of any scenic features of the mountains in the interest of posterity? Yellowstone has been established for nearly half a century. Every plan to exploit it for private gain has failed to receive the consideration of Congress. Mighty railroad projects have even gone down to everlasting defeat. Must all the victories of the past now become hollow memories by the granting of reservoir rights that will desecrate its biggest and most beautiful lakes, and form the precedent for commercial exploitation of all its scenic resources—its waterfalls, its forests, its herds of wild animals, its mineral waters?"

The particularly unfortunate aspect appeals to that sense of sacrifice which requires a gradual giving up of all our much prized national domain

for the sake of sordid, money-getting purposes. It is the rarity of these places that makes them precious, and it is a temptation to call these constant invasions insidious and destructive despite their material importance. A precedent was started in the case of the Yosemite Valley, and it is already being followed in the Yellowstone. Tradition is again called upon to give way to "progress."

## Time of the Essence of the Contract

It is true that when two parties stipulate that a certain work shall be completed by a certain time, it means what it says, whether the time is, or is not, of the essence of the stipulation. The difference between a mere stipulation for a certain time and a stipulation for that time as of the essence of the contract is that if the former is breached there is no forfeiture; there merely arises a cause of action for damages on the agreement which may approximately flow from the breach. But if the time is so fixed that there can be no performance except within that time, then a breach forfeits all right of the delinquent, under the contract. It is true that time may be made of the essence of the contract without being so expressly stated therein, but in the absence of an express stipulation, it must be clear and apparent from the terms agreed upon and the nature of the contract that the parties so intended. In the case of a building contract with provisions that the owner may interfere with the work, arrest its progress, and delay its completion, the Kansas City Court of Appeals holds, *Harris v. United States Fidelity etc. Co.*, 213 S. W. 151, that it is outside the bounds of good reason to say that the parties intended a time certain as of the essence, when one of them has it in his power, if he chooses, so to change the work and add to it as to render it impossible to be finished in the time set. The circumstance that afterwards a party may not exercise the privilege given him in the contract cannot, of course, bear on the intention entertained at the time it was executed. And it is held that where a building contract gave the owner the right to take possession and complete the contract in the event of the contractor's breach upon three days' notice to the contractor, the owner was not justified in taking possession and preventing the contractor from performing because of the contractor's failure to perform within the required time, without having given such notice, where time was not of the essence of the contract.



# Current News

---

## Happenings and Comment in the Fields of Architecture and the Allied Arts

### Annual Convention, New York Society of Architects

At the Annual Convention of the New York Society of Architects, held at the United Engineering Society Building on May 19, James Riely Gordon was unanimously re-elected for the fifth consecutive term as President; Adam E. Fisher, of Brooklyn, first vice-president; Edward W. Loth, of Albany, second vice-president; Frederick C. Zobel, of New York, Secretary; Henry Holder, of Brooklyn, Treasurer, and Walter H. Volckening, of New York, Financial Secretary.

The seriousness of the building, housing and labor situations was discussed at length. Many committees reported, and many others were appointed to investigate these conditions.

This was one of the most notable and enjoyable gatherings in the history of the Society, now entering upon the fifteenth year of its existence. About forty members were present, out of a total of two hundred and forty, scattered over the United States and Canada. Among the speakers called upon by the President was the Society's former secretary, C. Whitley Mullin, who in a brief address mentioned the fact of his being the only member present of the original seventeen who started the organization in Brooklyn in the year 1906.

The speaker took occasion to urge the necessity of adherence to a few fundamental principles, if the Society was to continue to progress as it had done in the past. These principles were, first, loyalty, whether of individual members to the organization as such, regardless of personal preferences; or loyalty to a sound code of ethics; or, lastly, loyalty to the public generally, which is synonymous with public spirit.

In the next place Mr. Mullin urged the importance of giving adequate publicity to the Society's proceedings, as affording the most effective safeguard against oppression and other evils too numerous to mention.

Lastly the speaker urged full and free representation of the various schools of thought or types of practice, included in the practice of architecture, regardless of race distinctions, or of any other consideration of a secondary nature. Let the Society be as little exclusive as possible; and give the observance of these three principles—loyalty, publicity and representation—the speaker predicted that the New York Society of Architects would endure as long as the great city itself would survive.

Mr. Adam E. Fisher, in a few well chosen words, emphasized the importance of the organization maintaining its old-time aggressive character, both as to extending its membership and as rendering due assistance to individual members—especially the younger men—in their dealing with the various departments of the City Government.

Vice-president Loth, in an able and instructive address, dealt with the question of Registration of Architects, especially commenting upon the unequal and unfair operation of the law as it stands at present, some States requiring an outside practitioner coming from another state to register, whereas his own state is free and open to all comers.

### A Building Guild

The first practical demonstration of the guild plan of industrial control is imminent, according to the Manchester *Guardian*. A group known as the Building Guild Committee has made a tentative offer to the Manchester City Council to build 2000 houses for artisans. There is a pressing demand in Manchester for houses, and the organized workers in the building industry claim that they can build quicker and better under their own democratic control than under conditions beset with profit taking. The Guild Committee has the especial backing of the local Operative Bricklayers' Society, and the Manchester branch of the National Federation of Building Trade Operatives has also pledged its co-operation and support in the building project.

A question which has come up in the negotiations between the City Council and the Guild Committee is whether the committee would submit to the usual guarantees and sign the usual bonds, if it entered into a contract. This raises an issue that has been theoretically discussed in guild circles for two years—the possibility of group credit based upon the power to produce, in contrast with bank credit based upon the purchasing power of gold. The Building Guild Committee argues that it is not in the same position as a contractor. His financial stability is the essential thing, because he cannot control the supply of labor. On the other hand, the Building Guild Committee has an ample supply of labor, perhaps even a monopoly of it, whatever its financial condition may be. Therefore, a financial guarantee on its part would be beside the point; what is called for is a guarantee that the labor will be forthcoming and the houses built. The City Council has recognized, to some extent, the validity of this argument.

While the immediate purpose of the Building Guild Committee is to build houses and so to ease the acute housing situation, its ambition is to become the parent body for similar committees in other towns and districts. With this in view it hopes to build up an organization which can serve as a model. Such an organization would include representatives from all the building trades and also from the architects and other technical men, for the guild idea entails the co-operation of non-manual as well as manual workers. The ultimate aim of the Manchester group is the formation of a National Guild.

### Electric Drill Cuts Labor Cost

Electrically operated appliances are said to be rapidly supplanting other forms of power tools in industrial fields, particularly during the present shortage of skilled labor.

In this connection a Cleveland concern manufacturing electric tools cites an interesting case where an electric drill earned within \$8 of its cost price of \$116 in four days.

In this case, according to the report in the *Plain Dealer*, a Cleveland manufacturer desired to erect a mezzanine floor, to be supported by twenty-eight iron columns. To anchor these columns securely at the base, it was necessary

to cut square openings, fifteen by eighteen inches, through the floor, which consisted of seven-eighths inch matched hardwood laid on two-inch planks imbedded in a heavy concrete base.

Sawing was out of the question. By drilling holes at the four corners and chipping with hammer and chisel, two men took four and two-sevenths hours to cut the first opening. Then it was decided to use a half-inch electric drill, which cut the remaining twenty-seven holes in an average of a third of the time required to cut the first one by hand. Two men would have taken twelve ten-hour days to do the work the electric drill did in four ten-hour days.

The electric drill is said to be frequently used for general millwright work of cutting openings in wood, iron and steel.

## Senate to Investigate the Housing Crisis

The Senate has approved a resolution by Senator Calder providing that a committee of five Senators is to inquire into and report to the Senate as follows:

(a) The existing situation in relation to the general construction of houses, manufacturing establishments and buildings, and the effect thereof upon other industries and upon the public welfare; and

(b) Such measures as it may deem necessary to stimulate and encourage such construction work, to encourage popular investment rather than spending, to foster private initiative in building, and to insure co-operation between labor and persons or corporations engaged in transportation, banking or other business necessary to the development of such construction.

The committee is instructed to report prior to December 1.

In explaining the need for the resolution, Senator Calder declared that the country is in need of \$4,000,000,000 worth of buildings. Senator Calder stated that he proposes to resist with all the power he possesses in the Senate and elsewhere any effort to induce the Government of the United States to go into the business of supplying housing for private individuals.

## Must Have Service

The business men of the City of New York, without attempting to judge the merits of labor controversies, have determined to put an end to the interruption of public utility service and the consequent demoralization of business.

The Merchants' Association led the revolt by taking the following steps:

It secured pledges from its shipping members to deliver and remove freight from steamship piers;

It asked the city authorities to provide police protection;

It appealed to President Wilson to direct the enforcement of the law by federal agencies;

It took steps to form an alliance of shippers for mutual protection;

It invited a conference of the leading commercial organizations of the city which formed the Committee for Protection of the Rights of the Public in the Transportation of Goods.

This committee averted a New Haven steamship tie-up by conferring with the railroad managers and the unions.

This committee has asked the Chamber of Commerce of the United States to take a referendum upon the enactment of legislation to insure the continuous operation of public utilities.

## Glasgow's Municipal Housing

The City of Glasgow has given more than one example of the successful management of municipal enterprises and is probably responsible for a large number of failures made by other municipalities who sought to follow in the footsteps of the Scotch city without realizing that something more than a formula is necessary, and that plans, be they ever so perfect on paper, come to failure unless there is back of them the organizing mind and the directing hand of skilled managers. It is now more than half a century since Glasgow took up the task of providing proper housing for its people, and at this time, when the whole world is in the throes of a lack of shelter, it may be profitable to show what the one thoroughly successful exponent of communal management has accomplished during the fifty years of the continuance of the experiment.

Glasgow started about 1870 to tear down the old rookeries, put up new buildings and construct wider and better streets at a total cost of \$8,500,000.

A beginning was made by the erection of two model tenements and seven model lodging houses, six for men and one for women. The city put up stone buildings of from three to five stories in height. In each there is a large dining-hall and abundant kitchen facilities. There is in each also a large recreation room.

The seven lodging places can accommodate 2235 persons. The charges vary from 8 to 12 cents a night.

An innovation was the erection of a "family home" in which rooms are let to workmen with motherless children. Servants look after the children while the father is away at work and see that those of school age go to school.

The children are boarded for about 45 cents a week. The room for the man and his family costs \$1.10 per week. Children beyond the number of three are given beds in the dormitory at an extra cost of 16 cents a week. The last reports showed that 122 men and 146 children were living in this home.

In all, the city has provided homes for 2199 families.

## "Temple of Peace" Proposed for Los Angeles

Plans for the proposed construction in Los Angeles of a "Temple of Peace and Commerce" to cost \$20,000,000, were announced by the Society of American Republics.

It was stated the society would forward to Congress in a few days a proposed bill calling for an appropriation of \$10,000,000 toward the building and that under present plans, the other \$10,000,000 should be appropriated by the other republics of North, South and Central America.

The building, to be internationally owned, would contain a library, museum, art gallery, "Hall of Fame" and an auditorium seating 20,000 in which the annual meeting of the society would be held.

Edgar Temple, a member of one of the oldest families in Los Angeles, is president of the society; Ben McLendon, lawyer and publicist, and Dr. J. H. Reider, educator, both of Los Angeles, are vice-presidents, and Charles M. Holly, a New York, capitalist, is secretary-treasurer.

## Luminous House Numbers

The Detroit Citizens' League has appealed for house numbers that are visible at night. They think, it seems, that numbers of a metal or with a coat of paint that would serve this purpose could be got at the same price as those now in general use. One may perhaps add that

in spite of years of agitation many of our cities are as yet without any complete system of house numbering; and some of the largest cities, including New York, yet fail even to mark the street names in such a way that he who runs may read.

The time has passed when the total absence of artificial light after sundown prevailed, and people were obliged to go to sleep with the chickens. In those days, luminous house numbers would have been of no avail. But at a time like the present, when the public never rests—with midnight train schedules and late shifts of weary workers, it would seem the first law of hospitality to facilitate their wanderings by the observance of so small a detail.

## Housing Committee Named for New York

As a move to stimulate the solution of the housing problem Mayor Hylan, of New York, gave out the names of eighty-two men and women appointed to a Housing Conference Committee to draw up plans to increase housing accommodations. The committee includes city officials, architects, labor leaders, bankers, real estate men, railroad executives and representatives of newspapers. Frank Mann, Tenement House Commissioner, is chairman. He will shortly call a meeting of the committee.

In a letter to the members of the committee notifying them of their appointment, Mayor Hylan said the object of the committee would be to increase the housing accommodations and to accelerate construction of new houses by devising ways and means to encourage the investment of capital in buildings. He spoke of the shortage of houses as a "crisis" and said the housing shortage was as dangerous to the community at large "as lack of food and clothing, and is the leaven for the fermentation of unrest."

## Chicago Goes Tenting

The latest manifestation of Chicago's fight against the rent profiteer is the decision on the part of some to spend the Summer in a canvas home.

Hundreds of Chicago families are preparing to spend the Spring and Summer out of doors, while they rent their homes, if owners, or suspend housekeeping altogether if flat dwellers. They are ordering regular house tents, with wooden floors, canvas walls three feet up from the ground, upper part screened with curtains.

As a result of the home shortage on the north side it is expected that tent colonies will spring up along the North Shore all the way to Ravinia.

It is thought possible that Chicago will follow Cleveland's plan to relieve congestion in the poorer districts of the city and establish municipally-governed tent colonies in the public parks.

Municipally owned cottages and dwelling houses built by the city on public lands, with private owners of large tracts co-operating, is another solution of the house problem shortage facing Chicago, according to Building Commissioner Bostrom.

Mr. Bostrom already has tentative plans worked out for an elaborate system of cottages to be built both on public and private lands.

Commissioner Bostrom pointed out that the city owns hundreds of acres of vacant lands in outlying sections of the city.

"My plan is, if the emergency arises, to make use of these lands," said Mr. Bostrom. "The city could divide these properties into lots to be leased for stated periods,

or until conditions again become normal. The city could erect its own houses and rent them, or the tenants could build, the city to maintain jurisdiction and control of the properties.

"The house I have in mind would not be a temporary affair, but would be built in such manner as to permit its use for other purposes later."

## Building Material High in Belgium

The difficulties which the Belgians have had to overcome in their work of reconstruction during the last year and a half have been greatly augmented by enormous rises in the cost of nearly all kinds of building material. According to a table printed in the Brussels *Peuple* the only materials showing a decline since the beginning of 1919 are cement, gypsum and reinforced glass. On March 1 cement was quoted at 145 francs a metric ton (2200 pounds), gypsum at 210 and glass at 18 francs per square meter, against 100, 275 and 20, respectively, at the same time last year, and 30, 40 and 2 in 1914.

Structural iron on March 1 was priced at 125 francs per 100 kilograms (220 pounds), compared with 60 in the beginning of 1919 and 14 in 1914; lead sold at 300 francs per 100 kilograms, against 175 and 35; zinc at 400, against 200 and 55, and lime at 47 per ton, against 40 and 10. Domestic oak lumber sold at 1000 francs per cubic meter, against 500 a year ago and 200 in 1914, while pine has advanced to 375 from 250 and 75. At the present rate of exchange this makes the price of oak about \$175 per 1000 feet. Brick were bringing 55 francs per 1000, against 50 and 18, while roofing tile cost 360 per 1000, against 325 and 90.

## Health Service

A public Health Information Bureau has been opened at 119 West Fortieth street, New York, under the auspices of the Red Cross. Its purpose is to advise free of charge in health matters and to assist through clinics, hospitals, agencies, pamphlets, charts and maps.

The Bureau is being conducted by the Health Service of the New York County Chapter of the Red Cross. It is open from 9 to 5 each week day, excepting Saturday, when its hours are from 9 to 1 o'clock.

## New British Garden City Scheme

An entirely new scheme for a British garden city is comprised in the program of a recently formed joint-stock company. As reported by the American consulate, the scheme covers the erection of houses where every modern improvement and convenience will be included, the servant problem solved, shopping made easy, and all profiteering banned. The actual ultimate annual rental, under the proposed plan, will amount to about £3 (say \$15) per annum.

In reality the rent of a house will be £75 (\$365); but against this will be offset the estimated profit of 9 per cent. due the tenant on his payment of a capital premium of £800 (\$3893), amounting to £72 (\$350), thus leaving a balance for rent of only £3. It is stated that, by employing direct labor, the cost of each house will be reduced from £2000 (\$9733) to £1500 (\$7300). Advantages to be provided will include electric cooking, heating, lighting and vacuum cleaning, telephone installation, central restaurant and participation in profits, and a department store, the profits of which are to be returned under a profit distribution scheme. Apart from the fees payable to the directors

of the company, all subsequent profits come under the profit-distribution scheme for the tenants.

Respecting the servant difficulty, the company proposes to employ as many as may be desirable. These servants will have stated hours, freedom after hours and good wages; and they may be hired by the tenants by the hour, day, part-day or for several days weekly.

## Book Notes

THE TURNPIKES OF NEW ENGLAND—AN EVOLUTION OF THE SAME THROUGH ENGLAND, VIRGINIA AND MARYLAND. FREDERICK J. WOOD, MEMBER AM. SOC. C. E., BOSTON SOCIETY OF CIVIL ENGINEERS, NEW ENGLAND HISTORIC GENEALOGICAL SOCIETY. MARSHALL JONES COMPANY, BOSTON. 1919. VII + 441 PP. DIAGRAMS AND ILLUSTRATIONS.

The author of this interesting and valuable volume discovered in 1908, when preparing a report on certain transportation facilities, that public and technical libraries contained little or no material regarding the old turnpikes of the northeastern section of the United States. These turnpikes were the first public utilities in this country, being antedated only by a few water companies. This book is the outcome of a genuine interest in early road-building transportation facilities and a commendable desire to provide a work which would contain a complete record of the old turnpike companies and their problems. The stories of the various companies are interestingly told, and the problems of the early bridge builders are given in detail. While primarily a historical volume, it will prove profitable reading for engineers. Those who enjoy a trip into the olden days will delight in the stories of the New England roads, which have become so well known in late years, particularly through the advent of the automobile. The author gives the reader a more thorough appreciation of the value of good roads to the country, which is summarized in the quotation from Ralph Waldo Emerson which graces the page preceding the frontispiece:

"When the Indian trail gets widened, graded and bridged to a good road, there is a benefactor, there is a missionary, a pacificator, a wealth bringer, a maker of markets, a vent for industry."

AMERICAN CIVIL ENGINEERS HAND BOOK. MANSFIELD MERRIMAN, EDITOR IN CHIEF. JOHN WILEY & SONS, INC., NEW YORK, 1920. FOURTH EDITION. 1,955 PP. DIAGRAMS AND TABLES.

Owing to the increasing size of the well-known Merriman's Pocket Book, the fourth edition, just issued, is now more properly called a hand book. With the revisions and the addition of 375 pages, this book maintains its pre-eminence as a reference volume for all engaged in civil engineering practice.

## Scotland Home of First Skyscrapers

Architectural history relates that Edinburgh, Scotland, is responsible for the original skyscraper dwellings, where, as early as 1698, the height of buildings had reached so dangerous a degree that legislative action was thought desirable and an act of the Scottish Parliament provided that no building should exceed five stories in front. As the restriction did not specifically apply to the rear the result was the piling up of story above story until it became common for a house with the legal limit of five stories in front to rise to ten or twelve stories in the rear.

A certain clergyman who had these high tenements for

his parish from 1837 to 1843 describes the abject poverty, the ignorance and the crime that he found. The sanitary conditions were appalling. How could they be otherwise when a mother had to descend several flights of stairs and mount them again for every pail of water, often with a child at her breast and another at her apron strings? The daily accumulation of filth was thrown out of the window on the street below at night.

Robert Louis Stevenson graphically depicts the fall of one of these buildings. It had grown rotten to the core and the entry beneath had closed in, when on a Sunday morning the whole structure ran together and tumbled story upon story to the ground, bringing death and desolation to the dwellers therein.

## Camouflage

Now that the war is over the camouflage artist may be seeking occupation, and the *Architects' Journal* of London has facetiously thought of a manner in which his talents might be used for the general good. We are surrounded by many buildings, which cause us daily pain, but which serve some utilitarian purpose. Why should not the camouflage artist so decorate the fronts of these buildings as to make them absolutely invisible from the street? It might excite wonder to see some hundreds of people passing into a building which apparently consisted of one floor only, but this would not matter. We should only consider that there were more marvels than had been dreamed of in our philosophy, while local authorities would have to determine what new buildings should be allowed to be visible.

## Personals

Manaco & Wright, architects, have opened an office at 168 North Michigan avenue, Chicago, Ill.

W. Whitehill, architect, announces the removal of his office from 32 Union Square to 12 Elm street, New York.

Frederick Putnam Plat & Brother, architects, announce the removal of their offices from 1123 Broadway to 680 Fifth avenue, New York.

John P. B. Sinkler, of the architectural firm of Bissell & Sinkler, Philadelphia, has received the appointment from Mayor Moore as city architect.

Wylie J. Van der Meer, architect, has returned from Europe and opened an office at 209 Trust Building, Rockford, Ill. Catalogues are desired.

M. I. Kast, architect, 222 Market street, was elected president at the annual meeting of the Pennsylvania Association of Architects in Pittsburgh yesterday.

Charles W. Andrews, architect, has opened an office in the First National Bank Building, Bethlehem, Pa., and desires catalogues and samples of building materials.

F. G. McCune, architect, has removed his office from 425 Hoyt Building, Wichita, Kan., to Holyrood, Kan., where he will superintend the construction of a school building.

Announcement is made by Dalton R. Wells of his association with H. G. Beckwith and Donald Cole in the incorporation of Wells, Beckwith & Cole, architects and engineers, with Dalton R. Wells as president, Donald Cole vice-president and Harry G. Beckwith secretary-treasurer. The business of Mr. Wells formerly conducted at 1601-2 Ford Building, Detroit, will be taken over and the present offices, 624-26 McKerchey Building, Detroit, continued.

# Weekly Review of Construction Field

## Comment on General Conditions of Economics With Reports of Special Correspondents in Prominent Regional Centers

The National Federation of Construction Industries in a circular letter states that it has given close attention to the report that the Federal Reserve Board has under consideration the announcement of a preference list to be applied by bankers. It has been informed, however, that such action is not contemplated by the Board but that a warning will be issued to bankers and the general public concerning the present financial condition of the country.

This effort to place capital at the service of constructive business will be watched closely and with the greatest interest. How successful such a policy may become depends upon whether its administration can prevent the diversion of these funds from one to some other speculative venture. As a generalization it inspires widespread acclaim.

Complaint has been made against the Federal Reserve Bank of Kansas City for discrimination against automobile dealers. It is said to be the only federal bank which has refused to accept more automobile paper for rediscount. The Kansas City Livestock exchange has demanded preferential treatment for the producers who claim an inability to borrow money to pay for their stock.

Speaking as chairman of a special committee to investigate housing and all forms of construction, Senator Calder said in the Senate: "As one who has spent his life in the building business, I naturally look to the improvement in the nation's machinery of production as the means of permanently increasing its supply of useful commodities. The necessity for plant improvement and increased construction of all kinds seems to be clearly written in modern history." He analyzed the present situation: "Being still unsettled and technically at war, the free and natural flow of men and material to places of exceptional demand is not taking place nor are we as a nation taking steps to gain a more complete understanding of the facts and to establish the equilibrium between supply and demand. Organized groups are impeding transportation and production in an effort to secure increased wages, made necessary in part by the shortage of efficient facilities. There seems to be a popular belief that the situation may be cured by legislation which may change the distribution of commodities among the peoples, rather than increase the quantity of commodities to be distributed. As we continue to spend and speculate in the limited products of our limited plant, giving little thought to its betterment, we find ourselves facing the law of diminishing returns. We are now face to face with a housing shortage throughout the land. The construction of manufacturing buildings is being postponed on account of high prices and also because transportation and labor are unavailable. It is believed the car shortage can not be made up for several years, in the meantime transportation is inadequate, grain is being held in elevators, and a severe fuel and food shortage is predicted for the coming winter and spring.

"The specific obligation now confronting the United States is so to increase its facilities for the production and distribution of useful commodities as to adequately meet the needs of its people. The manufacturing plant development in the United States today is not adequate for its

domestic needs. The United States cannot give foreign succor or meet world competition until it has corrected this situation and has facilities for the production of necessities in excess of those required at home. Structural development is necessary for the fuller utilization of the Nation's resources for the production of its essentials, and for the amelioration of its housing conditions; and that construction was curtailed by the war and is now hampered by an unprecedented demand for consumables."

While building operations are steadily increasing in volume, measured from the standpoint of space, they are by no means keeping up with the increasing requirements. According to S. W. Straus & Co. our volume of building for the month of February, 1920, is about equal to the volume for March, 1915—measured in actual new space. In other words, our new building operations in square footage are about on a par with the year 1915, and we are probably running behind in an amount which corresponds to the natural increased demands of the five-year period.

There seems to be no one who would dispute these facts, or dispute the conclusion of Senator Calder that the "plant development of the United States is not adequate for its domestic needs." In these circumstances there seems one thing to do: to increase our productive capacity. It seems an aim on which we might as a Nation unanimously agree. A consideration of these facts by the bankers will help; a placing of structural materials on a preferential list by the railroads would help; a little less hankering after the luxuries some other man enjoys would help.

Living costs are high. At a one-armed dairy lunch, a husky mechanic was heard to complain that his suit cost him a hundred dollars. It was a smart suit and may have been worth the price. The duty of those who are wearing out their ante bellum clothes is plain; by an effort of moral restraint they should avoid envying this husky mechanic his slick green suit with red stripes.

(By Special Correspondence to THE AMERICAN ARCHITECT)

CHICAGO—The lumber business of the country is to be conducted on a more efficient basis in the future, say the lumber dealers who are holding a convention in Chicago this week. A national association of wholesale dealers is to be organized for the purpose of improving the lumber business. I. R. Putnam, formerly president of the Southern Pine Association, is to be managing director.

According to Mr. Putnam, waste in the lumber trade amounts to more than 50 per cent. Of all the timber, only 37 per cent reaches the market as lumber. The balance is waste—mostly used as fuel in saw mill power plants. The new association will undertake research work so that a greater part of each tree cut will reach the market in some form. The association also plans to reform the shipping and distributing systems and, if possible, to rid the lumber industry of the speculator who is partly responsible for the uncertain market conditions and prevailing high prices.

The building industry will be benefited if the lumber organization succeeds in its plan to ship lumber where it is most needed and over the shortest possible route.

The freight situation in Chicago is at present alarming.

## THE AMERICAN ARCHITECT

It is estimated that over 235,000 cars are tied up or delayed in transit throughout the country—more than 100,000 of these are in or near Chicago, waiting to be unloaded. Priority of food, fuel, and perishables will bring other freight to a standstill. This situation will be immediately reflected in decreased production, slowing down of industry and increased prices. Many plants are being closed in the Chicago district because of lack of coal, raw material and insufficient cars to ship the finished product.

Events of the past few weeks have established clearly that failure on the part of the railroads to function properly menaces the whole business and financial fabric of the nation. Chicago bankers express the belief, which is shared by many, that the credit situation will right itself as soon as transportation difficulties are settled. A decline in prices is also anticipated.

*(By Special Correspondence to THE AMERICAN ARCHITECT)*

SAN FRANCISCO—Every day of the continuance of the present freight condition makes the building condition in this territory more serious. Very few cars of building materials are being handled in the freight yards so that they can be unloaded. The railroads declare that there is no strike of switchmen, as they have discharged the men who walked out, but either through sympathy or actual shortage of labor, very few men are applying for vacant positions in the switch-yards. As a consequence work on a number of jobs has slowed up or ceased altogether, and it is stated that if some improvement is not soon made it is likely that several brickyards will have to close.

As materials become scarcer, prices are remaining stationary, although in the case of some building material there is almost no demand. Bricks, common and face, hollow tile, structural iron, cement, plaster, lumber and other materials are all quoted nominally at the same prices as last week. Roofing tile, for which there has been considerable demand and which has been shipped in some cases by water, is quoted only as laid and the price is reported to have advanced about 35 per cent, although exact figures are impossible to give as each job is figured separately.

In the meantime the architects are kept reasonably busy on plans for the future.

*(By Special Correspondence to THE AMERICAN ARCHITECT)*

BOSTON—Statistics of building and engineering operations in New England show that from January 1 to May 6, 1920, contracts were awarded amounting to \$115,693,000. For the corresponding period in 1919 they amounted to \$43,193,000; in 1918; \$50,888,000; and in 1917, \$66,045,000; and in 1916, \$61,364,000. The building contracts awarded during the month of April, 1920, were \$28,589,000. For the same month of 1919, \$15,252,000; April, 1918, \$17,527,000; April, 1917, \$19,270,000; April, 1916, \$18,375,000; and April, 1915, \$16,711,000.

*(By Special Correspondence to THE AMERICAN ARCHITECT)*

SEATTLE—Although jobbers are having difficulty in getting delivery of materials from the East, prices have not yielded to the shortage. Closing down of several eastern mills because of the uncertainty of labor, shipping and production costs has practically driven investors in this territory during the past week to actual necessities only.

Eastern mills have not opened their books for the third quarter, although Seattle jobbers had hoped that they would be ready to do so by this date.

The first carload of small plumbing sizes of pipe to arrive here to one of the houses in 90 days was reported in this week—one jobbing house stating that it was their initial shipment in three months. Colorado mills are supplying jobbers with 50 per cent of their requirements of nails, but despite this condition some of the jobbers are able to report that their business has exceeded that of 1918, the record year, by 15 per cent. Prospective builders advise jobbers and architects that, owing to the price and the uncertainty of delivery, they will defer their projects until next year.

Embargoes resulting from the railroad strike are still permeating the delivery of all building materials shipped from the East. Jobbers complain that they are unable to get their cars past these restricted terminals, and the rail situation has had much to do with the irregularity of delivery of steel products into the Pacific Coast territory.

The quieting down of the demand for pipe, fittings, nails and enamelware is being reflected through the fabric of every essential that enters into construction. In few instances have prices been revised upward. Jobbers feel that in the present state of the investors' minds another new price differential would affect the situation but slightly either way.

Cultivator steel has vanished from the warehouses owing to past difficulties of getting it into the territory, and channel iron of  $\frac{1}{8}$  to  $\frac{1}{2}$  inches is replacing it. Plaster from Reno is being delayed on account of labor difficulties in San Francisco. The discount on radiation, 3 column 38 inch base has advanced to 46 per cent. Indiana mills are taking care of a few local jobbers on small pipe, excepting boiler tubes which are very scarce.

Owing to the fact that the fir lumber mills are busy on special cutting the market is holding steady. Quotations have been \$3 to \$10 under the list price announced March 1 by one of the larger manufacturers, but the mills are gradually loading up on orders for railways and export and are leaving only 20 to 25 per cent of the cut for eastern building assortments, which will vanish quickly if the demand increases. All orders now coming into the fir lumber mills from the East demand quick delivery, and buyers are refusing to accept transit cars.

# DEPARTMENT OF ARCHITECTURAL ENGINEERING

## Electric Arc Welding Applied to Structural Steel Framing

Possibilities of This Process as a Substitute for Riveting Considered

**T**HE extent to which electricity, that subtle form of energy, will at some future time be used is impossible to foretell. Judging from the record to date, a constantly broadening field of activity is sure to develop.

A new use to which it has just been adapted is the

specific instances. Some of these are included in this article.

The engineering department of one of the commercial organizations actively engaged in such work, the Electric Welding Company of America, has devoted much time on experimental and laboratory



TWO ELECTRICALLY ARC WELDED TRUSSES SUPPORTING A 50 PER CENT OVERLOAD

Representatives of the several Building Bureaus of Greater New York were present. As a result of the test an official approval to construct the proposed building by this method was given. The test was conducted at the site of the proposed structure, Foot of Court St., Brooklyn, N. Y.

connecting, by electric arc welding, of the members composing the structural steel frame work of a building. As is generally known, this type of welding was extensively used in steel ship construction during the World War, and its costs, as compared with riveting, have been worked out in many

research work in order to perfect known methods and devise new methods of application. The experimental work has finally reached a point which seems to assure the success of the electric arc welding process as a commercial possibility.

The interesting thing about electric arc welding

is not so much the method which is employed, but rather the constantly widening application of it as an industrial process. Since its introduction considerable progress has been made in developing various kinds of equipment to make its use more easy and general. But the real science of this method lies in the human skill behind the equipment.

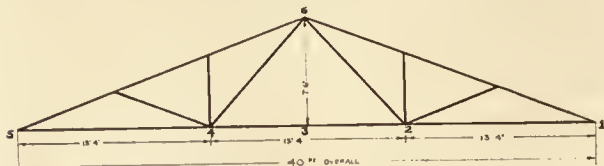

OUTLINE DIAGRAM OF ELECTRICALLY ARC WELDED TRUSS

Recently the Electric Welding Company required a new building as an addition to its Brooklyn plant. The company's engineering staff were convinced that the structural framework of this building could be connected by electric welding much more simply than by the usual process of riveting. But before such a method of construction could be employed it was necessary to secure the approval of the Bureau of Buildings, for which application was made. This approval was withheld, pending the result of certain tests ordered by the Brooklyn Superintendent of Buildings, to determine the efficiency of the process. Samples of welded joints were required, and these were subjected to strength tests of various kinds.

A sample of a lap weld of 1 1/4-in. x 3/8-in. bars, the ends lapped 1 3/4-in. and welded across the edges, was one of those submitted. This welded sample was put in the testing machine in direct tension and developed the full strength of the bar, the break occurring 3 in. above the weld. A strength close to 60,000 lbs. per square inch was developed without damaging the weld. Later the welds were cut across



WELDED CONNECTION AT PEAK OF TRUSS

but showed no line of demarcation between the welding metal and the original bar metal.

Another sample consisted of two 2-in. x 3-in. x 3/8-in. angles, set at right angles to each other and lap welded at the intersection, the 3-in. legs being upstanding. This sample was placed in the machine

so that a horizontal lever-arm of 8-in. was produced from the center of pressure to the center of weld or intersection. This test specimen developed a *beam load* of 11,375 lbs. or a *torsional stress* of 91,000 lbs. at the point of weld with no apparent distress to the weld. The above loading caused the angles to buckle to such an extent that they ceased to offer any resistance to further loading.

As a result of these specimen tests, permission was granted to proceed with the erection of the steel framework, using electric arc welding to connect the members. A further test of the welded steel trusses (forty-foot span) to be used to sustain the roof was specified. These trusses were of a fan type of design as shown in the line drawing. All members were welded together electrically, no bolts or rivets being employed. Trusses were spaced twenty feet apart, supported by 8-in. x 8-in. rolled steel columns 19 ft. high; on the sides of these



ROOF PURLINS WELDED TO TOP CHORD OF TRUSS

columns, brackets were fastened to carry an overhead traveling crane of five-ton capacity. The weight of each truss was about 1400 lbs. Top and bottom chords are composed of 4-in. x 5-in. x 3/8-in. tee irons, and the struts of 3-in. x 2-in. x 3/8-in. angles. Purlins are 10 in.—15 lb. channels.

The trusses were designed for a live load of 40 lbs. per square foot, each truss supporting a panel of 800 square feet. The total live load for which the trusses were figured thus being 16 tons. Two welded trusses, spaced 20 ft. apart, were placed on temporary supports, just above the ground, for testing, and the panel between loaded to 120 lbs. per square foot. Thus the total load on both trusses was 48 tons, or 50 per cent in excess of that for which the trusses were designed. Two trusses under test, fully loaded, are shown in the illustration. The load consisted of gravel in bags, which were



piled in tiers on planking arranged for the purpose.

Readings were taken at different increments of the loadings for the deflection in the truss or members.

The readings taken with trusses fully loaded gave the following results:—East support settled 15/16 in.; West support 3/4 in.; point No. 2, 7/16 in. (actual); point No. 4, 1/2 in. actual deflection. Point No. 3, 9/16 in. actual deflection. Two days afterward the load was entirely removed and readings taken at this time showed all points in the trusses had returned to their original position, leaving no permanent deflection except 1/16 in. at point No. 3.

The official report of the test states in conclusion that: "From the above it is evident that electric welding is a dependable method of uniting structural members and is stiffer than riveting if the work is properly performed."

The tests were witnessed by representatives of all the Building Bureaus of the various Boroughs of the Greater City, as well as by other interested persons.

Generally speaking, electric welding can be used in all parts of steel structures—but the following specific list shows its direct application in the construction of: (1) columns—plate and angle; channel and plate; latticed; (2) flooring—corrugated and z-bar; (3) trusses; and (4) for connecting (a) bearing plates to upper and lower ends of columns; (b) trusses to bearing plate and columns; (c) cross-bracing between columns; (d) purlins to roof trusses; (e) wind bracing supports; and (f) I-beam rail for trolley supports to columns.

These, of course, are only a few instances in which electric welding may be substituted for the use of bolts, rivets and gusset plates and in some cases connection angles and brackets.

An investigation indicates a saving in both material and labor cost where electric welding is used. The following table published by Mr. W. T. Bonner in *Marine Engineering* shows the relative cost of



MAKING AN ELECTRIC ARC WELD

Note the eye protection which is necessary for the operator, due to the intensity of the flame.

riveting and welding in construction sections of steel barges. These figures can be taken only as an approximate basis for comparing welding and riveting for structural steel.

Items.	†Riveted Design.	Welded Type.
A Plate Fitters .....	\$1,236.00	\$618.00
B Punching and Shearing.....	1,045.00	522.00
C Countersinking and Reaming....	976.00	0.00
D Riveting .....	3,427.00	0.00
E Chipping and Calking.....	523.00	265.00
F Smith Work .....	557.00	275.00
G Erection and Assembling.....	2,010.00	1,320.00
H Electric Power .....	*382.00	*95.00
I Foreman .....	360.00	360.00
J Plant-Special Equipment .....	0.00	300.00
K Superintendence .....	0.00	900.00
L Rivets .....	780.00	0.00
M Liners .....	142.00	0.00
N Shed and Shoring Lumber.....	0.00	145.00
O Electric Welding—Including "Tacking" 51,300 feet Single Fillet: Welder, 6,000 hours at 60c .....	\$3,600.00	
Current, 6,000x5—30,000 K.W.H., at 2½c.	750.00	
Wire, 7,200 lbs, at ⅙c	450.00	
	\$4,800.00	0.00 4,800.00
P Incidentals and Profit.	0.00	1,838.00
Q Total .....	\$11,438.00	\$11,438.00

\* Current used for lighting, punching, shearing and air compressors only. Current for welding covered in Item "O."

† All figures for riveted design based on actual book cost of three barges completed during preceding month.

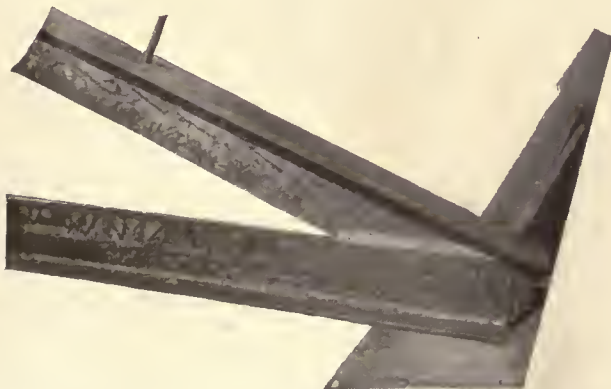

WELDED INTERSECTION OF UPPER AND LOWER TRUSS CHORDS

There are certain pronounced advantages to the electric welding process, as applied to structural steel work.

Noise and the boiler shop are synonymous. The noise coincident with the boilermaking industry is caused by riveting. In building construction the progress of the steel structure is also marked by the

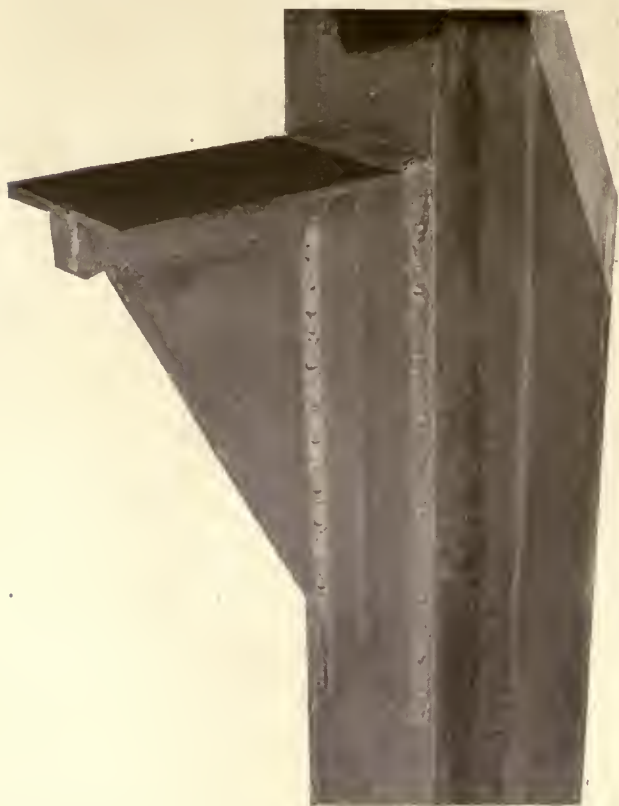

BRACKET SUPPORT FOR 5-TON CRANE RAIL,  
JOINED TO COLUMN BY ELECTRIC ARC  
WELDING

noise of the riveter's gun. The electric welding process is a *silent* one.

In making up such parts of a structure as roof trusses, or for that matter any type of light truss, the members of which are to be welded, extensive detail drawings are not necessary. The members can be cut to length, assembled on a horizontal surface and welded. Precise detailing is only required for riveted and bolted work in order that, when assembled, corresponding holes in the various members will accurately match.

In riveted work, tension members have their strength reduced at the joint due to a reduction of area from punching. It is possible to develop 100 per cent of the strength of a member at a welded joint. In light trusses, gusset plates can be eliminated, thus reducing the tonnage and consequently

the cost. A reduction in cost, so far as the process alone is concerned, also seems possible.

In large work, where beams, girders and columns are swung into place and must be temporarily but quickly connected, it would not of course be possible to arc weld the members on initial placement. The present method in steel erection is to use a few bolts for each connection, and later the regular gang makes a permanent bolted or riveted connection as the case may be. With the welding method, there seems to be two methods which might be employed for temporarily holding members in place. One is by electric spot welding or "tacking," which could be done rapidly and would be sufficient to hold the members securely in place until the arc welding gang made a permanent weld. The second method is to punch at least two holes for every such connection and employ the usual method of temporary bolting. For beam to girder connections, if the girder is of sufficient depth, seat angles could be welded on the girder in the shop, and on these the beams could be set temporarily pending welding. Undoubtedly an extension of this process to structural steel framing will develop satisfactory methods of taking care of this phase of the work.

The Electric Welding Company of America is



WELDED CONNECTION BETWEEN BASE PLATE  
AND BETHLEHEM H SECTION COLUMN

now designing some special trusses to be constructed by electric arc welding, which will be used for one of the governmental departments.

In the employment of electric arc welding there are certain dangers to be guarded against. Only highly skilled operators should be permitted to do electric welding. Very carefully supervision should

be maintained. If a bad rivet is difficult of detection, a bad weld is doubly so. Unskilled operators can do a great deal of damage and thus prove costly. All equipment must be of the most advanced type, and every precaution taken to furnish protection against electrical hazards.

Some idea of the actual welding process can be

gained from one of the photographs showing an operator at work.

Due to its many advantages, there is no doubt that electric arc welding will be employed to an increasing degree in structural steel work. Its future development will undoubtedly be watched with interest by all engaged in the building industry.

## Successful Building in Stucco

### VII—Magnesite Stucco—Its Characteristics and Application

ONLY in recent years has magnesite stucco, an oxychloride composition, been commercially exploited for exterior plastering or stucco work, although this composition has been employed as a building material in this country for over fifty years. It has been suggested by some persons, and it is not improbable, that some of the remarkable plaster and cement work done centuries ago by the Romans and Spaniards, the process of which has not been duplicated in modern building, was constructed of magnesite compositions, compounded by these early builders. The strength and durability exhibited in some present examples embodying the use of this

and more durable in its solidity will be the stucco. When no less than *three* coats of sand mortar besides the rendering coat have been laid we will make the mixture for the layers of powdered marble, the mortar being so tempered that when mixed the trowel comes out clear.

After the powdered marble has been spread on and gets dry, spread on a second medium coat. When that has been applied and well rubbed down, spread on a finish coat. The walls being thus rendered solid by three coats of sand mortar and as many of marble, will not possibly be liable to cracks or any other defects.

Further, such walls, owing to the thorough workmanship, will bring out in brilliant splendor the colors laid on at the same time with the polishing.

Stucco that is properly made does not get rough as time goes on or lose its color. So when the stucco is made



HÔTEL VICTORY, HARRIMAN, PA. MAGNESITE STUCCO ON WOOD LATH; DASH FINISH

material, might readily lend credence to that theory. The durability of ancient stucco, however, probably depended to a large extent on excellent workmanship in application. We might well, in these days when tendencies are toward skimping the work, pay more attention to the writings of men such as Vitruvius, that ancient architect, who some twenty centuries ago, in describing the method of applying certain stucco work over solid masonry walls stated:

The better the foundation of sand mortar the stronger

as described above, it will have strength and brilliancy and last to a great age.

However, since magnesite stucco as at present manufactured, is a distinctly modern product, this article without diverting attention further to historic data, will treat of the adaptability of such stucco to different types of present-day construction and of certain properties that are possessed by this product with a brief reference to its proper application.

In either the new or remodeled building, the in-



AN ATTRACTIVE SUBURBAN HOUSE. MAGNESITE STUCCO; DASH FINISH

evitable question concerning wall construction comes up for discussion and decision. Brick, stone, concrete, frame and stucco all have their advantages and disadvantages, and very often one type is better suited for certain definite purposes or a certain type of design than any of the others. Here the architect must use his knowledge of the advantages and limitations of each material.

Brick, stone and reinforced concrete are at once conceded to be ideal for heavy mill and factory construction as well as for the office buildings now predominant in our metropolitan centers. They are also used attractively in home building.

For residential work, however, stucco undeniably takes its place as one of the most versatile materials for exterior wall treatment. Exterior plaster or stucco adapts itself to many types of architecture, and combines economy in first cost with that of moderate expense in upkeep when properly specified and applied. It is substantial in appearance, is fire-resistant in character and is equally effective whether used on the modest cottage or the palatial mansion, if given the proper treatment.

In order to understand the difference between magnesite stucco and other materials ordinarily used for that purpose, a brief description of the nature of this material will here be given.

Magnesite is a dense white ore mined in rugged mountainous country and is burned in large furnaces under a specified temperature to eliminate certain of its constituents and to reduce it to a caustic state. It is then pulverized after which it is ground and mixed in agitating machines with other mineral ingredients producing what is known as magnesite stucco powder. This stucco powder is put up in bags usually containing one hundred pounds each, which are delivered to the job much the same as cement and plaster. Magnesite stucco, however, is not mixed with water; instead, a liquid chemical

(magnesium chloride) solution supplied by the manufacturer is used. This solution, shipped in heavy steel drums, or wooden casks, holding from thirty to fifty gallons each, is mixed with the powdered product in a regular plasterer's mixing box at the job as the stucco is being applied.

In considering the particular characteristics possessed by magnesite stucco it must be remembered that this material contains no cement, lime, gypsum (Plaster of Paris), or any similar ingredients. The hardening or setting up process is the result of a chemical reaction caused by the uniting of the caustic magnesite powder and the liquid chloride solution. The ingredients combine into a tough seamless mass quite hard, yet not brittle. It was described at one of the laboratories where tests had been conducted as a tough hornlike substance. When thoroughly set and cured magnesite stucco attains a considerable tensile strength, not possessed to any great extent by other materials hitherto used for exterior plastering work.

When studying the properties of any material, it is also necessary to consider the elements which they must resist. In order to insure permanence in exterior stucco construction, of utmost importance is the rendering waterproof of any type of stucco applied, since the absorption of moisture has been a source of considerable trouble in much of the stucco work so far executed. Particularly is this true in the Winter season after an all-day driving rain when a sudden drop in temperature to below 32 Deg. F. causes freezing of the moisture which has entered the stucco, which naturally cracks under this expansive action. Careful experimental work has made it possible to produce a magnesite stucco which can successfully resist the action of this destructive agent.

In some of the tests made it was found that a section of magnesite stucco could be bent or deflect-



FIRST MORMON TEMPLE, BROOKLYN, N. Y. MAGNESITE STUCCO FINISH

## THE AMERICAN ARCHITECT

ed several inches out of line in a span of eight feet without fracturing the material. This property is of vital importance in preventing its cracking by induced strains often prevalent in buildings shortly after erection due to slight settlements, shrinking of woodwork or other causes. In addition to this, it is not greatly affected by temperature changes, which produce expansion and contraction, another destructive element often causing stucco to crack. It is one of the reasons for advocating the use of metal

used over many kinds of building surfaces, including either wood or metal lath, hollow tile, reinforced concrete walls, either new or old brick walls, various kinds of patent stucco boards and patent sheathing. Thus it gives most satisfactory service for overcoating and remodeling old brick or frame houses.

Because of the fact that this stucco is mixed with a chemical liquid rather than with water, it does not freeze nor is it injured if applied in cold weather, that is at temperatures below 32 Deg. F. This will



HOUSE OF W. E. STANDART, DETROIT, MICH. HOWARD A. LADUE, ARCHITECT

Note the color contrast obtained by the use of brick foundation walls, chimney and window sills.

lath in cement stucco, since the metal reinforcement to some extent relieves the plaster of temperature strains.

From the viewpoint of the architect and contractor, one of the most valuable characteristics of magnesite stucco is its adhesive or bonding properties. Unlike many forms of plaster it does not depend solely on clinching or keying to hold it in place. Instead, this material will adhere or attach itself to the surfaces over which it may be spread, taking hold so tenaciously that it is difficult to separate it therefrom. On this account it may be successfully

permit such stucco work to be carried on safely throughout the Winter months.

During the war magnesite stucco was used in many of the housing developments, and since the time of construction had to be reduced to a minimum, much of the stucco work was carried on during temperatures considerably below freezing. So far as the writer has been able to learn from persons intimately connected with the work, there was no apparent damage to the stucco on this account. Much of this work was on wood lath.

All surfaces over which magnesite stucco is to be



HOUSE OF E. L. COHEN, LARCHMONT, N. Y. MAGNESITE STUCCO ON WOOD LATH; DASH FINISH. A. L. BENNIX, ARCHITECT

plastered should first be treated with a spray or brush coating of the liquid solution. The brown or base coat should then be spread so that it will cover the surface not less than one-quarter inch in thickness in all parts. After this base coat has set or hardened, it should be sprayed with the mixing liquid and immediately followed by the application of the second or finish coat, which is troweled and floated true and even. When this finish coat is still very fresh and soft, dash aggregate of the desired size and colors is cast forcibly into the soft finish coat and lightly patted with a float to bring all particles in contact with the fresh stucco. Once firmly imbedded the dash remains permanently in place and cannot be easily removed.

One particularly important point that should be remembered in using magnesite stucco is that under no circumstances should this material be applied less than one-half inch in total thickness exclusive of the dash finish. In order to cheapen the work, it is sometimes suggested that this kind of stucco be applied not over  $\frac{3}{8}$  in. thick, but to follow such advice would be to commit a serious error, which will result in disappointment. Better far apply a magnesite stucco  $\frac{5}{8}$  in. to  $\frac{3}{4}$  in. thick than less than a full  $\frac{1}{2}$  in. thickness.

Color effects harmonizing with the architectural scheme are created by mixing granite, marble and other stone chips of various shades, and casting them into the finish coat at the time of application as described. Dashes for various color effects are

furnished by the manufacturers. Often pleasing effects can be obtained by using dashes of varying shades for different parts of the structure.

In some cases architects wish to finish a structure with a smooth surface. It does not seem possible to trowel magnesite stucco smooth and obtain an even colored surface. Due to the working of some parts more than others, to bring the surface to a true plane, staining results. This is objectionable to many, although in some cases it has been considered artistic. In the course of time, the wall will weather to a fairly uniform color throughout. The manufacturers do not recommend finishing magnesite stucco smooth, and the dash finish seems to have become quite popular, especially on account of its possibilities from the color variation standpoint.

It is important to bear in mind that defects often arise from improper construction rather than from some inherent defect in the material used. One cannot obtain good work without paying a fair price. The walls are constructed of terra cotta tile.

An excellent example of magnesite stucco work is the house at Spuyten Duyvil, designed by Titus De Bobula, architect, illustrated elsewhere in this issue.

The illustrations accompanying this article show other examples of magnesite stucco applied on various types of wall construction.



DASH FINISH USED WITH MAGNESITE STUCCO

714<sup>a</sup>

Photopiece No 2320

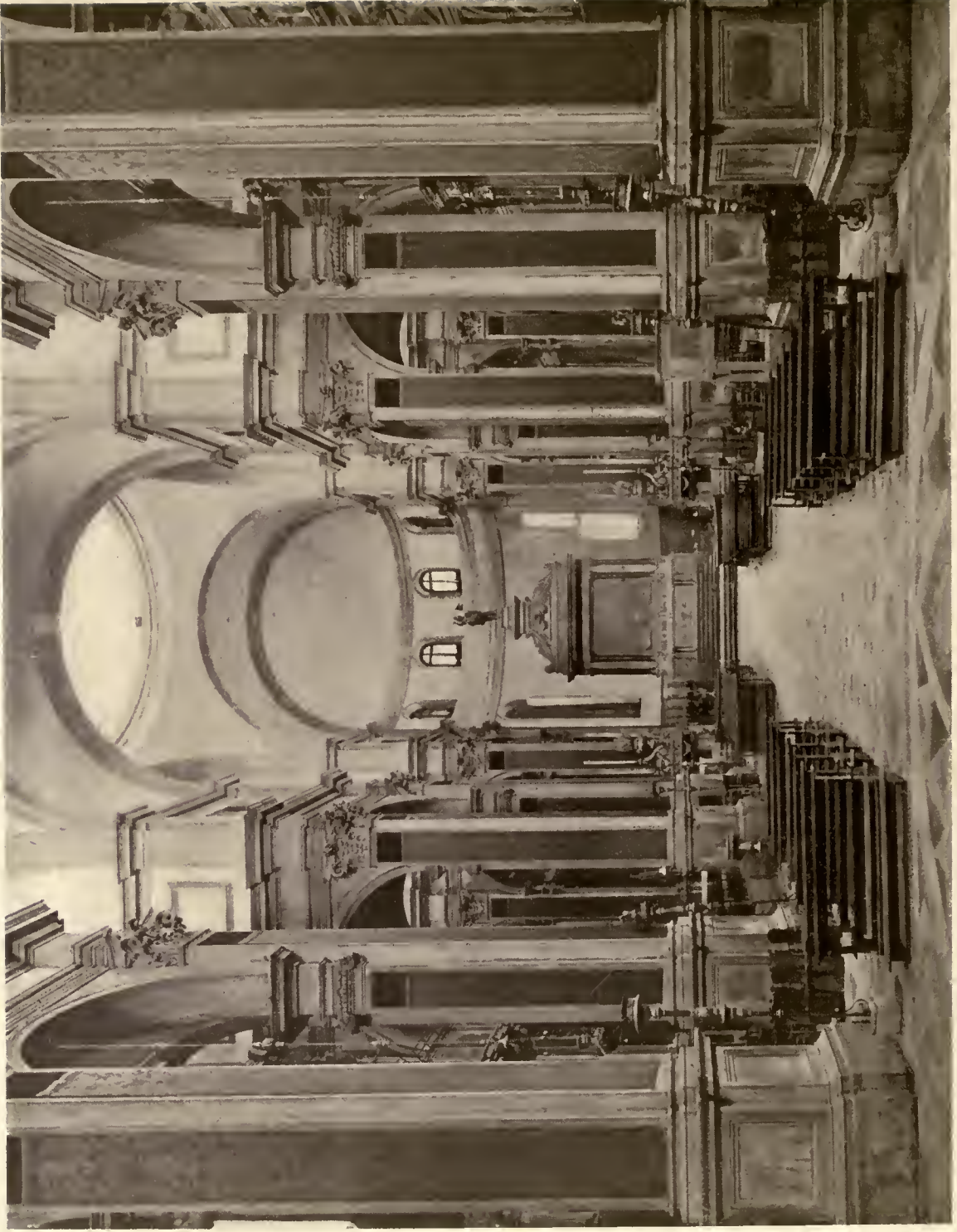

CHURCH OF THE SAVIOUR, VENICE



# THE AMERICAN ARCHITECT

VOL. CXVII.

WEDNESDAY, JUNE 9, 1920

NUMBER 2320

## Roosevelt and the Fine Arts

By MAJOR GENERAL LEONARD WOOD, U. S. A.

THE articles, by Glenn Brown, F.A.I.A., entitled "Roosevelt and the Fine Arts", printed in THE AMERICAN ARCHITECT of December 10-17, 1919, with the foreword and editorial by Cass Gilbert and Irving K. Pond, Past Presidents of the American Institute of Architects, are of value and interest to the layman as well as the architect. It is an added example of that versatility and comprehension of human problems that makes Theodore Roosevelt an outstanding figure of his time. He was not trained as an artist or architect, but his liberal education, culture and natural appreciation of the fine arts were combined with a rare degree of common sense, thus enabling him to attack the many problems that demanded his attention and quickly solve them in a logical manner. Perhaps his conclusions were more logical and correct by reason of this lack of an academic training in art than they otherwise would be. He certainly was not hampered by the restrictions of the precedents of the various schools of art and architecture.

Roosevelt had decided opinions on these matters and was boldly outspoken in discussing them. Being intensely American in all of his ideas, he failed to understand why certain things obtain in the American practice of architecture. This attitude can be clearly seen in the two quotations that follow. On November 16, 1919, addressing the American Academy of Arts and Letters on "Nationalism in Literature and Art", he said:

"But the greatest literature, the greatest art, must spring from the soul of the people themselves. There must be leadership in the blossoming period, in any blossoming period, of any great artistic or literary nation. But if the art is genuinely national the leadership must take advantage of the life of the people, and must follow the trend of its marked currents. Greek art, like Gothic architecture, owed more to the national spirit than to any conscious effort of any group of men; and this is likewise true of the Greek and English literatures. On the other hand, Latin literature was not really an expression of the soul of the Latin race at all, and this will seem strange only to the men who have not succeeded

715

in freeing their thought from the narrow type of scholastic education prevalent in our universities and schools up to the present day. Latin literature was merely an elegant accomplishment developed by small groups of Latin-speaking men who self-consciously set themselves to the production of a literature and an art modeled on Greek lines. It behooves us in the United States not to be content with repeating on a larger scale the history of commercial materialism of the great Phœnician commonwealths. This means that here in America, if we do not develop a serious art and literature of our own, we shall have a warped national life. It is eminently necessary that we should draw on every hoard of garnered wisdom and ability anywhere in the world of art and literature, whether it be in France or Japan, in Germany, England, Russia or Scandinavia. But what we get we must adapt to our own uses. Largely we must treat it as an inspiration to do original productive work ourselves, so that we may develop naturally along our own lines. When the greatest men, men whose appeal is to mankind at large, make their appeal it will be found that it carries most weight when they speak in terms that are natural to them, when they speak with the soul of their own land. Normally the man who can do most for the nations of the world as a whole is the man the fibers of whose being are most closely intertwined with those of the people to which he himself belongs. Merely to copy something already produced by another nation is probably useless. Now it is eminently right to try to add to our own development by the studies of great architecture and the great schools of painting of the Old World. If we do not study them we shall never develop anything worth having on our own side of the water. But neither the mere reproduction of a specimen of a great architecture nor the mere purchase of the product of a great school of painting is of the slightest consequence in adding to the sum total of worthy national achievement. Of course an over-self-conscious straining after the nationalistic form of expression may defeat itself. But this is merely because self-consciousness is almost always a draw-

back. The self-conscious striving after originality also tends to defeat itself. Yet the fact remains that the greatest work must bear the stamp of originality. In exactly the same way the greatest work must bear the stamp of nationalism. Americanism must smack of our own soil, mental and moral, not less than physical, or it will have little of permanent value."

In a letter addressed to the American Institute of Architects and read December 7, 1919, at its convention held at Minneapolis, Theodore Roosevelt made use of the following expressions:

"There can be no democracy without leadership, and there can be no leadership worth while in a democracy that is not in the interest of the people as a whole. This is just as true of art and literature as of government and war. It is to our discredit that our governmental buildings should so frequently be monuments of sordid ugliness. Let me add a most earnest plea to the architects themselves. Mere copying, mere imitation, is as thoroughly unworthy in architecture as in every other branch of art and life. We need to profit by everything which has been done in the past, or is now being done, in other countries. The need of avoiding the aberrations of false or artificial originality must not blind us to the fact that unless there is real originality there can be no greatness. To follow conventions merely because they are conventions is silly; the type of mind to which precedent becomes a purposeless but all-powerful fetish is that which regards as important the denial that Shakespeare's sonnets are sonnets because they lack the conventional sonnet versification or number of lines. Let me give one small instance: the lion, because of the way in which his name lends itself to us in stone, has always been a favorite for decorative purposes in architecture. He has in architecture become universally acclimatized and there is no objection to his use anywhere. But we happen to have here on this continent, in the bison with its shaggy frontlet and mane and short curved horns, a beast which equally lends itself to decorative use and which possesses the advantage of being our own. I earnestly wish that the conventions of architecture here in America would be so shaped as to include a widespread use of the bison's head; and in a case like that of the New York Public Library there would be advantage from every standpoint in substituting two complete bison's figures for the preposterous lions, apparently in the preliminary stages of epilepsy, which now front on and disgrace Fifth Avenue."

These brief excerpts from these notable papers by Theodore Roosevelt may well be studied and discussed by architects. They represent the attitude of many thoughtful Americans toward the profession of architecture, for it is evident that his references

to art and literature are applicable to architecture. Indeed, the application can be logically extended to the co-ordinate arts of engineering and construction. The development of a native American architecture presents problems not common to the majority of countries. America, with its extremes of climate, mountain and plain, diversified materials of construction, will hardly develop a universal type of architecture but probably there will be developed an American style variously modified so as to be truly indigenous to the different sections of the country.

American domestic architecture is in many respects peculiar to this country. The design of many of our ecclesiastical, public and commercial structures appears to be very strongly influenced by styles of architecture developed by peoples living in countries and under conditions that are entirely foreign to us. This condition will probably obtain until a real leadership in an American architecture is developed. This leadership will be composed of individualists, the results of their work blending into an indigenous style. This development would eventuate more rapidly if the legislative and executive departments of our municipal, state and national governments possessed a proper appreciation of the Fine Arts. Instances of this condition are only too rare and make that quality in Theodore Roosevelt so noticeable. Rather than to trust to the whims of fortune to place such men in positions of authority, there should be a constant effort to make such a condition universal. This can only be accomplished through education and a persistent exercise of the franchise.

A better architecture can be fostered by public art commissions. While such bodies may have no real powers to restrict and control architectural design, the effect of their work has been good. There should be such commissions in every community. One danger attends the formation of such bodies. The makeup of an art commission should be such that the adherents to many different styles or schools of architecture constitute its membership. Unless this is done architecture cannot develop along broad, democratic and indigenous lines.

Conceding the great importance of architectural design, of equal or greater importance is the element of sanitation with, in a lesser degree, adaptability to use. With these elements allotted in due proportion, the building for whatever purpose erected will exercise its proper influence on man. The influence of the building on man is of tremendous importance and this fact must be fully appreciated before an architect can properly exercise his true function. It is necessary that both the architect and the public realize this fact. Especially is good architecture important in school and college buildings.

As an executive, setting up a new government in

## THE AMERICAN ARCHITECT

Cuba and the Philippines, I found the engineer to be my able assistant. I use the word engineer in an inclusive sense and divisible into the architect; the sanitary, civil and mechanical engineer; the contractor and labor. The construction of sewers, buildings, docks, harbors, roads and railroads is the foundation on which a stable civil government can be erected. It does not require much reflection to arrive at this conclusion and a knowledge and appreciation of this fact must be possessed by those who lead, along with an understanding of the relative

importance of production, transportation, education, jurisprudence, commerce, finance, literature and the fine arts.

I am glad to express my admiration of that culture possessed by Theodore Roosevelt which qualified him to exercise such an influence on the architectural developments in Washington, as has been so well described by Mr. Brown. A realization of this influence will grow among us and a demand for a renewal of such leadership will develop and be satisfied.



THE WHITE HOUSE, WASHINGTON, D. C.



PRELIMINARY STUDY

AN ENTRANCE, CENTENNIAL BUILDING, SPRINGFIELD, ILLINOIS.

RICHARD E. SCHMIDT, GARDEN & MARTIN, ARCHITECTS

*Thirty-third Annual Joint Chicago Architectural Exhibition*



WM. R. JOHNSTON HOUSE, EVANSTON, ILLINOIS  
CHESTER H. WALCOTT, ARCHITECT  
*Thirty-third Annual Joint Chicago Architectural Exhibition*

## Thirty-third Annual Chicago Architectural Exhibition

Given Jointly by the Chicago Architectural Club, the Illinois Society of Architects and the Illinois Chapter of the American Institute of Architects, with the Co-operation of the Art Institute of Chicago

**E**ACH succeeding year, architects in Chicago, planning to present to the general public an exhibition of their work, introduce a feature so novel as to call for special mention and commendation. This year, the joint exhibition of architecture by the Chicago Architectural Club, the Illinois Society of Architects, and the Illinois Chapter of the American Institute of Architects, fills eight galleries in the Art Institute of Chicago. The outstanding feature is the gallery assigned to exhibitions referring to the "Chicago School." Just what are the ideals and aims of this school are very ably set forth by Mr. Louis Sullivan. He is quoted in the May Bulletin of the Art Institute as follows:

"The purpose of this movement is to arrive at a plastic architecture, in contradistinction to the purely intellectual architecture, as represented by the Greeks, and the emotionalism of the mediaeval period, as expressed in the Gothic cathedrals of northern France.

"The need of today is for an architecture based strictly upon utilitarian conditions and developed in such wise that these utilitarian conditions may find full expression. Hence such an architecture

must be plastic in its nature, and the work of a mind that is free and has emancipated itself from the tyranny, or autocracy, of tradition, no matter how beautiful the old architecture was, nor how well adapted it was to the needs of its day.

"By 'plastic' I mean that the utilitarian requirements must be allowed to find their full expression in plan and exterior, and this result cannot be accomplished by the prevailing method of suppression, that is to say, a method in which the tradition of one or another of the dominant styles of the past is imposed upon the utilitarian conditions of our own day.

"Putting this in practical form, a building must be allowed to grow out of its conditions, and these conditions, as we face them, are modern. We have been trying to solve these modern problems by application of ancient forms. An architecture of this sort, because it is the work of a free spirit, must naturally be democratic, because the essence of democracy is the expression of the free spirit of man."

Probably in no section of this country has the effort to arrive at a "plastic type" as described by Mr.



TENTH CHURCH OF CHRIST SCIENTIST, CHICAGO, ILLINOIS  
COOLIDGE & HODGDON, ARCHITECTS  
*Thirty-third Annual Joint Chicago Architectural Exhibition*



U. S. SOLDIERS' HOME HOSPITAL  
ALFRED GRANGER, ARCHITECT  
*Thirty-third Annual Joint Chicago Architectural Exhibition*



RESIDENCE FOR MR. LEWIS N. WIGGINS, SPRINGFIELD, ILLINOIS  
HELMLE & HELMLE, ARCHITECTS

*Thirty-third Annual Joint Chicago Architectural Exhibition*

a means of erecting a local sense of pride in the minds of the people of Chicago in the dignity and importance of their architectural development, no better method than the grouping of this exhibition in the "Chicago room" could have been devised.

This exhibition excluded all types of work. Mr. George W. Maher, whose efforts largely contributed to the success of the "Chicago Room," in referring to it said in part: "No greater educational propaganda could be suggested than that this entire exhibit be forwarded to various parts of the country where it may be viewed and explained to the general public. These examples are indigenous, since they spring from the soil and the people."

Sullivan, been more seriously made than in the Middle West and also probably has no man in that section nearer approached it than has Mr. Sullivan. Surely there has in some instances been noticed a tendency toward "emancipation from the tyranny or aristocracy of tradition" in spite of the allurements of an old architecture, acknowledged to be beautiful but so many times copied and so often improperly applied.

Throughout the period of the exhibition the Chicago room was the point of interest for the many thousands that daily visited the exhibition, but there might also be met that interesting group of men who were largely responsible for the inception and carrying forward of this important architectural movement. As



WHITING FOUNDRY-EQUIPMENT COMPANY, HARVEY, ILLINOIS  
CHATTEN & HAMMOND, ARCHITECTS

*Thirty-third Annual Joint Chicago Architectural Exhibition*



THE CAPITOL BUILDING OF THE LEAGUE OF NATIONS  
*BEAUX ARTS INSTITUTE OF DESIGN*  
12TH PARIS PRIZE COMPETITION  
FREDERICK M. HODGDON, ARCHITECT  
*Thirty-third Annual Joint Chicago Architectural Exhibition*



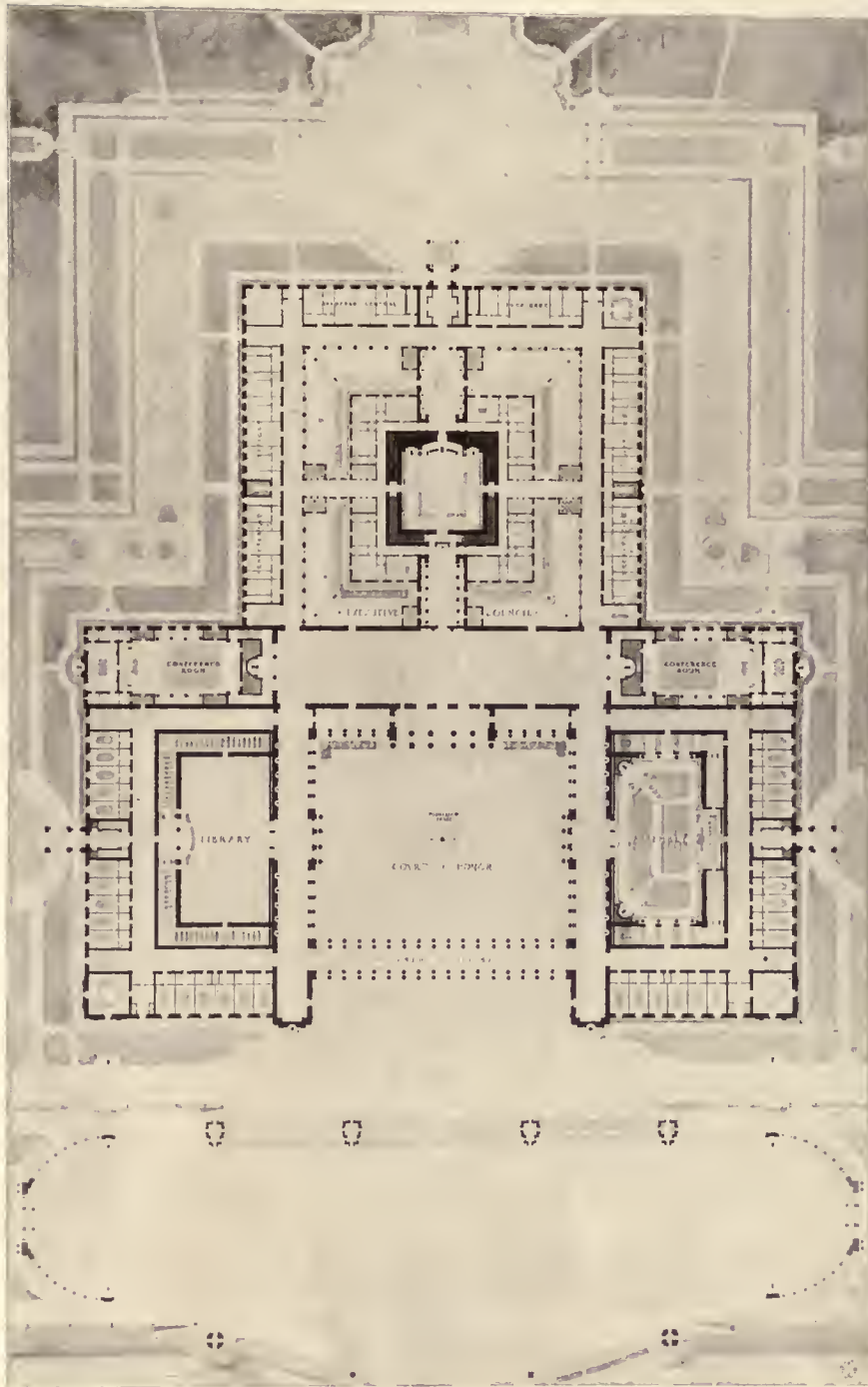

THE CAPITOL BUILDING OF THE LEAGUE OF NATIONS  
BEAUX ARTS INSTITUTE OF DESIGN  
12TH PARIS PRIZE COMPETITION  
FREDERICK M. HODGDON, ARCHITECT  
*Thirty-third Annual Joint Chicago Architectural Exhibition*

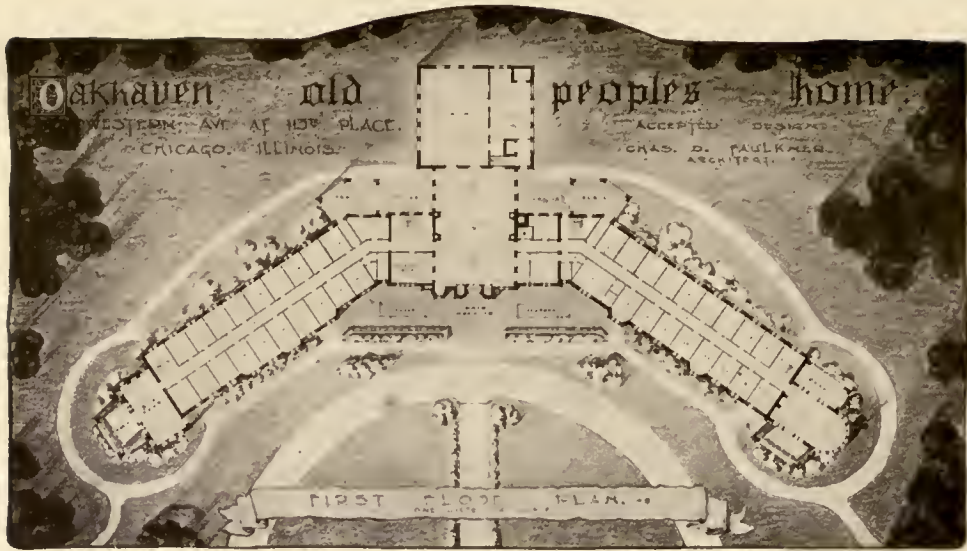

OAKHAVEN OLD PEOPLES HOME  
CHAS. D. FAULKNER, ARCHITECT

*Thirty-third Annual Joint Chicago Architectural Exhibition*

## THE AMERICAN ARCHITECT

In a foreword to the excellently prepared exhibition catalog, written by Irving K. Pond, it is stated:

"These annual exhibitions are for the purpose of letting society see somewhat of the process through which the architect works to accomplish his ends. The chief end is symbolizing, in terms of acting and interacting structural forces, the conflict of spiritual and of mental forces in the social body. Too often the architect and society itself fail to appreciate that the forces are at work, or how they work—and then the architecture becomes stupid and conventional and society is not elevated, however entertained and amused it may be, by this too valid symbolism of its own ignorant self. Too often sincere architects who comprehend that forces are at work in the social structure fail to note the direction and tendency of the effort, and their resultant symbolism, while not historically conventional, is scarcely appropriate to the society they would seek to interpret.

"These exhibitions are valuable as giving society (in its communal aspect) opportunity to see what the architect has in mind and how nearly in accord with his ideals is the result when the vision has been materialized in brick and stone. Sketches, made before the plans, even, are developed, suggest the spiritual vision; photographs (at best, poor substitutes for the reality) furnish a hint as to the accomplished 'materialization.' A closer connection between the 'vision' and the 'realization' might be made were the sketch by the architect to be shown, rather than conventional presentations by draughtsmen with personal and individual style of 'rendering' applied more or less indiscriminately to all types and conditions of buildings by numerous architects of varied personalities and predilections.

"Yet, however and from whomever the drawings may have found place upon these walls, there is meat here for the public, there is food for solid thought; and the public is more deeply concerned in the exhibition than it is, perhaps, aware. The architects and the public are mutually responsible for the state of architecture in the community, and neither can, nor

should wish to, shirk the responsibility. Where the work is sincere these and kindred exhibitions permit the public taste to see itself as the architect thinks he sees it. These exhibitions furnish society and the architect occasion to take stock of themselves and of each other."

This is a very accurately written statement as to just what an architectural exhibition should be, and just what it represents to those outside of the profession whose interest it is intended to attract and whose education in architecture it is sought to properly conduct.

It will be borne home to the careful observer that there is no danger in the assumption that architecture may be truthfully regarded as very much of a business. This attitude is very largely shared by the men of the Middle West. No equally thoughtful or competent observer will find that there is any lack of the fullest appreciation that architecture is an art, the highest and most complex of all.

This very successful showing of recent work is under the direction of three distinct organizations, each functioning separately and successfully. In all matters pertaining to organized architecture, the State of Illinois appears to stand as a brilliant example. On the floor of the Convention at Washington during the debate on State Societies, the fact that Illinois had accomplished great and lasting re-



OVER MANTEL PAINTING

ALEXANDER BOEHNER

*Thirty-third Annual Joint Chicago Architectural Exhibition*

sults through the harmonious co-operation of the Chapter and State Society was used as a strong point in argument. In this joint Chicago Architec-

ter alone would have secured equally satisfactory results, but they would have to prove it.

Many exhibitions during the past three years were by reason of the war's distraction necessarily omitted. It is now very much to be hoped that they will be resumed at their stated periods. While architects may not need them as educational measures, the public certainly does, and when conducted in the best educational way—as in the present exhibition for example—they serve the most valuable purposes.

More and more it becomes apparent that the very best place to hold an architectural exhibition is in the galleries of our large museums. The example set by the T-Square Club of Philadelphia, so successfully demonstrated the right of a showing of architecture to gallery space, with neighbors of the allied arts, no further proof was needed. The National Exhibition held in the Corcoran Galleries in Washington during the recent convention and the Chicago Joint Exhibition in the galleries of the Art Institute simply are added proof. Probably the day of the ultra technical architectural exhibition has passed and it is well that it should. For, in its place, there has grown a type of exhibition that serves a much greater and more valuable end,—the education of the public.

The calamitous fire which destroyed the exhibition of the Architectural League in New York almost at the very moment of its formal opening, deprived that city of the only place available for a large exhibition of architecture. Of course there is the Metropolitan Museum but, in view of the fact that the National Academy went to the Brooklyn Museum to hold its last exhibit, it does not seem possible that architects of New York might hope to hold any future exhibitions in the Metropolitan Museum where even larger numbers of people might view them than were admitted to the recent exhibitions in the Corcoran Gallery in Washington or the Art Museum in Chicago.

Just why New York's Museum should show so lukewarm an interest in the exploitation of American art we do not know and would be interested to learn.



DUNDEE STATE BANK  
DUNDEE, ILLINOIS  
CHILDS & SMITH, ARCHITECTS  
*Thirty-third Annual Joint Chicago Architectural Exhibition*

tural exhibition, probably one of the most successful local exhibitions yet held, we have further evidence of the good results to be obtained by this happy combination. Some will claim that the Chap-



## General Wood on Roosevelt and the Fine Arts

OF the interesting group of men Theodore Roosevelt gathered about him while President—all efficient and all of fine character—none has to a greater extent displayed greater constructive or administrative ability than Leonard Wood. His work in the Philippines and particularly in Cuba, disclosed so fine a knowledge of the attributes of a Master Builder as to receive the highest praise from architects and engineers.

The editors of this magazine, with much satisfaction, present in this issue an article by General Wood, further testifying to the valuable aid that Theodore Roosevelt at all times extended to the Fine Arts and particularly to the art of architecture.

Glenn Brown, in the series presented in earlier issues, clearly set forth the facts of Roosevelt's great work. General Wood has in this issue added a graceful tribute to the memory of his late Commander-in-Chief, and expressed in the finest way his agreement with those principles that Theodore Roosevelt with characteristic energy displayed towards our artistic well being and future development.

### A Need for Official Denial

DURING the convention of the American Institute of Architects, a delegate referred at some length to the recently issued report of a Senate Committee on the work of the Housing Commission and also to the debate in the Senate on this report during which it was directly stated that architects and engineers had been engaged in profiteering and were believed to have proved to a certain degree incompetent. Attention was called to the fact that so far as could be learned, no action had been taken by the organized bodies of architecture to refute these unwarranted statements and was also directed to the further fact that both the Engineering Associations and the Associated General Contractors had, by

well-directed propaganda, clearly shown that these attacks had no basis of fact but were purely political ammunition to serve a party purpose.

NO man in the profession of architecture will need assurance that the group of men who so unselfishly gave up large private practices and devoted a very considerable amount of time at a large personal loss, to the assistance of the Government in its housing operations, were anything but competent nor will it be necessary to produce facts to show how groundless any accusation of profiteering would be.

But as many of the ills that already beset the profession of architecture have been due to lack of alertness on the part of its organized bodies in keeping the public accurately informed, it would seem that this incident should not have been similarly ignored. THE AMERICAN ARCHITECT has taken occasion roundly to deny such political knavery, but it needs the stamp of authenticity of at least the Institute to give this denial its true weight and to set the profession clearly right before every layman in this country.

### The Farmer's Home Life Studied

THE Iowa Agricultural College has made a survey of all the farm homes in Orange Township, Blackhawk County, Iowa, and the following information was ascertained.

Half of all the farm homes in this township had furnaces, while the proportion having water baths and electric or gas light was slightly less. Nearly half the homes had such labor-saving conveniences as vacuum cleaners, power washers and electric irons. Nearly all the homes had telephones, more than half had pianos, and just about half had motor cars. This is not a picture of the average condition in farm homes throughout the country, but it is a picture of a condition rather exceptional at present, but to which we are rapidly approaching.

Each home improvement calls for others.

For example, it is the general experience of distributors of electric lighting plants that the pur-

chase of a lighting plant is followed by the purchase of a considerable amount of better furniture and house furnishings. Better wall paper is required. More paint and varnish are used. When the electric lights are turned on, the rugs, the furniture, and other house furnishings, which seemed satisfactory when kerosene lamps were in use, are not now so attractive.

The electric power plant makes it far easier to have a water system in the farm house, with indoor toilet and bath, and have the water system 100 per cent efficient. The power washer, the electrically operated ironing machine, the vacuum cleaner, the electric iron, and the electric fan can be utilized. The water can be pumped, the churn can be operated, the grindstone turned, the cream separated, and a variety of other minor operations performed in and about the farm home by electric power.

The installation of a water system and a lighting plant raises the standard of sanitation in the farm home. More soap and cleaning compounds of all kinds are used, and greater pride in personal appearance is stimulated, leading not only to a demand for better clothes, but for other things that are found essential by the well-groomed man or woman. The furnace eliminates the necessity of running several stoves and the resulting labor and inconvenience. Briefly stated, the modernizing of the farm home is an influence of tremendous power in promoting a taste for more and better things on the farm.

**I**T will appear from what has been said that the business of farming in the United States is becoming ever more important from the standpoint of the national welfare. Everything connected with farming is of direct interest to all other industries. Likewise, because of the broader outlook of the farmer and the increasing number of his contacts with the community life of the country, the promo-

tion of industry in general is of direct interest to the farmer. The forces of necessity and desire are working together to increase the complexity of relationships between the farming element and the rest of the country, and interdependence beyond the mere traffic in food is generally recognized.

At the same time the position of the individual farmer is being altered. More and more of them are attaining financial independence and are ready to shoulder a part of the investment burden which America must assume for her own protection as well as the succor of the world. With the farming industry flourishing and the men engaged in it prosperous, there must be optimism in any survey of the rest of the country and a feeling of confidence regarding the ability of our people to meet any situation which the reconstruction problem offers.

**F**OR two years and more this magazine has been endeavoring to point out the desirability for better farm homes, and to urge that at least as much thought be given to the home of the farmer and his dependent buildings as is received by the usual suburban dwelling. The question of farm labor is acute. Elementary selfishness would endorse the desirability of making farm life more attractive, and it is the type of home and environment that formulates that life. Elementary selfishness also recognizes the fact that our farming population comprises one of the largest groups in this country. What is typical of farm life will be typical of a majority of the people. If our high standards are to be national and not local the farm home must receive better consideration. The complete dependence with which the country reclines upon the farming people demands that compensating circumstances shall make them willing to support this burden. First and foremost is the farm home. It must be simplified, yet amplified—simplified as to its drudgeries and amplified as to its comforts. Then and only then dare the architectural conscience be at peace.



MEN'S DORMITORY, FRANKLIN COLLEGE, FRANKLIN, INDIANA  
COOLIDGE & HODGDON, ARCHITECTS  
*Thirty-third Annual Joint Chicago Architectural Exhibition*



RESIDENCE OF MRS. ALICIA OATMAN, DUNDEE, ILLINOIS  
CHILDS & SMITH, ARCHITECTS  
*Thirty-third Annual Joint Chicago Architectural Exhibition*



THE BANK OF ENGLAND, LONDON  
SIR JOHN SOANE, ARCHITECT

## Notes From London

(By Special Correspondent of THE AMERICAN ARCHITECT.)

### Rebuilding the Bank of England

AN announcement of very great interest to Londoners generally, and especially to the City of London, has been made that the Governors and Court of Directors are contemplating the rebuilding of the Bank of England. The news came as somewhat of a shock to many of us, but not altogether as a surprise to those who are "in the know"; for it was no secret that for at least a quarter of a century the Bank authorities had been contemplating alterations of a drastic character in the main structure of Sir John Soane's famous building, which is practically a ground floor only, with spacious underground apartments, but nothing above them.

City accommodation is now extremely scarce, and from the point of view of utility the present building, which occupies some of the most valuable space in the world, is extraordinarily wasteful. As a matter of fact, the Bank as it stands cannot offer sufficient accommodation for its own staff; even before the war accommodation was becoming uncomfortably

tight, and now with a staff of something like double the pre-war figure, nearly two-thirds of that staff has to be lodged outside, occupying the premises acquired for the supplementary departments in Princess Street, Lombard Street, Moorgate Hall, Bank Buildings, London Wall, and those only lately added in Tokenhouse Yard.

At the same time it must not be forgotten that although the Bank of England appears, and actually is, a one-storied building, there are a number of buildings within its circle which run up to four or five floors in height; hence the suggestion has been put forward to retain the familiar and really beautiful façade and rebuild the whole of the inner portion, raising it to at least 100 feet, or, in fact, subject to building regulations, to even more than this. We in London are more conservative in our treatment of existing buildings than in New York, where I once found on arrival that my hotel had been torn up only ten days before; and, apart from the cost of rebuilding the entire premises, which would cer-



tainly run into millions,—though even so the result might be well worth the expense,—on the sentimental as well as the aesthetic ground it might be preferable to many to see the familiar façade retained, in place of an entirely new structure.

On this difficult question it is of interest to hear the view recently expressed to a representative of *The Daily Telegraph* by Professor Sir Banister Fletcher, F.R.I.B.A. I have known Sir Banister Fletcher for many years, both personally and as a writer of distinction, whose "History of Architecture" holds as high a place in America as it does on this side; but in this special case he has not only the advantage of being a critic of architecture and architectural styles and also a practising architect, but besides these of being a Sheriff of the City of London, and in a position to know the views of the City on this important matter.

Sir Banister thoroughly approved of the public being taken into confidence in these semi-national undertakings, and admitted the loss from the present structure being a practically one-storied building, lighted from internal areas; though he stated that he had always heard that the absence of windows of the front was due to the fact that the Bank might have possibly to resist attack. There were two ways—he continued—of approaching the reconstruction of the Bank of England. One was the possible retention of the existing structure; the second was complete rebuilding. As an architectural historian and lover of old buildings he himself preferred the first of these two alternatives. The Bank was a beautiful building and a lasting monument to Sir John Soane. The architectural order which he employed was based on the little Temple of Vesta at Tivoli, not far from Rome. The internal courts and some of the halls were most effective examples of the later classic period at the end of the eighteenth century; and it would be a thousand pities if some of these, with their beautiful architectural detail and well-thought-out internal effects, were to be lost to London.

The method of rearranging the light courts and providing additional accommodation by pyramidal treatment would be probably the method of procedure. "You would then," he added, "retain the present very beautiful façade, and behind it successive receding stories up to 80 feet or 100 feet in height

would give an immense amount of additional accommodation. If the façade is to be retained this seems the only system of procedure to me."

As to rebuilding, he considered it would be a pity if this had to be done—but no one could shut his eyes to the necessity of proceeding along business lines in our great commercial enterprises. In the case of rebuilding, the new structure could be planned on the most up-to-date lines, with provision for plenty of light, and providing possibly sufficient accommodation for all departments of the Bank; but he pointed out very strongly that in this case great care would have to be exercised in the design, because the Bank, in the very center of London, was in close proximity to the Royal Exchange and Mansion House, both of which would have to be considered very carefully in their relation to the new structure. The proportions of the space in front of the Royal Exchange had been already very much altered,—and, in his opinion, damaged—by the erection of the large buildings in Cornhill. His conclusion was that any addition or rebuilding of the Bank of England must be in keeping with the surrounding classic treatment. The architecture must show some free expression of the Renaissance in its modern aspects, clearly indicating that it belonged to the England of the twentieth century.

The Bank of England, dating back to its projection by William Paterson, with the sanction and support of the Government, in 1694, is in fact a national institution, of which we are justly proud, as the agent of the government in the management of the National Debt; and has proved its value to the community in such crisis of our history as in the threatened French invasion of 1796, and yet later in the conduct of the late war. In detailing here the carefully reasoned opinion of Sir Banister Fletcher, which has my entire approval, it should be mentioned that not all agree with him as to the architectural merits of the present structure. It has been said that architecturally there will be little to lament in the disappearance of Sir John Soane's masterpiece. The long blank wall along Princess Street can well be spared. The Old Lady of Threadneedle Street has a heart of gold, but her face is not her fortune. Yet in quoting this point of view I believe the more conservative verdict will appeal to the British public, including the city man.

S. B.

# Specification Clauses

By FRANCIS W. GRANT

## REJECTED WORK AND MATERIALS

The contractor shall subject to arbitration as elsewhere herein provided, remove from the premises all material, whether incorporated in the building or not, when notified by the architect that such material or the workmanship employed thereon is not in accordance with contract requirements and shall restore all parts of the structure damaged by such removal. The architect may, in his discretion, and if the contractor so desires, permit material not in accordance with contract requirements to remain in place and in that event the contract sum shall be diminished by a sum fixed by the architect as compensation to the owner for such departure from the contract requirements, it being understood that the sum thus fixed shall not be made a subject of appeal to arbitration.

**T**HE contractor warrants a strict adherence to the program set forth in the specifications and the contract drawings as to form, quality and quantity of the several parts and the whole of the structure he binds himself to erect. He has no discretionary powers in the matter and, if competent, knows it.

Deviations will, however, occur in almost every building operation of magnitude. These need not by any means be always classed as fraudulent or made in wilful disregard of the contract requirements and a wise and tactful architect in supervising the work will grant a large measure of tolerance to the offending contractor in passing judgment on such deviations until convinced that back of them there lies a real intent to defraud the owner or to ignore the prerogatives of the architect.

In the case of a builder who really is competent and conscientious and an architect similarly endowed many deviations from the plans and specifications may be found to be actual betterments and their acceptance advantageous to the owner whose interests both should serve. If opinions differ as to the propriety of these deviations the judgment of the architect must, in the nature of the case, prevail.

A specification clause is required to establish a method of procedure in the event of deviations in the work and material from contract requirements; one that will apply whether such are of fraudulent

nature and intent or otherwise, and preferably one that will provide an equitable by-pass around absolute rejection.

It is thought that delinquencies on the part of the contractor involving departure from the specified form, quality and quantity of material for which the clause above suggested will not afford an adequate remedy are hopeless and that annulment of the contract is then in order under the provisions outlined in the clause entitled "Default of Contractor" elsewhere in the specifications provided or possibly the more conciliatory course of a resort to arbitration might be tried.

To provide that the owner may remove rejected material, if the contractor fails to do so with a degree of promptness satisfactory to the architect, and store it and subsequently sell it for drayage and storage charges as does the code of specification clauses promulgated by the American Institute of Architects is deemed by the writer too drastic. Such procedure contemplates an assumption of responsibility by the owner of a nature likely to prove embarrassing and is wholly unnecessary to the end sought.

The failure or neglect on the part of a contractor to remove from the premises within a period of time fixed by the architect certain rejected material or portions of finished work is not in itself always so heinous an offence as an excited architect or inspector is likely to construe it to be. Confiscation of the contractor's property as a penalty for insubordination is a procedure so hostile as to preclude any possibility of harmonious relations on the job thereafter. Its mere mention in the specifications is offensive and tends to breed a relationship between the parties quite inconsistent with that desired. It would be better, when conditions seem to prompt so drastic a course, to either patch up by arbitration or institute proceedings looking to the annulment of the contract.

In defense of the clause in the A. I. A. Standard Documents providing for the forcible taking possession of the contractor's property the statement has been made that the presence on the premises of rejected material constitutes a menace and a threat. The same could be said by the contractor of the presence continually on the works of an architect or his inspector and the contention would be as true in one case as the other. In neither case, however, is forcible removal by the interests menaced justified.

732



BUILDING FOR WARREN INSTITUTION FOR SAVINGS, BOSTON, MASS.  
THOMAS M. JAMES, ARCHITECT



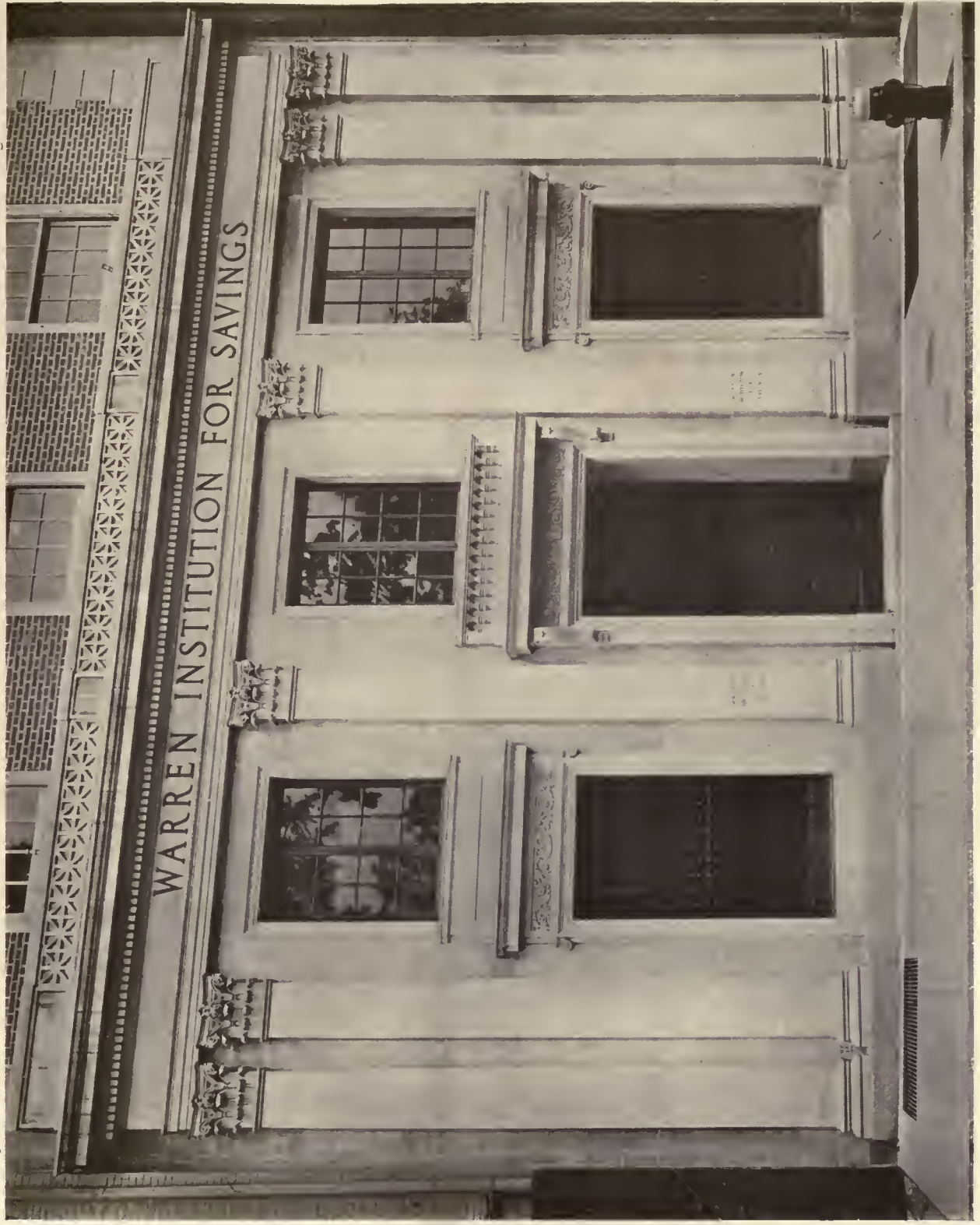

DETAIL OF LOWER STORY  
 BUILDING FOR WARREN INSTITUTION FOR SAVINGS, BOSTON, MASS.  
 THOMAS M. JAMES, ARCHITECT

7322



732



BANKING ROOM  
BUILDING FOR WARREN INSTITUTION FOR SAVINGS, BOSTON, MASS.  
/ THOMAS M. JAMES, ARCHITECT







HOUSE OF MRS. P. H. LOMBARD, POCASSET, MASS.  
JAMES PURDON, ARCHITECT

7324



7325

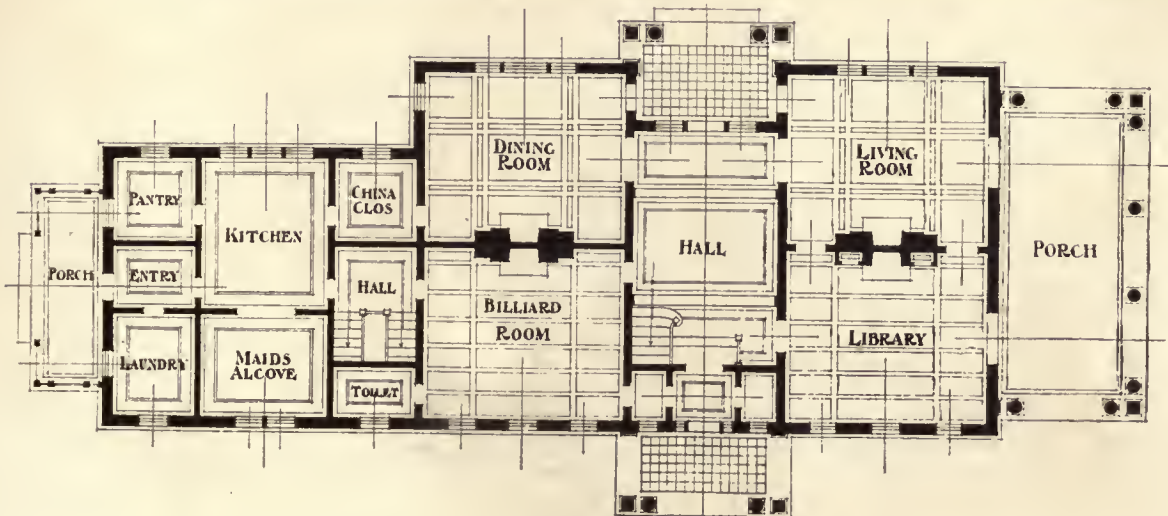

HOUSE OF MRS. P. H. LOMBARD, POCASSET, MASS.  
JAMES PURDON, ARCHITECT



732<sup>6</sup>

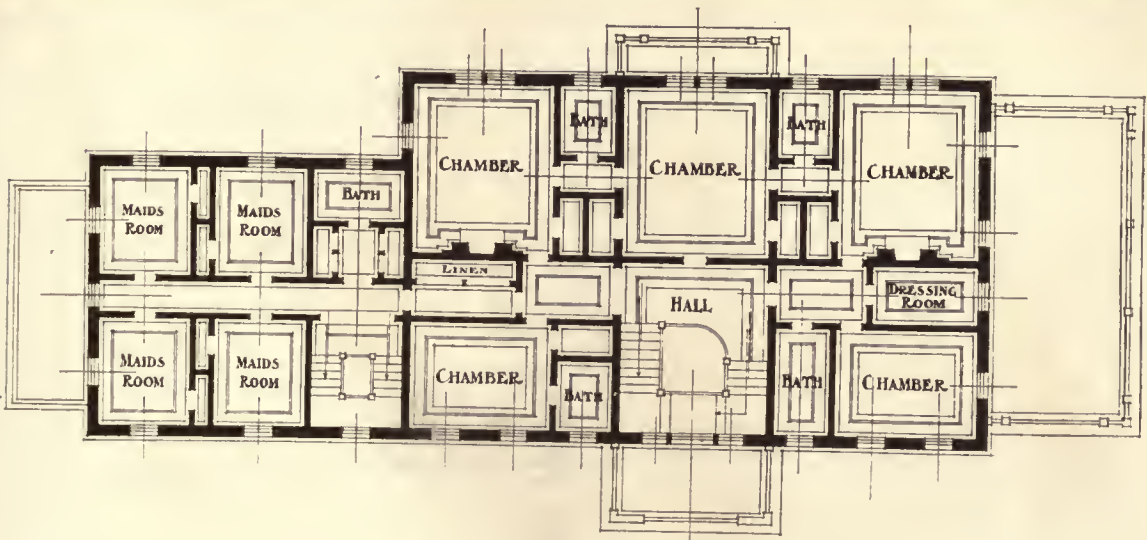

HOUSE OF MRS. P. H. LOMBARD, POCASSET, MASS.  
JAMES PURDON, ARCHITECT



Nothing should interfere with or diminish the architect's authority to demand exact compliance with the drawings and the specifications when in his judgment such is the only proper course, hence the provision looking to the acceptance of rejected work must be made applicable only at the architect's discretion and should be consistently treated as a compromise arranged for the contractor's relief. Arbitration of the relief thus offered would be inconsistent, the contractor being free to accept or to proceed to carry out the original intent of the drawings and specifications as his best interests might dictate.

### Persian Character in Art

#### The Revelation of Art and Literature in Persia as Disclosed by Closer Acquaintance

Of the ancient arts none give more pleasure to the student or the layman than that of Persia. Across its pages pass and re-pass mythical and historical figures, heroes and lovely princesses, doers of mighty deeds so dear to the heart of the Oriental. If we accompany them through exploits and trials, the subjects will live for us always in miniature paintings as well as in the literature and verse of that great country. This is delightfully told in *The Bulletin* of the Rhode Island School of Design:

"One of the pleasures which has come to Europe and America in the past few years is the revelation of the great interest to be found in Persian art and literature. The influence of this is seen in the theatre, with its scenery, dances and color schemes, in interior decoration, dress, illustrations and textile designs. Our collectors have yielded to the charm of Persian design in faience, textiles, rugs, woodwork, metal-work and miniatures; and the museums of art have sought, so far as opportunities permitted, to acquire for their permanent collections such examples as would do justice to Persian art expression at its best.

"It has been frequently pointed out that successful art in the Orient is dependent on the patronage of the court or some wealthy nobleman. The Persian rulers were in the main intensely interested in books for their libraries and gave every encouragement to artists and calligraphers. In this field was perhaps the greatest opportunity for the artist's success.

"But one does not have to be conversant with Persian literature to enjoy the artistic excellence of the technique and the inherent beauty. As soon as one admits the Eastern conventional treatment of perspective and the Oriental love of line, he is prepared to study Persian domestic life at close range, the polo games, battles, hunting scenes, glimpses of court and royal life. The beauty of

pattern in textiles of all kinds, costumes and tiles, and the Persian love of flowers and flowing streams. Then he will realize more fully a part of the spell of the East whose art is so very different from our own in many ways, and which, like all great art worthy of the name, takes us out of ourselves into the great world of imagination and beauty."

Of all the arts of the Orient that of Persia is the one that has had a positive influence upon the art of our epoch. Before its inspiration we all fall in an attitude of worship and from its principles of art representation we are evolving delightful designs with its forms of ornament as a background.

### A Characteristic Address by Willis Polk

#### California School of Fine Arts Told to Take All the Prizes, and Mr. Polk Shows How to Do It

All have heard the old story of the Bully who disputed the sidewalk in Jamestown with George Washington. The Bully said: "I never get out of the way of a blackguard." George Washington, with his best smile and in his most amiable manner, politely stepping aside, replied with a gracious wave of the hand, "I always do."

It was said that we were to proud to fight, but we did!

We entered the war to make the world free for democracy. Up-to-date it appears that the war has only made part of the world free for Bolshevism. But have no fear the war has made several million Americans sit up and take notice. There will be no Soviet Bolshevism, no autocratic rule in this country, the spirit of democracy will not perish from the earth—the American Legion will attend to that.

The American Legion is going to build in San Francisco a monumental group of buildings in memory of the men and women—soldiers, sailors and civilians who died that democracy might live. This group of buildings to commemorate the victory of democracy will be a nurturing place for all the highest ideals of a free people. It will be the home of the Fine Arts—painting, poetry, sculpture, music and architecture. It will be a fitting temple for those ideals for which we waged the war!

The faculty and students of the California School of Fine Arts and their successors will find in this memorial a home and be provided with facilities of study. Will they be worthy of it? This year your student body was awarded six out of ten of all the honors available to art students throughout the country. Next year you ought to get seven out of

ten. The year after eight out of ten and thereafter ten out of ten, for California is really and truly the true home of real art.

In the War Memorial, the Art Association will have its galleries, the school its ateliers. Students from all the world will, in time, seek this school for instruction, rather than will our students go forth for enlightenment. That is, if nature, temperament and determination are no less strong with us than were these characteristics with the Egyptians, Greeks, Italians and other predecessors of present-day ideals of civilization, order and art.

As far as the students here to-night, and the faculty too for that matter, are concerned, it must be remembered that success in any vocation means patient unending plodding. There is no short cut to success. Impressionist, cubist fads are entertaining, but usually are un instructive and detrimental to healthy artistic development. The student must study the methods of the old masters, not to copy them, but to seek inspiration.

Michelangelo, Rubens, Rembrandt, Raphael, Leonardo, Velasquez—all the masters were artisans as well as artists. Their work was complete to the last detail.

Can you match the incomparable finish of the winged Victory of Themathrase or the immortal sculptures of Phidias, with the incomplete and unfinished works of Rodin. I say No, a thousand times No!

## Uruguay Has Large Building Program

The next few years will afford opportunities for the sale of many kinds of construction materials in Uruguay, according to a report just issued by the Bureau of Foreign and Domestic Commerce, Department of Commerce. Uruguay is financially solid, its business is on a high plane, good workmanship is available, and there is a steady spirit of progress.

The biggest single project now being considered is a proposal for an international power plant to be erected on the Uruguay River by Argentina, Brazil and Uruguay jointly, with guaranties for the equitable distribution of power to the three countries concerned. On the site being considered it is calculated that 2,500,000,000 kilowatt hours per annum could be developed, or an energy equivalent to that of 3,000,000 tons of coal. The project contemplates the construction of two dams, one movable and one fixed, with canals to the power plant. It will utilize a fall of 77 feet. The installation would also open

for navigation 419 miles of river which today is inaccessible, and would permit the inundation of adjoining zones which are suitable for agriculture.

Other projects for the development of water power are also being considered by private persons and corporations. An official commission has prepared a plan for the irrigation of a 37,000-acre tract not far from Montevideo, to serve as an experiment and example. "Up to the present time," says the report, "nothing has been done in Uruguay in the way of taking advantage of the country's watercourses for irrigation and power."

Fifteen cities of Uruguay are also to install water and sewerage plants within the next few years, says Trade Commissioner W. W. Ewing, who writes the report. The pre-war estimates for this work totaled about \$15,000,000. In 1916 American engineers contracted for the installation of water and sewerage systems in three of the largest cities in Uruguay at a cost of \$5,000,000. The work was completed twelve months before the contract date and the bonds have now been retired by the Uruguayan Government. It is probable that a part of the new work of this nature will be given to American interests.

There is a present need in Montevideo for a large number of workmen's houses, for at least ten new business structures, a hotel, an opera house, cold-storage facilities, and a number of factories, the total cost of immediate needs in private construction of these kinds being estimated by architects at \$16,300,000. Within the new few years the Government will need new and modern edifices to the value of \$23,000,000. The chief imports which this program of construction will require are steel and finishing materials.

Uruguay has local supplies of granite, marble, porphyry, limestone in limited quantities, and cement. There is also abundance of excellent clay for brick-making, but it has not been fully utilized. No clay roofing tiles or sewer pipe are made in Uruguay. All fire bricks and plaster of Paris are also imported. There is a developing demand for many types of construction tools and machinery, and for heating and elevator installations, according to this report, which is known as Special Agents Series No. 189, "Construction Materials and Machinery in Uruguay," and is sold at the nominal price of 15 cents by the Superintendent of Documents, Government Printing Office, Washington, D. C. The report may also be obtained at any of the district or co-operative offices of the Bureau of Foreign and Domestic Commerce.



# The Bush Building as a Commercial Museum

**I**N a recently issued *Bulletin* of the Metropolitan Museum, it is stated that the Bush Terminal Sales Building in New York is the museum idea applied to commerce. THE AMERICAN ARCHITECT illustrated this structure, designed by Helmle & Corbett, when it was completed, so that architectural details need not here be repeated. It is, however, believed that the comments of J. Olin Howe in the *Bulletin* will prove of interest. He says in part:

The Bush Terminal Sales Building is the museum idea applied to commerce. It is the outgrowth of a vital need which developed at the great terminal plant in Brooklyn and probably the thought of an industrial museum had no place in Mr. Bush's mind as the plan took shape. Yet it is that. Instead of art objects it exhibits the products of American factories. Its collections of manufactures cover the widest range and are selected for merit. Painters and sculptors may be little concerned in them, but artisans and craftsmen are very deeply, and antiquarians have had to do with many of the furnishings. The building itself is the successful working out of a sound architectural conception; a slim, graceful tower which is a most attractive feature of the scene in the central section of New York.

The building is primarily meant for a meeting place for seller and buyer, American manufacturer and his customer from any far corner of the globe and from every part of this country; but through the thousands of buyers who come there contact with the public is close, and there are frequent special exhibitions to which everybody is invited.

One crosses the threshold of the building from busy 42nd street to enter a lofty-ceilinged lobby almost cathedral in aspect. Here are the atmosphere and appointments of a first-rate club, to which, indeed, the first three or four floors are devoted, the International Buyers' Club. In the club's quarters the decorations and furniture are in the English manor-house style and there are even huge tables about which business conferees take places once occupied by the valiant trenchermen who marred and scarred their solid oak.

Above for twenty or more floors are the collections gathered from all over the United States to show the nation's industrial and commercial resources. On some floors but a single general line is shown, on others several are grouped. In some cases the makers have their own representatives to care for their interests, but in more the Bush or-

ganization performs this service. Anything like a complete catalogue is, of course, out of the question here. House furnishings and home appliances, decorative arts and industries, furs, infants' and children's wear, jewelry and clocks, laces and embroideries, luggage and leather goods, men's wear, women's wear, millinery, notions, pianos and talking machines, shoes and shoe accessories, toilet goods and perfumery, toys, waterproof fabrics; these give an idea of the variety of even the larger divisions. Sometimes, perhaps, the arrangement of the exhibits is rather to suit a commercial purpose than after the manner of the museum, but it may be the desired result is the more readily gained that way.

What is of far more moment, back of it all is the sincere effort to perpetuate ideals which inspired designers and craftsmen of an earlier day. It may be a lamp-shade, a piece of tapestry or brocade, a bit of jewelry, a chair; whatever it is, it goes without saying that the every-day things of life gain in real beauty and in appeal to the finer sensibilities when the origin of the idea from which they result goes back some hundreds of years or two or three thousand. It is to this end that the International Buyers' Club has an extensive reference library which is consulted more and more as it becomes better known. In it are not only rare books of prints with the designs of the old-time masters, but many modern and even recent works by recognized authorities. Moreover, there is earnest co-operation with the Metropolitan Museum. Prints, photographs, and other things which may aid in the effort referred to are borrowed, and many a student has attended the Metropolitan's study-hours for practical workers upon advice given in the Bush Building.

It is always with the thought of improvement in commercial design that the temporary exhibitions of the Bush Building are brought together. The most complete showing of the ancient Japanese art of batik ever made in this country was one of the most noteworthy of these. Possibly rivaling it in interest was a lace exhibition, in which there were some good antique laces, but far more examples of fine modern work after old models and patterns. Recently a collection of Persian rugs and antiques gathered with the aid of that Government was exhibited. Just now the handiwork of modern France is being shown.

## Gardens on the Roof

The war garden movement has been largely responsible for a new type of roof-garden—not the kind famous in great cities before last July. At the height of the war garden movement, many city dwellers sought places where they might grow vegetables. Such places do not exist in ample quantities, particularly in New York, and apartment house owners have planned for and constructed garden spots on the roofs of the large buildings.

The construction work necessary to provide a building with garden space is simple. The gardens were made in boxes, similar to those used on the benches in greenhouses. These are set above the roof, so as to provide both ventilation and drainage. All the earth for the garden was taken up in the elevators of the building, and while undoubtedly the first cost of this garden was large, the expenditure was worth while.

Where land is subject to overflow or where water from rains would not run off quickly the floor level of cement storage bins should be well above what may be the high water line. This is applicable to either fixed or temporary plants for bare dry prairie is often covered with two feet of water from spring rains when culverts became choked. On this land the floors of cement warehouses were set 42 inches above the ground line.

Bird houses were erected on the soil pipes to camouflage them, and these pipes were used also as poles for the climbing beans.

When the war garden period had passed, the gardeners did not forsake their gardens for the simple reason that they found health and delight in caring for them. And each year now sees more and more gardens on the roofs of the larger city buildings.

## Court Decisions on Labor Questions

The Bureau of Labor Statistics of the United States Department of Labor has just issued its annual compilation of decisions of courts affecting labor (Bulletin No. 258), and of the 180 odd cases included therein more than a score involved the power of the legislature to enact the law under which suit was brought, the objector being in every case a person claiming to be injuriously affected by the act.

Sometimes the court decides adversely to the legislature, as in the case of the Federal Child Labor Law, by which Congress undertook to exclude from interstate commerce the products of child labor in the various States. It was held that the attempt to regulate the conditions covered by the law was in excess of the Federal authority, being purely within the control of the State, so that the law could not be enforced; so also of a law of

Louisiana, declaring a special liability of public service corporations for injuries to any of their employes, the court holding the act unconstitutional because it placed in one class workmen engaged in nonhazardous and in hazardous occupations.

Another instance in which the action of the lawmakers was held to exceed its constitutional powers involved a tipping law of California. This act did not actually prohibit the giving of tips, but forbade the employer to require employes to turn their tips over to him. This was said to be unwarranted interference with the right of employers and employes to contract.

In most cases, however, the legislatures have been vindicated, as by the Supreme Courts of Massachusetts and Washington, upholding the Minimum Wage laws of the respective States; that of Pennsylvania sustaining a law forbidding night work by children under 16 years of age, and those of New Jersey and New York upholding progressive legislation on the subject of workmen's compensation. The New York case involved the creation of a special fund to compensate second injuries, contributions to be made to it by employers of workmen fatally injured and leaving no beneficiary under the act.

The Clayton Act, amending the Federal Anti-Trust Law, was held by a United States District Court of Appeals to have set aside some of the judicial restrictions on the right of labor unions to maintain boycotts against objectionable products of manufacture. There was a strong dissent to this opinion, the statement being made that what would have been unlawful in this case before the passage of the Clayton Act was not made lawful by the act.

## A Recent Legal Decision

### Contractors' Bonds for Public Works

The bond required by Act of Congress Aug. 13, 1894, as amended by Act Feb. 24, 1903, giving persons furnishing labor or materials to a contractor for public work a right of action on the contractor's bond, performs a double function: First, to secure to the government a faithful performance on the part of the contractor; second, to protect persons from whom the contractor obtains labor and materials. The statute is to be liberally construed to effect these purposes; but the limitation of one year for bringing suit is a condition of the right conferred. The claims of the various persons furnishing labor or material are assignable, and each claim is separate and represents a distinct cause of action. *Salysers v. United States*, 257 Fed. 255.

## Convention of the American Federation of Arts

At the invitation of the directors of the American Museum, the eleventh annual convention of the American Federation of Arts was held at the Museum in New York, May 19, 20 and 21.

The Federation is a national organization; its conventions are devoted to national questions. This year much attention was given to the functions of museums in the community, suggestions being offered for places not yet provided with such public structures. In addition public matters such as billboards, shop windows and community centers were discussed.

This Federation has constantly on tour some forty traveling exhibitions of many kinds, paintings, sculpture, engravings, industrial arts, photography, textiles, wallpaper, prints for home decoration, etc., etc., selected by experts. These reach all parts of the country, having made 150 stops this year. It also circulates illustrated lectures, prepared by authoritative writers, museum curators, painters, sculptors and other qualified persons. The Federation publishes a wideawake monthly, *The American Magazine of Art*, and the official art directory of the country, *The American Art Annual*.

In various public questions affecting the arts, the American Federation of Arts has taken an active interest and has wielded a strong influence for their adequate and satisfactory solution, notably such matters as that of the Lincoln Statue Controversy, the placing of control over the designs for military medals and others of like character in the hands of the Federal Commission of Fine Arts, the furtherance of legislation to prevent the making of public gifts to foreign countries without approval of the proper authorities of the United States Government. The Federation has urged that industrial art be included in all schemes of vocational education and that the Design Registration bill be passed by Congress. In recent months the Federation has been actively engaged in an interesting campaign for good design in war memorials, the publications on the subject having reached many thousands of persons, institutions, the attention of organizations, periodicals and others interested in the subject. A General Committee on War Memorials, of which ex-President Taft is chairman, has been appointed.

The Federation works for better art education, uniform art legislation, establishment of competent art commissions; it supplies art information and study courses. It has thrown its weight in favor of the rapidly growing movement toward industrial arts design worthy of the stamp "Made in the U. S. A."

To advance these many lines of usefulness the Federation counts upon the services of many public-spirited men and women. Its president is Robert W. de Forest, who is also president of the Metropolitan Museum of Art.

## Personals

The offices of the American Park Building Co., landscape architects, are now located at 201 East Ontario street. The former address was 140 South Dearborn street.

Henry M. Congdon and Herbert Wheaton Congdon have moved from 18 Broadway, New York, where they have had offices for thirty years, to 10 West 23rd street, New York.

The Indianapolis, Ind., firm of architects, Bass, Knowlton & Graham, announce that they have opened an office at 201 Kimberly Building, Okmulgee, Okla., under the firm name of Bass, Knowlton, Graham & Carson.

Charles W. Dawson, A. I. A., with whom T. E. Bassham is associated for architectural practice, in the Barnes Building, Muskogee, Okla., has opened another office in the Merchants' Bank Building, Fort Smith, Ark., with Carnall Wheeler, associate.

The New Haven, Conn., Architects' Club will move to 781 Chapel street. The present officers are: C. F. Townsend, president; A. M. Thomas, vice-president; Walter Shiner, secretary and treasurer. The club desires catalogues and trade circulars.

The firm of Hatton, Klein & Holmes, of Cedar Rapids, Iowa, has been dissolved and the firm of Hatton, Holmes & Anthony formed, which will continue the work in architecture, engineering, etc., previously done by the old firm.

Edwin H. Clark and Chester H. Walcott have announced that they have formed a partnership for the practice of architecture, under the name of Clark & Walcott, at 8 East Huron street, Chicago. Associated with the firm are Russell S. Walcott, Robert G. Dwen and George W. Repp.

The Iowa Chapter of the American Institute of Architects, Eugene H. Taylor, secretary, Cedar Rapids, Iowa, has issued a circular of "Facts and Suggestions to Persons Interested in Building Operations." The circular answers four questions about the architect: Why is he? Why employ him? How select him? How deal with him?

# Current News

---

## Happenings and Comments in the Fields of Architecture and the Allied Arts

### Request \$2,000,000 to Build on City Owned Land

Request for an issue of \$2,000,000 of corporate stock has been made by Calvin D. Van Name, Borough President of Richmond, to the Board of Estimate, with which to build housing on city-owned land under the plan recently advocated by Borough President Curran of Manhattan.

Mr. Van Name accompanied his request with a specific plan for a six-room detached cottage, 18 x 30 feet, on a lot 25 x 100, containing kitchen, dining and living rooms, two bedrooms, complete bathroom, hot air furnace heat, with a stuccoed exterior, which he asserts can quickly be built on Staten Island to be sold at \$3,000.

Instead of building on city-owned property, Mr. Van Name would build on Staten Island, where the houses "will produce more per dollar invested than any other locality. Furthermore, I am prepared to say that if this money is appropriated and expended in Staten Island, the borough's building department will supervise the erection of these homes, to the end that the city and the purchasers will get full value for their money."

### Italian Government Aids Housing

In Rome it is estimated that at least one-third of the population is without a permanent home and living wherever it can find quarters. This city, not too well supplied with houses even under normal conditions, was compelled after the armistice to care for thousands of returned soldiers and the staffs and employes of new governmental departments which were concentrated there. Discussing the subject editorially, the *New York Sun* shows that a similar situation developed at Naples and at the large manufacturing cities of the north, owing to the fact that high wages drew a constantly increasing number of workmen to the industries centred in these places.

It was, however, the situation in Rome that first led the Government to take hold energetically of the housing difficulties and to seek relief as early as possible. In co-operation with the municipal authorities it decided upon an extensive building program that required the demolition of some of the old forts with which Rome is encircled and the development of new suburbs outside of the present city limits. The possibilities of this co-operation between the State and municipality thus discovered and proving feasible were taken up by other cities.

Among the municipalities besides Rome and Milan which have taken advantage of Government aid in carrying out some form of building program are Bologna, Florence, Modena, Turin and Venice. This assistance has come under provisions of law which permit the State to participate in the payment of interest on loans made to building organizations and co-operative societies.

The Government has in this way assumed annual interest charges which amount in normal times to about \$500,000 and which represent loans for building purposes of more

than \$25,000,000. This represents in Rome alone construction that will provide 25,000 rooms, and in the remainder of Italy houses the cost of which will exceed \$40,000,000. Other methods of stimulating building activities are certain exemptions from normal taxes and a complete exemption from import duties on building materials.

Italy is the only nation that has gone as far as this in furnishing Government aid in the present crisis to the home builder. The hope of success for the plan lies in the energetic manner in which the State has attacked the problem. That this will soon bring about a considerable improvement in prevailing conditions is the opinion expressed by the American Trade Commissioner at Rome.

### Forty Million Dollars in Huge Co-operative Building Plan

Two mammoth office buildings with more than 1,500,000 square feet of floor space are to be erected and owned by the tenants on a co-operative basis on three city blocks to the north and west of the Grand Central Terminal. The deal will involve \$40,000,000 and is said to be the largest single realty transaction ever made in New York City. Warren & Wetmore, who designed most of the big structures in the Grand Central Terminal zone, will be the architects.

S. Fullerton Weaver, a well known apartment house builder, is at the head of the syndicate that is to put up the structures. Associated with him are William Crawford, a general contractor, who has erected a number of large office buildings, and Walter Russell and Edward H. Everett. Mr. Russell is promoter of co-operative building enterprises and Mr. Everett is a capitalist living in Washington.

It is expected that work on the buildings will be started this fall, and the promoters hope to have them completed by May 1, 1922. The taller will have thirty-one stories and will occupy the block between Forty-sixth and Forty-seventh streets, from Madison to Park avenue. The other will have twenty stories and will cover the site between Forty-fifth and Forty-sixth streets and Madison and Vanderbilt avenues.

The co-operative ownership plan will be modelled after those now in vogue in apartment houses. It is stated that corporations and other tenants will buy space for a sum equivalent to six times the amount of their annual rental. In other words, the lessees will pay six years' rent in advance and in return will have a proprietary lease on the space they occupy without further payment of rent.

### Guests Buy a Hotel Property

The seventy guests of the Lancaster Gate Hotel in London being warned to vacate within two weeks could not find any other place wherein they could live, so a number of them mobilized their resources and purchased the property and set up for themselves both as landlords and tenants. One member of the buying syndicate said: "We

now employ a manageress, and run the place on the lines of a residential club. All visitors have to be introduced by a shareholder, so we shall not get any of those offensive people one usually finds spoiling a happy party at a residential hotel.

"As we want to just cover expenses, the fees of the residents are now about half what they were before the change was made."

## To Alter Grand Central Palace

After an existence of eight years as a house for large expositions and business shows, for which it was expressly built, the Grand Central Palace, on Lexington Avenue, New York, will cease to be used as such after April 1, 1921, notices to that effect having been sent out from the office of the Palace. Alfred I. du Pont is understood to be at the head of an organization that owns the property, and it will be altered for business purposes.

In the four exposition halls within the Grand Central Palace is a greater number of square feet of floor space than in any other auditorium structure in New York. The excessive demand for commercial space makes the building a better investment rented out to business firms for their permanent purposes, assuring the owners of the property from \$5.00 to \$6.00 a square foot a year, which, of course, is much more than the property yields now.

Unless some other exposition building is erected in this city, men who make a specialty of expositions assert that many large exhibition enterprises that meet here annually will have to go to other cities. The effect of such a situation on business in New York would not be salutary.

When the leasehold of the Grand Central Palace was bought by the organization headed by Mr. du Pont, the statement was made that the great building would continue to be used for various expositions and displays and that a vast market place for the exhibition of all sorts of goods from everywhere would be established there. Twelve stories in height, the Palace has four floors given over to exhibitions and offices.

## Dewey's Former Home Turned Into Store

Admiral Dewey's former home, gift of the American people for his victory at Manila Bay, is being remodeled into a store, having given way, as have a number of other historical residences, to the spreading commercial section of the city of Washington. The Dewey house at 1747 Rhode Island avenue, just off Connecticut avenue, was disposed of some years before Admiral Dewey's death.

The city's commercial expansion is gradually moving northward along Connecticut avenue and has passed beyond the British Embassy, which now finds itself amidst a group of fashionable shops. The historic old Corcoran mansion and the wisteria-clad John Slidell house, with their old-fashioned gardens and high brick garden wall, facing Lafayette Park, opposite the White House, at the beginning of Connecticut avenue, soon will be razed for a modern building for the Chamber of Commerce of the United States of America.

Among the historical mansions holding out against the march of commercial expansion are the famous Octagon House, residence of Colonel Taylor, which was occupied a year by President Madison after the White House was fired by the British in 1814.

## Roosevelt Road of Remembrance Proposed

A Roosevelt Road of Remembrance, planted with memorial trees from ocean to ocean, would be the greatest of all memorials that could be erected in honor of the former President, declared Charles Lathrop Pack, president of the American Forestry Association of Washington, in an address at Flushing recently. Mr. Pack spoke at a memorial tree planting in memory of Theodore Roosevelt and Quentin Roosevelt. Two white oaks that have been registered on the association's honor roll were dedicated.

"In a Roosevelt Road of Remembrance," said Pack, "every citizen of the United States would have a part and no finer memorial could be erected than such a memorial highway. As never before, the United States needs a great outstanding lesson in forest conservation, for this country to-day faces one of its gravest problems—the perpetuation of its greatest natural resource—the forests.

"Millions are to be spent on improved highways that the producer and consumer may be brought close together. Let us beautify these highways in the building. Let us keep the message Theodore Roosevelt gave us alive. That message was that national prosperity and well being are dependent upon a nation's forests. With such a memorial, arousing the whole Nation, as it surely would, for each would have a part, Theodore Roosevelt would both be honored and would know that his message had been heard."

## The Removal of Paint from Iron and Steel Surfaces

Scraping or burning paint from the surface of iron and steel structures previous to the application of a new coat is a slow and laborious process. An easier and more rapid way of doing this work is the method used by the United States Coast Artillery, for cleaning the exterior portions of the big guns and gun carriages in their care, and described by *Graphite*.

In practice, a one-pound can of concentrated lye is dissolved in three quarts of boiling water, and to this mixture sufficient lime is added to emulsify the solution. This solution is freshly mixed each time it is to be used and is applied with a brush and allowed to remain until it is almost dry. It is then removed and unless the paint is very old and thick it will come off with it. If one application of the mixture does not remove all of the paint, the surfaces are washed off and a second coating applied. Before a new coat of paint is put on, the surface of the metal should be thoroughly cleansed with a solution of washing soda (in the proportion of one-half pound to two gallons of hot water), and well dried either by wiping with soft cloths or by the application of heat.

## To Kill the House Fly

Among other suggestions made by the United States Government for the elimination of the house fly, the following timely information is made available:

Any odor pleasing to man is offensive to the fly and vice versa, and will drive them away.

Take five cents' worth of oil of lavender, mix it with the same quantity of water, put in a common glass atomizer and spray it around the rooms where the flies are. In the dining-room spray it lavishly even on the table linen. The odor is very disagreeable to flies but refreshing to most people.

Geranium, mignonette, heliotrope and white clover are offensive to flies. They especially dislike the odor of honeysuckle and hop blossoms.

According to French scientists flies have intense hatred for the color blue. Rooms decorated in blue will help to keep out flies.

Mix together one tablespoonful of cream, one of ground black pepper and one of brown sugar. This mixture is poisonous to flies. Put in a saucer, darken the room except one window, and in that set the saucer.

Borax is especially valuable around farms and out-of-doors. One pound of borax to twelve bushels of manure will be found desirable as a poison without injuring its manurial or farm stock. Scatter the borax over the manure and sprinkle with water.

Lye, chloride of lime, or copperas (sulphate of iron) dissolved in water, crude carbolic acid, or any kind of disinfectant may be used in vaults.

## England-France Channel Tunnel

In an engineering supplement the London *Times* publishes an article on the proposed tunnel under the Straits of Dover, written by J. C. Davies, of New York, who was prominent in the construction of the Pennsylvania Railroad and other under-water work in and about New York. According to Mr. Davies, the tunnel, about twenty-nine miles long between portals, could be driven under water 180 feet deep and that the section twenty-four miles long between the shore shafts could be excavated at the rate of 1275 feet per month, thus requiring about four years for the headings to meet. This somewhat exceeds the best speed heretofore attained, which was 932 feet a month in soft shale at Rogers Pass tunnel on the Canadian Pacific Railroad.

The character of the rock which can probably be advantageously excavated by machinery, the moderate temperature that will be encountered, the location convenient to good labor markets and improvements in machinery and appliances are considered to justify this estimate which corresponds with a cost of about \$150,000,000, nearly twice as much as was estimated before the war.

## X-Ray Being Used on "Old Masters"

Examination of old masters is the latest use to which the X-rays have been put, according to a recent London report. The results as Major G. W. Kaye demonstrated at the Royal Institution, are important. He showed two pictures by Dutch masters, one representing the Madonna and another the Crucifixion. In the former the Madonna appeared to be looking at something which was non-existent on the canvas, but a radiograph examination proved that the missing something was a child, which a former owner of the picture had evidently disapproved and had painted out.

In the second picture a woman in an attitude of prayer was discovered to have been painted over what was in the original the figure of a man in monkish garb.

## Glass Shortage Induced by Motor Cars

That a universal shortage of glass confronts the builders, now resuming their construction programs so long delayed by the bricklayers' strike, is reported in the *Brooklyn Eagle*. Not only are Brooklyn and Long Island hit, but the whole country and the South American republics

are likewise said to be at the mercy of a glass famine.

It is not because less glass is being made, but because the demand has grown out of all proportion to the supply. The motor car industry, with its new sedans and limousines and their shining expanses of plate glass windows, has developed into a glutton for glass.

"Time was," explained an official of one of the large glass companies, "when window and plate glass was used almost exclusively in building trades. Not so now. The demand from motor car manufacturers for glass is even greater than that from building contractors."

But for the bricklayers' strike, which tied up home building since the first of the year, the situation in glass would be locally impossible. Now that the bricklayers are returning to work, the glassmakers will be called upon to furnish window panes, and the motor car industry will furnish a stumbling block.

The General Motors Corporation, makers of Chevrolets, Cadillacs, Oldsmobiles, Scripps-Booths, Oaklands, Buicks and many brands of trucks, bought up three glass factories, whose entire output will be diverted to the motor car trade. This represents the old reserve. Other companies like the Packard and Ford have taken steps to insure their glass supply by long-term contracts, or by going into the market after glass factories.

The export trade has also carried off a large share of American-made glass. The Government figures seem to bear this out.

In 1910 the United States exported \$2,805,401 worth of glass. In 1918, the last figures available, it exported \$14,012,756.

Imports in 1910 were \$6,570,123. They had dwindled to \$1,723,014 in 1918. Only \$8 worth of plate glass was imported in 1918 and only \$101,842 in window glass entered American ports in that year.

## Building Loan Association Formed in New York

AN organization of a building loan association is contemplated in New York with a capitalization of \$30,000,000 which shall construct the modest type of house needed by the small salaried class. The purchaser would be required to pay 6 per cent of the purchase price—which would probably be \$2,500—in monthly installments; he would also be compelled to purchase stock, paid for on the installment plan. The total monthly payments would amount to about \$25 and at the end of twelve years he would own the house.

The scheme carries many of the commendable features of "the Detroit Plan" which seem to offer a solution, not only for the housing of our population, but for many of the social problems of the day.

## Germans Restoring Louvain

Restoration of the Louvain Library has been begun by the German Government at a cost of more than 5,000,000 francs gold, in execution of the agreement with Belgium, says the *National Zeitung*.

Restoration of paintings carried off during the war, is also proceeding, the newspaper says.

According to the same authority, Germany had restored to France up to April 1, 8,000,000,000 marks in cash and securities and large quantities of art works, documents and archives, and to Belgium about the same amount.

# Weekly Review of Construction Field

Comment on General Conditions of Economics With Reports of Special Correspondents in Prominent Regional Centers

---

In a statement made by the Governor of the Federal Reserve Board he said: "The board is insisting that all banks use a discriminating judgment in making loans, giving preference to those which are necessary for the production and distribution of the basic necessities of life, such as clothing, food and fuel." It would seem that shelter was also a necessity of life and that although the Federal Reserve is concerned with liquid funds and could have little to do with long-term mortgages, the "clothing, food, and fuel," might be very well extended to include "buildings materials," as worthy of the phrase "essential loans." And these funds also might advisedly be used in making temporary loans to carry on construction operations.

It is time that some national policy was developed which would support the building industry. There is somewhere a bill, offered by Senator Calder, which proposed the establishment of a system of home loan banks through which building and loan associations might rediscount real estate mortgages. It was also proposed that real estate mortgages be exempted from the income tax. But nothing has been done; building investments and construction stand at a disadvantage.

*(By Special Correspondence to THE AMERICAN ARCHITECT)*

CHICAGO:—Everybody seems to agree that the whole economic situation, affecting building as well as other industries, hinges on the proper solution of the transportation question. With both the rate hearing in Washington and the wage hearing in Chicago drawing out to such lengths, indications are that it will be some weeks before any final decision will be reached in either case. In the meantime, the movement of traffic from the congested terminals of Chicago is to be undertaken by the local terminal committee of rail and shipping representatives acting under authority of the Interstate Commerce Commission. Traffic here is hardly above 60 per cent of normal as yet.

Coupled closely with this question of rail transportation is that of bank rates which have risen in conformity with the policy of the Federal Reserve Board and cleared up a lot of loans of long standing. Non-essential credits and building loans are being restricted more and more. It is thought this policy may continue for probably another month.

Bankers explain that high prices will only be cured when unnecessary spending is checked. This it is hoped to bring about by increasing money rates and restricting loans.

Loans under 8 per cent in Chicago are now practically non-existent, although paper well secured by collateral is nominally quoted at  $6\frac{3}{4}$  to 7 per cent.

There is still a shortage of labor in the Chicago district, as well as in the agricultural areas. This cannot be cured under present conditions although it has been remarked that many persons are not working as regularly as they do in normal times. It is this class that is the "spending" problem discussed by economists. A Chicago railway official on returning from the West reported that there were more automobile tourists in the national parks in April than in any month last year and the regular season does not open until the latter part of June.

The builder in Chicago has been caught between two fires. He finds himself unable to get rail deliveries because of transportation failure on the one hand and is cut off or restricted in his credit. Even though he may have the money to pay for his materials, he cannot get supplies. Many local contractors charge that inefficient handling of cars is responsible for much of their troubles. It is claimed the average daily mileage of a freight car today is only 14 miles while in 1914 it was 20 miles.

Whatever the cause, building continues to decrease in Chicago. During the last week there were only 41 building permits, involving \$1,193,200, whereas during the corresponding week last year there were 110 permits involving \$2,084,600.

*(By Special Correspondence to THE AMERICAN ARCHITECT)*

SAN FRANCISCO:—Lumber is showing a downward tendency for all grades except hardwood. While there have been few changes as yet, the market is admittedly weak. Drastic reductions have taken place in white pine laths which are now quoted f.o.b. mil' at \$12. No other changes of building material are noted, but there is no doubt that bars will seek a lower level in the near future if freight and other conditions do not permit a larger local consumption. With the Oriental markets not buying at this time, the output of the local mills is accumulating rapidly, the lower prices will have to be quoted to clean them out or some of the mills

## THE AMERICAN ARCHITECT

will have to materially restrict production and possibly close down for a time.

Statistics of real estate sales for the first four months of the year exceeds the volume of business of the same period a year ago by nearly \$6,000,000. As prices have generally been higher these figures show a desire to build which is held back solely by freight conditions and scarcity of labor. Prices of materials has but little to do with the postponement of these buildings as the changes since the first of the year have not been sufficient to discourage the construction of large buildings.

The Standard Oil Company has laid off 700 employees at Richmond, Ind., because of the fact that it cannot get building materials for improvements the company is making. These improvements will aggregate nearly \$10,000,000.

*(By Special Correspondence to THE AMERICAN ARCHITECT)*

SEATTLE:—While eastern mills are unable to encourage jobbers to hope for any immediate improvement in date of delivery of steel, they have checked down the upward price movement. Careful canvass of the price situation in all building essentials here shows that prices have remained stationary during the past week. Lumber, however, has fallen sharply.

Enamelware and earthenware is almost unobtainable and stocks are very low. Manufacturers advise jobbers that they cannot agree to ship shower receptors in less than 25 days after receipt of order. These apparently trivial things are causing builders much embarrassment as they mean early or delayed completion and tenancy of building under construction.

There has been an improvement in the arrival of small pipe, but plumbing fittings will be delayed in eastern loading for three or four months, the mills advise.

No delivery for the third quarter is promised.

The mills say they are endeavoring to catch up on orders placed during the first and second quarter before accepting any more business.

The nail supply for the North Pacific Coast territory is arriving principally from Colorado mills, which have not been able to increase their percentage of delivery from 50 per cent of requirements.

Larger pipe is arriving, but the smaller sizes, where it runs heavily into tonnage, seems to be the dividing point in the supply.

Prices are stationary in cement, brick, roofing, plaster board and channel iron. Jobbers report increasing offerings.

There is a noticeable slacking down in transfers of real estate. Census figures giving this city 325,000 in place of the expected 400,000 apparently started the offers of homes costing \$2,000 to \$4,500 that had been on the market at \$6,000 flat. Owners are now willing to take \$1,000 less.

Recessions in the prices of lumber at the mill have been significant. Vertical grain fir flooring is offering freely at \$74; flat grain at \$64 to \$67; 1 x 6 drop siding is at \$61, and finish at \$76. In common lumber the decline is more marked. One by four common fir or hemlock boards and shiplap are \$26; 2 x 2 and 2 x 12, No. 1 common S4S is \$26.50; 4 x 4 to 4 x 8, No. 1 common is \$31.50; 3 x 6 to 3 x 12, No. 1 common is \$33 and 6 x 6 and larger is \$32. The red cedar shingle market has gone to pieces and half the mills have closed down.

*(By Special Correspondence to THE AMERICAN ARCHITECT)*

BIRMINGHAM:—Building during May will probably show a slight decrease as compared with April. The permits have been mostly for repairs and additions although there have been a number for small buildings. March, which was the biggest month since January, records permits for buildings estimated to cost \$444,068. April permits amounted to \$280,962.



# DEPARTMENT OF ARCHITECTURAL ENGINEERING

## Long Span Concrete Arches Used in Garage

Absence of Usual Truss Members Permits Excellent Natural Lighting

THE construction of garage buildings now constitutes a considerable percentage of the buildings erected for business purposes, both in number and cost. By far the greater number of such buildings are but one story in height and consist substantially of a cement finished concrete floor, four enclosing walls and a roof. In addition to the street elevations the latter element, the roof,

by means of long span trusses. These are usually constructed either of wood, steel or concrete, the frequency of use being in the order named.

In designing roof trusses for such buildings the elements to be considered are appearance, obstruction to light, fire resistance, durability and cost. The relative value of these elements depends largely on the character of the occupancy. Occupancy can



COTTAGE GROVE AVENUE ELEVATION. GARAGE FOR MANDEL BROTHERS, CHICAGO  
I. S. STERN, ARCHITECT. L. J. MENSCH, ENGINEER

is the one requiring particular attention and study on the part of the architect. It is necessary that unobstructed floor areas be provided for widths of at least 50 feet when two rows of automobiles are to be housed. Wider buildings are often in multiples of 50 feet or more. The freer the floor area is of columns the more efficiently can cars be handled and housed thereon. In order to secure this desired unobstructed floor area in buildings over 50 feet wide it is customary to support the roof

and does vary considerably in garages as well as in any other class of building.

The garage here illustrated and described was built for Mandel Brothers Department Store in Chicago. It is used as a garage for that firm's delivery automobiles and a distributing station as well. The articles to be delivered in the southern portion of Chicago are brought to the building in large motor trucks and placed on the floor in the center of the building. They are then assorted for the

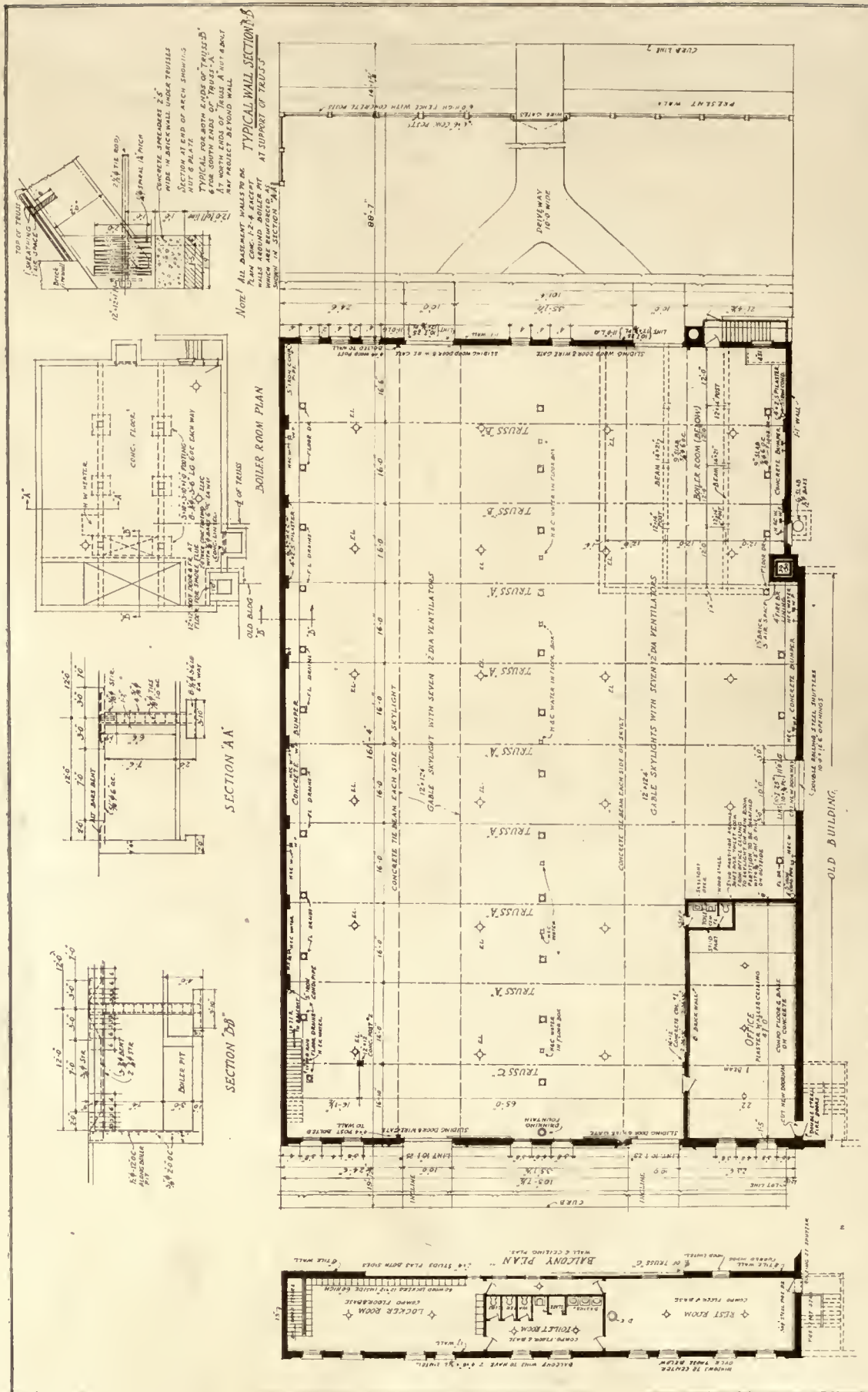

## THE AMERICAN ARCHITECT

various delivery districts and placed in smaller delivery automobiles. For this use it is highly desirable that good natural light be provided.

The building is 103 feet 7½ inches wide, outside measurement, and 161 feet 4 inches long, having an entrance from Cottage Grove avenue in the front and Evans avenue in the rear. The automobiles are parked along the side walls while the central portion of the floor is used for the storage and assorting of the packages of merchandise.

The boiler room is located at the rear (northwest corner) of the building and is built as a basement room with reinforced concrete floor over it. Entrance to this room is provided by means of an outside area stairs. The Chicago Building Code, as do many others, prohibits any direct connection between

hangers connect each concrete arch and 2½-inch tie rod, thus preventing sagging in the latter member. These hangers are spaced 17 feet on centers.

The arch, which is not built to a truly circular form, consists of short chords, each about 10 feet long. This design effected a saving in the form work and does not detract in any way from the appearance of the arch, as can be judged from the photograph of the interior. The method of supporting the forms for the concrete arches was to construct a falsework consisting of towers placed 10 feet apart, built 4 feet square of 4-inch by 4-inch posts well braced. These were constructed under and on line with each such arch.

The roof framing consists of 2-inch by 10-inch joists spaced 24 inches on centers and covered with



COTTAGE GROVE AVENUE END OF GARAGE DURING CONSTRUCTION. NOTE FALSEWORK SUPPORTING FORMS FOR CONCRETE ROOF ARCHES

a room used as a garage and one containing a boiler or heating plant.

Each of the roof trusses consist of an upper chord constructed as a reinforced concrete arch, 11½ inches wide and 24 inches deep with a rise of 17 feet. These arches, with the exception of that at the front or balcony end are laid out to a 90-foot radius. Each arch is reinforced with six ¾-inch rods, three being placed at the top of the section and three at the bottom. Stirrups are also used, spaced approximately 3 feet apart. The concrete is mixed in the proportions of one part cement, one part sand and two parts broken stone. A horizontal 2½-inch round steel tie rod connects the ends of each arch, these in reality forming the lower chord of the truss. The tie rods are 14 feet above the finished garage floor, which allows ample clearance for the motor trucks. Five vertical ¾-inch rods or

two thicknesses of 7⁄8-inch matched and dressed board with 2-inch by 2-inch wood strips and paper between. This air space between the two thicknesses of roof boarding is essential, since it provides insulation, preventing the transmission of excessive heat through the roof and also prevents condensation of moisture on the underside of the roof.

Notches were cut in the upper part of the forms for the arches. In these were placed the ends of the roof joists, which were imbedded in the concrete. The joists and roof sheathing were placed in position before the concrete was deposited in the forms, thus serving as a runway for the wheel barrows.

Four longitudinal concrete girders are built between the concrete arches, extending from end to end of the building. On these the vertical wood

# THE AMERICAN ARCHITECT

curbs that support the sky-lights were constructed. These two skylights extend lengthwise of the building except over the end bays.

The nine trusses cost in the aggregate \$800.00 more than a system of wood trusses would have cost last October at the time contracts were made.

An enclosed balcony extends across the front of the building in which is located the lockers, toilet

and rest rooms provided for the chauffeurs. Steam heat is provided, cast iron wall radiators being located along the side walls and pipe coils along the skylight curbs. Hot and cold water supply is accessible at frequent intervals along the walls for washing automobiles where they are parked rather than in a separate wash room. The floor is pitched to floor drains. Artificial light is provided by four

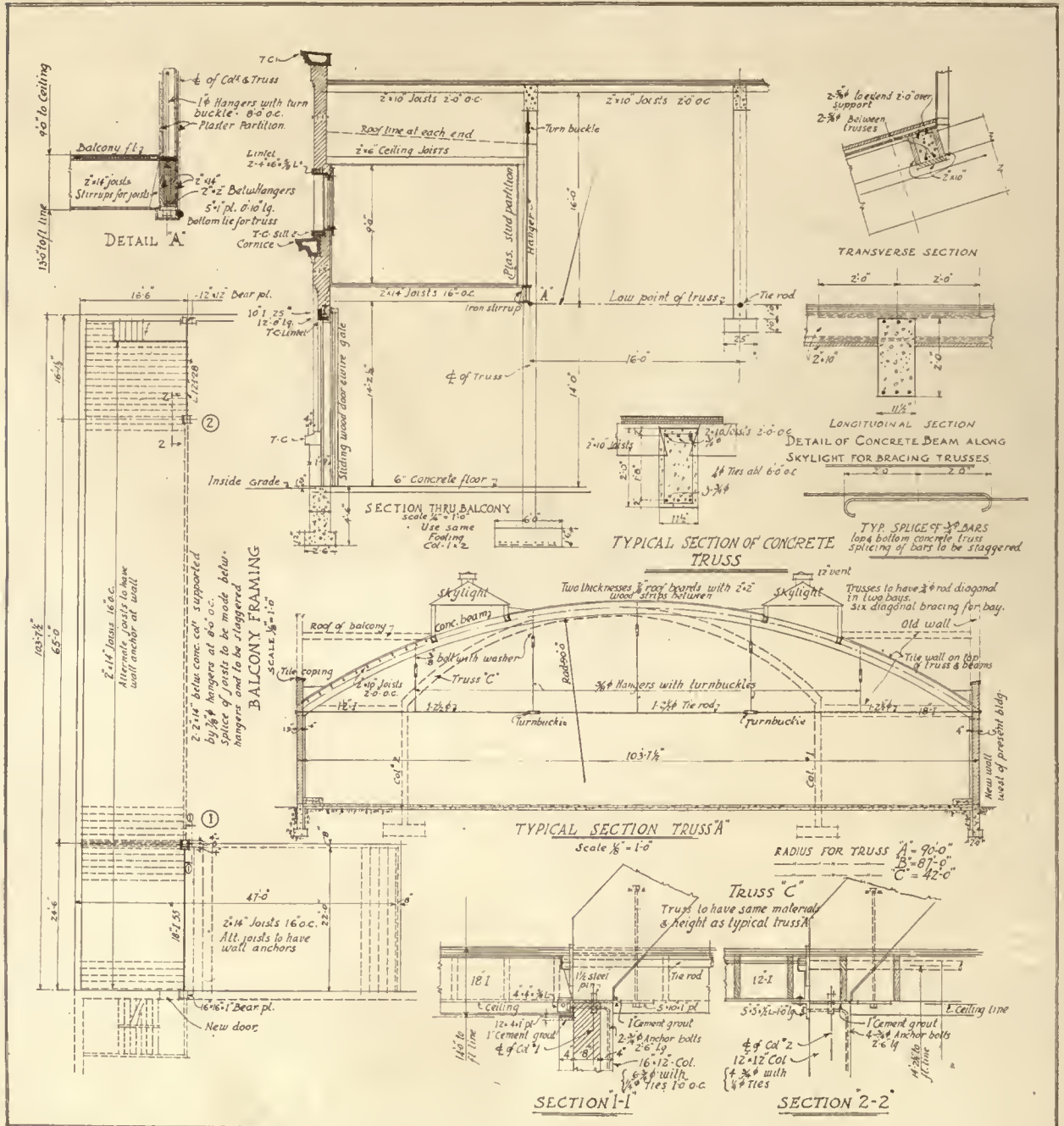

CONSTRUCTION DETAILS. GARAGE FOR MANDEL BROTHERS, CHICAGO  
I. S. STERN, ARCHITECT. L. J. MENSCH, ENGINEER

## THE AMERICAN ARCHITECT

rows of direct lighting fixtures with porcelain enamel reflectors. If desired, the roof could easily be made more fire resisting by covering the ceiling with metal lath and plaster or a heavy plaster board, and covering the steel tie rods with an asbestos pipe covering material. The expense would not be excessive under ordinary conditions.

This type of roof construction is not new by any means, although not much used in this country.

trusses constructed under more favorable conditions.

A feature of this garage is the natural lighting of the floor surface. An inspection of the illustration will show that the intensity of the light is uniform over the entire floor area, a condition that is most desirable and unusual in buildings of this kind. This is the result of making the skylights of such shape and area that sufficient light is ad-

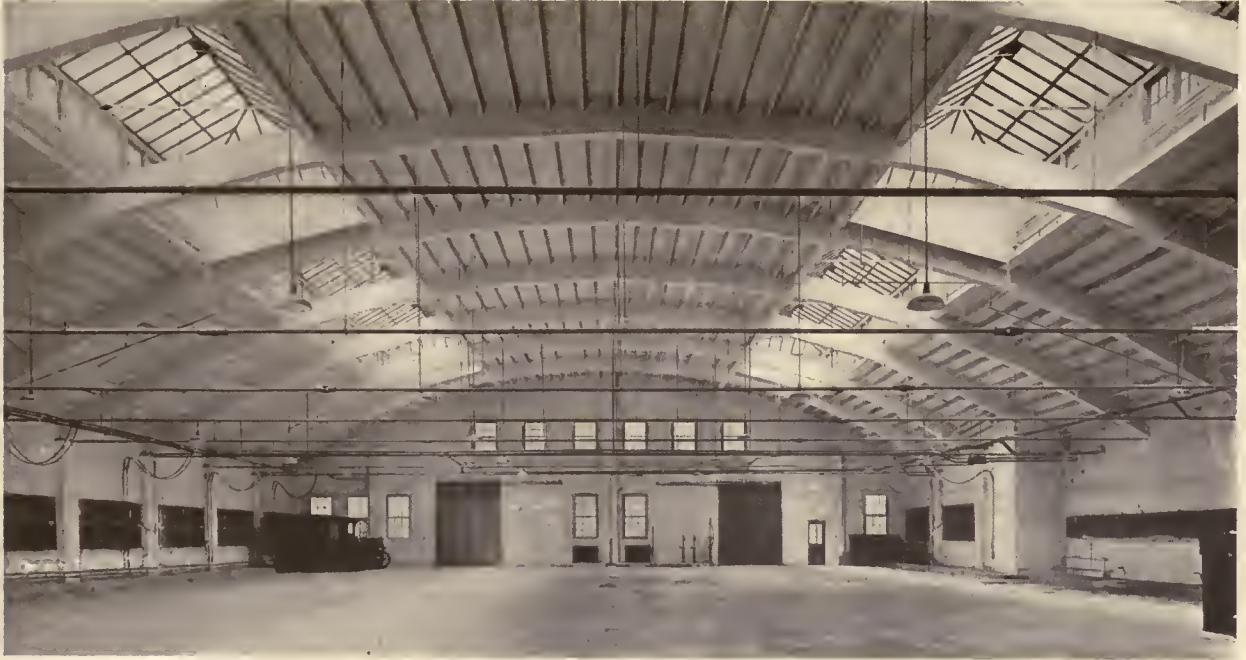

INTERIOR VIEW OF COMPLETED GARAGE LOOKING TOWARDS THE REAR. THE ABSENCE OF OBSTRUCTION IN THE TYPE OF ROOF FRAMING HERE USED, PERMITTING EXCELLENT NATURAL ILLUMINATION, IS EVIDENT

The designing is a simple matter as an engineering problem. The span of these trusses (over 100 feet) is probably greater than that of any yet built for similar purposes. The last two trusses constructed were finished at 3.30 P. M. December 31, 1919. The temperature dropped until at midnight of the same day the thermometer registered at zero. The concrete was just wet enough so that it could run and be rodded in place. Salamanders were placed under the arches to protect them from freezing. Apparently, these are as good as any of the other

mitted and the absence of shadows common to the ordinary types of truss construction. The natural lighting of such buildings is a very important factor and an added cost is often justified to obtain such a result. In this case a notable success has been secured.

The character and style of the street elevation was determined by the design of the adjoining building occupied by and the property of Mandel Brothers. This garage building was designed by I. S. Stern, architect, and the concrete arches constructed by L. J. Mensch, Mem. Am. Soc. C. E., engineer.

# National Board for Jurisdictional Awards Makes Additional Decisions

AT the second meeting of the National Board of Jurisdictional Awards, held at Washington, D. C., April 26, 27 and 28, the following members were present: E. J. Russell, chairman, representative of the American Institute of Architects; R. P. Miller, of the Engineering Council; Col. J. R. Wiggins and F. J. C. Dresser, of the Associated General Contractors; E. M. Craig, of the National Association of Building Trades Employers; Thomas R. Preece, substituting for William Dobson, and William L. Hutcheson and John J. Hynes, representing the Building Trades Department of the American Federation of Labor. Four awards were rendered and are presented below.

## ERECTION OF SCAFFOLDS AS APPLIED TO BUILDING CONSTRUCTION

Subject of dispute between the International Hod Carriers, Building and Common Laborers' Union, United Brotherhood of Carpenters and Joiners, Operative Plasterers and Cement Finishers' International Association and Bricklayers, Masons and Plasterers' International Union.

The Board agreed to the following award:

In the matter of the dispute between the laborers, bricklayers, plasterers and carpenters over the erection of scaffolds as applied to building construction, it is agreed that the erection and removal of all scaffolds, including tressels and horses used primarily by lathers, plasterers, bricklayers and masons shall be done by the mechanics and laborers in these trades as directed by the employer.

Self-supporting scaffolds over fourteen feet in height or any specially designed scaffold or those built for special purposes shall be built by the carpenters.

The making of horses and tressels other than temporary is the work of the carpenter.

## ASBESTOS PLASTER FOR BOILER ROOMS, ETC.

Subject of dispute between the Operative Plasterers and Cement Finishers' International Association and the International Association Heat & Frost Insulators and Asbestos Workers.

In the dispute between the asbestos workers and plasterers on the matter of plastering boiler rooms, etc., it is decided that the insulation and finishing coat on ceilings with asbestos and other insulating material, where the ground work has been prepared and installed by the asbestos worker, shall, including the application of insulating material on boilers, tanks, vats, etc., be awarded to the asbestos worker.

## BESTWALL, WHEN APPLIED AS A SUBSTITUTE FOR LATH AND PLASTER

Subject of dispute between the United Brotherhood of Carpenters and Joiners, Operative Plasterers & Cement Finishers' International Association and International Union of Wood, Wire and Metal Lathers.

In the matter of material known as Bestwall, forming a contention between the carpenters, plasterers and lathers, jurisdiction shall rest with the carpenters where material is panelled or used as sheathing; when cut, fitted and pointed, the plasterers are recognized to have jurisdiction.

## ASBESTOS SHINGLES, PREPARED PAPER ROOFING, ASPHALT ROLL ROOFING, SHINGLES AND STRIP SHINGLES

Subject of dispute between the United Brotherhood of Carpenters and Joiners and the United Slate, Tile and Composition Roofers, Damp and Waterproof Workers' Association.

The Board agreed to the following decision:

On the question in controversy between the roofers and carpenters on the subjects contained in the title, it is decided that jurisdiction over asbestos shingles, prepared paper roofing, asphalt roll roofing be awarded to the United Slate, Tile and Composition Roofers, Damp and Waterproof Workers' Association; jurisdiction over asphalt shingles, strip shingles, is awarded to the United Brotherhood of Carpenters and Joiners.

## LOW-PRESSURE HEAT REHEARING DENIED

A rehearing was asked in the dispute between the United Association of Plumbers and Steamfitters and the International Union of Steam Engineers in the matter covered under the title of Low Pressure Heat. The engineers desired the case reopened, but the Board declined to grant a rehearing.

Postponement of the hearing in the dispute in the matter of Unskilled Labor as Applied to Reinforced Concrete Construction between the International Hod Carriers, Building and Common Laborers' Union and the International Association of Bridge and Structural Iron Workers was granted at the request of the latter organization, to allow them sufficient time in which to compile and submit briefs.

The Board notified the United Brotherhood of Carpenters and Joiners that it cannot give consideration to the eleven subjects affecting carpenters, which were carried over from the former meeting, until these cases are submitted in the manner pro-

vided for now by the Board in its Constitution.

As in the carpenters' cases, the two disputants in the controversy over Corrugated Metal Sheathing, Metal Furniture, etc., involving the Amalgamated Sheet Metal Workers' International Alliance and the International Association of Bridge and Structural Iron Workers, were directed to submit the

case in the manner officially prescribed in Section 5 of the Constitution.

NEXT MEETING AUGUST 2ND

The Board has arranged to print its Constitution with a supplement of decisions rendered. The next meeting of the Board will be held at Atlantic City, N. J., Monday, August 2, at 12:30 P. M.

## Formulating Improved Contract Forms

### A Matter Requiring Careful Study and Active Support by Every Practising Architect

**F**RICITION reduces efficiency. The mechanical engineer governs his design with that fact ever before him. Reduction of friction almost to the point of elimination is his aim. To-day, much of the loss of energy in the building industry is caused by friction of one kind or another. One of the friction producing elements, contract forms, has become so assertive that it is receiving increasingly careful attention from architects, engineers, and constructors. Soon, let us hope, a satisfactory solution will be reached, but it is doubtful if a solution at this time will prove more than an emergency effort to bridge us over a turbulent and troublesome river of doubt. When in the future normal conditions are restored, a new solution must be evolved. It is necessary at this time to sound a note of warning. Let us not too seriously consider present forms, but rather seek to foster forms which are workable, and arrangements not partial to either contractor or owner, but fair to both. One form will not suit every case. Modifications of any standard form adopted must be numerous in order to meet varying local conditions. "Cost Plus," in the last analysis, means nothing more than retaining the builder's services at a fee, rather than purchasing the structure he has produced (in accordance with the architect's plans and specifications) at a price fixed by himself. The "lump sum" contract, if employed to-day, of necessity, means a high bid, since any figure given must be adequate to compensate the bidder for all the varying factors which may increase costs during progress of the work. Neither cost plus nor lump sum is to-day a fair form of contract without certain well-defined modifications.

If the builder is retained at a fee, it should be limited to a maximum amount, and not increase to an inordinate figure because of mounting construction costs, which to some extent may be caused by inefficient workmen and poor purchasing ability. Some premium must be placed upon the builder's ability to construct economically. A fair estimate of the cost of the building should be made, allowing

for increases above prices at the time of estimating. This allowance will depend upon the length of time the job is liable to take. In every "Cost Plus a Fixed Fee" contract a bonus and penalty clause should be inserted, so that in the event of the cost being lower than the estimate given, the builder's fee will automatically increase, while if the cost exceeds the estimate, the builder's fee is reduced.

But this is not enough. The builder may exert himself, personally, to the utmost, without accomplishing the economy and efficiency which the prospects of an increased fee lead him to desire. But let the builder extend to his subordinates that same incentive which he himself is under. What makes the piece worker more industrious than he whose wages are fixed? The prize of gold. More money for more work always produces more work. The superintendent and foreman who share their employer's profit are anxious that his profit be as large as possible. Every time a man is detected idling, wasting his time, visions of a shrinking bonus automatically appear in the minds of his bosses. Hence, few mechanics are permitted to loaf. If, in times past, bricklayers laid 1500 brick per day of 8 hours, why can they not be induced to lay the same amount now? Are they really afraid of a "lay off" if they work too industriously? We doubt it. Is there not really a feeling that nobody cares? And after all on the straight percentage job does anyone really care? If, as has been claimed, the cost plus contract and plenty of "overtime" are responsible for the depreciated morale of the mechanic, is it not time to so improve this form of contract that some real incentive to work is created.

On every job there are certain men, subordinate to the builder who are "key men." Every builder, awarded a contract on a cost plus basis, modified by a bonus or penalty clause based on a maximum cost figure, would find himself putting money into his own as well as the owner's pockets by extending that bonus to every "key man" in his organization. And the architect who feels, due to existing abnor-

mal conditions, that a cost plus form of contract is advisable, would do well to see to it that it is so modified, that the premium is upon economy and efficiency and not upon extravagance.

Following are several clauses incorporated in a contract form used successfully by a California architect. He has embodied these clauses in the first page of all specifications that leave his office, so that builders bidding on his work are familiar with these provisions from the start. They state:

1. Every bid shall specify a fixed sum or fee for which the Contractor agrees to execute the work complete (as indicated by plans and specifications); this sum to be his sole compensation for his part on the work and the use of his organization and equipment; not to be augmented by commission, discount, rebate or other profit, hidden or known.

2. Every bid shall also include a detailed estimate of the *net cost* of the work; and bidders are urged to carefully preserve their figures which will be used for reference by owner or architect, to facilitate settlements; for any changes, and to keep track of actual costs.

3. It is agreed that if the actual cost of the work is *less* than the estimate, under paragraph 2, the amount saved shall be divided equally between the owner and contractor; if the actual cost is *greater* than the estimate, the excess shall be equally borne by owner and contractor, the contractor's portion being deducted from his fixed fee compensation mentioned above in paragraph 1.

(The main purpose of this arrangement is to bring about friendly co-operation, in mutual confidence and helpfulness, in place of opposition of private interests.)

4. It is provided that if the cost be increased by fault of contractor or his men, such as neglect, carelessness, known wilful act, continuous loafing or correction of faulty work; he shall bear the loss due to such fault without the owner sharing it.

It is also provided that if the cost is increased by fault or act of the owner, such as failure to pay agreed-on instalments when due, or changes after work affected is under way, or unreasonable delay in making decisions; the loss due to this condition shall be borne by the owner without the contractor sharing it. (All as nearly as can be estimated and made practicable in either case.)

While this form may require modification under some conditions, it does not eliminate competition and serves to stimulate the work of construction.

The lump sum contract is by many deemed out of the question. As in the case of the cost plus form, the lump sum contract is not now advisable for use in its unmodified form. But it is capable of improvement to meet existing conditions. It is possible to accurately estimate the cost of a building at the time the bid is made up. The objection to submitting such a bid is that cost of labor and material will perhaps increase before the contract can be carried out. Now if the bid is submitted based on the cost of material and labor existing at the time it is made, and is accompanied by a detailed estimate (based on an accurate bill of quantities), subdivided into items of labor and material costs for each subdivision of the work, it will not be difficult to compute the added cost due to a change in

price of material or wages during construction.

To determine the increase due to such variations it is extremely important that the detailed estimate be worked out with great care. This method makes for more accurate bids. Preferably a quantity survey should be furnished each bidder by the owner, and a detailed estimate required, but only from the successful bidder.

If a clause is included in the contract requiring that the owner pay only the increase actually occurring from a rising market, the contractor will exert every effort to keep the cost of his work within bounds in order to assure his profit, and this profit, instead of being a percentage of the total cost of the work and mounting with it, will be that included in his estimate made under prices existing at the time of bidding. Inefficient workmen will reduce it, and therefore they will not be popular. The net result will be that the owner will only have paid current prices for what he has received. The price of waste and extravagance will not be a part of his bill.

This is in line with the recent action of the National Association of Building Trades Employers in adopting the following resolution at their 1920 annual meeting:

*Resolved*, That the National Association of Building Trades Employers recommend to its members that, on account of the present unsettled conditions wherever or whenever lump sum estimates are requested or submitted for contract work, the bidder shall protect himself by inserting in his proposition a paragraph substantially to this effect:

The above proposition is based upon the cost of labor and materials as of this date, as per schedule attached. If increase or decrease in cost of labor or materials occurs on this work, the owner will be charged or credited for such increase or decrease over or under prices which existed at date of contract.

And such a paragraph ought to be inserted in all lump sum contracts for the protection of the contractor, and be it further

*Resolved*, That it is recommended that, should any lump sum proposal or contract provide that any work shall be performed at any other time than the regular working day of eight hours, that the extra expense incurred by the contractor doing such work shall be added to the original sum stipulated in the contract.

Another resolution adopted at that meeting was as follows:

*Whereas*, The lack of apprentices in the building trades is being seriously felt at the present time on account of scarcity of competent mechanics to do building construction work, and

*Whereas*, The necessity for providing mechanics is apparent to those engaged in the industry and should receive the early and serious consideration of all contractors; therefore, be it

*Resolved*, That the members of this Association be instructed to use every means possible to encourage the young men in their respective localities to enter apprenticeships in the numerous building trades.



750

Jan 23 1891



GRAND CANAL, VENICE

# THE AMERICAN ARCHITECT

VOL. CXVII

WEDNESDAY, JUNE 16, 1920

NUMBER 2321



CONSOLIDATED SCHOOL

## New School Buildings, State of Delaware

By JAMES O. BETELLE, A.I.A.

*Illustrated by the work of Guilbert & Betelle, Architects for the Delaware School Auxiliary Association, a corporation organized for the purpose of expending the duPont Fund for new School Buildings to be built in the State of Delaware*

**T**HE school building program now in progress throughout the State of Delaware is at once the most interesting and probably the most important that has ever been undertaken by any State.

It so happens that the State of Delaware is in a peculiarly suitable condition for such a far-reaching building program. In the first place it is small in area and the replacement of all the buildings in the State does not mean such an outlay in time or money as would be involved in practically any other State. Further, few, if any, new schools have been built in the State for the past twenty or thirty years. The majority of the school buildings are fifty to one hundred or more years old. Inasmuch as nearly all of the school buildings are obsolete and in many cases a menace to the health and safety of the children, the rearrangement of the buildings, their elimination in some instances and consolidation in others, means only the discarding of old buildings which should have been razed years ago. The situation was not compli-

cated with a few new buildings at scattered points which were too good to be discarded. It is therefore possible to wipe the slate clean and make a new start. This means that the State will now have what almost amounts to an entirely new school building equipment, located and constructed along most modern lines.

The more progressive citizens of the State have long realized that the courses of studies and the buildings in which these studies were being taught did not measure up to modern educational requirements. Such conditions placed the school children of Delaware at a disadvantage when they met during their life's work in competition with the better prepared pupils from the neighboring States of New Jersey, Maryland and Pennsylvania. It was believed that some remedy should be found for existing conditions. It was decided to approach the problem in the most progressive way.

Following this determination, the General Educational Board of New York was retained to make a survey of the educational standards of the State

of Delaware, as well as the laws and conditions under which its educational system operated. The report at once indicated a desperate need for improvement and pointed out that nothing worth

D. Strayer, Dr. N. L. Englehardt and Mr. F. W. Hart, of the Department of Educational Administration, Teachers' College, Columbia University, N. Y. C., were retained to make the investigation



ONE TEACHER SCHOOL

while could be done under existing State laws. These laws were a patchwork of obsolete, conflicting and inadequate statutes, adopted from time to time during a century or more; none had ever been repealed, nor had they been made to co-ordinate with one another. Under these circumstances the only thing to do was to repeal all existing laws and enact an entirely new School Code along more modern lines. This important work was done by the General Educational Board under the capable direction of Dr. Frank A. Bachman, and the Code was adopted by the State Legislature and made a part of the laws of the State. The section of the Code applying to school buildings practically condemned all existing buildings, as none of them came up to the requirements of the new laws as applying to ventilation, sanitation, lighting and safety.

Now that certain standards of excellence of a school building were required by law, it was necessary to accurately determine the merits of all the schools in the State. While it was realized that the school buildings were in bad shape, it was not known just how bad they were or which were in the worst condition and first needed attention. Here again the assistance of the best authorities in school construction were called in. This time Dr. Geo.

and they spent several months in visiting every school in the State and rating them as to their relative merits. The results of this survey show conditions to be even worse than had been supposed. At the same time these gentlemen wrote a set of "Standards and Rules" applying to any new school building construction which must be strictly followed by the architects designing new buildings in Delaware.

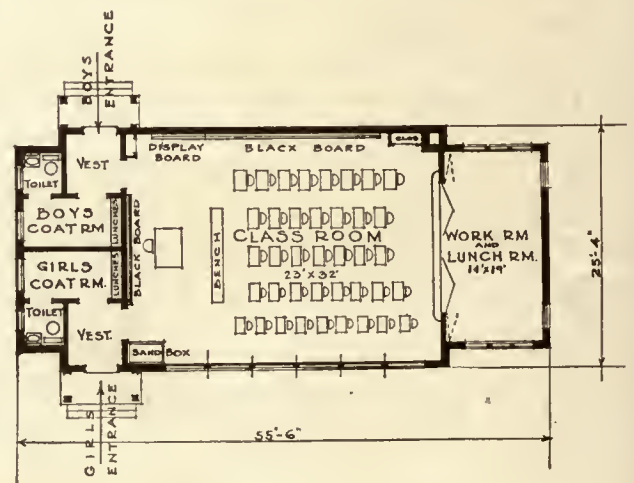

ONE TEACHER SCHOOL

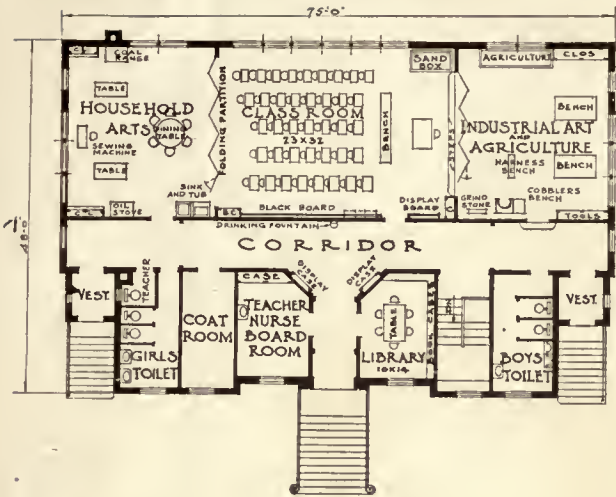

ONE TEACHER SCHOOL

It is not to be imagined that all this excellent work could have been done without some opposition. It was, of course, known that the construc-

tion and maintenance of these improved school facilities would mean an increase in the tax rate. The citizens of the State of Delaware are no different from those of any other community. An

increase in the tax rate means opposition from those to whom the present conditions seem "good enough." The majority of the citizens, however, stood firmly back of the work for the betterment of the schools, and they were in the end successful. While it was admitted that all these new buildings would be costly, especially at the present time, a way out of the difficulty was found in the person of Mr. Pierre S. duPont, who was appointed by the Governor a member of the State Board of Education which had been created by the new School Code. Mr. duPont belongs to that family of Delawareans which has done so much for the State, not only in roads and education, but in public improvements generally and in large business enterprises. It was through Mr. duPont's generosity and vision that it was made possible to defray the cost of preliminary investigations of the educational system and school buildings of the State. It could hardly be expected that the State Legislature would make an appropriation for such a purpose, with all the other urgent demands upon the State treasury,

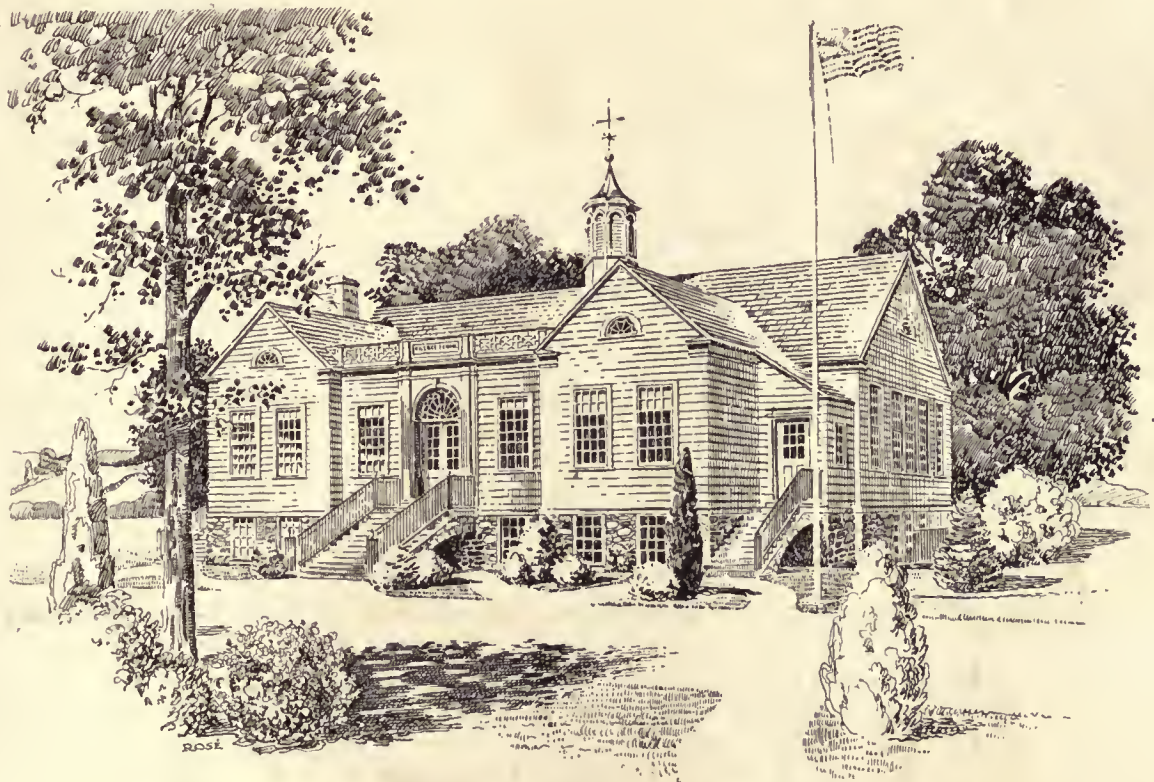

ONE TEACHER SCHOOL

nevertheless, to make the results of such an investigation worth while, it was necessary to retain the services of the best experts, which were necessarily costly.

tion and maintenance of these improved school facilities would mean an increase in the tax rate. The citizens of the State of Delaware are no different from those of any other community. An



TWO TEACHER SCHOOL

After the School Code was made a law and to serve to encourage the acceptance of this School Code by the various districts, Mr. Pierre S. duPont made a gift of the sum of \$2,000,000, which was to be apportioned to the districts accepting the new School Code and to assist them in the construction of new school buildings. To handle the expenditure of this money the Delaware School Auxiliary Association was incorporated and Dr. Joseph H. Odell, the director of the Service Citizens of Dela-

ware, was made its president. The principal duty of the Delaware School Auxiliary Association was to have charge of the expenditure of the duPont Fund and the able services of Dr. Odell and his associates of the Delaware School Auxiliary Association cannot properly be appreciated until later on when the results will undoubtedly speak for themselves.

Dr. Joseph H. Odell says, in speaking of Mr. duPont:

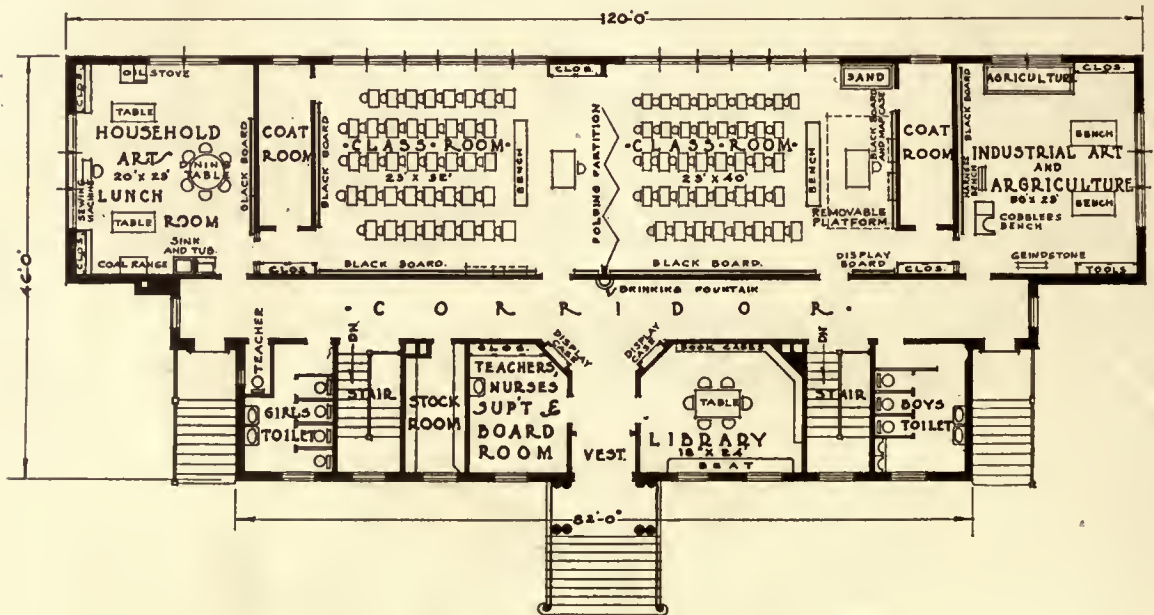

FIRST-FLOOR PLAN. TWO TEACHER SCHOOL

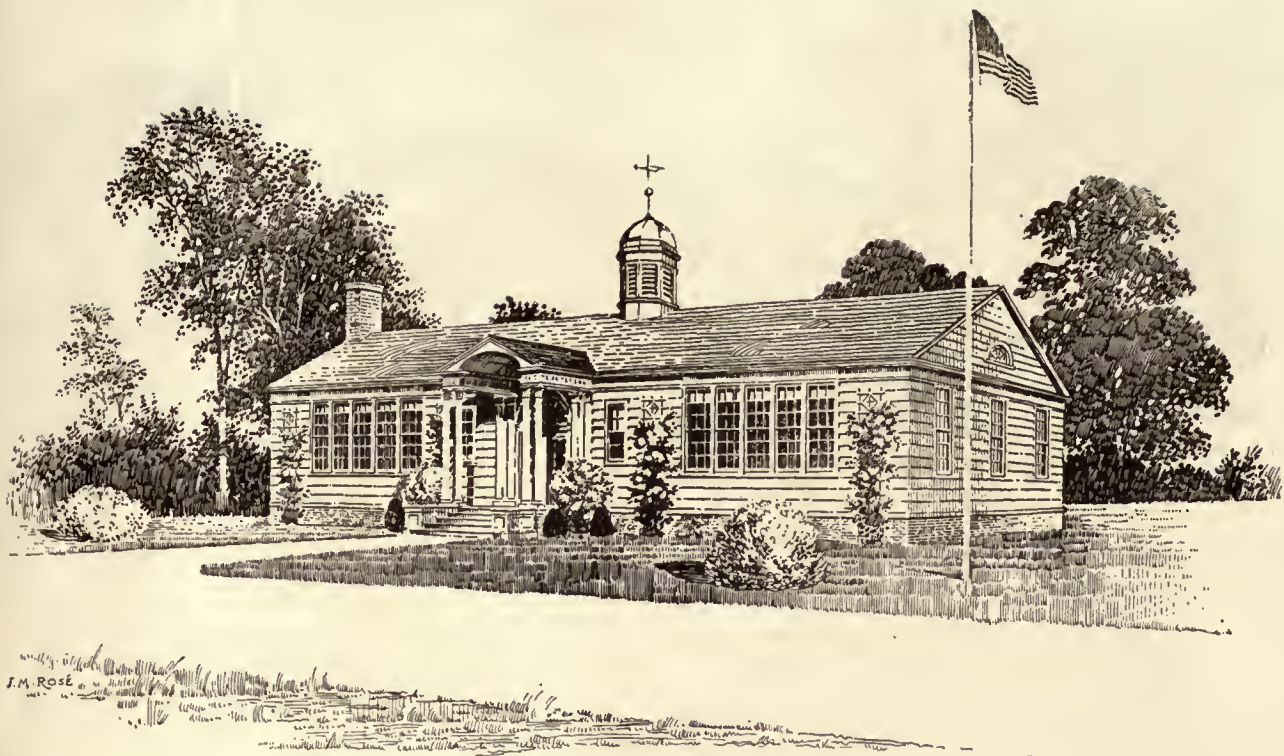

TWO TEACHER SCHOOL

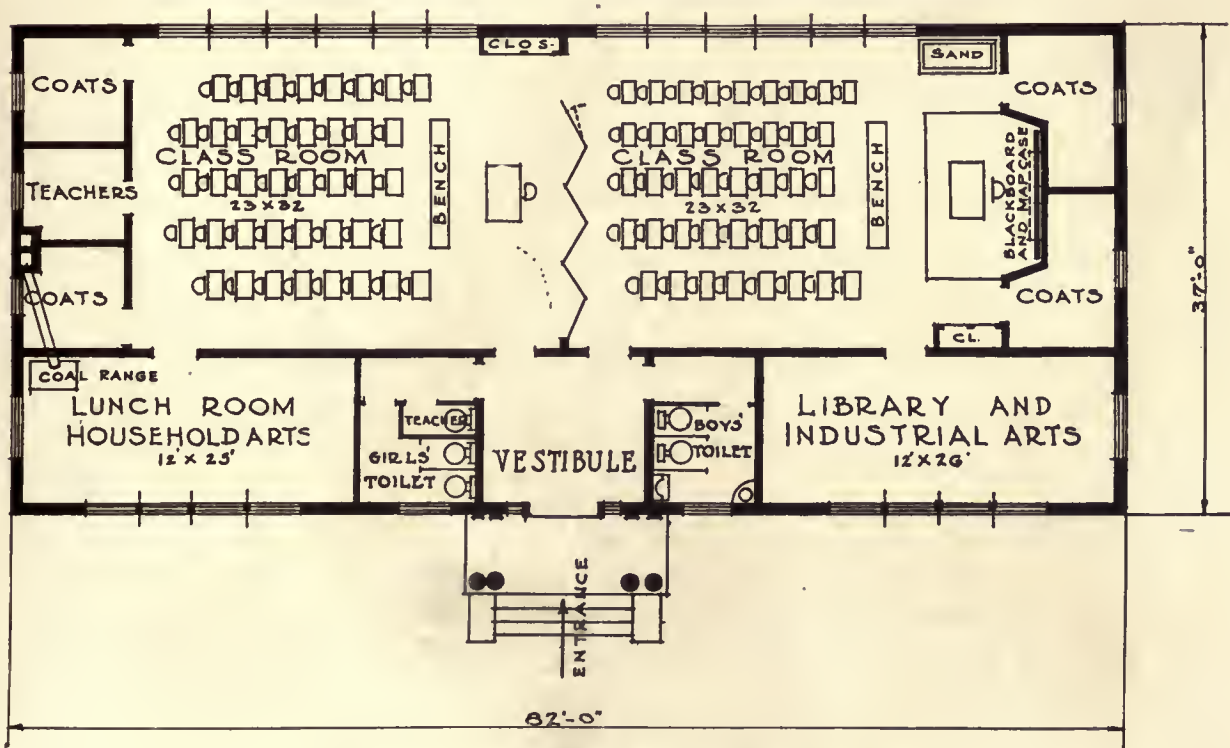

FIRST-FLOOR PLAN. TWO TEACHER SCHOOL

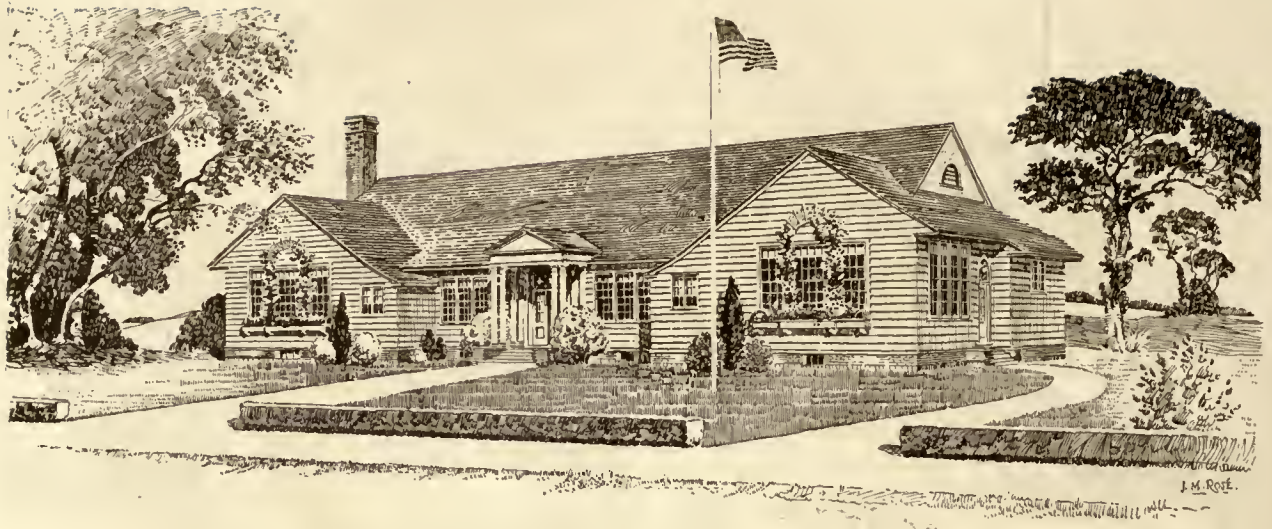

THREE TEACHER SCHOOL

"Pierre S. duPont is not yet fifty years of age, a reticent and quiet man, whose outstanding characteristics to those who know him are a tremendous capacity for organization, an intense love of flowers and trees, a passion for music and a fondness for seclusion in the rebuilt, ancient farmhouse which is his home. In the midst of the war, while he was president of the duPont de Nemours Corporation and was producing the larger part of the explosives that were blasting the German lines to pieces, he founded the Service Citizens of Delaware, an organization to study and make experiments which should improve vital conditions in the State—public health, education, housing and the general humanizing of human relationships. He set aside a million and a half dollars to finance this venture.

"Because of his commitment to the principles of the Service Citizens, Mr. duPont accepted Governor Townsend's appointment to a place on the State Board of Education. The man who had made 40 per cent. of the explosives that burst along 400 miles of trenches in Europe now turned his attention almost exclusively to the improvement of educational conditions in Delaware. He worked chiefly through the Service Citizens and called in the aid of the most experienced educationalists of America in meeting the problems as they arose. The conditions of public school property, which were ascertained by an exhaustive survey, led Mr. duPont to set aside \$2,669,000 for the rebuilding of school houses, nine hundred thousand of this amount to be used in building rural colored schools. Greater than

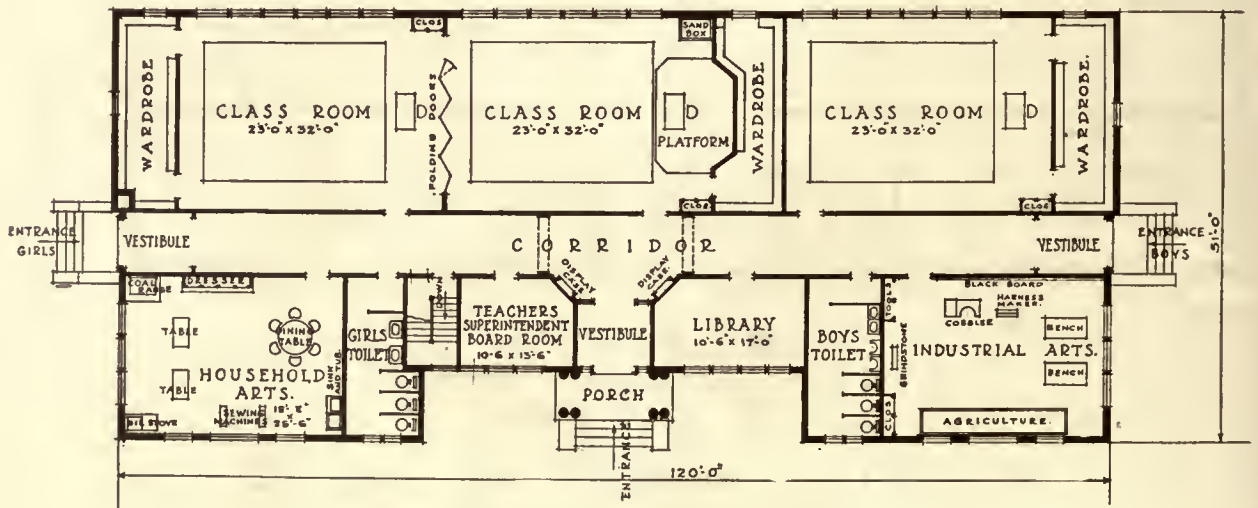

FIRST-FLOOR PLAN. THREE TEACHER SCHOOL



his gift of money has been his gift of himself. Delaware has had the privilege of seeing its richest and most influential citizen pass his business responsibilities on to others, foregoing the pleasures of leisure, society, travel, and spending his time and strength in going from place to place in the State, expounding the New School Code, conferring with local boards of education about consolidations and new buildings, discussing with any and every type of citizen the details of the projected educational program and, in the course of this work,

benefit to the community and the State as well.

In planning the school building program the entire State was considered as a whole. Dr. Strayer's survey commission mapped out a scheme for eliminating a great many of the One and Two Teacher Schools. It is a well established fact that better education at a lower cost is obtained in one large school than in a number of smaller ones. This is made possible by the good roads over which the pupils are transported in motor buses at the expense of the community. In a large school pupils



THREE TEACHER SCHOOL

eating and sleeping anywhere or missing meals entirely. Weeks together, Sundays as well as week days, he has devoted his undivided attention to education, and the entire State is recognizing its unrepayable debt to Mr. duPont."

In the schools for white children the various communities were to issue bonds up to 5 per cent. of the assessed values of the property in the districts and additional money was then to be appropriated from the duPont Fund to assist in paying the cost of a proper school building. On account of the reluctance of some of the districts to tax themselves for the school for colored children, Mr. duPont made a further donation of \$500,000, which, taken together with \$400,000 set aside for this purpose in the original gift, made a total of \$900,000 of the duPont Fund to be used for the purchase of ground and the construction and equipment of school buildings which were to be presented free of all cost to the colored people of the various districts. This is to be Mr. duPont's contribution towards the solution of the race problem. It would be difficult to imagine a more practical or more useful gift, or one that would be of greater

have the advantage of association with a large group of children of their own age; of well equipped shops, laboratories, auditoriums, etc., all of which could not be afforded in any small school. There will necessarily be a number of very small schools for the colored children, as the colored population in Delaware is scattered in small communities. The colored children will have schools of their own, but there will be no difference in design or construction between the buildings for white children and the buildings for the colored children.

A complete survey was made of the school population of the State by the various County Superintendents with the assistance of the Delaware School Auxiliary Association. From this survey the location of the new school site was determined. If it was found that the present school was not properly located in relation to where the pupils lived and with transportation on good roads available, a new site was purchased that was in the proper location. The selection of the school sites was therefore made along scientific lines. Not only was its location scientifically determined, but the State school authorities had the assistance of a corps of surveyors

and a consulting architect provided by the Delaware School Auxiliary Association out of the duPont Fund and without cost to the State. After a site was determined upon and approved by all parties concerned, the necessary legal matters were attended to, and it was purchased by the Delaware School Auxiliary Association out of the duPont Fund. The cost of all this work was of course charged against the money donated to the community, but it secured the advantage of getting quick action before bonds could be issued and sold by the communities and in many cases in getting a larger and better site than the local School Board would have felt justified in purchasing if the money was supplied by the taxpayers. In the One Teacher

much neglected. These buildings, with but few exceptions, are unattractive and without elements of good taste or good architecture. The reason for this is readily understood, as these buildings were built by widely separated communities, over a long period of years; the funds available and the importance of the work did not warrant the expense of competent architectural services that a larger building program in a limited area makes possible. The quality of the rural school building is, however, improving, and the instructive bulletins with standard plans that have been prepared by a number of the State Departments of Education and the U. S. Department of Rural Education, for free distribution to districts contemplating the erection of

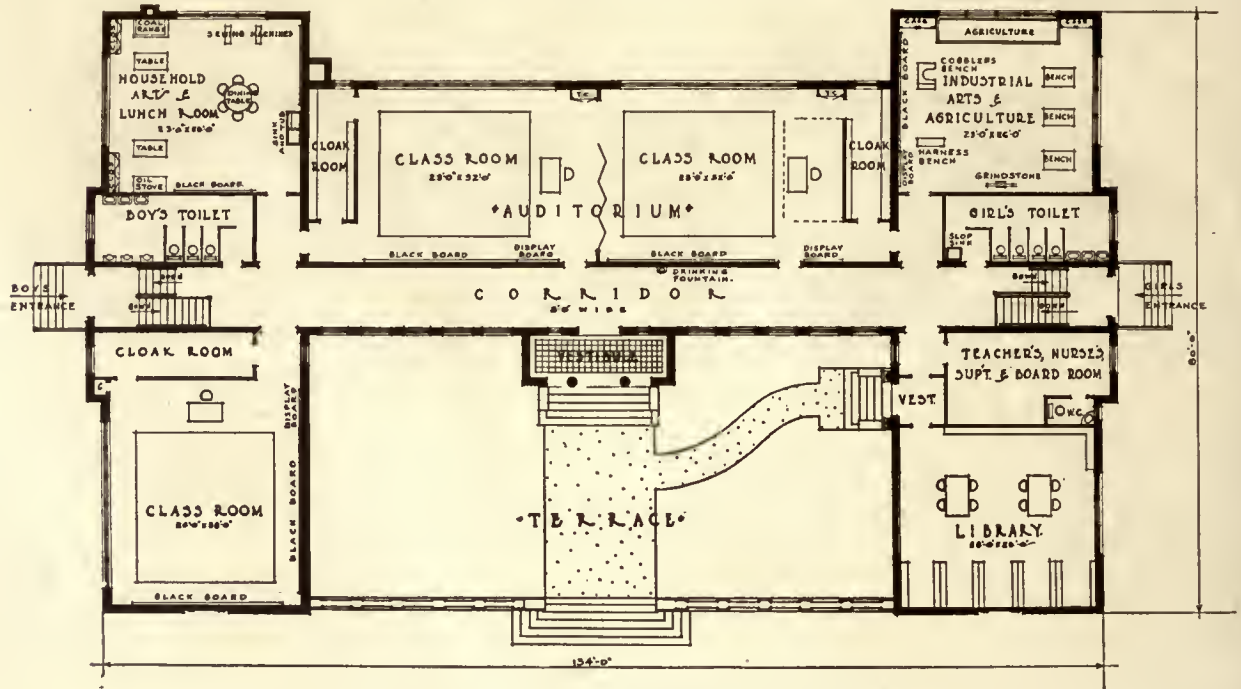

FIRST-FLOOR PLAN, THREE TEACHER SCHOOL

Schools a plot of at least two acres was obtained. While more land could have been afforded, it was not deemed advisable to make the sites for the small schools too large. It seemed more desirable to have a medium size plot, properly kept up, than to have a large plot left to grow up wild because it required too much labor to keep it in proper shape. For the Two Teacher Schools a three-acre plot was purchased and for schools larger than this four acres. For the Consolidated High Schools in the towns a ten-acre site has been provided; this will permit playgrounds, athletic fields, school gardens, etc.

The architecture of small rural schools throughout the United States has undoubtedly been very

a new school building, have contributed in a very large degree to this improvement.

It was desired in the new Delaware schools to make some advance in the design of the school buildings and at the same time keep down maintenance costs. The money would not be expended to the best advantage if a school building containing all city conveniences was presented to a community, the maintenance of which would always be a heavy burden of expense. Such a policy would bring in question the wisdom of Mr. duPont's gift. The cost of maintenance has therefore been seriously taken into consideration in order that the gift might be of the greatest possible benefit to the community.

The small rural school is not as simple a problem as it might at first glance seem. In the One and Two Teacher buildings it must be borne in mind that the teacher is usually the janitor as well. In addition to her duties as instructor she must be burdened with many other cares. How to reduce these duties and eliminate the cares and permit her to give the maximum time and energy to instruction has been given a great amount of thought and careful study. In the design of the building the layout of the heating, the water supply and the plumbing has been the most difficult to decide. From the standpoint of first cost it was possible with the funds available to place the very best systems of heating, running water for drinking purposes, and the installation of water closets. It was not this first cost, however, that was the deciding factor, but the attention and expense that was necessary for proper maintenance after the systems had been installed. It must be realized that these small buildings receive no attention during the holidays or from Fridays until Mondays, and that no heat is maintained in the building during those periods. Even if it were decided to keep heat up at all times during cold weather, so that running water system could be installed, heavy snows and impassable roads would often make it impossible to reach the school building for days at a time, and the freezing up of the plumbing system would naturally be the result.

After much consideration and investigation it was decided to install chemical toilet fixtures to be reached through the coat rooms inside the small buildings. For the water supply system it was further decided to install a hand pump over a sink in the work room. The water in the pump will be sufficiently below grade to prevent freezing, and it is in a convenient location for use for drinking purposes and for instruction purposes in connection with domestic science lessons. For the heating, a jacketed stove located in an alcove or a furnace placed in a small room outside of the class room was decided upon. It is realized that the jacketed stove will heat and ventilate the class room with considerably less coal than the furnace. It is admitted, however, that the jacketed stove does not give the required 30 cu. ft. of air per minute per pupil and on this account it of course consumes less fuel. A stove in the class room with the attending noise, confusion and dust caused by the putting on of coal and the removal of ashes is very much of a handicap to good instruction work. A furnace in a separate room, where the firing and the removal of ashes will not interfere with the classes and which will provide the proper amount of ventilation, will be installed wherever the community is willing to provide the additional amount

of fuel needed to obtain the more satisfactory results.

Actual construction is now under way on three experimental One Teacher schools, all three different in plan and containing different items of equipment. It was thought wise to build these three schools and have them visited and criticized by everyone interested before starting in on a wholesale construction of the hundred or more small buildings needed throughout the State. Any mistakes in layout which showed up after the completion and use of these buildings, or any improvements that may be suggested, could be taken advantage of and incorporated in the future buildings.

The community use of these small schools has always been kept in mind. In the isolated communities the church is usually near the school, and it is contemplated that these two elements of public welfare work will very closely co-operate. The class rooms will be fitted with movable desks which can be placed around the walls and the center of the room thus left clear for community meetings or dances. Additional chairs are kept in a convenient store closet and can be brought out and used for community lectures, entertainments, etc. The work room can be used not only for the instruction of pupils, but is available as additional seating space for meetings, for the serving of refreshments at entertainments or dances, and for adult instruction in sewing, canning and cooking in the summer months or during evenings.

The materials to be used in these buildings will be clapboards, or brick veneer on a frame structure. The roofs will be of shingles or slate. A paved space will be provided on the outside, adjoining the building, so that the children will always have a dry place for outdoor play during all periods of the year. A number of different types of these schools will be built. This is necessary on account of the different locations of the building sites and their exposure to different points of compass. Everything possible will be done to construct the building in such a way that the maintenance cost can be kept down to the minimum, and when completed the school will be finished in every way, including the landscape work, walks, drives, etc.

The large One Teacher school shown in the illustrations was designed to meet an ideal condition rather than with the thought of having any great number of them actually built. While there is but one standard class room with movable seats, there is a boys' work room where the children are taught the use of sharp tools, how to mend a harness, how to repair a pair of shoes, or a milk pail; also a girls' work room where they are taught cooking, sewing, housekeeping, laundry work, and the women of the community given an opportunity to take a

*(Continued on page 763)*

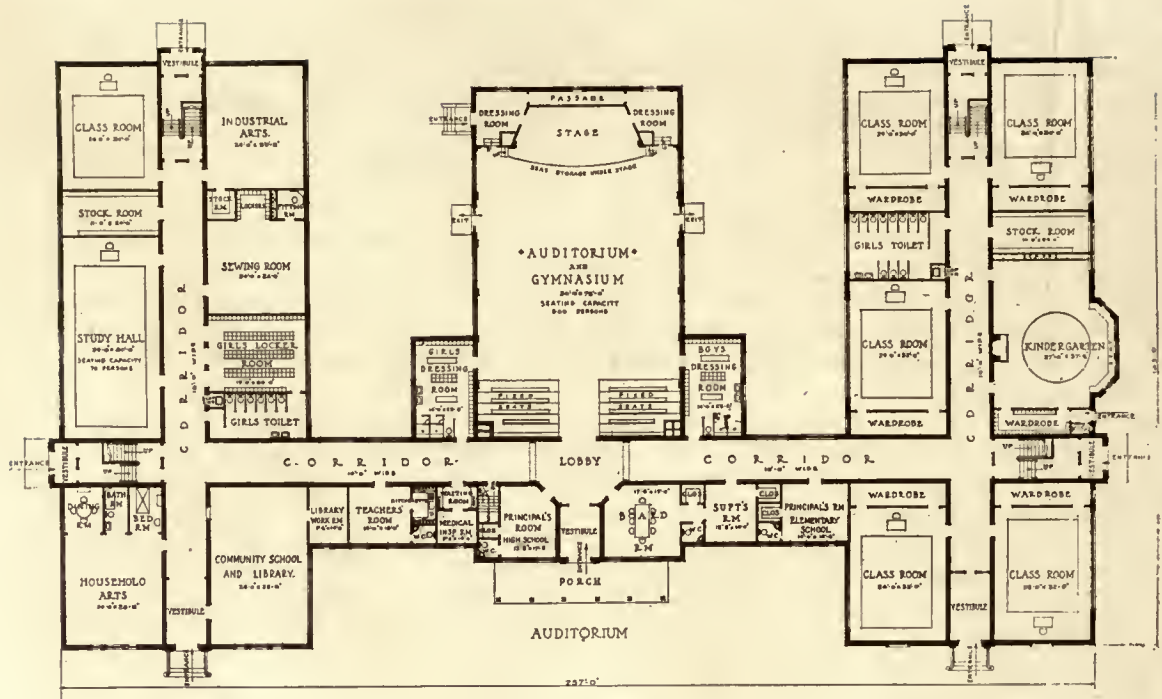

HIGH SCHOOL.

FIRST FLOOR PLAN  
CONSOLIDATED SCHOOL.

ELEMENTARY SCHOOL.

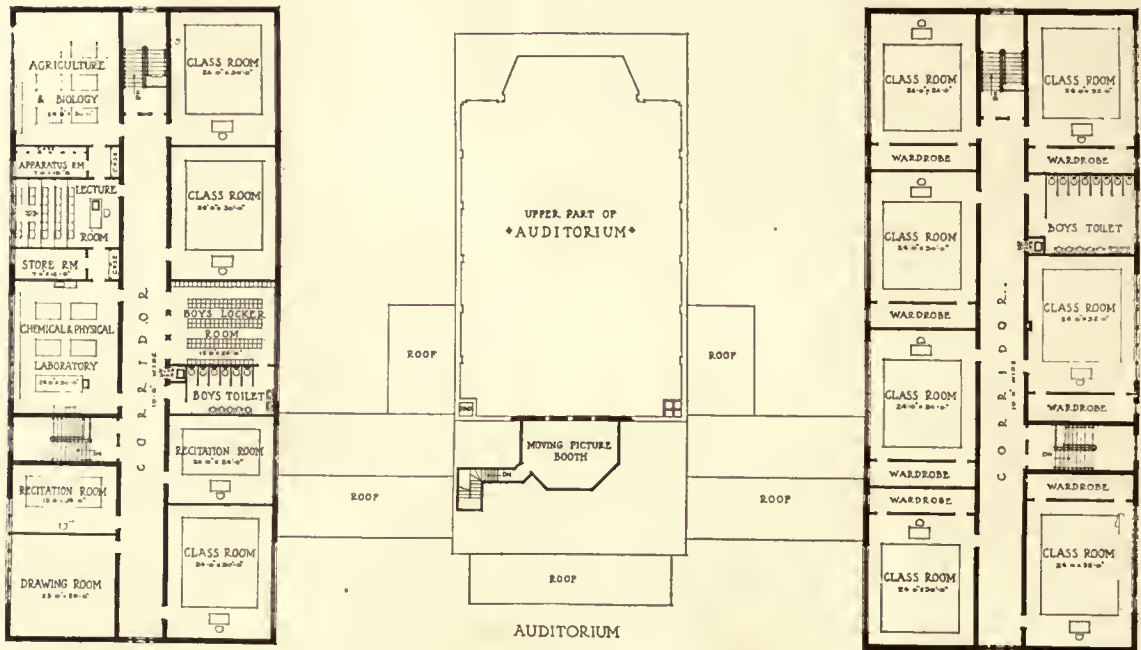

HIGH SCHOOL

SECOND FLOOR PLAN  
CONSOLIDATED SCHOOL.

ELEMENTARY SCHOOL



## Billboards

THE *American Art News* roundly criticizes Mr. Joseph Pennell's remarks as to inartistic billboards before the recent convention of the American Federation of Arts. It was supposed that every one who knew Pennell knew him for a man of many eccentricities, of sharpness of tongue and directness of speech. Finding fault with Pennell, although it tacitly endorses his arguments, lends small comfort to those who are striving to reform billboard advertising methods.

The *American Art News* fails to sense the true menace of the billboard. It can only see and comment on its inartistic aspect. It fails to take cognizance of its ubiquitous blatancy, its vulgar obtrusion in every place where it should not be. No matter how well groomed the vulgar man may be, there's no place for him in polite society. If it were possible to secure the services of our best landscape or decorative painters in the design and execution of billboards, they would, with all their artistic excellence and of which the *American Art News* would undoubtedly approve, be just a nuisance, nothing more or less, along the right of way of railroads where they would, in spite of their merit, deprive the passerby of unrestricted enjoyment of the face of nature. No high degree of artistic execution could excuse the placing of billboards in thousands of places now occupied by them.

ARE we never to be free of the insistence of commercialism? Can we ever hope calmly to saunter along a country roadside, or travel with our families in motor cars over our excellently maintained highways, without our attention being constantly distracted by the vulgar insistence of some advertiser? Can we ever become a thoughtful people and calmly pursue the trend of our own thoughts, when our mental processes are being constantly interrupted by the insistent nagging of billboards?

It is not so much the lack of artistic expression that is wrong with the billboards, but the intrusion of their placing, the nerve-racking insistence of their appeal. We shall get small help from the masses in any campaign against billboards based on their inartistic methods. But we could achieve some very necessary reforms if it was shown, as easily might be done, that their presence depreciates land values, vulgarizes the picturesque and defaces the out-of-doors, the unrestricted enjoyment of which should be the right of everyone.

## A Tri-city Architectural Exhibition

THE best argument as to the great value to members of the profession of architecture of exhibitions of their work is shown today in the awakened interest on the part of the general public in good architecture. It is a mistake to suppose that large cities are the only suitable places for these exhibitions. In fact, there is good reason for the contention that small cities or groups of small cities or towns may successfully plan and present exhibitions that will not only serve the very good purpose of architectural education of the public, but to a greater degree than in large cities promote a well developed civic pride. An example that proves this contention is the recently successfully held architectural exhibitions by the combined effort of the architectural profession in the cities of Davenport, Iowa, and Moline and Rock Island, Illinois.

These three cities grouped as of one community have a population of about a hundred and fifty thousand. A splendid spirit of co-operation has been shown by the architects in these three cities and this proper professional attitude has resulted during the past three years in an annual joint architectural exhibition. These yearly meetings have served the very laudable purpose of promoting exactly the right professional relation, creating a social event looked forward to with eager satisfaction and have further served to teach the general

public the value of their local architects' services in the up-building of their cities.

The tri-city exhibition just closed featured the present need for the well-designed small house. The work of a dozen different firms was shown, and added to this architectural showing was the presentation of a well selected lot of building material particularly adapted to the construction of low cost houses.

## Instability of Building Material Quotations

**T**RANSPORTATION difficulties, the uncertainty as to the attitude of organized labor in different sections and the consequent curtailment of supply, so seriously affect prices that dealers will only quote on immediate deliveries from the scanty stocks in hand and will not enter into what is virtually a gamble on future deliveries.

For these reasons it has been decided to abandon the publication in *THE AMERICAN ARCHITECT* of the usual weekly reports of building prices in regional markets, until such time as the building material market may become stabilized to an extent that a weekly statement of prices will present a fairly accurate and dependable basis for calculation.

Commenting on the instability of prices in New York City, and assigning the dominating cause, the *New York Tribune* states the situation exactly, as follows:

"In the matter of car shortage manufacturers are almost uniformly facing excess charges of one sort or another. About 30 per cent of the cars received are open flat-bottom cars. These can be loaded without extra expense. The other 70 per cent are saw-tooth or drop-bottom cars. These have to be floored with lumber (which costs \$65 per thousand square feet), and there is an extra charge of \$25 a car for flooring them. In addition to this charge the cars have to be protected by waterproofed tarpaulins, for which a charge of \$100 each is made to the consignee, and when returned in good condition a rebate of \$90 is allowed. Tarpaulins average six trips before they are unfit for further use. Furthermore, the extra cost of loading is \$25 a car over and above all other expenses.

"Supplementing all this, the manufacturers have said to the distributor here that they feel that the consignee should assume the risk of shipment, and if this arrangement is not acceptable to the purchaser his orders are held indefinitely until box cars are available.

"These are some of the conditions which have made necessary the immediate withdrawal of current price listings, and purchasers desiring to proceed with building operations in the future must expect to pay for building materials, price characteristic of an open market.

"The present situation demands more than passive interest by individuals and officials in public office. The alter-

native is almost complete cessation of building construction. The withdrawal of list prices on building material is a dangerous thing when a great city like New York faces the autumn with 60,000 less homes and apartments than there is already a market for. It is a crisis that calls for prompt and energetic work by the authorities at Washington, co-operating with railroad and city harbor officials. The building material dealers themselves have taken the matter up with United States Senator Calder with some promise of relief, but the situation can be cured quicker with cars than by promises."

These conditions in New York are present in a lesser degree in all large cities throughout the country. A shortage of buildings now acute to the danger point, if the Government action is not swift, will lead to results that it is not possible to contemplate with calmness.

## A Matter of Competitions

**I**N a recent invited competition where all but the prize winners were guaranteed an amount of \$2,000 to defray the expense of drawings, it has been disclosed that in following the exactions of the program it has cost each competitor not less than \$4,000.

Any transaction carried on in commercial fields based on such conditions would be "bad business," even considering the chances of winning. The percentage of expense is too largely in excess of the result achieved. Architects may advertise, the Institute has said it, but why should they be asked to pay so disproportionately for publicity?

It would seem that the present competition code might with reason be amended to correct a condition that works an absolute hardship as the penalty for non-success. It is only a degree nearer justice than the old unpaid contest. In an invited competition, each competitor should be assured that if on proper cost accounting the average expenditure in preparing plans was in excess of the amount guaranteed, the unsuccessful competitors should be entitled to additional compensation.

Of course it is not to be expected that any competitor who lavishly expended money in large renderings made outside of his office could hope to have such items of cost figured in the average. The average would naturally be computed by careful scrutiny of the expense sustained by competitors in actual compliance with the program as to size, number and character of drawings to be submitted.

It would appear that this matter might receive the serious consideration of the Committee on Competitions of the American Institute of Architects.

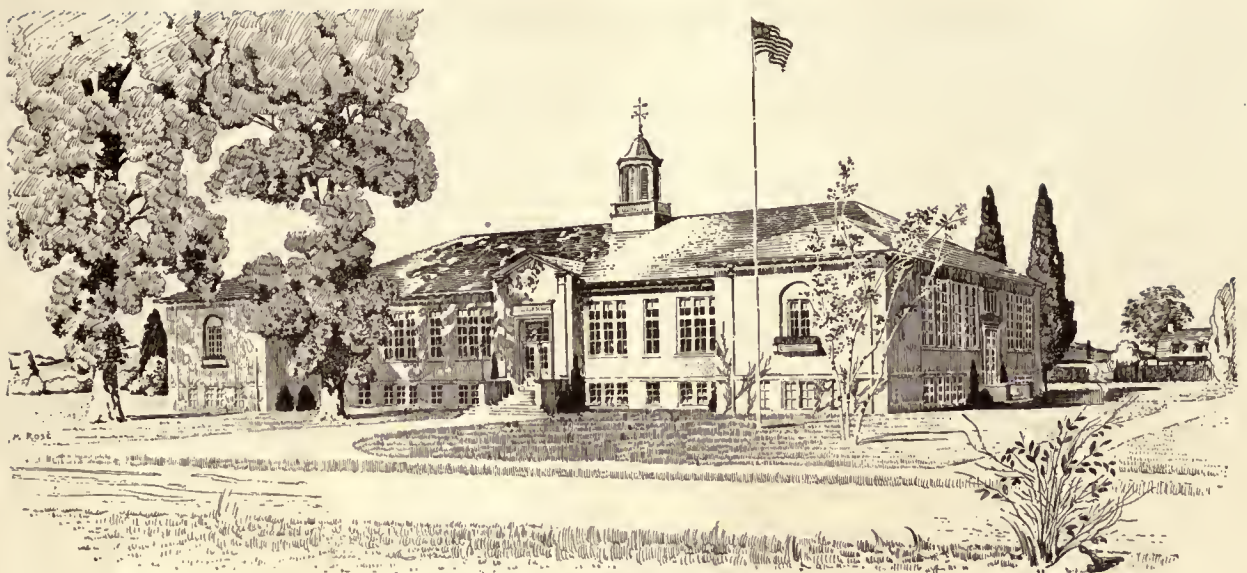

FOUR TEACHER SCHOOL

## New School Buildings

*(Continued from page 759)*

course in canning or other subjects to fit them to be better housekeepers. A community library is provided where the farm journals, current magazines and standard books forming a circulating library are kept for reference and loaning purposes. In the basement is located a large play room, the heat-

ing plant and a gas engine which pumps water into a storage tank and can also be used for charging storage batteries for electric lights. It is obvious that no one teacher could possibly handle or teach all these various activities. It could be arranged, however, that a manual training teacher and a domestic science teacher could have several of these schools in charge and travel from place to place,



FOUR TEACHER SCHOOL

## THE AMERICAN ARCHITECT

thereby using the valuable time of these special teachers to the best advantage.

A saving in equipment is also made possible in connection with these traveling special teachers. In the back of the small automobile in which the teacher travels from school to school can be fitted up a kitchen. Instruction can be given in this traveling class room or its equipment and materials moved into the workroom provided for it in the school building. As each school is a community centre and the class room available for lectures, etc., an automobile with moving-picture machine and reels, traveling from place to place, will be available. This automobile will be so constructed that it will generate electricity under its own power by which to show the pictures in remote districts where no elec-

probably in no other way so effectively produced.

The larger schools of three and four class rooms and more are usually located in communities where water supply, sewers and electricity are available. A janitor is provided, as the care of the building becomes too large a proposition for teachers to handle. The building problem then becomes more in line with the usual town school building, of which we have many good examples in various parts of the country.

Special mention should be made of the Consolidated High School shown in the illustrations. In this building one wing is designed to house the grade school, the other on the opposite side the high school. In the center is the auditorium, library, gymnasium, and rooms used in common by

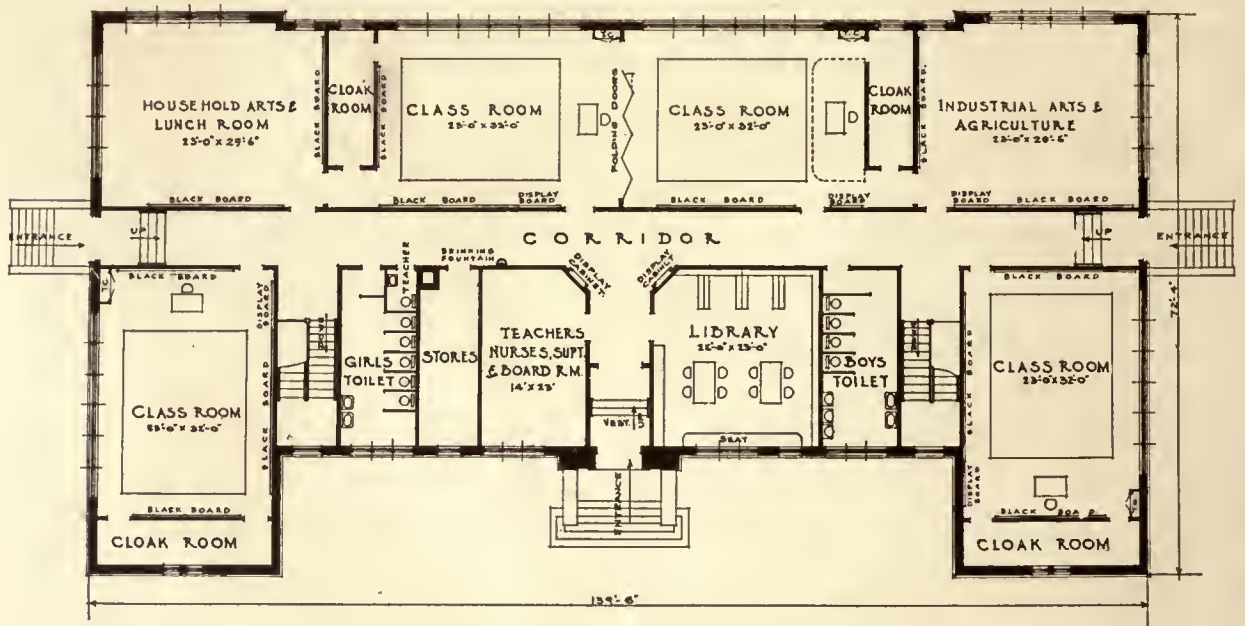

FLOOR PLAN. FOUR TEACHER SCHOOL

tric current is available. This will bring the world's news and some wholesome entertainment into the midst of a district which otherwise would be neglected.

In connection with the grounds surrounding the ideal rural school, there is sufficient space for a school garden and for instruction in practical agriculture. It is hoped that some of the communities will feel that they can afford not only to build such a complete school as this one, but that it can also afford to run it with a live and aggressive teacher as it should be. With such a building the community life would be enriched and the parents brought together for entertainments, educational meetings and civic gatherings, thus creating a school spirit and a neighborhood enthusiasm that can be

both schools and also for community purposes, the building being designed with the community idea particularly in mind. The school building would also be well adapted for use as a Memorial School, as the class room sections could be built by the town, and the center part containing the auditorium might be built as a war memorial, and used generally by the community. In such a building it is possible to use the community facilities during school session without disturbing the school and at night without opening or heating the remainder of the building. As a war memorial the center portion might form the memorial feature with its entrance hall containing inscription tablets and standards of flags around the walls, with meeting rooms for the American Legion, Red Cross, Boy



## THE AMERICAN ARCHITECT

Scouts and Campfire Girls. The auditorium and gymnasium could be used by the school and the public generally, with entrances so arranged as to give access directly from the outside, without need of passing through the school building when it is desired to use it in this way.

Aside from any memorial features in this school, a word about the advantages of the Consolidated Schools generally will not be out of place. The building of Consolidated Schools is becoming more common throughout the country, thus eliminating at isolated points the small one teacher schools. The educational and social advantages in a Consolidated School with a number of rooms are greatly in excess of anything possible in the one teacher buildings. It is possible to get many advantages in a large school where the combined use will reduce the cost of such features, as the auditorium, the circulating library, special rooms for agriculture, cooking, sewing and science.

The easy transportation by motor bus over improved roads permits all the children within a radius of six or eight miles to attend such a school and get the advantages of these combined features. The broadening influence of this wider contact with a larger group of children, its social and educational advantages are recognized and open opportunities to the children which it is not possible to give them any other way. It is also possible to employ teachers who have specialized in particular branches instead of teachers who try to teach all subjects, thus making for more efficient and a better quality of instruction. The teachers have fewer grades to handle and thus can give them more attention and more grounding in the fundamentals, which is not otherwise possible. Better types of teachers are available in these larger schools, whereas in the smaller isolated rural schools no teacher of ability and initiative is willing to remain for any length of time.

*(To be continued)*



ALLEY AND VISTA  
ESTATE OF MIDDLETON S. BURRILL, ESQ., JERICHO, L. I.  
JOHN RUSSELL POPE, ARCHITECT

# Recent Legal Decisions

## Penalty or Liquidated Damages for Delay

Where it cannot be ascertained from the face of a building contract that the damages stipulated to be paid in case of a breach are excessive, and there is no evidence of the amount of damages actually suffered, so that it cannot be determined from the evidence whether the stipulated amount reasonably approximates the actual damages, the provision cannot be construed as a penalty, but should be treated as liquidated damages. *Walsh v. Methodist Episcopal Church (Tex.)*, 212 S. W. 950.

## Estimates of Labor and Materials

Under a building contract designating the architect sole arbiter, with the power of final decision in matters relating to estimates for labor and materials furnished during the progress of the work, the Nebraska Supreme Court holds, *Howard County v. Resha*, 172 N. W. 55, that he must exercise his power with reasonable discretion and not arbitrarily or unreasonably. A building contractor is not bound by the arbitrary or unreasonable refusal of an architect to make an estimate justly due under the terms of the building contract.

Unchallenged estimates for labor and materials furnished during the progress of building operations are conclusive in the absence of fraud or mistake, when regularly made by an architect under a building contract, designating him as sole arbitrator in such matters and making his decision final. An architect employed by a county board to superintend the construction of a courthouse under a contract with a building contractor who is entitled to estimates as the work progressed is a fiduciary of the county, and if the architect knows any reason why an estimate demanded should not be made, he should state the facts to the county board without being asked. Where a county wrongfully forfeited a contract for the construction of a courthouse partially constructed by a contractor not in default, the county cannot justify its failure to pay the amount justly due under the contract as the work progressed by proving that what had been paid to the contractor and what it cost to finish the job exceeded the contract price. The county cannot, by pleading want

of power, escape payment of just claims for labor and materials accepted and used under the terms of the building contract. The failure of the owner, upon demand, to make a payment known to both parties to be due may justify the contractor, if not himself in default, in refusing to proceed further with the work of construction. Where the owner of a partially constructed building wrongfully cancels a building contract requiring him to pay 85 per cent of the estimates for labor and materials as the work progresses, and permitting him to retain 15 per cent of such estimates, the contractor may recover both percentages.

## Payment for Architect's Services— Extent of Public Body's Authority

Architects who entered into a valid contract with the building committee of a county board of supervisors to make plans for a courthouse addition, which contract was approved by the board, were held entitled, *Pauly v. Madison County (Ill.)*, 123 N. E. 281, to recover the reasonable value for their services rendered up to the time that the committee, without authority, interrupted the work by changing the plans so as to call for the construction of a new courthouse. They would not be entitled to recover for the plans for such new courthouse, made pursuant to instructions by the committee, unauthorized by the board; they being bound to know the extent of the committee's authority.

## Restrictive Building Covenants

In an action to enjoin the breach of a restrictive building covenant it appeared that the complainants' residence lot fronted on a street and the defendant's adjoining corner lot had a depth of 150 feet thereon and a frontage of 75 feet on an intersecting street. It was held, *Union Inv. Co. v. Fiske (N. J.)*, 107 Atl. 65, that the defendant's garage, on the rear inside corner of its lot, built within 40 feet of the line of the side street, did not violate a covenant in the deeds of the respective properties permitting necessary buildings not nearer to the street line than 70 feet, as the restriction applied only to the street on which the defendant's lot fronted, and not to the line of the street.

1  
766

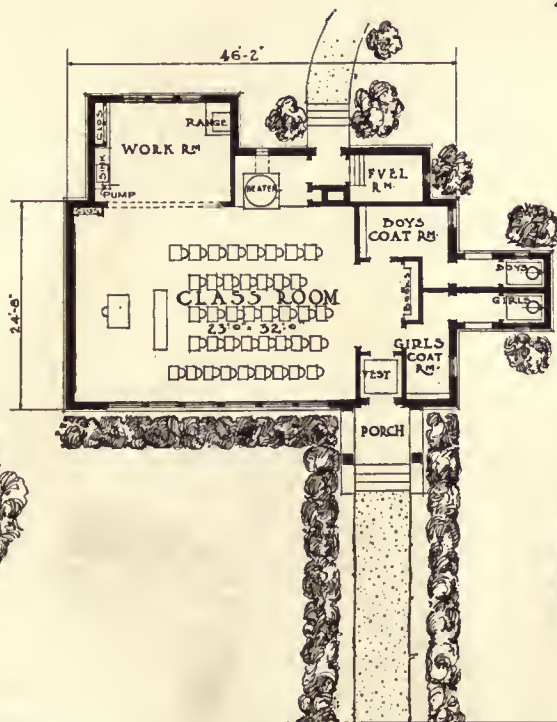

ONE TEACHER SCHOOL  
STATE OF DELAWARE

GUILDERT & DETELLE  
ARCHITECTS  
NEWARK N.J.



166  
2

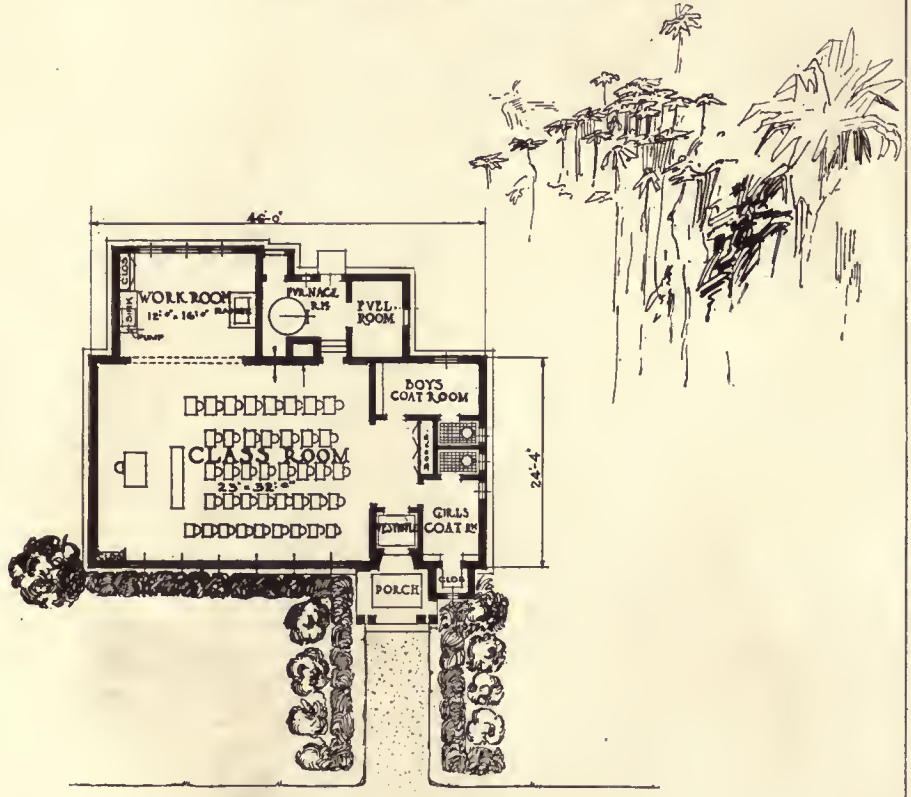

ONE TEACHER SCHOOL  
STATE OF DELAWARE

GILBERT & DETELLE  
ARCHITECTS  
NEWARK N.J.



3  
166

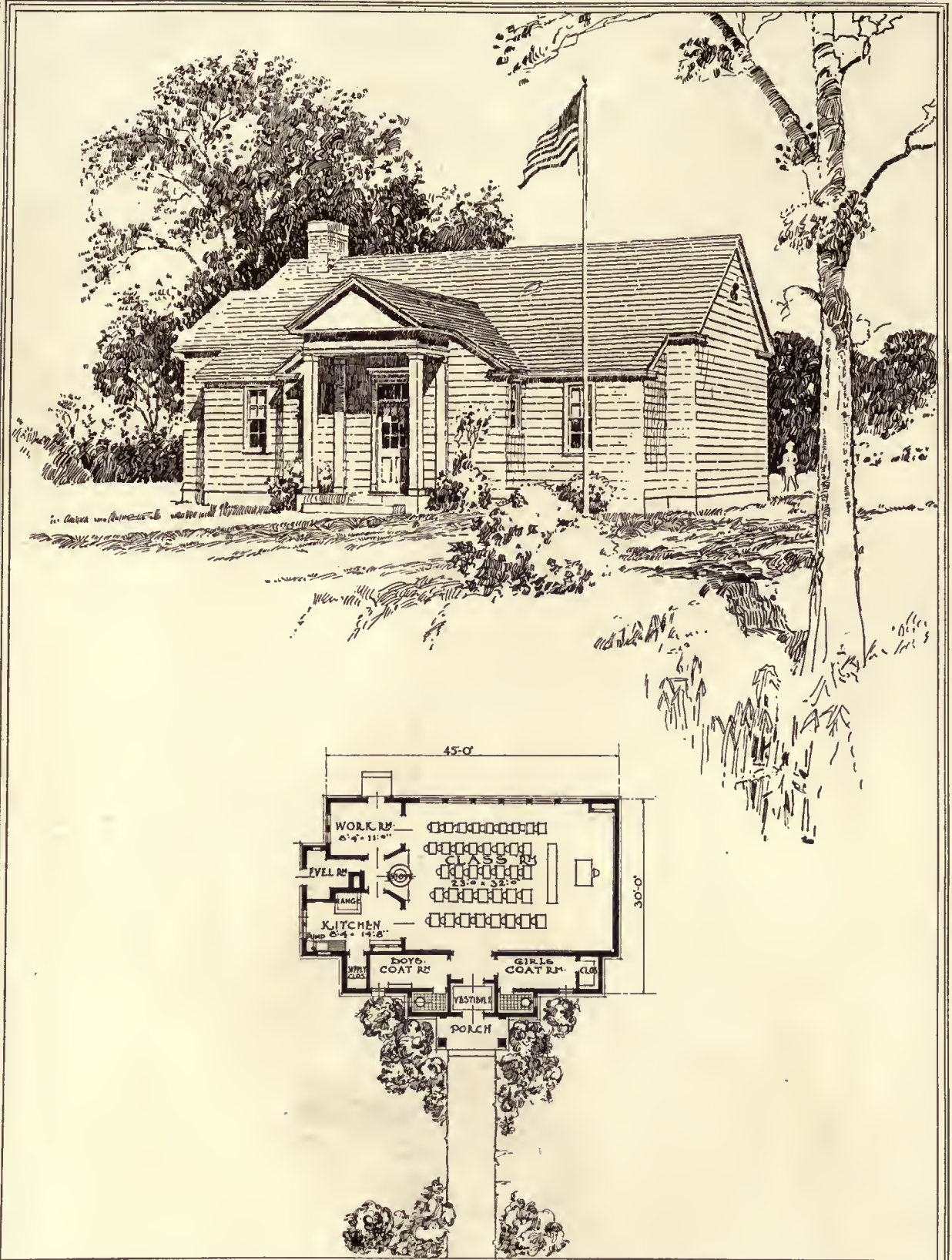

ONE TEACHER SCHOOL  
STATE OF DELAWARE

GUILDERT & DETELLE  
ARCHITECTS  
NEWARK N.J.





7664



ONE TEACHER SCHOOL  
STATE OF DELAWARE.

GILBERT & DETELLE  
ARCHITECTS  
NEWARK N.J.



766 51

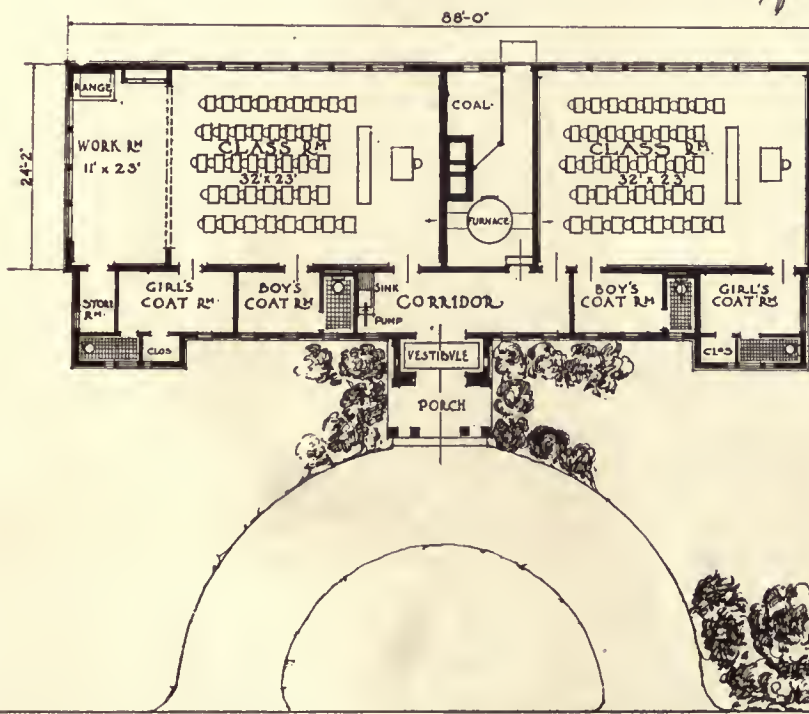

· TWO · TEACHER · SCHOOL ·  
STATE OF DELAWARE

G. VILBERT & BETELLE  
ARCHITECTS  
NEWARK, N.J.





EDWARD RUSS MEMORIAL DORMITORY, STATE NORMAL SCHOOL, UPPER MONTCLAIR, N. J.  
GUILBERT & BETELLE, ARCHITECTS

766<sup>6</sup>



7  
766



DETAIL OF EDWARD RUSS DORMITORY, STATE NORMAL SCHOOL, UPPER MONTCLAIR, N. J.  
GUILBERT & BETELLE, ARCHITECTS







EXTENSION TO THE ELMWOOD SCHOOL, EAST ORANGE, N. J.  
GUILBERT & BETELLE, ARCHITECTS

766 A





EXTENSION TO HIGH SCHOOL, SHORT HILLS, N. J.  
GUILBERT & BETELLE, ARCHITECTS



# Current News

---

## Happenings and Comments in the Fields of Architecture and the Allied Arts

### Council of Architectural Registration Boards

With the increase in registration laws, co-operation between the various State Boards has become more and more necessary during the past few years. At the time of the Minneapolis Convention a few members of such boards met informally to discuss their problems, again meeting during the Nashville Convention last year, at which time a tentative organization was formed.

During the recent Institute Convention a meeting was arranged for the evening of May 5th at The Octagon for members of State Boards and all those interested in such legislation, there being about forty architects in attendance.

It was decided to form a permanent organization to be known as the Council of Architectural Registration Boards with Professor Emil Lorch of the Michigan State Board as President, and Emory Stanford Hall, President of the Illinois State Board as Secretary. The primary purpose of the organization is to bring together the experience of those actually engaged in the work of registration, to make a comparative study of all existing laws and to work out a plan to facilitate reciprocity between States having such laws. Mr. W. P. Bannister of the New York State Board and Mr. M. I. Kast of Pennsylvania, together with Mr. Richard E. Schmidt, Chairman of the Institute Committee on Registration Laws are to make a digest of the various laws and report to a meeting of the Association to be held at some central point in October or November of this year. Another meeting will be held at the time of the next Institute Convention.

All those interested in this work should write Mr. Hall, Secretary, 64 East Van Buren Street, Chicago, Illinois.

---

### To Modernize City of Warsaw

The city of Warsaw, Poland, is to be modernized along American lines and for that purpose recently sent to this country Ladislav Michalski, city architect of Warsaw, to study transportation construction, subway building and modern housing. The plans for the remodeling of the city have been drawn up by a committee of the leading architects

and engineers of Poland and contemplate an expenditure of \$100,000,000 over a period of twelve years. Subways will be built for city passenger traffic, and viaducts and bridges will be constructed over the Vistula River to bring all railroad passenger trains into a union station, in the center of the city. The construction of houses and apartments for all classes of the people, particularly the workingmen, will be begun immediately, as to-day Warsaw stands in dire need of 40,000 single family houses. In explaining the necessity for this development, Mr. Michalski said:

"Greater Warsaw to-day has a population of 1,000,000 people and it is necessary that its development, from now on, be directed along most modern lines. For that reason, a City Planning Committee has been organized, which includes some of the leading engineers and architects of Poland. The committee has sent me to the United States on a six months' tour of the principal cities to collect data on which to proceed with our reconstruction."

---

### Spain Solving Farm Labor Shortage

To obviate the possibility of future strikes and arrest the alarming growth of unrest among agricultural workers, the large landowners of the Seville district of Spain have evolved a system which promises to solve the labor question so far as farming is concerned.

The owners of large tracts of farming land find themselves unable to get field laborers, even under the greatly advanced scale of wages, and are leasing their land in small holdings to families, approximately 480 acres to a family, depending on the size of the family. The farming implements and domestic animals, together with the upkeep of the former and feed for the latter, are provided free by the landlord; the incidental expenses and, where necessary, additional labor hire are also defrayed by him. The tenant pays for half the seed and fertilizer used, and receives at the end of the year half the net returns from his farm. These leases are in the form of a contract and run from two to five years.

In the districts where this system has been tried it has been found that the yearly return from the land, due to the added interest taken by the tenants and the consequent increased production, even allow-

ing for the tenant's half, is greater than the whole production less the wages paid labor under the old system. In addition the laborers are satisfied, realizing that their yearly income depends upon their own efforts. Not having the necessary capital with which to buy implements, animals, and feed, many small farmers, although possessing the requisite knowledge and experience, have been forced to sell their services as day laborers. But under the new system an adequate living is assured, and landlords feel confident that a solution of the labor difficulty has been found.

## Regulations of Building Heights in Chicago

An ordinance has been adopted by the City Council of Chicago changing the height limit of buildings from 200 feet, which has been the limit for the last nine years, to 260 feet, thus permitting the erection of 20-story buildings.

Whether this is wise legislation or not will be based on the effect on the entire city and not upon the Loop district alone. The Public Affairs Committee of the Western Society gave consideration to the subject and sent the following resolution to the City Council and the Mayor:

"WHEREAS, There is now pending before the Board of Aldermen, City of Chicago, an ordinance providing for the construction of buildings in the City of Chicago to a height of 260 feet; and

"WHEREAS, An ordinance has been recommended by the Building Committee of the City Council and adopted by the Board of Aldermen providing for the appointment of a Zoning Commission; and

"WHEREAS, Such Zoning Commission, when appointed by the Mayor, will be authorized to make a scientific survey of the building conditions of the City of Chicago, and to recommend the adoption by the city of zones and regulations with regard to the location of industries, the usefulness and type of construction of buildings therein, *including the height thereof*; and

"WHEREAS, It is recognized that the proper height of buildings in any zone depends upon the character of the improvements in each zone, and upon the width of the streets adjacent thereto, and that the limits when adopted should be such as will provide for the health, safety and convenience of the people of Chicago; and

"WHEREAS, Such adopted heights may in *certain locations* and for *certain uses* properly exceed even the limits now purposed by ordinances; therefore be it

"Resolved, That in the opinion of the Public Affairs Committee of the Western Society of Engineers the pending ordinance changing the height

limit of buildings should be referred to the Zoning Commission and new regulations with regard to the height of buildings should be adopted only as a part of a *comprehensive zoning plan* for the City of Chicago."

The question is not one that involves the limitations of the heights of buildings to even 260 feet, but rather, should we proceed in an orderly and logical manner and prescribe rules based on a broad study of the city as a whole. The Aldermen of Chicago evidently believe in immediate legislation and have bowed to a demand which is contrary to the recommendations of many civic and technical societies, which are composed of interested citizens.

Besides the Western Society of Engineers, other organizations which opposed the present legislation are the City Club, Woman's Club, Illinois Society of Architects and the Illinois Chapter American Institute of Architects. Building Commissioner Bostrom expressed views similar to those of the society.

## Relics of Mound-Builders' Homes Sacrificed—The Passing of a Landmark

Another landmark in the world's history is to be destroyed. The *Kansas City Star* recently printed the information that "after a lifetime of effort Fred Ramey, who owns the land on which the Cahokia mounds are situated, has given up the attempt to interest the Legislature of Missouri or of Illinois, or Congress, in their preservation. He intends selling the land to a firm which seeks a site for a factory. And with this sale the mounds will pass away."

The Cahokia mounds, the most imposing work of the lost race of mound-builders, according to M. L. Loomis in the *Outlook*, include in all seventy-five mounds; the purpose of their construction and their builders have been an unsolved puzzle for archæologists. The largest one, the great Monk's Mound, stands in the center of the group, 1,080 feet long—longer than the Great Pyramid of Egypt; its base covers nearly sixteen acres. In 1913 an attempt was made to interest Congress in their preservation, and Gerard Fowke, curator of the Missouri Historical Society, wrote of them: "The Cahokia Mounds are the most stupendous piles of earth ever erected by human hands solely as a monument or temple site. The countries of Europe would willingly spend large sums to preserve ruins or remains which scarcely would be noticeable if placed near the Cahokia Mounds. We have in them the culmination of the work of the mound-builders. It is among their works what the most magnificent cathedral is among our buildings. The Cahokia

Mounds should never be disturbed by pick or shovel."

However great the demand for money for industrial development may be, the United States should keep intact these archaic land profiles; for the refusal to preserve these mounds is a refusal to protect the natural wealth of the country.

"Natural wealth" means more than coal and iron and oil and water-power. It means also tradition, history, and romance. The loss in these which would come to the Nation with the destruction of the mounds would be poorly compensated for by the money earned on the ground which they occupy.

## New York Organizes Housing Drive

Mayor Hylan has announced the appointment of an Executive Committee of the Housing Conference Committee and has proposed a course of action. The Mayor's statement follows:

"Each member of the Executive Committee will act as chairman of the particular group or interest he represents on the general committee. Each of these representative groups or sub-committees into which the general committee is divided will endeavor to bring about a plan of action within its sphere that will fit in harmoniously with the plans to be submitted by the other sub-committees, in order to carry out effectively the object of the general committee, namely, to facilitate and expedite the necessary increase of housing.

"Each member of the Executive Committee, by virtue of his designation as chairman of a particular sub-committee of the general committee, will be asked to take up the following questions and report the findings of his sub-committee to the Executive Committee:

"Instructing the superintendents of buildings to give preference to housing construction of all kinds, including alterations. Retarding, wherever possible, the alteration of houses used for living purposes into buildings for commercial purposes.

"Interesting city employes in the purchase of homes, generally, singly or by the co-operative plan. Arranging for the formation of building loan associations among employes, where some plan might be devised for those who may be willing to invest from their earnings.

"Arranging for the gathering of weekly or monthly instalments by which a considerable fund could be collected every few months, and applications and requests for loans be considered and acted upon in the order of priority to enable such applicants to build or purchase the houses which that money would buy.

"Inquiring from the Sinking Fund Commission or the Comptroller as to the available lots owned by the city or State within the confines of the City of New York, that the city or State might be able or willing to lease out for twenty years, with a privilege of another twenty, for building sites.

"Discussing and considering any legislation that may be required to meet the necessities of the present housing conditions with respect to existing houses, as well as new construction."

The Executive Committee consists of: Henry H. Curran, Robert P. Brindell, Walter Stabler, E. A. MacDougall, Preston P. Lyon, Edward P. Doyle, Wright D. Goss, Laurence McGuire, Burt L. Fenner, James H. Post, Ralph Peters, Victor E. Ridder.

## Edison's "Eight-hour Day"

On the occasion of his seventy-third birthday, Mr. Thomas A. Edison consented to take a half-day off from work to permit his friends to celebrate the anniversary. On the subject of work and the eight-hour day he said:

"I am not against the eight-hour day, or any other thing that protects labor from exploitation at the hands of ruthless employers, but it makes me sad to see young Americans shackle their abilities by blindly conforming with rules which force the industrious man to keep in step with the shirker. I have always felt that one of the principal reasons for American progress in the past has been that every man had a chance to become whatever he wanted to be. It used to be fashionable to be ambitious. The employe planned to become an employer; the unskilled man sought to become skillful. A young man was not well thought of if he were not striving for a higher place in life.

"Today I am wondering what would have happened to me by now now if fifty years ago some fluent talker had converted me to the theory of the eight-hour day and convinced me that it was not fair to my fellow-workers to put forth my best efforts in my work. I am glad that the eight-hour day had not been invented when I was a young man. If my life had been made up of eight-hour days I do not believe I could have accomplished a great deal. This country would not amount to as much as it does if the young men of fifty years ago had been afraid that they might earn more than they were paid. There ought to be some labor leader strong enough and wise enough to make trade unions a means of fitting their members for better jobs and greater responsibilities."

## An Important Building Measure Presented in Congress

A measure introduced in the House of Representatives on June 4 by Representative James of Michigan requires that all public-building bills be submitted to the Secretary of the Treasury for investigation and report as to whether such buildings are justified, sites needed and expenditures justified.

Further, this measure requires that the Secretary of the Treasury must decide as to the lowest cost at which the buildings found necessary may be erected with economy and efficiency.

This is a measure that should become a law. It will interest every architect and builder.

The bill, designated as H. R. 14,411, reads as follows:

*Be it enacted by the Senate and House of Representatives of the United States of America in Congress assembled,* That whenever a bill is introduced for the erection of a Federal building, or the purchase of a site therefor, or for both such building and site, said bill shall be referred to the Secretary of the Treasury for investigation and report. The report of the Secretary of the Treasury shall set forth the following specific information:

First. Population of the municipality, according to the latest Federal or State census, wherein such building is proposed to be erected, and the population as shown by the next preceding Federal census.

Second. Total postal receipts of the office of such municipality for the preceding year; also the postal receipts for the preceding tenth year and the estimated postal receipts for the tenth succeeding year.

Third. Total square-foot space at present occupied by the several branches of the public service and estimated square-foot area required in new building to accommodate the present business and for the increase of business during the succeeding ten years.

Fourth. Annual rental of building, or buildings, then being used for such post-office purposes and for other branches of the Federal service.

Fifth. Amount of expenditures for the erection of such new building recommended by the Treasury Department.

Sixth. Approximate annual cost of maintaining such new building, the estimated cost of equipment, estimated cost of repairs, depreciation, and interest on cost of site and building.

Seventh. The branches of the Government to be accommodated and such other items as may enable him to make a comprehensive report to Congress.

Section 2. That in ascertaining the needs of the Government service he shall consult such other departments of the Government as require accommodation in the city or town for which the bill has been introduced, and in such cases as he deems it necessary or desirable shall cause examinations of the conditions involved to be made locally and reported upon to him by employes especially designated for the purpose.

Section 3. That the Secretary of the Treasury shall lay before Congress the result of his investigation, and shall state whether, in his judgment, the needs and interests of the Government service require the enactment of the bill, whether the expense is justified, and also the lowest cost at which a building found necessary or advisable may be erected consistently with economy and efficiency.

Section 4. That the Secretary of the Treasury is hereby authorized and directed to submit to Congress annually estimates of appropriation for the compensation, traveling expenses, and subsistence of such force of inspectors as he deems necessary to make the examinations locally as authorized in section 2 hereof.

## News from Various Sources

Under agreement reached May 11 by Senate and House conferees, U. S. Housing Corporation will pass out of existence June 30.

\* \* \* \* \*

Senator Calder (R.) April 17 introduced resolution for appointment of committee of five Senators to investigate housing conditions throughout country.

\* \* \* \* \*

Barcelona's industrial exposition, which was planned to be held during 1920, has been postponed and the organizers hope now to be able to arrange it for 1923.

\* \* \* \* \*

Governor Alfred E. Smith, New York, is author of comprehensive article, entitled "Saving of Millions Planned in State Reorganization," in *New York Times*, April 18.

\* \* \* \* \*

An inter-Allied colonial exposition to be held in Paris in 1925 is proposed, and the Chamber of Deputies has adopted the proposition in the text as coming from the Senate.

\* \* \* \* \*

An industrial fair devoted exclusively to the products of France and her colonies and protectorates will be held in the big Palais des Sports at Brussels June 12 to 27 of this year.

\* \* \* \* \*

According to an announcement in the *Japan Advertiser*, an American corporation will build up-to-date hotels in Yokohama, Shanghai, Hongkong, Manila and Singapore. The one in Yokohama is to be equipped with all modern hotel improvements and conveniences.

\* \* \* \* \*

It is announced that a conference will be held in New York within the next few weeks, which will attack from a new angle education with a special view to usefulness in the producing and distributing phases of industry. The meeting will be the second public step in the movement inaugurated on March 26 and 27 at Drexel Institute, in Philadelphia, by Technology Clubs Associated. Those in attendance will include representatives from nearly all the 620 higher educational institutions in United States and executives of 300 or more industrial corporations, invested capital of which has been estimated at more than \$25,000,000,000.



# Weekly Review of Construction Field

Comment on General Conditions of Economics With Reports of Special Correspondents in Prominent Regional Centers

---

"Reductions in retail prices have occurred at a considerable number of points throughout the country. More careful analysis has shown that there has been no material alteration in the underlying conditions affecting the situation, there being no decided increase in the volume of production sufficient to create a more normal relationship with consumption, no substantial change in the volume of credit extended, and no greater disposition to economize and invest than heretofore. These instances may, however, afford a basis for changes in business relationships that may broaden into more far-reaching alteration of the essential price structure," says the Federal Reserve Board's review of general business conditions.

It is quite probable that these recent price cuts will result in the further depletion of stocks and by creating an additional demand will tend to cause a rise in prices. There is no reason for expecting a drop in commodity prices. The situation cannot change until there has been an increase of production.

Production in this country is largely a question of distribution and the condition of the railroads is placing the building trades in a situation of great difficulty. Embargoes and car shortages have an immediate result in abnormally high prices but of much greater import is the shutting down of factories for lack of coal or raw material. With men on half time and the productive machinery idle we cannot hope for a healthy price reduction.

It was expected when the railroads returned to private operation that there would be shortcomings in service. It was well known that the equipment was badly deteriorated. Orders for rehabilitation were announced and in the course of time new cars and locomotives will be supplied. Until that time, the railroads and the country must get along with such equipment as it has.

The Interstate Commerce Commission, having found that its orders for the interchange of freight cars and the deviation of freight from regular routes, were not being obeyed, has stated to the railway executives that violations would be made a subject of inquiry and the possible enforcement of the penal provisions of the interstate commerce act.

It is expected by railway officials that the early part of July will see the principal gateways cleared

for traffic and that at that time the Commission will release the car equipment which is now used for foodstuffs, coal and similar necessities. Such hope as there is for the movement of building material is that it will take place in the latter part of July and during the months of August and September. After that time the handling of crops will absorb the railroad's equipment; and then the Winter's coal.

---

(By Special Correspondence to THE AMERICAN ARCHITECT)

CHICAGO:—It is generally conceded that inadequate distribution facilities tend to have the same effect on prices as limited supply.

Transportation conditions are and will continue to be an important factor in maintaining price on building materials. Chicago firms in the construction industry, recognizing this menace of a priority program which does not include building and construction materials are urging that the petition from the National Federation of Construction Industries be shown favorable consideration by the Interstate Commerce Commission. This petition urges recognition of the essential character of building and construction work at this time.

It is urged that it is absolutely necessary that the railroads through the Commission work out a policy which will be favorable to building.

The high rental rates and continued housing shortage still agitate the people of Chicago and no improvement can be expected until building activities are placed on a more favorable basis. Prospective builders confronted with the high cost of materials and the uncertainty of shipments, hesitate to begin work unless the structure is urgently needed.

The Chicago Housing Corporation has opened its first group of 175 houses for final inspection. About 100 of the homes have been sold and the completion of a larger group of 2,000 houses is expected before the coming winter. The corporation was organized and financed to build 10,000 homes for working men and has put through the first part of its undertaking in record time. Thirty of these houses were completed to the roof during the coldest winter Chicago has seen in years. The use of steam shovels in digging for foundations and of tank tractors for hauling greatly facilitated construction.

(By Special Correspondence to THE AMERICAN ARCHITECT)

SAN FRANCISCO:—During the past week there has been a general reduction in lumber prices in this city ranging from 10 to 25 per cent. This is said to be due to the falling off in the demand. With the great scarcity of private homes in this city the falling prices of all lumber prices, except for hardwood, would have a tendency to increase the number of small homes, especially in the outlying districts where such a large percentage of buildings are either entirely constructed of wood or whose frame and the bulk of the finish is of wooden construction. However, there is no noticeable increase in this direction yet, due, undoubtedly, to the high prices of other materials and their scarcity at any price.

The freight situation is without doubt the dominating one which is holding back building here, and while that appears to be showing improvements as regards some commodities, with others—which perhaps the railroads do not regard as vital—notice has been given that the car shortage is severe and is not only apt to continue but to grow worse.

SEATTLE:—The situation in regard to delivery and production of essential steel materials for the building trade has cleared signally during the past week, according to telegrams and correspondence from the mills of Youngstown and other portions of the East to jobbing houses in this territory. One order for 100 tons of sheet metal placed last September is to be loaded at once, and furnished the key to the outlook in the East for products that run heavily into tonnage. These mills say they expect to begin shipping small pipe immediately after July 1. Prices are stationary but firm.

This is the first specific information in regard to possible improvement in delivery into the North Coast territory of vital building items that has come through in 90 days. Jobbers feel greatly encouraged. They have been forced to reject heavy export orders to take care of their domestic trade on which the summer building program is based. With the weakness in lumber and a fair prospect of getting plumbing supplies and nails, jobbers and architects declare there is no reason why contemplated jobs should not now proceed.

The financial market with the gradual curtailment of loans, is held by local architects and contractors to be the specific reason for the stop in the advance of prices. A better feeling prevails among contractors in bidding on jobs, as they say they can with greater security figure on a piece of work and not fear loss from rising costs.

Nails are scarce, but the mills are much more optimistic in a commercial way over their

ability in the next 30 to 60 days to load stock for the Coast.

There is plenty of channel iron. Local jobbers picked up a large lot at San Francisco during the week on resale, which will tide over the scarcity on large jobs now under construction. Owing to fair local production and freer offerings, brick, cement, plaster, roofing and plaster board are plentiful, but in these lines builders are complaining of the high prices.

The market has been firm but unchanged through the week by any advance in building materials.

The fir lumber market is unsteady. The mills are reluctant to accept any orders other than finishing assortments due to the threatened collision between the cost of logs and what lumber will bring. Dimension is moving only a little above actual cost. West Coast mills are supplying their immediate eastern trade from storage stocks at Minnesota Transfer.

Wholesalers predict that the market will rebound, but not to the February peak. The fir lumber market today is \$23 to \$30 under the February market on finishing fir lumber and \$8 to \$10 on common dimension.

BOSTON:—According to a report the local rent and housing committee made to the city planning board, the number of dwelling houses erected in the last five years in Boston must be increased by 140 per cent in order that the average for the five years may equal the number of houses built in preceding years.

A total of 3280 buildings must be erected this year to bring the five year total up to the average number of homes built in five-year periods for the 30 years preceding the year 1914.

There has been a large increase recently, however, in the number of business blocks erected and much of the capital now needed for dwelling houses is being spent on the erection of buildings for business purposes. The planning board intends to use this report in connection with the investigation it is making to ascertain the exact housing needs of Boston.

The Massachusetts list of new corporations receiving charters in the State this week comprises thirty-three with an aggregate capitalization of over \$2,570,000.

Statistics of engineering and building operations in New England show that contracts awarded from January 1, 1920, to May 28, 1920, amounted to \$143,535,000 as against \$55,320,000 for the like period in 1918; \$78,976,000 in 1917, and \$79,128,000 in 1916; \$65,201,000 in 1915, and \$67,978,000 in 1914.

# DEPARTMENT OF ARCHITECTURAL ENGINEERING



VIEW SHOWING ENTRANCES TO UNDERGROUND CONVENIENCE STATION, SCRANTON, PA.  
DUCKWORTH BROTHERS, ARCHITECTS

Note excellent arrangement of entrance. Stairs to men's and women's section are from different streets.  
Exhaust for vitiated air disguised as a large flower urn

## The Need for Building Public Convenience Stations

### Investigation Discloses a Woeful Lack of Such Structures

THE United States is not lacking in imposing municipal buildings of a monumental character. Every town and city boasts of its City Hall, Court House, library or other structure of particular artistic merit. The City of Washington, D. C., being the Nation's Capital, naturally excels in this type of structure. We would in nowise dis-

courage the further construction of such buildings, nor reflect in any wise on the pride attendant to their possession. It is here desired not only to point out the regrettable lack and apparent unconcern which exists concerning a very necessary type of municipal structure, i.e., the Public Convenience (more commonly termed "Comfort") Station, but also to urge

the provision of an adequate number of such structures without delay. Perhaps in less arid times, some excuse existed for this unhygienic condition, since in a measure the now extinct saloon helped supply the convenience which the municipality had failed to provide. This excuse no longer exists and at the present time a campaign should be undertaken

of some of these will be of considerable interest.

There are here presented photographs and drawings illustrating an underground Convenience Station built in Scranton, Pa., designed by Duckworth Brothers, Architects; also plans of an underground Convenience Station, designed by the same architects, to be erected on Providence Square, Scranton.

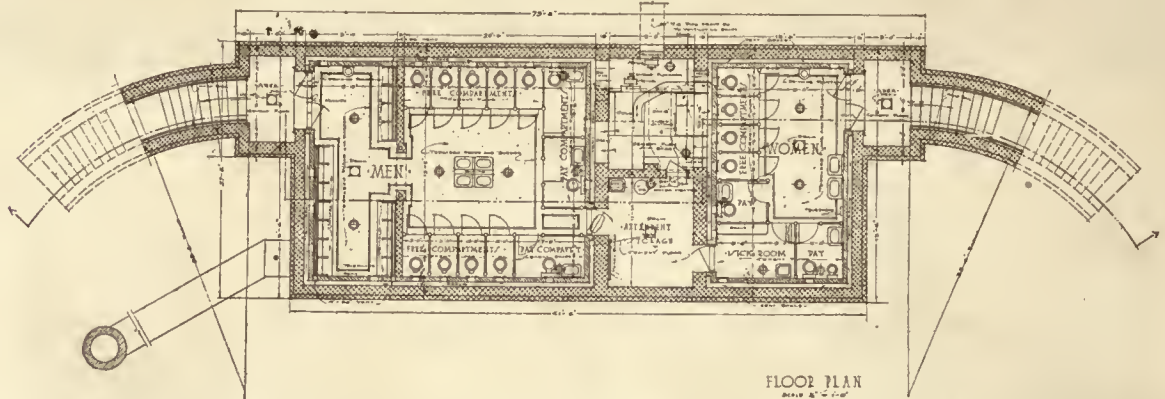

FLOOR PLAN  
PLAN OF UNDERGROUND PUBLIC CONVENIENCE STATION, SCRANTON, PA.  
DUCKWORTH BROTHERS, ARCHITECTS

in practically every community to bring about the erection of an adequate number of such structures. In order to aid in such a movement, THE AMERICAN ARCHITECT has collected considerable data on the subject, and this will be presented from time to time. An investigation has brought out the fact that it is not a difficult matter to make such stations self-sustaining.

Two of the most important problems to be worked

It will be noticed from the photograph showing the general location of the former, that this station is near the intersection of two busy thoroughfares, yet the entrances are so screened by shrubbery as not to be over prominent. The stairways leading to the men's and women's compartments are approached by walks leading from different streets, an admirable arrangement.

The station is under the charge of two male and

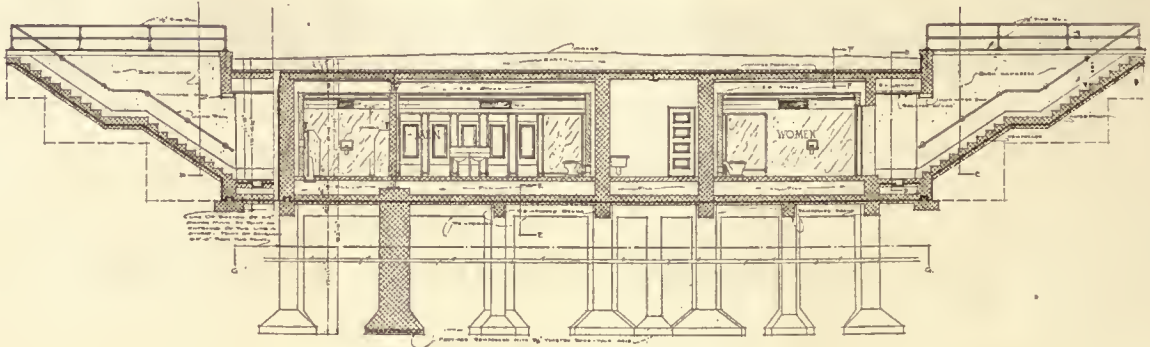

CROSS SECTION ON LINE AA

out in connection with this class of building, which of course is purely utilitarian in character, are the location, i.e., whether above or below ground, whether in a prominent or secluded location, arrangement of approach, etc., and adequate ventilation. Since these problems have been satisfactorily worked out in many structures now existing, a study

two female attendants who each work in 8-hour shifts, the station being closed from midnight until eight o'clock in the morning.

Data relating to this station, collected during the year 1918 is here presented.

Total number of persons visting the station during the year—1,111,519, this including both men and



INTERIOR VIEW, PUBLIC CONVENIENCE STATION AT SCRANTON, PA.

women. Approximately 20 per cent of this number were women.

Annual salary of four attendants, \$2,400. Cost of light, heat, water and supplies, \$1,726.04. Total cost of maintenance during 1918, \$4,126.04.

Revenue from pay compartments, \$478.32. Net cost, \$3,647.72.

Thus the cost of operation per person was 3.2 mills. The population of the city of Scranton is 150,000.

During 1919 the number of persons visting the

tain the incoming fresh air at the proper temperature during winter months. The station is practically odorless, something which unfortunately cannot be said of all such structures.

Mr. John S. Duckworth, of Duckworth Brothers, the architects, states relative to the design of Convenience Stations:

"The point I consider of utmost importance in the construction of a Comfort Station is the avoid-

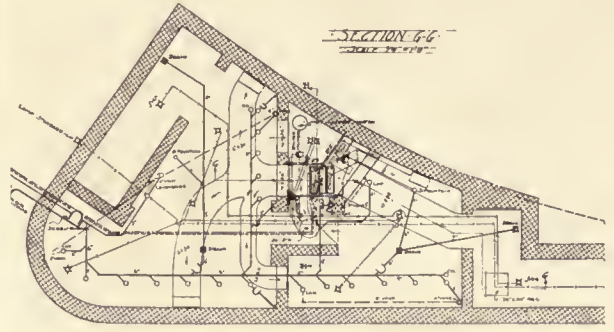

PLAN SHOWING MECHANICAL EQUIPMENT, PROVIDENCE SQUARE STATION

ance of any materials which will absorb uric acid gas. Concrete should be avoided for a finish, and even the joints between glazed tile will absorb this gas. Once any material becomes permeated with

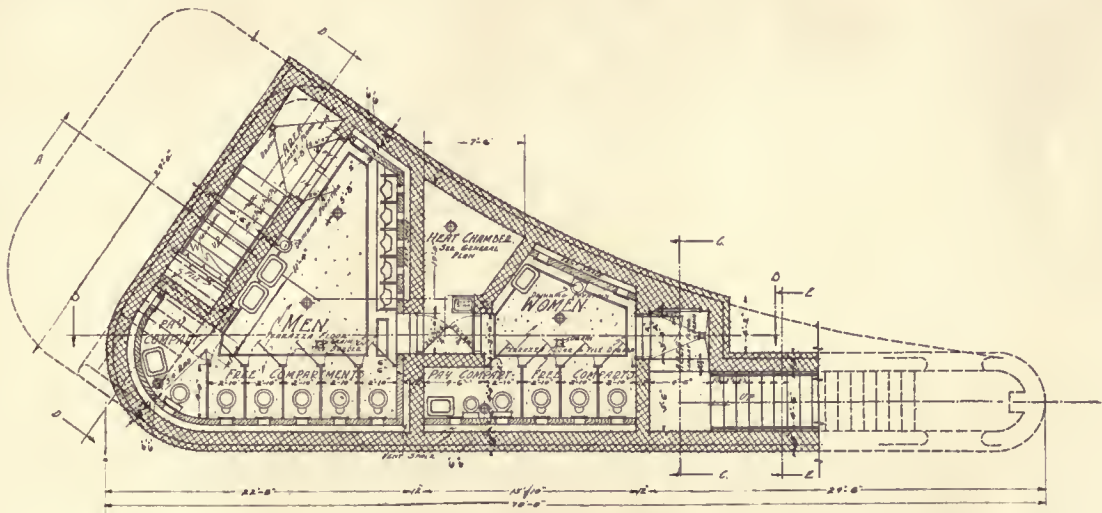

PLAN, PUBLIC CONVENIENCE STATION TO BE ERRECTED AT PROVIDENCE SQUARE, SCRANTON, PA.

DUCKWORTH BROTHERS, ARCHITECTS

station was in the neighborhood of two million. The need of additional stations is evident.

The ventilating system installed is capable of effecting a complete air change every three minutes. Ample indirect heating coils are provided to main-

tain this odor, it is impossible to keep the station either sanitary or odorless. Argentine glass has been found to be impracticable on account of its cracking.

"Another point I consider essential is to have all fixtures operate automatically, such as flush type

water closets which are flushed with the release of pressure on the seat. By using an automatic flush tank arrangement for the urinals they may be flushed at any stated interval.

"The approach to a Comfort Station should be attractively laid out, the landscape design incorporating the use of hedges, flowers and trees, so that the entrances will be somewhat secluded, and the whole appearance made so as to add to the attrac-

vided at such slight expense to the individual.

Every park development scheme should include plans for the inclusion of such stations. In addition they should be located at other points conveniently accessible to the public.

No industrial plant would consider for a moment the omission of such an important feature from its plans. Business men realize that money invested in such features, in rest rooms, etc., yields future

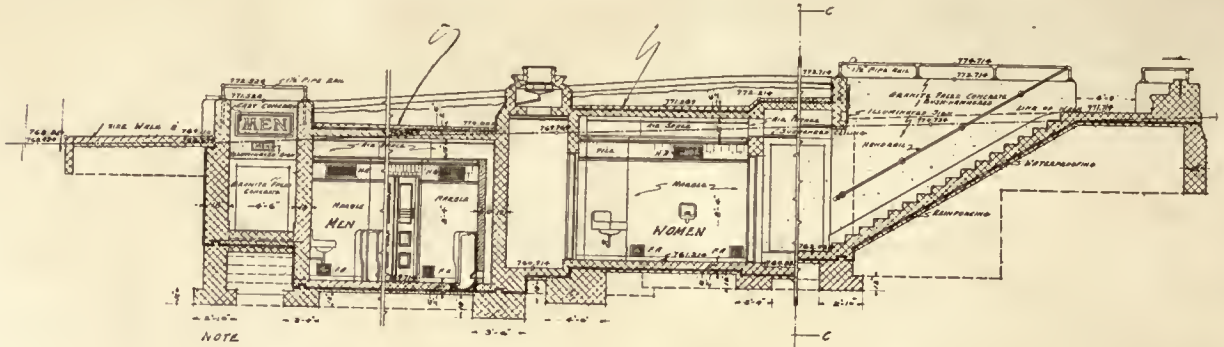

LONGITUDINAL SECTION. PROVIDENCE SQUARE STATION

tiveness of the parkway or other place where the structure is located."

In the Convenience Station illustrated this feature has been admirably worked out, even the exhaust for vitiated air having been camouflaged by treating it as a large flower urn, which adds to, rather than detracts from, the general appearance.

In every community there are certain conveniences which must be provided by the municipality, and certain which can be legitimately provided by private interests. Among the latter are transportation facilities, gas, electricity, etc. Included with the former is the public Convenience Station. There is no other public improvement which affects such a large number of taxpayers, and which can be pro-

fits. In many states the factory laws establish the minimum facilities of this nature which must be provided in such class of buildings, the lawmakers realizing that the health of the employees must be properly safeguarded. There seems no logical reason to compel the installation of such features in buildings constructed by private capital and ignore this necessity throughout the rest of the community. As a matter of fact, it is easy to determine the progressive city or town by investigating its municipal works, and to see to what extent the taxpayers are benefited thereby. Any city seeking to attract the public, both as residents and for business purposes, would do well to look into its needs along the line outlined and see if its own record is satisfactory in this respect.

### From War to Peace

THOSE who were intimately associated with the design and construction of buildings for the purposes of more expeditiously promoting the late war will be interested in hearing of the peacetime uses to which these structures have been put.

Among various developments which, mushroom-like, sprang up over night, was that at Nitro, W. Va., sometimes called the "Miracle City." This city is credited with having been built in eight months at a cost to the United States Government of 60 millions of dollars. It is stated that, after construction work was well under way, one new building reached completion every half hour. All modern improvements

such as gas, water, electrical service, roads and some 37 miles of railroad trackage were installed by the Government. The city is within 500 miles of Chicago, and New York is but a little further distant. It is somewhat centrally located as respects several other important cities, north, south, east and west.

The Charleston Industrial Corporation purchased the entire city from the United States Government, and from present indications it appears that this city will develop into a large industrial center.

A Chicago syndicate has recently completed arrangements with this Corporation to take possession of one of Nitro's plants, together with its tankage, machinery and adjoining grounds to provide for

future extension of their business. This plant is to be used for the manufacture of asphalt shingles, roofing and paving material. Mr. J. C. Woodley, the originator of several well-known trade brands of this type of roofing, is vice-president of the Fibrated Products Corporation who will shortly put

this Nitro plant at work to help put roofs over our heads instead of blowing them off. It is to be hoped that many more of the former "War Plants" will be used to increase the production of essential materials, so much needed. Our transition from war to peace is slowly but certainly progressing.

## Safety Engineering

AT a recent meeting of the American Society of Safety Engineers, in receiving a large number of new members and conferring Honorary Membership upon Mr. David Lindquist, Chief Engineer of the Otis Elevator Co., the following was given as the *raison d'être* for the Society:

There are killed accidentally in the United States each year about 70,000 people, or nearly 20,000 more than the total battle deaths and subsequent deaths from wounds in our army during the entire European War.

Of the wage earners in this country, over 700,000 each year lose members of their body or are so seriously injured by accidents as to be incapacitated for an average of four weeks each.

The total economic waste from casualties in the United States amounts to probably \$800,000,000 per year, with untold privation and suffering entailed.

About 90 per cent of this yearly casualty expense, or \$720,000,000, is caused by accidents that are preventable by engineering provisions. It is not claimed that even a large portion of the total casualties are preventable by engineering provisions—only 7 per cent; but it is *this 7 per cent which is preventable by engineering revision that causes the \$720,000,000 casualty expense.*

To cure the conditions that are causing this waste in life and property, the profession of Safety Engineering is developing. The Safety Engineer is the latest addition to the numerous family of engineers. His work is becoming clearly defined and he need make no apology nor abject pleading for his profession. The savings he makes in dollars and cents, as well as in human life, are many times the cost of his remuneration and the correction of unsafe conditions. In a single plant, for instance, a casualty cost of \$35,000 per year was reduced in five years to \$4,500. Because of many similar experiences, it has been demonstrated beyond question that Safety Engineering should have a real and substantial part in our economic life.

But Safety Engineering has not yet become a part of our economic life. Even in the numerous states having compulsory workmen's compensation,

it is the state or the insurance company that usually has to urge safeguarding and that employs large numbers of Safety Engineers to study the hazards of industry and recommend safeguards. It is only in isolated instances that an industrial establishment employs the services of a Safety Engineer just as the proprietor would employ a physician or a lawyer for his own welfare.

In order to make Safety Engineering a part of the regular daily business of our national life, it is necessary to recognize it universally as a profession, offer sufficient remuneration to attract men qualified to carry on effectively its diverse activities, and officially authenticate those who qualify.

It is unreasonable to expect mechanical, electrical or any other type of engineers to do other than stress those phases of engineering through the practice of which they obtain and retain their distinguishing name. Of course it is good, for them as for every one, to be familiar with the fundamentals of accident prevention. But they will not stress Safety Engineering any more than will a physician or a dentist. A mechanical engineer strives to create a means of production. He views his work from a particular angle. To assure that that means of production does not entail a hazard to life and the Safety Engineer checks up from an entirely different viewpoint. He sees that it is safe. That is *his* duty—his profession.

To provide a national professional association for Safety Engineers, this Society was formed and reorganized. Its prime object is the promotion of the arts and sciences of engineering as related to safety to life and property. That has nothing to do with industrial relations, democratizing industry, Americanization, education of employes, or the providing of a safety service for industrial plants. It does mean, however, that this Society is devoted primarily to the development of engineering ways and means of accident prevention. The need and importance of such work is shown above. The greater number and higher type of safety engineers there are associated in such activities, the more rapid and perfect will be the development of the art of Safety Engineering.

# Modification of New York Zoning Regulations Granted in Connection With Addition to an Important Building

HERE is no doubt that within the course of the next ten years practically every city of importance within the United States will have regulated the future development of its buildings along safe and sane lines by comprehensive zoning regulations. These have proven of such general benefit where now in force that the minor objections thereto are overruled by public opinion. In cities having already adopted such ordinances, cases frequently develop which show the necessity for a certain degree of elasticity in their enforcement. In some cases strict enforcement would result in the development of architectural monstrosities.

One interesting case recently decided by the Board of Appeals of New York City, of which John P. Leo, architect, is chairman, related to the erection of an addition to the 27-story American Telephone and Telegraph Building. Plans for an addition covering a slightly smaller area than is now contemplated were filed with the Building Department in July, 1916, about the time the zoning ordinance was adopted. These were approved the following October, but no constructional work was ever commenced, due to conditions created by the war.

The property is located in what is known as a two and one-half times height district; that is, the height at the building line may not exceed two and one-half times the width of the street. Above this height, "setbacks" must be provided in accordance with a specified slope.

Broadway, the wider of the two streets on which the property fronts, is approximately 80 ft. in width at this point, so that under the zoning rules, the perpendicular face of the addition could not exceed

a height of 200 ft., and this only for a distance of 150 ft. back from Broadway on the side street.

Since the addition has been designed to conform architecturally with that section of the structure already built, strict compliance with the zoning regulations would absolutely defeat the architectural ensemble.

It would also seem that there were good grounds for the architects asking an exemption from the strict provisions of the height regulations, since the property fronting on Fulton street is directly opposite St. Paul's Church yard, an open space which it can be assumed will remain unoccupied for many years to come.

The accompanying photograph shows the existing conditions. The church roof and adjoining graveyard can be clearly seen. The perspective drawing shows the structure as it would appear if the addition is erected as proposed, that is, to a height of 27 stories (360 ft.), making the appearance of the building on Broadway that of a unit, and not of two distinctly separate structures of unequal heights.

The resolution of the Board of Appeals granting the application for a modification of the zoning regulation as to height states in part:

"Whereas, the contemplated addition is part of a monumental and quasi-public edifice, situated upon the most important thoroughfare in the most important district of the city, the architectural features of which are therefore entitled to special consideration; and

"Whereas, the strict letter of the law as cited in the building zone resolution would create an unnecessary hardship, would do injustice to the owners

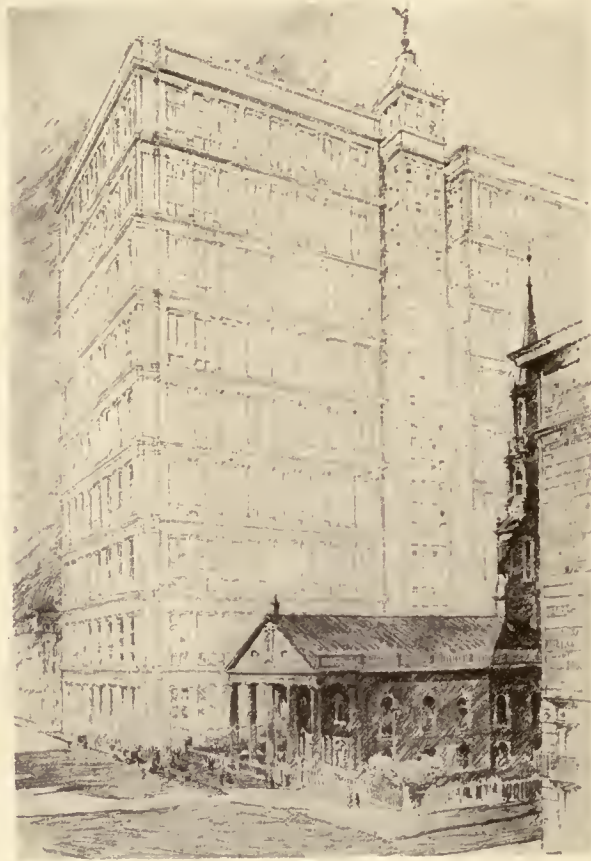

ARCHITECT'S SKETCH SHOWING AMERICAN TELEPHONE AND TELEGRAPH BUILDING AS IT WILL APPEAR WITH ADDITION



## THE AMERICAN ARCHITECT

of the property in question, and would be contrary for light and air. (See photograph below.)  
to the spirit of the zoning law; and "Resolved, that the Board of Appeal does hereby  
"Whereas, the proposed addition would front make a variation in the application of the height



VIEW SHOWING PRESENT CONDITIONS

The tall "L" shaped structure is the American Telephone and Telegraph Building. St. Paul's Church and Graveyard can be seen to the right. The corner in the foreground is the site of the proposed addition.

immediately upon a cemetery and church edifice, occupying the north side of Fulton Street, and would not materially interfere with the provisions

district regulations of the building zone resolution, and that the application be, and it hereby is *granted on condition* that all requirements of the building

zone resolution as to *area* be complied with."

It is interesting to note that the Board gave full consideration to the beneficial effects of good architectural treatment.

The plans were prepared by Welles Bosworth, architect.

This case clearly illustrates the extreme importance not only of placing zone restrictions on

Seely, Associate Professor of Theoretical and Applied Mechanics, and W. J. Putnam, Associate Professor of Theoretical and Applied Mechanics, has been issued as Bulletin No. 115 of the Engineering Experiment Station of the University of Illinois.

The severe uses to which carbon and alloy steels are put in some phases of engineering, as for example, in automobile and in aeroplane construction, have developed a need for more detailed knowledge of the action of steel, under various types of stress, as well as of the factors which affect the physical properties of the material.

This bulletin presents the results of experiments with six grades of steel, three carbon steels and three alloy steels, namely, soft, mild, and medium carbon steel; and vanadium, nickel, and chrome-nickel alloy steel. The elastic strength in tension, in compression, and in shear is given for each of the six grades of steel.

Copies of Bulletin No. 115 may be obtained without charge by addressing C. R. Richards, Director, Engineering Experiment Station, University of Illinois, Urbana.

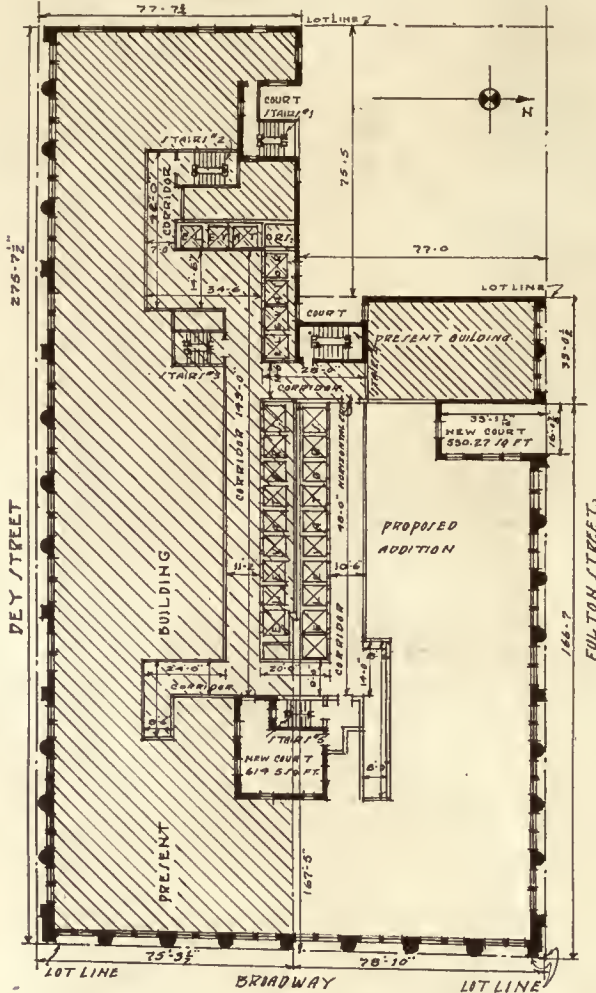

PLAN OF COMPLETED BUILDING

The existing structure is indicated by the hatched lines. The proposed extension fills out the northeast corner of the property

the class, height and area of buildings that may be erected, but also providing for the application and modification of the regulations in exceptional cases.

### Experiments on Steel in Tension, Compression and Shear

"The Relation Between the Elastic Strengths of Steel in Tension, Compression and Shear," by F. B.

### New York City Permits Use of Hydrated Lime in Concrete

The New York Board of Standards and Appeals at a recent meeting took action permitting the use of a limited quantity of hydrated lime in concrete entering into building construction.

The rule as adopted reads as follows:

The use of hydrated lime in all classes of concrete construction shall not be prohibited when used in accordance with the conditions hereinafter set forth.

The hydrated lime shall conform with the standard specifications for this material which have been adopted by the American Society for Testing Materials.

The maximum amount of hydrated lime which may be used shall conform with the following table, all weights given being the amount of lime which may be incorporated for each ninety-five pound bag of Portland cement.

1-1½-3 Mix, 4 pounds of hydrated lime per bag of cement.

1-2-4 Mix, 5 pounds of hydrated lime per bag of cement.

1-2½-5 Mix, 6 pounds of hydrated lime per bag of cement.

For hand mixed concrete, the hydrated lime and Portland cement shall be well mixed while dry.

Hydrated lime shall not be used in concrete which is to be deposited under water.

780<sup>a</sup>

frontispiece to No. 2322.



SILVER CUSTODIA OR-OSTENSORY, BY ENRIQUE DE ARTE  
IN CATHEDRAL OF CORDOBA

# THE AMERICAN ARCHITECT

VOL. CXVII.

WEDNESDAY, JUNE 23, 1920

NUMBER 2322



A VILLAGE SCENE IN THE MEUSE

## Reconstruction of Devastated France

### Part I.—Introductory

By RALPH FANNING, M.S., B.Arch.

READERS of THE AMERICAN ARCHITECT will remember an interesting collection of illustrations in the number of this periodical published October 10th, 1917. These illustrations show some of the charming bits of rural architecture in France, of types which devoted and optimistic lovers of "la belle France" hoped might serve as examples of architectural charm, and as a reminder and inspiration to those whose task it would be to perpetuate the quaint beauty of French building in the restoration of the war-torn regions. Nearly three years have passed since that inspiring collection of illustrations was published—years of great destruction, of decisive action, of grand accomplishment, but years that have brought even greater and more complicated problems than the hectic strenuousness of war ever suggested. The problems of reconstruction have always been more difficult

than those of destruction, and Europe, after four years of pitifully efficient attention to the latter, is now called upon to face the former with all its myriad perplexities.

Perhaps no group of citizens is more involved in responsibility of profession nor called upon to solve a more difficult problem in the great task of reconstruction than the architects and builders of all kinds, for upon material reconstruction depends so much of the progress of social and moral readjustment. From an architect's viewpoint, then, it may be of interest to those readers of THE AMERICAN ARCHITECT who have shared the fortunes of a beloved country through her years of travail, either by serving on her soil or by bearing equally arduous burdens supporting her with loyalty, faith and funds, on this side of the Atlantic, to review the present situation and immediate problem as formulated by

two years' building experience in one of the most devastated regions of France, that of the Meuse district directly west of Verdun.

Comparing the aforementioned illustrations with the ones that come from a post-bellum film pack, and



MOST ANY VILLAGE NEAR VERDUN-DOMBASLE

with the scenes that stamp themselves so indelibly upon the memory of a worker in the "regions liberes," does not make for optimism unless one be of a nature that is exhilarated by gigantic tasks.

Turning from the reproduction of that delightful scene from the brush of M. Renauden, that painting of Varennes-en-Argonne in its pre-war picturesque-ness, to the sad and dingy realities revealed by snapshots taken not far from the same site but a few months ago, there comes the feeling of great tragedy, of an unredeemable loss. The thrills of violent catastrophes and the excitement of great



RHEIMS—NOVEMBER, 1919

activities have been apt to push into the background the stern realities of the future problem. The builder who worked his way into the devastated areas immediately after the cessation of hostilities might go equipped with high ideals and splendid

plans, but they too often had to be pushed to the dim distance while the first home was being established in an excellent, though somewhat gloomy German dugout.

Such was the first civilian after-war home to be founded in historic Varennes. In such a home, the misfortune of having the only cook-stove and the breakfast porridge go violently ceilingward, as a result of the cook's experimenting with the use of stray high-explosives as kindling, seemed as great a tragedy, in retrospect, as the traditional overturning



VARENNES-EN-ARGONNE, AFTER THE BOMBARDMENT

of a furniture van that impeded the flight of the royal coach in that bygone day when Louis XVI and Marie Antoinette were captured but a few rods from this very dugout, and taken back to the frenzied revolters of Paris.

Thus the great war pageant looms up behind all those whose experience it was to have an orchestra seat at the performance, in such distortion that it is difficult to view it all in correct perspective. Yet only those near the stage can obtain the intimate view that seems essential to a correct and sympathetic understanding of both actors and spectators. Indeed, the reconstruction problem is as a drama that must be seen from many angles to be understood and appreciated. All authentic information will tend toward this greater appreciation and a more just solution for the future welfare of a country that, perhaps more than any other with the possible exception of Italy, is universally loved and revered by architects.

Those of the profession who were spending their time in France prior to the signing of the Armistice trying to ease the overcrowded housing conditions

of the French towns and cities where refugees were being herded and living conditions were pitifully abnormal, longed for the day when opportunity would be given for more permanent work. The American Red Cross and other relief organizations

an ancient Loire city staged fake air raids at night to induce the terrified refugees to move further south when housing conditions within their city walls became too congested for their sense of hospitality. Until the tide of battle definitely turned, few could do much but put every bit of energy into the always pressing problem of the moment,—evacuation, canteen and hospital work which could not wait. Inspired by the suffering and the patient heroism of the French people, there were ever hazy plans and fond dreams for Reconstruction, a word that was on the lips of many in their hopes and prayers for the future.

Only with the signing of the Armistice could any organization for relief or reconstruction begin any very tangible work along building lines, beyond the manufacture of portable houses and the collection of materials, for the region to which the government made special assignment. The section with which the writer became most personally familiar was that of some forty villages of the Meuse directly west of Verdun, a section assigned to the War Victims' Relief Organization of Anglo-American Quakers, known for their relief work in France as early as the Franco-Prussian War of 1870 under the name of Société des Amis. Working as a civilian branch of the American Red Cross and affiliating with the Croix Rouge Français and Croix Rouge Britannique, opportunities were given also for observing other attempts, both individual and private, that are being made in the first endeavors at reconstruction.



A CLEARED STREET IN RHEIMS

planned building projects to take care of some of the stranded population specially in connection with child welfare and settlements for tubercular victims. There was, however, little chance to do anything of a permanent architectural nature, so uncertain and critical were the times and so little cooperation could often be obtained from over-taxed French municipalities for encouraging a class of unfortunate dependents to rest too comfortably within their walls. There was a rumor of how some enterprising, though seemingly heartless, officials in



AN ARCHITECT'S POST-BELLUM PROBLEM

Much of the building that has been done to date has been emergency relief housing, but that is not without its architectural interest. The more permanent rebuilding is a French problem which many think can best be solved by the French themselves. However, much American interest, as well as capital, has already been bestowed upon France and many of the French people, both investors and architects, have expressed desire for aid and co-operation from their allies from across the Atlantic. Modern French architecture, referring especially to domestic buildings, has not always compared most favorably with that of other countries, although few can compete with their solutions of the more monumental formal planning. French architects, themselves, have admitted that and strived rather in vain to obtain the more naturalistic, unrestrained dwellings of the older periods, which strangely seems more often happily obtained by American or English designers. The Beaux Arts has made some interesting studies of reconstruction problems, but mostly in an extremely academic, theoretical fashion. Perhaps there may be places where such schemes may be carried out, but most of the village rebuilding problems must be approached through the dusty files of the prefect's office, for the deeds of individual land-owners, traditional rights and local customs must be known

and considered or else the most ideal of projects will come to naught. Withal, there must be an infinite amount of labor, infinite patience, tact and study. Such vast destruction as the past years have



THE FIRST CIVILIAN HOME, AFTER THE ARMISTICE, IN VARENNES-EN-ARGONNE, ONCE A GERMAN DUG-OUT

brought, and the economic waste the world over, are not to be redeemed in a day; neither are broken and wasted lives nourished on hate and distrust quickly restored to productive order and co-operation.



CHURCH OF S. CROCE, FLORENCE, ITALY



# New School Buildings, State of Delaware

## Part II.

By JAMES O. BETELLE, A.I.A.

*Illustrated by the work of Guilbert & Betelle, Architects, for the Delaware School Auxiliary Association, incorporated for the purpose of expending the duPont Fund for new School Buildings*

ONE of the most serious problems in connection with efficiently regulating the schools in small communities and suburban localities has centred around the proper housing of its teachers. The problem in many places has indeed become acute and has adversely affected the grade of teacher that might be secured and retained. Many of the causes at present reducing the number of workers on the farms and in the small communities are also effective in the case of teachers. And just as better housing would be the chief factor in adjusting the farm labor problem, so would the whole community life be improved if its teachers might find surroundings in keeping with their work and temperament. Teachers themselves preach the doctrine of the importance of proper environment. Their own development is not immune from its influence and a proper regard for community welfare demands that such environment be made available.

While we are all familiar with the recent housing problem in our cities, it has always been and always

will be a problem for the teachers in our rural schools. The teacher is usually a stranger in the district and the farm houses are in scattered locations, often remote from the schoolhouse. The type of family with whom the teacher would desire living will not take in a boarder; families who will accept a boarder are not congenial to the teacher. The duties of a teacher necessarily make her working hours and habits different from the ordinary farmer's family. She may have study or work to do in the evenings and the only warm, comfortable place is in the combined dining-room and kitchen around the stove, where the rest of the family is gathered discussing the latest neighborhood scandal and gossip. These conditions do not promote serious work or study, yet if the teacher went to her own room she would find it uncomfortable and without heat. Furthermore, she would run the chance of being misunderstood and accused of being exclusive and unsocial.

The real solution of the problem has been the

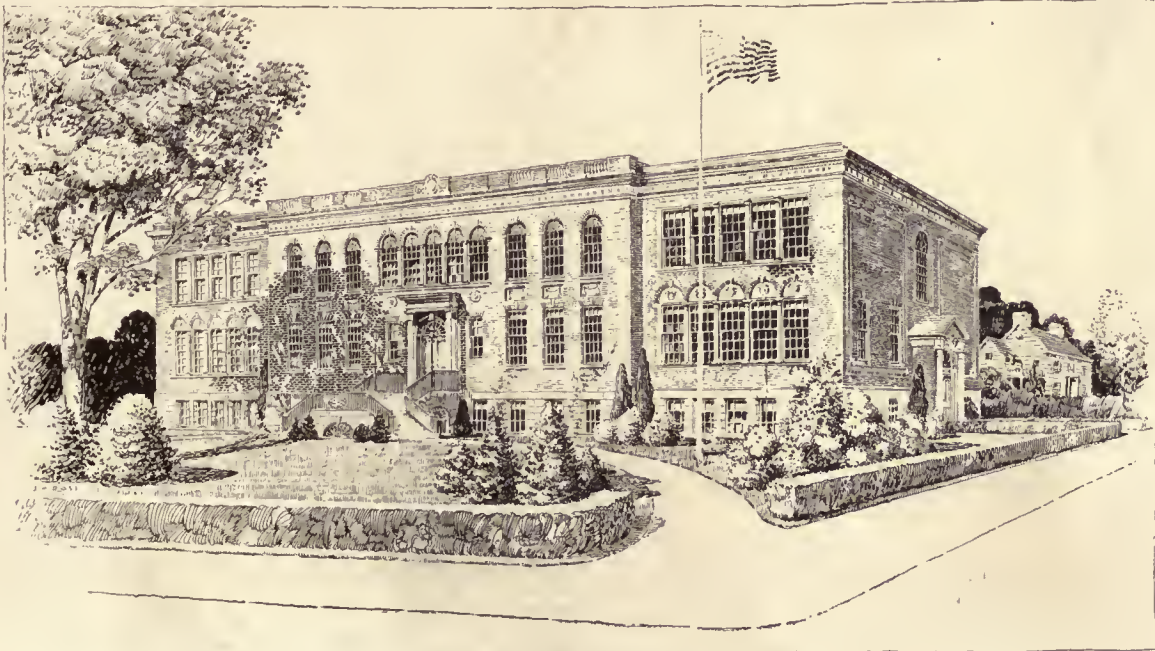

GRADE SCHOOL BUILDING

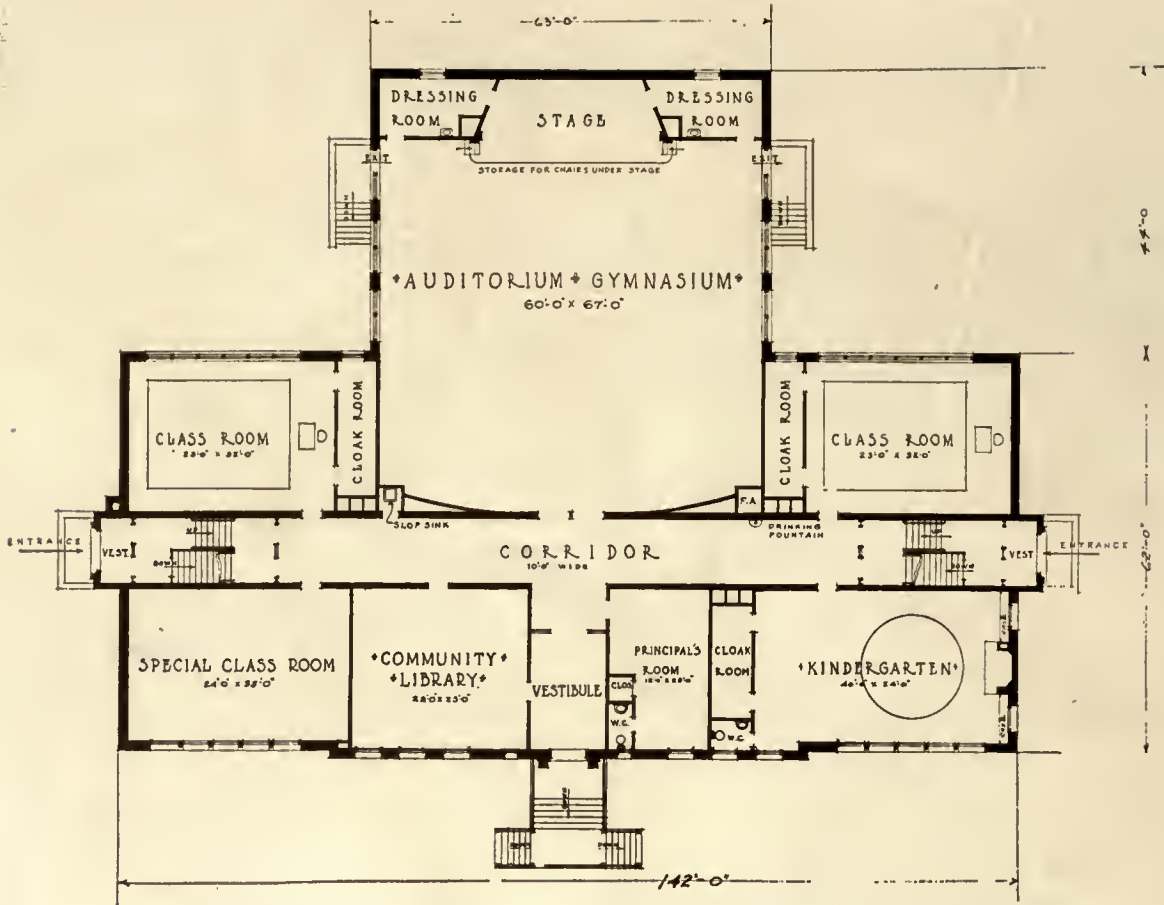

FIRST FLOOR PLAN—GRADE SCHOOL

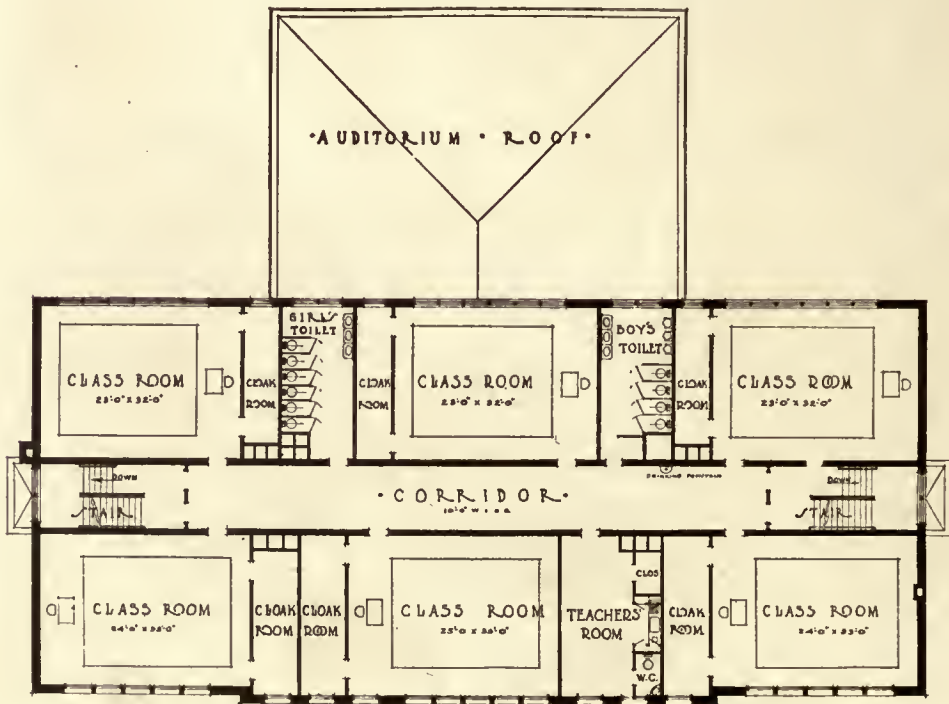

SECOND FLOOR PLAN—GRADE SCHOOL



TWO TEACHER COTTAGE

teachers' cottage or "Teacherage," as it is often called. It fills the purpose for the school that the "Rectory" does for the church, only it is really more necessary. Foreign countries have long recognized and met this need, but only recently have we in this country done anything toward its solution. An attempt has been made to build the school with living quarters for the teachers on the upper floor. This has been found to have many undesirable features and some State laws forbid any living quarters to be combined with the school building. With these things in mind, the architect at the present development has provided for the construction on the school property of small houses so designed as to afford housing for teachers that would attract dignified and worthy representatives of that important profession. As would naturally be inferred, the design of these cottages has followed along the lines of the school buildings of which they become a part. Illustrations of such cottages accompany this article.

A great many advantages are served by an innovation of this kind. The teacher is lifted above the petty annoyances of finding a living place and being subjected to the sordid cares of rent-paying and housekeeping. She is provided with dignified quarters that inspire the respect of the student body and of the community. She is spared the long and tiresome walks in inclement weather at present necessary between the usually remote "third floor back" and the school, and is permitted more time to avail of the library, laboratory and gymnasium facilities of the institution with which she is identified.

With the added time at her disposal and with the mental wholesomeness so secured, she is able to be

the source of stimulation and help to the entire community, and over a longer daily period, than is otherwise possible. The school in the small town is more and more the social center for community life. The proximity of the teacher puts her in a position of influence. She may be readily consulted; her well-trained mind will not be omitted from the general councils because she must be sought in a room miles away from the centre of activities.

This closer intercourse puts her in better touch with the needs of the community. It insistently demands that she apply the practical, common-sense

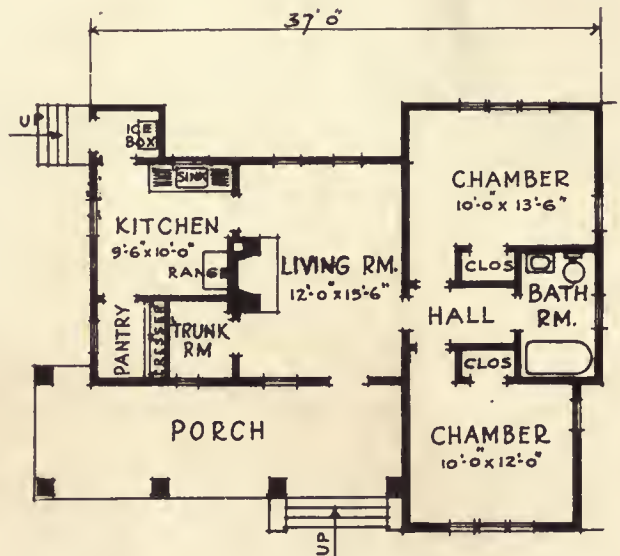

TWO TEACHER COTTAGE

attitude toward her work; for her intimate knowledge of community problems will prevent her from disregarding them or dealing only in far-away theories. She will thus make the school a living, growing thing, with tangible bearing on the needs of the people in it. Her nearness to the school puts her in friendlier relation with her colleague teachers, and a better spirit of co-operation among the teaching staff is made possible.

While perfection is not claimed for any of the plans of the school buildings illustrated, it is claimed that they show an advance in school designing and that the exteriors express the purpose for which the building is built and at the same time making a workable school and a building of good architectural quality. While these buildings were designed especially for the conditions to be met with in the State of Delaware and may not apply to other States where the conditions or requirements are different, they do contain many desirable features that might be taken advantage of for new schools to be built anywhere. It is hoped that the new building program in the State of Delaware will contribute its part to the general improvement in school design.

The outlook for the school children in the State of Delaware is a bright one. In a few years' time they will all be housed in new school buildings

where it will be possible to give proper instruction under first-class teachers. While the present conditions are not all they should be, the defects are known and the remedy is available. The results

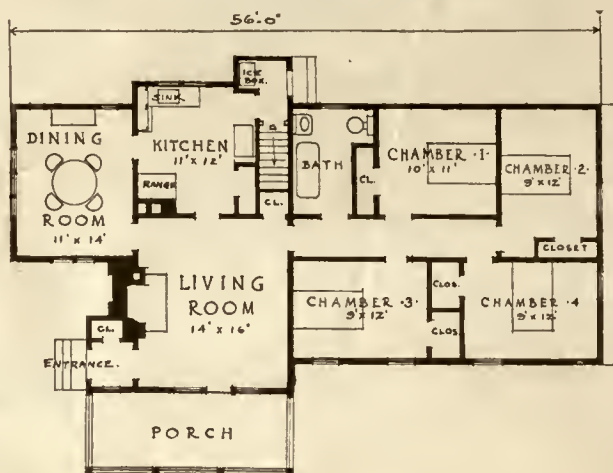

FOUR TEACHER COTTAGE

will justify all the labor and money spent and make healthier and better educated citizens for the "Diamond State" and indirectly benefit the nation as a whole.



FOUR TEACHER COTTAGE

# Chicago Solving House Shortage

WITH 175 model homes for workingmen and their families nearing completion Chicago, it is believed, is finding the solution of the housing problem.

That solution consists in a gigantic housing association, directed and financed by men of national reputation, encouraging small wage earners to acquire and own their homes, and providing a carefully worked out plan for enabling them to do so.

Forty acres of land have been devoted to the erection of specially designed houses by the Chicago Housing Association. The tract is known as "Garden Homes." A great many of the houses now nearing completion have already been distributed among the applicants who appear daily at the association's headquarters. There are many other home-seekers who have arranged to purchase houses on lots as yet untouched by building operations.

An effective plan of model housing has been adopted. A new principle for such enterprises has been adopted—that of devoting the profits from the sale of business frontage to helping buyers of inside frontage pay for their property.

Purchase of property in "Garden Homes" is restricted to small wage-earners with families and unfit housing conditions. The cost of each house, on its 162½x30-foot lot, is from \$4,000 to \$4,500. The housing plan calls for a 10 per cent payment down, the balance payable in 180 monthly installments lasting through a period of fifteen years.

As a part of the consideration for the property buyers agree not to resell without the consent of the housing association, which has first option on the property, being privileged to return the money paid and resell to another party, preventing speculation in the realty contained within the boundaries of the new sub-division.

To make sure that each family shall have a home in event of death of the breadwinner, a low-cost decreasing premium life insurance policy is to be taken out for each buyer. Part of each monthly payment made on the home will be diverted by the association to apply on the insurance premium, and, in event of death, a deed will be given immediately to the heirs of the home buyer. The face value of the policy, covering the amount due on the new home, is to be assigned to the association.

When it was decided to develop the forty acres, the plan of the entire property was placed in the hands of C. S. Frost, architect, who produced the several designs of homes adopted by the association. There are seven different architectural designs, all, however, based upon the same floor plans, but so

arranged as to exteriors, interiors and decorative effects as to preclude any liability of sameness in appearance. The houses contain five rooms, mostly detached, covering 22x27 feet of ground.

Mr. Frost also completed in conjunction with a number of landscape experts a working plan for landscape improvement designed to make the property as a whole, and each individual home as attractive in exterior as possible. There are to be two roadways of 100-foot width. Every avenue is to be planted with decorative shrubs and trees.

"Our experience so far," said James F. Basiger, general manager of the association, "seems to have proved that in large scale work such as ours it is better to trust operating details to established and skilled men, rather than to attempt building up an organization to do the work."

All the work of developing "Garden Homes" is being done by day labor directed by the appointed contractors in charge, except the plumbing, sewerage, electrical work, glazing and plastering.

Among the interesting methods employed was that of excavating for basements with a steam shovel. The shovel excavated an entire block of basements at an operation, digging a huge trench in which the concrete foundations were poured in prepared forms, which are used over and over as the building is advanced. It is cheaper and faster to dig the trenches thus, and later fill in between the houses by steam shovel, than to excavate manually or with teams.

Great economies and means of speed were worked out in the system of building employed. As fast as the steam shovel dug and leveled the trenches for basements, and dug the taplines for water and sewer, the concrete crews followed in with their basement forms. Cement mixers were put in operation at the cross street junctions. From these a steady stream of barrowmen took concrete to the basement forms. As fast as the foundations hardened, the brick and tile layers succeeded the foundation men. And as these artisans finished their work the carpenters came on to joist and roof the structures, in turn making room for the various craftsmen to finish and decorate the houses. Thus a force of from 350 to 400 men has been steadily employed.

Applications have been approved for all houses now nearing completion, and before the project is completed it is expected there will be a long waiting list. The housing association aims, eventually, it is said, to construct between 8,000 and 10,000 houses, providing model modern housing for workers' families in various localities.

# Recent Legal Decisions

By JOHN SIMPSON

## Assignment of Future Payment by Contractor

Where a contractor in alleged violation of his contract with his surety assigned a future payment under the contract to a bank to pay a materialman, it was held, *United States Fidelity etc. Co. v. Elliott (Ind.)*, 123 N. E. 178, that the surety, which, with knowledge of such assignment, took over the contract on the contractor's failure and completed the work, was thereby estopped from claiming that such assignment released it as surety, the surety's acts constituting a ratification of the assignment.

In an action for balance due on contracts for supporting and underpinning a building, the defense alleged nonperformance of work in consequence of which the building sunk and swayed over the property line, and a counterclaim was made for damages. The reply alleged the owner's interference, rendering performance impossible. The Pennsylvania Supreme Court held, *Kress House Moving Co. v. Hogg Co. (Pa.)*, 106 Atl. 351, that evidence as to conditions on the ground at the beginning of the work, explanatory of the method of the defendant's interference, was admissible, and also evidence that the disturbance of the building occurred after the completion of the work, and not from the method of work.

The Connecticut Supreme Court of Errors holds, *Lenox Const. Co. v. Colonial Const. Co.*, 105 Atl. 467, that under a construction contract providing that the owner, upon failure of the contractor, to prosecute the work with diligence, could provide labor and materials and deduct the cost thereof from any money due on the contract, on such failure being certified by the architect, recovery for labor and materials used was dependent upon a showing of such certificate by the architect. But the contract in question also provided, as a condition precedent to the owner's right to terminate the contract, that the architect should not only certify that there had been a failure on the part of the contractor, but also that such failure was a sufficient ground for the termination of the contract. It was held that the owner could not terminate the contract and take over tools, materials and appliances where the architect had certified failure to prosecute the work with diligence, but had not certified that such failure was sufficient ground for the termination of the contract.

General contractors for the erection of a building sublet the excavation. The plans and specifications called for the excavation of a cellar to a depth of

10 feet. After excavating about 2 feet, the subcontractor, to the surprise of everyone connected with the work, including the architect, struck solid rock. He stopped work and notified the architect that he did not consider blasting within the terms of his contract, and that he would not proceed unless he was paid for the blasting as extra work. He completed the work and sued the owner for the actual cost, claiming that the architect authorized him to proceed with the blasting as extra work.

The West Virginia Court of Appeals held, *Rosenberg v. Turner*, 98 S. E. 763, that ordinary words or phrases may by usage of trade acquire a restricted or limited meaning, and when they do, that meaning may be shown by parol evidence, and hence the word "excavate" as used in a building contract may be shown to be used in a certain locality to mean removal of dirt only and not of stone. While the court was of opinion that the word "excavate" as here used covered the removal of solid rock as well as earth and loose material, as the architect, under the building contract, had the power to decide whether or not such extra compensation should be paid by the owner, and the evidence conflicted as to whether or not he so agreed, the question was one for the jury, which decided in favor of the plaintiff.

A building contractor agreed to purchase a license for the use of a patented process for the construction of a floor, the license to be paid for upon the construction of a satisfactory sample floor. The sample floor was constructed and was satisfactory, but the proposed purchaser of the license found that the cost was greatly in excess of the representations made to him, and for that reason refused further to execute the contract. In an action by the owners of the patent process, the West Virginia Supreme Court of Appeals held, *Wetterwald v. Woodall*, 98 S. E. 890, that there could be no recovery against the proposed purchaser because of such refusal, it appearing that he could not inform himself in advance of the cost of construction of such a floor, because of the secret process used therein.

The Wisconsin Supreme Court holds, *School Dist. v. Blystone*, 170 N. W. 721, that a stipulation in a building contract that upon the contractor's non-performance the owner, upon the architect's certificate, could terminate the contract and complete the work, the damages to be certified to by the architect, is mainly for the owner's benefit, and waiver there-

*(Continued on page 793)*



## Playing the Game

**P**LAYING the game for all it is worth and with all we possibly have is the thing to do. In no walk of life today does the race go to the slow. Maxims such as "the race is not always to the swift" may have served to inculcate caution into earlier generations. That of today will have none of such sophistries. If we are to reach success we must play the game. And the reason is that every one with whom we come into contact is playing the game for all he has in him.

Today more than ever before competition is the life of trade. Competition that is honorable, that will bear the white light of day, is the impetus that spurs to big achievement. Not the competition that unfortunately deals in devious underhand methods, but the competition for accomplishment that is the soul of every contest. We must play the game, play it squarely and honorably as to our relations with our competitors. We must eliminate every contestant that will not subscribe and adhere to the ethics that should rule. And, when we play the game, we should play our game and not play our opponent's game.

A writer on sporting topics who brings to his work a fine mentality and much literary ability was asked why it was that players of lesser skill always made the greatest percentage of errors when facing "star performers" in their particular sport. He answered: "In fearing an opponent there is always the probability that you will not be near your best. The tendency then is to play him rather than to play the game." This being exactly true in the field of sport, it is equally true in any walk of life where competition exists. There's a vast difference between smug confidence born of a pronounced conceit and the effort to bring to our task everything we know, everything bearing upon it we can learn.

**E**VERY professional man has in a sense lined up at the start in his race, equally with his competitors. If he succeeds he must needs play the game,

his own game, and not that of his competitors.

Every man in the profession of architecture who has achieved high place and received just recognition for ability, has played the game—his own game—in his own way. This will not mean that he has entirely ignored the game as played by his competitors, for on the contrary he has probably studied it in all of its subtleties and knows exactly how to avoid the things which when put into play by his competitor may lead to his own defeat.

The game is based on knowing essentials and the elimination of non-essentials. It's the game as played by the Irish pilot who upon being asked if he knew the location of every rock and shoal in the Channel replied that he did not, but he "knew where they wasn't." And that is enough for certainty and safety.

If we are to pursue architecture as largely a business, we shall have to bring to our help anything that will help us play the game in a business-like way. Undoubtedly the best method will be to play our own game, with a good knowledge of that of our opponents. We must not, in an endeavor to beat him, play his game. If we do, we shall never finish better than second place in any game in which we are a contestant.

## The Housing Shortage in New York

**L**IKE the fabled king of Spain who marched his men up a hill only to march them down again, New York has worked with considerable effort to house its hotel and apartment population and then has deliberately set about marring what it had done.

For example, the Knickerbocker Hotel at Broadway and 42nd Street has ceased to exist and this well-known hostelry is now to be turned into an office building. Here more than five hundred rooms are withdrawn from New York's hotel accommodations and such withdrawal will be found a serious matter, for in spite of repeated building of hotels during the past two years it is true that every day hundreds seeking hotel accommodations seek in vain.

It is stated with authority that we are short in New York sixty thousand dwellings. In spite of this very serious condition, it is to be seen that all over Manhattan Island many of the largest apartment houses originally designed with apartments on the ground floor are being remodelled and these ground floor apartments turned into stores and offices. Such action consequently increases the scarcity of available dwelling accommodations. The fact that our hotels are inadequate to house our transient population or that the scarcity of apartments or the abnormal house rents work very serious hardship on the people appears to be ignored. Possibly these conditions may ultimately become checked by the extension of the zoning idea to individual structures and certain well defined laws become enacted to regulate the conversion of buildings from their original purpose.

Further, as relating to buildings under construction, it is found that the proportion of business structures to housing structures is excessively high. The present need of dwellings is ignored for the reason that the income possibilities of commercial structures are so very much greater.

**B**EFORE the war, office buildings in New York were not regarded as paying investments. The building of these structures was believed to have been overdone and large loaning or investment companies hesitated to extend loans except on the most "gilt edged" propositions. Is it not possible that similar conditions may exist within another decade?

Many new commercial buildings are being erected on former sites of dwellings, and the tenants, many of long occupancy, are forced at great expense and much inconvenience to seek for even a place to sleep. These conditions are even more apparent in the new clothing trade zone which abuts on Seventh Avenue south of Forty-second Street. Many large structures are being erected and dwellings from four to ten in number and in some instances those that cover half a city block have been demolished to make way for these commercial structures. In other localities conditions are equally bad and residences are being demolished for moving picture theatres, small shops and commercial enterprises of every description.

**T**O finance all of these large commercial propositions vast sums of money are required. This has caused a scarcity of money available for residential construction.

A concrete example as to how this works out in discouraging investors to embark in housing enterprises is shown in the petition of a housing corporation capitalized at \$500,000 asking for the appointment of a receiver. The bill of complaint as pre-

sent to the United States District Court reads in part as follows:

"On information and belief that the defendant corporation has declined to accept loans offered to it upon the ground of the excessive interest rates charged; that said interest rates and bonuses asked for said loans amount as high as 25 per cent on building loans for a period of four months; upon information and belief that the defendant corporation has since the first of February, 1920, conducted its operation on a basis of temporary loans and finances from your orator and others, due to the fact that on or about that date, having theretofore accepted a loan of \$600,000, which agreement was upon the time set for the closing thereof repudiated, leaving the defendant corporation dependent on such temporary loans as it has since been able to procure."

As those who are best informed as to our housing needs are agreed that we must encourage the greatest possible production, undertaken with all possible haste, it is difficult to understand why all these contributing factors to a diminishing of our housing requirements are permitted to proceed without such spoken protest.

### Engineers Effect a National Federation

**E**LSEWHERE in this issue will be found notice of the formation by Engineers of a National Federation, for the purpose of co-ordinating the efforts of the entire profession and to avoid that disjointed effort which in the past has resulted in "lost motion" and a failure to secure the best results. It is interesting to note that the sentiment expressed at this meeting as to the essential functioning of engineers is similar to the contention advanced by this journal as to the practice of architecture. Engineering, it was urged, was at all times a profession and equally a business. It was further contended that unless the interests of the engineering profession were conserved on the basis of agreed business policy there would never be attained the most fruitful results. This is exactly true. It is a healthy indication as to the practice of architecture and engineering that the thoughtful men in these professions are thoroughly of this belief.

THE AMERICAN ARCHITECT believes this organization by engineers is one that will result in a large measure of good to the profession of engineering. It is a practical demonstration of views long and stoutly maintained by this journal and exactly in line with definite progress toward a closer and more valuable working association of engineers throughout the country.





HIGH SCHOOL, MORRISTOWN, N. J.  
GUILBERT & BETELLE, ARCHITECTS

792





DETAIL OF MAIN ENTRANCE  
HIGH SCHOOL, MORRISTOWN, N. J.  
GUILBERT & BETELLE, ARCHITECTS



JUNE 23, 1920

THE AMERICAN ARCHITECT

VOL. CXVII, NO. 2322

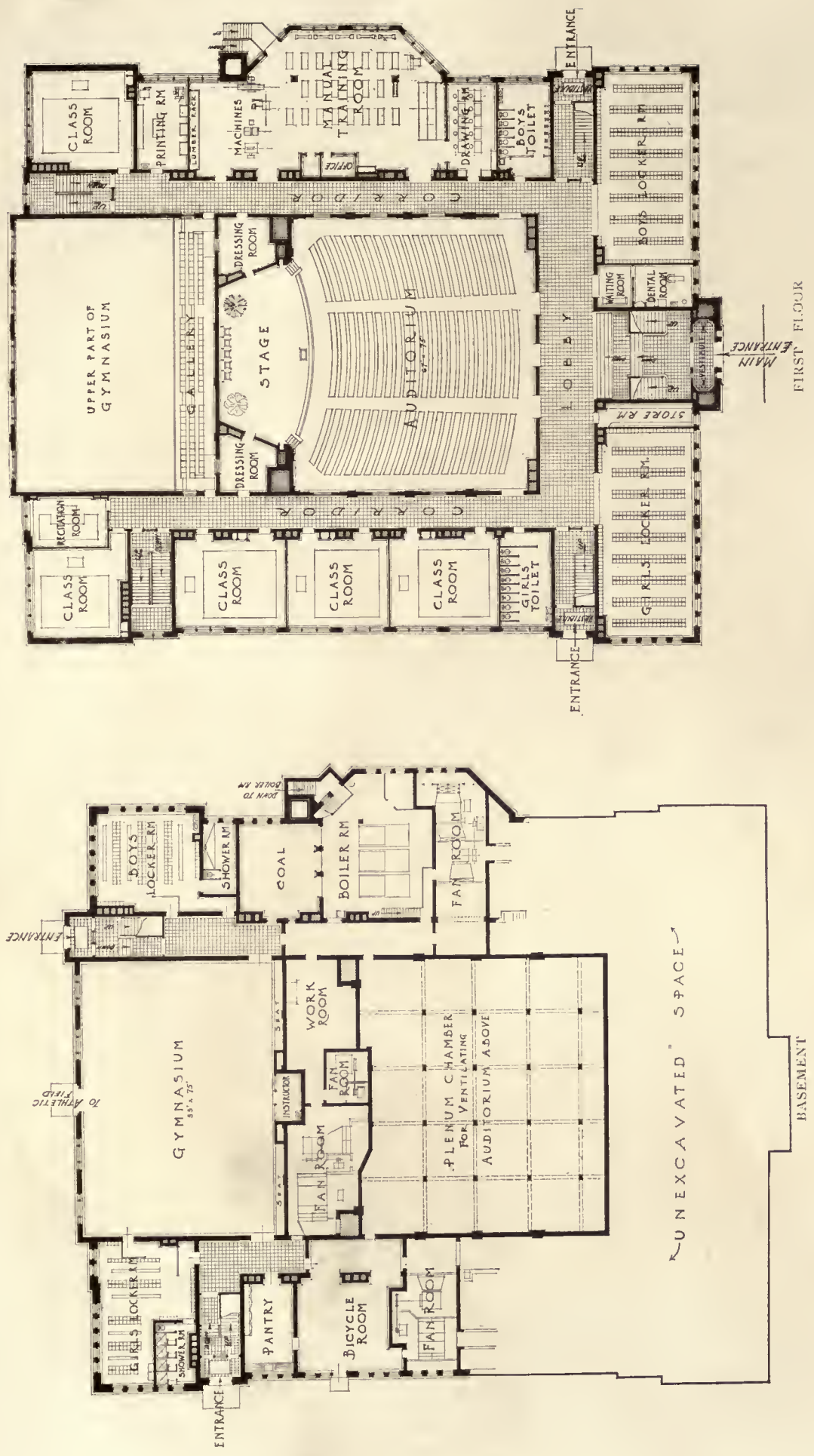

HIGH SCHOOL, MORRISTOWN, N. J.  
GUILBERT & BETELLE, ARCHITECTS

79 2 3





THIRD FLOOR PLAN



SECOND FLOOR PLAN

HIGH SCHOOL, MORRISTOWN, N. J.  
GUILBERT & BETELLE, ARCHITECTS

792







MOSES BIGELOW SCHOOL, NEWARK, N. J.  
E. F. GUILBERT, ARCHITECT, OF THE FIRM OF GUILBERT & BETELLE

792



797



MOSES BIGELOW SCHOOL, NEWARK, N. J.  
E. F. GUILBERT, ARCHITECT, OF THE FIRM OF GUILBERT & BETELLE





MOSES BIGELOW SCHOOL, NEWARK, N. J.  
E. F. GUILBERT, ARCHITECT, OF THE FIRM OF GUILBERT & BETELLE

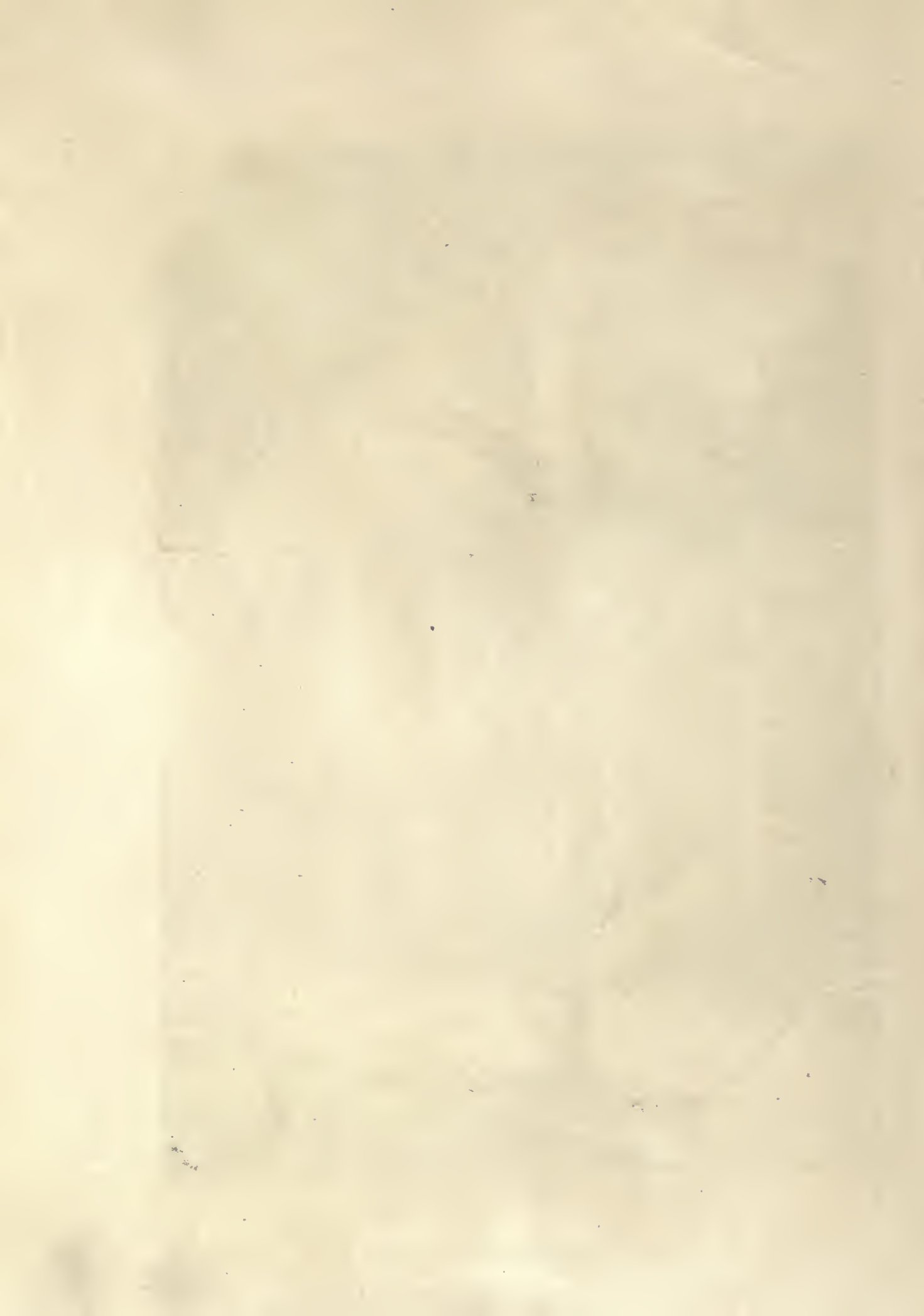



MOSES BIGELOW SCHOOL, NEWARK, N. J.  
E. F. GUILBERT, ARCHITECT, OF THE FIRM OF GUILBERT & BETELLE







DINING ROOM OF A HOUSE IN GLENRIDGE, N. J.  
GUILBERT & BETELLE, ARCHITECTS





DINING ROOM OF A HOUSE IN GLENRIDGE, N. J.  
GUILBERT & BETELLE, ARCHITECTS

792 1'



## Recent Legal Decisions

(Continued from page 790)

of by the contractor may be inferred from less significant circumstances than waiver on the part of the owner.

Under a building contract it was the duty of the contractor to furnish all material, and if there was any evidence of liens for which the owner might become liable, he had the right to retain an amount sufficient to indemnify him, and the contractor was bound to refund to the owner any money he might be compelled to pay in discharging liens. It was therefore the duty of the contractor to pay the materialmen, and the owner who paid the liens was subrogated to the materialmen's right to recover upon the contractor's bond. *Karel v. Baster* (Neb.), 170 N. W. 891.

The Connecticut Supreme Court of Errors holds, *Ford v. Miles*, 105 Atl. 443, that a covenant in a deed that the grantor should not construct buildings on land in front of a lot conveyed so as to interfere with a view of a bay, the lot conveyed being on a street intersecting a drive along the shore of the bay at an angle of 30 degrees, was a covenant not to construct a building on land between lines drawn at right angles to the drive along the shore, and not on land between lines drawn at right angles to the street on which the lot faced.

Ordinarily, the owner's measure of damage upon the contractor's failure to construct the building according to contract is the difference between the value of the building as constructed and its value if it had been constructed according to the contract. Where, however, the contractor wilfully varies from the contract by using materials not only different from those contracted for, but wholly unsuitable for the purpose, the true measure of damages is the actual cost of reconstructing the building according to the contract. Applying this rule, the Kentucky Court of Appeals holds, *Young v. Cumberland County Educational Soc.*, 210 S. W. 494, that where soft and unsuitable brick were used in the outside walls instead of hard brick, as required by the contract, the measure of the owner's damages was the cost of removing the defective brick and putting hard brick in their stead.

An architect's contract was to furnish all necessary general drawings, specifications and details for the construction of a building upon a commission of 2½ per cent of the total cost. A claim that under such a contract the architect was only entitled to recover his commission on the cost of construction as far as the building had proceeded at the time his employment was terminated was not sustained. The actual construction and its cost were only ma-

terial to him as fixing the amount of the owner's liability for the services rendered. *Havens v. Donahue* (1896), 111 Cal. 297.

In an action by an architect to recover a fee for services in remodeling a bank building, it appeared that he had made a written contract for an addition to the building, stipulating for 5 per cent on the cost of the work. During its progress it was decided to remodel the interior of the building, and the plaintiff was instructed to act as architect. There was no agreement as to compensation for this service, but the plaintiff testified he informed the bank's representatives he expected to be paid for his services in that particular kind of work. It was held that the rate paid in the original contract must prevail and the plaintiff could recover no higher rate. *Osterling v. Allegheny Trust Co.* (1918), 260 Pa. 64, 103 Atl. 528.

---

## Building Restriction Covenants

The New Jersey Court of Errors and Appeals holds that whether or not a covenant that "no building shall be erected on said lot unless the front foundation wall of the said building is at least 75 feet from" the street is violated by the construction of a second-story sleeping porch upon the original one-story inclosed porch which rested upon three small cement piers, and which latter porch and piers, while in part within the restricted area, admittedly were not in violation of the covenant, is not so clear that a court of equity will aid in its enforcement. *Marsh v. Marsh* (N. J.), 106 Atl. 810.

---

## Building Restrictions—Changed Conditions

The Michigan Supreme Court holds, *Windermere-Grand I. & P. Assn. v. American State Bank*, 172 N. W. 29, that where an unforeseen and radical change in the nature of a street from quiet suburban conditions to an exceptionally noisy street has defeated the object of restrictive covenants upon an owner's lot which had relation to protecting the home or dwelling house, a court of equity will not enjoin the owner from using the lot, made worthless for residential purposes, for the construction of a reinforced concrete and stone bank building. The right and equity of a chancery court to enforce restrictions is not absolute, and in the exercise of its jurisdiction the same general equitable consideration and rules are recognized as move the court in passing upon applications to compel specific performance of contracts.

# Wasted Water Power

**F**EW people need to be reminded of the high cost of all commodities. If anything, the desire is to forget it as far as they may be permitted. But the fact remains that prodigality is a large contributing cause, and this is particularly true in the case of essential products and fundamental necessities. On these are based so many subsequent operations and processes that it is only reasonable to conserve what nature has given, with the end in view that costs shall be reduced and emergencies minimized. Take water power, for example. The following statements given out by *Engineering World* illustrate the present point:

Now that the people at large have had the experience of the great need of coal even for domestic purposes, when coal is an important factor in maintaining comfort and health, while unmined millions of tons of it are available, and while man-power to mine it is plentiful, these people may be able more adequately to comprehend the value of water-power development. Engineers and others engaged in the industries long have recognized its value and have urged on Congress the necessity of enacting legislation that would permit its development. But members of Congress, either because of a desire to curry political favor by alleging that the demand for water-power legislation has come from those seeking profit at public expense, or because of the nonsensical idea of obstructing progressive legislation as a means of embarrassing political opponents, or because of a lack of good judgment, consistently have refused to heed the advice of technical and business men and have refused the legislation. Computations show that, had enabling legislation providing for water-power development been enacted only five or ten years ago, the amount of that development that reasonably might be expected to have occurred would have prevented the coal shortages that existed during the war and during the recent strike.

The estimated bituminous coal output of the country during 1919 is 530,000,000 tons, about five tons per capita. Two-thirds of it was used for power purposes. During the past ten years the population has increased 40 per cent., while coal production is said to have increased 175 per cent. If the rate of commercial and industrial development is only as large during the next decade as

it has been during the past, and the Nation's water-power resources are not developed, the coal output during 1930 must be approximately 1,500,000,000 tons. A coal strike then will be a calamity from which recovery may not be as rapid as it has been recently.

The estimated water-power resources of the country, irrespective of storage, amount to 60,000,000 horse-power. Of this amount 14,000,000 horse-power are of a private nature unaffected by legislation, whereas 46,000,000 horse-power are on public lands or navigable streams and are subject to restrictions imposed by Congress. Of the private resources 25 per cent. are developed, whereas of the 46,000,000 horse-power on the public domain only 4 per cent. are developed and serviceable to mankind. The other 96 per cent., 44,000,000 horse-power, more than enough power to supply all of the industries of this country that use bituminous coal, are wasted!

Engineers estimate that, if power development legislation had been enacted five years ago, 20 per cent. of the water-power supply under public regulation, 10,000,000 horse-power, would be available for use instead of the present 2,000,000 horse-power. This amount of power from energy abstracted from the forces of nature would have nullified the effect of the recent coal strike. With the average coal consumption per horse-power per year estimated at 6 tons, the annual saving of coal because of the 10,000,000 horse-power of water-power would be 60,000,000 tons, to mine, haul and handle which require the service of approximately 150,000 men, 100,000 freight cars, and 5,000 locomotives. If all of the available water-power of the country were developed, it would save 360,000,000 tons of coal annually, an amount of coal somewhat larger than the total amount of bituminous coal used in the country during 1919.

Water-power legislation should surely be enacted, and, while it is in its embryo stage, a word should be given to remind legislators that while this country wants to get the maximum material benefit from its natural resources, it also wants to preserve as far as possible all its natural beauties. An effort should be made to keep both objects in mind simultaneously—not to forego either for the sake of the other, but effect a compromise that will satisfy all.

# Current News

---

## Happenings and Comment in the Fields of Architecture and the Allied Arts

### Art Associations to Build a Home

A proposal to build another home for art, with lecture rooms and exhibition galleries, found a warm welcome at a conference of six artists' associations in the Pennsylvania Hotel when it was announced that the Art Centre, Inc., had received its papers of incorporation and that \$250,000 capital would be raised in \$10 shares for the purchase and remodeling of two or three houses in the Forties or Fifties, between Sixth and Lexington avenues. Cass Gilbert presided.

The idea is to provide a headquarters for the various art societies professionally related to the industries, to give these societies a central place in which to exhibit their work, salesrooms to facilitate its sale, staff and organization rooms, and all the other arrangements of space that add to the convenience and economy of carrying on co-ordinated effort in any specific field of activity.

Such a building has been needed before, but never so urgently as now. For the first time in the history of America art is widely recognized as an industrial asset, to be encouraged, to be sought, and to be bought, not only by connoisseurs and people of highly cultivated taste, but by manufacturers who must compete with others not merely in the quantity and soundness of their output, but in its attractiveness.

The organizations represented in the formation of the Art Centre are the American Institute of Graphic Art, Art Alliance of America, National Society of Craftsmen, Pictorial Photographers of America, Society of Illustrators and Society of Jewish Designers.

---

### Fine Arts School at University of Pennsylvania

A new School of Fine Arts has been created at the University of Pennsylvania and is expected to open next Fall. It will consist of the department of architecture, now included in the Towne Scientific School; the department of music and the group of fine arts studies now in the college and graduate school. The faculty of the new school will be composed of the faculties now teaching those subjects. As Pennsylvania has been a leading archi-

tectural school of the country, it is the belief of the trustees that the new school will immediately take rank as the first in America.

Under the new arrangement there will be both professional courses, leading to appropriate degrees, and courses in the history and appreciation of the fine arts, leading to the degree of bachelor of fine arts.

The establishment of this school will make possible, through co-operation with other art schools, the creation of professional departments of painting, sculpture, etc. That system of co-operation will enable the young painter or sculptor to secure a broad academic training while he is pursuing his professional studies in the arts school.

The new course was suggested and worked out by Charles L. Borie, Jr., architect, and a member of the board of trustees; Dr. Warren Powers Laird, director of the school of architecture; Professor Paul Cret, professor of design, and W. P. Robins, the last three being members of the faculty in architecture.

---

### Painting the Landscape

A new idea in gardening is being developed by persons of wealth in many parts of the country. This is to plant flowering shrubs in such quantities across rolling fields that the spread of bloom is a part of the view. It is called "painting the landscape" and considerable beauty in the aspect of the countryside may thereby be obtained.

A careful selection of shrubs will keep some part of the scene flooded with color throughout the year.

Lilacs are grown in such quantities, spread over a hillside, that the whole neighborhood is perfumed when the lilacs are blooming.

Lilacs growing naturally look very different from the trimmed shrub ordinarily exhibited. A bush shapes itself into a floral mound, with blossoms clear up from the ground.

Effects less pretentious, but no less satisfying, are within the reach of all; at least all who live in towns where there is more than elbow room, or at the outer edge of a city.

View of a long board fence or other ugly prospect can be transformed by a row of hollyhocks or other flowering plants or shrubs; even by a row of sunflowers!

## Inter-Racial Council Considers Safeguards for Immigration

The United States has a tremendous amount of work to do, Europe has a great many hundreds of thousands of idle men, hungry, homeless and despairing. They and their dependents must be fed, and the only nation with granaries large enough to feed them and itself is the United States. Why, then, should American food be transported far across the Atlantic to feed idle men when the men themselves, with their families, could be just as easily transported to America where they could be fed and housed while at the same time retaining their self-respect by earning good wages with which to pay for their keep and to provide for their future?

This is the subject to which the Inter-racial Council is devoted. The United States lacks 4,000,000 workmen who in the natural course of events would have emigrated from Europe and would have settled here but for the war and its interruptions. Our former common laborers have been separated forever, probably, from their old occupations through being drawn into war work and now have no desire to return to the unskilled labor class. Who is to take their places in performing the absolutely necessary day labor, not only in the steel mills, building construction, etc., but also in all lines of human endeavor?

But several things stand in the way of this restoration. One is the literacy test of our present immigration laws, put on the statute books at the behest of trade union leaders who shrewdly saw created thereby a shortage of immigrant labor. The New York council, however, in a series of striking resolutions, proposes the repeal of this literacy test, but in its place is suggested the creation of a Federal bureau of assimilation, "charged with the duty of co-ordinating all existing governmental activities relating to immigration, of facilitating the safe and expeditious distribution of immigrants arriving here to their several destinations, of supplying them with information and assistance in respect to the securing of employment in those industries for which they are best adapted, of affording them instruction in the English language and in the history, customs and institutions of our country, of protecting them against fraud, extortion and exploitation, of making them feel that they are not strangers in a strange land and of providing for co-operation by the several branches of the Federal, State and municipal governments and by appropriate civic agencies for inducting them into the life of the nation."

This would certainly be an improvement over the present brusque, cold and formal immigration serv-

ice. This nation's wartime experience with some immigrants, who forgot all too quickly allegiance to their adopted country and clung to the decaying and dying "fatherlands," must never be repeated. Provision as proposed by this council's resolutions must be made for the assimilation of future immigrants. Much more loyal and patriotic material by the hundreds of thousands went into the American army with its cosmopolitan mixture of foreign names, but every one of the wearers of the American khaki was a patriot, if not when he went into the army, then when he came out.

Our Federal Government is big, broad and rich enough to carry out such a comprehensive scheme of immigrant assimilation. It must be done some way and at some future time. It is not enough to wait for another war and its army training to give these men their opportunity. They ought to have it now, and devoid of the military side of the affair. They have had enough and to spare of military training. They are needed in the mills, the farms, the shops and the thousand and one other American industrial commercial activities that are starving for want of workmen. These workmen, not the products of their old country skill, are demanded imperatively.

## Profiteers After Mark Twain's Home

Mark Twain's home is a cherished landmark of Hartford, Conn., and should be preserved for the sentiment attached to it.

The officers of the Hartford Art Society have manifested a desire to buy the historic place—the home in which "Innocents Abroad" was written, and which is one of the oldest buildings in New England. The kitchen is on the top floor of the house, and the stairways are on the outside. The famous humorist liked the arrangements of the culinary apartments, for the kitchen force could "see the parades and funerals" without running through the house.

It was, however, acquired a few months ago by private interests at \$55,000 and the present owners are asking \$500,000. There is a question as to whether the money can be raised. The State Park Commission is about to condemn the landmark and use the ground for a State Park.

Lovers of Huckleberry Finn and other creations of Clemens are becoming aroused and from different parts of the country are coming generous offers of financial aid. It is believed that if the Hartford Art Society will make an energetic effort, three hundred thousand dollars or more can be raised for a sentimental but laudable purpose.

But the two speculators—the undertaker and the real estate man—should show some liberality and



civic pride and drop their price at least one hundred and fifty thousand dollars. It might pay them in the end, for if the Park Commission condemns the property, the owners would receive only the appraised value, which would be less than fifty-five thousand dollars.

## Good Roads, Past and Future

In an interesting discussion of present tendencies in our country's progress, J. Ogden Armour has set forth a terse account of the development of roads from the time of the old Romans and up to the present day. He states:

The country is entering a period of road-building. Projects which were planned during the war are being put into effect. The Federal Government has made large appropriations, to be spent conjointly with appropriations by the various States. Good roads have become a watchword of post-war progress.

There is occasion for reflection in the fact that the greatest of ancient empires was conspicuous for its road-building. The Roman roads were the railways and telegraph of an age that did not know steam and electricity. They were the pathways of the imperial couriers and the imperial legions. These roads were the girders that held the empire together. It is customary, today, to admire the Romans for their practical sagacity, nowhere better exemplified than in their road-building.

In a manner, "history repeats itself" in our newly bestirred zeal for constructing good highways. What to the Romans was a national necessity, has become for us an urgent need; and this, by virtue of a modern invention—the motor car. I look for much advancement to grow out of the "motor age;" and I am certain that this advancement will be contingent upon the attention we give to the improvement of our roads.

Those of us who have made observations for two decades have seen wondrous changes resulting directly from the use of the pleasure automobile. Once the city was the city, and the country was the country. Today they merge into one another. The city man knows the country as never before—is glad to have access to it and to live in it when possible. The countryman knows the city and frequents it often. Small villages of yesterday have become the rural metropolis that one finds here and there, everywhere. This is all good, for it is well that a nation be knit together in the spirit of mutual understanding and in a reciprocity of advantages.

But there are better arguments for good roads than those which apply merely to the passenger car. We are told, on the authority of the Government, that farmers lose \$300,000,000 yearly in mar-

keting their crops, because of bad roads. This is too much to waste. We should contemplate this figure in connection with the high cost of living.

There is no more serious problem before us today than the matter of reducing the cost of getting the products of the farm to the table of the consumer. One step, at least, in the solution, is plain—better roads.

As an instrument of economy the motor truck has not yet come into its own. Efficient servant as it is in certain restricted realms, it now awaits the further development of interurban and country highways to reach the measure of its full attainment. It has power and speed that put it outside the class of the horse-drawn vehicle, and a nimbleness and flexibility which give it certain advantages over the railways. It is my expectation to see it assume more and more the function of the "short haul" as its own peculiar province; in part relieving the railways of those duties which they are least able to perform; and in part, expanding the field of our national transportation system.

I say, therefore, all speed to the good roads movement! It will cheapen our methods of distribution and help to bring the people of our country closer to each other. I commend its common sense and practical wisdom. It may be less spectacular than some of our other national issues, but it strikes deep into the roots of fundamental progress.

## Illinois Chapter of A. I. A.

The annual meeting was held June 8, and officers were elected as follows:

Henry K. Holsman, president; Albert M. Saxe, first vice-president; Francis W. Puckey, second vice-president; Richard E. Schmidt, treasurer; Edwin H. Clark, secretary; John A. Nyden and John A. Holabird, directors for two years.

Mr. Ross Crane of the Art Institute gave an interesting illustrated address on the "Extension Work of the Art Institute" in behalf of the better housing campaign, telling how its representatives visit towns and small cities where they give a series of lectures and exhibits of plans, photographs and lantern slides. The range embraces farm houses, small dwellings, kitchen and utility apparatus, interior decoration and furniture, and landscape gardening. The lectures are paid for by local boards of trade or chambers of commerce. The demand for these lectures is increasing and new crews are being organized.

Mr. Crane spoke highly of the work of the Minnesota Chapter and said that the small house problem was the most important problem before the architect, owing to the necessity for good housing to overcome the present unrest.

Of the committee reports, that of the Legislative Committee was most interesting. This is a joint committee with the Illinois Society of Architects. Several important amendments were made to the building code and others are still under consideration. It shows the influence of well organized architects on legislation affecting the building industry and necessarily architecture. This is probably the most active chapter in the United States, in taking part in public affairs, and demonstrate that architects can be an influential factor in civic affairs if properly organized with efficient officers and committees.

### Personals

Ralph H. Cemeron has removed his offices from 606 Frost Building to 1115-6 Central Trust Building, San Antonio, Texas.

Chester H. Walcott, architect, is now located at 8 East Huron street, Chicago, having removed from 76 West Monroe street.

Wm. Newton Diehl, architect, formerly of Newport News, Va., has removed to 52 Virginia-Carolina Building, Norfolk, Va.

Hawk & Parr, architects, have moved their offices from 501 Security Building to 101 Magnolia Building, Oklahoma City, Okla.

John F. Jackson has moved his offices and is now practicing architecture in his own building at 141 East 45th street, New York.

J. N. Tilton, architect, announces the removal of his office from 226 South La Salle street to 5 North La Salle street, Chicago.

R. Spencer Soule has resumed the general practice of architecture, after two years' war service, at 429-A Carondelet street, New Orleans.

Elmer J. Welch, architect, located at 427 Williams street, Norfolk, Va., has made a request for manufacturers' catalogues and samples.

S. Wesley Haynes, architect, has removed from Leominster, Mass., and has opened new offices in rooms 28-29 Park Building, Fitchburg, Mass.

Robert Frank Jordan, architect, formerly of Baltimore, Md., has removed to Wilmington, N. C., and become associated with the W. J. Wilkins Co.

### News from Various Sources

Barcelona's industrial exposition, which was planned to be held during 1920, has been postponed and the organizers hope now to be able to arrange it for 1923.

\* \* \* \* \*

Ten years ago William C. Durant would have bought the Ford Motor Company for \$8,000,000, but Wall Street wouldn't lend him the money. About forty times that amount would be the discussion price today.

\* \* \* \* \*

Rheims is to have a new and modern hotel, constructed by the Société Porte-Mars in the boulevard Louis-Roederer, and which is to have 300 rooms. The capitalization is 3,000,000 francs.

\* \* \* \* \*

Sixty-five per cent. of all the acreage farmed in California now is being cultivated by gasoline or steam propelled tractor, and it is estimated that in the hauling of produce from California ranches the percentage is close to 85 per cent.

\* \* \* \* \*

Boston is ambitious of becoming the world's greatest wool market. The number of textile mills in New England renders Boston natural headquarters for the handling of wool. A cargo of wool valued at \$10,000,000 arrived recently at Boston from Australia.

\* \* \* \* \*

Princeton University has added to the courses of study of the institution a course in architecture leading to the degree of A. B. after four years of study and the professional degree after two additional years of post-graduate work.

\* \* \* \* \*

Every ton of waste paper that can be substituted in paper manufacture will save eight trees of mature growth required to produce a ton of wood pulp and we are sending annually to the dump 150,000 tons of waste paper representing substituted power for at least 1,200,000 trees of mature growth, says the Waste Reclamation Service of the Department of Commerce, in urging a more extensive use of waste paper as raw material in paper manufacture.

\* \* \* \* \*

Zurich, in Switzerland, has a communal forest of about 2,800 acres that yields an income to the community of about \$20,000 a year, according to American Forestry Association experts. This income of approximately \$7 an acre is derived chiefly from the sale of firewood. It would seem that it would be a good business proposition for American towns to establish public wood lots.

# Weekly Review of Construction Field

## Comment on General Conditions of Economics With Reports of Special Correspondents in Prominent Regional Centers

THERE has been no actual establishment of priorities by the Interstate Commerce Commission in regard to freight movement. It would be well if priorities are to be established that they be openly established and the case of each industry be settled on its merits. As the movement of freight (or rather the lack of such movement) is upsetting all building plans, the entire building fraternity from the materials manufacturer to the builder should make plain their needs to those at Washington who apparently would solve the situation by geographical distribution. Trainloads of empty box cars are being shipped westward (into the grain country) and the shortage for industrial uses is increased. The public has been educated of the fact that it must pay higher freight rates. We are all of us ready and willing to agree that the railroads need increased revenues; but should we not insist upon getting something for them?

A conference of those interested in intercity cartage by motor truck is to be held in Chicago June 26 with the purpose of organizing a national association. It is stated by those directing the movement that they hope to place the cartage industry on a basis where it can relieve the pressure on other methods of moving commodities where the older established arteries are now overtaxed. Possibly something may be hoped for in the development of this method of transportation. At any rate, it is the only kind we've got just now.

A report from Detroit estimates that 25,000 men are idle in that city because of the enforced curtailment of production. The report adds that 10,000 building trades employees are out on strike and there are 15,000 "floaters" who wouldn't be working anyway.

*(By Special Correspondence to THE AMERICAN ARCHITECT)*

CHICAGO.—The recent wage increase demanded and received by the building trades of Chicago has already proven a boomerang for the skilled workmen in the industry. By boosting his wages higher than almost anywhere in the country, he has attracted outside labor to Chicago and thus helped to create a glut in the labor of his own industry.

According to those in close touch with the situation, the \$1.25 per hour for skilled mechanics and \$1.00 for common labor has attracted hundreds of outsiders, thrown out of employment through the transportation break-down, into this section. Men who formerly worked as brakemen and switchmen

are now entering other fields and this has increased the labor supply in this particular field; contractors report competition among these former rail men for jobs.

This, it is explained, has resulted in increasing the output of the workers from 10 to 20 per cent over that of three months ago, bearing out the statement of builders who have contended that higher wages and labor scarcity always mean lowered output per man, while increased labor supply—meaning competition for jobs—brings more nearly normal production.

Small contractors here are hampered in their inability to borrow money because of credit restrictions. This has resulted in the temporary abandonment of many bungalows and small flat buildings scattered through the Chicago suburban districts which are really needed to relieve the housing situation. Demands are being made both of the banks and the railroads that the building industry should be placed on the essential list as to loans and transportation. Movement of building materials is still below normal because of car shortage. Broadly speaking, however, the advanced rediscount rate recently put into effect by the local Reserve Bank has had little effect on loan expansion.

Building permits in Chicago for the week ended June 5 were for 25 structures representing an outlay of \$709,300; compared with 90 structures for the corresponding week last year with an expenditure of \$1,218,685.

*(By Special Correspondence to THE AMERICAN ARCHITECT)*

SAN FRANCISCO.—The fact that two building permits call for an expenditure of \$2,500,000 during the month of May brings the record of that month up to \$3,879,000. This is the largest amount of permits issued in the city for any one month during five years' time. The two buildings to be built at once are the fifteen-story office building, at Montgomery and Pine Streets, and the Grenada Theater, at Market and Jones Streets.

The City Planning Commission is urging a zone ordinance for the regulation and establishment of locations for trades and industries, dwellings and other buildings designed for special purposes. The proposed ordinance will change the physical appearance of many sections of the city in a few years, if enforced as now drawn.

Building materials showed no changes in price this week. Reflecting the recent cut in lumber prices

here, information comes from Oregon of radical cuts made in that State. Difficulty in making shipments by rail is also complained of by the northern mills, and this is given as the principal reason for the lower prices in that territory.

In Portland the need for more houses for the people living there has resulted in an agreement by the City Council for changes in the building code permitting the erection of cheap houses, and a large number of low-priced houses will be erected in the near future. These will not add to the architectural beauty of Portland, but they will satisfy a pressing need.

*(By Special Correspondence to THE AMERICAN ARCHITECT)*

SEATTLE.—Searching for the most difficult problem in the building materials market today, North Coast jobbers have hit upon the car situation, and convinced that past shortages will look like a bounteous distribution in comparison with what is immediately at hand, they have begun to store such building materials as are now freely offering because of a quiet period in building commitments.

Carload lots of cement, plaster, patent roofing and all essentials that arrive by rail are now warehoused. There has been a plentiful supply of these materials during the past thirty days and jobbers have had no difficulty in getting ample offerings. Fears of these jobbers may prove to be groundless, but they frankly say that the problem of distribution is more critical today than finance.

There is probably no single item of building materials that can be reported higher this week. Difficulty of getting stock from the East is growing more pronounced, especially in steel pipe, radiation and nails. Jobbers unhesitatingly declare that due to the intermittent and undependable car supply, their profits are being sacrificed to a degree never before known. Production at eastern mills, particularly in the intermountain districts, is being vitally curtailed because of inexperienced labor. Manufacturers say it is a difficult thing to educate men who can do the finer grade of work successfully. One plant reports to jobbers here that it has been compelled to install sixty new nail machines because of destruction wrought by raw labor.

Nails are still being rationed. Eastern manufacturers advised in May that the June 1 and later production and delivery would be 50 per cent of normal—but to date it has not exceeded 25 per cent.

Wrought and galvanized pipe is scarce. Manufacturers assert that they cannot get raw materials

and are allotting shipment on the basis of business done for the corresponding period last year.

Fir lumber prices, with the announcement this week by one of the larger representative mills of a cut of \$4 on common and \$5 on uppers, has sounded the bottom of the market, and a turn is now expected, according to all branches of the trade. This list quotes to the trade No. 1 common dimension at \$24.50, boards, \$28; vertical grain flooring, \$64; slash grain flooring, \$54; drop siding, \$51, and ceiling, \$48. The mill that takes the cut has 80,000,000 feet of stock ready for immediate delivery. Red cedar shingles are stronger, coast loading at \$5.25 for clears and \$4.10 to \$4.20 for start.

*(By Special Correspondence to THE AMERICAN ARCHITECT)*

BOSTON.—While business conditions continue very much disturbed as a result of the tense credit situation and the tangled transportation condition, it is noticeable that there is less calamity talk in business circles than a fortnight ago, and indeed in some quarters signs which are very encouraging for the future are appearing.

In the retail trade conditions are very much confused. Many merchants who bought goods in quantity some time ago are feeling the pressure of the banks to reduce their loans. The mark-down sales are the natural result and even those who are not pressed by the banks are compelled to follow that example by the pressure of competition. This uncertainty and unsettlement in the retail trade is reflecting on the industrial field with a general tendency to curtail new purchases. But taking a broad view of the situation there is reason to believe that the factors which caused the disruption in business are improving. It is believed that when the smoke clears away it will be found that there will be still a tremendous unfilled demand for goods, the supply of which will ensure the operation for factories for a long time to come.

The building of apartments, which has been at a standstill, is slowly getting under way again. In one section of Boston an eight-story building containing 200 apartments has just been started while land for another to contain 300 apartments has been secured.

Statistics of building and engineering operations in New England show that contracts awarded from January 1 to June 10, 1920, amounted to \$157,509,000 as against \$67,295,000 for a corresponding period in 1919, \$64,867,000 in 1918, \$87,534,000 in 1917, \$86,685,000 in 1916, and \$72,814,000 in 1915.

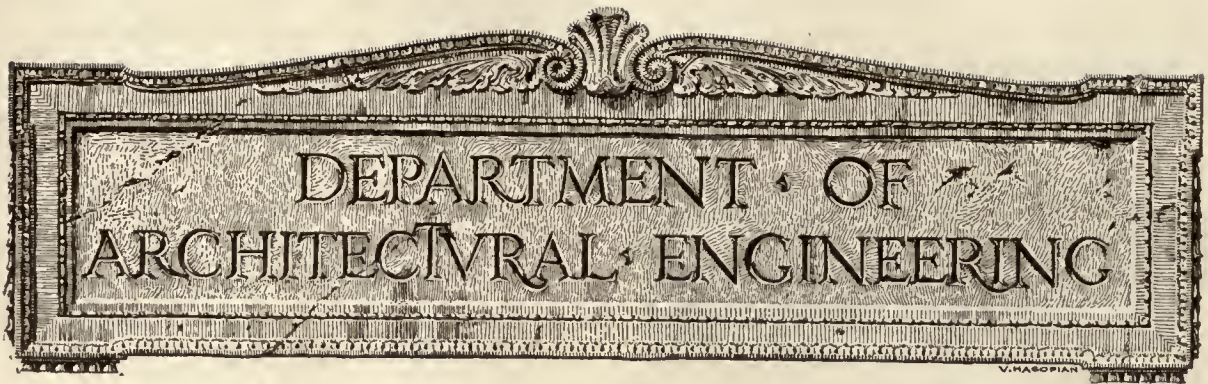

## A Study of the Practicability of Spray Painting\*

By HENRY A. GARDNER

THE war placed such great demands upon the painting industry that it was found necessary to utilize every means to accomplish the huge painting program that developed. The shortage of men capable of wielding brushes soon became apparent and the great speed demanded in production developed as a vital factor. As a result, the steel hulls of many vessels, the rough siding of many temporary buildings, and the surfaces of thousands of guns, tractors, and other military equipment were coated by the spray machine. Because of the speed obtained through the use of this device for preserving or camouflaging materials of warfare, attempts have been made to develop it for peace time painting purposes. To many observers the question has come as to whether the machine is of sufficient practical value to merit a permanent place in the art of painting and whether it will to any extent replace the old-time hand paint brush.

Some observers have stated that hand-brush manufacturers cannot produce sufficient brushes to apply the paint for which such great demands exist. While the apparent shortage of bristles might to some extent be held responsible for such a situation, it has been suggested that even though bristles were as plentiful as at any time previous to the war, it would be difficult for manufacturers to produce an over-abundance of brushes for coming needs, and that the brush industry could not therefore be injured through the development of the spray-painting machine.

Similarly it has been advanced that the occupation of the journeyman painter could not in any way be

injured by the adoption of spray painting for certain special classes of work, since it is often impossible to obtain sufficient labor to apply the paint for which such enormously increased demands exist. Furthermore, it has been claimed that unless some means is provided for at least partially relieving the situation, millions of dollars of loss may result from the surface decay that will take place on unpainted structures. It is undoubtedly true that painting was neglected to such an extent during the war period that immediate action must now be taken to preserve the property that will otherwise be damaged if longer left unpainted. This means that during coming years an even greater demand will develop for paint and varnish products. Any legitimate and satisfactory means for the application of these products should therefore be welcomed not only by the master painter but by the journeyman painter and the public. The use, for instance, of the spray machine (if found practicable) will not only be of service to the property owner but will actually stimulate the employment of and demand for painting labor. To make this more clear, it has been suggested that a comparison of the situation be drawn with the effect of the sewing machine upon the tailoring industry. The journeyman tailor undoubtedly at first looked askance at the development of such a machine. It was soon found, however, that this machine created an almost entirely new industry in the production of ready-made clothing. The availability of these products at once effected a great demand and increased usage. As a result, thousands of operators were required where but hundreds were employed before.

It is believed, therefore, that any device that

\* Presented at the 1920 convention of the International Association of Master House Painters and Decorators of the United States and Canada.

creates new business in new fields is to be given the hearty support of all, if found to be of a practical nature. Whether or not the machine will prove useful will depend upon the results obtained by the painter during the coming period of great activity

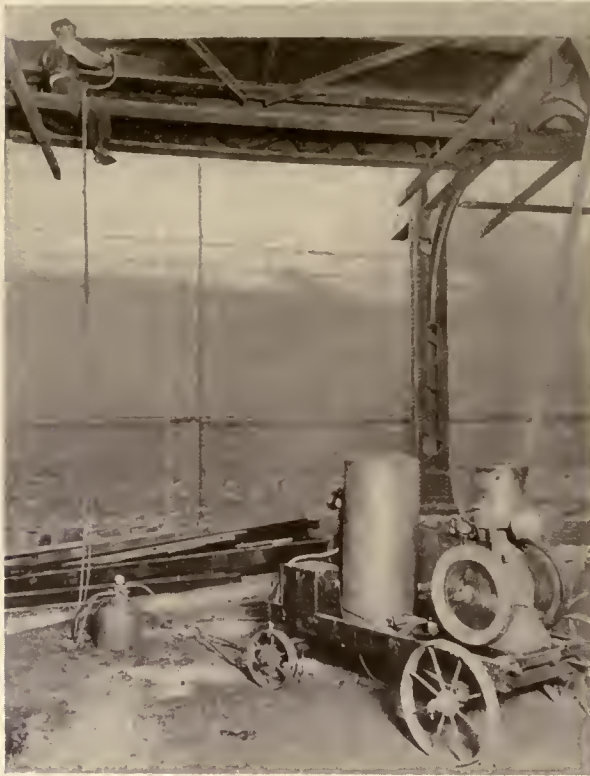

APPLYING PAINT TO THE STEELWORK OF AN ELEVATED RAILWAY STRUCTURE BY SPRAYING

in his trade. He may, for instance, find it well suited for certain classes of work and unsatisfactory for other kinds.

Some observations made by the writer on tests with the spray painting machine may be of interest in judging of its possible usefulness. The tests described below were made on large surfaces with both hand brushes and spray machines. After a sufficient period of exposure, data will be available as to the comparative durability of each type of work.

#### SPRAY PAINT TESTS AT WASHINGTON

The tests referred to were made in Washington on Government buildings by a prominent member of the International Association of Master House Painters and Decorators of the United States and Canada. The machine used in the experiments consisted of a 4 horsepower motor, a large air tank, and a 5-gallon paint tank. It required 220-volt direct

current. For the roof work the paint tank was hoisted to the roof and two hose leaders were carried from the air tank located on the ground. Two operators could work at the same time with the paint tank which was fitted with two spray guns.

For the exterior work an experienced spray brush operator started the work on one side of the building, and two journeymen with 4½-inch hand brushes started the work on the other side, which was a duplicate in size, shape and construction of the side selected for the spray test. After the work had been started a journeyman painter entirely unfamiliar with the use of the spray gun was shown how to operate it. He completed the tests, including the walls and roof area. It was apparent that a very short period of time was required to instruct a man to use a spray gun. The tests were of good size and included on the side walls an area of over 8,000 feet and on the roof an area of nearly 9,000 feet.

The paint used for the exterior wall work was a lead paint tinted with ochre, weighing 17.6 lbs. per gallon for the first coat and 20 lbs. per gallon for the second coat. Both paints were easily handled by the spray gun. The paint used on the roof was an oxide of iron paint weighing about 14 lbs. per gallon. The paint used for the interior work was a



IMPROVING THE APPEARANCE OF A COMMON BRICK FACTORY WALL

Spray painting is especially adapted to such work

modern sanitary flat wall paint of the lithopone type, weighing 14 lbs. per gallon. It was apparent that the spray gun would successfully handle paint of practically any weight per gallon.

In doing the first coat on the exterior brick walls,

all cornices and trim were cut in with the spray on the side of the building where the spray test was made. On the second coat, however, the cornices were cut in by hand with a brush, in order to assure a neat job. The time of the brush work was counted in as spray-gun time.

It has previously been assumed that the average journeyman painter, working on wall surfaces and using a hand paint-brush would do about 200 square feet an hour, or about 250 square feet an hour on roof work. It will be noted in the accompanying

the spray workmen. There was apparently little paint falling to the ground, the only loss being in the form of a fine mist. On a damp day this mist, of course, would be greatly intensified due to the presence of the volatile constituents of the thinner. This mist would lead an observer to believe that considerable paint was being lost, whereas, as a matter of fact, only a very little quantity of paint was being dissipated as mist. The mist was of a somewhat colloidal character and the effect was largely optical. On the interior work, however, a notice-



SPRAY PAINTING A FACTORY CEILING

tables that apparently much greater speed was attained in the hand-brush work. It is assumed that this was due to the great interest of the painters in the test.

Observation of the completed work showed that practically no difference in the appearance of the spray and the hand-brush work existed, with the exception that the spray work was slightly more opaque. The painters in applying the paint by hand with  $4\frac{1}{2}$ -inch brushes used drop cloths at the base of their work, whereas no drop cloths were used by

able difference was shown. The mist in the room where the paint was being applied by spray guns was very noticeable. Drop cloths were required on the floors in order to prevent staining. Painters employed for continuous periods on interior spray work might to advantage wear a simple form or respirator. The roof work was, of course, subjected to strong currents of air, but there was apparently no very large loss of paint. It was observed, however, that the overalls of the painters using the spray gun became somewhat more soiled than where



**SPRAY PAINTING A SHINGLE ROOF**  
Such surfaces often prove difficult for brush work

hand-brush work was being done on similar work.

On the interior tests, one room was done by two painters with hand brushes and two rooms with the spray gun by one operator. The rooms faced a courtyard in which the machine was placed with hose leaders running up to the work. The ceilings of the rooms were arched, four arches meeting in the centre of each. This made the painting rather difficult by hand but very much easier for spray work. The side walls had four projecting columns, one at each corner, and between the tops of these columns and the arched ceiling there was a heavy scroll cornice. Each room also had a fireplace and chimney breast and large recessed combination windows. The hand work was somewhat marred by streaks and the covering was poor. The spray work was greatly superior. A very much heavier coating



**AN EXCELLENT WAY TO PAINT ROUGH CAST CEMENT STUCCO**

of paint was apparently applied. It was necessary to put on two coats of paint by the hand brush in some instances in order to get satisfactory covering.

Information gathered from some of the journey-men painters indicate that they are not averse to the use of the spray gun after they become acquainted with it. In fact, the painters showed less fatigue at night than when using hand brushes. Some were therefore enthusiastic about its use.

**EXTERIOR WORK**  
*Previously Painted Metal Roof*

	Area of Surface Square Feet	Paint Used Gallons	Time 1 Man Hours
Spraying .....	578	1.49	.5 (1/2)
Brushing .....	578	1.35	1.5 (1 1/2)

*Results Calculated to 10,000 Sq. Ft.*

Spraying .....	10,000	25.8	8.6
Brushing .....	10,000	23.3	25.9



**BETTER FARM BUILDINGS OFTEN MEAN PAINTED BUILDINGS**

Rapid work can be done with a spray machine on large flat surfaces such as here shown

*Comparative Cost of 10,000 Square Feet of Work*

Spraying 25.8 gallons Paint at \$4.00.....	\$103.20
8.6 hours Labor at .90.....	7.74
	<hr/>
	\$110.94
Brushing 23.3 gallons Paint at \$4.00.....	\$93.20
25.9 hours Labor at .90.....	23.31
	<hr/>
	\$116.51

**SPRAYING REQUIRES APPROXIMATELY 10% MORE PAINT THAN BRUSHING.**

**BRUSHING REQUIRES APPROXIMATELY 200% MORE LABOR THAN SPRAYING.**

**EXTERIOR WORK**

*Previously Painted Brick Walls and Stone Cornice*

	Area of Surface Square Feet	Paint Used Gallons	Time 1 Man Hours
Spraying .....	8,364	10.8	20.
Brushing .....	8,188	9.87	41.

*Results Calculated to 10,000 Sq. Ft.*

Spraying .....	10,000	12.90	23.9
Brushing .....	10,000	12.05	50.

*Comparative Cost of 10,000 Square Feet of Work*

Spraying 12.90 gallons Paint at \$4.00.....	\$51.60
23.9 hours Labor at .90.....	21.51
	<hr/>
	\$73.11





SPRAYING METHOD APPLIED TO SPRING HOUSE PAINTING

Brushing	12.05 gallons	Paint at \$4.00.....	\$48.20
	50 hours	Labor at .90.....	45.00
			\$93.20

SPRAYING REQUIRED APPROXIMATELY 7% MORE PAINT THAN BRUSHING.  
 BRUSHING REQUIRED APPROXIMATELY 109% MORE LABOR THAN SPRAYING.

INTERIOR WORK  
 Combined Ceilings and Walls of Plaster

	Area of Surface Square Feet	Paint Used Gallons	Time 1 Man Hours
Spraying .....	2,600	6.39	5.33 (5 $\frac{1}{3}$ )
Brushing .....	1,000	1.75	5.33 (5 $\frac{1}{4}$ )

Results Calculated to 10,000 Sq. Ft.

Spraying .....	10,000	24.5	20.5
Brushing .....	10,000	17.5	53.3



PROLONGING THE LIFE OF THE "BLEACHERS" BY SPRAY PAINTING

Comparative Cost of 10,000 Square Feet of Work

Spraying	24.5 gallons	Paint at \$4.00.....	\$98.00
	20.5 hours	Labor at .90.....	18.45
			\$116.45
Brushing	17.5 gallons	Paint at \$4.00.....	\$70.00
	53.3 hours	Labor at .90.....	47.97
			\$117.97

SPRAYING REQUIRED APPROXIMATELY 40% MORE PAINT THAN BRUSHING BUT GAVE QUITE GOOD HIDING IN ONE COAT.

BRUSHING REQUIRED APPROXIMATELY 160% MORE LABOR THAN SPRAYING AND GAVE POOR HIDING IN ONE COAT.

## Forest Products Laboratory to Hold Decennial Celebration July 22d and 23d

The Forest Products Laboratory, located at Madison, Wis., was organized by the United States Forest Service in 1909 and formally opened in June, 1910. It is conducted in co-operation with the University of Wisconsin.

During the ten years of its existence the efforts of the laboratory have been devoted to the development of improved methods and processes for the better utilization of forest products of all kinds, and to the direct assistance of the industries concerned.

During the war direct assistance was rendered the War and Navy Departments and various other branches of the Government in the solution of many important problems. It was necessary, throughout this period, to abandon all work on the regular peace time program.

A good many men acquainted with the work of the laboratory have expressed the thought that the laboratory and the service rendered by it should receive some mark of recognition or appreciation from the industries which it serves. In response to this thought, the decennial celebration has been planned, and the General Committee organized to carry out the detailed arrangements.

The present plans call for a two-day program, including addresses by men prominent in science, industry, and commerce; inspection of the laboratory; a banquet; and various other forms of instruction and entertainment. It is proposed to make a permanent record of the decennial in the form of a souvenir publication to contain all the addresses and other relevant matter, including the names of those who can permit a permanent record of their co-operative contributions to be made.

A hearty invitation to attend the celebration is extended by the Forest Products Laboratory to the readers of THE AMERICAN ARCHITECT.

## Proposed Code for Hollow Tile Construction

The Hollow Building Tile Association with offices in the Conway Building, Chicago, has just issued a 12-page pamphlet bearing the title "Standard Building Code" containing provisions governing building construction in hollow tile. Section 1 contains specifications relating to the quality of the product, and thickness of bearing and enclosure walls; Section 2 gives thicknesses of non-bearing walls and partitions; Section 3 deals with floor and roof arch construction and fireproofing in connection with structural steel; Section 4 with combined reinforced concrete and hollow tile floor construction and Section 5 with masonry bearing walls in general. This information will serve as a guide in localities where no building regulations are in force, and where existing codes do not deal specifically with hollow tile construction, the sections can be adopted with such modifications as might be deemed necessary as a part of the existing code.

## Construction Work Starts on Huge Seattle Stadium

University of Washington to Possess Structure Rivaling Yale Bowl

**A** HUGE U-shaped concrete and steel stadium, matched in seating capacity only by the Yale Bowl, is now being built in Seattle on the University of Washington campus. The site is at the edge of Lake Washington on a spot where Siwash Indians less than fifty years ago held full sway. Some \$500,000, almost the total estimated

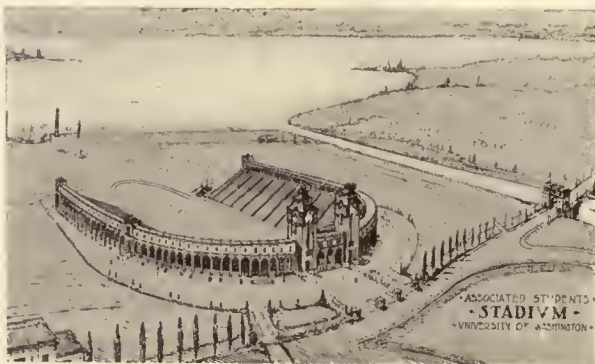

VIEW OF THE SEATTLE STADIUM AS IT WILL APPEAR WHEN COMPLETED

cost of the stadium, was recently raised in a period of less than one week. The day the last dollar was subscribed, earth was turned and a record in stadium construction will have been made when the stadium

is open for the Dartmouth game November 28 of this year.

The stadium will cost approximately \$600,000 and will seat about 60,000 persons. The open end of the U will face the lake, thus affording a view of the snow-capped Cascades in the distance. It will be accessible from four street car lines and four automobile highways. Through the Washington Canal and locks the stadium can be reached by water craft from Lakes Washington and Union and all of Puget Sound.

The Washington State University is now one of the ten largest educational institutions in the country. Its campus covers 400 acres, and is classed among the most beautiful in the United States. The stadium will be erected near the site of the athletic field used by the Alaska-Yukon-Pacific Exposition in 1909, and later rebuilt by the United States Naval Training Camp.

The structure will be built entirely of steel and concrete, and will rise above the surroundings as a monument of imposing dignity. Its architecture will conform with that of the new buildings on the university campus.

The height of the stadium from the field level will be 72 feet, with two great towers surmounting the main entrance at the bow of the U. The width from the exterior walls, including the field, will be 630 feet, and the length from the open end to the great towers will be 665 feet. A 25-foot colonnade covered with wide arches overlooking the field will flank the entire structure. The cantilever overhang will provide for an extra seating capacity of 13,000 persons.

The 60,000 seats will be constructed around a quarter-mile running track with a 220-yard straightway. The field will be large enough to hold football, baseball, track and other athletic contests, polo games, band concerts, May fêtes, pageants, carnivals, mass meetings, song fests, shows, fairs, military tournaments and all mass events for day or night. The size of the field will be 300 by 470 feet.

A minimum of 125,000 cubic yards of dirt will be excavated, which in turn will be used for the leveling of the great field. A thorough draining system will also be installed. Each seat will be of wood, raised above the concrete and affording space for passage behind the seated spectators.

Half of the structure will be above the ground level, with 28 runways passing from the exterior to the seat sections at midway points, so that the visitors may go up or down to their seats.

The easy accessibility of the building materials to be used will reduce the cost of construction nearly 20 per cent. Everything can be transported to the ground by water without extra hauling.

The Coliseum at Rome is the most widely known

structure of the amphitheatre type. It was a great four-story affair, enclosing an oval area, 176 by 280 feet. Its original seating capacity has been set at figures ranging from 50,000 to 87,000.

The Yale Bowl is in the form of a four-center oval, 750 feet by 930 feet from the faces of the outer walls, covering about 12½ acres of land. A continuous tier of seats entirely surrounds the field with thirty reinforced concrete tunnels giving access to the bowl.

The Palmer Memorial Stadium at Princeton has an exterior structure designed like an arcade, with two large towers 72 feet high at the curved ends. There are 26 runways extending from the exterior grade to the seating space.

The Harvard Stadium is a massive, imposing structure of steel and concrete, and suggests Roman types in construction and appearance. The total length is 570 feet and the total width over all 420 feet. The outer wall is 53 feet high, with two tiers of Roman arches and piers, separated by a molded belt course and surmounted with a parapet with massive cornice.

The Tacoma, Washington, Stadium was built for municipal purposes to entertain speakers and to use for high school athletic contests. It has admirably served the purpose. It is the only stadium of any size now constructed west of the Mississippi, and has made that city famous. It affords an excellent view of Puget Sound from the open end. The following is a list of stadia planned as well as those already constructed:

STADIA TO BE CONSTRUCTED

Date.		Seating Capacity.	Cost.
1920	University of Washington.	60,000	\$600,000
1920	Los Angeles, Cal.....	50,000	800,000
1920	Ohio State University....	50,000	500,000
1920	Chicago Park Board.....	55,000	900,000

COMPLETED STADIA

1914	Yale Bowl.....	61,000	400,000
1914	Princeton Stadium.....	41,000	300,000
1910	Tacoma Stadium.....	30,000	175,000
1909	Harvard Stadium.....	50,000	330,000
—	Circus Maximus, Rome...	400,000	.....

A description of the construction of Yale Bowl may be found in the Transactions of the American Society of Civil Engineers, V. 81, p. 249; of the Princeton Stadium in the *Engineering News*, V. 72, p. 1184; *Engineering and Contracting*, V. 43, p. 472; *Engineering News-Record*, V. 70, p. 334; of the Tacoma Stadium in the *Engineering News-Record*, V. 62, p. 498; of the Harvard Stadium in the *Assoc. of Engineering Societies Journal*, V. 32, p. 293.

## Engineers Lay Foundation for a National Federation

Organization Formed to Represent 100,000 Professional Men

ON June 3 and 4, 1920, 123 delegates representing 61 organizations whose aggregate membership includes in the neighborhood of 100,000 civil, mechanical, electrical, mining, heating, sanitary, chemical, agricultural, marine, refrigerating, radio, fire protection, automotive, industrial and military engineers, as well as some architects, marine architects and geologists assembled at Washington, D. C., to consider the advisability of organizing a national federation, capable of bringing the united efforts of the entire membership to a focus on any problem of mutual interest. After extended discussion The Conference decided to take such a course and adopted a resolution defining its object at the opening session. Following this action committees on constitution and by-laws, resolutions, and program were appointed. The report of the first-named committee was submitted to the delegates on the morning of June 4, and the constitution recommended by this committee was approved by The Conference in practically its original form.

The name of the new organization is "The Federated American Engineering Societies." Its object is "to further the interests of the public through the use of technical knowledge and engineering experience, and to consider and act upon matters common to the engineering and allied technical professions."

The membership will consist of national, local, State, and regional engineering and allied technical organizations and affiliations. The management of the organization is vested in a body designated as the American Engineering Council and an executive board of that body. The council is to consist of representatives of every member society. Each national, State, regional or local organization is entitled to one representative on the council for a membership of from 100 to 1,000 inclusive, and one additional representative for every additional 1,000 members or major fraction thereof. The duties of the council are to co-ordinate the activities of State councils and of local affiliations whenever these activities shall be of national or general importance, or affect the general interest of engineers. It is specified that no organization shall have more than 20 representatives on the council.

The constitution provides that the funds of the organization shall be provided on the basis of \$1.50 per member for national societies and \$1 per member for local, state, or regional organizations. The formation of local affiliations and State councils is provided for.

Among the resolutions approved was one endorsing the creation of a Federal Department of Public Works.

Many excellent and inspiring addresses were delivered. A pointed remark in the address of Mr. Homer L. Ferguson, past president, U. S. Chamber of Commerce, might be studied to advantage by the architectural profession. He said: "You won't have much of anything these days unless the voice of your business or profession is *heard*," and he meant heard by the Public and not by fellow members of the profession.

The trend of thought among many delegates and which found expression in the addresses reflected the idea that the engineer not only seemed to lack ability as a business man, but also had failed to assume his proper place of leadership in public affairs. This condition is probably not true alone of the engineering profession.

The organization of the new Federation should tend to correct these past deficiencies. Its creation is, in fact, placing our national motto "E Pluribus Unum" in action so far as the engineering profession is concerned.

## Engineering Council Bulletin

REORGANIZATION OF EXECUTIVE DEPARTMENTS OF THE GOVERNMENT by a joint committee as provided in Smoot-Reavis resolution passed Senate May 10. The joint committee is to make a study of existing conditions and recommend a plan for reorganization. This legislation was introduced with the approval and on the recommendation of the National Public Works Department Association. Senators Smoot and Underwood made speeches favoring the legislation.

INTERSTATE COMMERCE COMMITTEE has ordered favorably report on Senator Cummins' amendment to Transportation Act, designed to relieve the car shortage situation and otherwise aid the railroads. Senator Poindexter's anti-strike bill, designed to prevent tying up of interstate transportation on railroads, was reported to the Whole Committee.

DIVISION OF MINES AND GEOLOGY—A consolidation of the Bureau of Mines and U. S. Geological Survey, together with other mining activities of the executive departments has been proposed in bill introduced by Senator Henderson, Chairman of Committee on Mines and Mining. The proposed division to be administered by an assistant-secretary of the Interior, "technically qualified by experience and education for the position."

FEDERAL HIGHWAY LEGISLATION—The Townsend Bill which proposes to create a Federal Highway Commission in charge of all Federal road work is before the Senate Committee on Post Office and Post Roads. Present plans of cooperation with States was endorsed and advocated for the future by representatives of twelve State Highway Commissions. All witnesses have opposed further extension of road building work at present. The Public Works Department plan proposes to include present Bureau of Roads under appropriate administration, so that Federal Highway Commission is unnecessary.

INTERSTATE COMMERCE COMMISSIONERS—Senate confirmation of the appointment of three Interstate Commerce Commissioners, James Duncan, of Massachusetts; Mark W. Potter, of New York, and Henry J. Ford, Princeton, N. J., was held up until the Interstate Commerce Committee could further investigate their qualifications. The nomination of Roy S. McElwee to be director of Bureau of Foreign and Domestic Commerce confirmed by Senate.

APPROPRIATION BILLS—Sundry Civil Bill passed House carrying original power investigation and topographic appropriations, \$125,000 and \$330,000 respectively. Total in bill \$428,000,000. Legislative, Executive and Judicial bill

vetoed by the President. Conference report adopted on Fortifications Appropriation Bill and latter sent to President. Agricultural Appropriation bill recommitted to conference. Rivers and Harbors Appropriation Bill and Army Appropriation Bill held out of conference by House. Consular and Diplomatic Service Appropriation bill and Navy Appropriation Bill, passed by both Houses and held in conference.

SEASONAL COAL TRANSPORTATION RATES BILL as proposed by Senator Frelinghuysen has been reported to the main Interstate Commerce Committee, but action of the full committee was deferred.

RAILROADS AND SHIPPERS are to be aided by \$300,000,000 revolving fund for a period of five to fifteen years in legislation recommended by Senate Interstate Commerce Committee, after extensive hearings given principally to railroad executives, during which \$500,000,000 was requested for this fund.

PUGET SOUND ENTRANCE by canal from Grays Harbor which has been the subject of extensive study by Army Engineers has been reported adversely.

TRANSPORTATION AND COMMUNICATION between Pan-American countries and the United States is to be cared for by committee of twenty-five members headed by Secretary of Commerce Alexander and Admiral Benson. This committee was authorized by resolution of Pan-American Financial Conference, but above leaders have just been appointed by the Secretary of Treasury. The work of this committee is to cover ocean transportation, shipping insurance, documentation, railroad transportation, radio and cable communication, and postal facilities in five sub-committees.

MERCHANT MARINE POLICE of a permanent nature tentatively adopted by the Senate with committee amendments to the House bill. Strong opposition had previously developed to the extension of coastwise navigation laws to the Philippines and the apparent inelasticity of present bill.

INTERNATIONAL CONSORTIUM for loans to China has been organized by U. S., England and Japan. This loan will enable China to go ahead with large construction program. The plan for giving China financial aid has been held up for nearly two years because of objections by Japan, which have just been removed.

WAR LABOR BOARD is to be absorbed by Council of National Defense, and U. S. Housing Corporation will pass out of existence June 30, 1920.

888<sup>e</sup>

participes 62525

807

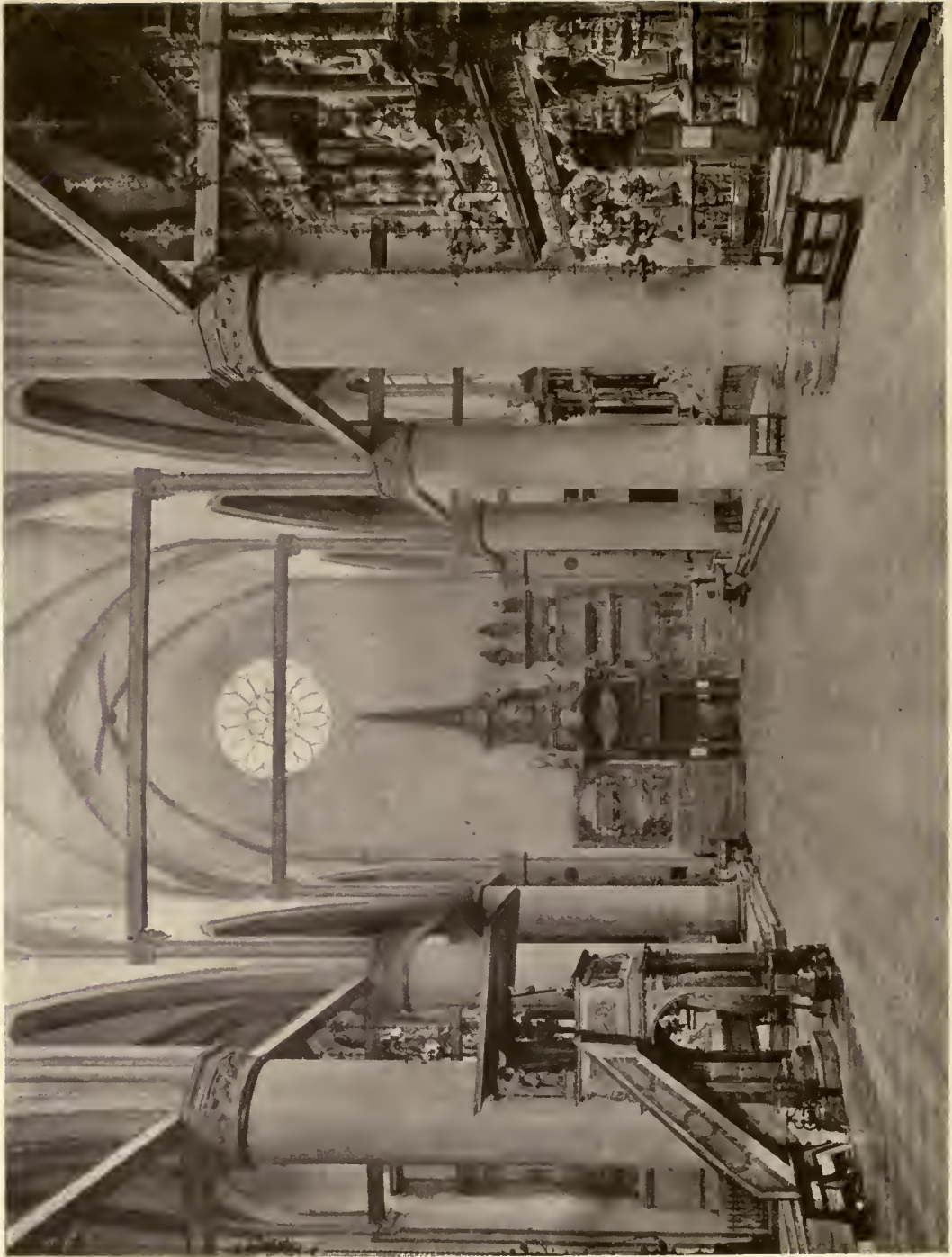

CHURCH OF SANTA MARIA DEI FRARI, VENICE

# THE AMERICAN ARCHITECT

VOL. CXVII

WEDNESDAY, JUNE 30, 1920

NUMBER 2323

## Alterations to the City Hall at Albany, N. Y.

H. H. RICHARDSON, *Architect*,

OGDEN & GANDER, *Associate Architects for the Alterations*.

**T**HE alterations to the interior of the City Hall Building, just completed, merit more than a passing notice.

This building has been considered the architectural gem of the work of the late Henry Hobson Richardson. In fact prominent authorities name it as one of the twenty best buildings of a public character in the United States. One has only to study its Romanesque style, its well proportioned features, its detail, showing so much variation in design of ornament, to obtain a clear conception of the real value of this beautiful building. What Trinity Church is to Boston, the Allegheny Court House to Pittsburgh, this City Hall should be to Albany; all the work of the same architect, who was a great teacher and a great artist. As was said in his time "He loved and produced so much for us that we may call him, with confidence, the greatest benefactor of American Art."

The exterior design of the City Hall is a free adaptation of southwestern Romanesque precedents or the Romanesque of southern France, or more truly, it is a bold development of these precedents along a new and individual line. At the time the City Hall was built it was admitted by Richardson that the interior was poor in effect as compared with its exterior. This he explained by saying, that as the money at command was not sufficient to make the whole building what it should be, he preferred to perfect the exterior at the ex-

pense of the interior, rather than let them suffer together, having in mind, no doubt, that at some future day the city authorities would perfect the interior along the lines suggested by his style of exterior design to meet the natural requirements of a growing city. The result of this prophecy is now seen.

About three years ago the city authorities realizing the necessity of increased space to accommodate the constantly growing city departments and appreciating fully the exterior beauty of the building and noting the wasted areas, congested hallways and poor lighting of the interior brought about a competition among architects to produce drawings and descriptions to improve existing conditions. The program for this competition was prepared by Frank R. Lanagan, City Engineer, and described concisely the requirements necessary to accommodate the increased business of a

growing city, particularly as to floor areas. One prominent feature of the program was that with the exception of the elimination of an entrance, provided for a connection by bridge from the City Hall to a contemplated Jail Building, and which entrance, in its unfinished state, was the cause of considerable comment, no changes in the design of the exterior of the building were to be attempted.

Consideration of the drawings submitted to the jury of award resulted in the commission being placed with C. G. Ogden and Jos. J. Gander, Associate Architects of Albany, N. Y., at the same time

### Henry Hobson Richardson

Born September 29, 1838.

Died April 27, 1886.

The City Hall at Albany, conceded one of the best examples of Richardson's work in its completeness, was marred by lack of sufficient funds to carry into execution Richardson's designs made for the interior.

The remodelling now so successfully undertaken, and at considerable expense, is a gratifying acknowledgment of the work of a great architect, and a laudable example of civic pride and appreciation.



MAYOR'S OLD OFFICE

the city authorities decided to avail themselves of the services of Mr. Arnold W. Brunner as Advisory Architect.

An exhaustive amount of study in making sketches and research into the best work of Richardson; time spent in travel and the very careful consideration of the replanning of the interior by the architects are now seen in the completed work—their intention being to carry out the same feeling in design that might have been Richardson's had he enjoyed a more free hand in the completion of the original building.

#### MAIN FEATURES

THE principal or main features of the new interior are the Entrance Vestibule, Main Lobby and Rotunda, Mayor's Room, Council Chamber with its main entrance, together with the different rooms for the City Courts. As one enters the new interior, the first impression gained and what seems to be a revelation is the spaciousness of the Main Lobby in its simple and dignified design. One realizes at once a plan with circulation free and direct, offices easily accessible, with elevators directly in view of the public.

From this Main Lobby one enters the elevator lobby serving two Otis type passenger elevators; then in the rear is the Light Well, square shaped with its stately Romanesque stone arches subdivided by intermediate arches and stone balustrade on the second floor. This Rotunda gives play of light essential to the design of the new interior and sadly lacking in the old arrangement; in fact, this Rotunda forms one of the most interesting features of the revised interior, for its different vistas, its mezzanine balconies, beautifully carved balustrade and spacious stairways provide in detail the real character of the Romanesque design. The large

skylight over Rotunda and the walls about it are decorated in a warm color contrasting pleasingly with the cooler gray of the surrounding stone work.

Main Lobby and vestibule are designed in Indiana stone, the same material as used in Light Well; the stone extends from floor to ceiling, with high Tennessee marble base and floor. The floors show careful consideration in the matter of appropriate design, relieving the monotony of a plain surface. The walls are plain, yet bold enough with their large arched openings as not to appear too delicate with the impressive exterior. This is apparent throughout the Lobbies and Rotunda. The coffered ceiling of Main Lobby is enriched with decoration to contrast with quiet walls, yet all is pleasing with its charming Romanesque detail. The Torcheres in the Lobby, together with the ceiling lanterns, are expected in ornamental cast bronze. There being no exact prototype of Romanesque lighting fixtures it was difficult to design fixtures of modern adaptation and still maintain a distinctive touch of the Romanesque detail. The result is a good solution of the problem presented and reflects credit on the designers. The same careful consideration to the requirements is apparent in designs of all lighting fixtures; where design and detail were required the fixtures are so treated and where efficiency was the predominating influence this was given careful consideration. Yet sufficient detail was maintained to give pleasing results.

#### MAYOR'S RECEPTION ROOM

THE Mayor's Reception Room is finished in selected American walnut from floor to ceiling, with Tennessee marble base and cork tile flooring. The design of this room is individual in its treatment, with its tasteful Romanesque carving and well balanced coffered ceiling richly but quietly decorated in keeping with the quiet dignity of the room. A marble fireplace is provided in this room carved in bas relief. With the exception of the Common Council Chamber this room is one of the most successful in the building.

The General Hearing Room is entered from the Main Lobby and is used for the hearing of public matters. It is simple in design, wainscoted and trimmed in American walnut with furniture of same material.

The Treasurers Room is opposite the General Hearing Room and directly off Main Lobby. The effect of this room is that of a large banking room with spacious public lobby separated from the working space by marble and mahogany counter screen; well lighted and planned for efficiency.

The architects having in mind the opportunity to make a feature of the Entrance to Council Chamber availed themselves of the extreme height from





NEW MAYOR'S OFFICE  
CITY HALL AT ALBANY, NEW YORK  
H. H. RICHARDSON, ARCHITECT  
OGDEN & GANDER, ASSOCIATE ARCHITECTS FOR THE ALTERATIONS

second to third floors, cutting off the mezzanine balcony from a continuous passage around the Rotunda, thus providing a monumental entrance giving importance and dignity to the most artistic room in the building. The heavy mahogany trim and doors to this entrance, with the appropriate carving and wrought iron grille work, shows again



OLD FIRST FLOOR LOBBY

the careful and painstaking study of the architects. A Romanesque lantern hangs from the ceiling, a fitting finish to a successful treatment of this entrance.

#### COUNCIL CHAMBER AND COURT ROOMS

**I**N replanning the interior the location of this, the principal room in the building, the architects have availed themselves of what was originally a congested and useless hall space, situated at the west front of the second floor. The high arched windows and lofty ceiling in this space and the proximity to elevators and public circulation resulted in one of the most beautiful rooms of its kind. The room is paneled 12 feet high with a very interesting paneling of American walnut with richly carved caps and variable designs in pilasters, the wood being specially selected as to grain, the large panels being particularly attractive. Here again we find a coffered ceiling tastefully ornamented and decorated in tones in perfect harmony with the walnut trim, hangings, etc. The treatment of side walls above wainscot is in effect that of very old unfinished plaster, giving a venerable dignity to this beautiful room. Here the cast bronze lighting fixtures in castellated Romanesque lend a pleasing effect.

Two City Court Rooms are provided on the second floor and Recorders Court in basement. Court Room No. 1 on second floor is the most

elaborate of the three. This room was formerly occupied as the Common Council Chamber.

The room is dignified and restful, no disturbing influence is manifest in its ornamentation. Paneled in oak, stained silver gray in lines proportional to height of ceiling and existing windows—the ornamental Romanesque ceiling with its deep panels is well in scale and proportion. The decoration is in monotone in keeping with the finish of wood work and furniture, the elaboration in detail being limited to the featured Judges' entrance, which is the center of attraction on entering the room. The other courts are simple in design of Romanesque character of the same period as other parts of the building.

While the above especially mentioned features are of interest, it must not be lost sight of that all other rooms to be occupied by the city offices have been designed with a view to the efficiency of the different departments and have been treated in a manner suitable to business offices, with simple decoration in soft restful colors, and arranged to secure the maximum of light. Considerable study was given to the location of these rooms with the result that the city's best interests have been conserved.

Too much cannot be said about the rearrangement of the interior with reference to the additional space gained; this particular feature being a con-



OLD FIRST FLOOR HALL AND VESTIBULE

siderable financial gain to the city. In the old interior the city was limited as to accommodation for certain office requirements and had no room for expansion. In the new planning an amount approximating 40 per cent additional floor area has been provided, making possible the housing of all city departments, with the exception of the Police

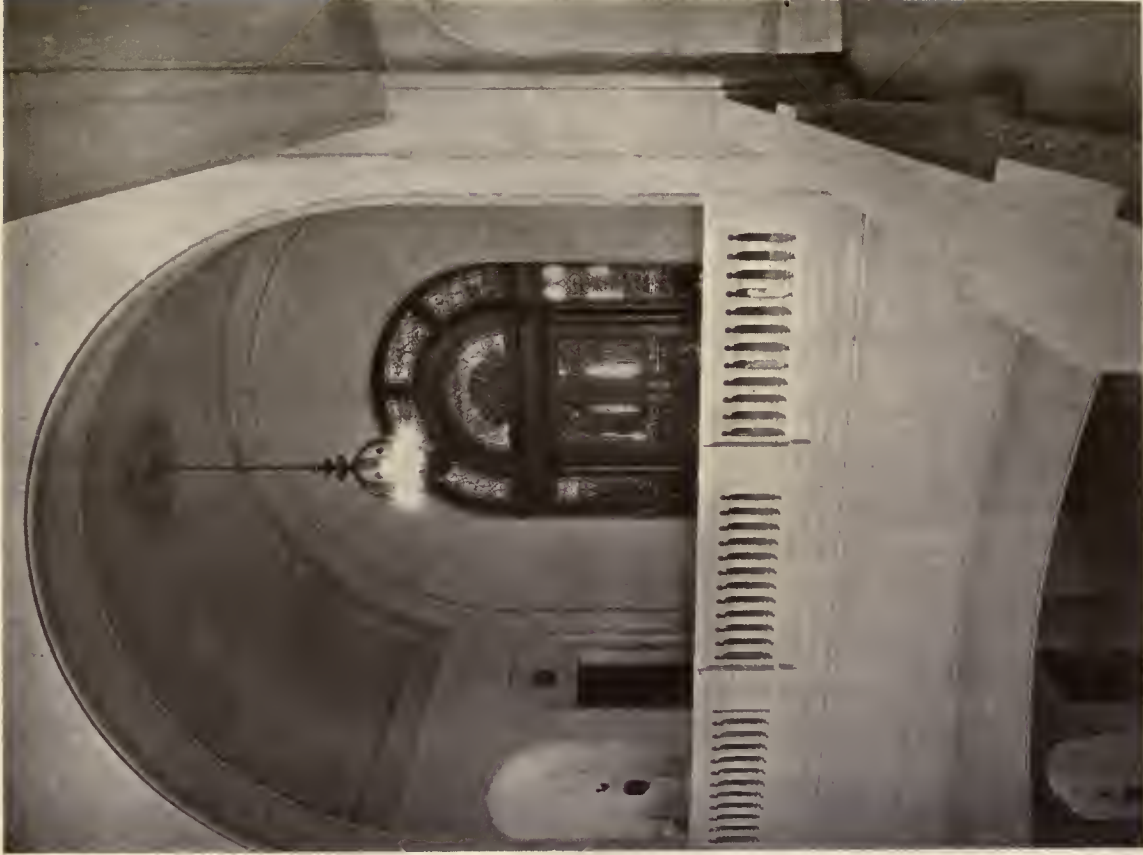

VIEW SHOWING NEW ENTRANCE TO COMMON COUNCIL ROOM

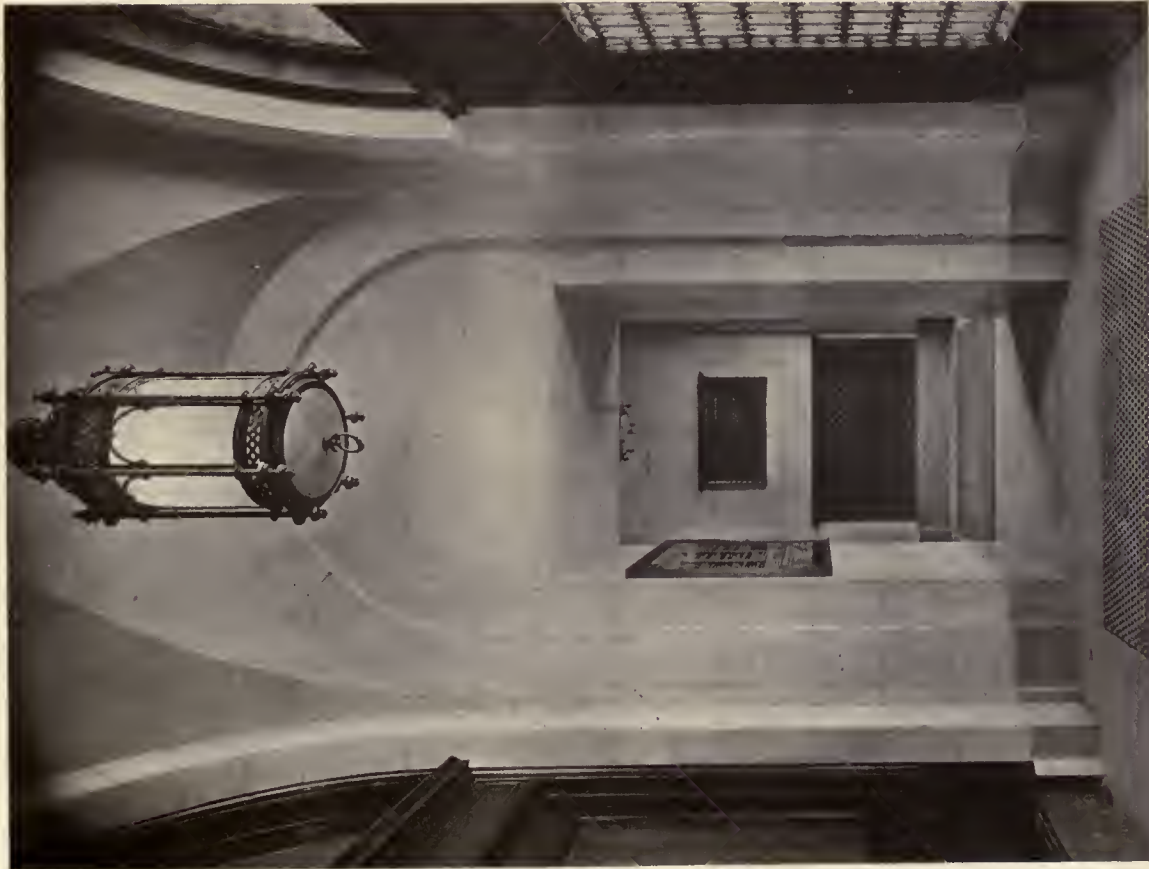

NEW MAIN ENTRANCE VESTIBULE

CITY HALL AT ALBANY, NEW YORK

H. H. RICHARDSON, ARCHITECT

OGDEN & GANDER, ASSOCIATE ARCHITECTS FOR THE ALTERATIONS

Department, for whom a separate building is contemplated. In addition, unassigned rooms for the use of future city offices are provided. This has been made possible by the replanning of the wasted hall space, the introduction of mezzanine floors and the turning of the wasted area under roof into usable floor area, providing an auditorium with a seating capacity of 400, together with storage rooms, etc., and space as yet unassigned.

HEATING AND VENTILATING

A modern vacuum system of modulated heating and ventilating has been installed, furnishing fresh tempered air to the building, with an exhaust system for the ventilation of the principal rooms and toilets. All radiators are controlled thermostatically.

PLUMBING

A system of plumbing has been installed furnishing both hot and cold water to all lavatories; with iced drinking water fountains placed at convenient points on each floor. Every effort has been made to make this system complete and sanitary in every respect. Fire lines are provided at each floor with



OLD COURT ROOM NO 1

sufficient hose to reach every part of the building.

FURNITURE AND DECORATIONS

The furniture throughout has been especially designed to meet the feeling expressed throughout the building.



VIEW IN NEW COURT ROOM NO. 1

## TELEPHONE SYSTEM

A full and complete telephone system is provided for the use of all departments.

## WORK IN GENERAL

The work has been of long duration and a great deal is to be said in this connection. First, it was one of the most difficult alterations of its kind. The new steel and fireproof roof, which was so essential to the reconstruction of the building, was a task in itself, as the architect's design called for the exact reproduction of the lines of the original

roof. Then when the steel was fabricated at the shop early in the fall of 1917, the United States Government, needing all the steel the country could produce, confiscated this material, which delayed the entire progress of the work. This was a great loss to the General Contractor and affected all those connected with the operation. Then again, when war was declared, embargoes on shipments, lack of materials, curtailment of supplies, together with shortage of labor caused by the higher wages paid delayed the progress of the work.



NEW FIRST FLOOR, MAIN LOBBY

# The Problem of the Foreign Language Newspaper

By FRED C. BUTLER, *Federal Director of Americanization*

THERE are those who loudly demand the abolition of everything published in any language they cannot understand. Either they are the chauvinists or hyper-patriots—those who would form another “Know-Nothing” party holding the fruits of America only for those who were accidentally fortunate enough to be born here—or they are those who think everything must be worthless or harmful which they themselves do not understand.

I hold no brief for the foreign-language press of America, but I would oppose as best I can its abolition. On the other hand, I sincerely hope that the day will soon come when it will no longer be *necessary* to publish books, magazines and newspapers in any language other than the language of this land. At the present time such publications are necessary if we are to have the means of carrying the truth to eyes that are blinded and ears that are deaf.

We have too long left the Americanization of our foreign-born to happy chance. We have opened the doors to our national warehouses and permitted all to enter who would. We have trusted to blind fortune to see that these newcomers absorbed what was good in our national life and cast out that which was bad. We have known that the forces of evil were carrying out definite programs for the sowing of their seeds. We have known that these seeds were germinating and that weeds of hate and distrust and unrest were growing. But we have been too busy with our own petty affairs of life to lend a hand. We have fatuously assumed that “truth crushed to earth would rise again.”

We have but one door into the minds of millions of our fellows, and that is the language of their birth. We must continue to use this door until a new one can be opened. This new door the nation has never made any definite effort to open. To close the old before opening the new would on the surface be “cutting off the nose to spite the face.”

Abolition of the foreign-language press is idle talk. Our task is rather the abolition of the special need for it. Toward that end there should be a concerted and definite movement, with the nation, the States and the communities working hand in hand.

Whether there should be a law compelling the publication in parallel columns of an English translation in all papers published in foreign languages I do not care to hazard an opinion. I do not like the

implicated thought that all foreign-language papers are publishing matter which is harmful to the nation. I know that such is not the case. In my own office we translate each week hundreds of the foreign-language papers and we seldom find anything which is worse than or even as bad as much that is openly published in the English tongue by scores of rabid, radical organs which exist by playing upon the passions of men and fanning them into a white heat over injustice actual or imagined.

Bolshevism and all the other “isms” which attack society from time to time are the natural fruit of injustice and ignorance. I am sincerely hoping that we as a people will soon return to our usual rules of fair play and an open mind and that we will not through hasty and ill-considered legislation destroy the confidence of those whose co-operation we must have if we are to reach the millions whom they represent. For in the elimination of injustice and ignorance we must have the cordial and active support of our foreign-language press.

Except for the mistrust which it implies, I see no objection to the requirement for bilingual publications. As a matter of fact, it seems to me that it would be the part of wisdom for the publishers of newspapers in foreign languages gradually to transform their publications into the English language. The nation will not much longer tolerate the existence of huge masses of people who cannot understand the rest of us and whom the rest of us cannot understand. I do not mean by this that there will be compulsory teaching of English and the forced abolition of foreign languages, but I do mean that we will soon see our duty so clearly that we will undertake it like men. We will proceed upon a definite, practical, well-thought-out program to make classes for the study of English by adults so easily available that whosoever will may learn. We will then, through the foreign-language press and the racial societies, build up a sentiment for the learning of English among immigrants just as we built up a desire to wear a Liberty Bond button. Within a decade illiteracy in the language of our land can be made a thing of the past.

We have had pastors of foreign-speaking churches who were so short-sighted as to oppose the use of the English language by their people. They thought by so doing that they were maintaining the solidarity of their congregations and setting up obstacles

against their drifting to other churches or creeds. As a matter of fact, they are beginning to find they were sowing the seeds of their own destruction, for it is those undigested masses that are making an exodus and returning to the lands of their birth. As a consequence, this department is receiving frantic appeals from many such pastors to come at once to assist them in making Americans of those whom in the past they have tried to keep as foreigners.

Exactly the same situation faces the publisher of a foreign-language newspaper. If he has endeavored to keep his readers Germans, or Italians,

or Poles, or what-not, he is finding a high mortality in his subscription list. If he has encouraged Americanization, his readers are not those who are standing in line before our outward-bound steamship offices.

And so I say that common business foresight and prudence should lead the owner of foreign-language publications gradually to transform his people into an English-reading one, and to commence at once through the printing of part of his paper in English to keep the custom of those who will from this time on, in increasingly greater numbers, learn to read the English language.

## Housing Brevities

### Camp Merritt Proposed for Homeless Families

Capt. James Watson, a Civil Engineer of Jersey City, and formerly connected with the city administration, is contending that Camp Merritt might be utilized to house families who are unable to find homes. It appears from a report which he has made on this subject that large gangs of men are demolishing the buildings and further, that all improvements made on the property, such as roads, sewers, water mains, fire hydrants, electric light poles, etc., made under the supervision of the Army are to be removed and the land restored to its original condition. In view of the housing situation, this seems like wanton destruction.

### City Favors Limited Theatre Building

The General Welfare Committee of the Board of Estimate in New York is endeavoring to limit theatre building until 1925. This is for no grudge against theatres, but in view of the fact that many dwellings and apartments have been destroyed to make way for them. It is true that many places so destroyed are not fit to live in, but people driven from them are left homeless, and it would seem that any condition might be better than that.

### \$5,000,000 Home Organization

Iron and steel corporations of Youngstown, Ohio, have agreed to subscribe for stock in a \$5,000,000 corporation to lend money for home construction. The movement has the backing of commercial and industrial interests, and six leading civic organizations, who hope in this manner to relieve the home

shortage. Youngstown Homes Company, as the new company is called, will lend an amount on first and second mortgages not to exceed 85 per cent of the value of the land and improvements, as fixed by a Board of Appraisers. Stock is to be sold through a city-wide campaign of subscriptions, in which all clubs, organizations, associations, and individuals interested in civic improvements will be asked to co-operate.

### From Bathrooms to Offices

Conversion of bathrooms into offices is the latest result of the shortage of business accommodations in Hartford, Conn. This unique scheme was put in operation in the Pilgard Building on Main Street, where five rooms that formerly were equipped as became first-class bathrooms, lost their fittings and the tubs, and were refinished as offices. The rooms, which are about 8x12 feet, meet the emergency very satisfactorily, it is reported.

### Cleveland Promoting Building

Preferential consideration for essential building projects has been assured by the various interests in connection with housing and factory development in Cleveland. Official and civic agencies co-operating in meeting present problems of the building situation in that city have brought about this movement. Material dealers are to extend preference to essential work. Financial institutions are to take that point into consideration and the organized building trades are to co-operate in manning essential jobs. Assistance also has been pledged in local railway movement of supplies. Good results are hoped for in consequence.

# Reconstruction of Belgian Devastated Area

THE Belgian public is much interested at present in the question of the reconstruction of the devastated region in West Flanders. Much of the delay to date has without doubt been due to uncertainty as to the exact program to be followed.

Commerce Reports state that there has been a popular demand that the two ruined cities of Ypres and Dixmude be left as they are, as a monument to those who lost their lives in the neighborhood, but this proposition has been opposed by the former inhabitants of the area, who desire to have their property restored. This has been particularly true of the former citizens of Ypres (population before the war, 18,000), who are returning in some numbers and starting to rebuild. The Government has therefore decided to take the matter in hand, and rebuild the entire city of Ypres, leaving none of the ruins except the Cloth Hall, the Cathedral and the Cloister, which are to serve as monuments.

The Royal Commissioner, recently appointed for the reconstruction of the Ypres Arrondissement, outlines the Government's program as follows: "It will be necessary, first, to clear and excavate the city of Ypres and the principal surrounding villages, to build about 20,000 houses, and to restore the roads, the water and gas installations, etc. The contract for this work has already been given to Ostend firms and work has now begun. The building material obtained from the ruins will be resold to the Government by the contractors and will be used in the foundations of the new city. Bricks, for example, will be bought by the Government at the fixed price of 30 francs per thousand.

Only the most necessary buildings are to be constructed, and schools, churches, stores, etc., are to be left till the last. All building is done by the Government, and the owner of the property is required to pay nothing. If the owner, however, wishes any particular plan followed this can be done, provided he is willing to bear any extra expense entailed, otherwise the plan for all buildings will be drawn up by a committee of architects. There are 19 architects at present assigned to the Ypres Arrondissement. Where the owner of a piece of land is known to have died without heirs the ownership reverts to the Government,

which will then dispose of it at public auction or otherwise, but for the present no construction is to be done on any piece of land whose owner is not accounted for.

The question of agricultural reconstruction in the devastated area is much more difficult. Almost the entire battle area of Belgium is included in the two districts having their centers at Ypres and Dixmude. These two districts had before the war a rural population of about 90,000. They included 24,000 small farms, with about 7,000 horses, 47,000 cattle and 42,000 pigs. There were 68 small villages, nearly all of which have been completely wiped out, such as Zonnebeke, Poelcappelle, Kemmel, etc. The value of the land was estimated at about 4,000 francs per hectare (roughly 1,600 francs per acre). The value of farm buildings was estimated at 3,000 francs for buildings on small farms of 2 or 3 acres and about 15,000 francs for large farms of about 50 acres. All this region is now covered with shell holes and scrap iron, and is almost worthless for agricultural purposes. Restoration of the land to its pre-war fertility and value is the work of several years and its ultimate cost cannot be estimated.

In order that the farmers may return to their farms and begin the work, the Government estimates that the following preliminary expenditures will be necessary, even if only the most indispensable buildings are constructed:

	Francs.
Partial reconstruction of buildings...	620,000,000
Roads and topographical improvements	74,000,000
Watercourses and canals.....	25,000,000
Houses for farm hands .....	54,000,000
Horses and cattle .....	144,000,000
Relief fund .....	25,000,000
Farm equipment .....	18,000,000
<b>Total.....</b>	<b>960,000,000</b>

These figures make no allowance for the construction of village stores, blacksmith shops and other necessary buildings. When these are included and incidental expenses are added in, the total figure will easily exceed 1,000,000,000 francs, and even then the work will only have begun.





## The Motor Truck As a Solution of the Transportation Problem

WHAT the "jitney bus" is to the usual trackage systems of city passenger transportation, the motor truck is to short hauls of merchandise transportation. We learned valuable lessons during the war. When our rail transportation, entirely controlled by the government to serve war's necessities, was withdrawn from customary service, the motor truck came to the front as a means of supplying the small towns throughout the country with the things for their daily use. To a certain degree the problem of supply is now being solved by efficiently organized motor truck service, but only for the shorter distances. It is not so wild a prediction to state that in the near future motor truck service will have become so thoroughly organized as to provide entirely for short hauls.

But we shall still have to depend on the railroads for the accumulation of stocks at regional points of supply. The major things that are now said to handicap the railroads in their efforts toward a resumption of former efficiency are shortages of rails and adequate terminal trackage facilities. Similar conditions would not affect the motor truck service.

Just now while we are struggling with these important matters there is a good opportunity for organized labor to show a patriotic attitude. Unfortunately when capital sets out to solve a problem and successfully does so, labor at once seeks to unionize it, and disturb by strikes, often based on the most unreasonable demands, the smooth working of an essential utility.

## The Housing Shortage

HOUSING is worrying the whole world. The London press is full of comment on the grave danger that confronts England. Its remarks relative to the work of the Inter-Allied Housing and Town Planning Congress, lately in session in London, are not complimentary and in no sense reassuring.

What we are of course more vitally interested in is the situation in this country. The solution of our problems would be comparatively easy were not this solution so overburdened with many factors themselves causing uneasiness. More prominent than any other is the question of transportation. Housing production on any scale sufficient to supply a satisfactory demand is made impossible through lack of transportation facilities.

Senator Calder of New York as Chairman of the Senate Committee on Reconstruction and Production has called the attention of the Interstate Commerce Commission to transportation conditions with particular reference to their effect on the building industry. He states in a letter to the Hon. C. B. Aitchison of the Commission:

"I am not unmindful of the fact that the railroads themselves are in greatest need of funds for rehabilitation," and further adds that but a comparatively small revenue can be derived from freight of the construction industry until the industry itself is in a thriving condition. As will be gathered from this statement, the situation as regards transportation of building materials is very complex and will require not only the most expert skill in its solution, but first of all a thorough knowledge as to just what will undoubtedly happen as the result of a housing shortage unless some solution is speedily worked out.

No group of investors has shown a more undaunted absence of fear as to the future than that which is willing, if it could, at once to proceed with building. Threatened strikes, high prices of materials, difficulties of financing, have not served to dampen the ardor of these men. But their patriotic efforts to keep the building industry alive are retarded by the transportation difficulties that are practically halting all plans for future construction.

There is a vast amount of building work accumulating that eventually must be done. Not so much to provide investment for capital as to provide homes for those who now seek in vain for even makeshift living quarters is building necessary.

## The Price of Lumber

For the year 1919, as compared with 1913, lumber increased the exact percentage in price, in the wholesale markets in Chicago, in carload lots, that our currency was inflated, says an eminent lumber authority, in discussing lumber prices. In other words, for every 1 per cent our money declined in value, lumber advanced 1 per cent. Consequently, this authority continues, it is not so much a question of the increase in lumber prices as it is the decrease in value of the medium of exchange, because we have had 101 per cent inflation of money, while we have had that exact increase in the value of lumber, and we have experienced a decline in the purchasing power of lumber, as measured in its exchange value with other commodities.

The figures for 1919 indicate definitely a decline in production despite extraordinary demand. This has been due to a number of causes, chief among which is this scarcity, high cost and inefficiency of labor. Many men in the lumber camps and mills who left to serve their country in the late war, did not return to their former places, and this fact, added to the general scarcity of labor in the country because of curtailment of immigration, left the saw-mills of the land with an insufficient and inefficient corps of employes. It has been said that the men in the mills and camps are from 10 to 39 per cent less efficient than formerly, due largely to the general labor unrest and turnover. At the same time, their wages have greatly increased.

Another reason for the low production of 1919, which of course means a decline in supply of lumber, was the unfavorable weather, especially in the Southern States, due to excessive rainfall, that interfered with logging during many weeks of the summer. Add to this the car shortage, with which the season closed, and which was particularly felt in the Northwest and on the Pacific Coast, and the diminution in supply may be readily understood. This car shortage not only interfered with the movement of lumber, but the necessary refusal of orders at the mills discouraged normal production and resulted in the temporary closing of some mills.

On the other hand, the demand for lumber during 1919 was unprecedented, owing largely to the tremendous need for buildings of every kind. Restriction of building during the war resulted in a big shortage of dwellings, schoolhouses, office buildings and even factories, and the summer and fall months of 1919 saw a prodigious effort to make up for the shortage. The sudden close of the war found the lumber merchants throughout the country generally with very low and ill-assorted stocks on hand, so that the building program in 1919 was

not inaugurated with anything like an even chance.

During the latter part of the year, it was a question not so much of the price of lumber as of early delivery at any price, and the market was therefore taken largely from the hands of the manufacturer and controlled by the buyer.

THERE has been some talk of restricting exports of lumber so as to keep the entire supply in this country, and a bill to this end was even introduced into Congress during the year. Government figures show, however, that the amount of lumber exported is only a small proportion of the annual production and that a curtailment of exports would not help the domestic situation to any appreciable extent. Besides, it is felt by many that it is a national duty to assist Europe in its progress of reconstruction, and that exports for this reason should not be prohibited.

One reason the prices of lumber seem high to the consumer at this time is their comparison with prices during the war or just previous to it. During the war the lumber prices fixed by the government gave a reasonable profit only, to the largest and best equipped mills of the country, partly to discourage the operation of those plants whose product was not definitely needed to support the war preparations, the government wishing to divert to the "essential" industries all labor and supplies used in the "less essential" industries. The price fixed for lumber, therefore, was not a fair price for the product of the lumber industry as a whole. Or, when comparison is made with 1914 prices, consideration is not given to the fact that there was a general slump in lumber prices during that year.

A truer comparison is with 1907 or 1908 prices, and with these as a basis a comparison with the increase in prices of other commodities shows that lumber has only advanced in practically the same percentage rate as food, clothing and other items.

A question of vital interest to the building public is: "Will the present prices of lumber continue?" This question dovetails in with a similar query as to all high prices. If there is a general recession because of lower labor and other costs, lumber prices will decrease. If labor continues high, scarce and often inefficient; if transportation rates remain the same or increase, and car shortage is not alleviated; if machinery and all overhead costs continue high, lumber prices will not go down and they may go up.

It is the general industrial situation with the immediate condition of supply and demand that will determine lumber prices for the next few years at least, rather than any question of timber shortage or forestation.



FRONT ELEVATION

CITY HALL AT ALBANY, NEW YORK

II. H. RICHARDSON, ARCHITECT

OGDEN & GANDER, ASSOCIATE ARCHITECTS FOR THE ALTERATIONS

820'

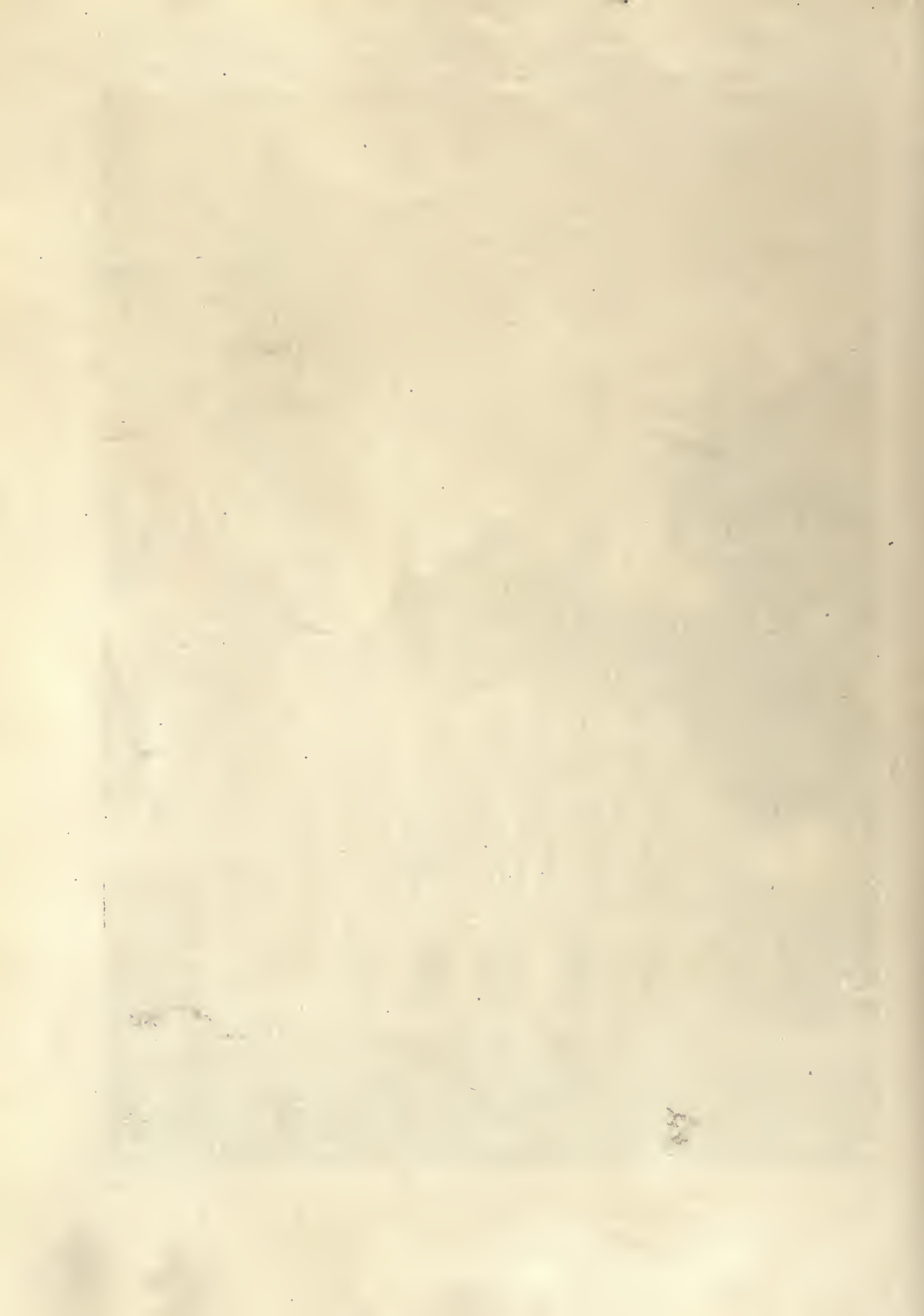

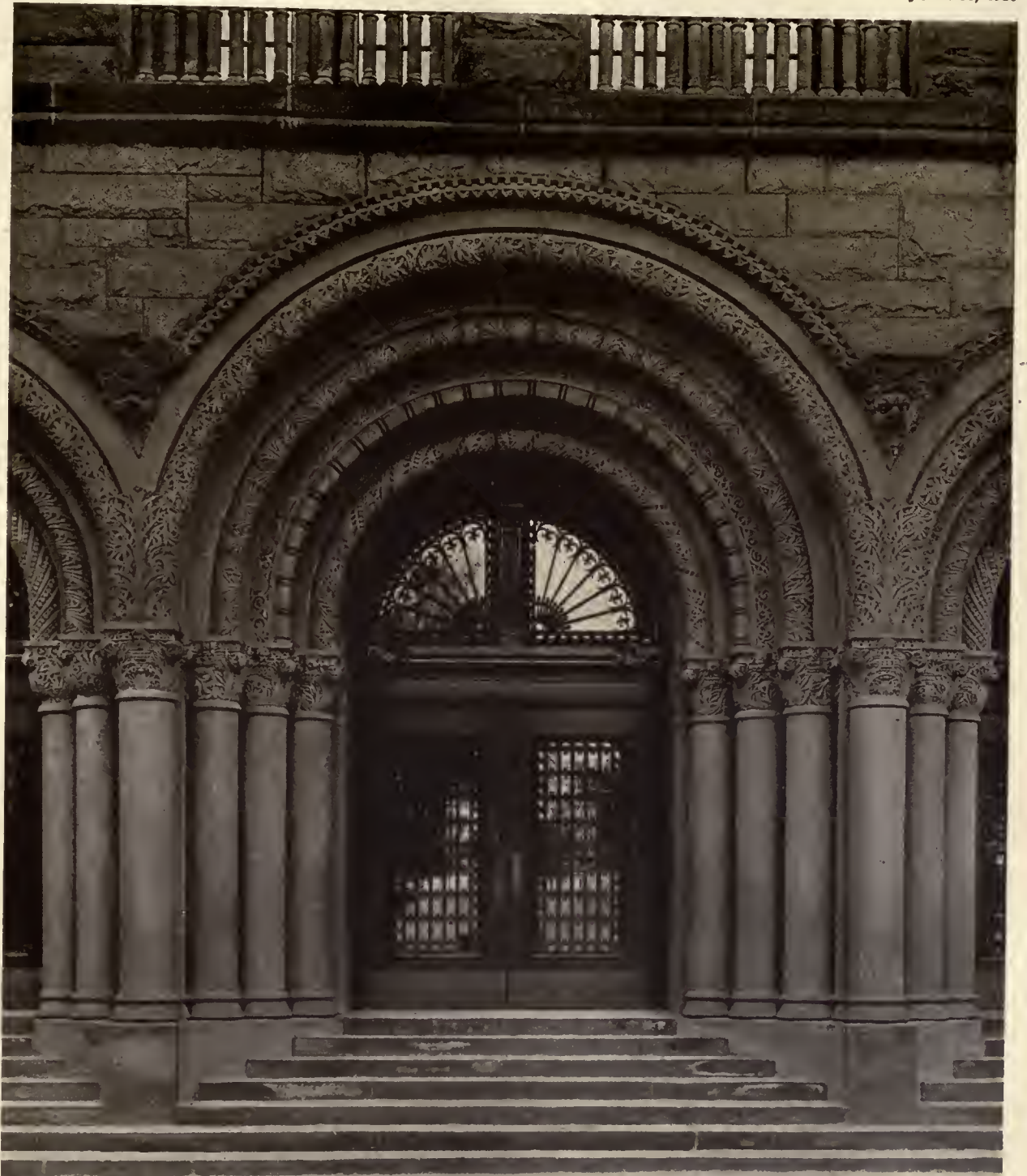

MAIN ENTRANCE DOORWAY, SHOWING ADDITION OF NEW GRILLES  
CITY HALL AT ALBANY, NEW YORK  
H. H. RICHARDSON, ARCHITECT  
OGDEN & GANDER, ASSOCIATE ARCHITECTS FOR THE ALTERATIONS

820<sup>2</sup>









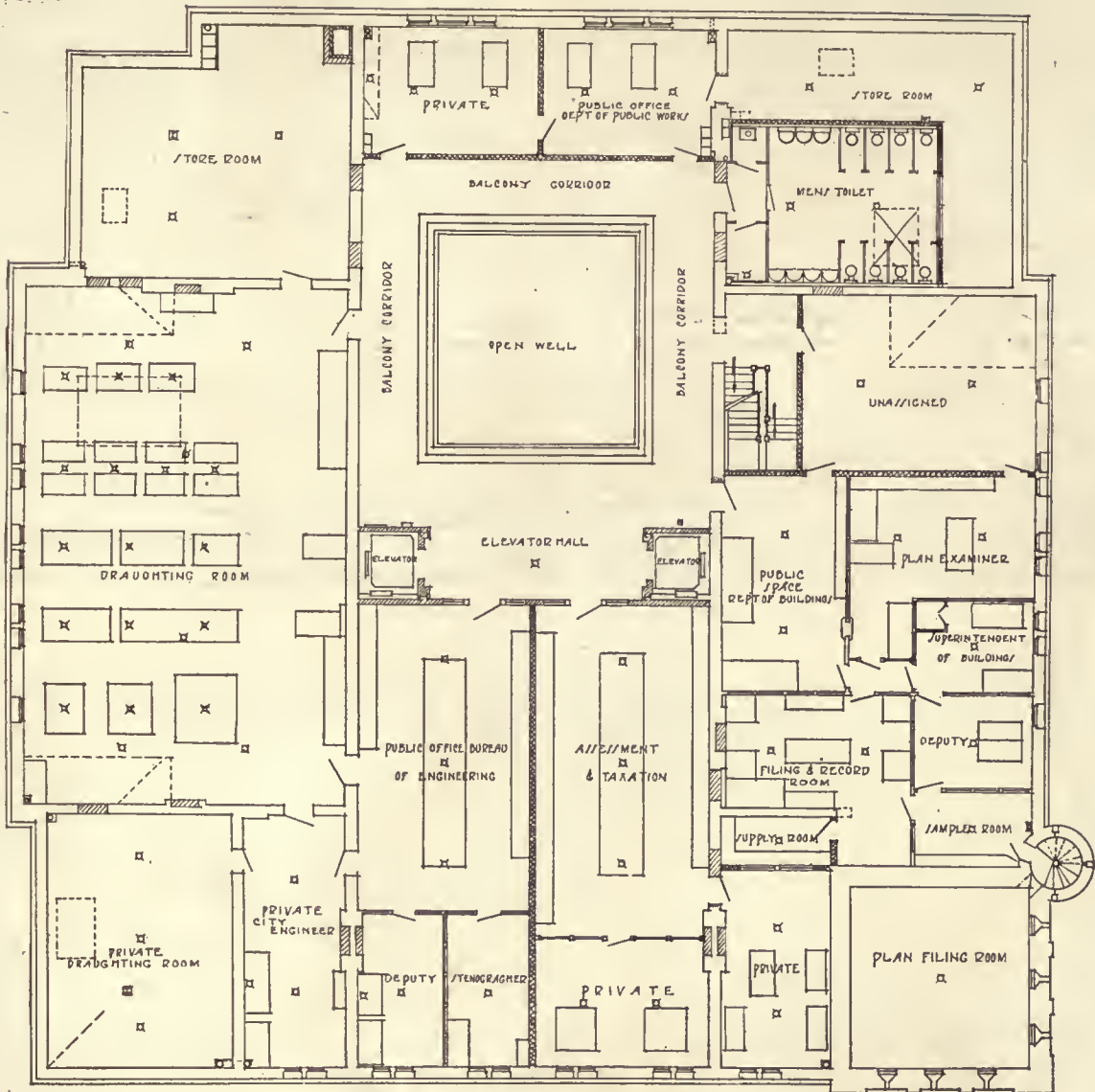

THIRD FLOOR PLAN

CITY HALL AT ALBANY, NEW YORK

H. H. RICHARDSON, ARCHITECT

OGDEN & GANDER, ASSOCIATE ARCHITECTS FOR THE ALTERATIONS

8204



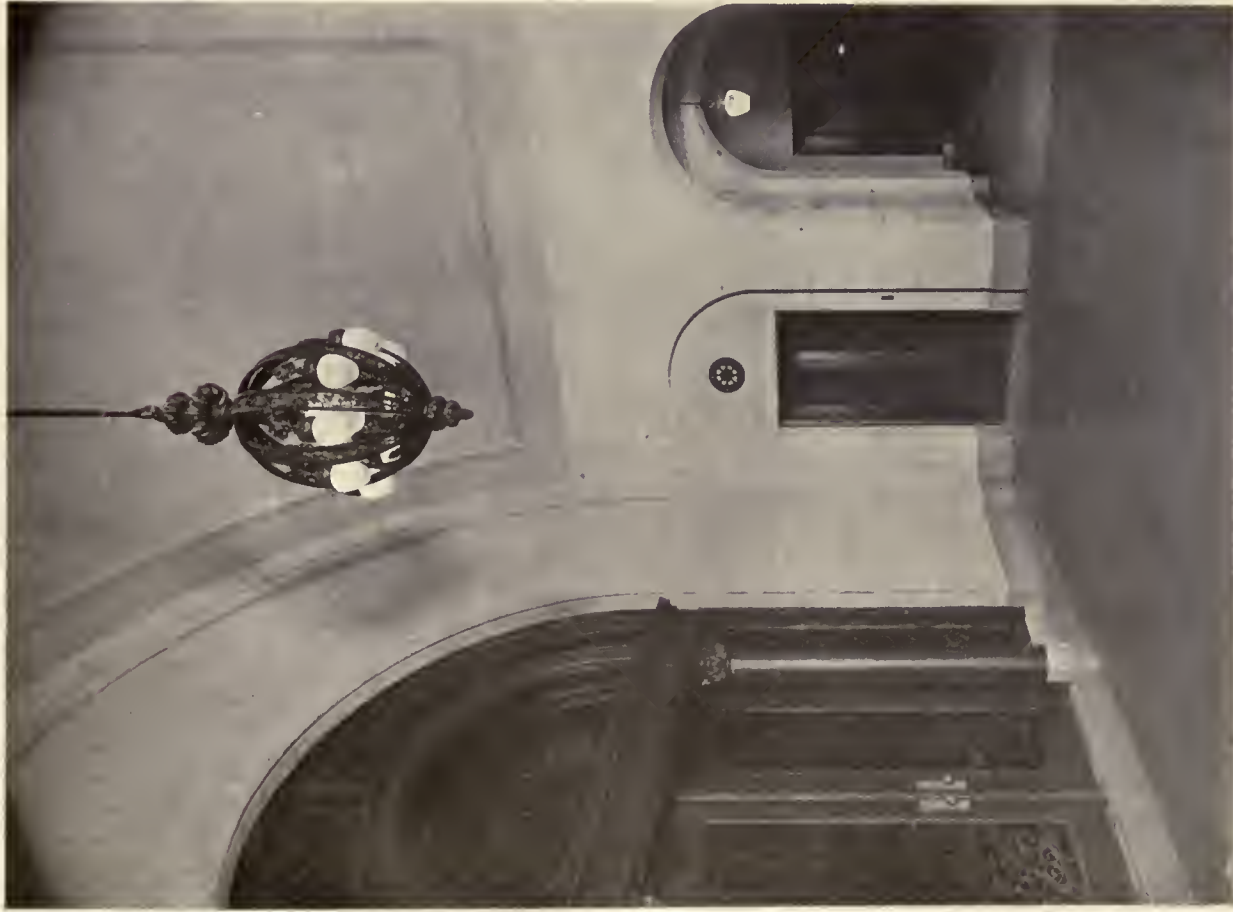

ENTRANCE TO COUNCIL CHAMBER



NEW VIEW FROM MAIN STAIRWAY LOOKING INTO LIGHT WELL

CITY HALL AT ALBANY, NEW YORK

H. H. RICHARDSON, ARCHITECT

OGDEN & GANDER, ASSOCIATE ARCHITECTS FOR THE ALTERATIONS

8205





VIEW OF MAIN LIGHT WELL



VIEW OF MAIN LOBBY

CITY HALL AT ALBANY, NEW YORK

H. H. RICHARDSON, ARCHITECT

OGDEN & GANDER, ASSOCIATE ARCHITECTS FOR THE ALTERATIONS

8206





INTERIOR OF A HOUSE ON E. 63RD STREET, NEW YORK  
F. BURRALL HOFFMAN, ARCHITECT

8207







DINING ROOM FIREPLACE IN A HOUSE ON E. 68TH STREET, NEW YORK  
TAYLOR & LEVI, ARCHITECTS



# Heating a Building With Waste Air

**T**HAT warm air generally allowed to go to waste may be profitably used in heating a large building is clearly shown by tests made at the State Hospital in Chicago, Ill., as described by the supervising engineer, Mr. F. J. Postel, in the "Heating and Ventilating Magazine." The air used in the test was that from the tunnel through which the steam pipes passed from the central heating plant. Where a group of buildings is supplied with steam and hot water from a central plant, Mr. Postel reminds us, the usual method is to carry the pipes in service tunnels. Even though the piping is properly covered, the temperature of such tunnels is more frequently over than under 100 degrees Fahrenheit, especially as the size and number of steam pipes increase. He goes on:

"The tunnels are generally near the surface; in fact, the concrete tunnel roof frequently serves as a sidewalk between the buildings. Under these conditions, it naturally follows that the heat lost by transmission through the walls, and especially through the roof of the tunnel, is considerable. The best visual evidence of this is the melted snow outlining the location of a tunnel system, even in very cold weather.

"With a view of determining the feasibility of utilizing some of the waste heat of a tunnel system in heating and ventilating buildings, the following experiment was made:

"At the Chicago State Hospital there is quite an elaborate system of tunnels connecting the various buildings on the grounds. The south end of this tunnel system is new and at present contains only a high-pressure steam line and a heating return line, the other service piping not having been installed as yet. The temperature in this new tunnel is, therefore, considerably lower than that in the remainder of the tunnel system and is undoubtedly lower than the average temperature usually found in tunnel systems. However, due to the fact that one of the newer buildings served by this tunnel had a blast system already installed and that it was a comparatively simple matter to arrange the fan to draw its air supply from the tunnel instead of from outdoors, we selected this building for the test. . . .

"The building is designed to house about one hundred patients. There are a large dormitory and a day-room on the first floor and two dormitories on the second floor. The solarium at the south end of the building and the toilet rooms, attendants' rooms, and the single rooms in the center

of the building are heated by direct radiation, while the day-rooms and dormitories are equipped with a blast system, in addition to direct radiation. The blast system has not been used for several years, the day-rooms and dormitories being heated entirely by direct radiation and ventilated by open windows. In the test the direct radiation of the day-rooms and dormitories was shut off entirely and the rooms heated by the blast system alone. The air was discharged into the room just as it was drawn from the tunnels, without reheating.

"As the object of this test was primarily to determine how hot the rooms would get under certain outside temperature conditions and with a certain drop in tunnel temperature, no attempt was made to regulate the temperatures. . . .

"All the air used in the test was heated from the outdoor temperature by passing into the tunnel at the skylight and through the tunnel to the building, absorbing heat from the tunnel walls and pipe and from the exposed tank and piping in the basement of the building. . . .

"The introduction of tunnel air into the rooms resulted in a material increase in humidity. This may be accounted for by the moisture absorbed by the air in passing over the damp tunnel walls and by the steam escaping from expansion joints in the steam line, which probably were not absolutely tight. . . .

"The tests show that the air conditions were quite satisfactory, especially considering the condition of the tunnel and the rather crude method of getting the air from the tunnel to the fan inlet. . . .

"The test proved conclusively:

"1. That it is entirely practical to heat and ventilate buildings with waste heat from a tunnel system.

"2. That with even a small amount of hot piping in a tunnel system insulated in the usual way, there is still sufficient waste heat to make its utilization well worth while.

"3. That if the tunnels are kept reasonably clean, the air conditions in the rooms may be maintained at a high standard of purity.

"It follows that as the temperature of the tunnels is decreased by this method, the heat loss through the tunnel walls and roof is decreased proportionately, and to this extent it represents a direct saving.

"Carrying this plan to its logical conclusion, it would appear that the limit to which we may safely go is reached only when the temperature of the tunnel gets down near the freezing-point. . . .

The heat transmission through tunnel walls and roof is a direct measure of the heat wasted and this becomes a minor waste if the tunnel temperature is, let us say, 40 degrees Fahrenheit.

"What this saving may amount to in the larger institutions is shown by the fact that, based on the results of the above test, plans are now being made to heat four buildings similar to the one used for this test at the Chicago State Hospital."

---

## New York's Anti-Litter Bureau Summarizes Year's Record

**T**HE Anti-Litter Bureau of The Merchants' Association of Greater New York has submitted a report summarizing its activities during the months from January 1, 1919, to January 1, 1920. The summary shows a wide range of activity.

The Association, through the Bureau, handled 3899 complaints regarding conditions in the streets. There were seventy-one complaints of litter in vacant lots, 1317 complaints of sidewalks unswept, 234 complaints of pavements in need of repair, fifty-one complaints of accumulations of rubbish in areas, under sidewalk gratings, etc., 226 complaints of non-removal of ashes and garbage, thirty-one complaints of over-filled ash cans, 106 complaints of exposed foodstuffs, 1188 complaints of spitters warned, seventeen complaints of dead animals in the streets, eight complaints of litter on fire escapes, 307 complaints of accumulations of rubbish, 104 complaints of obstacles to traffic, eighty-eight complaints of uncovered garbage cans and 151 miscellaneous complaints.

In order to make the work of the Bureau more widely known, the manager made a number of addresses, chiefly in the public schools. He spoke before sixty assemblies, including 33,210 persons.

A portion of the report is given to the work that is being done in the "Model District" of the lower east side. This district contains a population of about 150,000 inhabitants, making it one of the most densely populated districts in the world.

The Street Cleaning and Police Departments handled 1061 complaints regarding street conditions in the District, which has 2000 push-carts. Holes and depressions in the streets and sidewalks caused 471 complaints. Dirty rag shops caused eight. There were thirty-six complaints of cans left on the curb, ten of insufficient ash and garbage cans, and nineteen of insufficient bags for paper. The custom of throwing refuse and garbage out of the window in a bundle, known in the Street Cleaning Department as "throw-outs," caused twelve

complaints and the carelessness of peddlers caused six.

About 40,000 pamphlets have been distributed in the District which includes thirty-six blocks. Many persistent violators of the ordinance have been summoned to court, and, with the exception of six or eight cases, all the offenders have been fined and lectured by the magistrate. Conditions in the district show an outside improvement since the campaign was begun.

The success of this campaign caused another to be inaugurated in another section of the lower east side of the Borough of Manhattan. The section selected is considered the worst in the entire city for throw-outs, dirty sidewalks, overflowing ash and garbage cans, and similar evidences of carelessness. Through the Bureau, The Association distributed 50,000 pamphlets containing a summary of the laws and ordinances affecting streets, in English, Italian and Hebrew, and signed by the Police Commissioner. In addition, 1200 booklets containing a summary of the laws and ordinances were distributed to the various Police Stations for the use of policemen.

---

## Preserving a Prehistoric City

**L**YING almost forgotten, and long neglected, in the foothills of Sleeping Ute Mountain, a short distance west of Mesa Verde National Park, in the State of Colorado, are the remains of the ancient city which has come to be known, in recent years, as Aztec Springs. All that is left of the buildings which once occupied the spot are the crumbling walls of two great structures known as Upper and Lower House, and numerous smaller buildings, once forming an extensive Indian village.

Recently, by proclamation of President Wilson, the Yucca House National monument was created, and the first definite step taken to preserve, for the present and future generations, what many regard as a significant relic in American history and perhaps the earliest civilization, if so it may be termed, of the western hemisphere, writes an exchange. It is explained that the name selected for the monument, Yucca House, was decided upon as one more definitely descriptive of the ancient village than the name Aztec Springs, by which it has long been known. The impression has, it is said, prevailed that the city was built and peopled by the ancient Aztec Indians from Mexico, but that research establishes the fact that the Montezuma Indians were the builders, and that the village took the name of the mountain near it, Sleeping Ute having been known to the inhabitants as Yucca, so called because of the abundance of the yucca plant found growing on the mountain sides.

The establishing of this monument, and the setting apart, under governmental supervision of this tiny tract of land, embracing only about ten acres, in the Montezuma valley, is chiefly significant, it would seem, because it so definitely accords with the policy of the people of Colorado in preserving and perpetuating the scenic and historic beauty spots in their great State. No commonwealth in this republic, of which rugged and beautiful Colorado is a unit, can, perhaps, boast of a more romantic and stirring early history.

The little spot which is marked by the prehistoric relics of the Indian village is but one of many of a somewhat similar character which have been discovered in other parts of Colorado. These, for the most part, are not unlike the remnants of Indian villages and cities found in New Mexico and Arizona. The determination to preserve such places is, from many points of view, commendable and worthy. The inclination all too often, when considering a project of perpetuating some ancient relic, is to regard it as sentimental merely, or unnecessary and useless. It is not difficult, if one regards the accomplishments of the present day as all-sufficient, to imagine that all of history, really worth writing, is already written, and that the record which will be of informative value to those of the future will be the history, not of the seventeenth century, for instance, but of the twentieth. The tendency seems to be to lose sight of the somewhat important consideration that comparisons will be made, say 300 years hence, of the civilization and progress of that time with the civilization and the progress of what is now regarded as the all-important present. Is it not as well, therefore, that the students of some century of the future may be able to compare twentieth-century progress with the progress of the seventeenth century? If this is to be made possible, those of to-day must do their part in preserving and passing on, as those of future generations will no doubt be generous and wise enough to pass on, the available evidences in tangible form. Yucca House, in itself only a dot among the Montezuma foothills, but once the pride of a proud race, may seem insignificant in the great scheme, but it is a heritage to which the people of to-day have no exclusive title.

### Building Injured by Cleaning Acids

THE Indiana Limestone Quarrymen's Association in a recent communication to the Building Managers and Owners' Association of New York, declares that the proper cleaning of stone buildings is a matter of considerable importance. The letter said:

"Our field representatives report that irrespons-

ible cleaning concerns operating in the large cities are using acid or chemical compounds or preparations that have a very destructive action on natural stone. In fact, some of the preparations used have been so strong that they have resulted in disintegration of gray granite.

"We know of one fine bank building where the granite has peeled off and blistered from the cleaning process and this disintegration process is continuing and will probably result in ruining the appearance of the building. We know of another building where the preparations used have caused a continuous chemical action that makes it necessary to brush down the loose particles of the disintegrated surface of the stone about once a month, showing that long after the application of the cleaning preparations the acids are eating their way into the stone and the disintegration process continuing.

"We know of several beautiful limestone buildings in the City of New York which have been treated by cleaning processes during the last year, resulting in their turning a bleached white, and of others that have turned irregular in color or become streaked with dark spots, in all instances entirely changing the natural color and beauty of the stone and ruining the appearance of the building.

"Cleaning by 'sand blast' is also detrimental, as it removes the dense skin coat or protective film that is deposited on the face by the stone itself in the seasoning or drying-out process, opening the minute pores of the stone to a greater penetration and less easily cleaned off accumulation of soot and dirt from the atmosphere. Sand blasting furthermore cuts down the sharpness of arrises of mouldings, and tends to destroy the artistic value of the carving generally. The cleaning game appears to be one that is pursued largely by men who lack integrity and have little if any knowledge of the chemical action of the preparations which they employ, and, in fact, it often appears their only interest is to collect payment for their work and get away before the actual results are evident. If these practices are permitted to continue they will soon result in both ruining the appearance and depreciating the investment value of many fine structures.

"We feel that this subject is one which should be brought forcibly to the attention of all members of your organization, also to the attention of real estate holding companies and others in charge of valuable building properties. The way these fellows frequently operate is to clean off a little corner or patch of the stone and then invite the official in charge to view this demonstration of the 'before and after' process. The building may have weathered a good color and not need any cleaning, but this little patch of pristine newness is very tempting and it is a simple matter for a plausible salesman to

convince an owner, building manager or bank President of the advisability of cleaning down his building, without the latter realizing that unless this is done in a scientific manner it may have very serious results. Acid preparations should never be used on natural stone; only common washing soap or soap powder and clear water applied with fibre scrub brushes should be used for this purpose."

### The "Other Side" of Billboards

MUCH discussion on the subject of the ever-present billboard has made familiar a topic of considerable importance to the artistic aspect of the city and the countryside. Reasons have been urged why the billboard should be condemned—why the interests of the many should not be made subservient to the advantages of the few.

It seems fair to present the other side of this question, to show the possibilities of the billboard while it may stand, as an influence for better art and better life. This has been done by Thornton Oakley in the *American Magazine of Art* in a manner that will not fail to interest all who read it. Mr. Oakley writes:

Without question the hideous billboard—and the vast majority of billboards are so—must go, and any movement to annihilate it should be applauded. But let us in our eagerness to restrain the ugly, not forget the beautiful. Let us, in our efforts to clear our land of the offensive, not sweep away *all* billboards indiscriminately. A misdirected, a too uncompromising zeal on the part of our campaigners who seek to do away with all the frightful signs which blot our landscapes might easily result in an obliterating of one of the most dramatic, the most appealing opportunities for a national artistic expression which our country offers. To declare a billboard anathema simply because it is a billboard is as untrue a reasoning as though one would assert that drawings or water colors done on paper are intolerable because the debasing comic drawings in supplements of our Sunday newspapers are done on paper. A piece of paper may become as offensive as the crude vulgarity of the work upon it—it may, when Winslow Homer sweeps it with an immensity of light and space, become an enduring inspiration to mankind. So the billboard. It is not the board which we must take away, but the repellent commonness of work upon it—the revolting work which almost universally is flaunted at us.

A great artist can make a billboard as superb as the average sign painter hideous. I have seen billboards during the war, designed by master painters, which held the beholder spellbound, left him oblivious to material facts about him, absorbed him with their powerful appeals, stirred him with renewed determination to help bring about the goal for which his embattled nation struggled. I have stood in squalid quarters of a city before a masterpiece of Maxfield Parrish advertising a tire—and what symbol is more modern, more American than a tire—swiftness, sureness, inventiveness, a never-ceasing onward sweeping to the desired end—and I have been conscious as I looked, of nothing but the fairy, dream-like inspiration of the artist's message. All the sordidness, the dirt of streets, the wretchedness of cheap architecture which surrounded the dream of Parrish vanished. Only the billboard's vision remained.

I can think of no medium for the expression of an artist's thoughts greater, more telling, more dynamic in its power, than the billboard. Publicity far broader than the average gallery, the widest possible variety of localities where it can be erected to tell its tale, commanding dignity when properly erected, force, a scale and grandeur at times entirely equaling the walls of public buildings—it has them all. It is for our artists not to scorn, but to realize the marvelous modern opportunity it offers—to see that it be made a power for enlightenment.

What we must have is a commission of artists—recognizedly great—appointed by the State, by the Nation—who will see that all things to be built be acceptably beautiful, and nothing hideous be tolerated. They will reveal by the selection of eminent craftsmen, engineers, architects, sculptors, painters, that construction of today, the industrial monstrosities which blot the face of our land—frightful piles of stone and iron slung together by contractors, unknowing and uncaring of the possibilities of art—the thousands upon thousands of repellent rows of houses erected in our cities with whirlwind haste and greed for rents—the myriad and one kinds of smoke vomiting plants blackening, searing and laying waste American fair fields and hills—the bridges, mills and factories, stores—the fences, scaffoldings, outbuildings of vast warehouses, yea, the billboard, too, with all of them—they will reveal, say, that all this can be turned from ugliness to beauty, that all offer amazing, as yet almost undreamed of, chances for the expression of a national art.

# Current News

---

## Happenings and Comments in the Fields of Architecture and the Allied Arts

### Year's Trial Proves Value of Co-operative Plan at M. I. T.

For the past year an experiment in co-operative engineering education has been conducted by the Massachusetts Institute of Technology and the General Electric Co. While the co-operative scheme in itself is not new, several departures from the usual plan were introduced.

The class was limited to thirty students, chosen entirely upon the records which they had made in the equivalent of the first two years' work of the electrical engineering course at Technology. Included in this group were graduates from Yale, Harvard, Dartmouth, Princeton, the Naval Academy, besides men who had completed their first and second years solely at Technology. The year (12 months) is divided into four three-month periods, the students spending alternately thirteen weeks at the Lynn works of the General Electric Co. and eleven weeks at the Institute, followed by a two weeks' vacation. The group at Lynn is housed in a fine old residence which has been converted into a modern club house. No break is made in the major studies when the students are at Lynn, courses being conducted at the works in principles of electrical engineering and in general studies. The progress of the students through the plant is regulated, not by the production needs of the various departments, but by the advantage which the experience in each department is to the student.

The result of this year's work has been gratifying to the originators of the plan. Because the students were a selected group, were all taking the same course, and were thrown together intimately at work and at the club house, a spirit of loyalty to one another, to the Institute and to the General Electric Co., soon became manifest and every man strove to make a reputation for the course. Their enthusiasm was soon shared by the officials and superintendents of the co-operating company.

As evidence of its approval of the work, the company has increased the number of men who can be enrolled in this year's class to sixty and has already secured a new club house in order to furnish rooming accommodations for them. The new class which has already nearly completed its quota of members enters upon the work July 6.

### City to Use Franklin Fund

#### Century-Old Bequests Will Pay for Convenience Stations

Funds accrued from provisions of the wills of Benjamin Franklin and of John Scott, another early Philadelphian, are to be used by the Board of City Trusts for the erection of public convenience stations.

Agreement to that effect was reached at a recent meeting of the Board, which acted upon a suggestion by Mayor Moore.

The funds total \$80,408. They include and have accrued from a bequest of £1000 left by Franklin to "make living in the town more convenient to its people and more agreeable to strangers," to be applied after 100 years, and a similar bequest of \$3000 left by Scott.

### Ban on London Building

Under section 5 of the Housing (Additional Powers) Act, 1919, the London County Council has served notices on a number of firms ordering work to cease on their premises in respect to rebuilding or alterations. Among the firms receiving such notice are some of the largest department stores. This action is said to have been taken under the provision in the Act authorizing a stoppage of "any building contemplated or in the course of construction which may cause a shortage of labor or material for the provision of dwelling accommodation."

### Reconstruction Work in France

The work of reconstruction is proceeding so slowly in the devastated regions of France that efforts are being made to reorganize the administrative service, which seems to be wholly incapable of carrying out this vast undertaking. Apart from the reconstruction of roads and bridges, very little has been done beyond clearing up some of the areas. Most of them, according to the *Engineer*, have remained untouched. The inhabitants complain that they can obtain no assistance and no redress, and it is urged that something must be done at once to save the devastated regions from absolute ruin. The trouble arose first of all from the refusal to accept

British and American aid immediately after the Armistice, when efforts were made to carry out the work of reconstruction under conditions that would have been highly advantageous to France, some trouble arose first of all from the refusal to accept payment out of the war indemnity. The French Government, however, decided to reserve the work for French manufacturers. Besides, negotiations were in progress with the Germans to supply the necessary labor. The Germans have done practically nothing, and the French can do scarcely more on account of the financial situation not permitting of funds being devoted to the work. Now that it is proposed to compound with the Germans and secure from them a fixed sum for reconstruction, there is a prospect of a serious start being made with the work. In any case, if France is to benefit from a rapid reconstruction it can only be with foreign aid, so that there is a possibility of the Government being induced to relax its present exclusive policy and permit British firms to assist in the carrying out of this vast work.

### Research Council Elects Officers

The National Research Council has elected the following officers for the year beginning July 1, 1920: Chairman, H. A. Bumstead, professor of physics and director of the Sloane physical laboratory, Yale University; first vice-chairman, C. D. Walcott, president of the National Academy of Sciences and secretary of the Smithsonian Institution; second vice-chairman, Gano Dunn, president of the J. G. White Engineering Corporation, New York; third vice-chairman, R. A. Millikan, professor of physics, University of Chicago; permanent secretary, Vernon Kellogg, professor of entomology, Stanford University; treasurer, F. L. Ransome, treasurer of the National Academy of Sciences. Not all of the chairmen of the various divisions of the Council have been selected but will be announced later.

### Housing Shortage in Philippines

Neither the United States nor Europe has a monopoly of the housing problem for it is acute in the Philippines as well. So serious has the dispute between landlords and tenants become in the Philippines that the Governor-General, Francis Burton Harrison, has called the attention of the Legislature to the need of enacting laws to protect the poorer people from excessive charges for rent.

One method proposed in the Legislature to solve the housing problem in the city of Manila is to appropriate \$500,000 for the erection of four large apartment houses, each to contain 250 rooms. Eighty

per cent of the rents from these buildings would be deposited with the Government and used as it accumulates for the construction of additional buildings.

### Museum for Designers

The United States National Museum at Washington contains many collections and exhibitions rich in interest and value for the designer working in textiles, costumes, arts and crafts, and in other phases of decorative art. The economic value of museums in this respect is coming to be realized more and more by designers as the demand increases for unique and unusual designs. In the National Museum the forms of decorative art shown cover geographically practically every part of the globe, and in point of time, from crude prehistoric beginnings of art down to the present.

Decorative designs of the Orient are beautifully shown in a collection of real oriental rugs. Large collections showing native applications of decorative art in various parts of the world are full of suggestions of unusual and original designs, especially those from Scandinavia and the Balkans. In the latter region, where art is practically universal, we find preserved the designs of the ancient world.

A large display of laces, embroideries, brocades, silks, etc., show the widest range in color and design. These fabrics made up into costumes worn during the various periods of our country's history, from the early days to the present, make up another collection rich in interest to costume designers. Finally, the largest collections of all, and those which contain motives and designs of truly American origin, are the unexcelled exhibitions of American Indian weaving, basketry and pottery. There is an increasing demand for a native American art in decorative work, and this is furnished in the widest variety of form and color in the work of the native American Indian.

### London Disapproves of Skyscrapers

We learn from *The Architects' Journal* of London that sanguine persons are again advocating the admission, under the London Building Act, of the tall buildings known as skyscrapers. London, it believes, can very well do without such monstrosities, and the London limitation of height to 100 ft. is not at all likely to be altered except perhaps by a slight reduction. That London does not want to begin to look like a feeble imitation of New York may be set down to sentimental or insular prejudice; but there are more practical objections, among them being the multiplication of fire hazards and the conversion of London streets to sunless alleys, dark and noisome and unhealthy. In New York this deplorable condi-



tion is accepted because that city has no possibility of extending in any other direction than skyward. For skyscrapers in London there is no excuse whatever—nor even the allegation that they can be invested with something that is thought to resemble architectural character, although it is impossible to test this statement without using a telescope and risking crick in the neck. Even in New York the skyscraper has had its day, the recently amended building regulations of that city having decreed that no more shall be built.

### Parisians Use Paint Instead of Wallpaper

Hand-painted walls are being used everywhere in Paris, because of the scarcity and high cost of wall paper.

Scene painters and tableau artists from the Latin quarter are employed at a daily wage much cheaper than the cost of new paper, which has soared to more than eight times the pre-war price.

### Old English Sign Boards by Famous Artists

With the passing of the roadside inn in England there has also passed the sign-boards, which, on creaking hinges, have for years served to mark the location of many famous hostelrys.

The quaint names of some of these old inns have become immortal in song and story. Their sign-boards were often painted by men who later became famous, or, as was often the case, had already arrived.

A writer in the *Architectural Review* of London, in the course of an article printed in a recent issue, interestingly refers to these old sign-boards. He states:

The sign-board of the Royal Oak, Bettws-y-Coed—now in the market—is not the only one painted by a famous artist. The sign of a tavern called "The Pilgrim" is another on which, as the *Manchester Guardian* reminds us, two Royal Academicians collaborated, Frith painting one side and Augustus Egg the other. "We fully expected," writes Frith, "that our pilgrim would have been allowed to take the place always allotted to signs at inns, but, whether from respect for his calling or for the artistic merit with which he was invested, he was taken inside and relegated to the bar." There used to be a sign over an inn at Epsom, bearing the signature "T. L., Greek St.," to which an amusing story is attached. It was the work of George Harlow, an artist fairly well known in the early nineteenth century who, having a grievance against Sir Thomas Lawrence,

Painted a clever imitation of the style of the President of the Royal Academy, and after affixing the initials and address of that august personage, presented it to an innkeeper in payment of his bill. Shortly after hearing of this atrocity Lawrence met the sign-painter in Portland Place, and fumed at him: "If this were not a long street, sir, I would have kicked you from one end of it to the other. "Would you?" said Harlow; "then I'm remarkably glad it's so long."

### Double-Deck Theatre Buildings

It is proposed to erect in the Times Square district of New York what may be called a double-deck theatre building. Two theatres, one above the other, will be the result. The project, undertaken by A. L. Erlanger, is an elaboration of the instances where theatres have so-called roof gardens which are practically independent show places.

There is gross waste of space in the average theatre. It covers much ground and, where there are two balconies and a gallery, there is nothing more of revenue-producing area unless it be of stores on the street level.

The double-decker probably will not go so much to the present style of various balconies, but have one of more depth and width than now is customary.

This may mark a radical departure in theatre building. Economically it is sound, and there seem to be no engineering or architectural difficulties presented that cannot be met by present-day builders.

The present building will have a seating capacity of 2400, 1400 in the lower play house and 1000 in the upper.

### A Tax to Restrict Building

Among the new taxes which the Supervisors are proposing to adopt in California is a rental or license tax for the use of space under sidewalks. Such a tax or rental would be of doubtful legality, depending on the terms of the dedication of the streets. That such a tax would be fought in the courts there is no doubt. When owners dedicate land for street purposes they reserve all other uses.

It would be a very unjust tax because it would violate a custom existing from time immemorial, under which owners of abutting property have had unrestricted use of sub-sidewalk space. It would also be unjust—and probably illegal—as double taxation, because all sub-sidewalk structures are already taxed as part of the buildings to which they are appurtenant.

But even if such tax were lawful and just, it would still be exceedingly unwise, as tending to discourage good building and increase the fire risk.

Much sub-sidewalk space is used to store oil for heating purposes. A tax tending to thrust back such storage under the building would increase the fire risk and affect insurance on all adjacent or neighboring property.

Sub-sidewalk space is also largely used to provide lighting for basements and for sanitary installations. It is a use of dedicated property in no way interfering with the use to which the street land is dedicated and of so great an advantage not merely to owners and occupiers of abutting property, but to the public, that so far from being discouraged by special taxation, it should be encouraged in all possible ways. It is almost certainly unlawful, except on streets owned in fee simple by the city and in respect to such streets it would be grossly discriminatory.

### Modern Art Education

The teaching of art should be standardized, at least so far as the presentation of fundamental principles and their application is concerned. Let us stop talking about feeling, and emotion, and atmosphere, and other mysteries, and get down to essential principles. Let us teach something that can be understood by the pupils and parents. We may admit that we do not know much about art, but that does not prevent us from choosing hats and gowns and rugs and curtains and houses and every other commodity that man must use, and that art should influence. We boastfully affirm, "we know what we like"—but is what we like good?

—Hugo B. Froelich.

### Safety First in Glass

What should we do without glass? We regard it as one of the necessities of civilized life; yet under certain conditions, it can be almost as dangerous as a sharp knife in the hands of an irresponsible person.

Glass is a most useful servant; a utility of great convenience when conditions are normal, but when accidents occur causing glass to break and splinters and splinters to fly through the air, human life is endangered. Many a death and many a serious wound has resulted from flying pieces of broken glass.

Serious consequences are especially to be feared from the accidental breaking, in collision or otherwise, of automobile windshields, back and side curtain lights; street car doors and windows; railroad passenger car windows; locomotive cab windows; port hole and other window lights on ships; die cutting, grinding, polishing, loading and other types of machine guards; office and bank partitions; revolving doors; doors and windows generally in dwellings, stores, factories, etc.

Science has come to the rescue with a laminated glass consisting of two sheets of ordinary glass between which is interposed a thin sheet of pyroxylin plastic. Hydraulic pressure and the application of the proper degree of heat welds the glass and pyroxylin sheet together into a solid unit. The pyroxylin binder prevents any scattering of fragments in the event of violent breakage.

The transparency of the glass is reduced but 2½ to 3 per cent by the insertion of the plastic sheet. This would never be noticed by the ordinary person not especially looking for a difference.

If life and accident insurance statistics were consulted to get a record of the vast number of accidents in the aggregate resulting from broken glass, it could be really shown that the increased first cost of laminated glass to be used in exposed places where experience has proven accidents are most likely to happen, would be more than offset by savings in death and injury insurance payments, loss of wages due to lost time while recovering from wounds and damage to property. Then too, the suffering and disfigurement caused by cuts should be considered.

Laminated glass has its place in the world. As its uses become known, it is undoubtedly going to be specified in many industries in which it is now unknown.

### Como Island for Artists

The beautiful island in Lake Como, famous for its associations with Pliny and with Julius Caesar's colonies of Greeks who settled in Lombardy, will hereafter be known as the "Isle of Artists."

In admiration for the Belgian people and the conduct of their monarch throughout the war, the former proprietor of Comacina Island, Signor Caprini, bequeathed the isle to King Albert, and in his will expressed the wish that it might serve some noble purpose in which Italy also could share. King Albert has now sent to Italy M. Destree, Minister of Arts and Sciences, to hand over the property to the Italian Government with the object of making this spot a restful retreat and a centre of activity for those who have devoted their lives to art.

It is reported in the *New York Times* that under the auspices of the academy at Milan, villas are to be built for artist residents and the place will be transformed into a little capital for promoting industrial and fine arts in the Italian lakes district.

### When Bathing Was a Crime

The first bathtub in the United States was installed in Cincinnati, Ohio, on December 20, 1842, by Adam Thompson. At a Christmas party he exhibited and explained it, and four guests later took a

plunge. The next day some papers designated it as an Epicurean luxury, others called it undemocratic, as it lacked simplicity in its surroundings.

In 1843 the Philadelphia Common Council considered an ordinance prohibiting bathing between November 1 and March 15, and this ordinance failed of passage by but two votes.

During the same year the Legislature of Virginia laid a tax of \$30 a year on all bathtubs that might be set up. In Hartford, Providence, Charleston and Wilmington, Delaware, special and very heavy water rates were laid on persons who had bathtubs. Boston in 1845 made bathing unlawful except on medical advice.

### Zoning Setbacks Used as Gardens

A new idea in construction has been worked out in connection with the Ambassador Hotel, now being built on Park avenue from 51st to 52d streets, New York City. At the fourteenth floor there is a setback of a twelve-foot depth, made necessary in order to comply with New York City's zoning law, which requires that at certain distances from the ground, floors must be built back from the front of the structure.

In the case of the Ambassador Hotel, the fourteenth-floor setback is a bare roof area running the entire length of the block from 51st to 52d streets. Instead of leaving this space 200 by 12 feet, unoccupied, a lawn with grass, flower beds and shrubbery will be substituted. This will give the occupants of the floor a veritable front yard, although some 200 feet above street level.

At the front of the yard along the entire Park avenue side will be an artistic balustrade and lattice work, so that persons may utilize the little touch of green far above the street without danger or inconvenience.

### Inter-Allied Study of Housing Problem

Housing problems, made acute all over the world by the war, have been studied here by several hundred delegates to the first Inter-Allied Housing and Town Planning Congress, which opened its sessions at Central Hall, Westminster, this morning. Representatives of the United States, and sixteen European countries, in addition to Canada and other British dominions, are in attendance.

Collection and co-ordination of available information as to the construction of dwellings and stimulation of official effort are among the objects of the meeting. One of the chief aims of the congress will be the formulation of a scheme of international application by which every family may be provided with proper housing within a period of twenty years.

### News from Various Sources

Mayor Peters, of Boston, has called a meeting of bankers and builders and is endeavoring to get action in the erection of dwellings.

\* \* \*

J. Pierpont Morgan has offered his London mansion to the United States Government to be used for the American Embassy in London.

\* \* \*

The New York State Labor Department recently approved the first State-wide code in relation to building construction, after having held hearings in the principal cities, and it is now being promulgated.

\* \* \*

The annual wage scale compiled and issued by the Builders' Association is now ready for distribution. The list embraces the prevailing rate of wages paid per hour to building trades mechanics and laborers in seventy-seven of the principal cities of the United States and Canada. Copies will be mailed upon request—\$1 per copy. E. M. Craig, Secretary, 133 West Washington Street, Chicago, Ill.

\* \* \*

The Art School proposed last Winter by Louis Comfort Tiffany at Cold Springs Harbor, New York, is now open. It will be recalled by readers of this journal that at that time Mr. Tiffany announced the creation of an endowment of more than a million dollars for an art school for students who have real ability, where they might proceed in an environment that would stimulate them along proper lines.

\* \* \*

The Architectural School of Columbia University, New York, will offer more than twenty intensive courses this Summer. The school has adopted many of the army methods of training men in both theory and practice. The faculty includes Professor Charles A. Harriman, George M. Allen, M. Maurice Prevot, A. E. Flanagan, H. V. Walsh, Joseph Lauber and others. The Summer courses begin on July 6.

\* \* \*

The School of Architecture of the Carnegie Institute of Technology will be open to students for six weeks during the Summer. Courses will be given in design, working drawings and superintendence of works, and outdoor sketching. The scope of the Summer work of the Institute has been considerably broadened this year, owing to the unprecedented demand for instruction, that has been met since the war. In revising the curricula those in charge have also placed the work on as practical a basis as possible.

## Personals

Ferdinand Gibbert, architect, has opened an office at 319 Meyers Arcade Building, Minneapolis, Minn.

Clifford Allbright, architect, has opened an office at 6 Beacon street, Boston, Mass.

Benjamin Howell Lackey has opened offices at 509 Federal street, Camden, N. J., for architectural practice.

C. P. H. Gilbert, architect, has removed his New York offices to the Metropolitan Tower, No. 1 Madison avenue.

Thomas B. Lippincott, architect, has removed his office from 1505 Arch street to 10 South 18th street, Philadelphia.

S. S. Eisenberg, architect, has removed his office from 203 Broadway, Chelsea, Mass., to 15 Court square, Boston, Mass.

S. Wesley Haynes, architect, has opened new offices in Rooms 28-29, Park Building, 280 Main street, Fitchburg, Mass.

N. R. Bingham, architect, has removed his office from the City National Bank Building to the Kee-line Building, Omaha, Neb.

E. H. Reeds, Jr., has removed his architectural business from 108 North Dearborn street to Room 2237, 175 West Jackson boulevard, Chicago.

Benjamin H. Lackey, architect, announces that he has opened an office at 509 Federal street, Camden, N. J., for the practice of architecture.

The architectural firm of W. Scott Armstrong, formerly of 140 South Dearborn street, Chicago, may now be found at 127 North Dearborn street.

The architectural firm of Hutchings & French, formerly at 6 Beacon street, Boston, Mass., may now be found at 8 Winter street, Boston, Mass.

Ernest Forsell and Arthur M. Lindell have united to practice general architecture and will be located at 319 Meyers Arcade Building, Minneapolis, Minn.

Ross & McNeil, architects, have removed their office from 39 East 42nd street to Room 1105, the Monolith Building, 45 West Thirty-fourth street, New York City.

Davidson & Weiss, architects, have been obliged to enlarge their office and have taken additional space at Suite 1448, Monadnock Building, Chicago.

Announcement is made of the opening of Duff & Froenhoff, architects, at 348 West 14th street, New York City. The firm was formerly located at 407 West 14th street, and operated under the name of Thomas J. Duff.

Edward G. Garden, recently of the engineering department of the Standard Oil Co. of California, announces his resignation from that service and the reopening of his own offices for the practice of architecture at 781 Flood Building, San Francisco.

Announced that Goodyear Industrial University, the first of its kind, was opened at Akron, Ohio, April 17, with enrollment of 5,700. The classes, which are free, offer 33,000 employes courses ranging from Americanization work to post-graduate studies for college men and women.

Announcement has been made by Otis & Clark, architects, that their partnership has been discontinued. Mr. Otis, associated with his son, Samuel S. Otis, will retain the present offices, practicing under the firm name of W. A. Otis & Son, architects, 6 North Michigan avenue, Chicago. Mr. Clark will continue his practice as Edwin H. Clark, architect, at 8 East Huron street.

## Massachusetts May Pass Rent Laws

Five bills to prevent rent profiteering and relieve the housing situation are now before the State Senate in Massachusetts. The bills, it is said, are similar to those passed recently in New York. Favorable action has been taken on a bill authorizing cities and towns to provide shelter for their inhabitants in case of emergency.

## Book Note

THE ROMAN ALPHABET. BY CATHERINE MACARTNEY AND EDNA PATZIG. PUBLISHED BY THE AUTHORS AT IOWA CITY, IA.

This 9x12 folder offers an accurately drawn Roman Alphabet based on the best available standard models from historical as well as modern sources. It is fully dimensioned and explained, so that it may be easily copied and may serve as the basis for the entire study of modern lettering. Architects will find the explanation of the plates sufficient to gain a comprehension of the underlying principles of the Roman Alphabet and of all modern lettering based upon the same.

# Weekly Review of Construction Field

## Comment on General Conditions of Economics With Reports of Special Correspondents in Prominent Regional Centers

In encouraging hope for the delivery of building materials in New York, it is said that Ralph Peters, chairman of the Transportation Committee of the local housing conference, has been able to aid in rushing to New York various items which were held up in transit. It has also been announced that the Lime Manufacturers' Association would arrange for sufficient lime to come to New York to relieve the situation.

Prices, however, are reported to be higher on many commodities. Cement has advanced 30 cents to \$4.80 a barrel; finishing lime advanced to \$32.00 a ton, common lime is \$26.00 a ton (both in cloth). Brick remains at \$25.00 a thousand, plus the usual delivery charges.

In many cases the steel shipments have fallen off in the past few weeks. This is because of the Commerce Commission's order that coal cars shall be sent empty to the mines, whereas in the past they have been held for re-loading with other freight. The outbreak of fresh railroad strikes at Philadelphia and Baltimore has also added difficulties. Embargoes against the affected districts were put in effect at Pittsburgh.

*(By Special Correspondence to THE AMERICAN ARCHITECT)*

CHICAGO.—The construction industry reports a slight improvement in transportation conditions, very little change in the building material market, no shortage of labor, and "the usual strike."

The latest strike is that of the steam shovel engineers. As a result the excavation work for new buildings of any very great magnitude which were to have started this week, have been postponed. These engineers have been receiving \$1.15 an hour, but they want \$1.50 an hour. Like the majority of labor troubles in the building trades industry during the last two months, this strike is due to increased wage demands.

On the other hand, construction work continues hampered by lack of money, material and transportation. A few individual projects are under way and considerable activity is noted on large sub-division in which it is proposed to build on a wholesale scale for working men. Various housing corporations are interested in these projects including the Chicago Housing Corporation with \$750,000 pledged by a group of financiers which has already completed nearly 200 of its houses—of a total of several thousand.

The Calumet Housing Association is another project recently launched which plans to erect 1,000 houses for the Calumet district, the homes to be sold on easy payments—10 per cent cash with monthly payments. Work will begin July 1st under present plans, on the first group of a 50-house project which includes the development of about 100 acres.

Building permits during the last week indicate the trend of the construction industry. There were forty permits issued during the week ending June 12 aggregating values of \$2,143,300 compared with 114 permits and \$2,079,900 for the same week a year ago—a decrease of 74 permits and an increase of \$63,400 in the investment involved.

Interest rates remain unchanged in Chicago, the 7 per cent rate having been firmly maintained while the banks are refusing accommodations except for most urgent needs.

*(By Special Correspondence to THE AMERICAN ARCHITECT)*

SEATTLE.—Since the break in costs of building materials seems to be impending, the work could be hastened in this territory by an improvement in the car situation whereby steel and earthenware products congested in the Chicago zone could get release into transcontinental traffic and sent on their way west. Such is the conviction of jobbers in essentials manufactured in the East.

Lumber has fallen much more rapidly than any other product. Jobbers of pipe, fittings and vitroware who draw their supply from the East are firmly of the opinion that costs are due to decline. The market has not advanced in thirty days, save the rate of discount in a few items of small black pipe and radiation. More brick, cement, roofing and plaster board is offering than can be drawn away by the demand. Builders are being encouraged to watch the markets, and while building conditions are not active, it is believed that they would be so if there were a sufficient supply of sub-contractors' materials even at to-day's market.

Due to the long transcontinental haul, cars are inadequate to do 60 per cent of the business. West coast receivers say that the railways are playing politics in conservation of cars in the expectation that by July 1st the impending advance in freight rates will have been ordered into effect and the operating revenues greatly increased.

The advance in wrought iron pipe to Seattle job-

## THE AMERICAN ARCHITECT

bers' warehouse basis is 10 points, with a similar advance in steel pipe. Shipping conditions are such that the mills are allotting or rationing buyers according to the purchases for the preceding month. The mills report that because of the railway strike they have no more storage space and may be forced to close down. Export orders are being deferred by jobbers while endeavoring to take care of their domestic requirements. Black pipe of one to two inches is almost impossible to get. All stocks on the coast are low.

Fir lumber during the past week has fallen \$2 to \$5, which brings it \$30 lower on finishing sizes such as flooring, ceiling and drop siding and \$14 down on common dimension as compared with the high point up to March 1st. Lath is lower at \$7.50 to \$8.00—delivered on the job.

Building permits numerically look strong, but the amounts to be invested are small. The only big jobs now under construction here are: the Pacific Telephone & Telegraph office building of ten stories, estimated to cost \$1,000,000; one school building at \$250,000; and the stadium at the University of Washington calling for an outlay of \$600,000. The work on the three national bank buildings which approximates five to six million dollars is being deferred and will be held up, in all probability, until relieved from the competition of more urgent building.

*(By Special Correspondence to THE AMERICAN ARCHITECT)*

BIRMINGHAM:—Considerable local interest has recently centered about the report of lower prices just ahead in building material. Investigation of this subject discloses that there have been lower quotations in Southern territory for lumber, due to the freight jam in the Northern and Eastern States preventing railroads from getting shipments through to destinations with ordinary regularity. This has caused numbers of large orders for lumber to be cancelled, as purchasers preferred not to pay drafts with bills of lading attached involving many thousands of dollars and with no reasonable prospect of the material being delivered for several months. This has left many of the smaller lumber manufacturers entirely dependent upon nearby markets to dispose of their accumulated stocks manufactured for Northern and Eastern territory.

Naturally, this has had the effect of reducing prices in localities near the points of manufacture with a contrary effect in distant markets where local stocks have been reduced without hope of early replenishment, all of which means that the lumber market has been temporarily disarranged by economic disorders; but does not mean that when traffic once more resumes its natural course and cancelled orders are reinstated that prices will not respond accordingly and the law of supply and demand prevail as usual. When this takes place, it is believed that prices will return to former high levels.

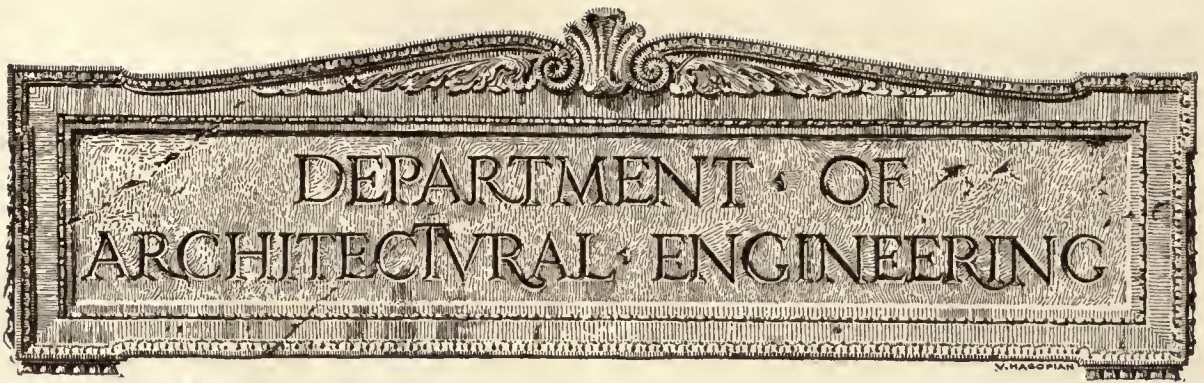

# The Fundamental Principles of Illuminating Design

## III.—Systems of Illumination

**W**HILE there are several distinct types of illumination in use, yet present-day developments are producing excellent lighting effects by methods which do not fall definitely within any of these classifications. It is also true that the terms direct, indirect and semi-indirect are not characteristic of the systems so called or the effects produced. A description of the principles involved will show the particular field and adaptability of each of these systems.

The research committee of the Illuminating Engineering Society has offered the following descriptive definition, covering in a general way these three types.

*“Direct Unit—A lighting device from which over half the emitted light flux is directed downward, or to the side, reaching the surface to be illuminated without being reflected by the walls or ceiling.”*

*“Semi-indirect—A lighting device employing a diffusing or translucent medium to direct most of the light to the walls or ceiling to be re-directed for use, a part of the light being diffused through this medium.”*

*“Indirect Unit—A lighting device from which all the light emitted is projected to the ceilings or walls and then reflected to the object to be lighted.”*

As was stated in the preceding article (published in the April 14 issue) practically any desired effect can be produced in illumination by properly controlling the light rays.

The essential features of each of the foregoing systems may be more fully described as follows:

### DIRECT LIGHTING

This type finds its greatest application in industrial plants (see *THE AMERICAN ARCHITECT*, June

19, 1918, page 835), garages, etc., although many direct lighting fixtures are used in residence illumination. When so used, a more attractive, though often less efficient, fixture is employed than for industrial work. In this system, all rays of light are directly projected on the working plane, and while being the most efficient, it possesses many disadvantages which largely limit its use to the types of buildings and occupancies aforementioned. The important features of accessories used for direct lighting are (1) correctly designed reflectors to properly distribute the light; (2) reflectors of high efficiency, which will retain their efficiency during an extended period of time, and (3) simplicity of construction providing ease of maintenance.

The reflector—the essential part of the direct lighting system—has a double purpose to perform. It must shade the bare lamp so as to eliminate its glaring effects, thus protecting the workers from injurious eye strain, and it must also re-direct all rays which would naturally go to the walls and ceiling, and distribute them evenly upon the working plane with as little loss as possible. In accomplishing this purpose, the light should have a uniform intensity throughout the entire area served by each unit. Absence of distinct shadows is also desirable.

In no other type of illumination is glare so likely to result from poor design. A proper choice of reflector is essential and one that is entirely suitable to the local conditions. The style or shape of the reflector will vary greatly with the area of distribution required and the height at which the fixture is located above the working plane. A reflector giving excellent results for one set of conditions may prove wholly unsuitable under a different set of conditions.

Technical data is given by manufacturers of such equipment to guide in the selection of suitable reflectors for specified conditions, and this data should be consulted before specifying.

REFLECTING SURFACES

There are several excellent types of reflectors on the market. *Mirrored reflectors* are extensively used for lighting fixtures. Their main disadvantage is the reflection of brilliant images of the lamp filament—called striations—on the surfaces illuminated. These may be eliminated either by constructing the reflector with a corrugated instead of plain surface, or by using a frosted lamp. In the latter case there is a greater loss of efficiency. The corrugated type of mirrored reflector has been found to give most satisfactory results.

A *semi-mat* surface, such as one coated with aluminum paint (Fig. 1), breaks up the light rays so as to eliminate any distinct image of the lamp



FIG. 1. ALUMINIZED STEEL REFLECTOR OF DEEP BOWL TYPE

filament while all rays are reflected in the same general direction. Dull finished reflectors of the deep-bowl shape must be carefully designed to avoid cross-reflection of the light rays from one side of the reflector to the other, since such cross-reflection will very considerably reduce the efficiency of the reflector.

*Prismatic glass* reflectors have come into quite general use for many occupancies. One type is shown in Fig. 2. The principle of prismatic reflection is illustrated by Fig. 3. It will be noted that a reflector composed of a series of true glass prisms reflects practically all of the light emanating from the source. In the manufacture of such reflectors, however, both the tops and intersections of the prisms are rounded slightly, which permits some rays of light to be transmitted directly through the reflector at these locations. This feature really adds to, rather than detracts from, the appearance of

such a fixture. Prismatic glassware, when produced along scientific lines, will not cause striation, and will be found to give quite satisfactory service.

Another material used for reflectors, also employed in enclosing glassware, is known as *opal glass*. A reflector constructed of this material is shown in

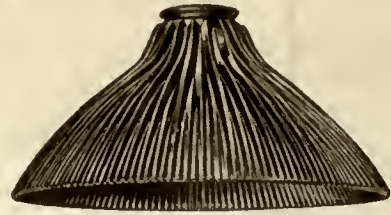

FIG. 2. PRISMATIC GLASS REFLECTOR

Fig. 4. *Opal glass* is made in both dense and light varieties. In its manufacture fine white particles are held in suspension, as it were, so that when used for lighting fixtures, light striking the smooth inner surface is partially reflected, some slight amount absorbed, and the balance transmitted through the reflector. This type of glass contains minute air bubbles.

The *porcelain enamel* metal reflector (see Fig. 5) finds extended use in industrial plants, and has given good service under severe conditions.

At a series of meetings of reflector and lamp manufacturers, attention was given to the shortcomings of existing industrial reflectors and plans for a standard line of reflectors which would best serve the *industrial* lighting field were outlined. The purpose of this standardization was to contribute toward better industrial lighting by establishing high

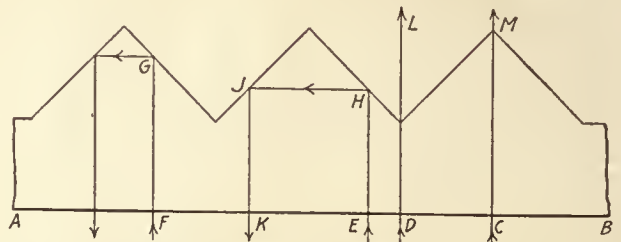

FIG. 3. PRINCIPLE OF PRISMATIC REFLECTION. Rays such as E-H and F-G striking inclined surfaces are reflected. Rays such as C-M and D-L striking lines of intersections pass through

standards of quality and performance for metal reflectors and to assist in simplifying the selection of proper reflecting equipment. The new reflector, a result of this co-operative work, is known as the RLM (reflector lamp manufacturers') Standard dome. Not only the angle of cut-off, but all other



factors which affect the performance of a porcelain-enamelled reflector were considered in the design of the RLM Standard dome. The specifications covering this design provide:

(a) A durable and highly efficient reflecting surface.

(b) A contour of reflector which will insure an effective light distribution.

(c) A diameter and depth for each size which will produce adequate diffusion of light and a sufficient screening which will serve to minimize glare.

The reflectors which comply with these specifications, the object of which is to maintain a uniform standard product of good quality, bear a statement to that effect in the form of a certificate of inspec-

excellent diffusing properties. This lamp is known as the "bowl-enamelled lamp."

Its production, from an industrial illumination standpoint, ranks among the most important developments since that of the Mazda C lamp itself. In the early days of tungsten filament lamps the problem of glare was considered so serious that practically half of the early Mazda lamps were either partially or entirely frosted. During the last few years, however, this proportion has dwindled until today the proportion of frosted lamps used is about two per cent. It is not to be assumed from these facts that glare is a less important item than it was first considered to be; rather, it was found that bowl-frosting does not adequately protect against glare in all



DIRECT LIGHTING IN MACHINE SHOP

Note evenness of illumination and absence of sharp shadows

tion service over the signature of the Electrical Testing Laboratories of New York.

#### ELIMINATION OF GLARE IN DIRECT LIGHTING

**T**HE most serious problem to contend with in direct lighting systems has been that of glare. The higher the candle power of the lamp, the more difficult of elimination this becomes. Since the tendency has been to use more and more powerful lamps, glare has become increasingly evident.

What appears to be a satisfactory solution of the problem has been brought about by the development of an improved incandescent lamp in which the lower part of the glass bulb, instead of being of clear glass, has an enamelled appearance and possesses most

instances, and in view of the shortcomings of bowl-frosted lamps, clear lamps have been going into industrial lighting installations to such an extent that the majority of such installations are unsatisfactory.

*The Bowl-Enamelled Lamp.* In appearance the bowl-enamelled lamp differs from the bowl-frosted lamp in that the bowl is decidedly white and might be described as having an egg-shell finish. When lighted the lamp can be viewed end-on at close range without discomfort. There is a decided contrast in this respect between a frosted lamp of a given wattage and a bowl-enamelled lamp of the same wattage. The bowl-enamelled lamp is now manufactured in the 100, 150, 200, 300, 500, 750 and 1,000-watt sizes.



ROOM FOR ASSEMBLY OF SEWING MACHINE PARTS

RLM Standard Dome and 150 W. Bowl-Enamelled Lamp. Spacing 10 Ft. Each Way

The lamp can be readily washed; it differs from the bowl-frosted lamp in this respect. The frosted lamp, when placed under water, becomes almost transparent with the result that it is decidedly difficult to detect the presence of dirt or grease, which will show up only after a lamp is dry. The bowl-enamelling, on the other hand, appears decidedly white even under water, and dirt is easily detected and also easily removed. Because of the smoother surface, the new lamp does not collect the dirt as easily as the frosted lamp.

As has been stated, the reason back of this lamp is one of avoiding glare. It is generally known that in the case of Mazda C lamps bowl-frosting does not satisfy the requirements as regards glare. Bowl-frosted lamps, even in the case of the 100-watt size, have a maximum brightness of something like 75 candlepower per square inch. The bowl-enamelled lamp has a brightness of about 10 or 12 candlepower per square inch. In fact, if one looks at a bowl-frosted lamp, he will see that the diffusion is by no means complete, for at the center of the frosted area

will be seen a very bright spot an inch or so in diameter, whereas with perfect diffusion the entire area would be of the same order of brightness. The latter is true in the case of the bowl-enamelled lamp.

In the design, which has been standardized, the edge of the enamel is vignettted or shaded off, thus avoiding the possibility of a sharp line of cut-off on the reflector. Furthermore, the enamel comes only as far as the edge of the filament and does not cover it, so that in the case of standard reflectors the inner surface is illuminated to an even brightness.

The bowl-enamelled lamp is, of course, designed for use with an open reflector. (See Fig. 5.) When used in this manner the lower part of a lamp becomes a semi-indirect bowl, serving the same purpose as is being accomplished at present by the use of the opal cap. This unit provides an equipment that will meet the requirements of a large majority of the industrial lighting plants of the country.

In the clear bulb lamp the amount of upward and downward light is practically the same, so that when it is used in an open reflector a large amount of the illumination comes directly from the concentrated lamp filament. Shadows are, therefore, comparatively sharp and reflected glare from polished surfaces is likely to be serious. Bowl-frosting partially diffuses the downward light from the filament, but re-directs upward only a very small proportion of the light flux. Bowl-enamelling, on the other hand, not only diffuses the downward light so as to make the bowl of the lamp of even brightness, but what is very important, serves to re-direct a high proportion of the light from the filament against the upper reflector. As a result the brightness of the lamp itself is much reduced and the reflector becomes the principal source of light. The larger light source of lower brightness provided by such a unit has the direct result of minimizing both direct and reflected glare and of softening shadows.

#### SEMI-INDIRECT LIGHTING

**T**HIS type of lighting is suitable for use over a wide range of occupancies. Fixtures designed for a system of semi-indirect illumination are usually



FIG. 4. OPAL GLASS REFLECTOR

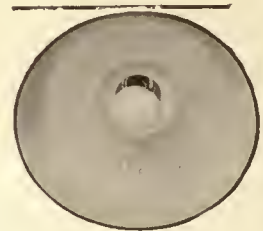

FIG. 5. PORCELAIN ENAMELED STEEL REFLECTOR AND ENAMELED-BOWL LAMP

of attractive appearance, and consist essentially of a translucent glass or alabaster bowl containing one or more lamps. The interior surface of the bowl is smooth, thus increasing its reflecting value. While a considerable quantity of light flux passes directly through the bowl, the majority is reflected upward to the ceiling and there re-directed to the working plane. Such fixtures effect good diffusion of the light and minimize glare.

In order that this system may operate as efficiently as possible, both ceiling and walls should be of light color. It is also best to use such fixtures in connection with a flat ceiling, since any extended projections below the ceiling line, such as beams, cause the casting of shadows, and a consequent reduction in the intensity and uniformity of the illumination produced. One type of semi-indirect fixture is shown in Fig. 6.

While formerly the direct type of illumination was largely employed in residence lighting, of recent years, semi-indirect illumination has met with much favor and is coming into quite general use, especially in such rooms as the dining rooms and living rooms.

In the artificial illumination of stores and offices, as well as in churches and public buildings, the semi-indirect system finds quite extensive use. For such occupancies, it is usually an improvement over the direct type, although the choice depends largely upon local conditions. Often direct illumination is necessary to produce the intensive lighting required for some special class of work.

Lack of proper care in maintenance will cause a higher rate of depreciation of light value than is the case in direct lighting, due to the rapid collection of dust in the bowl. It is important that such fixtures be periodically cleaned. The architect should impress upon the owner the need for this requirement when any bowl type of fixture is employed.



SEMI-INDIRECT ILLUMINATION IN DRAFTING ROOM OF AMERICAN CAN COMPANY, NEWARK, N. J.

Fixtures are so designed that majority of light is reflected on ceiling

#### INDIRECT LIGHTING

**I**NDIRECT lighting is a more recent development in the science of illumination. More than any other, this system approaches in principle that of natural daylight illumination. The underlying principle is to provide uniform distribution of the light by an extended lighting field or surface, rather than by a number of intense visible sources of light. It will be noted that during daylight, the entire visible sky becomes a source of illumination. For studio and other work requiring a steady, even light, a northern exposure is always preferred. The light obtained from such an exposure is due entirely to that reflected by the sky. To most persons, direct sunlight is objectionable, and windows so placed as to admit such rays should be glazed with diffusing glass. In like manner the indirect lighting system, instead of sending the light rays direct from a brilliant source, first diverts the light flux to the ceiling in such a way that it is evenly distributed thereon, diffused, and re-directed downward. As there is an entire lack of brilliant spots, a soft, even light is thus obtained.

Efficiency demands the use of the best reflecting surface commercially available in the reflector, the form of which must be designed on scientific principles in order to secure an even and adequate distribution.

Reflectors for indirect fixtures (see Fig. 7) require more attention than for direct units, due to



FIG. 6. A SEMI-INDIRECT UNIT

## THE AMERICAN ARCHITECT

their upturned position, thus making them liable to collect dust. The immediate source of light is, of course, not visible from below.

schools, residences etc. It has also been found satisfactory in drafting rooms and industries such as the needle trades where high intensities are required.



EBERHARDT MEMORIAL CHURCH, MISHAWAKA, IND.

BADGLEY & NICKLAS, ARCHITECTS

Indirect lighting has been here advantageously employed

Indirect lighting has been successfully employed for many and varying types of occupancies, including offices, hotels, clubs, banks, libraries, churches,

Before selecting this type consideration must be given to the fact that with indirect lighting the ceiling becomes a part, and a very important one, of the

system. The most scientifically designed fixtures will give very unsatisfactory results unless the ceiling (and to some extent the walls also) function as reflecting surfaces.

In industrial buildings employing pitched roofs, roof trusses, and dark ceilings, indirect illumination is out of the question, and direct lighting is practically the only system to use. In industries where considerable dirt and dust attend the process of manufacture, the indirect system would not be efficient as the fixtures would require too constant attention.

But wherever light ceilings can be used, without deep projections or recesses which would cast heavy shadows, it will be found possible to utilize indirect lighting.

There are certain classes of occupancies in which, for effect, it is sometimes desired to use fixtures with exquisitely etched glassware, the design of which becomes evident only upon the light shining through. If the intensity of lamp required would be such as to cause too great a brilliancy of such glassware if used in the common, semi-indirect type of fixture, it is possible so to construct an indirect fixture as to utilize an enclosing glass bowl, permitting a moderate quantity of light flux to pass through the glassware in order to bring out the pattern in the glass, while the greater portion of the light is directed to the ceiling. There are several methods by which this can be accomplished.

Thus a knowledge of the various types of systems and their adaptability to local conditions will make possible a satisfactory selection for each individual building.

It is hoped that more architects will make a thorough study of the different types of illumination, thus enabling them to assist in the proper selection of the lighting system to meet special conditions. The result is sure to be of benefit to both the architect and his client.



INDIRECT LIGHTING OF OFFICE OF VAN DUSEN HARRINGTON COMPANY, MINNEAPOLIS, MINN

### Effect of Storage of Cement

Professor Duff A. Abrams has again added to our knowledge of the characteristics of cement in Bulletin 6, just issued by the Structural Materials Research Laboratory, Lewis Institute, Chicago.

The tests illustrating the effect of storage of cement, the results of which are tabulated in this bulletin, extended over a period of three and one-half years, the storage conditions varying for different test samples. Strength tests were made at ages of from seven days to two years.

Compression tests of concrete and mortar showed a deterioration in strength with storage for all samples of cement, for all conditions and periods of storage and at all test ages. The deterioration was greatest for the samples stored in a shed in the yard, and least for the samples stored in the Laboratory. The basement storage was nearly as severe as outdoors. The deterioration was greater during the first three months than for the later three-month periods. A greater deterioration was found in the tests made at the age of seven days than at twenty-eight days and later test ages.

The tests in this investigation will be continued to include the 2-year period for all storage conditions. It is hoped that some opportunity may be found to study the effect of storing cement in bulk.

Copies of Bulletin 6 may be obtained on application to Lewis Institute.



FIG. 7. TOTAL-  
LY INDIRECT  
UNIT

The bowl screens the reflector, which is of the corugated mirrored type, and is invisible from below

## National Fire Protection Association Offers Plan for Local Organization

The aim of the National Fire Protection Association is to reduce the enormous and senseless annual wastage by fire. It seeks to enlist the support and co-operation of every organization and individual whose efforts will aid toward this end.

It has members in every city of the United States and Canada. At present they are collectively inactive, principally because they have never been asked to act collectively. They are individuals in various walks of life and local bodies like Chambers of Commerce, Rotary Clubs, Credit Men's Associations, Engineers' Clubs, etc. Fire prevention is not their main interest; they are busy with their own affairs. But the fact that they are members sets them apart in their communities as men or bodies who are awake to the significance of the fire waste and interested in reducing it. They are willing to assist in this object if some one will take the initiative and tell how they can help. It would seem that the fire chief is the man to do this, and a plan to assemble these local members about him as a sort of permanent committee or cabinet which he can call together monthly, or oftener if need be, tell his troubles and outline his plans to make his city fire safe should be fostered in every city.

The time is ripe for just such a plan as this and all the other agencies, physical and educational, working for fire prevention dovetail logically into it. The fire insurance companies are doing all they can to meet their responsibilities in furnishing reliable indemnity to those who burn; the cities are maintaining the most efficient fire departments the world has ever seen. The fire losses last year were nearly \$270,000,000. What then is the next step? What can be better than a sustained local effort fostered by those citizens of the municipalities who are alive to the significance of the fire waste and the present dire need of the world for its abatement?

The value of such co-operation is obvious. The fact that these men are in different walks of life is a peculiar advantage for nobody can charge that any special interest is behind the local fire prevention undertakings. A cross section of the N. F. P. A. membership in any average city will give the leading architect, the leading consulting engineer, the leading insurance agent, builder, manufacturer, warehouseman, credit man, department store manager, and so on. Here is a non-political, friendly, interested body of men, any or all of whom can be depended on to help the fire commissioner or chief in the right way. Wonderful things can be accomplished by such a group if it has the imagination to see it and the will and energy to effectively project

its plans. By persistent efforts it can influence every factor of civic life to advance the city in the direction of its endeavor. Cities are not made fire safe in a day. A long background beginning with proper building construction and following with proper safeguards is essential. There is hardly a city in the country which would not be benefited by certain amendments to its building ordinances.

The impoverishing effect of the fire waste is national, but every fire is local, it must start somewhere. Local organization and attack is therefore necessary—collective action by men and women who have been awakened, and who are capable of enthusiasm and devotion in eliminating local fire hazards. We must organize these forces already at our command, and begin in each city to eliminate those preventable fire losses which in their aggregate are impoverishing the collective life and blackening our national fame.

## Engineering Council Bulletin

CONSTRUCTION DIVISION, U. S. ARMY—As a separate service was approved in final vote in Senate by substantial margin of 18 to 38. This compares with vote of 158 to 168 against the separate Construction Division in the House. Indications are that the conferees will provide for separate division.

\* \* \*

CONSTRUCTION OF NEW SHIPS will probably be authorized as a result of Senate Commerce Committee vote to retain with modifications the House provision directing the sale of Government owned vessels "as soon as practicable" and also authorizing the Shipping Board to continue construction of new ships. This provision will be a part of the permanent merchant marine policy.

\* \* \*

COAL RATES—The coal bill recently introduced by Senator Frelinghuysen providing seasonal coal rates is now being heard before Senate Sub-Committee of Interstate Commerce. Mr. Eugene McAuliffe, formerly of the Fuel Conservation Section of the Railroad Administration, and representative of the American Institute of Mining and Metallurgical Engineers, has appeared in favor of the general plan embodied in this bill. A new writing of the bill recommending that graduated freight rates apply to tonnage, rather than to flat seasonal percentage increase was given by the Senate committee as recommendation of the engineers who have investigated this problem. A number of coal associations and some individuals have appeared against the Frelinghuysen bill.



