



ISRAEL DEFENSE DIRECTORY

2013/14

ISRAEL MINISTRY OF DEFENSE

סיב"ט לב"ט
SIBAT

INTERNATIONAL DEFENSE COOPERATION

Israel Defense Directory 2013-14

© Copyright 2013 by SIBAT

All rights reserved. No part of this book may be reproduced, stored in a retrieval system, or transmitted in any form or by any means - electronic, mechanical, photocopy, recording or otherwise - without the prior written consent of SIBAT.

First published in 1972

21th Edition 2013

ISSN 2221-7657

Published under the Authority of: 

The Israel Ministry of Defense, SIBAT - International Defense Cooperation

Compiled and Edited by:

SIBAT - Marketing Communications Department

Hakiryia

Tel Aviv 6473424, Israel

Tel: 972-3-6975916, 6975515

Fax: 972-3-6934639

E-mail: marcom@mod.gov.il

Web Site: www.sibat.mod.gov.il

Production

Hoffen Publishing House Ltd.

Tel: 972-3-9793006

E-mail: hanni@hoffen.co.il

E-mail: yael@hoffen.co.il

Web Site: www.hoffen.co.il

Production Team

Yael Pozniack-Hoffen, Hanni Hoffen-Nir

E-mail: yael@hoffen.co.il

Graphics

Sarit Shushlav

E-mail: sarityishai@gmail.com

Cover and Sections Design

Studio Yerushalmi

E-mail: michal897@gmail.com

Introductory Texts

Tamir Eshel

E-mail: tamir.eshel@gmail.com

Printing

Keter Press

Jerusalem

2013

How to use this Directory

Israel's Defense Directory 2013-14, brought to you by SIBAT, enables you to establish contact with the Israeli defense manufacturers engaged in the specialization that would be of interest to you. For your convenience, the Directory is divided into eleven sections, each comprising of several sub-sections, as listed in the Table of Contents. Within each section you will find your relevant manufacturers, listed alphabetically. Except in cases where double spread insertions made this impossible.

In order to facilitate tracing of a company or a specific product, two indices have been prepared: The first lists the various defense manufacturers and consultants, as well as basic and relevant information concerning the organization and its areas of activities. The second index lists the products by their brand name, acronym or abbreviated form. Both indices are alphabetically arranged.

We would also like to draw your attention to the fact that this Directory will be presented in the special internet website: www.sibat.mod.gov.il/catalog , in which all the companies advertising in the directory will be included and briefly described.

At the time of the publication (May 2013), the companies included in the Directory held MOD approval to offer their products and services. However, this authorization is valid for one year only and subject to renewal. According to Israeli law, special permits and authorizations govern all defense-related sales, and the fact that a company appears in this Directory does not necessarily mean that the company is entitled by law to export its products at any given time other than the date of publication. Moreover, each transaction requires an export license.

As the Israeli defense industry is extensive, and as manufacturers are not compelled to advertise in the Directory, we do not claim that the Directory includes all the companies, all items of defense equipment that are being manufactured, or all of the services offered by Israeli companies.

Although we have done our utmost to insure that the information herein is correct, it is the companies that are responsible for the accuracy of the information they submit.

We, therefore, cannot be held responsible for any inconsistency or inconvenience caused by discrepancies in the information.

The Directory will be current for 24 months, with the next one due to be published in May 2015.

In the event that you find it difficult to contact a company due to change of address, telephone or fax number, please call us. We will be happy to assist.

Please refer to the Directory as your source of information when contacting a company or SIBAT.

Please use the postcard on page 519 to order additional copies of the Directory.

Overview of Israel's Defense Industry

Israel is recognized the world over for its pioneering, operationally-proven defense systems - delivering advanced capabilities to meet today's increasingly sophisticated threats.

Developed by the country's defense industries - and utilized by defense and security forces around the globe- these ground-breaking systems are backed by a combination of cutting- edge technologies, a skilled and militarily experienced multi-disciplinary workforce, and a well-developed infrastructure. Together, they ensure Israel's national security - and support its worldwide customer base.

Israel's defense industry - which plays a leading role in the development of the country's industrial and technological capabilities - is open to cooperation, technology transfer, and the sharing of know-how through international initiatives.

Situated at the crossroads of Israel's defense sector, SIBAT is an essential division within the Israel Ministry of Defense (IMoD), while at the same time, enjoying a close relationship with Israel's defense industry. This unique position enables an in-depth understanding of defense concepts and the operational needs of the Israel Defense Forces (IDF) - as well as comprehensive knowledge regarding industry solutions, which are developed in response to the IDF's requirements and based on its experience.

SIBAT is your source for detailed information about this versatile, dynamic industry.

Israel Ministry of Defense - Organization Chart

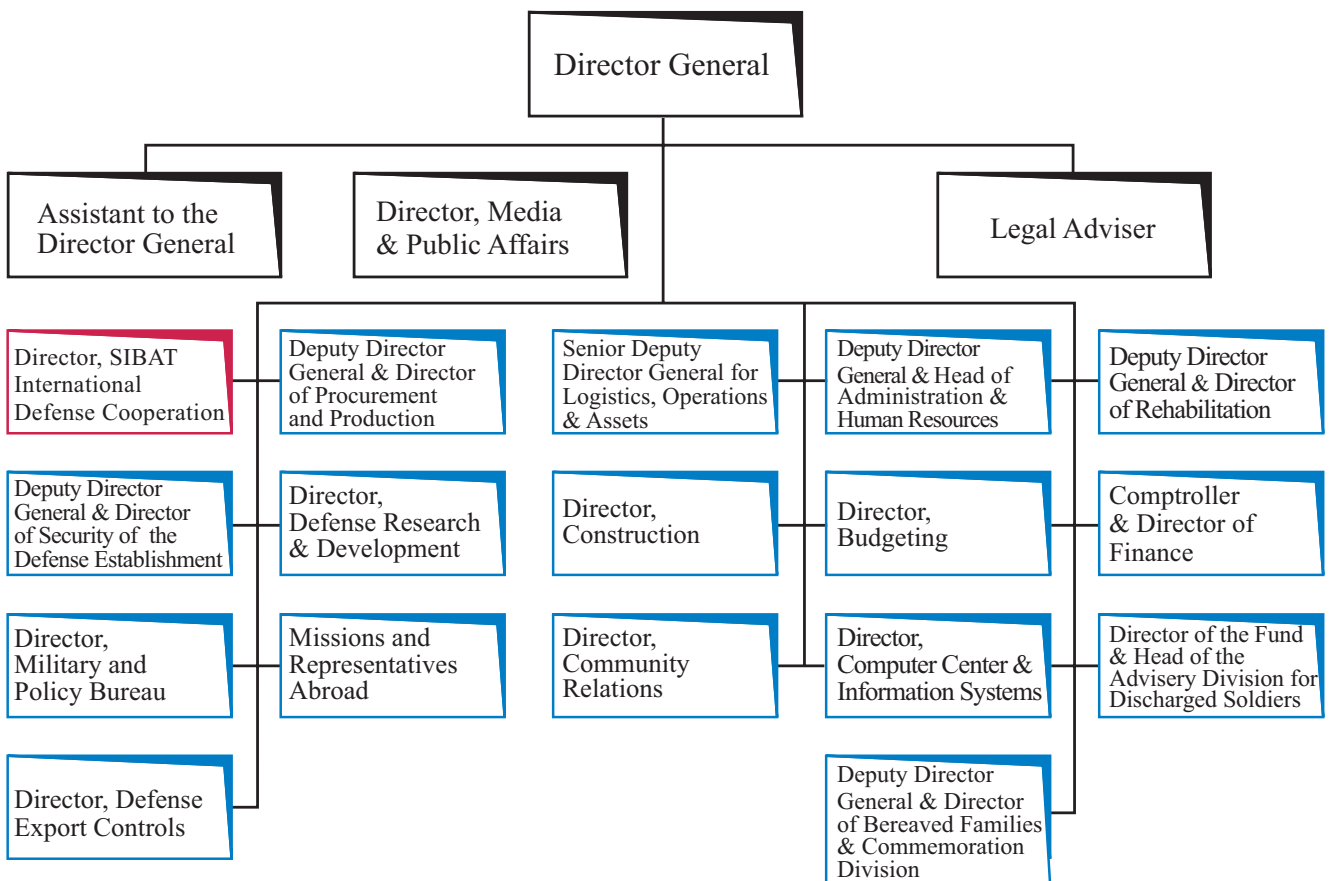

Overview of SIBAT

- Due to its unique position within Israel's defense domain, SIBAT is continuously updated regarding the wide variety of technologies and solutions being developed by Israeli defense companies. It also receives a steady stream of critical input regarding the IDF's evolving operational requirements.
- From this dual vantage point, SIBAT participates in the formulation of Israel's defense export policy - and coordinates all export-related activities. Among its most valued services are the initiation of collaborative ventures and long-term partnerships, the matching of needs with technologies, and the initiation and support of Government-to-Government agreements.
- SIBAT attaches great importance - and allocates significant management resources - to the support of small and medium-sized defense enterprises. SIBAT has become a unique source of information, as well as a meeting point, not only for established manufacturers, but for Israel's flourishing SME community as well - appreciated for its nurturing of innovative startups as well as its matching of mid-sized and large firms with global partners.
- SIBAT also manages the marketing and sale of Israel's entire defense Inventory, which is released by the Israel Defense Forces (IDF) and the Israel Ministry of Defense (IMoD). Inventory handled by SIBAT includes main platforms, weapon systems, spare parts and vehicles.

SIBAT - Organization Chart

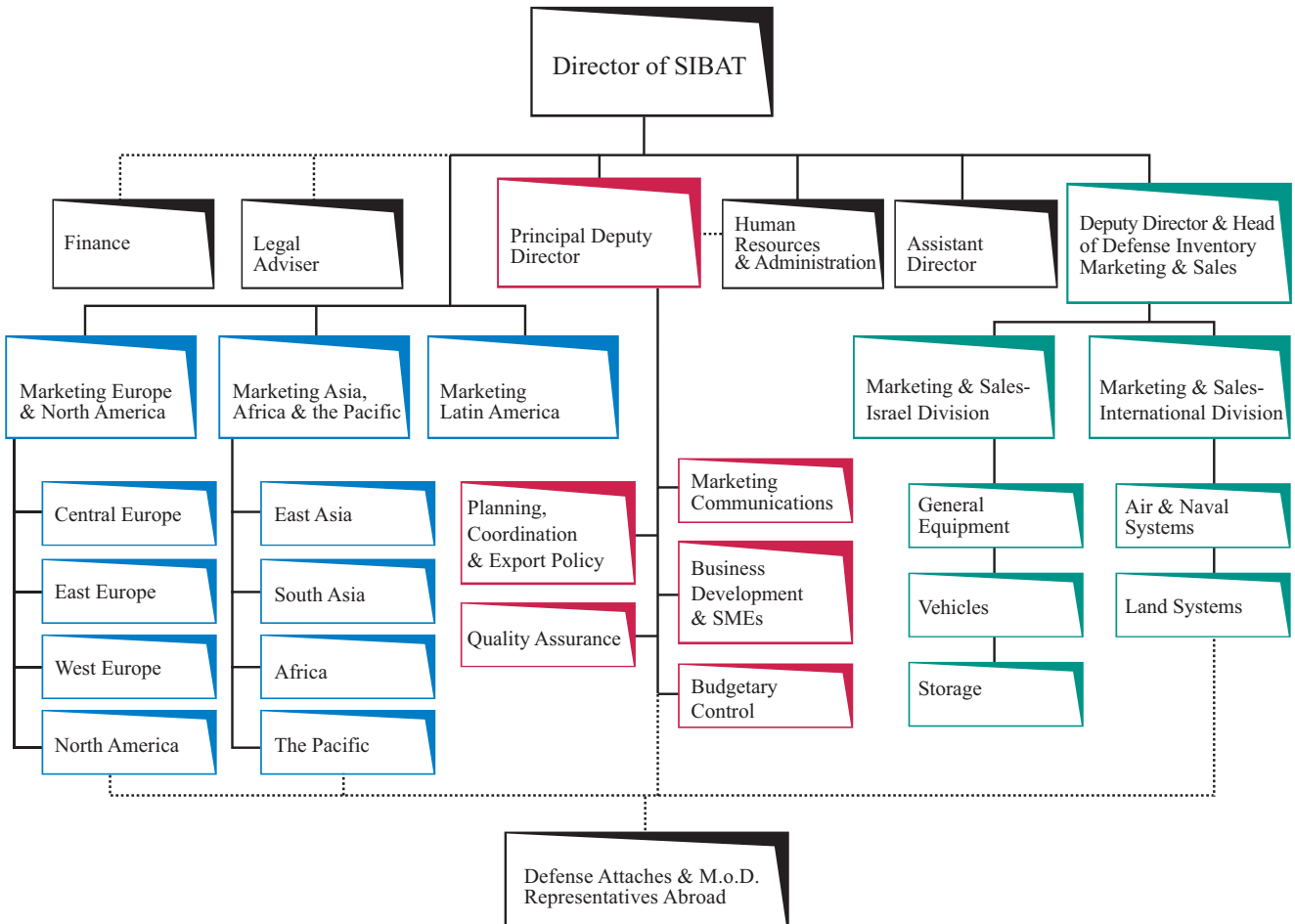

SIBAT - Facilitating International Cooperation

Among the activities designed to facilitate international cooperative initiatives, SIBAT:

- Generates and supports Government-to-Government agreements.
- Initiates and coordinates visits to Israel by foreign delegations and representatives from around the world.
- Organizes the visits of Israeli defense delegations abroad.
- Initiates, develops, and supports industrial cooperation with Israel's defense companies.
- Assists in the creation of joint ventures between Israeli defense industry manufacturers and foreign partners.
- Identifies the appropriate technological solutions required by potential clients - and establishes connections between these customers and the relevant Israeli defense companies.

The Marketing

The Marketing is divided to three regional divisions:

- Europe & North America
- Asia, Africa & the Pacific
- Latin America

The divisions are organized as follows:

EUROPE & NORTH AMERICA DIVISION:

UNITS	TEL.	FAX.	E-MAIL
Director of Europe & North America Division	972-3-6977936	972-3-6975097	
Central Europe	6934069	6975097	shelly_avidan@mod.gov.il
East Europe	6977903	6975097	golub@mod.gov.il
West Europe	6977930	6975097	daniel_pesotchinski@mod.gov.il
North America	6976586	6975097	eytan_levy@mod.gov.il

ASIA, AFRICA & THE PACIFIC DIVISION:

UNITS	TEL.	FAX.	E-MAIL
Director of Asia, Africa & the Pacific Division	972-3-6977921	972-3-6977959	eyalc@mod.gov.il
East Asia	6977928	6977959	nuni_sella@mod.gov.il
South Asia	6977964	6977959	alon_horesh@mod.gov.il
Africa	6977912	6977959	asaf_dvir@mod.gov.il
Pacific	6977920	6977959	nathan_barkan@mod.gov.il

LATIN AMERICA DIVISION:

UNITS	TEL.	FAX.	E-MAIL
Director of Latin America Division	972-3-6977925	972-3-6975097	jacovr@mod.gov.il
Regional Director	6977698	6975097	kobi_taibel@mod.gov.i

The Sale of Defense Inventory

SIBAT manages the sale of Israel's defense inventory - including main platforms (aircraft, tanks, ships, and armored vehicles), weapon systems (guns, missiles, light weapon systems), spare parts (air, ground, sea), and vehicles.

All sales are carried out either through tenders or by negotiation.

A selection of currently available inventory can be found on SIBAT's website.

The Defense Inventory Marketing & Sales

The Defense Inventory Marketing & Sales consists of the following professional divisions:

UNITS	TEL.	FAX.	E-MAIL
Deputy Director & Head of Defense Inventory Marketing & Sales	972-3-6975754	972-3-6976724	shlomo_alon@mod.gov.il
Deputy Head of Defense Inventory Marketing & Sales and Head of the International Division	6977207	6976724	anat_brill@mod.gov.il
Air & Naval Systems	6977991	6976864	shlomo_horn@mod.gov.il
Land Systems	6977333	6976864	menahem@mod.gov.il
Head of Marketing & Sales of Defense Inventory - Israel Division	6975176	6934692	sinay_sas@mod.gov.il
General Equipment	6977599	6976549	joseph_goor@mod.gov.il
Vehicles	6977630	6934692	rina@mod.gov.il

Expanding the Global Marketing of Israel Defense Exports

- Tasked with expanding the marketing and sales of Israel's defense exports, SIBAT disseminates information regarding the country's cutting-edge, combat-proven technologies - and supports global customers as well as defense exporters.
- Following Government-to-Government agreements, SIBAT provides comprehensive quality assurance and technical support services. It conducts advanced training seminars in Israel and abroad, and provides training for foreign forces around the world in the effective use of Israel's technologies.
- A biennial directory covering Israel's Defense Industry is published and distributed by SIBAT.
- Israel's technologies and capabilities are showcased under one roof at the Israel National Pavilion - organized by SIBAT at defense-related exhibitions around the world. SIBAT also produces conferences, attends global fairs and exhibitions, and facilitates direct contact between potential customers and Israeli defense companies.

The Export Services

The Export Services are headed by the Principal Deputy Director of SIBAT and consist of the following units:

UNITS	TEL.	FAX.	E-MAIL
Principal Deputy Director	972-3-6977906	972-3-6976843	itamar_graff@mod.gov.il
Business Development & SMEs	6977938	6976843	sibat_bic@mod.gov.il
Marketing Communications	6975515	6934639	alona_levintal@mod.gov.il
Planning, Coordination & Export Policy	6977942	6976843	ilan_itav@mod.gov.il
Quality Assurance	6934189	6934194	anordan@mailto.mod.gov.il

List of Israel Defense Attaches and M.o.D. Representatives Abroad

AUSTRALIA

EMBASSY OF ISRAEL
M.o.D. Representative
6 Turrana Street
Yarralumla Act 2600
Canberra, AUSTRALIA
Tel: +61-2-62733497
Fax: +61-2-62732874
E-mail: defence@canberra.mfa.gov.il

BRAZIL

EMBASSY OF ISRAEL
Defense Attache
Ses, Avenida Das Nacoes, Q809 Lote 38
Brazilia-Df, 70424-900 BRAZIL
Tel: +55-61-21050502
Tel/Fax: +55-61-21050561
E-mail: military@brasil.mfa.gov.il

CANADA

EMBASSY OF ISRAEL
M.o.D. Representative
O'Connor St. Suite 1005 50
Ottawa, Ontario
K1P 6L2, CANADA
Tel: +1-613-5676450 Ext. 520
Fax: +1-613-5672411
E-mail: attache@Ottawa.mfa.gov.il

CHILE

EMBASSY OF ISRAEL
Defense Attache
San Sebastian 2812, Piso 5
Casilla 146 Correo 35
Santiago de Chile, CHILE
Tel: +56-27500516
Fax: +56-2-2316626
E-mail: militaryatt@santiago.mfa.gov.il

COLOMBIA

EMBASSY OF ISRAEL
M.o.D. Representative
Calle 35 No.7-25, Piso 14
Bogota, COLOMBIA
Tel: +57-1-3236935
Fax: +57-1-2870340
E-mail: defense@bogota.mfa.gov.il

FRANCE

M.o.D.
EUROPEAN MISSION
3, Rue Rabelais
75008 Paris, FRANCE
Tel: +33-1-40765407
Fax: +33-1-40765347
E-mail: paris_tasam@mod.gov.il

EMBASSY OF ISRAEL

Defense Attache
3, Rue Rabelais
75008 Paris, FRANCE
Tel: +33-1-40765478
Fax: +33-1-40765404
E-mail: idf@paris.mfa.gov.il

GERMANY

M.o.D. MISSION
Auguste-Viktoria-Str. 74
D-14193 Berlin, GERMANY
Tel: +49-30-89045602
Fax: +49-30-89045639
E-mail: mod-berlin@mod.gov.il

EMBASSY OF ISRAEL

Defense Attache
Auguste-Viktoria-Str. 74
D-14193 Berlin, GERMANY
Tel: +49-30-89045630
Fax: +49-30-89045639
E-mail: berlin_attache@mod.gov.il

INDIA

EMBASSY OF ISRAEL
Defense Attache
3, Aurangzeb Road
New Delhi 110011 INDIA
Tel: +91-11-30414500/19
Fax: +91-11-23015166
E-mail: mod-def@newdelhi.mfa.gov.il
mod-isd@newdelhi.mfa.gov.il

ITALY

EMBASSY OF ISRAEL
Defense Attache
Via M. Mercatti 14,
00197 Roma, ITALY
Tel: +39-06-36198537
Fax: +39-06-36198596
E-mail: m-attache@roma.mfa.gov.il

KOREA

EMBASSY OF ISRAEL
Defense Attache
18th Fl., Cheonggye Bldg.
149 Seolin-Dong, Jongro-Ku
Seoul, 110-726 KOREA
Tel: +82-2-7392575
Fax: +82-2-7399962
E-mail: defense@seoul.mfa.gov.il

MEXICO

EMBASSY OF ISRAEL
M.o.D. Representative
Sierra Madre 215, Lomas de Chapultepec
Mexico D.F. 11000
Tel: +52-55-52011531
Fax: +52-55-52011555
E-mail: defenseattache@mexico.mfa.gov.il

NETHERLANDS

EMBASSY OF ISRAEL
Defense Attache
Buitenhof 47
2513 AH The Hague,
NETHERLANDS
Tel: +31-70-3760547, 3630334
Fax: +31-70-3760588
E-mail: mod@hague.mfa.gov.il

POLAND

EMBASSY OF ISRAEL
Defense Attache
24 L. Krzywickiego Street
Warsaw 02-078, Poland
Tel: +48-22-59705151
Fax: +48-22-8251550
E-mail: zhl@warsaw.mfa.gov.il

Peoples Republic of CHINA

EMBASSY OF ISRAEL
Defense Attache
No. 17 Tian Ze Lu
Chaoyang District
Beijing, 100600 P.R.C
Tel: +86-10-85320673
Fax: +86-10-85320616
E-mail: military@beijing.mfa.gov.il

ROMANIA

EMBASSY OF ISRAEL
Defense Attache
1 Blvd. Dimitrie Cantemir,
Sitraco Center, Etaj 5 Bucharest
ROMANIA
Tel: +40-21-3189418
Fax: +40-21-3189420
E-mail: military@bucharest.mfa.gov.il

RUSSIA

EMBASSY OF ISRAEL
Defense Attache
Bolshaya Ordynka Street 56
Moscow 113095
RUSSIAN FEDERATION
Tel: +7-495-6602716
Fax: +7-495-6602786
E-mail: military@moscow.mfa.gov.il

SINGAPORE

EMBASSY OF ISRAEL
Defense Attache
58 Dalvey Road
Singapore 259463, SINGAPORE
Tel: +65-6-2350793, 8349234/5
Fax: +65-6-7338559
E-mail: mod@singapore.mfa.gov.il

SPAIN

EMBASSY OF ISRAEL
M.o.D. Representative
Velazquez, 150-7º
28002 Madrid, SPAIN
Tel: +34-91-7829500/11/26
Fax: +34-91-5627147
E-mail: mod@madrid.mfa.gov.il

SWITZERLAND

EMBASSY OF ISRAEL
Defense Attache
Alpenstrasse 32
CH- 3006 Bern, SWITZERLAND
Tel: +41-31-3563511/2
Fax: +41-31-3521582
E-mail: mod@bern.mfa.gov.il

THAILAND

EMBASSY OF ISRAEL
M.o.D. Representative
Ocean Tower II, 25th Floor
75 Sukhumvit Soi 19 Road
Soi Wattana, Klongtoey
Bangkok 10110, THAILAND
Tel: +66-2-2049250/1
Fax: +66-2-2049225
E-mail: defence@bangkok.mfa.gov.il

UNITED KINGDOM

EMBASSY OF ISRAEL
Defense Attache
2A Palace Green
London W8 4QB U.K.
Tel: +44-207-4168198/9
Fax: +44-207-4168196
E-mail: defence-attache@london.mfa.gov.il

USA

EMBASSY OF ISRAEL
M.o.D. Representative
3514 International Dr. N.W.
Washington, D.C., 20008, USA
Tel: +1-202-3645608
Fax: +1-202-3645491
E-mail: mod@israeemb.org

Defense Technology at the Service of National Security

After more than a decade of continuous conflicts, in the Middle East, Central Asia, Africa and the global War on Terror, which consumed exceedingly larger resources and commitments by the world's leading countries, the U.S. and European nations are currently.

Scaling down their defense budgets, as fiscal pressures and stringent austerity measures are restraining military spending. In contrast, massive military build-up in Asia and the Middle East, and - to some extent in Latin America, growing powers are racing for regional domination on land at sea and in space by balancing the global military arena.

Regardless of their current level of spending, military organizations around the world are constantly required to modernize their equipment and acquire new capabilities to face evolving threats and new challenges. This necessity is also considered for those reducing their forces into smaller, more effective elements, or those growing powers, building new military might, through the fielding more sophisticated new weapons. Both are in search of advanced technologies, outpacing the enemy, while offering military leaders at all echelons, maximum command and control of such formidable powers, through network-enabled command structures.

Another characteristic of modern warfare is the 'dilution' of high intensity warfare into 'hybrid warfare', where military forces could be facing various types of threats, from low intensity to highly sophisticated and potent threats. Having experienced this kind of warfare for decades, Israel has been flexible to adapt, and respond with smart system developments in short cycles, thus virtually outpacing hostile evolution of threats. Sensitive to its obligation to minimize risk to human lives and unnecessary collateral damage to both sides, Israel has been seeking to field measurable military effects thus reduce unnecessary damage of its weapons.

Although Israel is not producing main platforms, it is confident to maintain its national security against superior military odds, by developing a sophisticated array of innovative and advanced defense systems, based on unique technologies. Through the years, Israel's defense industries have excelled in offering Israel's Defense Forces and foreign customers the ability to acquire new operational capabilities, by fielding advanced systems and to modernize existing platforms to assume new roles. These systems, some of which are presented in this bi-annual directory, demonstrate the best of what Israel's defense industries are offering. It represents Israel's foremost technologies, know-how and expertise, refined into unique products - complete weapon systems, subsystems, hardware, software or knowhow.

This directory provides a comprehensive review of Israel's defense industry's capabilities. This directory does not attempt to be complete. The companies listed have voluntarily decided to include a selection of their product listing, therefore, this directory does not contain Israel's entire list defense driven companies or all products available for export.

We hope you find it informative, and convenient to use.

TABLE OF CONTENTS

1

Aerospace

- Aircraft Manufacturing, Maintenance, Upgrading and Retrofit 14-29
- Aircraft Parts and Subcontracting 30-44
- Helicopters - Upgrade, Modernization, Maintenance and Avionics 57-58
- Weapon Systems and Missiles 59-67
- Electronic Warfare and Countermeasures 72-78
- Space Technology 89-94
- Avionics and Airborne Equipment 45-56
- Simulation and Training 68-71
- C⁴I 79-86
- Ground Support 87-88
- Ballistic Missile Defense 95

2

Naval Forces

- Naval Craft and Shipborne Equipment 98-105
- Naval Defense & Attack Systems 109-117
- Simulation and Training 122
- C⁴I 106-108
- Electronic Warfare and Countermeasures 118-121
- Sonar Systems 123-124

3

Land Forces

- Tanks and Armored Combat Vehicles 128-152
- Force Protection - Active Protection 162-165
- Border Protection 176-186
- Military Vehicles 208-215
- Demolition, Explosive Ordnance Disposal and Mine Clearing 217-225
- Electronic Warfare and Countermeasures 226-229
- Small Arms 248-255
- Air Defense Systems 259-262
- Force Protection - Armor Protection 153-161
- Force Protection - Personal Protective Gear 166-175
- Artillery 196-207
- Dry Storage 216
- Infantry Equipment 230-247
- Simulation and Training 256-258
- Aerostat Systems 263-264

4

Unmanned Systems and Robotics

- UAV 268-292
- UGV 293
- Robots 294-295

5

C⁴I (Command, Control, Communications, Computing & Intelligence) (Other C⁴I products and systems are also listed under chapters 1-3)

- Military Communications - Systems and Equipment 298-308
- Intelligence 319-336
- C⁴I 309-318

6

Optronics

- Day/Night E.O. Systems and Lasers 340-351
- Thermal Imaging 359-367
- Test, Measurement and Evaluation 369
- Airborne E.O. Pods 352-358
- Missile Components 368
- General Capabilities 370

7

Electronic Components and Sub-Systems

- Multi-Purpose 374-375
- Navigation 376-378

8

Military Inventory

- General 382-383
- Navy 400-402
- Ground Forces 384-387
- Scrap 403
- Air Force 388-399

9

Civil Defense and CBRN

- Emergency and Rescue Equipment 406
 - NBC 407-418
- (Other Civil Defense equipment and services are also listed in the Homeland Defense Directory)

10

Services

- Defense Consultants and Training 422-442
- Design, Engineering and Planning 450-452
- Export and Marketing Services 443-449
- Test Center 453
- Quality Assurance 454

11

Indices

- Companies 456-503
- Products Brand Names 504-518
- Postcard 519-520



AEROSPACE

Considered the mainstay of Israel's defense, Israel Air Force (IAF) relies on the superb technical skills, technological resources, know-how and innovation provided by Israel's aerospace industries to meet its constant challenges.

Innovative systems developed by Israel's leading aerospace companies include weapon systems, radar and electro-optical sensors, advanced avionics hardware and software, self-protection and electronic warfare systems. All are integrated into the world's most advanced fighter aircraft, including Lockheed Martin F-35, and F-16, Boeing F-15 and F/A-18, Sukhoi Su-30, Dassault Mirage 2000, Eurofighter Typhoon, Saab Gripen and more. In addition, the IAF and foreign air forces rely on Israeli expertise in providing advanced training and simulation technologies to develop superior pilot skills.

The IAF depends on the local industry to supply almost everything short of its manned platforms. These range from the development and modification of manned and unmanned aircraft, helicopters and weaponry, air and missile defense, spacecraft, to advanced, network-centric command, control and communications, computing, intelligence, surveillance and reconnaissance (C4ISR) systems.

In addition to supplying new equipment, Israeli companies have successfully completed numerous projects upgrading and converting existing platforms and systems, extending their useful life and operational capabilities. Such projects encompass combat, intelligence, surveillance and reconnaissance (ISR), transport and special mission aircraft and helicopters of both western and eastern origin, supporting the IAF and many foreign customers in Europe, Asia, Latin America, North America and the Middle East.

TACTICAL UNMANNED AERIAL SYSTEMS



Unleashing the True Power of UAV's

Specializes in the design, development and production of Tactical Mini and Micro Unmanned Aerial Systems and support equipment.

MicroB

Delivers On-Demand precision situation awareness to the tactical team level.

Uniqueness:

- Persistent surveillance capabilities like much larger mini UAV's
- Small size and weight - Less limited by regulations
- Pneumatic gun-launcher for mission flexibility
- Unique near-real-time mapping capability



GCS

The entire UAV family is controlled by Bluebird's user friendly and intuitive Common GCS

Uniqueness:

- Back-pack configuration for easy field deployment
- IP based Digital Communication Box with remote capabilities
- Multiple UAVs control
- Built in antenna tracker for longer control range
- Hand Held Emergency Control Unit, controls the UAV up to a range of 50 Km



MicroB micro UAV	
Gross weight	~1 Kg
Endurance	Up to 2 hours
Operational Range	> 15 Km
Speed Range	30-45 Kt
Wingspan	99 cm
Max payload weight	200 gr



ARMY

HLS & LAW

CIVIL

BLUEBIRD AERO SYSTEMS LTD.

Industrial Park, P.O.Box 5041
 Kadima, 6092000, Israel
 Tel: 972-9-899-9335
 Fax: 972-9-899-9345
 E-mail: sales@BlueBird-UAV.com
 Web Site: www.bluebird-uav.com

SpyLite

A Back-packed combat-proven mini UAV for tactical forces and HLS missions.

Uniqueness:

- Unmatched performance envelope - World records for Range, endurance, flight ceiling
- All weather operational capabilities
- High reliability with full system redundancy
- Thousands of flight hours already accumulated



Boomerang

A Fuel-Cell powered, long endurance mini UAV for Air-Force and Civilian Applications.

Uniqueness:

- The first proven operational Fuel-Cell powered mini UAV
- Integrated with Dual sensor payload (day & IR)
- High-end, long range, digital COFDM link
- All weather operational capabilities



<i>SpyLite mini UAV</i>	
Gross weight	8 Kg
Endurance	Up to 4 hours
Operational Range	> 60 Km
Speed Range	30-55 Kt
Wingspan	240 cm
Max payload weight	1.3 Kg



<i>Boomerang mini UAV</i>	
Gross weight	10 Kg
Endurance	> 10 hours
Operational Range	> 60 Km
Speed Range	30-55 Kt
Wingspan	275 cm
Max payload weight	1.3 Kg



TAKE-OFF WITH ASIO



BIRD AEROSYSTEMS LTD.

10 Hasadnaot St., P.O.Box 4038
Herzeliya 4614001, Israel
Tel: 972-9-9725700
Fax: 972-9-9579613
E-mail: info@birdaero.com
Web Site: www.birdaero.com



Airborne Surveillance, Intelligence and Observation (ASIO) Solution

ASIO is a complete special mission aircraft solution that provides decision makers and field commanders with accurate, real-time Intelligence, Surveillance and Reconnaissance (ISR) information.

Developed and marketing jointly with CASSIDIAN (an EADS Company) and Beechcraft Berlin, ASIO is highly customizable and can address diverse operational requirements ranging from terrestrial surveillance, maritime patrol and targeted monitoring.

ASIO can be supplied on a selection of aircraft with a wide range of sensors (RADAR, EOP, COMINT, ELINT, SPS) that are all integrated by BIRD's mission management system (MSIS) that provides a unified real-time situation awareness picture.

BIRD's MSIS boosts the overall mission effectiveness by integrating and managing the airborne sensors and subsystems and providing all users a common operational picture.

ASIO Advantages

- Operational in a number of military and para-military configurations
- Based upon extensive operational experience
- Supports real-time operation of multiple sensors and multiple air and ground operators
- Sensors and subsystem configuration can be adapted to fit any customer demand
- Installed on pre-owned or new aircraft (KA 200/350ER, Citation, PC-12 and others)



AIRBORNE MISSION SOLUTIONS



The Experts Behind The Aircraft

DYNAMIC JET ENGINEERING LTD. (DJE)

15 Abba-Eban Blvd. DIROM Bldg. Fl.1
P.O.Box 12832, Herzliya 4672533, Israel
Tel: 972-9-9514731
Fax: 972-9-9514733
E-mail: info@dynamicjet.com
Web Site: www.dynamicjet.com

Dynamic Jet Engineering Ltd. (DJE) was founded in 2004 as an aerospace company offering upgrades, modifications and conversions of military and civil aircraft.

DJE has extensive and proven experience in execution of conversions and aircraft upgrades in the field of special mission aircrafts and modernization projects. Its competences encompass all the disciplines applied for integration of:

- *Communications & Avionics* • *Various Payloads* • *Weapon Systems* • *Protection & Survival Suits*

DJE offers high value turn key projects from concept development to serial production. These include design, analyses, testing, integration, installation, production, training and certification of various airborne systems.

DJE maintains a steady staff of professionals who gained their experience in the aerospace industry in Israel and abroad.

DJE applies design tools like CATIA V, ENOVIA, NASTRAN etc. to meet the highest aviation industry standards.

DJE is AS 9100 certified, recognized contractor for international aerospace companies.



AEROSUPPORT



AeroSupport encompasses a wide range of services such as Contractor Logistics Support (CLS), Performance Based Logistics (PBL) and Private Finance Initiative (PFI) programs in which the contractor owns, maintains and operates aircraft, equipment and structures and is reimbursed according to flight hours.

ELBIT SYSTEMS - CYCLONE LTD.

P.O.Box 114
 Karmiel 2015600, Israel
 Tel: 972-4-9960710
 E-mail: aerospace@elbitsystems.com
 Web Site:
www.elbitsystems.com/cyclone



Elbit Systems' experience with military aircraft upgrades & CLS programs yields innovative solutions to grounded fleet situations. We determine the needs to keep aircraft operational, identify spares requirements, acquire spares, repair or replace faulty equipment, refurbish and return the aircraft to service and provide follow-on support. A typical CLS program is a 'window in the wall' operation with guaranteed spares availability, component repair, on-site technical assistance and maintenance, training & documentation.

Snunit Aviation Ltd. is a certified operator of the GROB 120A-I for the IAF Flight School. A fully owned subsidiary of Elbit Systems Ltd., Snunit's main purpose is to provide 100% of the screening sorties for the IAF Flight School. Snunit operates 17 GROB 120A-I trainer aircraft in accordance with civil regulations and laws. All technical/ logistical and maintenance tasks are done in-house together with Elbit Systems' Cyclone subsidiary.

Cyclone Aviation Products Ltd. offers numerous capabilities including design and manufacture of fixed and rotary wing metal and composite structural assemblies. Cyclone's services are performed domestically and internationally. They include overhauls, maintenance, systems installation, integration and upgrades. Cyclone has earned the citation of "Preferred Supplier" from Boeing, Inc.

Elbit Systems and its service-related subsidiaries provide:

- **Maintenance Activities (Outsourcing)** - Performance of maintenance activities
- **Overhauls & Refurbishments** - Return to service & upgrades for aircraft and helicopters.
- **R & R - Repair & Return** - "D" Level Product Support
- **CLS Contractor Logistic Support** - "I" & "D" Levels Availability of Spares, Logistics Management
- **PBH Power By the Hour** - "O", "I" & "D" Levels Availability of Aircraft



ENHANCED PAYLOADS FOR THE F-16



ELBIT SYSTEMS - CYCLONE LTD.

P.O.Box 114
Karmiel 2015600, Israel
Tel: 972-4-9960710
E-mail: aerospace@elbitsystems.com
Web Site:
www.elbitsystems.com/cyclone



600 GALLON External Fuel Tank for Extended Range

The 600 gallon external fuel tank, replacing the 370 gallon tank, offers a 35-45 percent increase in range or endurance, a 40 percent increase in combat air patrol time, and a 50 percent increase in operational range for Air-to-Ground missions. Fully backed by LMTAS, the 600 gallon fuel tanks have been purchased by the IAF and other leading air forces.

VER-2 - Vertical Ejection Bomb Rack

The Vertical Ejection Bomb Rack - VER-2 is a unique Elbit Systems' product, replacing the old TER-9 to provide an excellent solution for smart bomb carriage.

The VER-2 has been operational with the IAF for 10 years as the main F-16 bomb rack.

F-16 capabilities with VER-2:

- Additional weapon station - station 5.
- Mil- 1760 capability.
- Improved CEP. (Vertical Ejection).
- Low turnaround time.
- Improved release reliability.
- Release control for special weapons requirements.
- A variety of already cleared envelopes of Mk-82, Mk-83, CBU's etc.

Weapon Pylon for F-16 Stations 2 & 8

The sole solution for using F-16 stations No. 2 and 8 as weapon stations, the new pylon offers an extra 500 lbs. load capacity.

Stations 2 & 8, stores options include:

- Flare dispensers SUU-25
- Any stores up to 500 lbs.

AIRCRAFT UPGRADES

Elbit Systems

Elbit Systems' proven capabilities in design, manufacture and integration of advanced avionics in numerous Eastern and Western platforms, trainers and front-line fighter aircraft ensure enhanced performance and operational capabilities.

ELBIT SYSTEMS LTD.

P.O.Box 539
Advanced Technology Center
Haifa 3105301, Israel
Tel: 972-4-8315315
E-mail: aerospace@elbitsystems.com
Web Site: www.elbitsystems.com



Avionics Key Features:

- Open, modular architecture
- Core Avionics with complete redundancy
- New standards in Man-Machine-Interface
 - True Glass Cockpit
 - Display and Sight Helmet
 - HOTAS, HUD and UFCP
 - Digital Moving Map Generator (DMG)
- Advanced systems integration
 - Multimode RADARs
 - 4th generation weapons
 - Reconnaissance and Targeting pods
 - Data Link system

Tailored to customers' needs

- Integration of legacy and new weapons
- Integration of Eastern and Western armament
- NATO and ICAO compatibility

Operational Benefits:

- All weather, day/night capabilities
- Improved situational awareness
- Navigation and weapon delivery accuracy
- Increased safety and survivability
- Inherent growth potential and provisions
- Embedded debriefing capability

Long Term Support:

- Complete ILS package
- Proven CLS, PBH and PFI operation concepts
- On-site assistance
- Structural reinforcements and improvements



Eastern and Western Platforms



**B767-MMTT
(Multi Mission
Tanker Transport)**

**C-130
UNDERGOING PDM**



**SPECIAL MISSION
A/C CONVERSION**

**AIR REFUELING
POD**



**B-767
CARGO CONVERSION**

**F-110 ENGINE
OVERHAUL & REPAIR**



**LANDING GEARS
OVERHAUL
& REPAIR**



**Israel Aerospace Industries Ltd.
BEDEK Aviation Group**

Ben Gurion Int'l Airport 7010000 Israel
Tel: 972-972-3-9353845 ; 972-52-3663023
Fax: 972-3-9354262 E-mail: mscharf@iai.co.il

BEDEK - Full Service Provider:

The Bedek Aviation Group is the world's leading aviation maintenance center providing operators with the full range of maintenance services, from aircraft repair, overhaul and upgrading, up to engineering development, conversions and modernization programs, including engines and components maintenance - all under one roof.

With more than fifty years of solid, field-proven experience, and having around 3,000 high-skilled personnel, Bedek Aviation Group provides the entire gamut of technical and logistics support for aircraft, engines and components.

Bedek Aviation Group comprises the following Divisions: Aircraft Division; Programs Division; Engines Division; Components Division and Flight Operation Center

Aircraft:

- Boeing (Douglas) 707, 727, 737, 747, 757, 767, 777, DC-10, MD-80, MD-11
- Lockheed L382, C130
- Airbus A320 Series, A330 Series, A340 - 200/300
- Bombardier - Challenger CL600 Series
- IAI (Gulfstream) - G100, G150, G200 Series
- Hawker Siddeley - HS800 Series

Engine:

- P&W - JT3D-3B/-7, JT8D-7A thru - 17R, JT8D-200 Series, JT9D-7A thru- 7J, - 7Q, & 7R4's, F100, J52, 4000's
- PWC - PT6A-27 thru- 42, PT6A-50, PT6T Series
- G.E. - CF34-8E/C, J79, F110
- CFM I - CFM56-2,-3,-5,-7 Series
- RR - T56-15A/501
- Honeywell - T53
- IAE - V2500

Components & Systems:

- 13000 types of Components & Air Refueling Systems (PODS; HDU)

Annual Volume of Work:

- 30 Aircraft Conversion & Upgrading
- 150 Aircraft O/H & Maintenance
- 550 Engines O/H & Repair
- 40,000 Components O/H & Repair
- Total Maintenance to Support 65,000 fl. hrs

Approved & Licensed by the:

- Israel Civil Aviation Administration (CAA) # 01
- International Standards Organization ISO 9001:2000, 14000 AS 9100
- United States Federal Aviation Administration (FAA) # MK1Y325K
- European Aviation Safety Agency - Ref. EASA .145.0029
- Israel Standard 18000 and many others

Air to Air Refueling (AAR)

Bedek Aviation Group is a world leader in AAR Refueling, offering both Multi Mission Tanker Transport (MMTT) conversions' like the B767-200 ER MMTT and advanced refueling systems - Pods, Hose Drum Units (HDU) Fly by Wire Booms, Remote Operator Stations and more.

FIGHTER AIRCRAFT UPGRADE SUITE



IAI ELTA SYSTEMS LTD.

P.O.Box 330, Ashdod 7710202, Israel

Tel: 972-8-8572410

Fax: 972-8-8561872

E-mail: market@elta.co.il

Web Site: www.elta-iai.com

ELTA - Our Systems, Your Advantage

Advanced Self Protection Systems

ELL-8212/22 (Pod), ELL-8247/8 RWJS (Internal)

The Power-Managed Self Protection System (SPS) increases fighter aircraft survivability during operations in hostile electro-magnetic weapon system environments. The ELL-8212/22 and ELL-8247/8 perform electronic countermeasures against radars classified as threats and suppress the effectivity of hostile weapon systems. The systems are flight line reprogrammable for diverse threats, ECM techniques, and mission data. The SPS can be integrated with active reaction systems such as Chaff and Flares dispensers.



Multimode Fire Control Radar

ELM-2032

The ELTA ELM-2032 is an advanced Multimode Fire Control Radar for multi-mission fighters. It is designed for air-to-air, air-to-ground and air-to-sea missions. Modular hardware design, full software control and flexible avionic interfaces, ensure that the radar can be installed in most fighter aircraft and may be customized to meet the most stringent user requirements. The ELM-2032 radar design combines ELTA's technical expertise with extensive operational experience gained by the Israeli Air Force.

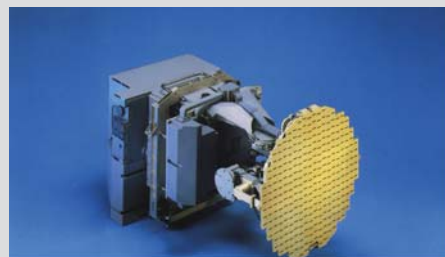

RTP - Radar Targeting Pod

ELM-20600

The ELTA ELM-20600 RTP is a unique Radar Targeting Pod featuring high performance Synthetic Aperture Radar (SAR) Imaging, Ground Moving Target Indication (GMTI) and Precision Target Tracking. The RTP is a complete All-Weather, Autonomous Real Time System. Data from the RTP is instantaneously displayed to the air-crew, significantly shortening Sensor-to-Shooter loops. The RTP provides high quality radar images of ground targets and terrain from Stand-Off ranges, even through clouds, rain, fog, battlefield smoke and man-made camouflage.

Active Phased Array Airborne Fire Control Radar

ELM-2052

The ELTA ELM-2052 is an advanced Airborne Fire Control Radar (FCR) designed for air-to-air superiority and advanced strike missions. The FCR is based on fully solid-state active phase array technology. This new technology enables the radar to achieve a longer detection range, higher mission reliability and a multi-target tracking capability of up to 64 targets. The ELM-2052 radar introduces new dimensions to the Air-to-Air, Air-to-Ground and Air-to-Sea operation modes of the aircraft by incorporating ELTA's decades of field-proven experience and operational feedback from Israeli Air Force combat pilots.



AEROSTRUCTURES & ELECTRICAL HARNESSSES

Build-to-Print / Build-to Spec



Israel Aerospace Industries Ltd.
Military Aircraft Group, LAHAV Division

LAHAV DIVISION MILITARY AIRCRAFT GROUP

Israel Aerospace Industries Ltd.
Ben-Gurion Int'l Airport, 7010000, Israel
Tel: 972-3-9353163, 9358198
Fax: 972-3-9353687, 9357010
E-mail: lahav_marketing@iai.co.il
Web Site: www.lahav-iai.com

Lahav has over 30 years experience in the design, development, manufacture, assembly, and testing of aircraft structures. Lahav has the infrastructure, skilled personnel, and fully equipped facilities to meet the demands of the production of quality aerostructures:

- Engineers specializing in design, structures, materials, testing, production, tooling & liaison, to implement advanced manufacturing and assembly methodologies
- Manufacturing capabilities: for machined parts, forged parts, sheet-metal parts, welded structures, bonded structures, and composite parts
- Proven management and control tools for assembly optimization, procurement management, quality control, lean initiatives with constant improvement

ELECTRICAL HARNESSSES

- Design and production using IAI's unique HarnesSys / CEED system
- Fully computerized harness production and testing
- Aircraft and helicopter rewiring
- Supplier of helicopter and aircraft wiring harnesses including the rewiring kit for the USAF F-15C/D aircraft



*F-15 Conformal Fuel Tank
Production at Lahav*



F-16 Wings Production at Lahav

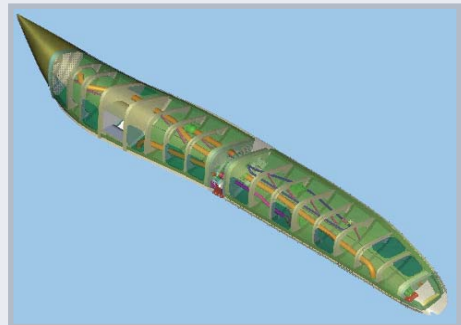

*F-16 Conformal Fuel Tank Detailed
Design & Production at Lahav*



Total Electrical Harnesses Capability



F-16 Vertical Fin Production at Lahav

HELICOPTER UPGRADE & MAINTENANCE



Israel Aerospace Industries Ltd.
Military Aircraft Group, LAHAV Division

LAHAV DIVISION MILITARY AIRCRAFT GROUP

Israel Aerospace Industries Ltd.
Ben-Gurion Int'l Airport, 7010000, Israel
Tel: 972-3-9353163, 9358198
Fax: 972-3-9353687, 9357010
E-mail: lahav_marketing@iai.co.il
Web Site: www.lahav-iai.com

Lahav provides a single address for helicopter maintenance, overhaul, refurbishment, retrofit, upgrade and modernization.

Lahav has the in-house infrastructure to transform all types of helicopters to meet today's and tomorrow's mission requirements. Lahav has successfully implemented numerous programs on a wide range of Eastern and Western platforms, including the Black Hawk, Apache, Bell 205/206/212/412, CH-53, Seaking, Mi-8/17, Mi-24/35, Ka-32, and ALH helicopters.

Lahav helicopter upgrades provide tailoring to the Customer's exact requirements:

- Enhanced mission performance with new capabilities for day/night missions
- Unique mid-air collision avoidance system for enhanced safety
- "Glass Cockpit" with optimized system display and control for reduced pilot workload
- NVG compatibility
- Integration of new avionics, navigation systems, observation/targeting sensors and weapons
- Effective self-protection systems
- On the ground and in cockpit mission planning

Lahav helicopter maintenance support capabilities and assets include:

- Authorized maintenance, inspection and repair center
- Helicopter overhaul and life extension
- Inspection and overhaul of engines, dynamic components, instrumentation and accessories
- Repair and balance of rotor blades
- Refurbishment of damaged and crashed helicopters
- Solutions for obsolete systems
- Comprehensive engineering & integrated logistic support



Mi-17 with Lahav Avionics & Glass Cockpit



Lahav's Upgraded CH-53



Lahav's Armed Mi-17



Lahav's Helicopter Maintenance Center

MILITARY AIRCRAFT UPGRADE & MAINTENANCE



Israel Aerospace Industries Ltd.
Military Aircraft Group, LAHAV Division

LAHAV DIVISION MILITARY AIRCRAFT GROUP

Israel Aerospace Industries Ltd.
Ben-Gurion Int'l Airport, 7010000, Israel
Tel: 972-3-9353163, 9358198
Fax: 972-3-9353687, 9357010
E-mail: lahav_marketing@iai.co.il
Web Site: www.lahav-iai.com

Lahav has proven experience in the design, development, manufacture, assembly, and upgrade of military aircraft. Lahav has successfully implemented programs on a wide range of Eastern and Western platforms, including the F-16, F-15, F-5, F-4, Kfir/Mirage, A-4, L-39, and MiG/Sukhoi aircraft.

Lahav's upgrade programs include comprehensive integrated logistic support packages.

Lahav upgrades provide:

- New capabilities for improved performance, mission success and flight safety
- Integration of advanced sensors and weapons to effectively combat new and changing threats
- EW packages for enhanced survivability
- Reduced pilot workload with "Glass Cockpit" and optimized system displays and controls
- Tailored systems to meet specific Customer requirements:
 - Advanced Net Centric Computer
 - Data Link (with over 20 years data link and network applications experience)
 - Fire Control Radar
 - Navigation and Communication systems
 - Digital Moving Map
 - Mission Planning and Debriefing systems

In addition to upgrade capabilities, Lahav also has the necessary maintenance, overhaul, and return to service infrastructure, to support the entire range of military aircraft programs. These capabilities include:

- Maintenance, repair, overhaul & structural life extension programs
- Solutions for obsolete systems & aging aircraft
- Flight safety improvements
- Airframe and structural modifications
- Engineering support & services



Lahav's Upgraded Glass Cockpit



Lahav Upgraded Combat Aircraft



Weapon Integration by Lahav



Lahav's Aircraft Maintenance Center

AVIONICS SYSTEMS AND AIRCRAFT UPGRADES

ISR Mission Aircraft Upgrade



RADA Electronic Industries LTD.

P.O.Box 8606
7 Giborei Israel Blvd.,
Netanya 4250407, Israel
Tel: 972-9-892-1111
Fax: 972-9-885-5885
E-mail: mrkt@rada.com
Web Site: www.rada.com



RADA offers affordable ISR Mission Aircrafts upgrade suits for any medium size military cargo airborne platform. Upon request RADA can provide the platform as well.

The ISR Mission Aircraft is a strategic asset that can detect hostile activities near and beyond the nation's borders from distant ranges (up to 50 kilometers, depending on the sensor), in day/night and almost all-weather scenarios. It is highly effective in low-intensity conflicts as in wartime. Using a special sensor suit, it provides a solution tailored for detection of rainforest illegal activities.

The combination of high-end sensors with the affordable costs of light commercial style aircrafts offers a low-cost alternative to UAVs and gives an easy access to the world of real time on demand intelligence.

Among the threats and illegal activities that the ISR Mission Aircraft System can survey, detect, isolate and designate are the following:

- Troops (Vehicles, Personnel, etc.)
- Human-Made Objects (Tunnels, Footpaths, Fabrics, Mines, Roads)
- Illegal agriculture, Water contamination, Stem Counting in forests
- Radio Communication monitoring and position fixing at frequencies between 30MHz to 3,000MHz (with the ability of accurate geographical fixing of any satellite communication)
- Changes detection compared to previous ISR missions

RADA's ISR sensors suit includes the following categories:

- Imaging Intelligence (IMINT) Systems (FLIR, High-resolution Digital Camera, Hyper Spectral Camera)
- Communication Intelligence (COMINT) Systems (including direction finding/position fix)
- Communication with Command & Control Units (Data Link, Satellite Communication, Radio, etc.)
- Mission Command & Control over the sensors suit and other platforms onboard the aircraft

RADA's ISR Mission Aircraft includes a ground infrastructure providing ISR mission planning, post-mission data analysis and mission data archiving able to network with any Command & Control station.

MISSION TAILORED SOLUTIONS



S.G.D ENGINEERING LTD.

P.O.Box 36637
Tel Aviv 6136601, Israel
41 Nachmani St., Tel Aviv 6777603
Tel: 972-3-5604135
Fax: 972-3-5602179
E-mail: marketing@sgd.co.il
Web Site: www.sgd.co.il

S.G.D Engineering Ltd. is a leading provider of Innovative Airborne Solutions for both the military and civil aviation markets. Over the past 30 years the company has successfully completed more than 140 projects worldwide. The company has demonstrated its expertise on a large variety of aircraft platforms and developed a broad range of airborne systems and products.

S.G.D Engineering Ltd. offers interdisciplinary Turnkey projects from design to serial production. These include concept development and analyses, design, production, qualification, testing, integration, installation and certification of various airborne systems.

S.G.D Engineering Ltd. Main Product Lines:

Airborne Pods development to serial production - Our pod package generally consists of the Environmental Control Systems (ECS), wire harnesses, power management and power generation systems. Our pods are deployed with airborne sensors and systems such as Reconnaissance Cameras (Recce), Synthetic Aperture Radars (SAR), ELINT, EW Jammers, chaff and flares dispensers etc.

Special Mission Aircraft - S.G.D is a leading provider of basic aircrafts platforms conversion into special mission aircraft. S.G.D's capabilities and experience in upgrade and modernization programs makes it a well qualified partner for such kind of programs.

Quality Assurance (QA)

S.G.D has been assessed and registered by NQA against the provisions of **AS 9100 Revision C** and **BS EN ISO 9001: 2008**



ELECTRO-OPTIC INTELLIGENCE, SURVEILLANCE AND RECONNAISSANCE (ISR)

Litening - Targeting & Navigation Pod

Litening is an innovative airborne infra-red targeting and navigation pod for fighter aircraft with high accuracy and reliability, day and night precision strike capability. Litening reduces pilot workload during targeting and tracking. It is easily integrated on any aircraft and possesses high growth potential.

In use in the Israeli Air Force, USAF, ANG, AFRES, Marines, German AF, Swedish AF, Spanish Navy & AF, Greek AF, and others, the Litening flies on F-16 , F-15, A-10, B-52, AV8-B, Gripen, Tornado, F-5, F-4, Mig-21, Mirage 2000, Jaguar and others.



Toplite EO System - Electro-Optical Surveillance, Observation & Targeting System

The Toplite family of electro-optic systems is an advanced multi-sensor, multi-purpose, highly stabilized EO systems for homeland security and defense applications, for aerial, maritime and ground based platforms.

RecceLite- Real Time Tactical Reconnaissance System

The RecceLite System consists of an E-O pod, a ground exploitation station and a data link. It is capable of collecting images day & night from 300 ft to 40,000 ft in all directions forwards, nadir, backwards, oblique - all down hemisphere and even when the aircraft is maneuvering in high G. The Ground Exploitation Station (GES) is capable of generating targets in real-time with exceptionally high accuracy due to state-of-the-art algorithms and technology. The data-link connects between the sensors and the GES and enables the images to be downloaded to the GES in real time. When your task is to close the attack cycle on many "time-critical targets" in less than 10 minutes, there is only one system - RecceLite.

Recce-U - Real-Time Persistent ISR System for UAVs

Recce-U is a self-contained, multi-sensor ISR system (based on the RecceLite Tactical Reconnaissance Pod). The Recce-U enables automatic photography, according to a mission plan prepared in advance, or updated mission plan uplinked in real-time, however the operator can initiate manual scanning for targets of opportunity.



Litening -on-Gripen



Toplite EOS



RecceLite System



Recce-U

RAFAEL
ADVANCED DEFENSE SYSTEMS
 P.O.Box 2250 (19)
 Haifa 3102102, Israel
 Tel: 972-4-8794714
 Fax: 972-4-8794657
 E-mail: intl-mkt@rafael.co.il
 Web Site: www.rafael.co.il

SpotLite Family
Electro-Optic Enemy Fire Detection System

The SpotLite family consists of electro-optical systems that detect and locate enemy fire in stationary positions as well as on the move. Rapid detection and precise location information provide forces with the capability to quickly neutralize the enemy, maintaining the upper-hand on the battlefield. The **SpotLite P** is a portable electro-optic system carried by two soldiers for day and night detection and location of small arms fire.



SpotLite P on Tripod

SpotLite M is a mobile electro-optic system installed on vehicles and AFV's that enables the detection and location of enemy fire sources from small arms, RPG rockets, ATGM and tank shells, on the move, day and night, up to 360° coverage.



SpotLite M on vehicle

Imilite - Multi-Source Multi-Task ISR Exploitation System / Command and Control System

Imilite is an intelligence system designed to receive process and exploit multiple standalone imagery video and other intelligence data in a centralized and a unified way.

Main system capability includes the reception, processing and exploitation of EO, IR, SAR/GMTI and VIDEO, in various formats, over one desktop. In order to enhance the exploitation process, Imilite further combines non-imagery data such as targets, threats, COMINT detection and mission status within the system workflow. Imilite generates a variety of standard and customer tailored ISR reports and IMINT products such as alphanumeric reports, annotated maps, GIS data layers and visual aids, and disseminates them to external information and operation systems over standard and tailored protocols.

Imilite's multi-source data integration and automation capabilities improve the efficiency of utilizing available collection and exploitation assets. The system GIS capabilities provide immediate accessibility to relevant imagery and intelligence data, thus shortening the ISR collection and exploitation cycle.

The Imilite is based on Rafael's combat-proven ISR and C⁴I systems already in service worldwide. Imilite is designed for use by Defense forces (air, ground) and police forces exercising various observation means for border patrol or coping with urban crime.



Imilite

ACKERMAN
 printing & photoanodize
 4 Volfson St.,
 Netanya 4237404, Israel
 Tel: 972-9-8823456
 Fax: 972-9-8624683
 E-mail: info@ackerman-printing.com
 Web Site:www.ackerman-printing.com

"We Label You Smart"

Ackerman printing & photoanodize specializes in the manufacture of anodized aluminum labels using metal-photo technology, screen printing & pad printing. We can turn any computerized file into a product with thickness of 0.003" - 0.032" (0.076-0.8 mm) finish in accordance with requirements, specification, or drawing. Thanks to their characteristics and high durability the signs manufactured at our plant are used in diverse industries including the electronics, electro-optics, aeronautical and military industries naval divisions and space industries. **Ackerman printing & Photoanodize was founded in 1953** and we offer our customers the perfect blend of new and old: state-of-the-art technology combined with years of tradition, knowledge and experience.

- Metalphoto nameplates, tags, labels • Dials and scales • Data matrix marking - U.I.D •
- R.F.I.D Tags • Piping labels for marking and identification systems in aircrafts •
- Warning flags - Remove Before Flight • Polyester and PVC labels • Stainless steel Signs •
- Overlays - Lexan panels • Engraving labels and panels • Laser marking •



MOTION & POWER SYSTEMS



BENTAL INDUSTRIES LTD.

Merom-Golan 1243600, Israel

Tel: 972-4-6960199

Fax: 972-4-6960187

E-mail: Bental_marketing@bental.co.il

Web Site: www.bental.co.il

Bental industries specializes in design and manufacture of innovative power and motion systems integrated into various ground and aerial platform and applications:

- Electric Motors
- Servo Actuators
- Blowers & Dust Scavengers
- Alternators & Starter Alternator

The company's ability to tailor cutting edge technology and innovative design to specific project requirements enables it to comply with the most challenging demands.

See also page 132



JET ENGINES AND GAS TURBINE ENGINES



Bet Shemesh Engines Ltd.

Bet Shemesh Engines Ltd. (BSEL) is Israel's creative center for developing, manufacturing, overhauling, and repairing jet engines for aircrafts and helicopters, and investment castings for aerospace and general industry.

BSEL MANUFACTURES VARIOUS ENGINES PARTS:

- Rotating machined parts such as disks, rings, seals, spacers, axial wheels
- Sheet metal parts and welded parts such as nozzles, combustion chambers, flameholders and shrouds
- Housings, pump covers
- BSEL produces parts for various engines, e.g. F100, J79, PW4000, PWC306, PWC307, PWC545, PWC530, V2500, CF6, CF34, PW1200, PW1500.

BSEL OVERHAULS, UPGRADES AND REPAIRS THE FOLLOWING ENGINES:

- PW-F100, 229
Overhaul, upgrade and repair of subassemblies, modules and engines
- GE-T700/CT7
Overhaul and repair
- J79-GE-J1E and J79-GE-17
Overhaul and repair of main assemblies
- RR 250 C20 & C30
Repair and overhaul of the engines
- PT6A, PT6T
Repair and overhaul of the engine

F100 engine in Bet Shemesh Engines' test cell

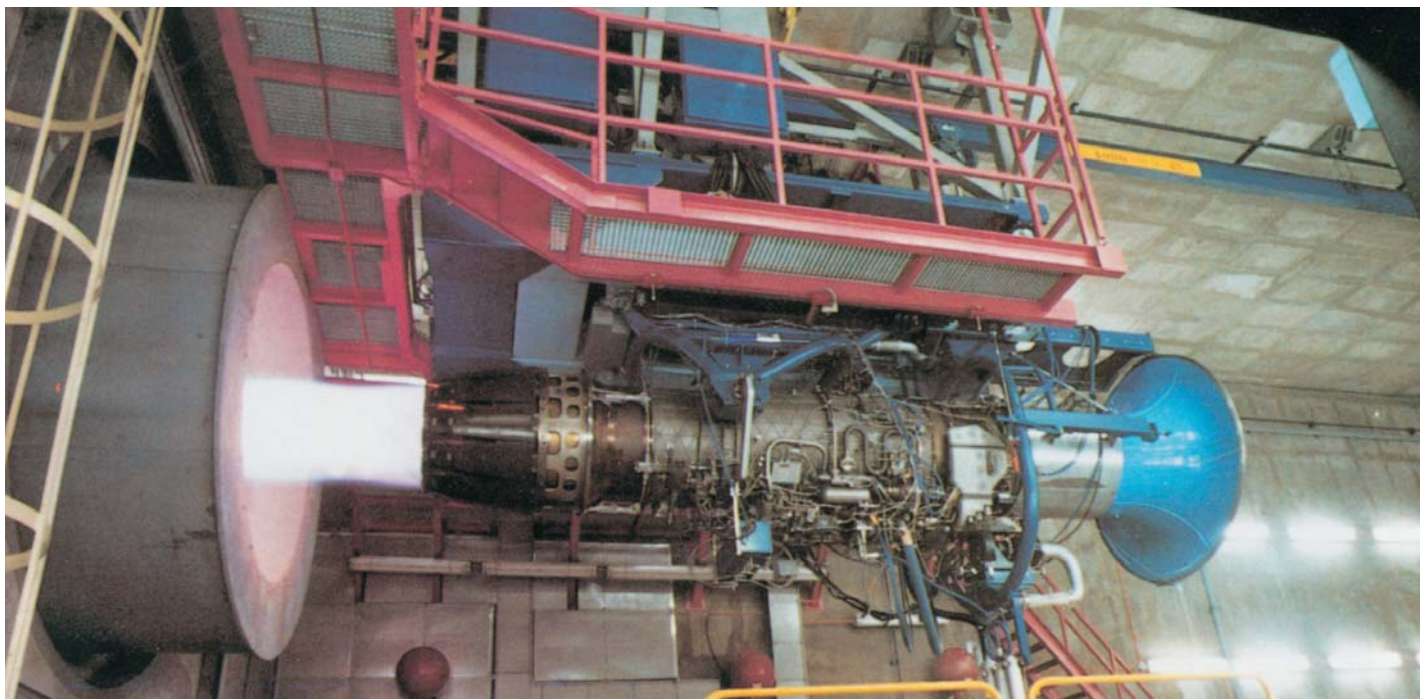

BET SHEMESH ENGINES LTD.

1 Virginia Avenue
Western Industrial Zone
Bet Shemesh 9905529, Israel
Tel: 972-2-9909486/7
Fax: 972-2-9911970
E-mail: info@bsel.co.il
Web Site: www.bsel.co.il

BSEL'S FOUNDRY SUPPLIES THE AEROSPACE INDUSTRY WITH:

- Gas turbine blades, vanes and integral wheels
- Aircraft engine components
- Airframe structural and integrated parts

R&D

The Division designs and develops small turbojet engines for UAVs.

CUSTOMERS

BSEL boasts a variety of customers, mainly engine manufacturers and users. They include Pratt & Whitney, GE Aviation, Hamilton Sundstrand, MTU Aero Engines, Israel Air Force, US Air Force, other air forces and navies around the world.

QUALITY ASSURANCE CERTIFICATIONS:

ISO 9001:2008 - AS 9100

Nadcap

FAA B7EY748J

EASA.145.0031

Bet Shemesh Engines' Quality Assurance system has all the above Standards as well as being approved by major OEMs such as Pratt & Whitney, GE Aviation, Hamilton Sundstrand, MTU Aero Engines, Israel Air Force and others. The Q.A. Department maintains complete inspection facilities, ranging from first article layout to final inspection. The company's laboratories provide nondestructive testing chemical analysis.

AEROSTRUCTURE METAL AND COMPOSITE



Israel Aerospace Industries Ltd.
Commercial Aircraft Group, RAMTA Division

RAMTA DIVISION

P.O.Box 323
Beer-Sheva 8410202, Israel
Tel: 972-8-6402250, 6272231
Fax: 972-8-6402252
E-mail: mktg@iai.co.il
Web Site: www.iai.co.il/ramta

PRODUCTS

AIRFRAME STRUCTURES (MILITARY AND CIVIL) METAL SHEET AND COMPOSITES

The IAI Ramta Division is a center of excellence for the design and manufacture of complex metallic and composite material aerostructures for both civilian and military fixed- and rotary-wing aircraft.

Certified to ISO-9001:2000, ISO-14001, ISO-18001 and certified by leading OEMs and militaries, major Ramta products include:

Folding composite stabilators, aircraft wings, rudders, horizontal and vertical stabilizers, cargo doors, ailerons, flaps, leading edges, UAV fuselages, bonded assemblies, canards, landing gear doors, air brakes, and access panels.

Kevlar parts (in production or under development): Fixed wing leading edges, wing and body fairings, ducts, wing tips, actuator fairings and interior panels.

Graphite-Kevlar epoxy hybrid parts (in production or under development): Landing gear doors.

Radomes made of glass, Kevlar and quartz from small to large sizes and symmetrical/asymmetrical shapes.

Ramta's customers include the Israeli Air Force and major foreign aircraft manufacturers.



Light-Weight Composite Helicopter Structure



Harpy Loitering Attack UAV Composite Fuselage Construction



F-15 Production Line



Gulfstream G200 (Galaxy) Empennage



UH-60M Folding Composite Stabilator (RH)



B-777 Empennage Leading edge and Tips

AEROSPACE & MILITARY SUPPLIES



I.S.P. INDUSTRY SALES PROMOTION LTD.

1 Lishansky St., P.O.Box 500
 New Industrial Zone
 Rishon-Lezion 7510401, Israel
 Tel: 972-3-9513333
 Fax: 972-3-9514444
 E-mail: ariel.goldman@isp-aero.com



Kaman K-Max Helicopter

- ◆ Established in 1977
- ◆ Provision of military and security consulting services
- ◆ Supply of military and aerospace equipment including hydraulic, pneumatic, fuel, structural, electronic and electrical systems, components and hardware
- ◆ Representation of foreign companies in Israel
- ◆ Promotion of products and services in the civilian and defense markets

I.S.P is Acting in the following fields:

- ◆ Aerospace systems and components (commercial and military)
- ◆ Weapon systems and components
- ◆ Overhaul and repair of aviation and military systems and components
- ◆ Hardware, Spare parts for aerospace and military equipment
- ◆ Participation in upgrading programs
- ◆ Border defense projects
- ◆ Small arms, artillery and various types of ammunition
- ◆ Composite materials

I.S.P is An exclusive representative and consultant of the following companies:

- ◆ KAVLICO - RVDTs, LVDTs, Cockpit controls
- ◆ B/E Aerospace - Hardware, bearings, spare parts for the aerospace industry including aircraft, helicopters and military equipment
- ◆ ITT AEROSPACE CONTROLS - actuators, regulators, solenoid and motor operated valves, airborne switches
- ◆ KAMAN - Manufactures of the K-MAX helicopter
- ◆ PNEUDRAULICS - hydraulic and pneumatic components and systems for the aerospace industry. Utility and solenoid valves, reservoirs, actuators
- ◆ NHBB - ball bearings, rod ends bearings, spherical bearings and thin section, ceramic and special bearings
- ◆ CRISSAIR - special miniature self-retained check and relief valves, restrictors, and other inline and cartridge valves for aerospace and military
- ◆ CROUZET - Pilot's control wheels, electrical limit switches, proximity switches and circuit breakers for military and aerospace industries



Servo Valves

Cockpit Control Systems

Valves

Control Wheel

COMPOSITE MATERIALS AND METALLIC APPLICATIONS FOR AEROSPACE AND MEDICAL DEVICES INDUSTRIES



KANFIT LTD.

Shaul Amor Avenue,
Ramat Gabriel Industrial Zone,
Migdal Haemek 2353002, Israel
Tel: 972-4-6547461
Fax: 972-4-6441065
E-mail: shachar@kanfit.com
Web Site: www.kanfit.com

Specializing in the combination and integration of composite and metal production for aerospace structures under one roof, Kanfit is a built to spec (and built to print) aerospace engineering development and production company. We offer turnkey solutions from customer product specifications to serial production. Our capabilities and expertise in Metal and composite structures, enable us to manufacture state of the art Hybrid structures and RTM products among high quality metal parts from sheet metal & block, and composite parts.

Kanfit quality assurance system is AS9100C & ISO 9001:2008 certified. Qualified by NADCAP, Boeing, Agusta Westland & Hamilton-Sundstrand for Heat treatment of Aluminum alloys and welding.

Our projects include parts and assemblies for: Gulfstream G150 & G280, 7X7, A320, F15, F16, F18, F35, Typhoon, Heron Eitan, Hermes 450 & 900 UAVs, UH60, V22, RTM chaff and flare magazines, Missiles and munitions parts, Airborne RTM antennas, Space Antennas, tools, fixtures, jigs, etc. Among our customers are Israel Aerospace Industries, Elbit Systems, Senior Aerospace, Rafael, Symetrics Industries, BAE systems and more.

Kanfit is active in the medical device industry where there is a growing demand for hybrid structures.

Description of offered products and services:

Composite parts and integrated assemblies:

- Resin Transfer Molding
- Liquid Resin Infusion
- Prepreg - oven & vacuum
- Wet lay up
- Knowledge and access to Autoclave

Plastic:

- Hot forming
- Vacuum forming
- Transparencies

Sheet Metal & Blocks, Primary parts & assemblies:

- Machining
- Forming
- Welding
- Processes (heat treatment, chemical conversion, etc)
- Painting

Space:

Manufacturing and assembly of jigs and deployable antennas



RTM chaff & flare magazine

UAV engine cowling

G280 Hybrid pedestal

RTM folding wing

G280 Hybrid instrument panel

CFRP satellite dish

ELECTRO-OPTIC INTELLIGENCE, SURVEILLANCE AND RECONNAISSANCE (ISR)

Litening - Targeting & Navigation Pod

Litening is an innovative airborne infra-red targeting and navigation pod for fighter aircraft with high accuracy and reliability, day and night precision strike capability. Litening reduces pilot workload during targeting and tracking. It is easily integrated on any aircraft and possesses high growth potential.

In use in the Israeli Air Force, USAF, ANG, AFRES, Marines, German AF, Swedish AF, Spanish Navy & AF, Greek AF, and others, the Litening flies on F-16 , F-15, A-10, B-52, AV8-B, Gripen, Tornado, F-5, F-4, Mig-21, Mirage 2000, Jaguar and others.



Toplite EO System - Electro-Optical Surveillance, Observation & Targeting System

The Toplite family of electro-optic systems is an advanced multi-sensor, multi-purpose, highly stabilized EO systems for homeland security and defense applications, for aerial, maritime and ground based platforms.

RecceLite- Real Time Tactical Reconnaissance System

The RecceLite System consists of an E-O pod, a ground exploitation station and a data link. It is capable of collecting images day & night from 300 ft to 40,000 ft in all directions forwards, nadir, backwards, oblique - all down hemisphere and even when the aircraft is maneuvering in high G. The Ground Exploitation Station (GES) is capable of generating targets in real-time with exceptionally high accuracy due to state-of-the-art algorithms and technology. The data-link connects between the sensors and the GES and enables the images to be downloaded to the GES in real time. When your task is to close the attack cycle on many "time-critical targets" in less than 10 minutes, there is only one system - RecceLite.

Recce-U - Real-Time Persistent ISR System for UAVs

Recce-U is a self-contained, multi-sensor ISR system (based on the RecceLite Tactical Reconnaissance Pod). The Recce-U enables automatic photography, according to a mission plan prepared in advance, or updated mission plan uplinked in real-time, however the operator can initiate manual scanning for targets of opportunity.



Litening -on-Gripen



Toplite EOS



RecceLite System

Recce-U

RAFAEL
ADVANCED DEFENSE SYSTEMS
 P.O.Box 2250 (19)
 Haifa 3102102, Israel
 Tel: 972-4-8794714
 Fax: 972-4-8794657
 E-mail: intl-mkt@rafael.co.il
 Web Site: www.rafael.co.il

SpotLite Family
Electro-Optic Enemy Fire Detection System

The SpotLite family consists of electro-optical systems that detect and locate enemy fire in stationary positions as well as on the move. Rapid detection and precise location information provide forces with the capability to quickly neutralize the enemy, maintaining the upper-hand on the battlefield.

The **SpotLite P** is a portable electro-optic system carried by two soldiers for day and night detection and location of small arms fire.



SpotLite P on Tripod

SpotLite M is a mobile electro-optic system installed on vehicles and AFV's that enables the detection and location of enemy fire sources from small arms, RPG rockets, ATGM and tank shells, on the move, day and night, up to 360° coverage.



SpotLite M on vehicle

Imilite - Multi-Source Multi-Task ISR Exploitation System / Command and Control System

Imilite is an intelligence system designed to receive process and exploit multiple standalone imagery video and other intelligence data in a centralized and a unified way.

Main system capability includes the reception, processing and exploitation of EO, IR, SAR/GMTI and VIDEO, in various formats, over one desktop. In order to enhance the exploitation process, Imilite further combines non-imagery data such as targets, threats, COMINT detection and mission status within the system workflow. Imilite generates a variety of standard and customer tailored ISR reports and IMINT products such as alphanumeric reports, annotated maps, GIS data layers and visual aids, and disseminates them to external information and operation systems over standard and tailored protocols.

Imilite's multi-source data integration and automation capabilities improve the efficiency of utilizing available collection and exploitation assets. The system GIS capabilities provide immediate accessibility to relevant imagery and intelligence data, thus shortening the ISR collection and exploitation cycle.

The Imilite is based on Rafael's combat-proven ISR and C⁴I systems already in service worldwide. Imilite is designed for use by Defense forces (air, ground) and police forces exercising various observation means for border patrol or coping with urban crime.



Imilite

ROCK WINGS

Rock Wings Ltd. is an aeronautical company serving the needs of its military, police, and civilian customers by providing modifications, technical support services and products for Fixed Wing and Rotary aircraft.

Rock Wings Ltd. offers:

■ Aircraft modifications:

- Night vision capabilities
- Airborne day and night compatible armament systems
- Armor protection for pilots and aircraft
- Various avionics and communication systems installation and integration (reconnaissance systems, chaff and flare units etc.)

- Aircraft technical inspections and evaluations

■ Law enforcement systems installation and integration

■ Services:

- Aircraft squadron establishment (operations and infrastructure)
- Establish customer's own aircraft maintenance capabilities
- Maintenance at customer's location
- Consultants
- Engineering
- Production

■ Pilots' training

■ Products:

- 2.75" Rocket Launchers
- Spare parts production

Rock Wings Ltd. has conducted projects in both western and eastern aircraft. Our projects have included:

■ Helicopter night vision illumination system modifications (including NVG supply and pilot training)

■ Helicopter Ballistic Bulletproof suit design, fabrication and installation

■ 0.5" machine gun design, kit fabrication and installation

■ 2.75" rocket launcher design, kit fabrication and installation

■ Pilots' training

■ Avionics installation

■ Spare parts production

■ And many more

Rock Wings Ltd. is ISO 9001 certified and all of its employees and subcontractors are certified to carry out aviation works. The company is a recognized contractor for various Defense Ministries around the globe and is an Israeli Ministry of Defense approved military exporter.

BALLISTIC ARMOR PROTECTION



Rock Wings Ltd.

11 Gazit St.,
Petach-Tikva 4927991, Israel
Tel: 972-2-5862468
Fax: 972-2-5713241
rockwings@rockwings.net
Web Site: www.rockwings.net

Flying into combat?

Concerned about being strafed
by ground fire?

Do you want to give your pilots
and aircrew the greatest
amount of shielding?

Rock Wings Ltd. will provide
you with practical solutions
designed to secure your
aircrew and passengers with
the highest levels of protection
and survivability.



MI 17 HELICOPTER



AS350B3 HELICOPTER

By offering "tailor-made" Armor Protection kits that use the most advanced, light-weight, battle-proven shielding panels comprised of Polyethylene composites, ceramics and other materials, Rock Wings Ltd. assures your aircrew and aircraft a maximum protection with a minimum weight penalty.

The Armor Protection kits are modular and can thus be easily removed from one aircraft and attached to another similar one thereby facilitating mission requirements. The panels are designed to fit the individual and unique needs of the customer in a cost effective way.

Recommended surfaces for protection kit application are pilot's seats, cockpit floor, passenger's seats etc.



LAMA HELICOPTER

ARMAMENT SYSTEMS

Most helicopters can be converted into a very effective Gun-Ship by adding compatible weapon systems.

Rock Wings Ltd. offers a pilot-operated Armament System for day- and night-time operations with machine guns, rocket launchers and other weapon platform that can be installed on both sides of the fuselage.

Our system fit not only helicopters but most Western and Eastern fixed- and rotary-winged multi-role aircraft and is custom designed to match customer's particular requirements.

Helicopter systems main components are:

1. External mount and 14" release units

An external mount is attached to the helicopter's fuselage providing stability for the weapons platform. 14" NATO release units are incorporated in the mount creating a carrying position for armaments or any other payload.



MI-17 Armament System

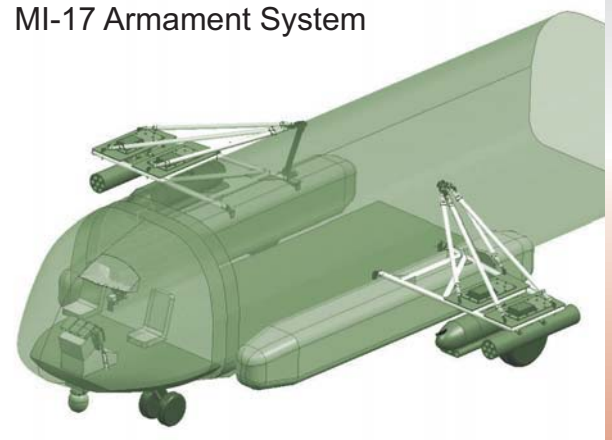

Rock Wings Ltd.

11 Gazit St.,
 Petach-Tikva 4927991, Israel
 Tel: 972-2-5862468
 Fax: 972-2-5713241
 rockwings@rockwings.net



2. Reflex Sight

The system is equipped with an electro-optical reflex sight used for axial weapons operations such as machine guns and rockets. The aiming reticle image is collimated to infinity and then reflected by a semi-transparent mirror that overlays it upon the target. An Electronic Control Unit controls the sight from the panel or from a switch located on the pilot's stick.

3. Laser Designator

Night aiming is accomplished by using a Long Range Infra-Red Laser Aiming Device which is installed parallel to the weapon allowing night targeting while using Night Vision Goggles.

4. Firing Control Box

The firing control box is located in front of the pilot, enabling the pilot numerous actions including control of the weapon type, choosing the firing side (LH, RH), number of rockets, laser designator, re-cocking and jettison in case of emergency. The system is secured by a safety pin which is removed prior to take off.



2.75" Rocket Launchers



5. Rocket Launchers and Rockets

Rock Wings Ltd. offers 2.75" FFAR & Wrap Around rocket launchers with single or ripple firing options.

The following are items available and sold separately:

- Electro optical reflex sight
- 2.75" FFAR & Wrap Around rocket launchers
- 14" suspension release unit

NIGHT VISION GOGGLE (NVG) COMPATIBLE CAPABILITIES



Rock Wings Ltd.

11 Gazit St.,
Petach-Tikva 4927991, Israel
Tel: 972-2-5862468
Fax: 972-2-5713241
rockwings@rockwings.net
Web Site: www.rockwings.net



Rock Wings Ltd. provides Night Vision Goggles (NVGs) capabilities. Our company excels in modifying aircraft lighting to comply with NVG requirements, trains pilots and technical staff in the new technology and supplies NVG and helmets.



Lighting Modifications

Rock Wings Ltd. offers a wide range of aircraft NVG compatible external and internal lighting modifications based on the cost-effective premise of modifying existing equipment. With the help of our own skilled and experienced NVG pilots and engineers, we offer our customers optimal NVG lighting adaptation. Our tailor-made options cover a range of customer specific requirements from mission needs and tactical environment considerations to budget issues and flight safety concerns.

Training

Flying with NVG is not just a matter of "Buy and Fly" - an instruction and training program is a must. Rock Wings Ltd. NVG instructor pilots - reserve officers of the Israel Air Force - offer the most advanced and focused NVG flight instruction program available.

Goggles

Rock Wings Ltd. offers a variety of lightweight and user-friendly binoculars mounted on a selection of helmets using a mounting adapter. The ANVIS are available with 2nd or 3rd generation, as well as XD-4 or XR5 intensifier tubes.



SPARE PARTS FOR THE MIRAGE AND KFIR FIGHTERS



Rock Wings Ltd.

11 Gazit St.,
Petach-Tikva 4927991, Israel
Tel: 972-2-5862468
Fax: 972-2-5713241
rockwings@rockwings.net
Web Site: www.rockwings.net

Rock Wings Ltd. is a well-known supplier of spare parts for the Mirage and Kfir fighters. Among the items that we have available are parts required for 'I, O and Depot Level' for Atar 9, Atar 9C, Atar 9K50 and Atar K50 engines. Our sources for supply have thousands of items which are available to our customers at competitive prices and dependable delivery. All parts are carefully inspected by highly qualified Quality Assurance Inspectors prior to shipment and are delivered with all the appropriate Serviceable Tags and Certificates of Conformance.



TRAINING AND INFRASTRUCTURE

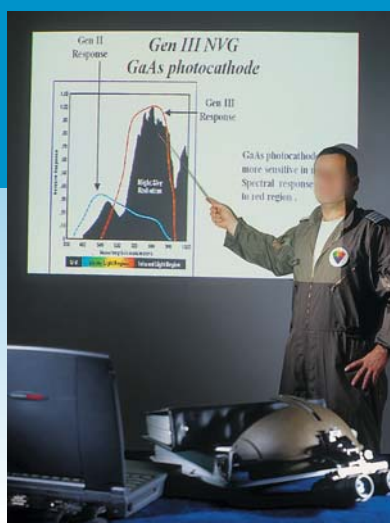

Operating an aircraft fleet in a professional way and being able to carry out every mission at all times requires great piloting skills, training, experience and a high level of maintenance.

Rock Wings Ltd. instructors, all former Israel Air Force pilots, have amassed hundreds of flight hours training pilots globally and are capable of instructing on a variety of aircraft in multiple languages.

Our training programs include (actual training program is outlined according to the customer's unique requirements):

1. Ground school - Theoretical training (ground school establishment if required can be offered)

2. In-flight training - Visual Flight Rules (VFR), Instrument Flight Rules (IFR), NVG flights, Cargo operations, SAR operations including rescue hoist, Medical evacuations, Firefighting and special missions.

In addition we offer **technical staff training** and **infrastructure establishment** which consists of:

1. Basic and theoretical training
2. Professional training as per customer requirements
3. Maintenance shops establishment including tooling, fixtures, publication etc.
4. Quality control, logistics and management

All training is done at operator's site.

EVERY DAY, WE FIND A WAY...

TO USE OUR SPEED, OUR STRENGTH, OUR INTEGRITY, OUR INGENUITY.



TSI -
Turbine Support International LTD.
9 Hamachtarot St.,
Ra'anana 4355007, Israel
Tel: 972-9-7716581
Fax: 972-9-7746573
E-mail: gadi@tsi.co.il
Web Site: www.tsi.co.il

Turbine Support International (TSI) Ltd.

applies the military and civilian experience that the company has acquired in the fields of tracing, import, export, organization, operations, field service and integrated logistic support (ILS), monitoring for weapon systems development and other aviation related activities in Israel and abroad. The company is currently involved in a wide range of operations, engineering, technical and commercial activities in the field of aviation.

Representing Foreign Firms

TSI serves as the Israeli representative of a number of leading, well-respected international firms, including:

- AAR Corporation (U.S.) and its various divisions
- Sifco Forge
- Akzo Nobel Advanced Coatings (ANAC)
- SOLIDFORM Inc,
- ARINC Aerospace
- Chemetall
- ARROW DYNAMICS LLC
- AERODATA
- AERO FASTENERS Co. Inc.

As such, the company is instrumental in introducing foreign companies to suitable partners in the Israeli industrial community, thereby facilitating the pursuit of joint ventures, strategic alliances and other areas of mutual cooperation and benefit.

At TSI the company takes advantage of the state of Israel's sophisticated technological infrastructure, calling on high-caliber human resources in a variety of high-tech fields. This has enabled us to garner hands-on experience in the import and export of military and civilian products, as well as consultancy and ILS service.

TSI in an excellent company to work with because of its:

- Multi-disciplinary skills in diverse fields such as mechanical/electrical engineering, avionics, aviation, weapon systems, software/hardware development and integration and more
- Years of experience in military & civilian arenas
- Worldwide customer base, with access to and experience in international markets
- Strong emphasis on after-sales service and professional customer support
- Diverse, dedicated and experienced team of professionals

Main Products and Services Supervision of:

- Weapons systems acquisition (aircrafts, helicopters and engines)
- Upgrading and modifications
- Military air-fields protection
- Communication systems

Professional Services

- Master plans
- Technical specifications
- Systems organization & administration
- Consulting
- Operational requirements and specification

Other Important Information Markets and Clients

- The Company's most important markets and clients include: Israel Aerospace Industries (IAI); Elbit Systems \ Cyclone; Israel Ministry of Defense; Israel Air Force; Israel Defense Force
- Airlines including: EL AL Israel Airline; Arkia; Israir; General Aviation
- Brief History: A former high-ranking officer, who had completed many years of dedicated service in the Israel Air Force, established TSI in 1987.



ILLUMINATED DISPLAY & CONTROL SYSTEMS



AEROMAOZ LTD.

Tel: 972-3-6095003
 Fax: 972-3-6095033
 E-mail: info@aeromaoz.com
 Web Site: www.aeromaoz.com

AEROMAOZ Ltd. established in 1980, is a world renowned designer and manufacturer of Illuminated Display and Control Systems. **AEROMAOZ** products can be found in the air, on the ground and at sea, in both military and commercial applications. Utilizing its expertise in Human-Machine Interface applications and Night Vision Imaging Systems (NVIS) lighting compatibility, **AEROMAOZ** had participated in prestigious projects throughout the world.

AEROMAOZ products include:

- Illuminated Panels
- Advisory Panels
- Electronic Control Boxes
- Dimming Controllers
- Integrated Control Panels
- Multi-Function Display Panels
- Multi-Function Keyboard Panels
- Bezels and Bezel Displays
- External / Internal Lighting
- Joysticks
- NVIS Conversions and Full Cockpit Conversions.
- Technologies include LED, EL and Conventional Lighting.

AEROMAOZ products are being integrated into the systems of organizations such as:

- United States Air Force
- United States Navy
- Rockwell Collins
- Korean Aerospace Industries
- Eurocopter
- Boeing
- Israeli Ministry of Defense
- Israel Aerospace Industries
- Elbit Systems
- Rafael
- Esterline Control Systems

AEROMAOZ is the holder of the following certifications:

USG QPL -AS7788, ISO 9001:2008, AS9100

AEROMAOZ will work with you from initial design and development, prototype production and evaluation through serial production, testing and qualification.



Lighting the Way...

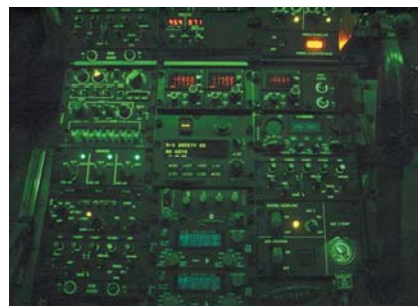

AIRBORNE PLATFORMS UPGRADES

Full glass cockpit configuration



ASTRONAUTICS C.A. LTD.

Astronautics C.A. LTD.

P.O.Box 3351, Kiryat Arie

Petah Tikva 4951207, Israel

Tel: 972-3-9251555

Fax: 972-3-9251550

E-mail: astro@astro.co.il

Web Site: www.astronautics.co.il

C-130 Modernization

The Astronautics solution is flexible, affordable and features an FAA certified avionics to comply with civil and military modern aviation regulations and most demanding mission requirements

Terrain / Traffic
Surveillance

Weather Radar

EFB w/ Digital Map

Dual Autopilot /
Flt Dir.

Dual INS

Dual Transponder

Digital FDR & CVR

6"x8"
EFIS / EICAS

Dual FMS with
embedded GPS

Standby Attitude
Indicator

Dual CADC

Dual HF

Dual VHF / UHF

Dual VOR

Dual ADF

Dual DME

Dual DME

Countermeasures
Dispenser System

Missile Warning
System



Tactical Fighter

Trainers

Transporters

Helicopters



AIRBORNE SYSTEMS



ASTRONAUTICS C.A. LTD.

Advanced Avionics Products

- **Mission and Display Computers**
- **Airborne Displays & MFCDs**
- **Digital 2D/3D moving Map**
- **Smart-I Electronics Instruments**
- **Air Data Computers**
- **Cockpit Instruments**
- **EFIS**
- **EICAS**

Astronautics C.A. LTD.

P.O.Box 3351, Kiryat Arie
 Petah Tikva 4951207, Israel
 Tel: 972-3-9251555
 Fax: 972-3-9251550
 E-mail: astro@astro.co.il
 Web Site: www.astronautics.co.il

Born out of necessity of the Israeli defense forces requirements, most of Astronautics' products are battlefield proven. Astronautics' Airborne products are suitable for use onboard fixed wing (fighters, trainers & transporters) and rotary wing aircraft. Astronautics' provides a single source of products and complete avionics solutions for aviations.

Mission & Display Computers (MDP)

Open Architecture, modular, re-configurable, easily tailored to any avionics requirements. Embedded digital map, Helmet Mounted Display (HMD) electronics and advanced image processing/image compression.

Airborne Displays & MFCDs

Astronautics include a wide variety of sizes (from 3" to 10"x10" display size), video, Smart Displays, EFI (Electronics Flight Instrument) and Engine Displays (EICAS).

Digital Moving Map with the unique 3D enhancement. Astronautics' Digital Map system provides state of the art 2D/3D situation awareness view, to be provided as stand-alone, or embedded into MFCD or Mission Computer.

Smart-I Mini Electronic Instruments.

Based on advanced technology, Astronautics is offering 3ATI Engine Displays, Electronic Flight Instrument (EFI), Electronic warfare (EW) displays and others. All share Astronautics' SMART-I technology, including wireless communication.

Air data Computers for UAV and tactical fighters, trainers and transporters among them F-16, F-5, F-4, A-4, L-159, MIG-21, Mirage III/V C-130 and others. Tailoring to specific aircraft is possible.



Cockpit Instrument A variety of over 100 types of instruments such as Attitude Indicator, Horizontal Situation indicator etc. All products designed and manufactures to the highest standards of the aviation industry, and certified by ISO-9001, as well as major industry manufacturers (Boeing, Lockheed, Bell helicopters and others). We are committed for a long term to support our customers, and have all the required infrastructure to implement such long-term commitment. Astronautics' Airborne products are currently onboard a wide range of aircraft, including F-16, F-5, C-130, F-4, A-4, MB-339 C/D, L-159, Mig-21, A-7, UH-1, CH-53, TORNADO and many other airborne platforms.



EFIS (Electronics Flight Instruments System), FAA certified avionics based on Astronautics computers and smart displays.



EICAS (Engine Instruments & Crew Alert System). Advanced replacement for electro-mechanical engine instruments with Astronautics FAA Certified application, conversion unit and displays.



HEAD-UP DISPLAYS



F-16 HUD



MiG-29 HUD



HUDs for Combat Aircraft

Elbit Systems Electro-optics Elop has developed an array of modern HUDs and Up Front Control Panels (UFCP) for combat aircraft. The HUDs can be configured as a single LRU or as two LRUs (with or without display processor / symbol generator and color cockpit TV sensor).

Our HUDs are compatible with T-6B, T-45, MiG-21, IDF, MiG-29, Su-30, F-5, Mirage, Su-25, F-4, F-16 and others.

Over the last 30 years, Elop has supplied more than 3,800 HUDs, in thirteen different models, for more than 20 different aircraft types.

Lockheed Martin certified and selected Elop's HUD-DU as standard F-16 production equipment.

Upgrades for Legacy HUD-DUs

Elop offers an upgrade of the F-16 legacy HUD-DU to a high performance Form Fit Function and Interface (FFF&I) HUD-DU.

Combining the advanced electronics of Elop's Combat Proven F-16/I HUD-DU with the optical module of your legacy system yields the following main operational and maintenance advantages:

- Significant increase in field MTBF
- Significant improvement in mission readiness
- Optimized symbology



ELBIT SYSTEMS
ELECTRO-OPTICS - ELOP LTD.
P.O.Box 1165, Rehovot 7611101, Israel
Tel: 972-8-9386211
Fax: 972-8-9386237
E-mail: eo@elbitsystems.com
Web Site: www.elbitsystems.com/elop

HUDs for Military Utility Aircraft

Digital Air Transport HUD



The digital air transport model is a technologically advanced overhead-mounted digital HUD, optimized for both military and commercial aircraft:

Military transport, airlift, tanker and maritime aircraft, including:

C-17, C-130, KC-135, C-295, C- 27J, C-235

Commercial aircraft, including:

MD-10, MD-11, Airbus 300, Airbus 310, B-757, B-737.



This line of products is designed with growth capacity to support emerging technologies, such as SVS (Synthetic Vision Systems). Combined with an Enhanced Visual System (EVS), the HUD's system enables reduction of landing and takeoff minima, as well as improved situational awareness, increased safety and enhanced operational capabilities. Among its features is a foldaway combiner with a specially designed breakaway position for pilot safety.

A smaller (mini) version of the HUD is available for regional and business jets.

Baby HUD



Elop's Baby HUD is a technically advanced state-of-the-art compact HUD, suitable for all military aircraft and trainers, as well as commercial aircraft.

The Baby HUD is capable of displaying high brightness cursive (stroke) symbology and raster with or without stroke symbology overlaid. It contains a customer-tailored UFCP, including provisions for CCTVS.

Among its other features and advantages: FOV of 20°/30°, improved symbol positioning accuracy, reduced power consumption/heat dissipation, reliable CRT protection circuitry, intensive Built-In Test (BIT).

DISPLAYS



ELBIT SYSTEMS LTD.

P.O.Box 539
Advanced Technology Center
Haifa 3105301, Israel
Tel: 972-4-8315315
E-mail: aerospace@elbitsystems.com
Web Site: www.elbitsystems.com

Elbit Systems' displays meet today's complex combat challenges through cutting-edge technologies assuring unmatched performance. The Company's comprehensive display family is fielded in a variety of fighter aircraft, helicopters, tanks and fighting vehicles.



Major Advantages

- All AMLCD displays
- High brightness and contrast
- Excellent readability in direct sunlight
- Full Night Vision Goggles compatibility
- Direct sunlight readability with various touchscreens
- Large variety of screen sizes and orientations
- Low power consumption
- Adaptable to various video sources and standards, analog and digital
- Compact and lightweight

6x8" High Performance Airborne AMLCD Multifunction Color Display

- High brightness and contrast, excellent resolution, readability and clarity
- Outstanding contrast ratio and brightness greater than 230 FL

- Available in both Landscape and Portrait orientations
- High resolution SVGA / XGA
- Available with integral pointing device and touchscreen
- Fully compatible with NVG class A/class B for night mode operation
- Installed on Puma, Super Puma and Blackhawk helicopters as well as on F-5 and ALX fighter and C-130 aircraft

5x7" High Performance AMLCD Multifunction Color Display

- Portrait display for the F-16 aircraft
- Available also in Landscape orientation for the OH-58 helicopter, and Portrait orientation for the IA-63 aircraft
- High resolution SVGA full color gray scale images. High brightness and contrast levels. NVG compatible for night mode operation

- Computer display interface is via LVDS digital video and RS-422 serial communication

5x5" Color MFD family

- Operational in F-5, F-4, AMX, MiG-21, F-15 aircraft, and chosen for A-10 aircraft upgrade
- Very high (120ppi) resolution. high brightness, extra-wide viewing angles, full color gray scale video images, variety of mechanical envelopes

6x8" Color AMLCD family

- For main battle tank applications, internal & external use
- Features high resolution SVGA displays, high brightness, landscape viewing angles, full color gray scale video images
- Extra slim envelope (only 40 mm deep), no forced cooling
- Available with integral pointing device and touchscreen
- Clearly readable in extreme ambient illumination conditions

HeliC⁴om™

Intelligent C⁴I and Mission Management for Helicopters

Elbit Systems

ELBIT SYSTEMS LTD.

P.O.Box 539
Advanced Technology Center
Haifa 3105301, Israel
Tel: 972-4-8315315
E-mail: aerospace@elbitsystems.com
Web Site: www.elbitsystems.com



Elbit Systems' HeliC⁴om™ is a fully digital, integrated Command, Control, Communications and Mission Management System providing helicopter pilots and crew with user-friendly data communications and transmissions, accurate, real time tactical pictures, enhanced situational awareness and optimal mission management.

Key Features

GUI and Digital Map for Mission Management

- Paperless Cockpit - No maps to carry to cockpit
- Highly graphical user interface GUI for mission editing
- Choice of tactical overlays
- Updates according to helicopter PP and orientation
- Digitized terrain elevation data
- Wide range of DMAP formats including Vector and 3D maps
- Touchscreen Control
- Single hand mouse e/HOCAS operation

Avionics interface to data interface including weapon and observation device slaving to Geo location.

Portable and Stationary Command and Control Ground Station

- System planning and transfer to flash memory cartridge and helicopter
- Tactical Situation Display
- Battle Management
- Ruggedized Portable Tactical Computer with 19" screen, input device, mouse
- Stationary Mission Planning Station with large screen and cartridge output
- Optional Video Debrief

Advanced Data Link

- Digital data transmission using existing onboard radios and up to four independent data networks with voice communication override
- Mission data (on demand)

- Can be integrated with various radios over a wide band of frequencies: VHF/UHF, KU, L-Band, cellular
- Easy transfer of data through graphical representation
- Extensive defaults and presets



HELMET MOUNTED DISPLAYS

Elbit Systems

ELBIT SYSTEMS LTD.

P.O.Box 539
Advanced Technology Center
Haifa 3105301, Israel
Tel: 972-4-8315315
E-mail: aerospace@elbitsystems.com
Web Site: www.elbitsystems.com

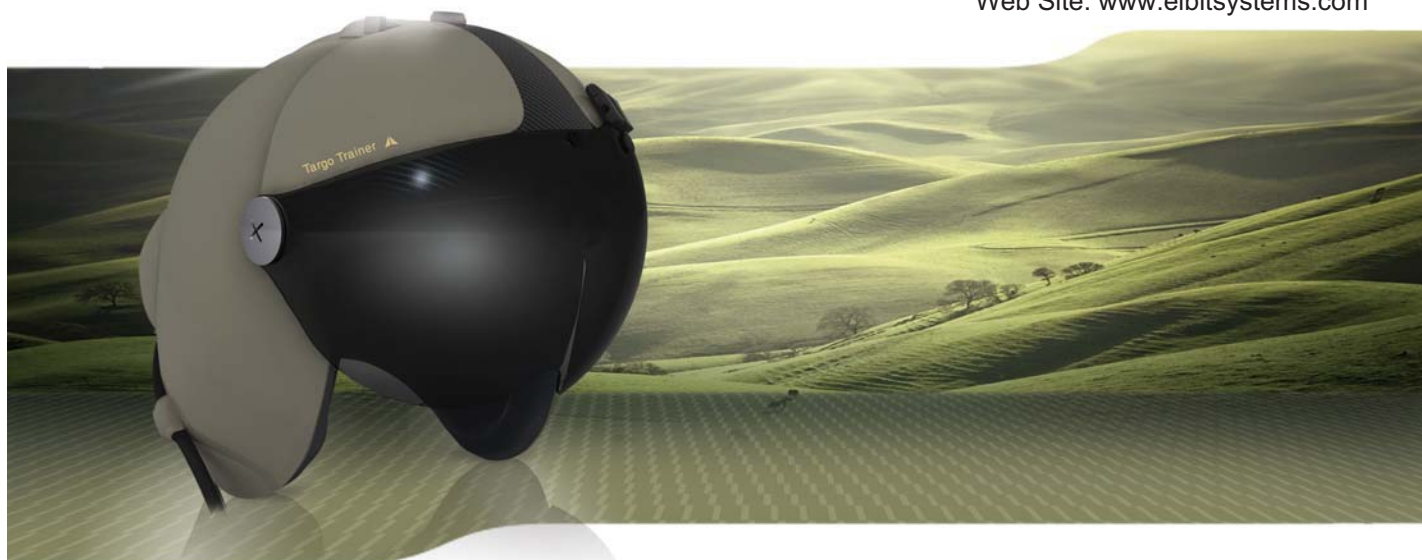

TARGO™

TARGO™ brings the power of advanced avionics to the portability of a helmet. For the first time, the most important operational systems are available directly on the helmet in packages tailored specifically to customer needs.

Helmet Mounted Avionics (HMA) technology is now accessible to fighters, training, airlifting and emergency services aviators, providing a cost-saving solution for improving mission success.

- Stand-Alone to Fully-Integrated Configurations
- Click-On Day, Night and Simulation Modules
- Off-Visor Safest Display
- On-Helmet Recording and Debriefing
- Minimal Integration. No Electronics Box

DASH - Display and Sight Helmet

The DASH family of helmets is operational in numerous international programs. Over 1000 DASH systems have been fielded on F-4, F-5, F-15, F-16, F/A-18, MiG-21, IAR-99, Mirage 2000, LCA, MiG29 and Tornado aircraft. Mature and proven, DASH is a monocular, visor projected HMD, with complete HMD electronics, including an advanced digital electro-magnetic helmet tracker for day and night use. DASH and the JHMCS are world leaders in number of systems fielded, number of users (over 25 international A/Fs) and level of operational experience. DASH -IV, the latest generation, is currently operational and in production for additional and follow-on programs.

Elbit Systems has vast experience in integrating HMDs with various advanced systems, and high off boresight in particular. DASH has been integrated with high off boresight Python, R-73, Mica, IRIS-T, Magic, Derby and others.



DASH Night



DASH

ROTORCRAFT HMDs

Elbit Systems

ELBIT SYSTEMS LTD.

P.O.Box 539,
Advanced Technology Center
Haifa 3105301, Israel
Tel: 972-4-8316244
E-mail: aerospace@elbitsystems.com
Web Site: www.elbitsystems.com

JEDEYE™

Elbit systems' JEDEYE™ is ideal for Apache and other rotorcraft. JEDEYE™ lets pilots take in the entire scene: wider than ever areas of ground and sky are displayed with crystal clear, high resolution and crisp focus.

The improved display features high resolution combined with a wide FOV increasing flight awareness, improving recognition of flight obstacles and mitigating risks. The sharp image scenery eliminates "tunnel effect", vertigo and other visual illusions. The head tracker accuracy minimizes spatial disorientation.



ANVIS/HUD®

Line-of-Sight (LOS) with Tracking Capability

Elbit Systems' day/night ANVIS/HUD® assures safe head-out flight and 24-hour operational capabilities from a single, integrated system.

The ANVIS/HUD® combines the standard Night Vision Goggles (NVG) scene with aircraft flight data. Adding the Day HUD "plug and play" module, fitted on any standard NVG helmet-mount, the same flight data information is displayed during daytime.

Addition of the LOS module is a vital feature not only for attack helicopter pilots but also for utility and assault helicopter flight crews. It improves situational awareness and crew coordination. With the LOS module there is complete correlation with what the pilot views and the outside world. The system provides the invaluable advantage of allowing each crew member to track the other's field of view, eliminating the need for verbal communication and improving mission performance.

The ANVIS/HUD® system can be installed on any type of helicopter - Eastern or Western, modern or legacy, and can support various A/C systems. Operational on over 6000 helicopters and 25 different types of platforms, the system is a performance-proven off-the-shelf solution.



ANVIS/HUD® - Day HUD



ANVIS/HUD® - Night HUD

ELECTRO-OPTIC INTELLIGENCE, SURVEILLANCE AND RECONNAISSANCE (ISR)

Litening - Targeting & Navigation Pod

Litening is an innovative airborne infra-red targeting and navigation pod for fighter aircraft with high accuracy and reliability, day and night precision strike capability. Litening reduces pilot workload during targeting and tracking. It is easily integrated on any aircraft and possesses high growth potential.

In use in the Israeli Air Force, USAF, ANG, AFRES, Marines, German AF, Swedish AF, Spanish Navy & AF, Greek AF, and others, the Litening flies on F-16 , F-15, A-10, B-52, AV8-B, Gripen, Tornado, F-5, F-4, Mig-21, Mirage 2000, Jaguar and others.



Toplite EO System - Electro-Optical Surveillance, Observation & Targeting System

The Toplite family of electro-optic systems is an advanced multi-sensor, multi-purpose, highly stabilized EO systems for homeland security and defense applications, for aerial, maritime and ground based platforms.

RecceLite- Real Time Tactical Reconnaissance System

The RecceLite System consists of an E-O pod, a ground exploitation station and a data link. It is capable of collecting images day & night from 300 ft to 40,000 ft in all directions forwards, nadir, backwards, oblique - all down hemisphere and even when the aircraft is maneuvering in high G. The Ground Exploitation Station (GES) is capable of generating targets in real-time with exceptionally high accuracy due to state-of-the-art algorithms and technology. The data-link connects between the sensors and the GES and enables the images to be downloaded to the GES in real time. When your task is to close the attack cycle on many "time-critical targets" in less than 10 minutes, there is only one system - RecceLite.

Recce-U - Real-Time Persistent ISR System for UAVs

Recce-U is a self-contained, multi-sensor ISR system (based on the RecceLite Tactical Reconnaissance Pod). The Recce-U enables automatic photography, according to a mission plan prepared in advance, or updated mission plan uplinked in real-time, however the operator can initiate manual scanning for targets of opportunity.



Litening -on-Gripen



Toplite EOS



RecceLite System

Recce-U

RAFAEL
ADVANCED DEFENSE SYSTEMS
 P.O.Box 2250 (19)
 Haifa 3102102, Israel
 Tel: 972-4-8794714
 Fax: 972-4-8794657
 E-mail: intl-mkt@rafael.co.il
 Web Site: www.rafael.co.il

SpotLite Family
Electro-Optic Enemy Fire Detection System

The SpotLite family consists of electro-optical systems that detect and locate enemy fire in stationary positions as well as on the move. Rapid detection and precise location information provide forces with the capability to quickly neutralize the enemy, maintaining the upper-hand on the battlefield.

The **SpotLite P** is a portable electro-optic system carried by two soldiers for day and night detection and location of small arms fire.



SpotLite P on Tripod

SpotLite M is a mobile electro-optic system installed on vehicles and AFV's that enables the detection and location of enemy fire sources from small arms, RPG rockets, ATGM and tank shells, on the move, day and night, up to 360° coverage.



SpotLite M on vehicle

Imilite - Multi-Source Multi-Task ISR Exploitation System / Command and Control System

Imilite is an intelligence system designed to receive process and exploit multiple standalone imagery video and other intelligence data in a centralized and a unified way.

Main system capability includes the reception, processing and exploitation of EO, IR, SAR/GMTI and VIDEO, in various formats, over one desktop. In order to enhance the exploitation process, Imilite further combines non-imagery data such as targets, threats, COMINT detection and mission status within the system workflow. Imilite generates a variety of standard and customer tailored ISR reports and IMINT products such as alphanumeric reports, annotated maps, GIS data layers and visual aids, and disseminates them to external information and operation systems over standard and tailored protocols.

Imilite's multi-source data integration and automation capabilities improve the efficiency of utilizing available collection and exploitation assets. The system GIS capabilities provide immediate accessibility to relevant imagery and intelligence data, thus shortening the ISR collection and exploitation cycle.

The Imilite is based on Rafael's combat-proven ISR and C⁴I systems already in service worldwide. Imilite is designed for use by Defense forces (air, ground) and police forces exercising various observation means for border patrol or coping with urban crime.



Imilite

AVIONICS SYSTEMS AND UPGRADES

Innovative Defense Electronics



RADA Electronic Industries LTD.
P.O.Box 8606
7 Giborei Israel Blvd.,
Netanya 4250407, Israel
Tel: 972-9-892-1111
Fax: 972-9-885-5885
E-mail: mrkt@rada.com
Web Site: www.rada.com



RADA Electronic Industries Ltd. (Nasdaq: "RADA") is a Defense Electronics System House specializing in sophisticated, military-oriented electronic systems for airborne and land applications. RADA, a developer and manufacturer of core avionics systems for over 30 years offers a wide spectrum of military avionics systems and upgrades, designed primarily for the aerospace and defense market. RADA's core avionics are installed onboard of a wide variety of manned and unmanned aircraft.

RADA's Aircraft Avionics Solutions:

- Integrated Avionics Upgrade Suits
- Mission Data Recorders
- Debriefing Solutions
- Mission and Display Computers
- Weapon Management Systems
- Data Interface and Processing Computers
- HUD Video Cameras
- Air Data Computers

RADA's UAV Avionics Family:

- All-in-one Modular Avionics and INS – including flight control (MAVINS)
- Interface Control Processors (ICP)
- Engine Control Computers (ECC)
- Payload Management Computers (PMC)
- Payload Interface Units (PIU)
- Electrical Power Management Units (EPMU)



AISR

Aeronautics

AERONAUTICS LTD.

P.O.Box 169
Yavne 8110101, Israel
Tel: 972-8-9433600
Fax: 972-8-9328912
E-mail: info@aeronautics-sys.com
Web Site: www.aeronautics-sys.com



AISR (Aerial Intelligence Surveillance & Reconnaissance)

Aeronautics AISR is the ultimate solution for expanding existing aerial platforms operations. Aeronautics provides robust interoperable solutions by using state of the art versatile components installed onboard fixed wing aircraft or helicopter.

By integrating the most advanced sensors, data-link systems and mission management tools, Aeronautics' AISR systems are operational worldwide, expanding capabilities for intelligence gathering, reconnaissance, search & rescue and target acquisition missions.



HELICOPTER SYSTEMS AND SOLUTIONS



ELBIT SYSTEMS LTD.

P.O.Box 539
Advanced Technology Center
Haifa 3105301, Israel
Tel: 972-4-8316244
E-mail: aerospace@elbitsystems.com
Web Site: www.elbitsystems.com

Elbit Systems is unique in its ability to provide total solutions encompassing long-term maintenance, technical support, full integration, installation and systems training.



In these large scale programs Elbit Systems often partners with local industries. Our range of core technologies, systems and products features Mission Computers, Helmet Mounted Display Systems, Digital Map Systems, Cockpit Displays, and Command, Control and Communication - HeliC³om capabilities including conversion of utility helicopters into day and night, multirole combat platforms and elevating **Eastern and Western** assault and attack helicopters to new performance levels.

Elbit systems has years of experience in upgrading platforms, both Eastern and Western. In these programs, legacy platforms are given the ability to perform as new ones, and new platform capabilities are enhanced.

The improved platforms enable the crews to reduce the workload in the cockpit, improve crew coordination, flight safety and situational awareness.

The modern technology Elbit Systems provides its customers also increase survivability and mission efficiency.



UH-60



Mi-24

YOUR SOURCE FOR HIGH-END FLIGHT ALGORITHMS AND ADVANCED FLIGHT SYSTEMS

AERODAN
www.aerodan.com

AERODAN SYSTEMS 1993 LTD.

17 Kaplan St.,
Tel-Aviv 6473418, Israel
Tel: 972-3-6961099
Fax: 972-3-6966343
E-mail: maerav@aerodan.com
Web-Site: www.aerodan.com

■ 120mm mortar guidance kit

GPS-based, the 120mm guidance kit withstands a launch impact of 10,000g. Initial flight tests demonstrated 5m CEP capability. This kit was originally designed and tested by Aerodan for a global defense industry.

■ High roll measurement module

This high roll-rate gyro-less measurement module, designed for an Israeli defense industry, is an autonomic unit to be incorporated into a smart munitions' system.

■ Fire-control computer for naval platforms

The fire-control computer is a general-purpose real-time firing control unit, suitable for any rocket/missile launch from a moving or anchored naval platform. The first computer was developed for an Israeli defense industry.



System Engineering and Integration

Using our vast experience accumulated over the years in the integration of systems. Aerodan provides its integration skills to support system engineering for smart munitions while making the best trade-offs between the mechanical, electronic, aerodynamics, GNC and budget considerations, to create the best-suited solution. Putting to use its extensive know-how, Aerodan has built several real-time based hybrid labs for various projects.

Simulations

Aerodan has designed a series of system simulations, 3, 3.5 & 6 DOF among them, which have been verified over the years by both flight tests and hybrid labs. These simulations are being used in the various smart munitions, be it rockets, missiles, satellite launchers or any other.

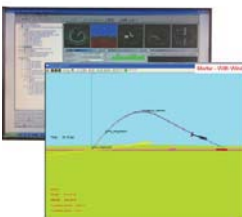

peruse-munitions at hand.

Aerodan has also developed and is maintaining the generic digital simulation of ballistic missile trajectories for the Israel MOD. Aerodan can provide a tailor-made system-simulation for any ballistic projectile.

GNC systems

Well experienced in the design and development of various GNC systems. Aerodan has lately designed a unique GNC platform, which combines high-end algorithms with COTS components, creating a sophisticated cost-affective platform that can be utilized in the design and engineering of smart munitions.

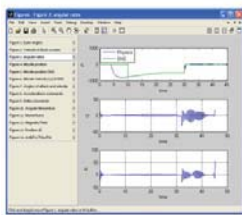

Safety, Footprints and Trajectories

Using its in-house designed simulation tools, Aerodan provides a full solution, including test trajectories, flight envelopes, safety maps, fragment dispersion analysis, foot-prints, lethality and more for any purpose specified by the customers.

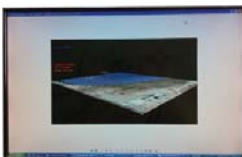

PRECISION GUIDED WEAPON KITS

Elbit Systems

Modular Guidance Kits for Precision Strike Capabilities Against a Full Spectrum of Threats

ELBIT SYSTEMS LTD.

P.O.Box 539
Advanced Technology Center
Haifa 3105301, Israel
Tel: 972-4-8315315
E-mail: aerospace@elbitsystems.com
Web Site: www.elbitsystems.com

STAR

Smart Tactical Advanced Rocket

STAR is a Laser Guidance Kit installed on 68/70/80 mm rockets to convert them into metric precision guided weapons. STAR is employed for Air-to-Ground or Ground-to-Ground missions, against soft or lightly armored, stationary or fast moving targets. An optimal solution for today's dynamic battlefield, STAR can be launched from a variety of platforms, providing high kill probability and very low collateral damage, at an affordable cost.



LIZARD is a family of modular guidance kits offering the option of Laser-Seeker (LIZARD2 and LIZARD3) or dual mode (GPS/INS and Laser, LIZARD4) guidance. All kits convert "dumb" general purpose bombs into smart munitions. They increase the capability to counter any target, any threat, from motorized vehicles and ships to power plants, infrastructures and radars. The LIZARD family provides a complete arsenal of capabilities to seek, attack and destroy a full spectrum of targets, just by switching seekers.

Key Advantages and Features

- NATO standard equipment
- Enhanced hit accuracy
- Day and night operation
- Compatible with all GBU certified and other A/Cs
- Aerodynamics; guidance; modular replaceable seekers; common LRUs and ILS

LIZARD-2 Laser

- Effective against any designated target.
- Unique guidance technique assures superior accuracy over comparable systems.
- Higher kill probability; fewer bombs per target.
- Improved jamming rejection.
- Compatible with all laser designators.
- Targets: bunkers, airfields, power plants and others.
- Optional-enhanced penetration capability.

LIZARD-3 Laser

- Proportional navigation guidance
- Improved hit accuracy against moving targets.
- Improved jamming rejection
- Controllable AOA for enhanced penetration
- Upgrades GEN 1, GEN 2 LGBs to GEN 3 LGB

GAL - LIZARD-4 GPS/INS Aided Lizard

- All weather GPS/INS guided bomb.
- Extended-range delivery envelopes
- Trajectory shaping capabilities.
- Optional terminal laser-homing to retain Lizard 2/3 CEP's
- MIL-STD 1760 A/C interface (or alternative).
- Controllable AOA for enhanced penetration.



LIZARD 2-3



LIZARD 4 (GAL)

LAHAT



Israel Aerospace Industries Ltd.
Systems Missiles & Space Group

LAHAT - LAser Homing ATtack Missile

Prime candidate for enhancing the fire power for your MBT

AIR & MISSILE DEFENSE DIVISION

P.O.Box 105
Yehud Industrial Zone
5610002, Israel
Tel: 972-3-5315699
Fax: 972-3-5315830
E-mail: marketing@iai.co.il
Web Site: www.iai.co.il



Advanced light weight laser homing missile

- Pinpoint accuracy for day and night operations
- Effective against both static and moving targets
- Low collateral damage
- LOS (Line of Sight) and Non LOS firing capability
- Simple to operate, easily integrated
- Same missile can be launched from various platforms:
- Canister launch: vehicles, helicopters, ships, remote installations for borders or bases protection
- Tanks gun launch (105 mm and 120 mm)
- Lofted and flat trajectories for effective penetration
- Cost effective

AEROSPACE

Weapon Systems & Missiles



ISRAEL MILITARY INDUSTRIES LTD. (IMI)

P.O.Box 1044, 64 Bialik Blvd.
Ramat Hasharon 4711001, Israel
Tel: 972-3-5485222
Fax: 972-3-5486125
E-mail: imimrktg@imi-israel.com
Web Site: www.imi-israel.com

MPR 500

MPR 500 is a 500lb. Multi-Purpose Rigid bomb with MK-84 effectiveness in MK-82 dimensions. Optimized for operation against challenging targets, MPR 500 penetrates 1 meter thick double-reinforced concrete or four double-reinforced concrete walls/floors 200mm thick each. The bomb guarantees controlled fragmentation focused on target lethality and minimal collateral damage. MPR 500 is certified with JDAM and fully compatible with all guidance kits.

WHIP SHOT

WHIP SHOT is a small-size (30lb.), low-cost precision guided weapon for engaging high-priority targets, including maritime, ground and lightly armored targets, while minimizing the risk of collateral damage. WHIP SHOT can also be used in Close Air Support (CAS) and COIN missions. The system combines a highly lethal fragmentation warhead,

coupled with a GPS/INS guidance system, enabling launch from Light Combat Aircraft (LCA) and Light Attack Armed Reconnaissance (LAAR) aircraft, as well as additional aerial platforms.

DELILAH

DELILAH is a combat-proven advanced, high-subsonic, long range, loitering E/O stand-off missile with precision hit capabilities against high value mobile, fixed and relocatable targets. DELILAH can be launched from various platforms: fixed-wing aircraft, helicopters, ground or naval platforms.

IFB 500

IFB 500 is a 500lb. improved penetration Anti-Personnel/Anti Materiel bomb for both eastern and western aircraft. IFB 500 fragments penetrate 10mm armor steel at a distance of more than 75 meters. The weapon incorporates a proximity fuze to ensure optimal area coverage.

MSOV

MSOV (Modular Stand-Off Vehicle) is a 2000lb. GPS/INS guided, stand-off, air-launched glider dispenser, aimed at meeting the evolving operational needs for deep strike capabilities, while remaining out of reach of enemy anti-aircraft SAM sites. The weapon's modular design enables the payload to be tailored to customer requirements.

MARS

MARS (Multi-Purpose Air-Launched Rocket System) is a 1000lb. supersonic precision weapon for long range air-to-ground strike missions. MARS features high survivability and operational flexibility, and enables salvo strikes against high value targets. The weapon comprises a launch booster, warhead and GPS/INS guidance system. It can be fitted to a variety of fighter jets.



FUZE SYSTEMS FOR AERIAL MUNITIONS

Orion
Advanced Systems Ltd.

**ORION
ADVANCED SYSTEMS LTD.**

P.O.Box 156
Yavne 8110101, Israel
Tel: 972-8-3770100
Fax: 972-8-3770101
E-mail: marketing@orion-as.com



FUZE Systems for Aerial Munitions

Orion Advanced Systems Ltd., formerly the Government Electronics Department (GED) at Motorola Israel Ltd., is a world leader with over 35 years experience in the design and manufacture of fuzes for aerial munitions. Orion's fuzes have been qualified by the Israeli Air Force for use with their aircraft and weapons systems and meet their rigorous standard safety requirements. The fuzes are renowned for their outstanding operational reliability.

Orion's product range covers the full spectrum of fuzes for aerial munitions:

- ID260MF Impact/Delay Fuze – Orion's flagship fuze specially designed for integration with Precision Guided Munitions.
- High-Altitude Proximity Fuzes and Sensors for Dispensing Munitions.
- Low-Altitude Proximity Fuzes and Sensors.
- Custom fuzes and Safe & Arm units tailored for specific bombs and rockets.



AEROSPACE AND MISSILES METAL EXPERTS

PALBAM Defense Specializes in advanced design and manufacturing technologies for the defense and aerospace industries. Our solid reputation is built on over 40 years of customer satisfaction.



PALBAM 2008 (A.C.S.)

En Harod Ihud 1896000, Israel
Tel: 972-4-6530700
Fax: 972-4-6531904
E-mail: info@palbam.co.il
Web Site: www.palbam-defense.com

Missile and Rocket Components Canisters, Launchers and High Pressure Vessels

- Design, to customer's specifications
- Manufacture to the highest standards level, including thermal and surface treatments
- Proof Of Design procedures.

We supply, Built to Print or Built to Spec HPV of up to 12,000 PSI.

The most challenging missiles canisters and missiles metal parts, using all kinds of alloys for the Israeli missile industry is made by Palbam.



Magnesium for Aeronautics and Advanced Soldier Systems

For airborne, UAV or future infantry equipment, be a step ahead of the others – choose Magnesium, and drop overweight from your product!

PALBAM's subsidiary Aero Magnesium, has developed the world's most professional knowledge center for Mg production of integrated aerospace parts.

We cover all procedures for Magnesium solution from **design and materials to forming, casting, forging, machining, surface protection and assembly.**

AS 9100 and ISO 9000 certified company.

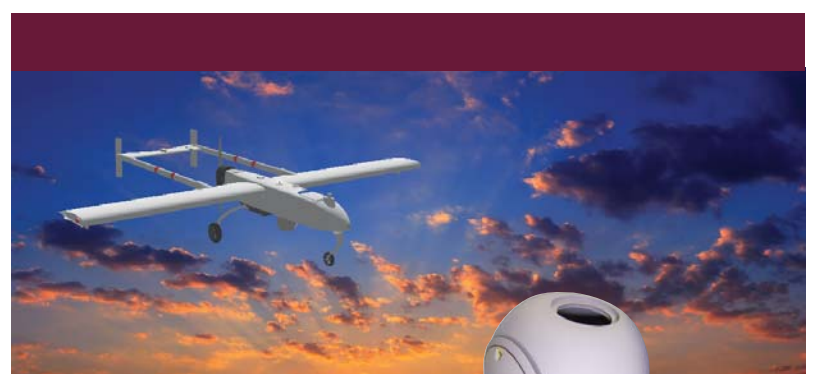

Magnesium has a specific gravity of 1.74, which is two thirds of Aluminum!

AIR DEFENSE SYSTEMS

IRON DOME SPYDER-SR/MR



RAFAEL
ADVANCED DEFENSE SYSTEMS
P.O.Box 2250 (19)
Haifa 3102102, Israel
Tel: 972-4-8794714
Fax: 972-4-8794657
E-mail: intl-mkt@rafael.co.il
Web Site: www.rafael.co.il

Air Defense

Rafael has extensive experience in missile development and production, and offers a variety of missiles in a broad range of areas.

IRON DOME

The Iron Dome is the only dual mission system in the world that provides an effective defense solution for countering rockets, artillery & mortars (C-RAM) as well as aircraft, helicopters, UAVs, PGMs. The system is an effective system for countering C-RAM threats with ranges of up to 70 km and for VSHORAD protection (up to 10 km). The system operates in all weather conditions, including low clouds, rain, dust storms or fog.



SPYDER-SR/MR

Short/Medium Range Mobile Air Defense Systems.

SPYDER (Surface-To-Air Python & DERBY) is a quick reaction, low level surface-to-air missile system designed to counter attacks by aircraft, helicopters UAVs and precision guided munitions. The system provides effective protection of valuable assets, as well as first-class defense for forces located in the combat area. SPYDER incorporates RAFAEL's most advanced, proven performance air-to-air missiles - the Derby active radar (RF) missile and Python-5, a dual waveband Imaging Infra Red (IIR) missile. The SPYDER family includes SPYDER-SR (Short Range) and SPYDER-MR (Medium Range) systems.



RAFAEL'S MISSILES

Rafael has extensive experience in missile development and production, and offers a variety of missiles in a broad range of areas.

Air-to-Air Missiles:

PYTHON

The Python-5 is an air-to-air missile that provides the pilot engaging an enemy aircraft with a full sphere launch capability. The missile can be launched from very short to beyond-visual ranges with greater kill probability, excellent resistance to countermeasures, irrespective of evasive target manoeuvres or deployment of countermeasures.



DERBY

The Derby is an active radar air-to-air missile that provides fighter aircraft with outstanding and effective performance in both short ranges and Beyond Visual Range (BVR) intercepts.

The missile enables operational flexibility and multi-shot capability. It can be launched at an enemy aircraft day or night and in all-weather conditions.

Additional Derby capabilities include look-down/shoot-down, sophisticated fire-and-forget mode and an advanced ECCM tailored to the customer's operational requirements. Derby's light weight allows it to be adapted to various modern fighter aircraft.



Air-to-Ground Weapon Systems:

POPEYE

Air-to-Ground Standoff missile POPEYE is effective against high-value ground targets such as power plants, missile sites, bridges and bunkers.

SPICE

Smart, Precise Impact and cost-effective guidance kit.

The SPICE integrates an electro-optical guidance kit onto an inexpensive standard general-purpose bomb, creating a sophisticated, affordable precision-guided munition.

SPARROW Targets

Surrogate Ballistic Target. The BLACK SPARROW is designed to simulate short-range ballistic threats. It was selected as the Israeli Theater Missile Defense (TMD) target for use with the US/Israeli Arrow program. The BLUE SPARROW is designed to simulate medium-range ballistic threats.



Multi Purpose Weapon Systems:

SPIKE FAMILY

The SPIKE Family consists of missiles suited for land, air and sea platforms, multiple ranges and a variety of targets. The missiles in this family have sophisticated electro-optic CCD or IIR sensors for day/night all-weather operation, as well as a tandem warhead. Their lofted trajectories enable the warhead to strike the target at its most vulnerable location with pinpoint precision and minimal collateral damage. All of the SPIKE Family members have a low life-cycle cost, due to high reliability and operational and logistic support and production commonality between members.

Designation	Max. Range	Application
Spike-SR	1,000m	Infantry and Special Forces
Mini-Spike	1,500m	Infantry and Special Forces
Spike-MR	2,500m	Infantry and Special Forces and Combat Vehicles
Spike-LR	4,000m	Infantry and Special Forces and Combat Vehicles
Spike-ER	8,000m	Infantry, LCV, Helicopters
Spike-NLOS	up to 25km	Multi-Purpose ,Multi-Platform

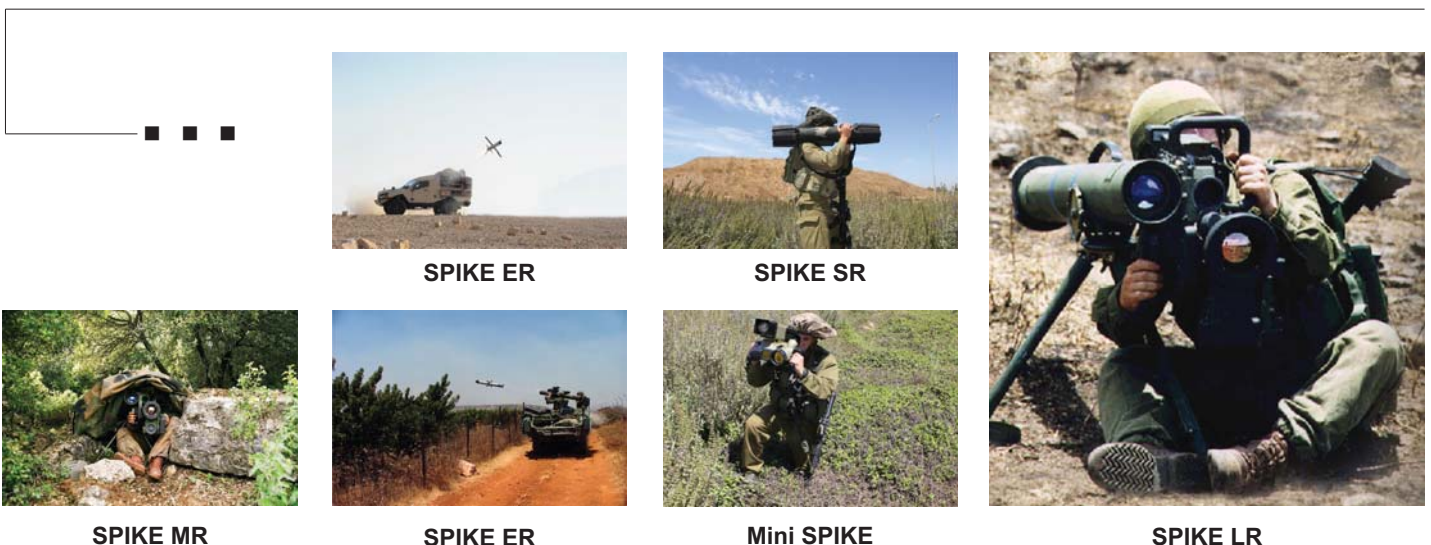

FLIGHT SIMULATORS



Tactical Training

MTC - Mission Training Center

The "Mission Training Center" (MTC) enables linked training between various trainees and platforms. Teams train in formations of pairs and foursomes in all aspects of the operational mission. The sessions are fully supervised by flight instructors, who are central to the training process. The system integrates with other training systems, and connects to various training centers that are geographically separated. The system's high quality and its near to eye visual capability allows training sorties onboard the trainers, rather than fighter jets and maximizes use of existing resources. The Mission Training Center is based on Elbit Systems BEST – Battlefield Enhanced simulation & training infrastructure.



Live Training

EHUD® AACMI - Autonomous Air Combat Maneuvering Instrumentation

EHUD® is a complete and fully Autonomous Air Combat Maneuvering Instrumentation (AACMI) system offering a combination of airborne combat training coupled with advanced ground-based capabilities. For Air-to-Air, Air-to-Ground and EW training/debriefing. EHUD® supports a virtually unlimited number of live participants networked through the patented datalink protocol. Packaged in an Air-to-Air training missile shell, which can be easily transferred from aircraft to aircraft. Operational since 1994 has been delivered to 17 air forces worldwide. Over 550 airborne pods, and more than 100 ground debriefing & real-time monitoring stations have been successfully deployed with over 1 million flying hours logged.



ELBIT SYSTEMS LTD.

P.O.Box 539
Advanced Technology Center
Haifa 3105301, Israel
Tel: 972-4-8315315
E-mail: aerospace@elbitsystems.com
Web Site: www.elbitsystems.com

**EVA - Embedded Virtual Avionics for Trainer Aircraft**

EVA, is installed in basic or advanced trainer aircraft, transforming the aircraft into a virtual advanced fighter while maintaining the hourly training costs of a trainer. Designed to reduce the large training gap between trainer and modern fighter aircraft. EVA is manufactured in a minimal integration configuration, thus cutting integration costs within the aircraft virtually to zero. EVA simulates radar that provides Air-to-Air and Air-to-Ground modes as well as simulated weapons, IR sensors, situation awareness and simulated electronic warfare. An advanced datalink network connects the participants and ground station for real-time monitoring and control.

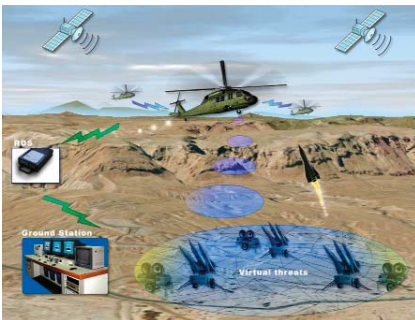
**IFEWS - In Flight Electronic Warfare Simulator**

IFEWS, is a complete, autonomous, on-board threat-environment training and safety suite, capable of simulating the EW suite and virtual threats range. The IFEWS on-board simulation system maintains a virtual range of ground, naval and airborne threats. During flight, the virtual and the real threats are presented to the pilot through the real or simulated EW suite. Threats are placed on the terrain and behave according to smart doctrines and aircraft actions (maneuver, decoys dispensing etc.) The IFEWS standard package consists of the IFEWS airborne unit and the IFEWS PC ground station. Operational in leading air forces.

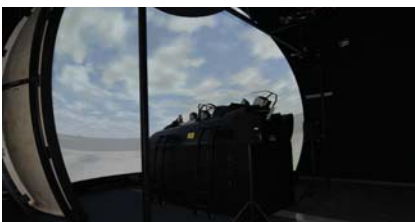
Virtual Training**F-16 Full Mission Simulators**

Elbit Systems supplies all F-16 simulators to the Israel Air Force. These include the F-16 Block 15, F-16 Block 52, and F-16 Block 40. The advanced F-16 Full Mission Simulator simulates all aircraft systems, emergencies and weapon deliveries. It also supports A/G, A/A and other mission types and features an integrated Instructor Operating Station (IOS) and After Action Review (AAR) capabilities.

**Mi-8/17/24 Full Motion Simulators**

The Mi-8/17 & Mi-24 FMS provide cost-effective, initial and recurrent training based on full modeling of the actual helicopter, mission environment, accurate and synchronized cue generation. The simulators cover every aspect of helicopter routine, emergency and mission operations in diverse scenarios, including day and night missions, with powerful cue generators maximizing realism and minimizing the transition to complex, actual missions. Simulators are equipped with electrical 6DoF motion system and powerful visual system.

FROM VISION TO REALISM



HARTECH TECHNOLOGIES LTD.

22 Maskit St.,
Herzliya 4673322, Israel
Tel: 972-74-7200800
Fax: 972-9-9549394
E-mail: marketing@hartech.co.il
Web Site: www.hartech.co.il

HarTech Technologies is an innovative and dynamic private company specialized in development, integration and setting to work of advanced command and control systems and simulation infrastructure solutions.

Our main projects and product lines include:

Command and Control systems for Air, Land, Naval and Special Forces as well as for intelligence and Homeland security applications. Our command and control systems make use of advanced state of the art data fusion algorithms as well as utilize modern multi-channel datalink systems.

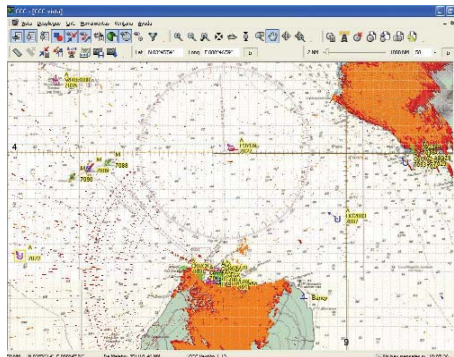

Simulation infrastructure solutions for large scale wargaming systems and tactical simulation systems. Our **SSG** (Smart Scenario Generator) is an advance scenario generation framework which enables the development and execution of large scale high fidelity simulation scenarios covering single platforms to a complete wargame.

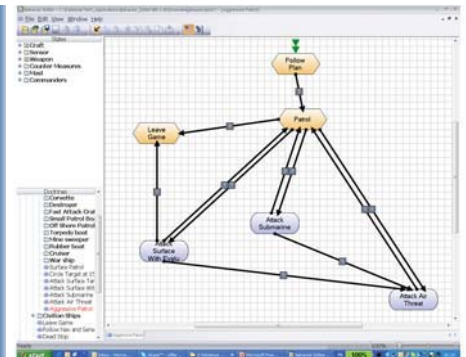

Situational Awareness 3-D system for use in urban areas, municipalities, complex plants, hazardous materials industries, environmental organizations and more. The **GEM** (Geospatial Management) our site management and protection solution provides a complete solution for all safety, environmental and security needs.

HarTech Technologies performs Turn-Key-Projects and provides services throughout the entire lifespan of a project starting from the operational specification definitions and solution design, system development, project management, management of procurement and installation process, setting the system to work and providing ongoing support to the project in the system assimilation and maintenance life cycle.

HarTech's main projects include:

- Coastal surveillance solutions (Command and control system and overall integration)
- Air surveillance systems (Command and control and mission planning)
- Naval Command and Control systems
- The Smart Scenario Generator (SSG) development framework
- Tactical simulation solutions



INNOVATIVE TRAINING SOLUTIONS



Israel Aerospace Industries Ltd.
Military Aircraft Group, LAHAV Division

LAHAV DIVISION MILITARY AIRCRAFT GROUP

Israel Aerospace Industries Ltd.
Ben-Gurion Int'l Airport, 7010000, Israel
Tel: 972-3-9353163, 9358198
Fax: 972-3-9353687, 9357010
E-mail: lahav_marketing@iai.co.il
Web Site: www.lahav-iai.com

Lahav provides the entire range of integrated training solutions to support efficient and cost-effective pilot training. These solutions include:

- Network-linked Simulators
- Embedded Synthetic Training Systems for Trainer Aircraft
- Real-time Ground Monitoring & Debriefing Stations
- Pilot Selection Systems

SIMULATORS

Lahav offers simulators and synthetic training environment networks for comprehensive and integrated training for complex battle scenarios, including:

- Full Mission Simulators
- Distributed Mission Operations with Netcentric Systems
- Planning/management, real-time monitoring, and debriefing of joint synthetic training
- Part Task Trainers/Avionics Simulators

TRAINER AIRCRAFT SYSTEMS

Lahav has integrated its avionics and training systems on numerous trainer aircraft, including:

- United States Air Force T-38 (new avionics for 450 aircraft)
- BAE Systems Hawk 127 and Hawk 128 (data link and embedded virtual radar)
- Spanish Air Force F-5B (new avionics for lead-in training, including simulated radar, EW and weapon systems with real-time ground station)

PILOT EVALUATION SYSTEM (PES)

- Reduced pilot training costs, by early elimination of unsuitable pilot trainees
- Ability to screen large numbers of potential pilot trainees
- Evaluation of multi-task performance, with increasing pressure on the trainee

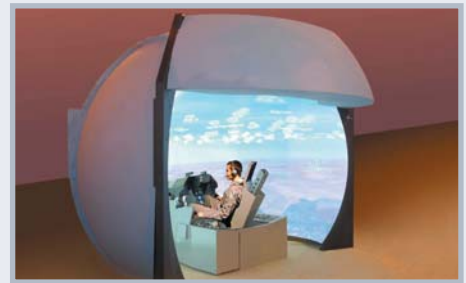

Lahav Network - Linked Simulators



Typical Lahav Simulator

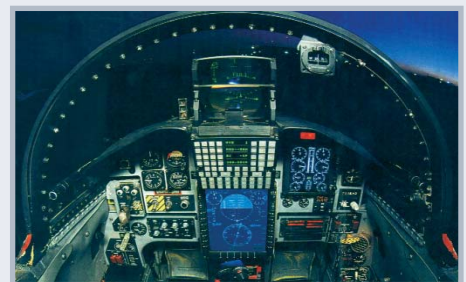

Upgraded USAF T-38 with Lahav Avionics



Lahav Pilot Evaluation System

BAE SYSTEMS - ROKAR OVERVIEW

BAE SYSTEMS

BAE Systems-Rokar is a trusted supplier of precision guidance systems for munitions, self-protection solutions for aerial platforms, and products that provide powerful video and data management capabilities for military platforms.

BAE SYSTEMS ROKAR

11 Hartom St., Har Hotzvim
P.O.Box 45049
Jerusalem 9777511, Israel
Tel: 972-2-5329888
Fax: 972-2-5822522
rokar.marketing@baesystems.com
www.baesystems.com

For more than three decades, Rokar's advanced defense electronics have been in use on a wide range of platforms by armed forces and leading defense contractors around the world. Based in Jerusalem, Rokar is a fully owned subsidiary of BAE Systems Inc., one of the world's largest defense contractors.

Advanced engineering and manufacturing capabilities

Rokar's highly skilled team has a deep operational understanding of product requirements and works closely with operational units to ensure product superiority. The company's advanced engineering and manufacturing capabilities include a rapid development cycle, in-house manufacturing capabilities and certified quality standards including AS 9100C, ISO 9001 and ISO 90003:2004.

Navigation and Guidance Systems

Rokar develops and manufactures GPS navigation systems for defense applications. Rokar's affordable systems are ideal for precise munitions as they offer high dynamics, fast GPS acquisition, GNSS DGPS solutions and GPS anti-jam technologies.

These systems include:

- Artillery programs.
- Integrated GPS/INS for projectiles and guided munitions.
- GPS for guided mortars.
- Flight computer for guided artillery rockets.
- Silver Bullet precision guidance kit for 155mm shells.
- Satellite Navigation Immune Receivers (SNIR) family of GPS anti-jam technologies.
- Space systems.

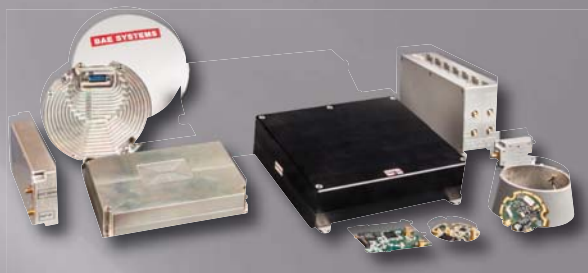

Electronic Warfare Systems

Rokar is renowned for its advanced countermeasure dispensing systems. Rokar's EW systems are combat proven with over 1500 systems operational on a wide range of platforms. These systems include:

- Advanced Countermeasure Dispensing System for advanced threats.
- Support and training equipment.
- CDT - Countermeasure Dispenser Tester.
- Functional and Stray Voltage Tester for armament stations .
- Smart Weapon Embedded Simulator for training aircrews.



Vision Systems

Rokar's innovative technologies include the ruggedized video management and video display systems. The company offers affordable, real-time embedded video processing units; advanced video routing, switching, recording and debriefing capabilities; and a complete integrated solution - sensor to display - for military applications.

Rokar's Vision Systems encompass:

- Embedded Advanced Video Solutions.
- Advanced Control Recording Box (ACRB) - an affordable situational awareness system and advanced digital video recording (DVR) solution for military applications.
- Video Routing Unit (VRU) - Powerful video and data management system for military platforms.
- Pview - 180 degree panoramic day/night camera pod.



AIRBORNE MISSILE PROTECTION SYSTEMS (AMPS)



BIRD AEROSYSTEMS LTD.

10 Hasadnaot St., P.O.Box 4038
Herzeliya 4614001, Israel
Tel: 972-9-9725700
Fax: 972-9-9579613
E-mail: info@birdaero.com
Web Site: www.birdaero.com



BIRD Aerosystems specializes in the development, production and marketing of Airborne Missile Protection Systems (AMPS). AMPS is provided in cooperation with CASSIDIAN (an EADS Company), integrates missile warning (MWS), radar warning (RWR) and laser warning systems (LWS) together with world leading countermeasure dispensing systems and provides a complete missile protection system for helicopters and wide body aircrafts against IR-guided SAMs.

The system is certified by leading aircraft manufactures such as EUROCOPTER (an EADS company) and MIL Design Bureau on MI Helicopters.

The AMPS is a NATO standard system and has been selected and installed on aircraft serving many customers including the NATO armed forces, the United Nations (UN) Air Operations, and the US government.

Main Features

- Fully autonomous system from detection to protection
- Small number of compact, light-weight units
- Stand alone configuration – no interfaces required to mission or avionic systems
- Full integration with MWS, RWR, LWR, CMDS, DIRCM
- Short installation and integration time
- Very wide installation base including: Cougar, Puma, S-92, EC-135/635/145/155/725, AW-139, BK-117, UH-60 and several types of Mi-8/17

AMPS is a turn-key solution operationally used on military and VIP aircraft around the world including: US, Canada, France, Germany, Spain, Italy, Australia, India, Czech Republic and many others.

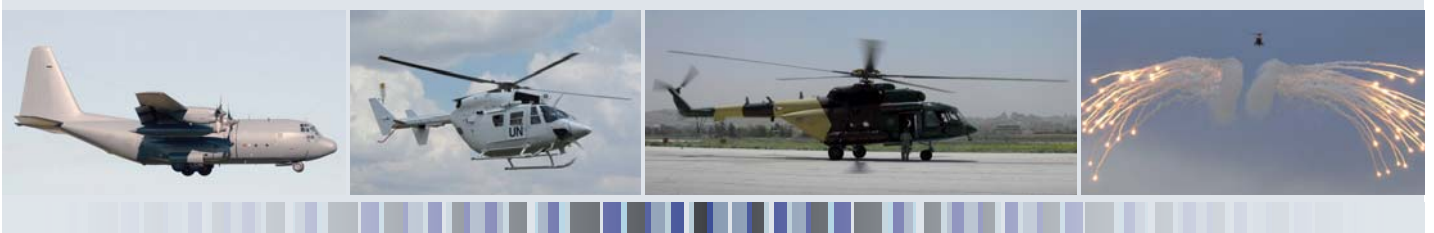

MUSIC®

MANPADS Protection Suite

Elbit Systems

Electro-optics - Elop

**ELBIT SYSTEMS
ELECTRO-OPTICS - ELOP LTD.**

P.O.Box 1165, Rehovot 7611101, Israel

Tel: 972-8-9386211

Fax: 972-8-9386237

E-mail: eo@elbitsystems.com

Web Site: www.elbitsystems.com/elop

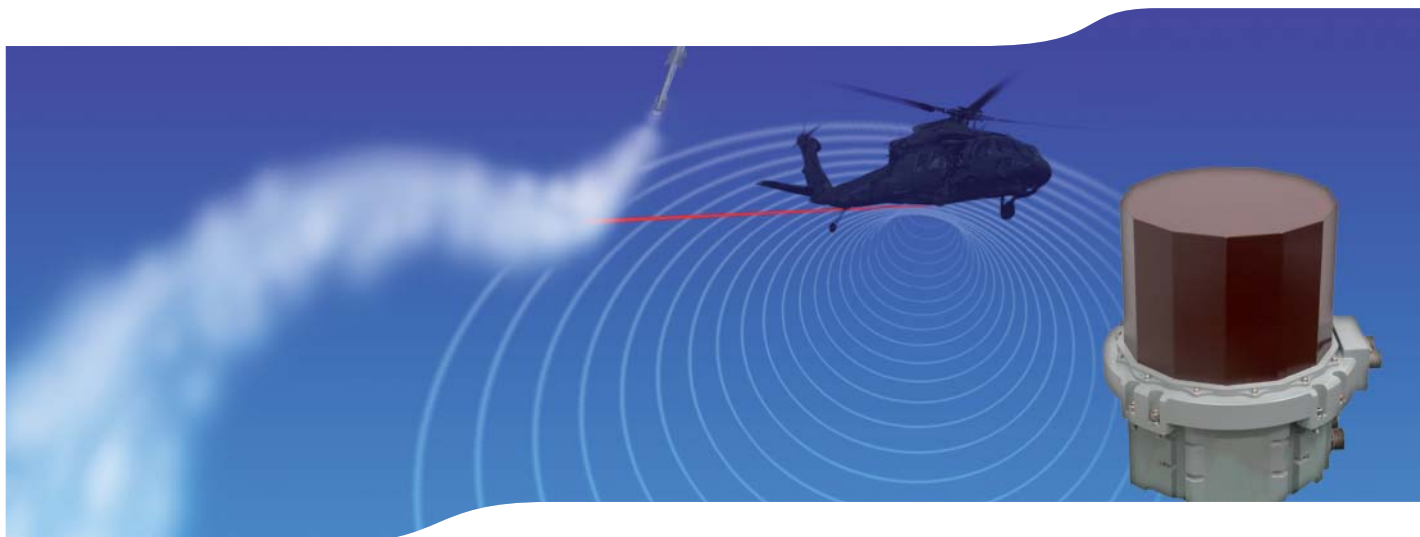

Elbit Systems Electro-optics Elop provides advanced threat protection systems and EO countermeasures for air platforms, based on leading technology in the fields of IR sensors, lasers, stabilized platforms and protection techniques.

MUSIC® (Multi Spectral Infrared Countermeasure) is an advanced DIRCM system that integrates a number of technological components into a compact, lightweight, highly reliable system. It provides a turnkey solution for countering surface-to-air heat-seeking missiles for both helicopters and small to medium-size fixed-wing aircraft. In the C-MUSIC™ configuration, the system is suitable for large civilian/commercial aircraft, military transports and tankers.

MUSIC® comprises a small, highly dynamic turret that uses innovative techniques to achieve exceptionally high slew rates, enabling the system to acquire and track a threatening missile rapidly with high accuracy. This is coupled to a multi-spectral fiber laser that enables the main part of the laser to be located a few meters away from the turret with the laser energy being transferred between them through an optical fiber. This in turn facilitates installation, especially on helicopters, as the turret can be installed in the optimal position for protecting the aircraft, while the electronics and laser units can be installed where convenient. The multi-spectral fiber laser outputs a number of different wavelengths simultaneously in order to jam a variety of missiles. In addition, utilization of the fiber laser technology ensures higher system reliability and availability, considerably reducing maintenance costs.

ELISRA'S AIRBORNE ELECTRONIC WARFARE & INTELLIGENCE SOLUTIONS



ELBIT SYSTEMS EW & SIGINT –
ELISRA LTD.

48 Mivtza Kadash St.,
Bene Beraq 5121701, Israel
Tel: 972-3-5577335
Fax: 972-3-5577793
E-mail: ew-sigint@elbitsystems.com
Web Site: www.elbitsystems.com



Integrating RWR, LWS, MWS ECM and Chaff/Flare, Elisra is a primary source of **EW suites** for the Israel Air Force and many other Air Forces around the world. A leader in sophisticated **EW solutions**, Elisra's EW systems are installed in over 30 types of fixed and rotary-wing aircraft of both Western and Eastern origin.

Elisra's **All-in-Small™** - a next-generation unified suite for airborne EW protection - is the preferred Self-Protection Suite (SPS) for all Airborne platforms. Merging in a single LRU - both high-end technological capabilities and proven operational experience of **SPS-65V-5** and **PAWS Family** (Passive Airborne Warning Systems) systems - ALL-in-SMALL delivers superior performance, enhanced platform survivability, and supports mission success.

Spectrolite - SPS-65V-5 - is yet another innovative protection solution, designed to fully protect helicopters and other aircraft against all threat types.

Advanced Self-Protection Suite (ASPS) for Fighter Aircraft - This combat-proven suite includes a passive multi-spectral self-protection and situation awareness system and active self-protection RF jammers, all integrated into one EW suite.

Elisra's **IR-CENTRIC®** Solutions, the only operational system of its kind, is a unique measurable self-protection force multiplier for airborne and ground application, which opens new possibilities for its users. IR-CENTRIC® offers multi-function, multi-usage capabilities and an interoperable unity providing its users with the ability and freedom to define, redefine, reconsider, and reconfigure mission objectives and outcomes. By enabling the redefining of mission parameters and significantly shortening the sensor to weapon loop, IR-CENTRIC® boosts survivability of crews and platforms both airborne and ground.

Elisra's **SKYFIX** and **SKYJAM families** for manned and unmanned Platforms - Elisra provides COMINT, COMINT/DF & COMJAM capabilities to tackle the range of airborne communications systems being used today including conventional, cellular, and satellite. The company offers UAS specific COMINT, COMINT/DF & COMJAM systems that are conceived as modular building blocks able to fit any UAS on the market. These solutions meet the requirements of any EW/SIGINT payload, offering tactical intelligence reception in real time, over wide areas both rural and urban.

Elisra's **Emerald airborne ESM/ELINT** system is a fully-featured, advanced system for manned and unmanned platforms ensuring mission-readiness in the most challenging scenarios. Incorporating Elisra's field-driven innovations and proven technologies, Emerald delivers the intelligence critical for effective prevention, fast response and powerful impact.

ALL-in-SMALL



SKYFIX



SELF PROTECTION SYSTEMS



IAI ELTA SYSTEMS LTD.

P.O.Box 330 Ashdod 7710202, Israel

Tel: 972-8-8572410

Fax: 972-8-8561872

E-mail: market@elta.co.il

Web Site: www.elta-iai.com

ELTA - Our Systems, Your Advantage

Integrated EW Self Protection Suite

ELL-8260/2 INEW-SPS

The ELTA integrated EW Self Protection Suite was designed to enhance the survivability of helicopters and fixed wing aircraft operating in hostile multi-spectral threat environments. Upon detection and identification of lethal threats by the warning subsystems, effective countermeasures can be automatically initiated. This modular system's configuration comprises of a selection, among the following elements: Radar Warning Receiver (RWR), Laser Warning Receiver (LWR), Missile Approach Warning Systems (MAWS), Electromagnetic Jammer, DIRCM, Advanced Chaff & Flare Dispenser and an EW Central Processor.



Missile Approach Warning System

ELM-2160 MAWS

The ELTA airborne radar-based Missile Approach Warning System greatly enhances the survivability of airborne platforms.

The system is operational on various types of transport aircraft, VIP and special mission aircraft and helicopters. It is based on a Pulse Doppler Radar, designed to detect all types of approaching missiles providing timely, accurate and reliable warning to the crew, and automatically activating Chaff/Flare dispensing for reliable and efficient missile deception. The system provides all weather capability and very low false alarm rates.



EW System Escort Jammer

ELL-8251

ELTA's ELL-8251 Escort Jammer (EJ) is an advanced EW system that suppresses all types of enemy Air Defense Surveillance and Fire Control Radars along the prescribed mission flight path. The system is designed for either an internal or external (pod configuration) installation supporting the Airborne Electronic Attack (AEA) missions. It significantly increases the survivability of the carrier aircraft and the entire attacking force. The Jammer is designed to operate automatically with minimal pilot intervention.



OTHELLO - Passive Optical Fire Locator

ELO-5220

The OTHELLO is a Short Wave Infra Red (SWIR) Passive Optical Fire Locator, which detects and precisely locates sources of hostile fire in the battlefield. OTHELLO can detect the launches of Anti -Tank Guided Missiles (ATGMs), Rocket Propelled Grenades (RPGs), cannon fire and gunfire. The system provides precise bearing (azimuth and elevation) to the fire source, and indicates launch timing and threat classification. The system can be stationary, vehicle mounted or man portable.

AEROSPACE

Electronic Warfare & Countermeasures



ISRAEL MILITARY INDUSTRIES LTD. (IMI)

P.O.Box 1044, 64 Bialik Blvd.
Ramat Hasharon 4711001, Israel
Tel: 972-3-5485222
Fax: 972-3-5486125
E-mail: imimrktg@imi-israel.com
Web Site: www.imi-israel.com

RED SKY-2

RED SKY-2 is a fast-deployment, compact VSHORAD system for protection of stationary sites, mobile dismounted and rapid-deployed peacekeeping forces. By integrating advanced, passive sensors with a remotely controlled operation, RED SKY-2 extends the capabilities and effective range of existing MANPAD missiles which are limited by human factors, to their maximum potential (beyond 15 km). The system is mounted on man-portable pedestals, with sensors and C³ capabilities. RED SKY-2 can be deployed in locations previously inaccessible to heavier air defense systems, such as mountainous terrain or urban environments.

ATALD

ATALD (Advanced Tactical Air launched Decoy) is an active decoy used in SEAD missions, enhancing the survivability of friendly aircraft and guided munitions by saturating

enemy air defense systems with multiple false targets. ATALD's modular design enables the use of the vehicle as a target drone for different scenarios depending on the payload selection (RF and/or IR).

SUNNY SAM

SUNNY SAM is a low-cost dynamic Threat Simulating System (TSS) for IR and/or UV simulation of SAM launches during training exercises. The system includes a Static Pyrotechnic Unit (SPTU) which simulates the initial flash created during ejection of a shoulder-launched missile; a Short Range Simulating Rocket (SRSR) unit which simulates the missile's flight and radiation trail and a control system for activating the SPTU and SRSR units.

AIRMOR

AIRMOR is a fully autonomous, modular self-protection suite designed for helicopters and transport aircraft.

Its core components are: a Management Control Unit (MCU), which processes information from EW sensors and aircraft avionics - generating the optimal response to a particular threat; a Control & Display Unit (CDU), which provides situational awareness and the controls for operating the system. AIRMOR also employs a passive UV Missile Warning Sensor (MWS) and a Counter Measure Dispensing System (CMDS) with various expendables.

ADVANCED SPECTRAL IR FLARES

IMI's ADVANCED SPECTRAL IR FLARES provide combat aircraft with increased survivability against most advanced MANPADS in today's battlefield. The state-of-the-art flares can be dispensed from AN/ALE-39/40/47, ADDS SAMP 60/120/240A and equivalent dispensers, and are in use and combat-proven by the Israeli Air Force (IAF).



ELECTRONIC WARFARE SYSTEMS



Platform Self-Protection Suites

RAFAEL
ADVANCED DEFENSE SYSTEMS
 P.O.Box 2250 (19)
 Haifa 3102102, Israel
 Tel: 972-4-8794714
 Fax: 972-4-8794657
 E-mail: intl-mkt@rafael.co.il
 Web Site: www.rafael.co.il

Naval EW System: Based on cutting-edge technology and combat proven, these unique products include ESM (**C-PEARL**) systems both compact and comprehensive with automatic detection and identification of signals, wide-band with accurate measurements, ECM (**SHARK**) with very high effective radiation power (ERP) using Multi-Beam Array Transmitters (MBAT) and DRFM based technique generators for effective jamming, and various Integrated EW suites (**SEWS**) tailored to any specific vessel and requirements.

C-GEM Off-board RF Active Decoy. Modern tracking radars and missiles exploit the principles of Mono-pulse & Lock On Receive-Only (LORO) techniques to track marine platforms. Many of these radars incorporate chaff identification and avoidance capabilities. **C-GEM** is the best solution with Wide-band frequency range, extended spatial coverage, high ERP, solid state active beam steering array, very fast response and installation options for all types of launchers: fixed, trainable and stabilized.

Airborne EW Systems: Critical means to enhance information superiority and survivability of aerial platforms, including Airborne ELINT/ESM systems (**TOP-SCAN**) suitable also for UAVs, Airborne Support Jammers (**SKY-SHIELD**) for Suppression of Enemy Air Defense (SEAD) missions providing comprehensive countermeasures against enemy threats, and Towed Decoy (**X-GUARD**) designed to provide maximum protection against modern missiles.

Airborne EW System for Helicopters: Rafael develops, manufactures and sells an electronic warfare self-protection system known as the Jam-Air.

The system includes a Directed Infra-Red Counter-Measures (DIRCM) turret and a Missile Warning System (MWS), detecting the threatening missiles and automatically and swiftly directing the DIRCM turret towards the threat, in order to disrupt its guidance and homing.



Jam Air



C-GEM



X-GUARD

SEWS



Ness TSG

Air Defense and Air Traffic Control Solutions



Ness TSG
Technologies & Systems Group
P.O.Box 58180
Tel Aviv 6158101, Israel
Tel: 972-3-5483518
Fax: 972-3-5483700
E-mail: tsg@ness.com
Web Site: www.ness.com/tsg

Ness Technologies & Systems Group (TSG) is a leading international systems house specializing in the integration of advanced command-and-control solutions for real-time military and civilian defense, homeland security, and telecom applications.

Ness TSG has a dedicated team of multidisciplinary professionals with expertise in system definition and design, system engineering, algorithm development, and hardware/software integration. With over four decades of experience, Ness covers a range of fields including C⁴I, real-time communications, image processing, data fusion, video transmission and IP communications.

We maintain a diverse international client base of armed forces and defense establishments, organizations and enterprises. Since 1969, Ness TSG has served as a strategic partner of the Israel Defense Forces (IDF), strengthening the IDF's operational advantage by implementing innovative solutions tailored to its unique needs.

Deployed by the Israeli Air Force and other air forces throughout the world, our air defense and air traffic control (ATC) systems provide complete information and support facilities for the most advanced air defense command-and-control systems (ADCCS).

We also have developed a unique automated terror threat analyzed system (ATTAS) that can be integrated with customers' existing ATC systems.

Ness TSG's air defense and ATC systems enable commanders and controllers to effectively execute a range of tasks including:

- Defending air space
- Evaluating threats introduced by enemy aircraft and tactical ballistic missiles (TBM)
- Controlling a range of air missions
- Delivering early warnings to civilian populations



TSG

Technologies & Systems Group

SENSORS FOR MARITIME PATROL AIRBORNE PLATFORMS



IAI ELTA SYSTEMS LTD.
P.O.Box 330 Ashdod 7710202, Israel
Tel: 972-8-8572410
Fax: 972-8-8561872
E-mail: market@elta.co.il
Web Site: www.elta-iai.com

ELTA - Our Systems, Your Advantage

Maritime Patrol Radar

ELM-2022A

The ELTA ELM-2022A Maritime Patrol Radar (MPA) is an advanced multi-mode airborne maritime surveillance radar designed for Fixed or Rotary Wing Airborne Platforms. Key features include detection of small targets, long range Surveillance, target Range-Profiling, SAR and ISAR Classification Modes, Search & rescue location and support, Moving Target Indication (MTI), navigation and weather modes.

The MPA System provides a cost-effective force multiplier solution for Maritime Surveillance and EEZ Patrol, Surface and Littoral Warfare, Search and Rescue, drug interdiction and prevention of illegal immigration and terrorist activities, Coast Guard and Fisheries Patrol, and Image Intelligence Operations.

Airborne ESM/ELINT for Maritime Patrol A/C

ELL-8382MPA

The ELTA ELL-8382 is a state-of-the-art ESM/ELINT system designed for tactical and strategic Maritime Patrol Aircraft missions. The system performs Anti-Surface Warfare (ASuW), Anti-Submarine warfare (ASW), and Search and Rescue missions. These missions are enabled through surveillance, geo-location and tracking of all radar emitters in the arena. In addition, continuous ELINT data collection and analysis are performed throughout the mission. The system automatically generates a reliable and accurate Electronic-Order-of-Battle for all radar types, including Low Probability of Interception radars.

Maritime Patrol Airborne Platforms

Maritime Surveillance Radar

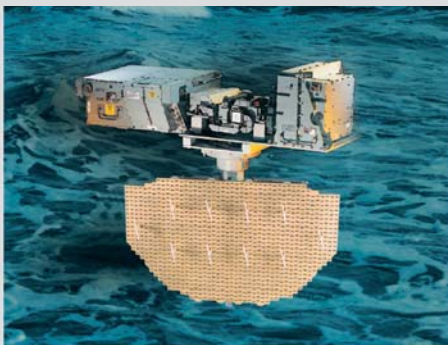

Maritime Patrol Helicopter



Maritime Patrol Mission Aircraft



Maritime UAV Radar

SPECIAL MISSION AIRCRAFT



IAI ELTA SYSTEMS LTD.

P.O.Box 330, Ashdod 7710202, Israel

Tel: 972-8-8572410

Fax: 972-8-8561872

E-mail: market@elta.co.il

Web Site: www.elta-iai.com

ELTA - Our Systems, Your Advantage

Multi-Mission Airborne Reconnaissance & Surveillance System (MARS²)

ELI-3150

MARS² is a Multi-Role Airborne System designed to operate as a fast-deployment, all-in-one task force. It enables complete Ground Situational Awareness for the theater under surveillance. MARS² comprises a high performance aircraft (business jet or similar) equipped with a powerful Sensor-Suite and with the means to integrate the sensors' data effectively. An internal Command & Control and Communication (C³) Station translates intelligence and situational awareness into battle management.



CAEW - Conformal Airborne Early Warning & Control

ELW-2085

ELW-2085 is ELTA's third generation of Conformal Airborne Early Warning & Control (CAEW) systems.

The system is mounted on a modified long-range, highperformance and low operating cost Gulfstream 550 business jet. ELTA's onboard integrated Sensor Suite, with a powerful Communication System, supports a variety of operational missions.



MPA - Maritime Patrol Aircraft

ELI-3360

The ELTA MPA is a multi-role airborne system designed to operate as a fast-deployment independent asset, providing comprehensive situational awareness and maritime domain superiority. The MPA comprises of a high performance aircraft equipped with a powerful Sensor-Suite and a Mission System to effectively integrate the sensors' data. An on board Command & Control and Communication (C³) System derives intelligence and situational awareness for the maritime arena management and disseminates the information to operational users and to the NCW infrastructure.

Compact Multi-Mission Aircraft

ELI-3120

The ELI-3120 Aircraft is designed to cope with the challenges of present and future operational theatres. Utilizing an airborne multi-sensor system installed onboard, this Intelligence, Surveillance and Reconnaissance Aircraft provides tactical and strategic intelligence to a variety of users. The ELI-3120 system may be installed either on a customer provided aircraft or supplied on a suitable aircraft preferred by the customer.



ELECTRO-OPTIC INTELLIGENCE, SURVEILLANCE AND RECONNAISSANCE (ISR)

Litening - Targeting & Navigation Pod

Litening is an innovative airborne infra-red targeting and navigation pod for fighter aircraft with high accuracy and reliability, day and night precision strike capability. Litening reduces pilot workload during targeting and tracking.

It is easily integrated on any aircraft and possesses high growth potential.

In use in the Israeli Air Force, USAF, ANG, AFRES, Marines, German AF, Swedish AF, Spanish Navy & AF, Greek AF, and others, the Litening flies on F-16 , F-15, A-10, B-52, AV8-B, Gripen, Tornado, F-5, F-4, Mig-21, Mirage 2000, Jaguar and others.

■ ■ ■

Toplite EO System - Electro-Optical Surveillance, Observation & Targeting System

The Toplite family of electro-optic systems is an advanced multi-sensor, multi-purpose, highly stabilized EO systems for homeland security and defense applications, for aerial, maritime and ground based platforms.

RecceLite- Real Time Tactical Reconnaissance System

The RecceLite System consists of an E-O pod, a ground exploitation station and a data link. It is capable of collecting images day & night from 300 ft to 40,000 ft in all directions forwards, nadir, backwards, oblique - all down hemisphere and even when the aircraft is maneuvering in high G.

The Ground Exploitation Station (GES) is capable of generating targets in real-time with exceptionally high accuracy due to state-of-the-art algorithms and technology.

The data-link connects between the sensors and the GES and enables the images to be downloaded to the GES in real time. When your task is to close the attack cycle on many "time-critical targets" in less than 10 minutes, there is only one system - RecceLite.



Litening -on-Gripen



Toplite EOS

RAFAEL
Advanced Defense Systems
 P.O.Box 2250 (19)
 Haifa 3102102, Israel
 Tel: 972-4-8794714
 Fax: 972-4-8794657
 E-mail: intl-mkt@rafael.co.il
 Website: www.rafael.co.il

Recce-U - Real-Time Persistent ISR System for UAVs

Recce-U is a self-contained, multi-sensor ISR system (based on the RecceLite Tactical Reconnaissance Pod). The Recce-U enables automatic photography, according to a mission plan prepared in advance, or updated mission plan uplinked in real-time, however the operator can initiate manual scanning for targets of opportunity.



RecceLite System

Recce-U

***SpotLite Family
 Electro-Optic Enemy Fire Detection System***

The SpotLite family consists of electro-optical systems that detect and locate enemy fire in stationary positions as well as on the move. Rapid detection and precise location information provide forces with the capability to quickly neutralize the enemy, maintaining the upper-hand on the battlefield.

The **SpotLite P** is a portable electro-optic system carried by two soldiers for day and night detection and location of small arms fire.



SpotLite P on Tripod

SpotLite M is a mobile electro-optic system installed on vehicles and AFV's that enables the detection and location of enemy fire sources from small arms, RPG rockets, ATGM and tank shells, on the move, day and night, up to 360° coverage.



SpotLite M on vehicle

DATA LINK COMMUNICATION & NETWORKS



Rafael provides communication products that include data links, airborne relay systems, communication networks & voice radios

C⁴I-ConNeCT

Voice Communication System for Air Force C&C

- Voice Communication System designed for the specific needs of air force command & control
- Tactical, IP & VoIP based Communication System
- Seamless connectivity from anywhere to anywhere
- Scalable solution to support a broad range of systems
- Converge different types of voice communication systems – Various legacy & IP Radios, Satcom, telephony – to a single system
- **Field proven in Israeli IAF**



RAVNET 300

Airborne Voice & Data Communication Radio Network

- Air-to-Air, Air-to-Ground, instantaneous high data rate
- Highly advanced Voice & Data Networks
- High Availability: Long range communication, auto relay via multi hops
- High efficiency utilization of V/UHF spectrum
- Legacy radios support for practical evolution
- **Field proven in Israeli IAF**



RAFAEL

ADVANCED DEFENSE SYSTEMS

P.O.Box 2250 (19)
Haifa 3102102, Israel
Tel: 972-4-8794714
Fax: 972-4-8794657
E-mail: intl-mkt@rafael.co.il
Web Site: www.rafael.co.il

DLV-53 MF™

ISTAR Wideband Data Link

- Ultra Wide Band data-link providing communication solutions for UAVs/ USVs/ UGVs & Airborne Reconnaissance pod systems
- Use of a single, small & light - weight unit for PTP LOS/SatCom, one hop LOS Relay & CAS waveforms simultaneously
- Supports data rates from 200Kb/s to 274 Mb/s - selectable from the Ground Station
- Growth capability up to 548Mbps without HW change
- Full spectrum support (L, S, C, X, Ku, MMW), highly immune
- Seamless secured connection between standard Airborne IP LAN and Ground IP LAN over a Gigabit WAN



AIR STAR

Multi-Sensor Aerostat based system for Extended ISR

- The most advanced field proven Aerostat based IAR system
- Expands early warning and surveillance capabilities
- Supports air dominance
- Consists of multiple sensors: Radar, ELINT, COMINT & Receivers/Transmitters
- Communication to Command and Control & to Targets Interceptors
- High availability



RAFAEL
ADVANCED DEFENSE SYSTEMS
P.O.Box 2250 (19)
Haifa 3102102, Israel
Tel: 972-4-8794714
Fax: 972-4-8794657
E-mail: intl-mkt@rafael.co.il
Web Site: www.rafael.co.il

Multi-Source Multi-Task ISR Exploitation System / Command and Control System Imilite is an intelligence system designed to receive process and exploit multiple standalone imagery video and other intelligence data in a centralized and a unified way.

System capabilities:

data reception, processing and display of Video, imagery, targets, threats, mission status, force locations, SIGINT detection and others.

The system GIS capabilities provide synchronized display of all the data as overlays on maps, video and images.

Imilite improves the Command-and-Control process by various automated image processing algorithms such as geo-referencing, change and motion detection, video/image enhancement, video stabilization and others.

Imilite can disseminate operational data, tactical mission reports, targets and treats to other forces, to facilitate close support operations, targeting and platform/sensor management.

ImiLite allows scalable Command and Control solutions and adaption to specific operational needs, both in mobile and stationary configurations for Command and Control centers, deployable operational units.

Benefits:

- Centralized and unified workflow and data display
- Improved efficiency utilizing all available collection assets
- Shortened exploitation cycle
- Efficient Command and Control workflow
- Immediate accessibility to relevant data
- Real-time mission command-and-control workflow
- SR and mission product sharing with external operational users

Features:

- Multi-source data reception in various formats
- GIS capabilities: image/video geo-referencing, data overlays, Geo data retrieval
- Advanced Image Processing Algorithms: change and motion Detection, image/video enhancement, video stabilization and others
- ISR and mission products and reports generation and dissemination
- Scalability and Adaptability
- Stationary, Mobile or Airborne configurations



MIC⁴AD



**RAFAEL
ADVANCED DEFENSE SYSTEMS**

P.O.Box 2250 (19)
Haifa 3102102, Israel
Tel: 972-4-8794714
Fax: 972-4-8794657
E-mail: intl-mkt@rafael.co.il
Web Site: www.rafael.co.il

MIC⁴AD is an advanced, unified, integrated C⁴I system that commands and controls the operation of both air and missile defense, including air-superiority missions. MIC⁴AD provides a total solution for multi-system, multi-layer and multi-range air and missile defense, traditionally operated as separate commands.

MIC⁴AD correlates real-time data from distributed sensors/platforms (radars, IFF system, data links, electro-optics), all connected to the air traffic control picture and mission planning system. The data is analyzed to deliver a real-time, coherent national Air Situation Picture (ASP).

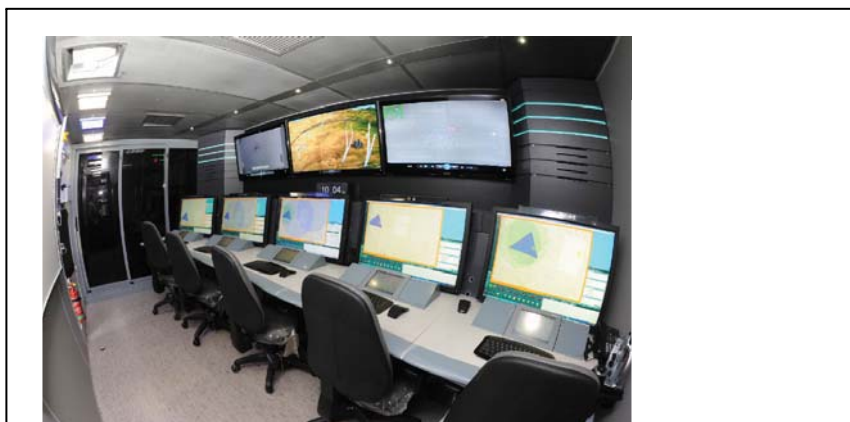

Simultaneously, MIC⁴AD performs threat assessment and hostile target classification, generating an interception plan for threats at any command level (national, regional, tactical). MIC⁴AD optimizes resource management and swiftly allocates the most appropriate defense system, such as SPYDER, David's Sling, Iron Dome or other customer systems to the type of challenge. Response includes target allocation to weapon systems (TAWA - Threat Assessment Weapon Allocation) with full, semi-automatic or manual fire control according to customer doctrine.

MIC⁴AD open, modular architecture can be adapted to customer operational needs. The system can be integrated with a customer's existing or future air and missile defenses. This flexibility allows incorporating new technologies and systems with the existing arrangement. MIC⁴AD can serve as an add-on to the customer's current C⁴I setup, or replace existing systems entirely.

Highly automated, easy-to-use and with advanced interactive displays, MIC⁴AD is a true force-multiplier. Enabling unified command and fire control of multiple air and missile defense systems, MIC⁴AD delivers multi-mission, multi-layer and multi-range C⁴I capabilities that ensure end-to-end air and missile protection.

B.L. ADVANCED GROUND SUPPORT SYSTEMS



Best Solution on Time

B.L. Advanced Ground Support Systems LTD.

18 Hasivim St., Kiryat Matalon
Petach-Tikva 4959376, Israel
Tel: 972-3-9210404
E-mail: sales@bl-il.com
Web Site: www.bl-il.com



BL Advanced Ground Support Systems Ltd. has been in the business for more than 30 years developing multi-discipline advanced products for the defense industry.

BL offers development, production, sales and after sales service in two main areas:

- Advanced ground support systems
- Advanced military products for ground forces

BL's strength is comprised of its ability to develop new and smart solutions rapidly and cost effectively.

Line of Products:

- Bomb Loaders
- Aircraft Towbarless Tug
- HPU - computerized hydraulic power supply

MAGAM SAFETY

Protective, Rescue and Survivability Equipment



MAGAM SAFETY LTD.

6 Hasadna St.,
Ziporit Industrial Zone 1789020, Israel
Tel: 972-73-2665800
Fax: 972-4-6412118
E-mail: info@magam-safety.com
Web Site: www.magam-safety.com

Magam Safety Ltd. designs, manufactures and distributes a wide range of rescue, survivability and protective equipment for over 70 years. Magam Safety products are developed in close relationship and constant feedback from the Israeli Defense Forces (IDF). The company is the sole supplier of parachutes, Anti-G suits and fuel tanks to the IDF. Magam's R&D and production facility is located in northern Israel and employs top-line professionals.

Magam Safety offers comprehensive solutions - from research and development, product design, materials consultation, rapid prototyping trial, serial and mass production, product test reporting and certification, and complete after-sale support throughout the products' life cycle.

Magam Safety provides both off-the-shelf as well as custom made products & solutions tailored to meet customer's specific needs and requirements.

The company's products encompass a variety of combat proven solutions and are made from state-of-the art materials.

Quality Assurance

Magam Safety complies with strict quality control procedures according to international standards, from performing acceptance tests of raw materials till full scale inspection of the finalized product.

Magam Safety is approved to perform self-inspection procedures to Israel's major military institutions; Israeli Ministry of Defense (IMoD), Israeli Air Force (IAF), Israel Aerospace Industries (IAI), Israel Military Industry (IMI), The Ground Forces Command and RAFAEL.

The company's products are designed, manufactured and tested in accordance with international standards: ISO 9001:2008 Quality Managements Systems, ISO 14001:2004 Environmental Management Systems and are under the control of the Standards Institution of Israel.

Areas of Activity

Personal protection equipment

- Ballistic helmets
- Bullet-proof vests
- Advanced armored plates

Rescue and survivability equipment

- Parachutes for paratroopers, pilots, cargo, and brake chutes
- Anti-G suits
- Life-saving jackets

Rubber fuel tanks & self-sealing solutions

- Rubber and self-sealing fuel tanks for Aircrafts, UAVs, Armored fighting vehicles (AFVs) and Battle tanks
- Self-sealing protective coating for fuel tankers

Inflatable equipment

- Inflatable life rafts and boats
- Inflatable Decoys

About Star Defense Systems (SDS)

Magam Safety is a subsidiary of Star Defense Systems (SDS), one of the largest defense companies in Israel, offering innovative defense solutions for Sea, Air, Land, and HLS Forces worldwide. SDS strategic alliances and commitment to R&D provide a solid backbone for products and solutions development at the cutting edge of technology.



FEEL FREE AND SECURED THROUGH CUTTING EDGE & STATE OF THE ART TECHNOLOGIES



DYNAMO RISK DEFENSE (DRD)

P.O.Box 21157
Tel Aviv 6121101, Israel
Tel: 972-3-7265033
Fax: 972-3-6059592
E-mail: office@dynamo-defense.com
Web Site: www.dynamo-defense.com

Dynamo Risk Defense (DRD) is an Israeli corporation, accredited and licensed by the Israeli Ministry of Defense, with valid export licenses. DRD's focus is defense, homeland security, police, military, ICT units, CIO's and the other various government agencies.

DRD creates centre(s) of excellence for their clients. This puts to use DRD's experience, which has been extracted out of numerous elite international and IDF projects, cutting-edge engineering designs and integration projects, led by the team's members during their many years of defense service. The hands on experience from the actual operation of numerous products which were born on the battlefield, helps DRD to offer the best fit of our core products, mapped to the customer's need! DRD's team is a balanced mix of engineers, designers, integrators, security & surveillance experts, former military personal and most important of all, DRD has a support system for relationship building! We have our eye on budget concerns, so we design our product to be strong while we lower operating costs and maintain sustainability and upgradeability. **DRD makes sure to provide clarity and direction to the project, to the stakeholders and to the investors.**

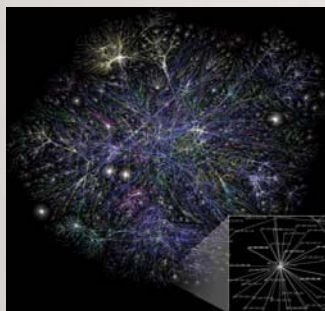
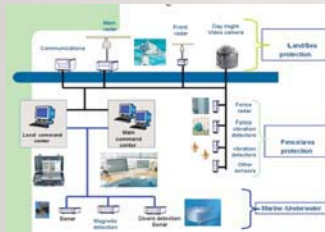

DRD IS ORGANIZED UNDER SIX BUSINESS SEGMENTS WITH LEADING PRODUCTS

SAT-2013:

Space and satellite mission design; nano-satellite turn key projects; communication satellites.

SBSS®:

All Weather Invisible Security System for different types of operations. Coastal and underwater protection; open terrain area protection. The system prevents illegal swimmers, boats, fisherman, smugglers, illegal immigrants and intruders etc. from entering the closed territory which is scaled to the situation. The system has its own C4I and can be integrated.

ELIJAH CYBER SOFTWARE & INFRASTRUCTURE:

Software Security, cellular security combined with software and infrastructure for banks, industries and corporations; Intense network security and cyber security practical courses.

FEAT®:

DRD's courses improve team collaboration in mission environments. Participants broaden their know-how to meet the challenges of the entire security arena.

SEED®:

Sensor-tech protective invisible wireless perimeter security for government areas, bases, facilities, factories, and large homesteads; and other sensitive systems. Low false alarm rate.

ENGINEERING AND LOGISTICS SERVICES:

Special electronic devices; surveillance systems; IMOD authorized weapons reseller and armed SSO logistics; foreign entity setting up operations in Israel; offset; GIS programming and planning.

**PEOPLE,
EXPERT DESIGN,
OPTIMAL OPERATIONAL PRICE,
STRATEGIC SITUATIONAL PRODUCT**

SPACE PROGRAMS

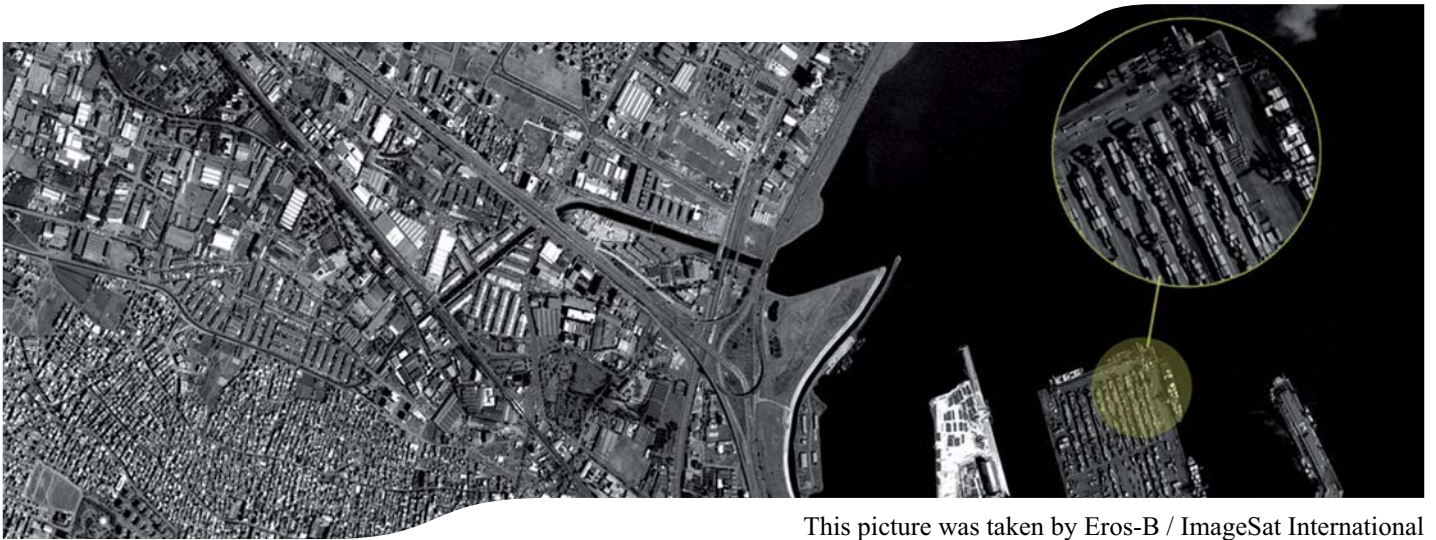

This picture was taken by Eros-B / ImageSat International

Elop is among a select group of manufacturers worldwide incorporating under one roof the complete infrastructure for carrying out a wide variety of cutting-edge space projects, in cooperation with high-tech companies and defense authorities.

Our cameras provide high spatial resolution earth imaging and mapping for a wide range of military / security, commercial and scientific applications.

Elop's advanced facilities, considered a national asset, include latest generation design tools, clean rooms, controlled chambers for testing under space-simulating thermal-vacuum conditions, set-ups for alignment of large aperture optics, detectors, thermal control systems and other cutting edge equipment for camera testing.



URANUS - MSC

Multi-Spectral Space Camera - Payload System

The URANUS Multi-Spectral Space Camera (MSC), a high resolution panchromatic and multi-spectral payload system, is a complete end-to-end spaceborne remote-sensing payload originally designed for the KOMPSAT II satellite developed by the Korea Aerospace Research Institute (KARI) for multi-purpose use. KOMPSAT II was launched in July 2006.



NEPTUNE

High Resolution Remote Sensing Camera

The high resolution NEPTUNE remote-sensing camera provides real-time, detailed panchromatic images. NEPTUNE, integrated in the EROS B satellite launched in April 2006 and still fully operational, has proved its high reliability. The EROS B satellite is the second in a family of Earth Global Monitoring systems, operated by ImageSat International N.V.



Jupiter

Very High Resolution Remote Sensing Camera

The JUPITER camera is a top-end performance earth observation system for government and commercial applications and missions. JUPITER, our next generation camera, will be integrated in the OPTSAT 3000 satellite. JUPITER contains panchromatic and optional multi-spectral (MS) imaging capabilities sharing a common optical assembly and is capable of simultaneous operation and the creation of pan, MS and pan-sharpened images.

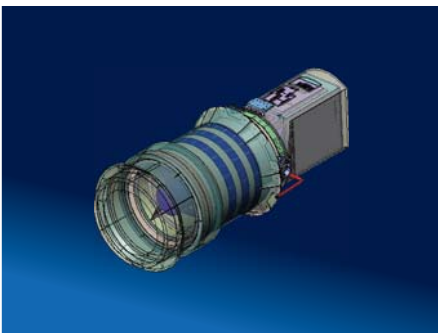

VEN μ S

Super-Spectral Remote Sensing Camera

The VEN μ S camera was developed and manufactured by Elop for a joint effort between the French Centre National d'Etudes Spatiales (CNES) and the Israeli Space Agency (ISA). Ven μ s is lightweight and low in power consumption and can easily be integrated into small/micro, lightweight buses. With 12 narrow spectral bands in the visible and near infra-red spectral regions and 5.3 meter ground resolution, the Ven μ s camera introduces a new level of superspectral high spatial resolution earth imaging for a wide range of commercial and scientific applications.



MERCURY

Earth Global Monitoring System

The MERCURY remote sensing camera provides real-time, detailed high resolution, panchromatic images of broad geographical areas. The reliable and proven MERCURY is integrated in the EROS A satellite that was launched in December 2000 and is still fully operational. The EROS A satellite is the first in a family of Earth Global Monitoring systems, operated by ImageSat International N.V. MERCURY is a modular, lightweight, low power camera which is easily integrated in LEO small/micro, lightweight satellites.

SPACE SYSTEMS TOP PERFORMANCE IN SMALL AND MEDIUM PACKAGES



Israel Aerospace Industries Ltd.
Systems Missiles & Space Group

IAI SPACE DIVISION Systems Missiles & Space Group

P.O.Box 105
Yehud Industrial Zone
5610002, Israel
Tel: 972-3-5315699
Fax: 972-3-5315830
E-mail: marketing@iai.co.il
Web Site: www.iai.co.il



Opsat 2000

Opsat 3000

TECSAR

IAI's OFEQ, EROS optical observation and TECSAR SAR imaging satellites provide top notch performance in a small, lightweight package.
The AMOS family of GEO communication satellites provides very high tailored performance in small to medium size satellites.
IAI provides comprehensive turnkey solutions, including ground stations and related services.
IAI welcomes governmental and industrial participation and partnerships.

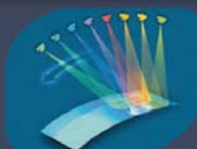

Mosaic Mode



AEROSPACE

Space Technology



ISRAEL MILITARY INDUSTRIES LTD. (IMI)

P.O.Box 1044, 64 Bialik Blvd.
Ramat Hasharon 4711001, Israel
Tel: 972-3-5485222
Fax: 972-3-5486125
E-mail: imimrktg@imi-israel.com
Web Site: www.imi-israel.com

IMI is the National Center of Excellence for Solid Rocket Propulsion

Main Activities:

- Rocket Motors for Interceptor Missiles
- Boosters for Satellite Launchers
- UAV Boosters
- Thruster Kit for Attitude Control

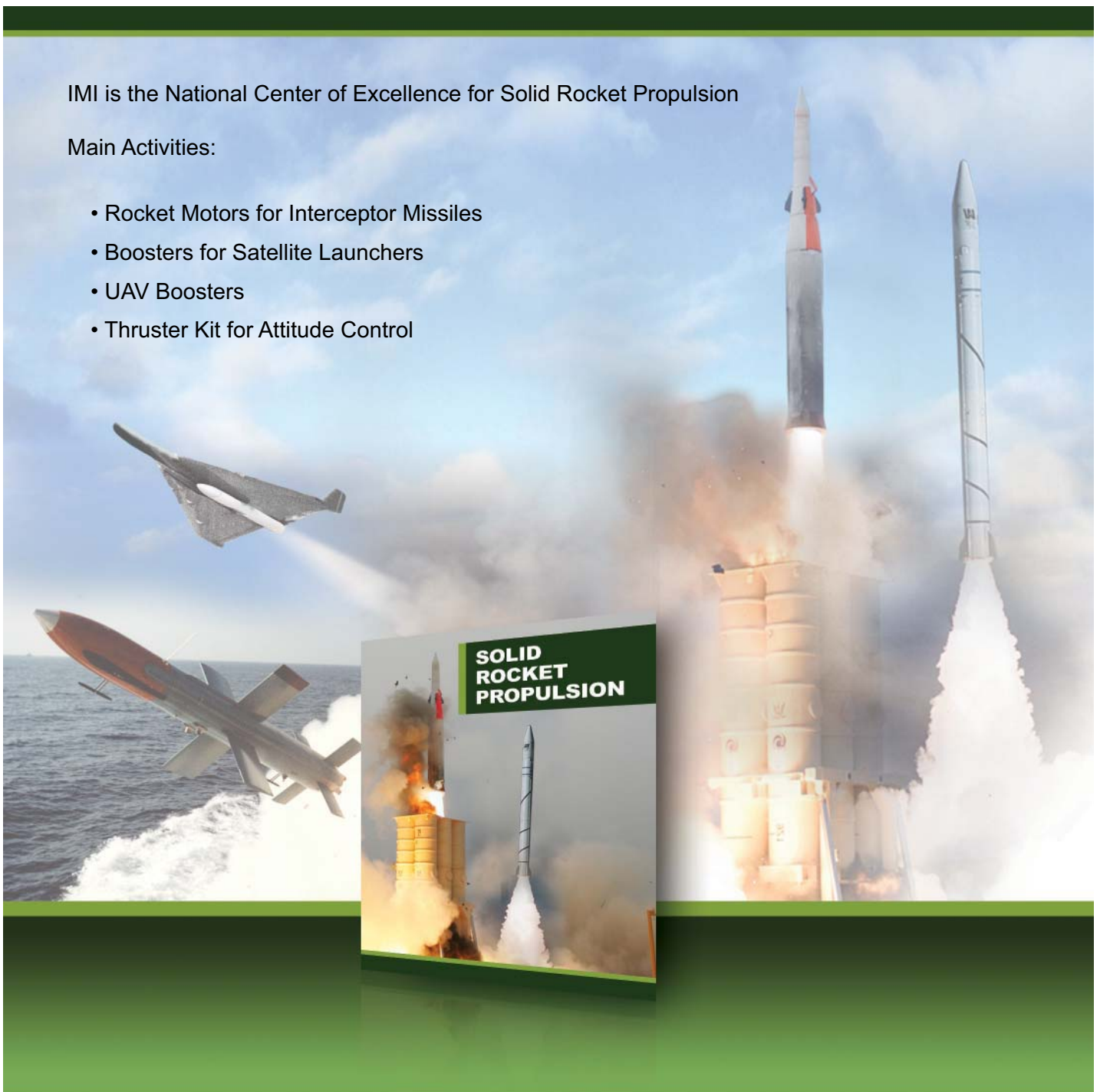

SPACE TECHNOLOGIES



RAFAEL
ADVANCED DEFENSE SYSTEMS
P.O.Box 2250 (19)
Haifa 3102102, Israel
Tel: 972-4-8794714
Fax: 972-4-8794657
E-mail: intl-mkt@rafael.co.il
Web Site: www.rafael.co.il

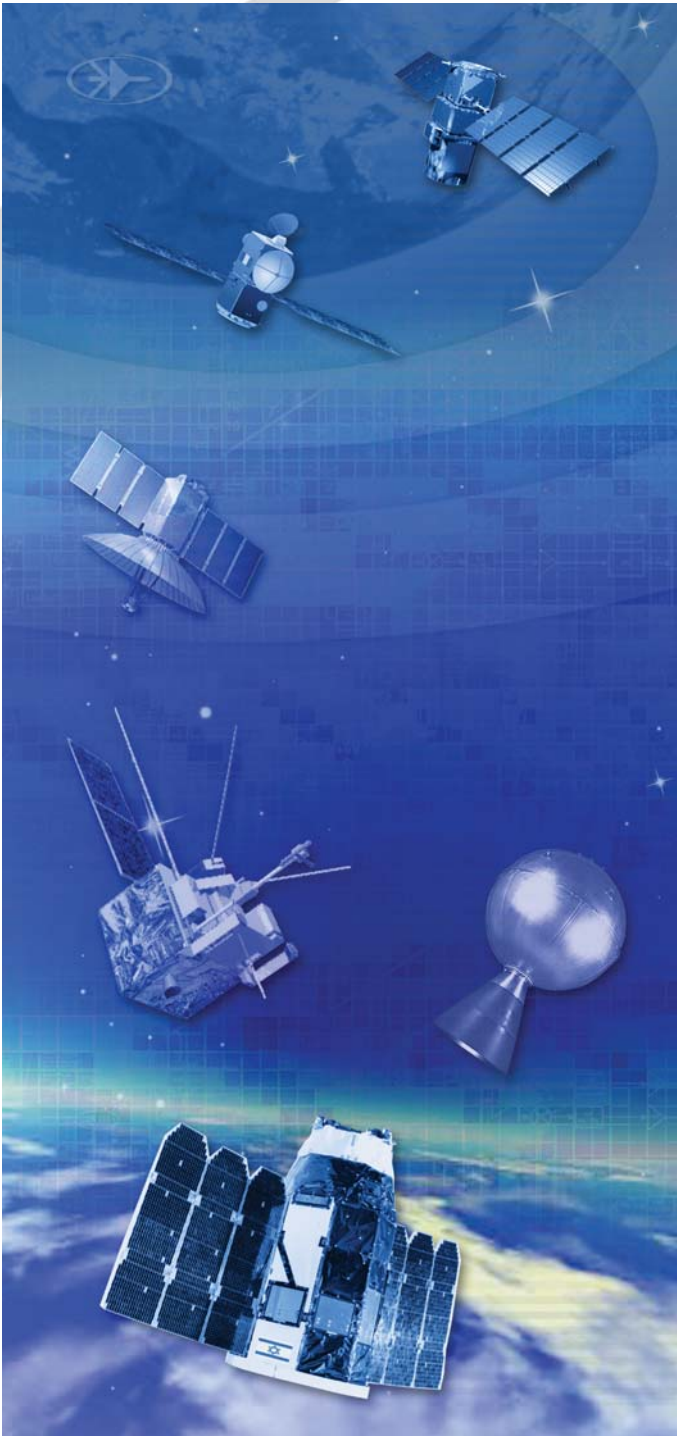

Rafael continues to expand its space activities to include micro-satellite technologies and systems, complete propulsion systems for satellites and satellite launchers and airborne satellite launchers. It offers affordable and highly-effective advanced solutions for both military and commercial Low Earth Orbit (LEO) missions.

The propulsion systems include attitude control and orbital transfer propulsion modules for the Ofek, Eros and TecSAR satellite series, attitude control systems for satellite launchers, electric propulsion systems and cold-gas reaction control systems for micro-satellites.

In addition, Rafael supplies propellant tanks, thrusters and valves for hydrazine propulsion systems, as well as third-stage solid propellant rocket motors.

Rafael's components are presently in orbit, on numerous Israeli and European satellites.

Rafael is a partner in the Israeli Joint Venture (together with IAI) which is building the Joint French-Israeli Venus scientific micro-satellite.

AIR DEFENSE SYSTEMS

IRON DOME SPYDER-SR/MR



RAFAEL
ADVANCED DEFENSE SYSTEMS
P.O.Box 2250 (19)
Haifa 3102102, Israel
Tel: 972-4-8794714
Fax: 972-4-8794657
E-mail: intl-mkt@rafael.co.il
Web Site: www.rafael.co.il

Air Defense

Rafael has extensive experience in missile development and production, and offers a variety of missiles in a broad range of areas.

IRON DOME

The Iron Dome is the only dual mission system in the world that provides an effective defense solution for countering rockets, artillery & mortars (C-RAM) as well as aircraft, helicopters, UAVs, PGMs. The system is an effective system for countering C-RAM threats with ranges of up to 70 km and for VSHORAD protection (up to 10 km). The system operates in all weather conditions, including low clouds, rain, dust storms or fog.



SPYDER-SR/MR

Short/Medium Range Mobile Air Defense Systems.

SPYDER (Surface-To-Air Python & DERBY) is a quick reaction, low level surface-to-air missile system designed to counter attacks by aircraft, helicopters UAVs and precision guided munitions. The system provides effective protection of valuable assets, as well as first-class defense for forces located in the combat area. SPYDER incorporates RAFAEL's most advanced, proven performance air-to-air missiles - the Derby active radar (RF) missile and Python-5, a dual waveband Imaging Infra Red (IIR) missile. The SPYDER family includes SPYDER-SR (Short Range) and SPYDER-MR (Medium Range) systems.





NAVAL FORCES

Naval warfare, with special emphasis on littoral defensive operations, has always played a significant role in the planning, operational readiness and deterrence capability of Israel's defense forces.

Maintaining a modern fleet of surface vessels, optimized for littoral warfare, and a strong submarine force, the Israel Navy constantly sought to gain superiority over its opponents by introducing technological innovation based on indigenous capabilities.

Since the late 1970s Israel pioneered the concept of layered defense and sea-skimming anti-ship missiles - a strategy that led to a perfect score during the 1973 war. Along with the local defense industries, Israel is also leading the 21st century technology of 'networked operations', introducing fully-integrated combat systems, comprising a wide range of domestic and foreign weapons, sensors, and processing systems.

The Israeli industry is also building and equipping the manned and unmanned platforms used by the navy, to maintain their offensive and defensive capability, providing the situational awareness, command and control for naval operations. Specific Israeli systems are integrated into combat suits designed by other navies and prime contractors, as part of international teaming and cooperation.

For coastal and EEZ security missions Israel offers a wide range of solutions, from manned and unmanned aerial and surface vehicles to integrated naval, land-based and aerial platforms, carrying maritime and coastal surveillance radars and EO sensors, and integrated communications systems.

C-MAN

Computerized Maritime Navigation system

For surface and sub-surface vessels
Features Monolithic Ring Laser Gyro INS/GPS navigation sensors or MEMS based INS sensors for Coastguard and littoral Patrol Boat



- **Turn key system solution for Integrated** Navigation and inertial Data Distribution.
- **Data computation** and data distribution to all shipboard sub-systems of all directions motion sensing, attitude and position.
- **Interface** to Command & Control, Weapons, Electro Optical Directors, Radar Antennas and all ship's inertial data users.
- **High accuracy, high reliability** inertial sensor with embedded GPS, accurate positioning at minimal drift rates.
- **System redundancy:** Designed for full MEMS or RLG INS/GPS sensors redundancy architecture. Multiple outputs of Synchro and/or digital signals to support multiple-outputs redundancy.
- **Flexibility and Modularity**
 - Modular architecture allowing the use of any combination of sensors (INS/GPS, EM/Doppler Log, Echo sounder, Metrological center, etc.).
 - From basic low cost small vessels single sensor system to high-end large surface vessels and advanced EP-Extended Performance Lowest Drift submarines applications.
 - Multiple outputs – supporting modern digital format sub-systems as well as analog/Synchro shipboard systems.
- **Advanced Processing-utilizing Kalman Filters** optimized for naval navigation data, incorporates accurate compensation and data filtering, taking into account latency and utilizing unique prediction algorithm considering the characteristics of naval vessels.



ASTRONAUTICS C.A. LTD.

ASTRONAUTICS C.A. LTD.

P.O.Box 3351, Kiryat Arie
Petah Tikva 4951207, Israel
Tel: 972-3-9251555
Fax: 972-3-9251550
E-mail: astro@astro.co.il
Web Site: www.astronautics.co.il

C-MAN System Characteristics

Navigation Data Generation & Distribution

- Heading
- Attitude (Roll, Pitch)
- Heading, Roll, Pitch rates
- Velocity and speed (Relative to Water Mass)
- Accelerations
- Water depth
- Wind speed and direction (Absolute and Relative)
- Barometric Pressure
- Relative Humidity
- Air temperature

Reliability

The C-MAN actual MTBF, per typical naval mission profile is over 10,000 hours

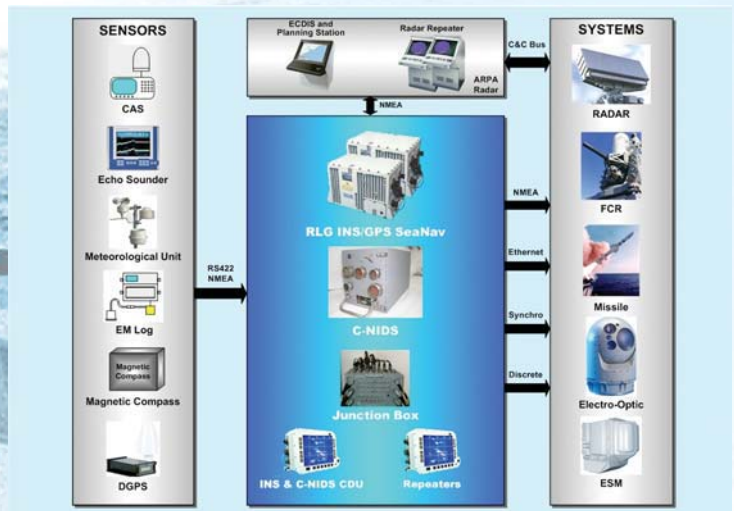

Operating and Control Consoles (OCC)

- Displays multiple video inputs
 - High-speed synthetic graphics
 - Networked display system
 - Built-in self-tests
 - Excellent ergonomic configuration
- Designed to withstand harsh Naval environment conditions



SILVER MARLIN AND STINGRAY USV SYSTEMS



ELBIT SYSTEMS LTD.

P.O. Box 539
Advanced Technology Center
Haifa 3105301, Israel
Tel: 972-4-8315315
E-mail uas@elbitsystems.com
Web Site: www.elbitsystems.com



Silver Marlin and Stingray Unmanned Surface Vessels (USVs) incorporate Elbit Systems' extensive experience in Naval systems and UAVs. In our systems the mission is the main design driver. As in the UAVs, the USVs are designed to allow the operator to concentrate on the mission rather than on driving the vessel. Elbit Systems' USVs are highly autonomous featuring advanced obstacle avoidance capability and patented autonomous maneuvering in compliance with rules of the sea.

The Silver Marlin systems are integrated on medium-sized USVs (~11 meter long) and the Stingray systems are integrated on a small sized USV (3-5 Meter). These cutting edge USV Systems have been developed to meet the need for an affordable, simple to deploy unmanned solution for maritime tasks. Both of them are optimized for homeland security and coast guard applications, and are highly adaptable to HLS and naval combat ISR missions.

The Silver Marlin systems are also designed to execute versatile long endurance missions. They feature autonomous navigation and position keeping capabilities, cruise safety sensors and the capability to transmit outputs of all on-board sensors to the mission control system. The systems are optimal for numerous additional applications such as Law Enforcement, Force Protection, Anti-Smuggling, Search and Rescue (SAR), and more.

Elbit Systems' USVs are fast, maneuverable vessels with extended autonomous capabilities. They are controlled and monitored by a Mission Control Station (MCS) via a suite of advanced Data Links. The Silver Marlin is capable of carrying a wide variety of payloads including Elbit Systems' Stabilized Day and Night Naval Electro-Optic Payload (EOP), Maritime Radar, Small Caliber Remotely Controlled naval Stabilized Weapon Station, and more.

"SAAR S-72" CORVETTE



Our experience Your benefit

A New Generation Of SAAR Class Vessels

The new design of the modern SAAR S-72 is available now.

This new generation of the famous SAAR class Fast Attack Mini Corvettes, is a larger vessel.

It is a multipurpose vessel at the length of 72 meter and full displacement of about 800 tons.

As the existing Naval vessels of Israel Shipyards, the new corvette will also reach the speed of above 30kn with an extended endurance.

The S-72 can operate a medium size marine helicopter. It also supports unique possibilities of deploying Special Forces units.

The main improvements of the S-72 include:

- Significant upgrade of the SAAR 4.5 combat capabilities
- Major improvement of signatures
- State-of-the-art weapon and electronic systems (can be Tailor-Made to customer specific requirements)

The S-72 missions include:

- Open Sea Patrolling and Surveillance operations
- Maritime Sovereignty protection
- Off - Shore facilities protection
- EEZ protection
- Anti terror / smuggling / illegal activities interdiction
- Minimize illegal immigration transits
- Search and Rescue operations in coordination with SAR Helicopters
- Participation in Naval combat operations
- Fishing protection and control
- Support of boarding / landing and intervention forces
- Sea Pollution containment activities

The S-72 is offered as a missile corvette or in an OPV version. The S-72 is the most cost effective corvette available today.

ISRAEL SHIPYARDS LTD.

P.O.Box 10630
Haifa Bay 2611702, Israel
Tel: 972-4-8460246
Fax: 972-4-8418744
E-mail:
marketing@israel-shipyards.com
Web Site: www.israel-shipyards.com



The S-72 can accommodate advanced weapon configurations, including:

- Launchers for anti-missiles defense missiles
- Surface-to-surface missiles launchers
- Up to 76 mm Naval gun
- Remotely controlled stabilized Naval gun system up to 30mm
- Command and Control system
- ESM
- Advanced Multifunction Search Radar
- Heavy machine guns – 0.5" / 7.62 mm
- Most advanced day and night vision system

The S-72 complies with international regulations regarding stability, full construction, navigation systems, etc.

SAAR S-72 Particulars

Length Overall	72.00 m
Beam, Molded	10.25 m
Draught	2.92 m
Flight Deck	10 × 15.3 m
Displacement	Abt. 800 tons
Engines	2×MTU 16V1163M94
Max. Speed	Above 30 Knots
Sustained Speed	28 Knots
Cruising Speed	18 Knots
Range at 18 Knots	Above 3000 NM
Endurance	21 Days
Crew	50 + 20 special troops

"NIRIT"

UPGRADED SA'AR 4.5 CLASS

In active service in the Israeli Navy



Our experience Your benefit

ISRAEL SHIPYARDS LTD.

P.O.Box 10630
Haifa Bay 2611702, Israel
Tel: 972-4-8460246
Fax: 972-4-8418744
E-mail:
marketing@israel-shipyards.com
Web Site: www.israel-shipyards.com



The "Nirit" type Fast Attack Missile Boat is a direct descendant of the Sa'ar 4.5 combat-proven vessels developed by Israel Shipyards in close cooperation with the Israeli Navy.

The upgrading of the Sa'ar 4 and Sa'ar 4.5 series is a cost-effective modernization program that extended the boat's life and enhanced significantly their operational capabilities.

The addition of 32 vertical launched "Barak" antimissile missiles and new electronic and electro-optic equipment imposed a complete replacement of the mast and C.I.C. room as well as changes in the internal arrangements, electric and auxiliary systems.

The hull and the propulsion systems remain the same well proven components as in the previous Sa'ar 4.5 class boats that are serving in the Israeli Navy.

The "Nirit" is a modern missile boat with an unmatched ratio of fire power to displacement and an outstanding survivability due to major improvements of the E.C.M. and the "hard kill" capability.

Similar upgrading concepts can be implemented on many other types of Naval vessels, Israel Shipyards has the know-how and technical skills to design and carry out such cost effective modernization programs on existing Naval platforms.

Technical Data

Displacement	488.0 Tons
L.O.A.	61.7 M.
Beam	7.6 M.
Draft	2.7 M.
Fuel capacity	116.0 Tons
Speed (max.)	32 Knt
Endurance	3000 N.M.

Armament

- 8 x "Harpoon" Long range SSM.
- 6 x "Gabriel" Middle range SSM.
- 32 x "Barak" Anti-Missile missiles.
- 1 x "Vulcan Phalanx" CIWS.
- 1 x 76/62 Oto-Melara gun.
- 6 x 20 mm or 0.5" machine guns.

OFFSHORE PATROL VESSEL (OPV)



Our experience Your benefit

ISRAEL SHIPYARDS LTD.

P.O.Box 10630
Haifa Bay 2611702, Israel
Tel: 972-4-8460246
Fax: 972-4-8418744
E-mail:
marketing@israel-shipyards.com
Web Site: www.israel-shipyards.com

The most cost effective OPV available today

General Description

Based on the combat proven SAAR 4 and SAAR 4.5 missile corvettes, Israel Shipyard's 400- 500 tons OPV is the most cost effective OPV concept available today.

The 400 tons OPV has been selected by the Hellenic Coast Guard as a significant part of the Naval security forces for the Athens 2004 Olympic Games.

The 500 tons model can support a light marine helicopter.

The OPV missions

- Open sea patrolling and Surveillance operations
- Seaborne terrorism / smuggling / illegal activities interdiction
- Launch and recovery of light marine helicopter (up to 5 tons).
- Off-Shore facilities protection
- Support of special operations forces.
- Search and Rescue operations
- Fishing control.
- Anti pollution missions.

The OPV can accommodate advanced weapon configurations

- Up to 76 mm remotely controlled gun
- 2 x 0.5" / 7.62 mm stabilized gun mounts
- Command and Control system
- ESM
- Search Radar
- Most advanced day and night vision system
- ARPA Navigation Radar
- ECDIS
- Optional - Short range missiles.

The OPV is certified by Lloyd's and complies with international regulations regarding stability, Hull construction, navigation systems etc.



The OPV main specifications

	400 tons	500 tons
Model		
Length Overall	58 m	62 m
Beam, Moulded	7.6 m	7.6 m
Draught	2.65 m	2.70 m
Flight Deck	N/A	7 x 7.7m
Displacement	400 tons	470 tons
Maximum Speed	33 knots	32 knots
Sustained Speed	30 knots	30 knots
Cruising Speed	18 – 20 knots	18 – 20 knots
Range at 18 Knots	2200 NM	3200 NM
Endurance	10 – 12 days	14 – 20 days
Crew	20 – 30	20 – 30

"SHALDAG" FAST PATROL BOAT



Our experience Your benefit

ISRAEL SHIPYARDS LTD.

P.O.Box 10630
Haifa Bay 2611702, Israel
Tel: 972-4-8460246
Fax: 972-4-8418744
E-mail:
marketing@israel-shipyards.com
Web Site: www.israel-shipyards.com

The best solution for interdiction of seaborne terrorism / smuggling and illegal activities

The new SHALDAG MK III is operational in the Israeli Navy

General Description

The SHALDAG Fast Patrol Boat series are multi mission combat proven all aluminium vessels for security tasks where high intercept speeds are required.

Operational experience gained from several Navies was implemented in the new SHALDAG MK III Model.

The boat's special characteristics are:

- High speed in rough seas.
- Good seakeeping.
- Outstanding maneuverability.
- Exceptionally low slamming in all sea states.
- Dry decks at all speeds.
- Minimal draft, allowing operation in shallow waters.
- Very spacious and accessible internal arrangements.
- Low vibrations and accelerations.



Various Weapon

Configurations are available:

- Remotely controlled gun systems - up to 30 mm (SS missiles are optional)
- Stand alone guns - 20 - 23 mm Twin or single barrel
- Heavy machine guns - 0.5" / 7.62 mm
- Most advanced day and night vision system

Dimensions

Length Overall
Beam Max.
Draft Max.
Displacement
Engines
Waterjets Propulsors

Max Speed
Sustained Speed
Range at 32 Knots

	SHALDAG MK II	SHALDAG MK III
Length Overall	24.80 m	26.30 m
Beam Max.	6.00 m	6.00 m
Draft Max.	1.20 m	1.20 m
Displacement	abt. 58 tons	abt. 66 tons
Engines	MTU	MTU
Waterjets Propulsors	LIPS / KAMEWA / MJP	LIPS / KAMEWA / MJP
Max Speed	48 Knots.	45 Knots
Sustained Speed	Over 40 Knots.	40 Knots
Range at 32 Knots	650 Nm	700 Nm

IMPROVED FAST PATROL CRAFT

SUPER DVORA MK III



Israel Aerospace Industries Ltd.
Commercial Aircraft Group, RAMTA Division

RAMTA DIVISION

P.O.Box 323
Beer-Sheva 8410202, Israel
Tel: 972-8-6402250, 6272231
Fax: 972-8-6402252
E-mail: mktg@iai.co.il
Web Site: www.iai.co.il/ramta

Super Dvora MK III Fast Patrol Craft

The 27m, 70 tonne "Super Dvora MK III" is the newest and most advanced member of the purpose-designed class of multi-mission fast patrol craft. With its ability to support a variety of sensor and weapons suites, the "Super Dvora MK III" is capable of performing all-weather, littoral and deep water missions including complex operations with other land, air and sea based systems, surveillance, insertion/extraction, search & rescue missions as well as providing protection against a wide variety of threats.

The "Super Dvora MK III" is a combat proven design, with over 30 years of accumulated experience in the Israeli Navy and over a dozen other Navies and Coast Guards worldwide. Her excellent sea keeping, extreme shallow water capability, maneuvering/agility and acceleration/deceleration are second to none.

With top speeds approaching 50 knots at full displacement, and a range in excess of 1000 nautical miles (at economic speed), the twin diesel-powered, surface driven "Super Dvora MK III" has already entered operational service with the Israel Navy as its next generation multi-mission patrol and attack craft.

Ramta has begun production of the Mini Dvora; a 20m variant of the proven high speed Dvora platform, designed for close support of harbors, shipping facilities, gas/oil platforms, and coast/guard/maritime policing missions.



PROTECTOR® USV



RAFAEL ADVANCED DEFENSE SYSTEMS

P.O.Box 2250 (19)
Haifa 3102102, Israel
Tel: 972-4-8794714
Fax: 972-4-8794657
E-mail: intl-mkt@rafael.co.il
Web Site: www.rafael.co.il

PROTECTOR® USV

Is an unmanned integrated system for Intelligence, Surveillance, Target Acquisition and Reconnaissance (ISTAR).

The **PROTECTOR® USV** is fitted with a comprehensive sensor suite and can accommodate a variety of mission modules. The TOPLITE Electro-optical director and a radar system provide day/night detection, identification and tracking of targets. TOPLITE subsystems include a third-generation Forward-Looking Infra-Red (FLIR) sensor, color Charge-Coupled Device (CCD) camera an eye-safe laser rangefinder (LRF), and an advanced correlation tracker.

The Anti Terror/Force Protection payload includes the TOPLITE Electro-Optical Director (EOD), MINI-TYPHOON Stabilized Weapon Station, a Water Cannon System and auxiliary sensors. The MINI-TYPHOON is a stabilized gun mount that is highly accurate and includes fire control capabilities, yielding excellent shooting accuracy. The Water Cannon system provides less-lethal engagement at close range as well as firefighting capabilities.

PROTECTOR is operated from a Control Station. The Control Station includes two control consoles, one for the USV commander and one for the Payload Systems operator.

The Control Station receives, via communications links, all the system data, video imagery and audio required to effectively build a situational awareness picture and operate the system. The system can be easily incorporated in a wider defense array via a standard interface to an external C⁴I system.

Based on a highly maneuverable platform the USV has excellent maneuvering capabilities. The platform has water jet propulsion systems powered by diesel engines. The platform systems include control over propulsion, maneuvering, and navigation.

The **PROTECTOR's** core element is an advanced control system, which interfaces with all of the **PROTECTOR's** sub-systems and provides a remote operator with the ability to plan, prioritize and execute naval missions by day and night, under adverse weather conditions, without exposure to risk.

The **PROTECTOR's** modular design enables the Customer to select those sub-systems that will best meet his own particular operational requirements.

When mounting effectors, the **PROTECTOR** can effectively close the fire circle for an all-round "sensor-to-shooter" solution.

PROTECTOR® USV Operational Advantages

- Performs dangerous tasks without risking human lives.
- Performs long and wearisome missions such as patrolling and ongoing security tasks.
- Provides Real-time data and video transmission from the field to the headquarters.
- Can operate at high seas without a crew that is affected from the harsh conditions.
- The **Protector® USV** Command and Control system can be integrated with external C⁴I systems, making it an integral part of the defense array.
- The **Protector® USV** can be used to approach suspicious vessels and verify their intentions, thus distinguishing friend from foe without having risking crew safety.
- A highly effective sensor suite, capable of detecting and identifying targets and threats from a great distance.
- Integrated combat suite that enables a rapid "sensor to shooter" response.
- Equipped with a highly accurate combat proven stabilized Weapon Station capable of eliminating threats from afar.
- Equipped with high pressure Water Cannon for non-lethal deterrence, and crowd control tasks.
- The **Protector® USV** has the ability to record video and audio data of its surrounding for debriefing, legal purposes and other considerations.
- The **Protector® USV** can be deployed anywhere at sea, from oil rigs, mother ships or shore installations, thus maximizing its range of action and versatility.
- Onboard payload can be replaced to fit different designated missions, thus providing the ability to conduct a wide range of missions using a single platform.
- Fully-tested, serially-produced and operationally deployed in navies' world-wide.

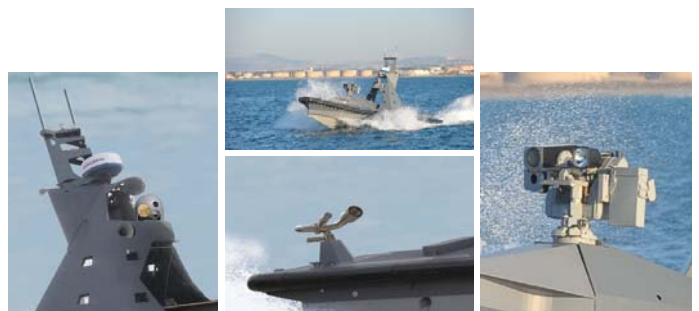

Ness TSG

Maritime Solutions



Ness TSG
Technologies & Systems Group
P.O.Box 58180
Tel Aviv 6158101, Israel
Tel: 972-3-5483518
Fax: 972-3-5483700
E-mail: tsg@ness.com
Web Site: www.ness.com/tsg

Ness Technologies & Systems Group (TSG) is a leading international systems house specializing in the integration of advanced command-and-control solutions for real-time military and civilian defense, homeland security, and telecom applications.

Ness TSG has a dedicated team of multidisciplinary professionals with expertise in system definition and design, system engineering, algorithm development, and hardware/software integration. With over four decades of experience, Ness covers a range of fields including C4I, real-time communications, image processing, data fusion, video transmission and IP communications.

We maintain a diverse international client base of armed forces and defense establishments, organizations and enterprises. Since 1969, Ness TSG has served as a strategic partner of the Israel Defense Forces (IDF), strengthening the IDF's operational advantage by implementing innovative solutions tailored to its unique needs.

Comprised of both shore-based and seaborne C² systems, our maritime solutions help naval forces and coast guards conduct highly effective coastal and blue water naval surveillance and operations, as well as vessel traffic management. All solutions are compliant with

search-and-rescue global maritime distress and safety systems (GMDSS).

Ness TSG's reliable, field-proven maritime solutions feature:

- Comprehensive, high-quality situation picture generation, covering underwater, surface and air activities
- Optimal sensor management (i.e. time, energy) for continuous situation picture maintenance
- Cost-effective, optimal integration of multi-vendor sensors
- Built-in redundancy for uninterrupted operation over long periods of time



TSG

Technologies & Systems Group

OCEANA TECHNOLOGIES

Underwater. Under Control.

Tactical Maritime Systems



Oceana Technologies (2009) Ltd.

11 Granit St., P.O.Box 3034
Petach Tikva 4951410, Israel
Tel: 972-3-9009600
Fax: 972-3-9017079
E-mail: info@oceanatec.com
Web Site: www.oceanatec.com

Oceana Technologies (2009) Ltd. is a leading manufacturer of advanced tactical maritime systems for divers, DPVs, SDVs and Landing crafts since 1989. Customers are NAVY SEAL units, EOD units, Armies and Civilian organizations around the globe.

Utilizing best-of-breed technologies of Communication, Navigation and Sonar, the company's systems provide, for the first time, total underwater control.

Working closely with the Israeli Navy, Oceana Technologies benefits from both hands-on experience and constant feedback, from one of the most advanced Navies in the world.

Oceana's Products

EDGE™

The EDGE™ is the first system designed to deliver full tactical underwater command & control capabilities. Created to meet the highest demands of real operational underwater missions, EDGE™ provides divers and commanders with full underwater situational awareness, on a level never experienced before.

DNS 300™ Nav

The DNS300™ Nav is a 3rd generation diver navigation system including a variety of integrated sensors and an intuitive user interface. The system supports most chart formats and includes mission preparation & debriefing capabilities. The system can be hand carried, DPD or SDV mounted.

DNS 300™ Sonar

The DNS300™ Sonar is the best hand-held sonar solution in the market today offering coverage for all ranges, powered by BlueView™ Sonars, coupled with advanced navigation capabilities. Effective in detecting large and small underwater objects and suitable for EOD divers when low magnetic signature is required.

About Star Defense Systems (SDS)

Oceana Technologies is a subsidiary of Star Defense Systems (SDS), one of the largest defense companies in Israel, offering innovative defense solutions for Sea, Air, Land, and HLS Forces worldwide. SDS strategic alliances and commitment to R&D provide a solid backbone for products and solutions development at the cutting edge of technology.



EDGE™



DNS 300™ Nav



DNS 300™ Sonar

RAFAEL
ADVANCED DEFENSE SYSTEMS
 P.O.Box 2250 (19)
 Haifa 3102102, Israel
 Tel: 972-4-8794714
 Fax: 972-4-8794657
 E-mail: intl-mkt@rafael.co.il
 Web Site: www.rafael.co.il

■ **DEEP LINK - Low Probability of Intercept Acoustic Communication Network**

DeepLink's dimensions enable the system to be carried by small underwater vehicles or divers.

Using CDMA communication with MIMO (Multi-Input, multi-Output) techniques, DEEPLINK overcomes. The multipath interferences of the UWAC, ensuring high reliability n various environments such as deep Water, shallow water, harbors and etc. DEEPLINK is designed as an ad-hoc network including a multi-hop mechanism. Both built-in message distribution protection and multi-hop mechanisms increase the reliability of the network and the connectivity between nodes, providing solution for non-line-of-sight scenarios.

DEEPLINK supports both SMS and navigational control messages, allowing the user to create his own Mission status. Each node contains a user interface which includes virtual keyboard (for SMS writing), navigation system and network display.



■ ■ ■

■ **SEA-COM - IP/VoIP Shipborne Communication System**

Sea-Com provides a full, modular, IP based Naval Ships & Submarines communication suite. Full integrates internal communication: voice, data, video & external communication Systems: HF, V/UHF and Satcom. Easy mission planning & allocation of the ships radio and antenna Distributed architecture provides high availability & scalability Meets harsh naval environmental conditions.



NAVAL RADARS



IAI ELTA SYSTEMS LTD.

P.O.Box 330 Ashdod 7710202, Israel

Tel: 972-8-8572410

Fax: 972-8-8561872

E-mail: market@elta.co.il

Web Site: www.elta-iai.com

ELTA - Our Systems, Your Advantage

Multi-Function Surveillance, Track and Guidance Radar

ELM-2248 MF-STAR

The MF-STAR (ELM-2248) is a multi-function solid-state active conformal phased array radar system for the new generation of military ships. The radar system delivers a high quality arena situation picture and weapons support, under the toughest target and environmental conditions, in the current and future naval arena. The MF-STAR antenna includes 4 faces of active arrays in S-band frequency. The antenna can be tailored to fit even relatively small ship sizes (such as corvettes).

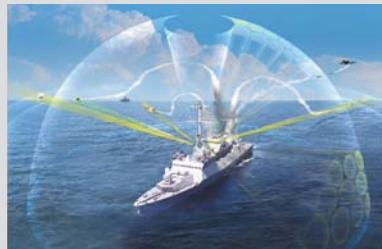

ALPHA - Advanced Lightweight Phased Array Naval Radar

ELM-2258

The ELM-2258 ALPHA is a multi-function solid-state active phased array radar system for the new generation of medium sized combat ships. The ALPHA Radar antenna consists of a rotating/scanning, two-dimensional active array in the S-band that is suited for installation on-board a variety of ship classes such as corvettes, frigates and larger vessels. The radar system delivers high quality naval theater situation awareness pictures and supports the ship's weapon systems, under the toughest target and environmental conditions in the current and future naval arena.



Surveillance & Threat Alert Radar

ELM-2238 STAR

The STAR is a fully coherent S-band Pulse Doppler 3D multi-beam and multimode search radar. The radar performs simultaneous Long Range Air Surveillance combined with surface surveillance providing fast detection and automatic threat alert of air targets with an extremely low false alarm rate. STAR supports surface gunnery engagements through a unique splash-spotting capability and anti-air warfare through target designation to the fire control system. The STAR's azimuth and elevation tracking accuracy and its high update rate makes it an excellent choice for Anti-Air & Anti-Missile weapon systems.

Search, Track & Guidance Radar

ELM-2221

The STGR is an advanced light weight shipboard coherent Pulse Doppler dual-band (X/Ka) monopulse tracking radar, optimized for operation in adverse sea, clutter and electromagnetic environmental conditions. The multimode STGR performs Surface-to-Air Missile (SAM) guidance, Surface-to-Surface Missile (SSM) guidance, and automatic gun fire control against surface and air targets and has several search modes as a backup to the vessels main search radar. The STGR comes in both X and X/Ka configurations.



NAVAL SYSTEMS

Electronic Warfare and Countermeasures



NAVAL SYSTEMS

Elbit Systems' expertise in diverse areas such as: Navigation, Communication, Command & Control Systems, Unmanned Surface Vehicles, EW Systems, Decoy Control Systems, Electro-Optical Payloads and ELINT Systems has led to being one of the few companies in the world offering comprehensive solutions for the EEZ challenges as well as,- complete ship upgrades, systems integration and full responsibility from a single source.



ENTCS - Naval Combat Management System

ENTCS is a Network Centric Naval Combat Management System (CMS) designed to assure information superiority over potential threats, support a Common Tactical Picture (CTP), shorten decision cycles and execute rapid and accurate weapon engagement in the task force.

Based on open architecture, easily upgradable COTS building blocks and Windows™ software, its distributed architecture results in enhanced redundancy, with no single point of failure.

Key Features

- Multifunction Consoles fully redundant
- Radar, EW, EO, Guns, Missiles, Sonar, SAM, SSM and Communication System integration
- Highly automated
- Rapid response
- Advanced GUI for ease of operational need implementation
- Interoperability and Network Centric Operation based on Modern Communication Layer
- Integration with new and/or existing legacy combat systems

ELBIT SYSTEMS LTD.

P.O.Box 539
Advanced Technology Center
Haifa 3105301, Israel
Tel: 972-4-8315315
E-mail: uas@elbitsystems.com
Web Site: www.elbitsystems.com

**TIMNEX II
ADVANCED ESM/ELINT SYSTEM**

Timnex II is an advanced ESM/ELINT system for receiving, identifying, displaying and recording radar signals and parameters. Modular and fully automatic, TIMNEX II can perform both tactical (ESM, self defense) and ELINT missions in submarines and surface ships.

Key Features

- Frequency coverage: 2-18 GHz (0.5-40 GHz option)
- 100% intercept probability
- Processes up to 1 M pulses/sec
- Digital data recording and replay
- High sensitivity
- IFM channelized receiver
- Powerful computer unit
- Fully integrated with the Combat Management System (CMS)
- Operation in dense electromagnetic environments
- Very fast reaction time
- Detailed and comprehensive BIT

**DESEAVER
Decoy Control and Launching System**

DESEAVER can handle multiple threats from multiple directions simultaneously. Acting on data received and processed from the ship's command and control system and/or sensors, the system launches a barrage of expendable decoys with precise priority and timing. Combining an array of fixed and fast maneuvering stabilized rocket launchers, backed by advanced processing and control units, DESEAVER delivers payloads at accurate time intervals and according to specified anti-missile doctrines and guidelines.

Key Features

- Evaluation of threat tactical picture and selection of appropriate passive countermeasures
- Operation in conjunction with the EW defense system and within the entire combat system of the ship
- Deployment procedure computation
- Recommendation of preferred ship's course and speed as part of the anti-missile defense procedure
- Launching of defense decoys

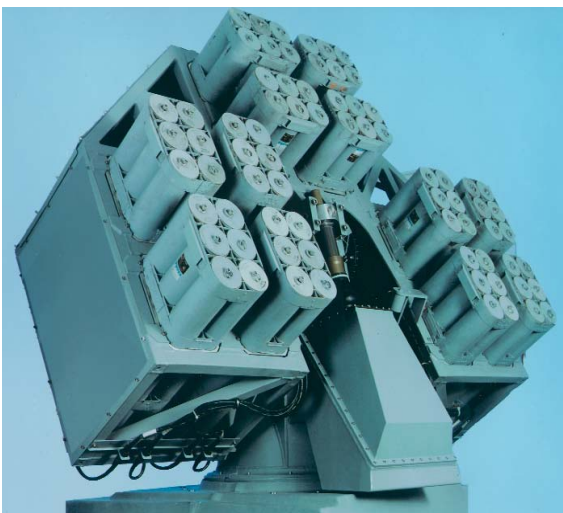

BARAK-8

NAVAL AND LAND BASED



Israel Aerospace Industries Ltd.
Systems Missiles & Space Group

BARAK-8 Air & Missile Defense System

Naval & Land-based, Short to long Range, Point & Area

AIR & MISSILE DEFENSE DIVISION

P.O.Box 105
Yehud Industrial Zone
5610002, Israel
Tel: 972-3-5315699
Fax: 972-3-5315830
E-mail: marketing@iai.co.il
Web Site: www.iai.co.il

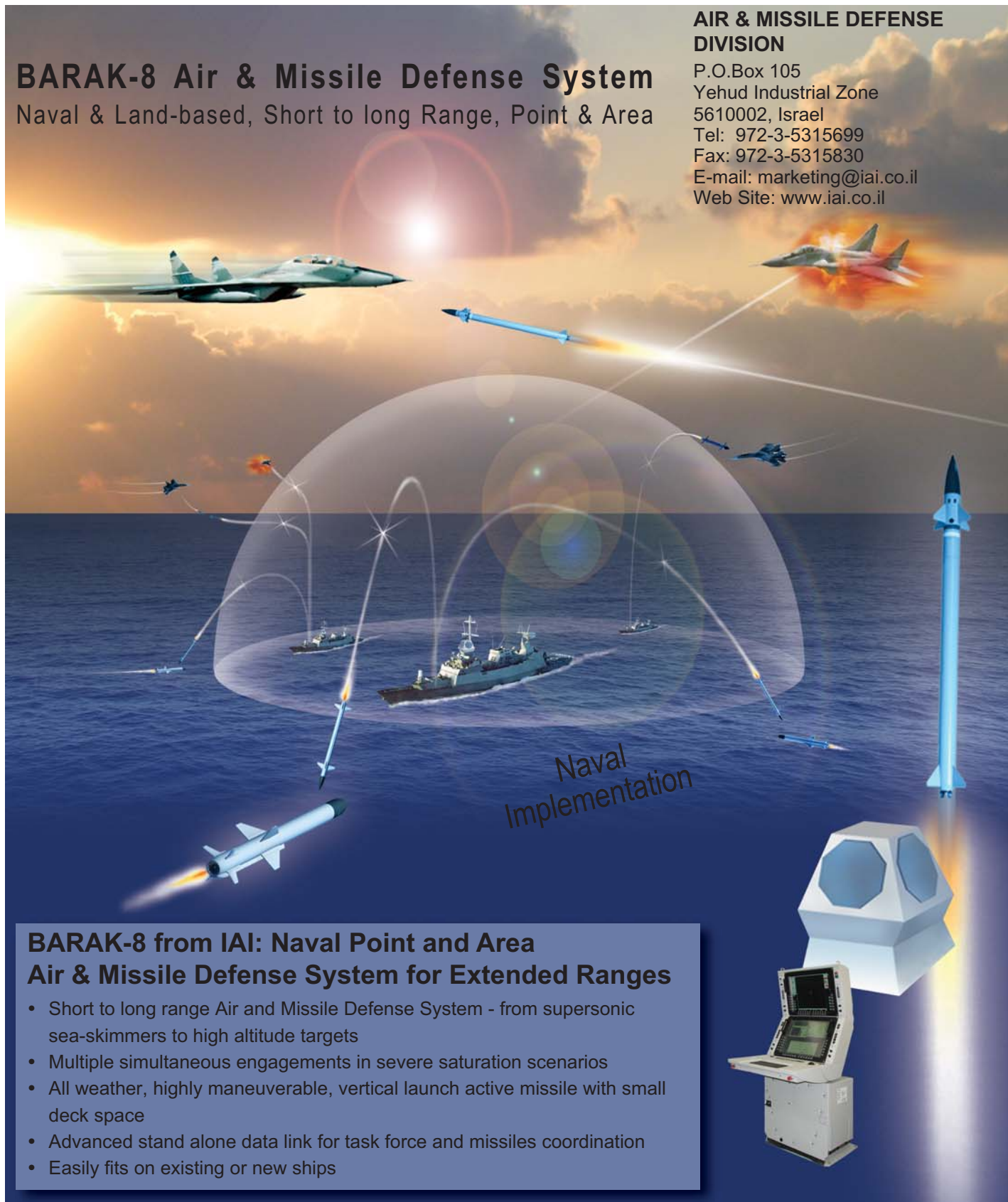

BARAK-8 from IAI: Naval Point and Area Air & Missile Defense System for Extended Ranges

- Short to long range Air and Missile Defense System - from supersonic sea-skimmers to high altitude targets
- Multiple simultaneous engagements in severe saturation scenarios
- All weather, highly maneuverable, vertical launch active missile with small deck space
- Advanced stand alone data link for task force and missiles coordination
- Easily fits on existing or new ships

NAVAL FORCES

Naval Defense & Attack Systems



ISRAEL MILITARY INDUSTRIES LTD. (IMI)

P.O.Box 1044, 64 Bialik Blvd.
Ramat Hasharon 4711001, Israel
Tel: 972-3-5485222
Fax: 972-3-5486125
E-mail: imimrktg@imi-israel.com
Web Site: www.imi-israel.com

TRIGON

TRIGON is a naval version of the 306mm EXTRA rocket system. The rocket system provides precise long range capability in day, night and all weather conditions. Its equipment permits a reduced crew for accomplishing a complete fire mission including loading and unloading operations. TRIGON guarantees increased naval independence and enhanced naval value in joint force operations. The system has a maximum range of 150 km and a Circular Error of Probability (CEP) of 10 meters.

DELILAH SL

DELILAH SL is an advanced Ship-Launched version of the combat-proven DELILAH missile. The long range, high-subsonic stand-off missile is designed to defeat high value mobile, fixed and relocatable targets at extended ranges, with pinpoint accuracy.

The missile includes an E/O seeker for target discrimination at day, night and adverse weather. Additional features include real time video imagery for man-in-the-loop, autonomous navigation, pre-programmed mission with post launch update and target selection.

SHOCK ABSORBER

SHOCK ABSORBER is a portable, lightweight 'Soft-Kill' active protection system (APS) for maritime vessels. The compact APS offers effective alarming of incoming threats, jamming capabilities against second-generation ATGMs and situational awareness. The system is a variant of IMI's family of active protection systems for ground and aerial applications.

BALLISTIC PROTECTION FOR MARITIME VESSELS

IMI offers advanced ballistic protection for maritime vessels. Based on a hybrid composite of metals and ballistic ceramics, the add-

on armor protects vital areas, such as the Command Bridge, fuel tanks and ammunition stores, and provides protection against up to 14.5mm ammunition. The lightweight armor significantly minimizes the weight penalty and is easy to install.

ASA35A1 FLOATING PERSONAL BODY ARMOR

The ASA35A1 is a lightweight, floating personal body armor designed for use by marines, sailors and coast guard personnel. The body armor provides Level IIIA bullet-resistant protection, in accordance with NIJ Standard 0101.04. It comes in a variety of sizes and can be tailored with front and rear pockets for add-on Level III/IV body armor.

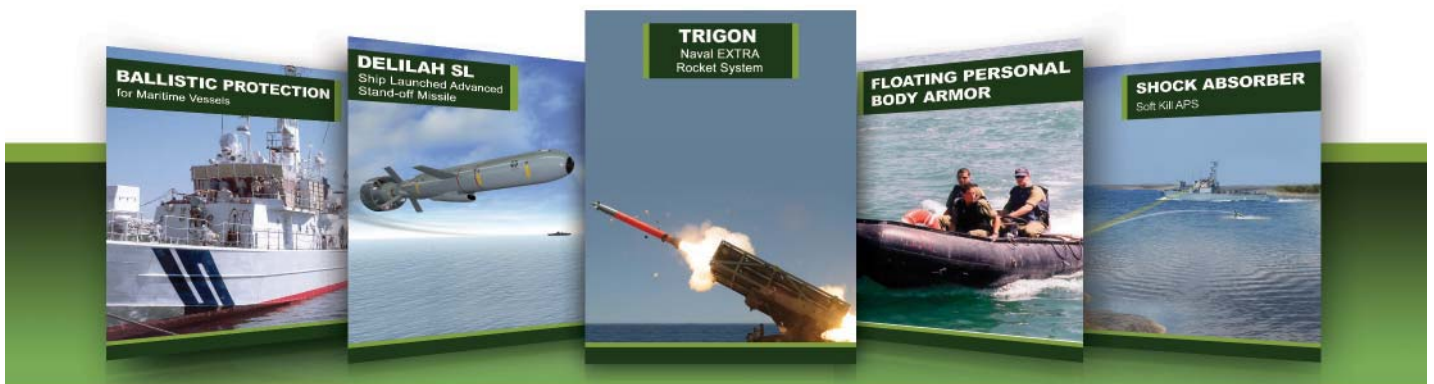

NAVAL DEFENSE SYSTEM

Rafael is a world class provider of Naval Combat Systems, offering a wide range of naval systems, which have been developed based on the company's extensive experience and know-how in defense technology.

Rafael's naval systems provide solutions for any capability gap in naval surface warfare, ship defense, anti-submarine and underwater warfare, and costal defense.

These combat systems, stand-alone as well as integrated combat suite, are the optimal solution for both newly constructed and upgraded naval vessels.

Rafael's naval combat systems have been successfully tested, and proven in real combat situations, and are currently in service with numerous navies around the world.

Rafael's Naval Combat Systems includes:

Naval Surface systems :

PROTECTOR®USV - is an unmanned integrated system for Intelligence, Surveillance, Target Acquisition and Reconnaissance (ISTAR). The PROTECTOR®USV is fitted with a comprehensive sensor suite and can accommodate a variety of mission modules.

Based on a highly maneuverable platform the USV has excellent maneuvering capabilities. The platform has water jet propulsion systems powered by diesel engines. The platform systems include control over propulsion, maneuvering, and navigation.

The PROTECTOR's core element is an advanced control system, which interfaces with all of the PROTECTOR's sub-systems and provides a remote operator with the ability to plan, prioritize and execute naval missions by day and night, under adverse weather conditions, without exposure to risk.

The PROTECTOR's modular design enables the Customer to select those sub-systems that will best meet his own particular operational requirements.

When mounting effectors, the PROTECTOR can effectively close the fire circle for an all-round "sensor-to-shooter" solution.



Typhoon Family - Naval Weapon Station for Anti-Terror / Force Protection

The TYPHOON is remotely operated from an operator console. Operation sequence includes surveillance, target identification, automatic tracking and engagement. The TYPHOON can be operated as a stand-alone system relying on its own sensors and controls, or alternatively through integration to other onboard combat systems. The built-in ballistic computer calculates a firing solution based on target and own-ship data, as well as environmental factors, feeding the gun mount with lead angle and super-elevation that result in high hit probability. An electro-optical director, coupled with the fire control computer and automatic tracker, maintain on-going engagement until mission success.

The Typhoon family has set the standards for stabilized, remotely controlled, small caliber, naval gun systems. The TYPHOON can serve as a secondary gun for large vessels, as well as main gun for patrol boats. Firepower can be boosted with on-mount integration of various missile types.

The MINI-TYPHOON is a lightweight, naval, stabilized and remote operated machine gun system.

The MINI-TYPHOON is an optimal solution as perimeter protection for large vessels. The MINI-TYPHOON can also function as main gun for small, fast patrol boats, significantly enhancing hit probability under rough conditions.



**RAFAEL
ADVANCED DEFENSE SYSTEMS**

P.O.Box 2250 (19)
Haifa 3102102, Israel
Tel: 972-4-8794714
Fax: 972-4-8794657
E-mail: intl-mkt@rafael.co.il
Web Site: www.rafael.co.il

TOPLITE

Electro-Optical Surveillance, Observation & Targeting System

TOPLITE is RAFAEL's advanced high performance stabilized sight system operational in several navies worldwide.

TOPLITE EOS (electro-optical system) provides advanced day/night all-weather observation and precision targeting in a compact, high-stability multi-sensor payload. COMBAT-PROVEN, TOPLITE EOS delivers maximum performance in minimum space on aircraft, helicopters, naval vessels and land vehicles. TOPLITE EOS is a derivative of Rafael's state-of-the-art LITENING targeting and navigation pod.

The TOPLITE is used for target detection, identification, tracking and engagement. The Mini-Typhoon or the Water Cannon can be slaved to the TOPLITE Line of Sight.



SEA SPOTTER IRS²T

Naval IR Staring and Tracking System

The Sea Spotter is an advanced Naval IRST system that will enable a naval vessel to automatically locate and pinpoint threats and targets located around it without being exposed to enemy systems.

The system, dubbed Sea Spotter, is a new generation (third generation) infrared staring system that is capable of automatically locating both surface and airborne targets, supersonic and slow, very small targets above and around the vessel, from horizon to zenith and transferring the data to the ship's combat system for interception.

Based on infrared sensors, the Sea Spotter is a completely passive system. Unlike electromagnetic radar systems, it does not emit any signals, so that as part of its situational awareness, it can "see" but not be seen without emitting any beams and without giving away the ship's position.



NAVAL DEFENSE SYSTEM

Rafael is a world class provider of Naval Combat Systems, offering a wide range of naval systems, which have been developed based on the company's extensive experience and know-how in defense technology.

Rafael's naval systems provide solutions for any capability gap in naval surface warfare, ship defense, anti-submarine and underwater warfare, and costal defense.

Ship Defense systems:

Integrating soft-kill and hard-kill systems. These includes the PROTECTOR unmanned surface vehicle integrated with MINI-TYPHOON stabilized weapon station or non-lethal weapon provide an effective solution for anti-terror force protection (AT/FP) tasks, C-PEARL DV ESM and SHARK ECM, IDS WIZARD (corner reflector), C-GEM active RF decoy and BARAK air-defense missiles.

Underwater systems:

■ TORBUSTER

Combined Soft Kill/Hard Kill Torpedo Decoy
The TORBUSTER is a fourth generation torpedo decoy for submarines. It provides effective defence against all types of acoustic homing torpedoes. Upon detection of an incoming torpedo (external to the system), the TORBUSTER system will launch a decoy from an external launcher. The decoy will propel itself to a safe distance from the submarine, and seduce the incoming torpedo by transmitting specific acoustic signals using a technology based on the Scutter, reactive acoustic decoy.



■ DEEP LINK - Low Probability of Intercept Acoustic Communication Network

DeepLink's dimensions enable the system to be carried by small underwater vehicles or divers.

Using CDMA communication with MIMO (Multi-Input, multi-Output) techniques, DEEPLINK overcomes .The multipath interferences of the UWAC, ensuring high reliability n various environments such as deep Water, shallow water, harbors and etc.

DEEPLINK is designed as an ad-hoc network including a multi-hop mechanism. Both built-in message distribution protection and multi-hop mechanisms increase the reliability of the network and the connectivity between nodes, providing solution for non-line-of-sight scenarios.

DEEPLINK supports both SMS and navigational control messages, allowing the user to create his own Mission status. Each node contains a user interface which includes virtual keyboard (for SMS writing), navigation system and network display.



■ SCUTTER - Reactive Expendable Acoustic Torpedo Countermeasure

SCUTTER is a self-propelled, third generation reactive, expendable torpedo Countermeasure, capable of Protect a submarine from passive and active acoustic homing torpedoes. Scutter has a threat library, based on intelligence programmed by the user, which is used to select the appropriate response. Designed to respond simultaneously to multiple torpedoes of various types. SCUTTER is self-destructs at the end of its mission.

An effective defense for surface ships in addition to submarines, SCUTTER is operational in several World-class navies.



■ LESCUT - Torpedo Countermeasure for Surface Ships

LESCUT is an intelligent, third generation reactive Countermeasure, designed to identify the incoming threat and provide a customized response. Surface vessel-launched, LESCUT is designed to respond simultaneously to multiple torpedoes of various types , and programmed to defeat all types of modern torpedo logic, including range gates, Doppler shift, pulse discrimination, AGC/DVG, and more.

LESCUT requires no pre-launch input or tests, shortening the response time and eliminating errors due to incorrect settings or Operator mistakes. Lescut is based on the Ultra Electronic Oceans Systems hardware and Rafael's proven Reactive acoustic module electronics and software.



RAFAEL ADVANCED DEFENSE SYSTEMS

P.O.Box 2250 (19)
Haifa 3102102, Israel
Tel: 972-4-8794714
Fax: 972-4-8794657
E-mail: intl-mkt@rafael.co.il
Web Site: www.rafael.co.il

NAVAL ATTACK SYSTEMS



RAFAEL ADVANCED DEFENSE SYSTEMS

P.O.Box 2250 (19)
Haifa 3102102, Israel
Tel: 972-4-8794714
Fax: 972-4-8794657
E-mail: intl-mkt@rafael.co.il
Web Site: www.rafael.co.il

■ TYPHOON FAMILY - Naval Weapon Station for Anti-Terror / Force Protection

The TYPHOON is remotely operated from an operator console. Operation sequence includes surveillance, target identification, automatic tracking and engagement. The TYPHOON can be operated as a stand-alone system relying on its own sensors and controls, or alternatively through integration to other onboard combat systems. The built-in ballistic computer calculates a firing solution based on target and own-ship data, as well as environmental factors, feeding the gun mount with lead angle and super-elevation that result in high hit probability. An electro-optical director, coupled with the fire control computer and automatic tracker, maintain on-going engagement until mission success.



The Typhoon family has set the standards for stabilized, remotely controlled, small caliber, naval gun systems. The TYPHOON can serve as a secondary gun for large vessels, as well as main gun for patrol boats. Firepower can be boosted with on-mount integration of various missile types.

The MINI-TYPHOON is a lightweight, naval, stabilized and remote operated machine gun system.

The MINI-TYPHOON is an optimal solution as perimeter protection for large vessels. The MINI-TYPHOON can also function as main gun for small, fast patrol boats, significantly enhancing hit probability under rough conditions.



■ SPIKE NLOS - Rafael's Ultra - Long Range, High-Impact SPIKE Missile

SPIKE NLOS is an electro-optically guided multipurpose missile for ranges of up to 25 km with pinpoint accuracy and midcourse navigation. The weapon system can be launched from land, air and naval platforms.

SPIKE-ER – Multi-Purpose Missile System for Combat Vehicles, Helicopters and Naval Vessels

The SPIKE-ER is an extended-range, multi-purpose anti-armor missile system designed for mounting on various platforms, including helicopters, fast boats and combat vehicles. It can also be dismounted to a ground position and fitted onto a tripod. SPIKE-ER is capable of defeating tanks at a range of up to 8 kilometers.



ELISRA'S NAVAL ELECTRONIC WARFARE SOLUTIONS FOR LATEST GENERATION SURFACE VESSELS AND SUBMARINES



ELBIT SYSTEMS EW & SIGINT – ELISRA LTD.

48 Mivtza Kadash St.,
Bene Beraq 5121701, Israel
Tel: 972-3-5577335
Fax: 972-3-5577793
E-mail: ew-sigint@elbitsystems.com
Web Site: www.elbitsystems.com



Elisra's **Aqua Marine Integrated Naval RESM / CESM / LWS & ECM Suite** is a combat-proven, modular family of advanced naval EW suites. Fully integrable and interoperable, these state-of-the-art, 4th generation systems provide today's most critical capabilities - situation awareness, electronic attack, ship self-defense and electronic intelligence. Uniquely flexible, Aqua Marine systems are suitable for all platform sizes - from the smallest patrol boats to the largest combatants, such as corvettes and frigates.

Delivering excellent performance, Aqua Marine utilizes the full benefits of a digital system:

- Lightweight, small footprint
- Improved system operation and reliability
- Cost-effective

Designed with modular building blocks, the systems offer unprecedented customization options that allow the individual design of end-to-end EW suites.

NATACS 2000 – Elisra's Advanced Naval Tactical COMINT/DF System belongs to a new generation of Naval EW Systems capable of coping with advanced agile frequency communication radios. A fully integrated system, equipped with ultrafast, Wide Band Receivers and Direction Finding Systems, NATACS 2000 is the only onboard COMINT/DF System of its kind. With outstanding scanning rates, the system is capable of handling extremely dense electromagnetic environments in the HF and VHF/UHF frequency bands, characterized by frequency hopping, burst and other agile transmissions. Fusion of the data extracted by NATACS 2000 with data obtained from on-board ESM systems, enables completion of the tactical naval picture.

Operating optimally in the densest electromagnetic environments, **TIMNEX II ESM/ELINT** system for submarines and surface ship assures fast and efficient detection, bearing information, identification and tracking of electromagnetic emissions. TIMNEX II can be configured as a stand-alone system or fully integrated with the platform Combat Management System (CMS).



DELIVERING CUTTING EDGE ELECTRONIC WARFARE AND SPECTRUM DOMINANCE SOLUTIONS

Netline Communications Technologies (NCT) Ltd. develops and manufactures cutting edge EW and spectrum dominance solutions: advanced **COMMINT & SIGINT**, communication & counter IED jamming, and cell phone detection systems to the global defense and homeland security markets.

COUNTER IED JAMMING SOLUTIONS

Netline's C-Guard active and reactive counter - IED jamming systems protect against remote radio detonation of IEDs. Robust jamming systems for vehicular, trolley/briefcase, manpack, miniaturized and stationary applications can include pre-initiation, hybrid active/reactive capabilities and other advanced features. Our software defined jamming technology enables interoperability with other communication devices, supports definition of communication windows and generating jamming mission profiles, streamlining waveform strategies to match mission requirements. Netline offers advanced jamming efficiency testing and evaluation equipment and counter- IED training systems.

COMMUNICATION JAMMING SOLUTIONS

Netline's communication jamming systems block RF communications and isolate arenas targeting cellular, satellite, WiFi/Bluetooth, walkie/talkie and all other wireless communication frequencies from 20-6000MHz. Our communication jamming systems can be deployed in various platforms including land, naval and airborne.



NETLINE COMMUNICATIONS TECHNOLOGIES (NCT) LTD.

Azrieli Circular Tower
132 Menachem Begin Rd.
Tel Aviv 6701101, Israel
Tel: 972-3-6068100
Fax: 972-3-6068101
E-mail: info@netline.co.il
Web Site: www.netline.co.il











CYBER PROTECTION & CELL PHONE DETECTION SOLUTIONS

Netline's Radio Frequency (RF) detection systems detect potentially hostile communications, uncovering unauthorized use of radio frequencies by cyber, cellular and other information leakage threats in military, government, corporate and other sensitive compartmented information facilities.

TACTICAL INTERCEPTION AND SIGINT SOLUTIONS

Netline's Communications Intelligence solutions integrate a variety of tactical SIGINT capabilities including spectral analysis, signal classification and demodulation, cell phone monitoring and location/direction finding – all tailored per customer specifications. Netline's tactical cell phone interception systems include both semi - active and passive interception systems enabling competent authorities to intercept and manage cellular voice, data and WiFi communications. The uniquely compact form factors of Netline solutions meet harsh military environmental requirements to facilitate deployment in scenarios and arenas that are often not covered by traditional SIGINT solutions.

Netline systems are in use worldwide for:

-  Convoys and route clearance
-  Infantry and special forces protection
-  SWAT operations
-  EOD missions
-  Counter - terror
-  Riot / crowd control
-  Tactical communication jamming
-  Communications interception
-  VIP protection
-  Military base protection
-  Border security



ELECTRONIC WARFARE AND COUNTERMEASURES

■ SEA SPOTTER IRS²T - Naval IR Staring and Tracking System

The Sea Spotter is an advanced Naval IRST system that will enable a naval vessel to automatically locate and pinpoint threats and targets located around it without being exposed to enemy systems.

The system, dubbed Sea Spotter, is a new generation (third generation) infrared staring system that is capable of automatically locating both surface and airborne targets, supersonic and slow, very small targets above and around the vessel, from horizon to zenith and transferring the data to the ship's combat system for interception.

Based on infrared sensors, the Sea Spotter is a completely passive system. Unlike electromagnetic radar systems, it does not emit any signals, so that as part of its situational awareness, it can "see" but not be seen without emitting any beams and without giving away the ship's position.

■ SCUTTER - Reactive Expendable Acoustic Torpedo Countermeasure

SCUTTER is a self-propelled, third generation reactive, expendable torpedo Countermeasure, capable of Protect a submarine from passive and active acoustic homing torpedoes. Scutter has a threat library, based on intelligence programmed by the user, which is used to select the appropriate response. Designed to respond simultaneously to multiple torpedoes of various types. SCUTTER is self-destructs at the end of its mission.

An effective defense for surface ships in addition to submarines, SCUTTER is operational in several World-class navies.



■ ■ ■

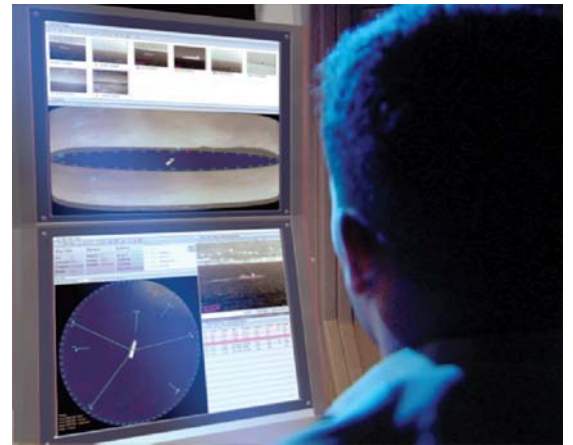

■ TORBUSTER - Combined Soft Kill / Hard Kill Torpedo Decoy

The TORBUSTER is a fourth generation torpedo decoy for submarines. It provides effective defence against all types of acoustic homing torpedoes.

Upon detection of an incoming torpedo (external to the system), the TORBUSTER system will launch a decoy from an external launcher. The decoy will propel itself to a safe distance from the submarine, and seduce the incoming torpedo by transmitting specific acoustic signals using a technology based on the Scutter, reactive acoustic decoy.



**RAFAEL
 ADVANCED DEFENSE SYSTEMS**

P.O.Box 2250 (19)
 Haifa 3102102, Israel
 Tel: 972-4-8794714
 Fax: 972-4-8794657
 E-mail: intl-mkt@rafael.co.il
 Web Site: www.rafael.co.il

■ **LESCUT - Torpedo Countermeasure for Surface Ships**

LESCUT is an intelligent, third generation reactive Countermeasure, designed to identify the incoming threat and provide a customized response. Surface vessel - launched, LES CUT is designed to respond simultaneously to multiple torpedoes of various types, and programmed to defeat all types of modern torpedo logic, including range gates, Doppler shift, pulse discrimination, AGC/DVG, and more. LES CUT requires no pre-launch input or tests, shortening the response time and eliminating errors due to incorrect settings or Operator mistakes. Les cut is based on the Ultra Electronic Oceans Systems hardware and Rafael's proven Reactive acoustic module electronics and software.



■ **C-PEARL-DV - Compact, High Performance Digital ESM System**

C-Pearl-DV is a digital naval Electronic Support Measures (ESM) system that enables automatic detection, data measurement and identification of threats. Designed to fit on-board all types of ships, including OPVs, frigates and destroyers.

The C-Pearl-DV meets naval standard requirements. Operated by a single crew member, C-Pearl-DV features high reliability and low maintenance, as well as full modularity, enabling expansion According to user requirements. The C-Pearl family of ESM systems is fully qualified and operational in conjunction with on-board radars and can be integrated with Rafael's Digital Shark ECM system and to the ship's Combat Management System (CMS) and other on-board combat and data systems.



■ **SEWS - Digital Shipborne Electronic Warfare Suite**

SEWS-DV is a naval EW suite comprised of digital receivers and digital technique generators, Optimized to handle very dense electromagnetic environments. Capable of threat identification and simultaneous jamming and deception of multiple threats, the SEWS-DV is designed for both ESM and ECM applications.

The system features high effective radiated power (ERP), an advanced DRFM-based technique generator and sophisticated power management techniques. From real-time detection and analysis in a complex electromagnetic environment to the identification, jamming and deceiving of surface ships, attacking missiles, aircraft and radar sites, the SEWS-DV is the system of choice, whatever the threat.

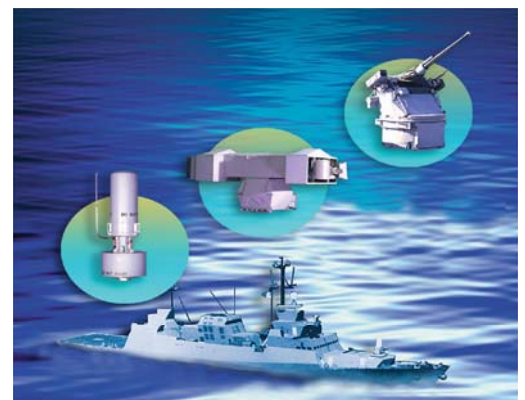

NAVAL TRAINING & SIMULATION SYSTEMS



ELBIT SYSTEMS LTD.

P.O.Box 539
Advanced Technology Center
Haifa 3105301, Israel
Tel: 972-4-8315315
E-mail: aerospace@elbitsystems.com
Web Site: www.elbitsystems.com

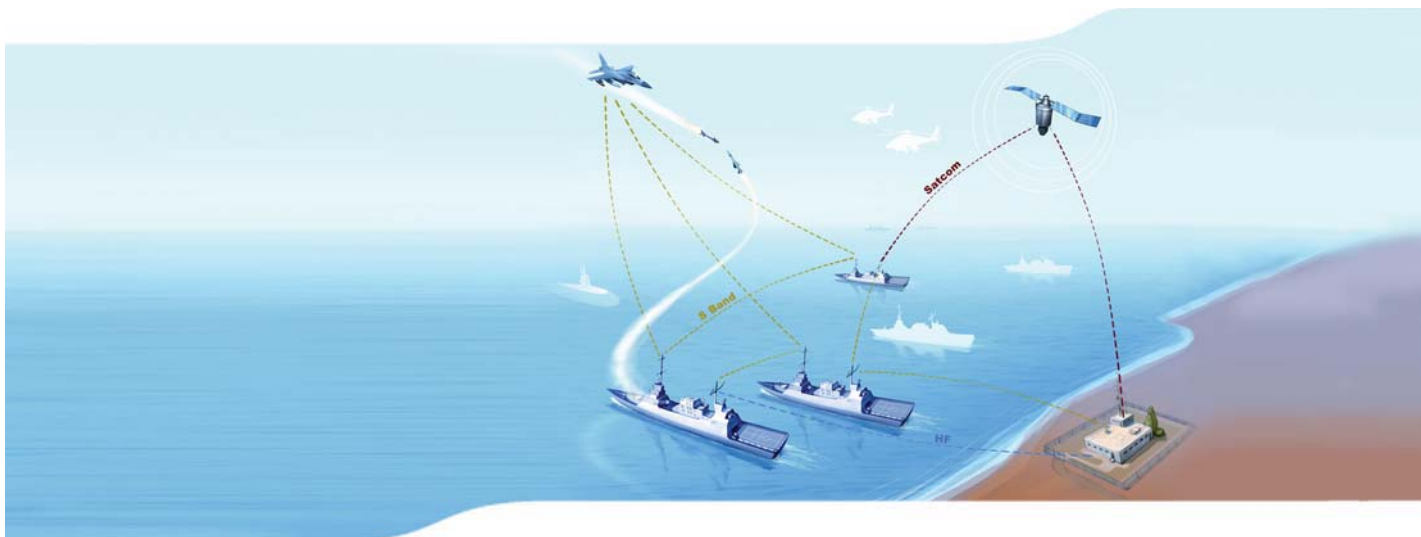

NTT - Naval Tactical Trainer

The NTT is an advanced tactical and procedural warfare training system, covering multi-threat scenarios including anti-surface warfare, anti-submarine warfare, anti-air warfare, counter-terrorism operations, littoral warfare, electronic warfare, and others. It allows training to be performed with worldwide multi-threat scenarios from subunit to force levels. It can expand to support operators' training at console level allowing simulation and stimulation of specific combat systems.

Trainees benefit from a realistic, up-to-date naval operations environment, in which they draw upon their theoretical knowledge and undertake naval operations in real-time with the objective of improving abilities, and testing and evaluating new tactics. NTT architecture enables the connection and sharing of the training scenario with other tactical training systems thus supporting joint force tactical training.

NCMI - Naval Combat Maneuvering Instrumentation system

Modern naval combat requires a high level of expertise in all modes of littoral and maritime warfare.

The NCMI system instruments the different combat systems and stimulates superimposed detections of virtual targets while displaying actual detections on the operational systems.

The coherent exercise situation is distributed via a dedicated simulation Data Link network to all participants.

The NCMI solution was designed by naval officers in order to achieve high level naval warfare training. It is a full scale ready-to-run onboard training system that enables advanced onboard training both ashore and at sea.

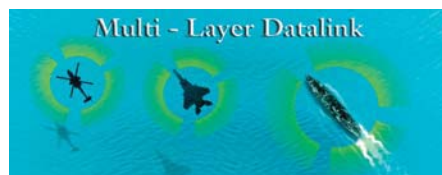

NTC - Naval Training Center

The NTC is a unique training facility. It includes a Naval Tactical Trainer (NTT), Navigation Simulator and Close Range Weapon Trainer (CRWT). It enables individual training using each of the individual modules as well as combined and large scale exercises at all exercise posts. It is an ideal solution for all vessels, from utility through patrol boats and up to modern frigates. Designed for operator proficiency training as well as large scale naval combat scenarios from littoral and asymmetric warfare up to blue water warfare, its high-fidelity simulation software features advanced autonomous Computer Generated Forces (CGF) and physics based motion, sensor and weapon algorithms implemented through intuitive Graphic User Interface (GUI).



ADVANCED SONAR AND ACOUSTIC APPLICATIONS



DSIT SOLUTIONS LTD.

2 Rechavam Zeevi St.,
Givat Shmuel 5401777, Israel
Tel: 972-3-5313333
Fax: 972-3-5313322
E-mail: marketing@dsit.co.il
Web Site: www.dsit.co.il

▼ AquaShield™ Diver Detection Sonar (DDS)

DSIT Solutions Ltd. provides highly accurate and effective underwater security systems for the protection of critical waterside and offshore assets. Our fully automatic Shield™ family of diver detection sonar (DDS) systems includes the long range AquaShield™ DDS and the light, portable PointShield™ PDDS.

▼ Static Active Sonar (SAS)

The SAS is a powerful surveillance system that guards the coastline against approaching enemy submarines and other smaller submersible intruders.

▼ Portable Acoustic Range

Accurately measures the radiated noise of submarines and ships at significantly reduced costs to enable shipyards and navies to reduce vessel noise.

▼ Underwater Acoustic Signature Analysis (UASA)

A system that analyzes all types of acoustic signals from submarine sonars, towed arrays, fixed bottom moored sonar systems, etc. to derive the platforms' acoustic signatures.

▼ Submarine Simulators and Trainers

DSIT offers a wide range of sonar simulation solutions for all levels of sonar operations: Operator, Team, and Tactical. The company's flagship trainer is a full mission Submarine Tactical Trainer, a trainer that accurately simulates all sonar and weapon systems present on board a submarine.

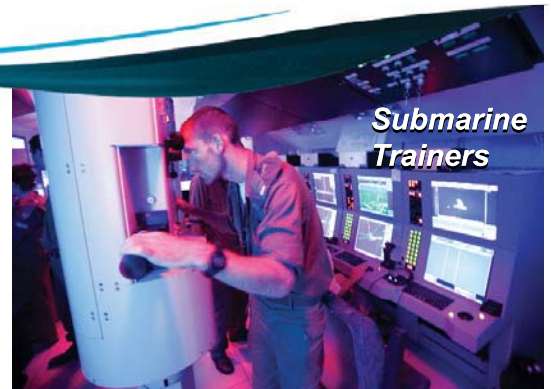

Portable Acoustic Range



COMPANY DESCRIPTION

DSIT develops and produces advanced sonar systems for the defense, commercial, energy and homeland security markets. Our systems provide customers with state of the art underwater technologies for site security as well as acoustic measurement & analysis and sonar training & simulation. The company is a subsidiary of Acorn Energy Inc. (NASDAQ: ACFN).

UTC UDI™ – UNDERWATER DIGITAL COMMUNICATION

SOS - SMS - 3D Compass - Homing - Diving Computer

The UDI™ underwater acoustic digital communication device is a reliable safety apparatus for diving missions. The UDI device enables the diver to navigate, send messages and use it as a diving computer. All these features are incorporated into one single device, which increases diving safety and decreases response time to deal with in-water emergencies. The boat unit enables colleagues on the surface to maintain contact with the diving team.

Navigation

Real-time location guided with Doppler Effect to diver in distress. The navigation feature works up to 1,000 meter range.

SOS

Broadcast SOS alerts to all other UDIs in all networks. If the diver suspects that a fellow diver is in trouble, he can send a Remote SOS which activates the fellow diver's unit. The UDI "Homing" feature provides graphical instructions on how to easily locate other divers or the boat.

Messaging

Two-way acoustic communication via pre-set text messages.

Diving Computer

RGBM algorithm diving computer, with any EAN mixture, altitude correction and multiple dives, without the need of 24 hour reset for a new diver.

3D Compass

3D compass corrected to elevation of up to $\pm 60^\circ$ with either graphical or digital digit display.

Advantages:

- User friendly
- High contrast OLED display easy to read.
- High capacity rechargeable battery
- Log book, internal memory, store the dive profile and data.
- Applications are software based with full communication to windows 7/8.

Organizations around the globe use the UDI device in complex diving operations and training. UTC's UDI device is a robust, proven and patented technology, leading the field of underwater communications.



Underwater Technologies Center LTD.

7A Industrial Park, P.O.Box 3003

Omer 8496901, Israel

Tel: 972-77-4050811

Fax: 972-8-6900466

E-mail: info@utc.co.il

Web Site: www.utc-digital.com

UDI™ PRO 28 - FOR CRITICAL MISSIONS

- 28 pre-configured messages
- Dual channel transmission
- Long distance communication
- 28 users in the network
- SOS signals- Navigation to/from target with clear path and depth



UDI™





LAND FORCES

Modern land warfare has shifted from the massive deployment of large military formations using heavy firepower, to 'hybrid' warfare, employing smaller forces equipped with highly effective firepower to achieving decisive, measured effects.

Israel's land forces are relying on advanced, battle-proven systems designed to perform effectively in both low- and high-intensity battlespace. From the Mk 4 Main Battle Tanks and Namer Armored Infantry Fighting Vehicles, to smart grenades and assault rifles, Israeli made systems are providing the IDF with the battle winning technological advantages its soldiers rely upon. Based on the knowhow that evolved with these sophisticated platforms, Israel's defense industries are also offering equipment upgrading solutions meeting evolving requirements.

Such systems support numerous domestic and foreign modernization programs, extending the life span of tanks, Armored Personnel Carriers (APC), mortar and artillery systems and wheeled armored vehicles of western and eastern origin. Such programs often include armor improvements, integration of remotely controlled weapon stations, optronic and battle management systems, threat detection and countermeasures systems, including active protection means. Most upgrades also address logistical improvements, implementing integrated testing and fault isolation, embedded training and support.

Equipping the modern soldier, Israel's defense industries are providing a wide range of infantry-oriented products. Modern infantry equipment ranges from bulletproof vests and helmets, advanced night vision devices, camouflage, harnesses, webbing and boots to miniature sensors and robotics, special munitions, assault breaching and multi-purpose missiles and rockets. Integrated into the Future Infantry ensemble, such gear enables the dismounted leader to perform as an integral element of the army-wide network-centric domain.

MERKAVA Mk. 4

The Merkava Mk. 4 Tank is the fourth generation of the Merkava family of tanks. Like its older generations, it represents the same basic design concept. It has many new systems and innovations in Protection, Mobility and Fire Power.

Basic description:

Protection: The Merkava family of tanks represents an aggregated approach regarding the protection concept. Top priority is assigned to protection and survivability. This is why the engine is located at the front end of the tank, utilizing its considerable weight to enhance the crew ballistic protection. The same idea applies to many other systems.

The Mk. 4 provides all-around protection, including roof protection. The enhanced survivability is achieved also by the state of the art Laser Warning System.

Mobility: the Mk. 4 is equipped with a 1500 HP modern power-pack and a durable mechanical suspension. The automotive system enables the tank to negotiate rough terrain while maintaining crew comfort and suspension durability.

Fire-Power: The upgraded 120 mm main gun is capable of firing high power ammunition, to achieve better penetration capability from longer distances. The advanced Fire Control System is capable of tracking, locking and hitting moving targets like tanks and helicopters.

Many other modern systems were incorporated into the Merkava Mk. 4, including:

- Advanced thermal imaging and TV systems.
- A new technology was utilized for the electrical turret control which enhances the first round hit probability.
- Modern Commander's stabilized Sight, Thermal and TV channels.
- An integrated command system, easily operated by the crew to control the tank systems.
- Rearward looking camera.
- An upgraded internal mortar, increased firing range.
- An auxiliary Battle Management System, including navigation capability.

The Merkava project has generated a considerable expansion of Israel's industrial and technological potential. Improved technologies related to tank manufacturing include welding and machining of large armor bodies, casting of ballistic steels, manufacturing guns, as well as electro-optical industries that utilize laser technology. The Merkava project has enabled the export of many systems based on Merkava technology which have also been used to upgrade other tanks.

סיבט **SIBAT**

SIBAT - Israel Ministry of Defense
International Defense Cooperation
Hakirya, Tel Aviv 6473424, Israel
Tel: 972-3-6975916
Fax: 972-3-6934639
E-mail: sibat_bic@mod.gov.il
Web Site: www.sibat.mod.gov.il



MERKAVA MK.-4

Main Contractors



סיבט
SIBAT

SIBAT - Israel Ministry of Defense
International Defense Cooperation
Hakirya, Tel Aviv 6473424, Israel
Tel: 972-3-6975916
Fax: 972-3-6934639
E-mail: sibat_bic@mod.gov.il
Web Site: www.sibat.mod.gov.il

Achidatex Nazareth Elite (1977) Ltd.
Agam Maalot

- Ballistic Shield
- Battery compartments
- General metal products

Amcoram Ltd.

- Periscope ballistic drive
- Peritelescope mount

Ardonan Elec. Packing Industries Ltd.

- Metal Works

Ashot Ashkelon Industries Ltd.

- Automotive suspension system
- Track Tension Mechanism
- Final drive
- Automatic transmission
- Navigation Systems

Azimuth Tech. Ltd. Bental Ind. Ltd. Beth-El Zikhron Yaaqov Ind.

- Electrical Motors, Blowers for Air Filters
- Air Filtration Systems

Blumstein Metal Works Ltd. Dynamica Design Ltd. Elbit Systems Ltd.

- Metal Works
- Noise and Vibration Control
- Fire Control System
- Commander Panoramic Sight
- All Electric gun & Turret drive & stabilization System
- Battle Management System
- Laser Warning System
- Turret Vetrronics
- Drivers Control Panel & Display

Eltam Ein Hashofet

- IDLS - Intelligent Dome Light System

Fermet

- Armor Castings

I.A.I.-Ramta

- Ballistic Armor
- Turret floor

I.A.I.-Tamam

- Inertial Measurement Unit (IMU)

IDC Imco Industries Ltd.

- Revolving Magazine
- Distribution, relay and control boxes
- Delay relays
- Headlights
- Electric cables & harnesses

I.M.I.- Israel Military Industries Ltd.

- 120 mm gun & ammunition
- Ballistic Armor
- Wire Race Turret bearing

Isra-laser

- Metal cutting, General metal products
- Optic Systems

ITL Optronics Ltd. Karmiel Ltd. Kinetics Ltd.

- General metal products
- Air Conditioning System
- NBC Protection System
- Transmission & Braking System Components
- Hydraulic Track Tensioning Mechanism
- Auxiliary Power Unit-APU
- Fuel System
- Engine Sensors

Magam MER MTLM Mechanics Nir - Or Ltd.

- Rubber fuel tanks
- Digital Communication
- Air duct deflecting and sealing system
- Controller Systems
- TCP/IP Communication Interface
- Optic Systems
- Water systems

Opgal Oran-heating products Orlite OSG Palbam Pladot

- Ammunition Containers
- afety Glass
- Fuel containers
- Air inlet and exhaust system
- Emergency Brake
- General Mechanical Items

Peretz Yerushalmi Rada Elec. Ind. Rafael Ltd.

- Ballistic Shield
- Optic Systems
- Ballistic Armor Components

Reshef Tech. Ltd. Ronen Metal Works Ltd.

- Ammunition Fuzes
- Commander's mechine gun mount
- Gunner's Seat
- Machine Gun Mounts
- NBC system

Shalon Chemical Ind. Simat Ltd.

- Cooled NBC Garments
- Loader's and driver's hatches
- Crew seats
- General metal products
- Support wheels
- Road Wheel Hubs
- 60 mm internal mortar & ammunition
- Electrical Commander's Hatch
- Road Wheels
- Fire extinguishing and suppression system
- Communication system
- V.R.C-120
- Inter communication system Vic
- Fuel tank system
- Drinking water system
- Support wheels
- Fuel tank vent valve
- Precision castings
- General metal products
- General Mechanic System
- Periscopes
- Hull, front and deck castings
- Turret main body castings
- Road -idler and sprocket wheels, hubs, track shoes
- Various castings for suspension
- hydraulic bumpers.
- Thermal Sleeve
- Air inlet selector
- Peritelescope mount
- Braking, steering
- Gearshift and accelerator systems

Soltam Systems Ltd.

Spectronix Ltd. Tadiran Communications Ltd.

Tamor S.M.R. LTD.

T.A.T. Tec. Ltd. Tefen

Casting Ltd. Tool Metal Ltd.

Uni-Scope Optical Sys. Ltd. Urdan Industries Ltd.

Vidco Ltd.

Yail Noa

NAMER - MERKAVA APC



SIBAT - Israel Ministry of Defense
International Defense Cooperation
Hakiryia, Tel Aviv 6473424, Israel
Tel: 972-3-6975916
Fax: 972-3-6934639
E-mail: sibat_bic@mod.gov.il
Web Site: www.sibat.mod.gov.il

General

The Merkava APC is built to meet a variety of combat missions and is planned as a common chassis to a family of vehicles (recovery, command, medical and more)

The Merkava APC is capable of carrying up to 12 people. Three crewmembers (commander, machine-gunner and driver) 8 infantrymen and an option for an additional crewmember.

The vehicle is equipped with advanced systems and has a high level of human engineering, based on the IDF experience in a variety of combat situations.

The APC was fielded late 2008 and took part in actual battle and peace-keeping operations since January 2009.

Ballistic Protection & Survivability

Advanced armor technology based on modular special armor combined with active protection, roof and belly protection and emphasis armor coverage. The basic design concepts of the Merkava tank are applied: using the vehicle systems as extra protection to the crew, eliminating combustible materials from the crew compartment. NBC protection combined with air-conditioning system. The energy-absorbing crew seats are isolated from

the chassis thus eliminating shock-wave hazard. The rear ramp system enables fast and safe boarding and dismounting of the infantrymen.

Fire Power

The APC is fitted with a remote controlled weapon system, using 0.5", 7.62mm or grenade launcher. The system is combined with day and night TV viewer. The APC is also equipped with additional 7.62mm machine gun, mechanically remote controlled and a 60mm mortar operated by the commander.

The commander's control system includes all-round day and night cameras, two of them are located in the crew compartment serving the crew. The commander also has a protected post for safe observation through his hatch.

An advanced control & communication system enabling efficient operation in the battlefield.

Mobility

The running gear is similar to the Merkava Mk. 3, namely: 1200 Hp AVDS engine, Automatic RK304 transmission, external mechanical suspension with independent road arms and rotary shock absorbers.



ASHOT ASHKELON

Drive Train, Suspension and Mobility Solutions for Tanks & APC's; Tungsten Based Armor Penetrators and Fragments Manufacturer.



ASHOT ASHKELON INDUSTRIES LTD.

P.O.Box 21
Ashkelon 7810001, Israel
Tel: 972-8-6721366
Fax: 972-8-6721711
E-mail: info@ashot.co.il
Web Site: www.ashot.co.il

Ashot provides Built to Print & Built to Spec. capabilities of Suspensions Systems, Main Automatic Transmissions, Final Drives, Transfer Boxes, Drop Boxes, PTO's, wide range of Gear based assemblies and Shafts for Main Battle Tanks such as the Merkava and Abrams, Heavy & Light Armored Personal Carriers (Tracked & Wheeled) such as the Namer, M113 and various of defense applications.

Your Natural Partner

Ashot is an active partner for innovative design and large scale production for the finest Main Battle Tanks and APC's global programs. Ashot combines sophisticated engineering and high quality production capabilities to meet its finest products.

A one of its kind Combat Experience

Ashot engineers and program managers possess a strong and high ranked military background in the field of armored vehicle design

and demands. The leading teams use their unique specialties, based on their vast experience and know-how in mobility and armored vehicles design, to define performance and demands needed in combat areas and at the battle field; those in-sights are translated into Ashot products and sustain a common language and a long term relationship with our end costumers, the fighting forces.

In-House Development and Manufacture Synergy

Ashot is a vertically integrated company which owns full facilities and state-of-the-art equipment needed for design, manufacture, assemble and perform full load test to the myriad of military components produced under a single roof.

References

Ashot solutions and products have been purchased by various Ministries of Defense such as the Israeli Defense Forces, American TACOM Warren, Turkish MOD,

Indian MOD and more; all products had been tried and tested by dozens of armed forces in the most demanding battlefields such as Lebanon, Afghanistan, Iraq and more.

Why Ashot

With both build to-print and full design capabilities, Ashot offers gear-based systems assemblies and components for existing products, for new programs and for upgrade programs, including all stages of design, production and delivery. Ashot has full capabilities to upgrade or provide life extension programs to a variety of Tanks, Armored Personnel Carriers, various Tracked & Wheeled Vehicles; Western or Eastern Bloc design.

Well experienced engineering skills along with high capacity production capabilities and in addition to strong financial strength, Ashot is placed as a leader in new design or upgrade programs for Tanks and APC's.



MOTION & POWER SYSTEMS



Bental Industries Ltd.

Merom-Golan 1243600, Israel

Tel: 972-4-6960199

Fax: 972-4-6960187

E-mail: Bental_marketing@bental.co.il

Web Site: www.bental.co.il

Bental industries specializes in design and manufacture of innovative power and motion systems integrated into various ground and aerial platform and applications:

- Electric Motors
- Servo Actuators
- Blowers & Dust Scavengers
- Alternators & Starter Alternator

The company's ability to tailor cutting edge technology and innovative design to specific project requirements enables it to comply with the most challenging demands.

See also page 31



ARMOR DIVISION



HATEHOF LTD.

P.O.Box 639
Nazareth Elite 1710502, Israel
Tel: 972-4-6410641
Fax: 972-4-6418555
E-mail: hatehof@hatehof.co.il
Web Site: www.hatehof.co.il

YOUR FRONTLINE PROTECTION

Founded in 1947, Hatehof is among Israel's leading manufacturers of high quality, combat and field proven Armored vehicles and a major supplier to both IDF and other armed forces.

Hatehof specializes in providing tailor-made Armored vehicles by use of:

- Protective levels (STANAG 1-5) against bullets, mines and IEDs
- Passive add-on armoring
- High performance automotive systems and power lines
- Complete range of In-House services: concept, design, ballistic & antimine certification, inspection, manufacture, assembly, professional literature & maintenance.

Our Armored Vehicles typical applications range from Personnel carrier through Law-enforcement, Logistics, Tactical command & patrol, Defense missions, Peacekeeping, Ambulance, General utility, Reconnaissance and more.

Through housing both R&D department as well as production facilities, **Hatehof can provide the client the most cost-effective Tailor-made solution.**

Hatehof Ltd is ISO 9001 and ISO14001 certified manufacturer of armored and designated vehicles. As such, we maintain a rigid quality-oriented process designed for after sales services supplied by atehof, among which are:

Pre-delivery QA inspection and CoC, Three degrees maintenance service, Spare parts contract, provided literature and warranty.



Xtream – A 16 Ton all terrain 4X4 MRAP, up to 7 people, KE Stanag 2 and Mine protection Stanag 3a+2b



Wolf – A 9 Ton multi purpose 4X4 APC, up to 8 people, KE Stanag 2 and Mine protection up to Stanag 1



Hurricane – An 8 Ton all terrain 4X4 APC, up to 7 people, KE Stanag 2 and Mine protection Stanag 3a+2b



Navigator – An 18.5 Ton all terrain 4X4 MRAP, up to 13 people, KE Stanag 3 and Mine protection Stanag 4a+4b

INTEGRATED SIGHTS



Elbit Systems Electro-optics Elop's Combat Vehicle Systems unit specializes in providing turnkey and tailor-made integrated gunner and commander sight solutions for virtually every MBT and AFV in service today.

The integrated sights' modular design combines direct view observation, TV channels, eyesafe laser rangefinders and a wide variety of night

vision technologies with LOS stabilization and hunter-killer solutions.

Elop's battle-proven integrated sights feature modular upgradable designs which are tailored to our customers' requirements, all weather 24/7 observation and aiming capability, advanced image processing and fast, accurate target acquisition.



COAPS: *Commander Open Architecture Panoramic Sight*

- 3rd generation modular sight for AFVs, easily adaptable to sensor additions/changes
- Facilitates long-range target acquisition day and night, from stationary positions as well as on the move
- Wide range of advanced sensors, including 3-5 μ m or 8-12 μ m thermal imager, color zoom camera, eyesafe laser range finder (ELRF) and color TV day channel with continuous zoom



Merkava MK IV: *Commander Panoramic Day/Night Sight*

- 3rd generation advanced panoramic sight for MBT
- Facilitates long-range target acquisition day and night, from stationary positions as well as on the move
- Dual-axis independent stabilized mirror head
- 360° x N panoramic observation
- 3-5 μ m staring array dual FOV thermal channel
- TV day channel – B/W or color



Merkava MK IV: Gunner Stabilized Sight

- Advanced, modular sight
- Facilitates long-range target acquisition day and night, from both stationary and mobile positions
- Dual-axis independent stabilized mirror head with mechanical backup
- 8-12 μ m dual FOV thermal channel with 480 x 4 TDI detector
- ELRF with direct view optics
- TV day channel – B/W or color, unity vision WFOV channel



M-60: Gunner Stabilized Sight

- Advanced modular sight for MBTs
- Facilitates long-range target acquisition day and night, from stationary positions as well as on the move
- Dual-axis independent stabilized mirror head
- 8-12 μ m dual FOV thermal channel with 480 x 4 TDI detector
- ELRF with direct view optics
- TV day channel – B/W or color, unity vision WFOV channel



T-72: Thermal Imaging Stand Alone System (TISAS)

- Modular drop-in TI (night) sight for all T- family tank solutions
- Can be adapted to a ballistic computer for full FCS solution
- Single-axis electrical mirror head
- 8-12 μ m dual FOV thermal channel with 256 x 4 TDI detector
- Biocular display units for gunner and commander



T-55: Day/Night Sight

- Modular, compact drop-in day and night solution for T- family tanks
- Can be adapted to a ballistic computer for full FCS solution
- Single-axis electrical / mechanical mirror head
- ELRF including day channel with dual FOV and day color TV channel
- Dual FOV 3-5 μ m thermal night channel



BMP: Day/Night Sight

- Modular, compact drop-in day and night solution for BMP 1 & BMP 2 AFVs
- Can be adapted to a ballistic computer for full FCS solution
- Single-axis electrical / mechanical mirror head
- ELRF including day channel with dual FOV and day color TV channel
- Dual FOV 3-5 μ m thermal night channel

LAND SYSTEMS



A total-solution concept, covering the entire spectrum of combat vehicles, from complete modernization and training to maintenance depots and life-cycle support services, providing a full-suite of net-centric solutions enhancing combat effectiveness, lethality and survivability.



Unmanned Turret UT30

Combat-proven firepower for armored personnel carriers; fully overhead without compromising troops safety

Encompassing a broad range of weapon systems, countermeasures and advanced electro-optics, the system can be configured with all types of cannons (25 or 30 mm), coaxial machine guns (7.62 mm/0.3") and guided anti-tank missiles. Featuring a high first-round hit probability, the dual-axis stabilized UT30 is designed for firing on-the-move and at moving targets. Fully overhead with no deck penetration, the UT30 does not compromise the vehicle's armor protection and preserves existing space within the vehicle.



Overhead Remote Controlled Weapon Stations (ORCWS)

Adaptable, effective and field-proven range of ORCWS – leveraging over 30 years of experience and in-house development

With dual-axis stabilization, the weapon stations provide a high first-round hit probability while shielding the operator from danger. Offering unparalleled performance in battlefield conditions, the ORCWS product range includes weapons of different types and calibers including 5.56 mm (0.22"), 7.62 mm (0.3") and 12.7 mm (0.5") in addition to 40 mm automatic grenade launchers.



Surveillance, Reconnaissance and Targeting

Fully-customizable ground and mobile solutions for real intelligence collection and dissemination

Comprised of a broad array of lightweight network-ready sensors and C⁴I systems, the various system components can be fully customized to deliver effective intelligence in a broad range of operational scenarios. The solution provides day and night observation, target detection and recognition, radar, and identification of friendly forces. All sensors are fully controlled from the commander terminal, with digital maps for navigation and orientation.



Comprehensive Protection for Fighting Vehicles

Supports effective and timely responses to laser and radar-guided threats

Offering 360-degree threat coverage, the range of systems can be tailored to provide the required degree of accuracy and meet an extensive array of threats. Whether installed as a stand-alone system or integrated with countermeasures, the systems can be easily fitted to all AFVs. The systems detect, categorize and pinpoint laser and radar/RF sources. Using a combination of decoys, smoke, electro-optical signals, infrared or laser jamming, the systems effectively neutralize incoming missiles.



Warning Systems

Fully customizable; detecting laser and radar-guided threats

Elbit Systems' Laser Warning System (E-LAWS) and Threat Detection System (TDS) accurately detect, categorize and pinpoint laser sources such as rangefinders, designators, beam riders, infrared illuminators and trainers. In addition to laser sources, the Multi Threat Detection System (MTDS) detects, categorizes and pinpoints radar/RF sources. An essential component of the vehicle's defensive capabilities, the systems feature audio and visual warnings, high detection probability, and a low false-alarm rate.



See-Through-Armor (STA)

360-degree situational awareness under closed hatches

A revolutionary, panoramic observation system, enabling operators to understand and experience their environment from a single image. Using algorithms that electronically join imagery collected by video cameras installed around the vehicle, the STA provides a seamless 360-degree real-time panoramic view.



Fire Control Systems (FCS)

Highly accurate, modular and reliable. Battle-proven and adaptable to a wide range of AFVs and tanks

Features long-range, day and night, on-the-move high first-round hit probability against moving targets. Reliable and cost-effective, the systems range from simplified FCS for one-man light turrets to high-performance hunter-killer FCS for front-line main battle tanks (MBTs). Every FCS is configurable with battle management systems used in net-centric warfare.

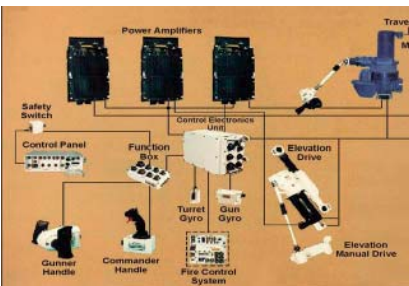

Electric Gun and Turret Drive System (EGTDS)

Improved fire control capabilities for heavy turrets and guns

Elbit Systems' EGTDS significantly enhances turret stabilization and firing on the move. The system provides smooth target tracking at high-speeds and in all firing positions, even for heavy guns and turrets. In addition the system improves safety by eliminating the need for the highly flammable hydraulic fluid used in conventional systems.



Driver Thermal Vision System

Uncooled thermal imaging kit

Fully ruggedized and suitable for a wide range of vehicle-mounted applications. The vision system includes a thermal imaging camera based on an uncooled detector and a ruggedized LCD display installed inside the vehicle.



Kinetics Auxiliary Power Unit (APU)

For MBTs and AFVs

Improves the crew's performance and safety by reducing fatigue and minimizing exposure to noise, heat and vibrations. The APU allows the vehicle to operate in silent mode while reducing the thermal signature. The unit also supports the increased power demand for sophisticated electronic equipment.

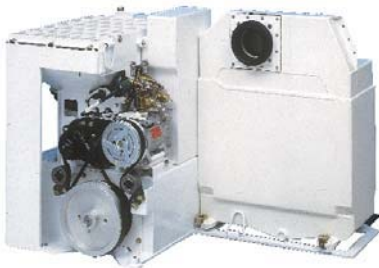

Kinetics Life Support Systems (LSS)

For AFVs and MBTs

Includes chemical, biological, radiological and nuclear (NBC/CBRN) protection and detection. The system also includes Heating, Ventilation and Air Conditioning (HVAC), Water Generation and Fire Suppression Systems. The LSS can be powered by the platform engine or can be self-propelled when it includes an APU.



Kinetics Individual Crew and Equipment Cooling System (ICECS)

Optimal crew performance in extreme conditions

Available as a standalone system or as part of a comprehensive Life Support System (Kinetics-LSS), the Kinetics ICECS is an ideal solution when cooling is required for several crewman in spite of open hatches or ramps. The system's air-conditioner provides cooled, dried filtered air and NBC/CBRN protection to Air-Cooled Overalls and NBC Facemask. In addition, spot cooling is available for specific equipment..

For a range of C⁴I solutions for AFV's please see page 310.

LAND FORCES

Tanks & Armored Combat Vehicles



ISRAEL MILITARY INDUSTRIES LTD. (IMI)

P.O.Box 1044, 64 Bialik Blvd.
Ramat Hasharon 4711001, Israel
Tel: 972-3-5485222
Fax: 972-3-5486125
E-mail: imimrktg@imi-israel.com
Web Site: www.imi-israel.com

MBT & IFV MODERNIZATION

IMI Specializes in the conversion, upgrading and modernization of MBTs and IFVs, enabling customers to maximize the use of existing inventories and extend the lifespan of in-service systems by improving lethality, survivability and mobility. Such programs include replacing and upgrading guns and weapons, new fire control systems, armor and automotive enhancements, remote controlled weapon stations, active protection systems and more. IMI has upgraded 170 M60A3 MBTs, in what is considered to be the largest tank upgrade program in recent years.

HYBRID PROTECTION AGAINST IEDs & RPGs

IMI develops, manufactures and installs passive and reactive ballistic armor kits for MBTs, AFVs, heavy earth moving equipment and light tactical vehicles. Amongst these: IRON WALL passive protection kit against medium-sized IEDs (e.g. EFP

& SFF) and BREAKWATER reactive armor kit for protection against large EFPs with copper liners, including RPG-7. Both armor kits provide STANAG 4569 Level 4 small arms protection.

ACTIVE PROTECTION SYSTEMS (APS)

IMI's family of APSs for ground forces and other applications include the IRON FIST APS for light to heavy AFVs, BRIGHT ARROW combined 'Soft', 'Hard-Kill' APS and remote controlled weapon station, for light/medium armored vehicles and SHOCK ABSORBER portable 'Soft-Kill' protection and situational awareness system for infantry, naval vessels and stationary sites. IMI's IRON FIST effectively defeats the full spectrum of anti-tank threats: RPGs, ATGMs and tank cartridges, including KE.

IFVs FOR LIC

IMI offers various solutions for infantry

operating in low intensity conflicts. These include the WILDCAT 4x4 all-terrain armored wheeled vehicle. This multi-role vehicle provides protection against RPGs, IEDs and up to 14.5mm AP cartridges. Other solutions include affordable modernization programs for APCs, such as the URBAN FIGHTER up-armored M113, optimized for asymmetric warfare scenarios.

TANK AMMUNITION

IMI develops and manufactures combat-proven tank cartridges of various calibers (100,105,120 & 125mm). These include Multi-Purpose High-Explosive (MP-HE), APFSDS-T, HEAT, HESH, Training and Less-Than-Lethal cartridges. IMI's MP cartridges provide tank crews with a highly-effective solution for engaging bunkers, vehicles and fortifications, as well as AT squads and infantry in the open. IMI's Tank Ammunition is in use with the IDF, NATO and various armies worldwide.

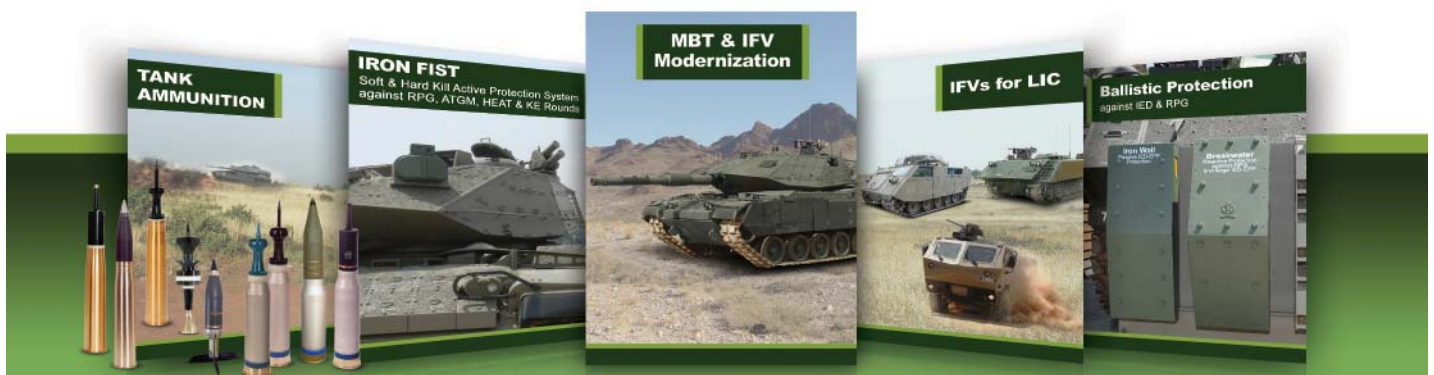

NIMDA CO.

More than 40 years of modernization and upgrading programs for tanks, APC(S), military trucks and naval propulsion proven technology

NIMDA CO. MAIN PROJECTS:



NIMDA CO.

P.O.Box 768 Lod 7110604 , Israel
Tel: 972-8-9781111
Fax: 972-8-9781137
E-mail: info@nimda.co.il
Web Site: www.nimda.co.il

T-72-M4 CZ



New Power Pack For T-72-MBT Nato Standard, & Recovery Tank.

T-72 N-2000

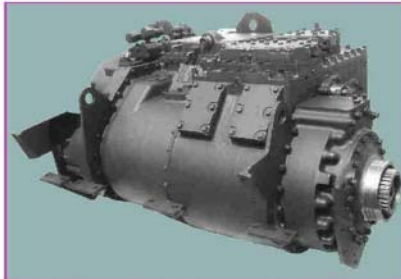
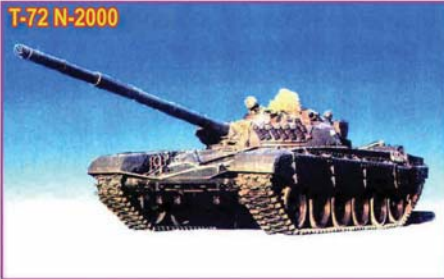

New Manufacturing Allison Automatic & Electronic Transmission, 1,000 HP Rating Model XTG 411-6-N Application: T-72 Tanks and Similar Application.

ACHZARIT-X3A1

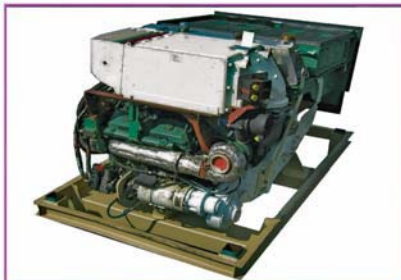

New Power Pack For IDF "Achzarit" Heavy APC DDC - 8V92T(N)710 HP Allison - XTG411-5(N).

M-113.A2.5/N:2000



New Power Pack For M-113 N-2000 DDC - 6V53T 300 HP engine Allison Automatic Transmission – 3000 series, upgraded Final Drive and Suspension System.

M-41



New Diesel Power Pack DDC 8V71T/8V92T Allison CD-500 Transmission For M-41. Total M-41 Upgrading & Modernization Program.

ADD ON ARMOR



Rafael's Add On Armor Products

Rafael is a major and unique armor company dealing with all protection technologies: passive, reactive, hybrid and Active Protection systems. Rafael conducts development, design, integration and production of the most advanced armor systems to enhance the protection level of armored vehicles.

Rafael uses its extensive past experience to provide high level of protection, lightweight and low cost enhancements integrated on all types of combat platforms. All armor products are modular and capable to protect combat vehicles from a broad range of threats such as small and medium kinetic energy (KE) armor piercing (AP) projectiles, high energy anti-tank Shaped Charges (SC), high speed fragments of artillery and Improvised Explosive Devices (IEDs) and Explosive Forming Projectiles (EFPs).

The performance and specifications of the systems meet the protection requirements and standards of the Israel Defense Forces (IDF), the US Army, USMC and NATO force standards. The systems have been tested, qualified and approved for application by the customers worldwide and are combat proven. Rafael had eight different add-on armor systems, served in the Iraqi / Afghan theater with the coalition forces.

Reactive Armor

Rafael is the world leading company in the application of the reactive armor technology. It was the first company to develop, design and integrates reactive armor systems on combat vehicles. The reactive armor is the most effective add-on armor technology to protect Armored Fighting Vehicles (AFV's), Armored Personal Carriers (APC's) and Main Battle Tanks (MBT's) against shaped charge threats of Rockets and ATGMs.

For light armored vehicles, Rafael developed Hybrid armor which combines reactive and passive elements to provide complete, 360 degrees protection against anti-tank rockets, medium KE AP projectiles and high speed fragments. Upgraded multi-threat hybrid armor, Multi-Threat Armor Protection (MTAP) system has recently been developed to defeat also EFPs and IEDs.

Rafael's reactive and hybrid system have been fitted to many combat vehicles worldwide. In the US, Rafael, together with its partner General Dynamics ATP, integrated produced and supplied reactive / hybrid armor systems for the Bradley AFV and the Stryker vehicles.



M60



Bradley



M113

RAFAEL
ADVANCED DEFENSE SYSTEMS
 P.O.Box 2250 (19)
 Haifa 3102102, Israel
 Tel: 972-4-8794714
 Fax: 972-4-8794657
 E-mail: intl-mkt@rafael.co.il
 Web Site: www.rafael.co.il

Passive Armor

Rafael has developed and applied various passive armor technologies to protect combat vehicles, including ceramic, metallic, shaped, laminated and perforated technologies. The passive add-on armor is modular, lightweight and easily installed by the crew. It is maintenance-free and combat-proven.

The systems provide protection against 14.5 mm AP projectiles, high speed fragments of artillery shells and IED (STANAG 4569, Level 4 and beyond). Rafael has recently developed passive add-on lightweight, effective modular armor to defeat EFPs.

Rafael's armor systems are in use by the IDF, USMC, Italian Army, New Zealand Army, Czech Army and others. They are combat proven and received excellent reports about their performance in the Operation Iraqi Freedom and peace keeping missions worldwide. Rafael's Enhanced Appliqué Armor Kit (EAAK) add-on armor system was selected by the USMC as a sole source, for the AAV7 amphibious APC.

RAFAEL's Reactive Armor installed on the US Bradley AFV (left) and Passive Armor installed on the USMC AAV7 APC (right).



AAV7

M113

Rosomak

■ **Certificates from the US Army and USMC to Rafael for its reactive and passive armor systems, installed on the Bradley, Stryker and AAV7** ■



FORCE PROTECTION – ACTIVE PROTECTION



TROPHY – Situational Awareness and Active Protection Systems

The Trophy is a situational awareness and active protection hard kill system that operates in three major stages: Threat detection and threat tracking followed by hard kill countermeasure (Multiple Explosive Formed Penetrators – MEFP) activation and threat neutralization. The neutralization process takes place only if the threat is about to hit the platform.

Trophy-HV

The Trophy was declared operational by the IDF in August 2009 and is currently in full production. Merkava 4 tanks integrated with Trophy active protection systems are presently being deployed in combat areas along Israel's borders.

Exceptional Capabilities

- 360° protection, while permitting sectors of the vehicle-mounted system to be rendered inactive when necessary for the protection of troops on the ground
- 360° situational awareness by detecting all incoming threats and identifying their launch position
- Extremely high elevation protection
- Neutralizes threats fired from very short range
- Neutralizes simultaneous threats arriving from one or more directions
- Minimum collateral damage
- Suitable for multiple platforms
- High kill probability while static or on the move
- Reduces platform weight

The Trophy system is adaptable to any combat platform. Once a platform is chosen, a short trade study is completed to work out any integration issues that may arise. Numerous elements are taken into consideration for each vehicle variant or type. For vehicles with relatively basic or light armor, e.g. the Stryker, the Trophy provides full protection against all types of RPG (as well as other threats) due to the fact that the Trophy destroys these types of threats without detonation.

Currently, the full Trophy HV system weighs 800kg. Since space and weight will continue to be major issues on combat platforms, not only for current forces, but also for new vehicle programs, i.e. FCS / FRES, great efforts to miniaturize the electronics of the Trophy have been made.



**RAFAEL
ADVANCED DEFENSE SYSTEMS**

P.O.Box 2250 (19)
Haifa 3102102, Israel
Tel: 972-4-8794714
Fax: 972-4-8794657
E-mail: intl-mkt@rafael.co.il
Web Site: www.rafael.co.il

■ **The result is additional systems for lighter vehicles:**

Trophy-MV

The Trophy-MV offers the same hard kill capabilities as the Trophy-HV and includes built-in soft kill capabilities as well. The Trophy-MV (previously Trophy II) is at TRL 7 and the first prototype is currently undergoing enhanced field testing. Trophy-MV a 450kg APS, for light - and medium-weight (10-30 ton) vehicles.

Trophy-LV

This active protection hard kill system for light armored vehicles utilizes the same superior operating principles as the Trophy-HV and Trophy-MV at a fraction of the weight. Trophy-LV's high kill probability against advanced threats, including the most sophisticated shoulder-launched AT rocket propelled grenades, makes it a significant force-multiplier at shorter ranges on the modern battlefield.

The Trophy-LV's dimensions are specially designed for easy integration and installation onto smaller platforms without impairing system performance. This ensures 360° protection including the vehicle's windows and doors with minimal risk of collateral damage. The Trophy-LV is an all-round efficient, affordable, and cost-effective solution that is currently undergoing field testing in a variety of operational scenarios.

Operational Concept

- Radar identifies and tracks incoming threat/s and delivers the exact threat launching point to a battle management system or weapon station
- The computer identifies the threat, determines whether it will hit the vehicle, and if so
- A ballistic cover opens
- A countermeasure head slews to the proper location
- The computer continues to track, acquire, and plot the best intercept solution
- The countermeasure is launched and neutralizes the threat



The Trophy systems have a very high kill probability and testing has shown them to be successful against all known CE threats (RPG, ATGM, tank-fired CE, etc.) The systems' average collateral damage is estimated at a <1% chance of a dismounted soldier being injured by Trophy or an incoming threat.

UNIQUE DEFENSE PATENTED SYSTEMS



Tal & Hadas. A privately owned Company established in 1982. We provide real time solutions according to customers' specific requirements. From the design of systems through development and testing to the manufacture of end products.

TAL & HADAS LTD.

P.O.Box 1011
Afula Elite 1855010, Israel
Tel: 972-4-6408400
Fax: 972-4-6408401
E-mail: info@tal-and-Hadas.com
Web Site: www.tal-and-Hadas.com

We design, manufacture and market for vehicle, railway, truck and military industries. Our engineering department provides top-standard quality design, using error proof manufacturing methods.

Tal & Hadas Ltd. works in compliance with the TS16949 and ISO 9001 standards. The company holds international patents on many exclusive and innovative products, which have both military and civilian applications.

Our unique designs and over 25 years of experience with both military and transportation industries, allows us to supply customers with systems, "tailored" according to their requirements.

Our key costumers include: GM, VW, Siemens, IDF, General Dynamics

R.U.F - Rescue Under Fire products

R.U.F system provides rapid under fire extraction for damaged or disabled vehicles, APC's and tanks without having to expose the crew to the external hostile environment.

- The R.U.F system can be mounted quickly on any platform using Extraction hooks which already mounted on the vehicle.
- The R.U.F system does not require any special driving skills or extensive training. Allowing you to quickly hook up and tow your platform to a safer environment for maintenance.
- System can handle 8 - 80Ton weight range.



In use by Israel Defense Forces

Samson system - load reduction system

- Designed for up to 60kg loads.
- Reduced more than 80% of the load on the soldiers' back, hence allows carrying extra weight (ammunition, supply, water, and stretcher) in extreme terrains.
- Does not diminish the soldier ability to fight.
- Our unique solution in a real-time, provide the best solution at the battlefield with unique sophisticated mechanical systems.



Parachuted systems

EAPS - Energy Absorbing Pallet System for parachuted/air drop equipment

The pallet allows safe parachute dropping of loads/supplies from the air, including sensitive and fragile equipment with ease. Without causing damage to the equipment.

SWALLOW - An automatic parachute disconnecting system

Enabling better equipment/supply drop with precision and accuracy to ground forces. Eliminating equipment damage from being dragged by the parachute.

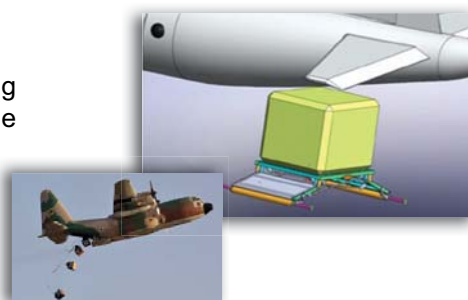

TURNKEY SYSTEMS



Tactical Mobility and Versatility On All Terrains

TECHNOLOGY IN MOVEMENT

Southern Industrial Zone
P.O.Box 19, 6 Hacharoshet St.,
Migdal Haemek 2310001, Israel
Tel: 972-4-6546735
Fax: 972-4-6546738
E-mail: main@tamor.co.il
Web Site: www.tamor.co.il



Manufacturer of **Turnkey Systems**, Subsystems, Kits, Assemblies and Components for Wheeled and Tracked Vehicles per customer specification

SYSTEMS, SUBSYSTEMS, KITS, ASSEMBLIES

- Traversing Machine Gun Mount Systems
- Armored Hatches and Mechanisms
- Fuel Tanks and Water Tanks
- Equipment Compartments, External, Internal
- Structural Kits

CHASSIS AND SUSPENSION SYSTEMS

- Wheels Solid Rubber
- Track Shoe Parts and Track Assemblies
- Track Tension Adjusters
- Sprockets and Carriers
- Supporting Road Arms
- Hydraulic Bumpers
- Brake Systems

DEFENSE VEHICLES

- Main Battle Tanks (MBTs)
- Armored Fighting and Recovery Vehicles (AFVs, ARVs)
- Armored Personnel Carriers (APCs)
- Amphibious Vehicles
- Land Recovery Vehicles
- Heavy Military Trucks

INDUSTRIAL VEHICLES

- Rolling Stock
- Agriculture
- Mining
- Construction
- Forestry and Logging
- Specialized Heavy Vehicles

The Tamor factory's versatility in implementing in-house multi-process technologies in metalwork and rubber vulcanization is particularly suitable for modernization programs, comprehensive upgrading solutions and improvements to proven field tested standards.

Quality Assurance: ISO 9001:2008, AQAP 2110, U.S. ARMY TACOM QSL-01, QSL-03, QSL-04

OUR TECHNOLOGY LIGHTENS THE MOBILITY OF HEAVY VEHICLES



TECHNOLOGY IN MOVEMENT

Southern Industrial Zone
P.O.Box 19, 6 Hacharoshet St.,
Migdal Haemek 2310001, Israel
Tel: 972-4-6546735
Fax: 972-4-6546738
E-mail: main@tamor.co.il
Web Site: www.tamor.co.il

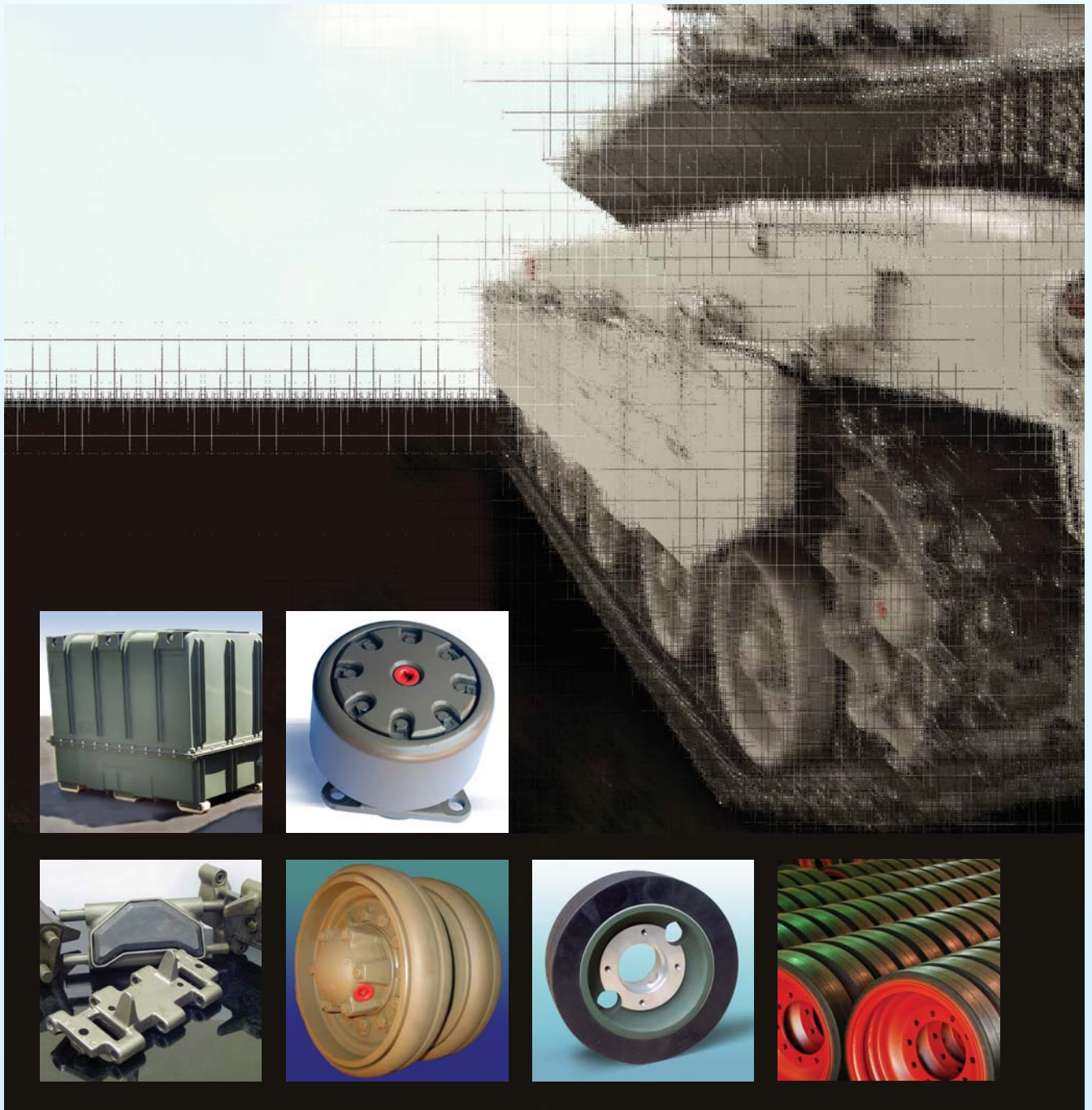

DEFENSE - INDUSTRIAL - CIVIL

- **WHEELS**
- **TRACK SHOES**
- **FUEL TANKS**
- **RUBBER ANTIVIBRATION**



TECHNOLOGY IN MOVEMENT

Southern Industrial Zone
P.O.Box 19, 6 Hacharoshet St.,
Migdal Haemek 2310001, Israel
Tel: 972-4-6546735
Fax: 972-4-6546738
E-mail: main@tamor.co.il
Web Site: www.tamor.co.il

TAMOR S.M.R. PRODUCTS

**built to customer specification*

- Wheels Solid Rubber: Road, Single / Double Support, Tension, Idlers, Rollers, Sprockets, Forklifts
- Track Shoe Parts and Track Assemblies with: Pads, Bushings, Pins, Connectors, Parts
- Fuel Tanks and Water Tanks: Steel, Stainless Steel, Aluminum
- Antivibration Rubber Products: Vibration Dampening, Shock Absorbing Rubber
- Chassis and Suspension Components and Assemblies: Control Arms, Cross Members, Primary Suspension
- Body Frame Components and Assemblies
- Large Heavy Metalwork Products: Specialized Transport and Storage Containers
- Other Rubber / Metal Products: Portable Signposts, Asphalt Paving Machine Pads, Full tracks, Endless Rubber Bands, Exercise Ammunition, Ladders, Other custom-made items

IN-HOUSE TECHNOLOGIES

- Metalwork: CNC machining, deep drawing, forming, welding, cutting, stamping, shot peening, painting, preservation
- Rubber Vulcanization: rubber bonded to metal and rubber molding using compression, transfer and injection molding

DEFENSE APPLICATIONS

- Tanks
- Armored Fighting and Recovery Vehicles (AFVs, ARVs)
- Heavy Military Trucks
- Land Recovery Vehicles
- Armored Personnel Carriers (APCs)
- Amphibious Vehicles

Tamor manufactures for the Abrams, Bradley M-1, M-2, M-24, M47, M-48, M-51, M-107, M-109, M-113, M-60, M-88, Sherman, AMX-10, AMX-13, AMX-30, Leopard I, Leopard II, LVTP-7, Half trucks, BMP-1, BMP-2, BMP-3, Leonidas, T-80, T-54, T-55, T-72, HUMWVV, Mark IV, Mark V, and others.

Reconditioning of track shoe assemblies in compliance with field-tested standards.

CIVIL & INDUSTRIAL APPLICATIONS

Tamor SMR manufactures diverse products for Rolling Stock, Mining, Construction, Agricultural, Forestry and Logging and Other Specialized Heavy Vehicles (asphalt pavers). Products include fuel tanks for dynamic (trains, trucks) and static (power generating units, central heat units) applications, antivibration and shock absorbing rubber products, potable water tanks.

QUALITY ASSURANCE

- ISO and IQ Net 9001:2008
- Welding: AWS D 17.1, AWS D1.1, European EN 15085-2 Class 1
- NATO AQAP-110
- U.S. Army TACOM: QSL-03, QSL-01, QSL-04
Wheeled Vehicle Components (QSL-03) Tracked Combat Vehicle Suspension Components and Padded Cushions (QSL-01, QSL-04)
- Field-testing under actual operating conditions



VIDCO THERMAL SHROUD

Environmental Influence on a Bare Barrel

VIDCO INDUSTRIES LTD.



VIDCO INDUSTRIES LTD.

2 Ha'ofan St.,
Industrial Zone
Holon 5881419, Israel
Tel: 972-3-5570981
Fax: 972-3-5595715
E-mail: ron.zukerman@vishaypg.com



THE PROBLEM

Great efforts and money are invested in installation of fire control systems in modern tanks, in order to increase the probability of hitting enemy targets with the first round, thereby providing the tank with destruction superiority over its enemy. Fire-control systems provide the cannon with its super-elevation angle. This angle is a result of measurements and computer calculations based on data from the

target, from the tank itself and from the environment. The final result (destruction of target), however is heavily influenced by the bending of the cannon's barrel regardless of the precision of the fire-control system. The aiming errors resulting from barrel bending induce changes in the direction of the plane of the barrel's muzzle compared to the line of aiming. The curvature due to bending can reach up to 3/1000 of a radian and is unavoidable

since the barrel is a long metal tube influenced by thermal conditions. Curvature of 3/1000 of a radian is equivalent to an aiming error of 3 meters when a target is located 1000 meters from the cannon. In other words, first-hit probability at 1000 meters is very low. The tube bending, therefore, introduces unpredictable major errors in accuracy and practically cancels out the advantages of modern fire-control systems.



Merkava tank with thermal shroud.

VIDCO THERMAL SHROUD

Protecting the Gun Barrel from the Environmental Influence



THE SOLUTION

VIDCO's thermal shroud reduces the bending of the barrel to a minimum regardless of thermal conditions due to the environment or firing rate and thereby substantially reduces the problems mentioned above. The efficiency, E, of a thermal shroud is expressed as follows:

$E = 100 \times (A-B)/A$, (%), where (A) is the bending of the bare barrel (barrel without thermal shroud) due to environmental and / or firing conditions expressed in thousands of a radian, (B) is the bending of the same barrel but with the thermal shroud attached to it and under the same environmental and / or firing conditions as the bare barrel, also expressed in thousands of a radian.

VIDCO's Thermal Shroud compared to others:

VIDCO's thermal shroud reaches an efficiency of 75% to 80% **under all environmental and firing conditions**; the efficiency of other thermal shrouds under the same conditions is within 30% to 40%. Simply stated, this means that under severe environmental and firing field conditions, the target will be hit within ± 20 to 25 centimeters if it is placed at a distance of 1000 meters from the gun which uses the VIDCO thermal shroud. For other thermal shrouds, this error, at the same distance, will be at best ± 60 to 70 centimeters. Since the error is proportional to distance, it follows that at a 2000-meter target distance, the total bending error for a gun with a VIDCO type shroud will be ± 40 to 50 centimeters, thus still providing for a high first-hit probability. For other

VIDCO INDUSTRIES LTD.



VIDCO INDUSTRIES LTD.

2 Ha'ofan St.,
Industrial Zone
Holon 5881419, Israel
Tel: 972-3-5570981
Fax: 972-3-5595715
E-mail: ron.zukerman@vishaypg.com

shrouds under the same environmental and firing conditions as above, the error will be ± 120 to 140 centimeters, hence quite probably the round will not hit the enemy tank. Therefore, **without an efficient thermal shroud, the fire-control system, even if it is very sophisticated, will not be effective.** VIDCO Industries has over 30 years experience in making Thermal Shrouds. The Israel Defense Forces (I.D.F.) studied the barrel bending problem and examined VIDCO's solution. As a result, the I.D.F. adapted VIDCO's Thermal Shroud for the Merkava tanks as well as for its other tanks (Centurion, M48 and M60 Patton, etc.). In the I.D.F., VIDCO's Thermal Shroud has proven its **efficiency and durability** in many **battle conditions.**

VIDCO's Thermal Shroud can be adapted to any barrel of any tank, according to the customer's requirements.

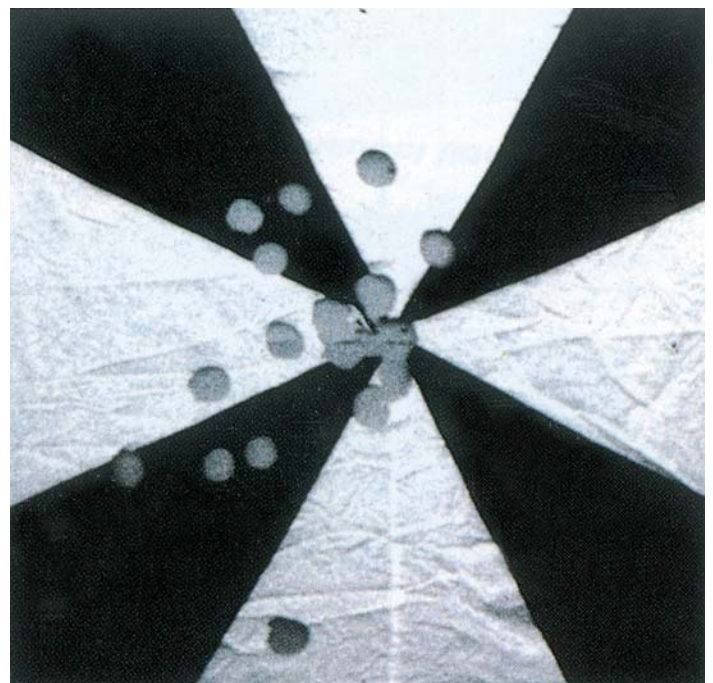
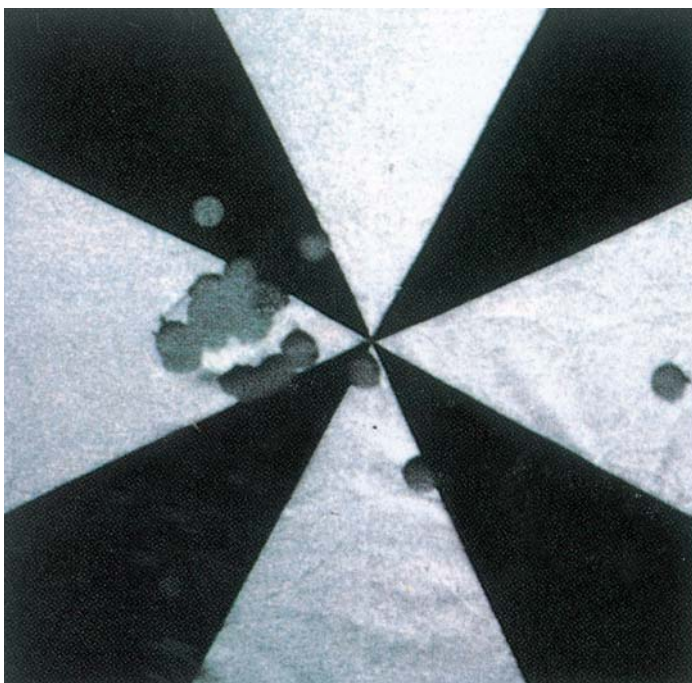

18 rounds, 105 mm ammunition, 1000 m range. Target is 1x1 m.

Suspension Components

Specialize in Metal and Rubber Parts

**TGL SP
INDUSTRIES LTD.**

TGL S.P. INDUSTRIES LTD.

P.O.Box 183
Yokneam 2069203, Israel
Tel: 972-4-9937537
Fax: 972-4-9935546
E-mail: mail@tgl-sp.com
Web Site: www.tgl-sp.com

TGL serves defense industries internationally since 1952, by manufacturing, designing and developing suspension systems for a wide variety of armored vehicles.

TGL fulfills requirements of Armed Forces worldwide, including but not limited to the U.S. Army, NATO and I.D.F.

TGL combines expertise gained from field experience with strong in-house engineering and advance manufacturing capabilities to produce the high quality and sophisticated suspension system items required by its customers.

TGL certified quality management standard ISO 9001:2000 scope: design and manufacture for military and civilian purposes.

List of Suspension System Items:

- Road wheels (Steel & Aluminum)
- Solid Rubber Wheels
- Wear ring
- Sprocket wheel, sprocket carrier
- Support Wheel, Roller
- Idler Wheels
- Hub assembly
- Track Shoe Assembly, Pad Assembly
- Others

Polyurethane products

- Rocket head covers.
- Roller covers.
- Wheel covers.
- Variety of technical products.

Other Rubberized Components:

- Protection armor.
- NBC items.
- Combustible cartridge for 120 mm gun.
- Shrapnel absorbent products.
- Hoses.

List of most Supported Armored Vehicles:

- M-113 Family
- M-1
- M-2
- LVTP-7
- M-60, M-48
- M-109, M-110, M-107
- M-551
- T-72, T-90
- M-9 ACE
- M-88
- Merkava
- Leopard
- M-41
- AMX-13, AMX-30
- BMP Family



OSG ARMOR

Experience - Based Solutions



OSG - ORAN SAFETY GLASS

Kibbutz Palmach Zova
D.N. Harei Yehuda 9087000, Israel
Tel: 972-2-5706109
Fax: 972-73-2752109
E-mail: info@oran.co.il
Web Site: www.osg.co.il

OSG is a leading worldwide developer and producer of bullet resistant, forced entry and blast resistant glass for both the automotive and architectural industries.

OSG's superior product line offers thinner, lighter and more sophisticated solutions which are the culmination of intensive professional R&D programs for the last 30 years, and carried out in close cooperation with the Israeli defence forces and other forces around the world.

Real time data from the battlefield is fed back to the OSG-ARMOR R&D teams and is immediately processed allowing us to offer the most efficient, updated solutions to the soldiers in the field.

OSG has succeeded in defining and deriving optimum solutions to a broad threat spectrum up to the highest levels (STANAG 4, etc).

OSG offers its clients wide-ranging and comprehensive services, including system engineering and complete packages of technical planning for glass, features, frames, gun ports, assembly solutions and more.

From R&D and engineering to full scale production of the glass, frames, assembly and more OSG is one stop in house solution for all of your needs for transparent armor. OSG is fully qualified and willing to collaborate with your engineers when requested in order to provide assistance with engineering, producing, installing and integrating armored glass into all aspects of your projects.

Our two primary production facilities (320,000 sqf total) in Tzuba, Israel are supported by our state of the art (84,000 sqf) US factory in Emporia, Virginia.

Our proven excellence enables us to serve the world's most advanced military forces including the Israeli defence force, the US Army, the French Army, NATO Forces, the German Army, and many more.

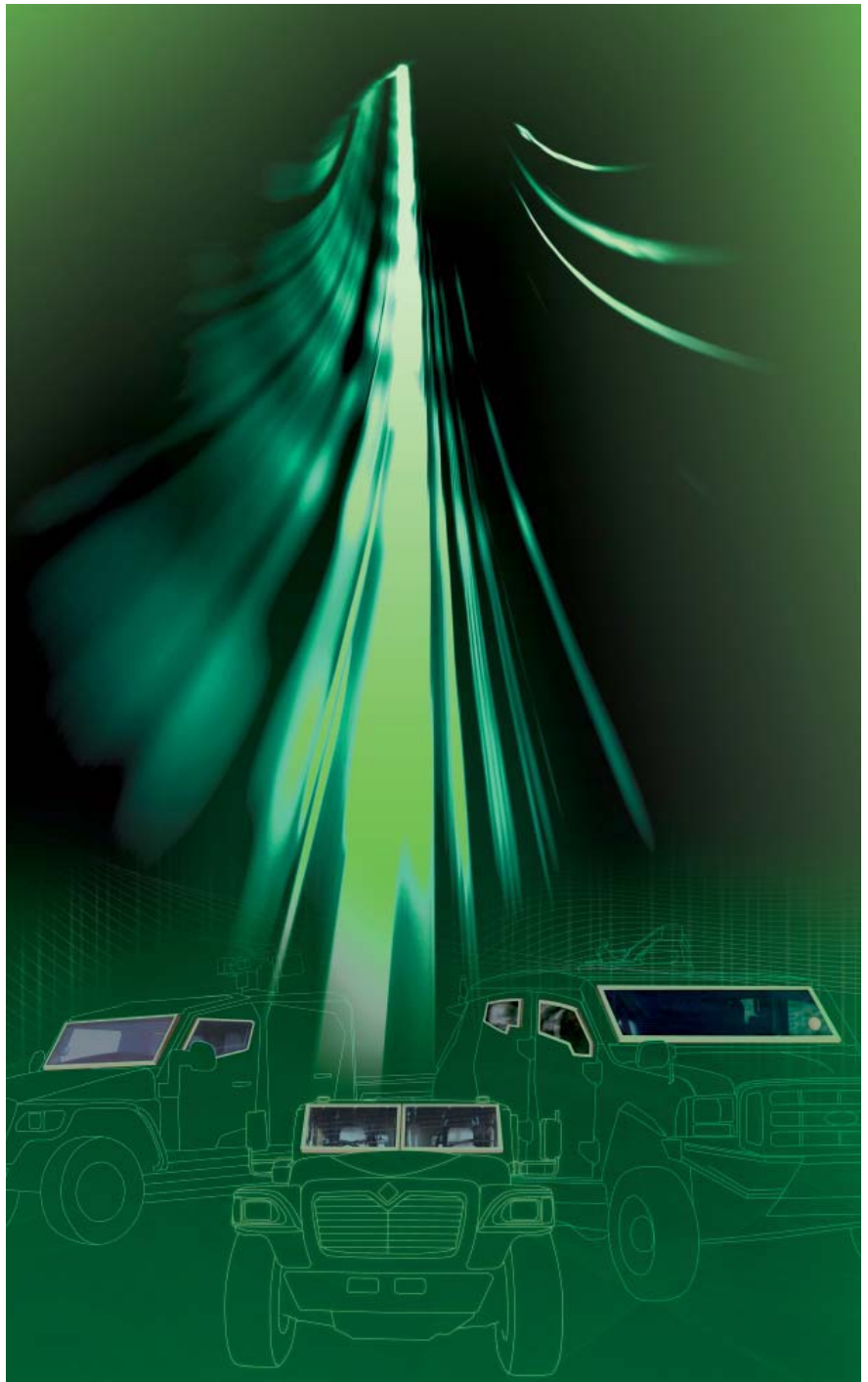

It takes vast experience and continuous innovation to make your safety clear!

BULLET PROOF OBSERVATION TOWERS



MIFRAM LTD.

6 Josef Levi St., P.O.Box 1165
Ind. Zone Kiriat Bialik
Zur Shalom 2711101, Israel
Tel: 972-4-8808800
Fax: 972-4-8745745
E-mail: sales@mifram.com
Web Site: www.miframsecurity.com



Ramgan



Priest



Shark



Mantis

Mifram has accumulated vast professional experience in the development and production of protective structures and barriers. The company is the exclusive manufacturer of several unique bullet proof watch towers and observation structures and defense posts which are designed to protect against the changing threats of our times. The towers and guard posts provide protection to meet the customer's specific defense and security needs.

Sentinel Milspec Observation Tower (PRIEST)

Lightweight observation tower for security and protection missions withstands harsh environmental conditions (sand, dust, corrosion, heat).

RAMGAN Observation Tower

Bullet-proof observation tower meets NIJ Types III and IV standards plus mortar protection, and comes with machine gun stands, shooting slits, and a protected observation porch.

Mantis Autonomous Self-Rising Mobile Watch Tower

World's first truck-borne fast-response observation tower, suitable for a range of security applications (C² missions, border control, special ops) and civilian uses (mass events, major sports events, crowd control).

Features

- Autonomous self-rising bullet-proof watch tower
- Bulletproof - 5.56SS109/M16 7.62M80/AK47 AP
- World's first truck-borne fast-response observation tower
- Ideal operational solution to quick response missions
- Can be made operational within 30 minutes
- All weather conditions
- Standard container size

Shark Rapid Response Sniper Post

Highly versatile rapid response observation and sniper tower offering 300 degree visibility and 270 degree firing angle. Designed for use in airports and other sensitive locations.

Features

- Rapid response observation and sniper tower
- Highly versatile functionality
- Robust construction for constant use
- 300 degree visibility
- 270 degree firing angle
- Canopy opens in 1.5 seconds
- Searchlight is activated automatically when unit in use
- Table/shelf runs round the circumference of the cabin
- AC unit
- 25W light installed at floor level
- Thermally insulated cabin (when closed)
- Windows close slowly

MOBILE BALLISTIC SHELTERS



MIFRAM LTD.

6 Josef Levi St., P.O.Box 1165
 Ind. Zone Kiriya Bialik
 Zur Shalom 2711101, Israel
 Tel: 972-4-8808800
 Fax: 972-4-8745745
 E-mail: sales@mifram.com
 Web Site: www.miframsecurity.com



Gabriel Mobile NBC Shelter

Fully-protected autonomous C² shelter. Designed for security and emergency authorities, offers battle-proven protection for up to 20 people against conventional threats and all known types of chemical and biological warfare agents.

MSC Multi-Purpose Security Container/Shelter

Bullet proof and blast proof versatile 20' container that withstands NIJ Type III threats, ideal as armory, cashier's office, mobile control post, mobile first-aid post and accommodation unit.

MBS Modular Ballistic Shelter

Designed for use in open public spaces, attached to buildings and homes, or mounted on a truck, this mobile shelter provides ballistic protection of 5.56/7.62 and against direct impact from a light missile or rocket.

Turtle

Multi-purpose (personnel, equipment) rapid fortification kit for constructing guard posts for personnel and equipment, meets NIJ IV standard for the ballistic resistance of personal body armor.

Phalanx

Quickly assembled multi-purpose rapid fortification kit for constructing a protective wall in fluid combat conditions. The wall protection elements meet the NIJ IV standard for the ballistic resistance of personal body armor.

Sky Guard

Roof and housing protection system that meets ballistics threats from 120-160 mm mortars and light missiles. Ideal for civilian housing, federal buildings, military bases, border installations, and key infrastructure facilities.

IMPS - Indoor Modular Protection System

Unique patented indoor protection solution against the threat of direct impact from high trajectory weapons such as Quassam II and Katyusha 122mm rockets. Suitable for apartments, houses, offices and other facilities.



TURTLE

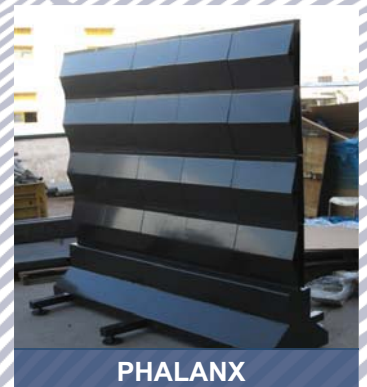

PHALANX



GABRIEL



MBS



MSC



IMPS



SKY GUARD



ARMORED VEHICLES METAL EXPERTS

PALBAM Defense Specializes in advanced design and manufacturing technologies for the defense and aerospace industries.

Our solid reputation is built on over 40 years of customer satisfaction.



PALBAM 2008 (A.C.S.)

En Harod Ihud 1896000, Israel
Tel: 972-4-6530700
Fax: 972-4-6531904
E-mail: info@palbam.co.il
Web Site: www.palbam-defense.com

Fuel and Water Tanks Solutions

Palbam is the contractor for the fuel and water tanks of MERKAVA tanks, NAMER and ACHZARIT APC's for the last 25 years.

Palbam design and manufacture fuel and water tanks according to the space, location, damping, and other demands of the Armored Vehicle.

When a new or upgraded tank or wheeled armored vehicle program is on the board, Palbam is the supplier you can trust for the fuel and water tanks.

Palbam integrates special techniques for bullet protection for its water and fuel tanks.

Custom Components for Armored Fighting Vehicles

Palbam provide most complex components for systems used in AFV, including the design and manufacturing of water tanks, holders for fuel pump systems installed on a number of AFVs, and other metal solutions and components for armored vehicles.

Armored Plating

Palbam provides unique solutions for armored plating utilizing several technologies to suit complicated client's requirements. Palbam's armored plating includes special protectors, as well as other technologies.

Palbam has manufactured plating for the Bradley fighting vehicle, the AAV 7 and the Storm APCs processing Titanium sheets.

AS 9100 and ISO 9000 certified company.

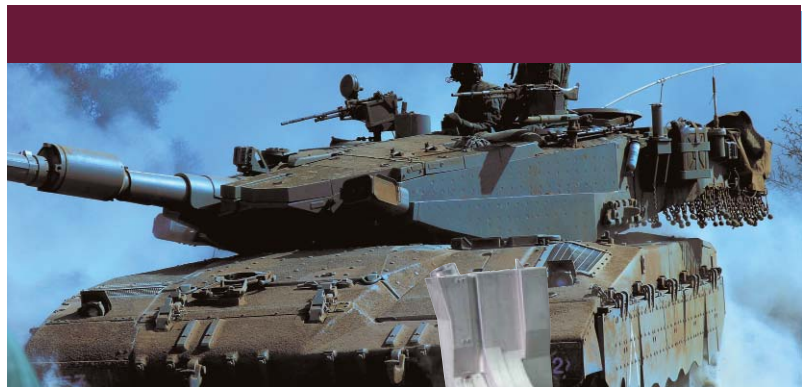

MERKAVA Fuel Tank



PALBAM's armored planting is used by armored vehicles all over the world, such as the AAV 7 and Storm APCs, as well as the Bradley
PALBAM's armored planting can be made from a variety of alloys, including steel.

SURVIVABILITY AND ARMOR INTEGRATED SOLUTIONS



PLASAN

Kibbutz Sasa M.P.
Merom Hagalil 1387000, Israel
Tel: 972-4-6809000
Fax: 972-4-6809001
E-mail: plasan@plasan.com
Web Site: www.plasan.com

*Ongoing Commitment
New Capabilities*



Plasan is an international company engaged in the design, development, and manufacture of state-of-the-art, lightweight, ballistic armor protection products and integrated survivability systems. Plasan provides customized survivability solutions for tactical wheeled vehicles, aircraft, naval platforms, civilian armored vehicles and personal protection for military, police and law enforcement applications.

Plasan combines innovative survivability engineering and design with advanced armor materials' development. Plasan's unique development process is based on continuous dialogue between the ballistic R&D and the Design & Prototyping departments. This integration between the different disciplines enables us to give the

defense forces the optimized survivability system for a range of military and law enforcement purposes. Plasan combines computer-generated analysis and simulations with real-time calibration and ballistic test data. The effective combination of test and simulation data enables improved simulation accuracy and performance, resulting in the optimal survivability solution.

Plasan's success is rooted in the combination of innovation, a high level of commitment and a full range of in-house capabilities. As a preferred supplier to the Israel Defense Forces and an approved supplier to ministries of defense around the world, Plasan's solutions have been tested and approved by dozens of armed forces in the most demanding battlefields.

POLYCARD TECHNOLOGIES LTD.



POLYCARD TECHNOLOGIES LTD.
Quality Tailor Made Solutions

POLYCARD TECHNOLOGIES LTD.

P.O.Box 8
Shlomi 2283201, Israel
Tel: 972-4-9858088
Fax: 972-4-9858084
E-mail: polycart@polycartt.com
Web Site: www.polycart.co.il



Polycart Technologies LTD. specializes in the design and manufacturing of various tailor made military and HLS applications. The company offers wide range of solutions to suit our customer's specific requirements, including the designs of new models, or modifying and improving existing models. Products range covers areas like protective cases, anti-riots shields, shooting targets, rescue systems, weapon projects all under one roof.

Heavy Duty Cases

Polycart heavy duty cases are designed to withstand the most severe conditions while giving the maximum protection to the most sensitive equipment. The impact resistant case walls are made from high molecular weight polyethylene (HMWPE) and are also resistant to oil, acids and solvents. These products are water tight and dust proof. Design of inner foaming is available and catered to product's shape and protection needs.

Light Duty Cases

Polycart light duty cases offer the highest quality in wide range of sizes. The cases are made of ABS, Polycarbonate, PS & PA+Glass. Light duty cases serve both military and civil applications. For civil applications there is a vast use within various types of professions such as physicians, technicians, sales people, inspectors and alike.

Combat Packs and Fluorescent Vests

A combination of textile and plastics brings different material into one product utilizing weight benefits allowing faster and easy move.

Weapon Accessories

A new line of products made of exotic plastic materials. The use of fiberglass provides a light weight and firm products such as magazines, rifle handles etc..



Type of Business

Packaging, Industry, Safety and Security,
Equipment and vacuum forming

Seeking

Joint Venture
International Distribution and representation
Prototype Development, engineering and
re-engineering Technological cooperation

S.W.A.T.

Equipment & Training



TAR IDEAL CONCEPTS LTD.

5 Ma'avar Yabok St.,
Tel - Aviv 6744007, Israel
Tel: 972-3-6914564, 6914565
Fax: 972-3-6914567
E-mail: tar@tarideal.com
Web Site: www.tarideal.com

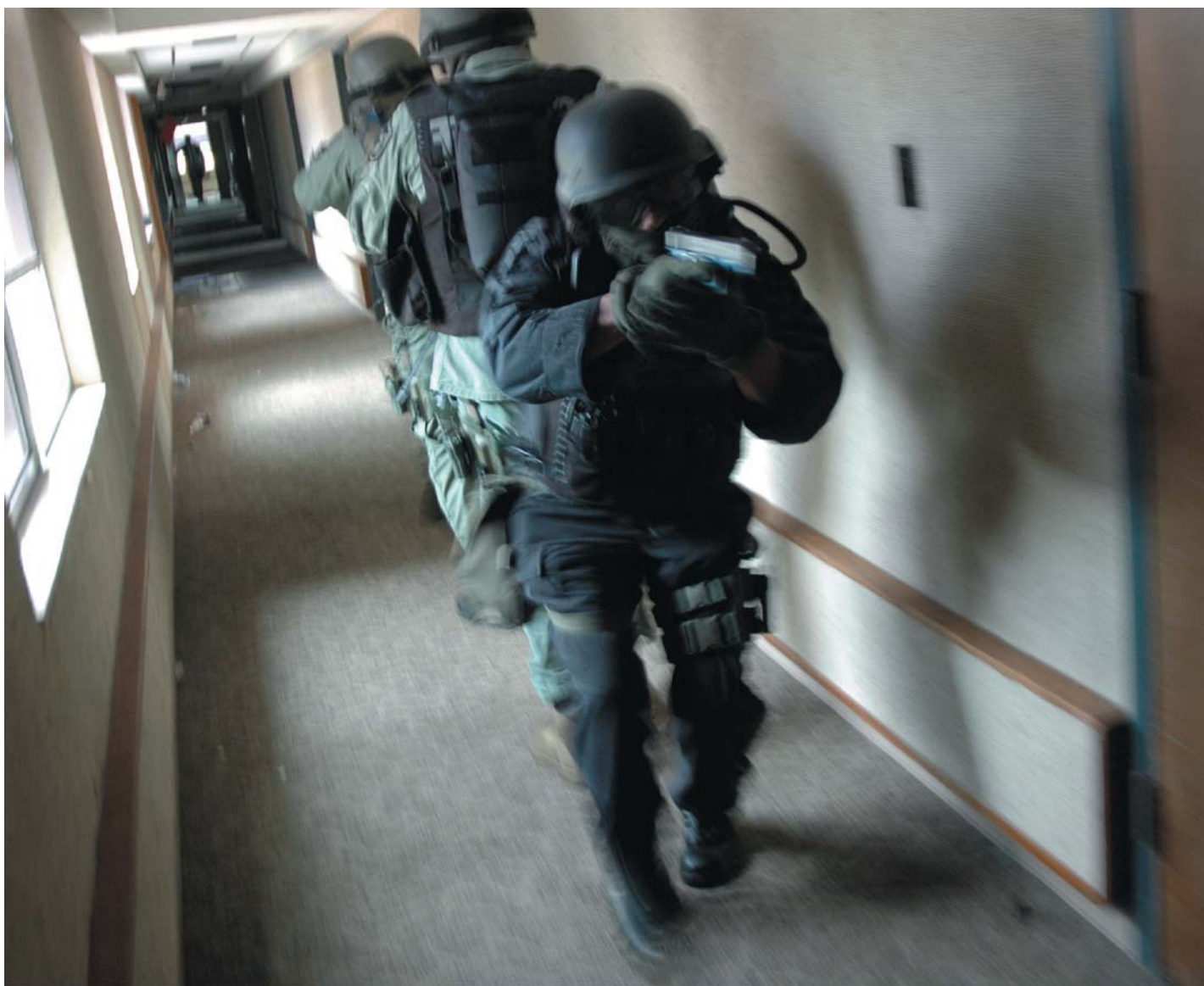

**World Leader in Supplying
S.W.A.T. Equipment and Training**



ARMOR PROTECTION



Rafael's Add On Armor Products

Rafael is a major and unique armor company dealing with all protection technologies: passive, reactive, hybrid and Active Protection systems. Rafael conducts development, design, integration and production of the most advanced armor systems to enhance the protection level of armored vehicles.

Rafael uses its extensive past experience to provide high level of protection, lightweight and low cost enhancements integrated on all types of combat platforms. All armor products are modular and capable to protect combat vehicles from a broad range of threats such as small and medium kinetic energy (KE) armor piercing (AP) projectiles, high energy anti-tank Shaped Charges (SC), high speed fragments of artillery and Improvised Explosive Devices (IEDs) and Explosive Forming Projectiles (EFPs).

The performance and specifications of the systems meet the protection requirements and standards of the Israel Defense Forces (IDF), the US Army, USMC and NATO force standards. The systems have been tested, qualified and approved for application by the customers worldwide and are combat proven. Rafael had eight different add-on armor systems, served in the Iraqi / Afghan theater with the coalition forces.

Reactive Armor

Rafael is the world leading company in the application of the reactive armor technology. It was the first company to develop, design and integrates reactive armor systems on combat vehicles. The reactive armor is the most effective add-on armor technology to protect Armored Fighting Vehicles (AFV's), Armored Personal Carriers (APC's) and Main Battle Tanks (MBT's) against shaped charge threats of Rockets and ATGMs.

For light armored vehicles, Rafael developed Hybrid armor which combines reactive and passive elements to provide complete, 360 degrees protection against anti-tank rockets, medium KE AP projectiles and high speed fragments. Upgraded multi-threat hybrid armor, Multi-Threat Armor Protection (MTAP) system has recently been developed to defeat also EFPs and IEDs.

Rafael's reactive and hybrid system have been fitted to many combat vehicles worldwide. In the US, Rafael, together with its partner General Dynamics ATP, integrated produced and supplied reactive / hybrid armor systems for the Bradley AFV and the Stryker vehicles.



M60



Bradley



M113

RAFAEL
ADVANCED DEFENSE SYSTEMS
 P.O.Box 2250 (19)
 Haifa 3102102, Israel
 Tel: 972-4-8794714
 Fax: 972-4-8794657
 E-mail: intl-mkt@rafael.co.il
 Web Site: www.rafael.co.il

Passive Armor

Rafael has developed and applied various passive armor technologies to protect combat vehicles, including ceramic, metallic, shaped, laminated and perforated technologies. The passive add-on armor is modular, lightweight and easily installed by the crew. It is maintenance-free and combat-proven.

The systems provide protection against 14.5 mm AP projectiles, high speed fragments of artillery shells and IED (STANAG 4569, Level 4 and beyond). Rafael has recently developed passive add-on lightweight, effective modular armor to defeat EFPs.

Rafael's armor systems are in use by the IDF, USMC, Italian Army, New Zealand Army, Czech Army and others. They are combat proven and received excellent reports about their performance in the Operation Iraqi Freedom and peace keeping missions worldwide. Rafael's Enhanced Appliqué Armor Kit (EAAK) add-on armor system was selected by the USMC as a sole source, for the AAV7 amphibious APC.

RAFAEL's Reactive Armor installed on the US Bradley AFV (left) and Passive Armor installed on the USMC AAV7 APC (right).



AAV7

M113

Rosomak

■ **Certificates from the US Army and USMC to Rafael for its reactive and passive armor systems, installed on the Bradley, Stryker and AAV7** ■



EoSHIELD

Vehicle Infra-Red Counter-Measure System (VIRCM) for Protection Against Anti-Tank Ground Missiles



ELBIT SYSTEMS
ELECTRO-OPTICS - ELOP LTD.
P.O.Box 1165, Rehovot 7611101, Israel
Tel: 972-8-9386211
Fax: 972-8-9386237
E-mail: eo@elbitsystems.com
Web Site: www.elbitsystems.com/elop



Main Advantages & Features:

- Multiple, simultaneous ATGM jamming
- 360° platform protection
- Low-profile, low-signature
- Adaptable to a variety of combat vehicles
- Automatic operation without crew intervention
- High system reliability

Platforms:

- AFVs and MBTs
- Helicopters
- Maritime vessels

Applications:

- Interface with a missile warning system
- Integration with ATGM hard-kill solution
- Full soft-kill solution

Technical Data:

Coverage:	360° x 23°
Power:	28VDC, MIL-STD 1275A(AT)
Power consumption:	2.5 kW (omni-directional coverage)
Weight:	35 kg x 2 units (omni-directional coverage)
Dimensions (cm):	29 x 41 x 41 (H x W x D)
MTBF:	> 4,000 Hours
Environmental conditions:	MIL-STD-461D, MIL-STD-810F

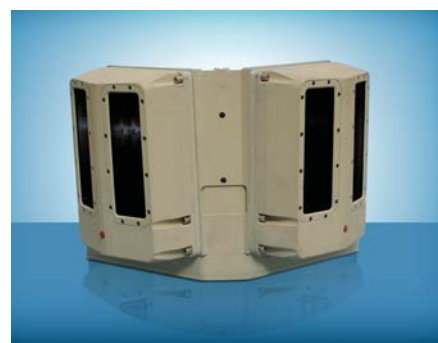

TACTICAL RADARS FOR FORCE AND BORDER PROTECTION

The Ultimate Combat Threat Management



RADA Electronic Industries LTD.

P.O.Box 8606
7 Giborei Israel Blvd.,
Netanya 4250407, Israel
Tel: 972-9-892-1111
Fax: 972-9-885-5885
E-mail: mrkt@rada.com
Web Site: www.rada.com



RADA's Software Defined tactical radars enable advanced force and border protection solutions. These Pulse-Doppler, multi-mission, AESA radars demonstrate extremely wide range of target velocity detection, and are suited for detection and management of all classes of hostile fire and for aerial and perimeter surveillance.

RADA offers two radars hardware platforms: the Compact Hemispheric Radar (CHR), designed for combat vehicles and short-range protection applications; and the Multi mission Hemispheric Radar (MHR), designed for force and border protection applications. Both platforms demonstrate very high reliability and excellent performance-to-price ratio.



The CHR Family:

- RPS-10: Radar Sensors System for Active Protection Systems (APS)
- RPS-15: Hostile Fire Detection System for Combat Vehicles



The MHR Family:

- RPS-40: Combat Threat Management (Hostile Fire Detection)
- RPS-42: Tactical Air Surveillance
- RHS-44: Surface and Air Border Intrusion Management

FORCE PROTECTION – ACTIVE PROTECTION



TROPHY – Situational Awareness and Active Protection Systems

The Trophy is a situational awareness and active protection hard kill system that operates in three major stages: Threat detection and threat tracking followed by hard kill countermeasure (Multiple Explosive Formed Penetrators – MEFP) activation and threat neutralization. The neutralization process takes place only if the threat is about to hit the platform.

Trophy-HV

The Trophy was declared operational by the IDF in August 2009 and is currently in full production. Merkava 4 tanks integrated with Trophy active protection systems are presently being deployed in combat areas along Israel's borders.

Exceptional Capabilities

- 360° protection, while permitting sectors of the vehicle-mounted system to be rendered inactive when necessary for the protection of troops on the ground
- 360° situational awareness by detecting all incoming threats and identifying their launch position
- Extremely high elevation protection
- Neutralizes threats fired from very short range
- Neutralizes simultaneous threats arriving from one or more directions
- Minimum collateral damage
- Suitable for multiple platforms
- High kill probability while static or on the move
- Reduces platform weight

The Trophy system is adaptable to any combat platform. Once a platform is chosen, a short trade study is completed to work out any integration issues that may arise. Numerous elements are taken into consideration for each vehicle variant or type. For vehicles with relatively basic or light armor, e.g. the Stryker, the Trophy provides full protection against all types of RPG (as well as other threats) due to the fact that the Trophy destroys these types of threats without detonation.

Currently, the full Trophy HV system weighs 800kg. Since space and weight will continue to be major issues on combat platforms, not only for current forces, but also for new vehicle programs, i.e. FCS / FRES, great efforts to miniaturize the electronics of the Trophy have been made.



RAFAEL
ADVANCED DEFENSE SYSTEMS

P.O.Box 2250 (19)
Haifa 3102102, Israel
Tel: 972-4-8794714
Fax: 972-4-8794657
E-mail: intl-mkt@rafael.co.il
Web Site: www.rafael.co.il

■ **The result is additional systems for lighter vehicles:**

Trophy-MV

The Trophy-MV offers the same hard kill capabilities as the Trophy-HV and includes built-in soft kill capabilities as well. The Trophy-MV (previously Trophy II) is at TRL 7 and the first prototype is currently undergoing enhanced field testing. Trophy-MV a 450kg APS, for light - and medium-weight (10-30 ton) vehicles.

Trophy-LV

This active protection hard kill system for light armored vehicles utilizes the same superior operating principles as the Trophy-HV and Trophy-MV at a fraction of the weight. Trophy-LV's high kill probability against advanced threats, including the most sophisticated shoulder-launched AT rocket propelled grenades, makes it a significant force-multiplier at shorter ranges on the modern battlefield.

The Trophy-LV's dimensions are specially designed for easy integration and installation onto smaller platforms without impairing system performance. This ensures 360° protection including the vehicle's windows and doors with minimal risk of collateral damage. The Trophy-LV is an all-round efficient, affordable, and cost-effective solution that is currently undergoing field testing in a variety of operational scenarios.

Operational Concept

- Radar identifies and tracks incoming threat/s and delivers the exact threat launching point to a battle management system or weapon station
- The computer identifies the threat, determines whether it will hit the vehicle, and if so
- A ballistic cover opens
- A countermeasure head slews to the proper location
- The computer continues to track, acquire, and plot the best intercept solution
- The countermeasure is launched and neutralizes the threat



The Trophy systems have a very high kill probability and testing has shown them to be successful against all known CE threats (RPG, ATGM, tank-fired CE, etc.) The systems' average collateral damage is estimated at a <1% chance of a dismounted soldier being injured by Trophy or an incoming threat.

HAGOR INDUSTRIES LTD.

- HUMAN ENGINEERING
- ADVANCED DEVELOPMENT
- TOP QUALITY
- RELIABILITY



MILITARY EQUIPMENT MANUFACTURING

HAGOR INDUSTRIES LTD.

P.O.Box 3211 Kiryat-Ariye
Petach-Tikva 4951601, Israel
Tel: 972-3-9248990
Fax: 972-3-9243996
E-mail: info@hagor.co.il
Web Site: www.hagor.com

PROFILE:

HAGOR was founded in 1952 and HAGOR Industries today is a leading supplier of military equipment to the Israeli defense forces, the Israeli police and anti terror units both domestically and internationally.

HAGOR has experience and the expertise in the manufacturing of every item in the field and manufacture according to customer specifications and requirements.

LINE OF PRODUCTS:

PROTECTIVE BULLETPROOF VESTS: HAGOR produce numerous models of ballistic vests with protection levels according to customer requirements, and N.I.J. standards.

Our products are manufactured with the latest high tech solutions and raw materials.

COMBAT HARNES: Single-unit combat harness distributes the weight of combat fighting gear proportionally over the body, providing comfort and greater mobility with maximum load.

PERSONAL GEAR: Kitbags, rucksacks, field cots, sleeping bags ,etc.

MILITARY TENTS: From personal tents up to camp tents, giant tents, Hospital and dining room tents etc.

VERSATILE COVERING: To suit all different types of vehicles, weapon Systems, cannons, tanks, jeeps etc.



Personal gear



Combat harness



HBA- 2042

HPV- 1540

HPV- 1642

SAYAR

ISRAGOR PROTECTIVE GEAR & SYSTEMS



ISRAGOR PROTECTIVE GEAR & SYSTEMS LTD.

3 Hagesher St.,
Hod-Hasharon 4526603, Israel
Tel: 972-9-7493105
Mobile: 972-50-3227997
Fax: 972-9-7493834
E-mail: isragor@zahav.net.il

ISRAGOR Ltd has become a leader in development, manufacturing and marketing Protective vests due to a synergy of advantages including practical Experience and the utilization of development and manufacturing technologies.

ISRAGOR utilizes the most advanced forms of ballistic materials.

ISRAGOR products are custom made, adding Value to the product, relative to its price.

ISRAGOR has developed expertise in the manufacturing of protective vests for V.I.P. anti terror, seals, s.w.a.t. teams paratroops from level I up to IV.

ISRAGOR manufactures its products in Israel in accordance with the standards stipulated by the I.D.F yet has the flexibility to meet customer specifications.

ISRAGOR manufactures military gear such as: battle vests, Bags, Tents, dry storages systems etc... and facilitates all stages Involved in supplying them.

ISRAGOR has the power to be your liaison to the Israeli military industries as well.

For any of your requirements contact us.

We keep a supply of tents for immediate shipment, in case of emergencies such as floods, earthquakes etc.



Gendarme Vest



Tactical Anti Terror Vest

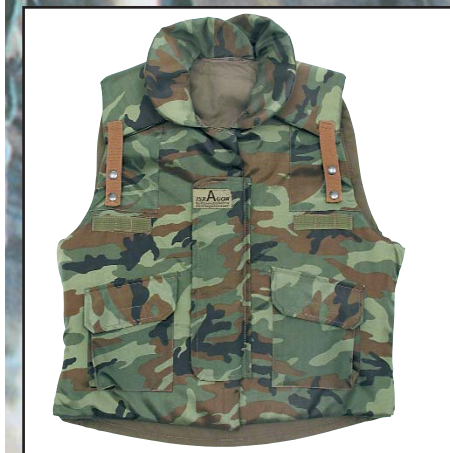

Pasgat Vest



V.I.P Vest



Combat Harness



Police Vest

Your duty is our mission



www.ispraltd.com



Founded in 1969, ISPRAs is a global leader in developing, manufacturing and marketing of Less Lethal devices for riot control, crowd management, anti terror equipment and police gear.



ISPRAs LESS LETHAL

By combining our technical know-how with practical field experience, ISPRAs manages to deliver smart Less Lethal solutions to its clients, helping them deal with the growing challenges of crowd management. ISPRAs's Innovative product line has kept us in the forefront of Less Lethal ammunition throughout the years. We are developing today smart solutions for the problems of tomorrow.





ISPR
Israel Product Research Co. LTD.
20A Galgaley Haplada St.,
P.O.Box 2086
Herzelya 4672220, Israel
Tel: 972-9-9555464
Fax: 972-9-9559146
E-mail: ispra@netvision.net.il
Web Site: www.ispraltd.com

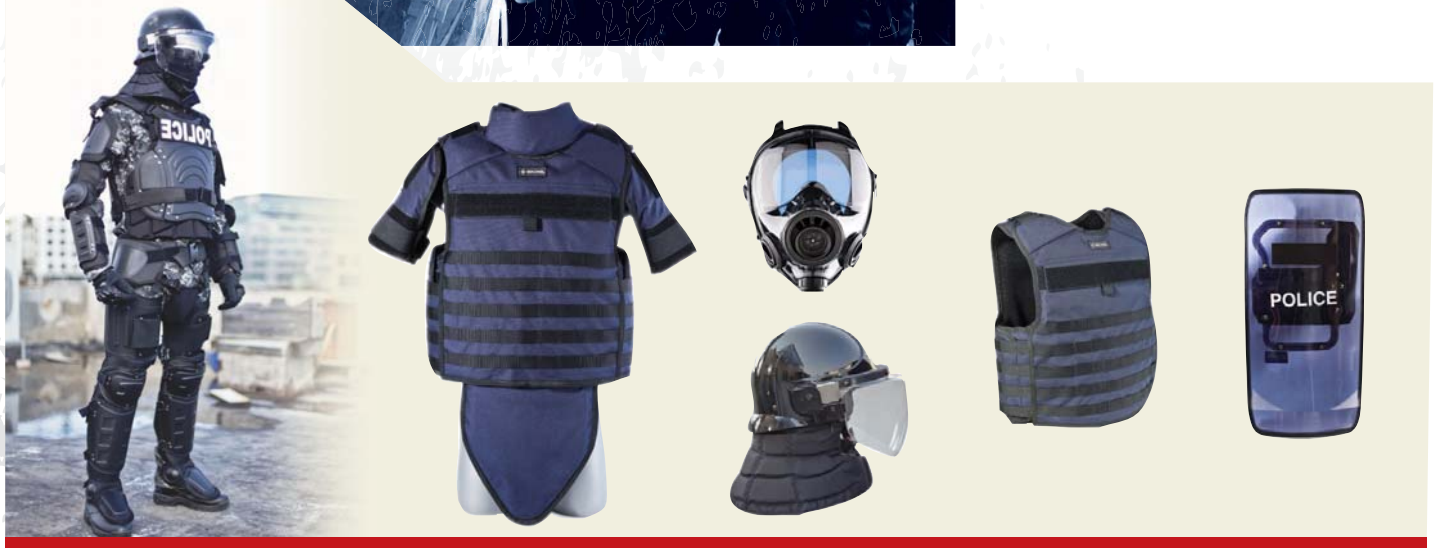

Sentinel Tactical Gear provides top-quality equipment for law enforcement, military and homeland security agencies. Providing them with the tools to complete their missions safely and effectively.

Sentinel Tactical Gear product line includes a full range of police duty gear, protective gear and tactical equipment. These products are of the highest quality in terms of materials, construction and durability. Sentinel Tactical Gear products are tested and approved by our product development team with collaboration and field testing by our security force partners.

LIOR TEXTILE INDUSTRIES LTD.

Protecting People™ since 1976



LIOR TEXTILE INDUSTRIES LTD.

P.O.Box 11, Dora Ind. Zone
Shlomi 2283201, Israel
Tel: 972-4-9808815
Fax: 972-4-9808816
E-mail: info@lior-protective.com
Web Site: www.lior-protective.com
www.concordusa-jackets.com



For the last 35 years, **LIOR** has been a licensed vendor of the I.D.F, Israel Police & special anti-terror units.

Areas of Activity

Development, Design, Manufacture & global marketing of protective products:

- Body armor for the army, police, SWAT & jackets for civil & V.I.P use
- Fire brigade suits, Nomex pilot & tanker coveralls, underwear
- N.B.C. protective suits for biological & chemical threats
- Work wear outdoor clothing: including reflective rain suits
- Extended Cold Weather Clothing System (ECWCS)
- Ballistic shields & plates
- Ballistic helmets
- E.O.D - Bomb Suits
- Tactical Vests
- Dry storage solutions
- Inflatable tent & stretcher
- Backpacks



Quality Assurance:

- ISO 9001:2008
- "Level A" of the Israeli MOD

Standards:

NIJ Standard, HOSDB
NFPA, CGSB, NSN, ASTM,
IDF Mil-spec, US Mil-std.



MAROM DOLPHIN

Dedicated to Highest Standards

www.MAROM-DOLPHIN.com



MAROM DOLPHIN LTD.

Industrial Zone Alon Tavor
P.O.Box 1126
Afula 1800001, Israel
Tel: 972-4-6400797
Fax: 972-4-6403074
E-mail: info@marom-dolphin.com

Marom Dolphin Ltd., founded in 1993 develops, manufactures and markets top quality personal military supplies for armed forces, police units, security services and civilians around the world.

Each of the founders of **Marom Dolphin Ltd.** comes from an army combat background having served in different fighting units in the Israeli Defense Forces (IDF). Together, we are a dynamic and flexible team. Combining our knowledge and experience, we have dedicated ourselves to developing safe, ergonomic products essential for any and all security tasks. The wide range of military and security products are of the highest quality and meet the demands of all service standards.

Our products are manufactured and tested in accordance with the Quality Assurance standards of military forces world wide, as well as in strict adherence to ISO 9002 Standards, awarding them worldwide recognition for their high quality and durability.

Among our customers are military, paramilitary, law enforcement and security organizations across the globe. We are the main authorized supplier of tactical and bulletproof vests to the Israeli Military and to the Israeli Ministry of Defense, as well as many other customers, world wide.

Marom Dolphin Ltd. maintains the highest manufacturing standards in strict adherence to ISO 9001:2008 international standards.

A large photograph of three soldiers in desert camouflage uniforms and helmets, equipped with tactical gear and rifles, standing in a doorway. The Marom Dolphin logo is overlaid on the image. To the left of the main image is a vertical column of five smaller inset images, each showing a different piece of military equipment: a tan tactical bag, a bulletproof vest, a tan messenger bag, a tan pouch, and a black tactical case.

Mission of Confidence

www.marom-dolphin.com

MYFORM

Defense • Define & Develop

- **Body Armor and Carrying Vest**
- **Concealable Protection**
- **Personal Protection Gear for NBC**
- **Riot Control Suits**

MYFORM

DEFENSE • DEFINE & DEVELOP

MYFORM LTD.

9 Lincoln St., P.O.Box 14233

Tel Aviv 6713402, Israel

Tel: 972-3-6244488

Fax: 972-3-6244499

E-mail: myform@myform.co.il

Web Site: www.myform-security.com

MYFORM Defense Define & Develop was established at 1996 and is one of the leading companies in Israel for Unique solutions of personal protections gear for combatants, Defense Force personnel and VIP's, as well as Chemical protective Clothing, anti-riot equipment and dray storage solutions.

MYFORM management members have all served in the Israeli IDF special elite units and in Senior positions in various governmental Agencies, and have worked in the most challenging security environments around the world and put this experience and vast practical know-how in developing, manufacturing and customizing its products.

MYFORM is well known for its tailor-made solutions and developments, Manufactured at our factory in Northern Israel, and is an authorized supplier of the IDF, Israeli Police and Prison Authorities and governmental Agencies.

MYFORM provides solutions that are compatible with international quality standards, and is certified by the Institute of Standards. (ISO 9001:2008).



NOGA EINAT ARMY DIVISION



NOGA-EINAT SHOE INDUSTRIES LTD.

Kibbutz Givat Hashlosha 4880000, Israel

Tel: 972-3-9030150

Fax: 972-3-9030151

E-mail: info@nogaeinat.co.il

Web Site: www.nogaeinat.co.il

Since 1950 the major supplier to the I.D.F. Noga-Einat Shoe Industries is an Israeli manufacturer and supplier of military, safety and working shoes, serving both local and foreign markets.

Product lines include: army boots and shoes, products for unusual conditions and special forces, police boots and shoes, and boots for anti-terror units and anti-rioting units.

Drawing on its close working relationship with the R&D unit of the Israeli Defense Forces, Noga-Einat engineers constantly strive to design better, more comfortable, and more durable footwear. In addition, Noga-Einat also offers customized products to meet special requirements of customers.

Noga-Einat products are manufactured using the most durable, top-quality materials available.

Shoes and boots are typically composed of: leather/canvas uppers; non-woven, anti-perspiration leather insoles; and nitrite rubber/polyurethane soles. Most models offer optional fittings such as double-density soles, special removable insoles, built-in air cushioning, fur lining, etc.

Noga-Einat products meet or surpass the requirements of the IDF and other armies. The company has earned ISO 9001:2008 certification.

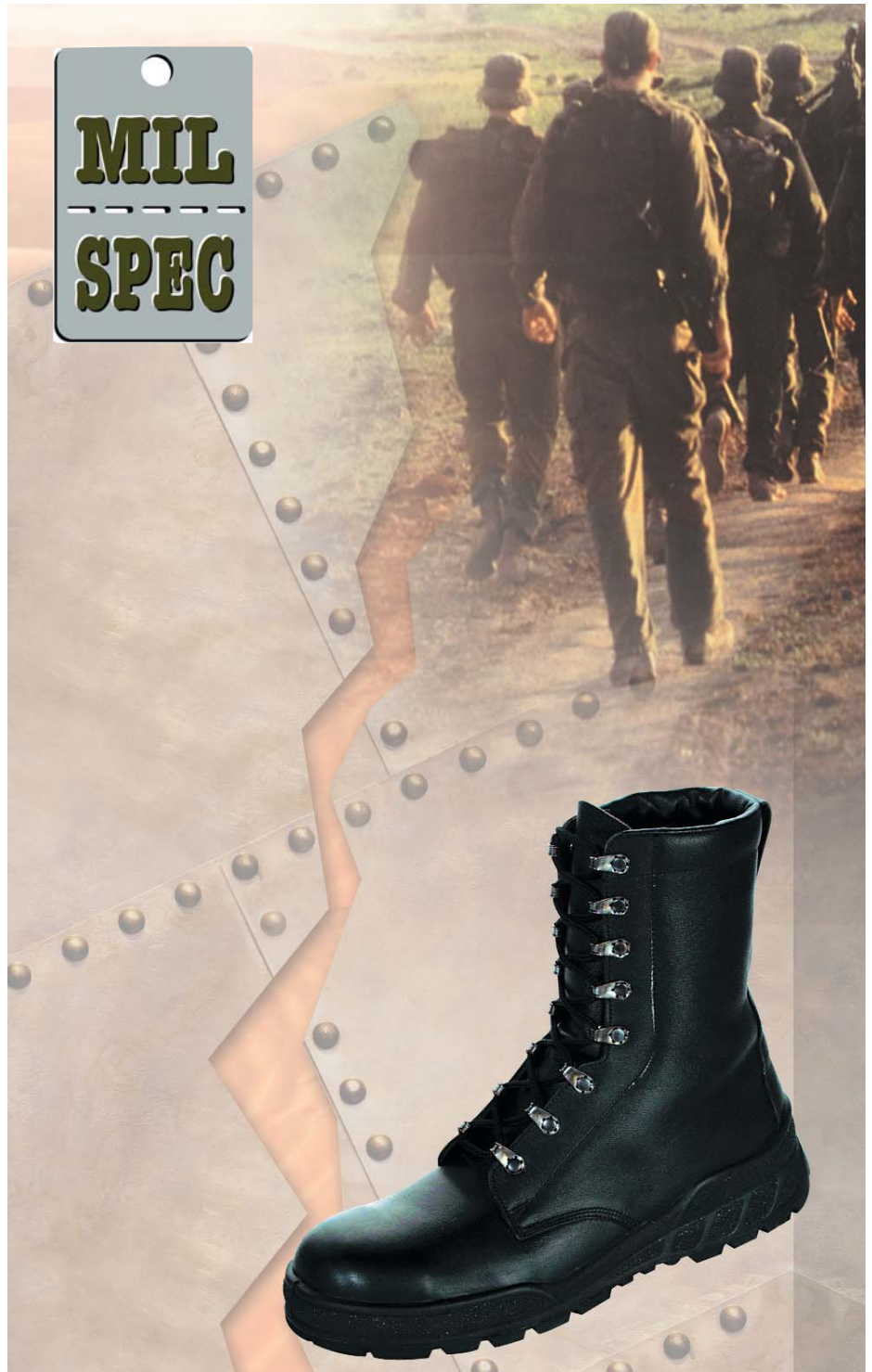

PERSONAL PROTECTIVE GEAR



RAFAEL ADVANCED DEFENSE SYSTEMS

P.O.Box 2250 (19)
Haifa 3102102, Israel
Tel: 972-4-8794714
Fax: 972-4-8794657
E-mail: intl-mkt@rafael.co.il
Web Site: www.rafael.co.il

Ceramic Ballistic Protection

RAFAEL has developed a unique cost-effective technology for manufacturing boron carbide products for ballistic protection, offering high performance, lightweight, multi-hit capability properties.

Boron carbide combines high ballistic efficiency with high mass efficiency, and therefore suits all applications in which a low weight, high ballistic protection is required. (Personal body armor, armor for helicopters, airplanes, vehicles, military posts etc).

RAFAEL's patented technology is based on pressure less sintering. This process provides lower production costs (low than hot press technology), thus offering a combination of high performance, light weight, flexibility in shape, design and low cost.

RAFAEL's infrastructure, with its high in-house production capacity is able to supply bare ceramic products in large quantities.

RAFAEL can supply the boron carbide products in various shapes: Flat tiles, multi-curve tiles, hexagonal tiles of various sizes and others.

RAFAEL's boron carbide products provide NIJ level IV protection and withstand all requirements of E-SAPI.



EPS 21™

THE NEW GENERATION IN EYE PROTECTION

Advanced combat goggles for ballistic, sun, wind, dust and laser eye protection



SHALON CHEMICAL INDUSTRIES LTD.

Head Office: 2 Kaplan St., 10th Floor,
Tel-Aviv 6473403 Israel
Tel: 972-3-6957191, Fax: 972-3-6957980
Plant: Kiryat Gat 8202501, Israel
Tel: 972-8-6879111, Fax: 972-8-6811115
E-mail: shalon@shalon.co.il
Web Site: www.shalon.co.il

Shalon Chemical Industries, world leader in designing and manufacturing of personal protective equipment, has developed new combat goggles

 EPS-21™, which are approved by the Israel Defense Forces as its standard combat goggles.

 EPS-21™ is based on a key design concept of a basic platform that provides ballistic, dust and wind protection, which can accommodate different types of secondary lenses as filters against solar and laser radiation.

The modular product design incorporates special features:

- Peripheral and frontal ballistic protection while keeping full field of vision.
- One size fits all.
- Good fit to user's face prevents dust penetration while insuring maximum comfort.
- Improved interface with optical sighting equipment.
- Labyrinth design of ventilation ports insures ventilation without filtration elements.
- Donning and removing while wearing a helmet.
- Secondary snap-on lens protects against solar or laser radiation, only when required.
- Integral adaptor for prescription lenses frame.
- Very attractive appearance.



U.S patent pending

CONTROP'S LAND SYSTEMS FOR BORDER PROTECTION

CONTROP is a world leader in EO / IR technologies and systems, providing innovative day / night EO / IR solutions for air, land and sea surveillance, defense and Homeland Security applications worldwide.



CONTROP Precision Technologies Ltd

**CONTROP
Precision Technologies LTD.**

P.O.Box 611
Hod Hasharon 4510502, Israel
Tel: 972-9-7440661, Fax: 972-9-7440662
E-mail: sales@controp.co.il
Web Site: www.controp.com

Unique qualities and features about CONTROP's EO / IR Land Systems:

- EO / IR cameras for observation missions providing CCD, IR video and panoramic imagery.
- Fast panoramic EO / IR scanning.
- EO / IR "radar" for Automatic Intruder Detection and Recognition – providing a Virtual Fence.
- Variety of capabilities – from short range systems (1 km) to very long range systems (25 km).
- Gyro-stabilized systems for long range capabilities and for tall mast mounting.
- Light weight, gyro-stabilized, ruggedized EO / IR systems for mobile applications.
- Unique EO / IR payloads for use on aerostats / balloons for persistent surveillance - high performance systems with very low weight including stabilization in pitch, yaw and roll.
- EO / IR payloads for use on UAVs for day and / or night applications.
- Systems for 24/7 missions.

CONTROP's EO / IR Land Systems Sensors:

- IR Camera for Observation and Scanning.
- CCD Camera for Observation and Scanning.
- Laser Range Finder (Optional).
- Laser Pointer for Target Marking (Optional).



Applications for CONTROP's EO / IR Land Systems:

- Security of High-value Sensitive Installations (Airports, Power Plants, Fuel Storage Depots, Oil Refineries, Water Reservoirs, Armed Forces Facilities etc).
- Coastal Surveillance (including small boat detection, swimmer detection, etc).
- Border Surveillance (smuggling, illegal immigration etc).
- Perimeter Surveillance.
- Military Bases/Port Security.
- Force Protection and Ground Troops Security.
- Virtual Fence from short to long ranges.

Platforms for CONTROP's EO / IR Systems:

- UAVs
- SUAVs
- Aerostats / Balloons
- High masts, poles and towers
- Patrol Vehicles
- Armored Vehicles
- Armed Combat Vehicles
- Surveillance Vehicles

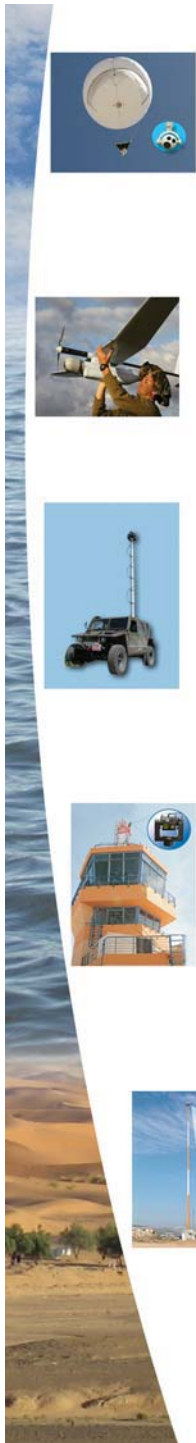

DEFENSE AND SHIELDING IMPROVEMENTS FOR EXISTING AND PLANNED BUILDINGS AND FACILITIES.



ORTECH
DEFENCE SYSTEMS LTD.
 Kibbutz Carmia 7913500, Israel
 Tel: 972-8-6749781
 Fax: 972-8-6749779
 E-mail: info@ortechisrael.co.il
 Web Site: www.ortechisrael.co.il

ORTECH is a leading provider of advanced protection solutions against Shooting, Missiles - Scuds, Grads, Mortar shells, Blast and Ballistics hits for structures and variety of sites.

We designs and implements for our clients, security and military institutions, firing and explosion experiments for the testing of verity of product.

We are an approved supplier of the Israeli Ministry of Defense and holds ISO 9001 international quality management system standard.

Ours protection specialists will customize the most suitable protection for you, to counter the nature of threats to be confronted.

We find importance to provide the protection solutions that will meet your needs to safety and protection required for routine existence even during emergencies.

Products:

- **BRF** - blast resistance fabric for shielding improvements of walls and existing structures.
- **Composite Materials and E-glass** - protection improvements for existing structures.
- **Hazardous Materials Containers Protection** - shield against direct hits & Fragments and blast.
- **Antenna Protection** - To protect cables of Radar, Sensors, Antennas, for military and civilian uses.
- **Piping and Infrastructure Protection** - For Ground Cabling, communication infrastructure, general piping and Gas and oil pipelines.
- **Lightweight portable Shooting protection for VIP** - Can be quickly placed and easy to dismantle.
- **Windows & Doors Shielding** - Range of solutions by defining the threat.
- **"Judea Fort"** - Modular cubes for building bonkers and physical barriers against missiles ,blast, shooting and gunfire spray.
- **Mobile Shelters** - wide range of size and form.
- **Nuclear Shelters** - Tailor made Personal Counseling.

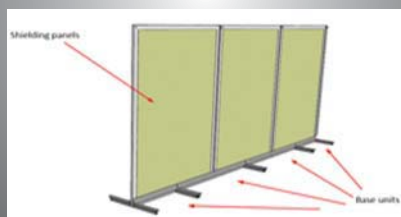
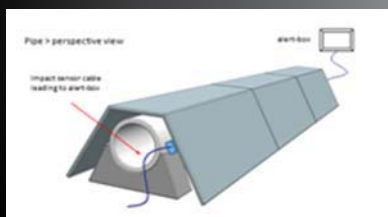

BORDER PROTECTION



RAFAEL ADVANCED DEFENSE SYSTEMS

P.O.Box 2250 (19)
Haifa 3102102, Israel
Tel: 972-4-8794714
Fax: 972-4-8794657
E-mail: intl-mkt@rafael.co.il
Web Site: www.rafael.co.il

Rafael Advanced Defense Systems, as a designer and developer of multi-disciplinary, field-proven "system-of-systems", is well-versed in complex large-scale integration and development of solutions for critical asset protection programs, both for Israel and for various countries around the world.

Rafael Advanced Defense Systems provides an end-to-end solution for today's challenges in critical asset protection and well into the future, with its vast experience and based on extensive knowledge gained over the last 60 years.

Rafael's tailor-made solutions address the customer's unique requirements, after conducting an in-depth geographical review of the area, as well as analysis of all the major potential threats, including the motivation and the ability of an attacker to carry out hostile acts.

Rafael's solution supports connectivity with **Customer-defined** sensors.

Ground-Based Sensors (Stationary and Mobile), including:

- **Terra-Sonic**- a passive warning and detection system designed to alert to possible threats on or in the vicinity of the pipeline
- **Toplite**- an advanced day/night Electro-Optic System (EOS) mounted on a mast to provide large area continuous surveillance.
- **Stalker**- a multi-sensor system mounted on a Customer-furnished vehicle for efficient surveillance, based on an advanced day/night Electro-Optic Pod and radar, mounted on an electrically-operated telescopic mast.
- **SpotLite-P**- tripod-mounted system for the detection of small arms fire sources.

Airborne Sensors, including:

- **RecceLite** - a self-contained self-cooled multi-sensor tactical reconnaissance system, consisting of an airborne pod based on the Litening Targeting and Navigation Pod and a ground exploitation station. The RecceLite simultaneously collects Infra-Red (IR) and Visual (VIS and near IR) digital images within a very wide field of regard, in accordance with an automatic mission plan and/or manual operation. The images and the data annotation are recorded on a solid state recorder and transmitted to the exploitation station via the RecceLite data link. The Images are then interpreted at the ground exploitation station.
- **Recce-U** - a self-contained, multi-sensor ISR system (based on the RecceLite Tactical Reconnaissance Pod). In addition to the persistent ISR payload, the system also comprises of a Ground Data Link Station (GDLS) and Ground Exploitation Station (GES). Recce-U simultaneously collects high-resolution infrared and visual digital images, day and night, within a very wide field of regard, in accordance with an automatic mission plan and/or manual operation, and transmits the images, which are then viewed and interpreted at the GES.
- **Toplite** - an advanced day/night Electro-Optic System (EOS) mounted on a mast to provide large area continuous surveillance.

USV/UAV/UGV, including:

- **Unmanned Airborne Vehicle (UAV)**: a tactical surveillance system, which consists of a stabilized day/night electro-optical payload mounted on a Customer-furnished UAV.
- **Protector USV** - unmanned integrated system for Intelligence, Surveillance, Target Acquisition and Reconnaissance (ISTAR).

C⁴, including:

- **IMILITE Situational Awareness Command and Control Centers** that act as the command and control operational hubs, and used to connect all the sensors and to allow video and data transfer between the IMILITE centers and the ground forces.
- **Mobile and deployable IMILITE Surveillance, Command and Control systems**: installed in a vehicle that can be deployed to strategic locations to closely manage and control specific events and operations.

■ ■ ■

RAFAEL
ADVANCED DEFENSE SYSTEMS
P.O.Box 2250 (19)
Haifa 3102102, Israel
Tel: 972-4-8794714
Fax: 972-4-8794657
E-mail: intl-mkt@rafael.co.il
Web Site: www.rafael.co.il

Multi-Source Multi-Task ISR Exploitation System / Command and Control System Imilite is an intelligence system designed to receive process and exploit multiple standalone imagery video and other intelligence data in a centralized and a unified way.

System capabilities:

data reception, processing and display of Video, imagery, targets, threats, mission status, force locations, SIGINT detection and others.

The system GIS capabilities provide synchronized display of all the data as overlays on maps, video and images.

Imilite improves the Command-and-Control process by various automated image processing algorithms such as geo-referencing, change and motion detection, video/image enhancement, video stabilization and others.

Imilite can disseminate operational data, tactical mission reports, targets and treats to other forces, to facilitate close support operations, targeting and platform/sensor management.

ImiLite allows scalable Command and Control solutions and adaption to specific operational needs, both in mobile and stationary configurations for Command and Control centers, deployable operational units.

Benefits:

- Centralized and unified workflow and data display
- Improved efficiency utilizing all available collection assets
- Shortened exploitation cycle
- Efficient Command and Control workflow
- Immediate accessibility to relevant data
- Real-time mission command-and-control workflow
- SR and mission product sharing with external operational users

Features:

- Multi-source data reception in various formats
- GIS capabilities: image/video geo-referencing, data overlays, Geo data retrieval
- Advanced Image Processing Algorithms: change and motion Detection, image/video enhancement, video stabilization and others
- ISR and mission products and reports generation and dissemination
- Scalability and Adaptability
- Stationary, Mobile or Airborne configurations



ELECTRO-OPTIC INTELLIGENCE, SURVEILLANCE AND RECONNAISSANCE (ISR)

Litening - Targeting & Navigation Pod

Litening is an innovative airborne infra-red targeting and navigation pod for fighter aircraft with high accuracy and reliability, day and night precision strike capability. Litening reduces pilot workload during targeting and tracking. It is easily integrated on any aircraft and possesses high growth potential.

In use in the Israeli Air Force, USAF, ANG, AFRES, Marines, German AF, Swedish AF, Spanish Navy & AF, Greek AF, and others, the Litening flies on F-16 , F-15, A-10, B-52, AV8-B, Gripen, Tornado, F-5, F-4, Mig-21, Mirage 2000, Jaguar and others.



Toplite EO System - Electro-Optical Surveillance, Observation & Targeting System

The Toplite family of electro-optic systems is an advanced multi-sensor, multi-purpose, highly stabilized EO systems for homeland security and defense applications, for aerial, maritime and ground based platforms.

RecceLite- Real Time Tactical Reconnaissance System

The RecceLite System consists of an E-O pod, a ground exploitation station and a data link. It is capable of collecting images day & night from 300 ft to 40,000 ft in all directions forwards, nadir, backwards, oblique - all down hemisphere and even when the aircraft is maneuvering in high G.

The Ground Exploitation Station (GES) is capable of generating targets in real-time with exceptionally high accuracy due to state-of-the-art algorithms and technology. The data-link connects between the sensors and the GES and enables the images to be downloaded to the GES in real time. When your task is to close the attack cycle on many "time-critical targets" in less than 10 minutes, there is only one system - RecceLite.

Recce-U - Real-Time Persistent ISR System for UAVs

Recce-U is a self-contained, multi-sensor ISR system (based on the RecceLite Tactical Reconnaissance Pod). The Recce-U enables automatic photography, according to a mission plan prepared in advance, or updated mission plan uplinked in real-time, however the operator can initiate manual scanning for targets of opportunity.



Litening -on-Gripen



Toplite EOS



RecceLite System

Recce-U

RAFAEL
ADVANCED DEFENSE SYSTEMS
 P.O.Box 2250 (19)
 Haifa 3102102, Israel
 Tel: 972-4-8794714
 Fax: 972-4-8794657
 E-mail: intl-mkt@rafael.co.il
 Web Site: www.rafael.co.il

SpotLite Family
Electro-Optic Enemy Fire Detection System

The SpotLite family consists of electro-optical systems that detect and locate enemy fire in stationary positions as well as on the move. Rapid detection and precise location information provide forces with the capability to quickly neutralize the enemy, maintaining the upper-hand on the battlefield.

The **SpotLite P** is a portable electro-optic system carried by two soldiers for day and night detection and location of small arms fire.



SpotLite P on Tripod

SpotLite M is a mobile electro-optic system installed on vehicles and AFV's that enables the detection and location of enemy fire sources from small arms, RPG rockets, ATGM and tank shells, on the move, day and night, up to 360° coverage.



SpotLite M on vehicle

Imilite - Multi-Source Multi-Task ISR Exploitation System / Command and Control System

Imilite is an intelligence system designed to receive process and exploit multiple standalone imagery video and other intelligence data in a centralized and a unified way.

Main system capability includes the reception, processing and exploitation of EO, IR, SAR/GMTI and VIDEO, in various formats, over one desktop. In order to enhance the exploitation process, Imilite further combines non-imagery data such as targets, threats, COMINT detection and mission status within the system workflow. Imilite generates a variety of standard and customer tailored ISR reports and IMINT products such as alphanumeric reports, annotated maps, GIS data layers and visual aids, and disseminates them to external information and operation systems over standard and tailored protocols.

Imilite's multi-source data integration and automation capabilities improve the efficiency of utilizing available collection and exploitation assets. The system GIS capabilities provide immediate accessibility to relevant imagery and intelligence data, thus shortening the ISR collection and exploitation cycle.

The Imilite is based on Rafael's combat-proven ISR and C⁴I systems already in service worldwide. Imilite is designed for use by Defense forces (air, ground) and police forces exercising various observation means for border patrol or coping with urban crime.



Imilite

MIC⁴AD



**RAFAEL
ADVANCED DEFENSE SYSTEMS**

P.O.Box 2250 (19)
Haifa 3102102, Israel
Tel: 972-4-8794714
Fax: 972-4-8794657
E-mail: intl-mkt@rafael.co.il
Web Site: www.rafael.co.il

MIC⁴AD is an advanced, unified, integrated C⁴I system that commands and controls the operation of both air and missile defense, including air-superiority missions. MIC⁴AD provides a total solution for multi-system, multi-layer and multi-range air and missile defense, traditionally operated as separate commands.

MIC⁴AD correlates real-time data from distributed sensors/platforms (radars, IFF system, data links, electro-optics), all connected to the air traffic control picture and mission planning system. The data is analyzed to deliver a real-time, coherent national Air Situation Picture (ASP).

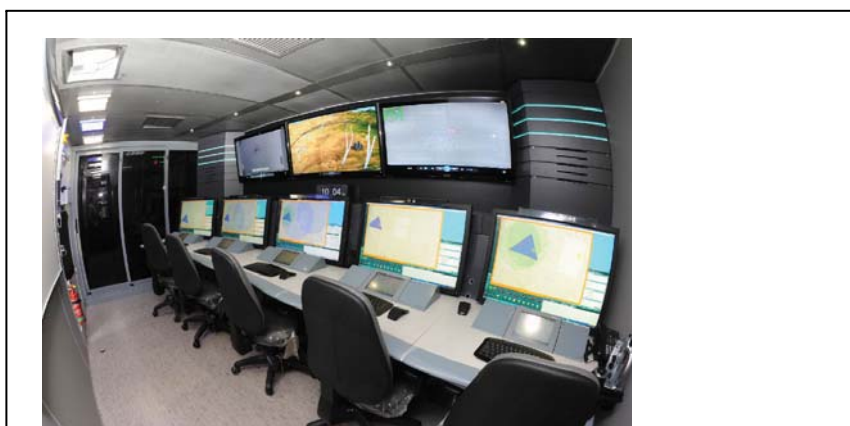

Simultaneously, MIC⁴AD performs threat assessment and hostile target classification, generating an interception plan for threats at any command level (national, regional, tactical). MIC⁴AD optimizes resource management and swiftly allocates the most appropriate defense system, such as SPYDER, David's Sling, Iron Dome or other customer systems to the type of challenge. Response includes target allocation to weapon systems (TAWA - Threat Assessment Weapon Allocation) with full, semi-automatic or manual fire control according to customer doctrine.

MIC⁴AD open, modular architecture can be adapted to customer operational needs. The system can be integrated with a customer's existing or future air and missile defenses. This flexibility allows incorporating new technologies and systems with the existing arrangement. MIC⁴AD can serve as an add-on to the customer's current C⁴I setup, or replace existing systems entirely.

Highly automated, easy-to-use and with advanced interactive displays, MIC⁴AD is a true force-multiplier. Enabling unified command and fire control of multiple air and missile defense systems, MIC⁴AD delivers multi-mission, multi-layer and multi-range C⁴I capabilities that ensure end-to-end air and missile protection.

PROTECTOR® USV



RAFAEL ADVANCED DEFENSE SYSTEMS

P.O.Box 2250 (19)
Haifa 3102102, Israel
Tel: 972-4-8794714
Fax: 972-4-8794657
E-mail: intl-mkt@rafael.co.il
Web Site: www.rafael.co.il

PROTECTOR® USV

Is an unmanned integrated system for Intelligence, Surveillance, Target Acquisition and Reconnaissance (ISTAR).

The **PROTECTOR® USV** is fitted with a comprehensive sensor suite and can accommodate a variety of mission modules. The TOPLITE Electro-optical director and a radar system provide day/night detection, identification and tracking of targets. TOPLITE subsystems include a third-generation Forward-Looking Infra-Red (FLIR) sensor, color Charge-Coupled Device (CCD) camera an eye-safe laser rangefinder (LRF), and an advanced correlation tracker.

The Anti Terror/Force Protection payload includes the TOPLITE Electro-Optical Director (EOD), MINI-TYPHOON Stabilized Weapon Station, a Water Cannon System and auxiliary sensors. The MINI-TYPHOON is a stabilized gun mount that is highly accurate and includes fire control capabilities, yielding excellent shooting accuracy. The Water Cannon system provides less-lethal engagement at close range as well as firefighting capabilities.

PROTECTOR is operated from a Control Station. The Control Station includes two control consoles, one for the USV commander and one for the Payload Systems operator.

The Control Station receives, via communications links, all the system data, video imagery and audio required to effectively build a situational awareness picture and operate the system. The system can be easily incorporated in a wider defense array via a standard interface to an external C⁴I system.

Based on a highly maneuverable platform the USV has excellent maneuvering capabilities. The platform has water jet propulsion systems powered by diesel engines. The platform systems include control over propulsion, maneuvering, and navigation.

The **PROTECTOR's** core element is an advanced control system, which interfaces with all of the **PROTECTOR's** sub-systems and provides a remote operator with the ability to plan, prioritize and execute naval missions by day and night, under adverse weather conditions, without exposure to risk.

The **PROTECTOR's** modular design enables the Customer to select those sub-systems that will best meet his own particular operational requirements.

When mounting effectors, the **PROTECTOR** can effectively close the fire circle for an all-round "sensor-to-shooter" solution.

PROTECTOR® USV Operational Advantages

- Performs dangerous tasks without risking human lives.
- Performs long and wearisome missions such as patrolling and ongoing security tasks.
- Provides Real-time data and video transmission from the field to the headquarters.
- Can operate at high seas without a crew that is affected from the harsh conditions.
- The **Protector® USV** Command and Control system can be integrated with external C⁴I systems, making it an integral part of the defense array.
- The **Protector® USV** can be used to approach suspicious vessels and verify their intentions, thus distinguishing friend from foe without having risking crew safety.
- A highly effective sensor suite, capable of detecting and identifying targets and threats from a great distance.
- Integrated combat suite that enables a rapid "sensor to shooter" response.
- Equipped with a highly accurate combat proven stabilized Weapon Station capable of eliminating threats from afar.
- Equipped with high pressure Water Cannon for non-lethal deterrence, and crowd control tasks.
- The **Protector® USV** has the ability to record video and audio data of its surrounding for debriefing, legal purposes and other considerations.
- The **Protector® USV** can be deployed anywhere at sea, from oil rigs, mother ships or shore installations, thus maximizing its range of action and versatility.
- Onboard payload can be replaced to fit different designated missions, thus providing the ability to conduct a wide range of missions using a single platform.
- Fully-tested, serially-produced and operationally deployed in navies' world-wide.

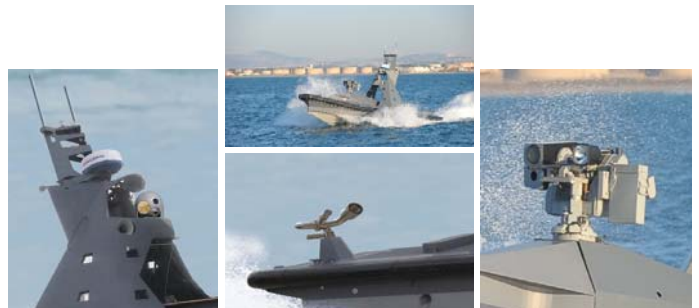

SPOTLITE FAMILY



RAFAEL
ADVANCED DEFENSE SYSTEMS
P.O.Box 2250 (19)
Haifa 3102102, Israel
Tel: 972-4-8794714
Fax: 972-4-8794657
E-mail: intl-mkt@rafael.co.il
Web Site: www.rafael.co.il

Spotlite Family

In-motion Or Portable enemy fire source Detection, positioning and classification system

Mechanized warfare is particularly complex. Sniper fire, RPG rockets, and in particular anti-tank missiles are lethal threats to the various types of ACVs moving in the battle field. Inability to detect threats and locate the position of the firing enemy causes numerous casualties, massive, inaccurate, and wasteful fire by our forces. Most importantly it lets the enemy retain the initiative in the battle field. Spotlite is a family of electro-optical products that quickly and accurately detect and locate enemy fire and swiftly close the sensor-to-shooter loop so as to neutralize the enemy and to keep initiative on the battle field in our hands.

The first product unveiled about two years ago was the Spotlite P, formerly MK2. This is a man-portable system that detects and locates enemy shooting small arms. It immediately investigates the target to verify that it is indeed a terrorist and quickly sends the target data to snipers or any other relevant shooters that can neutralize the source of fire. Since the system is man-portable and battery-operated it has great operational flexibility and can be positioned inside buildings as well as in areas impassible by vehicle.

An additional product, Spotlite – M, has recently joined the family. Spotlite – M is an electro-optical system installed on ACVs and other vehicles that detects and locates an enemy that is firing small arms, RPG bombs, anti-tank missiles, and rockets, in motion, day and night, at a range of up to 360°.



STALKER FAMILY



RAFAEL
ADVANCED DEFENSE SYSTEMS
P.O.Box 2250 (19)
Haifa 3102102, Israel
Tel: 972-4-8794714
Fax: 972-4-8794657
E-mail: intl-mkt@rafael.co.il
Web Site: www.rafael.co.il

STALKER FAMILY - Mobile Observation Multi Sensor Systems for Security Missions

STALKER Family has two new members: the STALKER-URBAN and STALKER-PATROL. Both are designed to support urban security missions from a stand-off distance. Equipped with day/night electro-optical sensors, long-range laser range finding capabilities and GPS, STALKER provides the information required for effective security decision-making.

The STALKER systems allow operational flexibility in multiple, simultaneous scenarios during both routine and special situations. Routine missions can include monitoring crime zones and controlling crowds. In addition, during special situations like mega sporting events, the STALKERS play an active role in securing vital infrastructures (stadiums, governmental buildings, and tourist facilities), monitoring access routes, and protecting VIPs. Where required, STALKER-furnished information is shared with other network elements to provide a complete situation picture for decision-makers.

Benefits:

- Specially designed for mobile security missions
- Kit configuration for easy installation and disassembly on any Customer-defined 4x2/4x4 vehicle
- Continuous, 10hr surveillance, target acquisition, reconnaissance and intelligence collection, with GPS positioning with self-rechargeable power
- Stand-alone operation or networking via integrated Command & Control (C²) System
- Intuitive operation and quick training cycle
- Enables quick response to evolving events



TERRA SONIC



RAFAEL
ADVANCED DEFENSE SYSTEMS
P.O.Box 2250 (19)
Haifa 3102102, Israel
Tel: 972-4-8794714
Fax: 972-4-8794657
E-mail: intl-mkt@rafael.co.il
Web Site: www.rafael.co.il

TERRA SONIC - Pipeline Integrity Monitoring System

Rafael's Terra Sonic is an operational, field-proven monitoring and protection system for oil pipelines. It is a passive system employing an array of sensors to detect, classify and localize seismic sound waves propagated through the pipe and/or the oil. These sound waves are generated by occurrences or vents such as hitting, digging, leaks, and third-party action in or near the pipeline and its vicinity. The system provides valuable early warning while maintaining maximum sensitivity and minimizing nuisance alarms.



Terra Sonic uses patented algorithms and unique signal processing to analyze seismic and acoustic signals. The algorithms enable the system to distinguish between different events. These algorithms make it possible to overcome ambiguity, multi-event interference and provide high probability of interception. The system provides automatic detection, classification, and localization of activities in the vicinity of the pipeline including digging, hits to the pipe and leaks.

The system's modularity offers the capability to satisfy varied security policies and requirements.

BRIDGING THE GAP BETWEEN REQUIREMENTS AND TECHNOLOGY WORLDWIDE



KARIL INTERNATIONAL MARKETING LTD.

6 Maskit St.,
Herzliya 4614002, Israel
Tel: 972-9-9568212
Fax: 972-9-9568141
E-mail: sales@karil.com
Web Site: www.karil.com



Karil International is a member of the Mistral Group; a team of independent companies, each operating in different markets worldwide, while collectively sharing the mission of "Bridging" strategic gaps in the Defense and Law Enforcement Markets with practical and innovative solutions.

Karil International has been providing innovative security products and services since 1996 and is responsible for representing the Group's interests in Europe, Africa and the Far East.

Mistral Group's market proficiency and trusted relationships allow us to provide our global partners with an expert understanding and intimacy with the Defense and Homeland Security targeted markets while providing fully integrated Defense and Security solutions to our customers.

Defense Markets

Karil International utilizes the best of emerging American and Israeli military trends and technologies to create tailor-made solutions for a variety of tactical challenges on today's battlefields. We harness our in-depth understanding of operational needs to address current necessities and prepare for future requirements.

As a member of the Mistral Group, Karil International has access to the world's most advanced technology providers which allows us to offer our customers unique and advanced solutions specializing in:

- Tactical Ground Platforms
- C⁴ISR
- Dismounted Soldier
- Combat Engineering and EOD



Ness TSG

Land Forces Solutions



Ness TSG
Technologies & Systems Group
P.O.Box 58180
Tel Aviv 6158101, Israel
Tel: 972-3-5483518
Fax: 972-3-5483700
E-mail: tsg@ness.com
Web Site: www.ness.com/tsg

Ness Technologies & Systems Group (TSG) is a leading international systems house specializing in the integration of advanced command-and-control solutions for real-time military and civilian defense, homeland security, and telecom applications.

Ness TSG has a dedicated team of multidisciplinary professionals with expertise in system definition and design, system engineering, algorithm development, and hardware/software integration. With over four decades of experience, Ness covers a range of fields including C⁴I, real-time communications, image processing, data fusion, video transmission and IP communications.

We maintain a diverse international client base of armed forces and defense establishments, organizations and enterprises. Since 1969, Ness TSG has served as a strategic partner of the Israel Defense Forces (IDF), strengthening the IDF's operational advantage by implementing innovative solutions tailored to its unique needs.

Our land forces systems deliver highly detailed, real-time situation pictures that can be distributed to various echelons both in the field and at command-and-control centers, thereby optimizing decision-making. Deployed by defense, public security, crisis and emergency

management organizations, our fully scalable solutions are available with customized doctrine adaptation.

In addition to our ground command-and-control land forces systems, Ness TSG has developed a unique integrative solution for effective intelligence management and dissemination. The system selects critical information, creates possible links between pieces of data, and develops conclusions for decision-making in both peaceful and threatening situations.



TSG

Technologies & Systems Group

Ramim Engineering Works Ltd.

The Shelter People (Since 1971)

WORLD LEADING SUPPLIER OF FOAM AND BEAM TACTICAL SHELTERS (MILITARY)



RAMIM ENGINEERING WORKS LTD.

P.O.Box 668
Kiryat Shmona 1101502, Israel
Tel: 972-4-6940072, 6942776
Fax: 972-4-6949782
E-mail: office@ramim.net
Web Site: www.ramims.com

Ramim Engineering Works Ltd., manufacture a specialized line of transportable prefabricated communications cabins, mobile laboratories, collapsible cabins, refrigerated container trucks. Established in 1971, Ramim is a subsidiary of Koor Metals Ltd., and receives direct technical, financial and logistical support from this organization. The company build communication shelters in accordance with American military specifications.

Ramim's rugged transportable shelters are used by every branch of the modern armed forces.

Ramim's manufacturing and engineering capabilities go beyond assembly of the basic shelter structure. They include the ability to design shelters and shelter modifications to customer specifications ready for integration of tactical equipment.



Quality Assurance

The company maintains a quality control system per ISO STD 9001:2008 and the Plant is equipped with modern machinery, so that when operating on one shift, it has the capacity to produce 50 shelters per month.

Manufacturing Experience

Since the founding of the company in 1971, Ramim has produced thousands of S-250 and S-280 shelters in various configurations for numerous customers, the vast majority with EMI shielding. Nearly 1000 S-250 and over 1500 S-280 shelters have been manufactured under U.S. Government contracts.

Types of Shelters

Ramim has documented work and process instructions for all the major operations required to manufacture the S-280C/G, S-250/G, S-250/E, ISO shelters and different types of shelters up to a size of 50' long shelters, including cleaning, conversion coating, bonding, spot welding, fusion welding, metalizing, painting and application of sealing material.

Major Customers

Israel Defense Forces, Israel Aerospace Industries Ltd., Elbit, Rafael, U.S. Army, U.S. System House Companies & various customers around the world.

Areas of Activity

Ramim's shelter construction consists of hot bonded sandwich panels, a polyurethane foam core, aluminum skins and framework. Portable environmental electronics shelters produced by Ramim meet US Military standards: S-250/G, S-280C/G, S-788, S-1497. ISO shelters 20', 40', 10' & meet European / NATO standards: NATO-I, NATO III(1), ACE III, ACE-I.

Products

- Shelter Electrical Equipment S-250/G shielded
N.S.N 5411-00-489-6076 per (MIL-S-55541) ASTM E-1974-07.
- Shelter Electronic Equipment S-280C/G unshielded
NSN 5411-01-092-0892 per (MIL-S-55286E) ASTM E-1975-07
- Shelter Electronic Equipment S-280C/G shielded
N.S.N 5411-00-304-3069 per (MIL-S-55286E) ASTM E-1975-07.
- 20' ISO shelter per MIL-M-81957(AS).
- Various housing boxes for mini - RPV/MISSILES etc.
- 40' (L) x 11' (W) x 10' - Control and Maintenance shelter for radar systems.
- Shelter type 1497 for HMMWV, per MIL-STD-907B (ASTM E-1925-07).
- NATO shelters types NATO 1, NATO III(1), ACE(1), ACE-II, ACE-III.
- 20' expandable shelters one side or two sides (Foldable panels system) per ASTM E-1977-06 & ASTM E-1978-06 in foam & beam construction for mobile hospitals.
- S-788 shelter (Foam and Beam construction) per MIL-S-44408.
- Mobile after action review shelter (MAAR) - 50'x11.5'x12' (2 sides expandable telescopic system).

ELECTRO-OPTIC INTELLIGENCE, SURVEILLANCE AND RECONNAISSANCE (ISR)

Litening - Targeting & Navigation Pod

Litening is an innovative airborne infra-red targeting and navigation pod for fighter aircraft with high accuracy and reliability, day and night precision strike capability. Litening reduces pilot workload during targeting and tracking. It is easily integrated on any aircraft and possesses high growth potential.

In use in the Israeli Air Force, USAF, ANG, AFRES, Marines, German AF, Swedish AF, Spanish Navy & AF, Greek AF, and others, the Litening flies on F-16 , F-15, A-10, B-52, AV8-B, Gripen, Tornado, F-5, F-4, Mig-21, Mirage 2000, Jaguar and others.



Toplite EO System - Electro-Optical Surveillance, Observation & Targeting System

The Toplite family of electro-optic systems is an advanced multi-sensor, multi-purpose, highly stabilized EO systems for homeland security and defense applications, for aerial, maritime and ground based platforms.

RecceLite- Real Time Tactical Reconnaissance System

The RecceLite System consists of an E-O pod, a ground exploitation station and a data link. It is capable of collecting images day & night from 300 ft to 40,000 ft in all directions forwards, nadir, backwards, oblique - all down hemisphere and even when the aircraft is maneuvering in high G.

The Ground Exploitation Station (GES) is capable of generating targets in real-time with exceptionally high accuracy due to state-of-the-art algorithms and technology. The data-link connects between the sensors and the GES and enables the images to be downloaded to the GES in real time. When your task is to close the attack cycle on many "time-critical targets" in less than 10 minutes, there is only one system - RecceLite.

Recce-U - Real-Time Persistent ISR System for UAVs

Recce-U is a self-contained, multi-sensor ISR system (based on the RecceLite Tactical Reconnaissance Pod). The Recce-U enables automatic photography, according to a mission plan prepared in advance, or updated mission plan uplinked in real-time, however the operator can initiate manual scanning for targets of opportunity.



Litening -on-Gripen



Toplite EOS



RecceLite System

Recce-U

RAFAEL
ADVANCED DEFENSE SYSTEMS
 P.O.Box 2250 (19)
 Haifa 3102102, Israel
 Tel: 972-4-8794714
 Fax: 972-4-8794657
 E-mail: intl-mkt@rafael.co.il
 Web Site: www.rafael.co.il

SpotLite Family
Electro-Optic Enemy Fire Detection System

The SpotLite family consists of electro-optical systems that detect and locate enemy fire in stationary positions as well as on the move. Rapid detection and precise location information provide forces with the capability to quickly neutralize the enemy, maintaining the upper-hand on the battlefield.

The **SpotLite P** is a portable electro-optic system carried by two soldiers for day and night detection and location of small arms fire.



SpotLite P on Tripod

SpotLite M is a mobile electro-optic system installed on vehicles and AFV's that enables the detection and location of enemy fire sources from small arms, RPG rockets, ATGM and tank shells, on the move, day and night, up to 360° coverage.



SpotLite M on vehicle

Imilite - Multi-Source Multi-Task ISR Exploitation System / Command and Control System

Imilite is an intelligence system designed to receive process and exploit multiple standalone imagery video and other intelligence data in a centralized and a unified way.

Main system capability includes the reception, processing and exploitation of EO, IR, SAR/GMTI and VIDEO, in various formats, over one desktop. In order to enhance the exploitation process, Imilite further combines non-imagery data such as targets, threats, COMINT detection and mission status within the system workflow. Imilite generates a variety of standard and customer tailored ISR reports and IMINT products such as alphanumeric reports, annotated maps, GIS data layers and visual aids, and disseminates them to external information and operation systems over standard and tailored protocols.

Imilite's multi-source data integration and automation capabilities improve the efficiency of utilizing available collection and exploitation assets. The system GIS capabilities provide immediate accessibility to relevant imagery and intelligence data, thus shortening the ISR collection and exploitation cycle.

The Imilite is based on Rafael's combat-proven ISR and C⁴I systems already in service worldwide. Imilite is designed for use by Defense forces (air, ground) and police forces exercising various observation means for border patrol or coping with urban crime.



Imilite

Rafael Provides Communication Products that Includes Data Link, Airborne Relay Systems, Communication Networks & Voice Radio

RAFAEL
ADVANCED DEFENSE SYSTEMS
 P.O.Box 2250 (19)
 Haifa 3102102, Israel
 Tel: 972-4-8794714
 Fax: 972-4-8794657
 E-mail: intl-mkt@rafael.co.il
 Web Site: www.rafael.co.il

DLV-53 MFTM - ISTAR Wideband Data Link

- Ultra Wide Band data-link providing communication solutions for UAVs/ USVs/ UGVs & Airborne Reconnaissance pod systems
- Use of a single, small & light - weight unit for PTP LOS/SatCom, one hop LOS Relay & CAS waveforms simultaneously
- Supports data rates from 200Kb/s to 274 Mb/s - selectable from the Ground Station
- Growth capability up to 548Mbps without HW change
- Full spectrum support (L, S, C, X, Ku, MMW), highly immune
- Seamless secured connection between standard Airborne IP LAN and Ground IP LAN over a Gigabit WAN

BNET - Broadband MANET IP Software Defined Radio

- Ultra high data rate software defined radio (SDR)
- Tactical Voice, Video & Data on the move
- Mobile Ad-hoc network (MANET)
- Unique spectral efficiency features
- IP Radio
- Immune and secured
- Vehicular and hand-held formations

TACMAX - Tactical 4G Cellular Broadband Network for Ground Forces

- Fast deployable
- Secured and immune
- Soldier and vehicle radio
- Up to 45 Mbps per cell
- Mesh capability
- Standard IP backhaul



RAVNET 300 - Airborne Voice & Data Communication Radio Network

- Air-to-Air, Air-to-Ground, instantaneous high data rate
- Highly advanced Voice & Data Networks
- High Availability: Long range communication, auto relay via multi hops
- High efficiency utilization of V/UHF spectrum
- Legacy radios support for practical evolution
- Field proven in Israeli IAF



AIR STAR - Multi-Sensor Aerostat based system for Extended ISR

- The most advanced field proven Aerostat based ISR system
- Expands early warning and surveillance capabilities
- Supports air dominance
- Consists of multiple sensors: Radar, ELINT, COMINT & Receivers/Transmitters
- Communication to Command and Control & to Targets Interceptors
- High availability



RAFAEL
ADVANCED DEFENSE SYSTEMS
P.O.Box 2250 (19)
Haifa 3102102, Israel
Tel: 972-4-8794714
Fax: 972-4-8794657
E-mail: intl-mkt@rafael.co.il
Web Site: www.rafael.co.il

Multi-Source Multi-Task ISR Exploitation System / Command and Control System Imilite is an intelligence system designed to receive process and exploit multiple standalone imagery video and other intelligence data in a centralized and a unified way.

System capabilities:

data reception, processing and display of Video, imagery, targets, threats, mission status, force locations, SIGINT detection and others.

The system GIS capabilities provide synchronized display of all the data as overlays on maps, video and images.

Imilite improves the Command-and-Control process by various automated image processing algorithms such as geo-referencing, change and motion detection, video/image enhancement, video stabilization and others.

Imilite can disseminate operational data, tactical mission reports, targets and treats to other forces, to facilitate close support operations, targeting and platform/sensor management.

ImiLite allows scalable Command and Control solutions and adaption to specific operational needs, both in mobile and stationary configurations for Command and Control centers, deployable operational units.

Benefits:

- Centralized and unified workflow and data display
- Improved efficiency utilizing all available collection assets
- Shortened exploitation cycle
- Efficient Command and Control workflow
- Immediate accessibility to relevant data
- Real-time mission command-and-control workflow
- SR and mission product sharing with external operational users

Features:

- Multi-source data reception in various formats
- GIS capabilities: image/video geo-referencing, data overlays, Geo data retrieval
- Advanced Image Processing Algorithms: change and motion Detection, image/video enhancement, video stabilization and others
- ISR and mission products and reports generation and dissemination
- Scalability and Adaptability
- Stationary, Mobile or Airborne configurations



MIC⁴AD



**RAFAEL
ADVANCED DEFENSE SYSTEMS**

P.O.Box 2250 (19)
Haifa 3102102, Israel
Tel: 972-4-8794714
Fax: 972-4-8794657
E-mail: intl-mkt@rafael.co.il
Web Site: www.rafael.co.il

MIC⁴AD is an advanced, unified, integrated C⁴I system that commands and controls the operation of both air and missile defense, including air-superiority missions. MIC⁴AD provides a total solution for multi-system, multi-layer and multi-range air and missile defense, traditionally operated as separate commands.

MIC⁴AD correlates real-time data from distributed sensors/platforms (radars, IFF system, data links, electro-optics), all connected to the air traffic control picture and mission planning system. The data is analyzed to deliver a real-time, coherent national Air Situation Picture (ASP).

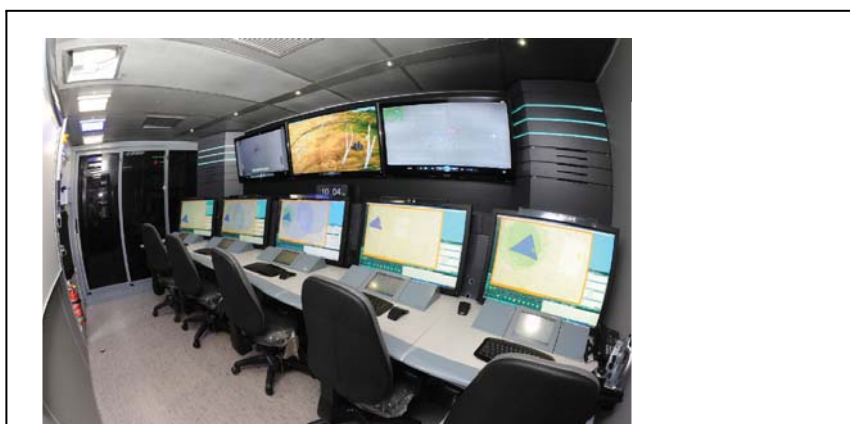

Simultaneously, MIC⁴AD performs threat assessment and hostile target classification, generating an interception plan for threats at any command level (national, regional, tactical). MIC⁴AD optimizes resource management and swiftly allocates the most appropriate defense system, such as SPYDER, David's Sling, Iron Dome or other customer systems to the type of challenge. Response includes target allocation to weapon systems (TAWA - Threat Assessment Weapon Allocation) with full, semi-automatic or manual fire control according to customer doctrine.

MIC⁴AD open, modular architecture can be adapted to customer operational needs. The system can be integrated with a customer's existing or future air and missile defenses. This flexibility allows incorporating new technologies and systems with the existing arrangement. MIC⁴AD can serve as an add-on to the customer's current C⁴I setup, or replace existing systems entirely.

Highly automated, easy-to-use and with advanced interactive displays, MIC⁴AD is a true force-multiplier. Enabling unified command and fire control of multiple air and missile defense systems, MIC⁴AD delivers multi-mission, multi-layer and multi-range C⁴I capabilities that ensure end-to-end air and missile protection.

SPOTLITE FAMILY



**RAFAEL
ADVANCED DEFENSE SYSTEMS**

P.O.Box 2250 (19)
Haifa 3102102, Israel
Tel: 972-4-8794714
Fax: 972-4-8794657
E-mail: intl-mkt@rafael.co.il
Web Site: www.rafael.co.il

Spotlite Family

In-motion Or Portable enemy fire source Detection, positioning and classification system

Mechanized warfare is particularly complex. Sniper fire, RPG rockets, and in particular anti-tank missiles are lethal threats to the various types of ACVs moving in the battle field. Inability to detect threats and locate the position of the firing enemy causes numerous casualties, massive, inaccurate, and wasteful fire by our forces. Most importantly it lets the enemy retain the initiative in the battle field. Spotlite is a family of electro-optical products that quickly and accurately detect and locate enemy fire and swiftly close the sensor-to-shooter loop so as to neutralize the enemy and to keep initiative on the battle field in our hands.

The first product unveiled about two years ago was the Spotlite P, formerly MK2. This is a man-portable system that detects and locates enemy shooting small arms. It immediately investigates the target to verify that it is indeed a terrorist and quickly sends the target data to snipers or any other relevant shooters that can neutralize the source of fire. Since the system is man-portable and battery-operated it has great operational flexibility and can be positioned inside buildings as well as in areas impassible by vehicle.

An additional product, Spotlite – M, has recently joined the family. Spotlite – M is an electro-optical system installed on ACVs and other vehicles that detects and locates an enemy that is firing small arms, RPG bombs, anti-tank missiles, and rockets, in motion, day and night, at a range of up to 360°.



ASTRONAUTICS ARTILLERY MODERNIZATION SYSTEMS



ASTRONAUTICS C.A. LTD.

Astronautics C.A. LTD.

P.O.Box 3351, Kiryat Arie
Petah Tikva 4951207, Israel
Tel: 972-3-9251555
Fax: 972-3-9251550
E-mail: astro@astro.co.il
Web Site: www.astronautics.co.il

ASTRONAUTICS MAFCS:

- **Astronautics** together with Astronautics Corp. of America subsidiary **Kearfott Guidance and Navigation Corporation (KGN)** has developed the **Modular Artillery Fire Control System (MAFCS)** to provide an inexpensive, highly adaptive solution for the upgrade of Self-Propelled and Towed Artillery Guns and Mortars, so as to enhance their responsiveness and survivability in contemporary and future battlefield environments, comprising full navigation and control capabilities to the individual vehicle.
- The **MAFCS** enables autonomous gun Navigation and Pointing and provides ballistic computation capabilities to enhance weapon operation.
- The **System Ability** to perform rapid changes of position, as well as its high responsiveness, enables the crew to Shoot and Scoot and thus gains the force-multiplier advantage, which is essential for better situational awareness and effective / rapid response, in the modern battlefield.

The MAFCS consists of the following main elements:

- Vehicle Reference Unit (VRU)- Kearfott's MILNAV[®], KN-4053, three axis Monolithic Ring Laser Gyro (MRLG). The VRU is a fully integrated inertial navigation unit with an optional GPS receiver, which may either be embedded, or external (PLGR). The VRU is installed on the elevating mass of the Gun and provides a continuous high precision output of position and attitude of the weapon.
- Commander's Modular Processing, Control & Display Unit (MPCDU). The MPCDU provides overall control, management and fire control computation within the system. It includes advanced & powerful processor, communication ports, a high brightness/high resolution color Liquid Crystal Display and software programmable keys, to provide a state-of-the-art flexible multi-function computer & tactical display.
- Muzzle Velocity Radar (MVR). The MVR allows real time monitoring of the gun wear effect. Based on the MVR output the MPCDU improves the ballistic computation, in a predictive manner, utilizing proprietary Astronautics algorithm.

MAFCS Applications

M109



120mm Mortar



SB155/52



ASTRONAUTICS CONTROL & DISPLAY UNITS (CDU'S)

- Field Proven & Fully Ruggedized CDU's
- Sunlight Readable Displays
- Powerful Processor
- Full Mil-Spec.
- Display: 8.4", 10.4", 12.1" and 15" AMLCD (VGA, SVGA, XGA)
- I/O Capabilities: - Serial RS232, RS422, RS485 & CAN BUS
- Ethernet 10/100/1000Mbps
- Wireless Port
- Options: - PAL/NTSC Video Input
- Touch Screen
- Detachable Ruggedized Large Capacity Storage Device

CDU for C³
Applications



CDU for Artillery
Applications



PARACHUTE SYSTEMS FOR ILLUMINATING FLARES AND TEXTILE ARTICLE FOR ALL MILITARY APPLICATIONS



D. YOLAND LTD.
17 Hamasger St., P.O.Box 13518
Old industrial zone
Natanya 4237927, Israel
Tel: 972-9-8616103
Fax: 972-9-8847221
E-mail: info@yolandcorp.com
Web Site: www.yolandcorp.com

D. Yoland is a private company established in 1976 and has a vast experience in the production of parachutes as well as other military articles. D. Yoland is a major parachutes producer in Israel and its parachutes are assembled in munitions that are in service by foreign armies, including the US Army.

D. Yoland established its subsidiary, Yoland Corporation Inc. in 1999 to manufacture tank and artillery components to the IDF. During the years Yoland Corp became a qualified parachute manufacturer to the US Army and USMC.

Yoland's policy is not only to meet but to exceed most stringent requirements of their customers and on-time deliveries.

Yoland offers all types of parachutes for artillery, mortar and air-delivered illumination flares:

- Artillery 155 mm, 105 mm
- Mortar parachutes: 120 mm, 81 mm, 60 mm illuminating Parachute
- 40 mm illuminating grenade
- Aircraft Flare Parachutes: LUU-19 B/B, LUU-2 D/B

Bags for tank ammunition, artillery and mortar propelling charges including protective sleeve of all types Such as M3A1, M4A2, M9A2, M119A1, M10.



ARTILLERY



With the integration of Soltam, Elbit Systems Land and C⁴I is now in a position to offer a comprehensive range of fully integrated, modular artillery and mortar solutions, incorporating C⁴I, Fire Control systems and platform upgrades as well as a complete range of artillery and mortar ammunition.



Artillery Platform Upgrade

Support for multiple firing platforms using existing infrastructure

Providing upgrades for the full range of firing platforms including towed, tracked, truck-mounted and self-propelled guns as well as rocket launchers. Enabling rapid and accurate execution of fire mission together with full command and control (C²) capabilities.



Autonomous Mortar Platform Upgrade

Comprehensive platform upgrade – fully integrated C², fire control systems, navigation, positioning and communication

Adaptable to a wide range of wheeled and towed platforms, the autonomous mortar is battle-proven and is in service globally.

Guns



Soltam ATMOS

155mm, Computerized Autonomous Truck Mounted Self-Propelled Gun

Meeting the need for light, long-range and fast moving artillery on the battlefield Offering the advantages of high fire power, mobility and short response time, the ATMOS is rapidly deployed and operable in rugged terrain. Highly adaptable, the modular ATMOS system is available with various qualified in-service trucks and gun calibers. The combination of an embedded electronic suit, an automatic laying system and automatic loading system provides exceptional benefits including accurate navigation and autonomous operation, reduced crew size, increased fire power and accuracy. The artillery systems are equipped with fire control computers (FCC), muzzle velocity radar (MVR), an inertial navigation system (INS) and a target acquisition system (TAS).



Soltam ATMOS D-30

Advanced tactical computation and sensors in a wheeled, self-propelled 122mm Howitzer

The ATMOS D-30 is a wheeled, self-propelled 122mm Howitzer which can be mounted on almost any modern 6X6 or 8X8 truck. An upgraded version of the in-service 122mm D-30 gun system, the ATMOS D-30 currently features a modified cabin, APU-driven hydraulic systems, onboard ammunition storage, and semi-automatic loading systems. The ATMOS D-30 can be fully integrated with an electronic suit, enabling accurate and semi-autonomous operation, reduced crew size and increased fire power. The artillery systems are equipped with fire control computers (FCC), muzzle velocity radar (MVR), an inertial navigation system (INS) and a target acquisition system (TAS).



Soltam ATHOS

155mm Autonomous Towed Howitzer System

Operational efficiency combined with highly versatile advanced towed gun concept The 155 mm 52 caliber Autonomous Towed Howitzer – ATHOS – towed independent gun features autonomous operation and automatic laying capabilities. The gun's low center-of-gravity, overall length and tandem wheels mounted on the walking beams ensure smooth travel at all speeds and on rough terrain, posing no limitations on the towing vehicle's speed and capabilities. The gun can also maneuver in and out of position under its own power. The artillery systems are equipped with fire control computers (FCC), muzzle velocity radar (MVR), an inertial navigation system (INS) and a target acquisition system (TAS).



Soltam M-46S 130mm

Upgraded version of Soviet 130mm field gun, substantially increasing firing range The M-46S is a hybrid of a 155mm 45 caliber cannon assembly. The upgraded version is comprised of a new 155mm barrel, breech assembly and muzzle brake that is mounted on the undercarriage and recoil systems of the battle-proven 130mm M-46 field gun. The upgrade kit has increased its firing range by 40% to 39km with conventional ERFB/BB projectile. The artillery systems are equipped with fire control computers (FCC), muzzle velocity radar (MVR), an inertial navigation system (INS) and a target acquisition system (TAS).



Soltam M-114S 155mm

Upgraded version of 155mm 33 caliber assembly with 54% increase in range The M-114S is a hybrid of a 155mm 33 caliber cannon assembly. The upgraded version is comprised of a new 155mm barrel and muzzle brake that is integrated with the original M-114 breech mechanism. It is mounted on the battle-proven undercarriage and recoil systems of the 155mm M114 field gun. The upgrade kit has extended the gun's firing range with advanced ammunition to 22.5km with the ERFB/BB projectile (a 54% increase compared to the original M-114).

Mortars

A wide range of mortars designed to suit a variety of battlefield scenarios



Soltam CARDOM

Unique self-propelled recoiling mortar capable of firing in any condition and at every angle (360 degrees)

81/120mm autonomous, self-propelled recoiling mortar mounted on a tracked or wheeled vehicle. The Soltam CARDOM provides significant advantages including fast deployment, accuracy, area coverage, tactical mobility flexibility and survivability. Equipped with state-of-the-art navigation, command control and communication (C³) devices, the Soltam CARDOM offers infantry and mortar commanders enhanced operational capabilities, quick response time and automatic laying features. Battle-proven and NATO-qualified, the Soltam CARDOM system is currently employed in the US Army and in the Israel Defense Forces (IDF).

Soltam 60mm mortars

Weapon of choice for special forces, commando units and infantry forces

The lightweight 60mm mortar is an effective support weapon for close, medium, long and extended-range shooting. User-friendly, quickly deployed and reliable in all weather conditions, it is operated with a light handheld fire control system (FCS) – SOLMAC PDA. The mortar systems come with all auxiliary equipment necessary for field operation including a Fire Control computer and target acquisition systems.

Possible configurations include:

Soltam C-03 (1,000m) ,Soltam C-576 (1,600m) ,Extended-range mortar Soltam C-06A1 (6,000m)



Soltam 81mm mortars

Effective support weapon for short, medium, long and extended-ranges

Available as both dismounted and vehicle-mounted, the 81mm mortars are easy to operate and reliable in all weather conditions. The systems come with all auxiliary equipment necessary for field operation including a Fire Control computer and target acquisition systems.

Possible configurations include:

Soltam B-502 split barrel (6,500m), Soltam B-433 lightweight mortar (4,100m), Soltam B-599 Extended-range (7,000m)



Ammunition

Soltam Mortar Ammunition – 60mm, 81mm and 120mm



Quick response fire support at the platoon and company level for infantry or mechanized infantry Elbit Systems' range of high-quality mortar ammunition is used to provide effective fire support (FS) to all types of combat units. The advanced bombs can be fired from all suitable and qualified smooth bore mortars in the customer's inventory. High explosive, WP, and smoke mortars are available in 60mm, 81mm and 120mm calibers, and are equipped with point detonating, proximity and electronic time fuses. Training and illuminating bombs are also available.

LAND FORCES

Artillery Fire Power



ISRAEL MILITARY INDUSTRIES LTD. (IMI)

P.O.Box 1044, 64 Bialik Blvd.
Ramat Hasharon 4711001, Israel
Tel: 972-3-5485222
Fax: 972-3-5486125
E-mail: imimrktg@imi-israel.com
Web Site: www.imi-israel.com

LYNX

LYNX is an autonomous, multi-purpose artillery rockets and missiles launching system. The system can fire various artillery rockets and tactical missiles from 122mm to 306mm, including IMI's 160mm ACCULAR GPS guided rocket, 306mm EXTRA extended-range rocket and the DELILAH-GL (Ground-Launched) precision, deep strike loitering missile. LYNX features fully autonomous ballistic calculation and launch capabilities and comprises an advanced fire control system, INS and C⁴I for network centric operations as an element of larger artillery formations. LYNX automatically identifies the munitions on board and can be reloaded in less than 10 minutes. The system is operational and has been successfully deployed in several armies worldwide.

EXTRA

EXTRA is a 306mm extended-range, GPS-guided artillery rocket system. The rocket system provides precise long range capability in day, night and all weather conditions. EXTRA has a maximum range of 150 km and a Circular Error of Probability (CEP) of 10 meters.

ACCULAR

ACCULAR is a 160mm autonomous, surface-to-surface GPS-guided artillery rocket with a range of 14-40 km and a CEP of 10 meters. The rocket can be equipped with a variety of warheads and can be launched from LAR-160, LYNX and similar launching platforms.

155mm M454 S-HE

The M454 is a 155mm Super - High-Explosive (S-HE) artillery projectile for use against

infantry and LAVs. The projectile introduces a unique solution based on a pre-fragmented drogue parachuted warhead, guaranteeing up to five times more lethality than standard HE projectiles. The M454 joins IMI's family of 155mm artillery projectiles. These include various Extended-Range (ER), HE, Smoke and Illumination projectiles.

UMACS / BMACS

The UMACS/ BMACS are uni and bi-modular artillery charge systems. The charges are designed to replace all existing 155mm artillery bag charges, which typically differ in size, shape, weight and nature of propellant. This typically leads to wastage of residual charge components and ultimately to additional logistics costs. UMACS/ BMACS are interoperable with all 155mm gun systems (39, 45, 52 cal.) and comply with NATO JBMoU.

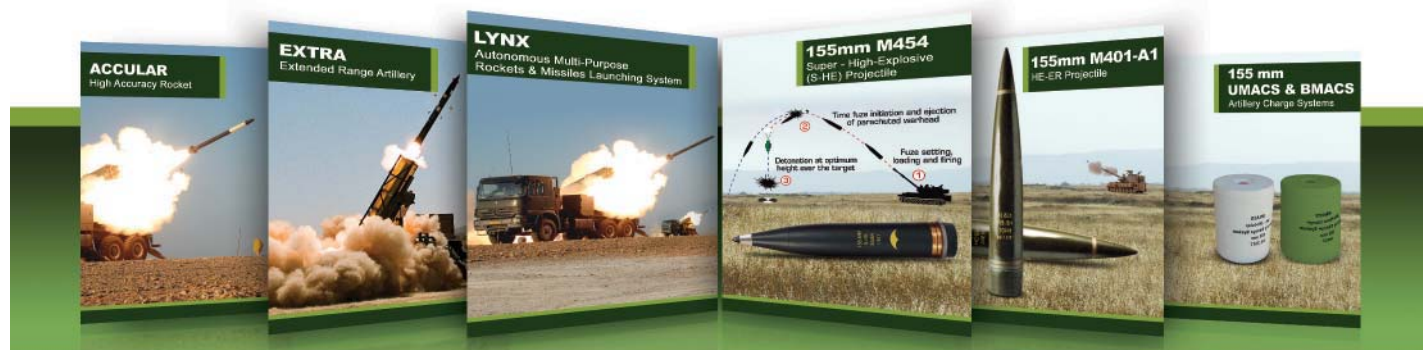

SPIKE FAMILY



RAFAEL
ADVANCED DEFENSE SYSTEMS
 P.O.Box 2250 (19)
 Haifa 3102102, Israel
 Tel: 972-4-8794714
 Fax: 972-4-8794657
 E-mail: intl-mkt@rafael.co.il
 Web Site: www.rafael.co.il

Multi Purpose Weapon Systems:

SPIKE FAMILY

The SPIKE Family consists of missiles suited for land, air and sea platforms, multiple ranges and a variety of targets. The missiles in this family have sophisticated electro-optic CCD or IIR sensors for day/night all-weather operation, as well as a tandem warhead. Their lofted trajectories enable the warhead to strike the target at its most vulnerable location with pinpoint precision and minimal collateral damage. All of the SPIKE Family members have a low life-cycle cost, due to high reliability and operational and logistic support and production commonality between members.

Designation	Max. Range	Application
Spike-SR	1,000m	Infantry and Special Forces
Mini-Spike	1,500m	Infantry and Special Forces
Spike-MR	2,500m	Infantry and Special Forces and Combat Vehicles
Spike-LR	4,000m	Infantry and Special Forces and Combat Vehicles
Spike-ER	8,000m	Infantry, LCV, Helicopters
Spike-NLOS	up to 25km	Multi-Purpose ,Multi-Platform



SAMSON FAMILY



SAMSON RWS

Rafael's Remote Weapon Station (RWS) Family Globally integrated on thousands of fielded ground and naval platforms, Rafael's Samson family of advanced remote weapon stations (RWS) capitalizes on extensive combat experience with a deep understanding of emerging military needs.

Designed for high performance and survivability on land and at sea, the Samson RWS have been adapted to a wide variety of main battle tanks, trucked and wheeled armored personnel carriers and marine craft.

The Samson Family is offered in six land configurations and two naval configurations. Samson RWS support diverse, interchangeable weapons and sensors including 5.56/7.62/12.7 mm machine guns, 40mm automatic grenade launchers, anti-tank missiles, observation pods, and non lethal capabilities.

Deployed in over 25 countries under rigorous combat and environmental conditions, these robust weapon stations are a dependable force multiplier and trusted partner for the most challenging missions.

Battle-proven land applications include thousands of RWS for the Israel Defense Forces (IDF), the Czech Republic Army, the UK Royal Armed Forces, and many others. Rafael is currently the sole supplier of RWS to the IDF.

Breakthroughs in RWS Development

Under-Armor Reloading

The superior capabilities and performance of Rafael's RWS have been further enhanced by various ingenious force survivability multipliers, including in-hull ammunition reloading which enables uninterrupted operation while minimizing the crew's exposure to life-threatening battlefield dangers. The patented system is loaded from under the deck, and in addition to its operational benefit, is ergonomically designed for loader convenience and operation with minimum effort and maximum consideration of physical health.

Non-Lethal Capabilities

The newest addition to the Samson RWS family is its Non-Lethal (NL) capability which bases its response on all human biological senses. Whether employed for crowd control or other urban scenarios, the Samson NL capability provides the symmetrical response required to alleviate potentially explosive situations.

Samson NL concept is based on a five-sense response and the dual use of the RWS; interchangeable for NL and L use.

Samson Jr.

The lightest of the Samson RWS family, the Samson Jr. is intended for wheeled, tracked, and naval platforms which mandate minimum deck load and silhouette. Designed for defensive fire in military and paramilitary operations, the Samson Jr. mounts a variety of crew-exchangeable small caliber armaments, including 7.62mm or 5.56 machine guns, sharpshooter rifles and non-lethal weapons.

**RAFAEL
 ADVANCED DEFENSE SYSTEMS**

P.O.Box 2250 (19)
 Haifa 3102102, Israel
 Tel: 972-4-8794714
 Fax: 972-4-8794657
 E-mail: intl-mkt@rafael.co.il
 Web Site: www.rafael.co.il

SAMSON MINI

The Samson Mini dual-axis, gyro-stabilized RWS is designed for use on light wheeled or tracked combat vehicles, fast attack boats and other platforms requiring improved offensive capabilities. The system enables target engagement with enhanced accuracy, while maximizing crew protection from enemy fire.

This single-weapon RWS accommodates a variety of armaments including a 5.56mm SAW and LMG, 7.62mm GPMG and Gatling gun, 12.7mm HMG, 14.5mm, 40mm AGL, ATGM launcher, ASM, fed by high-capacity magazines. Supported by a ballistics-protected multi-sensor Sight Pod, with an optional mechanism for super elevation ballistic angle calculations, the Samson Mini provides a 'round-the-clock response to high-maneuvering battlefield challenges.

SAMSON DUAL

The Samson Dual is a dual-axis, gyro-stabilized RWS that simultaneously mounts two weapons. Developed originally to carry a 25-30mm lightweight weapon as main armament and 7.62mm secondary weapon for short range engagements, the Samson Dual enables multiple-threat handling in high-mobility scenarios. Much more robust than equivalent systems, the Samson Dual is also strong enough to incorporate an ATGM Launcher as a force multiplier. Featuring a special mode that decouples the weapons from the sight pod, this Samson configuration is also ideal for reconnaissance and peace-keeping missions.

NEW SAMSON 30MM MKII

The new Samson 30mm MKII is a 30mm Weapon RWS designed for use on any modern light-armored, high-mobility fighting vehicle, new or upgraded, without modifications. It mounts main and secondary armaments, of Eastern and Western origins, including a 30/40 mm automatic cannon, 40 mm AGL (optional), and 7.62 mm coaxial machine gun. Additional mountable force multipliers include ATGM launchers, ASM, and SGL obscurants.

Equipped with a dual-axis, gyro-stabilized, retractable, dual-sight, weapon mounting system, and the system's configuration provides the commander with full "hunt-kill" capabilities without interfering with the Gunner's current missions.

Main Advantages of the Samson RWS family:

- Commonality and Affordability
- Optimized Survivability Design
- Environmental Compliance
- Precision and Lethality
- High Versatility
- Viable Alternative to the Traditional Turret
- Lighter in weight and more compact, rendering better overall platform mobility and maneuverability
- Safer - No gas emissions or rotating mechanical parts in the hull
- No RWS deck penetration, providing more space in the hull
- Plug-and-play fire control system - Same main computer unit (MCU) for all systems
- Superior 360° situational awareness
- Higher reliability, availability, maintainability, and durability
- Ability to interface with C⁴I and external sensors including hostile fire indicators



SPOTLITE FAMILY



RAFAEL
ADVANCED DEFENSE SYSTEMS
P.O.Box 2250 (19)
Haifa 3102102, Israel
Tel: 972-4-8794714
Fax: 972-4-8794657
E-mail: intl-mkt@rafael.co.il
Web Site: www.rafael.co.il

Spotlite Family

In-motion Or Portable enemy fire source Detection, positioning and classification system

Mechanized warfare is particularly complex. Sniper fire, RPG rockets, and in particular anti-tank missiles are lethal threats to the various types of ACVs moving in the battle field. Inability to detect threats and locate the position of the firing enemy causes numerous casualties, massive, inaccurate, and wasteful fire by our forces. Most importantly it lets the enemy retain the initiative in the battle field. Spotlite is a family of electro-optical products that quickly and accurately detect and locate enemy fire and swiftly close the sensor-to-shooter loop so as to neutralize the enemy and to keep initiative on the battle field in our hands.

The first product unveiled about two years ago was the Spotlite P, formerly MK2. This is a man-portable system that detects and locates enemy shooting small arms. It immediately investigates the target to verify that it is indeed a terrorist and quickly sends the target data to snipers or any other relevant shooters that can neutralize the source of fire. Since the system is man-portable and battery-operated it has great operational flexibility and can be positioned inside buildings as well as in areas impassible by vehicle.

An additional product, Spotlite – M, has recently joined the family. Spotlite – M is an electro-optical system installed on ACVs and other vehicles that detects and locates an enemy that is firing small arms, RPG bombs, anti-tank missiles, and rockets, in motion, day and night, at a range of up to 360°.



MOST POPULAR ELECTRONIC FUZES

**RELIABLE, SAFE AND ACCURATE -
RESHEF'S ELECTRONIC FUZES DELIVER
TOP PERFORMANCE**



RESHEF TECHNOLOGIES LTD.

7 Haplada St.,
P.O.Box 5035
Or-Yehuda 6055001, Israel
Tel: 972-3-5388604
Fax: 972-3-5339223
E-mail: info@resheffuzes.com
Web Site: www.resheffuzes.com

Reshef offers experience and leading edge know-how in development and production of latest-generation electronic fuzes for all types of Mortar bombs, Artillery projectiles, Tank rounds and Artillery Rockets.

Reshef's modern facilities and production techniques assure effective implementation of the company's comprehensive R&D experience to match customer demands. Broad and multidisciplinary capabilities enable Reshef to meet every special requirement.

All the fuzes are qualified for safety and environmental conditions, according to the Military Standards (MIL-STD and STANAG).



THETA M788

THETA M788

- Dual-option Electronic Proximity fuze for Mortar bombs, with a Point-Detonating (PD) mode by selection or as a backup. Dual safe without safety pull-wire.
- Compatible with 60mm, 81mm, 82mm & 120mm Mortar bombs, HE & WP smoke types, all charges and all muzzle & terminal velocities.

LAMBDA M760

- Highly accurate Electronic Time (ET) fuze for Mortar bombs, dual safe without safety pull-wire.
- Compatible with 60mm, 81mm, 82mm & 120mm Mortar bombs, illumination, smoke & cargo types.

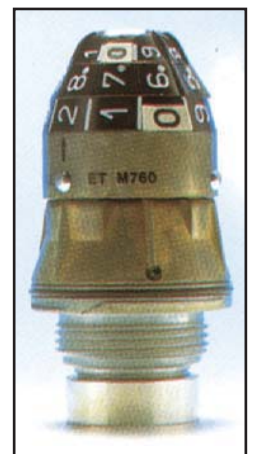

LAMBDA M760

OMICRON M180

- Time gated Electronic Proximity fuze based on FMCW RF Sensor.
- Compatible with all types of HE & WP Artillery projectiles of 105mm, 155mm & 203mm (8") Howitzer and 130mm & 175mm Field Gun projectiles.



OMICRON M180

ZETA M138

- Highly accurate Electronic Time (ET) fuze for Artillery projectiles. Accuracy better than 0.1 sec over entire time-set range of 200 sec.
- Compatible with 105mm, 155mm & 203mm (8") Howitzer ammunition and 130mm & 175mm Field Gun projectiles. Produced in both expelling and detonating modes.

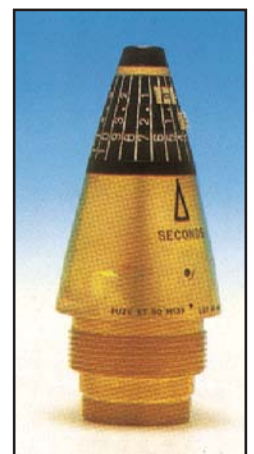

ZETA M138

MSV - MOBILE SURVEILLANCE VEHICLE

Aeronautics

AERONAUTICS LTD.

P.O.Box 169
Yavne 8110101, Israel
Tel: 972-8-9433600
Fax: 972-8-9328912
E-mail: info@aeronautics-sys.com
Web Site: www.aeronautics-sys.com



MSV System

Aeronautics' Mobile Surveillance Vehicle (MSV) system provides a comprehensive Ground Intelligence Surveillance and Reconnaissance solution for military and homeland security missions. The MSV system consists of a Stabilized Automatic Intruder Detection and Recognition system, mounted on a telescopic pole. The operational gear and displays are installed inside the platform for convenient and rapid usage.



4 X 4

ALL-TERRAIN TACTICAL AND ARMORED VEHICLES



Automotive Industries Ltd.

AUTOMOTIVE INDUSTRIES LTD.

P.O.Box 535
Nazareth Illit 1710501, Israel
Tel: 972-4-6558104/147
Fax: 972-4-6558103
E-mail: info@ail.co.il
Web Site: www.ail.co.il

Automotive Industries Ltd. (AIL) is a manufacturing and assembly plant for vehicles specializing in 4 x 4 all terrain tactical vehicles for military and commercial use. All vehicles are also available in an armored version. In addition the company produces a variety of sophisticated metal works and assemblies for the "Hi-Tech" Industry.

Storm 3 M-243 4 x 4 Light Utility Vehicle

This multipurpose new generation military vehicle has a payload of up to 1200 kg and is ideally suited to military missions requiring high power, speed, off road capability and high reliability. The Storm 3 features a 2.8L diesel engine (196hp), automatic transmission and a specially designed suspension system. The vehicle incorporates a 5 door hard top cab (with a soft top option) for quick and convenient entrance and exit of passengers. The Storm 3 is available in an armored version, Troop carrier and LSV(Light Strike Vehicle)

ABIR II - 4X4 Light Tactical Truck

This multipurpose high performance military vehicle is designed to meet the power, speed, mobility and reliability requirement of modern armies. Turbo Diesel engine, 305hp 6.7L, 6 speed automatic transmission.

With high standard cabin and payload of up to 1700 kg / 3750 lbs. Abir II can carry up to 3+16 troops. This vehicle can be supplied with either soft top or metal cab version and is also available in various configurations: Armored, Missile Launcher, Tow Truck.



IMCO

**“A Sterling Reputation
is the Best Recommendation”**



IMCO INDUSTRIES LTD.

8 Hataasia St., P.O.Box 188

Tel-Hanan 3660102, Israel

Tel: 972-4-8213322

Fax: 972-4-8210508

E-mail: marketing@imco-ind.com

Web Site: www.imco-ind.com

IMCO Industries Ltd. (TASE: IMCO), and its subsidiaries Advanced Defense Technologies Inc. (ADT) in Baltimore, USA, Atena Ltd. and Nir-Or (Israel) Ltd. in Israel provide a full line of military and commercial electrical harnesses, control boxes, assemblies and electromechanical devices to the global defense and aerospace markets. Imco Group is a market leader in military and commercial applications, ranging from airborne, missiles, naval, ground vehicles and UAV to custom and off-the-shelf commercial systems for automotive, medical and industrial markets.

Imco's top-level manufacturing teams continue to provide reliable industry-leading electrical harnesses and a variety of electromechanical devices for customers in the defense industry:

- **Airborne Products and Systems:** Aircraft and helicopters systems such as Nomex® coated cable harnesses, control boxes (including illuminated panels), power boxes, pilot sticks and throttles, PITOT tubes, fuse boxes, contactor boxes, thermocouples for jet engines and test equipment for airborne fuel systems and drop tank universal testing apparatus.
- **Missiles and Unmanned Aerial Vehicles (UAV):** Test equipment, control systems and cable harnesses for missile launchers, special harnesses, gimbals, control boxes, relay boxes and fuse boxes.
- **Land Systems (Battle Tanks, Combat and Armored Vehicles, Artillery Systems, Tracked and Wheeled Vehicles, Combat Engineering, Mine Clearance Equipment): Automotive control and electrical systems, including:** cable harnesses , driver and commander control panels, tank commander and gunner turret control handles, smoke grenade launching (SGL) systems, slip rings, front LED headlamps and rugged, military-grade cabin LED lighting systems for battle tanks and armored personnel carriers (APC) , tactical LED lighting systems inside and outside of vehicle with blackout function and low-battery indication as well as control boxes for heating, ventilation - and air-conditioning (HVAC) systems.
- **Naval applications:** Electrical harnesses, electromechanical and electronic boxes, as well as LED Lights for submarines, OPVs, Corvettes and Frigates.

With manufacturing capability on two continents, the company is well positioned to respond quickly to customer requirements. Designed-in flexibility allows rapid product customization to meet specific customer requirements.

All Imco facilities are ISO 9001:2008 certified. Imco complies with IPC-WHMA-A-620, AS-9100 and US MIL-STD requirements. Our design, manufacturing and quality assurance functions are integrated under Imco's global organization, ensuring our customers a fast time-to-market with our products.



VEHICLES ARMORING AND PATENTED SPECIAL PERSONAL UNIVERSAL ARMORING KIT FOR PASSENGERS INSIDE SOFT VEHICLES



TOP CAR ARMORING Ltd.
 10 Amsterdam St.,
 Sderot, 8714401 Israel
 Tel: 972-8-6496192
 Fax: 972-8-6483494
 Mobile: 972-54-4957184
 E-mail: dorontopcar@012.net.il
 Web Site: www.topcar-armorring.com

TOP CAR ARMORING Ltd. specializes in vehicle armoring and is a manufacturer of civilian type armored vehicles. such armored vehicles as SUV, sedans, commercial vehicles, VIP cars, pick-ups, trucks, buses and vans.

TOP CAR ARMORING has certified QMS ISO 9001 2008 the standards institutions of israel. The company is an official supplier of the israeli mod (Number: 0011008980) and the company has the israeli ministry of transportation approval for armoring cars.

The founder of Top Car Ltd. is in this business for over 30 years and has armored hundreds of cars for governments, security companies, policeforces, embassies and VIPs in countries all around the world.

TOP CAR ARMORING has developed the most advanced car armoring technologies.

TOP CAR ARMORING is a company with the most advanced know-how and experience in armoring of passengers cars with High-Tech and Light Weight composite armor materials, (more protection and survivability) and supplies all international markets.

TOP CAR ARMORING has unique knowledge and experience on international standards (USA, Europe and Israel) including extensive knowledge in producing materials to get the best ballistic solution.



ADD ON ARMOR



Rafael's Add On Armor Products

Rafael is a major and unique armor company dealing with all protection technologies: passive, reactive, hybrid and Active Protection systems. Rafael conducts development, design, integration and production of the most advanced armor systems to enhance the protection level of armored vehicles.

Rafael uses its extensive past experience to provide high level of protection, lightweight and low cost enhancements integrated on all types of combat platforms. All armor products are modular and capable to protect combat vehicles from a broad range of threats such as small and medium kinetic energy (KE) armor piercing (AP) projectiles, high energy anti-tank Shaped Charges (SC), high speed fragments of artillery and Improvised Explosive Devices (IEDs) and Explosive Forming Projectiles (EFPs).

The performance and specifications of the systems meet the protection requirements and standards of the Israel Defense Forces (IDF), the US Army, USMC and NATO force standards. The systems have been tested, qualified and approved for application by the customers worldwide and are combat proven. Rafael had eight different add-on armor systems, served in the Iraqi / Afghan theater with the coalition forces.

Reactive Armor

Rafael is the world leading company in the application of the reactive armor technology. It was the first company to develop, design and integrates reactive armor systems on combat vehicles. The reactive armor is the most effective add-on armor technology to protect Armored Fighting Vehicles (AFV's), Armored Personal Carriers (APC's) and Main Battle Tanks (MBT's) against shaped charge threats of Rockets and ATGMs.

For light armored vehicles, Rafael developed Hybrid armor which combines reactive and passive elements to provide complete, 360 degrees protection against anti-tank rockets, medium KE AP projectiles and high speed fragments. Upgraded multi-threat hybrid armor, Multi-Threat Armor Protection (MTAP) system has recently been developed to defeat also EFPs and IEDs.

Rafael's reactive and hybrid system have been fitted to many combat vehicles worldwide. In the US, Rafael, together with its partner General Dynamics ATP, integrated produced and supplied reactive / hybrid armor systems for the Bradley AFV and the Stryker vehicles.



M60



Bradley



M113

RAFAEL
ADVANCED DEFENSE SYSTEMS
 P.O.Box 2250 (19)
 Haifa 3102102, Israel
 Tel: 972-4-8794714
 Fax: 972-4-8794657
 E-mail: intl-mkt@rafael.co.il
 Web Site: www.rafael.co.il

Passive Armor

Rafael has developed and applied various passive armor technologies to protect combat vehicles, including ceramic, metallic, shaped, laminated and perforated technologies. The passive add-on armor is modular, lightweight and easily installed by the crew. It is maintenance-free and combat-proven.

The systems provide protection against 14.5 mm AP projectiles, high speed fragments of artillery shells and IED (STANAG 4569, Level 4 and beyond). Rafael has recently developed passive add-on lightweight, effective modular armor to defeat EFPs.

Rafael's armor systems are in use by the IDF, USMC, Italian Army, New Zealand Army, Czech Army and others. They are combat proven and received excellent reports about their performance in the Operation Iraqi Freedom and peace keeping missions worldwide. Rafael's Enhanced Appliqué Armor Kit (EAAK) add-on armor system was selected by the USMC as a sole source, for the AAV7 amphibious APC.

RAFAEL's Reactive Armor installed on the US Bradley AFV (left) and Passive Armor installed on the USMC AAV7 APC (right).



AAV7

M113

Rosomak

■ Certificates from the US Army and USMC to Rafael for its reactive and passive armor systems, installed on the Bradley, Stryker and AAV7 ■



SAMSON FAMILY



SAMSON RWS

Rafael's Remote Weapon Station (RWS) Family Globally integrated on thousands of fielded ground and naval platforms, Rafael's Samson family of advanced remote weapon stations (RWS) capitalizes on extensive combat experience with a deep understanding of emerging military needs.

Designed for high performance and survivability on land and at sea, the Samson RWS have been adapted to a wide variety of main battle tanks, trucked and wheeled armored personnel carriers and marine craft.

The Samson Family is offered in six land configurations and two naval configurations. Samson RWS support diverse, interchangeable weapons and sensors including 5.56/7.62/12.7 mm machine guns, 40mm automatic grenade launchers, anti-tank missiles, observation pods, and non lethal capabilities.

Deployed in over 25 countries under rigorous combat and environmental conditions, these robust weapon stations are a dependable force multiplier and trusted partner for the most challenging missions.

Battle-proven land applications include thousands of RWS for the Israel Defense Forces (IDF), the Czech Republic Army, the UK Royal Armed Forces, and many others. Rafael is currently the sole supplier of RWS to the IDF.

Breakthroughs in RWS Development

Under-Armor Reloading

The superior capabilities and performance of Rafael's RWS have been further enhanced by various ingenious force survivability multipliers, including in-hull ammunition reloading which enables uninterrupted operation while minimizing the crew's exposure to life-threatening battlefield dangers. The patented system is loaded from under the deck, and in addition to its operational benefit, is ergonomically designed for loader convenience and operation with minimum effort and maximum consideration of physical health.

Non-Lethal Capabilities

The newest addition to the Samson RWS family is its Non-Lethal (NL) capability which bases its response on all human biological senses. Whether employed for crowd control or other urban scenarios, the Samson NL capability provides the symmetrical response required to alleviate potentially explosive situations.

Samson NL concept is based on a five-sense response and the dual use of the RWS; interchangeable for NL and L use.

Samson Jr.

The lightest of the Samson RWS family, the Samson Jr. is intended for wheeled, tracked, and naval platforms which mandate minimum deck load and silhouette. Designed for defensive fire in military and paramilitary operations, the Samson Jr. mounts a variety of crew-exchangeable small caliber armaments, including 7.62mm or 5.56 machine guns, sharpshooter rifles and non-lethal weapons.

**RAFAEL
 ADVANCED DEFENSE SYSTEMS**

P.O.Box 2250 (19)
 Haifa 3102102, Israel
 Tel: 972-4-8794714
 Fax: 972-4-8794657
 E-mail: intl-mkt@rafael.co.il
 Web Site: www.rafael.co.il

SAMSON MINI

The Samson Mini dual-axis, gyro-stabilized RWS is designed for use on light wheeled or tracked combat vehicles, fast attack boats and other platforms requiring improved offensive capabilities. The system enables target engagement with enhanced accuracy, while maximizing crew protection from enemy fire.

This single-weapon RWS accommodates a variety of armaments including a 5.56mm SAW and LMG, 7.62mm GPMG and Gatling gun, 12.7mm HMG, 14.5mm, 40mm AGL, ATGM launcher, ASM, fed by high-capacity magazines. Supported by a ballistics-protected multi-sensor Sight Pod, with an optional mechanism for super elevation ballistic angle calculations, the Samson Mini provides a 'round-the-clock response to high-maneuvering battlefield challenges.

SAMSON DUAL

The Samson Dual is a dual-axis, gyro-stabilized RWS that simultaneously mounts two weapons. Developed originally to carry a 25-30mm lightweight weapon as main armament and 7.62mm secondary weapon for short range engagements, the Samson Dual enables multiple-threat handling in high-mobility scenarios. Much more robust than equivalent systems, the Samson Dual is also strong enough to incorporate an ATGM Launcher as a force multiplier. Featuring a special mode that decouples the weapons from the sight pod, this Samson configuration is also ideal for reconnaissance and peace-keeping missions.

NEW SAMSON 30MM MKII

The new Samson 30mm MKII is a 30mm Weapon RWS designed for use on any modern light-armored, high-mobility fighting vehicle, new or upgraded, without modifications. It mounts main and secondary armaments, of Eastern and Western origins, including a 30/40 mm automatic cannon, 40 mm AGL (optional), and 7.62 mm coaxial machine gun. Additional mountable force multipliers include ATGM launchers, ASM, and SGL obscurants.

Equipped with a dual-axis, gyro-stabilized, retractable, dual-sight, weapon mounting system, and the system's configuration provides the commander with full "hunt-kill" capabilities without interfering with the Gunner's current missions.

Main Advantages of the Samson RWS family:

- Commonality and Affordability
- Optimized Survivability Design
- Environmental Compliance
- Precision and Lethality
- High Versatility
- Viable Alternative to the Traditional Turret
- Lighter in weight and more compact, rendering better overall platform mobility and maneuverability
- Safer - No gas emissions or rotating mechanical parts in the hull
- No RWS deck penetration, providing more space in the hull
- Plug-and-play fire control system - Same main computer unit (MCU) for all systems
- Superior 360° situational awareness
- Higher reliability, availability, maintainability, and durability
- Ability to interface with C⁴I and external sensors including hostile fire indicators



DRY STORAGE SYSTEMS

(Save time - save money and stay operational ready)

Mifram Ltd.

The developers and suppliers of creative physical security solutions



MIFRAM LTD.

6 Josef Levi St., P.O.Box 1165
Ind. Zone Kiriya Bialik
Zur Shalom 2711101, Israel
Tel: 972-4-8808800
Fax: 972-4-8745745
E-mail: sales@mifram.com
Web Site: www.miframsecurity.com



Our dry storage buildings are developed to protect military/commercial equipment and vehicles against damage caused by humidity and corrosion leaving them operational ready at all times.

The dry storage facilities can accommodate all type of important equipment and machines that may be needed on an instant notice, such as:

- Tanks
- Mobile canons
- Radar weapons
- APVS
- Missiles
- Optical electronics
- Associated ammunitions

When utilizing our dry storage buildings you can reduce your maintenance and service costs for such equipment by about sixty percent.

Equipment can be stored for up to two years without the need for periodic maintenance; as an additional benefit you are increasing the life of such equipment .That's a major impact on over all operational costs.

Principles of our storage concepts:

The customized shed becomes a barrier developed to keep humidity and dirt from reaching stored equipment. Temperatures are controlled by a sophisticated insulation system. This is accomplished by the installation of custom developed dehumidifiers keeping the average humidity levels under 35 % RH. The lack of moisture, dust and dirt ensures that all stored equipment and goods remain in the same condition they were at time of storage.

Additional available monitoring devices:

- Fire detection
- Intrusion detection
- Hydrogen level

Benefits of a dry shed:

Keeps machinery clean, preserves paint, protects rubber parts and keeps vehicles disc brakes shiny and rust free due to ultraviolet light. Ozone fresh air with oxygen and moisture is eliminated from the storage environment

Storage sheds are needed if:

- Machinery receives moisture during storage.
- Machinery must remain clean and operational ready.
- Corrosion needs to be reduced on vehicles and machinery.

The Mifram Group:

For over 40 years we have been developing simple cost effective and efficient engineering solutions in the ever changing environment of the security and protection arenas. Solutions are developed to the client's individual needs in the most effective and cost effective manner possible.

With our specially developed storage systems you are always operational ready and your savings in time and money are an additional benefit.



ANTI PERSONAL MINE SAFETY SHOES

PATENTED

The MFC CHECKMATE Safety Shoes (MATRAMINE) - Minefield-shoes NSN: 8430-15-121-9857. NSN: 1385-14-508-8844/5. are the culmination of years of research: designed and developed by a team who have tested and used them in the field.

A totally unique concept: inflatable and deflatable in seconds.

The MFC CHECKMATE Safety Shoes enable the soldier, sapper, commando, to traverse a minefield over mud, over water, over any terrain in safety, simply by slipping the compact unit out of his regulation pack, inflating the air cushions and continuing on his way. In seconds.

The MFC CHECKMATE Safety Shoes is the successful result of research and testing.

The shoes has been in use succesfully for more than 10 years as part of regulatory equipment of IDF army - French army and most of the NATO forces.

The MFC CHECKMATE Safety Shoes are built on the theory of air-cushions, which support the body while reducing the pressure in relationship to the minefield.

The CHECKMATE is completely portable, folds up into a small lightweight object and easily slipped into a regulation army pack.

It has an exceptional lifespan of 25 kilometers, which can be traversed by a soldier carrying a weight of up to 250 kilos: his own weight, that of a full pack and a wounded comrade- the minimum requirement.

The CHECKMATE is made of sturdy nylon, nylon-reinforced PVC, coated aluminum and steel alloys, the five air cushions are of specially-designed, patented material created for maximum strength and resiliency.

The fully inflatable CHECKMATE can be used to float 25 kilos of equipment across water. The marine commando simply places his equipment on it, floats it across the water, then uses the CHECKMATE himself upon landing. Even if there should be a loss of air, or a puncture, it is still possible to traverse tens of meters before inflating the air-cushions again. And this can be accomplished in a matter of a few seconds.

FEATURES

- Fully inflatable and deflatable in seconds.
- Foldable into a small 350x160x120 mm pack.
- Lightweight - 2.3 kilos.
- Completely portable.
- Made of tough nylon, nylon-reinforced PVC; air cushions of PVC-type L 152.
- Upper rigid frame of aluminum and steel alloys. Self-locking error-proof device with no moving parts - eliminates maintenance problems.
- Metallic parts will not interfere with mine detector apparatus.
- Can be used to traverse any terrain: water, mud, swamp, brush will not decrease the efficiency.
- Designed to adapt to the conformation necessary to overcome obstacles with maximum safety.
- An much safer, more effective, easier to use.



D.T.E

D.T.E. CO. LTD.

P.O.Box 41, Industrial Zone,
Ashkelon 7810001, Israel
Tel: 972-8-6750342, 972-50-5236865
Fax: 972-8-6751045
E-mail: dte_com@netvision.net.il
Web Site: www.minefield-shoes.com

ARMORED DEVICE



Israel Aerospace Industries Ltd.
Commercial Aircraft Group, RAMTA Division

RAMTA DIVISION

P.O.Box 323
Beer-Sheva 8410202, Israel
Tel: 972-8-6402250, 6272231
Fax: 972-8-6402252
E-mail: mktg@iai.co.il
Web Site: www.iai.co.il/ramta

RAM MK III Light Armored Multi-Mission Vehicle

A high-performance, light-weight armored vehicle combining the finest in multi-mission wheeled designs with advanced human engineering:

- Monocoque hull constructed entirely from armored steel with customer-defined threat protection.
- Utilizes a robust and flexible structure allowing it to be outfitted and configured to perform a variety of military, paramilitary, policing and peacekeeping roles.
- High terrain capability and a solid 27.6:1 power to weight ratio.
- Excels as a mechanized infantry support vehicle in a variety of missions.
- Can be supplied with an assortment of sensors, light arms and precision missiles.
- Excellent maneuvering and high performance in rough terrain.



Armored D9 Tractor:

Every component of the Armored D9 Tractor, including a specially manufactured crew cabin, engine, fuel & oil tanks, hydraulic and electrical systems, is sheathed in customer-defined ballistic armor. Standard configuration includes weapon mounts, storage compartments, spot light and projector lamps, and communication equipment. Optional equipment includes smoke grenade launchers, and provisioning for customer-specific communication equipment.

The crew cabin accommodates a driver and commander, and comes equipped with communications, fire-suppression and personal weapon retention systems. Ergonomically positioned armored glass in the crew cabin provides maximum ballistic protection with high visibility, allowing views of all vehicle components in all directions.



On Board AMMAD:

The On Board Anti Magnetic Mine Actuating System detonates up to and including the latest generation magnetically fused passive, multi-mode and active mines in front of the vehicle, outside the 'kill zone'. The On Board AMMAD is an add-on kit and can be easily adapted to a wide variety of wheeled and tracked vehicles.



VERSATILE ARMORED VEHICLE RAM MK III



Israel Aerospace Industries Ltd.
Commercial Aircraft Group, RAMTA Division

RAMTA DIVISION

P.O.Box 323
Beer-Sheva 8410202, Israel
Tel: 972-8-6402250, 6272231
Fax: 972-8-6402252
E-mail: mktg@iai.co.il
Web Site: www.iai.co.il/ramta

RAM MK III Family of Light Armored Vehicles:

The Ram MK III is a high-performance lightweight armored vehicle combining the finest in multi-mission wheeled design with advanced human engineering. Ram MK III armored construction provides full ballistic protection from short-range arms fire up to 7.62mm armor-piercing ammunition (higher ballistic protection available per customer specifications).

The unique Ram MK III monocoque armored shell construction, coupled with extensively tested and operationally proven geometric hull shaping deflects energy and blast waves associated with mine detonation or enemy fired explosives.

This hull design also minimizes the possibility of overturning under combat conditions.

Configurations Include:

- Reconnaissance and armored support vehicle
- Mechanized infantry fighting vehicle
- Tank hunter/killer
- Command & control vehicle
- Signals command platform
- Anti-aircraft defense vehicle
- Mobile mortar platform
- Police, patrol and peacekeeping vehicle

Key Features:

- Excellent maneuverability in rough terrain
- High water fording (1m), extreme grade (60%) and side slope handling (30%)
- Versatile multi-mission capabilities
- Low life-cycle support & maintenance costs
- Low weight/silhouette for easy transport by air or sea



HBA SYSTEMS INTEGRATORS



SYSTEM INTEGRATORS
High-tech solutions for defense industries

Integrative Security Solutions

HBA SYSTEMS INTEGRATORS

Oasis Towers
77 Herzl St.,
Ramat Gan 5244350, Israel
Tel: 972-3-6722226
Fax: 972-3-6722193
E-mail: manuel.bar-gil@hba.co.il
Web Site: www.hba.co.il

A professional team of veterans from the Israeli IDF Special Forces and Police Special units, experts in the field of homeland security and anti terror, with 30 years' experience and exceptional achievements. The company specializes in providing full security solutions for governmental and private sectors worldwide.



Robotics & E.O.D.

Management and supply of EOD robot fleets, bomb technicians' units and EOD equipment with advance and diverse deployment.

Disrupters and binary explosives - The Perfect solution for bomb disposal operations and explosions in safe environment and transportation.

Electronic initiation systems - Complete, safe and cost effective initiation systems for long/short range which can be used in a wide range of applications: civil, military, EOD, off/on shore.



Training & Simulation

Designated anti-terror training & unique counter measures:

- Tactical ammunition for training
- Equipment, non-lethal weapons and ammunition for riot control
- Advanced multi magazine shot gun for counter terrorism use

Forensics

Full deployment for forensics and crime scene equipment, supporting laboratories and professionals for civil, military and police sections.

SANSOLO

Explosives, Demolition & Combat Pyrotechnics



**SANSOLO Security Consulting,
Development & Manufacturer Ltd.
Special Operations Equipment -
Explosive Entry**

19 Harel St.,
Ashkelon 7864919 , Israel
Tel: 972-54-7886261
972-52-3843758
Fax: 972-8-6780986
E-mail: info@sansolo.co.il
Web Site: www.sansolo.co.il

The SANSOLO Security Consulting, Development & Manufacturer Ltd. Company is an Israeli company that specializes in Security Consulting, Explosives, Demolition, Combat Pyrotechnics & new products development (Patent Protected).

Arie Sansolo, the company founder and president has a 25 year of experience in a variety of the Israeli top combat units, while in the last 15 years specialized as the head of an Israeli bomb disposal unit in a top anti-terrorist unit.

Main products / services:

Products

- Custom design development.
- Defensive/Offensive demolition products.
- Variety of combat pyrotechnics products & development.
- Specializes in unique tactical marking products.

Consulting Specialist

- Bomb disposal expert.
- Writing procedures, guidelines and safety instructions.
- Security & Special units consultant.

Training Specialist

- Courses on various aspects of demolition.
- Training on working methods for defensive and offensive demolition.



**A TELESCOPIC HEIGHT ELEMENT
FOR MARKETING SL-076**



**BREAK-IN/ASSAULT KIT
SL-056**



**RAPID DEPLOYMENT ELECTRICAL
DETONATION KIT SL-020**



**SANSOLO KIT
SL-030**

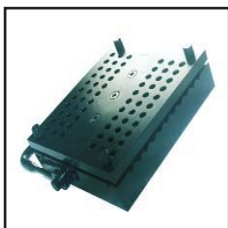

**BURSTMASTER
SL-015**



**BANG BUFFER
SL-012**



**DUAL PURPOSE
SLEEVE SL-003**



**DETONATION SIMULATOR
SL-010**

Quadro Projects & Technologies Ltd.

Disposal of Dangerous War Remnants Division

Quadro is a part of selected group of Israeli companies which are authorized by the Israeli "MOD" (Israeli Ministry of Defense) -"MOD" No. 83924941& 39170621, "Sibat" No. 100-62814. To operate world wide (In Israel and around the Globe) in the line of :

Humanitarian Mine Clearance & UXO Disposal Projects/Operations.

Humanitarian Mine Clearance & EOD/UXOD,IEDD,IEOD UXO Projects/Operations.

EOD – Explosives Ordinance Disposal.

IEOD – Improvised Explosives Ordinance Disposal.

UXOD – Un Exploded Ordinance Disposal.

IEDD – Improvised Explosives Disposal Devices.

WHO ARE WE?

Our Team consists a group of former senior Officers and NCO's From the Corps of Combat Engineers/I.D.F (Israel Defense Forces) with De-Mining and EOD background .

These Experts are backed by many years of extensive field experience, and retain strong links with the Mine Clearance and the EOD communities.

In addition we are updated with the latest developments in those Highly specialized fields.

We have a list of authorized and dedicated Personnel for International Mine Clearance and UXO disposal Projects.

WHAT DO WE DO?

- ❑ Consulting services for mine clearance and UXO disposal.
- ❑ Global humanitarian de-mining projects.
- ❑ Disposal of unexploded ordnance.
- ❑ Disposal of dangerous war remnants in urban zones.
- ❑ Treatment/handling of dangerous materials (Chemical and more).
- ❑ Inspection of Vessels for "Non Explosive" load (Ammunition verification)
- ❑ Disposal of classified material (For governmental organizations/offices).
- ❑ Blasting services for construction projects, roads & airfields.
- ❑ Designing & manufacture/production of instruction auxiliaries.
- ❑ Cross sections & models.
- ❑ Training - erectind of de-mning & UXO centers/school.
- ❑ Mine & explosives detection dogs services.
- ❑ Educating communities - awarness teams.
- ❑ Asistance to victims -medical centers & rehabilitation.
- ❑ Supervisionqinspection & quality control for de-mining/ EOD projects.
- ❑ Environmental consulting services.





Quadro Projects & Technologies Ltd.
 33 Yahadut Canada St., (Kaplan)
 Or Yehuda 6037533, Israel
 Tel: 972-3-9413010
 Mobile: 972-50-8818886
 Fax: 972-3-9410743
 E-mail: quadro@quadro.co.il
 Web Site: www.quadro.co.il

EOD (Explosive Ordnance Disposal) Capabilities

- Transportation.
- Disassembly.
- Destruction techniques.
 (Explosion Burning, Plasma, Crushing, Grinding).
- Burning Disposal.
 ("Red Termite" special Powder ... and more).
- Design and Manufacture of Instruction Auxiliaries and Cross Sections.



Quadro Projects & Technologies Ltd.

Disposal of Dangerous War Remnants Division



Mine Clearance Capabilities & Techniques

- Manual Technique.
- Mechanical Technique/Technology.
- Dogs Technique.
- Destruction Techniques.
(Burning, Explosion, Crushing/Grinding).





Quadro Projects & Technologies Ltd.
 33 Yahadut Canada St., (Kaplan)
 Or Yehuda 6037533, Israel
 Tel: 972-3-9413010
 Mobile: 972-50-8818886
 Fax: 972-3-9410743
 E-mail: quadro@quadro.co.il
 Web Site: www.quadro.co.il

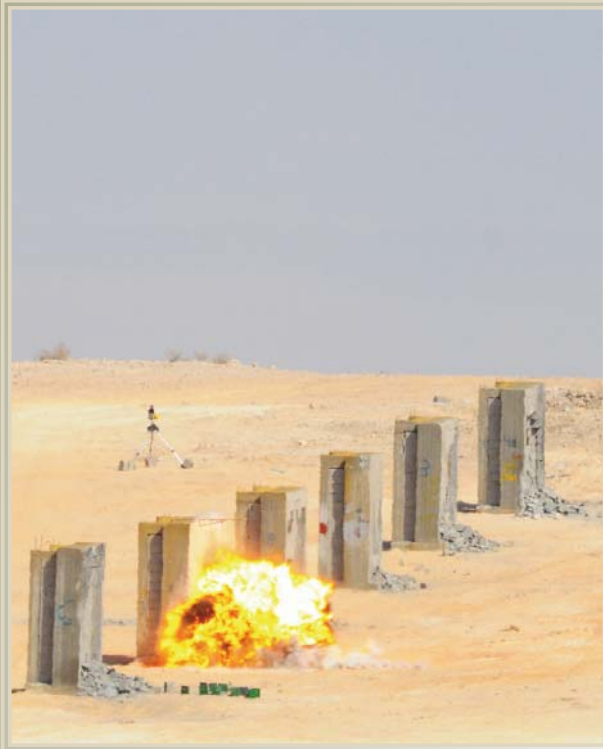

Mine Clearance & EOD - R & D (Research & Development)

- EDS - Explosive Destruction Systems
- CCAS - Cleaning Contaminated Areas Solutions
- CMAT - Crossing Mined Areas Technologies
- DMTS - Dangerous Material Treatment Systems
- BTUZ - Breaching Techniques in Urban Zones

Breaching in Urban Zones - Technologies, Techniques and Training

I E O D Capabilities

(Integration with/in Swat Teams)

- Hot Breaching Technologies.
- Cold Breaching Technologies.
- Training - Courses/Seminars (from 1 week to 6 weeks for all levels).



ELISRA'S ELECTRONIC WARFARE SOLUTIONS FOR LAND FORCES



ELBIT SYSTEMS EW & SIGINT – ELISRA LTD.

48 Mivtza Kadash St.,
Bene Beraq 5121701, Israel
Tel: 972-3-5577335
Fax: 972-3-5577793
E-mail: ew-sigint@elbitsystems.com
Web Site: www.elbitsystems.com



Elisra develops, produces and markets a diversified range of EW systems, products and components for military battlefields. Amongst Elisra's advanced solutions are:

■ Elisra's **Ground Integrated Electronic Warfare Suite**, comprised of Signal Intelligence (**SIGINT**) capabilities, Communication Jamming (**COMJAM**) and Electronic Counter Measures (**ECM**), handles communication and non-communication advanced signals. The system includes cutting-edge technologies in receiving, processing, jamming, and countermeasure techniques, enabling efficient operation in future combat scenarios

Elisra's **COMINT DF** Systems include advanced signal demodulators, classifiers, fast wide band receivers and activity detectors that work together to assure smart, swift and pinpoint detection, identification and interception of the most sophisticated signals spanning the full frequency band.

Elisra's **COMJAM** capabilities are engineered to withstand the harshest combat environments - tough and ready to go where the action is. They are adaptable to all platforms - even AFVs where they can be positioned close to front line forces - an invaluable tactical asset.

■ **Counter IED Systems for LIC Situations:** Elisra's unique, innovative and sophisticated Electronic Jammers Against Bombs (EJAB) family is designed closely with operational unites of the IDF to provide a wide range of combat-tested LIC (Low Intensity Conflicts) uses for today's challenging environment. The easily programmable EJAB family of systems is currently in use of some NATO countries' mission-forces in various scenarios.



GROUND EW

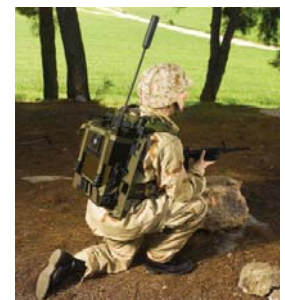

EJAB



FOXTRACK™

■ **TANDIR™** - Advanced Threat Warning System for Combat Vehicles. A highly effective and unique passive warning system, TANDIR provides early and accurate alerts for anti-tank threats, activation of onboard passive/active countermeasures, and enhanced survivability of frontline combat vehicles.

■ The recently introduced **FOXTRACK™** is a Portable Ground Surveillance Radar System designed to provide surveillance at medium to long ranges. The new system is deployed for the protection of sensitive installations, airports, or along borders, and is designed to cope with challenging terrains, including coastal environments.

KAVIT ELECTRONICS INDUSTRIES LTD.



KAVIT ELECTRONICS INDUSTRIES LTD.

1 Platin St., New Industry Zone,
Rishon Lezion 7565339, Israel
Tel: 972-3-9523540
Fax: 972-3-9523511
E-mail: info@kavit.com
Web Site: www.kavit.com



KAVIT Electronics Industries Ltd was established in 1994 to provide superior information security products to local public safety organizations. Since its inception, KAVIT has gone from strength to strength and quickly become a trusted worldwide leader with a worldwide client base to match. With a growing product range, which offers excellent value for money, KAVIT is now clearly recognized within the Security markets as a valued partner. KAVIT has been an accredited MOTOROLA Partner since March 2000.

KAVIT's customer base spans almost every country in the world, including the Israeli Security Services, Argentinean National Border Guard, Brazilian Police, Mexican Army, Nigerian Air Force, United Kingdom Ministry of Defense, US Police, Spanish Police, Italian Air Force, Royal Thai Army and South Korean Military, just to name a few.

All KAVIT products incorporate unique development and manufacturing technologies which makes each model superior to any other product in its class in terms of security, reliability and performance. Tried and tested and at competitive prices, KAVIT ensures you get the best products on the market with the support you would expect from a global leader.

MAIN PRODUCT LINES

- Leading Security Voice Encryption Modules for Two-Way Radios
- Professional Jammers for Cellular Phones & RF Communications
- Military Grade Secure Telephones
- Military Grade File Encryption
- Customized Solutions



DELIVERING CUTTING EDGE ELECTRONIC WARFARE AND SPECTRUM DOMINANCE SOLUTIONS

Netline Communications Technologies (NCT) Ltd. develops and manufactures cutting edge EW and spectrum dominance solutions: advanced **COMMINT & SIGINT**, communication & counter IED jamming, and cell phone detection systems to the global defense and homeland security markets.

COUNTER IED JAMMING SOLUTIONS

Netline's C-Guard active and reactive counter - IED jamming systems protect against remote radio detonation of IEDs. Robust jamming systems for vehicular, trolley/briefcase, manpack, miniaturized and stationary applications can include pre-initiation, hybrid active/reactive capabilities and other advanced features. Our software defined jamming technology enables interoperability with other communication devices, supports definition of communication windows and generating jamming mission profiles, streamlining waveform strategies to match mission requirements. Netline offers advanced jamming efficiency testing and evaluation equipment and counter- IED training systems.

COMMUNICATION JAMMING SOLUTIONS

Netline's communication jamming systems block RF communications and isolate arenas targeting cellular, satellite, WiFi/Bluetooth, walkie/talkie and all other wireless communication frequencies from 20-6000MHz. Our communication jamming systems can be deployed in various platforms including land, naval and airborne.



NETLINE COMMUNICATIONS TECHNOLOGIES (NCT) LTD.

Azrieli Circular Tower
132 Menachem Begin Rd.
Tel Aviv 6701101, Israel
Tel: 972-3-6068100
Fax: 972-3-6068101
E-mail: info@netline.co.il
Web Site: www.netline.co.il











CYBER PROTECTION & CELL PHONE DETECTION SOLUTIONS

Netline's Radio Frequency (RF) detection systems detect potentially hostile communications, uncovering unauthorized use of radio frequencies by cyber, cellular and other information leakage threats in military, government, corporate and other sensitive compartmented information facilities.

TACTICAL INTERCEPTION AND SIGINT SOLUTIONS

Netline's Communications Intelligence solutions integrate a variety of tactical SIGINT capabilities including spectral analysis, signal classification and demodulation, cell phone monitoring and location/direction finding – all tailored per customer specifications. Netline's tactical cell phone interception systems include both semi - active and passive interception systems enabling competent authorities to intercept and manage cellular voice, data and WiFi communications. The uniquely compact form factors of Netline solutions meet harsh military environmental requirements to facilitate deployment in scenarios and arenas that are often not covered by traditional SIGINT solutions.

Netline systems are in use worldwide for:

-  Convoys and route clearance
-  Infantry and special forces protection
-  SWAT operations
-  EOD missions
-  Counter - terror
-  Riot / crowd control
-  Tactical communication jamming
-  Communications interception
-  VIP protection
-  Military base protection
-  Border security



ADVANCED JAMMING SOLUTIONS



PHANTOM TECHNOLOGIES LTD.

68 Amal St.,
Petach Tikva 4951368, Israel
Tel: 972-3-9215720
Fax: 972-3-9215434
E-mail: sales@phantom.co.il
Web Site: www.phantom.co.il

Since 1996, **PHANTOM TECHNOLOGIES LTD.** specializes in designing, developing and manufacturing of multipurpose jammers. The company's diversified line of products covers all known communication bands from the VLF band to the C band. All systems vary in size and configuration to meet various operational needs and applications such as stationary, man pack, mobile and airborne.

PHANTOM TECHNOLOGIES LTD. holds an R&D team that constantly deals with the latest cutting edge transistor amplifier technology and digital processing. The R&D team is also in charge of customizing company products to client needs and specifications while conserving performance and system reliability.

PHANTOM TECHNOLOGIES LTD. tests 100% of all products manufactured, using state of the art measurement equipment.

PHANTOM TECHNOLOGIES LTD. provides after sales technical support and grants a full two year warranty for all products.

PHANTOM TECHNOLOGIES LTD. is a regular supplier of special equipment to the local armed forces, special forces, prison authorities and government agencies.



TACTICAL THROUGH WALL IMAGING SYSTEMS



CAMERO-TECH ISRAEL LTD.

Grand Netter Industrial Zone,
Intergama Building P.O.Box 3521
Kfar Netter 4059300, Israel
Tel: 972-73-7172333
Fax: 972-73-7172323
E-mail: info@camero-tech.com
Web Site: www.camero-tech.com

Camero is a world leading provider of Sense-Through-The-Wall (STTW) solutions.

Utilizing unique pulsed based UWB micro-power radar technology, **Camero's** through wall imaging systems were designed in close cooperation with the users' community to provide optimal and reliable tactical solutions for urban operations.

Camero solutions provide real-time information on multiple stationary and moving objects concealed behind walls or barriers - providing operators with unprecedented situational awareness and operational advantage. The Xaver™ life saving products have become the solution of choice for top military and law enforcement agencies throughout the world and have been successfully operationally deployed.

The Xaver through wall radar product line includes:

Xaver™ 800

The Xaver™ 800 is a portable, high performance sensor system, optimized for gathering instant and accurate real time information from behind solid walls. The Xaver™ 800 is unique in providing true 3D imaging of objects behind walls. The Xaver™ 800's superior object resolution allows quick location of people hidden behind walls and barriers, and tracking their movement patterns enabling differentiation between victims and hostiles.



Xaver™ 800

Xaver™ 400

The Xaver™ 400 is a compact, lightweight and durable personal device, optimized for the speed of tactical entries. The Xaver™ 400 gives special ops and rescue forces critical information in real time about the number of people and their location behind a wall. Simple to operate, the Xaver™ 400 provides mission-critical information when and where it is needed.



Xaver™ 400

Xaver™ 100

The Xaver™ 100 is a handheld through wall life detector. Developed with the specific needs of tactical operators in mind, the Xaver™ 100 provides instant critical situational awareness and target acquisition data. By providing accurate and reliable information on the occupancy of enclosed spaces, the Xaver™ 100 enables better tactical decision making in many operational scenarios.



Xaver™ 100

SK Group

Camero is a part of the SK Group - a leading global Defense and Security group that includes Israel Weapons Industries (IWI), Meprolight, PI Systems, Israel Shipyards, Uniscope, and more.

PROTECTING PEOPLE, INFRASTRUCTURE AND PROPERTY AROUND THE GLOBE



DEFENSE INDUSTRIES INTERNATIONAL, INC.

Defense Industries International, Inc

12 Hamefalsim St.,
Petach-Tikva 4951421, Israel
Tel: 972-3-7168383
Fax: 972-3-7168484
E-mail: Info@dfns-group.com
Web Site: www.dfns-group.com



Human life is priceless. Protection of human life demands significant investment. Our subsidiaries are committed to its customers focused philosophy by providing innovative, top quality products and quick response.

DFNS diversified high quality technologies and products, serve many armed forces, law enforcement and emergency relief agencies throughout five continents, providing highest levels of protection.

Defense Industries International Inc. is a leading defense contractor of both personal and automotive armored systems. Established in 2002, DFNS is a publicly traded company on the NASDAQ exchange. Through its wholly owned subsidiaries, DFNS designs, develops and manufactures, a broad range of products for military and civilian markets worldwide

In a rapidly changing world of warfare and law enforcement, DFNS group and its subsidiaries are striving to set the pace by developing advanced products and exploring new markets. The group's creative approach to technological challenges has helped it gain a world-wide reputation while positioning it as the preferred brand among security forces all over the world.

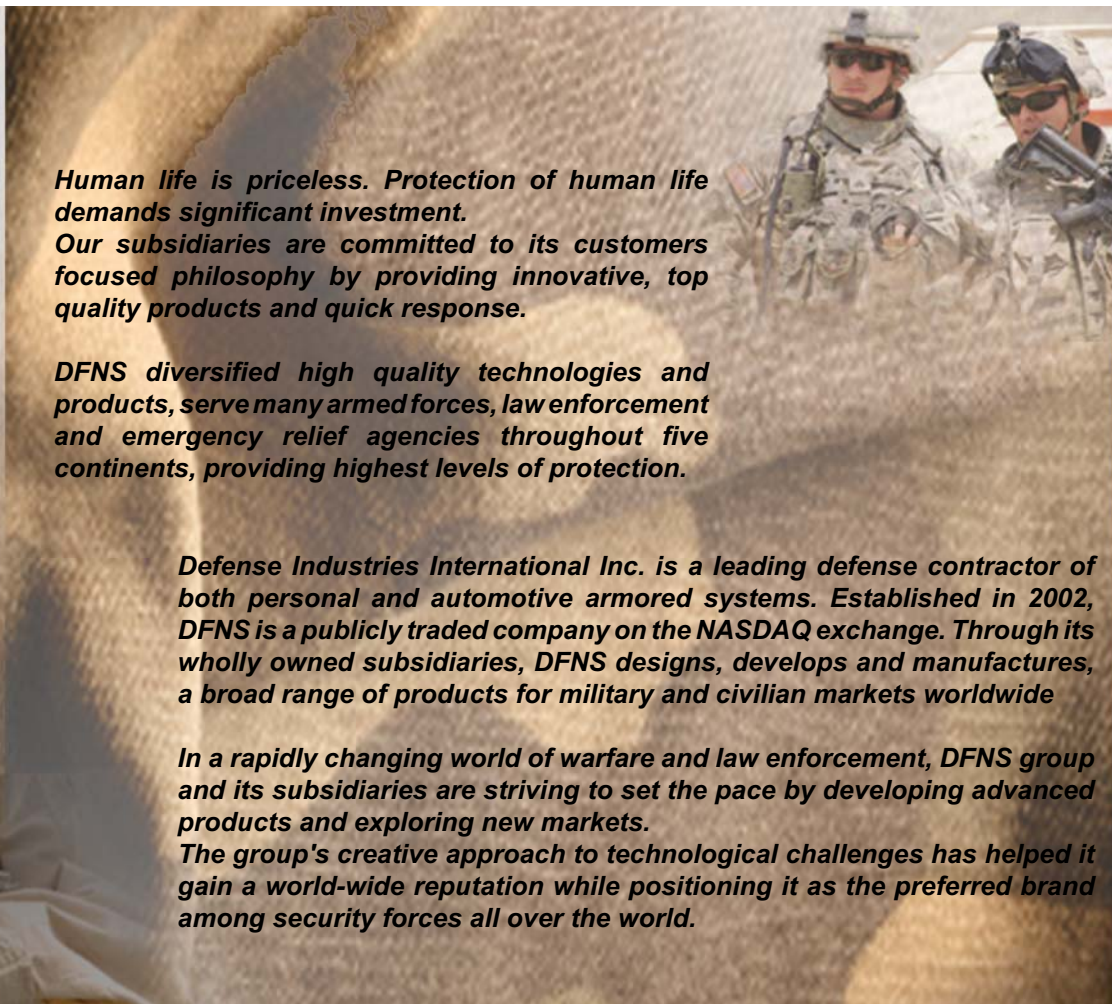

MAYOTEX PHILCAR
INNOVATIVE VEHICLE MODIFICATION & PROTECTION

EX EXPORT EREZ LTD
MILITARY & PROTECTION TEXTILE EQUIPMENT

ACHIDATEX LTD
SAFETY & PROTECTION TECHNOLOGIES

DFNS Group
DEFENSE INDUSTRIES INTERNATIONAL, INC.

RABINTEX
QUALITY SINCE 1950

OM TACTICAL



LAND FORCES

Infantry Survivability & Protection



ISRAEL MILITARY INDUSTRIES LTD. (IMI)

P.O.Box 1044, 64 Bialik Blvd.
Ramat Hasharon 4711001, Israel
Tel: 972-3-5485222
Fax: 972-3-5486125
E-mail: imimrktg@imi-israel.com
Web Site: www.imi-israel.com

SHOCK ABSORBER

SHOCK ABSORBER is a man-portable Active Protection System (APS) designed to protect dismounted troops and stationary sites from ATGM threats.

The lightweight system offers dismounts an effective portable 360° situational awareness and E/O directional jammer-based 'Soft-Kill' protection against second generation ATGMs. SHOCK ABSORBER provides accurate detection of the enemy launch position as well as an immediate alarm of launched threats and small arms bursts. The system can easily be deployed on the ground within minutes and can be integrated on vehicles and naval vessels as well. SHOCK ABSORBER is based on IMI's IRON FIST APS technologies.

SPB/FMAB

SPB/FMAB is a combat-proven, lightweight, aluminium alloy, tactical, man-portable Sectional Personnel Bridge, designed to enable fully equipped infantry to cross wet or dry obstacles, up to 50 meters long.

The bridge is in use and combat-proven by the United States Marine Corps (USMC) in Afghanistan. Recently, IMI has been awarded the United States Department of Defense (DoD) Defense Contract Management Agency (DCMA) Certificate of Appreciation for its outstanding industry partnership in producing the FMAB, a variant of the SPB, for the USMC.

BODY ARMOR

IMI offers a wide range of body armor solutions for military, law enforcement and security personnel. The lightweight armor is based on a hybrid composite of metals and ballistic ceramics, guaranteeing enhanced survivability and operational flexibility in close combat conditions over long periods of time. The body armor comes in a variety of types and weights according to ballistic threat and user needs. Body armor vests vary by size and are offered with optional groin, shoulders and neck protection.

IMI offers the X3 - an advanced lightweight ballistic insert, which guarantees multi-hit protection against up to 7.62mm AP and Ultra High Hardness (UHH WC Core) cartridges.

IM SAFE & ARM MECHANISM

IMI offers an Insensitive Munition (IM) Safe & Arm Mechanism for hand grenades, designed to prevent detonation if the grenade is shot or set on fire. The IM Safe & Arm Mechanism is designed for use in any existing hand grenade, providing enhanced safety and reliability, and ensuring size, capabilities and lethality similar to the standard variant. The mechanism complies with the latest safety requirements for IM, in accordance with MIL-STD 2105: up to 0.5" bullet impact, fast cook-off, slow cook-off and sympathetic detonation.

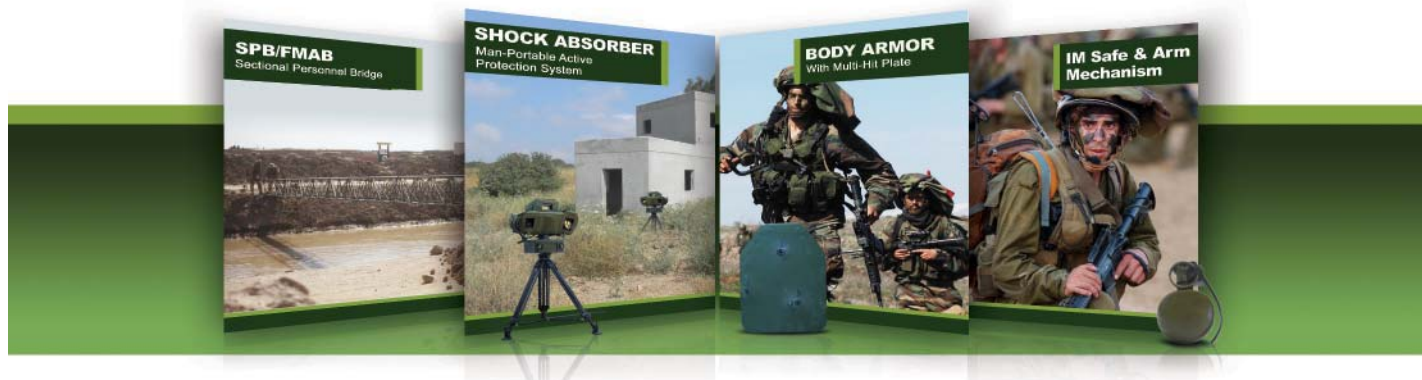

LAND FORCES

Infantry Fire Power



ISRAEL MILITARY INDUSTRIES LTD. (IMI)

P.O.Box 1044, 64 Bialik Blvd.
Ramat Hasharon 4711001, Israel
Tel: 972-3-5485222
Fax: 972-3-5486125
E-mail: imimrktg@imi-israel.com
Web Site: www.imi-israel.com

SMALL CALIBER AMMUNITION

IMI is a world-leading manufacturer and supplier of high-quality small caliber ammunition. This includes various 5.56, 7.62, 9, 12.7mm and 0.388" cartridges.

The 5.56 and 9mm cartridges are NATO qualified. IMI also offers GREEN lead-free cartridges, which are identical in performance to lead-based cartridges, minimize muzzle burnout and meet international standards. IMI is the leading supplier of small caliber ammunition to the Israel Defense Forces (IDF). Other customers include the U.S. Army, armed forces of major NATO members, law enforcements, special units and customers in commercial markets worldwide.

GMM120

GMM120 is a GPS and/or Semi Active Laser (SAL) 120mm guided mortar bomb designed for engaging and defeating personnel inside a building, behind a corner, ridge or inside masonry structures, earth and timber

bunkers and LAVs. The mortar bomb is equipped with a GPS with a CEP of 10m and SAL homing system with a CEP of 1.5m.

The bomb has an increased effective range of up to 9 km and is suitable for firing from any 120mm smoothbore mortar.

MPRS

The MPRS (Multi-Purpose Rifle System) is a powerful force-multiplier for the modern and future infantry warrior, enabling improved lethality, incapacitation and target suppression effectiveness through the use of advanced 40mm multi-purpose, airburst grenades. The system features a choice between Air Burst (AB) and Point Detonation (Super Quick/Time Delay) modes of operation and also incorporates a self-destruct mechanism. In AB mode, the appropriate elevation is transferred to the grenade's fuze while the grenade is still in the launcher. In Time Delay (TD) mode, the fuze can be set to explode at a preset delay after impact, enabling engagement of

soft targets, such as a window. MPRS can be integrated on a wide range of assault weapons and multiple grenade launchers.

SHIPON FFE

SHIPON FFE is a man-portable, lightweight, disposable shoulder-launched weapon system for close-range combat. The weapon system is fitted with a tandem multi-purpose warhead for engaging and defeating personnel protected by buildings, earth and timber bunkers or LAVs. The weapon system can be fired from within enclosed spaces. Its multi-purpose warhead can penetrate up to 8" reinforced concrete and triple-brick wall. The weapon system meets the potential U.S. Army's Individual Assault Munition (IAM) requirements.

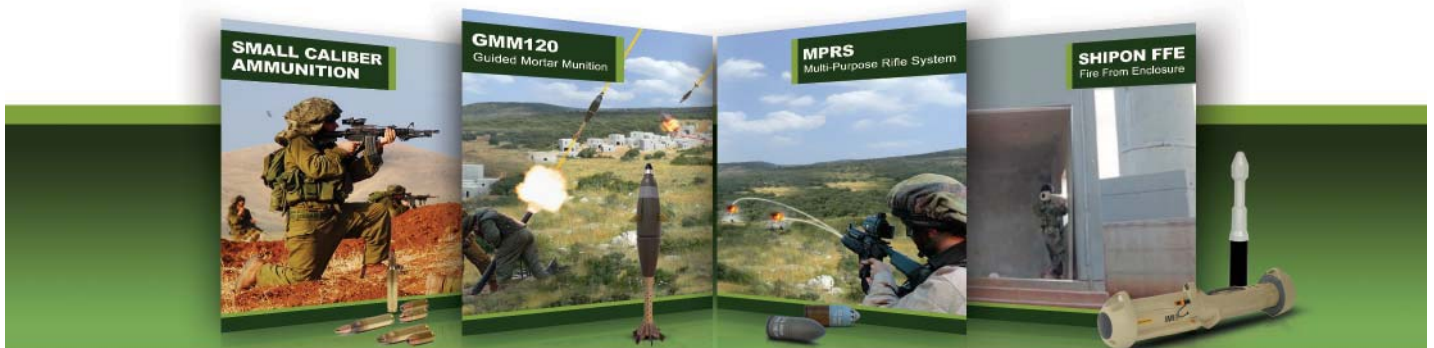

MAVERICK DEFENSE TECHNOLOGIES

Maverick Defense Technologies is a world wide supplier of Military and Law Enforcement Equipment and training, offering Equipment ranging from personal gear to sophisticated Electronics and weapon platforms.



**MAVERICK
DEFENSE TECHNOLOGIES LTD.**

P.O.Box 5512
Caesarea 3088900, Israel
Tel: 972-4-6362360
Fax: 972-4-6362361
E-mail: maverick@netvision.net.il
WebSite: www.maverick-defense.com

Sample categories offered;

Home Land Security, NBC and disaster management - consulting, training and Equipment

Light arms, ammunition, personal gear and equipment:

Artillery, tanks, armored personal carriers, all terrain vehicles, un manned vehicles,

Patrol boats, RIB's, cruisers, Hovercraft, submarines, special naval and diving quipment.

Military aircraft, UAV's, Helicopters etc. - spare parts and upgrading

Second hand cargo and passenger aircraft - sale, leasing and upgrades

Land sea and air missiles and rockets

special Electronics, surveillance and long range observation posts,

communication systems, voice scramblers, Cellular interception,

Surplus equipment

Security and perimeter electronic fencing and intrusion detection

Spare parts, upgrading and service for Armored vehicles, aircraft and boats.

Rescue & NBC equipment and training

Medical equipment, and medications, field hospitals, ambulances and training

Anti Riot EOD and Anti Drug - equipment and training

Water treating and purifying, mobile water producing equipment - Military and Civilian/Disaster.

Bridges, quick deploy airstrip and airstrip lighting & Navigation systems

Personal gear, tents, uniforms, bullet proof vests,

Mine clearing equipment

Expired Ammunition disposal and EOD services.

Second hand cargo and passenger aircraft - sale, leasing and upgrades

VIP armored vehicles and body guard training

upgrading of T72 & T 55 tanks to western standards: reactive armor, electronic protection, modern Thermal fire control, western caliber canons etc.

security scanners for airports, container scanners for sea ports, under vehicle scanners and more, Explosives & Narcotics detection systems.

General Aviation anti theft/temper locking systems with central control post.

NEW;

Anti Piracy consulting, training and provision of armed guards for merchant ships in the East Africa and Indian Ocean regions.



MEPROLIGHT -

Years of Bright Ideas



MEPROLIGHT (1990) LTD.

58 Hazait St., P.O.Box 26
Industrial Park
Or Akiva 3060000, Israel
Tel: 972-4-6244111
Fax: 972-4-6244123
E-mail: sales@meprolight.com
Web Site: www.meprolight.com

Meprolight is an Electro-Optics company, developing, manufacturing and marketing systems for infantry, armed forces, law enforcement agencies and civilian markets since 1990.

Meprolight provides comprehensive solutions with a wide array of combat-proven products:

- Optics - Electro-optical and Optical sights and devices, including night vision devices
- Thermal – Uncooled Thermal weapon sights
- Tritium – A variety of self-illuminated night sights and other tritium products
- LED - Illuminated products for safety and security applications
- LRF- Wide range of innovative Laser Rangefinders, Hand Held Rangefinders and Fire Control systems

All of Meprolight's products undergo meticulous quality assurance according to international standards. The products are fully certified to ISO-9001:2008, complying with NATO and US military specifications and International MIL Standards. State-of-the-art technology combined with high reliability and simplicity of use have made Meprolight the vendor of choice among military forces, law enforcement agencies, defense agencies and weapon manufacturers.

SK GROUP

Meprolight is a member of SK Group, a leading global defense and security group of companies comprising Israel Weapon Industries - IWI Ltd.(firearms manufacturer), Pulse Inteco Systems Ltd. (lasers and night vision systems), Camero-Tech Ltd. (through-the-wall sensing), Israel Shipyards Ltd. (ship manufacturing and repair), Uni-Scope Ltd. (optical periscopes) and more.



MEPRO NOA – Uncooled Thermal Weapon sight, reaching targets at over 1,000 meters



MEPRO MOR – Multi-Purpose Reflex sight with two laser pointers

MSE

Accuracy as a Way of Life

- Electro-Optic Day Sights/Reflex Sights
- Night Sight/Observation Night Scope
- Shooting Courses and Training



MSE LTD.

11 Granit St., P.O.Box 3034
Petach Tikva, 4951410, Israel
Tel: 972-73-2324517
Fax: 972-72-2448646
E-mail: info@mse-il.com
Web Site: www.mse-il.com

MSE (Marksmanship, Sniper, Excellence) Ltd., develops, manufactures and markets innovative user-friendly day sights and a unique Night Vision sight to the military, paramilitary and civilian markets worldwide.

MSE offers, with every product, tailored "Train the Trainers" theoretical and practical, shooting implementation courses, maximizing its clients shooting skills to their highest level.

MSE is headed by Lt. Colonel (Res.) Mikey Hartman, founder and former commander of IDF's marksmanship and sharpshooting school for the last two decades.

MSE Sights

MSE new line of sights incorporates extremely user-friendly features, integrating both speed and accuracy for sharpshooters, marksmen, machine-gunners and hunters answering all battle field scenarios.

AQC Reflex sights – Setting New Standards of Accuracy

AQC (Accurate Quick "Chot") series of reflex sights sets a new standard of accuracy. The sights are parallax free and use a uniquely sharp reticle, thus enabling faster target acquisition and higher accuracy, maximizing your shooting ability to its highest level.

All AQC sights include unique fighter friendly features, such as: three built-in reticles, remote PTT (Press To Transmit) cable, hand-adjustable zeroing knobs, sleep mode/sleep mode deactivation, motion sensor and an extremely large window size.

Or Sight - Innovative night vision sight for the everyday shooter

The Or sight is a unique Night Vision sight/observation night scope for commanders, soldiers and hunters allowing them to see clearly up to 100-150 meters and beyond at fraction of the cost of a standard Night Vision device.

Or-Sight makes night vision accessible to all shooters - delivering enhanced vision capabilities with unmatched price-performance to military organizations and weapon manufacturers alike.

About Star Defense Systems (SDS)

MSE is a subsidiary of Star Defense Systems (SDS), one of the largest defense companies in Israel, offering innovative defense solutions for Sea, Air, Land, and HLS Forces worldwide. SDS strategic alliances and commitment to R&D provide a solid backbone for products and solutions development at the cutting edge of technology.



BREACHING



RAFAEL ADVANCED DEFENSE SYSTEMS

P.O.Box 2250 (19)
Haifa 3102102, Israel
Tel: 972-4-8794714
Fax: 972-4-8794657
E-mail: intl-mkt@rafael.co.il
Web Site: www.rafael.co.il

BREACHING & URBAN WARFARE DEVICES

Rafael's breaching solutions provide a modern spectrum of operational solutions for military forces to surprise the enemy and reduce risk to friendly forces, eliminate collateral damage and ensure that innocent people will not be hurt.

Rafael has developed a variety of breaching products – rifle launched, shoulder launched and static hand placed munitions - to assist in urban warfare confrontations. These products can solve door entry problems, create mobility corridors through walls and structures as well as defeat urban structures, bunkers and light armored vehicles.

Rafael's breaching systems family includes:

Matador Family

Matador (RGW 90) AS - Anti-Structure Munition

The MATADOR AS is a combat proven shoulder launched, multipurpose munition, based on a ballistic rocket carrying an innovative tandem warhead. It can operate in two modes: emplacement against structures and fortified positions and mouse holing against walls and light armor vehicles.

It is fully disposable, cost effective, low maintenance weapon. Its effective range is from 14m to 400m, and its weight is 10kg (22lbs).

Matador AS Breaching Objectives:

- Fortified positions
- Timber bunkers
- Urban structures
- Light armored vehicles



Matador WB - Wall Breaching Munition

The MATADOR (RGW 90) WB (Wall Breaching) is a shoulder-launched wall breaching munition, based on a ballistic rocket carrying an innovative Explosively Formed Ring (EFR) warhead. Its weight is 13kg (28.7lbs) and its operational distance is 20m to 120m.

Matador WB Breaching Objectives:

- Urban walls
- Double brick walls
- Triple brick walls
- Double reinforced concrete
- Walls



SIMON (GREM) - Rifle-launched entry breaching grenade for urban & anti-terrorist warfare

SIMON rifle launched grenade is a stand-off & surprise-attack type weapon; it Replaces older breaching methods, which involved loss of surprise and the risking of assault troops in directly breaching doors by mechanical means or by attaching explosive charges.

Simon Benefits:

- Stand-off door breaching
- Increases the element of surprise
- Increases force survivability
- Minimizes collateral damage
- Simple to operate
- Easily adaptable to a variety of rifles
- Effective against variety types of doors



ADD ON ARMOR



Rafael's Add On Armor Products

Rafael is a major and unique armor company dealing with all protection technologies: passive, reactive, hybrid and Active Protection systems. Rafael conducts development, design, integration and production of the most advanced armor systems to enhance the protection level of armored vehicles.

Rafael uses its extensive past experience to provide high level of protection, lightweight and low cost enhancements integrated on all types of combat platforms. All armor products are modular and capable to protect combat vehicles from a broad range of threats such as small and medium kinetic energy (KE) armor piercing (AP) projectiles, high energy anti-tank Shaped Charges (SC), high speed fragments of artillery and Improvised Explosive Devices (IEDs) and Explosive Forming Projectiles (EFPs).

The performance and specifications of the systems meet the protection requirements and standards of the Israel Defense Forces (IDF), the US Army, USMC and NATO force standards. The systems have been tested, qualified and approved for application by the customers worldwide and are combat proven. Rafael had eight different add-on armor systems, served in the Iraqi / Afghan theater with the coalition forces.

Reactive Armor

Rafael is the world leading company in the application of the reactive armor technology. It was the first company to develop, design and integrates reactive armor systems on combat vehicles. The reactive armor is the most effective add-on armor technology to protect Armored Fighting Vehicles (AFV's), Armored Personal Carriers (APC's) and Main Battle Tanks (MBT's) against shaped charge threats of Rockets and ATGMs.

For light armored vehicles, Rafael developed Hybrid armor which combines reactive and passive elements to provide complete, 360 degrees protection against anti-tank rockets, medium KE AP projectiles and high speed fragments. Upgraded multi-threat hybrid armor, Multi-Threat Armor Protection (MTAP) system has recently been developed to defeat also EFPs and IEDs.

Rafael's reactive and hybrid system have been fitted to many combat vehicles worldwide. In the US, Rafael, together with its partner General Dynamics ATP, integrated produced and supplied reactive / hybrid armor systems for the Bradley AFV and the Stryker vehicles.



M60



Bradley



M113

RAFAEL
ADVANCED DEFENSE SYSTEMS
 P.O.Box 2250 (19)
 Haifa 3102102, Israel
 Tel: 972-4-8794714
 Fax: 972-4-8794657
 E-mail: intl-mkt@rafael.co.il
 Web Site: www.rafael.co.il

Passive Armor

Rafael has developed and applied various passive armor technologies to protect combat vehicles, including ceramic, metallic, shaped, laminated and perforated technologies. The passive add-on armor is modular, lightweight and easily installed by the crew. It is maintenance-free and combat-proven.

The systems provide protection against 14.5 mm AP projectiles, high speed fragments of artillery shells and IED (STANAG 4569, Level 4 and beyond). Rafael has recently developed passive add-on lightweight, effective modular armor to defeat EFPs.

Rafael's armor systems are in use by the IDF, USMC, Italian Army, New Zealand Army, Czech Army and others. They are combat proven and received excellent reports about their performance in the Operation Iraqi Freedom and peace keeping missions worldwide. Rafael's Enhanced Appliqué Armor Kit (EAAK) add-on armor system was selected by the USMC as a sole source, for the AAV7 amphibious APC.

RAFAEL's Reactive Armor installed on the US Bradley AFV (left) and Passive Armor installed on the USMC AAV7 APC (right).



AAV7

M113

Rosomak

■ **Certificates from the US Army and USMC to Rafael for its reactive and passive armor systems, installed on the Bradley, Stryker and AAV7** ■



ELECTRO-OPTIC INTELLIGENCE, SURVEILLANCE AND RECONNAISSANCE (ISR)

Litening - Targeting & Navigation Pod

Litening is an innovative airborne infra-red targeting and navigation pod for fighter aircraft with high accuracy and reliability, day and night precision strike capability. Litening reduces pilot workload during targeting and tracking. It is easily integrated on any aircraft and possesses high growth potential.

In use in the Israeli Air Force, USAF, ANG, AFRES, Marines, German AF, Swedish AF, Spanish Navy & AF, Greek AF, and others, the Litening flies on F-16 , F-15, A-10, B-52, AV8-B, Gripen, Tornado, F-5, F-4, Mig-21, Mirage 2000, Jaguar and others.



Toplite EO System - Electro-Optical Surveillance, Observation & Targeting System

The Toplite family of electro-optic systems is an advanced multi-sensor, multi-purpose, highly stabilized EO systems for homeland security and defense applications, for aerial, maritime and ground based platforms.

RecceLite- Real Time Tactical Reconnaissance System

The RecceLite System consists of an E-O pod, a ground exploitation station and a data link. It is capable of collecting images day & night from 300 ft to 40,000 ft in all directions forwards, nadir, backwards, oblique - all down hemisphere and even when the aircraft is maneuvering in high G.

The Ground Exploitation Station (GES) is capable of generating targets in real-time with exceptionally high accuracy due to state-of-the-art algorithms and technology. The data-link connects between the sensors and the GES and enables the images to be downloaded to the GES in real time. When your task is to close the attack cycle on many "time-critical targets" in less than 10 minutes, there is only one system - RecceLite.

Recce-U - Real-Time Persistent ISR System for UAVs

Recce-U is a self-contained, multi-sensor ISR system (based on the RecceLite Tactical Reconnaissance Pod). The Recce-U enables automatic photography, according to a mission plan prepared in advance, or updated mission plan uplinked in real-time, however the operator can initiate manual scanning for targets of opportunity.



Litening -on-Gripen



Toplite EOS



RecceLite System

Recce-U

RAFAEL
ADVANCED DEFENSE SYSTEMS
 P.O.Box 2250 (19)
 Haifa 3102102, Israel
 Tel: 972-4-8794714
 Fax: 972-4-8794657
 E-mail: intl-mkt@rafael.co.il
 Web Site: www.rafael.co.il

SpotLite Family
Electro-Optic Enemy Fire Detection System

The SpotLite family consists of electro-optical systems that detect and locate enemy fire in stationary positions as well as on the move. Rapid detection and precise location information provide forces with the capability to quickly neutralize the enemy, maintaining the upper-hand on the battlefield.

The **SpotLite P** is a portable electro-optic system carried by two soldiers for day and night detection and location of small arms fire.



SpotLite P on Tripod

SpotLite M is a mobile electro-optic system installed on vehicles and AFV's that enables the detection and location of enemy fire sources from small arms, RPG rockets, ATGM and tank shells, on the move, day and night, up to 360° coverage.



SpotLite M on vehicle

Imilite - Multi-Source Multi-Task ISR Exploitation System / Command and Control System

Imilite is an intelligence system designed to receive process and exploit multiple standalone imagery video and other intelligence data in a centralized and a unified way.

Main system capability includes the reception, processing and exploitation of EO, IR, SAR/GMTI and VIDEO, in various formats, over one desktop. In order to enhance the exploitation process, Imilite further combines non-imagery data such as targets, threats, COMINT detection and mission status within the system workflow. Imilite generates a variety of standard and customer tailored ISR reports and IMINT products such as alphanumeric reports, annotated maps, GIS data layers and visual aids, and disseminates them to external information and operation systems over standard and tailored protocols.

Imilite's multi-source data integration and automation capabilities improve the efficiency of utilizing available collection and exploitation assets. The system GIS capabilities provide immediate accessibility to relevant imagery and intelligence data, thus shortening the ISR collection and exploitation cycle.

The Imilite is based on Rafael's combat-proven ISR and C⁴I systems already in service worldwide. Imilite is designed for use by Defense forces (air, ground) and police forces exercising various observation means for border patrol or coping with urban crime.



Imilite

SAMSON FAMILY



SAMSON RWS

Rafael's Remote Weapon Station (RWS) Family Globally integrated on thousands of fielded ground and naval platforms, Rafael's Samson family of advanced remote weapon stations (RWS) capitalizes on extensive combat experience with a deep understanding of emerging military needs.

Designed for high performance and survivability on land and at sea, the Samson RWS have been adapted to a wide variety of main battle tanks, trucked and wheeled armored personnel carriers and marine craft.

The Samson Family is offered in six land configurations and two naval configurations. Samson RWS support diverse, interchangeable weapons and sensors including 5.56/7.62/12.7 mm machine guns, 40mm automatic grenade launchers, anti-tank missiles, observation pods, and non lethal capabilities.

Deployed in over 25 countries under rigorous combat and environmental conditions, these robust weapon stations are a dependable force multiplier and trusted partner for the most challenging missions.

Battle-proven land applications include thousands of RWS for the Israel Defense Forces (IDF), the Czech Republic Army, the UK Royal Armed Forces, and many others. Rafael is currently the sole supplier of RWS to the IDF.

Breakthroughs in RWS Development

Under-Armor Reloading

The superior capabilities and performance of Rafael's RWS have been further enhanced by various ingenious force survivability multipliers, including in-hull ammunition reloading which enables uninterrupted operation while minimizing the crew's exposure to life-threatening battlefield dangers. The patented system is loaded from under the deck, and in addition to its operational benefit, is ergonomically designed for loader convenience and operation with minimum effort and maximum consideration of physical health.

Non-Lethal Capabilities

The newest addition to the Samson RWS family is its Non-Lethal (NL) capability which bases its response on all human biological senses. Whether employed for crowd control or other urban scenarios, the Samson NL capability provides the symmetrical response required to alleviate potentially explosive situations.

Samson NL concept is based on a five-sense response and the dual use of the RWS; interchangeable for NL and L use.

Samson Jr.

The lightest of the Samson RWS family, the Samson Jr. is intended for wheeled, tracked, and naval platforms which mandate minimum deck load and silhouette. Designed for defensive fire in military and paramilitary operations, the Samson Jr. mounts a variety of crew-exchangeable small caliber armaments, including 7.62mm or 5.56 machine guns, sharpshooter rifles and non-lethal weapons.

**RAFAEL
 ADVANCED DEFENSE SYSTEMS**

P.O.Box 2250 (19)
 Haifa 3102102, Israel
 Tel: 972-4-8794714
 Fax: 972-4-8794657
 E-mail: intl-mkt@rafael.co.il
 Web Site: www.rafael.co.il

SAMSON MINI

The Samson Mini dual-axis, gyro-stabilized RWS is designed for use on light wheeled or tracked combat vehicles, fast attack boats and other platforms requiring improved offensive capabilities. The system enables target engagement with enhanced accuracy, while maximizing crew protection from enemy fire.

This single-weapon RWS accommodates a variety of armaments including a 5.56mm SAW and LMG, 7.62mm GPMG and Gatling gun, 12.7mm HMG, 14.5mm, 40mm AGL, ATGM launcher, ASM, fed by high-capacity magazines. Supported by a ballistics-protected multi-sensor Sight Pod, with an optional mechanism for super elevation ballistic angle calculations, the Samson Mini provides a 'round-the-clock response to high-maneuvering battlefield challenges.

SAMSON DUAL

The Samson Dual is a dual-axis, gyro-stabilized RWS that simultaneously mounts two weapons. Developed originally to carry a 25-30mm lightweight weapon as main armament and 7.62mm secondary weapon for short range engagements, the Samson Dual enables multiple-threat handling in high-mobility scenarios. Much more robust than equivalent systems, the Samson Dual is also strong enough to incorporate an ATGM Launcher as a force multiplier. Featuring a special mode that decouples the weapons from the sight pod, this Samson configuration is also ideal for reconnaissance and peace-keeping missions.

NEW SAMSON 30MM MKII

The new Samson 30mm MKII is a 30mm Weapon RWS designed for use on any modern light-armored, high-mobility fighting vehicle, new or upgraded, without modifications. It mounts main and secondary armaments, of Eastern and Western origins, including a 30/40 mm automatic cannon, 40 mm AGL (optional), and 7.62 mm coaxial machine gun. Additional mountable force multipliers include ATGM launchers, ASM, and SGL obscurants.

Equipped with a dual-axis, gyro-stabilized, retractable, dual-sight, weapon mounting system, and the system's configuration provides the commander with full "hunt-kill" capabilities without interfering with the Gunner's current missions.

Main Advantages of the Samson RWS family:

- Commonality and Affordability
- Optimized Survivability Design
- Environmental Compliance
- Precision and Lethality
- High Versatility
- Viable Alternative to the Traditional Turret
- Lighter in weight and more compact, rendering better overall platform mobility and maneuverability
- Safer - No gas emissions or rotating mechanical parts in the hull
- No RWS deck penetration, providing more space in the hull
- Plug-and-play fire control system - Same main computer unit (MCU) for all systems
- Superior 360° situational awareness
- Higher reliability, availability, maintainability, and durability
- Ability to interface with C⁴I and external sensors including hostile fire indicators



RAFAEL
ADVANCED DEFENSE SYSTEMS
P.O.Box 2250 (19)
Haifa 3102102, Israel
Tel: 972-4-8794714
Fax: 972-4-8794657
E-mail: intl-mkt@rafael.co.il
Web Site: www.rafael.co.il

Multi-Source Multi-Task ISR Exploitation System / Command and Control System Imilite is an intelligence system designed to receive process and exploit multiple standalone imagery video and other intelligence data in a centralized and a unified way.

System capabilities:

data reception, processing and display of Video, imagery, targets, threats, mission status, force locations, SIGINT detection and others.

The system GIS capabilities provide synchronized display of all the data as overlays on maps, video and images.

Imilite improves the Command-and-Control process by various automated image processing algorithms such as geo-referencing, change and motion detection, video/image enhancement, video stabilization and others.

Imilite can disseminate operational data, tactical mission reports, targets and treats to other forces, to facilitate close support operations, targeting and platform/sensor management.

ImiLite allows scalable Command and Control solutions and adaption to specific operational needs, both in mobile and stationary configurations for Command and Control centers, deployable operational units.

Benefits:

- Centralized and unified workflow and data display
- Improved efficiency utilizing all available collection assets
- Shortened exploitation cycle
- Efficient Command and Control workflow
- Immediate accessibility to relevant data
- Real-time mission command-and-control workflow
- SR and mission product sharing with external operational users

Features:

- Multi-source data reception in various formats
- GIS capabilities: image/video geo-referencing, data overlays, Geo data retrieval
- Advanced Image Processing Algorithms: change and motion Detection, image/video enhancement, video stabilization and others
- ISR and mission products and reports generation and dissemination
- Scalability and Adaptability
- Stationary, Mobile or Airborne configurations



SPIKE FAMILY



RAFAEL
ADVANCED DEFENSE SYSTEMS
 P.O.Box 2250 (19)
 Haifa 3102102, Israel
 Tel: 972-4-8794714
 Fax: 972-4-8794657
 E-mail: intl-mkt@rafael.co.il
 Web Site: www.rafael.co.il

Multi Purpose Weapon Systems:

SPIKE FAMILY

The SPIKE Family consists of missiles suited for land, air and sea platforms, multiple ranges and a variety of targets. The missiles in this family have sophisticated electro-optic CCD or IIR sensors for day/night all-weather operation, as well as a tandem warhead. Their lofted trajectories enable the warhead to strike the target at its most vulnerable location with pinpoint precision and minimal collateral damage. All of the SPIKE Family members have a low life-cycle cost, due to high reliability and operational and logistic support and production commonality between members.

Designation	Max. Range	Application
Spike-SR	1,000m	Infantry and Special Forces
Mini-Spike	1,500m	Infantry and Special Forces
Spike-MR	2,500m	Infantry and Special Forces and Combat Vehicles
Spike-LR	4,000m	Infantry and Special Forces and Combat Vehicles
Spike-ER	8,000m	Infantry, LCV, Helicopters
Spike-NLOS	up to 25km	Multi-Purpose ,Multi-Platform



SPOTLITE FAMILY



RAFAEL
ADVANCED DEFENSE SYSTEMS

P.O.Box 2250 (19)
Haifa 3102102, Israel
Tel: 972-4-8794714
Fax: 972-4-8794657
E-mail: intl-mkt@rafael.co.il
Web Site: www.rafael.co.il

Spotlite Family

In-motion Or Portable enemy fire source Detection, positioning and classification system

Mechanized warfare is particularly complex. Sniper fire, RPG rockets, and in particular anti-tank missiles are lethal threats to the various types of ACVs moving in the battle field. Inability to detect threats and locate the position of the firing enemy causes numerous casualties, massive, inaccurate, and wasteful fire by our forces. Most importantly it lets the enemy retain the initiative in the battle field. Spotlite is a family of electro-optical products that quickly and accurately detect and locate enemy fire and swiftly close the sensor-to-shooter loop so as to neutralize the enemy and to keep initiative on the battle field in our hands.

The first product unveiled about two years ago was the Spotlite P, formerly MK2. This is a man-portable system that detects and locates enemy shooting small arms. It immediately investigates the target to verify that it is indeed a terrorist and quickly sends the target data to snipers or any other relevant shooters that can neutralize the source of fire. Since the system is man-portable and battery-operated it has great operational flexibility and can be positioned inside buildings as well as in areas impassible by vehicle.

An additional product, Spotlite – M, has recently joined the family. Spotlite – M is an electro-optical system installed on ACVs and other vehicles that detects and locates an enemy that is firing small arms, RPG bombs, anti-tank missiles, and rockets, in motion, day and night, at a range of up to 360°.



GROUND FORCES

Equipment & Training



TAR IDEAL CONCEPTS LTD.

5 Ma'avar Yabok St.,
Tel - Aviv 6744007, Israel
Tel: 972-3-6914564, 6914565
Fax: 972-3-6914567
E-mail: tar@tarideal.com
Web Site: www.tarideal.com



***World Leader In Supplying
Ground Forces Equipment and Training***



FOR THE ULTIMATE IN ISRAELI-MADE SEMI-AUTO PISTOLS



BUL TRANSMARK LTD.

10 Rival St.,
Tel Aviv 6777845, Israel
Tel: 972-3-6392911
Fax: 972-3-6874853
E-mail: info@bultransmark.com
Web Site: www.bultransmark.com



Over the past decade, **Bul Transmark** has become an Israeli leader in hand-gun development and production. We are a small- arms manufacturer in Israel producing with the quality control assurance of an **ISO-9002 Certification**. The "Bul Collection" now includes single action 1911 based pistols as well as three lines of Double Action pistols. Both Steel frames as well as state-of-the-art Polymer frames are available. Bul currently exports over 95% of its production to 25 countries world wide.

Bul Transmark's other fields of activities include indoor range construction, shooting training courses and seminars as well as Import and Export of firearms and related products.

The proven and tested **BUL M-5** is a lightweight Hi-Capacity pistol, designed around John Browning's famous 1911 system. Its simplicity, proven reliability, ease of use and availability of standard parts make it the natural choice for a Military or Police pistol. The BUL M-5 frame is totally 1911 compatible, making it an ideal choice for forces using older single stack 1911 pistols who want to upgrade to a high capacity gun.

The **BUL IMPACT**, **BUL STORM** and the **BUL CHEROKEE** make up the Double Action division of the BUL line. They are tough, durable and reliable pistols, based on the reliable CZ-75 mechanism. The IMPACT is a Polymer frame pistol, lightweight, compact size and perfect for carry. The STORM is the Steel frame line, strong and resistant, built for service. The **BUL CHEROKEE** is another polymer framed pistol, unique in its ergonomics, light weight and high capacity!



Bul Modified



Bul Commander

	BUL M-5	BUL STORM	BUL IMPACT	BUL CHEROKEE
Capacity 9mm	18+1	16+1	18+1/13+1	17+1
Capacity .45ACP	14+1	N/A	14+1/10+1	N/A
Capacity .40SW	17+1	N/A	17+1/11+1	N/A
Weight	34 OZ (980gr)	36 OZ (1050gr)	26 OZ (750gr)	25 OZ (690gr)
Overall length	8.6", 220mm	8.1", 205mm	7.5", 190mm	7.5", 190mm
Barrel length	5"4"/4.25"	4.75"/3.85"	4.75"/3.85"	3.85" , 19cm
Sights	Fixed/Adj	Fixed, 3-dot	Fixed, 3-dot	Fixed, 3-dot
Safties	Thumb safety, Grip safety, Disconnecter safety	Thumb safety, Disconnecter safety, FP safety	Thumb safety, Disconnecter safety, FP safety	Thumb Safety, Disconnecter safety, FP safety



Bul Cherokee



Bul Storm



Bul Impact

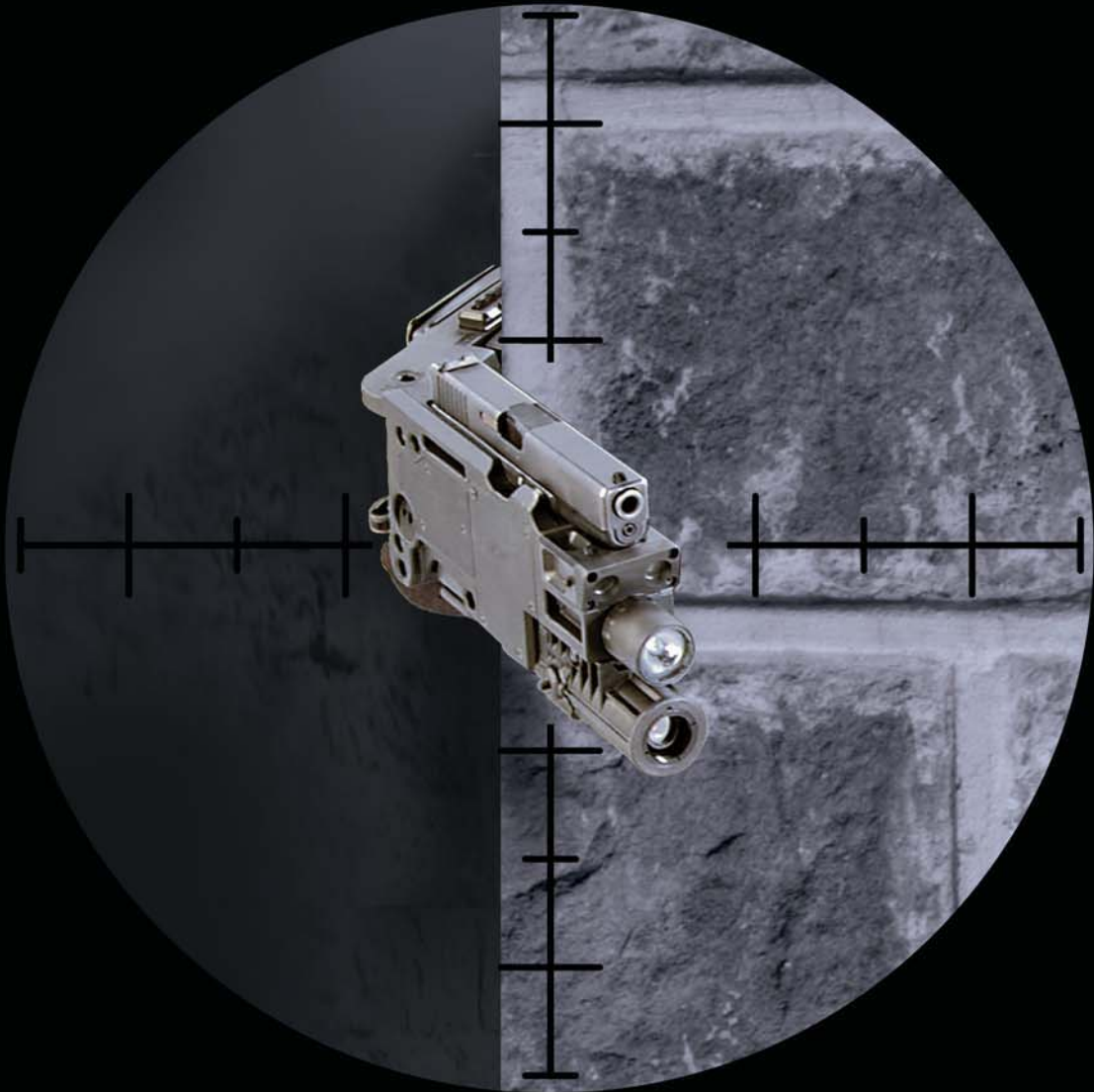



**CORNER
SHOT[®]
SAVES
LIVES**

**COMBAT
PROVEN**

Systems modified to accept various firearms

CS APR™ – M16



BackPack
Transmission kit



CSM™ – handgun
Glock version



CSM™ – handgun
H&K version



CS GP25
Grenade Launcher



CS 40
Grenade Launcher



CS AK-74/47

Integrate video technologies designed for the battlefield



33 Ma'ale Ha-Migdal St., P.O.Box 761
Or Yehuda 6025603, Israel
Tel: 972-3-6326116
Fax: 972-3-6326115
E-mail: israel@cornershot.net
Web Site: www.cornershot.com

The Corner Shot Company, established in 2003, invented the revolutionary **Corner Shot**® weapon system (patented worldwide) that enables the user to observe & engage targets located "around the corner" ("Right/Left" or "Up/Down"), with the user situated behind a cover or barricade, especially in urban warfare situations.

The Corner Shot® weapon system offers crucial tactical advantages in various situations by combining video technology & clever mechanics with conventional firearms.

A detachable video camera makes it possible to scan the target area prior to pinpointing the target & transmit the image directly, in real time, to other friendly elements.

The Corner Shot® weapon system can be integrated & deployed with several firearm types (handguns, SMGs, grenade launchers, non-lethal weapons, etc.) and can also be adapted to specific firearms if so required.

Over the last few years, products & concept by the **Corner Shot Company** have been employed in various countries, by dozens of military & police forces, in high-risk situations & complex tactical operations, all to maximum effect & with great success.

The Corner Shot® has actually saved lives.

POLYMER PRODUCTS BATTLE PROVEN INTELLIGENT DESIGN



IMI DEFENSE LTD.

P.O.Box 396
Zihron Yaakov 3095203, Israel
Tel: 972-77-5321622
Fax: 972-77-5356512
E-mail: marketing@imidefense.com
Web Site: www.imidefense.com



IMI Defense was established with one mission: design, manufacture, and supply the highest-quality and most innovative firearm products and accessories to the military, law enforcement, and civilian communities. Ground-breaking polymer holsters and polymer magazine pouches are hallmarks of the IMI Defense line of products. With the expertise of a team of the world's foremost engineers, military/law enforcement experts, and firearms production specialists, IMI Defense products integrate years of military "know-how" with battle-proven, durable and ergonomic materials.

Developed in Israel, each IMI Defense product has met the most demanding needs of the military and defense community, and has won acclaim among the elite units of both the Israel Defense Force and Israel Police Force. We are proud that today IMI Defense products are used all over the world by the military, law enforcement, and civilians.

MILITARY EQUIPMENT LAW ENFORCEMENT GEAR COMMERCIAL FIREARMS

***Benefit From Our
Experience & Tailor Made Solutions!***



NORTH EAST TECHNOLOGIES LTD.

Gamla House, Building A
34 Jerusalem St.
Raanana 4350108, Israel
Tel: 972-9-7489038/9
Fax: 972-9-7489066
E-mail: netech@ne-tech.com
Web Site: www.ne-tech.com

North East Technologies LTD (NET) is a privately owned company established in 1994. NET is a long term, experienced and highly reputable vendor of a large variety of defense articles and state of the art technologies to the military. NET is also a key supplier of security products to national and federal agencies, the law enforcement community and other institutional customers in Israel and worldwide.

The company's operations are renowned for their professionalism, determination, quick response and reliability which constitutes the basis for its high rate of success over the years. NET's team works closely with its business partners and affiliates in the USA, Europe, Latin America and South East Asia to find the best practical solution suitable for them using the most advanced technology available in the global arena.



IWI - BEYOND INNOVATION



IWI

Israel Weapon Industries (IWI) Ltd.

64 Bialik Blvd., P.O.Box 63
Ramat Hasharon 4710001, Israel
Tel: 972-3-7606000
Fax: 972-3-7606001
E-mail: info@iwi.net
Web Site: www.iwi.net

Company Profile

Israel Weapon Industries (IWI), located in the center of Israel, has been a world leader in small arms for the past 70 years. IWI is a member of the SK Group, which is composed of companies that develop and manufacture a wide array of military products for governmental entities, armies, and law enforcement agencies around the world. IWI's best-known products include the TAVOR® and GALIL® ACE families of Assault Rifles, the NEGEV™ Light Machine Gun, the legendary UZI® SMG (Mini, Micro and UZI® PRO) and the JERICHO® family of pistols - which have all been considered weapons of choice by military units and top law enforcement agencies around the world. The company's firearms are developed in close collaboration with the Israel Defense Forces (IDF). IWI and the IDF join forces in developing these weapons, whose final configurations are the product of ongoing interaction, field tests, and modifications, resulting from combat requirements and experience. All IWI weapon systems are in compliance with the most stringent military standards (MIL-STD) and ISO 9000 standards.

About SK Group:

IWI is a member of SK Group, a leading global defense and security group of companies comprising Meprolight Ltd. (electro-optic systems), Pulse Inteco Systems Ltd. (lasers and night vision systems), Camero-Tech Ltd. (through-the-wall sensing), Israel Shipyards Ltd. (ship manufacturing and repair), Uni-Scope Ltd. (optical periscopes) and more.

*Weapons are available in different calibers



***NEGEV NG7 LMG**



***X95 Flattop with Mepro M5 Red Dot
Weapon Sight**



***ACE 22 N with Mepro 21 Reflex Sight**

Gilboa™



The New Assault Rifle Made in Israel

SILVER SHADOW

advanced security systems Ltd.

SILVER SHADOW - GILBOA RIFLE

3 Ma'ale Ha-Migdal St., P.O.Box 761
Or Yehuda 6025603, Israel
Tel: 972-3-6326666
Fax: 972-3-6326099
E-mail: silversh@silver-shadow.com
Web Site: www.gilboa-rifle.com



The **Gilboa™**, a new series of military-grade firearms made in Israel, is produced using cutting-edge manufacturing techniques with the purpose of improving the well-known and proven system platform.

The **Gilboa™** series is manufactured by **Silver Shadow**, an authorized Israeli weapon manufacturer. Our R&D laboratory utilizes state-of-the-art equipment and its personnel consists of leading Israeli firearms designers. With a combined experience spanning many decades, our R&D team specializes in military firearms design and customized solutions for special operations units.

Gilboa™ rifle are manufactured in 5.56 NATO; 7.62x51, 7.62x39, 9mm .22LR and suppressed version.



LAND OPERATIONS TRAINING SYSTEMS



ELBIT SYSTEMS LTD.

P.O.Box 539
Advanced Technology Center
Haifa 3105301, Israel
Tel: 972-4-8315315
E-mail: aerospace@elbitsystems.com
Web Site: www.elbitsystems.com



TBT - TACTICAL BATTLE GROUP TRAINER

Elbit Systems' Tactical Battle Group Trainer (TBT) is the ideal solution for training commanders and crew from Company level to Battalion/Battle Group and Brigade-sized operations. Combining tactical battlefield simulation with actual C⁴I systems, the TBT's unique concept enables Battle Group leaders to acquire tactical reasoning methods, skills and procedures. It facilitates developing and learning doctrines, situational awareness, and C⁴I usage.



TBT

ATCT - APPENDED TANK CREW TRAINER

A mobile training system that transforms tanks into simulators

The Appended Tank Crew Trainer (TCT) is a portable training system enabling training and mission rehearsal onsite, with minimum risk and logistics effort, and resulting in maximum combat readiness. The system connects to the actual combat vehicle and systems, providing a complete simulation environment for the crew. ATCT is one example of Elbit systems robust line of training solutions for platforms and weapons operators.



ATCT

CLTS - COMBAT LIVE TRAINING SYSTEM

The CLTS is a complete tactical combined arms, two sided, live training system. It combines infantry and armored vehicles laser suites, independent field communication and control capabilities into an integrated, realistic live training solution, operating according to specific doctrines. CLTS is fully independent and deployable with no need for external infrastructures.



CLTS

CST - COMMAND AND STAFF TRAINER

Elbit Systems' CST is designed to improve the operational readiness of headquarters personnel up to division echelons. It simulates complex, joint operations in both high and low intensity conflicts (HIC/LIC) as well as operations other than war.

INTEGRATED TRAINING SOLUTIONS



ELTEL TECHNOLOGISTICS LTD.

11 Tuval St.,
Ramat Gan 5252226, Israel
Tel: 972-3-7557000
Fax: 972-3-7527001
E-mail: info@eltel.co.il

Eltel Technologists Ltd. is a leading defense provider of technological and logistics solutions that specializes in the field of training and simulation.

Areas of activity:

Tactical Defense Training



- ▶ **Advanced live fire training**
computerized pop-up and moving targets for both infantry and armour units.
- ▶ **Digital shooting ranges**
shooting simulator for marksmanship training of infantry and armour units and decision making situations. Systems are available for both indoor and outdoor solutions.
- ▶ **Scenario Simulation**
various simulation equipment for creating authentic scenarios for the training, including urban combat training, pyrotechnics, smoke, etc.
- ▶ **Exercise monitoring, debriefing and performance analysis**
Advanced control and monitoring systems that allow complete and accurate review of the trainees' performance for debriefing and improvement purposes.

Synthetic Arena Simulation (SAS)



- ▶ The system is based on military doctrine, physical and operation models to simulate a realistic combat environment.
- ▶ SAS features a full and operational interface with various C⁴I systems.
- ▶ Operational plan examination and decision support system (DSS).

Competence and Readiness Performance Management (CRPM)



- ▶ An advanced BI system that supports the decision making process along the chain of command.
- ▶ The system maintains an up-to-date status of the various units and displays the current availability of the operational crews.
- ▶ The system interfaces with the client's information systems and databases in order to access the most updated status reports.
- ▶ CRPM enables the users to better allocate their resources in order to keep their operating efficiency high while minimizing costs.

YOU SEE US! *Day and night*

No External Power Source



RVTT[®] RESHEF TECHNOLOGY LTD.

RVTT

Reshef Visual Thermal Technology

P.O.Box 4298

Rosh-Ha'ayin 4856156, Israel

Tel: 972-3-9382804

Fax: 972-3-9383702

E-mail: resh@inter.net.il

Targets

- Constructing a battlefield scenario for ground forces
- Enemy target Construction during ground battle simulation
- Ground forces training during day/night simulations
- Improvement of night warfare skills
- Training of ground counter intelligence gathering during day/night

Mission Statement

We want to improve capabilities of the simulated battlefield using our **visual reality™** solutions for day and night (using passive thermal signatures). We are dedicated to enhancing our customers training scenarios under CPI (Continuous Process Improvement).

Identification and Marking

- Friendly / foe identification capabilities for the ground and air forces
- Safety marking of forces during training to prevent friendly fire
- Road direction signs night/day and ranging aids

AIR DEFENSE RADARS



IAI ELTA SYSTEMS LTD.

P.O.Box 330 Ashdod 7710202, Israel

Tel: 972-8-8572410

Fax: 972-8-8561872

E-mail: market@elta.co.il

Web Site: www.elta-iai.com

ELTA - Our Systems, Your Advantage

MMR – Multi Mission Radar

ELM-2084

The ELTA ELM-2084 Multi Mission Radar is an advanced phased-array radar able to detect a wide range of low RCS airborne objects - including missiles, artillery shells and rockets. The objects can be detected even in the presence of ground clutter and electromagnetic interference. When encountering ballistic motion type targets, the radar rapidly detects and pinpoints the location of the adversary weapon launching point and calculates the anticipated impact points.



AD STAR - Air Defense and Air Traffic Control Radar

ELM-2288

The ELTA AD-STAR ELM-2288 is an advanced 3D target position, solid-state long-range S-Band family of transportable radars designed to support Air Defenses, Early Warning and Traffic Control activities. Featuring fully digital beam forming in elevation (receiving and transmitting) the AD-STAR provides high accuracy 3D data on detected targets, while initiating automatic target tracking based on preprogrammed target parameters. Including multiple transmitters and digital receivers, the AD-STAR ensures high redundancy and reliability, and high availability. The radar system can be integrated with a compatible IFF (SSR) system features mounted on the primary antenna.



GREEN PINE

ELM-2080

ELM-2080 is a search, acquisition and fire control radar that can simultaneously detect and track dozens of ballistic missiles in a wide array of ranges and altitudes. The modern signal processor embedded in the system enables flexibility in waveform generation and data processing. The large power aperture, combining state-of-the-art solid state modules, provides a long detection range, even in adverse weather conditions, land and sea clutter, or chaff.

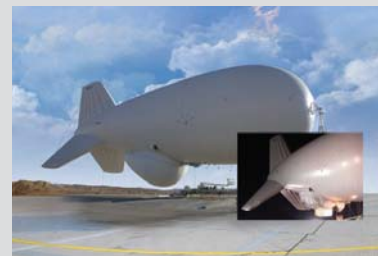

APR – Aerostat Programmable Radar

ELM-2083

ELTA and TCOM L.P. have combined their capabilities to provide an efficient and affordable Aerostat-Mounted Airborne Early Warning Radar. The radar provides continuous long range and low altitude coverage on a 24 hour basis. The Phase Array Radar normally operates in a 360° coverage search mode, and can be switched to sector scan mode for extended range and improved tracking capability. The system provides 3D coverage for air defense operations and simultaneous surface target detection.

BARAK-8

LAND-BASED AND NAVAL



Israel Aerospace Industries Ltd.
Systems Missiles & Space Group

BARAK-8 Air & Missile Defense System

Land-based, Short to Long Range, Point & Area

AIR & MISSILE DEFENSE DIVISION

P.O.Box 105
Yehud Industrial Zone
5610002, Israel
Tel: 972-3-5315699
Fax: 972-3-5315830
E-mail: marketing@iai.co.il
Web Site: www.iai.co.il



Land Based
Implementation

BARAK-8 from IAI: Point and Area Air & Missile Defense System for Extended Ranges

- Advanced Air & Missile Defense System
- From short to long ranges - low to high altitude targets
- Multiple simultaneous engagements in severe saturation scenarios
- Active seeker enables all-weather operation
- Missiles vertical launch and high maneuverability supports 360° coverage
- Advanced 2 way data link supports missiles and batteries coordination

AIR DEFENSE SYSTEMS

IRON DOME SPYDER-SR/MR



RAFAEL
ADVANCED DEFENSE SYSTEMS
P.O.Box 2250 (19)
Haifa 3102102, Israel
Tel: 972-4-8794714
Fax: 972-4-8794657
E-mail: intl-mkt@rafael.co.il
Web Site: www.rafael.co.il

Air Defense

Rafael has extensive experience in missile development and production, and offers a variety of missiles in a broad range of areas.

IRON DOME

The Iron Dome is the only dual mission system in the world that provides an effective defense solution for countering rockets, artillery & mortars (C-RAM) as well as aircraft, helicopters, UAVs, PGMs. The system is an effective system for countering C-RAM threats with ranges of up to 70 km and for VSHORAD protection (up to 10 km). The system operates in all weather conditions, including low clouds, rain, dust storms or fog.



SPYDER-SR/MR

Short/Medium Range Mobile Air Defense Systems.

SPYDER (Surface-To-Air Python & DERBY) is a quick reaction, low level surface-to-air missile system designed to counter attacks by aircraft, helicopters UAVs and precision guided munitions. The system provides effective protection of valuable assets, as well as first-class defense for forces located in the combat area. SPYDER incorporates RAFAEL's most advanced, proven performance air-to-air missiles - the Derby active radar (RF) missile and Python-5, a dual waveband Imaging Infra Red (IIR) missile. The SPYDER family includes SPYDER-SR (Short Range) and SPYDER-MR (Medium Range) systems.



MIC⁴AD



RAFAEL
ADVANCED DEFENSE SYSTEMS

P.O.Box 2250 (19)
Haifa 3102102, Israel
Tel: 972-4-8794714
Fax: 972-4-8794657
E-mail: intl-mkt@rafael.co.il
Web Site: www.rafael.co.il

MIC⁴AD is an advanced, unified, integrated C⁴I system that commands and controls the operation of both air and missile defense, including air-superiority missions. MIC⁴AD provides a total solution for multi-system, multi-layer and multi-range air and missile defense, traditionally operated as separate commands.

MIC⁴AD correlates real-time data from distributed sensors/platforms (radars, IFF system, data links, electro-optics), all connected to the air traffic control picture and mission planning system. The data is analyzed to deliver a real-time, coherent national Air Situation Picture (ASP).

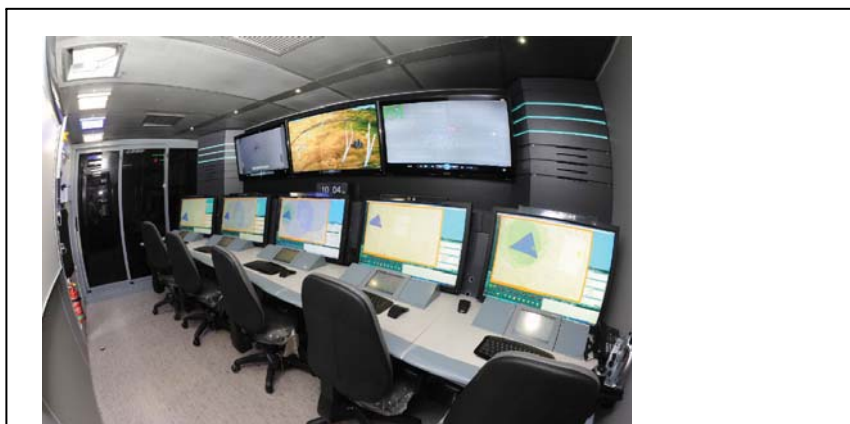

Simultaneously, MIC⁴AD performs threat assessment and hostile target classification, generating an interception plan for threats at any command level (national, regional, tactical). MIC⁴AD optimizes resource management and swiftly allocates the most appropriate defense system, such as SPYDER, David's Sling, Iron Dome or other customer systems to the type of challenge. Response includes target allocation to weapon systems (TAWA - Threat Assessment Weapon Allocation) with full, semi-automatic or manual fire control according to customer doctrine.

MIC⁴AD open, modular architecture can be adapted to customer operational needs. The system can be integrated with a customer's existing or future air and missile defenses. This flexibility allows incorporating new technologies and systems with the existing arrangement. MIC⁴AD can serve as an add-on to the customer's current C⁴I setup, or replace existing systems entirely.

Highly automated, easy-to-use and with advanced interactive displays, MIC⁴AD is a true force-multiplier. Enabling unified command and fire control of multiple air and missile defense systems, MIC⁴AD delivers multi-mission, multi-layer and multi-range C⁴I capabilities that ensure end-to-end air and missile protection.

SKYSTAR 300 AEROSTAT SYSTEM

Aeronautics

AERONAUTICS LTD.

P.O.Box 169
Yavne 8110101, Israel
Tel: 972-8-9433600
Fax: 972-8-9328912
E-mail: info@aeronautics-sys.com
Web Site: www.aeronautics-sys.com



Skystar 300 Aerostat System

The Skystar 300 aerostat system raises a powerful, day/night payload to a height of up to 1,000 ft AGL. The Skystar 300 can be transported anywhere onboard its mobile Ground System and quickly deployed and launched to provide prolonged, effective, wide area 360° surveillance coverage. The system's GPS navigation sensors enable easy pinpointing of detected targets and objects.

ADVANCED AEROSTAT SYSTEMS



RT LTD.

10 Nahal Snir St.,
Yavne 8122447, Israel
Tel: 972-8-9433616
Fax: 972-8-9433607
Web Site: www.rt.co.il



RT Company Profile

R-T LTA Surveillance is a world-class designer, developer and manufacturer of the SkyStar™ aerostat family for use in intelligence, surveillance, reconnaissance, and communication applications. Users active in prevent - prepare - respond - recover settings requiring continuous and compact aerial support are a natural fit for SkyStar™ products.

RT LTA delivers self-contained, versatile, easily transportable, cost-effective tactical system comprised of a mobile control station, ground system module, a tether, lighter-than-air platform, stabilized payload platform and sophisticated sensor suite. SkyStar™ systems are easy to operate, rapidly deployed and customized for a range of operating conditions worldwide in various military and civilian missions.

Currently, systems are deployed in countries such as Afghanistan, Israel, Mexico, Thailand, Canada, Africa and Russia.

Skystar Applications

- Unmanned Aerial ISR and target acquisition
- Border and coastal security
- Crisis and emergency management
- Law enforcement and public safety
- Search and Rescue
- Communication relay
- Offshore/onshore business continuity recovery
- Event traffic/crowd control
- VIP protection
- Environmental measurement





UNMANNED SYSTEMS & ROBOTICS

Israel pioneered the field of unmanned aerial systems in the 1970s and is now considered world leader in this field. Today, Israeli developed unmanned systems are offered along with avionics, mission payloads and support systems, providing the unmanned aerial platforms, land vehicles of all sizes, and surface vessels for military, homeland security and civil use.

Israeli unmanned systems have been operationally proven for decades, enduring cold, high-altitude and high temperature conditions, tropical and desert climates, as well as the maritime environment. In addition to supporting the IDF, these vehicles, sensors and mission systems have operated routinely in all recent conflicts, from Afghanistan and Iraq in the Middle East to Mali, Libya in Africa, providing essential intelligence support and saving the lives of soldiers and civilians alike.

The Israel Air Force (IAF) operates several UAV squadrons equipped with Israeli made Medium Altitude Long Endurance (MALE) platforms, along with tactical and mini-UAVs utilized by the ground forces. The Israel Defense Forces (IDF) also became the first army to employ a robotic, unmanned patrol vehicle as part of regular, operational forces while the Israel Navy has been employing Unmanned Surface Vessels (USV) - these agile and persistent platforms are assuming growing responsibility for the country's port, coastal and offshore security. Aerostats are also employed in support of ground forces, providing persistent, wide-area electronic surveillance and high fidelity imaging. Aerostats also provide ground and air surveillance and other services.

Supporting missions other than war, Israeli unmanned vehicles are also operating in Latin America, the Indian Ocean, Europe, Asia, South Pacific and Africa. Patrolling vast areas of desert, open country, jungles or open sea, such UAVs are securing borders, oil fields and pipelines, monitor maritime traffic in littorals, assist in combatting piracy and assisting in rapid response and recovery in emergency situations.

AEROSTAR TACTICAL UAV



Aeronautics

AERONAUTICS LTD.

P.O.Box 169
 Yavne 8110101, Israel
 Tel: 972-8-9433600
 Fax: 972-8-9328912
 E-mail: info@aeronautics-sys.com
 Web Site: www.aeronautics-sys.com



Aerostar Tactical UAV

The Aerostar Tactical Unmanned Air Vehicle System (TUAV) provides reliable, high quality real time intelligence gathering capability.

The system has accumulated thousands of operational hours, giving the system its maturity, reliability and credibility.

The Aerostar system is cost-effective, user friendly, and can be deployed in a very short time due to its small logistics footprint.

Among the system's customers are the IDF, U.S. Navy, and other customers around the globe.

Performance

Service Ceiling	18,000 ft
Endurance	>12 hours
LOS Datalink Range	200 km

Technical Data

Wingspan	8.7 m (28.5 ft)
Length	4.4 m (14.5 ft)
Height	1.2 m (4 ft)
MTOW	230 kg (507 lb)
Max Payload Weight	50 kg (110 lb)

DOMINATOR[®] MALE UAV



Aeronautics

AERONAUTICS LTD.

P.O.Box 169
Yavne 8110101, Israel
Tel: 972-8-9433600
Fax: 972-8-9328912
E-mail: info@aeronautics-sys.com
Web Site: www.aeronautics-sys.com



Dominator® MALE UAV

The Dominator MALE UAV is a strategic asset providing comprehensive situational awareness at ranges beyond line of sight. Carrying multiple sensors and payloads, the Dominator is capable of performing a wide range of operational missions.

The Dominator MALE UAV system is based on the DA42 platform. The system combines the remarkable performance of the DA42, a fully certified aircraft, with over 640 units produced since 2005 and over 360,000 hours of accumulated operating experience, and the proven unmanned technology by Aeronautics, which has logged over 80,000 operational flight hours onboard UAVs worldwide.

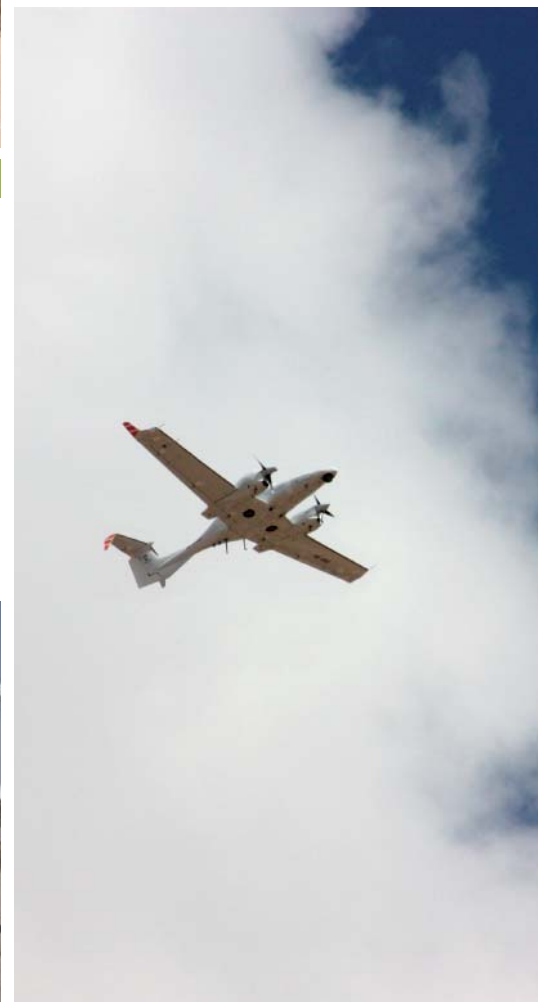

ORBITER[®] MINI UAV



Aeronautics

AERONAUTICS LTD.

P.O.Box 169
 Yavne 8110101, Israel
 Tel: 972-8-9433600
 Fax: 972-8-9328912
 E-mail: info@aeronautics-sys.com
 Web Site: www.aeronautics-sys.com



Orbiter® Mini UAV

The Orbiter Mini UAV System Is a compact and lightweight system designed for use in Military and Homeland security missions.

The system presents the ultimate solution for Over The Hill reconnaissance missions, Low Intensity Conflicts and Urban warfare operations as well as any close range mission.

Performance

Operational Altitude	500-3,000 ft
Endurance	3-4 hours
LOS Datalink Range	15/50/80 km
Operational Speed.....	25-75 kt
Service Ceiling	18,000 ft

Technical Data

Wingspan.....	2.2 m (7.2 ft) / 3 m (9.8 ft)
Length.....	1 m (3.2 ft)
Height	0.3 m (1 ft)
Max Payload Weight.....	1.5 kg (3.3 lb)

ORBITER[®] 3 SMALL UAS



Aeronautics

AERONAUTICS LTD.

P.O.Box 169
Yavne 8110101, Israel
Tel: 972-8-9433600
Fax: 972-8-9328912
E-mail: info@aeronautics-sys.com
Web Site: www.aeronautics-sys.com



ORBITER® 3 small UAS

The Orbiter 3 Small Tactical Unmanned Aerial System (STUAS) combines the advantages of an impressive performance envelope and radically reduced logistical and operational requirements, making it a remarkably capable yet efficient solution for Intelligence, Surveillance, Target-Acquisition and Reconnaissance (ISTAR) purposes.

Performance

Operational Altitude	500-3,000 ft
Endurance	up to 7 hours
LOS Datalink Range	up to 100 km
Operational Speed	30-70 kt
Service Ceiling.....	18,000 ft

Technical data

Wingspan	4.2 m (13.8 ft)
Length	1.5 m (5 ft)
Height	0.5 m (1.7 ft)
Max T/O Weight	28 kg (62 lb)



MINI UAV DEVELOPMENT

AeroTactiX LTD.
Advanced UAS Solutions

AEROTACTIX LTD.

68 Amal St.,
Petach Tikva 4951368, Israel
Tel: 972-3-9215720
Fax: 972-3-9215434
E-mail: info@aerotactix.com
Web Site: www.aerotactix.com



AeroTactiX (Israel) LTD. Develops and manufactures mini UAS and sub-systems including Autopilots, Communication systems and ground control stations, and offers integration for various Payloads and components.

AeroTactiX (Israel) LTD. Delivers high-end, cost effective, mini UAS solutions for various applications.

Our mini-UAS is based on the latest technology available on the market, and is also based on the experience and knowledge accumulated in thousands of operational missions.

Turn Key solutions precisely matched to our customer's requirements is our business philosophy.

When a tailor made system is required AeroTactiX will do its best effort to optimize all technical aspects and to provide the best suitable solution for our client.



LOS (LINE OF SIGHT) DATA LINK SOLUTIONS

Comm**tact**

COMMTACT LTD.

P.O.Box 169
Yavne 8110101, Israel
Tel: 972-8-9433602
Fax: 972-8-9433603
E-mail: info@commtact.co.il
Web Site: www.commtact.co.il



LOS (Line Of Sight) Data Link Solutions

Commcontact specializes in providing advanced wireless communication solutions and Tactical Data Link Systems for various applications. Commcontact's products are being operated successfully onboard fixed wing aircraft, helicopters, UAVs and in a variety of naval and mobile ground platforms. All systems are operationally proven in a broad range of short/medium/long range of portable and mobile applications.



UNMANNED AERIAL VEHICLES (UAVs)

Elbit Systems is a world-leading supplier of advanced tactical and MALE UAVs. Our UAVs have accumulated over 400,000 operational flight hours demonstrating outstanding reliability, superior performance and smaller ground footprint.



The SKYLARK® Family:

- Real-time reconnaissance (ISTAR)
- silent operation-Electric propulsion Counter-terror oriented; convoy airborne escort
- Fully autonomous flight with high level control Simple and quick field deployment
On-the-move operation
- Interoperability

SKYLARK® I-LE

- Endurance – up to 3 hours
- Max. altitude - 15,000 ft
- Operational altitude - (-1,200) to 4,000 ft AGL



ELBIT SYSTEMS LTD.

P.O.Box 539
Advanced Technology Center
Haifa 3105301, Israel
Tel: 972-4-8315315
E-mail: uas@elbitsystems.com
Web Site: www.elbitsystems.com

The HERMES® Family:

- In-house major system building blocks and technologies
- C⁴I oriented system-of-systems approach
- Highly reliable, fully autonomous.

- Commonality - avionics, payloads, data-link, GCS
- Long endurance and high payloads capability
- Growth potential - weight, volume, power

**HERMES® 900**

- Multi-payload configuration
- Maximum Useful Load - 450Kg
- Max. takeoff weight - 1,180Kg
- Wingspan – 15.3 m
- Max. endurance > 33 hours
- Max altitude - 30,000 ft
- Integrated automatic takeoff and landing

**HERMES® 450**

- Dual payload capability - 150 kg, 300 liter
- Max. takeoff weight 550 kg
- Wingspan - 10.5 m
- Max. endurance - 18 hours / 450LE - 30 hours
- Max. altitude - 18,000 ft
- Onboard automatic takeoff and landing (ATOL)
- Short/semi-prepared runway
- Remote taxi braking option

**HERMES® 90**

- Wingspan - 5 m
- Takeoff weight - 115 kg
- Max. payload weight - 25 kg
- Mission radius -100 km
- Endurance – up to 15 hours
- Altitude ceiling - 15,000 ft
- Operational altitude - 1,000-5,000 ft AGL

ELBIT SYSTEMS LTD.

P.O.Box 539
Advanced Technology Center
Haifa 3105301, Israel
Tel: 972-4-8315315
E-mail: uas@elbitsystems.com
Web Site: www.elbitsystems.com



Design Concept

- H/W - PC-based, fully redundant, client-server open architecture
- S/W - object-oriented, commercial tools, Windows-type advanced HMI
- Interoperability - STANAG ready
- Safety:
 - Standard 882C compliant, DEFSTAN 56 designed
 - Flight & mission critical failure redundancy
- Expansion - Easy integration of new payloads, new data-links, new air vehicles
- Embedded Mission Trainer

UAV Mission Trainer

- Training in actual operator environment - standard GCS environment
- Simulation of all UAV systems, all mission phases, malfunctions and emergencies
- Highly realistic training with comprehensive 3D geographic high-resolution database
- Diverse weather, terrain and arena situations
- Effective tool for risk and flight hours reduction for operators training and qualification and mission rehearsal

Functions

- Multi-payload operation
- Dual mission capability with 2 GDTS
- Sensor-to-shooter integrated solution
- In-house system building blocks and technologies
- C4I oriented system-of-systems approach
- Highly reliable, fully autonomous system capability

Configurations

- Mobile shelters
- Tailored downsizing:
 - Jeep-sized vehicles
 - Indoor configuration
 - Shipboard
- RVT - Man-pack



UAV PAYLOADS



IAI ELTA SYSTEMS LTD.

P.O.Box 330 Ashdod 7710202, Israel

Tel: 972-8-8572410

Fax: 972-8-8561872

E-mail: market@elta.co.il

Web Site: www.elta-iai.com

ELTA - Our Systems, Your Advantage

UAV Maritime Patrol Radar System ELM-2022U

The ELM-2022U Maritime Patrol Radar (MPR) System consists of a UAV Maritime Surveillance Radar Payload, and a Ground Radar Operator Station that controls the radar's operation and processes the data sent by the Radar Payload via the UAV's dedicated data link. The MPR System provides a cost-effective force multiplier solution for Maritime Surveillance and EEZ Patrol, Surface and Littoral Warfare, Search and Rescue, Drug Interdiction and prevention of Illegal Immigration and Terrorist activities, Coast Guard and Fisheries Patrol, and Image Intelligence Operations.



SAR/GMTI UAV Reconnaissance System ELM-2054/2055

The ELM-2054/55 is a family of a high performance Synthetic Aperture Radar (SAR) and Ground Moving Target Indication (GMTI) all weather Reconnaissance System, for Unmanned Air Vehicles (UAVs). The system consists of the UAV payload, a radar sensor and the Ground Exploitation Segment (GES). The ELM-2055 produces radar images which approach photographic quality, and operates as a true all-weather, day and night sensor capable of penetrating clouds, rain, smoke, smog, fog and man-made camouflage. The SAR Imagery and GMTI plots generated on board are transmitted via the UAV's dedicated data link to the Ground Exploitation Segment (GES) for interpretation and extraction of intelligence data.



Integrated UAV ESM/ELINT System (IUELIS) ELL-8385

The ELTA ELL-8385 is a UAV Integrated Electronic Support Measures (ESM) and Electronic Intelligence (ELINT) System. The system disseminates intelligence reports, including real-time Electronic Order of Battle (EOB). The system's tasks include search, interception, measurement, location, analysis, classification and monitoring of ground, airborne and naval radar transmissions- which are characterized by high mobility, short duration, modern signals forms and frequent changes in signal parameters.



Integrated UAV COMINT/DF System (IUCOMS) ELK-7071

The ELTA ELK-7071 is a UAV Integrated Communication Intelligence (COMINT) System. The system disseminates intelligence reports including, real-time Electronic Order of Battle (EOB) of communication transmissions. The system's tasks include search, interception, measurement, location, analysis, classification and monitoring of ground, airborne and naval radar transmissions- which are characterized by high mobility, short duration, and frequent changes in signal parameters.

INNOVATION INVENTION IMPLEMENTATION



**INNOCON
INNOVATIVE CONTROLLERS LTD.**

32 Habanai St.,
Holon 5885607, Israel
Tel: 972-3-5586330
Fax: 972-3-5588382
E-mail: zvika@innoconltd.com
Web Site: www.innoconltd.com



Micro Falcon Mini UAS family

- Innocon's lightest UAV family designed for soldier level missions of over the hill observation missions
- Innovative structure of tandem configuration constructed as box and belly mounted payload
- Remarkably rugged
- Operates at an altitude of max. <15,000 feet
- Endurance of up to 3 hours day or night



Mini Falcon TUAS family

- For tactical ISTAR (Intelligence, Surveillance, Target Acquisition and Reconnaissance) missions Range of up to 200km LOS
- Large platform performance in a small size air frame
- Automatic Takeoff and Landing for both runway and harsh terrain
- Operates at an altitude of max <18,000 feet



ASIS – Airborne Surveillance and Intelligence System

- Enabling you to accomplish airborne surveillance and intelligence missions without the use of UAV
- Great solution for overcoming UAV flight regulations over urban areas
- Payload operation from either GCS or by the Air Crew themselves
- The payload can communicate with a GCS at 200km



Falcon Eye MALE UAS

- Cost effective highly reliable system, for long endurance medium altitude reconnaissance surveillance and intelligence missions
- The Falcon Eye demonstrates Innocon's technological strength in converting manned civilian aircraft into UAV
- Endurance of up to 24 hours
- Capable of carrying a large variety of payloads, from SAR to COMINT SIGINT, ELINT and large EO/IR payloads
- Operates at an altitude <20,000ft

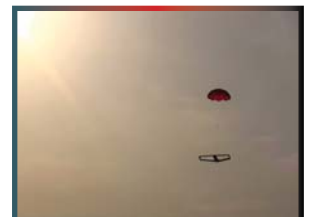

Innovation

Invention

Implementation

IAI - MALAT DIVISION



Israel Aerospace Industries Ltd.
Military Aircraft Group, MALAT Division

ISRAEL

Tel: (972)3-9358169 Fax: (972)3-9355781

USA

Tel: (1)703-8753722 Fax: (1)703-8753770

EUROPE

Tel: (33)1-46404747 Fax: (33)1-46404748

E-mail: malat@iai.co.il

Web Site: www.malat-iai.com

www.iai.co.il/malat



1,000,000 Operational UAS Flight Hours

at Your Service

Whatever your needs, IAI-MALAT brings you total battlefield UAS solutions

With an unsurpassed track record of **over 1,000,000 operational flight hours** for 49 customers on five continents, **IAI-MALAT** is a global leader in comprehensive UAS-based solutions - offering the widest range of combat-proven systems.

E-mail: malat@iai.co.il | www.malat-iai.com



Israel Aerospace Industries Ltd.
Military Aircraft Group, MALAT Division

ISRAEL

Tel: (972)3-9358169 Fax: (972)3-9355781

USA

Tel: (1)703-8753722 Fax: (1)703-8753770

EUROPE

Tel: (33)1-46404747 Fax: (33)1-46404748

E-mail: malat@iai.co.il

Web Site: www.malat-iai.com
www.iai.co.il/malat

MULTI-ROLE MALE UAS

Heron TP



Missions

Deep-penetration, strategic multiple operational missions: surveillance, reconnaissance, target acquisition and specific electronic tasks for theater commanders.

Payloads

- Simultaneous multi-payload capability
- Electro Optical (TV&IR combi or TV/IR/LD triple sensor)
- Synthetic Aperture Radar (SAR)
- Maritime Patrol Radar (MPR)
- COMINT & ESM
- Customer furnished sensor suites
- Communication relay package
- Integrated ATC radio

Datalinks

- Direct line of sight (LOS) data-link
- UAV airborne data relay for beyond LOS missions
- Ground-based data relay for beyond LOS missions
- Satellite data-link capability (SATCOM)

Performance

Endurance	36 hr
Range (with SATCOM)	Beyond LOS
Altitude	45,000 ft

Technical Data

Weights	
Max take-off weight	4,650 kg
Max payload weight	1,000 kg
Dimensions	
Overall length	14 m
Wingspan	26 m



Missions

Deep-penetration, wide-area, multi-role surveillance, reconnaissance, target-acquisition and fire adjustment missions for national agencies, theater commanders and lower echelons.

Payloads

- Electro Optical (TV & IR Combi or Triple Sensor TV/IR/LD)
- Synthetic Aperture Radar (SAR)
- Maritime Patrol Radar (MPR)
- COMINT & ESM capability
- Customer furnished sensor suites
- Communication relay package
- Integrated ATC Radio

Datalinks

- Direct Line-of-Sight (LOS) data link
- UAV airborne data relay for beyond LOS missions
- Ground-based data relay for beyond LOS missions
- Satellite datalink capability (SATCOM)

Launch & Recovery

- Automatic wheeled take-off & landing

Heron



Performance

Endurance	20-45 hr
Range	350 km
Range with satellite coverage	BLOS
Altitude	30,000 ft

Technical Data

Weights	
Max take-off weight	1,250 kg
Max payload weight	250 kg
Dimensions	
Overall length	8.50 m
Wingspan	16.60 m





ISRAEL

Tel: (972)3-9358169 Fax: (972)3-9355781

USA

Tel: (1)703-8753722 Fax: (1)703-8753770

EUROPE

Tel: (33)1-46404747 Fax: (33)1-46404748

E-mail: malat@iai.co.il

Web Site: www.malat-iai.com
www.iai.co.il/malat

MULTI-ROLE TACTICAL UAS

Missions

Surveillance, reconnaissance, target-acquisition, artillery adjustment and damage assessment.

Payloads

- Electro Optical (TV & IR Combi or Triple Sensor TV/IR/LD)
- Synthetic Aperture Radar (SAR)
- COMINT & ESM Integration Capability
- Customer furnished payloads

Datalinks

- Direct Line-of-Sight (LOS) data link
- UAV airborne data relay for beyond LOS missions
- Ground-based data relay for beyond LOS missions

Launch & Recovery

- Automatic take-off & landing

Searcher MK III

Performance

Endurance	18 hr
Range	350 km
Altitude	23,000 ft
Four Strokes, silent engine	



Technical Data

Weights	
Max take-off weight	436 kg
Max payload weight	120 kg
Dimensions	
Overall length	5.85 m
Wingspan	8.55 m

NAVAL UAS

Missions

Operating from any aviation-capable warship and/or unprepared area for: Long range surveillance in day/night and severe weather conditions, Anti-submarine warfare, Moving target indication, COMINT/DF activities, ESM activities, Target acquisition and target range measurement

Payloads

- Multi sensor capability
- Multimode radar:
 - Sea Surveillance
 - Moving Target Indicator (MTI)
 - Air-to-Air mode
 - Navigation & Weather Avoidance
 - SAR
 - ISAR
- Electro-Optical
- COMINT/DF
- ESM

NRUAS

Data Links

- Direct Line-of Sight (LOS) data link

Launch & Recovery

- Automatic take-off & landing (ATOL)

Performance

Endurance	6 hours
Range	150 km
Altitude	15,000 ft



Technical Data

Weights	
Max take-off weight	2,200 kg
Max payload weight	220 kg
Dimensions	
Main rotor diameter	11.02 m
Tail rotor diameter	1.91 m
Overall length	12.84 m



Israel Aerospace Industries Ltd.
Military Aircraft Group, MALAT Division

ISRAEL

Tel: (972)3-9358169 Fax: (972)3-9355781

USA

Tel: (1)703-8753722 Fax: (1)703-8753770

EUROPE

Tel: (33)1-46404747 Fax: (33)1-46404748

E-mail: malat@iai.co.il

Web Site: www.malat-iai.com

www.iai.co.il/malat

TACTICAL VTOL UAS

Missions

- Covert special operation missions
- Ship Deck Operation
- Intelligence, Surveillance and Reconnaissance Missions (ISR)
- Silent Observation and Stakeout Missions
- Convoy escort and protection
- Border and Coastal Surveillance Missions
- Law enforcement Missions
- Emergency Response and Support Missions

Payloads

- Mini POP EO/IR/LP Payload (day/night)

Launch & Recovery

- Automatic Vertical Take Off & Landing Capability

Data Links

- Direct Line-of-Sight (LOS) data link

Panther



Performance

Endurance	4 hr
Range	60 km
Altitude	3,000 ft AGL
Dash Speed	60 knots



Technical Data

Weights	
Max take-off weight	65 kg
Max payload weight	8.5 kg
Dimensions	
Overall length	2.85 m
Wingspan	8 m
Powerplant	
	Electrical

Missions

- Covert special operation missions
- Ship Deck Operation
- Intelligence, Surveillance and Reconnaissance Missions (ISR)
- Silent Observation and Stakeout Missions
- Convoy escort and protection
- Border and Coastal Surveillance Missions
- Law enforcement Missions
- Emergency Response and Support Missions

Payloads

- Micro POP EO/IR Payload (day/night)

Launch & Recovery

- Automatic Vertical Take Off & Landing Capability

Datalinks

- Direct Line-of-Sight (LOS) data link

Mini Panther



Performance

Endurance	120 min
Range	20 km
Altitude	1,500 ft AGL
Dash Speed	40 knots



Technical Data

Weights	
Max take-off weight	12 kg
Max payload weight	2 kg
Dimensions	
Overall length	1.3 m
Wingspan	3.2 m
Powerplant	
	Electrical



ISRAEL

Tel: (972)3-9358169 Fax: (972)3-9355781

USA

Tel: (1)703-8753722 Fax: (1)703-8753770

EUROPE

Tel: (33)1-46404747 Fax: (33)1-46404748

E-mail: malat@iai.co.il

Web Site: www.malat-iai.com
www.iai.co.il/malat

MINI UAS

General

The Bird-Eye 650 system is equipped in 2 backpacks and consists of:

- 3 UAV platforms
 - EO&IR payloads
 - Portable Ground Control System (PGCS)
 - Data Link
 - Power source and repair kit
- It is man-portable with fast field deployment by a team of two

Missions

- Real-time day/night imagery intelligence gathering for low echelon forces
- "Over the hill" Intelligence, reconnaissance and surveillance (ISR)
- Urban Operation
- Counter Terrorism
- Silent Observation and Stakeout
- Law enforcement
- Patrol and Convoy Escort

Bird-Eye 650



Payloads

- Gimballed, plug-in, lightweight day/night stabilized observation system (TAMAM's Micro-Pop)

Launch & Recovery

- Mini launcher take-off, unique patented turn-over landing

Data Links

- Direct Line-of-Sight (LOS) data link

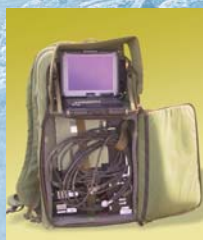

Performance

Endurance	3.5 hr
Range	20-50 km
Altitude	1,500 ft AGL
Loiter Speed	40 knots

Technical Data

Weights	
Take-off weight	11 kg
Payload weight	1.2 kg
Dimensions	
Overall length	1.07 m
Wingspan	3 m
Powerplant	
	Electrical

Bird-Eye 400

Missions

Real time day / night imagery data for law-enforcement and "Over-the-Hill" reconnaissance and surveillance.

Payloads

- Gimballed video camera - day/night

Launch & Recovery

- Hand or bungee launch

Performance

Endurance	60 min
Range	10 km
Altitude	1,000 ft AGL

Technical Data

Weights	
Take-off weight	5.6 kg
Payload weight	1.2 kg
Dimensions	
Overall length	0.8 m
Wingspan	2.2 m
Powerplant	
	electrical



IAI - MALAT DIVISION



Israel Aerospace Industries Ltd.
Military Aircraft Group, MALAT Division

ISRAEL

Tel: (972)3-9358169 Fax: (972)3-9355781

USA

Tel: (1)703-8753722 Fax: (1)703-8753770

EUROPE

Tel: (33)1-46404747 Fax: (33)1-46404748

E-mail: malat@iai.co.il

Web Site: www.malat-iai.com
www.iai.co.il/malat

ROTARY MINI UAS

General

Versatile, highly maneuverable rotary mini UAS.

Missions

- Support ISR missions in urban warfare
- Silent observation and stakeout missions
- Covert special operations missions

Main Features

- Automatic vertical take-off and landing in any terrain
- Silent electrical propulsion
- Low acoustic signature
- Day and night operation
- Quick and easy assembly and disassembly



Ghost

Performance

Endurance	30 min
Operational speed	0-35 kts

Technical Data

MTOW	4 kg
Dimensions	
Length	145 cm (106 cm folded)
Width	75 cm (11 cm folded)
Powerplant	Electrical
Payload	E/O day or night
Data link	Line of Sight (LOS) and Non Line of Sight (NLOS) data link for urban scenarios



HAS (HOVERING AERIAL SYSTEMS)

General

- One click operation
- Deployment within seconds
- Operator free/full automation
- Low signature
- Operational in extreme weather conditions
- Unlimited hovering time (with ground source of energy)
- Easily integrated on a ground vehicle or on a vessel

Missions

- Ad-hoc observation for unlimited time from a stationary or a moving platform
- Coastal and border protection
- Emergency response operation
- Special forces operation

ETOP (Electrical Tethered Observation Platform)

Payloads

- POP 300

Deploy time to 100m

- 30 sec

Performance

Hovering time	Unlimited with ground energy source
Altitude	100 m AGL



Technical Data

Weights	
Payload weight	20 kg
Dimensions (cm)	160L X 160W X 20H
Powerplant	Electrical

MTC INDUSTRIES & RESEARCH



**Complete Engineering Solutions
Under One Roof**

MTC
Industries & Research Carmiel Ltd.
P.O.Box 232, Karmiel 2161102, Israel
Tel: 972-4-9987772
Fax: 972-4-9981189
E-mail: marketing@mtcind.com
Web Site: www.mtcind.com



GYROSCOPES

CANAD FIN ACTUATION SYSTEMS

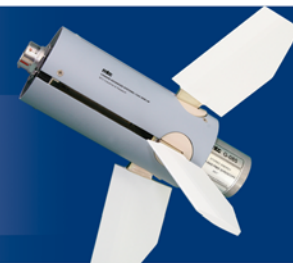

ELECTRIC MOTORS, LVTD, RVTD AND SOLVERS

SERVO ACTUATORS



HIGH PRESSURE VESSELS

SLIP RINGS



SOLENOIDS

MTC designs, develops and customizes a wide range of products for the Aerospace, Defense and Medical industries worldwide. visit MTC's website for a full range of products and services including: Engineering Solutions and Thermal Spray Coatings. MTC is AS9100C certified and conforms to MIL-STD.

Typical Applications

UAV

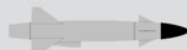

Missiles



Tanks



Ships

PROTECTOR® USV



RAFAEL ADVANCED DEFENSE SYSTEMS

P.O.Box 2250 (19)
Haifa 3102102, Israel
Tel: 972-4-8794714
Fax: 972-4-8794657
E-mail: intl-mkt@rafael.co.il
Web Site: www.rafael.co.il

PROTECTOR® USV

Is an unmanned integrated system for Intelligence, Surveillance, Target Acquisition and Reconnaissance (ISTAR).

The **PROTECTOR® USV** is fitted with a comprehensive sensor suite and can accommodate a variety of mission modules. The TOPLITE Electro-optical director and a radar system provide day/night detection, identification and tracking of targets. TOPLITE subsystems include a third-generation Forward-Looking Infra-Red (FLIR) sensor, color Charge-Coupled Device (CCD) camera an eye-safe laser rangefinder (LRF), and an advanced correlation tracker.

The Anti Terror/Force Protection payload includes the TOPLITE Electro-Optical Director (EOD), MINI-TYPHOON Stabilized Weapon Station, a Water Cannon System and auxiliary sensors. The MINI-TYPHOON is a stabilized gun mount that is highly accurate and includes fire control capabilities, yielding excellent shooting accuracy. The Water Cannon system provides less-lethal engagement at close range as well as firefighting capabilities.

PROTECTOR is operated from a Control Station. The Control Station includes two control consoles, one for the USV commander and one for the Payload Systems operator.

The Control Station receives, via communications links, all the system data, video imagery and audio required to effectively build a situational awareness picture and operate the system. The system can be easily incorporated in a wider defense array via a standard interface to an external C⁴I system.

Based on a highly maneuverable platform the USV has excellent maneuvering capabilities. The platform has water jet propulsion systems powered by diesel engines. The platform systems include control over propulsion, maneuvering, and navigation.

The **PROTECTOR's** core element is an advanced control system, which interfaces with all of the **PROTECTOR's** sub-systems and provides a remote operator with the ability to plan, prioritize and execute naval missions by day and night, under adverse weather conditions, without exposure to risk.

The **PROTECTOR's** modular design enables the Customer to select those sub-systems that will best meet his own particular operational requirements.

When mounting effectors, the **PROTECTOR** can effectively close the fire circle for an all-round "sensor-to-shooter" solution.

PROTECTOR® USV Operational Advantages

- Performs dangerous tasks without risking human lives.
- Performs long and wearisome missions such as patrolling and ongoing security tasks.
- Provides Real-time data and video transmission from the field to the headquarters.
- Can operate at high seas without a crew that is affected from the harsh conditions.
- The **Protector® USV** Command and Control system can be integrated with external C⁴I systems, making it an integral part of the defense array.
- The **Protector® USV** can be used to approach suspicious vessels and verify their intentions, thus distinguishing friend from foe without having risking crew safety.
- A highly effective sensor suite, capable of detecting and identifying targets and threats from a great distance.
- Integrated combat suite that enables a rapid "sensor to shooter" response.
- Equipped with a highly accurate combat proven stabilized Weapon Station capable of eliminating threats from afar.
- Equipped with high pressure Water Cannon for non-lethal deterrence, and crowd control tasks.
- The **Protector® USV** has the ability to record video and audio data of its surrounding for debriefing, legal purposes and other considerations.
- The **Protector® USV** can be deployed anywhere at sea, from oil rigs, mother ships or shore installations, thus maximizing its range of action and versatility.
- Onboard payload can be replaced to fit different designated missions, thus providing the ability to conduct a wide range of missions using a single platform.
- Fully-tested, serially-produced and operationally deployed in navies' world-wide.

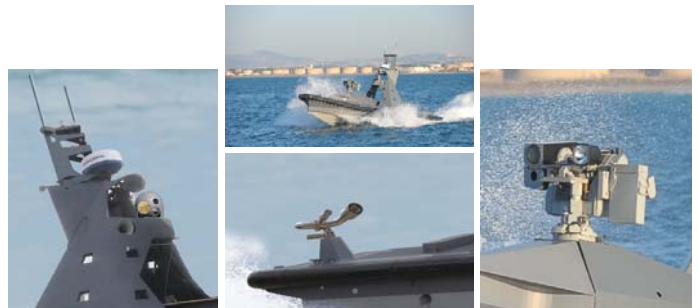

Top I Vision

Tactical Unmanned Air Vehicles



TOP I VISION LTD.

25 Hathiya St.,
Holon 5840245, Israel
Tel: 972-3-9335469
Fax: 972-3-9339327
E-mail: info@topivision.com
Web Site: www.topivision.com

Top I Vision Ltd. develops and manufactures the latest generation of tactical UAV systems and sub systems.



Mini UAV- Casper 250

- Max. altitude: 15,000 ft ASL
- Operational Endurance >120 minutes
- Mission radius > 10 km
- Take off weight: 5.5 kg

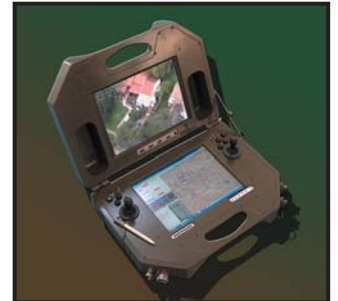

Casper 350

- Max altitude: 16,000 ft ASL
- Operational Endurance >5 hours
- Line of Sight data-link range > 50 km
- Take off weight: 35 kg
- Max. Payload weight- 5 kg.

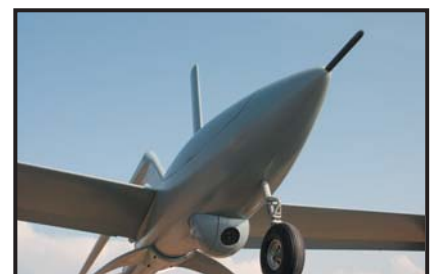

UVISION

INNOVATION • TECHNOLOGY • VISION



UVISION AIR R&D LTD.

4 Bazelet St.,
Sapir Industrial Park
Zur Igal 4486200, Israel
Tel: 972-9-7496822
Fax: 972-9-7496823
E-mail: uvision@uvisionuav.com
Web Site: www.uvisionuav.com

UVision designs, develops and manufactures unique, cost-effective, UAV system solutions. Our core competencies include highly innovative aerodynamic platform configurations tailored for unique flight qualities, advanced airborne guidance and navigation systems and command and control stations fully integrated with communication links.

UVision offers affordable Products based on the most advanced and operationally effective UAS technologies, tailored to meet the specific operational needs of its customers around the world. **UVision** has a broad mandate for establishing global UAS collaborations.

UVision's unmanned vehicles technology has matured over more than six years of operational experience using unmanned vehicles of various classes. Throughout these years we have developed and tested multiple technologies and approaches for remote command and control, imaging and video processing, air-ground communications, and man-machine interaction. Our systems were tested in the field and user feedback has directly influenced the evolution of several generations of UVision solutions.

UVision brings to the table a depth of operational knowhow that is based on significant combat experience.

The company's operations are ISO 9001:2008 certified for Research & Development, Production, UAV Services, Aviation Quality Composite Material Production and UAV flight services.

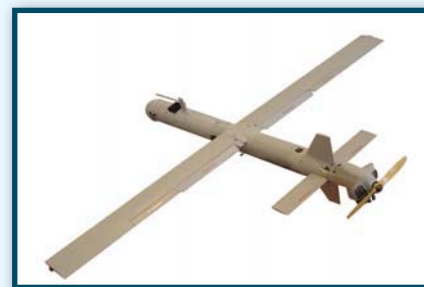

THE WORLD'S FIRST OPERATIONAL AUTONOMOUS UGV



GNIUS
UNMANNED GROUND SYSTEMS (UGS) LTD
 9 Einstein St.,
 Advanced Technology Park
 P.O.Box 4018
 Nes-Ziona 7414001, Israel
 Tel: 972-8-9308402
 Fax: 972-8-9308420
 E-mail: marketing@g-nius.co.il
 Web Site: www.g-nius.co.il



G-NIUS - A world leader in the development and fielding of unmanned ground vehicle systems.

G-NIUS Unmanned Ground Systems already logs thousands of UGV operational hours and extensive experience in the development, integration, operation, fielding, training and field-support of autonomous unmanned ground vehicles system.

Already deployed and operational system, the Guardium UGV revolutionize the effectiveness and utility of perimeter security and represent a long awaited breakthrough in combat & HLS applications such as:

- Force/Site protection
 - Route proving
 - Observation, detection and surveillance
 - Combat and maneuver support, convoy leader
 - First responding and investigation
 - Logistics support
-
- Modular combinations of payloads
 - Fix and mobile OCU – Operation Command Unit
 - Simple integration with User's available C⁴I infrastructure
 - **4 modes of operation:**
 tele-operated, semi-autonomous, full autonomy, manned driven
 - High level of safety
 - Obstacle detection and avoidance

The autonomous capability can be modified and be integrated in almost any customer vehicle in service.



Guardium MK I



Guardium MK II



Guardium MK III



AvantGuard MK II



Guardium EV

ELBIT VIPeR™



ELBIT SYSTEMS LAND AND C4I LTD.

2 Ha'machshev St.,
Netanya 4250712, Israel
Tel: 972-9-8898080
Fax: 972-9-8898231
E-mail: landc4i@elbitsystems.com
www.elbitsystems.com/landc4i



The ultimate unmanned portable combat systems

ELBIT VIPeR™ Family

The dismounted soldier's partner in combat, detecting and defeating hidden threats

A family of intelligent and portable robots – Mini VIPeR and Maxi VIPeR – that support dismounted forces in both urban and subterranean areas. Featuring intuitive operation, the one-man combat system enables real time reconnaissance around the clock in addition to arena clearing, in- building mapping, decoy and screening functions.



LAHAV ROBOTICS CENTER



Israel Aerospace Industries Ltd.
Military Aircraft Group, LAHAV Division

Center of Excellence Innovative Optimal Robotic Solutions

**LAHAV DIVISION
MILITARY AIRCRAFT GROUP**
Israel Aerospace Industries Ltd.
Ben-Gurion Int'l Airport, 7010000, Israel
Tel: 972-3-9353163, 9358198
Fax: 972-3-9353687, 9357010
E-mail: lahav_marketing@iai.co.il
Web Site: www.lahav-iai.com

IAI/Lahav's robotics center is at the cutting edge of robotics technology in autonomous navigation, C⁴I, sensor integration, communications, high and low level control, and micro robotics. IAI's robotics development methodology is integrated with operational experience, creating practical robotic solutions for a wide variety of operational fields and missions.

IAI's IN-HOUSE ROBOTICS BUILDING BLOCKS:

- World Modeling Technology
- Localization & Navigation Technology
- Command & Control
- Decision Support
- Communication Systems
- Platforms

STAGES IN DEVELOPING SOLUTIONS:

- Operational Needs and Threat Characterization
- Requirements Design
- Demonstrator Prototype Design
- Integration and Tests
- Demonstration Delivery

IAI EXPERTISE AND SKILLS

- Project Management
- JAUS Standard
- Design & HMI Engineering
- Systems Engineering
- Software/Algorithms Engineering
- Network Engineering
- Mechanical/Electrical Engineering
- Scientists



G-NIUS

GUARDIUM- Unmanned Patrol System



REX- Infantry Robotic Porter



SAHAR- Autonomous CIED System



Micro Hovering Aerial Vehicles



C4I

Today's military networks are not merely transmitting voice communications. They distribute information - video, images and dynamic maps to enable advanced command and control services. Israel's state of the art network-centric applications are supporting such advanced solutions, with open and adaptable services, empowering commanders wherever they are - in the command post, inside the combat vehicle or on dismounted operations.

These solutions span a wide range of sensors, processors and displays presenting command, control, communications, and computing, intelligence surveillance and reconnaissance (C4ISR) solutions. Advanced visualization of information in rich, geographically oriented 3D presentation enables commanders to better assess complex situations and gain battlespace awareness for better decision making, while focusing on critical problems and opportunities.

Modern military communications equipment offers more capabilities, higher reliability, and better utilization of the spectrum at a lower weight and smaller form factor. Israeli companies are defining the military networks of the 21st century with the latest in Software Defined Radios (SDR) and ad-hoc networking, implementing commercial standards and secure military communications. Using Common Off The Shelf (COTS) technologies, these standard-based systems are utilizing terrestrial, satellite, and datalink systems to carry voice and data over Internet Protocol (IP) networks.

Specific sensor technologies include radar, electronic signal intelligence (ESM, ELINT, COMINT), electro-optical, magnetic, acoustic, and more. Some sensors are designed to operate unattended, providing persistent surveillance, while others operate on manned or unmanned platforms, controlled via broader intelligence gathering networks. Intelligence analysts also benefit from access to more knowledge by fusing multiple sources into an integrated, multi-layered situational picture. These entire systems, from the sensor to the center, rely on unique Israeli know-how.

COMMUNICATIONS



A complete range of tactical radio, IP and satellite communication solutions that meet the requirements of the individual soldier through to large systems required by HQ.



Military IP Radio (MIPR)

Next generation tactical IP radio delivering high-speed broadband data communication to the battlefield

Mapacked or mounted, MIPR is a lightweight (4kg) tactical IP radio that delivers ultra-high bandwidth (up to 13.3 Mbps), real-time high-resolution video, images, voice and data.

MIPR provides connectivity for dozens of members per network. The system supports a variety of configurations, including point-to-point (PtP), point-to-multipoint (PtMP) and mobile ad-hoc networks (MANET).



Tadiran SDR-7200

Software-defined radio

Driven by combat experience, the Tadiran SDR-7200 enables improved battle group C⁴I functions through a range of unique capabilities. Housed in a single radio unit, the Tadiran SDR-7200 provides soldiers and commanders with improved operational efficiency, using fewer radios and lowering both cost and weight.



**ELBIT SYSTEMS
LAND AND C⁴I LTD.**

2 Ha'machshev St.,
Netanya 4250712, Israel
Tel: 972-9-8898080
Fax: 972-9-8898231
E-mail: landc4i@elbitsystems.com
www.elbitsystems.com/landc4i



Tadiran SDR-7200 HH

Redefining handheld tactical communications – flexible, powerful and lightweight software-defined radio

The latest in a series of combat-proven communications systems, delivering state-of-the-art voice and data communication together with C² applications in a single, integrated and lightweight handheld unit. Offering unprecedented ease of use, the highly intuitive user-interface delivers the elegance and simplicity of today's leading commercial devices to the battlefield.



Tadiran CNR-9000HDR

Multi-adaptive, VHF/FM radio systems for tactical voice and high-speed data communication

Driven by combat experience and featuring advanced capabilities, the Tadiran CNR-9000HDR is the latest in a line of combat-proven tactical communication systems offering high-speed data in addition to reliable voice communication.



Tadiran CNR-9000

Advanced multi-mode VHF/FM COMSEC/ECCM radio systems

Reliable communications are critical to mission success. The compact and lightweight Tadiran radio systems feature powerful encryption and ECCM and provide reliable communications even in densely jammed environments. The Tadiran CNR-9000 is available in a variety of manpack and vehicular/fixed station configurations.



Tadiran CNR-710MB

Multi-band radio family for multi-mission communications

An advanced, multi-band, handheld radio, the Tadiran CNR-710MB is ideal for military voice and data communication. Specifically designed to meet the growing demand for versatile and highly-reliable communication in operations involving multiple forces, it provides ground-to-ground, ground-to-air and ground-to-sea communication. Exceptional frequency band coverage and multiple waveforms enable seamless communications among various forces, units and stations, all through a single, handheld radio unit. Available configurations are: Manpack, Vehicular, Base, Marine and Airborne



Tadiran CNR-710

A highly advanced, lightweight handheld VHF/FM voice and data COMSEC/ECCM radio

The lightest radio in its class, the Tadiran CNR-710 offers robust voice and message security. The radio features advanced capabilities including unique ECCM, powerful error detection and correction codes, and an innovative user interface.



Tadiran HF-8000

Multi-adaptive HF radio systems for continuous long-range communication

Expands the traditional boundaries of HF communication, while maintaining user-friendliness and operational efficiency. This HF SSB/2-LSB radio system features cutting-edge technology, ensuring robust and reliable communication even in the harshest battlefield conditions.



**ELBIT SYSTEMS
LAND AND C⁴I LTD.**

2 Ha'machshev St.,
Netanya 4250712, Israel
Tel: 972-9-8898080
Fax: 972-9-8898231
E-mail: landc4i@elbitsystems.com
www.elbitsystems.com/landc4i



Tadiran HF-6000

Combat-proven, multi-adaptive HF radio system for reliable long-range communication

Delivering highly advanced HF operations to the modern battlefield, Tadiran HF-6000 offers advanced COMSEC/ECCM functions to assure reliable HF voice and data operations.



Micom-3 Family

Field-proven, delivering long-range radio communication in fixed and mobile configurations

The software-based Micom-3 radios deliver unmatched, cost-effective and reliable HF communication. This comprehensive product portfolio along with many available configurations supports a broad range of communication solutions. The Micom family of transceivers delivers long-range wireless communication to thousands of organizations worldwide for over 30 years.



Tadiran VIC-500

Advanced, reliable and customizable digital intercommunication system for fighting vehicles

An advanced 4th generation digital vehicular intercommunication system, meeting the most demanding operational scenarios and easily tailored to specific requirements. The Tadiran VIC-500 offers crew members reliable voice and data communication both inside and outside the vehicle.



Tadiran PNR-500

Personal network radio (PNR) – tactical conference communication for maximum mission coordination

Deployed at the platoon or company level, the Tadiran PNR-500 provides voice and data communication over a 1500 meter range. The PNR's light weight, long range and comprehensive set of features are rarely found in similar equipment of its class, making it an important component for effective C⁴I.



Tadiran GRC-2000

The most advanced line-of-sight frequency hopping, multi-channel, radio relay system in its class

Provides full-band IV orthogonal fast frequency hopping for simultaneous, interference-free communications. The Tadiran GRC-2000 is field-proven under harsh combat conditions and includes advanced error correction and interleaver to ensure high quality communications.



Tadiran GRC-408E

High-capacity, multi-interface IP and TDM radio relay

The latest generation of the high-capacity line-of-sight (HCLOS) broadband radio relay systems. Designed to meet present and future tactical communication requirements, the software-defined radio relay systems support the latest IP and legacy communication protocols. The Tadiran GRC-408E is ECCM-capable, enabling interference-free communication.



ELSAT-2000

Satellite communications on-the-move

Delivers voice and video conferencing, real-time video streaming, and data communications even to the most remote locations. The system's low-profile array antenna seamlessly and automatically acquires the designated satellite signal. Easily mounted on any vehicle, the antenna and all of its components are ruggedized to sustain extreme weather conditions, severe shock and harsh vibrations.



**ELBIT SYSTEMS
LAND AND C4I LTD.**

2 Ha'machshev St.,
Netanya 4250712, Israel
Tel: 972-9-8898080
Fax: 972-9-8898231
E-mail: landc4i@elbitsystems.com
www.elbitsystems.com/landc4i

BRO@DNET

Battle-proven broadband wireless communication infrastructure solution



The first fully-operational, battle-proven military wireless infrastructure solution that enables secure broadband communication. BRO@DNET integrates all echelons of military hierarchy into a unified communication solution, offering the flexibility and reliability required for any operational scenario.

MaXess®

Enhanced military wireless LAN



An efficient, cost-effective and immune wireless system for broadband data communication. Demonstrating strong survivability in dynamic and noisy military environments, MaXess® utilizes proprietary ad-hoc networking and MAC protocols.

IRCS

Field-proven integrated radio communication system



Enables all echelons – from high-ranking commanders down to the individual soldier in the field – to directly communicate with anyone in the military network. IRCS facilitates direct communication amongst a broad range of radios and communication devices including VHF, HF and multi-channel radios, LAN, WAN, PABX, satellite and cellular networks.



**ELBIT SYSTEMS
LAND AND C⁴I LTD.**

2 Ha'machshev St.,
Netanya 4250712, Israel
Tel: 972-9-8898080
Fax: 972-9-8898231
E-mail: landc4i@elbitsystems.com
www.elbitsystems.com/landc4i



Multimedia Routing Solutions

Transforming NCW from concept to reality

Effectively creating a "tactical internet," Elbit Systems' multimedia routing solutions enable seamless voice, data and video connectivity between all echelons. The field-proven multimedia solutions range from a soldier-carried portable light weight unit (mTMR™) to full scale multimedia routing units (TMR™ and VRGs). With increased availability of tactical video sources such as UAVs and surveillance vehicles, Elbit Systems' routing solutions and video streamers mViDi™ and ViDi™) deliver vital visual and C⁴I data to soldiers and commanders throughout the operational arena.



InterSKY® G4S

Two-way broadband satellite communication system

A scalable and robust multi-service platform enables the delivery of a wide range of IP applications to remote regions in harsh weather conditions. InterSKY's field-proven DVB-52 implementation and dynamic BM-FDMA technology provide 30-50% greater space segment efficiency, along with high-quality connectivity. Customizable design tools enable rapid configuration and deployment.



Snapshield

Flexible secure communications solutions, offering the highest level of security

Snapshield's secure managed communications solutions are trusted by the military, governments, emergency services and enterprises worldwide. Designed to meet the highest security standards and with its advanced management tools, Snapshield provides a comprehensive voice, data and fax security solution across the full spectrum of fixed line, wireless, satellite and newer IP-based networks. Snapshield's solutions are completely transparent to the end-user, deploying cutting-edge encryption technology and supporting commercial off-the-shelf (COTS) telecommunications equipment and mobile devices.

TACTICAL, ON-THE-MOVE BROADBAND SATELLITE COMMUNICATIONS

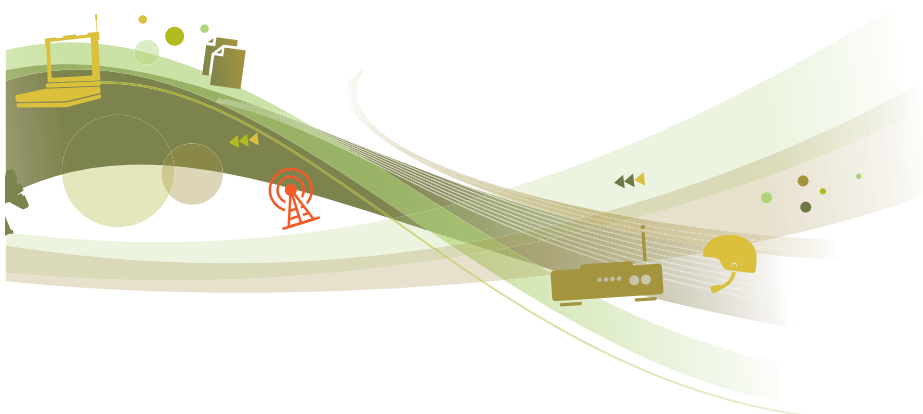

Achieve total situational awareness with our complete range of high-performance VSAT solutions

Today's net-centric battlefield demands cutting edge solutions to keep the front line in perfect synch with your command & control center. Fast and secure access to voice, data, and video are no longer luxuries - they can easily make the difference between victory and defeat. That is why leading military and defense organizations choose tactical broadband satellite communications solutions from Gilat.

Gilat delivers best of breed VSATs, modems, antennas and amplifiers for high-speed connectivity in the most challenging environments.

Our military communications products for land, sea and air applications include:

- RaySat low-profile and lightweight antenna systems for dependable Satellite on The Move (SOTM)
- MLT-1000 battle-tested, fast to deploy military modems
- Wavestream next-generation amplifiers (SSPAs and BUCs)
- SatTrooper 1000 military manpack terminals for C⁴I tactical applications



Integrated UAV solution



Matchbox BUC



StealthRay 200 on-the-move antenna



GILAT SATELLITE NETWORKS LTD.

21 Yegia Kapaim St., Kiryat-Arye
Petach-Tikvah 4913011, Israel
Tel: 972-3-9252003
Fax: 972-3-9213321
E-mail: info@gilat.com
Web Site: www.gilat.com



About Gilat

Gilat is a leading provider of products and services for satellite-based broadband communications. Gilat develops and markets high-performance satellite ground segment equipment and VSATs, SOTM solutions providing low-profile antennas, next generation SSPAs and modems. Gilat also provides managed network services via its subsidiaries in the USA, Peru and Colombia.

Gilat Satellite Networks Ltd. | www.gilat.com

COMMUNICATION SYSTEMS



IAI ELTA SYSTEMS LTD.

P.O.Box 330, Ashdod 7710202, Israel

Tel: 972-8-8572410

Fax: 972-8-8561872

E-mail: market@elta.co.il

Web Site: www.elta-iai.com

ELTA - Our Systems, Your Advantage

Airborne Wideband SATCOM Data Link ELK-1894

The ELTA's ELK-1894 "On-The-Move" SATCOM system is designed to enable bi-directional wideband communications data link for airborne, maritime and ground vehicle platforms typically deployed for government, military or commercial uses.

The mobile terminal is particularly suited for special mission platforms such as Reconnaissance Aircraft, Maritime Patrol Aircraft, Airborne Warning & Control Systems (AWACS), airborne SAR platforms and UAVs.



Tactical Intelligence Microwave Data Link ELK-1850

The ELTA ELK-1850 is a wide-band integrated microwave communication data-link network designed for a variety of Ground-to-Ground, Ground-to-Air, Ship-to-Air and Air-to-Air applications. Common applications include long-range data link for surveillance aircraft, and fixed and mobile point-to-point data link guidance data for long-range projectiles. The system consists of a monopulse tracker, secure modem, message encoder/decoder and video compressor. The systems is available in lightweight and downsized configurations, depending on customer requirements.



SDR - Software Defined Radio ARC 840D

The ARC-840D is a state-of-the-art multi-band, multi-channel Software Defined Radio (SDR) featuring Software Communication Architecture (SCA). The advanced SDR communication system is designed for simultaneous transmission and reception of voice and data, by Line-Of-Sight or Satellite Communications. A growing demand for a wide range of communication applications requiring minimal resources make the ELTA's ARC-840D Software Defined Radio set the perfect solution for today's multi-band communication needs.



Manpack Tactical SATCOM Terminal ELK-1895

The ELTA ELK-1895 is a lightweight tactical SATCOM terminal, carried and operable by a single soldier. The tactical SATCOM terminal enables communication with all network subscribers within the satellite footprint, by sending and receiving, via a secured communication link - voice, data and compressed video. The ELK-1895 is a tripod mounted, ruggedized, self-contained communication terminal that enables fast SATCOM deployment.

The terminal can be locally or remotely operated through a laptop computer or by a Personal Digital Assistant (PDA).

MISSION- CRITICAL COMMUNICATION SYSTEMS



Orbit Communication Systems Ltd. is a global leading provider of mission-critical communication systems and related services in the commercial and defense/homeland security markets.

**ORBIT
COMMUNICATION SYSTEMS LTD.**

8D Hatzoran St., P.O.Box 8657
New Industrial Zone
Netanya 4250608, Israel
Tel: 972-9-8922777
Fax: 972-9-8855944
E-mail: info@orbit-cs.com
Web Site: www.orbit-cs.com

Fulfilling the communication needs of its customers for over 60 years, Orbit offers advanced solutions, supporting applications in the areas of satellite tracking (GEO and non-GEO), earth observation (tracking LEO satellites), aeronautical telemetry, navigation, UAV Command & Control, Mobile Satellite Communications and Communication Management Systems. Orbit's international network of sales/customer support offices and technical service centers covers the United States, Europe, Brazil and the Far East.

Orbit's portfolio includes:



Mobile SatCom Systems and Services

Orbit's Mobile Satellite Communication solutions consist of stabilized broadband antennas (VSAT) for continuous communications with moving platforms and TV Receive-Only antennas. These proven systems are deployed on thousands of marine vessels and platforms, trains and aircrafts. Orbit's Mobile SatCom systems help to power the broadband infrastructure required for critical services and applications, including global Internet connectivity for voice, video and data, as well as television reception.



Tracking & Telemetry

Orbit's Tracking & Telemetry systems enable uninterrupted communication from static and moving platforms to a moving target. These systems are used for flight telemetry in aircraft, missile testing, UAV C&C, LEO/MEO satellite TT&C and data download. Orbit's highly dynamic digital tracking systems deliver pinpoint accuracy under extreme weather and environmental conditions. Supporting antennas from 1-10 meters (3-33 ft) and featuring breakthrough multi-band feed technology, Orbit's solutions reduce CAPEX and the need to maintain multiple tracking systems.

Communication Management Solutions

Orbit provides innovative digital and analog audio Communication Management Systems (CMS) for airborne and seaborne platforms. These systems manage internal and external communications, including wireless intercommunication and compatibility with legacy radios, digital and IP-based communications. Orbit's CMS solutions meet the most demanding requirements for flexible and secure audio management systems, and are customized to comply with each customer's needs.

SOURCE OF SOUND

Leading Military Communication



SOURCE OF SOUND LTD.

P.O.Box 8628, 19 Yad-Harutzim St.,
Netanya 4250506, Israel
Tel: 972-9-8658370
Fax: 972-9-8658373
E-mail: sos@s-o-s.co.il
Web Site: www.s-o-s.co.il

24 / 7 Combat Proven

MAIN ACTIVITIES - ARMY AND SECURITY AUDIO ACCESSORIES

Communication supplier to IDF ground forces and provider to US army, Special Forces, Marines, FBI and many more.

Manufacture of combat proven ruggedized headsets for communication in:

- Combat
- CBRN
- Submersible Maritime Headsets
- Security-Covert and VIP guard operations
- Extreme noise with Ear protection



COMBAT HEADSETS

Waterproof, combat proven and reliable headsets in ruthless conditions. Helmet clip attachment or headband wear with ear tip option in both configurations. Feature fast adaptation character in ever-changing warfare situations.



IN EAR NOISE REDUCTION HEADSETS

Clear- Smart Tactical in-ear headsets system designed for infantry.

Keeping active noise reduction, comprehension in high noise and impulse noise protection.

Enhanced hearing and sound localization while keeping full situational awareness. Support full duplex radio. Dual radio capabilities.

Clear can be also used by: Military heavy vehicles crew, Artillery etc.



MARITIME DEEP WATER HEADSETS

Unique low weight headsets which endure water pressures of more than 20 m.

SOS radio Bags which convert hand held radios of any size, into deep-water items.

SECURITY

VIP guards and miniaturized Secret hidden Communication including digital wireless miniaturized earphones.

ELISRA'S COMPREHENSIVE C⁴ISR SOLUTIONS



ELBIT SYSTEMS EW & SIGINT – ELISRA LTD.

48 Mivtza Kadash St.,
Bene Beraq 5121701, Israel
Tel: 972-3-5577335
Fax: 972-3-5577793
E-mail: ew-sigint@elbitsystems.com
Web Site: www.elbitsystems.com



Elisra's network-centric C⁴ISR solutions provide a comprehensive line of operations support and intelligence applications that enables a winning edge for our customers. Creating a seamless horizontal operational arena that supports topdown and bottom-up intelligence gathering, management and distribution, Elisra's C⁴ISR solutions maximize firepower, increase survivability and generate an accurate real-time situation picture in both traditional High Intensity Conflicts (HIC), as well as asymmetric Low Intensity Conflicts (LIC).

Ballistic Missile Defense (BMD) - Elisra has been a world leader in the development of missile defense systems for over two decades. The company is a prime contractor for major BMD programs, including **the Israel National Upper Tier and Lower Tier BMD** Command, Control, Battle Management, and Communications (C²BMC) Centers; **the Arrow Weapon System's (AWS)** and the **David's Sling Weapon System's** Fire Control Centers; and the **Israel BMD Battle Lab**.

Artillery Fire Support and Coordination - The **TADFICCS** (Fire Command & Control Systems) is Elisra's line of combat proven fire support systems suitable for all artillery echelon deployment and for all fire support missions.

DACCS and **Bombard** artillery command and control systems are ideal for divisional and battalion-level fire support operations. All facets of the fire process are supported, resulting with a sensor to shooter short time response and with a high precision and effective fire process.

The AMTS (Active Man-Pack Transceiving System) is an active control unit variant optimized for controlling airborne and ground sensors such as electro-optical and FLIR payloads - significantly shortening the sensor-to-shooter loop without compromising flight safety.

The latest generation **MRS-2000M** is an all-digital, ruggedized, transportable intelligence system for precise, 3-D situation awareness picture build-up of the battlefield, providing an "over-the-hill" view of the enemy while avoiding danger of exposure. By bringing mission-critical information to the front, the MRS enables all armed forces to make the most of real-time information -while assuring greater accuracy and safety.

Elisra's **Data Links** include advanced wireless communications systems for manned and unmanned aircraft, guided weapons, and space platforms - as well as unique SAR (Search and Rescue) systems for combat and non-combat applications. Product line includes Tracking, Telemetry, Ranging, and Control (TTR&C) systems for space vehicles and satellite earth stations.

MRS- 2000M



C⁴I

Systems and Solutions

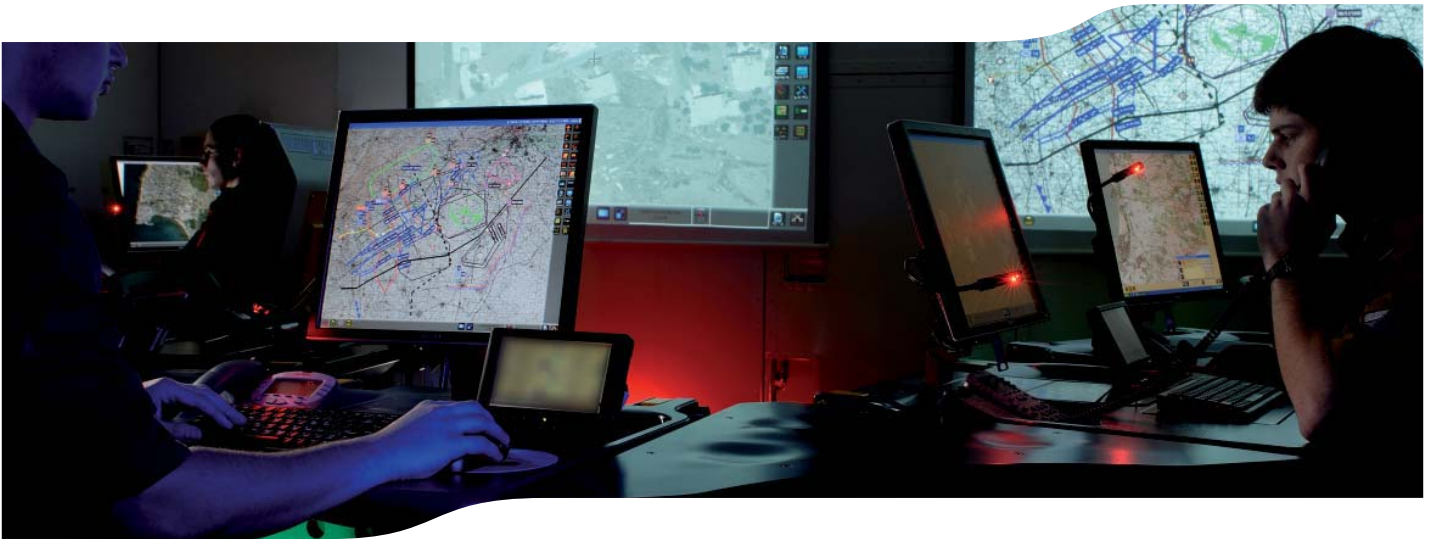

A major supplier of command, control, communication, computers and intelligence (C⁴I) systems, delivering mission-critical information and situational awareness to all levels of command.



C⁴ISTAR

A powerful force multiplier, C⁴ISTAR connects and coordinates all land, air, and sea forces - from the highest echelon HQs to the individual platform, sensor and soldier. C⁴ISTAR implements advanced combat concepts that increase operational effectiveness and connectivity throughout all echelons - in all combat situations - under a unified operational doctrine.

Elbit Systems Land and C⁴I is the lead system integrator behind the development and integration of the world's first fully deployed and operational C⁴ISTAR system in the Israeli Defence Forces - The Digital Army Program (DAP).



Combat-NG

Fire control and command solutions for artillery and air defense enable accurate delivery of lethal firepower.

With vastly enhanced C² capabilities, Combat-NG improves the artillery forces' ability to destroy and degrade enemy targets. Combat-NG integrates advanced C² applications, tactical computers, FCS, advanced radio communication.

**ELBIT SYSTEMS
LAND AND C⁴I LTD.**

2 Ha'machshev St.,
Netanya 4250712, Israel
Tel: 972-9-8898080
Fax: 972-9-8898231
E-mail: landc4i@elbitsystems.com
www.elbitsystems.com/landc4i



WINBMS

Advanced networked battle management

Integrating the entire sensor-to-shooter loop, WINBMS (Weapon-Integrated Battle Management System) enables real-time coordination between fighting vehicles, thereby providing universal situational awareness, in-depth collaborative mission, planning and management, and a continuously updated common operational picture.



ELBIT TIGER[®]

Tactical Intranet Geographic dissemination in Real-time

This powerful information grid delivers relevant data instantly, with optimum message transfer flow and guaranteed delivery. This state-of-the-art tactical communication system is based on the company's in depth knowledge of real battlefield conditions. Harnessing the entire infrastructure and integrating all communication media including legacy narrow-band channels, TIGER[®] creates an end-to-end, unified, flexible, and continuously learning Intranet.



TORC²H[®]

All-in-one C⁴I system

covers all army branches and echelons, enabling universal situational awareness as well as in-depth collaborative mission planning and management based on real-time information, and an always-updated common operational picture. TORC²H[®] is the only C⁴I solution to be fully deployed and operational in a major military organization, the IDF.



Infantry Combat Systems (DOMINATOR[®])

An integrated infantry combat system enabling full situational awareness from the infantry battalion level down to the individual soldier. DOMINATOR[®] dramatically shortens the sensor-to-shooter loop, enhancing the combat effectiveness of the dismounted soldier.

TACTICAL COMPUTERS

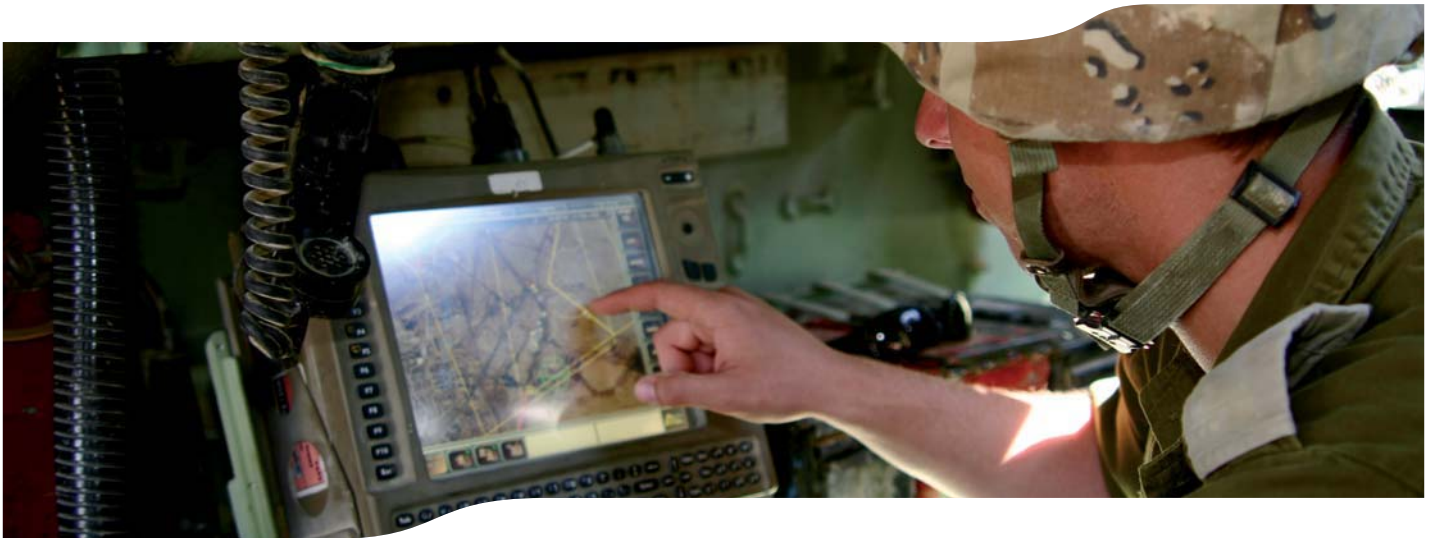

A range of versatile, rugged and battle-proven tactical computers and displays, delivering C⁴I applications to the modern battlefield.



Enhanced Tactical Computers (ETC)

Ultra rugged, battle-proven, high-performance tactical computing for combat vehicles

Providing state-of-the-art C⁴I capabilities and tactical data dissemination to a broad range of combat, command and reconnaissance vehicles. Designed for success in the harshest conditions, this versatile range of tactical computers is fully battle-proven and currently in use by numerous armed forces around the world.



Ground Smart Display Unit (GSDU)

Multi-function C⁴I display unit

A high-brightness display unit supporting multiple video formats.

Featuring a customizable front panel, the GSDU is fully ruggedized and compliant with all relevant military standards.



**ELBIT SYSTEMS
LAND AND C⁴I LTD.**

2 Ha'machshev St.,
Netanya 4250712, Israel
Tel: 972-9-8898080
Fax: 972-9-8898231
E-mail: landc4i@elbitsystems.com
www.elbitsystems.com/landc4i



TACTER[®]-31D

Versatile tactical computer in a tablet configuration supporting both vehicle mounted and dismounted applications

An indispensable C⁴I tool for the digital battlefield, ensuring complete continuity across vehicle mounted and dismounted applications. Designed with flexibility in mind, the TACTER[®]-31D's unique vehicular docking station and latch enable seamless operation both in and out of vehicle.

The lightweight tablet configuration and integrated handle allow the unit to be quickly and easily transported.



RPDA 57

Situational awareness on-the-move

A reliable rugged multi-function tactical PDA, delivering real-time data access even in the harshest conditions.

SUPERIOR SOLUTIONS FOR THE DEFENSE & AEROSPACE ARENAS & HOMELAND SECURITY (HLS)



mPrest SYSTEMS LTD.
Azorim Park, Kiriat Arie
94 Em Hamoshavot Rd. P.O.Box 3027
Petah Tikva 4970602, Israel
Tel: 972-7-3216666
Fax: 972-7-3216636
E-mail: contact@mprest.com
Web Site: www.mprest.com

Leading C² system house that developed the command and control system of the "iron dome"

mPrest Systems is a recognized market leader in the design, development and implementation of high-performance C⁴I solutions for the defense & aerospace, homeland security and civilian arenas.

mPrest proprietary software suite enables the integration of large amounts of input data from a variety of sources (sensors, devices and other systems) and coherently manages a wealth of applications on interactive displays. Seamlessly integrating all C⁴I elements & sensors, our software capabilities reduce the time required for system development. Utilizing our systems cut the operational response time and enables each level in the chain of command to be focused on the success of their critical missions and significantly enhance the decision-making process.

mPrest developed a unique generic C² engine-based operational system which allows **REDUCING** development **TIME** while **INCREASING** system **RELIABILITY** and **REDUCING** project **RISKS**.

mPrest unique generic C² engine-based operational system makes it easier to connect weapons & sensors and also provide the customer an easy to operate build-in state-of-the-art decision making rules engine.

Defense & Aerospace Arena

Backed by a wealth of operational experience, our field-proven software platform provides the required robust C² functionality and system intelligence for land, air and sea forces.

- Delivering complete mission-critical situation awareness and fire control capabilities necessary for successful military operations, mPrest's patented algorithms and state-of-the-art infrastructure are used at the core of many C⁴I platforms. Provide Tactical C² system to the battalion level
- Integrating of C², communications, procurement means and attacker weapons

Our software suite enables the integration of large amounts of input data from a variety of sources (sensors, devices and other systems) and coherently manages a wealth of applications on interactive displays.

Our automated capabilities significantly enhance the decision-making process, dramatically cut operational response time and enable each and every echelon in the chain of command to focus their attention on the success of their missions.



Home Land Security (HLS) Arena

Backed by a wealth of experience, our proven platform delivers enhanced interoperable functionality for all forces engaged in the management of crisis and emergency situations.

- Critical facilities protection integration & management of Variety of means (cameras, radars, vehicles, access control, alarms, fire detection and more)
- Connecting to existing systems and providing a complete solution for the customer

Detection systems, sensors monitoring and tracking fleet management system.

Seamlessly integrating all your C⁴I elements, mPrest Homeland Security solutions provide feature-rich, scalable and affordable systems. Offering a full suite of automated capabilities, mPrest enables operators to focus their full attention on successful event resolution.

mPrest - taking your Homeland Security C⁴I to a new level.



MIC⁴AD



**RAFAEL
ADVANCED DEFENSE SYSTEMS**

P.O.Box 2250 (19)
Haifa 3102102, Israel
Tel: 972-4-8794714
Fax: 972-4-8794657
E-mail: intl-mkt@rafael.co.il
Web Site: www.rafael.co.il

MIC⁴AD is an advanced, unified, integrated C⁴I system that commands and controls the operation of both air and missile defense, including air-superiority missions. MIC⁴AD provides a total solution for multi-system, multi-layer and multi-range air and missile defense, traditionally operated as separate commands.

MIC⁴AD correlates real-time data from distributed sensors/platforms (radars, IFF system, data links, electro-optics), all connected to the air traffic control picture and mission planning system. The data is analyzed to deliver a real-time, coherent national Air Situation Picture (ASP).

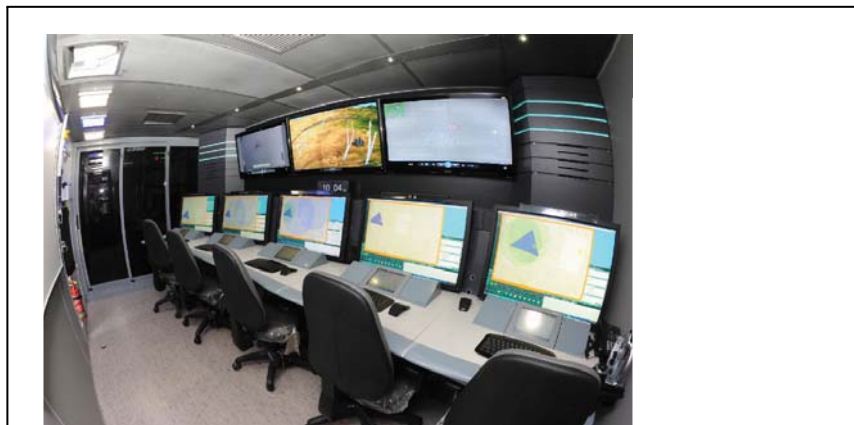

Simultaneously, MIC⁴AD performs threat assessment and hostile target classification, generating an interception plan for threats at any command level (national, regional, tactical). MIC⁴AD optimizes resource management and swiftly allocates the most appropriate defense system, such as SPYDER, David's Sling, Iron Dome or other customer systems to the type of challenge. Response includes target allocation to weapon systems (TAWA - Threat Assessment Weapon Allocation) with full, semi-automatic or manual fire control according to customer doctrine.

MIC⁴AD open, modular architecture can be adapted to customer operational needs. The system can be integrated with a customer's existing or future air and missile defenses. This flexibility allows incorporating new technologies and systems with the existing arrangement. MIC⁴AD can serve as an add-on to the customer's current C⁴I setup, or replace existing systems entirely.

Highly automated, easy-to-use and with advanced interactive displays, MIC⁴AD is a true force-multiplier. Enabling unified command and fire control of multiple air and missile defense systems, MIC⁴AD delivers multi-mission, multi-layer and multi-range C⁴I capabilities that ensure end-to-end air and missile protection.

RAFAEL
ADVANCED DEFENSE SYSTEMS
 P.O.Box 2250 (19)
 Haifa 3102102, Israel
 Tel: 972-4-8794714
 Fax: 972-4-8794657
 E-mail: intl-mkt@rafael.co.il
 Web Site: www.rafael.co.il

■ **DEEP LINK - Low Probability of Intercept Acoustic Communication Network**

DeepLink's dimensions enable the system to be carried by small underwater vehicles or divers.

Using CDMA communication with MIMO (Multi-Input, multi-Output) techniques, DEEPLINK overcomes. The multipath interferences of the UWAC, ensuring high reliability n various environments such as deep Water, shallow water, harbors and etc. DEEPLINK is designed as an ad-hoc network including a multi-hop mechanism. Both built-in message distribution protection and multi-hop mechanisms increase the reliability of the network and the connectivity between nodes, providing solution for non-line-of-sight scenarios.

DEEPLINK supports both SMS and navigational control messages, allowing the user to create his own Mission status. Each node contains a user interface which includes virtual keyboard (for SMS writing), navigation system and network display.



■ **SEA-COM - IP/VoIP Shipborne Communication System**

Sea-Com provides a full, modular, IP based Naval Ships & Submarines communication suite. Full integrates internal communication: voice, data, video & external communication Systems: HF, V/UHF and Satcom. Easy mission planning & allocation of the ships radio and antenna Distributed architecture provides high availability & scalability Meets harsh naval environmental conditions.



Rafael Provides Communication Products that Includes Data Link, Airborne Relay Systems, Communication Networks & Voice Radio

RAFAEL
ADVANCED DEFENSE SYSTEMS
 P.O.Box 2250 (19)
 Haifa 3102102, Israel
 Tel: 972-4-8794714
 Fax: 972-4-8794657
 E-mail: intl-mkt@rafael.co.il
 Web Site: www.rafael.co.il

DLV-53 MFTM - ISTAR Wideband Data Link

- Ultra Wide Band data-link providing communication solutions for UAVs/ USVs/ UGVs & Airborne Reconnaissance pod systems
- Use of a single, small & light - weight unit for PTP LOS/SatCom, one hop LOS Relay & CAS waveforms simultaneously
- Supports data rates from 200Kb/s to 274 Mb/s - selectable from the Ground Station
- Growth capability up to 548Mbps without HW change
- Full spectrum support (L, S, C, X, Ku, MMW), highly immune
- Seamless secured connection between standard Airborne IP LAN and Ground IP LAN over a Gigabit WAN



BNET - Broadband MANET IP Software Defined Radio

- Ultra high data rate software defined radio (SDR)
- Tactical Voice, Video & Data on the move
- Mobile Ad-hoc network (MANET)
- Unique spectral efficiency features
- IP Radio
- Immune and secured
- Vehicular and hand-held formations



TACMAX - Tactical 4G Cellular Broadband Network for Ground Forces

- Fast deployable
- Secured and immune
- Soldier and vehicle radio
- Up to 45 Mbps per cell
- Mesh capability
- Standard IP backhaul



RAVNET 300 - Airborne Voice & Data Communication Radio Network

- Air-to-Air, Air-to-Ground, instantaneous high data rate
- Highly advanced Voice & Data Networks
- High Availability: Long range communication, auto relay via multi hops
- High efficiency utilization of V/UHF spectrum
- Legacy radios support for practical evolution
- Field proven in Israeli IAF



AIR STAR - Multi-Sensor Aerostat based system for Extended ISR

- The most advanced field proven Aerostat based ISR system
- Expands early warning and surveillance capabilities
- Supports air dominance
- Consists of multiple sensors: Radar, ELINT, COMINT & Receivers/Transmitters
- Communication to Command and Control & to Targets Interceptors
- High availability



Xi INFORMATION PROCESSING SYSTEMS

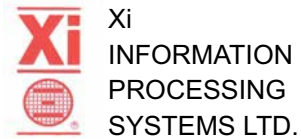

Xi INFORMATION PROCESSING SYSTEMS LTD.

P.O.Box 60
Savyon 5691501, Israel
Tel: 972-3-9215891
Fax: 972-3-5343520
E-mail: xi00001@attglobal.net

Xi is a privately owned company established in 1968. Xi develops geo-referenced systems for defense, homeland security and commercial applications. Main line of products is; command and control, remote monitoring and tracking in real time, incorporating multiple sensors terminals. Xi products developed for defense applications particularly for UAV's (Unmanned Aerial Vehicles) and RADAR's were deployed by numerous defenses forces including the US Navy, and are field and battle proven.

Xi offers a family of Location Based products and solutions for mobile and security applications; real time command and control, management, tracking and monitoring, guiding and navigation.



Xi Mobilinx® C4I



**Xi Hand held Terminals
Touch screens, 7" and 5"**

Among Xi products are:

- Mobilinx® - Geo-Referenced Security Command and Control and management system.
- Pathmarker® AVL – Automatic Vehicle Location system. Pathmarker® AVL system offers real time vehicle and assets monitoring and tracking for variety of applications; fleet management, field operations management and assets management.
- SecurePath™ - Security system. SecuerPath is a geo-referenced wireless security solution enabling real time monitoring of remote sensors, stationary and mobile
- TrainTrack™ - Train cars monitoring and security system
- Nav X info™ – Hybrid navigation system for rural and urban areas navigation on hand held PND's, tablets and desktop computers.

INNOVATION. KNOWLEDGE. EXPERIENCE.

Athena is a security and intelligence solutions provider delivering a wide range of proactive services and systems. Athena was established by Israeli security veterans, headed by Mr. Shabtai Shavit - Former Director of the Israeli Mossad.



ATHENA GS₃ SECURITY IMPLEMENTATIONS LTD:

5 Hatzoref St.,
Industrial Zone
Holon 5885633, Israel
Tel: 972-3-5572462
Fax: 972-3-5572472
E-mail: general@athenaiss.com
Web Site: www.athenaiss.com



Athena provides Advanced Software Solutions, Consulting, HR services, and Project Management for Governmental Intelligence Agencies as well as financial and commercial clients worldwide. The company works with its clients to upgrade each of these aspects, as well as integrating them for streamlined, effective solution.

Cutting – edge Technology

Advanced technology provides unprecedented benefits for implementing policies and working procedures, while allowing analysts to focus on critical information and conduct sophisticated investigations.

CK2I

A unified, comprehensive knowledge exploitation platform for managing intelligence process workflow, based on powerful data mining and analysis capabilities. CK2I enables analysts to turn raw data into operational intelligence, complete with timely alerts on signs of suspicious behavior, providing the right information to the right person at the right time.

CY - HUMINT

A cutting edge solution for virtual world operations, including social media, blogs and forums. This powerful suite enables deep web analysis and silent download of contents from a variety of online sources for advanced analysis, complemented by identity management and camouflage capabilities for a one-stop online operation.

Belisario

Belisario is an innovative system for managing routine operations in control centers and gathering Visual Intelligence (VisINT) from existing video surveillance infrastructure.

Consulting

Athena's team of world renowned expert provides the following consulting services: Strategic Consulting, Consulting and security engineering, TVRA™ (Threat, Vulnerability and Risk Assessment), Disaster preparedness, management and recovery, Intelligence reports and "Red Teams"

Training, Vetting and Personnel Selection

Athena's rich experience is transferred through a professional offering which aims to enable it clients to achieve best results.



INTELLIGENCE



**ELBIT SYSTEMS
LAND AND C4I LTD.**
2 Ha'machshev St.,
Netanya 4250712, Israel
Tel: 972-9-8898080
Fax: 972-9-8898231
E-mail: landc4i@elbitsystems.com
www.elbitsystems.com/landc4i



Converting data to intelligence, by enabling personnel to gather, research, comprehend and analyze intelligence data at a multifaceted level.



WiT™ (Wise Intelligence Technology)

Technology solutions supporting organizational doctrine and improving the intelligence process

A comprehensive end-to-end solution for intelligence organizations, WiT™ addresses all phases of the intelligence process including the reception, adaption and conversion of intelligence data from multiple sources as well as processing and disseminating intelligence reports. Fully customizable, WiT™ is one of the few intelligence solutions to be field-proven and fully operational.



ICE Comprehensive, multi-sensor, field-proven imagery intelligence solution

A field-proven solution addressing the operational imagery intelligence (IMINT) requirements of numerous armed forces around the world. ICE provides a solution for every phase of the IMINT operational cycle. ICE is sensor independent and can be customized to a specific operational doctrine. ICE's scalable architecture enables seamless implementation of additional sensors and rapid modification of the mission planning and monitoring process.

SENSORS



**ELBIT SYSTEMS
LAND AND C4I LTD.**
2 Ha'machshev St.,
Netanya 4250712, Israel
Tel: 972-9-8898080
Fax: 972-9-8898231
E-mail: landc4i@elbitsystems.com
www.elbitsystems.com/landc4i

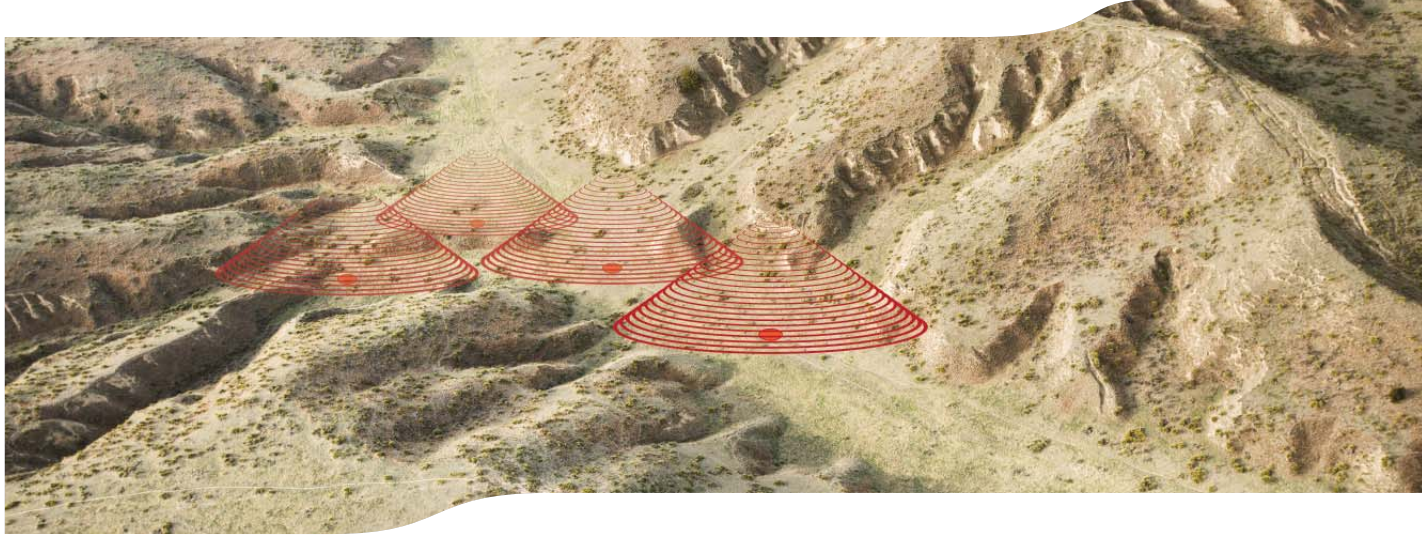

Total control and terrain dominance, with a networked array of sensors and firepower.

Smart All-Terrain Networked Detectors (SAND)

Detects and tracks the movement of people and vehicles in any terrain

An advanced, stand-alone, long-life, wireless security system that remotely monitors wide areas. The system detects and tracks both the movements of people as well as the movements of all types of vehicles. The SAND system meets the operational needs of a wide range of military and homeland security missions including perimeter security, border control, surveillance and intelligence.



RICENT - REAL-TIME IMAGERY INTELLIGENCE CENTER



IAI ELTA SYSTEMS LTD.
 P.O.Box 330, Ashdod 7710202, Israel
 Tel: 972-8-8572410
 Fax: 972-8-8561872
 E-mail: market@elta.co.il
 Web Site: www.elta-iai.com

ELTA - Our Systems, Your Advantage

RICent - Real Time Imagery Intelligence Center ELS-8994RT

The ELTA RICent ELS-8994RT is a modular, end-to-end, comprehensive solution for Intelligence, Surveillance and Reconnaissance (ISR) requirements, from Imagery Acquisition to Image Intelligence (IMINT) dissemination. The system is designed to produce all-weather IMINT, 24 hours a day, by real-time processing and integration of the images delivered through a variety of space, airborne and ground based IMINT sensors, such as Electro-Optical sensors (E/O), Infra-Red sensors (IR), Video, Synthetic Aperture Radar (SAR) and Ground Moving Target Indication (GMTI). The exploitation and dissemination processes employ a variety of automatic and semi-automatic tools necessary for quick detection, identification and acquisition of time critical targets. RICent's modularity and open architecture design allows for a wide range of implementation solutions, ranging from a single standalone tactical station to a whole network based hub serving as either a regional or national strategic IMINT center. The RICent employs ELTA's field-proven technologies and experience in signal and image processing and analysis and features Multi-Sensor Support, Automatic Imagery Geo-referencing, IMINT Data Fusion and Interpretation, On-the-fly Mosaic, Dynamic 3D and Stereo Display, and Intelligence Production Management.

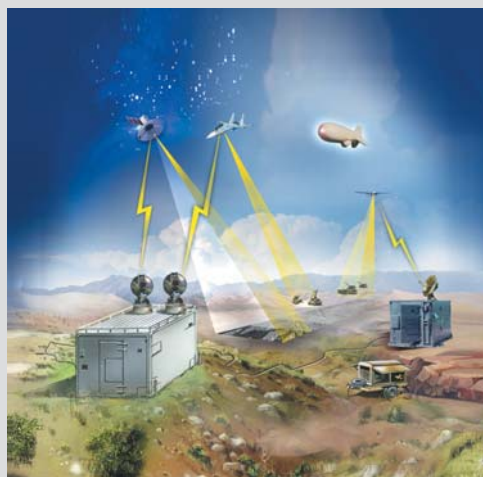

Imagery Acquisition

RICent/VEX Video Exploitation System ELS-8994 VEX

The RICent VEX Video Exploitation System transforms Airborne platforms' sensor video, especially UAV's, into a significant source for geospatial intelligence used in a network-centric environment. The RICent Vex is designed to be easily incorporated and integrated into existing Ground Stations enabling advanced video archiving and advanced geospatial exploitation, for immediate correlation and cross sensor cueing with other sources and sensors. In addition, geo-referenced annotation on dynamic video and video mosaics allow for advanced reporting and updated production of relevant imagery data. The system features multi-channel recording, real time VOD services, multi-dimensional indexing – both temporal and spatial, and near real-time video mosaic.

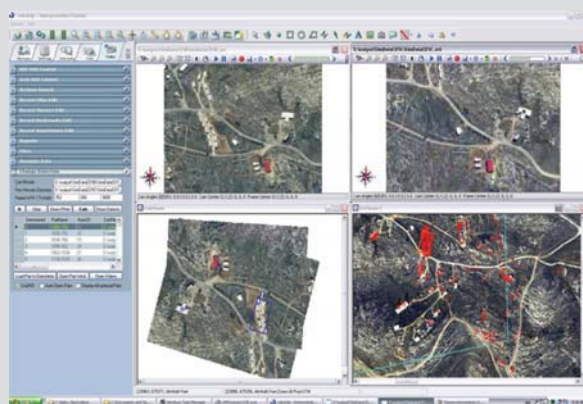

Video Exploitation



Geo-Mosaic

SIGINT SYSTEMS



IAI ELTA SYSTEMS LTD.

P.O.Box 330, Ashdod 7710202, Israel
Tel: 972-8-8572410
Fax: 972-8-8561872
E-mail: market@elta.co.il
Web Site: www.elta-iai.com

ELTA - Our Systems, Your Advantage

AISIS - Airborne Integrated SIGINT System

ELI-3001

The ELTA AISIS ELI-3001 is a multi-platform, multi-role Airborne Integrated Signal Intelligence System. The main purpose of the system is to build-up a real-time Electronic Order of Battle (EOB) picture, and to provide valuable tactical and strategical intelligence which can be seamlessly integrated into the nation's intelligence database. As a secondary mission, part of the airborne segment of the system can be converted into an Airborne Command and Control Center (ACC). The system is designed to cope with the challenges of modern dense non-communication (mostly radars), and communication network environments. The AISIS performs long-range, high endurance SIGINT missions. The system's tasks are to search, intercept, measure, locate, analyze, classify and monitor ground, airborne and naval transmissions, characterized by short duration, a variety of signal types and frequent changes in signal parameters.



ELINT Ground System

ELL-8382/5

ELTA's ELINT Ground Station receives and analyses all radar type signals within the 0.5-18GHz frequency range. It is designed to operate in a dense electromagnetic environment by combining high sensitivity and high probability of interception. The instantaneous Direction of Arrival measurement is based on DTOA DF Technology. The Ground Station can be remote-operated by a Central Control Station.

COMINT Ground System

ELK-7036

ELTA's COMINT System meets the operational challenges of dense communication environments. It searches, acquires and monitors emissions - even those characterized by short transmissions and frequent changes in network parameters over the 20 to 3000 MHz frequency range. The Ground Station can be remote-operated by a Central Control Station.



SYNTHETIC APERTURE RADAR (SAR) SYSTEMS



IAI ELTA SYSTEMS LTD.

P.O.Box 330, Ashdod 7710202, Israel

Tel: 972-8-8572410

Fax: 972-8-8561872

E-mail: market@elta.co.il

Web Site: www.elta-iai.com

ELTA - Our Systems, Your Advantage

SAR Synthetic Family

ELTA's family of high performance Ground Surveillance and Reconnaissance SAR/GMTI systems includes the following members:

- ELM-2060P: A Pod-mounted SAR/GMTI System installed on fighter aircraft.
- ELM-2060T: A SAR/GMTI System installed on Business Jets or transport aircraft.
- ELM-2055/2054: A lightweight SAR/GMTI System installed on UAVs, helicopters or lightweight aircraft.
- ELM-20600: Fighter Aircraft Radar Targeting Pod (RTP)
- TECSAR: A lightweight Satellite SAR Payload.

The systems produce high resolution radar images which approach photographic quality and operate as true all-weather, day and night sensors capable of penetrating clouds, rain, smoke, smog, fog and a variety of man-made camouflage. The images produced onboard are transmitted via a built-in data link to a Ground Exploitation Station (GES) or to an Airborne Exploitation Station (AES) for interpretation and extraction of valuable Image Intelligence (IMINT) data, and may be presented to the operators or air-crew for quick Sensor-to-Shooter cycle.

Typical Imaging Modes of Operation

STRIP Mode allows for quick coverage of large areas at stand-off ranges, while mapping details sufficient for target detection and overall assessment of an entire region. This mode enables detailed examination of a designated area of interest and allows high resolution sub-modes for target classification. In order to focus on an area of interest the systems can operate in a dedicated SPOT Mode. Additionally, a **MOSAIC Mode** is available which can combine images of Spot Modes to achieve large images with high resolutions. In the **Moving Target Indication (GMTI)** modes the system can overlay ground moving targets on top of the SAR Image Strip (SAR/GMTI Mode)

Ground and Aerial Imagery Exploitation Stations The Ground and Aerial Imagery Exploitation Stations employ COTS equipment with advanced data processing and user-friendly Man-Machine Interface to provide computer-aided tools for mission planning and management, data exploitation and intelligence reporting.

The stations enable mission planning, mission management and in-flight retasking.

Typical configurations include:

- Airborne Exploitation Station (AES) : includes 1 or 2 operator consoles.
- Ground Exploitation Station (GES) in a fixed facility: up to 10 operators
- Mobile GES: large (S-280 or similar) shelter: typically includes 5 operators
- Tactical GES: small shelter, includes 1 or 2 operators

TECSAR



SAR Pod for fighters



Radar Targeting Pod on fighters



Lightweight SAR/GMTI Aircraft



SAR/GMTI UAV



SAR/GMTI on Business Jet



VERY HIGH RESOLUTION IMAGING SATELLITES



IMAGESAT INTERNATIONAL N.V.

6 Yoni Netanyahu St.,
Or Yehuda 6037604, Israel
Tel: 972-3-7960600
Fax: 972-3-5163430
E-mail: orders@imagesatintl.com
Web Site: www.imagesatintl.com

ImageSat International N.V. is a commercial provider of Very-High-Resolution (GSD 0.7m), satellite imagery collected by its Earth Remote Observation Satellites EROS-A & EROS-B.

ImageSat is distinguished by:

- Exclusive service packages, including exclusive use of the EROS satellites over a designated footprint
- Direct Reception & Direct Tasking options
- Flexible imaging parameters
- Fast image acquisition and delivery
- No Risk - Pay only for services received



EROS-B image: Light Water Reactor Construction, Yongbyon – North Korea

HAVE AN EAR IN THE RIGHT PLACE



MIPHA INTERNATIONAL LTD.

MIPHA INTERNATIONAL LTD.

8 Har Nevo St.,
Ramat Hasharon 4722508, Israel
Tel: 972-3-5402403
Fax: 972-3-5490931
E-mail: mipha@mipha.co.il
Web Site: www.mipha.co.il

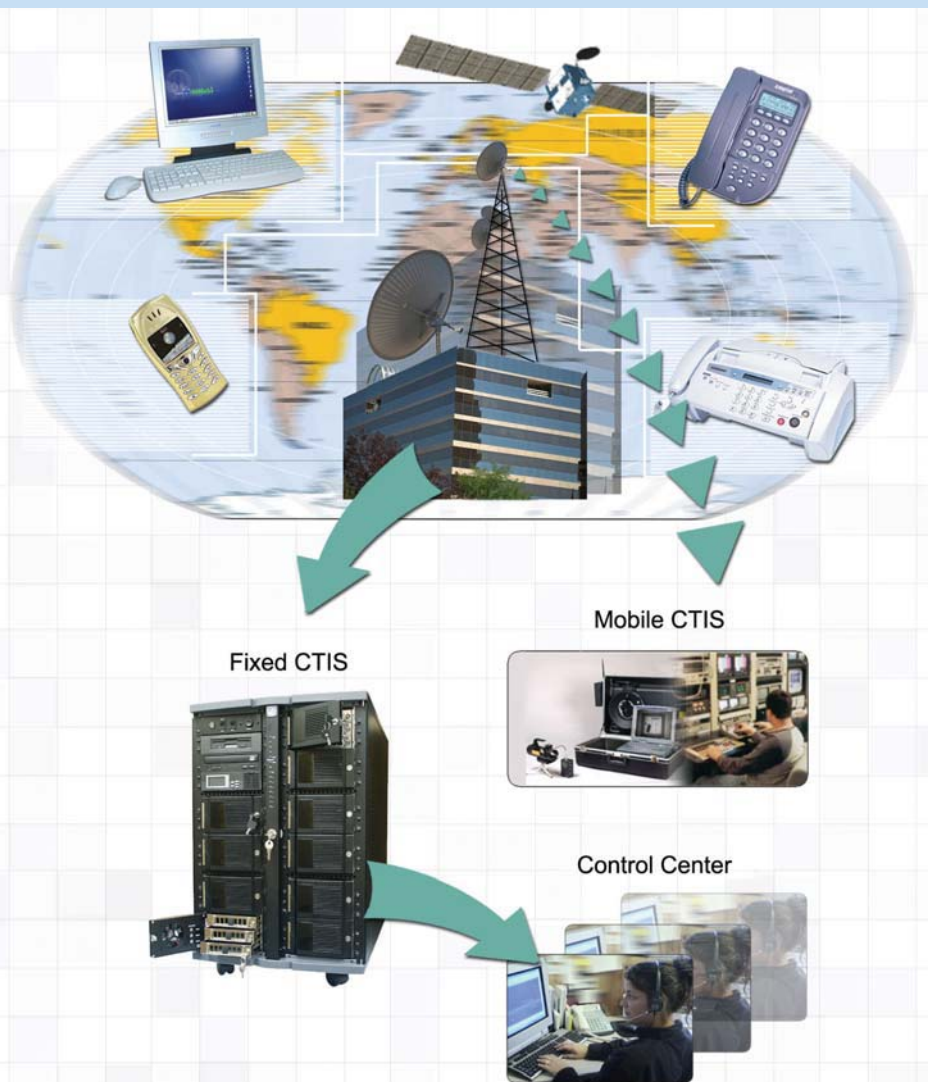

CTIS - COMPUTERIZED TELEPHONE INTERCEPTION SYSTEM

MIPHA offers a variety of solutions that can meet needs of government agencies, military intelligence, police forces and security services to supervise and intercept all telecom & IP solutions, lawful interception, intelligence gathering, cellphone location tracking and data mining.

We also offer an advanced intelligence inference system for link analysis and inferring intelligence from information coming from different data bases.

These technologies have become crucial nowadays in homeland security in the struggle against terrorism and crime.

SURVEILLANCE AND COUNTER SURVEILLANCE SYSTEMS

- DATA CRYPTOGRAPHY, PKI and DIGITAL SIGNATURE TECHNOLOGY for information and data security.
- VOICE/FAX, CELLPHONE & SMART-PHONES ENCRYPTION to secure telecommunication lines.
- DATA RECOVERY, passwords recovery, forensic services to discover improper computer use.
- VOICE ANALYSIS SYSTEM as an investigation tool, access control and reliability tool.
- COMMUNICATIONS Jammer to avoid misuse of cellphones and use of any radio transmissions as a monitoring and transmitting device to protect cars or VIP public appearance from detonating a remote controlled bomb.
- COUNTER SURVEILLANCE checks at customer's premises in order to detect eavesdropping, bugging, commercial & industrial espionage, etc.

MIPHA INTERNATIONAL LTD. is licensed by the Israeli Ministry of Defense to handle international sales of intelligence equipment, consulting in the field of security, including surveillance and counter-surveillance, courses, training and equipment.

SURVEILLANCE & COUNTER-SURVEILLANCE

Secure Your Assets & Protect Your Privacy



MIPHA INTERNATIONAL LTD.

MIPHA INTERNATIONAL LTD.

8 Har Nevo St.,
Ramat Hasharon 4722508, Israel
Tel: 972-3-5402403
Fax: 972-3-5490931
E-mail: mipha@mipha.co.il
Web Site: www.mipha.co.il

Whether to counter state threats like terror and crime, or to counter commercial and industrial espionage, you need experts to provide you with consultancy, solutions, threat assessment, risk analysis and of course state-of-the-art technologies.

Mipha International Ltd. specializes in the field of surveillance & counter-surveillance; providing consultancy services, planning & performing to governments as well as the private sector (industry, banking and other businesses).

Mipha's qualified management & personnel have vast experience in the fields of intelligence, counter terrorism and security.

We offer:

- Professional survey and consultancy in risk analysis and threat assessment.
- Counter surveillance checks at customer's premises in order to detect eavesdropping, bugging, commercial & industrial espionage, etc.
- High-end technologies for information & data security (cryptography, PKI, Digital Signature).
- Biometric identification solutions (vein, face, voice, etc).
- Encryption of telecommunication lines (point-to-point up to multipoint & PBX's). Encryption of cellular communication, smart-phones, etc.
- Electronic jamming of communication including cellular phone for protection against remote activated explosive charges for use in military, Special Forces and VIP protection, as well as unauthorized use of cellphones.
- High-end surveillance methods and systems.
- Data Recovery as an investigation tool and forensic applications.
- Voice analysis as an investigation tool and Access Control System.

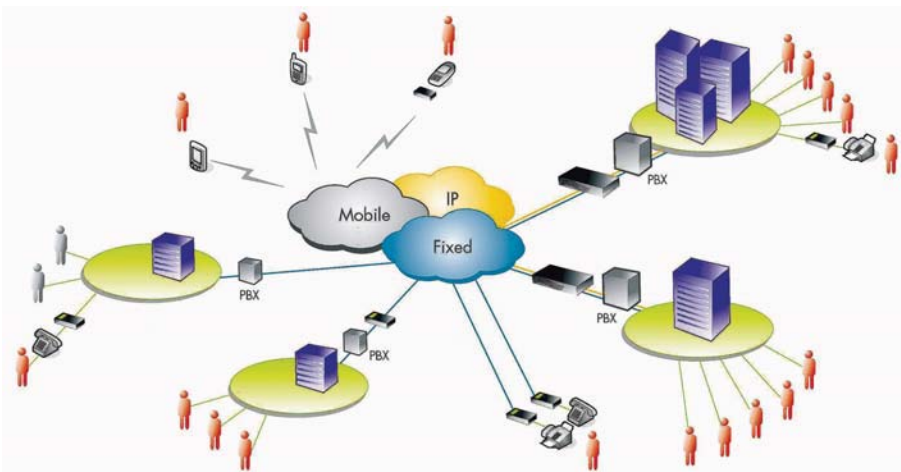

Encryption network

MIPHA INTERNATIONAL LTD. is licensed by the Israeli Ministry of Defense to handle international sales of intelligence equipment, consulting in the security field, including surveillance and counter-surveillance, courses, training and equipment.

DELIVERING CUTTING EDGE ELECTRONIC WARFARE AND SPECTRUM DOMINANCE SOLUTIONS

Netline Communications Technologies (NCT) Ltd. develops and manufactures cutting edge EW and spectrum dominance solutions: advanced **COMMINT & SIGINT**, communication & counter IED jamming, and cell phone detection systems to the global defense and homeland security markets.

COUNTER IED JAMMING SOLUTIONS

Netline's C-Guard active and reactive counter - IED jamming systems protect against remote radio detonation of IEDs. Robust jamming systems for vehicular, trolley/briefcase, manpack, miniaturized and stationary applications can include pre-initiation, hybrid active/reactive capabilities and other advanced features. Our software defined jamming technology enables interoperability with other communication devices, supports definition of communication windows and generating jamming mission profiles, streamlining waveform strategies to match mission requirements. Netline offers advanced jamming efficiency testing and evaluation equipment and counter- IED training systems.

COMMUNICATION JAMMING SOLUTIONS

Netline's communication jamming systems block RF communications and isolate arenas targeting cellular, satellite, WiFi/Bluetooth, walkie/talkie and all other wireless communication frequencies from 20-6000MHz. Our communication jamming systems can be deployed in various platforms including land, naval and airborne.



NETLINE COMMUNICATIONS TECHNOLOGIES (NCT) LTD.

Azrieli Circular Tower
132 Menachem Begin Rd.
Tel Aviv 6701101, Israel
Tel: 972-3-6068100
Fax: 972-3-6068101
E-mail: info@netline.co.il
Web Site: www.netline.co.il











CYBER PROTECTION & CELL PHONE DETECTION SOLUTIONS

Netline's Radio Frequency (RF) detection systems detect potentially hostile communications, uncovering unauthorized use of radio frequencies by cyber, cellular and other information leakage threats in military, government, corporate and other sensitive compartmented information facilities.

TACTICAL INTERCEPTION AND SIGINT SOLUTIONS

Netline's Communications Intelligence solutions integrate a variety of tactical SIGINT capabilities including spectral analysis, signal classification and demodulation, cell phone monitoring and location/direction finding – all tailored per customer specifications. Netline's tactical cell phone interception systems include both semi - active and passive interception systems enabling competent authorities to intercept and manage cellular voice, data and WiFi communications. The uniquely compact form factors of Netline solutions meet harsh military environmental requirements to facilitate deployment in scenarios and arenas that are often not covered by traditional SIGINT solutions.

Netline systems are in use worldwide for:

-  Convoys and route clearance
-  Infantry and special forces protection
-  SWAT operations
-  EOD missions
-  Counter - terror
-  Riot / crowd control
-  Tactical communication jamming
-  Communications interception
-  VIP protection
-  Military base protection
-  Border security



**YOUR COUNTRY.
YOUR CITY.
YOUR PEOPLE.
SAFE & SECURE**



NICE SYSTEMS LTD.

22 Zarhin St.,
Ra'anana 4362248, Israel
Tel: 972-9-7753777
Fax: 972-9-7434282
E-mail: info.security@nice.com
Web Site: www.nice.com



NICE's Security solutions help governments and enterprises anticipate, manage and mitigate security, safety, and operational risks, and make the world a safer place.

The **NICE** security, intelligence and cyber offering empowers organizations to capture, correlate and analyze "big data" generated by multiple sensors and channels.

NICE Security solutions are used by thousands of customers worldwide, including government agencies, transportation systems, critical infrastructure, city centers, banks and enterprises, to secure people and leverage their most important business assets.

NICE Security Solutions:

- Situation Management
- IP Video Surveillance
- Audio Recording Solution
- Incident debriefing and investigation using complete event reconstruction
- Communications interception and analysis
- 3D Mobile Location Tracking
- Web Intelligence
- Social Network Analysis
- Anti-Money Laundering



Statue of Liberty



New Jersey Transit



London Underground

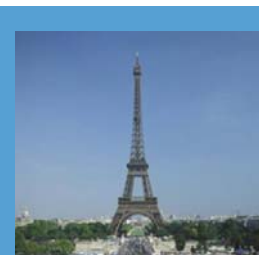

Eiffel Tower



Los Angeles International Airport



Beijing Subway



PICSIX



The Perfect Interception

PICSIX LTD.

41 HaMeyasdim St.,
P.O.Box 6006
Even Yehuda 4051113, Israel
Mobile: 972-544-335197
Fax: 972-9-8911298
E-mail: mk@pic-six.com
Web Site: www.pic-six.com

PICSIX LTD. is a designer and manufacturer of Interception and counter interception products and solutions. We offer compact passive systems that offer the greatest capacity and performance in the market, state of the art active interception systems and unique and sophisticated "semi-active" solutions geared to manipulate key parameters. In addition we pioneer a line of counter interception equipment designed to detect, locate and sabotage interception systems in the near vicinity.

Other products available from PICSIX LTD. Include:

- Jamming systems for conference rooms, prisons and convoy protection
- Cyber protection and attack,
- Interception and counter interception covert vehicles including a large variety of systems
- Cellular communication systems for disaster recovery



Vehicular installation of GSM active and 144CH passive interception systems



PICSIX battery powered Passive 48 - 80CH backpack form factor



PICSIX Man-In-The-Middle GSM and UMTS Systems



Pelican 2400 case hosting a 128CH passive system, decipher included



Internal 1U size battery pack to support 5 - 7 hours of Passive system



PICSIX Counter Interception Detection and elimination modules

VERINT COMMUNICATIONS AND CYBER INTELLIGENCE SOLUTIONS



ACTIONABLE INTELLIGENCE FOR A SAFER WORLD™

VERINT SYSTEMS LTD.

33 Maskit St.,
Herzliya 4673333, Israel
Tel: 972-9-9624119
Fax: 972-9-9624747
E-mail: marketing.lis@verint.com
Web Site: www.verint.com/cis

Verint® Systems Ltd is a leading provider of Actionable Intelligence® solutions that help governments protect people and property and neutralize terror and crime. The Verint Communications and Cyber Intelligence Solutions™ intercept, monitor and analyze huge volumes

of voice, video, and unstructured data communications from a wide array of sources: telephony, SMS, emails, and Internet, including chat, VoIP, social networks, and other Web 2.0 applications.

Communications and Cyber Intelligence Solutions Portfolio



The Verint Communications and Cyber Intelligence portfolio features solutions for:

Communications Interception

Verint RELIANT™ target interception and VANTAGE® mass interception solutions, intercept, filter and analyze huge volumes of Internet, voice, and satellite communications and helping to uncover critical information in less time.

Service Provider Compliance

Verint STAR-GATE™ helps communications service providers comply with ETSI, CALEA, and other lawful interception regulations and standards.

Mobile Location Tracking

Verint RELIANT, VANTAGE and ENGAGE™ provide real-time mobile location tracking, with analytics and workflows to support investigative activities.

Tactical Communications Intelligence

Verint ENGAGE portable communications intelligence solutions (including ENGAGE GI2, PI2, SI2, LAN) provide interception and location tracking capabilities for field operations.

Open Source Web Intelligence

The Verint FOCAL-INFO™ web intelligence solution collects and analyzes large volumes of Internet content, increasing the productivity and efficiency of investigations.

Cyber Security

The Verint CYBERVISION™ solution portfolio protects national assets from ever-evolving cyber threats.

Law enforcement, national security, national intelligence, national computer emergency response teams (CERTS) and other government agencies can deploy these solutions to generate evidence and intelligence and promote more efficient and productive investigations.

RAFAEL
ADVANCED DEFENSE SYSTEMS
P.O.Box 2250 (19)
Haifa 3102102, Israel
Tel: 972-4-8794714
Fax: 972-4-8794657
E-mail: intl-mkt@rafael.co.il
Web Site: www.rafael.co.il

Multi-Source Multi-Task ISR Exploitation System / Command and Control System Imilite is an intelligence system designed to receive process and exploit multiple standalone imagery video and other intelligence data in a centralized and a unified way.

System capabilities:

data reception, processing and display of Video, imagery, targets, threats, mission status, force locations, SIGINT detection and others.

The system GIS capabilities provide synchronized display of all the data as overlays on maps, video and images.

Imilite improves the Command-and-Control process by various automated image processing algorithms such as geo-referencing, change and motion detection, video/image enhancement, video stabilization and others.

Imilite can disseminate operational data, tactical mission reports, targets and treats to other forces, to facilitate close support operations, targeting and platform/sensor management.

ImiLite allows scalable Command and Control solutions and adaption to specific operational needs, both in mobile and stationary configurations for Command and Control centers, deployable operational units.

Benefits:

- Centralized and unified workflow and data display
- Improved efficiency utilizing all available collection assets
- Shortened exploitation cycle
- Efficient Command and Control workflow
- Immediate accessibility to relevant data
- Real-time mission command-and-control workflow
- SR and mission product sharing with external operational users

Features:

- Multi-source data reception in various formats
- GIS capabilities: image/video geo-referencing, data overlays, Geo data retrieval
- Advanced Image Processing Algorithms: change and motion Detection, image/video enhancement, video stabilization and others
- ISR and mission products and reports generation and dissemination
- Scalability and Adaptability
- Stationary, Mobile or Airborne configurations



MIC⁴AD



**RAFAEL
ADVANCED DEFENSE SYSTEMS**

P.O.Box 2250 (19)
Haifa 3102102, Israel
Tel: 972-4-8794714
Fax: 972-4-8794657
E-mail: intl-mkt@rafael.co.il
Web Site: www.rafael.co.il

MIC⁴AD is an advanced, unified, integrated C⁴I system that commands and controls the operation of both air and missile defense, including air-superiority missions. MIC⁴AD provides a total solution for multi-system, multi-layer and multi-range air and missile defense, traditionally operated as separate commands.

MIC⁴AD correlates real-time data from distributed sensors/platforms (radars, IFF system, data links, electro-optics), all connected to the air traffic control picture and mission planning system. The data is analyzed to deliver a real-time, coherent national Air Situation Picture (ASP).

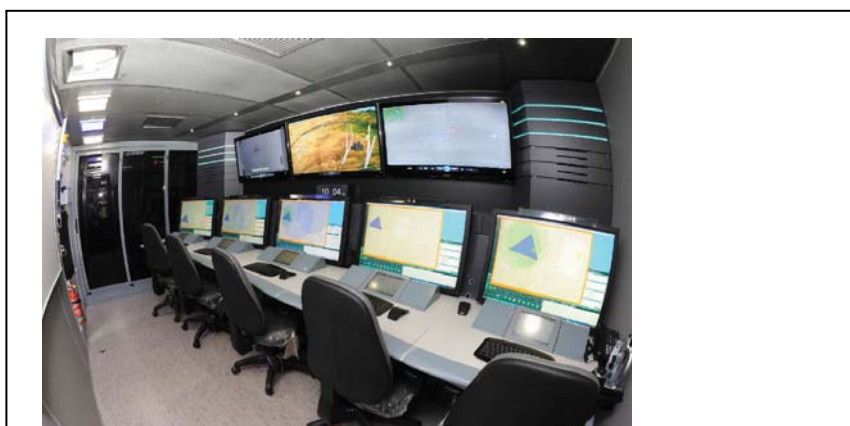

Simultaneously, MIC⁴AD performs threat assessment and hostile target classification, generating an interception plan for threats at any command level (national, regional, tactical). MIC⁴AD optimizes resource management and swiftly allocates the most appropriate defense system, such as SPYDER, David's Sling, Iron Dome or other customer systems to the type of challenge. Response includes target allocation to weapon systems (TAWA - Threat Assessment Weapon Allocation) with full, semi-automatic or manual fire control according to customer doctrine.

MIC⁴AD open, modular architecture can be adapted to customer operational needs. The system can be integrated with a customer's existing or future air and missile defenses. This flexibility allows incorporating new technologies and systems with the existing arrangement. MIC⁴AD can serve as an add-on to the customer's current C⁴I setup, or replace existing systems entirely.

Highly automated, easy-to-use and with advanced interactive displays, MIC⁴AD is a true force-multiplier. Enabling unified command and fire control of multiple air and missile defense systems, MIC⁴AD delivers multi-mission, multi-layer and multi-range C⁴I capabilities that ensure end-to-end air and missile protection.

ELECTRO-OPTIC INTELLIGENCE, SURVEILLANCE AND RECONNAISSANCE (ISR)

Litening - Targeting & Navigation Pod

Litening is an innovative airborne infra-red targeting and navigation pod for fighter aircraft with high accuracy and reliability, day and night precision strike capability. Litening reduces pilot workload during targeting and tracking. It is easily integrated on any aircraft and possesses high growth potential.

In use in the Israeli Air Force, USAF, ANG, AFRES, Marines, German AF, Swedish AF, Spanish Navy & AF, Greek AF, and others, the Litening flies on F-16, F-15, A-10, B-52, AV8-B, Gripen, Tornado, F-5, F-4, Mig-21, Mirage 2000, Jaguar and others.



Toplite EO System - Electro-Optical Surveillance, Observation & Targeting System

The Toplite family of electro-optic systems is an advanced multi-sensor, multi-purpose, highly stabilized EO systems for homeland security and defense applications, for aerial, maritime and ground based platforms.

RecceLite- Real Time Tactical Reconnaissance System

The RecceLite System consists of an E-O pod, a ground exploitation station and a data link. It is capable of collecting images day & night from 300 ft to 40,000 ft in all directions forwards, nadir, backwards, oblique - all down hemisphere and even when the aircraft is maneuvering in high G. The Ground Exploitation Station (GES) is capable of generating targets in real-time with exceptionally high accuracy due to state-of-the-art algorithms and technology. The data-link connects between the sensors and the GES and enables the images to be downloaded to the GES in real time. When your task is to close the attack cycle on many "time-critical targets" in less than 10 minutes, there is only one system - RecceLite.

Recce-U - Real-Time Persistent ISR System for UAVs

Recce-U is a self-contained, multi-sensor ISR system (based on the RecceLite Tactical Reconnaissance Pod). The Recce-U enables automatic photography, according to a mission plan prepared in advance, or updated mission plan uplinked in real-time, however the operator can initiate manual scanning for targets of opportunity.



Litening -on-Gripen



Toplite EOS



RecceLite System

Recce-U

RAFAEL
ADVANCED DEFENSE SYSTEMS
 P.O.Box 2250 (19)
 Haifa 3102102, Israel
 Tel: 972-4-8794714
 Fax: 972-4-8794657
 E-mail: intl-mkt@rafael.co.il
 Web Site: www.rafael.co.il

SpotLite Family
Electro-Optic Enemy Fire Detection System

The SpotLite family consists of electro-optical systems that detect and locate enemy fire in stationary positions as well as on the move. Rapid detection and precise location information provide forces with the capability to quickly neutralize the enemy, maintaining the upper-hand on the battlefield.

The **SpotLite P** is a portable electro-optic system carried by two soldiers for day and night detection and location of small arms fire.



SpotLite P on Tripod

SpotLite M is a mobile electro-optic system installed on vehicles and AFV's that enables the detection and location of enemy fire sources from small arms, RPG rockets, ATGM and tank shells, on the move, day and night, up to 360° coverage.



SpotLite M on vehicle

Imilite - Multi-Source Multi-Task ISR Exploitation System / Command and Control System

Imilite is an intelligence system designed to receive process and exploit multiple standalone imagery video and other intelligence data in a centralized and a unified way.

Main system capability includes the reception, processing and exploitation of EO, IR, SAR/GMTI and VIDEO, in various formats, over one desktop. In order to enhance the exploitation process, Imilite further combines non-imagery data such as targets, threats, COMINT detection and mission status within the system workflow. Imilite generates a variety of standard and customer tailored ISR reports and IMINT products such as alphanumeric reports, annotated maps, GIS data layers and visual aids, and disseminates them to external information and operation systems over standard and tailored protocols.

Imilite's multi-source data integration and automation capabilities improve the efficiency of utilizing available collection and exploitation assets. The system GIS capabilities provide immediate accessibility to relevant imagery and intelligence data, thus shortening the ISR collection and exploitation cycle.

The Imilite is based on Rafael's combat-proven ISR and C4I systems already in service worldwide. Imilite is designed for use by Defense forces (air, ground) and police forces exercising various observation means for border patrol or coping with urban crime.



Imilite

GOVERNMENT SURVEILLANCE SOLUTIONS



VSENSE TECHNOLOGIES LTD.

Office Address: Kibbutz Einat, Israel
Post Office: P.O.Box 24254
Tel Aviv 6124102, Israel
Tel: 972-72-2113111
Fax: 972-3-5422557
E-mail: mail from the web site
Web Site: www.vsense.net

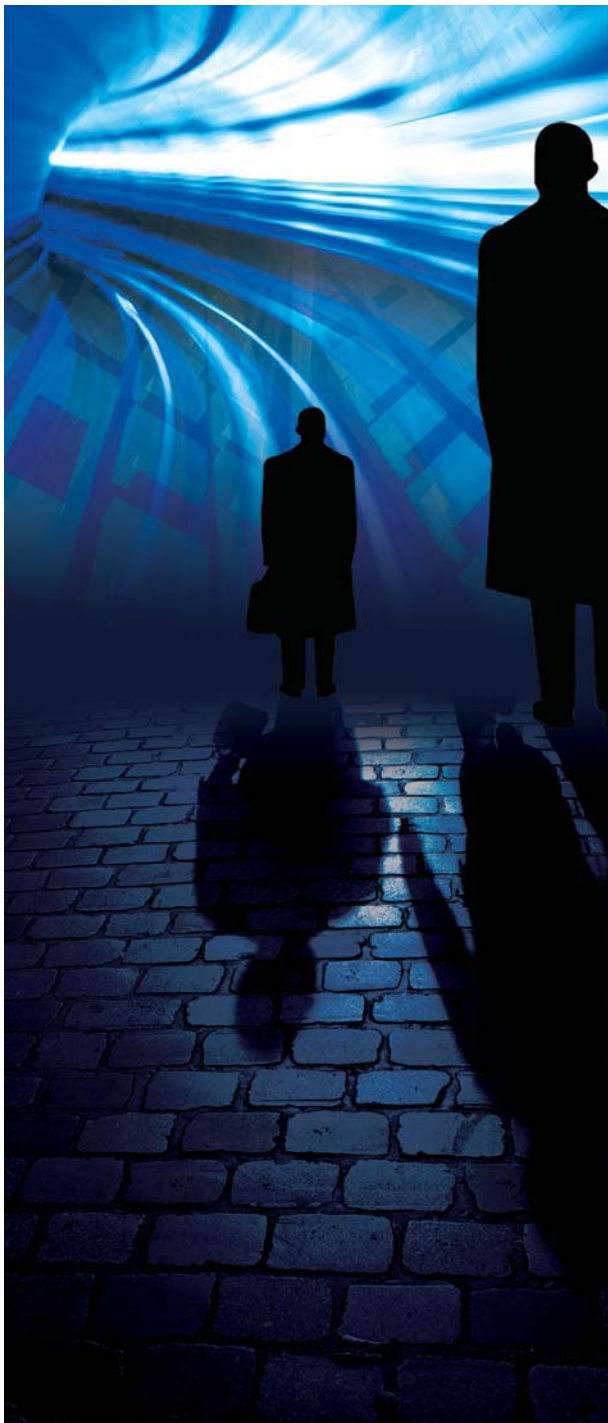

COFDM Solutions



Audio Intelligence



Interception Systems



Tactical Equipment



Jamming Systems



Micro DVR's

Vsense Technologies Ltd. operating as a system integration company, specializes in providing high end intelligence systems and solutions to police, military units and foreign government's intelligence agencies. Offering advanced COFDM WiMax video/audio transmission systems, body worn tactical equipment, tracking and audio systems.



OPTRONICS

Israel's defense industries are among the world leaders in offering defense and security oriented optronic applications based on innovative, state of the art technologies that have evolved at Israel's scientific research establishments. Nurtured at Israel's academic institutions, and actively supported by the Israel Ministry of Defense and armed forces, this knowhow is shared by the country's EO specialist companies evolving into highly sophisticated products.

Israel's electro-optical industry provides everything from basic components to complete multi-sensor systems. Israel is among a few countries producing advanced cooled and uncooled thermal imaging sensors, employing all usable bands of the IR spectrum. Ultimately, thermal imagers, lasers, and video cameras are integrated into gimballed and stabilized payloads to support observation, reconnaissance, targeting, and force protection applications.

Israel's optronic industries and academic research centers are at the forefront of technology in the fields of lasers. Typical systems include the latest eyesafe, diode-pumped laser, fiber-laser and other technologies, integrated into miniaturized laser-based systems employed in numerous applications including rangefinders, countermeasures, laser radar and indoor navigation. Higher power lasers are employed for target designators, guidance, counter-IED and EOD missions.

In the field of Image Intensification (I2) and Thermal Imaging (TI) state-of-the art Israeli systems are employed with military forces worldwide. These systems are known for their superior visibility, night vision, dust and smoke penetration capability and high reliability. Israeli based EO companies are relying on indigenous, top performance, miniature thermal engines, designed for cooled or uncooled operation, embedded in systems of all sizes from miniature stabilized payloads for mini-UAVs to large, high resolution camera payload for reconnaissance satellites.

CONTROP'S DAY / NIGHT EO / IR SYSTEMS

CONTROP is a world leader in EO / IR technologies and systems, providing innovative day / night EO / IR solutions for air, land and sea surveillance, defense and Homeland Security applications worldwide.



CONTROP Precision Technologies Ltd

**CONTROP
Precision Technologies LTD.**

P.O.Box 611
Hod Hasharon 4510502, Israel
Tel: 972-9-7440661, Fax: 972-9-7440662
E-mail: sales@controp.co.il
Web Site: www.controp.com



About CONTROP:

- CONTROP specializes in the development and production of Electro Optical and Precision Motion Control Systems.
- CONTROP's products are used worldwide for Surveillance, Defense and Homeland Security applications on air, land and maritime platforms.
- CONTROP's specialists have over 30 years of experience in electro-optics, electronics, servo-control, precision mechanics and software.
- CONTROP's products have many years of proven operational success and have been the chosen Electro Optical Systems for many national and international requirements.



CONTROP's main product lines include:

- Thermal Imaging Cameras with high performance and high power Continuous Zoom Lenses.
- High performance Stabilized Observation Payloads of many sizes and weights used for day and night surveillance on board UAVs, small UAVs, aerostats/balloons, helicopters, fixed wing aircraft, maritime boats and ground vehicles.
- EO / IR observation and panoramic scanner systems with unique real time automatic passive intruder detection capability, providing the most cost effective solution for security of sensitive sites, airports, coastal surveillance, port / harbour security, border surveillance, perimeter security and surveillance, force protection and ground troops security.
- Airborne wide-area EO / IR scanner and observation system for day and night (real time) reconnaissance.
- Directional Antenna Pedestals for UAV, A/C and ground applications.
- Two axes Pan & Tilt gimbal systems for cameras, antennas etc. – stabilized or non-stabilized and remote controlled.

CONTROP's QA is ISO-9001 certified and the company's products are in daily operational use on many different air, land and maritime vehicles and programs worldwide.



EO TACTICAL SOLUTIONS



ELBIT SYSTEMS - ITL

P.O.Box 1165, Rehovot 7611101, Israel
Tel: 972-8-9386662
Fax: 972-8-9307939
itl-marketing@elbitsystems.com
Web Site: www.elbitsystems.com/elop



A subsidiary of Elbit Systems, ITL specializes in the development, production, marketing, maintenance and after-sales support of advanced electro-optics tactical systems and OEM solutions. Our products are optimized for the fields of: counter-terrorism, special operations equipment, tactical measures for military and paramilitary solutions.

Night Vision Products

ITL's compact, monocular night vision systems, including the Mini N/SEAS, offer high resolution and a clear, bright image, even under adverse environmental conditions. The newest member of ITL's night vision monocular family, XACT-NV32, is the lightest and smallest monocular in the world, capitalizing on all the advantages of its predecessors without compromising high resolution.



XACT-NV32

Uncooled Thermal Weapon Sights & Pocket Scopes

Our Coyote family of uncooled thermal imagers can be used as either hand-held or weapon-mounted sights, for ranges between 0-1500 meters. The family incorporates several different configurations, all providing outstanding target discrimination and recognition capabilities.



Coyote 45

Target Acquisition Systems (Azimuth)

The Azimuth product line includes Atlas LT, a target acquisition system for forward observers, artillery fire coordination, close air support coordination, and target intelligence; ATRIS MP, a man-portable remotely controlled day/night observation system; Comet FNS, a north finding system; and ATLAS GUN- LAYING SYSTEM, a portable gun laying system. The products and systems are used by infantry, special forces, armor, artillery and air forces.



ATLAS LT

OEM Solutions

Elbit Systems ITL develops and supplies integrated laser range finder solutions for maritime, airborne and ground applications. The Ranger family is a closed-frame line of modules designed for OEM implementations, ideal for integration as part of a multi-sensor suite and/or weapon system, compact, simple and easy to handle, assemble and dismount, under all operational, terrain and weather conditions.

LASER DESIGNATORS FOR LAND APPLICATIONS



ELBIT SYSTEMS
ELECTRO-OPTICS - ELOP LTD.

P.O.Box 1165, Rehovot 7611101, Israel

Tel: 972-8-9386211

Fax: 972-8-9386237

E-mail: eo@elbitsystems.com

Web Site: www.elbitsystems.com/elop



PLDR-II

*Portable Lightweight Designator / Rangefinder
with Built-in Laser See-Spot Camera*

Main Advantages and Features

- Laser designation for all types of laser-guided munitions
- Can be carried by an individual soldier
- Built-in electronic compass and GPS
- Built-in tactical computer for target location calculations
- Built-in laser spot camera and video display
- Data link to the thermal sight, remote data transmission and test equipment
- Stand-off designation for maximum protection
- Option: add-on thermal camera with laser see-spot for nighttime observation capability



SERPENT

*Portable Lightweight Designator / Rangefinder
for Laser-Guided Munitions*

Main Advantages and Features

- Diode-pumped technology
- Built-in electronic compass, GPS and tactical computer for target location
- Increased designation range
- Reduced life cycle costs, increased system uptime
- Passive cooling for high reliability and silent operation
- Reduced battery consumption
- Extended duty-cycle capability
- Data link to the thermal sight, remote data transmission and test equipment
- Standard external rails for add-on devices



Applications: CAS designation and ranging missions; FO operation;
FAC mission; LIC/urban warfare

RATTLER™

Miniature Coded Laser Designator / Marker



ELBIT SYSTEMS
ELECTRO-OPTICS - ELOP LTD.
P.O.Box 1165, Rehovot 7611101, Israel
Tel: 972-8-9386211
Fax: 972-8-9386237
E-mail: eo@elbitsystems.com
Web Site: www.elbitsystems.com/elop



Rattler™ is a miniature, coded diode-pumped laser (DPL) designator /marker developed especially for the requirements of the modern battle field for SWAP (size, weight and power). Featuring ultra-light weight, high performance and high-reliability, the Rattler is based on a unique new pumping architecture. The Rattler can be carried along with all other infantry equipment, or installed on micro-payloads and mini-UAVs.

Rattler™ A for airborne applications

Rattler A provides observation payloads with full targeting capabilities, enabling designation for all laser-guided munitions and coded illumination. Designed to be easily fitted into the smallest available payload (~ 5" diameter), Rattler A is extremely compact and lightweight, with an exceptionally small form factor.



Rattler™ H for ground marking/designation applications

Rattler H offers a new solution for Close Air Support (CAS) enhanced target engagement and ground surface-to-surface precision laser-guided munitions target engagement:

Marking: The CAS platform's laser spot tracker can find the reflected laser spot from the target and display that position to the pilot, then slave the weapon system to the laser spot.

Designation: Coded target designation for air or gun-fired/mortar laser-guided munitions



TAMAM

A Complete Line of Laser Designator Solutions for the Modern Battelfield



Israel Aerospace Industries Ltd.
Systems Missiles & Space Group, TAMAM Division

TAMAM DIVISION

P.O.Box 75
Industrial Zone
Yehud 5610001, Israel
Tel: 972-3-5315205
Fax: 972-3-5315140
E-mail: infotmm@iai.co.il
Web Site: www.iai.co.il/tamam

IAI TAMAM –

A Complete Line of Gyrostabilized Electro Optical, Laser Designation Payloads and Systems

TAMAM Division of Israel Aerospace Industries Systems Missiles and Space Group is IAI's electro optics (EO) and navigation system house.

TAMAM designs and manufactures gyrostabilized EO payloads for a wide variety of UAVs, helicopters, fixed wing aircraft, aerostats, marine vessels and ground applications. Thousands of TAMAM's payloads are in service worldwide.

TAMAM provides the ultimate designation solution, offering various laser payloads and systems for the modern battlefield - covering short, medium and long targeting ranges - for different airborne, naval and ground platforms. These compact payloads are equipped with state-of-the-art, diode pumped laser designators, compatible with US and NATO laser guided weapons.

Short Range Designation Payloads

MINIPOP-D (Miniature Plug-in Optronic Payload-Designator) - 8 inch, 7.7 Kg dual axis gyrostabilized payload. The payload is equipped with a continuous zoom thermal imager, a continuous zoom color CCD camera, a new Laser Designator/Rangefinder and an Automatic Video Tracker. MINIPOP-D's small dimensions make it a perfect solution for mini UAVs and UGVs with weight, power and volume limitations. It is also installed on boats.

GTADS (Ground Target acquisition and Designation System) - An innovative, portable, tripod mounted, gyrostabilized, observation and laser targeting system for ground missions.

The system is based on TAMAM's MINIPOP-D and includes also a tactical computer, an eyepiece-joystick, a north finder, a GPS receiver, and a power pack.

GTADS is remotely operated and therefore its functions can be controlled from a protected location thus ensuring operator's survivability.

Medium Range Designation Payloads

POP300D – (Plug-in Optronic Payload) - 10 inch, 20 Kg, compact, stabilized electro optical payload, designed for night and day designation. It includes a thermal imager, TV camera, Laser Pointer and Laser Designator Rangefinder.

POP300D is used on tactical UAVs, on ground platforms and on marine vessels.

Long Range Designation Payloads

MOSP3000 – (Multi-mission Optronic Stabilized Payload) - 14" or 15" ball (31 Kg) – MOSP3000 is an advanced payload available with a variety of day, night and laser configurations.

MOSP3000 has several sensor configurations of CCD and IR Cameras together with a Laser Pointer and a Laser Designator Rangefinder.

It is installed on fixed or rotary wing aircraft, unmanned airborne platforms, land vehicles or naval vessels, providing very long ranges of observation and laser targeting capabilities.

Excellent long range performance is achieved by MOSP3000's very high degree of stabilization.

Accurate laser targeting is assured due to MOSP3000's built-in automatic bore-sight mechanism.

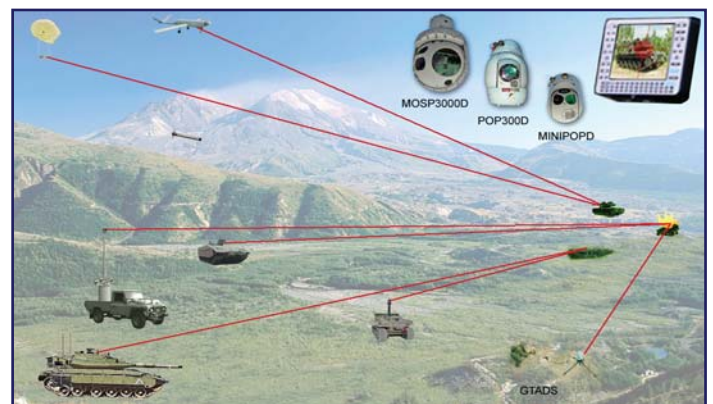

OPTICAL POWER CONTROL SOLUTIONS



KILOLAMBDA TECHNOLOGIES LTD.

22a Raoul Wallenberg St.,
Ramat-Hachayal
Tel-Aviv 6971918, Israel
Tel: 972-3-6497662
Fax: 972-3-6497665
E-mail: info@kilolambda.com
Web Site: www.kilolambda.com

Kilolambda is an industry leader in passive optical power control. Established in 2001, the company developed a unique optical layer, based on its proprietary, patented nano-technology.

This layer is used in industrial, defense and commercial optical systems.

Kilolambda surpassed the traditional techniques of light control by developing its own nano-technology and applying it in an effective manner to everyday applications. The technology controls optical power for all wavelengths and does so in a totally passive way, as opposed to conventional solutions of limiting or blocking specific wavelengths using active components.

The company is now applying its breakthrough technology in the development of next-generation non-linear components and devices, to control and regulate optical power, passively.

Industry Solutions

The implications of KiloLambda's technology are enormous in their ability to protect the human eye and expensive equipment against damage by destructive light sources, from sunlight to lasers, as well as improving the dynamic range of imaging systems. It is used to protect optical sensors, high-end communications devices and other light conducting applications, with enormous significance to industries in the photographic, laser, defense, security, digital imaging, automotive, building and eyewear fields. The inherent passivity and solid state reliability of KiloLambda's products make them compatible with almost any IEC, MIL or other industry standard specifications.

Wideband Laser Protection Filter (WPF)

- Wavelength independent – one filter blocks all lasers
- High transmission – no degradation of the image quality
- Activated only when the threshold power is exceeded
- Based on blocking mechanism
- Fast response time
- Impingement-angle independent



Dynamic Sunlight Filter (DSF)

The DSF, implemented in camera will limit strong sunlight, enabling the taking of clear pictures against the sun, while protecting their sensors and electronics.

- Passive solution
- Sensor protection
- Bright, clear images when taking pictures in front of the sun
- No need for software adjustments
- Built in solution or Add-on



Illustration of a picture taken without DSF



Illustration of a picture taken with DSF

NEW NOGA LIGHT

Seeing You Through™

Electro-Optics Day & Night Vision Systems



NEW NOGA LIGHT (2000) LTD.

11 Granit St., P.O.Box 3034
Petach Tikva 4951410, Israel
Tel: 972-3-9206004
Fax: 972-73-2324598
E-mail: info@newnogalight.com
Web Site: www.newnogalight.com

New Noga Light (2000) Ltd. (NNL) was founded in 1987 and is the leading supplier of night vision and thermal imaging systems to the Israel Defense Forces.

Based on over three decades of military and special operations experience, and leveraging special access to unique technology and top industry expertise - NNL delivers a variety of electro-optics systems, based on Image Intensifying Tubes and Uncooled Thermal Technologies as well as testing equipment and accessories.

NNL is one of the few companies providing world-class refurbishment and upgrade services for Image Intensifying Tubes and optical systems.

Reputation and Knowhow

With an ever-increasing pool of both domestic and international law enforcement and homeland security clients, NNL also specializes in custom or shared development of night vision systems to accommodate its specific end-user requirements.

Fully committed to client success, NNL places special emphasis on quick deliveries, dynamic response to client needs, quality after sales support and tailored

training programs to help users maximize their Return on Investment.

The seasoned NNL management team brings broad and multidisciplinary experience from the Military, Special Forces, and Homeland Security markets. Complementing the management are experienced and professional technical teams who together constitute a creative, professional and industry-leading force.

NNL is ISO 9001:2008 certified.

About Star Defense Systems (SDS)

NNL is a subsidiary of Star Defense Systems (SDS), one of the largest defense companies in Israel, offering innovative defense solutions for Sea, Air, Land, and HLS Forces worldwide. SDS strategic alliances and commitment to R&D provide a solid backbone for products and solutions development at the cutting edge of technology.

Main Product Lines

- Night vision systems for Sea, Air and Land
- Thermal imaging systems for ground forces
- Test and maintenance equipment
- Refurbishment and upgrade services
- Operational and technical training services



© Ziv Koren

SERAPHIM OPTRONICS LTD.



Seraphim Optronics Ltd
Persistent Covert Surveillance

Designed to be Camouflaged

SERAPHIM OPTRONICS LTD.

P.O.Box 621, 2 HaYetsira St.,
Yokneam 2069207, Israel
Tel: 972-4-9894444
Fax: 972-4-9894446
E-mail: yelena_ro@seraphim.co.il
Web Site: www.seraphim.co.il

Seraphim Optronics Ltd. is a well-established company for over 18 years, which specializes in electro-optical systems for covert surveillance in defense, military, paramilitary and civilians markets. Seraphim develops, produces, sells and supports its products worldwide. As a system house, Seraphim can tailor the solution to the customer's requirements.

The MUGI - Mini Unattended Ground Imaging sensor - is a fully operational system built to supply the ground forces with a real-time persistent covert surveillance. Unlike UAVs, the MUGI can remain in the area of interest for months, performing intelligence gathering 24/7 from a hidden spot using its IR Imager or its CCD camera to send live video streams to the C⁴I center thus enabling the operator to gain a full situational awareness. The MUGI can operate autonomously - detecting suspicious movements and alerting the user using its Internal Video Motion Detection (VMD) capability, which also facilitates unmanned persistent intelligence collection, by automatically recording events for later analysis.

One observer can control up to 32 systems for extended time periods without fatigue.

The MUGI can be connected to other, small, UGS (Unattended Ground Sensors) creating a network of concealed sensors for missions such as breach sealing or gap filling in border control or force protection.

The MUGI is a versatile system that can perfectly match military, paramilitary, police and homeland security missions.

New for 2013!

UGF - Unattended Gap Filler system combines the MUGI with ELTA/IAI's ELM2112V1 Tactical Radar for total wireless control of a 2 km² area with automatic detection, alert and video, communications and energy platform for long duration missions.

Combine UGF with additional UGSs (seismic, acoustic) to hermetically seal gaps in the border suite.

UGF can be installed in fixed locations (covert & powered by solar) or quickly deployed for tactical RECON and force protection.

The Chameleon 2 is an unattended persistent covert surveillance system for urban reconnaissance missions.

The Chameleon 2 gathers real time visual Intelligence by remotely monitoring hostile movements and supplying early warnings for military and law enforcement forces.

The Chameleon 2 has the same operational concept and advantages as the MUGI with an integral VMD, but uses shorter range cameras to reduce size and cost and is capable of identifying a human from 250m and transmitting full motion video, for immediate and future prosecution and incrimination. Chameleon 2 employs a CCD camera (VIS & NIR) & IR imager, with a Panning capability of 90° with no external movement, very small aperture and no light reflection.

Seraphim persistent covert surveillance imaging & integrated systems are combat proven solutions for:

- Force Protection
 - Border Protection
 - Intelligence Gathering
 - War On Terror
 - Forward Operating Base Protection
 - Denied Area Observer
 - Securing Strategic Infrastructures (ports, nuclear sites, power plants, oil & gas pipelines) Operational in Special Forces units,
 - Border Protection Agencies and other elite military, paramilitary and civil organizations worldwide,
- Seraphim solutions provide:
- Best of Breed (real-time FMV, VMD, PTZ, area scanning)
 - All-in-One Solution (visual & IR cameras, simple deployment, integrated communications)
 - High Survivability (compact, efficient power management, no external movement, easily camouflaged).



ELECTRO-OPTIC INTELLIGENCE, SURVEILLANCE AND RECONNAISSANCE (ISR)

Litening - Targeting & Navigation Pod

Litening is an innovative airborne infra-red targeting and navigation pod for fighter aircraft with high accuracy and reliability, day and night precision strike capability. Litening reduces pilot workload during targeting and tracking. It is easily integrated on any aircraft and possesses high growth potential.

In use in the Israeli Air Force, USAF, ANG, AFRES, Marines, German AF, Swedish AF, Spanish Navy & AF, Greek AF, and others, the Litening flies on F-16 , F-15, A-10, B-52, AV8-B, Gripen, Tornado, F-5, F-4, Mig-21, Mirage 2000, Jaguar and others.



Toplite EO System - Electro-Optical Surveillance, Observation & Targeting System

The Toplite family of electro-optic systems is an advanced multi-sensor, multi-purpose, highly stabilized EO systems for homeland security and defense applications, for aerial, maritime and ground based platforms.

RecceLite- Real Time Tactical Reconnaissance System

The RecceLite System consists of an E-O pod, a ground exploitation station and a data link. It is capable of collecting images day & night from 300 ft to 40,000 ft in all directions forwards, nadir, backwards, oblique - all down hemisphere and even when the aircraft is maneuvering in high G.

The Ground Exploitation Station (GES) is capable of generating targets in real-time with exceptionally high accuracy due to state-of-the-art algorithms and technology. The data-link connects between the sensors and the GES and enables the images to be downloaded to the GES in real time. When your task is to close the attack cycle on many "time-critical targets" in less than 10 minutes, there is only one system - RecceLite.

Recce-U - Real-Time Persistent ISR System for UAVs

Recce-U is a self-contained, multi-sensor ISR system (based on the RecceLite Tactical Reconnaissance Pod). The Recce-U enables automatic photography, according to a mission plan prepared in advance, or updated mission plan uplinked in real-time, however the operator can initiate manual scanning for targets of opportunity.



Litening -on-Gripen



Toplite EOS



RecceLite System

Recce-U

RAFAEL
ADVANCED DEFENSE SYSTEMS
 P.O.Box 2250 (19)
 Haifa 3102102, Israel
 Tel: 972-4-8794714
 Fax: 972-4-8794657
 E-mail: intl-mkt@rafael.co.il
 Web Site: www.rafael.co.il

SpotLite Family
Electro-Optic Enemy Fire Detection System

The SpotLite family consists of electro-optical systems that detect and locate enemy fire in stationary positions as well as on the move. Rapid detection and precise location information provide forces with the capability to quickly neutralize the enemy, maintaining the upper-hand on the battlefield.

The **SpotLite P** is a portable electro-optic system carried by two soldiers for day and night detection and location of small arms fire.



SpotLite P on Tripod

SpotLite M is a mobile electro-optic system installed on vehicles and AFV's that enables the detection and location of enemy fire sources from small arms, RPG rockets, ATGM and tank shells, on the move, day and night, up to 360° coverage.



SpotLite M on vehicle

Imilite - Multi-Source Multi-Task ISR Exploitation System / Command and Control System

Imilite is an intelligence system designed to receive process and exploit multiple standalone imagery video and other intelligence data in a centralized and a unified way.

Main system capability includes the reception, processing and exploitation of EO, IR, SAR/GMTI and VIDEO, in various formats, over one desktop. In order to enhance the exploitation process, Imilite further combines non-imagery data such as targets, threats, COMINT detection and mission status within the system workflow. Imilite generates a variety of standard and customer tailored ISR reports and IMINT products such as alphanumeric reports, annotated maps, GIS data layers and visual aids, and disseminates them to external information and operation systems over standard and tailored protocols.

Imilite's multi-source data integration and automation capabilities improve the efficiency of utilizing available collection and exploitation assets. The system GIS capabilities provide immediate accessibility to relevant imagery and intelligence data, thus shortening the ISR collection and exploitation cycle.

The Imilite is based on Rafael's combat-proven ISR and C⁴I systems already in service worldwide. Imilite is designed for use by Defense forces (air, ground) and police forces exercising various observation means for border patrol or coping with urban crime.



Imilite

NIGHT VISION SYSTEMS & Allied Products



**TCI - Technical Consultants
International Ltd.**

P.O.Box 72
Hod Ha'Sharon 4510001, Israel
Tel: 972-9-7462518
Fax: 972-9-7462519
E-mail: techg@attglobal.net
Web Site: www.nightvision.org

TCI is an organization devoted to the design and manufacture of a wide range of highly sophisticated Night Vision Systems and Allied Products, including the M89 Sniper Rifle.

TCI has agents in more than 20 countries worldwide. Military and Law Enforcement agencies all over the globe work with TCI equipment for both under water and dry land applications.

Our systems are in use in many different roles, either directly on the battlefield or for anti-terrorist operations, underwater inspection of ship hulls or EOD tasks on the seabed, long range surveillance of borders to prevent incursions, or from patrol vessels, helicopters to stop arms or drug smuggling. Apart from manufacturing NVS and the M89 Sniper Rifle, TCI's workshop also undertakes projects for upgrading and customizing of other weapons, as well as modernizing Night Vision Systems, where possible.

TCI employs modern CNC equipment to attain a high standard of accuracy followed by strict quality control.

This is all part of our **CCAP 'Client Commitment Attitude Policy'**, a policy of helping the client realize the best possible standards of Night Vision Systems and Allied Products.

TCI Ltd. designs and manufactures:

- ✓ Underwater Night Vision for Frogmen
- ✓ Individual Weapon Sights for most small arms
- ✓ Observation/Photographic Night Vision Systems
- ✓ Day/Night Closed Circuit Television Systems
- ✓ Laser Illuminators & I.R Markers for above & below water
- ✓ M89-SR Sniper Rifle



A Clear View Of The World

ALL-WAYS AT THE FRONT
Technology. Performance. Partnership



UNI-SCOPE
Optical System Ltd.

SK GROUP MEMBER

**UNI-SCOPE
OPTICAL SYSTEMS LTD.**

34 Hanapch St., P.O.Box 817
Carmiel 2161701, Israel

Tel: 972-4-9887022

Fax: 972-4-9887023

E-mail: uniscopes@zahav.net.il

Web Site: www.uni-scope.co.il

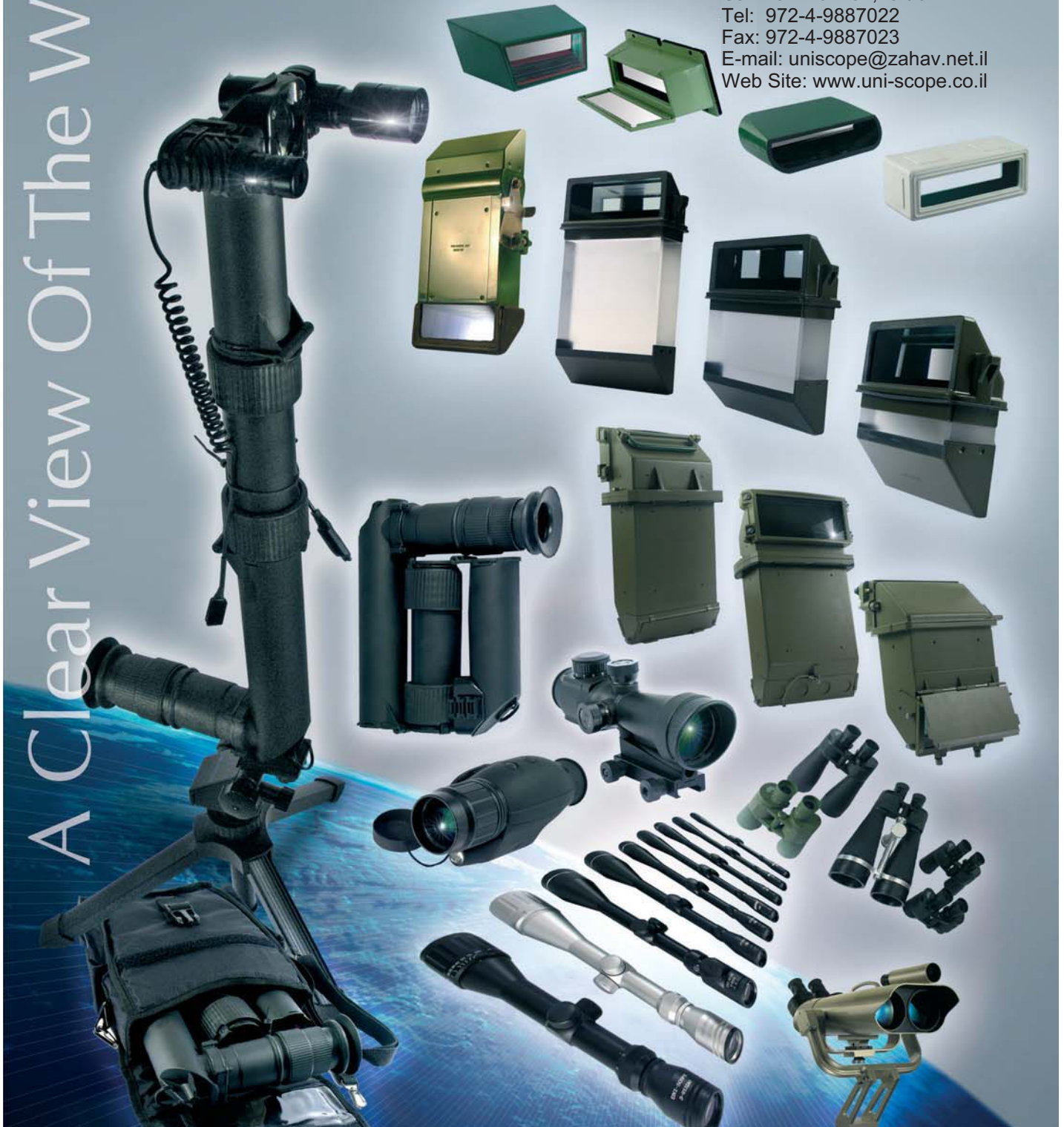

AMPS

Advanced Multi-Sensor Payload System



ELBIT SYSTEMS
ELECTRO-OPTICS - ELOP LTD.
P.O.Box 1165, Rehovot 7611101, Israel
Tel: 972-8-9386211
Fax: 972-8-9386237
E-mail: eo@elbitsystems.com
Web Site: www.elbitsystems.com/elop



AMPS is a member of our battle-proven family of stabilized airborne EO payloads, providing outstanding top-end, highly stabilized real time imagery. Optimized for airborne applications, AMPS delivers superb day and night intelligence, surveillance, target acquisition and tactical reconnaissance (ISTAR) capabilities in all weather conditions.

By providing long observation ranges, the AMPS enhances the quality and increases the output target intelligence production, while allowing for increased crew survivability.

The AMPS is in operational service with the Israel Navy, Air Force and other customers worldwide.

Main advantages and features

- Automatic tracking of dynamic targets
- Scanning with choice of automatic patterns
- Autonomous navigation using inertial and GPS sensors
- Highly accurate navigation capabilities including target gathering
- Long range capability or higher resolution in short ranges

Applications

- Long range, stand-off missions
- Border and maritime patrol
- Force protection
- Homeland security



CONDOR[®]2



ELBIT SYSTEMS
ELECTRO-OPTICS - ELOP LTD.
P.O.Box 1165, Rehovot 7611101, Israel
Tel: 972-8-9386211
Fax: 972-8-9386237
E-mail: eo@elbitsystems.com
Web Site: www.elbitsystems.com/elop

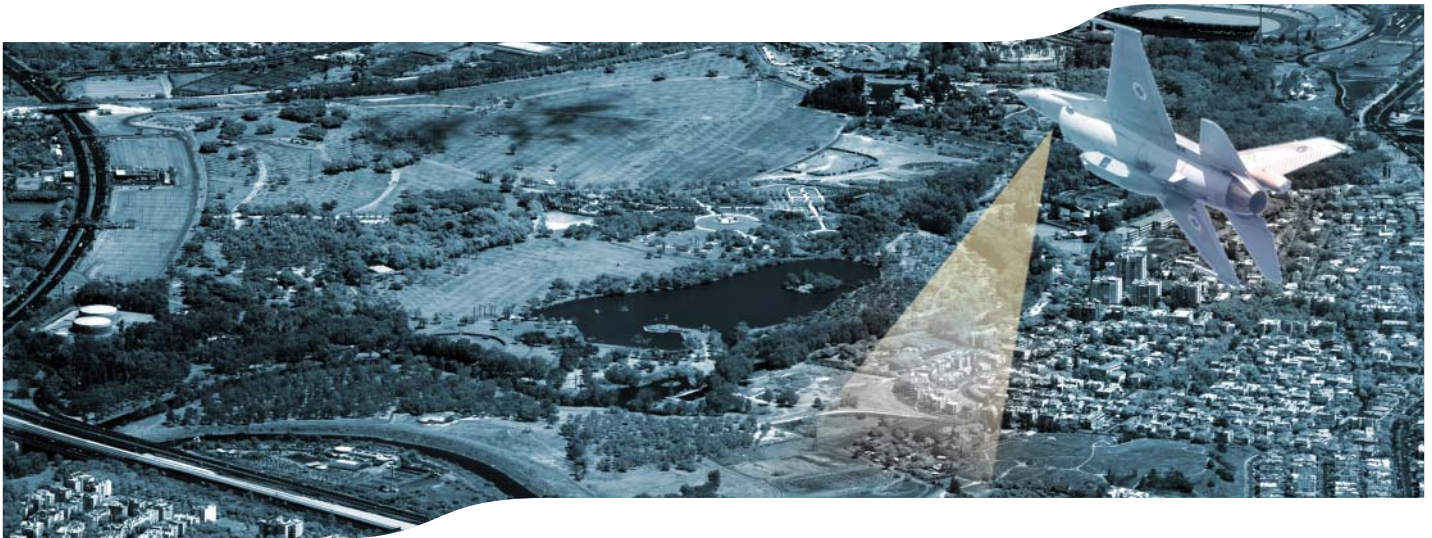

CONDOR[®]2

LOROP Airborne Standoff Reconnaissance System

In use by several air forces, CONDOR[®]2 offers real-time data record/transmit capabilities; includes camera, video processing, reconnaissance management, data link transmitter, digital video recorder. Can be mounted in a pod external to the aircraft or inside the aircraft.

A turnkey system – it can serve as an airborne camera system, ground or airborne mission planning or image exploitation system.

Major System Characteristics:

- Day and night standoff missions
- High resolution images at very long distances
- Very large imaging area in short flight time
- Autonomous navigation
- Pilot override for targets of opportunity
- On-board mission data recording
- Wide band data link for real-time image transmission
- Self-contained pod configuration
- Fully complies with the F-16, RF-4 and other aircraft flight envelopes
- Minimal interface with existing aircraft avionics

Condor[®]TAC

Dual Band Tactical Photography System

A unique solution for day and night tactical vertical and oblique reconnaissance photography, the Condor[®]TAC is a tactical reconnaissance system with autonomous navigation capabilities, providing 24/7 high-res, visible and IR mono/stereo images, from very low to very high altitudes. Operational in five different air forces, it provides continuous rapid wide-area coverage and full-resolution imagery for each EO/IR channel. Available in EO panchromatic or color RGB versions.

Main System Characteristics:

- Operational suitability for a wide range of missions
- Very high resolution imagery and large area coverage in high, medium altitudes
- High-precision optics – high-end refractive cameras
- Extremely high V/H ratio
- Platform interface with a wide range of aircraft
- High performance at a wide range of altitudes & mach numbers
- Pilot override for targets of opportunity
- On-board mission data recording
- Wide band data link for real time image transmission

DCoMPASS®

Digital Compact Multi-purpose Advanced Stabilized System



ELBIT SYSTEMS
ELECTRO-OPTICS - ELOP LTD.
P.O.Box 1165, Rehovot 7611101, Israel
Tel: 972-8-9386211
Fax: 972-8-9386237
E-mail: eo@elbitsystems.com
Web Site: www.elbitsystems.com/elop



DCoMPASS® is a highly stabilized, fully digital, lightweight (33-38 kg), single LRU electro-optical 15" class payload, available for fixed and rotary wing aircraft, UAVs, naval and ground platforms.

The DCoMPASS® is equipped with 5 major EO elements: thermal imager, HD color TV, laser designator, laser range finder and laser illuminator.

The system delivers superb day and night intelligence, surveillance, target acquisition and tactical reconnaissance (ISTAR) capabilities, in all weather conditions.

Main advantages and features:

- Highly stabilized crystal clear image on both HD color TV and thermal imager
- Lightweight, small size payload, made possible by new miniature digital electronics and advanced lightweight materials
- Fully digital system providing open architecture
- Embedded IMU allows for highly accurate navigation capabilities, including target gathering and geo-location
- Highly accurate Line of Sight (LOS) positioning, enabling LOS data for fire control applications
- Automatic multi-target dynamic tracking and area scanning with choice of automatic patterns
- Dual wavelength laser range finder and designator
- Unique in-flight boresight mechanism enables long-range precise laser designator
- Simple integration with HUD system, radar and fire control applications
- Step & Stare capabilities
- Advanced video enhancement package including: haze penetration, color restoration and sharpening features
- Fully operational in the harshest marine and air environmental conditions



MicroCoMPASS™

Micro Compact Multi-purpose Advanced Stabilized System



ELBIT SYSTEMS
ELECTRO-OPTICS - ELOP LTD.

P.O.Box 1165, Rehovot 7611101, Israel

Tel: 972-8-9386211

Fax: 972-8-9386237

E-mail: eo@elbitsystems.com

Web Site: www.elbitsystems.com/elop



The MicroCoMPASS™ is a day/night highly stabilized (3 gimbals) surveillance system that includes a 3rd generation 3-5 μ m continuous zoom thermal imager, color TV day camera, eyesafe laser range finder (ELRF), laser illuminator and automatic tracking capabilities. Its small size (8" diameter) and lightweight design (only 9 kg) facilitate easy installation of the MicroCoMPASS™ on UAVs, maritime, rotary wing and ground platforms.

The MicroCoMPASS™ is currently in operational service and provides high-resolution images.

Main advantages and features

- Lightweight (< 9 kg), compact design (8") with low power consumption
- Long-range continuous zoom thermal imager and zoom color CCD camera
- Unique, miniature, cooled continuous zoom thermal imager
- Equipped with 3 gimbals which provide high stabilization level
- Laser illuminator & eyesafe laser range finder (ELRF)
- Automatic tracking of observed targets
- Multiple communication protocols
- Single LRU configuration and minimum cabling
- Simple and straightforward installation utilizing interface with platforms, fire control and navigation systems
- Meets the most severe operational requirements of marine and low altitude applications.



ELECTRO-OPTIC INTELLIGENCE, SURVEILLANCE AND RECONNAISSANCE (ISR)

Litening - Targeting & Navigation Pod

Litening is an innovative airborne infra-red targeting and navigation pod for fighter aircraft with high accuracy and reliability, day and night precision strike capability. Litening reduces pilot workload during targeting and tracking. It is easily integrated on any aircraft and possesses high growth potential.

In use in the Israeli Air Force, USAF, ANG, AFRES, Marines, German AF, Swedish AF, Spanish Navy & AF, Greek AF, and others, the Litening flies on F-16 , F-15, A-10, B-52, AV8-B, Gripen, Tornado, F-5, F-4, Mig-21, Mirage 2000, Jaguar and others.



Toplite EO System - Electro-Optical Surveillance, Observation & Targeting System

The Toplite family of electro-optic systems is an advanced multi-sensor, multi-purpose, highly stabilized EO systems for homeland security and defense applications, for aerial, maritime and ground based platforms.

RecceLite- Real Time Tactical Reconnaissance System

The RecceLite System consists of an E-O pod, a ground exploitation station and a data link. It is capable of collecting images day & night from 300 ft to 40,000 ft in all directions forwards, nadir, backwards, oblique - all down hemisphere and even when the aircraft is maneuvering in high G. The Ground Exploitation Station (GES) is capable of generating targets in real-time with exceptionally high accuracy due to state-of-the-art algorithms and technology. The data-link connects between the sensors and the GES and enables the images to be downloaded to the GES in real time. When your task is to close the attack cycle on many "time-critical targets" in less than 10 minutes, there is only one system - RecceLite.

Recce-U - Real-Time Persistent ISR System for UAVs

Recce-U is a self-contained, multi-sensor ISR system (based on the RecceLite Tactical Reconnaissance Pod). The Recce-U enables automatic photography, according to a mission plan prepared in advance, or updated mission plan uplinked in real-time, however the operator can initiate manual scanning for targets of opportunity.



Litening -on-Gripen



Toplite EOS



RecceLite System

Recce-U

RAFAEL
ADVANCED DEFENSE SYSTEMS
 P.O.Box 2250 (19)
 Haifa 3102102, Israel
 Tel: 972-4-8794714
 Fax: 972-4-8794657
 E-mail: intl-mkt@rafael.co.il
 Web Site: www.rafael.co.il

SpotLite Family
Electro-Optic Enemy Fire Detection System

The SpotLite family consists of electro-optical systems that detect and locate enemy fire in stationary positions as well as on the move. Rapid detection and precise location information provide forces with the capability to quickly neutralize the enemy, maintaining the upper-hand on the battlefield.

The **SpotLite P** is a portable electro-optic system carried by two soldiers for day and night detection and location of small arms fire.



SpotLite P on Tripod

SpotLite M is a mobile electro-optic system installed on vehicles and AFV's that enables the detection and location of enemy fire sources from small arms, RPG rockets, ATGM and tank shells, on the move, day and night, up to 360° coverage.



SpotLite M on vehicle

Imilite - Multi-Source Multi-Task ISR Exploitation System / Command and Control System

Imilite is an intelligence system designed to receive process and exploit multiple standalone imagery video and other intelligence data in a centralized and a unified way.

Main system capability includes the reception, processing and exploitation of EO, IR, SAR/GMTI and VIDEO, in various formats, over one desktop. In order to enhance the exploitation process, Imilite further combines non-imagery data such as targets, threats, COMINT detection and mission status within the system workflow. Imilite generates a variety of standard and customer tailored ISR reports and IMINT products such as alphanumeric reports, annotated maps, GIS data layers and visual aids, and disseminates them to external information and operation systems over standard and tailored protocols.

Imilite's multi-source data integration and automation capabilities improve the efficiency of utilizing available collection and exploitation assets. The system GIS capabilities provide immediate accessibility to relevant imagery and intelligence data, thus shortening the ISR collection and exploitation cycle.

The Imilite is based on Rafael's combat-proven ISR and C⁴I systems already in service worldwide. Imilite is designed for use by Defense forces (air, ground) and police forces exercising various observation means for border patrol or coping with urban crime.



Imilite

TAMAM

A Complete Line of Multi-Sensor Electro-Optical Payloads



Israel Aerospace Industries Ltd.
Systems Missiles & Space Group, TAMAM Division

TAMAM DIVISION

P.O.Box 75
Industrial Zone
Yehud 5610001, Israel
Tel: 972-3-5315205
Fax: 972-3-5315140
E-mail: infotmm@iai.co.il
Web Site: www.iai.co.il/tamam

Tamam Division of Israel Aerospace Industries' Systems Missiles & Space Group is IAI's inertial components, navigation and electro-optics (EO) systems house.

Tamam's (EO) payloads are supplied to a wide variety of helicopters, fixed wing aircraft and UAV programs and for ground and sea applications:

- Surveillance and Reconnaissance
- Search and Rescue Missions
- Fire control and Targeting

POP Family:

MICROPOP - is a very small and light (4 inch 2.2 lb) dual axis, gyro-stabilized payload, built on a one line replaceable unit (LRU) open architecture carrying a single sensor that can be switched in minutes. Sensors contain either a "day" continuous zoom color camera or a "night" uncooled thermal imaging camera.

MINIPOP - is a 8 inch 15 lb dual axis, gyro-stabilized payload. The system is built on a one line replaceable unit (LRU) open architecture and carries a variety of sensors. The payload has a continuous zoom color day camera, a zoom thermal imaging camera and a laser range finder or designator. An automatic video tracker can also be installed.

POP - Plug-in Optronic Payload, is a 10" and 16 kg. modular, lightweight, compact, stabilized, electro-optical payload, designed for night and day. Different sensor combinations exist, such as IR, TV LRF, LD and LP. POP's unique modular concept allows sensor 'slices' to be easily and rapidly replaced - in the field - within minutes.

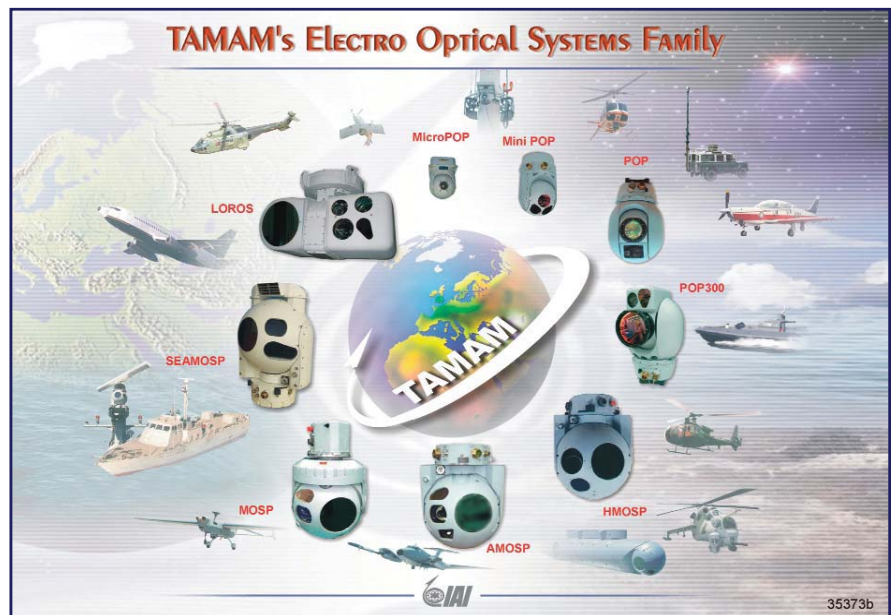

MOSP - Multimission Optronic Stabilized Payload, 14" 15" and 32 kg. is an advanced lightweight family of payloads available in a variety of day, night and laser configurations. Modular construction allows the simultaneous installation of three or more sensors. Excellent long range performance is achieved by MOSP's very high degree of stabilization. Many different sensor configurations give the customer the possibility of tailoring the MOSP to meet specific needs, by variety of CCD and IR Cameras and also available with LP, LRF and LD. All the payloads were designed for installation in fixed or rotary wing, manned or unmanned airborne platforms, land vehicles or naval vessels.

Typical applications include:

- Surveillance, Reconnaissance, Targeting
- Border control
- Coastguard and Customs

- Traffic monitoring and control
- Drug interdiction

LOROS - is a 30" and 90 kg. Long Range Observation System for intelligence gathering and surveillance missions during night and day missions. LOROS maximizes TAMAM's expertise of high level of stabilization and navigation technologies.

LOROS provides:

- 3rd generation 3-5 μ m FLIR
- Color CCD with zoom lens
- B/W CCD with Spotter
- Intensified CCD (ICCD) Camera
- Laser Range Finder (LRF)
- Automatic target tracker
- Accurate target geo-location and Line Of Sight navigation
- Enhanced image processing
- Long range downlink of video imagery and annotation data

CONTROP'S THERMAL IMAGING PRODUCTS

CONTROP is a world leader in EO / IR technologies and systems, providing innovative day / night EO / IR solutions for air, land and sea surveillance, defense and Homeland Security applications worldwide.



CONTROP Precision Technologies Ltd

**CONTROP
Precision Technologies LTD.**

P.O.Box 611
Hod Hasharon 4510502, Israel
Tel: 972-9-7440661, Fax: 972-9-7440662
E-mail: sales@controp.co.il
Web Site: www.controp.com



In 1995, CONTROP was the first company to supply an IR Camera with a Continuous Optical Zoom Lens and has since then developed a wide variety of IR cameras based on many years of proven field experience.

Unique qualities about CONTROP's FOX Family of Thermal Imaging Cameras:

- Proprietary highly powerful (up to x36) Continuous Optical Zoom Lens.
- Quality image and focus for all FOVs.
- Unique Image Enhancement features for dynamic battlefield applications ensuring that every picture is perfect, even when there is a "hot spot" (explosion, fire, etc.).
- Cameras are suitable for observation and scanning applications.
- Small volume and light weight.
- Flexibility for new technology modifications.
- May be supplied with an enclosure (FOX-ZE) or without an enclosure (FOX-Z).
- Fixed CG through zoom – Optional.



Features about CONTROP's FOX Family of Thermal Imaging Cameras:

- 3-5 μm IR Spectral Range.
- Third Generation InSb FPA 320x256 or 640x512 (P) Pixels Standard.
- Various Focal Lengths 250 mm (x12.5), 450 mm (x22), 720mm (x36), 1400mm (x35).
- Housing - Optional.



Applications for CONTROP's FOX Family of Thermal Imaging Cameras:

- Integration in Observation Systems – Short to Long Ranges.
- Integration into Camera Payloads – Airborne, Maritime and Ground.
- Integration with Weapon Sites and Systems.
- Panoramic Scanning Systems.
- Air Defense Systems.



INTEGRATED THERMAL SYSTEMS



Elbit Systems Electro-optics Elop's Integrated Thermal Systems Business Unit provides optimal operational responses to the present and future challenges facing modern fighting forces:

- from thermal sights and thermal driving solutions
- through upgrades for ATGMs and anti-aircraft and anti-tank guided missile defense systems that optically track and engage targets
- to FLIRs for OEM and MWS, and homeland security applications

Incorporating Elbit's and Elop's extensive technological and integration know-how and experience, we create a complete solution to the challenge, based on the customer's operational requirements.

Using the most advanced electro-optics capabilities and significant R&D investments, we provide 24/7 all-weather solutions to our clients, enabling them to operate in any environment with optimal results.



IVORY-Z

Compact 3-5 μ m Thermal Imaging Camera/Sight for Remote Operation Applications, with Continuous Optical Zoom

- Lightweight and compact
- Long-range performance
- Excellent image quality
- Full remote control capability
- Add-on x2 telescope (optional)

Applications:

Border/coastal surveillance; air defense; security; target acquisition; tank and AFV weapon stations; radar systems; naval EO clusters



LIZ

Advanced Multi-sensor Day/Night EO Sight for Remote Operations

- Advanced, grounded TI technology
- Advanced high resolution detector
- Long-range performance
- IR optical zoom
- Telescope magnifier
- Color day camera with continuous zoom
- Integral eyesafe LRF

Applications:

Observation & surveillance; security & perimeter defense; stationary & mobile weapon stations



A-TIM

Advanced Clip-on Thermal Imaging Sight for ATGM Launchers

- Provides full day/night operability, in all weather conditions
- Boresight free – quick installation on standard launcher day sight
- Uses existing eyepiece for both standard & thermal sight
- Lightweight & compact

Applications:

Applicable for any ATGM launcher; already operational with FAGOT, FLAME, Konkurs/AT-5 Spandrel



LOTUS-G/GL

Man-Portable Long-Range 3-5µm Thermal Imaging Camera

- Housed in ruggedized sealed case including display, controls and battery compartment
- Advanced high resolution detector
- Three FOVs
- Day/night operation
- Low power consumption
- Easy integration with host system

Applications:

Field observation; border & coastal surveillance; security & perimeter defense; anti-terror operations

CORAL

Thermal Imaging Cameras



Elbit Systems Electro-optics Elop's CORAL Thermal Imaging Systems have gained significant momentum around the globe in recent years.

The CORAL FLIR family has secured an industry-leading position in the field of hand-held lightweight Thermal Imaging Cameras.

Elop's CORAL dual-FOV Thermal Imaging Cameras are in use by security forces on four continents.

Based on Elop's advanced, proven 3-5 μ m FPA InSb

detector technology, CORAL can be optimized for a wide range of applications, from infantry, scouts and special units, through night sight and target acquisition, to security and perimeter defense, and target acquisition for infantry commanders.

CORAL produces thermal images of outstanding quality based on Elop's unique image processing circuitry and software algorithms implemented in the system.

CORAL-CR

Advanced, Hand-held, 3-5 μ m Thermal Imaging Binocular Camera with Continuous Optical Zoom and Target Acquisition Capabilities

- Continuous electronic and IR optical zooms
- Integral eyesafe LRF, day CCD cameras, digital magnetic compass and GPS
- Real-time target acquisition and target coordinates calculation
- Can be used in conjunction with:
 - ATRIS – Man-portable remote-controlled target acquisition system
 - Mini Atlas – Precision electronic goniometer



**ELBIT SYSTEMS
ELECTRO-OPTICS - ELOP LTD.**

P.O.Box 1165, Rehovot 7611101, Israel

Tel: 972-8-9386211

Fax: 972-8-9386237

E-mail: eo@elbitsystems.comWeb Site: www.elbitsystems.com/elop**CORAL***Hand-held, 3-5 μ m Thermal Imaging Binocular Camera**Selected by the USMC*

- Lightweight and compact
- Continuous E-zoom
- High resolution OLED display
- Low acoustic noise
- Adjustable binocular viewer

CORAL-LS*Hand-held Thermal Imaging Camera with
Integral 1.06 μ m Imaging Capability*

- Integral "See-Spot" capability
- Advanced InSb FPA detector
- Lightweight and compact
- Continuous E-zoom
- Adjustable binocular viewer

CORAL-Z*Advanced, Hand-held, 3-5 μ m Thermal Imaging
Binocular Camera with Continuous Optical Zoom*

- Continuous IR optical and digital zoom
- Lightweight and compact
- Advanced high resolution color OLED display
- Advanced high resolution detector
- Adjustable binocular viewer
- Option: Enhanced performance when used with
ATRIS – man-portable remote-controlled target acquisition system

MINI CORAL*Uncooled Hand-held Thermal Imager with Target
Acquisition Capabilities*

- Dual FOV (thermal imager)
- Continuous E-zoom
- Integral eyesafe LRF
- Color day camera
- Integral digital magnetic compass and GPS
- Built-in real time video recorder (Mpeg compression)

SMART THERMAL IMAGING SOLUTIONS



**OPGAL
OPTRONIC INDUSTRIES LTD.**

P.O.Box 462, Industrial Area 5
Karmiel 2161401, Israel
Tel: 972-4-9953903
Fax: 972-4-9953900
E-mail: info@opgal.com
Web Site: www.opgal.com



OPGAL OPTRONIC INDUSTRIES - a leading global manufacturer of innovative thermal imaging cameras, core engines and custom made solutions. OPGAL offers a wide selection of infrared thermal imaging cameras and core engines for military, homeland security, gas leak detection and aviation applications. OPGAL's cameras and core engines have been field tested worldwide for the past 28 years.

The company's creative R&D, cutting edge technology, speed and flexibility, makes OPGAL your best partner for thermal imaging applications. OPGAL's diverse product line includes fully-integrated thermal imaging systems customized to specific applications, as well as off-the-shelf thermal imaging cameras and engines for private labeling, OEM partners and other systems integrators. OPGAL's solutions are chosen by integrators worldwide due to OPGAL's vast experience in thermal imaging applications. Rafael Ltd. and Elbit Systems Ltd., two major world-renowned defense contractors, are OPGAL's equal owners and shareholders.

OPGAL's cameras and core engines are widely used in the following key military and defense applications:

- TWS Thermal Weapon Sights
- RCWS Remote Controlled Weapon Stations
- DVE Driver Vision Enhancers
- UGS Unattended Ground Systems
- UAV/UGV/USV Unmanned Aerial/Ground/Sea Vehicles
- Reconnaissance and Observation PODS
- Missile Homing Devices

Additionally, OPGAL'S products are integral to the following solutions:

- Homeland Security
- Aviation EVS
- Gas leak detection



COMPACT EYE™
Thermal Imaging
Core Engine

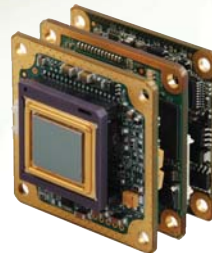

EYE R640™ 17μ
Thermal Imaging
Core Engine



ARBEL™
Ruggedized Dual
FOV Camera



TAVOR™ - DVE Kit



EYE-LITE™
Continuous Zoom
Thermal Camera

VISUAL INFORMATION & TARGETING SOLUTIONS

SENSOPTICS
SENSING YOUR TARGET

Senso Optics is a leader in R&D, Design, Production & Delivery of Innovative Thermal Imaging Technologies and Advanced Electro-Optical Solutions for Military, Law Enforcement, Search & Rescue, Security and Commercial Aviation Markets.

SENSO-OPTICS LTD.

P.O.Box 600
Industrial Park
Yokneam 2069207, Israel
Tel: 972-4-9935527
Fax: 972-4-9935894
E-mail: senso@senso-optics.com
Web Site: www.senso-optics.com



Senso Optics offers a wide range of targeting and visual information products, systems and solutions for day, night and low visibility missions. Senso-Optics' Electro-Optical solutions are robust and divided to three categories:

Sensor products: Intelligent Cameras, Lenses and Sights, based on company's core technology in un-cooled thermal imaging & image processing.

Defense Systems: Fire Control Systems (FCS), Command & Control units.

Dual use solutions: Thermal Vision Sensors within Enhanced Vision Systems (EVS) for situational awareness of commercial aircrafts (DO - 254), Vehicles mounted enhanced driving forward looking thermal imaging, Fire-Fighters & Miners Thermal vision solutions, Oil Spills detection solutions, Border and strategic infrastructure 7/24 monitoring solutions, etc.

Senso-Optics' Product lines include:

- **Senso-Drive™** - Vehicle/cars mounted thermal imaging cameras.
- **TVS** - Thermal Vision Sensor for Aircrafts' Enhanced Vision System (EVS).
- **Fire-Fighting Thermal vision helmets** for Emergency search & rescue teams.
- **Thermal Cameras** for Border & strategic infrastructure 7/24 monitoring solutions.
- **GSS / AGSS / EDAN-FCS** - Multi-sensors (Day/Night/LRF) E-O targeting systems.
- **Senso-Cam™** - Hand-held thermal goggles/scopes.
- **Shanny Day zoom Camera** - Military long range, zoom Day Cameras and Sights.
- **Leann / Smadar/X-Lite** - Uncooled Thermal Digital & Analogue **Engines**.
- Special **Thermal lenses** (Manual / motorized / zoom, periscopic, WFOV etc.).
- Video & Laser Muzzle **Bore-sights** & Muzzle Reference systems (MRS).



TEMMEK OPTICS LTD.



The Leader in IR Zoom Lenses

TEMMEK OPTICS LTD.

4 Faran St., P.O.Box 159

Yavne 8110101, Israel

Tel: 972-8-9438408

Fax: 972-8-9438390

E-mail: temmek@temmek.com

Web Site: www.temmek.com

Temmek Optics Ltd. is active in the design and manufacture of LWIR and MWIR lenses. Temmek's Infrared Lens line includes continuous zoom, discrete zoom and fixed focus lens assemblies. Temmek's products are designed to operate with cooled and uncooled detectors, with a fast customization to the customer's detector, both optically and mechanically.

Temmek holds the manufacturing technologies in-house, both mechanical and optical, which gives Temmek an intimate know how in the manufacturing and assembly of optical assemblies. This expertise is incorporated into Temmek's designs, and allows for very short time to market of prototypes, and a swift prototype to production transition.

As part of the Gal Shvav Industrial Group, Temmek has close access to complementary industries, and a vast manufacturing capacity. The Gal Shvav Group has strong abilities in the design and manufacturing of electro optical assemblies, including precise metal machining, and class 1000 clean room assemblies.

Temmek has a wide range of existing lenses suitable for both cooled and uncooled detectors that may support both defense and commercial thermal camera systems produced by our customers. Temmek also specializes in "build to spec" and "full turnkey solutions" of specialized lens requirements, and thus can meet a wide spectrum of lenses for diverse applications.

Temmek's tailored components can be found worldwide in advanced complex thermal imaging systems, with added value and innovation creating a competitive advantage. Serving leading edge technology clients worldwide, such as Defense Providers for Land, Maritime and Aviation Applications, both for commercial and defense markets.



SECURE OPTICAL SIGNALING

Thermal Beacon Ltd. is a leading company developing and producing high-end innovative thermal IFF (Identification Friend or Foe) emitters and high power visible and infrared laser illuminators and designators.



THERMAL BEACON LTD.
10 Heshvan St., P.O.Box 1312
Kiryat-Gat 8202366, Israel
Tel: 972-72-2500690
Fax: 972-72-2500691
E-mail: info@thermalbeacon.com
Web Site: www.thermalbeacon.com

Thermal Beacons

The Thermal-Beacon is a unique infrared emitter - being used as an identification device in the thermal spectrum region (mid-IR and long-IR) - for use with people, vehicles, yachts, pilots, police SWAT teams, SAR, emergency services and mountain rescue teams

- A solid state optical IFF beacon.
- The most compact beacon for thermal observation
- Extremely long working range.
- Innovative design.
- Design for outdoor operation, military demands and standards.
- Field proven product.
- The selected product among elite forces.
- Patent pending technology.

The Thermal-Beacon is an innovative and unique infrared emitter, radiates in the thermal spectrum (8-12 micron and most efficiently at 3-5 micron) and does not emit radiation in the visible or the near infrared region. It is used as an identification device in the thermal spectrum region, for persons or vehicles.

The MS (Multi Spectrum) version allows the user to control the spectrum of radiation from the following:

- Only thermal region
- Only near infrared region (for image intensifiers and SLS)
- Both thermal and near infrared regions simultaneously.

High Power Laser Illuminators

Thermal Beacon Ltd. is specialized in very high power laser illuminator. The line of products includes near infrared (from 780nm up to 980nm) red (from 635nm up to 675nm) and green (532nm) illuminators. The output power is from 30mW and up to 10 Watts and higher.

Systems contain either free space or fiber coupling, continuous output power control, continuous beam divergence control, etc.

- The selected product among elite-forces.
- Field proven product.
- Design to withstand recoils of heavy machineguns
- The most compact high-power laser illuminator.
- Miniature size to fit into gyro stabilized platforms
- Extremely long effective working ranges.
- Design for outdoor operation, military demands and standard.
- Modular design, allowing costume-tailored structure.



ROTEM INDUSTRIES - CRYSTALS DIVISION



Rotem Industries' Crystals Division pioneered the development of sapphire single crystal domes more than 45 years. Since then Rotem has been producing sapphire domes & windows for Aerospace, Defense and Optics applications.

Rotem carries out R&D, manufacturing (growth, fabrication and quality control) and marketing activities mainly aimed at the high quality Defense market (smart components) and Optics.

ROTEM INDUSTRIES - CRYSTALS DIVISION

ROTEM Industrial Park,
D.N. Arava P.O.Box 9046
Beer-Sheva 8419001, Israel
Tel: 972-8-6579781, 972-8-6568300
Fax: 972-8-6573186, 972-8-6554502
E-mail: bennyb@rotemi.co.il
Web Site: www.rotemi.co.il/crystals



The Crystals Division at Rotem Industries offers a full range sapphire production:

- Growing** – a complete production line of large boules.
 - Development** – the hyper-hemispherical sapphire dome or above 240° hemisphere in various diameters is specially designed for advanced DIRCM/CIRCM systems.
 - With over 45 years of experience in offering state-of-the-art solutions, Rotem is well known R&D center for the defense and smart high-end optical components markets.
 - Processing** – manufacturing of dome-like products and flat windows using advanced equipment for optical fabrication (standard & CNC).
 - Characterization** – inspection of final product as well as in-process control utilizing advanced methods and tools (interferometry, spectral and non-contact roughness measurements).
 - Coating** – ability to offer advanced coating by local sub-contracting.
- The sapphire-components production line of Rotem is ISO-9001:2000 certified since 1994.

Main Applications

Sapphire domes for:

- Air-to-Air/Air-to-Surface Missiles/ Guided Weapons
- Surface-to-Surface/Anti-Tank Missiles
- Missile warning & protection systems

Sapphire windows for:

- Anti-ballistic Missiles
- Targeting & Reconnaissance Pods/UAV payloads
- Missile warning & protection systems/HLS

A Remarkable Technological Breakthrough by Rotem Industries Hyper Hemi-Spherical Sapphire Dome

Rotem Industries Ltd. is a leading developer and manufacturer of advanced technologies, for growing Sapphire and processing windows and domes for military and civil applications. Rotem has successfully developed remarkable technological breakthrough:

The hyper-hemispherical Sapphire dome 240° or above hemisphere in various diameters

This unique technological development was extremely challenging due to its dimensions and geometric characteristics. The hyper-hemispherical dome is specially designed for advanced DIRCM/CIRCM systems due to its wide viewing angle. With over 45 years of experience in offering state-of-the-art solutions, Rotem is a well-known R&D center for the defense and smart high-end optical components markets.



ELECTRO-OPTICAL TEST SYSTEMS FOR FIELD & DEPOT



CI SYSTEMS LTD.

P.O.Box 147
 Industrial Park Ramat Gabriel
 Migdal Haemek 2310101, Israel
 Tel: 972-4-6448888
 Fax: 972-4-6543570
 E-mail: market@ci-systems.com
 Web Site: www.ci-systems.com

CI Systems develops, manufactures, markets and services sophisticated electro-optical test and measurement systems primarily for the design, testing and maintenance of military electro-optical systems. CI's experience over the years has gained it a reputation as a reliable partner in the Worldwide defense programs.

ILET (Intermediate Level Electro-optical Tester)

- Compact and ruggedized athermal design.
- Accurate at a wide ambient temperature range.
- Easy to use.
- Capable of automatic operation (with added PC and AFT software).

FTC - Field Test Colimator

- Objective "0" level Go/No Go FLIR testing.
- Light weight and portable self contained miniature collimator.

OLT - O Level Laser Tester

- Objective O level laser tests.
- Lightweight and portable.

CI's products provide:

- Field and depot level maintenance staff with test equipment to ensure maximum operational readiness.
- Developers of night vision equipment, FLIRS, Lasers, day sight, multi spectral systems and other sophisticated electro-optical systems.
- Defense contractors with comprehensive test systems to ensure high quality, repetitive, reliable and fast testing.

CI's METS (Modular Electro-optical Test System) is a fully integrated system mainly used for depot level.

Its main features are:

- Wide spectral range and apertures
- Superior optical quality, temperature resolution and accuracy.
- Modular design to meet the specific needs of customers.
- Easy to operate advanced software package (AFT) to automatically perform MTF, NETD, MRTD, SiTF, etc. tests.
- User friendly optical alignment to Unit Under Test.
- Built to test visible (CCDs) to Far IR FLIR systems.



EO SENSING SOLUTIONS: INSTRUMENTATION, MEASUREMENTS AND MODELING



**IARD
Sensing Solutions Ltd.**

Yagur 3006500, Israel
Tel: 972-4-8216402
Fax: 972-4-8216396
E-mail: info@iard.co.il
Web Site: www.iard.co.il

IARD Sensing Solutions develops manufactures and markets radiometers, proprietary electro-optical instrumentation and custom built electro-optical systems. IARD also provides Research, Development and Measurement services in the fields of EO Signatures, Radiometry and Remote Sensing. The services include development of physical and mathematical models in the fields of heat engineering, gas dynamics of hot multi-phase flows and electro-optics.

Products:

Radiometers:

A family of fast multi-channel radiometers which are capable to perform simultaneous radiometric measurements in up to 4 channels to choose from the UV, VIS, NIR, SWIR, MWIR, LWIR with high sensitivity and speed (up to 250K samples per second). It satisfies the requirements of scientists and engineers who need to measure the signatures of fast transients phenomena from close (meters) and large (>100 km) distances. The radiometers are all fully computer controlled via USB interface with 16 bit data acquisition integrated in the radiometer. The family of radiometers includes the following products:

- ◆ **ColoRad:** the perfect tool for performing field measurements with high sensitivity in up to 4 user-defined spectral bands.
- ◆ **Orion:** Dual band, compact, fast radiometer. Used as a stand alone radiometer or as an add-on to slow imaging devices or spectro-radiometers for measurements of fast transients.
- ◆ **MicroRad:** Compact Single channel radiometer. Supports a wide range of spectral bands. The radiometer can be used for EO systems calibration and other various applications.

OFRI:

Real Time Observation Range Enhancer. Ideal for surveillance systems and all outdoor imaging applications. Compact, simple to use, Stand-alone unit enhances the observation range by up to 3 times in bad weather conditions. Accepts any standard analog video input in the Visible, NIR, SWIR and Thermal IR spectral bands. Based on a sophisticated physical model, OFRI reverses the image degradation caused by atmospheric absorption and path radiance (airlight), thus achieving outstanding results.



DBS:

Dual band CCD camera for detection applications. The DBS enhances spectral differences between the target and its background. Applications include detection of camouflage nets, missile plumes, water stress in vegetation; authenticity verification and many more.

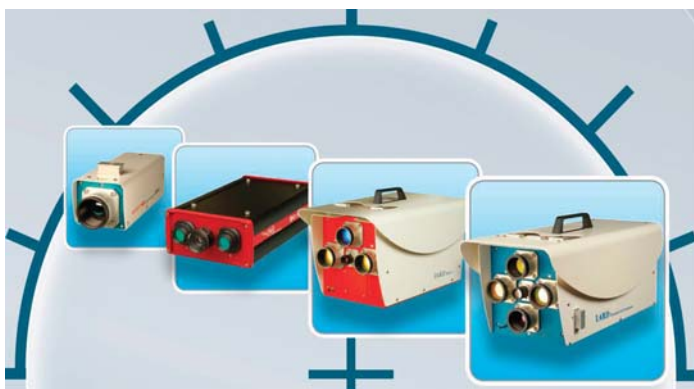



ELECTRONIC COMPONENTS & SUB-SYSTEMS

Advanced electronic and electro-optical systems are the core of Israel's high-technology industry. With defense companies rated among Israel's leading electronics and computing industries, defense electronics has also evolved into a highly sophisticated field of activity in the country. The field is attracting highly experienced engineering and scientific talents from academic, military, intelligence, research and development branches. Some of Israel's defense electronics firms have grown into world-leading enterprises, offering a broad range of high-tech products for defense and security as well as for commercial applications.

Others have specialized in specific fields, including communications security (COMSEC) and encryption, high-speed data links over terrestrial, aerial and satellite communications, electronic intelligence, navigation, positioning and timing, sensors, signal processing and display technology. Israeli technologies are often integrated into larger systems offered by local defense industries or with foreign system integrators, where Israeli systems are available for export without the restrictions often imposed by ITAR regulation.

Israel-based specialist industries are also providing state-of-the-art subsystems ranging from components for thermal sensors – from detectors and coolers to complete 'engines', and subsystems for imaging systems. Others are specializing in gyro stabilization and servo systems, miniature motion systems and micro- electro-mechanical systems (MEMS), along with rugged electronics, special-purpose displays, high-density batteries and miniature and high capacity power supplies. All these are only few examples of Israel's wide range of electronic components and subsystems.

MTC INDUSTRIES & RESEARCH



**Complete Engineering Solutions
Under One Roof**

MTC
Industries & Research Carmiel Ltd.
P.O.Box 232, Karmiel 2161102, Israel
Tel: 972-4-9987772
Fax: 972-4-9981189
E-mail: marketing@mtcind.com
Web Site: www.mtcind.com



GYROSCOPES

CANAD FIN ACTUATION SYSTEMS

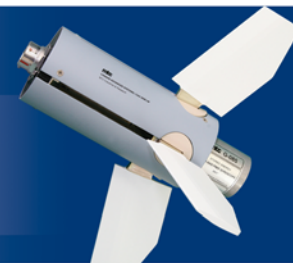

ELECTRIC MOTORS, LVTD, RVTD AND SOLVERS

SERVO ACTUATORS



HIGH PRESSURE VESSELS

SLIP RINGS



SOLENOIDS

MTC designs, develops and customizes a wide range of products for the Aerospace, Defense and Medical industries worldwide. visit MTC's website for a full range of products and services including: Engineering Solutions and Thermal Spray Coatings. MTC is AS9100C certified and conforms to MIL-STD.

Typical Applications

UAV

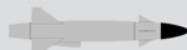

Missiles



Tanks



Ships

HERLEY ISRAEL



General Microwave & Eyal

HERLEY ISRAEL- (General Microwave & Eyal)

20 Pierre Koenig St.,
Jerusalem 9346928, Israel
Tel: 972-2-5689444
Fax: 972-2-6782460
E-mail: sales@hgmi.biz
Web Site: www.herley.com

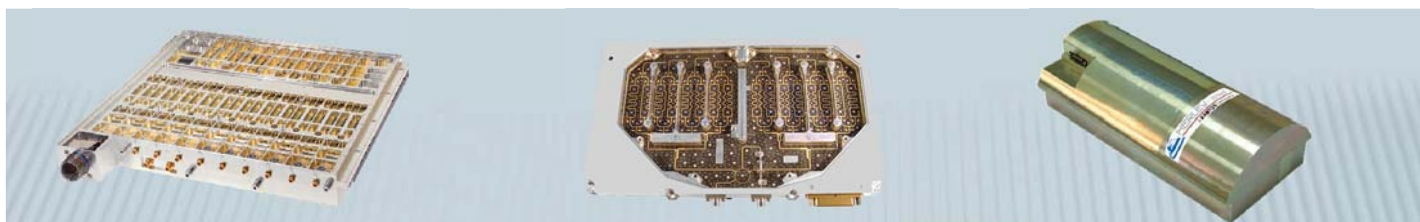

Herley Israel is a recognized worldwide leader in the design and manufacture of high performance, State-of-the-Art Microwave components and subassemblies for the defense as well as non-defense markets. The company consists of two divisions: Herley General Microwave Israel and Herley GMI Eyal (Previously Eyal Microwave Industries). Both companies were founded in the 80's. Today Herley Israel is part of Kratos (nasdaq KTOS) under Kratos Electronic Products Division. Herley Israel is one of the largest international independent microwave companies. The company provides a unique combination of cutting edge technology at very competitive prices.

Herley Israel's primary customers are leading international system houses and defense agencies; it provides its customers with the highest level of support throughout the lifetime of a project.

The products are used in a wide variety of demanding environments including airborne, ground, naval and space.

Main Applications:

Defense Market: Electronic Warfare (EW) systems, Phased Array Radars, Missiles, Communications, Space and Simulators. Non-defense market: Test equipment, Radio and Fiber Optic Communications, Oil Industry, Research Laboratories and Civilian Radars.

Herley Israel – Products

Broadband Oscillators and Synthesizers (0.5 to 18GHz and beyond)

Fast Indirect Synthesizers with 1 microsecond settling time, Direct Coherent Synthesizers with 40 nanosecond settling time, Frequency Locked Oscillators (FLOs), Digitally Tuned Oscillators (DTOs) and Voltage Controlled Oscillators (VCOs).

Solid State Power Amplifiers (SSPAs)

Up to 400 W in X and Ku- bands for missiles and airborne Radars, up to 1 KW in VHF range, for military and non-military applications, Pulse Power Amplifiers for IFF systems and Low Noise Amplifiers.

Integrated Microwave Assemblies (IMAs) and Sub-Systems: Compact, state-of-the-art, military and commercial applications, unique price/performance combination, over 0-40 GHz. This product line includes Down-Converters, Up-Converters, RF Front Ends, Amplitude and Phase Control Modules, Switched Filter Banks, Detector Log Video Amplifiers (DLVAs), IF Assemblies and more.

Beam Forming Modules: a versatile line of complicated high-density modules utilizing Surface Mount Technology, incorporated in Phase Array Radars.

Receivers: superior performance and cost effective. This product line includes both Narrowband and Broadband receivers covering 0.4 – 18 GHz, for various applications such as Direction Finder subsystem for ELINT and ESM airborne systems.

Control Components (0.1 – 40 GHz): Based upon PIN diode and proprietary coupler technology. This product line includes Switches (SPST up to SP26T) for low, medium and high power, Attenuators, Modulators, Phase Shifters, Frequency Translators and I/Q Vector Modulators. All these products, with either digital or analog control.

Quality

Herley Israel is certified to ISO 9001, AS9000 and international quality management standards.

AL CIELO LTD.

5 Nahum Hefzadi St.,
 Jerusalem 9548401, Israel
 Tel: 972-2-6595539
 Fax: 972-2-6541221
 E-mail: info@alcielo.com
 Web Site: www.alcielo.com

Al Cielo – Navigation and Control Inertial Sensors

Al Cielo applies unique, advanced fiber-optic technologies to a growing range of inertial control and navigation solutions.

Al Cielo's commitment is to exploit significant innovation and manufacturing resources for solutions that deliver a clear competitive edge to customers.

With over 40 patents, world class facilities and a decade of experience in development and manufacturing of

electro and fiber optical systems, Al Cielo now brings measurable advantages to Fiber Optic Gyroscopes (**FOG**), Inertial Measurement Units (**IMU**) and Inertial Navigation Systems (**INS**).

Today, Al Cielo is the prime local supplier in Israel for closed loop FOGs with sensors engaged in a variety of navigation and control applications.

Applications

- ▼ Navigation
- ▼ Missile and torpedoes guidance
- ▼ Flight controls
- ▼ UUV/UAV guidance and control
- ▼ Gyro compassing / Target acquisition systems
- ▼ Camera/Mapping
- ▼ AHRS
- ▼ Motion compensation
- ▼ EO/FLIR/Radar stabilization
- ▼ Line-of-sight tracking / Precision pointing

Advantages

- ▼ Superior precision
- ▼ True "solid state" system without moving parts, dither or gaseous cavities, ensuring long reliable shelf and usage life.
- ▼ Bandwidth which enables gimbal stabilization and motion Compensation in dynamic environments.
- ▼ Best performance to volume ratio
- ▼ Best performance to price ratio
- ▼ Optional customization for specific applications
- ▼ Utilizes the latest telecommunication technology



TAMAM

A Complete Line of Land & Airborne Inertial Navigation Systems

Reference Systems, Inertial Components,
Precision Technologies



Israel Aerospace Industries Ltd.
Systems Missiles & Space Group, TAMAM Division

TAMAM DIVISION

P.O.Box 75
Industrial Zone
Yehud 5610001, Israel
Tel: 972-3-5315205
Fax: 972-3-5315140
E-mail: infotmm@iai.co.il
Web Site: www.iai.co.il/tamam



artillery deployment and forward observation applications. VGLPS uses the navigation data from the AMAPS so all the inertial data is constantly available. VGLPS provides the vehicle's own position coordinates, the observation line of sight Azimuth and the gun or targets coordinates.

RNAV/RNAV-IPON

RLG based Terrain Navigation System - Tamam's Ring Laser Gyro (RLG) based Reference and Navigation System (RNAV) fits all types of tracked and wheeled platforms (Rocket Launchers, tanks, self-propelled air-defense vehicles, Mobile Mortars, APCs etc.). This small lightweight, self-contained and fully qualified system offers Hybrid (Inertial/GPS integrated) Position and Azimuth determination.

ADNAV

FOG based low cost land navigation systems for tanks, APC and other land vehicles.

Tamam activities include:

- Land-navigation and reference systems.
- Strap-down inertial reference and navigation systems.
- Airborne inertial navigation systems.
- Multi-Mission Electro-Optical stabilized payloads for day/night surveillance and Target Identification.
- Stabilized electro-optical observation systems (long range).
- Gyros and accelerometers (inertial; semi-inertial) free gyros; rate gyros.
- Computerized test and calibration equipment.
- Artillery upgrades.

LAND NAVIGATION SYSTEM

AMAPS/TMAPS

General description:

AMAPS and TMAPS are third generation, small-size, integrated, survey and target acquisition systems for autonomous ground indirect fire units, survey, air defense and any other type of military unit that requires continuous and highly accurate azimuth and position data.

AMAPS and TMAPS provide continuous and accurate azimuth, elevation and location data, enabling simultaneous positioning and pointing for Self Propelled Guns (SPG), missiles or rocket launchers. AMAPS and TMAPS are compatible with MIL-D-70789A (MAPS) and Tamam's GONS/LANS family of inertial land navigation systems, allowing a smooth transitioning system upgrading.

VGLPS Vehicle Gun Laying & Positioning System

General description:

VGLPS is a hybrid autonomous high precision navigation, gun laying and target acquisition system.

The VGLPS performance, which is based upon the AMAPS, is suitable for

AIRBORNE NAVIGATION SYSTEM

TNL-16G

RLG based Airborne Inertial Navigation system -

TNL-16G is a Ring Laser Gyro (RLG) based small, lightweight, GPS aided, inertial navigation system. The TNL-16G utilizes three 16cm. path length RLG and three high accuracy Accelerometers. The TNL-16G contains an embedded GPS receiver (external GPS is optional)

TRF-90

TRF-90 is a FOG based miniature Inertial Measurement Unit (IMU) -

The TRF-90 is a small, lightweight, low cost, strap down IMU. The TRF-90 is based upon open-loop Fiber Optic Gyro (FOG) technology. The TRF-90's modular design allows for easy adaptation for various configurations.

Applications for airborne nav. sys.

- Guided missiles and smart bombs
- Guided Artillery projectiles
- Unmanned aerial vehicles
- Optronic and targeting systems
- Instrumentation pods
- Antenna stabilization
- Vertical Gyro Unit (VGU)
- Radar Stabilization

AHRS

TNF FOG based miniature attitude, heading and reference system (AHRS) for Aircraft, Helicopters and UAVs.

NAVIGATION SYSTEMS

INS for Aerial and Land Tactical Vehicles



RADA Electronic Industries LTD.

P.O.Box 8606
7 Giborei Israel Blvd.,
Netanya 4250407, Israel
Tel: 972-9-892-1111
Fax: 972-9-885-5885
E-mail: mrkt@rada.com
Web Site: www.rada.com



RADA Electronic Industries Ltd. is offering a broad range of advanced – yet affordable - Inertial Navigation Systems, designed for Aerial and Land Tactical Vehicles. RADA's navigation solutions introduce sophisticated and unique sensor fusion algorithms, and embed modular design principles leading to minimal integration efforts into larger mission systems. The compact, reliable and affordable INS are applicable to manned and unmanned platforms, and to expendable applications. Among RADA's customers are air forces and prime integrators worldwide.

RADA's families of navigation solutions are the following:



The FOG Family:

A high precision, tactical-grade, Embedded GPS-INS (EGI) solutions, applicable for aircraft, helicopters and ground combat vehicles. The EGI is based on modern, precise and reliable Fiber-Optical Gyro (FOG) sensors.



The MEMS Family:

An extremely compact, highly reliable and affordable Inertial Navigation System (INS), embedding inertial MEMS sensors, 16-channel GPS, air pressure sensors and 3-axis magnetometer, providing multi-sensor aided navigation solution.



The Inertial Measurement Unit (IMU) Family:

FOG-Based, state-of-the-art, IMU and AHRS solutions.

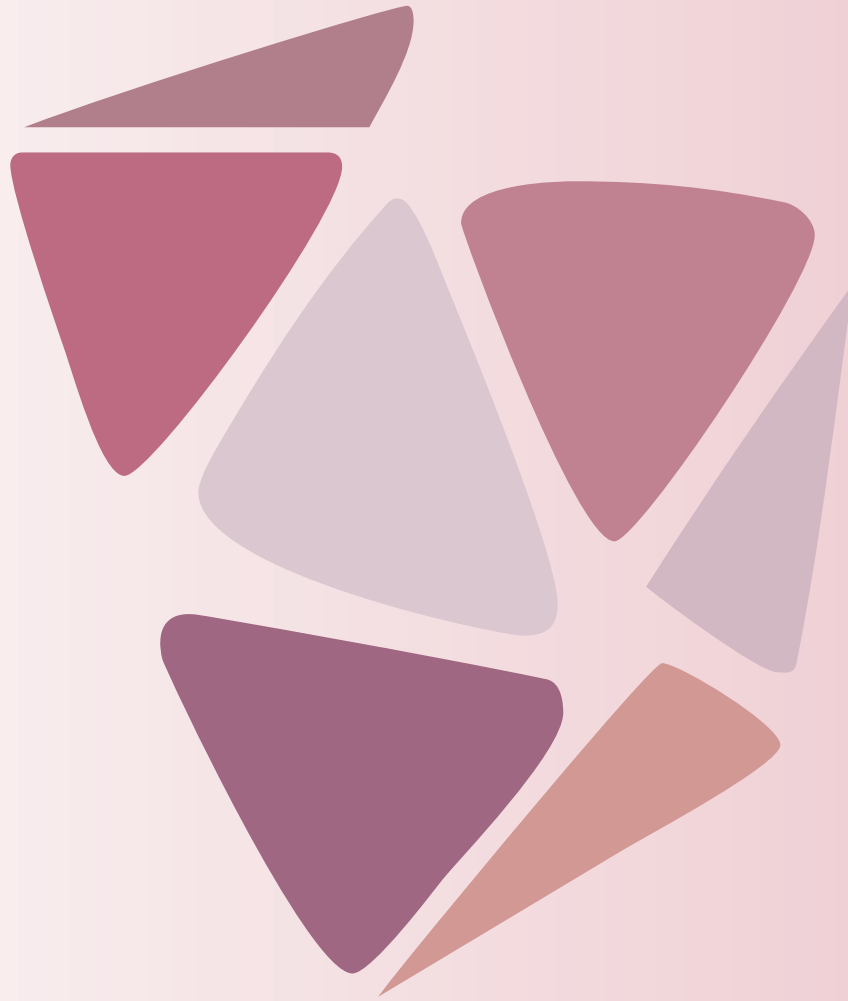

MILITARY INVENTORY

Israel's defense forces are maintained at a constant state of high readiness to meet the challenges presented by any threat. Maintaining such readiness levels requires all weapon systems to undergo modernization and upgrading in order to prolong their lifespan. High readiness levels are also maintained by stocking large quantities of spare parts, which are necessary to retain the adequate logistic levels required to support combat systems in times of war.

When newer systems replace older ones that may still be valuable for other users, such systems are offered as military inventory. In recent years Israel's military has phased earlier generation of weapons systems, releasing relatively advanced aircraft, helicopters, main battle tanks and naval boats. Offered to friendly nations that seek to obtain modern, reliable, well-maintained military systems, excess inventory can meet customer requirements, affordably supported over long period.

These weapon systems and platforms are exportable with their logistical stocks including spares, maintenance and repair shops. All systems offered have been proven in operational use with the IDF. Most of the equipment has already been upgraded to perform in modern combat scenarios. Within the full package provided, equipment can be purchased at its present status, or upgraded to meet the customer's requirements.

A new field of activity offered by the Ministry of Defense and the Israel Air Force are training services. Among these services are simulations and training systems related to all generations of F-16 - from A/B, C/D, to the latest Block 50/52 versions and F-15 aircraft, UH-60 and CH-53 type helicopters. Training services are not limited to simulation - foreign air forces visiting Israel are offered with combat training, using instrumented ranges that also serve developmental testing of various weapon systems.

MILITARY EQUIPMENT SALES DIVISION

סיבט
SIBAT

SIBAT - Israel Ministry of Defense

International Defense Cooperation

Hakiryia, Tel Aviv 6473424, Israel

Tel: 972-3-6975754, 6977207

Fax: 972-3-6976724

E-mail: sibat_bic@mod.gov.il

Web Site: www.sibat.mod.gov.il

The **Military Equipment Sales Division** in SIBAT is in charge of marketing and sales of military systems and equipment that are either excess inventory, surplus or phased out.

We offer a Total Package approach:

- Equipment: Air Force, Navy and Land Forces
- Upgrading of systems
- Spare parts
- Logistic support (ILS)

The Division consists of six professional departments. The first is the Business Development department which is responsible for international marketing, new customers, business information and strategic issues. Two departments are corresponding to the military branches: Land, Air and Naval, Communications and Optronics. They specialize mainly in military equipment. The other two departments specialize in Dual Use equipment as detailed below.

The departments offer equipment in the following categories:

- Land -** Tanks, Armored vehicles, Trucks, Infantry weapons, ammunition and medical equipment.
- Air -** Aircraft, Airborne systems, Missiles, Radars, Armament and Ammunition.
- Naval -** Vessels, Weapon systems.
- Communication & Optronic -** Tank Driving Simulator, Tank Gunnery Training System, Armored Combat Vehicle Optics, Personal Optics, Night Vision Magnifiers, Radars, P.R.C. and V.R.C. Flight Simulators, Airborne Systems.
- Scrap -** Metallic (Ferrous and Non - Ferrous), Non - Metallic.
- Dual Use equipment -** Including engines, generators, hardware, tools, petrolume products, construction equipment, office equipment.
- Vehicles -** Variety of Vehicles.

The Division engages in a variety of sales forms including: itemized, negotiation of packages and of main platforms, long - term revolving contracts and Tenders.

For detailed information, Please refer to the Procedures and Regulations page.



PROCEDURES AND REGULATIONS

סיבית
SIBAT

SIBAT - Israel Ministry of Defense
International Defense Cooperation
Hakiryia, Tel Aviv 6473424, Israel
Tel: 972-3-6975754, 6977207
Fax: 972-3-6976724
E-mail: sibat_bic@mod.gov.il
Web Site: www.sibat.mod.gov.il

Purchases are executed in accordance with Israeli Ministry of Defense (IMOD) procedures and regulations.

Purchases are subject to the approval of an IMOD internal committee.

A major portion of the purchasable equipment is of non-Israeli origin. Hence, a relevant Re-Export License should be obtained by IMOD before any sale is finalized.

Buyers are required, from time to time and according to the nature and origin of the equipment, to submit to IMOD an original End Use / End User certificate, before sale is finalized.

Purchases are based on a signed contract between IMOD and the Buyer.

Purchasable equipment is usually offered "As is Where is" condition. Nevertheless, inspection visits are welcomed.

Purchases are 'Ex-Base' (INCOTERMS, 2000). Inland transportation and shipping are usually footed by the Buyer.

Purchases can be on the basis of an upgrade program.

Inquiries for items should be made by citing NSN or Part Numbers.

SIBAT's approach is discrete as pertains to security. It adheres to norms binding government employees and commercial confidentiality.

Information concerning the various purchasable items is valid as at the date of publication and is subject to changes.



ARMY EQUIPMENT FOR SALE

סיבט **SIBAT**

SIBAT - Israel Ministry of Defense
International Defense Cooperation
Land Sales Division
Hakiryia, Tel Aviv 6473424, Israel
Tel: 972-3-6975754, 6977207
Fax: 972-3-6976724
E-mail: sibat_bic@mod.gov.il
Web Site: www.sibat.mod.gov.il

SIBAT is proposing for sale
combat-proven
equipment and offers:

Combat Ready Tanks -
Phased Out
Upgrading - Active & Surplus
Total Package Approach:
Equipment
Logistic Support

Equipment includes:

Battle Tanks
(Western & Eastern origin)
Armored Vehicles
Infantry Weapons
Ammunition
Communication
Spare Parts

For additional information
please contact:

SIBAT

Land Sales Division

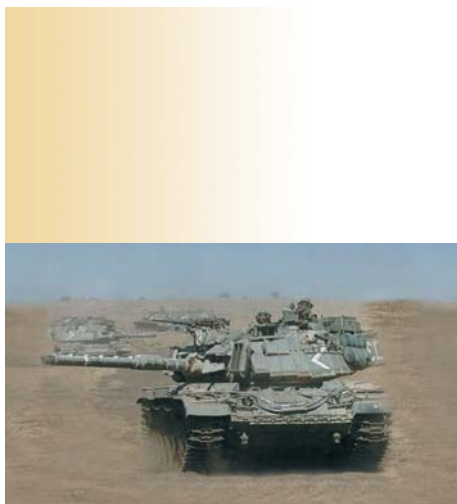

M60 A1/A3 Patton Battle Tank



Modified Centurion



M-48A3/A5



CENTURION BATTLE TANK

סיבט **SIBAT**

SIBAT - Israel Ministry of Defense
International Defense Cooperation
Land Sales Division
Hakirya, Tel Aviv 6473424, Israel
Tel: 972-3-6975754, 6977207
Fax: 972-3-6976724
E-mail: sibat_bic@mod.gov.il
Web Site: www.sibat.mod.gov.il

General Description

Made in -	Britain
Length -	7.55 m or 7.84 m
Height -	2.94 m
Width -	3.38 m
Ground Clearance -	0.42 m
Weight (Combat) -	53.5 ton

Technical Data

Powerplant -	V-12 , Air cooled
Model -	AVDS-1790-2AC (USA made improved by Israel)
Fuel capacity -	1190 liter
Transmission type -	CD-850-6A1
Electrical system -	24 VDC

Performance

Max speed -	50 kph
crusing range -	500 km

Armament

Main gun	105 mm
----------	--------

Ammunition

105 mm -	71
7.62 mm -	7500

Systems

Fire control
Instant smoke
Personal gas protection



M48A3/A5 PATTON BATTLE TANK

סיבט
SIBAT

SIBAT - Israel Ministry of Defense
International Defense Cooperation
Land Sales Division
Hakiryia, Tel Aviv 6473424, Israel
Tel: 972-3-6975754, 6977207
Fax: 972-3-6976724
E-mail: sibat_bic@mod.gov.il
Web Site: www.sibat.mod.gov.il

General Description

Made in - USA
Length - 8.25 m
Height - 3.29 m
Width - 3.63 m
Ground Clearance - 0.42 m
Weight - 54 ton

Performance

Max speed - 48 kph
Cruising range - 500 km
Ascending capability - 60%
Descending capability - 60%
Side slope - 30%
Ground pressure - 0.8 atm

Ammunition

105 mm - 59
7.62 mm - 7500

Technical Data

Powerplant - V-12, air cooled
Model - AVDS-1790-2C
Fuel capacity - 385 gal.
Transmission type - CD-850-6A1
Electrical system - 24 VDC

Armament

Main gun - 105 mm
Machine gun - 2 X 7.62 mm

Systems

Fire control
Instant smoke
Personal gas protection



M60A3

MAIN BATTLE TANK



SIBAT - Israel Ministry of Defense
International Defense Cooperation
Land Sales Division
 Hakiryia, Tel Aviv 6473424, Israel
 Tel: 972-3-6975754, 6977207
 Fax: 972-3-6976724
 E-mail: sibat_bic@mod.gov.il
 Web Site: www.sibat.mod.gov.il

DATA	IDF M60A1	IDF M60A3
General Description		
Combat-Ready Weight (metric ton)	52.5	53
Length (m)	9.44	9.44
Height (m)	3.29	3.29
Width (m)	3.64	3.64
Fuel (liter)	1457	1457
No. of Crew Members	4	4
Armor	Add-on	Add-on

Development of the US built M-60 A3 Main Battle Tank began in the 1970s, with the first production units rolling off the assembly line at the Chrysler Factory (now General Dynamics Land Systems) in 1979. The M-60A3 entered operational service with the IDF in the early 1980s and underwent subsequent upgrading based on the vast experience, which it has accumulated in armored warfare. The upgraded IDF M-60 A3 features an improved fire control system as well as increased armor protection. Moreover, the loader/radio man has been provided with both a mortar and machine gun for enhanced defensive capabilities against infantry tank killing teams.



AIR FORCE EQUIPMENT FOR SALE

סיבט SIBAT

SIBAT - Israel Ministry of Defense
International Defense Cooperation
Air Sales Division
Hakiryia, Tel Aviv 6473424, Israel
Tel: 972-3-6975754, 6977207
Fax: 972-3-6976724
E-mail: sibat_bic@mod.gov.il
Web Site: www.sibat.mod.gov.il



A-4 SKYHAWK

The Israel Air Force is releasing from its active inventory combat-proven equipment and offers:

**Total Package Approach:
Equipment
Logistic Support**

Equipment includes:

- Aircrafts
- Airborne Systems
- Armament / Ammunition
- Missiles
- Radar Systems
- AA Defence Systems
- Spare Parts



KFIR

**For additional information
please contact:**

SIBAT

Air Sales Division



F-16 FIGHTING FALCON



MD-500 DEFENDER



C-130 HERCULES



AH-1 COBRA

A-4 SKYHAWK

KFIR

סיבט
SIBAT

SIBAT - Israel Ministry of Defense
International Defense Cooperation
Air Sales Division
Hakiryia, Tel Aviv 6473424, Israel
Tel: 972-3-6975754, 6977207
Fax: 972-3-6976724
E-mail: sibat_bic@mod.gov.il
Web Site: www.sibat.mod.gov.il

A-4 SKYHAWK

The Douglas A-4 Skyhawk is a carrier-capable ground-attack delta winged, single turbo-jet aircraft.

This delta winged designed aircraft combines speed and maneuverability with a large fuel capacity and small overall size, thus not requiring folding wings, albeit at the expense of cruising efficiency.

The Skyhawk played an integral role in Israel's successes in the Yom Kippur War and is currently in use by the IAF for both advanced combat training and operational missions.



A-4 Skyhawk (Ayit)	
Platforms for Sale	44
Engine Type	J-52
Engines for Sale (in addition to those installed on platform)	16

KFIR

The Israel Aerospace Industries Kfir is an all-weather, multi-role combat aircraft with Israeli avionics and an Israeli-made version of the GE J79 turbojet engine.

The Kfir has outstanding agility, high instantaneous and sustained turn rates, and excellent low speed flight characteristics. It's ruggedness and dependability make the Kfir a tough opponent in the air-to-air combat arena.

The aircraft has been warmly integrated into several air forces around the globe.

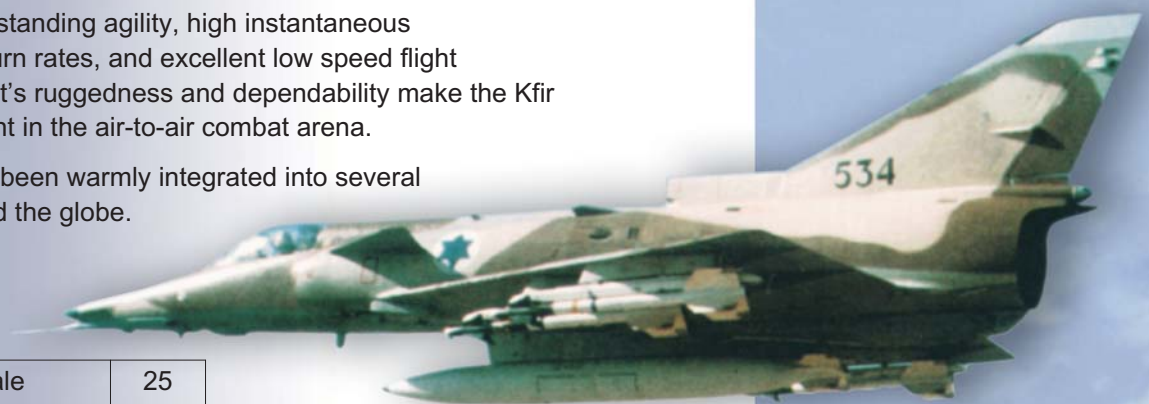

Platforms for Sale	25
Engine Type	J-79

TZUKIT



SIBAT - Israel Ministry of Defense
International Defense Cooperation
Air Sales Division
Hakiryia, Tel Aviv 6473424, Israel
Tel: 972-3-6975754, 6977207
Fax: 972-3-6976724
E-mail: sibat_bic@mod.gov.il
Web Site: www.sibat.mod.gov.il

The Tzukit was the standard trainer of the IAF from 1980-2010. It is a fully modified version of the CM-170 Fouga Magister, upgraded for maximum flight and maintenance efficiency.

The Tzukit has a single mid-wing, two cockpits in tandem, three-point landing gear, V-shaped tail assembly and carrier its engines in the wing roots.

This aircraft can be used for primary, basic and advanced training and can also be used for light bombing and ground support missions. Also, the Fouga is cherished as a recreational aircraft and may be sold as such.

Fouga Magister (Tzukit)	
Platforms for Sale	25
Engine Type	Marbore VI



C-130 HERCULES



SIBAT - Israel Ministry of Defense
International Defense Cooperation
Air Sales Division
Hakiryia, Tel Aviv 6473424, Israel
Tel: 972-3-6975754, 6977207
Fax: 972-3-6976724
E-mail: sibat_bic@mod.gov.il
Web Site: www.sibat.mod.gov.il

The Lockheed C-130 Hercules is a four-engine turboprop military transport aircraft designed and built by Lockheed Martin. Capable of using unprepared runways for takeoffs and landings, the C-130 is one of the world's primary troop, medical evacuation, and cargo transport aircraft.

Two of the aircrafts for sale were retired in 2005, and the third in 2009.

Still in use in Israel, in addition to the platforms for sale, the IAF offers engines and spare parts for sale as well.

C-130 Hercules (Karnaf)	
Platforms for Sale	3
Engine Type	T-56

Platforms for Sale	3
Engine Type	T-56



F-16 FIGHTING FALCON

סיב"ט SIBAT

SIBAT - Israel Ministry of Defense
International Defense Cooperation
Air Sales Division
Hakiryia, Tel Aviv 6473424, Israel
Tel: 972-3-6975754, 6977207
Fax: 972-3-6976724
E-mail: sibat_bic@mod.gov.il
Web Site: www.sibat.mod.gov.il

With over 20 years of service in the IAF, the F-16 A/B Netz is a light multi-role fighter jet. The Fighting Falcon is a dogfighter with numerous features including a frameless bubble canopy for better visibility, side-mounted control to ease control while under high G-forces, and reclined seat to reduce the effect of G-forces on the pilot.

In the IAF, this aircraft has been used for a wide range of tasks and is especially recommended as an aggressor force.

F-16 Fighting Falcon (Netz)	
Platforms for Sale	18
Engine Type	F-100



AIR DEFENSE SYSTEMS

סיב"ט
SIBAT

SIBAT - Israel Ministry of Defense

International Defense Cooperation

Air Sales Division

Hakiryia, Tel Aviv 6473424, Israel

Tel: 972-3-6975754, 6977207

Fax: 972-3-6976724

E-mail: sibat_bic@mod.gov.il

Web Site: www.sibat.mod.gov.il

PAR - portable pulse acquisition radar, with high detection capabilities.

Operational as a stand-alone system or part of the Hawk missiles battery.

L-70 Cannon - 40mm anti - aircraft cannon. Can be installed on diverse military vehicles.

M-163-A1 - lightweight mobile 20mm 6-barrel cannon, effective defense against low - flying aircraft and ground targets.



SIMULATION TRAINING SERVICES

The Israel Air Force (IAF) offers international air forces a full range of courses and training services on a broad spectrum of simulators. IAF training packages and services are customized to meet individual air force demands, and provide an extremely cost-effective method for preparing pilots and aircrews with optimum pre-mission preparedness. The following is a brief description of the proven performance simulators that are available:

F-16A Simulator (Manufacturer: Link/1987) "NETZ"

Trainer, simulating the fighter's systems, flight profiles, failures and malfunctions.

F-16 A Simulator (NEW!! Manufacturer: Elbit Systems/Projected Operation: 2006) "NETZ"

Trainer, simulating the fighter's systems, flight profiles, failures and malfunctions.

Functions and Features

- Configuration and aerodynamic database: F-16A/Block 15, after falcon-up and special Israeli-made improvements
- 150° x 60° FoV (Field of View) finite display system on a partial dome
- Display system based on 3-channel TILTAN PCIG
- Aircraft Common: full avionics, flight instruments, cockpit panels, stick, throttle, pedals
- Full systems training for advanced, complex air-to-air and air-to-ground mission scenarios/ all aircraft malfunctions are simulated.
- Advanced after action review station

F-16C Simulator (Manufacturer: Link/1987) "BARAK"

Quality trainer, simulating the fighter's flight profiles, failures, malfunctions, and equipment. Veteran trainer, upgraded to conform to high quality performance.

F-16I Simulator (Manufacturer: Lockheed martin) "SUFA"

Quality trainer, simulating the fighter's flight profiles, failures, malfunctions, and equipment.

F-15 Simulator (NEW!! Manufacturer: Lockheed Martin/2002) "BAZ/RAAM"

The most advanced trainer for F-15AUP and F-15I fighters, simulating flight profiles, emergency situations, failures and malfunctions, instrumentation flights.

A-4 Skyhawk Simulator (Manufacturer: Link/1970s) "AYIT"

Trainers, simulating aircraft failures and malfunctions, emergency situations, flight profiles and instrumentation flights. Three simulators are available: two for the A-4 Skyhawk N; one for the A-4 Skyhawk T.



Blackhawk/ CH-53 "YASSUR" Simulator (NEW!! Manufacturer: CAE/2003)

Cutting edge trainer, among the most advanced of its kind, for Blackhawk 3 (UH60) and Sikorsky 2000 (CH53) helicopters, simulating flight profiles, malfunctions, equipment, and providing unique pre-mission preparedness training - including training for mid-air refueling, landings in dust and Collaboration with naval vessels, payload hoists, low altitude flights.

Searcher 2 UAV Simulator

Exceptional capabilities for comprehensive training: flight, deciphering, payload and communications systems operations. The simulator comprises the instructor's portable PC which runs the UAV simulation and includes the user interface, control module (the application that activates the simulator's scenario components), connection to the ground control station, in addition to a fixed display computer (PC) which runs the display application.

The simulator enables control of the UAV's location, atmospheric conditions, and inputting of malfunctions/faults. The special target control module allows real-time control of the target location.

EOT Electro-Optical Trainer

Dedicated simulator provides electro-optical weapon operators with operational skills by presenting them with real battlefield conditions, enabling mission rehearsals for operations in enemy territory.

Unique Cognitive Stress Inoculation Training - Empowering Combat Forces, tailored to the specific needs and resources of the target population. Commanders run the program, aided by psychologists.

instilled and take root, and achievements are generalized beyond a specific situation.

Advantages:

- Helps soldiers deal with stress of war
- Sharpens performance/overcomes negative consequences
- Stress inoculation training can be also applied to work related stress of military personal during peace time



HELICOPTERS

סיב"ט
SIBAT

SIBAT - Israel Ministry of Defense
International Defense Cooperation
Air Sales Division
Hakiryia, Tel Aviv 6473424, Israel
Tel: 972-3-6975754, 6977207
Fax: 972-3-6976724
E-mail: sibat_bic@mod.gov.il
Web Site: www.sibat.mod.gov.il

AH - 1 Cobra

The Bell AH-1 Cobra is a two-bladed, single engine attack helicopter manufactured by Bell Helicopter. Capable of special day and night flight and highly effective in joint operations with land forces.

This helicopter was the backbone of the IAF's combat helicopter forces.

For countries interested in integrating the AH-1 into their forces, it is possible to receive technological upgrades with a local Israeli industry as well as the purchase of engines, spare parts and ILS.

Platforms for Sale: 8

Engine Type: T-53

MD-500 Defender

This light multi-role utility helicopter is currently operated in several countries around the globe.

It contributed to Israel's successes in conflicts during the 1970s and 1980s, until its retire in the 1990s.

Today, the IAF still has a large inventory of spare parts.

This helicopter is popular among customers interested in small, capable anti-armor helicopters and for police and emergency response units.

Platforms for Sale: 16

Engine Type: Allison 250 C20R



SPARE PARTS

סיבט **SIBAT**

SIBAT - Israel Ministry of Defense
International Defense Cooperation
Air Sales Division
Hakiryia, Tel Aviv 6473424, Israel
Tel: 972-3-6975754, 6977207
Fax: 972-3-6976724
E-mail: sibat_bic@mod.gov.il
Web Site: www.sibat.mod.gov.il

The IAF has over 350,000 part numbers for sale!

There are parts for platforms currently in use by the IAF as well as platforms no longer in use such as Bell 212, CH-53, F-4, F-15, F-16, C-130 and more!



BELL 212



F-15



C-130



CH-53 (Stallion)



F-16

COURSES



SIBAT - Israel Ministry of Defense
International Defense Cooperation
Air Sales Division
Hakiryia, Tel Aviv 6473424, Israel
Tel: 972-3-6975754, 6977207
Fax: 972-3-6976724
E-mail: sibat_bic@mod.gov.il
Web Site: www.sibat.mod.gov.il

The IAF offers a variety of training exercises and courses:

Flight (Combat, Helicopter, Transport) Courses

Search and Rescue Courses

Air Traffic Control and CGI Courses

Medical and Stress Inoculation Courses

Other Unique Courses Developed in the IAF

**The IAF can provide courses
in many subjects of interest.
Please contact us for
information on specific
training you would like to
receive.**

SERVICES



SIBAT - Israel Ministry of Defense
International Defense Cooperation
Air Sales Division
Hakiryia, Tel Aviv 6473424, Israel
Tel: 972-3-6975754, 6977207
Fax: 972-3-6976724
E-mail: sibat_bic@mod.gov.il
Web Site: www.sibat.mod.gov.il

MAINTENANCE & REFURBISHING

Diverse capabilities of maintenance and refurbishing aircraft, systems and armament (O - level & D - level).

MILITARY EXPERIMENTS & DATA PACKAGES

Different kinds of armaments (guided and nonguided bombs, rockets or missiles) air defense systems tests, airborne systems and ground systems (communications, radar, etc).

IAF laboratories service (chemical tests, enviromental tests, etc).nvolves full cooperation of the IAF - operational, technical & logistical.

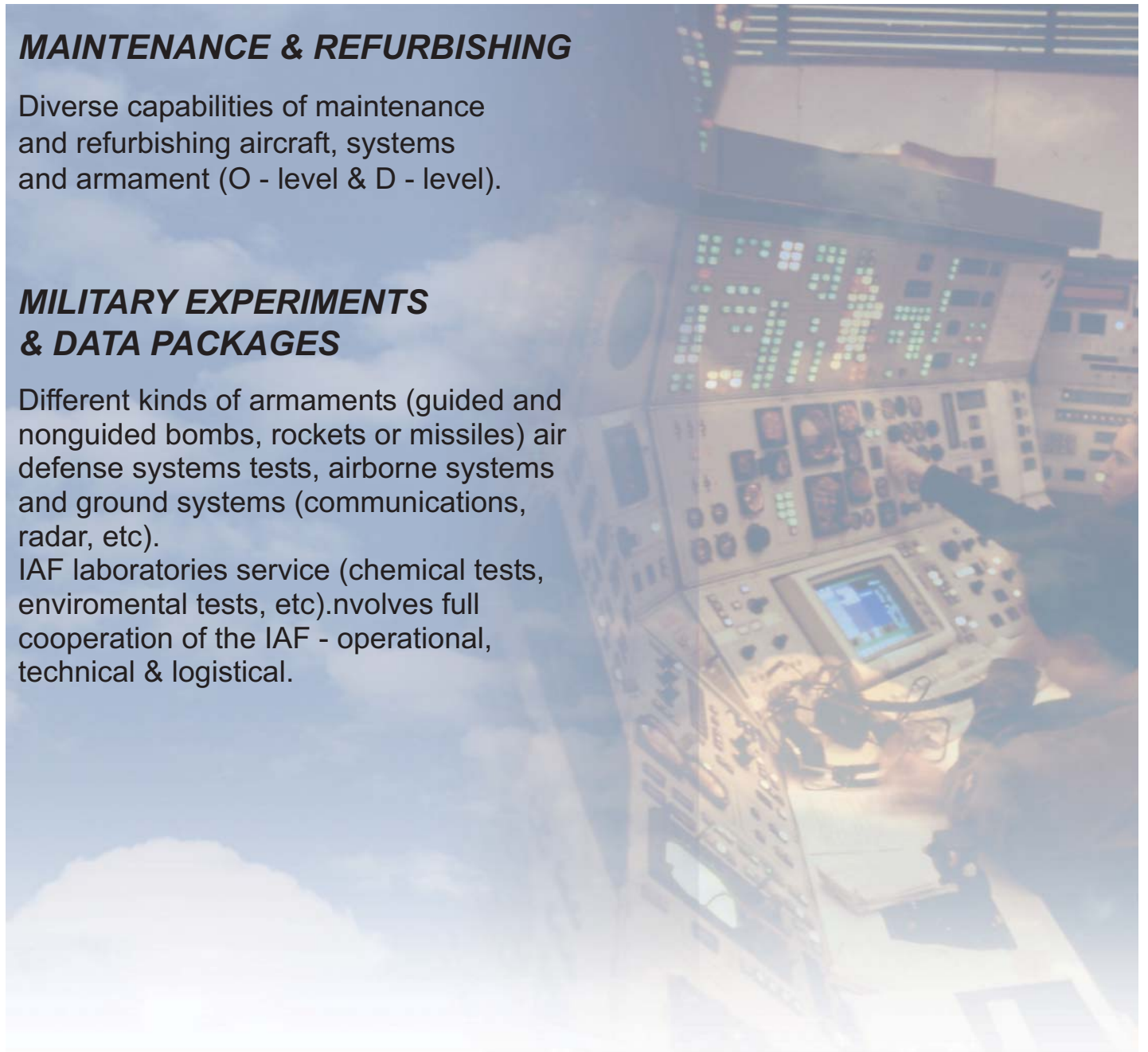

NAVAL EQUIPMENT FOR SALE

סיבט **SIBAT**

SIBAT - Israel Ministry of Defense
International Defense Cooperation
Naval Sales Division
Hakiryia, Tel Aviv 6473424, Israel
Tel: 972-3-6975754, 6977207
Fax: 972-3-6976724
E-mail: sibat_bic@mod.gov.il
Web Site: www.sibat.mod.gov.il

SIBAT is proposing for sale combat-proven vessels & naval equipment

Total Package Approach including:

- Vessels / Equipment
- Upgrading Options
- Weapon Systems
- Logistic Support
- Simulators
- Maintenance
- Spare Parts



SAAR 4 - Fast Gun Boat



KLEINE KLASSE

"SAAR 4"

FAST GUN BOAT



SIBAT - Israel Ministry of Defense
International Defense Cooperation
Naval Sales Division
Hakiryia, Tel Aviv 6473424, Israel
Tel: 972-3-6975754, 6977207
Fax: 972-3-6976724
E-mail: sibat_bic@mod.gov.il
Web Site: www.sibat.mod.gov.il

General Characteristics

- Developed and built by Israel Shipyards Ltd. Based on the extensive experience of the Israeli Navy.
- Proven operational use by the Israeli Navy.
- ILS support, maintenance and training.
- Long endurance at sea.
- Gabriel Mk II missiles
- Guns- optional
- ASW

Dimensions

- Overall length 58.1 m
- Maximum beam 7.62 m
- Mean draft (max. load) 2.80 m

Displacement

- Full load 445 t
- Standard 390 t

Speed

- Max. 33 kts
- Cruising 19 kts

Operational range

- At 19 kts 4800 n.m.
- At 30 kts 2200 n.m.
- Seakeeping Up to state 5

Detection and Navigation

- Surface/air search radar
- C&C system

Weapon Systems

Optional

Communication

Full range of HF, VHF, HVHF, UHF

Machinery

- 4 MTU 16v 538 TB91 engines-
- Max. power- 3380 hp (per engine)
- 4 propellers
- Fuel consumption- 154gr./hp.h

Anti-Submarine Warfare

VDS(optional)

Safety and Damage Control

- Fire detection and extinguishing systems and equipment
- Life saving equipment

Accommodation

- Provides separate quarters for Captain, officers and crew
- Air-conditioned

Born of necessity

Developed by experience



KLEIN KLASSE

סיבט
SIBAT

SIBAT - Israel Ministry of Defense
International Defense Cooperation
Naval Sales Division
Hakiryia, Tel Aviv 6473424, Israel
Tel: 972-3-6975754, 6977207
Fax: 972-3-6976724
E-mail: sibat_bic@mod.gov.il
Web Site: www.sibat.mod.gov.il

General Features

- Hull Material - Steel
- LBP - 34.6 m
- LOA - 38.55 m
- Breadth - 9.2 m
- Max. Displacement - 528.3 ton
- Max. Draft - 3.45 m
- FB - 3.1 m
- Max speed - 12.7 knots
- Range - about 1000 [M]
- Tanks Volume (full capacity):
 - Diesel Oil - 82,000 litter
 - Fresh water - 10,000 litter
- Crew capacity - 12-14
- Endurance at sea - 14 days

Engine

Master Engine-Deutz-MWM SBV
6M 628-A6 cylinder, straight engine
(890kW at 720 rpm)

The engine's cooling water are
chilled in a sea water "box cooler"-
similar concept to a keel cooler.



SCRAP AND GENERAL SURPLUS



SIBAT - Israel Ministry of Defense
International Defense Cooperation
General Equipment Division
Hakiryia, Tel Aviv 6473424, Israel
Tel: 972-3-6975754, 6977207
Fax: 972-3-6976724
E-mail: sibat_bic@mod.gov.il
Web Site: www.sibat.mod.gov.il

Metaalic scrap (Mostly Mixed)

Ferrous scrap

- Casted steel
- Casted iron
- Quality Hardened steel

Non - Ferrous scrap

- Aluminum
- Copper
- Brass
- Bronze
- Titanium
- Lead
- Light and heavy alloys (Tungsten)

Non - Metallic scrap (Mostly Separated)

- Rubber
- Textile
- Plastic
- Wood

Useable surplus

Cartridge cases (Brass)

- Electric Batteries
- Generators
- Rubber tubes
- Vehicles
- Construction equipment
- Plumbing equipment
- General equipment

Petroleum Products : Oil, lubricant, grease

- Communication equipment
- Computer and peripheral equipment
- Screws
- Metal ring, cylinders and clamps.
- Hardware and Tools (including Electrical)
- Plant and general machinery equipment (Lathes)
- Electrical wiring
- Textile & clothing (Tarpaulin)



CIVIL DEFENSE & CBRN PREPAREDNESS

With the growing risk of unconventional weapons proliferation, defense against Chemical, Biological and Radiological/Nuclear (CBRN) threats is becoming more acute. Israel has been facing threats of Weapons of Mass Destruction (WMD) for many years, and has established comprehensive means for the protection of its military and emergency units and the civilian population.

These defenses range from individual and collective protection systems for military vehicles, military installations and emergency evacuation and medical treatment facilities, to personal protection gear. Today, Israel maintains one of the worlds most advanced defenses against unconventional attack through CBRN weapons.

Advanced protection equipment produced by Israeli CBRN defense specialist companies includes individual protective systems for soldiers and CBRN defense specialists, and collective protection systems for vehicles, equipping combat vehicles of various types. Specialized CBRN protection is also provided for emergency services such as Medevac points and emergency rooms in hospitals.

Protecting operational facilities in a disaster zone or areas infected by CBRN or other Hazardous Materials (HAZMAT), complete collective ventilation and filtration systems are applied, to supply clean and fresh air to shelters, hospitals, schools, nurseries and kindergartens, retirement homes, command posts, tents and vehicles – allowing people to operate inside protected environments without gas masks or any other type of protective equipment.

In addition to the hardware and systems, local companies are able to provide consultancy, planning and training services to civil defense and homeland security establishments worldwide, based on the extensive experience gained by Israel's civil defense specialists.

More Civil Defense offerings from Israeli companies are available through the "Israel Homeland Defense Directory 2013-2014" also published by SIBAT.

SYS TECHNOLOGIES

life Saving Systems



SYS TECHNOLOGIES LTD.

12 Harei Efraim St.,
Or Akiva 3060000, Israel
Tel: 972-77-3012063
Fax: 972-77-3012064
E-mail: sales@systechnologies.biz
Web Site: www.systechnologies.biz

SYS Technologies Ltd. uses extensive field knowledge and experience, as well as cutting-edge production methods, to develop, produce and distribute breakthrough products in the field of clean air technology in order to provide medical teams with handy tools and improve the quality of medical treatment for patients and casualties.

The company employs teams of product developers, planners, and medical experts-and cooperates with Medical organizations around the globe - in order to meet the needs raised by the medical teams in the field. The necessity to perform lifesaving surgeries in non-sterile conditions, during crises/war situations, leads to -endangering the lives of casualties; post-surgery complications due to infections; extended recovery period and significant resources investment in post-surgery treatment.

Medi-T Clean Environment System is an Effective, Versatile and Simple solution for creating a clean treatment environment - anywhere, anytime, by anyone.

It is a high quality, mobile, fast deployed medical treatment unit, especially designed and developed, using extensive field experience, in order to provide optimal solution for the medical teams out there.

Medi-T Clean Environment System uses positive pressure technology in order to create an absolute clean and isolated environment - 26 HEPA filters evenly distribute clean air inside the Medi-T unit and the entire air volume within the unit is being replaced 70 times per hour.

Medi-T Clean Environment System complies with ISO class 6 according to ISO 14644, IES RP-CC006.2 and NEBB directions.

Medi-T Clean Environment System is suitable for a wide variety of medical applications, from lifesaving surgical procedures under field conditions, to mobile, handy solution in cases of emergency or disasters situations.

Medi-T Clean Environment System can be used in various modes of operation, according to the client specific needs:

- Outdoors or indoors
- Single or number of units (separate or combined together)
- Fast deployment or standby

Medi-T Clean Environment System is an "All In One" integrated solution:

- Packed in three, mobile, hand carried bags
- Easily transportable and storable
- Simple to install and operate
- Integral lightning system
- Integral air-conditioning system (optional)

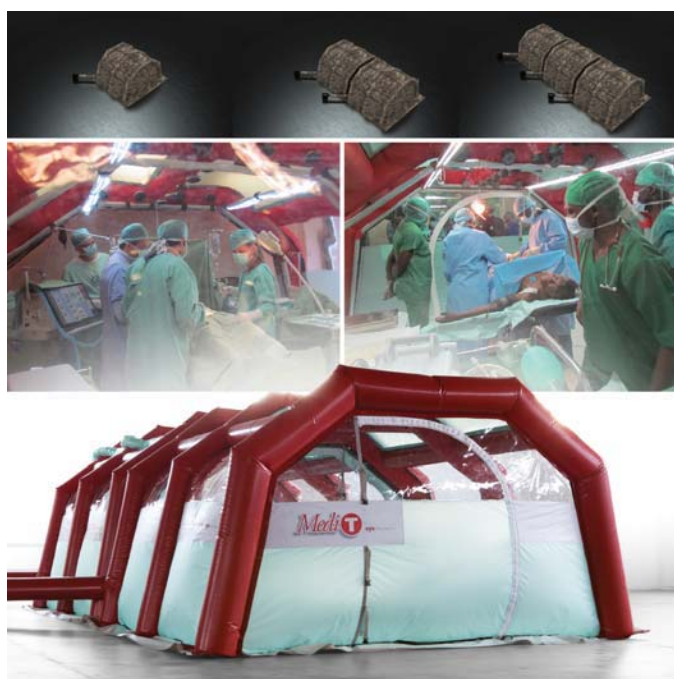

DEA R&D

Design & Human Engineering

Many years of activity, specializing in the R&D of life support have contributed to the development of skills and capabilities applicable to military, civilian and industrial protective equipment development.



DEA

Research and Development Ltd.

P.O.Box 34436

Jerusalem 9134302, Israel

Tel: 972-2-6540878/9

Fax: 972-2-6540885

E-mail: Dea_ltd@netvision.net.il

Web Site: www.dea-rd.com

CAPABILITIES AND SKILLS

Our capabilities are based on a blend of design disciplines in many fields: Human engineering Design, tooling, production and assembly, testing, and management of complex projects. The majority of projects are Turn Key Projects including feasibility studies, design of prototyping, testing and documentation.

DEA is carrying out industrial design and full scale engineering development.

DEA cooperates with research institutes in carrying out a variety of tests as part of feasibility studies and qualification tests.

HUMAN ENGINEERING

DEA is carrying out theoretical and applied studies in human engineering:

- Product design.
- Man - machine interface.
- Environments and working stations.



ENVIRONMENTAL PROTECTION SYSTEMS FOR VEHICLES, TENTS, MOBILE SHELTERS AND COMMAND POSTS

Ventilation, Dust Filtration, Air Conditioning, NBC-Protection, CO Filtration



Certified Quality Assurance Program According to AQAP-2110



Armoured Vehicles



Ventilation, NBC-Filtration, Toxic Shooting Fume Filtration, Air Conditioning



Container / Mobile Shelters



Ventilation, NBC-Filtration, Air Conditioning



Field Camps, Command Posts, Field Hospitals



Ventilation, NBC Filtration, Complete Turnkey Projects



Heavy Vehicles



Engine Air Cleaners



Bomb Shelters, Buildings, Critical Infrastructure



Ventilation, NBC-Filtration, Blast Protection



Protection for Vehicles and Rooms



Biological Protection / Isolation

Beth-El Industries is a world leader in the development, design, and manufacture of filtration, ventilation, air conditioning, integration of turnkey projects, and other technologies for custom implementation into bomb shelters, vehicles, containers, and tents. Founded in 1973, Beth-El has supplied tens-of-thousands of systems to more than 60 armies worldwide, which include most of the NATO states, most of the European countries, as well as a large number of forces in the Far East and North / South America.

In the civil sector, Beth-El has furnished an equally large number of bomb shelter protection systems for critical infrastructure and tens-of-thousands of homes in Israel and abroad. Along with NBC protection, Beth-El produces isolation systems for the medical field and specialized protection systems for fire brigades and other civil services. A few of the key features of the Beth-El systems include coarse and fine dust filtration, carbon monoxide extraction, CAN-bus control, simple interface with Beth-El air conditioning systems, and compliance to all important military standards, such as NATO AEP-54, MIL-PRF-321387, AC 225 (Panel VII) D/251, and German TL standards, amongst others.

Beth-El's extensive experience, within multiple interrelated fields, includes the supply of ventilation & NBC filtration systems to vehicle manufacturers in over 120 different vehicle types. These platforms include the Piranha, Duro, and Eagle vehicles of MOWAG GmbH, the Boxer, Dingo, Mungo, GFF4, and other vehicles of Krauss-Maffei Wegmann GmbH & Co. KG, the Yak and Wiesent vehicles of Rheinmetall Landsysteme, the Cobra vehicle of Otokar, the Zetros, Actos, Unimog, and G-Wagen vehicles of Daimler AG, the TEP 90 vehicle of Iveco, and the Multi vehicle of MAN, just to name a few.



**BETH-EL ZIKHRON YAAQOV
INDUSTRIES LTD.**

1 Avshalom Road, P.O.Box 166
Zikhron Yaaqov 3095101, Israel
Tel: +972-4-6299904/05
Fax: +972-4-6299900
E-mail: export@beind.com

Ventilation and NBC-Filtration Systems
for Tents and Army Camps



NBC-Filtration and Ventilation Systems
for Bomb Shelters and Civil Infrastructure



Engine Air Cleaners for Tanks
and Heavy Duty Vehicles



Mobile Medical Isolation Systems for Pandemic Protection,
Industrial Clean Rooms, and Mobile Surgical Centres



Ventilation, Air Conditioning, NBC-Filtration,
& Weapon's Fire Fume Filtration for Vehicles & Containers



THE HOME FOR HOMELAND SECURITY

Shalon Chemical Industry is internationally recognized as a leading company in the manufacture and design of personal and collective NBC protective equipment for military personnel and civilian population. The company's impressive achievements in respiratory protection is the result of applied state-of-the-art technology together with creative design and high quality. Shalon's quality management system is certified to ISO 9001: 2000. Laboratories and test equipment are certified by IMOD. Strong R&D department engaged in continuous improvement of existing products and design of innovative products in cooperation with the MOD.

MILITARY NBC PROTECTIVE GEAR

M15A1T NBC respirator

The IDF standard military mask. A modular design enabling mounting of the filter canister in front or on either side. Including drinking system, main and side voicemitters, and attachment for corrective lenses. Supplied in 3 sizes. NIOSH approved for riot-control.



Panoramic NBC protective mask



CETER First responder positive pressure NBC protective hood and blower system



Specially designed for NBC military units, riot-control personnel, first responders and medical assistance personnel. A modular design enabling mounting of the filter canister in front or on either side. A very wide panoramic field of vision. Including drinking system and attachment for corrective lenses. With a central voicemitter. One size fits all. Widely used by industrial and laboratory personnel. "CE" marked.

M15S80 NBC respirator for armored vehicle crew member

Includes all the features of the M15A1T as well as a built-in dynamic microphone with an external connector. Can be supplied with a corrugated rubber hose and adaptor for connection to the collective filtration system of the vehicle.



A positive-pressure hood system for protection in prolonged exposure to high concentration of NBC agents. Specially designed by Israeli MOD, for NBC military and police units, first responders and medical assistance personnel. A highly effective neck seal and blower unit, affords a high level of protection while ensuring comfort. One size fits all. Allows use of regular optical eyeglasses.



NEW!

**SHALON'S
NEW
GENERATION
OF
PERSONAL
FILTER
CANISTERS**



A wide range of filters providing effective protection in military, police, civil defense/ homeland security, emergency and industrial applications.

PA12 model: qualified by Israeli MOD for NBC civil protection.

CBRN model: for first responders, meeting NIOSH CBRN standards.

Tear gas model: for riot control.

Parallel pleated high-efficiency particulate filter (P100/P3). 40 mm thread compatible with most military & industrial masks. Robust, durable plastic body providing excellent mechanical & chemical protection. Low breathing resistance design that does not compromise filtration

ACBS Armored vehicle crew member positive pressure NBC protective hood and blower system



Designed by the Israeli MOD for armoured vehicle crew members, enabling performance of all required tasks on the modern battlefield in prolonged exposure to high concentration of NBC agents. Affording ease of operation and maximum compatibility with other personal safety equipment. Voicemitter and a built-in dynamic microphone system. Drinking system compatible with military canteen threads. One size fits all.

HOPER Helicopter pilot positive pressure NBC protective hood and blower system

Specially designed by the Israeli MOD. A highly effective neck seal and blower, affording a high level of protection, ease of operation and maximum compatibility with flight and personal safety equipment. Special holders for use in the cockpit. Providing at least 15 hours of uninterrupted operation. Voicemitter and a built-in dynamic microphone system. Drinking system compatible with military canteen threads. One size fits all.



Head Office: 2 Kaplan St., 10th Floor
Tel-Aviv 6473403, Israel
Tel: 972-3-6957191, Fax: 972-3-6957980
Plant: 35/2 Israel Pollak Rd.,
Kiryat-Gat 8202501, Israel
Tel: 972-8-6879111, Fax: 972-8-6811115
E-mail: shalon@shalon.co.il
Web Site: www.shalon.co.il

BL-90 NBC air supply unit



A compact and reliable air-supply unit that maintains positive pressure in military and civilian NBC protective hood systems and masks. Developed by the Israeli MOD, the blower draws filtered air from 2 standard personal NBC filters, and supplies up to 90 liter/min. Fits all types of personal filter canisters with a standard (40mm / 1/7") thread. Flat design, allowing access to narrow spaces. Special features for mounting the blower on a waist belt.

M80 NBC filter canister



A personal gas particulate filter which provides protection against all chemical and biological warfare agents and radioactive dust. It is manufactured according to IDF specifications and meets all the performance requirements for the US army C-2 canister.

THE HOME FOR HOMELAND SECURITY

Air permeable NBC protective suit / overall

Designed to enable specialized units to operate in NBC-contaminated environments, affording chemical and biological protection while reducing heat stress buildup and ensuring relative comfort and ease of operation. Suitable for use by NBC military and police units, first responders and medical assistance personnel. The overall is especially designed for armored vehicle crews. Flame Resistant. 4 sizes: S, M, L, XL. Detachable hood. Compatible with all Shalon's NBC protective masks and hoods.



CIVIL DEFENSE NBC PROTECTIVE GEAR



10A1 NBC Youth respirator

Like the 4A1 NBC Adult respirator. For the protection of youth aged 10 to 16 years.



RESPRO NBC protective hood for children



For the protection of children aged 3 to 8 years. Positive pressure inside the hood is assured by means of a blower unit with an operation time of 13-15 hours. A drinking system is included.

4A1 NBC Adult respirator

For the protection of civilian population. Including drinking system, voicemitter and peripheral sealing lip that assures high protection factor to the wearer.

INPRO NBC infant protector



Like the Respro, the Inpro is a positive pressure system, especially designed by the Israeli MOD for newborns up to 3 years old. The infant is conveniently placed and safely secured inside the hood. The Infant can be carried and fed through a built-in nipple system.

CAPS 2000 NBC Civilian Adult Protective System

CAPS is a new respiratory protection device developed by the Israeli MOD. A silicone neck dam around the neck, and a blower system provide high protection and comfort, regardless of donning skill. Can be worn by bearded men. Allows use of regular optical eyeglasses without interference.





CAHBS NBC Civilian Adult Hood & Blower System

CAHBS is a positive-pressure system designed for civil defense by the Israeli MOD. Two air-supply units makes it suitable for the elderly population and for persons with breathing difficulties. One size fits all. Allows use of regular optical eyeglasses without interference.



ATROMAT Automatic Injectors

A lightweight, compact and reliable injector for quick and painless intramuscular self-injection of atropine solution, or atropine solution with oxime. Supplied in 3 doses: 2.0 mg for adults, 1.0 mg for children and elderly, 0.5 mg for infants. Complies with IDF and US army specifications.



BL 45 Mini-blowers



Designed by the Israeli MOD, it fits a standard 40mm x 1/7" thread, for use with different types of personal filters. Suitable for use with different sources of energy.

COLLECTIVE NBC PROTECTIVE EQUIPMENT

For Shelters



Collective NBC filtration systems

A wide range of Collective NBC filtration systems designed and developed by Shalon, providing complete NBC protection to occupants of communal shelters. Meeting Israeli civil defense specifications. The complete purification system is comprised of: Pre-filter, Blast valve, NBC Gas-particulate filter, Fan unit, Flowmeter, Overpressure valve. 5 models available: FA-75 for up to 12 people, FA-150 for up to 25 people, FA-5 for up to 50 people, FA-10 for up to 100 people, FA-900 for up to 150 people.



Head Office: 2 Kaplan St., 10th Floor
Tel-Aviv 6473403, Israel
Tel: 972-3-6957191, Fax: 972-3-6957980
Plant: 35/2 Israel Pollak Rd.,
Kiryat-Gat 8202501, Israel
Tel: 972-8-6879111, Fax: 972-8-6811115
E-mail: shalon@shalon.co.il
Web Site: www.shalon.co.il

A compact and reliable air-supply unit maintaining positive pressure and connecting easily to all civilian NBC protective systems and masks.

For Armored Vehicles

ME4 Merkava tank NBC gas-particulate filter



Designed and developed by Shalon and the IDF. A robust and durable high capacity

filter (3000-5000 LPM). Constructed of stainless steel. Withstand extremely heavy vibrations with no distortion of its charcoal bed or any detrimental effects to its performance. Also suited for use in armoured cars, troop carriers, riot dispersal vehicles and mobile shelters.

M48 Gas-particulate filter for Abrams M1A1 tank

Designed by the US army. A compact, lightweight, radial flow filter (100 CFM). Constructed from aluminum alloy and coated with a special chemical resistant paint. Also suited for use in armoured cars, troop carriers, riot dispersal vehicles and mobile shelters.



SUPERGUM INDUSTRIES

Blower BL - 45

The BL-45, originally designed as part of the advanced protection system for children, supplies 45 liters of filtered air per minute, at an overall resistance of up to 35mm water, and operating on 3 volts of power.



NBC sampling kit

Includes inspection and sampling apparatus for the detection and identification of NBC contaminations.



BLOWER BL - 45 Type B

The BL-45 type b is multi purpose blower, designed to be integrated with all the civilian NBC protective respirators. Supplies 45 liters of filtered air per minute.



Blower - BL - 90

The BL-90 blower is designed as part of the group of advanced military protection. The blower is designed to supply 90 liters of air per minute at resistance of up to 65 mm water.



N.B.C RESPIRATORY PROTECTION

Supergum is Israel's leading manufacturer of protective clothing and protection systems for use by military personnel and the civilian population.

Supergum manufactures high quality rubber, plastic and sealing products for civilian, military and industrial applications. The company's R&D and engineering departments support a wide range of standard and custom-made rubber and plastic products for highly diverse markets.

Rubber technologies: injection molding, compression molding, extrusion and die cutting.

Plastic technologies: heat, H.F. and U.S. sealing, injection molding Certifies to ISO 9000 : 2008.

SUPERGUM

SUPERGUM INDUSTRIES LTD.

11 Shontzino St.,
Tel-Aviv 6721611, Israel
Tel: 972-3-5622333
Fax: 972-3-5622345
E-mail: giladg@supergum.co.il
Web Site: www.supergum.com

Children's protective hood



Suitable for infants from day 1 to children 10 years old. New design allows more flexibility, freedom of movement and enhanced wider field of view.

The hood provides a complete respiratory protection and is equipped with blower supplying clean air to the hood making it easy to breath. The blower maintains overpressure thus preventing entry of contaminated air.

Civilian Adult Hood

This system is intended for relevant civil defense and special military personnel who must function under CW conditions while performing a variety of missions.

C.A.H.-system including 2 blower (BL-45).



Adult protective hood for civilians

New concept in civilian respiratory NBC protection. The new design allows high degree of comfort with reliable protection.

The new visor enables clear and undistorted field of view. The hood is suitable for all facial structures for adults 10 years or older. The hood is equipped with a blower and a filter and a drinking device.

Supergum with a joint venture with ILC-Dover (USA) is the exclusive distributor for this product in North America and Europe.



Baby & Child-shield Clean-air Overpressure Module

Clean-air overpressure protection system for infants and toddlers ages 0 to 3 and 3 to 8.



Pet Protective Kit

The kit protects pets (dogs, cats and pet birds) against NBC hazards by enveloping a standard closed transport cage, creating a protected space around the pet.

The kit has been examined and approved by veterinarians.



SUPERGUM - N.B.C RESPIRATORY PROTECTION

Adult protective hood for military personnel



Based on the civilian hood with adaptation to military requirements providing high reliability in the field combined with superior NBC protection. The hood utilizes new design which provides great physical comfort and freedom of movement allowing long periods of wear. The hood is equipped with a dual filter and a blower and a drinking device.

Adult protective hood for combat soldiers



State of the art NBC protection for the combat soldier, hood includes dual filter system with a blower, communications equipment interface and external drinking system. The hood was developed to answer the most rigid battlefield conditions in terms of NBC protection.

Armored Vehicle Crew-member Blower System-ACBS

A fully integrated protective system allowing an armored vehicle crew member to perform all the required tasks on the modern battlefield (communication, use of Electrooptics and night vision devices). It is based on an under-the-helmet protective hood and blower unit.



Chemical Team Respirator - CETER



Soldiers in specialized CW units, - reconnaissance, Decontamination, bomb disposal and medical corps are exposed to high concentrations of chemical agents for long periods. These types of activities require a special system for eye and respiratory protection.

The system includes:

A nose cup integrated into the hood, providing a platform for the valves, speech membrane, communications and drinking devices, A neck seal serving as the required closure

A blower that provides air through two standard filters and supplies the hood with 90 liters of purified air per minute.

Disposable N.B.C. Protective Suit

The disposable N.B.C. Protective Suit is made of transparent multi-layered plastic and consists of a two piece (blouse and trousers) protective suit. The blouse has a cutout-contoured hood that fits any mask, and a quick fastener for easy closing.

The garment is light and permits freedom of movement. Combines to give excellent barrier properties and strength. The suit stamping and sealing process is done by specially designed equipment, ensuring dependability and based on many years of research and development.

SUPERGUM INDUSTRIES LTD.

11 Shontzino St.,
Tel-Aviv 6721611, Israel
Tel: 972-3-9365692
Fax: 972-3-9367742
E-mail: giladg@supergum.co.il
Web Site: www.supergum.com



NBC protective suit

Full body protective suit allows maximum NBC protection; the suit is easy to wear, flexible and low weight. The suit comes in 4 sizes to fit all.



Over-shoes Type 2

Allow NBC protection per MIL standard, comes in 8 sizes.



Supplement Kit

The kit is designed for individuals aged 13 years and above. The kit contains all clothing items and footwear necessary for maximum body protection from head to toe. The kit elements are modular and can also be purchased separately.

The Supplemental Kit elements are as follows: Protective Suit, Protective Overshoes and Protective Rubber Gloves.



SUPERGUM-N.B.C. Multi Purpose Over-Shoes

The multi purpose over-shoes have been designed by Supergum to meet the requirements and approval of the Israel Defence Forces. The over-shoes are made of PVC with minimum 1.3 thickness to provide the optimum Weight / protection ratio for the soldier.

The material ensures an almost unlimited storage shelf life. The over-shoes are available in 3 sizes (small, medium and large), with additional sizes available according to customers' specific requirements.



NBC DIVISION



HATEHOF LTD.

P.O.Box 639
Nazareth Elite 1710502, Israel
Tel: 972-4-6410641
Fax: 972-4-6418555
E-mail: hatehof@hatehof.co.il
Web Site: www.hatehof.co.il

YOUR FRONTLINE PROTECTION

Founded in 1947, Hatehof is among Israel's leading manufacturers of high quality, field proven NBC vehicles for Detection, Identification and Purification of NBC agents.

Hatehof specializes in providing tailor-made vehicles by use of:

- State-of-the-Art craftsmanship
- Protective levels (STANAG 1-5) against bullets – Upon client's request
- High performance automotive systems and power lines
- Complete range of In-House services: concept, design, QA, inspection, manufacture, assembly, professional literature & maintenance

Through housing both R&D department as well as production facilities, **Hatehof can provide the client a cost-effective Tailor-made solution.**

Our NBC Division products range from C/C Armored vehicle for Commanding team, NBC Armored Detection & Identification vehicle with automatic and/or manual detection systems through NBC Purification unit, to be mounted on truck upon necessity and a complete variety of accessories and clothing to receive a complete product, ready-to-use.

Hatehof Ltd is ISO 9001 and ISO14001 certified manufacturer of armored and designated vehicles. As such, we maintain a rigid quality-oriented process designed for after sales services supplied by Hatehof, among which are: Pre-delivery QA inspection and CoC, Three degrees maintenance service, Spare parts contract, provided literature and warranty.



C/C – NBC C/C Armored vehicle equipped to enable complete unconventional event management



Sniffer – NBC Reconnaissance Armored vehicle equipped to meet customer's demands for Detection & Identification of Hazardous NBC agents



Girit – NBC Decontamination Unit to be mounted on truck when needed, equipped with unique mixer device to perform thorough area decontamination



SERVICES

Spanning the entire spectrum of Israel's defense industrial activity, professional services complete a cycle that address all the phases of defense programs – from the definition of combat-based specifications, through research and development (R&D), engineering, production, subcontracting, in-process quality assurance (QA) to after-sale support, induction and training. Specific consultancy services may also require specific knowhow in software integration or integrated logistics (ILS) – all in accordance with specific, comprehensive customer requirements. Professional services constitute a substantial part of Israel's defense export, supporting foreign customers and companies in research, planning and proposal submission process, as well as setting multi-national cooperation initiatives.

A substantial percentage of Israel's professional consultants and trade companies are "graduates" from various branches of Israel's Defense Forces (IDF), the Ministry of Defense and industry, where they acquired first-hand knowledge of military disciplines, methodologies and specialized proficiency for their area of expertise.

Israeli consultants operating under SIBAT's supervision offer a full spectrum of solutions, specialties and expertise, ranging from the upgrading and modernization process of weapon systems, to concept planning and design of communications networks, aircraft protection systems or training security forces at airports and border crossings.

Israeli consultant experts are intimately familiarized with both Israeli and foreign made systems operated by the IDF and are therefore capable of offering objective recommendations on hardware utilization, based on extended field experience.

Labeled "made in Israel" is therefore not merely the source identification, but a token representing the quality and professionalism of the service provider

INTELLIGENCE SOLUTIONS



BIKS INTELLIGENCE SOLUTIONS

4 Hamaayan St., (Ligad center 2)
 Modi'in 7173001, Israel
 Tel: 972-722504212
 Fax: 972-8-9266413
 E-mail: biks@biks.info
 Web Site: www.biks.info



About Us

BIKS team includes top ranking intelligence and strategic planning experts. BIKS provide solutions and services in various aspects of the Intelligence cycle: data-collection, multi-discipline intelligence analysis, imagery exploitation, and strategic planning.

Main domains of practice:

- **Characterization and Implementation of advanced intelligence systems.**
- Providing tailored **ISTAR courses and training.**
- **Strategic consulting** services for decision makers level.

Intelligence

BIKS offers intelligence solutions for a wide array of military and civilian needs, suitable for national and joint levels. BIKS intelligence team is constantly developing and enhancing operational and intelligence concepts.



Systems and Applications

- End to end guidance to **intelligence systems development projects**: characterization, design, implementation and marketing phases.
- Specialization in **ORBAT, Military operations** and HLS missions.
- Designing **system architecture of C4i, ISR centers** and multi-source systems for **IMINT exploitation.**
- Years of experience derived from **collaboration with known Israeli defense companies.**



Training and guidance

- BIKS offers ISTAR courses, workshops and seminars in various intelligence subjects, tailored to the client's specific needs:
- Military intelligence.
 - Intelligence processes, Collection & Analysis.
 - Cyber warfare.

IMINT

Expertness in **Imagery collection & exploitation cycle.** Focusing on the development of new methods & concepts regarding:

- **Integration of multi-disciplinary collection assets** (EO, IR, SAR, VIDEO, GMTI, OMTI).
- Collection **assets management.**
- Multi-source **Imagery analysis and production** (satellite, aerial photography, UAV).

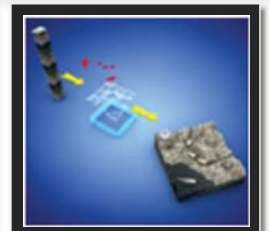

Strategic Intelligence Consulting

Implementing Strategic Planning Process

- **Preparation** of public and private companies and organizations to **future challenges.**
- **Building methodologies** for the analysis of **complex issues.**
- **Making a choice between different alternatives.** Mapping of considerations and feasibility study through scenarios.
- **Initiating of brainstorming teams and War-Games** intended to identify challenges, opportunities and options.

COUNTERING GLOBAL JIHAD'S WEAPONS OF CHOICE



DEMOMAN INTERNATIONAL LTD.
Security & Defense Solutions

P.O.Box 3896
Nazareth Illit 1752606, Israel
Tel: 972-50-5901655
Fax: 972-4-6561632
E-mail: info@demoman.co.il
Web Site: www.demoman.co.il
www.suicide-terrorism.com

IED's, VBIED's and Suicide bombers pose serious threats to your operation.

We will train you to prevent, detect and respond to these threats - and we keep it real.

WE OFFER:

BOMB SECURITY:

- Counter Suicide Terrorism training
Details: www.suicide-terrorism.com
- Bomb security, search, evaluation & first response
- Training in the bomb security field
- Explosives detection - X-Ray, Sniffers, K-9, E.T.K
- VBIED/Car Bomb countermeasures & Blast mitigation
- Strategy and training to deal with WMD's
- Mail bomb security
- Threat assessment

Who needs it ?

Air & Sea Ports, High Security Facilities, Law Enforcement Personnel, First Response Teams, Security Officers, Customs and Border Crossings, Executive Protection Teams and Special Forces.

EXPLOSIVE ORDNANCE DISPOSAL:

- Demilitarization - destruction of munitions and explosive waste
- Mobile Disassembly System - a unique cost-effective system which renders various munitions safe, by disassembling them to their primary components
- Special Units - forming new teams to deal with bomb disposal and other explosive devices
- Explosive Entry - tactical pyrotechnics & explosive breaching for Special Forces
- Mines & UXO Clearance - consulting, training and project management
- Supplies - full provision of body armor, professional equipment, and munitions training models

DEMOMAN provides customized services of training, consulting and project management. Our methods are focused on "Hands-On" training. Our E.O.D teams consist of Israeli bomb security experts, Explosive Ordnance Disposal officers and bomb disposal personnel, who are highly trained with extensive field experience from various government agencies.



Enabling You to Make the Most of Our Experience...

HIGHTECH LTD.

Hightech

HIGHTECH LTD.

P.O.Box 65184
Tel-Aviv 6949218, Israel
Tel: 972-3-6414306, 6418265
Fax: 972-3-6415930
E-mail: ronylr@hslrl.com
hightech@hslrl.com

***HIGHTECH WAS ESTABLISHED BY TOP-EXPERTS
IN THE FOLLOWING AREAS OF ACTIVITY:***

- ★ Consulting & planning of security program in airports, airlines, and high risk installations (military and civilian)
 - ★ Implementation and integration of security systems
- ★ D.A.T. - Defence anti-terrorism / special force & anti-terror training (by ex-commanders of special anti-terror units)
 - ★ Equipment for Special forces - Unique developments, which can be supplied only to selected customers
 - ★ Riot Control Vehicles - remotely controlled
 - ★ Explosive disposal & demolition - equipment & vehicles
 - ★ Supply of military and paramilitary equipment

TRAINING IS THE KEY TO SUCCESS



IMI ACADEMY for Advanced Security & Anti Terror Training

64 Bialik Blvd. P.O.Box 1044
Ramat Hasharon 4720525, Israel
Tel: 972-8-9357040/1
Fax: 972-8-9357042
E-mail: academy@imi-israel.com
Web Site: www.imi-academy.com

About IMI - Academy

The IMI Academy for Advanced Security & Anti-Terror Training is a leading integrated solutions provider for military, law enforcement, government agencies and commercial clients worldwide.

Established in 1999 by veterans of the Israeli Security Forces, the Academy specializes in a wide range of comprehensive security training programs, including anti-terrorism, anti-crime and homeland security. It is a subsidiary of Israel Military Industries Ltd. (IMI), a government owned company.

The Academy draws its strength from the accumulated knowledge of the Israeli security establishment. Its facilities, highly-experienced instructors and range of courses and seminars, have positioned the Academy as a model organization of its kind, one that its competitors attempt to emulate.

Fields of activity:

Security:

VIP, Aviation, Maritime, Installation, High-Risk Installation Security

Anti-Terror:

Combat & Firearm Training, KRAV-MAGA (Israeli martial arts), EOD, Operational Driving, Sniping, Rappelling, Rock-Climbing, Rescue, Fire Fighting, First Aid Courses, Operational Planning.

Police & Law Enforcement:

Police Readiness Response to mega-terrorist attacks, Comprehensive Disaster Response, Police Intelligence for combating crime, drugs, fraud and white collar crime, Border Crossing Security, Immigration Control, Crowd Dispersion and more.

Homeland Security:

Search and Rescue, Academic and Practical Homeland Security Training, Crisis Management and Emergency Response (human caused and natural disasters).

Special Projects & Consulting:

Information and Computer Security, Counter-Intelligence, Police Intelligence, Army Intelligence, Penitentiary Intelligence, Police force upgrading, turnkey security projects, Special Military Training, Sensitive Risk Assessment, Operational Studies, establishment of Special Operation Units, Recruitment Centers, Establishing Security Academies and other security solutions.

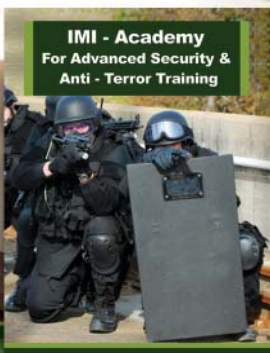

ISDS

HOMELAND SECURITY

INFRASTRUCTURE SECURITY



**INTERNATIONAL SECURITY
& DEFENCE SYSTEMS**

Tel: 972-8-9227699
Fax: 972-8-9235104
P.O.Box 173, Nir Zvi, 7290500, Israel
E-mail: isds@isds.co.il
Web Site: www.isds.co.il

ISDS specializes in Threat and Risk Analysis, Planning, Implementation, and Managing of large scale Homeland Security and Infrastructure Security projects.

ISDS' Homeland Security Solutions emphasize the prevention of threats, danger, and attacks. Our teams provide the knowledge, skills, technology and equipment needed to prepare and respond.

Common threats include:

Terror
Crime
Global Extremist Groups
Industrial Espionage
Employees or other individuals

ISDS' Homeland Security scope of solutions include:

- Emergency preparedness and response (for both terrorism and natural disasters).
- Domestic and International intelligence activities
- Critical infrastructure and perimeter protection
- Border Security
- Transportation security, including aviation and maritime transportation
- Advanced and efficient security technologies
- Cyber Security



ISDS – HLS Turnkey Solutions include:

- Concept of Operations (CONOPS)
- Basic and detailed engineering
- Systems and Installation Design
- Technology and Equipment
- Purchasing and Support
- Training of Security Forces, Teams, and Personnel
- Overall supervision on installation, testing, and commissioning

ISDS

HOMELAND SECURITY

INFRASTRUCTURE SECURITY



**INTERNATIONAL SECURITY
& DEFENCE SYSTEMS**

Tel: 972-8-9227699

Fax: 972-8-9235104

P.O.Box 173, Nir Zvi, 7290500, Israel

E-mail: isds@isds.co.il

Web Site: www.isds.co.il

ISDS has a long track record of protecting Critical Infrastructure and Key Assets. ISDS has been involved with security projects in the fields of Energy, Oil, Gas, Aviation, Mass Transportation and Communication.



Security for the Oil and Gas Industry

ISDS services all parts of the industry process: exploration, perforation, production, storage, communication, and transportation. ISDS secures pipelines, gas lines, and refineries.

The security projects involve:

1. Risk Analysis
2. Security Concept
3. Integral Security System
4. Human Factor: Personnel
5. Procedures
6. Technology
7. Implementation
8. Training and exercises
9. Supervision and maintenance

ISDS has experience providing security to clients in:

- Mexico: Energy Projects since 1991
- Brazil: Instruction, Studies and Analysis
- Chile: Oil and Mine Sector
- Peru: Oil and Mine Sector
- Bolivia: Oil and Gas Sector
- Argentina: Training Programs

Programs range from studies and training solutions to development and implementation of Integral Security Systems.

ISDS' experience in Airport Security include the following areas:

1. Personnel
2. Aircrafts
3. Infrastructure - Airport/Facilities
 - Includes Cargo and Baggage Security
 - Includes Perimeter Protection
4. Ground Security
5. Surveillance
6. Security Plans and Communications
 - Includes Command and Control and Communication Systems
 - Includes Emergency Response
 - Includes Procedures
7. Special Operations: Includes screening

ISDS MEGA EVENTS SECURITY



**INTERNATIONAL SECURITY
& DEFENCE SYSTEMS**

Tel: 972-8-9227699

Fax: 972-8-9235104

P.O.Box 173, Nir Zvi, 7290500, Israel

E-mail: isds@isds.co.il

Web Site: www.isds.co.il



Success in Mega Events Security is a result of proper planning, effective training, application of efficient methods and technology, as well as coordination of different entities and services, all functioning under a unified command. ISDS' Mega Events Security solutions combine and implement these factors for the best results.

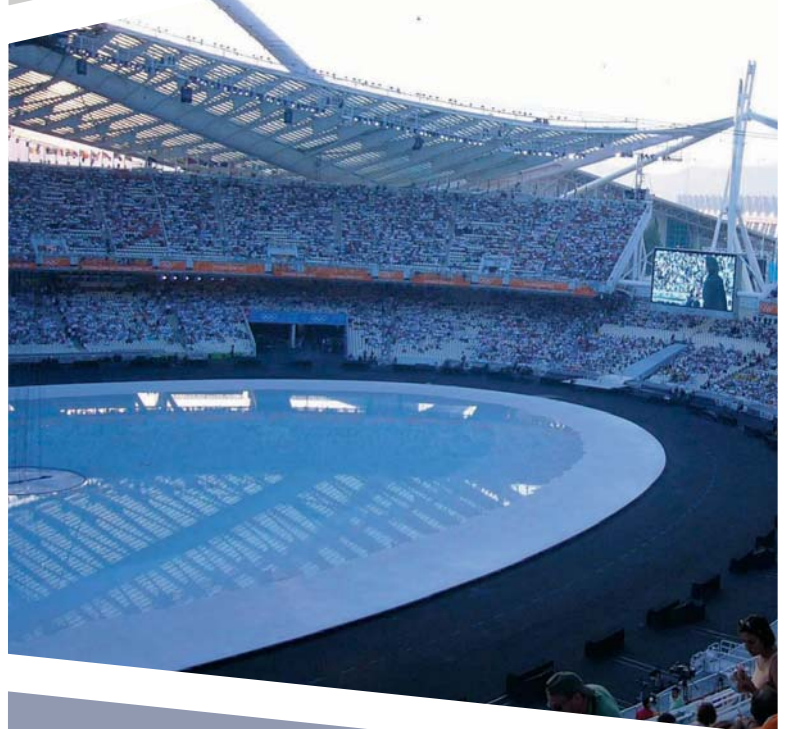

With experience in the development and implementation of security for several large sporting events, ISDS provides the expertise necessary for the security of large events.

ISDS specializes in Risk Analysis, Planning, and Implementation of Integral Security Systems for Mega Events.

ISDS MEGA EVENTS SECURITY



INTERNATIONAL SECURITY & DEFENCE SYSTEMS

Tel: 972-8-9227699

Fax: 972-8-9235104

P.O.Box 173, Nir Zvi, 7290500, Israel

E-mail: isds@isds.co.il

Web Site: www.isds.co.il

Mega Event Security involves decision making at the national level and games level.

Mega Event Security planning includes:

- Open Source Intelligence Report (OSINT)
- Threat Assessment Study (TAS)
- Security Risk Assessment (SRA)
- Tactical and Operational Security Planning
- Operational Readiness Targeted Training
- Risk, Crisis, and Contingency Preparation
- Systems, Technology and Equipment
- Command, Communication, Technology, Control, and Intelligence Center
- Security of Vital Facilities and Infrastructure supporting the Mega Event



ISDS covers sport events, conventions, and music events. ISDS' services include the security of VIPs, dignitaries, and delegations.

Special Services:

- Security Screening
- VIP and Expatriate Protection
- Evacuation plans and services
- Seminars and conferences



ISDS Experience:

- Mexico 1986 World Cup
- Italy 1990 World Cup
- RIO 2007 Pan American Games
- SOUTH AFRICA 2010 World Cup
- BARCELONA 1992 Olympic Games
- SYDNEY 2000 Olympic Games
- ATHENS 2004 Olympic Games
- BEIJING 2008 Olympic Games

ISDS

CIVIL AND CITIZEN SECURITY SMART AND SAFE CITY



**INTERNATIONAL SECURITY
& DEFENCE SYSTEMS**

Tel: 972-8-9227699
Fax: 972-8-9235104
P.O.Box 173, Nir Zvi, 7290500, Israel
E-mail: isds@isds.co.il
Web Site: www.isds.co.il

ISDS mission is to provide complete solutions to decision makers responsible for groups and citizens.

ISDS' solutions include many aspects of our security concept such as: personnel, top of the line technical and technological equipment, procedures for routine operation, training and instruction of professional personnel, exercises and simulations of dangerous events and operative procedures for times of emergency.

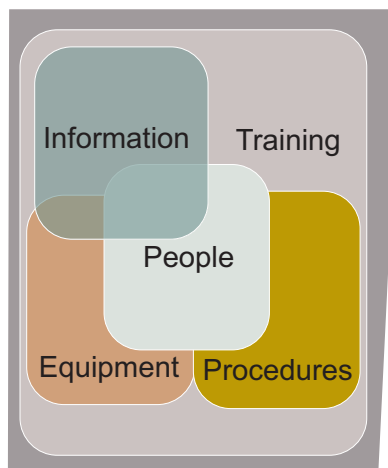

Command and Control is central to Safe City and Citizen Security. Command and Control is about the right leadership and decision making that is supported by Information and Technology.

ISDS provides the best methods and technology to achieve total integration of all systems and subsystems. ISDS provides information that enable our clients to make better and faster decisions.

ISDS' approach includes the following:

- Coordination and integration of all relevant agencies (police, fire department, ambulance service, municipalities, the judiciary, prison system, ministries of Health, Labor, Education)
- Creation of a central command and control center
- Modernization, training and exercising all emergency response organizations
- Emergency and Crisis management
- Organization of community activities and citizen educational programs

ISDS – C4I

Command and Control Center is central to Citizen, Civil, and City Security

The C4I provides

PUBLIC BENEFITS through:

- I. Security
- II. Technological Development
- III. Employment Opportunities
- IV. Public Image
- V. Public Confidence
- VI. Public Accessibility

ISDS' Safe City and Citizen's Security solutions and programs target a wide range of threats and risks such as:

- Terrorism
- Crime
- Public Disorder
- Natural Disasters
- Mass Transportation
- Accidents and more

ISDS

CIVIL AND CITIZEN SECURITY

SMART AND SAFE CITY



INTERNATIONAL SECURITY & DEFENCE SYSTEMS
 Tel: 972-8-9227699
 Fax: 972-8-9235104
 P.O.Box 173, Nir Zvi, 7290500, Israel
 E-mail: isds@isds.co.il
 Web Site: www.isds.co.il

Our Safe City approach relates to the complete process of an incident:

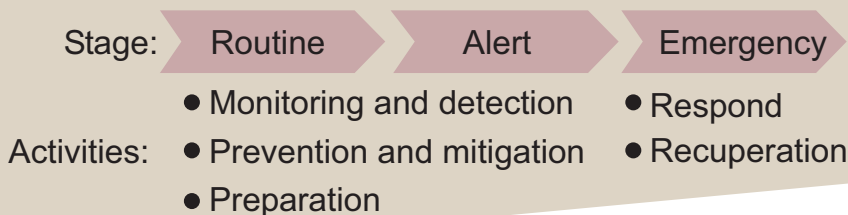

The international experience accumulated by ISDS in the field of "Safe City" Security includes projects around the world and is conducted as a general security concept that includes an analysis of the current security situation, preliminary survey, and threat and risk analysis with short and long term recommendations.

Our Experience:

- "Safe City"
- Mexico D.F. - Mexico
- Brasilia - Brazil
- Guayaquil - Ecuador
- Infrastructure installations
- Mega-Events
- More

Our work is also executed in high risk zones.

The objective of the ISDS Safe City concept is to achieve control of the security operation. Civil, Citizen, and City Safety requires the following goals and workflow:

- Prevention
 - Preparation
 - Response
 - Recovery
- ISDS has the experience and knowledge to achieve these goals.

ISDS has developed unique programs to improve civil defense against disasters and overall security in cities. These include:

- General Emergency Programs
- Urban Crime Prevention
- Development of Smart and Effective Command and Control Centers

ISDS' solutions provide:

A Comprehensive Security Plan that includes:

- Concept of Operations (ConOps)
- Manuals and procedures
- Crime prevention programs
- Crisis Management programs

Training and Education Programs for all levels:

- Crisis Management
- Training programs
- C4I2 management training programs
- C4I2 Operators training programs
- Community, Education and Participation Program Drills And exercises

Cutting Edge Systems, Methods, and Technology Implementation of Command and Control systems such as:

- CCTV surveillance cameras
- Vehicle plate number alarms
- Panic alarms
- GIS system
- TETRA communication system

ISDS TECHNOLOGY



**INTERNATIONAL SECURITY
& DEFENCE SYSTEMS**

Tel: 972-8-9227699

Fax: 972-8-9235104

P.O.Box 173, Nir Zvi, 7290500, Israel

E-mail: isds@isds.co.il

Web Site: www.isds.co.il

ISDS emphasizes the importance of innovative and specialized security technology.

ISDS has an established relation with a wide range of suppliers to provide effective access to **Cutting Edge** defense and homeland security technology.

Our goal is to deliver effective systems and equipment.



FORT1

FORT1

A fully equipped, totally secured, all terrain, command and control center combat vehicle.

ISDS is involved in the development and procurement of security technology developed to meet customers' needs and specifications.

ISDS works only with selected partners to provide the technology required to effectively deal with current and future security needs.

ISDS Security Technology Services include:

- Determination of required technology
- Equipment purchasing and bidding support
- Supervision of system installation
- System integration and testing
- System operation training

ISDS TECHNOLOGY



INTERNATIONAL SECURITY & DEFENCE SYSTEMS

Tel: 972-8-9227699

Fax: 972-8-9235104

P.O.Box 173, Nir Zvi, 7290500, Israel

E-mail: isds@isds.co.il

Web Site: www.isds.co.il



ISDS provides technology suitable for all areas of security operations

Ground Forces

Vehicles, Armor Protection, Explosive Ordnance Disposal and Mine Clearing
Personal Protective Gear, Small Arms,
Simulation and Training

Law Enforcement

Surveillance Systems, Riot Control, Armor Protection, Explosive Ordnance Disposal,
Special Anti-Terror Technologies, Small and Medium Weapons, Ammunition

Electronics

Electronic Warfare, Intelligence, Communications Systems and Equipment, Surveillance Products

Security

Perimeter Security, Access Control, CCTV Systems, C4I Centers, N.B.C. Protection, Emergency and Rescue, Scanners, Scanning and Observation Systems



Qylur

**Security Technology must answer the threat
Technology must be useful, friendly,
and innovative**

Qylur

The only self-service, multi-threat checkpoint system

Tailored to the needs of mass public venues

The ISDS Team provides the technology together with the skills and knowledge necessary to apply it effectively

ISDS TRAINING



INTERNATIONAL SECURITY & DEFENCE SYSTEMS

Tel: 972-8-9227699

Fax: 972-8-9235104

P.O.Box 173, Nir Zvi, 7290500, Israel

E-mail: isds@isds.co.il

Web Site: www.isds.co.il

Training is an essential part of an integrated security solution. The underlying concept of ISDS training is the human factor which is the key to success. ISDS training solutions enable participants to be ready to confront real-world situations.

ISDS invests time, effort and experienced professionals to develop effective training facilities and programs.

ISDS was involved in the development and implementation of the Force 1 assault team in Mumbai, India. The force was created in response to the 2008 Mumbai attacks.

All programs have guaranteed safety standards and utilize cutting edge technology and equipment.

Training involves:

- Training facilities
- Proven training knowledge
- Modern technology
- Instruction, evaluation and follow-up



ISDS TRAINING



INTERNATIONAL SECURITY & DEFENCE SYSTEMS

Tel: 972-8-9227699

Fax: 972-8-9235104

P.O.Box 173, Nir Zvi, 7290500, Israel

E-mail: isds@isds.co.il

Web Site: www.isds.co.il



ISDS training applies proven Israeli security knowledge and practice.

ISDS' Range of Programs:

- Operational programs
- Diploma programs
- Seminars and Conferences
- Special Events

ISDS offers training in:

- VIP protection
- Selection of Security Manpower
- Counter Terrorism
- Maritime Security
- Crisis Management
- Security Technology
- Operational Training
- Intelligence
- Tactical Medicine
- Bank Security Management
- Hotel Security
- Oil & Energy Security



ISDS MARITIME SECURITY



INTERNATIONAL SECURITY & DEFENCE SYSTEMS

Tel: 972-8-9227699
Fax: 972-8-9235104
P.O.Box 173, Nir Zvi, 7290500, Israel
E-mail: isds@isds.co.il
Web Site: www.isds.co.il

ISDS specializes in providing complete security solutions for ports, shipping companies, and refineries.

ISDS' Maritime offers a comprehensive range of services, including technological solutions, operations, experts training, anti-piracy, underwater security, cable laying protection, and investigation.

ISDS Maritime Security Team, Services, and Management are available 24/7/365.

ISDS provides Real Time Targeted solutions for real-time targeted given case.

ISDS Maritime has a proven record in several areas of security. ISDS is a Recognized Security Organization (RSO) and follows IMO's ISPS code and guidelines.

ISDS Maritime is committed to providing unmatched service and value to meet both customer requirements and government regulations. ISDS' Maritime Security Services include consulting, management, operation, logistics and training services in the maritime and hospitality industries.

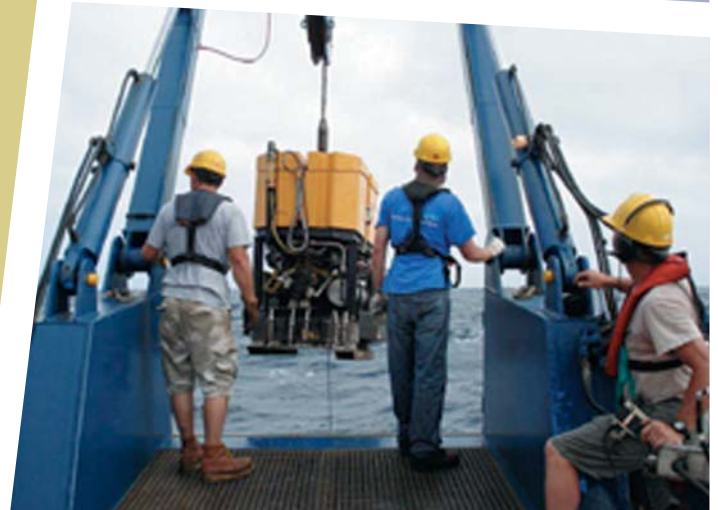

ISDS Maritime Services are offered in three main areas:

- I. Anti-Piracy and Maritime Protection
- II. Port Security and Integrated Systems
- III. Energy Security: On-Shore and Off-Shore Installations

ISDS provides services for transportation companies, cargo vessels, cruise ships, passenger ferries, off-shore oil rigs and service vessels, seaports and terminals, and others.

ISDS MARITIME SECURITY



INTERNATIONAL SECURITY & DEFENCE SYSTEMS

Tel: 972-8-9227699
Fax: 972-8-9235104
P.O.Box 173, Nir Zvi 7290500, Israel
E-mail: isds@isds.co.il
Web Site: www.isds.co.il

ISDS Maritime has an experienced, professional team with experience in securing vessels traveling in high risk areas.

ISDS' teams operate 24/7 anywhere on the globe. Teams can be deployed within 24-48 hours.

ISDS anti-piracy offers a range of personnel and equipment specially designed to ensure maximum security for vessels along with their cargo and manpower. ISDS' goal is to prevent unwanted hostile acts at sea and in port.



ISDS Maritime Security Services include:

- Armed Security Detachments
- Maritime Liaison Officer (MLO)
- Specially designed Ship Physical Perimeter
- Marine Vessels Detection System
- Non-lethal Anti-Piracy Weapons Systems
- Security Command and Control Centers
- Satellite Emergency Positioning System

TOTAL SOLUTION TO THE SHIPPING CLIENT

ISDS' armed security personnel will embark and disembark along a number of strategically chosen ports covering high-risk area routes.

Anti-Piracy Security Training

We offer a wide range of training courses and programs dealing with anti-piracy security in our training academies around the world.

Our courses include:

- Anti-piracy security training for guards
- Anti-piracy security training for vessel crew members
- Anti-piracy security management training for captains and shipping company officials

M.L.M. PROTECTION

Extending Beyond Technology



M.L.M. - PROTECTION

6 Ha'Choshlim St., 7th Floor
P.O.B 12590, Herzliya 4672406, Israel
Tel: 972-9-9574377
Fax: 972-9-9574370
E-mail: office@mlm-protection.com
Web Site: www.mlm-protection.com

ABOUT US - M.L.M. Protection:

M.L.M Protection develops and implements cutting-edge, customized security solutions for various sectors and environments, based on broad expertise and operational experience accumulated within the framework of the Israel General Security Service (Israeli Secret Service), where it's founders and members of its professional staff held senior positions, and subsequently, in civilian security projects carried out in many countries around the world. The company provides modular solutions ranging from specific, ad-hoc services to meet specific needs, to all-inclusive, turn-key security solutions and training programs.

CONSULTING

The unique RT™ Model to confront security problem designed by our company is based on continuous development and enhancement aimed at identifying and preempting future threats.

Our company provides Aviation Security, Public Transportation Security, Corporate Security, Securing Events, Securing Sensitive Facilities, VIP Security, Tactical Teams and Police Units.

TRAINING

Training programs developed by M.L.M. Protection's training department (TACT system™) are designed to maximize these qualities in order to ensure a continuous process of independent learning, development and growth. Our company provides training in these areas- Security Units (Aviation Security \ VIP and Delegation Security \ Facility Security), SWAT Teams, K-9 units, Intelligence Units, Security Professions (Security Screening, Security Searches and Bomb Sweeping, Security Dialogue), Combat (shooting and marshal arts), Operational Driving and Lectures and Seminars.

SECURITY PROVIDERS

M.L.M. Protection supplies world-class security solutions for the civilian market

Our team's professional level is unparalleled in the civilian market.

All members of M.L.M. Protection security staff were trained within the framework of the Israeli governmental security establishment.

All members of the VIP security staff have undergone additional, specialized training in the protection of dignitaries. Our company can provide these services - VIP Security \ Delegation Security \ Securing Events \ Supervision over Security Operations \ K-9 UNITS.

TECHNOLOGY & SECURITY EQUIPMENT

Based on its broad know-how and operational experience, M.L.M Protection defines the security equipment and state of the art technology required by various security units to effectively perform their functions in each specific area, such as VIP and executive security, facility security, SWAT teams, intelligence units, etc. The company supplies precise specifications and bills of quantities. If desired by the client, M.L.M Protections specialists can assist in negotiations with potential suppliers, and can also supply all required security equipment on a turn-key basis.



NIRTAL TRAINING AND SUPPLY OF COMBAT EQUIPMENT LTD.



NIRTAL TRAINING & SUPPLY OF COMBAT EQUIPMENT LTD.

4 Hahagana St.,
Or-Yehuda 6021204, Israel
Tel: 972-3-6341175
Fax: 972-3-6341176
E-mail: elad@nirtal.com
Web Site: www.nirtal.com

Founded in 1995, and staffed by experienced officers from the ranks of the Israeli Defense Force elite anti terror, and special-forces units; Nirtal is an international forerunner in the provision of security solutions. Covering all aspects of security, consulting, training services, and supplying advanced technology systems -all combining to provide comprehensive solutions, custom made for each individual client.



Nirtal's Main Expertise:

- Anti terror & Anti-crime operational training.
- Armed forces training: Special Forces & regular infantry units.
- V.I.P. & Executive Protection training.
- Supplier of various advanced technology systems, (interception, jamming, surveillance, ballistic protection, bomb disposal, explosive detection technologies et al). Security combat equipment. Spy & anti-spy equipment, investigation and detection equipment.
- Security consulting and training using most advanced techniques, technologies and combat experienced instructors.
- All aspects of Airport and Aviation, Seaport & Maritime Security.
- Petroleum & Natural gas pipeline infrastructure security.
- Security in the private sector - Banking, Public transportation, Public institutions.
- Surveillance and counter surveillance courses, training of police units for special assignments.
- Crowd control and event management.
- Prison enforcement, special units and technologies.
- "K-9"-Task Dog training: explosive and drug sniffing and guard dogs.

Nirtal's technology division provides the most advanced Israeli technological systems and leading world - wide security solutions and combat equipment.

Nirtal has been globally operational since 1995 operating in numerous countries & locations including : Georgia, Greece, Latvia, Kazakhstan, Bulgaria, Mexico, USA, Brazil, Nigeria, Tanzania, Kenya, Ethiopia, Honduras and more.



SILVER SHADOW® advanced security systems Ltd. is an Israeli company dedicated to the provision of specialized security systems. SILVER SHADOW® is a member of the Israel Export Institute (IEI), a certified firearms trader and an authorized supplier to the Israel Ministry of Defense and Israel Police. All of our services and products fully comply with the requirements of the ISO-9001:2000 quality assurance standard.

We are extensively involved in the design, development, manufacturing and distribution of various cutting-edge defense and security products and systems. Over the years, we have initiated and executed several equipment upgrading projects, involving mainly eastern-block firearms and weapon systems.

Since its establishment, SILVER SHADOW® has successfully performed hundreds of defense and security-related projects in Israel and around the world. This scope of activity has established us as one of the undisputed world leaders in this highly competitive field.

Our main activities & services are:
Security: VIP & personal; commercial airlines, airports, seaports & other installations; establishment & training of security organizations; specialized instruction/training courses for security personnel.

Military & defense: development of concepts & strategies; establishment & training of military organizations/units with special emphasis on counter-terrorism and anti-guerrilla warfare.

Police & law enforcement: planning, establishment & training of special police units, including border patrol units, SWAT teams & bomb squads.

Technical & specialized services: demolition, explosives & bomb disposal (personnel training, methods/procedures, specialized equipment); Command, Control & Communications, intelligence, reconnaissance & surveillance (concepts, methods/procedures & equipment); operational driving; operational first aid; firearms instruction; martial arts instruction.

A highly focused R&D division.
An experienced military equipment sales division.

All of the photographs in this brochure were taken in the course of our diversified activities around the globe.

TACTICAL TRAINING EQUIPMENT & SYSTEMS

FOR MILITARY & LAW ENFORCEMENT



SILVER SHADOW®

advanced security systems ltd.

3 Ma'ale Ha-Migdal St., P.O.Box 761
Or Yehuda 6025603, Israel
Tel: 972-3-6326666
Fax: 972-3-6326099
E-mail: silversh@silver-shadow.com
Web Site: www.silver-shadow.com

MAND & CONTROL

AND PERSONAL SECURITY

ELISHMENT & TRAINING

MILITARY TRAINING

COMMERCIAL AIR LINES

SKORNIK TAL LTD.

**TO BE THE BEST
TRAIN WITH THE BEST**



SKORNIK TAL LTD.

37 Arbel St.,
Kohav-Yair 4486400, Israel
Mobile: 972-57-7629393
Office: 972-54-4629393
Fax: 972-77-9112393
E-mail: skorniktal@gmail.com
info@clear-zone.org
Web Site: www.clear-zone.org

Skornik Tal Ltd. is a Worldwide Provider of Homeland Security, Security Consulting, Counter-terrorism, Operational Training Solutions and Marketing of Military Equipment.

Our main department is Clear-Zone that is operated by Tal Skornik

Clear-Zone was established on 1995 and is staffed with veterans of the Israeli military army and elite police units.

Clear-Zone specialists accumulated priceless knowledge and combat experience during their years in the line of duty.

Clear-Zone team members specialize in: Counter-Terrorism, Warfare, Intelligence, Special urban warfare, Crime fighting, Executive protection, Security consulting, Military training.

Clear-Zone is composed of three operating divisions: security consulting, combat training, and equipment provision.

These divisions collaborate with each other to provide a comprehensive solution for each client.

The company's consultation division is founded on the most advanced Security Techniques and Theories. Our equipment division has acquired and utilizes the most updated security technology.

Every project accepted initially goes through a threat assessment and risk analysis, to examine and determine every possible threat. Our security training projects are tailor-made to suit each individual client and designed to offer appropriate answers to the threats defined in our initial assessment. Whether the threat assessment relates to either LIC or HIC, our goal is to provide the optimum and most professional solution.

Our intelligence division is manned by experts fully updated in this field. This division specializes in agent recruitment and operating management of intelligence units, operation of anti-terror warfare, technological devices, operation of anti-terror software, and more.

As you well aware the Arab-Israeli conflict is a major case-study which provides the base of the considerable knowledge of our representatives who are among the leading experts in this field.

All projects are handled at the highest level of discretion and confidentiality.

Courses length - according to the customer demand

VIP protection in High Risk Zone

- Familiarize the I.D.F Anti-terror fighting concept
- Self-defense: I.D.F. krav-maga
- Improving weapons control with varies weapons: 9MM pistols, M-16, M-16 A4, Ak-47, HK K4&9MM Uzis
- Improving fighting skills in open Areas
- Improving fighting skills in urban warfare
- Improving driving skills
- VIP protection
- Sniper Training
- Shooting with night vision optics

Special Police and Army units

- Swat
- Special police unit's course
- Sniper training
- Special army unit's course

VIP Security Officer

- VIP protection
- Self-defense: I.D.F. "KRAV-MAGA"
- Convoy training
- Improving weapons control with varies weapons: 9MM pistols, M-16, M-16 A4, Ak-47, HK K4&9MM Uzis.

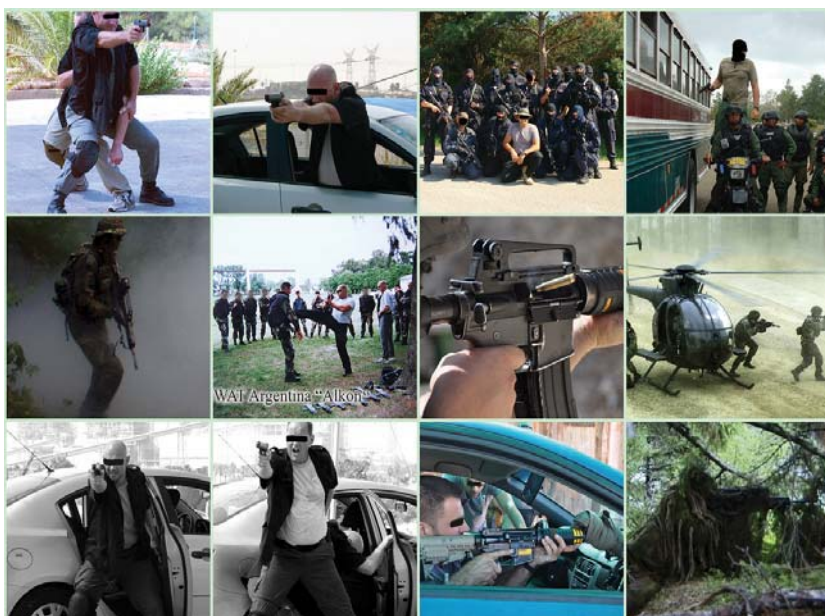

MILITARY AND SECURITY EQUIPMENT AND TRAINING

FOR GROUND FORCES, AIRFORCE,
NAVY, POLICE AND GENDARMERIE

**A.D.
CON LTD.**

A.D. CONSULTANTS GROUP

7 Golda Meir St.,
Science Park
Nes-Ziona 7403650, Israel
Tel: 972-8-9313600
Fax: 972-8-9404317
E-mail: adcon@adcon.co.il
Web Site: www.adcon.co.il



CASA CN235



MI-35



MI-17



C-130



ELAND



RM-70



IGLA-S



RADAR 36D6

Do you need to set up a project from beginning to end, including:

Consultancy, Supply, Delivery, Installation,
Training And Maintenance.

A.D. Consultants group has been dealing in military and security consultancy services as well as supplies of new and surplus equipment since 1987.

A.D. Consultants group specializes in:

- Security equipment and devices
- Upgrade of Air and Ground Sales and updates systems
- Training of pilots and technicians on various systems
- Ammunition, light and heavy arm
- Police/Gendarmerie equipment and system
- Communication – clear and cryptic
- Monitoring, direction finding and jamming of both HF and U/VHF

A.D. Consultants group is experienced in planning and controlling entire project or elements of it and provides high standards of services, professional solutions on “turnkey” basis.

Worldwide reputation for absolute discretion, highest quality standards and reliability are A.D. Consultants’ most important value.

Our worldwide network of agents and suppliers enable us to provide special deliveries either by sea or air, to all destinations.

MILITARY AND SECURITY EQUIPMENT



CONTACT INTERNATIONAL (KALIA) LTD.

P.O.Box 18434
Jerusalem 9118301, Israel
Tel: 972-2-5354565, 5354057
Fax: 972-2-5354566
E-mail: contintl@netvision.net.il

CONTACT INTERNATIONAL (KALIA) SPECIALIZING IN THE SUPPLY OF SURPLUS AND NEW MILITARY EQUIPMENT.

Established in 1979, CONTACT INTERNATIONAL (KALIA) is one of the leading suppliers of surplus and new manufacture military equipment in Israel, with an international reputation for service and reliability.

CONTACT INTERNATIONAL (KALIA) has the advantage of its own storage facilities and an expert staff qualified in refurbishing and processing ordnance and other equipment.

We can offer our customers quality products from our own inventory and from a variety of local and foreign sources.

Ground Forces

Arms and Ammunition,
Weapon Parts and Accessories,
Personal Equipment,
Combat Vehicles and Spare Parts,
Optics and Communications,
Riot Control and
Less Lethal Weapons

Air Force

Engines and Spare Parts,
Ground Support Equipment
And Ordnance

Navy

Vessels, Weapons and Ammunition

Rescue and Survival Equipment

Gas Masks,
Blankets,
Stretchers etc.



MILITARY & SECURITY EQUIPMENT

DEXORD LTD

DEXORD LTD.

P.O.Box 12702
Ashdod 7760049, Israel
Tel: 972-8-8681150
Fax: 972-8-8681169
E-mail: dxord_1@netvision.net.il

DEXORD LTD. is a leading supplier of new and surplus equipment, weapons and weapon systems, and security systems.

Internationally renowned for quality, reliability and discretion.

Our expertise is in reconditioning and upgrading of weapons and equipment.

We have our own storage and workshop, which ensure fast delivery and high quality control.

Our range of products covers:

Ground forces: arms and ammunition, spare parts and accessories, personal equipment, combat vehicles and parts, optics, night vision and communication equipment.

AIRFORCE: Airborne weapons, weapon systems and gunpacks, bomb racks, ammunition, weapon control systems, anti aircraft artillery.

NAVY: Vessels, Naval guns and weaponry, parts thereof.



EBONY ENTERPRISES LTD.

EBONY Enterprises Ltd. is a company with 20 years of experience in providing total defense solutions to several countries in **Africa, Europe, North America, South America and Far East.**

We are involved in several fields of activities: Defense, HLS and Critical Assets, Acquisition Banking Investment, Infrastructure Roads Construction, Telecomm, IT, Energy, Oil and Gas, HR Development, Turn-Key Medical Projects, Environmental and Water Solutions, Agriculture, Waste Management.

DUE TO OUR ACTIVE FOOHOLD IN THESE SPHERES AND FAMILIARITY WITH INTERNATIONAL MARKETS, EBONY IS ALSO ABLE TO MAXIMIZE UTILIZATION OF ECONOMIC CONDITIONS CREATED BY AGREEMENTS BETWEEN THE COUNTRIES IN WHICH IT OPERATES.

Ebony Enterprises Ltd. team includes top experts with demonstrated ability to vie for, and capitalize on opportunities. Furthermore, our professional personnel are immersed in the local markets and are often the first to espy and hence profit from the most lucrative business opportunities. Our unique asset is our Intellectual Capital, recruited to analyze the customers' needs, to design turn-key projects, including Knowledge Transfer and Capacity Building together with our customers, our Partners and Vendors.

OUR EXPERIENCE:

EBONY ENTERPRISES LTD - FROM VISION TO REALITY

EBONY ENTERPRISES LTD - FROM VISION TO REALITY



Military communication



C4I / EW



Advanced artillery weapons



Advanced personal missiles TV and laser guided



Intelligence sensors



Upgrading of all kind of helicopters and fixed wings



Upgrading of all kind of existing fleet



Thermo imaging and night vision



Special vehicles for special forces



Advanced light weapons



Advanced personal carrier



Modernized maintenance center



Training



Special transportations



From Vision To Reality

ELIEL SECURITY TECHNOLOGIES LTD.



Development Production and Consultancy

ELIEL SECURITY TECHNOLOGIES LTD.

P.O.Box 9949
Haifa 3109901, Israel
Tel: 972-4-8222279
Fax: 972-4-8327613
E-mail: eliela@netvision.net.il

ELIEL Security Technologies Ltd. (EST) is a privately owned company involved in International Marketing, Consulting Advanced Marketing & Business Development within the Security, Civil and Military Environment.

EST's is highly experienced in the development and production of a variety of Electro - Optical based solutions.

Consultancy: Providing Technical and Operational Support for our clients, developing formal requirements plans (In an RFP form) and evaluates received proposals. Delivering technical presentations at a senior level, keeping up to date on the market, competitive solutions, products and services, are commercially aware; provide design - effective - solutions. Offer exceptional training facilities and development.

Categories & Technologies:

- ▶ Perimeter Protection
- ▶ Integrated Systems
- ▶ Surveillance & Sighting Systems, Day / Night



GAZIT RAN



Ran Gazit Advocate & Notary
רן גזית עורך דין ונוטריון

GAZIT RAN - Law Office & Notary

One Azrieli Center Circular Tower
132 Menachem Begin Rd.
Tel Aviv 6702101, Israel
Tel: 972-3-5607711
Fax: 972-3-5607712
E-mail: contact@ran-gazit.com
Web Site: www.ran-gazit.com

THE RAN GAZIT LAW OFFICE & NOTARY WAS ESTABLISHED IN 1987

The firm specializes in corporate and commercial law (emphasis financial area), and also provides tax planning consultation and services. Its activities span the broad range of civil law.

ISREX (94) LTD.



More Than
40 years

ISREX (94) LTD.

Clal Building, 5 Droyanov St.,
Tel Aviv 6111001, Israel
Tel: 972-3-6200611
Fax: 972-3-5283280
E-mail: isrexmng@isrex.com
Web Site: www.isrex.com



*Subsidiaries in Latin
American Countries*

M
O
R
E

T
H
A
N

4
0

Y
E
A
R
S

O
F

E
X
P
E
R
I
E
N
C
E

*The best solutions for your requirements
that only the experience and reliability
acquired since its establishment in 1968
can offer.*



- Upgrading, repowering and maintenance of aircraft
- Technical consultancy services
- Transfer of technology

- Military and civil communications
- Aviation spare parts
- Electronic systems
- Electro-optics
- Special vehicles
- Support equipment
- Simulators
- UAV'S
- C⁴I



STRONGER TOGETHER



DIGNIA SYSTEMS LTD.

9 Shenkar St.,
Herzlia 4672509, Israel
Tel: 972-74-7200700
Fax: 972-9-9612021
E-mail: recp-d@dignia.com
Web Site: www.dignia.com



DIGNIA at a GLANCE

Dignia is a global leader and trusted provider of Security and Defence solutions. Our customers include military and internal security organizations, intelligence and law enforcement agencies worldwide. With over 25 years experience we bring reliable field-proven technology, backed by professional expertise and "real world know-how" to any large scale government project.

OUR MISSION

We deliver mission-critical technology and operational expertise to safeguard national security, increase public safety and protect critical infrastructure.

PROFESSIONAL EXPERTISE

Dignia brings together world-class military and security experts to address every aspect of your operational needs. Many of our experts are high ranking officers with vast operational experience in air, land and sea combat. Dignia intelligence and security experts are valued advisors to governments and major security forums worldwide.

CUSTOMER FOCUS

Dignia offers scalable, tailored solutions to meet your operational needs and budget. Dignia makes sure you achieve your objectives, and helps your organization to keep pace with technology innovation and evolving security and intelligence threats.

OPERATIONAL LIFE CYCLE

Dignia supports the full operational life cycle of any project. From system design and development, to integration, training and assimilation, we are with you every step of the way. Dignia trains and prepares your personnel and delivers full maintenance and technical support services based on recognised international standards.

HOW WE WORK

Dignia specializes in complex large scale, turn-key projects. Our success is based on TITAS, a proprietary, customer-focused project implementation methodology that covers each stage of your project: Technology; Integration; Training; Assimilation and Support.

DIGNIA HOLDS A LARGE VARIETY OF PRODUCTS:

- Border control integrated projects
- Forensic laboratories
- Cyber solutions
- Command and control systems
- Intelligence solutions
- Critical infrastructure
- Etc...

KEY STRENGTHS

- Customized solutions for military, security and intelligence purposes
- Reliable, high performance systems and equipment
- Seamless integration to all mission-critical systems
- Comprehensive project life cycle support.
- Access to world-class military and security experts
- Professional, high quality training programs
- Creative financing and flexible payment terms



HOSHEN - ELIAV SYSTEM ENGINEERING



HOSHEN - ELIAV SYSTEM ENGINEERING LTD.

19 Wisburg St.,
Tel-Aviv 6935831, Israel
Tel: 972-3-6482182
Fax: 972-3-6481635
E-mail: office@hoshen-eliav.co.il
Web Site: www.hoshen-eliav.co.il

Know-Think-Move

Hoshen-Eliav Systems Engineering Ltd. (ISRAEL) is a System Analysis & System Engineering Consulting Company, active mainly in the defense market. The company employs 80 highly qualified engineers, operational experts and analysts. It has developed in-depth knowledge and expertise in a wide range of fields. The company has acquired a strong reputation in the defense community for its ability to innovate and initiate new products and programs for Israel's defense industries, Israeli Ministry of Defense and the Israel Defense Forces.

Hoshen-Eliav's major strength is the ability to perform an End-to-End process: starting from a comprehensive Operational Analysis, leading to systematic identification of Operational Gaps and definition of Future Required Capabilities. The next phase is to create a set of Candidate Solutions and perform a comparative analysis, resulting in the Most Promising system. The implementation phase include system Architecture Design, Development Monitoring and Control, System Integration and Operational Activation.

A brief sample of projects:

Upper-Tier Ballistic Missiles Defense

- Client: Israeli Ministry of Defense
The need: To augment the current Arrow system in order to counter advanced long Range Ballistic Missiles
- H-E Mission: Carried out an operational & technical analysis in order to recommend the "Most Promising" architecture: Interceptor, long range detection systems, tracking & fire control sensors and enhanced C² center.

This was achieved by using a specific methodology developed by H-E, employing a multi-agency analyst team, using simulation tools to analyze the effectiveness of candidate architectures to counter a massive ballistic missiles salvo, and performing LCC analysis.

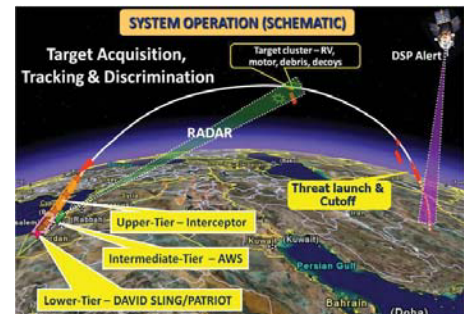

Joint Staff C² System (ICCS)

- Client: IDF C⁴I Directorate
- The need: To provide the IDF senior command and decision makers (down to division commander level) with multi-discipline, multi-service data and knowledge required for decision making, planning operations and to maintain Command & Control over the campaign.
- H-E Mission: Carried out an operational & technical analysis in order to recommend the "Most Promising" architecture: Interceptor, long range detection systems, tracking & fire control sensors and enhanced C² center.



Israel National Crisis Management Center

- Client: Prime Minister Office
- The need: Center for the management of national crisis situations, both at the senior political level and operational level
- H-E Mission: Operational Needs Analysis, characterization of information required for decision-making, Concept Definition, definition of organization structure and working processes, Pilot System - construction & testing, detailed design, planning and management of system operational activation, professional training and training exercises.





VERSIA MILITARY DESIGN

P.O.Box 8220, Tel Aviv 6108102, Israel
 Tel: 972-77-5354513
 Fax: 972-3-7617077
 E-mail: info@versiamilitary.com
 Web Site: www.versiamilitary.com



Leaders in Military Design



Versia Military Design is a leading international industrial design bureau, specializing in the defense sector.

Headed by award winning designer Tamir Porat, Versia Military Design has more than 20 years experience in designing Small arms, Automotive, Robotics, Optics, Training Aids and HLS products.

Our methodology allows maximum flexibility taking into account the product

complexity, customer requirements and the development budget.

Versia Military Design offers a variety of services including:

- Design Concepts
- Engineering
- Models & Prototypes
- Research
- Marketing aids



SERVICES



Test Center & Ammunition Reutilization/Demil/Disposal

ISRAEL MILITARY INDUSTRIES LTD. (IMI)

P.O.Box 1044, 64 Bialik Blvd.
Ramat Hasharon 4711001, Israel
Tel: 972-3-5485222
Fax: 972-3-5486125
E-mail: imimrktg@imi-israel.com
Web Site: www.imi-israel.com

TEST CENTER

IMI's Test Center is the largest and most advanced test site in Israel. The Test Center performs comprehensive evaluations and testing of various kinds of explosives, propellants and gun-fired ammunition ordnance, ranging from small caliber to 8" projectiles, mortars, rockets, missiles and aircraft armament warheads, as well as land based ammunition, grenades, mines, and pyrotechnic devices. Testing within the Test Center is carried out in labs and on open firing ranges. The live firing ranges are operated at the IMI Proving Ground, offering live testing of artillery and tank ammunition, at ranges of up to 40 km.

IMI's highly-experienced

professionals are constantly focusing on creating the most diverse and rigorous test capabilities, guaranteeing the customer's systems and munitions meet the test requirements of advanced militaries.

AMMUNITION REUTILIZATION, DEMILITARIZATION & DISPOSAL

IMI offers advanced environmentally-friendly solutions for obsolete munitions and explosives.

The solutions include reuse, recycling and disposal of High-Explosives (HE), propellants, pyrotechnic products, metal parts and other materials.

Main activities include: conversion of operational ammunition for training purposes, disassembly and reuse of components and raw materials ("like new" status) and disposal of ammunition through detonation or burning. IMI's safe and highly-reliable demilitarization facilities have a proven zero-casualties track record. In addition, IMI's Mobile Demiling Recycling Plant (MDRP) offers customers a unique cost-effective solution for overcoming the need of transporting munitions to demilitarization and disassembly sites.

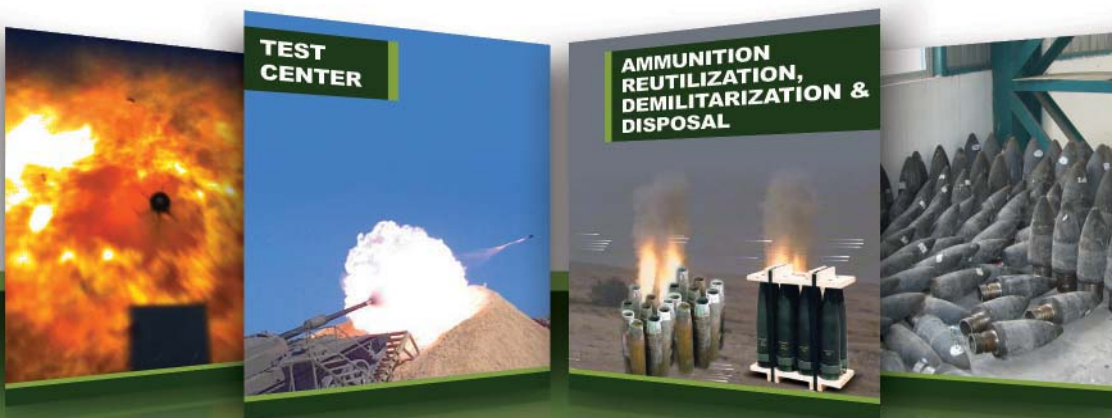

GOVERNMENT QUALITY ASSURANCE SERVICES FOR FOREIGN COUNTRIES



SIBAT - Israel Ministry of Defense
International Defense Cooperation
Quality Assurance Division
Hakiryia, Tel Aviv 6473424, Israel
Tel: 972-3-6084548
Fax: 972-3-6084529
E-mail: anordan@mailto.mod.gov.il
Web Site: www.sibat.mod.gov.il

The Quality Assurance Division at IMOD-SIBAT provides Government Quality Assurance services for foreign contracts placed by foreign governments in the Israeli industries.

QA SERVICES ARE PROVIDED FOR A WIDE RANGE OF COMMODITIES:

- Aircraft
- Ammunition
- Automotive
- Communication
- Electronics
- Materials
- Chemicals
- Computer Software
- Others

Quality Assurance tasks and activities are based on IMOD/SIBAT Quality Assurance Directives as well as on NATO Standardization Agreement, STANAG No. 4107, and ISO 9001: 2000 Quality Management System.

The QA personnel rely on I.D.F, and on civilian Q.A. specialists. They are well trained, with many years of experience in performing Q.A. functions.

Periodic Audits are performed by first line supervisors on the QARs Q.A. activities.

Technical support is provided (when required), by experienced engineers and specialists.

All of the QARs are certified engineers and technicians, trained and qualified in various QA systems skill areas, like:

- Non Destructive Tests.
- Soldering.
- Software Quality Assurance
- Preservation, Packing, Packaging and Marking.
- Statistical Process Control.
- Statistical Sampling.
- Calibration.

QUALITY ASSURANCE CONCEPTS OF OPERATION AND METHODOLOGY

- Reviewing the contract and associated technical requirements.
- Generating a Quality Assurance Surveillance Plan based on identification and classification of risks.
- Performing QA Surveillance - Floor level process audits, support process audits and product audits.
- Reviewing Supplier Quality Management System Documentation.
- Establishing and maintaining QA surveillance records.
- Collect and Analyze Data.
- Initiating and processing quality deficiency reports, including validation of corrective and preventive actions.
- Providing risk information feedback.
- Conducting Post-award meetings with the supplier.
- Verifying and validating supplier's quality evidence.
- Verification of prime contractor controls over subcontractors.
- Preparation of product release.



INDICES

INDEX OF COMPANIES

ACKERMAN PRINTING & PHOTOANODIZE

4 Volfson St.,
Neve Itamar
Netanya 4237404, Israel
Tel: 972-9-8823456
Fax: 972-9-8624683
E-mail: info@ackerman-printing.com
Web Site: www.ackerman-printing.com
C.E.O: Mr. Ori Ackerman
C.O.O: Mrs. Orit Ackerman
Date established: 1953
Ownership: Private

Areas of activity

Ackerman Printing and Photoanodize specializes in the manufacture of anodized aluminum labels, U.I.D Data Matrix, using metal-photo technology, screen printing, pad printing & R.F.I.D Tags.

The company's production processes are performed in accordance with the highest international standards.

The company has ISO 9001:2008 certification.

Ackerman Printing and Photoanodize was founded in 1953 and we offer our customers the perfect blend of new and old: state-of-the-art technology combined with years of tradition, knowledge and experience.

See page: 30

A.D. CONSULTANTS GROUP

7 Golda Meir St.,
Science Park
Nes Ziona 7403650, Israel
Tel: 972-8-9313600
Fax: 972-8-9404317
E-mail: adcon@adcon.co.il
Web Site: www.adcon.co.il
Managing Director:
L.T. Col. (R) Gaby Peretz
Number of Employees: 30
Date Established: 1987

Areas of activity

A.D. Consultants has been dealing in military and security supplies of new and surplus equipment, as well as consultancy services.

Our worldwide network of agents and suppliers enable us to provide special deliveries either by sea or air, to all destinations.

See page: 443

AERODAN SYSTEMS (1993) LTD.

17 Kaplan St.,
Tel-Aviv 6473418, Israel
Tel: 972-3-6961099
Fax: 972-3-6966343
E-mail: maerav@aerodan.com
Web Site: www.aerodan.com
C.E.O: Dr. Elkana Rooz
C.T.O: Dr. Vladimir Brotskey
V.P Marketing & Business Development:
Mrs. Maerav Rooz Michaelson
Number of employees: 30
Date established: 1988
Ownership: Private

Areas of activity

Aerodan has since 1988 become an R&D source and an established provider of high-end engineering based software and hardware integrated solutions for aerospace and avionic applications to customers worldwide. Aerodan specializes in systems engineering and integration. Initially providing aerospace engineering support for the Israel MOD, the company provides aerospace development services and solutions for all the major defense industries in Israel. Today Aerodan is mainly involved in the development of avionic modules, products and systems such as flight systems and fire-control computers.

See page: 59

AEROMAOZ LTD.

Tel: 972-3-6095003
 Fax: 972-3-6095033
 E-mail: info@aeromaoz.com
 Web Site: www.aeromaoz.com
 C.E.O: Mr. Yaniv Gadish
 V.P. Sales & Marketing: Mr. Eli Avivi
 Marketing Manager: Mr. Marc Steinberg
 Number of Employees: 90
 Date Established: 1980
 Ownership: Private

Areas of activity

- Internal & External Lighting
- Illuminated Panels Electronic Controls
- Night Vision Imaging System (NVIS) Compatible Products
- NVIS Cockpit Upgrades
- Joysticks & Handgrips
- Bezels/Display Bezels
- Keyboard Bezels
- MFD Bezels
- LED, EL & Conventional Lighting Technologies

See page: 45

AERONAUTICS LTD.

P.O.Box 169
 Yavne 8110101, Israel
 Tel: 972-8-9433600
 Fax: 972-8-9328912
 E-mail: info@aeronautics-sys.com
 Web Site: www.aeronautics-sys.com
 C.E.O: Mr. Sami Totach
 V.P. Marketing: Mr. Dany Eshchar
 Number of employees: 750
 Date established: 1997
 Ownership: Private

Areas of activity

Aeronautics Ltd. is a global leader in the area of unmanned systems (UAVs). With core technologies in the areas of C⁴I, navigation, communication, and electro-optics, Aeronautics offers its customers a full spectrum of superior ISTAR solutions at air, sea and on the ground.

See pages: 57, 208, 263, 268, 269, 270, 271, 272, 273, 274, 275

AEROTACTIX (ISRAEL) LTD.

68 Amal St.,
 Petah-Tikva 4951368, Israel
 Tel: 972-3-9215720
 Fax: 972-3-9215434
 E-mail: info@aerotactix.co.il
 Web Site: www.aerotactix.co.il
 C.E.O: Mr. Roei Itshakov
 Director: Mr. Eldad Golstein
 Number of employees: 6
 Date established: 2012
 Ownership: Private

Areas of activity

AeroTactiX unmanned solutions develops and provides high end mini UAV systems that are compact, simple to operate, and highly capable. The systems are developed according to the experience and knowledge accumulated in thousands of operational missions. Designed for use in military and homeland security missions, AeroTactiX's systems excel in every ISTAR mission.

See page: 276

AL CIELO LTD.

5 Nahum Hefzadi St.,
 Jerusalem 9548401, Israel
 Tel: 972-2-6595539
 Fax: 972-2-6541221
 E-mail: info@alcielo.com
 Web Site: www.alcielo.com
 C.E.O: Dr. Arnon Arbel
 V.P. Progrmas: Mr. Yitzhak Yoselis
 H.R & Licenses: Mrs. Yudit Nechmad
 Number of employees: 70
 Date established: 2005
 Ownership: Aeronautics Ltd.

Areas of activity

Al Cielo specializes in the research, development, manufacturing and integration of laser technologies and navigation & control inertial sensors. With over 40 patents, world class facilities and a decade of experience in development and manufacturing of electro and fiber optical systems, Al Cielo brings measurable advantages to Fiber Optic Gyroscopes (FOG), Inertial Measurement Units (IMU) and Inertial Navigation Systems (INS). Al Cielo is the prime local supplier in Israel for closed loop FOGs with sensors engaged in a variety of navigation and control applications.

See page: 376

ASHOT ASHKELON INDUSTRIES LTD.

P.O.Box 21
Ashkelon 7810001
Tel: 972-8-6721366
Fax: 972-8-6721711
E-mail: info@ashot.co.il
Web Site: www.ashot.co.il
President & C.E.O: Mr. Dan Katz
V.P. Marketing & Business Development:
Mr. Yaron Gilboa
Marketing Manager & Business
Development Manager, Defense Products:
Mr. Yigal Kelman - Avni
Number of employees: 400
Date established: 1967
Ownership: Government 85%,
Public 15%

Areas of activity

Ashot Ashkelon - Drive Train,
Suspension and Mobility solutions for
Tanks & APC's; Tungsten based Armor
Penetrators and Fragments Manufacturer.
Ashot provides Built to Print & Built to
Spec. Capabilities of Suspensions
Systems, Main Automatic Transmissions,
Final Drives, Transfer Boxes, PTO's,
wide range of Gear based assemblies and
Shafts for Main Battle Tanks.
Ashot is AS 9100B & ISO 9001:2008
certified.

See page: 131

ASTRONAUTICS C.A. LTD.

16 Martin Gehl St.,
P.O.Box 3351
Kiryat Arie
Petach-Tikva 4951207, Israel
Tel: 972-3-9251555
Fax: 972-3-9251550
E-mail: astro@astro.co.il
Web Site: www.astronautics.co.il
General Manager: Mr. David Ronen
V.P. Business Development:
Mr. Jeahezkel Hoch
Naval Programs & Business Development
Director: Mr. Eli Avraham
Airborne Systems & Business
Development Manager:
Mr. Menahem Donner
Ground Systems & Business
Development Manager: Mr. Eli Avraham
Number of employees: 100
Date established: 1971
Ownership: Private

Areas of activity

Advanced high-technology systems for
Airborne, Naval and Land applications.

Main Products:

Naval:

Advanced Naval Navigation systems for
surface vessels and submarines, Naval
Multi Function Consoles and
Computerized Displays, Ring Laser Gyro
based solutions and advanced
MEMS/GPS INS Systems, Wireless
Broadband Communication System.

Airborne:

Full Glass Cockpit Upgrade Solutions,
Airborne Mission and Display
Computers, Tactix - Tactical Mission
System, EICAS-Engine Indication &
Crew Alert Systems, EFIS- Electronic
Flight Instruments Systems, Displays &
MFCs, Smart Displays, EW Displays,
Digital Air Data Computers, Digital
Moving Map (2D/3D), Airborne Mission
Management systems, Cockpit
Instruments (Electro-mechanical and
Electronic - EHSI/EADI/EFI).

Land:

Tactical Computers and Displays, Ground
INS/GPS Ring Laser Gyro based
Navigation and Fire Control Systems for
artillery and heavy rockets launching
systems (MLRS), Instant Network-
Centric System (INCS).

See pages: 46, 47, 98, 196

ATHENA GS₃ SECURITY IMPLEMENTATIONS LTD.

Israel Office:
5 Hatzoref St.,
Industrial Zone
Holon 5885633, Israel
Tel: 972-3-5572436
Mobile: 972-54-655 9137
Fax: 972-3-5572472
E-mail: general@athenaiss.com
Web Site: www.athenaiss.com
Athena R&D center:
Kibutz Nahal OZ
M.P Hanegev 8514500, Israel
Tel: 972-8-6805441
Fax: 972-8-6610097
Chairman: Mr. Shabtai Shavit
C.E.O: Mr. Omer Laviv
Number of employees: 40
Date established: 2002
Ownership: Mer Security &
Communications Ltd.

Areas of activity

Athena is a security and intelligence
solutions provider delivering a wide range
of proactive services and systems. **Athena**
was established by Israeli security
veterans, headed by Mr. Shabtai Shavit -
Former Director of the Israeli Mossad.
Athena provides Advanced Software
Solutions, Consulting, HR services, and
Project Management for Governmental
Intelligence Agencies as well as financial
and commercial clients worldwide. The
company works with its clients to upgrade
each of these aspects, as well as
integrating them for streamlined, effective
solution.

See page: 319

AUTOMOTIVE INDUSTRIES LTD.

P.O.Box 535
Nazareth Iliit 1710501, Israel
Tel: 972-4-6558104/147
Fax: 972-4-6558103
E-mail: info@ail.co.il
Web Site: www.ail.co.il
General Manager: Mr. Noam Kishinovski
Marketing & Sales Coordinator:
Mrs. Chen Shitrit
Number of employees: 88
Date established: 1966
Ownership: Mr. Tzvi Neta

Areas of activity

Founded in 1966 Automotive Industries Ltd (AIL) is a manufacturing and assembly plant for vehicles, specializing in 4 x 4 all terrain tactical vehicles for military and commercial use. Main products include the "Storm 3" 4 X 4 light utility vehicle and the "Abir" and the all new "Abir II" 4 X 4 combat support vehicle. All vehicles are available in armored versions.

See page: 209

BAE SYSTEMS - Rokar

11 Hartom St.,
Har Hotzvim
P.O.Box 45049
Jerusalem 9777511, Israel
Tel: 972-2-5329888
Fax: 972-2-5822522
E-mail:
rokar.marketing@baesystems.com
Web Site: www.baesystems.com
President & General Manager:
Mr. Yaron Kulas
Director, Marketing & Business
Development: Mr. Nir Lavi
Finance Director: Mr. Roi Levy
Number of employees: 150
Date established: 1981
Ownership: BAE Systems North America

Areas of activity

BAE SYSTEMS Rokar specializes in the development, production, maintenance and technical support of electronic countermeasures dispensing systems, GPS navigation and guidance systems and land vision systems. Rokar serves the armed forces and defense industries of Israel and of customers around the world as a leading provider of combat-proven products.

The products of BAE SYSTEMS Rokar meet the highest standards of quality assurance in accordance with ISO 9001:2008 specifications, as well as the standards set by the Israel Defense Forces, the Standards Institution of Israel, and the relevant authorities of the U.S. and many European customers.

See page: 72

BENTAL INDUSTRIES LTD.

Kibbutz Merom-Golan
1243600, Israel
Tel: 972-4-6960199
Fax: 972-4-6960187
E-mail: bental_marketing@bental.co.il
Web Site: www.bental.co.il
C.E.O: Mr. Shmuel Mandel
C.M.O: Mr. Moshe Poolat
V.P. Marketing & Sales:
Mr. Moshe Poolat
Director of Development & Engineering:
Mr. Moti Nitzan
Marketing Manager:
Mr. Moshe Yeshourown
Marketing Comm.: Mrs. Naama Yehudai
Number of employees: 114
Date established: 1983
Ownership: 70% TAT , 30% Merom-Golan

Areas of activity

Bental industries specializes in design and manufacture of innovative power and design motion systems integrated into various ground and aerial platform and applications:

- Electric Motors
 - Servo Actuators
 - Alternators and Starter Alternator
- The company's ability to tailor cutting edge technology and innovative design to specific project requirements enables it to welcome the most challenging demands.

See pages: 31, 132

BETH-EL ZIKHRON YAAQOV INDUSTRIES LTD.

1 Avshalom Road
P.O.Box 166
Zikhron Yaaqov 3095101, Israel
Tel: 972-4-6299904/05
Fax: 972-4-6299900
E-mail: export@beind.com
Web Site: www.beind.com
Managing Director: Mr. Albrecht Fuchs
Export Director: Mr. Joachim Blind
Head of International Sales & Marketing:
Mr. Jehuda Fehlauer
Number of employees: 1,000
Date established: 1973
Ownership: Private

Areas of activity

Beth-El is a major supplier for combined ventilation & NBC filtration systems as well as combined air conditioning, ventilation & NBC filtration systems, Engine Air cleaners, blast valves, fuel pumps and other subsystems. Beth-El systems are installed in numerous platforms like the Merkava MBT, Namer APC, Piranha IIIC, Piranha V, Duro IIIP, Eagle IV, new Eagle, Dingo II, Boxer, VAB Mark II, Cobra, YAK and dozens of other vehicle types. Systems for containers, tents, shelters and infrastructure are as well in the scope of the Beth-El product line. Some of the key features of Beth-El systems include: coarse and fine dust filtration; toxic shooting fumes filtration; CAN-bus control; compliance to all the important military standards, such as: NATO AEP-54, MIL – PRF – 321387, AC 225 (PANEL VII) D/251, and German TL Standards, amongst other Standards. Beth-El's systems are in service with more than 60 armies worldwide.

See pages: 408, 409

BET SHEMESH ENGINES LTD.

1 Virginia Avenue
Western Industrial Zone
Bet Shemesh 9905529, Israel
Tel: 972-2-9909486/7
Fax: 972-2-9911970
E-mail: info@bsel.co.il
Web Site: www.bsel.co.il
President & C.E.O: Mr. Avner Shacham
V.P. Marketing & Sales:
Mr. Avigdor Hirsch
Number of employees: 500
Date established: 1968
Ownership: Company traded on Tel-Aviv Stock Exchange

Areas of activity

- **Maintenance, Repair and Overhaul** of gas turbine engines - PWA F100 series, PWC PT6A, PT6T series, GE Aviation T700 series, Rolls-Royce 250 series and Turbomeca's Marbore II/VI.
- **Manufacture** of various jet engine parts; Spacers, Disks, Airseals.
- **Investment Casting** of hi-temp alloys, mainly gas turbine engines blades and vanes.
- **Design**, development and manufacture of small jet engines for UAVs and missiles.

See page: 32

BIKS INTELLIGENCE SOLUTIONS

4 Hamaayan St.,
(Ligad center 2)
Modi'in 7173001, Israel
Tel: 972-722504212
Fax: 972-8-9266413
E-mail: biks@biks.info
Web Site: www.biks.info
Owner & C.E.O: Mr. Itzik Ben-Sasson
Number of employees: 36
Date established: 2002
Ownership: Private

Areas of activity

BIKS team includes top ranking intelligence and strategic planning consultants in all aspects of the Intelligence cycle: data-collection, multi-discipline intelligence analysis, imagery exploitation, actionable intelligence and data-mining. BIKS teams supports detailed design and characterization for the development of C⁴I systems. BIKS also offers advanced training and intelligence courses.

See page: 422

BIRD AEROSYSTEMS LTD.

10 Hasadnaot St.,
P.O.Box 4038
Herzeliya 4614001, Israel
Tel: 972-9-9725700
Fax: 972-9-9579613
E-mail: info@birdaero.com
Web Site: www.birdaero.com
C.O-C.E.O: Mr. Ronen Factor
C.O-C.E.O: Mr. David Dargucki
V.P. Marketing: Mr. Shaul Mazor
Number of employees: 55
Date established: 2001
Ownership: Private

Areas of activity

BIRD specializes in developing and deploying of mission critical solutions including:

AMPS -

The Airborne Missile Protection System (AMPS) is an advanced 3rd generation self protection protects military and civil aircraft against ground missiles. AMPS is certified by MIL-Moscow and EUROCOPTER and is the NATO standard system selected and installed on US, Canadian, UN and NATO aircrafts.

ASIO -

ASIO is a complete Special Mission Aircraft Solution provided in cooperation with CASSIDIAN (an EADS Company) and Beechcraft Berlin. ASIO is installed on several aircraft including the KA-350 and includes state-of-the-art sensors by CASSIDIAN which are integrated by BIRD's Mission Management system (MSIS) that provides real time situational awareness picture of military, paramilitary and civilian targets in the air and on the ground.

See pages: 16, 73

BL ADVANCED GROUND SUPPORT SYSTEMS LTD.

Offices:
18 Hasivim St.,
Kiryat Matalon
Petach-Tikva 4959376, Israel
Mail:
P.O.Box 7782
Petach-Tikva 4934829, Israel
Tel: 972-3-9210404
Fax: 972-3-9210405
E-mail: sales@bl-il.com
Web Site: www.bl-il.com
C.E.O: Mr. Rafi Bivas
E-mail: rafi@bl-il.com
Engineer Manager: Mr. Yoav Koster
E-mail: yoav@bl-il.com
Number of employees: 23
Date established: 2004
Ownership: Private

Areas of activity

BL offers development, production, sales and after sales service in two main areas:

- Advanced ground support systems
- Advanced military products for ground forces

BL's strength is comprised of its ability to develop new and smart solutions rapidly and cost effectively.

Line of Products:

- Bomb Loaders
- Aircraft Towbarless Tug
- HPU - computerized hydraulic power supply

See page: 87

BLUEBIRD AERO SYSTEMS LTD.

P.O.Box 5041
Industrial Park
Kadima 6092000, Israel
Tel: 972-9-8999335
Fax: 972-9-8999345
E-mail: sales@bluebird-uav.com
Web Site: www.bluebird-uav.com
C.E.O: Mr. Ronen Nadir
C.O.O: Mrs. Hila Strick
Number of employees: 30
Date established: 2002
Ownership: Private

Areas of activity

Bluebird Aero Systems specializes in the design, development and production of Tactical Unmanned Aerial Systems (UAS) and peripheral equipment, and delivers exceptional, unprecedented combat proven solutions for the Military, HLS and civilian markets. With our patented technology, Bluebird's operational UAVs surpass the capabilities and performance envelope known in the UAS market today.

See pages: 14, 15

BUL TRANSMARK LTD.

10 Rival St.,
 Tel-Aviv 6777845, Israel
 Tel: 972-3-6392911
 Fax: 972-3-6874853
 E-Mail: info@bultransmark.com
 Web Site: www.bultransmark.com
 General Manager: Mr. Eli Ozalvo
 General Manager: Mr. Zion Lachiano
 Marketing Manager: Mr. Roy Salem
 Number of employees: 20
 Date established: 1989
 Ownership: Private

Areas of activity

Manufacturers and distributors of Hi-capacity polymer frame single and double action pistols and accessories:

BUL M-5: 1911 based. Models available for carry and competition use. All popular calibers available.

The New BUL Cherokee: Double action pistols, extremely lightweight and ergonomic. Reliable and ideal for police, military and self-defense uses.

BUL Storm: All-steel Hi capacity double action pistol. Reliable and ideal for police, military and self-defense uses.

High-Quality 1911 parts: User friendly, prepped and easy to install metal injection molding parts. **High-Quality Rifle & pistol polymer parts and accessories** for the pro Spec. Ops & Swat members.

See page: 248

CAMERO-TECH ISRAEL LTD.

Grand Netter Industrial Zone,
 Intergama Building
 P.O.Box 3521
 Kfar Netter 4059300, Israel
 Tel: 972-73-7172333
 Fax: 972-73-7172323
 E-mail: info@camero-tech.com
 Web Site: www.camero-tech.com
 C.E.O: Mr. Amir Beeri
 V.P. Business Development:
 Mr. Hagay Keller
 Number of employees: 30
 Date established: 2004
 Ownership: Private

Areas of activity

Camero is a leading provider of Radar based tactical through-wall imaging solutions.

The Xaver™ products have become the solution of choice for military and law enforcement agencies throughout the world, including:

Xaver™ 800 - high performance 3D imaging solution for ISR applications

Xaver™ 400 - small and lightweight tactical tool providing mission-critical information

Xaver™ 100 - a compact handheld through-wall detector

See page: 230

CI SYSTEMS LTD.

P.O.Box 147
 Industrial Park Ramat Gabriel
 Migdal Haemek 2310101, Israel
 Tel: 972-4-6448888
 Fax: 972-4-6543570
 E-mail: market@ci-systems.com
 Web Site: www.ci-systems.com
 C.E.O.: Dr. Robert Buckwald
 V.P. General Manager & Haed of Electro-Optic Division:
 Mr. Efraim Tzafir
 C.F.O.: Mr. Tzvi Haroon
 Number of employees: 120
 Date established: 1977
 Ownership: Public, Tel-Aviv stock exchange

Areas of activity

IR Sources - Blackbodies.

IR targets.

FLIR testers.

Visible sources.

CCD testers.

Laser range finder testers.

Laser designator testers.

Multi-sensor payload testers.

Spectro-radiometers and remote sensing.

Boresight equipment.

E-O guided missile testing.

Missile warning systems - testers and simulators.

See page: 369

COMMTACT LTD.

P.O.Box 169
 Yavne 8110101, Israel
 Tel: 972-8-9433602
 Fax: 972-8-9433603
 E-mail: info@commtact.co.il
 Web Site: www.commtact.co.il
 C.E.O: Mr. Shai Palti
 Purchase Manager: Mrs. Rachel Steiner
 Marcom & Marketing: Mr. Itay Sherman
 Number of employees: 40
 Date established: 1991
 Ownership: Aeronautics Ltd.

Areas of activity

Commtact Ltd. specializes in developing and manufacturing state-of-the art Data-link and communication systems for defense, homeland security, and civil applications.

Commtact offers the following data link solutions:

- UAVs (Unmanned Aerial Vehicles)
- Fixed wing aircraft and helicopters
- Naval platforms and USVs
- Ground vehicles, UGVs
- Mobile Satellite Terminals
- Missile applications

See page: 277

CONTACT INTERNATIONAL (KALIA) LTD.

P.O.Box 18434
 Jerusalem 9118301, Israel
 Tel: 972-2-5354565, 5354057
 Fax: 972-2-5354566
 E-mail: contintl@netvision.net.il
 Managing Director: Mr. Zev Kaptowsky
 Date established: 1979
 Ownership: Private

Areas of activity

Supply of surplus military equipment for Ground Forces, Air Force and Navy, including:

- Arms and ammunition.
- Weapons spare parts and accessories. Personal equipment.
- Combat vehicles and spare parts. Optronics and communications equipment.
- Aircraft spare parts and components.
- Own storage and processing facilities.

See page: 444

CONTROP PRECISION TECHNOLOGIES LTD.

P.O.Box 611
 Hod Hasharon 4510502, Israel
 Tel: 972-9-7440661
 Fax: 972-9-7440662
 E-mail: sales@controp.co.il
 Web Site: www.controp.com
 C.E.O: Mr. Dror Sharon
 V.P. Marketing: Mr. Johnny Carni
 Director, Marketing & Communications: Mrs. Lori Erlich
 Number of employees: 190
 Date established: 1988
 Ownership: Private

Areas of activity

Development and manufacture of servo-control and electro-optical systems:

- Electro-optical stabilized payloads for day-night observation on board of light aircraft, helicopters, UAVs, ships and marine patrol aircraft.
- Automatic intruder detection systems.
- Thermal imaging cameras (FLIR) with continuous zoom lens.
- Antenna pedestals and positioners for communication and radar equipment (including satellite communication).
- Reconnaissance film cameras.

See pages: 176, 340, 359

CORNER SHOT (ISRAEL) LTD.

3 Ma'ale Ha-Migdal St.,
 P.O.Box 761
 Or-Yehuda 6025603, Israel
 Tel: 972-3-6326116
 Fax: 972-3-6326115
 E-mail: israel@cornershot.com
 Web Site: www.cornershot.com
 President: Mr. Amos Golan
 Vice President: Mr. Rami Shaul
 Number of employees: 15
 Date established: 2003
 Ownership: Amos Golan

Areas of activity

Corner Shot is a weapon system that provides the ability to observe and shoot a target from behind a corner.

Corner Shot can change the course of events by providing security forces with an effective tool to accurately pinpoint and engage a target, at minimal risk to their personal safety.

See pages: 249, 250, 251

DEA**Research and Development Ltd.**

P.O.Box 34436
 Jerusalem 9134302, Israel
 Tel: 972-2-6540878/9
 Fax: 972-2-6540885
 E-mail: Dea_ltd@netvision.net.il
 Web Site: www.dea-rd.com
 General Manager: Mr. Reuven Fichman
 Number of employees: 10
 Date established: 1980

Areas of activity

DEA R&D specialized in research, development, management and design of multidisciplinary Projects. Personal NBC life support equipment for the civilian and military markets, hood blower system, ventilated garments and detectors. Our capabilities are based on a blend of design disciplines: human engineering, tooling, production, assembly, testing and documentation. DEA is carrying out theoretical and studies in human engineering.

See page: 407

**DEFENSE INDUSTRIES
INTERNATIONAL, INC**

12 Hamefalsim St.,
Petach-Tikva 4951421, Israel
Tel: 972-3-7168383
Fax: 972-3-7168484
E-mail: Info@dfns-group.com
Web Site: www.dfns-group.com
Marketing Director: Mr. Omer Nissani
Number of employees: 300
Date established: 2002
Ownership: DFNS - Group

Areas of activity

DFNS-GROUP is a leading defense contractor of both **personal** and **automotive** armored systems. Established in 2002, DFNS is a publicly traded company on the NASDAQ exchange. Through its wholly owned subsidiaries, DFNS **designs, develops** and **manufactures**, a broad range of products for military and civilian markets worldwide.

See page: 231

**DEMOMAN
INTERNATIONAL LTD. -
Security & Defense Solutions**

P.O.Box 3896
Nazareth Illit 1752606, Israel
Tel: 972-50-5901655
Fax: 972-4-6561632
E-mail: info@demoman.co.il
Web Site: www.demoman.co.il
www.suicide-terrorism.com
C.E.O: Mr. Tal Hanan
Head of Strategy Department:
Col. (Res.) Dr. Hanan Shai (Shewartz)
Chief Instructor: Mr. Samuel Bashan
Date established: 1999
Ownership: Private

Areas of Activity:

STRATEGY DEPARTMENT:
- Strategic Intelligence.
- Strategic, Multi-National, Financial Investigations.
- Counter Terrorism Funding & Money Laundering.
- Crisis Management and turning Risk into Opportunities.
- Rapid Decision-Making & Coping with Uncertainty.
- Operational Concepts & Operational Field Solutions.

**SUICIDE TERRORISM & BOMB
SECURITY DEPARTMENT:**

- Counter Suicide Terrorism in HLS environment (www.suicide-terrorism.com) & Bomb Security Training & Consulting.
- Explosives Detection.
- Anti-Sabotage Awareness.

SECURITY DEPARTMENT:

- Terrorism Awareness, and Countering Terrorism Trends.
- Experience Sharing - Rapid Deployment Security Training
- Executive Protection Training & Consulting.
- Disaster security and logistical support (Including Medical Support and Supplies).
- Defense Systems & Security Supplies.

See page: 423

DEXORD LTD.

P.O.Box 12702
Ashdod 7760049, Israel
Tel: 972-8-8681150
Fax: 972-8-8681169
E-mail: dxord_1@netvision.net.il
President & C.E.O: Mr. G. Arazi
Chief Q.A.R: Mr. M. Horn
Number of employees: 5
Date established: 1984
Ownership: Private

Areas of activity

Supply of military and security equipment to all military, police and special forces, new or surplus equipment. Representation of foreign manufacturers.

See page: 445

DIGNIA SYSTEMS LTD.

9 Shenkar St.,
Herzlia 4672509, Israel
Tel: 972-74-7200700
Fax: 972-9-9612021
E-mail: recp-d@dignia.com
Web Site: www.dignia.com
C.E.O: Mr. Itzhak Tzadik
Ownership: Private

Areas of activity

Dignia holds a large variety of products:
- Border control integrated projects
- Forensic laboratories
- Cyber solutions
- Command and control systems
- Intelligence solutions
- Critical infrastructure
- Prison security solutions
- Special surveillance vehicalles
- Etc...

See page: 450

DSIT SOLUTIONS LTD.

P.O.Box 2
2 Rechavam Zeevi St.,
Givat Shmuel 5410001, Israel
Tel: 972-3-5313333
Fax: 972-3-5313322
E-mail: marketing@dsit.co.il
Web Site: www.dsit.co.il
C.E.O: Mr. Benny Sela
V.P Sales & Marketing:
Mr. Dan Ben-Dov
Number of employees: 80
Date established: 1985
Ownership: Ownership:
Acorn Energy 84%, Management 16%

Areas of activity

DSIT Solutions develops and applies state-of-the-art technology to create advanced sonar and acoustic systems for defense, commercial, energy and homeland security markets. The Company's systems are designed to bring customers the latest technology in acoustic measurement and analysis and in sonar operation simulation and training as well as in underwater security systems. The company is a subsidiary of the US company, Acorn Energy Inc. (NASDAQ: ACFN).

See page: 123

D.T.E. CO. LTD.

P.O.Box 41
Industrial Zone,
Ashkelon 7810001, Israel
Tel: 972-8-6750342
972-50-5236865
Fax: 972-8-6751045
E-mail: dte_com@netvision.net.il
Web Site: www.minefield-shoes.com
General Manager: Mr. Shlomo Ringler
Date established: 1959
Ownership: Private

Areas of activity

Manufacturer of anti-personal mine protecting shoes, (sapper platform for crossing mine field). MINEFIELD SHOES.

The MFC CHECKMATE Safety Shoes (NSN: 8430-15-121-9857) are built on the theory of air-cushions, which support the body while reducing the pressure in relationship to the minefield. The CHECKMATE is completely portable, folds up into a small lightweight object and easily slipped into a regulation army pack. It has more than ten years of extensive use with IDF, the French army and most of NATO forces.

See page: 217

DYNAMIC JET ENGINEERING LTD. (DJE)

15 Abba Eban Blvd.
Herzliya 4672533, Israel
Tel: 972-9-9514731
Fax: 972-9-9514733
E-mail: info@dynamicjet.com
Web Site: www.dynamicjet.com
President: Mr. Shalom Lahat (Col. Res)
V.P. & Head of Engineering:
Mr. Chanan Orpaz
Head of Q.A. & Logistics:
Mr. Shuki Abuav
Number of employees: 16
Date established: 2004
Ownership: Private

Areas of activity

DJE provides Upgrades, Modifications and Conversions solutions. Its capabilities and performances, reflects decades of experience and qualities, sustained by its staff with extensive knowledge. It has gained expertise and practical experience in the aerospace industry in Israel and abroad, allows the firm to provide tailored solutions for most stringent requirements and needs on a variety of military and civil aircraft platforms.

CERTIFICATES

DJE is AS 9100 certified, recognized contractor for international aerospace companies.

See page: 17

DYNAMO RISK DEFENSE (DRD)

P.O.Box 21157
 Tel Aviv 6121101, Israel
 Tel: 972-3-7265033
 Fax: 972-3-6059592
 E-mail: office@dynamo-defense.com
 Web Site: www.dynamo-defense.com
 Chief Executive Officer:
 Lori Solberg M.B.A
 Mobile: 972-52-8137883
 Number of employees: 10
 Date established: 2012
 Ownership: Private

Areas of activity

Security of everything one values is paramount. DRD is focused on creating centers of excellence for our customers.

Our premier products are Cyber protection; Secure infrastructure and software products including for cellular; Coastal and Underwater protection; Space and Satellite training and nano satellite mission design for turn-key projects; UAV team practical and simulated training and Urban/Open terrain warfare trainer; Special security electronics; Surveillance systems; Sensor-tech protective invisible Wireless Perimeter and Open Terrain Security; IMOD authorized weapons reseller and armed SSO logistics; Assisting foreign entities in setting up operations in Israel; Opinions regarding Strategic business operations; Offset; GIS programming and planning.

See page: 89

D. YOLAND LTD.

17 Hamasger St.,
 10 industrial zone
 P.O.Box 13518
 Natanya 4237927, Israel
 Tel: 972-9-8616103
 Fax: 972-9-8847221
 E-mail: info@yolandcorp.com
 Web Site: www.yolandcorp.com
 Chairman: Mr. Dani Ginat
 Managing Director: Mr. Roni Ginat
 Marketing Manager: Mr. Adi Ginat
 Date Established: 1976
 Number of employees: 40
 Ownership: Private

***US Subsidiary (100% owned):
 Yoland CORPORATION INC.***

235 36TH St.,
 Brooklyn, NY 11232
 Tel: 718-499-4803
 Fax: 718-499-4834
 President: Dani Ginat
 General Manager: Tal Ginat
 E-mail: yolandcorp1@gmail.com

Areas of activity

Yoland manufactures military textile articles:
 Parachutes for:
 - Artillery illumination ammunition
 - Mortar illumination ammunition
 - Air dropped illumination flares
 - 40mm illuminating grenades
 - Other types
 Bags for artillery and mortar charges
 Body armor.
 Seats cover for airplanes, trains and buses.
 Yoland also manufactures nonstandard and mil-spec textile products which require high quality production.

See page: 197

EBONY ENTERPRISES LTD.

14 Shenkar St.,
 Nolton House
 P.O.Box 12358
 Herzliya Pituah 4672514, Israel
 Tel: 972-9-9601300
 Fax: 972-9-9601301
 E-mail: niso@ebonyltd.com
 Chairman: Mr. Niso Bezalel
 C.O.O: Mr. Josef Fishman
 Number of employees: 30
 Date established: 1995
 Ownership: Private. Niso Bezalel

Areas of activity

EBONY is a Professional Entrepreneur, working with leading Israeli and International world-wide enterprises to market, export and deliver solutions, products and services to countries in Africa, Europe, South America and Asia. EBONY thrives to implement in those countries solutions that are up-to-date, on demand, and personalized to increase productivity and drive know-how.

See page: 446

ELBIT SYSTEMS LTD.

Advanced Technology Center
 P.O.Box 539
 Haifa 3105301, Israel
 Tel: 972-4-8315315
 Web Site: www.elbitsystems.com
 President & C.E.O:
 Mr. Bezahel (Butzi) Machlis
 Executive V.P. International Marketing &
 Business Development: Mr. Jacob Gadot
 Senior Director, Marketing
 Communications: Mrs. Roni Ganani
 Number of employees: 13,000
 Date established : 1966
 Ownership: Public Co.
 Major shareholder: Federmann Group
 NASDAQ Global Market: ESLT

Areas of activity

- Defense & Commercial Airborne Systems & Simulators
- Unmanned Systems
- C⁴I - Command, Control, Communications, Computers and Intelligence
- ISR & Electro-optical Systems
- Combat Vehicle Systems
- Naval Systems
- EW & Countermeasures
- Radio Communication & Data Links
- Homeland Security
- Support & Services

See pages: 18, 19, 20, 50, 51, 52, 53, 58, 60, 68, 69, 99, 110, 111, 122, 256, 278, 279, 280

ELBIT SYSTEMS ELECTRO-OPTICS - ELOP LTD.

Advanced Technology Park
 P.O.Box 1165
 Rehovot 7611101, Israel
 Tel: 972-8-9386211
 Fax: 972-8-9386237
 E-mail: eo@elbitsystems.com
 Web Site: www.elbitsystems.com/elop
 E.V.P. & Managing Director:
 Mr. Adi Dar
 V.P. Business Development & Marketing:
 Mr. Roy Zentner
 Number of employees: 1,400
 Date established: 1938
 Ownership: Elbit Systems Ltd.

Areas of activity

An industry leader in all aspects of electro-optic products and systems, offering a full spectrum of solutions aimed mainly at the defense market: laser and thermal imaging systems; head-up displays; ISR systems, including payloads for space, airborne, naval and land-based missions; space and air IMINT systems; ground integrated sights, EO countermeasures (EOCM) and homeland security solutions.

See pages: 48, 49, 74, 90, 91, 134, 135, 162, 341, 342, 343, 352, 353, 354, 355, 360, 361, 362, 363

ELBIT SYSTEMS EW & SIGINT – ELISRA LTD.

29 Hamerkava St.,
 Holon 5885118, Israel
 Tel: 972-3-5577335
 Fax: 972-3-5577793
 E-mail: ew-sigint@elbitsystems.com
 Web Site: www.elbitsystems.com
 Chairman of the Board: Joseph Ackerman
 C.E.O: Mr. Edgar Maimon
 V.P. Marketing & Business Development:
 Mr. Irmin Mencher
 V.P C.F.O: Mr. Nir Shani
 V.P. & G.M. Operations: Mr. Avi Elya
 Number of Employees: 1,500
 Date Established: 1967
 Ownership: Elbit Systems Ltd.

Areas of Activity

- Complete, Integrated Self-Protection Suites including RWR, LWS, Jammer, and Passive IR Missile Warning System for Fighters, Helicopters, Transport Aircraft, MPA and Combat Vessels
- Intelligence, including ESM/ELINT Systems for MPA, Reconnaissance Aircraft and Helicopters
- ESM and COMINT for UAVs
- EW, COMINT/DF, COMJAM and Integrated Communication Systems for Modern Air, Ground and Navies
- Search and Rescue Systems for the most advanced combat and peacetime requirements
- Data Links for various types of UAVs, Guided Weapons and Satellites
- C² for BMD (Theater Missile Defense, including Test Bed and Battle Management Center for the ARROW Weapon System), C⁴I for Integrated Intelligence, EW, and Land systems for all operational levels.
- Network Centric Warfare
- Spectrum Management and Control
- Microwave Components and Sub systems

See pages: 75, 118, 226, 309

ELBIT SYSTEMS LAND AND C⁴I LTD.

2 Ha'machshev St.,
Netanya 4250712, Israel
Tel: 972-9-8898080
Fax: 972-9-8898231
E-mail: landc4i@elbitsystems.com
Web Site: www.elbitsystems.com/landc4i
Executive Vice President & General
Manager: Mr. Yehuda Vered
Vice President Marketing & Business
Development: Mr. Boaz Cohen
Number of employees: 2,450
Date established: 2003
Ownership: Elbit Systems Ltd.

Areas of activity

- Armored Vehicle Systems
- Artillery
- Guns
- Mortars
- Ammunition
- Unmanned Ground Vehicles
- Sensors
- Robotics
- Radio Communication
- C⁴I - Command, Control,
Communications, Computers and
Intelligence
- Homeland Security
- Intelligence

See pages: 136, 137, 138, 139, 198, 199,
200, 201, 294, 298, 299, 300,
301, 302, 303, 304, 310, 311,
312, 313, 320, 321

ELIEL SECURITY TECHNOLOGIES LTD.

P.O.Box 9949
Haifa 3109901, Israel
Tel: 972-4-8222279
Fax: 972-4-8327613
E-mail: eliela@netvision.net.il
Web Site: N/A
General Manager & Marketing Director:
Mr. Eli Cohen
Number of Employees: 2
Date established: 1996
Ownership: Private

Areas of activity

ELIEL Security Technologies Ltd is involved in Marketing, Consultancy Import/Export of Technological Systems applicable in the Military and Security Fields.

Company Specialization

Services: International Marketing, Governmental Agencies Ties and Industrial Cooperation.

Technology & Products: Special and common Electro-Optical Systems applicable in the Military and Security Fields, Like: Day/Night Observation Integrated Systems, under water Cameras and Laser Gated & Illuminated Devices, Special EO System etc.

Countries of Export: Central & Eastern Europe, Scandinavia and SADC (South African Development Community).

See page: 447

ELTEL TECHNOLOGISTICS LTD.

11 Tuval St.,
Ramat Gan 5252226, Israel
Tel: 972-3-7557000
Fax: 972-3-7527001
E-mail: info@eltel.co.il
Web Site: www.eltel.co.il
V.P. Marketing & Business Development:
Mr. Meir Harel
Business Development Director:
Mr. Ariel Avrech
C.E.O: Mr. Yotam Gadot
Number of Employees: 380
Date established: 1979
Ownership: 50% Elul Tamarynd Ltd.,
50% Malam Team

Areas of activity

Eltel Technologists Ltd. Is a leading defense provider of technological and logistics solutions that specializes in the field of training and simulation:

- Advanced live fire training.
- Digital shooting ranges.
- Scenario simulation (urban combat training, pyrotechnics, smoke, etc.).
- Exercise monitoring, debriefing and performance analysis.
- Synthetic Arena Simulation (SAS).
- Competence and Readiness Performance Management (CRPM) - an advanced BI system that supports the decision making process along the chain of command.

See page: 257

GAZIT RAN LAW OFFICE & NOTARY

One Azrieli Center Circular Tower
132 Menachem Begin Rd.
Tel Aviv 6702101, Israel
Tel: 972-3-5607711
Fax: 972-3-5607712
E-mail: contact@ran-gazit.com
Web Site: www.ran-gazit.com
Ran Gazit, Advocate
Date established: 1987

Areas of activity

Legal services.

See page: 448

GILAT SATELLITE NETWORKS LTD.

21 Yegia Kapaim St.,
Kiryat-Arye
Petach-Tikvah 4913011, Israel
Tel: 972-3-9252003
Fax: 972-3-9213321
E-mail: info@gilat.com
Web Site: www.gilat.com
Chairman of the Board & Chief Executive Officer: Mr. Amiram Levinberg
Number of Employees: 950
Date Established: 1987
Ownership: Publicly traded company on the TASE in addition to the NASDAQ

Areas of activity

Gilat Satellite Networks Ltd. is a leading provider of satellite communications products and services. For more than 20 years, Gilat has been at the forefront of VSAT technology and services and continues to be an innovator and developer of new satellite technologies. Gilat's solutions serve the communications needs of carriers, enterprises, governments, service providers and consumers around the globe.

Gilat offers a full range of satellite communications products and solutions:

- SkyEdge and SkyEdge II - Advanced high performance cost-effective and flexible VSAT systems supporting diverse needs.
- NetEdge - Dedicated solution for multi star networks, specifically designed to meet the needs of corporations and cellular backhaul applications.
- Value-added solutions for specific markets and industries, integrating SkyEdge and SkyEdge II with other technologies and applications.
- Turnkey projects to help rapidly create and implement fully functional communications solutions.
- Outsourcing for cost-effective network operations.

See page: 305

G-NIUS

Unmanned Ground Systems (UGS) LTD.
9 Einstien St.,
Advaced Technology Park
P.O. Box 4018
Nes-Ziona 7414001, Israel
Tel: 972-8-9308402
Fax: 972-8-9308420
E-mail: marketing@g-nius.co.il
Web Site: www.g-nius.co.il
C.E.O: Mr. Yoav Hirsh
V.P. Marketing & Business Development: Mr. Gabi Davidson
V.P. R&D: Mr. Amram Yanai
Number of Employees: 35
Date Established: 2008
Ownership: 50% Elbit Systems, 50% IAI

Areas of activity

G-NIUS Unmanned Ground Systems Ltd. is a pioneer in unmanned ground vehicle (UGV) systems for defense and security applications. Founded in 2007, G-NIUS is a joint venture between Israel Aerospace Industries Ltd. (IAI) and Elbit Systems Ltd.

See page: 293

HAGOR INDUSTRIES LTD. MILITARY EQUIPMENT MANUFACTURING

P.O.Box 3211
Kiryat Arie
Petach-Tikva 4951601, Israel
Tel: 972-3-9248990
Fax: 972-3-9243996
E-mail: info@hagor.co.il
Web Site: www.hagor.com
General Manager: Mr. Haim Frenkel
Number of employees: 80
Date established: 1952
Ownership: Private

Areas of activity

Production, marketing and sales of armored vests of many different kinds, battle vests for infantry units, armored corps, demolition squads, medical units, anti-terror units, naval commando, etc. Winter gear - long and short cold parkas and overalls. Rucksacks, kitbags, sleeping bags, stretchers, field cots, carriers, special personal gear. Unique, reinforced PVC vehicle covers for all kinds of trucks, jeeps, command cars etc. All kinds of tents, from personal tents to giant hospital and camp tents.

See page: 166

HARTECH TECHNOLOGIES LTD.

22 Maskit St.,
Herzliya 4673322, Israel
Tel: 972-74-7200800
Fax: 972-9-9549394
E-mail: marketing@hartechnology.co.il
Web Site: www.hartechnology.co.il
C.E.O: Mr. Offer har
Offer@Hartechnology.co.il
Director Business Development:
Mrs. Rachel Wolstein
Date established: 2002
Ownership: Private

Areas of activity

HarTech's products include:

- Command and Control Systems
- High fidelity simulation engine for the generation of high fidelity simulation solutions
- Provision of Constructive Simulation and Training solutions
- Geo Spatial Management System (GEM)
- HarTech's Behavior Editor for Advanced Computer Generated Forces
- Smart Scenario Generation Technology (SSG)

See page: 70

HATEHOF LTD.

P.O.Box 639
Ind. Zone Ziporit
Nazareth Elite 1710502, Israel
Tel: 972-4-6410641
Fax: 972-4-6418555
E-mail: hatehof@hatehof.co.il
Web Site: www.hatehof.co.il
C.E.O: Mr. Alon Guttel
Number of employees: 120
Date established: 1947

Areas of activity

Design and Manufacture of Armored vehicles, Aircraft Refuellers, Tankers, Fire fighting and Rescue vehicles, Riot Control vehicles, Comprehensive solution of NBC vehicles, Tank transporter, Add-on Armor design and solution, Palletised load system (hook lift), Trailers and Wagons.

We have the ability and capability to meet the customer's needs while offering the most cost effective tailor-made solution.

See pages: 133, 418

HBA SYSTEMS INTEGRATORS

77 Herzl St.,
Oasis Towers
Ramat Gan 5244350, Israel
Tel: 972-3-6722226
Fax: 972-3-6722193
E-mail: manuel.bar-gil@hba.co.il
Web Site: www.hba.co.il
President & C.E.O: Mr. Haim Ben-Ari
Vice President: Avi Golan
V.P Marketing & Sales:
Mr. Manuel Bar-Gil
Date established: 1979
Ownership: Private

Areas of activity

- EOD solutions - EOD Robots, professional training
- Logistic Solutions for Emergency Deployment - Hospitals, Military & Civilian camps
- Unique non-lethal equipment & world wide security consultation services
- Integration of border crossing checkpoints & marine cargo inspection facilities and maritime protection
- Security commercial trade
- Explosives - Binary explosives and disrupters, electronic initiation system
- Forensics equipment

See page: 220

HERLEY ISRAEL (General Microwave and Eyal)

20 Pierre Koenig St.,
Jerusalem 9346928, Israel
Tel: 972-2-5689444
Fax: 972-2-6782460
E-mail: sales@hgmi.biz
Web Site: www.herley.com
General Manager: Mr. Yonah Adelman
Operation Manager: Mr. Ami Gorbat
Sales and Marketing Manager:
Mr. Koby Pinsker
Number of employees: 350
Date established: 1985
Ownership: A Kratos Company

Areas of activity

Herley Israel is a recognized worldwide leader in the design and manufacture of high performance, State-of-the-Art Microwave components and subassemblies for the defense as well as non-defense markets. Herley Israel is one of the largest international independent microwave companies. Herley Israel designs and manufactures a high performance microwave sources, Integrated Microwave Assemblies (IMAs) and Microwave Control Components, Millimeter Wave Modules (MWM) and Beam Forming Modules (BFM), providing catalog and custom solutions. Herley Israel products provide a unique combination of cutting edge technology at a very competitive price. Its products are used in a wide variety of demanding applications including airborne electronic warfare (EW) systems, phased array radar systems, missiles and EW simulators.

See page: 375

HIGHTECH LTD.

P.O.Box 65184
 Tel-Aviv 6949218, Israel
 Tel: 972-3-6414306, 6418265
 Fax: 972-3-6415930
 E-mail: hightech@hslrl.com
 C.E.O: Mr. Rony Lerner
 E-mail: ronylr@hslrl.com
 V.P. Marketing: Mr. Ofer Lerner
 Number of employees: 8
 Date established: 1988
 Ownership: Private - Rony Lerner

Areas of activity

Riot control special equipment.
 Ground Forces equipment.
 Riot control vehicles equipped with most advanced pulse jet cannon system.
 Equipment for elite military/police units.
 Explosive disposal and demolition equipment and vehicle.
 Offensive anti-terrorist SWAT demolition and disposal equipment and vehicle.
 Supply of military and paramilitary equipment.

See page: 424

**HOSHEN - ELIAV
SYSTEM ENGINEERING LTD.**

19 Weissburg St.,
 Tel-Aviv 6935831, Israel
 Tel: 972-3-6482182
 Fax: 972-3-6481635
 E-mail: office@hoshen-eliav.co.il
 Web Site: hoshen-eliav.co.il
 C.E.O: Mr. Gideon Hoshen
 C.E.O: Mr. Jossef Eliav
 C.O.O: Mr. Daniel Lederer
 Number of employees: 80
 Date established: 1986
 Ownership: Private

Areas of activity

System engineering company.
 Hoshen Eliav plays an important role in the research and development of national mission critical projects, amongst them the ARROW active defense system, AEW systems, SIGINT systems and C² systems. The core capability of Hoshen-Eliav is in the fields of system engineering and consulting to government, defense agencies and defense industries as well as civilian industries.

See page: 451

IAI**BEDEK AVIATION GROUP**

Ben-Gurion International Airport
 70100, Israel
 Tel: 972-52-3663023, 9353845
 Fax: 972-3-9354262
 E-mail: mscharf@iai.co.il
 Web Site: www.iai.co.il
 IAI Corp V.P. & General Manager
 Bedek Aviation Group: Mr. E. Hattem
 Corp. Dep. V.P & General Manager
 Marketing & Business
 Development: Mr. J. Gaber
 Director, Marketing & Business
 Development: Mr. M. Scharf

Areas of activity

Full service provider center for military and civil aircraft. Local and offshore airline support, repair, overhaul, retrofit, modification, upgrading, conversion and customizing of some 30 types of military and civil aircraft, 25 types of engines and 13000 types of components, in three Divisions:
 Aircraft Division
 Engine Division
 Components Division

See page: 21

IAI**ELTA SYSTEMS LTD.**

100 Yitzchak Hanasi Blvd.
 P.O.Box 330
 Ashdod 7710202, Israel
 Tel: 972-8-8572410
 Fax: 972-8-8561872
 E-mail: market@elta.co.il
 Web Site: www.elta-iai.com
 Chairman of the Board of Directors
 President & C.E.O of IAI:
 Mr. Joseph Weiss
 President & IAI Corp. V.P.:
 Mr. Nissim Hadas
 V.P Operations: Mr. Yacob Saraf
 V.P. Finance: Mr. Moshe Lippel
 V.P. General Counsel: Mr. Tal Sagee
 General Manager/ELTA Ground & Naval Radars & Systems Division:
 Mr. Yosef Oren
 General Manager/ELTA Airborne Systems & Radars Division:
 Mr. Gideon Landa
 General Manager/ELTA SIGINT, EW & Communication Division:
 Mr. Eyal Danan
 General Manager/ELTA Microwave Systems Division: Mr. Yosef Fouks
 General Manager/ELTA Technologies Division: Mr. Ronen Zagoory
 ELTA Group Marketing Director:
 Mr. Igo Licht

Areas of activity

Military and Para-Military Systems House based on Electromagnetic Sensors (Radar, Electronic Warfare and Communication) & Advanced Technologies, for Intelligence, Surveillance & Reconnaissance, Early Warning, Air Defense, Weapon Location, Self-Protection, Target Acquisition, Fire Control, Signal Intelligence, Electronic Warfare and Home-Land Security Applications.

See pages: 22, 76, 80, 81, 109, 259, 281, 306, 322, 323, 324

IAI
LAHAV DIVISION
Military Aircraft Group
Ben-Gurion International Airport
7010000, Israel
Tel: 972-3-9353163, 9358198
Fax: 972-3-9353687, 9357010
E-mail: lahav_marketing@iai.co.il
Web Site www.lahav-iai.com
General Manager:
Mr. Yosef (Yosi) Melamed
Deputy General Manager:
Mr. Jacob Rozmann
Director of Marketing: Mr. Netta Kerem

Areas of activity

Lahav provides innovative solutions for:

- Military aircraft and helicopter upgrade, refurbishment, overhaul, maintenance, repair, and life extension
- Avionics system and software design, development, integration, and testing
- Stand-alone and networked tactical simulators, trainer upgrades with embedded synthetic training, and pilot evaluation systems
- Design and production of aerostructures, and electrical harnesses
- Robotic solutions for a wide range of operational fields and missions utilizing cutting edge of robotics technology

See pages: 23, 24, 25, 71, 295

IAI
MALAT DIVISION
Military Aircraft Group
Ben-Gurion International Airport
7010000, Israel
Tel: 972-3-9358169
Fax: 972-3-9355781
E-mail: malat@iai.co.il
Web Site: www.malat-iai.com
General Manager: Mr. Shaul Shahar
Marketing Director: Mr. Avi Bleser

Areas of activity

IAI/MALAT specializes for over 38 years in the design, development, integration, manufacturing and support of UAS (Unmanned Aerial Vehicle Systems) for military, para-military and civilian applications. IAI/MALAT's systems have accumulated over 1,000,000 operational flight hours. IAI/MALAT covers the full spectrum of UAV systems, providing solutions for urban warfare, tactical and strategic missions and comprehensive maritime solutions by using its micro, mini, tactical close range, tactical short range, VTOL systems and Medium Altitude Long Endurance (MALE) systems. IAI/MALAT provides comprehensive UAV systems with complete ILS (Integrated Logistic Support) and customer support in order to ensure their smooth entry into operational service.

See pages: 283, 284, 285, 286, 287, 288

IAI
AIR & MISSILE DEFENSE DIVISION
Systems Missiles & Space Group
P.O.Box 105
Industrial Zone
Yehud 5610002, Israel
Tel: 972-3-5315699
Fax: 972-3-5315830
E-mail: marketing@iai.co.il
Web Site: www.iai.co.il

Areas of activity

Point and area advanced air and missile defense systems from short to long ranges - low to high altitude targets fully net centric highly effective naval and land based applications.

See pages: 61, 92, 112, 260

IAI
MISSILES DIVISION
Systems Missiles & Space Group
P.O.Box 105
Industrial Zone
Yehud 5610002, Israel
Tel: 972-3-5315699
Fax: 972-3-5315830
E-mail: marketing@iai.co.il
Web Site: www.iai.co.il
General Manager: Mr. Ariel Malchi

Areas of activity

- Missile Systems and PGM
- Naval Systems
- Ground Systems
- Air Defense Systems
- Laser weapons

See pages: 61, 92, 112, 260

**IAI
SPACE DIVISION
Systems Missiles & Space Group**

P.O.Box 105
Industrial Zone
Yehud 5610002, Israel
Tel: 972-3-5315699
Fax: 972-3-5315830
E-mail: marketing@iai.co.il
Web Site: www.iai.co.il
General Manager: Mr. Opher Doron

Areas of activity

Space Systems, including GEO communication and LEO EO and SAR imaging satellites, ground stations and related services.

See page: 61, 92, 112, 260

**IAI
SYSTEMS MISSILES & SPACE
GROUP**

P.O.Box 105
Industrial Zone
Yehud 5610002, Israel
Tel: 972-3-5315699
Fax: 972-3-5315830
E-mail: marketing@iai.co.il
Web Site: www.iai.co.il
Corporate V.P & General Manager
Systems Missiles & Space Group:
Mr. Boaz Levi
Director of Marketing:
Mr. Yoram Shimoni

Areas of activity

Defense Systems, Advanced Weapon Systems and Space:
- Missile Systems and PGM
- Air and Missile Defense Systems
- Naval Systems
- Ground Systems
- Intelligence, Surveillance and Reconnaissance (ISR) Systems
- Anti-Ballistic Missile Defense
- Space Systems - Satellites, Launchers and Ground Stations
- Optronic Payloads

See pages: 61, 92, 112, 260

**IAI
RAMTA DIVISION
Commercial Aircraft Group**

P.O.Box 323
Beer Sheva 8410202, Israel
Tel: 972-8-6402250
Fax: 972-8-6402252
E-mail: mktg@iai.co.il
Web Site: www.iai.co.il/ramta
General Manager: Mr. M. Gilboa

Areas of activity

Aluminium Fast Patrol Boats.
Minefield Breaching Systems.
Multipurpose armored vehicles.
Combat ground and naval robotic platforms and kits.
Air and ground defense weapon subsystems.
Aircraft ground support equipment.
Missile Launchers.
Manufacture, overhaul and upgrade of aircraft structure.
Metal and composite material parts and subsystems in civil and military aviation.
B747 Cargo Door.

See pages: 33, 104, 218, 219

**IAI
TAMAM DIVISION
Systems Missiles & Space Group**

P.O.Box 75
Industrial Zone
Yehud 5610001, Israel
Tel: 972-3-5315205
Fax: 972-3-5315140
E-mail: infotmm@iai.co.il
Web Site: www.iai.co.il/tamam
General Manager: Mr. Shaul Shahar
Deputy General Manager:
Mr. David Dina
Director of Marketing: Mr. Igal Mevorach

Areas of activity

TAMAM Division is an integral part of Israel Aerospace Industries Ltd. (IAI) Systems, Missiles and Space Group. Since its foundation in 1964, TAMAM has been a leader in advanced electro-optical systems and inertial navigation technologies for use on air, land, sea and space platforms. TAMAM leads advanced projects for the Israel Defense Forces (IDF) and other armed forces around the world. Among the company's main products are day/night electro-optical systems for unmanned air vehicles (UAVs), helicopters, fixed-wing aircraft, ground and maritime applications - such as LOROS, MOSP, POP, MiniPOP, MicroPOP and GTADS. TAMAM supplies an array of land and airborne inertial navigation and reference systems such as NFS, TMAPS, ADNAV, RNAV-IPON and TNL-16, competitively priced strapdown systems for tactical weapons and smart ordnance such as TRF-90 as well as guidance and reference systems for space platforms.

See pages: 344, 358, 377

IARD**Sensing Solutions Ltd.**

Yagur 3006500, Israel
Tel: 972-4-8216402
Fax: 972-4-8216396
E-mail: yossi.b@iard.co.il
Web Site: www.iard.co.il
C.E.O: Dr. Yossi Bushlin
C.T.O: Dr. Adam Devir
Number of employees: 30
Date established: 1998
Ownership: Private

Areas of activity**Radiometry, E-O Systems**

Design and construction of unique E-O instrumentation for accurate radiometric measurements. Design, performance and analysis of complicated radiometric field-tests.

Signature Control

Multispectral signatures management (measurement, evaluation, and development of suppression measures) for various platforms and installations.

Modeling and Simulation

Modeling and simulation of Electro-optical systems. Image processing and algorithms development. Analysis and modeling of aero-optics and heat & mass transfer phenomena.

See page: 370

IMAGESAT**INTERNATIONAL N.V.**

6 Yoni Netanyahu St.,
Or Yehuda 6037604 , Israel
Tel: 972-3-7960600
Fax: 972-3-5163430
E-mail: orders@imagesatintl.com
Web Site: www.imagesatintl.com
C.E.O: Mr. Avi Winter
V.P Marketing & Sales: Mr. Noam Zafirir
V.P Business Development:
Mr. Rani Helerman
Number of employees: 60
Date established: 1997
Ownership: IAI, Elbit Systems, Private Share Holders

Areas of activity

ImageSat International N.V. is a commercial provider of Very High Resolution (VHR), satellite earth-imagery from EROS constellation of satellites, principally for intelligence, homeland security and national development purposes worldwide.

The Company also provides imagery to customers for a wide-range of civilian applications, including mapping, disaster assessment and monitoring, infrastructure planning, agricultural monitoring, environmental monitoring etc.

See page: 325

IMCO INDUSTRIES LTD.

8 Hataasia St.,
P.O.Box 188
Tel-Hanan 3660102, Israel
Tel: 972-4-8213322
Fax: 972-4-8210508
E-mail: marketing@imco-ind.com
Web Site: www.imco-ind.com
C.E.O: Mr. Efraim Grimberg
C.F.O: Mr. Dan Sraya
VP Marketing: Mr. Boaz Weiss
Number of Employees: 300
Date Established: 1974
Ownership: Public Company traded in Tel-Aviv Stock Exchange (TASE: IMCO)

US OFFICE

4820 Seton Dr.
Baltimore, MD 21215
Tel: 410-358-1717

Fax: 410-358-7707

SUBSIDIARIES

ADT - ADVANCED DEFENCE TECHNOLOGIES Inc. USA,
Nir-Or (Israel) Ltd.
Atena Ltd.

Areas of Activity

Engineering and Manufacturing of military and commercial electrical, electro-mechanical and electronic assemblies, cable harnesses, for airborne, land and naval applications.
LED Lights (interior & exterior) for tanks and armored fighting vehicles
Slip-rings, fuel-gauges, smoke grenade launchers.

See page: 210

IMI DEFENSE LTD.

P.O.Box 396
Zihron Yaakov 3095203, Israel
Tel: 972-77-5321622
Fax: 972-77-5356512
E-mail: marketing@imidefense.com
Web Site: www.imidefense.com
C.E.O: Mr. Nisim Zusman
Office Manager: Mrs. Milla Ravzin
Engineer: Mr. Shahar Choen
Number of employees: 30
Date established: 1998
Ownership: Private

Areas of activity

Made and developed in Israel, as a result of the need for the best quality Polymer Holster system for the military and defense community, IMI Defense was developed to fulfill this mission. Specializing in producing of tactical polymer holsters and magazine pouches, as well as tactical accessories for rifles and pistols.

See page: 252

IMI ISRAEL MILITARY INDUSTRIES LTD.

P.O.Box 1044
64 Bialik Blvd.
Ramat Hasharon 4710001, Israel
Tel: 972-3-5485222
Fax: 972-3-5486125
E-mail: imimrktg@imi-israel.com
Web Site: www.imi-israel.com
Chairman of the Board:
Adv. Nitza R. Posner
President & C.E.O.: Mr. Avi Felder
V.P. Marketing: Mr. Avinoam Zafir
V.P. Finance & Control:
Mrs. Zmira Ganani
V.P. Research & Development and
Business Development: Dr. Dan Peretz

Areas of activity

Established in 1933 and fully owned by the Israeli government, IMI specializes in the development, integration and manufacture of offensive and defensive solutions for the modern battlefield, homeland security and terror threats. IMI's state-of-the-art systems for land, air and naval forces, draw on the extensive experience of the Israel Defense Forces (IDF), most of them are combat- proven and have been type classified by the IDF, US Armed Forces (Army, Air Force & Navy) and various NATO members. IMI provides full combat solutions, professional training and services, designed to fully respond to specific customer requirements of survivability and protection, firepower and mobility on the modern battlefield. The company employs 3,400 professional, customer-devoted employees in five divisions. In addition to modern design and development shops, IMI operates production facilities, supported by advanced laboratories and test facilities accounting for 30% of the company's infrastructure. IMI's comprehensive support for its customers includes end-to-end product assistance, from training and integrated logistics to maintenance, mid-life upgrades to the transfer of technology know-how and complete after sales support.

See pages: 62, 77, 93, 113, 140, 202, 232, 233, 425, 453

IMI ACADEMY FOR ADVANCED SECURITY & ANTI-TERROR TRAINING

P.O.Box 1044
64 Bialik Blvd.
Ramat Hasharon 4710001, Israel
Tel: 972-8-9357040/1
Fax: 972-8-9357042
E-mail: academy@imi-israel.com
Web Site: www.imi-academy.com
President & C.E.O: Mr. Amiram Maor
V.P. Professional: Mr. Yigal Levin
V.P. Operation Manager:
Mr. Itzhak Agami
Marketing Manager: Mr. Guy Lalush
Ownership: Israel Military Industries Ltd. (I.M.I)

Areas of activity

The IMI Academy for Advanced Security & Anti-Terror Training is a leading integrated solutions provider for military, law enforcement, government agencies and commercial clients worldwide. Established in 1999 by veterans of the Israeli Security Forces, the Academy specializes in a wide range of comprehensive security training programs, including anti-terrorism, anti-crime and homeland security. It is a subsidiary of Israel Military Industries Ltd. (IMI), a government owned company. The Academy draws its strength from the accumulated knowledge of the Israeli security establishment. Its facilities, highly-experienced instructors and range of courses and seminars, have positioned the Academy as a model organization of its kind, one that its competitors attempt to emulate.

See page: 425

**IMI
ADVANCED SYSTEMS DIVISION
(ASD)**

P.O.Box 1044
64 Bialik Blvd.
Ramat Hasharon 4710001, Israel
Tel: 972-3-5486170
Fax: 972-3-5486633
E-mail: asdmrkte@imi-israel.com
Web Site: www.imi-israel.com
V.P. & Division Manager:
Mr. Yuval Sharony
Director of Marketing & Business
Development: Mr. Shmulik Geler

Areas of activity

ASD develops and manufactures advanced weapon systems, sub-systems and ordnance for aerospace, land and naval platforms. ASD offers a full range of innovative, combat-proven solutions, including electro-optically guided missiles, stand-off offensive weapons, advanced decoys and aerial targets and very short range, low-level air defense integrated systems (VSHORAD).

**IMI
MUNITION SYSTEM DIVISION
(MSD)**

P.O.Box 1044
64 Bialik Blvd.
Ramat Hasharon 4711001, Israel
Tel: 972-3-5486243
Fax: 972-3-5485365
E-mail: imiimrktg@imi-israel.com
Web Site: www.imi-israel.com
V.P. & Division Manager:
Mr. Shemuel Moran
Director of Marketing & Business
Development: Dr. Mordechai Ilovich
Tel: 972-3-5486499
E-mail: ilo@imi-israel.com
Systems Directorate Manager:
Mr. Israel Latovitz
Tel: 972-3-5485745
E-mail: latovitz@imi-israel.com
Land Munition Directorate:
Mr. Daniel Davidi
Tel: 972-3-5486452
E-mail: ddavidi@imi-israel.com

Areas of activity

MSD develops and manufactures a full range of ammunitions. MSD is renowned for its innovative developments in the fields of:

- Advanced tank ammunition
- Advanced artillery ammunition
- Mortar, aerial land and naval ammunition
- Smart, precise munitions
- Infantry combat systems, such as rifle grenades, hand grenades, demolition and breaching equipment, non-lethal, engineering combat systems, ordnance and ammunition components
- Homeland security products and services
- Self-destruct warheads for various platforms (artillery, tank, mortar and aerial)
- Insensitive Munition (IM) technology

MSD also specializes in:

- Refurbishment and upgrading of all types of munitions
- Ammunition disposal, including a Mobile Demiling and Recycling Plant
- Manufacture of all kinds of metal parts and explosive materials

**IMI
ROCKET SYSTEMS DIVISION
(RSD)**

P.O.Box 1044/6604
64 Bialik Blvd.
Ramat Hasharon 4711001, Israel
Tel: 972-8-9242684
972-8-9277447/9
Fax: 972-8-9252896
E-mail: iweinreb@imi-israel.com
Web Site: www.imi-israel.com
V.P. & Division Manager:
Mr. Nathan Wechsler
Director of Marketing: Mr. Israel Weinreb
R&D Director: Mr. Izhak Bagizada

Areas of activity

RSD develops and manufactures rocket motors, from small motors to satellite launchers, artillery rocket systems, anti-tank weapon systems, pyrotechnic and counter measure products, including IR spectral decoy flares, chaff products, as well as protection suites (i.e. AIRMOR) for aircraft, ballistic armor for personnel, aircraft and naval vessels.

**IMI
SLAVIN - LAND SYSTEMS
DIVISION**

P.O.Box 1044
64 Bialik Blvd.
Ramat Hasharon 4711001, Israel
Tel: 972-3-5485790
Fax: 972-3-5486797
E-mail: info_slavin@imi-israel.com
Web Site: www.imi-israel.com
V.P. & Division Manager:
Mr. Eyal Ben-Haim
Director of Marketing & Business
Development: Mr. Rami Sokolower
Manufacturing Director: Mr. Avi Fuks

Areas of activity

SLAVIN LSD specializes in:
Upgrade programs and systems for MBTs
& AVFs.

Development and Production of:

- Guns and Barrels: 120mm (Merkava, M60), 105mm (M60, T55), 90mm, 76mm, 60mm aircraft guns, 106mm recoilless guns
- Ballistic armor protection for MBTs, AVFs and light combat vehicles
- Active Protection Systems for vehicles and other applications
- Remote Controlled Weapon Stations for 5.56, 7.62, 12.7mm/0.5" machineguns and 40mm grenade launchers
- Assault logistic and infantry bridging systems
- Training equipment, inbore sub-caliber training device

**IMI
SMALL CALIBER
AMMUNITION DIVISION
("Yitzhak" PLANT)**

P.O.Box 1044
64 Bialik Blvd.
Ramat Hasharon 4711001, Israel
Tel: 972-4-6500700/5
Fax: 972-4-6560686/6578058
E-mail: israels@imi-israel.com
Web Site: www.imi-israel.com
Division Manager: Mr. Israel Shmilovitz
Director of Marketing: Mr. Paul Flaisher
E-mail: paulf@imi-israel.com

Areas of activity

IMI's Small Caliber Ammunition (SCA) Division specializes in the manufacture of high-quality cartridges, which are supplied in accordance with NATO, MIL-SPEC, IDF, SAAMI and CIP standards. These include 5.56, 7.62, 9, 12.7mm and 0.388" cartridges. SCA is the leading supplier of small caliber ammunition to the Israel Defense Forces (IDF). Other customers include the U.S. Army, armed forces of major NATO members, law enforcements, special units and customers in commercial markets worldwide.

**INNOCON
Innovative Control Solutions**

32 Habani St.,
Holon 5885607, Israel
Tel: 972-3-5586330
Fax: 972-3-5588382
E-mail: innocon@innoconltd.com
Web Site: www.innoconltd.com
President: Mr. Zvika Nave
C.E.O: Mr. Michael Armon
C.T.O: Mr. Ziv Nave
Number of employees: 10
Date established: 2001
Ownership: Private

Areas of activity

INNOCON Ltd. is a developer and manufacture of UAVs (unmanned aerial vehicles) ranging from micro-UAVs weighing a mere 2.5kg to 650kg full-size UAVs, equipped with the company's proprietary command and control systems. The company delivers either complete systems or major sub-systems. INNOCON's technological advantages are clearly demonstrated in the superior performance of its core command and control technology on all company UAVs. Combined and interoperable onboard and ground-based computers feature modular software, enabling unprecedented levels of flight, take-off and landing control capabilities. INNOCON's UAVs are in service in the U.S. and Israel as well as in numerous Asian, African and South American countries.

See page: 282

ISDS LTD. -**International Security & Defence Systems**

P.O.Box 173
 Nir-Zvi 7290500, Israel
 Tel: 972-8-9227699
 Fax: 972-8- 9235104
 E-mail: isds@isds.co.il
 Web Site: www.isds.co.il
 President: Mr. Leo Gleser
 CEO: Mr. Tomer Fulman
 Vice President: Mr. Ron Shafran
 Number of employees: 25
 Date established: 1982
 Ownership: Private

Areas of activity

- ISDS Ltd. specializes in planning, integrating, and managing large scale security and defense systems/projects.
- ISDS Ltd. specializes in the development, procurement, integration and implementation of security technology. The company provides special services and operations and supplies military and defense equipment.
- ISDS Ltd. specializes in setting up programs and training special units.
- ISDS Ltd. specializes in the design, integration, and implementation of Security Systems for Major Events and VIP's.

See pages: 426, 427, 428, 429, 430, 431, 432, 433, 434, 435, 436, 437

I.S.P. INDUSTRY SALES PROMOTION LTD.

1 Lishansky St.,
 New Industrial Zone
 P.O.Box 500
 Rishon-Lezion 7510401, Israel
 Tel: 972-3-9513333
 Fax: 972-3-9514444
 E-mail: ariel.goldman@isp-aero.com
 Chairman of the Board:
 Mr. Ariel Goldman
 Sales Manager: Mrs. Smadar Goldman
 Sales Manager: Mr. Ori Yovel
 Number of employees: 8
 Date established: 1977
 Ownership: Ariel Goldman

Areas of activity

- Aerospace Systems and components
- Weapon Systems and components
- Small arms, artillery and ammunition
- Spare parts for aerospace and military equipment
- Overhaul and repair of aviation and military systems
- Upgrading programs
- Border defense projects

See page: 34

ISPRA**Israel Product Research Co. LTD.**

16 Galgalei Haplada St.,
 P.O.Box 2086
 Herzeliya 4672220, Israel
 Tel: 972-9-9555464
 Fax: 972-9-9559146
 E-mail: ispra@netvision.net.il
 Web Site www.ispraltd.com
 General Manager: Mr. Jacob Bialy
 V.P. Marketing: Mr. Alon Slonim
 Export Manager: Mrs. Chana Michaeli
 Quality Assurance Manager:
 Mr. Yohanan Stein
 Number of employees: 30
 Date established: 1969
 Ownership: Dr. A. Jacobson

Areas of activity

Development, manufacturing, export of less-lethal ammunition, riot control, anti-terror equipment, police gear, and personal protection devices.
 Tear gas devices for short, medium and long range operation.

See pages: 168, 169

ISRAEL SHIPYARDS LTD.

P.O.Box 10630
 Haifa Bay 2611702, Israel
 Tel: 972-4-8460246
 Fax: 972-4-8418744
 E-mail: marketing@israel-shipyards.com
 Web Site: www.israel-shipyards.com
 Chairman of the Board: Mr. Samy Katsav
 General Manager: Mr. Avi Shahaf
 V.P for Marketing: Mr. Oded Breier
 Number of employees: 500
 Date established: 1959
 Ownership: Private

Areas of activity

Experts in design and construction of Naval and Coastal Defense vessels, Commercial ships and Marine projects:

- Fast Patrol Craft (SHALDAG Class)
- Offshore Patrol Vessels
- Fast Missile Corvettes - SAAR 4, SAAR 4.5 and SAAR S – 72 Class.
- Commercial vessels, Tugs, Floating Docks and multi purpose boats.
- Heavy engineering products - Container cranes, Cranes, desalination plants.
- Ship repairs and maintenance.

See pages: 100, 101, 102, 103

ISRAGOR PROTECTIVE GEAR & SYSTEMS LTD.

3 Hagesher St.,
 Hod-Hasharon 4526603, Israel
 Mobile: 972-50-3227997
 Tel: 972-9-7493105
 Fax: 972-9-7493834
 E-mail: isragor@zahav.net.il
 President: Mr. Israel Goren

Areas of activity

Isragor develops, produces and markets all over the world protective military gear such as bullet proof vests, battle harnesses, covers and camping equipment.
 Special department of the company specializes in planing and establishing dry storage systems for military and civil uses.
 The core business of the company supplies all types of bullet proof vests.

See page: 167

ISREX (94) LTD.

Clal Building
 5 Droyanov St.,
 P.O.Box 11035
 Tel-Aviv 6111001, Israel
 Tel: 972-3-6200611
 Fax: 972-3-5283280
 E-mail: isrexmng@isrex.com
 Web Site: www.isrex.com
 Chairman of the Board: Mr. Danny Biran
 President: Mr. Gad Hitron
 Number of employees: 25
 Date established: 1968

Areas of activity

Export of products, systems and Israeli know-how. Police and anti-riot equipment. Electronic systems. Telecommunications. Night vision systems. Special vehicles. Command and control systems (C⁴I). Intelligence systems. Aircraft upgrading, and spare parts. Mobile hospitals and hospital equipment. Airborne and naval surveillance, Electro-optic systems and UAV'S.
 Wide experience in financing solutions.

See page: 449

IWI**ISRAEL WEAPON INDUSTRIES (IWI) Ltd.**

64 Bialik Blvd.
 P.O.Box 63
 Ramat-Hasharon 4710001, Israel
 Tel: 972-3-7606000
 Fax: 972-3-7606001
 E-mail: info@iwi.net
 Web Site: www.iwi.net
 V.P. Marketing & Sales:
 Mr. Ronen Hamudot
 Number of employees: 400
 Ownership: Private

Areas of activity

Israel Weapon Industries (IWI) is a world leader in small arms for the past 70 years. IWI's most-known products include the **TAVOR**, **X95** & **GALIL ACE** families of Assault Rifles, the **NEGEV LMG**, the legendary **UZI SMG** (Mini, Micro and UZI PRO) and the **JERICHO** family of pistols – which have all been considered weapons of choice by military units and top law enforcement agencies around the world. The company's firearms are developed in close collaboration with the Israel Defense Forces (IDF). IWI and the IDF joint forces in developing these weapons, whose final configurations are the product of ongoing interaction, field tests, and modifications, resulting from combat requirements and experience.

See page: 254

KANFIT LTD.

Shaul Amor Avenue,
Ramat Gabriel Industrial Zone,
Migdal Haemek 2353002, Israel
Tel: 972-4-6547461
Fax: 972-4-6441065
E-mail: shachar@kanfit.com
Web Site: www.kanfit.com
General Manager: Mr. Shai Fine
Director & Business Development:
Mr. Shachar Fine
Mobile: 972-50-2231729
Number of employees: 138
Date established: 1986
Ownership: Shai Fine

Areas of activity

Specializing in manufacturing, combination and integration of composite and metal products, Kanfit is a built to spec, aerospace engineering development and production company. A turn-key, one stop shop solution provider with advanced capabilities in RTM and Hybrid aero-structures.

Kanfit QA system is AS9100C certified. Kanfit manufactures aero-structures, RTM chaff and flare magazines, Missiles and bombs parts, Airborne and space antennas, tools, etc.

See page: 35

**KARIL INTERNATIONAL
MARKETING LTD.**

6 Maskit St.,
Herzliya 4614002, Israel
Tel: 972-9-9568212
Fax: 972-9-9568141
E-mail: sales@karil.com
Web Site: www.karil.com
Senior V.P. & General Manager:
Mr. Tal Yeshaya
V.P Marketing & Business Development,
Israel: Mr. Ran Ofer
Director of HLS: Mr. David Friesem
Number of employees: 16
Date established: 1996
Ownership: Private

Areas of activity

Karil International Marketing a Member of the Mistral Group, providing innovative Defense and Security product solution and services to the International market since 1996. Karil excels at bridging gaps between urgent requirements in the global Defense and Security markets with cost effective, state-of-the-art technological solutions.

See page: 187

**KAVIT
ELECTRONICS INDUSTRIES LTD.**

1 Platin St.,
New Industry Zone
Rishon Lezion 7565339, Israel
Tel: 972-3-9523540
Fax: 972-3-9523511
E-mail: info@kavit.com
Web Site: www.kavit.com
Technical Sales Manager:
Mr. Shahar Flex
Date established: 1994
Ownership: Private

Areas of activity

KAVIT has been an accredited MOTOROLA Partner for in excess of 10 years.

The company develops and manufactures professional jamming systems and industry leading radio encryption modules.

KAVIT's battle-proven products are heavily used by government, police and armed forces throughout the world.

See page: 227

**KILOLAMBDA
TECHNOLOGIES, LTD.**

22a Raoul Wallenberg St.,
Tel-Aviv 6971918, Israel
Tel: 972-3-6497662
Fax: 972-3-6497665
E-mail: info@kilolambda.com
Web Site: www.kilolambda.com
President & CEO: Mr. Doron Nevo
Chief Scientist: Dr. Moshe Oron
VP Marketing: Mrs. Karin Golding
Number of employees: 15
Date established: 2001
Ownership: Private

Areas of activity

KiloLambda's patented nano-technology based optical layer is designed to protect the human eye as well as optical sensors from damage, which may be caused by high power destructive light sources, such as lasers. KiloLambda's layers can improve the dynamic range of imaging systems utilizing their limiting capabilities.

KiloLambda's layers are used in binoculars, sights, communication systems etc.

See page: 345

**LIOR
TEXTILE INDUSTRIES LTD.**

Dora Ind. Zone,
P.O.Box 11
Shlomi 2283201, Israel
Tel: 972-4-9808815
Fax: 972-4-9808816
E-mail: info@lior-protective.com
Web Site: www.lior-protective.com
www.concordusa-jackets.com
General Manager: Mr. Itshak Bookris
Marketing Manager: Mr. Haim Avnaim
Sales Manager: Mr. Lior Bookris
Number of employees: 75
Date established: 1976
Ownership: Private

Areas of activity

**Developing, Designing, Manufacturing
and global marketing of protective
gear:**

- Body armor for the army, police, special units & jackets for civil & V.I.P use.
- E.O.D - Bomb Suits.
- Inflatable tent & stretcher.
- N.B.C. protective suits for biological & chemical threats.
- Fire brigade suits, Nomex pilot & tanker coveralls, underwear.
- Dry storage solutions.
- Extended Cold Weather Clothing System (ECWCS).
- Ballistic shields & plates.
- Ballistic helmets.
- Tactical Vests.
- Backpacks.

See page: 170

MAGAM SAFETY LTD.

A subsidiary of Star Defense Systems (SDS)

6 Hasadna St.,
Ziporit Industrial Zone 1789020, Israel
Tel: 972-73-2665800
Fax: 972-4-6412118
E-mail: info@magam-safety.com
Web Site: www.magam-safety.com
C.E.O: Mr. Micha Atir
Marketing & Sales Manager:
Mr. Yair Schultz
Purchasing Manager: Ms. Gila Robinson
Date established: 1934
Ownership: Star Defense Systems Ltd.
(SDS)

Areas of activity

Magam Safety Ltd. designs, manufactures and distributes a wide range of rescue, survivability and protective equipment;

- Personal protection equipment
- Rubber fuel tanks & self-sealing solutions
- Rescue and survivability equipment
- Inflatable equipment

Magam Safety products are developed in close relationship and constant feedback from the Israeli Defense Forces (IDF). The company is the sole supplier of parachutes, Anti-G suits and fuel tanks to the IDF.

See page: 88

MAROM DOLPHIN LTD.

Industrial Zone Alon Tavor
P.O.Box 1126
Afula 1800001, Israel
Tel: 972-4-6400797
Fax: 972-4-6403074
E-mail: info@marom-dolphin.com
Web Site: www.marom-dolphin.com
C.E.O: Mr. Yariv Sagi
International Marketing Manager:
Mr. Shlomo Baime
International Marketing Manager:
Mr. Itay Benkuzary
Number of employees: 45
Date established: 1993

Areas of activity

Since founded in 1993, **Marom Dolphin** has established itself as one of the leading companies for developing, designing, manufacturing and marketing top quality tactical textile solutions such as: Tactical Vests, Body Armor Vests, modular carrying solutions, tactical backpacks and other accessories for armed forces, police units, security services and civilians around the world.

Among our customers are military, paramilitary, law enforcement and security organizations across the globe. We are the main authorized supplier of tactical textile solutions to the Israeli Military, the Israeli Ministry of Defense and many other governmental and private customers, worldwide.

Our products are manufactured and tested in accordance to ISO 9001:2008 international standards as well as with the Quality Assurance standards of military forces worldwide, awarding them worldwide recognition for their high quality and durability.

See page: 171

MAVERICK DEFENSE TECHNOLOGIES LTD.

P.O.Box 5512
Caesarea 3088900, Israel
Tel: 972-4-6362360
Fax: 972-4-6362361
E-mail: maverick@netvision.net.il
Web Site: www.maverick-defense.com
Managing Director:
Lt.Col. (Ret.) Dov R. Magen, Advocate

Areas of activity

Suppliers of Israeli, Western and Eastern manufactured military and law enforcement equipment and training - from light arms and ammunition to armored vehicles, tanks, naval vessels, aircraft - (sales, lease and upgrade) missiles, electronics, electro optics, electronic warfare, NBC and rescue equipment, special forces equipment, surplus equipment, police and anti-riot equipment, Anti Piracy Guards for shipping.

See page: 234

MEPROLIGHT (1990) LTD.

P.O.Box 26
58 Hazait St.,
Or Akiva Industrial Park
Or Akiva 3060000, Israel
Tel: 972-4-6244111
Fax: 972-4-6244123
E-mail: sales@meprolight.com
Web Site: www.meprolight.com
C.E.O: Mr. Eli Gold
V.P. Marketing: Mr. Golan Kalimi
Number of employees: 160
Date established: 1989
Ownership: Private

Areas of activity

Meprolight is an International Electro-Optics company, developing, manufacturing and marketing systems for infantry, armed forces, law enforcement agencies and civilian markets since 1990. **Meprolight** provides a wide array of combat-proven products; Electro-optical and Optical sights and devices, night sights, marking devices night sights, marking devices, LRF- laser rangefinders, hand held rangefinders and fire control systems and LED illuminated products for safety and security. The products are fully certified to ISO-9001:2008.

See page: 235

MIFRAM LTD.

6 Josef Levi St.,
 P.O.Box 1165
 Ind. Zone Kiriath Bialik
 Zur Shalom 2711101, Israel
 Tel: 972-4-8808800
 Fax: 972-4-8745745
 E-mail: sales@mifram.com
 Web Site: www.miframsecurity.com
 C.E.O & President: Mr. Amos Klein
 V.P. Business Development:
 Mr. David Noy
 Number of Employees: 80
 Date established: 1962
 Ownership: Private

Areas of activity

Mifram Security (from 1962) handles all types of defense projects. Mifram Security specializes in designing, manufacturing and supplying:
Force Protection Equipment - Modular Vehicle Barriers, Mobile Observation Towers & Posts, Shelters and Crowd-Control Equipment.
Ballistic and Blast Protection for Infrastructure - (Meet the threat level of direct impact by 122mm Katyusha rockets).
 Indoor protection, External Building Cover, Self-Sustaining Protection Systems.
Dry Storage Solutions.
All our products have been Combat-Tested and Approved.
 Among Mifram Security's satisfied customers are Military Forces (USMC, US-Army, MFO, IDF, UN), and Major Integrators & Government Law Enforcement Agencies.

See pages: 154, 155, 216

MIPHA INTERNATIONAL LTD.

8 Har Nevo St.,
 Ramat Hasharon 47225, Israel
 Tel: 972-3-5402403
 Fax: 972-3-5490931
 E-mail: mipha@mipha.co.il
 Web Site: www.mipha.co.il
 President & C.E.O:
 Mr. Michael Itzhar Belachovsky
 V.P Business Development:
 Mr. Amichai Erez
 Date established: 1983
 Ownership: Private

Areas of activity

- Homeland Security and Operations Consultancy
- Security & Surveillance Systems for Borders, Airports, Seaports, Safe & Secure City, Pipelines and Sensitive Installations
- Specialize in Intelligence and Law Enforcement Consultancy and Equipment
- Interception systems for all communication technologies, cellphone location tracking and data mining for government agencies
- Advance Intelligence Inference Systems
- Surveillance and Counter-Surveillance including on-site checks to detect eavesdropping
- Advanced Biometric Identification Systems
- Data Communications, Storage Security and Data Recovery
- GPS Tracking and Fleet Management

See pages: 326, 327

M.L.M - PROTECTION

6 Ha'Choshlim St., 7th Floor
 P.O.Box 12590
 Herzliya 4672406, Israel
 Tel: 972-9-9574377
 Fax: 972-9-9574370
 E-mail: ofer@mlm-protection.com
 Web Site: www.mlm-protection.com
 C.O - C.E.O & Director: Mr. Ofer Bar
 C.O - C.E.O & Director:
 Mr. Sharon Botzer
 Number of employees: 15
 Date established: 2002
 Ownership: Private

Areas of activity

M.L.M Protection is the leading provider of turn-key security solutions and one of the few companies able to supply a high degree of services and professionalism in all areas of security and assault, in both the private and public sectors.
 M.L.M Protection was founded by ex-Israeli security service personal, who have served in the Israeli **"Dignitary and delegation protection unit"** of the Israeli "shen bet".

See page: 438

mPrest Systems LTD.

Azorim Park, Kiriat Arieh
 94 Em Hamoshavot Rd.
 Petah Tikva 4970602, Israel
 P.O.Box 3027
 Tel: 972-7-3216666
 Fax: 972-7-3216636
 E-mail: contact@mprest.com
 Web Site: www.mprest.com
 CEO: Col. (ret.) Natan Barak
 V.P R&D: Mr. Eli Arlazoroff
 C.T.O: Mr. Alexander Arlievsky
 C.F.O: Mr. Udi Schwartz
 Manager of Sales & Marketing Division:
 Mr. Beny Shlomi
 International Marketing Director:
 Col. (ret.) Adi Bershady
 Number of employees: over 100
 Date established: 1996
 Ownership: 50% Private, 50% Rafael

Areas of activity

mPrest Systems is a recognized market leader in the design, development and implementation of high-performance C⁴I solutions for the defense & aerospace, homeland security and civilian arenas. mPrest proprietary software suite enables the integration of large amounts of input data from a variety of sources (sensors, devices and other systems) and coherently manages a wealth of applications on interactive displays. Seamlessly integrating all C⁴I elements & sensors, our software capabilities reduce the time required for system development. Our Defense solutions: Air Defense C² System, Intelligence C² System, Ground C⁴I, HQ's C² System and simulations . Our HLS solutions: Disaster Management System, Critical Facilities System, Border Control, Detection and tracking.

See page: 314

MSE LTD.**(Marksmanship, Sniper, Excellence)**

A subsidiary of Star Defense Systems (SDS)
 11 Granit St.,
 P.O.Box 3034
 Petach Tikva 4951410, Israel
 Tel: 972-73-2324517
 Fax: 972-72-2448646
 E-mail: info@mse-il.com
 Web Site: www.mse-il.com
 C.E.O: Mr. Mikey Hartman
 Marketing & Sales Manager:
 Mr. Aviv Fastman
 Date established: 2010
 Ownership: Star Defense Systems Ltd.
 (SDS)

Areas of activity

MSE (Marksmanship, Sniper, Excellence) Ltd., develops, manufactures and markets innovative user-friendly day sights and a unique Night Vision sight to the military, paramilitary and civilian markets worldwide. MSE offers tailored "Train the Trainers" theoretical and practical, shooting implementation courses, maximizing its clients shooting skills to their highest level.

See page: 236

MTC**INDUSTRIES & RESEARCH CARMIEL LTD.**

P.O.Box 232
 Karmiel 2161102, Israel
 Tel: 972-4-9987772
 Fax: 972-4-9981189
 E-mail: marketing@mtcind.com
 Web Site: www.mtcind.com
 President: Mr. Yechiel Cohen
 Vice President: Mr. Yair Avni
 Vice President: Mrs. Jemy Gershonovich
 Number of employees: 130
 Date established: 1977
 Ownership: Private

Areas of activity

The development and manufacture of gyroscopes, inertial sensors, actuators and servo actuators, motors and servo motors, resolvers, RVDT, LVDT, slip rings, high pressure vessels, solenoids, canard actuation steering units, tachogenerators and other electro-mechanical components for the Aerospace, Defense and UAV industries. Services include engineering and thermal spray coatings. Scientific instruments for the dental field. AS9100C, ISO 9001:2008 and MIL-STD compliant.

See pages: 289, 374

MYFORM LTD.

Factory:
Kiryat Shmona, Israel
Main Office:
9th Lincoln St' Tel-Aviv
Mail:
P.O. Box 14233
Tel-Aviv 6114102, Israel
Tel: 972-3-6244488
Fax: 972-3-6244499
E-mail: myform@myform.co.il
C.E.O: Mr. Igal Hayoun
E-mail: igal@myform.co.il
C.F.O: Mr. Ilan Leybovich
E-mail: ilan@myform.co.il
V.P. Business Development:
Mr. Arik Almog E-mail:
arik@myform.co.il
Number of employees: 90
Date established: 1996
Ownership: Private

Areas of activity

Myform is one of the leading companies in Israel, manufactures and provides unique protection gear and personal security solutions for combatants, Defense forces personnel and VIP's in Israel and overseas.

Myform is producing and supplying:

- Body armor and carrying vest.
- Concealable Protection vests.
- Riot control suits, helmets and detachable visors.
- Protection suits and equipment for Krav Maga training.
- Personal protection gear for NBC (nuclear, biologic, chemical).
- Dry Storage solutions for deferent kinds and sizes of army vehicles.
- Customized equipment for combatants and security forces.

See page: 172

Ness TSG

(Technologies & Systems Group)
P.O Box 58180
Tel-Aviv 6158101, Israel
Tel: 972-3-548-3518
Fax: 972-3-548-3700
E-mail: tsg@ness.com
Web Site: www.ness.com/tsg
President: Michael Zinderman
Senior V.P. C4ISR Group:
Mr. Ofer Burin
V.P Marketing & Business development:
Mr. Avi Berger
Marketing Directors: Mrs. Gal Kabakov,
Mr. Roy Gordon, Mr. Yossi Refaelov,
Mr. Avishai Levi
Marcom Director: Mrs. Noga Alon
Number of employees (Ness Technologies): over 7,000
Date established: 1969
Ownership: Private

Areas of activity

Ness Technologies is a global provider of advanced Command, Control, Communications, Computers, Intelligence, Surveillance, Target Acquisition and Reconnaissance (C⁴ISTAR) solutions.

With over four decades of experience, Ness specializes and has a proven track record in designing, developing, supplying and integrating advanced, comprehensive and highly innovative solutions and systems for the defense and homeland security sectors. Dedicated to delivering cutting-edge, best-of-class solutions, Ness serves a diverse client base of governmental organizations worldwide. The proven record of TSG's deployed systems, combining command and control with intelligence and surveillance systems, enables us to offer unique solutions that bridge effective intelligence processing and operational command and control, providing our customers with incomparable value.

See pages: 79, 106, 188

NET**North East Technologies Ltd.**

Gamla House, Building A
34 Jerusalem St.
Raanana 4350108, Israel
Tel: 972-9-7489038/9
Fax: 972-9-7489066
E-mail: netech@ne-tech.com
Web Site: www.ne-tech.com
President & C.E.O: Mr. Yehuda Amon
V.P. Marketing & Business Development:
Mr. Gil Elharar
Marketing & Business Development
Manager: Mr. Nir Weisser
Operations Manager & Compliance
Officer: Mrs. Merav Zeewi
Number of employees: 6
Date established: 1994
Ownership: Private

Areas of activity

North East Technologies Ltd. is engaged with the following activities:

- Defense Projects Development, Marketing & Management
- Supply of Law Enforcement & Security Equipment
- Setting-up Joint Ventures and Partnerships
- Supply of Firearms, Ammunition, Accessories, Optical and Electro-Optical Devices
- Setting-up Distribution Networks of Firearms Ammo & Accessories for the Institutional & Commercial Markets Worldwide
- Supply of Military Gear Tailor Made to the End User's Specs

See page: 253

NETLINE COMMUNICATIONS TECHNOLOGIES (NCT) LTD.

Azrieli Circular Tower
132 Menachem Begin Rd.
Tel Aviv 6701101, Israel
Tel: 972-3-6068100
Fax: 972-3-6068101
E-mail: info@netline.co.il
Web Site: www.netline.co.il
General manager & C.E.O: Mr. Gil Israeli
C.O & C.E.O: Mr. Ben Te'eni
V.P Marketing: Mr. Yallon Bahat
Number of employees: 70
Date established: 1998
Ownership: Private

Areas of activity

Netline Communications Technologies develops and manufactures cutting edge electronic countermeasures and spectrum dominance solutions to the global defense and homeland security markets.

- Counter IED & communication jamming solutions with advanced features such as pre-initiation and hybrid active/reactive capabilities
- Tactical interception and SIGINT solutions including spectral analysis, signal classification and demodulation, cell phone monitoring and location/direction finding
- Prison cell phone control solutions including cell phone jamming, detection and managed access systems
- RF leakage detection & monitoring system and cell phone detection solutions for government and corporate sensitive facilities
- Emergency mobile communications & emergency victim location solutions for search and rescue operations

See pages: 119, 228, 328

NEW NOGA LIGHT (2000) LTD.

A subsidiary of Star Defense Systems (SDS)
11 Granit St.,
P.O.Box 3034
Petach Tikva 4951410, Israel
Tel: 972-3-9206004
Fax: 972-73-2324598
E-mail: info@newnogalight.com
Web Site: www.newnogalight.com
C.E.O: Mr. Lior Shalev
V.P Business Development, Marketing & Sales: Mr. Ilan Abramovich
Regional Marketing & Sales Managers:
Mr. Yacov Galam- Israel & Africa
Mr. Tomer Snir- APAC
Date established: 1987
Ownership: Star Defense Systems Ltd. (SDS)

Areas of activity

New Noga Light (2000) Ltd. (NNL) designs, manufactures and markets electro-optic Day & Night vision systems;
- Night vision systems based on Image Intensifying Tubes
- Uncooled Thermal imaging systems
- Test and maintenance equipment
- Refurbishment and upgrade services
- Operational and technical training services

New Noga Light is the leading supplier of Night Vision and Thermal Imaging systems to the Israel Defense Forces (IDF).

See page: 346

NICE SYSTEMS LTD.

22 Zarhin St.,
P.O.Box 4122
Ra'anana 4362248, Israel
Tel: 972-9-7753777
Fax: 972-9-7434282
E-mail: info.security@nice.com
Web Site : www.nice.com
President Security Group:
Mr. Yaron Tehwella
General Manager, Intelligence Solutions:
Mr. Mark Gazit
General Manager, Surveillance Solutions:
Mrs. Adina Enden
Number of employees: 3,500
Date established: 1986
Ownership: Public

Areas of activity

NICE Systems is a global provider of homeland security and defense solutions.

Our portfolio includes:

- Communications Interception and Analysis
 - Web Intelligence
 - 3D Mobile Location Tracking
 - Real-Time Situation Management
 - IP Video Surveillance
 - Integrated C⁴I systems
 - Incident debriefing and investigation using complete event reconstruction
- NICE customers include leading government and intelligence agencies, airports, critical infrastructure, transportation systems, smart/safe cities, banks and enterprises.

See page: 329

NIMDA CO.

P.O.Box 768
 North Industrial Zone
 Lod 7110604, Israel
 Tel: 972-8-9781111
 Fax: 972-8-9781137
 E-mail: info@nimda.co.il
 Web Site: www.nimda.co.il
 C.E.O: Mr. Nimrod Avni
 President: Mr. Arie Semel
 V.P. Marketing: Mr. Isaac Pery
 Number of employees: 100
 Date established: 1972
 Ownership: Private

Areas of activity

Turn-key programs for modernization, integration and production of military vehicles of U.S., British, French and Russian origin. Upgrading of MBTs, APCs, amphibious armored vehicles, such as T-72, M-60, T-55, M-41, M113, Shilka, BMP II, Achzarit HAPC, Puma Engineering MBT.
 Design and manufacture of power packs and advanced automotive applications, assembly and installation of ground forces Power Trains and marine propulsion systems.
 Advanced weapon systems integration modernize platforms for anti-tank and air defense use.
 Building customer's local military shops infrastructure logistic centers and vehicles production plants.

See page: 141

NIRTAL TRAINING & SUPPLY OF COMBAT EQUIPMENT LTD.

4 Hahagana St.,
 Or-Yehuda 6021204, Israel
 Tel: 972-3-6341175
 Fax: 972-3-6341176
 E-mail: nirtal@nirtal.com
 elad@nirtal.com
 Web Site: www.nirtal.com
 C.E.O: Mr. Nir Shaul
 V.P. Marketing & Business Development:
 Mr. Elad Tamir
 Mobile: 972-57-7722222
 Number of employees: 12 (+ 200 - 300
 Temporary workers)
 Date established: 1995
 Ownership: Private

Areas of activity

- Counter Terrorism & Anti-crime operational training
- Armed forces training: Special Forces & regular infantry units.
- V.I.P. & Executive Protection training.
- Supplier of various advanced technology systems & a variety of combat equipment.
- Security consulting and training using most advanced techniques, technologies and combat experienced instructors.
- All aspects of Airport and Aviation, Seaport & Maritime Security.
- Security in the private sector - Banking, Public transportation, Public institutions Petroleum & Natural gas pipeline infrastructure Etc.
- Surveillance and counter surveillance courses, training of police units for special assignments.
- Prison enforcement, special units and technologies.
- Crowd control and event management.
- "K-9" supply & training.
- VIP & Delegations Security Escort.

See page: 439

NOGA EINAT SHOE INDUSTRIES LTD.

Kibbutz Givat Hashlosa 4880000, Israel
 Tel: 972-3-9030150
 Fax: 972-3-9030151
 E-mail: info@nogaeinat.co.il
 Web Site: www.nogaeinat.co.il
 General Manager: Mrs. Ora Gilad
 Finance Manager: Mrs. Noga Polishuk
 Number of employees: 50
 Date established: 1930
 Ownership: Kibbutz Einat & Kibbutz Givat Hashlosa

Areas of activity

Noga-Einat Shoe Industries Ltd. is a manufacturer and supplier of military- and safety shoes.
 Product lines include: army boots, products for unusual conditions and special forces, police boots & shoes and boots for anti-terror and anti-rioting units.

See page: 173

**OCEANA TECHNOLOGIES
(2009) LTD.**

A subsidiary of Star Defense Systems (SDS)

11 Granit St.,
P.O.Box 3034
Petach Tikva 4951410, Israel
Tel: 972-3-9009600
Fax: 972-3-9017079
E-mail: info@oceanatec.com
Web Site: www.oceanatec.com
C.E.O: Mr. Lior Shalev
V.P Business Development, Marketing &
Sales: Mr. Ilan Abramovich
Marketing & Sales Manager:
Mr. Or Melinek
Date of establishment: 1989
Ownership: Star Defense Systems Ltd.
(SDS)

Areas of activity

Oceana Technologies (2009) Ltd. is a leading company in advanced tactical maritime systems and solutions in the areas of C⁴I, navigation and reconnaissance in the underwater domain. The company offers combat proven, MIL-STD, diver navigation systems including C⁴I and sonar. Utilizing best-of-breed technologies of Communication, Navigation and Sonar, the company's systems provide, for the first time, total underwater control.

See page: 107

**OPGAL
OPTRONIC INDUSTRIES LTD.**

P.O.Box 462
Industrial Area 5
Karmiel 2161401, Israel
Tel: 972-4-9953903
Fax: 972-4-9953900
E-mail: info@opgal.com
Web Site: www.opgal.com
President & C.E.O: Mr. Amit Mattatia
V.P Defense Bu.: Mrs. Sylvie Dascalu
Senior Director of Marketing Defense:
Mr. Liad Ben-Ishai
Number of employees: 130
Date established: 1983
Ownership: 50% Elbit Systems Ltd.,
50% Rafael Ltd.

Areas of activity

OPGAL Optronic Industries is a leading global manufacturer of innovative thermal imaging safety systems and infrared cameras. Its safety applications are used for detection of gas and hazardous material leaks and for areal remote fire detection. **OPGAL** offers the widest selection of infrared cooled and uncooled OEM cameras and engines for military, paramilitary, security and aviation applications. Its products have been field tested worldwide for the past 30 years. The company's creative R&D, cutting edge technology, speed and flexibility make us your best partner for IR applications.

OPGAL's diverse product line includes fully-integrated thermal imaging systems customized to specific applications, as well as off-the-shelf thermal imaging cameras and engines for private labeling, OEM partners and other systems integrators.

See page: 364

**ORBIT COMMUNICATION
SYSTEMS LTD.**

New Industrial Zone,
P.O.Box 8657
8D Hatzoran St.,
Netanya 4250608, Israel
Tel : 972-9-8922777
Fax: 972-9-8855944
E-mail: info@orbit-cs.com
Web Site: www.orbit-cs.com
Number of employees: 230
Date established: 1950
Ownership: Mr. Zeev Stein - 45%,
Excellence + Phoenix - 5.5%,
Psagot - 6.5%, Migdal - 8.0%,
Public - 35.0%

Areas of activity

Orbit Communication Systems Ltd. is a global leading provider of mission-critical communication systems and related services in two target markets - commercial and defense/homeland security. Fulfilling the communication needs of commercial, defense and government customers for over 60 years, Orbit offers advanced solutions, supporting applications in the areas of satellite tracking (GEO and non-GEO), earth observation (tracking LEO satellites), aeronautical telemetry, navigation, UAV Command & Control, Mobile Satellite Communications and Communication Management Systems.

See page: 307

**ORION
ADVANCED SYSTEMS LTD.**

P.O.Box 156
Yavne 8110101, Israel
Tel: 972-8-3770100
Fax: 972-8-3770101
E-mail: marketing@orion-as.com
Number of employees: 65
Date established: 2009
Ownership: Aeronautics Ltd.

Areas of activity

Orion Advanced Systems Ltd.

specializes in the research, development, manufacturing and integration of advanced fuzes for aerial munitions and custom fuzing systems. Orion's state-of-the-art fuzes are compatible with modern guided bombs and hard penetrator warheads. Orion is the sole supplier of fuzes to the Israeli Air Force and has an outstanding reputation for safety and reliability. Orion also manufactures and customizes fuzes for customers around the globe.

See page: 63

**ORTECH DEFENCE SYSTEMS
LTD.**

Kibbutz Karmiya 7913500, Israel
Tel: 972-8-6749781
Fax: 972-8-6749779
E-mail: Info@ortechisrael.co.il
Web Site: www.ortechisrael.co.il
C.E.O: Mr. Ran Naor
Number of employees: 20
Ownership: Ran Naor

Areas of activity

Transportation, Land, Maritime & aviation Security – Armored Vehicles, Blast mitigation, Cockpit protection, Missile countermeasures, Security Vehicles, Urban Surveillance, railway security.

Industrial Security – Ballistic Glass, Ballistic walls, Blast Mitigation, Hazardous materials security, Pipeline Security.

Ballistic & Armor Protection – composite materials, protective eyewear, ballistic shields, helmets, protective visors, Bullet proof vests, lightweight Armor, transparent armor, ceramic armor, Mine protected vehicles, vehicles protections,

Access control – Alarms, Barriers, Ramps, Gates, Doors.

Civil defence, Emergency & Response – Dry Storage, Passive Ballistic Protection, Protected structures (Blast & Ballistic).

Explosives Ordnance & bomb Disposal (EOD – C – IED) – blast protection, ballistic protection – Shields Suites, boots. Blast Resistant containers.

Personal Gear – ballistic shields, Helmets & Helmets mounted accessories, Personal protection Vests, Textile products.

Consulting & Advisors.

See page: 177

OSG - ORAN SAFETY GLASS

Kibbutz Palmach Zova
D.N. Harei Yehuda 9087000, Israel
Tel: 972-2-5706109
Fax: 972-73-2752109
E-mail: info@oran.co.il
Web Site: www.osg.co.il
C.E.O: Mr. Daniel Cohen
V.P. Marketing: Mr. Assaf Karni
C.F.O: Mr. David Yogev
Number of employees: 250
Date established: 1979
Ownership: Kibbutz Palmach Zova

USA: Oran Safety Glass Inc.

48 Industrial Parkway,
P.O.Box 126, Emporia, VA 23847, USA
Tel: 301-913-9366
Fax: 301-913-9369
E-mail: paul@mistralgroup.com
Web Site: www.osg-armor.com

Representative Office EUROPE:

IbA Industrieberatung Dirk Abrie
Koblener Str. 33
D – 66115 Saarbrücken
Tel: 49-681 9705 863-0
Fax: 49-681 9705 863-1
Mobil D: 49-171 7613 467
E-mail: info@oran-glas.de
Web Site: www.oran-glas.de

Areas of activity

OSG Transparent Armor is a world leading fabricator of transparent armor, for 30 years now, providing protective glass to military and civilian customers worldwide.

OSG unique product line consists:

- Ballistic-resistant glass up to the highest threat levels , both flat and curved
- Blast resistant glass (FSP), both flat and curved
- Forced entry-resistant glass (FE), both flat and curved
- Heating elements (wire, grid, coating)
- Communications Attenuation of electromagnetic emissions
- Special coatings
- Aluminum or steel frames

Based on decades of extensive field experience, OSG R&D , engineering and production departments is constantly developing unique, innovated product line that answer the highest threat levels, often offer most thinnest and lightest solution per threat. From our three state-of-the-art production facilities, we supply cost-effective and reliable transparent armor solutions for armies and security services all around the world.

See page: 153

PALBAM 2008 (A.C.S.)

En Harod Ihud 1896000, Israel
 Tel: 972-4-6530700
 Fax: 972-4-6531904
 E-mail: info@palbam.co.il
 Web Site: www.palbam-defense.com
 C.E.O: Mr. Dov Brav
 V.P. Defense Business: Mr. Gal Schwartz
 Marketing and Bus. Dev.:
 Mr. Reuben Fuchs
 Number of employees: 100
 Date established: 1953
 Ownership: Kibbutz En Harod Ihud

Areas of activity

PALBAM specializes in advanced metal work manufacturing technologies.

Missiles components: Canisters, Launchers and High Pressure Vessels for missiles.

Armored vehicle solutions: PALBAM supply fuel systems solutions both for new or upgraded tank or wheeled armor vehicle.

Aero Magnesium: PALBAM, through its subsidiary Aero Magnesium, developed the world's most professional solution provider for Mg production of integrated aerospace UAV or future infantry parts.

See pages: 64, 156

PHANTOM TECHNOLOGIES LTD.

68 Amal St.,
 Petah-Tikva 4951368, Israel
 Tel: 972-3-9215720
 Fax: 972-3-9215434
 E-mail: sales@phantom.co.il
 Web Site: www.phantom.co.il
 C.E.O: Mr. Roei Itshakov
 C.M.O: Mr. Etl Har-Chen
 C.T.O: Mr. Idan Itshakov
 Number of employees: 30
 Date established: 1996
 Ownership: Private

Areas of activity

Ari-Phantom Technologies provides a variety of jamming solutions for all RF based communications applications such as Cellular, Wi-Fi, tactical communications and satellite phones. The company develops and manufactures its systems in all sizes and in multiple configurations – from low power to extreme high power jammers, for stationary, man pack, vehicular/convoy protection and complete compound area coverage. The company offers both off the shelf solutions and customized products to meet special client requirements.

The company's line of products includes also internally developed digital receivers used for conditioned jamming systems, counter surveillance systems and SIGINT applications.

See page: 229

PICSIX LTD.

41 HaMeyasdim St.,
 P.O.Box 6006
 Even Yehuda 4051113, Israel
 Mobile: 972-544-335197
 Fax: 972-9-8911298
 E-mail: mk@pic-six.com
 Web Site: www.pic-six.com
 V.P Business Development:
 Mr. Moshe Haim
 Number of employees: 9
 Date established: 2011
 Ownership: Private

Areas of activity

PICSIX LTD. Designs, produces and sells a variety of unique solutions for interception and counter-interception. Our solutions include:

- Advance features Man In The Middle Systems for GSM and UMTS
- IMSI Catchers including DF capabilities
- Smallest form-factor largest capacity PASSIVE INTERCEPTION SYSTEMS in the market facilitating 10s to hundreds of channels per system
- Integrated solutions combining Passive and Active Interception as well as jamming and selective jamming.
- Counter Interception measures detecting a blocking of-the-air interception systems.

See page: 330

PLASAN

Kibbutz Sasa
M.P.Merom Hagalil 1387000, Israel
Tel: 972-4-6809000
Fax: 972-4-6809001
E-mail: plasan@plasan.com
Website: www.plasan.com
Number of employees: 700
Date established: 1985
Ownership: Kibbutz Sasa

Areas of activity

Plasan provides customized survivability and armor solutions for tactical wheeled vehicles, aircraft and personal protection. A recognized global leader and industry veteran, Plasan's survivability solutions offer the optimal combination of protection, weight and cost by combining in-house R&D, design, prototyping and manufacturing capabilities.

Land Systems

- Military tactical vehicles (Light and medium)
- APCs
- Commercial vehicles

Personal Protection

- Personal protection armor plates
- Ergonomic plate carriers
- Modular light personal armor equipment carrier systems
- Portable ballistic shields

Airborne Armor

- Fixed and rotary wing airborne platforms

See page: 157

POLYCARD TECHNOLOGIES LTD.

P.O.Box 8
Shlomi 2283201, Israel
Tel: 972-4-9858088
Fax: 972-4-9858084
E-mail: polycart@polycartt.com
Web Site: www.polycart.co.il
C.E.O: Mr. Menahem Grinshpan
Number of employees: 30
Date established: 1997
Ownership: Private

Areas of activity

Polycart Technologies LTD. specializes in the design and manufacturing of various tailor made military and HLS applications. The company offers wide range of solutions to suit our customer's specific requirements, including the designs of new models, or modifying and improving existing models. Products range covers areas like protective cases, anti-riots shields, shooting targets, rescue systems, weapon projects all under one roof.

See page: 158

Quadro

Projects & Technologies Ltd.
33 Yahadut Canada St., (Kaplan)
Or Yehuda 6037533, Israel
Tel: 972-3-9413010
Mobile: 972-50-8818886
Fax: 972-3-9410743
E-mail: quadro@quadro.co.il
Web Site: www.quadro.co.il
President & C.E.O: Mr. Pini Dagan
E.O.D: Mr. Moshe Chaky
Number of employees: 12
Date of established: 2000
Ownership: Private

Areas of activity

Treatment & Disposal of dangerous war remnants and other Explosive Obstacles.

- Consulting ,Planning ,Management and Supervision of Humanitarian Mine Clearance Operations.
- Disposal of all Explosive (EOD, IEOD's and UXO) circumstances.
- Cleaning of "Contaminated Arenas".
- Planning , Designing & Manufacturing of Training Aids, Models and Mockups.
- Assistance & Support in / of all Ammunition Tests / Experiments.
- Mine & Explosives Detection Dogs Services.

Integrated Defense Technologies Solutions.

- Traffic ability problem solutions .
- Special infrastructure operations .
- Permanent disposal services for Government offices (consulting planning & implementation)
- Documents identify recognition systems.
- Consulting ,Tests ,Supply& Laboratory services of Safety systems for all land Transportation / Vehicles (Air bags , Belts)

Crisis Solutions / Emergency Preparations.

Homeland Security:

- Integrated security systems for country Border lines and borders, boundaries and crossing points.
- Detection and Identification of Explosives and Narcotics :Detection of Smuggling operations.
- Planning ,conducting & supervision of all national and local emergency exercises.

Safety , Q.A [Quality Assurance] & Risk Analysis Services.

Quadro are conducted under the following standards:

ISO 9001:2008 - # 45248

ISO 14001:2004 - # 45247

OHSAS 18001:2007 - # 44794

See pages: 222, 223, 224, 225

**RADA
ELECTRONIC INDUSTRIES
LTD.**

7 Giborei Israel Blvd.,
P.O.Box 8606
Netanya 4250407, Israel
Tel: 972-9-8921111
Fax: 972-9-8855885
E-mail: mrkt@rada.com
Web Site: www.rada.com
President: Mr. Herzle Bodinger
C.E.O.: Mr. Zvika Alon
Chief Business Development Officer:
Mr. Dubi Sella
Number of employees: 105
Date established: 1970
Ownership: Public company – Traded on
NASDAQ (RADA)

Areas of activity

RADA Electronic Industries Ltd. is a Defense Electronics System House specializing in advanced electronic systems for airborne and land applications.

RADA's product lines include:

- **Tactical Land Radars**
- **Inertial Navigation Systems**
- **Avionics Systems and Upgrades**

RADA offers advanced Pulse-Doppler, multi-mission, AESA radars for tactical applications. The company's INS solutions provide best value solutions for aerial and land tactical vehicles. RADA is a leading provider in the field of airborne video and data recorders, and complete avionic upgrade suits for combat and ISR aircraft.

See pages: 26, 56, 163, 378

**RAFAEL
Advanced Defense Systems Ltd.**

P.O.Box 2250
Haifa 3102102, Israel
Tel: 972-4-8794714
Fax: 972-4-8794657
Web Site: www.rafael.co.il
President: VADM (Ret.) Yedidia Yaari
Executive V.P Business development & Marketing: Mr. Oron Oriol
Number of employees: 7,000
Date established: 1948
Ownership: Government of Israel (Since 2002)

Areas of activity

Rafael designs, develops, manufactures and supplies a wide range of advanced defense systems. These leading edge products include naval, air and ground precision weapons, electro-optic systems, electronic warfare (EW) systems, C⁴I and unmanned systems, acoustic defense systems, armored protection, breaching munitions and space technologies.

See pages: 28, 29, 36, 37, 54, 55, 65, 66, 67, 78, 82, 83, 84, 85, 86, 94, 95, 105, 108, 114, 115, 116, 117, 120, 121, 142, 143, 144, 145, 160, 161, 164, 165, 174, 178, 179, 180, 181, 182, 183, 184, 185, 186, 190, 191, 192, 193, 194, 195, 203, 204, 205, 206, 212, 213, 214, 215, 237, 238, 239, 240, 241, 242, 243, 244, 245, 246, 261, 262, 290, 315, 316, 317, 332, 333, 334, 335, 348, 349, 356, 357

**RAMIM ENGINEERING
WORKS LTD.**

P.O.Box 668
Kiryat Shmona 1101502, Israel
Tel: 972-4-6940072
Fax: 972-4-6949782
E-mail: office@ramim.net
Web Site: www.ramims.com
Plant Manager: Mr. Haim Segev
Chief of Engineering:
Mr. Eliezer Zanovich
Number of employees: 100
Date established: 1971
Ownership: Koor Metals Ltd.

Areas of activity

- Portable environmental shelters per U.S. specifications and NATO standards.
- Production of high tension electric towers.
- Metal works, infrastructure and construction projects.

See page: 189

RESHEF TECHNOLOGIES LTD.

7 Haplada St.,
P.O.Box 5035
Or-Yehuda 6055001, Israel
Tel: 972-3-5388604
Fax: 972-3-5339223
E-mail: info@resheffuzes.com
Web Site: www.resheffuzes.com
Managing Director: Mr. Shlomo Manoach
Plant Manager: Mr. Eitan Shemesh
R&D Manager: Mr. Ehud Lahav
Bus. Dev. Manager: Mr. Uri Woldiger
Number of employees: 80
Date established: 1984
Ownership: Aryt Industries Ltd.

Areas of activity

Reshef manufactures the most sophisticated Electronic Fuzes for ground forces units:

- Proximity, Time and Point Detonating (PD) fuzes for Mortar bombs, Artillery projectiles and Artillery Rockets.
- Time / Distance fuzes and Anti Personnel Anti Material fuzing system (APAM) for Tanks rounds.

See page: 207

ROCK WINGS LTD.

11 Gazit St.,
 Peth Tikva 4927991, Israel
 Tel: 972-2-5862468, 972-52-2862428
 Fax: 972-2-5713241
 E-mail: rockwings@rockwings.net
 Web Site: www.rockwings.net
 General Manager:
 Mr. Yitshak Zuckerman
 Operation Manager: Mr. Moshe Shalev
 Administration Manager:
 Mrs. Yael Greiner
 Number of employees: 5
 Date established: 1997
 Ownership: private

Areas of activity

- Aircraft modification:
 - Night vision capabilities
 - Airborne armament systems
 - Armor protection
 - Systems installation and integration
- Law enforcement systems
- Services:
 - Aircraft squadron establishment
 - Establish customer's own maintenance capabilities
 - Maintenance at customer's location
 - Consultants
 - Engineering
 - Production
- Pilot training
- Products:
 - 2.75" Rocket Launchers
 - Spare parts production

See pages: 38, 39, 40, 41, 42, 43

ROTEM INDUSTRIES LTD.

ROTEM Industrial Park,
 D.N. Arava P.O.Box 9046
 Beer-Sheva 8419001, Israel
 Tel: 972-8-6564779
 Fax: 972-8-6555984
 Web Site: www.rotemi.co.il
 President: Mr. Dan Peer
 Director, Defense Technologies:
 Col. (Res.) Mr. Dino Zeev
 Number of employees: 170
 Date established: 1980
 Ownership: Government of Israel

Areas of activity

- Radiation monitoring meters and systems for HLS, NPP's, Environmental, Nuclear Medicine & Cyclotron applications.
- Crystal growth and fabrication, mainly sapphire domes and windows.
- Engineering & Computational Mechanics Center- system development, mechanical design, advanced numerical simulations and experiments.
- Green Energy Technological Center - renewable energy test-field , seed project investment mechanism and R&D Industrial Services.
- Health & Safety- Import, export, marketing, development and distribution of safety products

See page: 368

RT LTD.

10 Nahal Snir St.,
 Yavne 8122447, Israel
 Tel: 972-8-6433616
 Fax: 972-8-6433607
 E-mail: info@rt.co.il
 Web Site: www.rt.co.il
 General Manager: Mr. Rami Shmueli
 Number of employees: 25
 Date established: 1996
 Ownership: Private

Areas of activity

RT Ltd., is a world – class designer, developer and manufacturer of the SkyStar™ aerostat family proven for use in intelligence, surveillance ,reconnaissance, and communication applications.
 Users active in prevent-prepare-respond-recover settings requiring continuous and compact aerial support are a natural fit for Skystar™ products.
 RT Ltd., delivers self-contained, versatile, easily transportable, cost- effective tactical system comprised of a mobile control station, ground system module, tether, lighter-than-air platform, stabilized payload platform, and sophisticated sensor suite. SkyStar™ systems are easy to operate, rapidly deployed and customized for a range of operating conditions worldwide in various military and civilian missions.
 Currently, systems are deployed in countries such as Afghanistan, Israel, Mexico, Thailand, Canada, Africa and Russia.

Applications:

Unmanned Aerial ISR and target acquisition, Border and coastal security, Crisis and emergency management, Law enforcement and public safety, Search and Rescue, Communication relay, Offshore/Onshore business continuity recovery, Event traffic/crowd control, VIP protection, Environmental measurement.

See page: 264

**RVTT RESHEF
TECHNOLOGY LTD.**

P.O.Box 4298
Rosh-Ha' Ayin 4856156, Israel
Tel: 972-3-9382804
Fax: 972-3-9383702
E-mail: resh@inter.net.il
C.E.O: Mr. David Reshef
Operation & Administration
Director: Mrs. Hadassa Reshef
Number of employees: 10
Date established: 1999
Ownership: David Reshef

Areas of activity

RVTT (Reshef Visual Thermal Technology) developed the "Visual Reality™" training concept and based on it, the Multi Spectral Technology (MST). Using MST in training enables all MST passive signatures: NVG, Thermal, Radar, Laser etc. MST is used for targets (realistic picture with 3D effect), battlefield constructions, live fire MST targets, recognition & marking MST products.
All RVTT MST solutions work without power supply and yet function day & night. Quick deployment and cost effective make the MST green products very attractive for the modern forces. Making armies training simple and innovative is our goal!
In use by the I.D.F.

See page: 258

**SANSOLO Security Consulting,
Development & Manufacturer Ltd.
Special Operations Equipment -
Explosive Entry**

19 Harel St.,
Ashkelon 7864919, Israel
Tel: 972-54-7886261
972-52-3843758
Fax: 972-8-6780986
E-mail: info@sansolo.co.il
Web Site: www.sansolo.co.il

Areas of activity

The SANSOLO Security Consulting, Development & Manufacturer Ltd. Company is an Israeli company that specializes in Security Consulting, Explosives, Demolition, Combat Pyrotechnics & new products development (Patent Protected).

Main products / services:

Products

- Custom design development.
- Defensive/Offensive demolition products.
- Variety of combat pyrotechnics products & development.
- Specializes in unique tactical marking products.

Consulting Specialist

- Bomb disposal expert.
- Writing procedures, guidelines and safety instructions.
- Security & Special units consultant.

Training Specialist

- Courses on various aspects of demolition.
- Training on working methods for defensive and offensive demolition.

See page: 221

SENSO-OPTICS LTD.

P.O.Box 600
Industrial Park
Yokneam 2069207, Israel
Tel: 972-4-9935527
Fax: 972-4-9935894
E-mail: senso@senso-optics.com
Web Site: www.senso-optics.com
President & C.E.O: Mr. Jacob Dagan
V.P R&D: Mr. Avi Katz
Number of employees: 26
Date established: 2001
Ownership: private

Areas of activity

Senso-Optics is a leader in R&D, design, production & delivery of innovative thermal imaging technologies and advanced electro-optical solutions for military, law enforcement, search & rescue, homeland security and commercial markets.

Senso-Optics offers a wide range of **State-of-the-Art thermal sensing, visual information & targeting solutions, products and systems** for day, night and low visibility missions.

Senso-Optics is committed to be at the forefront of thermal Imaging technology such as the world first **Thermal Camera-on-Chip (ASIC)**.

See page: 365

SERAPHIM OPTRONICS LTD.

2 Hayetzira St.,
 New Industrial Park Yokneam
 P.O.Box 621
 Yokneam 2069207, Israel
 Tel: 972-4-9894444
 Fax: 972-4-9894446
 E-mail: marketing@seraphim.co.il
 Web Site: www.seraphim.co.il
 President & C.E.O: Mr. Israel Kasher
 V.P Sales & Marketing:
 Mr. Gadi Bar-Ner
 V.P R&D: Mr. Uri Adar
 Number of employees: 25
 Date established: 1996
 Ownership: private

Areas of activity

Seraphim Optronics Ltd., specializes in electro-optical systems for covert surveillance in defense, military, paramilitary and civilians markets. Our products: MUGI - Mini Unattended Ground Imager & Chameleon both provide Real time digital video communication and day/night covert surveillance @ long duration missions.

Applications:

- Intelligence gathering
- Special Operation
- Border control
- Force Protection
- Forward Observer
- Home land security
- Law & drug enforcement
- Securing strategic infrastructures (ports, nuclear sites, power plant, etc.)
- Military operation in urban terrain (Chameleon)
- Incrimination & apprehension of suspect (Chameleon)

See page: 347

SHALON CHEMICAL INDUSTRIES LTD.

Head Office:
 2 Kaplan St., 10th Floor
 Tel-Aviv 6473403, Israel
 Tel: 972-3-6957191
 Fax: 972-3-6957980
 E-mail: shalon@shalon.co.il
 Web Site: www.shalon.co.il
 Plant:
 35/2 Israel Pollak Rd.,
 Kiryat Gat 8202501, Israel
 Tel: 972-8-6879111
 Fax: 972-8-6811115
 General Manager: Mr. Michael Barel
 Marketing Manager: Mr. Itai Barel
 QA Manager: Mr. Ken Samet
 Number of employees: 210
 Date established: 1968
 Ownership: private

Areas of activity

Shalon Chemical Industries Ltd. is internationally recognized as a leading company specializing in the manufacture and design of personal and collective NBC protective equipment for the military and civilian markets. The company's impressive record of innovations and achievements in respiratory protection is the result of applied state-of-the-art technology together with a firm commitment to creative design and high quality. Production is effected in a high-volume, extensively equipped, vertically integrated manufacturing plant with research laboratories employing the latest high-tech methods, and with comprehensive quality control systems enhanced by application of Total Quality.

See pages: 175, 410, 411, 412, 413

S.G.D ENGINEERING LTD.

P.O.Box 36637
 Tel Aviv 6136601, Israel
 41 Nachmani St.,
 Tel Aviv 6777603
 Tel: 972-3-5604135
 Fax: 972-3-5602179
 E-mail: marketing@sgd.co.il
 Web Site: www.sgd.co.il
 President & C.E.O: Mr. Dov Cohen
 Executive V.P: Mr. Jacob Baron
 Director, Head of Marketing & Business Development: Mr. Nir Baram
 Number of employees: 75
 Date established: 1980
 Ownership: Private

Areas of activity

S.G.D Engineering Ltd. is a leading provider of Airborne Mission Solutions. Over the past 30 years the company has successfully completed more than 140 projects worldwide. S.G.D's vast experience allows it to deliver tailored solutions for most stringent customer requirements, needs and expectations, on a variety of aircraft platforms. Among S.G.D's customers are governments, leading aerospace industries and airborne systems providers.

Our main product lines:

- **Airborne Pods** - from development to serial production. Our pods are generally deployed with ECS, wire harnesses, power management and power generation systems and sensors such as Recce Cameras, SAR, ELINT, etc.
- **Special Mission Aircraft** - Upgrades and modernizations of special mission aircraft and installations of airborne sensors and systems such as Recce Cameras, SAR, ELINT, EW Jammers, CMDS etc.

See page: 27

**SIBAT - MINISTRY OF DEFENSE
International Defense Cooperation**

Hakiryia Tel-Aviv 6473424, Israel
Tel: 972-3-6975585, 6977906
Fax: 972-3-6976359
E-mail: sibat_bic@mod.gov.il
Web Site: www.sibat.mod.gov.il
Director: Brig. Gen. (Res.) Shmaya Avieli
Principal Deputy Director:
Mr. Itamar Graff
Deputy Director & Head of Defense
Inventory Marketing & Sales:
Mr. Shlomo Alon

Areas of activity

SIBAT, the Israel MOD International Defense Cooperation agency is uniquely positioned as an essential division within the Israel Ministry of Defense (IMOD), while having a close, ongoing relationship with the defense industry. This combination ensures SIBAT to maintain in-depth and up-to-date knowledge of the defense world's relevant concepts, as well as a clear understanding of the Israel Defense Forces' (IDF) operational needs.

SIBAT facilitates international cooperation through its various services.

- Generating Government-to-Government agreements
- Initiating official foreign delegations
- Identifying industrial cooperation with the Israeli defense industry
- Pinpointing the relevant technological solutions for specific requirements
- Establishing of joint ventures
- Conducting advanced training seminars
- Managing the sales of IDF inventory
- Providing in-depth information on Israel's defense industry through biennial directory and national pavilions

See pages: 128, 129, 130, 382, 383, 384, 385, 386, 387, 388, 389, 390, 391, 392, 393, 394, 395, 396, 397, 398, 399, 400, 401, 402, 403, 454

**SILVER SHADOW ADVANCED
SECURITY SYSTEMS LTD.**

3 Ma'ale Ha-Migdal St.,
P.O.Box 761
Or-Yehuda 6025603, Israel
Tel: 972-3-6326666
Fax: 972-3-6326099
E-mail: silversh@silver-shadow.com
Web Site: www.silver-shadow.com
President & C.E.O: Mr. Amos Golan
Number of employees: 25
Date established: 1995
Ownership: Mr. Amos Golan

Areas of activity

An experienced, knowledgeable and dynamic Israeli firm with an extensive track record of various security and defense-related projects worldwide, offering a complete range of consulting, planning, product development, system analysis, licensed weapon manufacturer for Assault Pistol Rifles and sniper's rifles, weapon system upgrading, equipment sales, training and instruction services.

Owner and staff are uniquely qualified and have impressive personal records.

See pages: 255, 440, 441

SKORNIK TAL LTD.

37 Arbel St.,
Kohav-Yair 4486400, Israel
Mobile: 972-57-7629393
Office: 972-54-4629393
Fax: 972-77-9112393
E-mail: skorniktal@gmail.com
info@clear-zone.org
Web Site: www.clear-zone.org
C.E.O: Mr. Tal Skornik
Director of the Training Department:
Mrs. Moran Skornik
Secretary: Ruth Bar-Ad
Number of employees: 33
Date established: 2008
Ownership: Private

Areas of activity

Skornik Tal Ltd. is a worldwide provider of Homeland Security, Counter-terrorism, operational training solutions and marketing of military equipment. Our main department is "Clear-Zone" that is operated by Tal Skornik. Clear-Zone is staffed with veterans of Israeli Elite Military and Police Units. We will provide these services across the globe at the highest level of discretion and confidentiality.

See page: 442

SOURCE OF SOUND LTD.

19 Yad Harutzim St.,
 P.O.Box 8628
 Netanya 4250506, Israel
 Tel: 972-9-8658370\1
 Fax: 972-9-8658373
 E-mail: sos@s-o-s.co.il
 Web Site: www.s-o-s.co.il
 General Manager: Mr. Ron Klein
 Vice President: Mr. Nir Klein
 Number of employees: 70
 Date established: 1989
 Ownership: shamrock Israel
 Growth fund, Adi Nir & Ruth Nir

Areas of activity

Main activities:

A primary manufacturer and supplier of Communication Headsets to the Israeli Defense Forces.

As well as a provider to US Special Forces, Military, Police and Security forces worldwide.

As such, SOS has acquired considerable expertise in combat proven communication in harsh conditions.

Combat

Reliable and proven communication in ruthless conditions.

In Ear noise reduction headsets

Clear - Smart Tactical in-ear headset system designed for infantry Military heavy vehicles crew, Artillery etc.

Submersible

20m waterproof for maritime operations.

CBRN

Unconventional, innovative communication in Special conditions,

Security

VIP guards and miniaturized Secret hidden communication.

See page: 308

SUPERGUM INDUSTRIES LTD.

11 Shoncino St.,
 Tel-Aviv 6721611, Israel
 Tel: 972-3-5622333
 Mobile: 972-50-6659993
 Fax: 972-3-5622345
 E-mail: giladg@supergum.co.il
 Web Site: www.supergum.com
 General Manager: Mr. Yehuda Gescheit
 Head of NBC Division: Mr. Golan Gilad
 Number of employees: 250
 Date established: 1956
 Ownership: Private

Areas of activity

Specialization in CBRN protective equipment. Manufacture of high quality rubber, plastic and sealing products for civilian, military and Industrial applications.

R & D and engineering department support a wide range of standard and custom made rubber and plastic products for highly diverse industrial and automotive applications.

- Rubber technologies: Injection molding; Compression molding; Extrusion: Die-cutting.
 - Plastic technologies; Heat; H.F and U.S sealing; injection molding
- Certified to ISO 9000:2008, QS9000

See pages: 414, 415, 416, 417

S.Y.S TECHNOLOGIES LTD.

12 Harei Efraim St.,
 Or Akiva 3060000, Israel
 Tel: 972-77-3012063
 Fax: 972-77-3012064
 E-mail: sales@systechnologies.biz
 Web Site: www.systechnologies.biz
 C.O - C.E.O: Mr. Yossi Zur
 C.O - C.E.O: Mr. Sagi Unger
 President: Dr. Shalom Zilbershmidt
 Date established: 2010
 Ownership: Private

Areas of activity

SYS Technologies Ltd. uses extensive field knowledge and experience, as well as cutting-edge production methods, to develop, produce and distribute breakthrough products in the field of clean air technology in order to provide medical teams with handy tools and improve the quality of medical treatment for patients and casualties.

See page: 406

TAL & HADAS LTD.

P.O.Box 1011
 Afula Elite 1855010, Israel
 Alon Tavor Ind. Zone
 Tel: 972-4-6408400
 Fax: 972-4-6408401
 E-mail: info@tal-and-Hadas.com
 Web Site: www.tal-and-Hadas.com
 Owner: Mr. Eli Tayar
 Project Manager: Mrs. Zelevich Ornit
 Number of employees: 60
 Date established: 1982
 Ownership: Private

Areas of activity

Tal and Hadas. A privately owned Company established in 1982. We provide real time solutions according to customers' specific requirements. From the design of systems through development and testing to the manufacture of end products. We design, manufacture and market for vehicle, railway, truck and military industries. Our engineering department provides top-standard quality design, using error proof manufacturing methods. Tal & Hadas Ltd. works in compliance with the TS16949 and ISO 9001 standards. The company holds international patents on many exclusive and innovative products, which have both military and civilian applications. Our unique designs and over 25 years of experience with both military and transportation industries, allows us to supply customers with systems, "tailored" according to their requirements. Our key costumers include: GM, VW, Siemens, IDF, General Dynamics.

See page: 146

TAMOR S.M.R LTD.

Southern Industrial Zone
 P.O.Box 19
 6 Hacharoshet St.,
 Migdal Haemek 2310001, Israel
 Tel: 972-4-6546735
 Fax: 972-4-6546738
 E-mail: main@tamor.co.il
 Web Site: www.tamor.co.il
 President: Mr. Moshe Mazor
 C.E.O: Mr. Ronen Mazor
 Number of employees: 50
 Date established: 1988
 Ownership: Private Corporation

Areas of activity

Manufacturer of Turnkey Systems, Subsystems, Kits and Assemblies Production for Wheeled or Tracked Vehicles Prototypes, Low Series, Full Production.

TECHNOLOGYMETALWORK

- Multi-processes in-house
- RUBBER VULCANIZATION
- Bonding of rubber and metal
- Rubber molding

PRODUCTION

- Traversing Machine Gun Mount Systems
- Armored Hatches and Mechanisms
- Fuel Tanks and Water Tanks
- Equipment Compartments, External, Internal
- Structural Kits
- Wheels, Solid Rubber
- Track Shoe Parts and Track Assemblies
- Track Tension Adjusters
- Sprockets and Carriers
- Supporting Road Arms
- Hydraulic Bumpers
- Brake Systems

QUALITY ASSURANCE

- U.S. Army TACOM
(Tank- Automotive and Armaments Command) QSL-01, QSL-03, QSL-04
- NATO AQAP 2110
- ISO 9001:2008
- European and American Welding Certifications and Compliance

See pages: 147, 148, 149

TAR IDEAL CONCEPTS LTD.

5th Ma'avar Yabok St.,
 Tel Aviv 6744007, Israel
 Tel: 972-3-6914564
 Fax: 972-3-6914567
 E-mail: tar@tarideal.com
 Web Site: www.tarideal.com
 C.E.O: Mr. Tomer Avnon
 V.P Sales: Mr. Aviad Matza
 Number of employees: 12
 Date established: 1990
 Ownership: Private

Areas of activity

- Military & Police Equipment and Training
- Counter & Anti Terror
- Riot & Crowd Control
- K9: Attack, Drugs / Explosive Detection, Search & Rescue
- CBRN Protective Gear & Detection Devices
- EOD/IED
- Bulletproof & Ballistic Protection
- Professional Consulting
- HLS
- Perimeter Security
- Intelligence

See pages: 159, 247

TCI - Technical Consultants International Ltd.

P.O.Box 72
Hod Ha'Sharon 4510001, Israel
Tel: 972-9-7462518
Fax: 972-9-7462519
E-mail: techg@attglobal.net
Web Site: www.nightvision.org
Managing Director:
Mr. Donald C.A Watson
Operations Manager: Mrs. Yael Hurvitz
Head of R & D: Mr. Dan Ben-Ari
Number of employees: 6
Date established: 1992
Ownership: Private

Areas of activity

TCI-Technical Consultants International Ltd. designs and manufactures sophisticated Night Vision Systems and other electro-optical products for the Military and Law Enforcement sectors around the world.
Surface and Underwater Systems for observation or weapons applications.
Maritime Systems for observation & photography.
Infrared Markers, Laser Co-ordinators for above and below water.
Day-Night CCTV systems for use in aircraft hijacking, coastal monitoring or covert anti-terrorist applications.
TCI also manufactures a lightweight Sniper Rifle for anti-terrorist operations and promotes Hostage Rescue Ammunition.

See page: 350

TEMMEK OPTICS LTD.

4 Faran St.,
P.O.Box 159
Yavne 8110101, Israel
Tel: 972-8-9438408
Fax: 972-8-9438390
E-mail: temmek@temmek.com
Web Site: www.temmek.com
C.E.O: Mrs. Tami Shimoni
Number of employees: 90
Date established: 1973
Ownership: Gal- Shvav Group

Areas of Activity:

Development and manufacturing of Lenses for Thermal Imaging, for LWIR, MWIR and Multispectral (combinations between SWIR, MWIR and LWIR) suitable for Cooled and Uncooled Thermal Imaging Detectors. In-house complex Optical, Mechanical Electronic Design and Manufacturing of Infrared Assemblies, in addition and adaptations for customer's requirements. Specialization in High Precision Off-The-Shelf and Custom Built, continuous and discrete zoom lenses.

See page: 366

TGL S.P. INDUSTRIES LTD.

P.O.Box 183
Yokneam 2069203, Israel
Tel: 972-4-9937537
Fax: 972-4-9935546
E-mail: mail@tgl-sp.com
Web Site: www.tgl-sp.com
General Manager: Mr. Tal Dekel
Commercial Manager:
Mr. Tomer Margalit
Number of employees: 75
Date established: 1952
Ownership: Private

Areas of activity

TGL is leader in research, design, development and production of suspension and rubberized components such as armored vehicles road wheels, sprocket wheels, track shoes and a vast variety of suspension components, polyurethane and rubber products. Offering high quality and dependable products, TGL is certified ISO-9001:2000. Scope: design and manufacture for military and civilian purposes.
TGL is a foremost supplier to major international customers including the U.S. Army, NATO countries and the Israel Defense Forces.

See page: 152

THERMAL BEACON LTD.

10 Heshvan St.,
Kiryat-Gat 8202366
P.O.Box 1312
Kiryat-Gat 8211202, Israel
Tel: 972-72-2500690
Fax: 972-72-2500691
E-mail: info@thermalbeacon.com
Web Site: www.thermalbeacon.com
C.E.O: Mr. Avi Peer
Number of employees: 12
Date established: 2003
Ownership: Private

Areas of activity

Thermal Beacon Ltd. is a leading company developing and producing high-end innovative thermal IFF (Identification Friend or Foe) emitters and high power visible and infrared laser illuminators and aimers.

See page: 367

TOP CAR ARMORING LTD.

10 Amsterdam St.,
Sderot 8714401 Israel
Tel: 972-8-6496192
Fax: 972-8-6483494
Mobile: 972-54-4957184
E-mail: dorontopcar@012.net.il
Web Site: www.topcar-armor.com
C.E.O: Mr. Doron Labock
Number of employees: 7
Date established: 2012
Ownership: Private

Areas of activity

TOP CAR has developed the most advanced car armoring technologies. TOP CAR is a company with the most advanced know-how and experience in armoring of passengers cars with High-Tech and Light Weight composite armor materials, (more protection and survivability) and supplies all international markets. TOP CAR has unique knowledge and experience on international standards (USA, Europe and Israel) including extensive knowledge in producing materials to get the best ballistic solution.

See page: 211

TOP I VISION LTD.

25 Hathia St.,
Holon 5840245, Israel
Tel: 972-3-9335469/6
Fax: 972-3-9339327
Cell: 972-52-2686334
E-mail: info@topivision.com
Web Site: www.topivision.com
C.E.O: Mr. Nir Shental
Director Business Development:
Mr. Amos Baruchin
Number of employees: 12
Date established: 1996
Ownership: Private

Areas of activity

Top I Vision Ltd. develops and manufactures tactical high-performance surveillance systems for customers throughout the world.

In an age of rapid and dynamic event, where intelligence is vital, Top I Vision provides the ability to detect, gather, process, analyze and effectively react in real time.

Top I Vision major business activities includes:

- Unmanned air vehicle (UAV) systems
- Tactical Aerostat system (TAS)
- C⁴I systems
- Electro-optic systems and products
- Technology spin-offs for commercial activities

Our objective is to combine excellence and cost effectiveness with outstanding service and customer support, to deliver high quality turnkey solutions and to improve our Customer's technological and operational capabilities within limited budgets.

See page: 291

**TSI -
Turbine Support International Ltd.**
9 Hamachtarot St.,
Ra'anana 4355007, Israel
Tel: 972-9-7716581
Mobile: 972-542112261
Fax: 972-9-7746573
E-mail: gadi@tsi.co.il
Web Site: www.tsi.co.il
C.E.O: Mr. Gadi Reches
Vice President: Mrs. Aliza Reches
Vice President Operation: Mr. Ari Reches
Number of employees: 5
Data established: 1987
Ownership: Private

Areas of activity

Turbine Support International Ltd. should be your best solution when you are looking to do business in Israel with major entities in the aerospace arena. TSI is very high reputed by major companies all over the world TSI will give you the best service and solutions to execute any project in Israel.

See page: 44

**UNDERWATER
TECHNOLOGIES CENTER LTD.**
7a Industrial Park,
P.O. box 3003
Omer 8496901, Israel
Tel: 972-77-4050811
Fax: 972-8-6900466
E-mail: info@utc.co.il
Web Site: www.utc-digital.com
Chairman of the Board:
Mr. Yair Rabinowitch
Busuness Development Manager:
Mrs. Ofra Malka
Date established: 2003
Ownership: Private

Areas of activity

UTC develops underwater communication, navigation and rescue technologies, used by leading organizations around the globe.

With extensive knowledge and expertise, UTC's mission is to create the best possible multifunctional platforms for mission critical and leisure diving expeditions.

UTC's underwater two-way digital messaging technology with SOS and homing capabilities, advanced dive computer and 3D compass, enables communication between teams of divers and boat, and location navigation to divers in need.

See page: 124

**UNI-SCOPE
OPTICAL SYSTEMS LTD.**
34 Hanapch St.,
P.O.Box 817
Carmiel 2161701, Israel
Tel: 972-4-9887022
Fax: 972-4-9887023
E-mail: uniscope@zahav.net.il
Web Site: www.uni-scope.co.il
Managing Director: Mr. Danny Marely
Chairman: Mr. Samy Katsav
Director: Mr. Arie Bar-Ner
Number of employees: 32
Date established: 1991
Ownership: Oshira Ltd. & Danny Marely

Areas of activity

- Design and production of:
 - a. Acrylic and glass periscope for armored vehicles.
 - b. Vision blocks for armored vehicles.
 - c. Handheld periscopes for infantry and special force units
- Comprehensive metal parts machining according
- Comprehensive optical and mechanical assembly
- ISO 9001:2009 and Mil-Spec, Quality Assurance and Quality Control facility
- Field and in-house maintenance and technical support

See page: 351

UVISION AIR R&D LTD.

4 Bazelet St.,
 Sapir Industrial Park
 Zur Igal 4486200, Israel
 Tel: 972-9-7496822
 Fax: 972-9-7496823
 E-mail: uvision@uvisionuav.com
 Web Site: www.uvisionuav.com
 C.E.O: Mr. Yair Dubester
 V.P. Business Dev., Sales & Marketing:
 Mr. Amit Morag
 Number of employees 30
 Date established: 1986
 Ownership: Private

Areas of activity

UVision's UAV system solutions are unique, cost-effective and tailored to meet the needs of our customers.

UVision's products include precision attack munitions and advanced airborne guidance and navigation systems and command and control stations fully integrated with communication links. UVision is ISO 9001:2008 certified for R&D, Production, and UAV flight services.

See page: 292

VERINT SYSTEMS LTD.

33 Maskit St.,
 Herzliya 4673333, Israel
 Tel: 972-9-9624119
 Fax: 972-9-9624747
 E-mail: marketing.lis@verint.com
 Web Site: www.verint.com
 Corporate Officer and President, Verint Communications & Cyber Intelligence Solutions: Mr. Meir Sperling
 V.P Sales & Marketing, Verint Communications & Cyber Intelligence Solutions: Mr. Zvi Fischler
 Number of employees: 3,200 (worldwide)
 Date established: 1994

Areas of activity

Verint® Communications and Cyber Intelligence Solutions™ efficiently collect, monitor, and analyze information from virtually any communications network. Built on decades of experience and hundreds of deployed projects, our portfolio features solutions for communications interception, communications service provider compliance, mobile location tracking, open source Web intelligence, tactical communications intelligence, and cyber security.

See page: 331

VERIA MILITARY DESIGN

P.O.Box 8220
 Tel Aviv 6108102, Israel
 Tel: 972-77-5354513
 Fax: 972-3-7617077
 E-mail: info@versiamilitary.com
 Web Site: www.versiamilitary.com
 C.E.O: Mr. Tamir Porat
 V.P. Business Development:
 Mr. Miron Atzmon
 Creative Manager: Mrs. Avigail Arafeli
 Number of employees: 8
 Date established: 2004
 Ownership: Private

Areas of activity

A leading industrial design studio specializing in the defense sector, with a "One Stop Shop" approach from initial concept to final product.

Versia Military Design has more than 15 years of experience specializing within a wide range of areas such as small arms, vehicles, unmanned systems etc.

Services:

- **Research:** Market overview, cost feasibility, technologies, materials and processes, ergonomics, safety.
- **Design concepts:** 2D sketches and 3D CAD simulations, configuration, Material, finishes and Colors.
- **Models & prototypes:** Virtual computerized prototyping, full size mock-ups, CNC, STL, LOM, RTV, MMI, UI and GUI.
- **Engineering:** Technology assessment, mechanical design, component Survey, DFM, production and assembly documentation.
- **Marketing aides:** Animated movies, graphic & web design, print, exhibitions, 3D simulations, photography, promotional gifts.

See page: 452

VIDCO INDUSTRIES LTD.

2 Ha'ofan St.,
 Industrial Zone
 Holon 5881419, Israel
 Tel: 972-3-5570981
 Fax: 972-3-5595715
 E-mail: ron.zukerman@vishaypg.com
 Thermal Shroud Producat Manager &
 Chief Engineer: Mr. Ron Zukerman
 Number of employees: 500
 Date established: 1969
 Ownership: VISHY Advanced
 Technology Inc ISRAEL

Areas of activity

The gun barrel of a tank is heavily influenced by the surrounding environmental conditions and changing firing rates. This may have a significant effect on the curvature of the barrel - resulting in a very low first hit probability, regardless of the powerful capabilities of modern fire control systems

- A smart, efficient and durable solution was specifically designed to solve the gun barrel bending problem.
- Efficiency of 75% to 80% under all environmental and firing conditions (compared to a naked barrel), while other thermal shrouds under the same conditions are within 30% to 40%.
- VIDCO's thermal shroud has proven its efficiency and durability in many battle conditions, from the first generation of the Merkava tank up to the current one
- Our expertise is based on over 25 years of experience with shrouds adapted & applied to various types of tanks, exposed to different climates (desert, snow, forest, etc.)

See pages: 150, 151

VSENSE TECHNOLOGIES LTD.

Office Address:
 Kibbutz Einat, Israel
 Post Office:
 P.O.Box 24254
 Tel Aviv 6124102, Israel
 Tel: 972-72-2113111
 Fax: 972-3-5422557
 E-mail: mail from the web site
 Web Site: www.vsense.net
 C.E.O: Mr. Jacob Gal
 Business Development:
 Mr. Ronen Kaplan
 Number of employees: 50
 Date established: 1999
 Ownership: Private

Areas of activity

Vsense is a leading integration company offering advanced intelligence solutions to government law enforcement agencies in Israel, USA, Europe and Africa. Offering concealed video & audio transmitters and recorders, COFDM digital video links, cellular based video systems, Jammers, Micro digital audio transmitters, WiFi & WLAN interception and custom made solutions. In addition we offer professional training seminars in various fields including intelligence and counter surveillance.

See page: 336

Xi INFORMATION PROCESSING SYSTEMS LTD.

P.O.Box 60
 Savyon 5691501, Israel
 Tel: 972-3-9215891
 Fax: 972-3-5343520
 E-mail: xi00001@attglobal.net
 President: Mr. Igal Levy
 Number of employees: 10
 Date established: 1968
 Ownership: Private

Areas of activity

Xi designs, develops and manufactures telematics and location centric systems for homeland security surveillance, assets and vehicle tracking and monitoring. Xi's expertise and decades of track record in digital mapping, geo-location, telematics and wireless data communications technologies, enable it to offer its customers professional services and end to end solutions, including end terminals and geo-location C4I² Center.

Among Xi Products are:
 Time Critical location based Command, Control, Communications and Information server, Mobile information, management and navigation, security and surveillance systems, tracking and Automatic Vehicle Location (AVL) system.

See page: 318

PRODUCT BRAND NAMES

BRAND NAME/ ACRONYM/ ABBREVIATION	EXPLANATION	COMPANY	PAGE
A			
101A1	NBC youth respirator	Shalon Chemical Industries	412
4A1	NBC adult respirator	Shalon Chemical Industries	412
A-4 SKYHAWK	Delta winged single turbo-jet aircraft	SIBAT- Ministry of Defense	388, 389
AAR	Air to air refueling system	IAI - Bedek Aviation Group	21
ABIR II	4x4 light tactical truck	Automotive Industries	209
ACBS	NBC protective hood & blower system	Shalon Chemical Industries	411
ACCULAR	160 mm autonomous surface to surface GPS-guided artillery rocket	IMI - Israel Military Industries	202
ACRB	Advanced control recording box	BAE Systems Rokar	72
ADCCS	Air defense command & control systems	Ness TSG	79
ADNAV	Land navigation systems for tanks & APCs	IAI - Tamam Division	377
AEROSTAR	Tactical unmanned air vehicle system	Aeronautics	268, 269
AH-1 COBRA	Attack helicopter	SIBAT- Ministry of Defense	388, 396
AHRS	Altitude heading & reference system for aircraft, helicopters & UAVs	IAI - Tamam Division	377
AIR STAR	Multi-sensor aerostat based ISR system	RAFAEL	84, 192, 317
AIRMOR	Fully autonomous modular self-protection suite for helicopters & transport aircraft	IMI - Israel Military Industries	77
AISR	Aerial intelligence surveillance & reconnaissance systems	Aeronautics	57
ALL-IN-SMALL	Airborne EW protection suite	Elbit Systems - Elisra	75
AMAPS	Survey & target acquisition systems	IAI - Tamam Division	377
AMLCD	Family of multifunction color display	Elbit Systems	50
AMMAD	Anti-magnetic mine actuating system	IAI - Ramta Division	218
AMOS	Fixed service satellite	IAI - Space Division	92
AMPS	Airborne missile protection systems	Bird Aerosystems	73
AMPS	Family of stabilized airborne EO payloads	Elbit Systems - Elop	352
AMTS	Active man-pack transceiver system	Elbit Systems Land & C ⁴ I	309
ANVIS/HUD	Head out flight integrated system	Elbit Systems	53
APS	Active protection systems	IMI - Israel Military Industries	140
APU	Auxiliary power unit for MBTs & AFVs		
	Reflex sights for sharpshooters, marksmen, machine gunners & hunters	Elbit Systems Land & C ⁴ I MSE	139 236
AQC			
AQUASHIELD	Diver detector sonar	DSIT Solutions	123
ARBEL	Ruggedized dual FOV camera	OPGAL Optronics Industries	364
ARC 840D	Software defined radio	IAI - Elta Systems	306
ASA35A1	Floating personal body armor	IMI - Israel Military Industries	113
ASIO	Airborne surveillance, intelligence & observation system	Bluebird Aero Systems	16
ASIS	Airborne surveillance & intelligence system	INNOCON	282
ASIS	Airborne integrated SIGINT system	Elbit Systems Land & C ⁴ I	323
ATALD	Advanced tactical air launched decoy	IMI - Israel Military Industries	77
ATCT	Appended tank crew trainer	Elbit Systems	256
A-TIM	Clip-on thermal imaging sight	Elbit Systems - Elop	361

BRAND NAME/ ACRONYM/ ABBREVIATION	EXPLANATION	COMPANY	PAGE
ATLAS	Portable gun laying system	Elbit Systems - ITL	341
ATLAS LT	Target acquisition system for forward observers	Elbit Systems - ITL	341
ATRIS MP	Remotely controlled day/night man portable observation system	Elbit Systems - ITL	341
ATRISP	Man-portable remote controlled target acquisition system	Elbit Systems - Elop	362
ATROMAT	Automatic injectors	Shalon Chemical Industries	413
ATTAS	Automated terror threat analyze system	Ness TSG	79
AvantGuard MK II	Unmanned ground vehicle systems	GNIUS Unmanned Ground Sys.	293
AYIT	A-4 Skyhawk trainer simulator	SIBAT - Ministry of Defense	394
B			
Baby HUD	Compact HUD	Elbit Systems - Elop	49
BARAK	F-16C trainer simulator	SIBAT - Ministry of Defense	394
BARAK-8	Air & missile defense system	IAI - Air & Missile Defense Div.	112, 260
BAZ/RAAM	F-15AUP & F-15I trainer simulator	SIBAT - Ministry of Defense	394
BELISARIO	Visual intelligence gathering system	Athena GS ₃ Security	319
BIRD EYE 400	Mini UAS	IAI - Malat Division	287
BIRD-EYE 650	Mini UAS	IAI - Malat Division	287
BL-45 Type B	NBC multi-purpose blower	Supergum Industries	413, 414
BL-90	NBC air supply unit	Shalon Chemical Industries	411
BL-90	Blower for military protection	Supergum Industries	414
BNET	Broadband MANET IP software defined radio	RAFAEL	192, 317
BOMBARD	Artillery command & control system	Elbit Systems Land & C ⁴ I	309
BOOMERANG	Long endurance mini UAV	Bluebird Aero Systems	15
BRF	Blast resistance fabric for wall shielding	Ortech Defense Systems	177
BRIGHT ARROW	Combined soft/hard kill APS	IMI - Israel Military Industries	140
BRO@DNET	Broadband wireless communication infrastructure solution	Elbit Systems Land & C ⁴ I	303
BTUZ	Breaching techniques in urban zones	Quadro Projects & Technologies	225
BUL CHEROKEE	Polymer frame pistol	BUL Transmark	248
BUL IMPACT	Polymer frame pistol	BUL Transmark	248
BUL M-5	Lightweight hi-capacity pistol	BUL Transmark	248
BUL STORM	Steel frame pistol	BUL Transmark	248
C			
C.A.H.	Civilian adult hood	Supergum Industries	415
C/C	NBC C/C armored vehicle for unconventional event management	Hatehof	418
C-130	Military transport aircraft	SIBAT - Ministry of Defense	388, 391
C⁴ConNeCT	Voice communication system for Air Force	RAFAEL	84
C⁴ISTAR	C ⁴ system for land, air & sea forces	Elbit Systems Land & C ⁴ I	310
CAHBS	NBC civilian adult hood & blower system	Shalon Chemical Industries	413
CAPS 2000	NBC civilian adult protective system	Shalon Chemical Industries	412
CASPER 250	Mini UAV system	Top I Vision	291
CASPER 350	UAV system	Top I Vision	291
CCAS	Cleaning contaminated areas solutions	Quadro Projects & Technologies	225

BRAND NAME/ ACRONYM/ ABBREVIATION	EXPLANATION	COMPANY	PAGE
CENTURION	Battle tank	SIBAT - Ministry of Defense	385
CESM	Integrated EW suite	Elbit Systems - Elisra	118
CETER	NBC protective hood & blower system	Shalon Chemical Industries	410
CETER	Chemical team respirator	Supergum Industries	416
C-GEM	Off-board RF active decoy	RAFAEL	78, 116
C-GUARD	Active & reactive counter-IED jamming systems	Netline Communications	119, 328
CHAMELEON 2	Unattended persistent surveillance system	Seraphim Optronics	347
CK21	Exploitation platform for managing intelligence workflow	Athena GS ₃ Security	319
CLTS	Combat live training system	Elbit Systems	256
C-MAN	Computerized maritime navigation system	Astronautics C.A.	98
CMAT	Crossing mined areas technologies	Quadro Projects & Technologies	225
CMS	Communication management system	Orbit Communication Systems	307
COAPS	Commander panoramic sight	Elbit Systems - Elop	134
ColoRad	Field measurement spectral band radiometer	IARD Sensing Solutions	370
COMBAT-NG	Fire control & command for artillery & air defense	Elbit Systems Land & C ⁴ I	310
COMET	North finding system	Elbit Systems - ITL	341
COMPACT EYE	Thermal imaging core engine	OPGAL Optronic Industries	364
CONDOR 2	LOROP airborne standoff reconnaissance system	Elbit Systems - Elop	353
CONDOR TAC	Dual band tactical photography system	Elbit Systems - Elop	353
CORAL	Thermal imaging binocular cameras	Elbit Systems - Elop	362, 363
CORAL-CR	Thermal imaging binocular camera	Elbit Systems - Elop	362
CORAL-LS	Thermal imaging camera	Elbit Systems - Elop	363
CORAL-Z	Thermal imaging binocular camera	Elbit Systems - Elop	363
COYOTE	Uncooled thermal imagers	Elbit Systems - ITL	341
C-PEARL	ESM Naval EW systems	RAFAEL	78, 116, 121
CRPM	Competence & readiness performance management	Eltel Technologicals	257
CS 40	Video technology for grenade launcher	Corner Shot	251
CS AK-74/47	Video technology for indirect firing	Corner Shot	251
CS APR M16	Video technology for M-16 around the corner shooting	Corner Shot	251
CS GP25	Video technology for grenade launcher	Corner Shot	251
CST	Command & staff trainer	Elbit Systems	256
CTIS	Computerized telephone interception system	Mipha International	326
CY - HUMINT	Web analysis system	Athena GS ₃ Security	319
CYBERVISION	Cyber threats protection	Verint Systems	331
D			
DACCS	Artillery command & control system	Elbit Systems Land & C ⁴ I	309
DASH	Display & sight helmet	Elbit Systems	51
DBS	Dual band CCD camera for detection applications	IARD Sensing Solutions	370
DCoMPASS	Digital compact multi-purpose advanced stabilized system	Elbit Systems - Elop	354
DEEP LINK	Acoustic communication network	RAFAEL	108, 116, 316
DELILAH	Long range loitering E/O stand-off missile	IMI - Israel Military Industries	62
DELILAH SL	Ship launched DELILAH missile	IMI - Israel Military Industries	113
DERBY	Active radar air-to-air missile	RAFAEL	65, 66, 95, 261
DESEAVER	Decoy control & launching system	Elbit Systems	111
DLV-53 MFTM	ISTAR wideband data link	RAFAEL	84, 192, 317

BRAND NAME/ ACRONYM/ ABBREVIATION	EXPLANATION	COMPANY	PAGE
DMTS	Dangerous material treatment systems	Quadro Projects & Technologies	225
DNS 300 NAV	Diver navigation system	Oceana Technologies (2009)	107
DNS 300 SONAR	Hand-held sonar for EOD divers	Oceana Technologies (2009)	107
DOMINATOR	MALE UAV	Aeronautics	270, 271
DOMINATOR	Infantry combat system	Elbit Systems Land & C ⁴ I	311
DSF	Dynamic sunlight filter	Kilolambda Technologies	345
DVE	Driver vision enhancer devices	OPGAL Optronics Industries	364
E			
EAPS	Energy absorbing pallet system for parachute/air drop equipment	Tal & Hadas	146
ECC	Engine control computers for UAVs	RADA Electronic Industries	56
ECM	Integrated EW suite	Elbit Systems - Elisra	118
EDGE	Tactical underwater command & control capabilities	Oceana Technologies (2009)	107
EDS	Explosive destruction systems	Quadro Projects & Technologies	225
EFIS	Electronics flight instrument system	Astronautics C.A.	47
EGTDS	Electric gun & turret drive system	Elbit Systems Land & C ⁴ I	138
EHUD	Autonomous air combat maneuvering instrumentation	Elbit Systems	68
EICAS	Engine instruments & crew alert system	Astronautics C.A.	47
E-LAWS	Laser warning system	Elbit Systems Land & C ⁴ I	137
ELI-3001	Airborne integrated SIGINT system	Elbit Systems Land & C ⁴ I	323
ELI-3120	Compact multi mission aircraft	IAI - Elta Systems	81
ELI-3150	Multi-mission airborne reconnaissance & surveillance system (MARS2)	IAI - Elta Systems	81
ELI-3360	Maritime patrol aircraft	IAI - Elta Systems	81
ELIYAH	Cyber & cellular security	Dynamo Risk Defense	89
ELK-1850	Tactical intelligence microwave data link	IAI - Elta Systems	306
ELK-1894	Airborne wideband SATCOM data link	IAI - Elta Systems	306
ELK-1895	Manpack tactical SATCOM terminal	IAI - Elta Systems	306
ELK-7036	COMINT ground system	Elbit Systems Land & C ⁴ I	323
ELK-7071	Integrated UAV COMINT/DF system	IAI - Elta Systems	281
ELL-8212/22	Power managed self-protection systems	IAI - Elta Systems	22
ELL-82160/2	EW self-protection suite	IAI - Elta Systems	76
ELL-8247/8	Power managed self-protection systems	IAI - Elta Systems	22
ELL-8251	EW system escort jammer	IAI - Elta Systems	76
ELL-8382/5	ELINT ground system	Elbit Systems Land & C ⁴ I	323
ELL-8382MPA	Airborne ESM/ELINT for maritime patrol A/C	IAI - Elta Systems	80
ELL-8385	Integrated UAV ESM/ELINT system	IAI - Elta Systems	281
ELM-2022A	Maritime patrol radar	IAI - Elta Systems	80
ELM-2022U	UAV maritime patrol radar system	IAI - Elta Systems	281
ELM-2032	Multimode fire control radar	IAI - Elta Systems	22
ELM-2052	Active phased array airborne fire control radar	IAI - Elta Systems	22
ELM-2054	SAR/GMTI UAV reconnaissance system	IAI - Elta Systems	281, 324
ELM-2055	SAR/GMTI UAV reconnaissance system	IAI - Elta Systems	281, 324
ELM-20600	Radar targeting pod	IAI - Elta Systems	22, 324
ELM-2060P	Pod mounted SAR/GMTI system on fighter aircraft	IAI - Elta Systems	324
ELM-2060T	SAR/GMTI system on business jets & transport aircraft	IAI - Elta Systems	324
ELM-2080	GREEN PINE search, acquisition & fire control radar	IAI - Elta Systems	259

BRAND NAME/ ACRONYM/ ABBREVIATION	EXPLANATION	COMPANY	PAGE
ELM-2083	Aerostat programmable radar	IAI - Elta Systems	259
ELM-2084	Multi-mission radar	IAI - Elta Systems	259
ELM-2160	Airborne radar based missile approach warning system	IAI - Elta Systems	76
ELM-2221	Search, track & guidance radar	IAI - Elta Systems	109
ELM-2238	Surveillance & threat alert radar	IAI - Elta Systems	109
ELM-2248	Multi-function surveillance, track & guidance radar	IAI - Elta Systems	109
ELM-2258	Advanced lightweight phased array naval radar	IAI - Elta Systems	109
ELM-2288	AD STAR – Air defense & air traffic control radar	IAI - Elta Systems	259
ELS-8994 VEX	RICent/VEX video exploitation system	Elbit Systems Land & C ⁴ I	322
ELS-8994RT	Real time imagery intelligence center	Elbit Systems Land & C ⁴ I	322
ELSAT-2000	Satellite communications on-the-move	Elbit Systems Land & C ⁴ I	302
ELW-2085	Conformal airborne early warning & control	IAI - Elta Systems	81
EMERALD	Airborne ESM/ELINT system for manned & unmanned platforms	Elbit Systems - Elisra	75
ENGAGE	Mobile location tracking system	Verint Systems	331
ENTCS	Naval combat management system	Elbit Systems	110
EoSHIELD	Vehicle IR countermeasure system	Elbit Systems - Elop	162
EOT	Electro-optical trainer simulator	SIBAT- Ministry of Defense	395
EPMU	Electrical power management units for UAVs	RADA Electronic Industries	56
EPS 21	Combat goggles for ballistic, sun, wind, dust & laser eye protection	Shalon Chemical Industries	175
EROS	Optical observation satellite	IAI - Space Division	92
EROS-A	High resolution imaging satellite	IMAGESAT International N.V.	325
EROS-B	High resolution imaging satellite	IMAGESAT International N.V.	325
ETC	Enhanced tactical computers	Elbit Systems Land & C ⁴ I	312
ETOP	Hovering aerial observation system	IAI- Malat Division	288
EVA	Embedded virtual avionics for trainer aircraft	Elbit Systems	69
EXTRA	306 mm GPS-guided artillery rocket system	IMI - Israel Military Industries	202
EYE R640	Thermal imaging core engine	OPGAL Optronon Industries	364
EYE-LITE	Continuous zoom thermal camera	OPGAL Optronon Industries	364
F			
F-16 FIGHTING FALCON	Light multi-role fighter jet	SIBAT- Ministry of Defense	388, 392
FALCON EYE	MALE UAS	INNOCON	282
FCS	Fire control systems	Elbit Systems Land & C ⁴ I	138
FCT	Field test collimator	CI Systems	369
FEAT	Training system	Dynamo Risk Defense	89
FOCAL-INFO	Open source web intelligence collect & analyze system	Verint Systems	331
FOG	GPS-INS solution for aircraft, helicopters & ground combat vehicles	RADA Electronic Industries	378
FORT 1	All terrain command & control center combat vehicle	ISDS	432
FOX	Thermal imaging cameras	CONTROP Precision Tech.	359
FOXTRACK	Portable ground surveillance radar system	Elbit Systems - Elisra	226
G			
GABRIEL	Mobile NBC shelter	MIFRAM	155
GALIL ACE	Assault rifles	IWI - Israel Weapon Industries	254

BRAND NAME/ ACRONYM/ ABBREVIATION	EXPLANATION	COMPANY	PAGE
GAL-LIZARD-4	GPS/INS guidance kit for bombs	Elbit Systems	60
GENDARME	Protective vest	Isragor Protective Gear & Systems	167
GHOST	Rotary mini UAS	IAI - Malat Division	288
GILBOA	Military-grade firearms	Silver Shadow – Gilboa Rifle	255
GIRIT	NBC decontamination unit	Hatehof	418
GMM120	GPS &/or Semi Active Laser (SAL) 120mm guided mortar bomb	IMI - Israel Military Industries	233
GSDU	Multi-function C ⁴ I ground display unit	Elbit Systems Land & C ⁴ I	312
GTADS	Ground target acquisition & designation system	IAI - Tamam Division	344
GUARDIUM EV	Unmanned ground vehicle systems	GNIUS Unmanned Ground Sys.	293
GUARDIUM MK I	Unmanned ground vehicle systems	GNIUS Unmanned Ground Sys.	293
GUARDIUM MK II	Unmanned ground vehicle systems	GNIUS Unmanned Ground Sys.	293
GUARDIUM MK III	Unmanned ground vehicle systems	GNIUS Unmanned Ground Sys.	293
H			
HeliC⁴om	Intelligent C ⁴ & mission management system	Elbit Systems .	51
HERCULES	Military transport aircraft	SIBAT - Ministry of Defense	388, 391
HERMES	Family of UAVs	Elbit Systems	279
HERMES 450	UAV	Elbit Systems	279
HERMES 90	UAV	Elbit Systems	279
HERMES 900	UAV	Elbit Systems	279
HERON	MALE UAS	IAI - Malat Division	284
HERON TP	Multi-role MALE UAS	IAI - Malat Division	284
HOPER	Helicopter pilot NBC protective hood & blower system	Shalon Chemical Industries	411
HPU	Computerized hydraulic power supply	B.L. Advanced	87
HUD	Head up displays	Elbit Systems - ELOP	48, 49
HURRICANE	8 ton all terrain 4x4 APC	Hatehof	133
I			
ICE	Comprehensive multi-sensor field proven imagery intelligence solution	Elbit Systems Land & C ⁴ I	320
ICECS	Individual crew & equipment cooling system	Elbit Systems Land & C ⁴ I	139
ICP	Interface control processors for UAVs	RADA Electronic Industries	56
ID260MF	Impact delay fuze for precision guide munitions	Orion Advanced Systems	63
IDS WIZARD	Corner reflector	RAFAEL	116
IFB 500	500 lb penetration antipersonnel/anti material bomb	IMI - Israel Military Industries	62
IFEWS	In-flight electronic warfare simulator	Elbit Systems	69
ILET	Electro-optical tester	CI Systems	369
IM SAFE & ARM MECHANISM	Insensitive munition safe & arm mechanism for hand grenades	IMI - Israel Military Industries	232
IMILITE	ISR exploitation & C&C system	RAFAEL	29, 37, 55, 83, 85, 178, 179, 181, 191, 193, 241, 244, 332, 335, 349, 357

BRAND NAME/ ACRONYM/ ABBREVIATION	EXPLANATION	COMPANY	PAGE
IMPS	Indoor modular protection system	MIFRAM	155
IMU	FOG-based inertial measurement unit & AHRS solutions	RADA Electronic Industries	378
INPRO	NBC infant protector	Shalon Chemical Industries	412
InterSKY G4S	Two-way broadband satellite communication system	Elbit Systems Land & C ⁴ I	304
IR-CENTRIC	Self-protection force multiplier for airborne & ground application	Elbit Systems - Elisra	75
IRCS	Integrated radio communication system	Elbit Systems Land & C ⁴ I	303
IRON DOME	Counter rockets, artillery & mortars system	RAFAEL	65, 95, 261
IRON FIST	Active protection systems for heavy AFV's	IMI - Israel Military Industries	140
IVORY-Z	Thermal imaging camera/sight	Elbit Systems - Elop	360
J			
JAM-AIR	Electronic warfare self-protection system	RAFAEL	78
JEDEYE	HMDs for Apache & other rotorcrafts	Elbit Systems	53
JERICHO	Pistol	IWI - Israel Weapon Industries	254
JUDEA FORT	Modular cubes for building bunkers	Ortech Defense Systems	177
JUPITER	Remote sensing camera	Elbit Systems - Elop	91
K			
K-9	Task dog training	NIRTAL	439
KFIR	All-weather multi-role combat aircraft	SIBAT - Ministry of Defense	388, 389
KLEINE KLASSE	Support boat	SIBAT - Ministry of Defense	400, 402
KRAV-MAGA	Israel martial arts	IMI ACADEMY	425
KRAV-MAGA	Self-defense method	Skornik Tal	442
L			
L-70	40 mm anti-aircraft cannon	SIBAT - Ministry of Defense	393
LAHAT	Laser home attack missile	IAI - Air & Missile Defense Div.	61
LAMBDA M760	Electronic time fuze for mortar bombs	Reshef Technologies	207
LEANN	Uncooled thermal digital & analog engines	Senso-Optics	365
LESCUT	Torpedo countermeasure for surface ships	RAFAEL	116, 121
LITENING	Targeting & navigation pod for fighter aircraft	RAFAEL	28, 36, 54, 82, 178, 180, 190, 240, 334, 348, 356
LIZ	Multi-sensor day/night EO sight	Elbit Systems - Elop	361
LIZARD	Family of modular guidance kits for general purpose bombs	Elbit Systems	60
LIZARD-2 Laser	Modular guidance kit for bombs	Elbit Systems	60
LIZARD-3 Laser	Modular guidance kit for bombs	Elbit Systems	60
LOROS	Long range observation system	IAI - Tamam Division	358
LOTUS-G/GL	Man-portable long-range thermal imaging camera	Elbit Systems - Elop	361
LSS	Life support systems for AFVs & MBTs	Elbit Systems Land & C ⁴ I	139
LWS	Integrated EW suite	Elbit Systems - Elisra	118
LYNX	Autonomous multi-purpose artillery rockets & missile launching system	IMI - Israel Military Industries	202

BRAND NAME/ ACRONYM/ ABBREVIATION	EXPLANATION	COMPANY	PAGE
M			
M15A1T	NBC respirator	Shalon Chemical Industries	410
M15S80	NBC respirator for armored vehicle crew member	Shalon Chemical Industries	410
M-163-A1	Lightweight mobile 20 mm 6-barrel cannon	SIBAT - Ministry of Defense	393
M454 S-HE	155 mm super-high-explosive artillery projectile	IMI - Israel Military Industries	202
M48	Gas particulate filter for Abrams M1A1 tank	Shalon Chemical Industries	413
M-48A3/A5	Battle tank	SIBAT - Ministry of Defense	384, 386
M-48A3/A5 PATTON	Battle tank	SIBAT - Ministry of Defense	386
M60 A1/A3	Patton battle tank	SIBAT - Ministry of Defense	384
M60A3	Main battle tank	SIBAT - Ministry of Defense	387
M80	NBC filter canister	Shalon Chemical Industries	411
M89-SR	Sniper rifle	TCI	350
MAFCS	Modular artillery fire control system for upgrade of self-propelled & towed artillery guns & mortars	Astronautics C.A.	196
MANTIS	Autonomous self-rising bullet proof mobile watch tower	MIFRAM	154
MARS	Multi-purpose air-launched rocket system	IMI - Israel Military Industries	62
MATADOR (RGW 90) AS	Anti-structure munitions	RAFAEL	237
MATADOR WB	Wall breaching munitions	RAFAEL	237
MAVINS	All in one modular avionics & INS system for UAVs	RADA Electronic Industries	56
MaXess	Military wireless LAN	Elbit Systems Land & C ⁴ I	303
Maxi VIPeR	Portable robot	Elbit Systems Land & C ⁴ I	294
MBD	Ballistic missile defense system	Elbit Systems Land & C ⁴ I	309
MBS	Modular ballistic shelter	MIFRAM	155
MD-500 DEFENDER	Light multi-role utility helicopter	SIBAT- Ministry of Defense	388, 396
MDP	Mission & display computers	Astronautics C.A.	47
ME4	NBC gas particulate filter for Merkava battle tank	Shalon Chemical Industries	413
MEDI-T	Clean environment systems for medical applications	SYS Technologies	406
MEMS	Inertial navigation system	RADA Electronic Industries	378
MERCURY	Earth global monitoring system	Elbit Systems - Elop	91
MERKAVA Mk. 4	4th Generation Merkava battle tank	SIBAT - Ministry of Defense	128, 129
MFC CHECKMATE	Anti-personal mine safety shoes	D.T.E. Co.	217
MIC⁴AD	Integrated C ⁴ system	RAFAEL	86, 182, 194, 262, 315, 333
MICOM-3	Family of long-range radio communication in fixed & mobile configurations	Elbit Systems Land & C ⁴ I	301
MICRO FALCON			
MINI UAS	Family of light UAS	INNOCON	282
MicroB	Tactical unmanned aerial system	Bluebird Aero Systems	14
MicroCoMPASS	Micro compact multi-purpose advanced stabilized system	Elbit Systems - Elop	355
MicroPOP	Gyro-stabilized payload	IAI - Tamam Division	358
MicroRad	EO systems calibration single channel radiometer	IARD Sensing Solutions	370
MINI ATLAS	Precision electronic goniometer	Elbit Systems - Elop	362
MINI CORAL	Hand-held thermal imager	Elbit Systems - Elop	363
MINI FALCON	Tactical ISTAR UAS	INNOCON	282
MINI PANTHER	Mini tactical VTOL UAS	IAI - Malat Division	286
MINI VIPeR	Portable robot	Elbit Systems Land & C ⁴ I	294
MINIPOP	Gyro-stabilized payload	IAI - Tamam Division	358

BRAND NAME/ ACRONYM/ ABBREVIATION	EXPLANATION	COMPANY	PAGE
MINIPOP-D	Miniature EO systems for site & coast protection	IAI - Tamam Division	344
MINI-SPIKE	Multi-purpose missiles for infantry & special forces	RAFAEL	67, 203, 245
MIPR	Military IP radio	Elbit Systems Land & C ⁴ I	298
MLT-1000	Military modem	Gilat Satellite Networks	305
MMTT	Multi-mission tanker transport	IAI- Bedek Aviation Group	21
MOBILINX	Geo-referenced security command & control & management system	Xi Information Processing Sys.	318
MOSP	Multi-mission optronic stabilized payload	IAI - Tamam Division	358
MOSP3000	EO systems for site & coast protection	IAI - Tamam Division	344
MPR 500	Multi-purpose rigid bomb	Israel Military Industries	62
mPrest	Software for integration of input data	mPrest Systems	314
MPRS	Multi-purpose rifle system	Israel Military Industries	233
MRS-2000M	All-digital intelligence system	Elbit Systems Land & C ⁴ I	309
MSC	Multi-purpose security container/shelter	MIFRAM	155
MSOV	Modular stand-off vehicle glider dispenser	IMI - Israel Military Industries	62
MSV	Mobile surveillance vehicle	Aeronautics	208
MTC	Mission training center	RAFAEL	68
mTMR	Lightweight multimedia routing unit	Elbit Systems Land & C ⁴ I	304
MUGI	Unattended ground imaging sensor	Seraphim Optronics	347
MUSIC	Multispectral infrared countermeasures against MANPADS	Elbit Systems - Elop	74
mVIDI	Video streamer	Elbit Systems Land & C ⁴ I	304
N			
NAMER	Merkava APC	SIBAT- Ministry of Defense	130
NATACS	Naval tactical COMINT/DF system	Elbit Systems - Elisra	118
NAV X INFO	Hybrid navigation system for rural & urban area navigation	Xi Information Processing Sys.	318
NAVIGATOR	18.5 ton all terrain 4x4 MRAP	Hatehof	133
NCMI	Naval combat maneuvering instrumentation system	Elbit Systems	122
NEGEV	Light machine gun	IWI - Israel Weapon Industries	254
NEPTUNE	High resolution remote sensing camera	Elbit Systems - Elop	91
NETZ	F-16 trainer simulator	SIBAT - Ministry of Defense	394
NEW SAMSON MKII	30 mm weapon RWS for light-armored, high mobility fighting vehicle	RAFAEL	205, 215, 243
NIRIT	Upgraded SAAR 4.5 fast attack missile boat	Israel Shipyards	101
NRUAS	Naval UAS	IAI - Malat Division	285
NTC	Naval training center	Elbit Systems	122
NTT	Naval tactical trainer	Elbit Systems	122
O			
OFEQ	Surveillance satellite	IAI - Space Division	92
OFRI	Real time observation range enhancer	IARD Sensing Solutions	370
OLT	“O” level laser tester	CI Systems	369
OMICRON M180	Electronic proximity fuze	Reshef Technologies	207
OPTSAT 2000	High resolution observation satellite	IAI - Space Division	92
OPTSAT 3000	Three axis stabilized, autonomous satellite	IAI - Space Division	92
OPV	Offshore patrol vessel	Israel Shipyards	102
OR	Innovative night vision sight	MSE	236

BRAND NAME/ ACRONYM/ ABBREVIATION	EXPLANATION	COMPANY	PAGE
ORBITER	Mini unmanned air vehicle	Aeronautics	272, 273
ORBITER 3	Small unmanned air vehicle	Aeronautics	274, 275
ORCWS	Overhead remote controlled weapon stations	Elbit Systems Land & C ⁴ I	136
ORION	Fast transient radiometer	IARD Sensing Solutions	370
OTHELLO			
ELO-5220	Shortwave optical fire locator	IAI- Elta Systems	76
P			
PANTHER	Tactical VTOL UAS	IAI - Malat Division	286
PAR	Portable pulse acquisition radar	SIBAT - Ministry of Defense	393
PASGAT	Protective vest	Isragor Protective Gear & Sys.	167
PATHMARKER	Automatic vehicle location system	Xi Information Processing Sys.	318
PELICAN 2400	Passive interception system	PICSIX	330
PES	Pilot evaluation system	IAI - Lahav Division	71
PHALANX	Multi-purpose fortification kit	MIFRAM	155
PICSIX	Interception & counter-interception systems	PICSIX	330
PIU	Payload interface units for UAVs	RADA Electronic Industries	56
PLDR-II	Portable lightweight designator/rangefinder	Elbit Systems - Elop	342
PMC	Payload management computers for UAVs	RADA Electronic Industries	56
POP	Plug-in optronic payload	IAI - Tamam Division	358
POP300D	EO systems for site & coast protection	IAI - Tamam Division	344
POPEYE	Air-to-ground standoff missile	RAFAEL	66
PRIEST	Sentinel MILSPEC observation tower	MIFRAM	154
PROTECTING PEOPLE	Design, manufacture & global marketing of protective products	Lior Textile Industries	170
PROTECTOR USV	Unmanned integrated system for intelligence, surveillance, target acquisition & reconnaissance vehicle	RAFAEL	105, 114, 116, 178, 183, 290
PVIEW	Panoramic day/night camera pod	BAE Systems Rokar	72
PYTHON	Air-to-air missile	RAFAEL	65, 66, 95, 261
Q			
QYLUR	Self-service multi-threat checkpoint system	ISDS	433
R			
R.U.F	Rescue under fire products	Tal & Hadas	146
RAM MK III	Light armored multi-mission vehicles	IAI - Ramta Division	218, 219
RAMGAN	Bullet proof observation tower	MIFRAM	154
RATTLER	Family of miniature coded laser designator/marker	Elbit Systems - Elop	343
RAVNET 300	Airborne voice & data communication radio network	RAFAEL	84, 192, 317
RAYSAT	Antenna systems for satellite communications	Gilat Satellite Networks	305
RECCELITE	Multi-sensor tactical reconnaissance system	RAFAEL	28, 36, 54, 82, 178, 180, 190, 240, 334, 348, 356

BRAND NAME/ ACRONYM/ ABBREVIATION	EXPLANATION	COMPANY	PAGE
RECCE-U	Multi-sensor ISR system	RAFAEL	28, 36, 54, 82, 178, 180, 190, 240, 334, 348, 356
RED SKY-2	Fast deployment compact VSHORAD system	Israel Military Industries	77
RELIANT	Communication interception system	Verint Systems	331
RESM	Integrated EW suite	Elbit Systems - Elisra	118
RESPRO	NBC protective hood for children	Shalon Chemical Industries	412
RICent	Real time imagery intelligence center	Elbit Systems Land & C ⁴ I	322
RNAV	RLG based terrain navigation system	IAI - Tamam Division	377
RNAV-IPON	RLG based terrain navigation system	IAI - Tamam Division	377
RPDA 57	Situational awareness on-the-move PDA	Elbit Systems Land & C ⁴ I	313
RPS-10	Active protection radar	RADA Electronic Industries	163
RPS-15	Hostile fire detection system for combat vehicles	RADA Electronic Industries	163
RPS-40	Combat threat management & hostile fire detection radar	RADA Electronic Industries	163
RPS-42	Tactical air surveillance radar	RADA Electronic Industries	163
RPS-44	Surface & air border intrusion management	RADA Electronic Industries	163
S			
SAAR 4	Fast gun boat	SIBAT - Ministry of Defense	400, 401
SAAR S-72	Fast attack mini corvettes	Israel Shipyards	100
SAMSON	Load reduction system on the soldier's back	Tal & Hadas	146
SAMSON DUAL	Two weapons dual-axis, gyro-stabilized RWS	RAFAEL	205, 215, 243
SAMSON Jr.	Remote weapon station for wheeled, tracked & naval platforms	RAFAEL	204, 214, 242
SAMSON MINI	Mini dual-axis gyro-stabilized RWS for light wheeled or tracked combat vehicles, fast attack boats & other platforms	RAFAEL	205, 215, 243
SAMSON RWS	Remote weapon station family	RAFAEL	204, 214, 242
SAND	Smart all-terrain networked detectors	Elbit Systems Land & C ⁴ I	321
SAS	Static active sonar	DSIT Solutions	123
SAS	Synthetic arena simulation	Eltel Technologicals	257
SAT-2013	Satellite mission design	Dynamo Risk Defense	89
SatTrooper 1000	Military manpack terminal for C ⁴ I tactical applications	Gilat Satellite Networks	305
SBSS	Invisible system for coastal, underwater & area protection	Dynamo Risk Defense	89
SCUTTER	Reactive expendable acoustic torpedo countermeasure	RAFAEL	116, 120
SEA SPOTTER IRS2T	Naval IR staring & tracking system	RAFAEL	115, 120
SEA-COM	IP/VoIP shipborne communication system	RAFAEL	108, 316
SEARCHER 2	UAV simulator	SIBAT - Ministry of Defense	395
SEARCHER MK III	Multi-role tactical UAS	IAI - Malat Division	285
SECUREPATH	Geo-referenced wireless security system to monitor remote sensors	Xi Information Processing Sys.	318
SEED	Wireless perimeter security system	Dynamo Risk Defense	89
SENSO-CAM	Hand-held thermal goggles/scopes	Senso-Optics	365
SENSO-DRIVE	Vehicle/cars mounted thermal imaging cameras	Senso-Optics	365
SENTINEL	Equipment for law enforcement, military & homeland & security agencies	ISPRA	169
SERPENT	Portable lightweight designator/rangefinder for laser guided munitions	Elbit Systems - Elop	342

BRAND NAME/ ACRONYM/ ABBREVIATION	EXPLANATION	COMPANY	PAGE
SEWS	Integrated EW suites	RAFAEL	78, 121
SEWS-DV	Digital shipborne electronic warfare suite	RAFAEL	121
SHALDAG	Fast patrol boat	Israel Shipyards	103
SHANNY	Military day camera & sight	Senso-Optics	365
SHARK	ECM system	RAFAEL	78, 116, 121
SHARK	Rapid response sniper post	MIFRAM	154
SHIPON FFE	Shoulder launched weapon system for close range combat	IMI - Israel Military Industries	233
SHOCK ABSORBER	Soft-kill active protection system	IMI - Israel Military Industries	113, 140, 232
SILVER MARLIN	Unmanned surface vessel	Elbit Systems	99
SIMON (GREM)	Rifle launched breaching grenade	RAFAEL	237
SKY GUARD	Roof & housing protection system	MIFRAM	155
SKYFIX	COMINT/DF capabilities for manned & unmanned platforms	Elbit Systems - Elisra	75
SKYJAM	COMJAM self-protection system for manned & unmanned platforms	Elbit Systems - Elisra	75
SKYLARK	Family of tactical & MALE UAVs	Elbit Systems	278
SKYLARK I-LE	Mini UAVs	Elbit Systems	278
SKY-SHIELD	Airborne support jammers	RAFAEL	78
SKYSTAR	Aerostatic intelligence, reconnaissance & communication system	R-T	264
SKYSTAR 300	Aerostat system	Aeronautics	263
SL-003	Dual purpose sleeve	SANSOLO Security	221
SL-010	Detonation simulator	SANSOLO Security	221
SL-012	Bang Buffer kit	SANSOLO Security	221
SL-015	Burstmaster kit	SANSOLO Security	221
SL-020	Rapid deployment electrical detonation kit	SANSOLO Security	221
SL-030	SANSOLO kit	SANSOLO Security	221
SL-056	Break-in/assault kit	SANSOLO Security	221
SMADAR	Uncooled thermal digital & analog engines	Senso-Optics	365
SMART-I	Mini electronics instruments	Astronautics C.A.	47
SNAPSHIELD	Secure communication solutions	Elbit Systems Land & C ⁴ I	304
SNIFFER	NBC reconnaissance armored vehicle	Hatehof	418
SOLTAM 60 MM MORTARS	Lightweight 60 mm mortar	Elbit Systems Land & C ⁴ I	201
SOLTAM 81 MM MORTARS	81 mm mortars	Elbit Systems Land & C ⁴ I	199
SOLTAM ATHOS	155 mm autonomous towed Howitzer system	Elbit Systems Land & C ⁴ I	199
SOLTAM ATMOS	155mm, computerized autonomous truck mounted self-propelled gun	Elbit Systems Land & C ⁴ I	199
SOLTAM ATMOS D-30	Advanced tactical computation & sensors in a wheeled, self propelled 122 mm Howitzer	Elbit Systems Land & C ⁴ I	199
SOLTAM CARDOM	Self-propelled recoiling mortar	Elbit Systems Land & C ⁴ I	200
SOLTAM M-114S 155 MM	Upgraded version of 155 mm 33 caliber assembly	Elbit Systems Land & C ⁴ I	200
SOLTAM M-46S 130 MM	Upgraded version of Soviet 130 mm field gun	Elbit Systems Land & C ⁴ I	200
SPARROW	Surrogate ballistic targets	RAFAEL	66
SPB/MAB	Aluminum alloy, tactical man-portable sectional personnel bridge	IMI - Israel Military Industries	232
SPECTROLITE – SPS – 65-5	Protection system for helicopters & other aircraft	Elbit Systems - Elisra	75
SPICE	Precise impact guidance kit	RAFAEL	66
SPIKE	Family of multi-purpose missiles	RAFAEL	67, 117, 203, 245

BRAND NAME/ ACRONYM/ ABBREVIATION	EXPLANATION	COMPANY	PAGE
SPIKE NLOS	Electro-optically guided multipurpose missile	RAFAEL	67, 117, 203, 245
SPIKE-ER	Multi-purpose missiles for combat vehicles, helicopters & naval vessels	RAFAEL	67, 117, 203, 245
SPIKE-LR	Multi-purpose missiles for infantry, LCV & helicopters	RAFAEL	67, 203, 245
SPIKE-MR	Multi-purpose missiles for infantry, special forces & combat vehicles	RAFAEL	67, 203, 245
SPIKE-SR	Multi-purpose missiles for infantry & special forces	RAFAEL	67, 203, 245
SPOTLITE	EO fire detection system	RAFAEL	29, 37, 55, 83, 181, 184, 191, 195, 206, 241, 246, 335, 349, 357
SPOTLITE M	Mobile EO system for detection & location of enemy fire sources	RAFAEL	29, 37, 55, 83, 181, 184, 191, 195, 206, 241, 246, 335, 349, 357
SPOTLITE-P	Small arms fire detection system	RAFAEL	29, 37, 55, 83, 178, 181, 184, 191, 195, 206, 241, 246, 335, 349, 357
SPYDER-SR/MR	Short/medium range mobile air defense systems	RAFAEL	65, 95, 261
SpyLite	Back-packed mini UAV	Bluebird Aero Systems	15
SSG	Smart scenario generator	Hartech Technologies	70
STA	See-through-armor	Elbit Systems Land & C ⁴ I	138
STALKER	Multi-sensor surveillance system	RAFAEL	178, 185
STAR	Smart tactical rocket system	Elbit Systems	60
STAR-GATE	Compliance with interception regulations for communication providers	Verint Systems	331
STINGRAY	Unmanned surface vessel	Elbit Systems	99
STORM 3 M-243	4x4 light utility vehicle	Automotive Industries	209
SUFA	F-16I trainer simulator	SIBAT - Ministry of Defense	394
SUNNY SAM	Dynamic threat simulating system	IMI - Israel Military Industries	77
SUPER DVORA MK III	Fast patrol craft	IAI - RAMTA Division	104
SWALLOW	Automatic parachute disconnecting system	Tal & Hadas	146
T			
TACMAX	Tactical 4G cellular broadband network	RAFAEL	192, 317
TACTER-31D	Tactical computer in tablet configuration	Elbit Systems Land & C ⁴ I	313
TADFICCS	Fire command & control system	Elbit Systems Land & C ⁴ I	309

BRAND NAME/ ACRONYM/ ABBREVIATION	EXPLANATION	COMPANY	PAGE
TADIRAN CNR-710	Handheld VHF/FM COMSEC/ECCM radio	Elbit Systems Land & C ⁴ I	300
TADIRAN CNR-710MB	Multi-band radio family for multi-mission communications	Elbit Systems Land & C ⁴ I	300
TADIRAN CNR-9000	Multi-mode VHF/FM COMSEC/ECCM radio system	Elbit Systems Land & C ⁴ I	299
TADIRAN CNR-9000HDR	Tactical VHF/FM radio system	Elbit Systems Land & C ⁴ I	299
TADIRAN GRC-2000	Frequency hopping, multi-channel, radio relay system	Elbit Systems Land & C ⁴ I	302
TADIRAN GRC-408E	Multi-interface IP & TDM radio relay	Elbit Systems Land & C ⁴ I	302
TADIRAN HF-6000	Multi-adaptive HF radio long range communication system	Elbit Systems Land & C ⁴ I	301
TADIRAN HF-8000	Multi-adaptive HF radio system	Elbit Systems Land & C ⁴ I	300
TADIRAN PNR-500	Personal network radio tactical conference communication	Elbit Systems Land & C ⁴ I	301
TADIRAN SDR 7200	Software-defined radio	Elbit Systems Land & C ⁴ I	298
TADIRAN SDR 7200 HH	Software-defined radio	Elbit Systems Land & C ⁴ I	299
TADIRAN VIC-500	Digital communication system for fighting vehicles	Elbit Systems Land & C ⁴ I	301
TANDIR	Threat warning system for combat vehicles	Elbit - Elisra	226
TARGO	Helmet mounted avionics technology	Elbit Systems	52
TAVOR	Assault rifles	IWI - Israel Weapon Industries	254
TAVOR	Driver vision enhancer kit	OPGAL Optronics Industries	364
TBT	Tactical battle group trainer	Elbit Systems	256
TECSAR	SAR imaging satellites	IAI - Space Division	92, 324
TERRA-SONIC	Pipeline monitoring system	RAFAEL	178, 186
THETA M788	Dual option electronic proximity fuze for mortar bombs	Reshef Technologies	207
TIGER	Tactical intranet geographic dissemination system	Elbit Systems Land & C ⁴ I	311
TIMNEX II	Advanced ESM/ELINT system	Elbit Systems	111, 118
TITAS	Project implementation methodology	Dignia Systems	450
TMAPS	Survey & target acquisition systems	IAI - Tamam Division	377
TMR	Multimedia routing unit	Elbit Systems Land & C ⁴ I	304
TNL-16G	Airborne inertial navigation system	IAI - Tamam Division	377
TOPLITE	Advanced day/night EO system	RAFAEL	28, 36, 54, 82, 105, 115 178, 180, 183, 190, 240, 290, 334, 348, 356
TOP-SCAN	Airborne ELINT/ESM systems	RAFAEL	78
TORBUSTER	Combined soft kill/hard kill torpedo decoy	RAFAEL	116, 120
TORC2H	C ⁴ I system	Elbit Systems Land & C ⁴ I	311
TrainTrack	Train car monitoring & security system	Xi Information Processing Sys.	318
TRF-90	Miniature inertial measurement unit	IAI - Tamam Division	377
TRIGON	Naval version of the EXTRA rocket system	IMI - Israel Military Industries	113
TROPHY	Situational awareness & active protection systems	RAFAEL	144, 164
TROPHY-HV	Active protection systems	RAFAEL	144, 164
TROPHY-LV	Active protection hard kill system for light armored vehicles	RAFAEL	145, 165
TROPHY-MV	Active protection hard kill systems for lighter vehicles	RAFAEL	145, 165
TURTLE	Multi-purpose rapid fortification kit	MIFRAM	155
TVS	Thermal vision sensor for aircraft enhanced vision system	Senso-Optics	365
TYPHOON	Family of naval weapon stations	RAFAEL	114, 116, 117

BRAND NAME/ ACRONYM/ ABBREVIATION	EXPLANATION	COMPANY	PAGE
TZUKIT	Single mid-wing two cockpit in tandem trainer	SIBAT- Ministry of Defense	390
U			
UASA	Underwater acoustic signature analysis	DSIT Solutions	123
UDI	Underwater digital communication systems	Underwater Technologies Center	124
UDI PRO 28	Underwater digital communication systems for critical missions	Underwater Technologies Center	124
UGCS	Universal ground control system	Elbit Systems	280
UGF	Unattended gap filler system	Seraphim Optronics	347
UMACS/BMACS	Uni & bi-modular artillery charge systems	IMI - Israel Military Industries	202
URANUS	Multi-spectral space camera	Elbit Systems - Elop	90
UT30	Unmanned turret for armored personnel carriers	Elbit Systems Land & C ⁴ I	136
UZI PRO	Submachine gun	IWI - Israel Weapon Industries	254
UZI SMG	Submachine gun	IWI - Israel Weapon Industries	254
V			
VANTAGE	Mass interception solutions	Verint Systems	331
VENμS	Super-spectral remote sensing camera	Elbit Systems - Elop	91
VER-2	Vertical ejection bomb rack	Elbit Systems - Cyclone	19
VGLPS	Vehicle gun laying & positioning system	IAI - Tamam Division	377
VIDI	Video streamer	Elbit Systems Land & C ⁴ I	304
VIPeR	Family of portable robots	Elbit Systems Land & C ⁴ I	294
VRG	Multimedia routing unit	Elbit Systems Land & C ⁴ I	304
VRU	Video routing unit	BAE Systems Rokar	72
W			
WAVESTREAM	SSPA & BUC amplifiers	Gilat Satellite Networks	305
WHIP SHOT	Precision guided weapon	IMI - Israel Military Industries	62
WINBMS	Weapon integrated battle management network system	Elbit Systems Land & C ⁴ I	311
WiT	Wise intelligence technology	Elbit Systems Land & C ⁴ I	320
WOLF	9 ton multi-purpose 4x4 APC	Hatehof	133
WPF	Wideband laser protection filter	Kilolambda Technologies	345
X			
XACT-NV32	Night vision monocular	Elbit Systems - ITL	341
XAVER 100	Sense-Through-The-Wall sensors	Camero-Tech Israel	230
XAVER 400	Sense-Through-The-Wall sensors	Camero-Tech Israel	230
XAVER 800	Sense-Through-The-Wall sensors	Camero-Tech Israel	230
X-GUARD	Towed decoy	RAFAEL	78
X-Lite	Uncooled thermal digital & analog engines	Senso-Optics	365
XTREAM	16 ton all terrain 4x4 MRAP	Hatehof	133
Y			
YASSUR	Blackhawk/CH-53 trainer simulator	SIBAT- Ministry of Defense	395
Z			
ZETA M138	Electronic time fuze for artillery	Reshef Technologies	207

ISRAEL DEFENSE DIRECTORY 2013-14

This official publication is the visiting card of the Israeli Defense Industry, characterized by battle-proven products featuring unrivalled know-how and reliability, designed to meet the challenges of the 3rd millennium.

Over 200 companies engaged in defense manufacture and services are listed in this Directory. If you wish to purchase the Directory, please use this convenient order card and enclose your payment by check.

The Directory had been produced both as this book and as a CD, the price of each, book or CD, is equal - USD100.

Should you encounter any difficulty in contacting a company, please get in touch with us in SIBAT, and we will be happy to assist. Please mention the Directory in your company contacts.

Use the postcard/s to inquire for additional information about products and services advertised in the Directory.

ISRAEL DEFENSE DIRECTORY 2013-14

Please process my order for _____ copy/ies at a single copy price of US \$100 (air freight included). Enclosed is my check # _____

Please process my order for _____ C.D/s at a single copy price of US \$100 (air freight included). Enclosed is my check # _____

Name _____

Position _____

Company/Organization _____

Street _____ City _____

State _____ Zip _____ Country _____

Signature _____ Date _____

ISRAEL DEFENSE DIRECTORY 2013-14

Please process my order for _____ copy/ies at a single copy price of US \$100 (air freight included). Enclosed is my check # _____

Please process my order for _____ C.D/s at a single copy price of US \$100 (air freight included). Enclosed is my check # _____

Name _____

Position _____

Company/Organization _____

Street _____ City _____

State _____ Zip _____ Country _____

Signature _____ Date _____

Fill out form and mail to:

MINISTRY OF DEFENSE
SIBAT
Marketing Communications Department
Hakirya, Tel Aviv 6473424
ISRAEL



Fill out form and mail to:

MINISTRY OF DEFENSE
SIBAT
Marketing Communications Department
Hakirya, Tel Aviv 6473424
ISRAEL

