

CAMBRIDGE INTRODUCTIONS TO PHILOSOPHY

An Introduction to Non-Classical Logic

From If to Is

GRAHAM PRIEST

Second Edition

CAMBRIDGE

CAMBRIDGE

www.cambridge.org/9780521854337

This page intentionally left blank

An Introduction to Non-Classical Logic

This revised and considerably expanded edition of *An Introduction to Non-Classical Logic* brings together a wide range of topics, including modal, tense, conditional, intuitionist, many-valued, paraconsistent, relevant and fuzzy logics. Part I, on propositional logic, is the old *Introduction*, but contains much new material. Part II is entirely novel, and covers quantification and identity for all the logics in Part I. The material is unified by the underlying theme of world semantics. All of the topics are explained clearly and accessibly, using devices such as tableau proofs, and their relations to current philosophical issues and debates is discussed. Students with a basic understanding of classical logic will find this book an invaluable introduction to an area that has become of central importance in both logic and philosophy. It will also interest people working in mathematics and computer science who wish to know about the area.

GRAHAM PRIEST is Boyce Gibson Professor of Philosophy, University of Melbourne and Arché Professorial Fellow, Departments of Philosophy, University of St Andrews. His most recent publications include *Towards Non-Being* (2005) and *Doubt Truth to be a Liar* (2006).

An Introduction to Non-Classical Logic

From If to Is

Second Edition

GRAHAM PRIEST

University of Melbourne

and

University of St Andrews



CAMBRIDGE
UNIVERSITY PRESS

CAMBRIDGE UNIVERSITY PRESS

Cambridge, New York, Melbourne, Madrid, Cape Town, Singapore, São Paulo

Cambridge University Press

The Edinburgh Building, Cambridge CB2 8RU, UK

Published in the United States of America by Cambridge University Press, New York

www.cambridge.org

Information on this title: www.cambridge.org/9780521854337

© Graham Priest 2001, 2008

This publication is in copyright. Subject to statutory exception and to the provision of relevant collective licensing agreements, no reproduction of any part may take place without the written permission of Cambridge University Press.

First published in print format 2008

ISBN-13 978-0-511-39361-7 eBook (EBL)

ISBN-13 978-0-521-85433-7 hardback

ISBN-13 978-0-521-67026-5 paperback

Cambridge University Press has no responsibility for the persistence or accuracy of urls for external or third-party internet websites referred to in this publication, and does not guarantee that any content on such websites is, or will remain, accurate or appropriate.

To all those from whom I have learned

Contents

<i>Preface to the First Edition</i>	page xvii
<i>Preface to the Second Edition</i>	xxi
<i>Mathematical Prolegomenon</i>	xxvii
0.1 Set-theoretic Notation	xxvii
0.2 Proof by Induction	xxix
0.3 Equivalence Relations and Equivalence Classes	xxx
Part I Propositional Logic	1
1 Classical Logic and the Material Conditional	3
1.1 Introduction	3
1.2 The Syntax of the Object Language	4
1.3 Semantic Validity	5
1.4 Tableaux	6
1.5 Counter-models	10
1.6 Conditionals	11
1.7 The Material Conditional	12
1.8 Subjunctive and Counterfactual Conditionals	13
1.9 More Counter-examples	14
1.10 Arguments for \supset	15
1.11 *Proofs of Theorems	16
1.12 History	18
1.13 Further Reading	18
1.14 Problems	18
2 Basic Modal Logic	20
2.1 Introduction	20
2.2 Necessity and Possibility	20

2.3	Modal Semantics	21
2.4	Modal Tableaux	24
2.5	Possible Worlds: Representation	28
2.6	Modal Realism	28
2.7	Modal Actualism	29
2.8	Meinongianism	30
2.9	*Proofs of Theorems	31
2.10	History	33
2.11	Further Reading	34
2.12	Problems	34
3	Normal Modal Logics	36
3.1	Introduction	36
3.2	Semantics for Normal Modal Logics	36
3.3	Tableaux for Normal Modal Logics	38
3.4	Infinite Tableaux	42
3.5	S5	45
3.6	Which System Represents Necessity?	46
3.6a	The Tense Logic K^t	49
3.6b	Extensions of K^t	51
3.7	*Proofs of Theorems	56
3.8	History	60
3.9	Further Reading	60
3.10	Problems	60
4	Non-normal Modal Logics; Strict Conditionals	64
4.1	Introduction	64
4.2	Non-normal Worlds	64
4.3	Tableaux for Non-normal Modal Logics	65
4.4	The Properties of Non-normal Logics	67
4.4a	S0.5	69
4.5	Strict Conditionals	72
4.6	The Paradoxes of Strict Implication	72
4.7	... and their Problems	73
4.8	The Explosion of Contradictions	74
4.9	Lewis' Argument for Explosion	76
4.10	*Proofs of Theorems	77
4.11	History	79

4.12	Further Reading	80
4.13	Problems	80
5	Conditional Logics	82
5.1	Introduction	82
5.2	Some More Problematic Inferences	82
5.3	Conditional Semantics	84
5.4	Tableaux for C	86
5.5	Extensions of C	87
5.6	Similarity Spheres	90
5.7	C_1 and C_2	94
5.8	Further Philosophical Reflections	97
5.9	*Proofs of Theorems	98
5.10	History	100
5.11	Further Reading	101
5.12	Problems	101
6	Intuitionist Logic	103
6.1	Introduction	103
6.2	Intuitionism: The Rationale	103
6.3	Possible-world Semantics for Intuitionism	105
6.4	Tableaux for Intuitionist Logic	107
6.5	The Foundations of Intuitionism	112
6.6	The Intuitionist Conditional	113
6.7	*Proofs of Theorems	114
6.8	History	116
6.9	Further Reading	117
6.10	Problems	117
7	Many-valued Logics	120
7.1	Introduction	120
7.2	Many-valued Logic: The General Structure	120
7.3	The 3-valued Logics of Kleene and Łukasiewicz	122
7.4	LP and RM_3	124
7.5	Many-valued Logics and Conditionals	125
7.6	Truth-value Gluts: Inconsistent Laws	127
7.7	Truth-value Gluts: Paradoxes of Self-reference	129
7.8	Truth-value Gaps: Denotation Failure	130
7.9	Truth-value Gaps: Future Contingents	132
7.10	Supervaluations, Modality and Many-valued Logic	133

7.11	*Proofs of Theorems	137
7.12	History	139
7.13	Further Reading	140
7.14	Problems	140
8	First Degree Entailment	142
8.1	Introduction	142
8.2	The Semantics of <i>FDE</i>	142
8.3	Tableaux for <i>FDE</i>	144
8.4	<i>FDE</i> and Many-valued Logics	146
8.4a	Relational Semantics and Tableaux for L_3 and RM_3	149
8.5	The Routley Star	151
8.6	Paraconsistency and the Disjunctive Syllogism	154
8.7	*Proofs of Theorems	155
8.8	History	161
8.9	Further Reading	161
8.10	Problems	161
9	Logics with Gaps, Gluts and Worlds	163
9.1	Introduction	163
9.2	Adding \rightarrow	163
9.3	Tableaux for K_4	164
9.4	Non-normal Worlds Again	166
9.5	Tableaux for N_4	168
9.6	Star Again	169
9.7	Impossible Worlds and Relevant Logic	171
9.7a	Logics of Constructible Negation	175
9.8	*Proofs of Theorems	179
9.9	History	184
9.10	Further Reading	185
9.11	Problems	185
10	Relevant Logics	188
10.1	Introduction	188
10.2	The Logic B	188
10.3	Tableaux for B	190
10.4	Extensions of B	194
10.4a	Content Inclusion	197
10.5	The System R	203
10.6	The Ternary Relation	206

10.7	<i>Ceteris Paribus</i> Enthymemes	208
10.8	*Proofs of Theorems	211
10.9	History	216
10.10	Further Reading	217
10.11	Problems	218
11	Fuzzy Logics	221
11.1	Introduction	221
11.2	Sorites Paradoxes	221
11.3	... and Responses to Them	222
11.4	The Continuum-valued Logic L	224
11.5	Axioms for L_{\aleph}	227
11.6	Conditionals in L	230
11.7	Fuzzy Relevant Logic	231
11.7a	*Appendix: <i>t</i> -norm Logics	234
11.8	History	237
11.9	Further Reading	238
11.10	Problems	239
11a	Appendix: Many-valued Modal Logics	241
11a.1	Introduction	241
11a.2	General Structure	241
11a.3	Illustration: Modal Łukasiewicz Logic	243
11a.4	Modal <i>FDE</i>	244
11a.5	Tableaux	247
11a.6	Variations	250
11a.7	Future Contingents Revisited	251
11a.8	A Glimpse Beyond	254
11a.9	*Proofs of Theorems	255
	Postscript: An Historical Perspective on Conditionals	259
	Part II Quantification and Identity	261
12	Classical First-order Logic	263
12.1	Introduction	263
12.2	Syntax	263
12.3	Semantics	264
12.4	Tableaux	266
12.5	Identity	272

12.6	Some Philosophical Issues	275
12.7	Some Final Technical Comments	277
12.8	*Proofs of Theorems 1	278
12.9	*Proofs of Theorems 2	283
12.10	*Proofs of Theorems 3	285
12.11	History	287
12.12	Further Reading	287
12.13	Problems	288
13	Free Logics	290
13.1	Introduction	290
13.2	Syntax and Semantics	290
13.3	Tableaux	291
13.4	Free Logics: Positive, Negative and Neutral	293
13.5	Quantification and Existence	295
13.6	Identity in Free Logic	297
13.7	*Proofs of Theorems	300
13.8	History	304
13.9	Further Reading	305
13.10	Problems	305
14	Constant Domain Modal Logics	308
14.1	Introduction	308
14.2	Constant Domain K	308
14.3	Tableaux for CK	309
14.4	Other Normal Modal Logics	314
14.5	Modality <i>De Re</i> and <i>De Dicto</i>	315
14.6	Tense Logic	318
14.7	*Proofs of Theorems	320
14.8	History	325
14.9	Further Reading	326
14.10	Problems	327
15	Variable Domain Modal Logics	329
15.1	Introduction	329
15.2	Prolegomenon	329
15.3	Variable Domain K and its Normal Extensions	330
15.4	Tableaux for VK and its Normal Extensions	331
15.5	Variable Domain Tense Logic	335
15.6	Extensions	336

15.7	Existence Across Worlds	339
15.8	Existence and Wide-Scope Quantifiers	341
15.9	*Proofs of Theorems	342
15.10	History	346
15.11	Further Reading	346
15.12	Problems	347
16	Necessary Identity in Modal Logic	349
16.1	Introduction	349
16.2	Necessary Identity	350
16.3	The Negativity Constraint	352
16.4	Rigid and Non-rigid Designators	354
16.5	Names and Descriptions	357
16.6	*Proofs of Theorems 1	358
16.7	*Proofs of Theorems 2	362
16.8	History	364
16.9	Further Reading	364
16.10	Problems	365
17	Contingent Identity in Modal Logic	367
17.1	Introduction	367
17.2	Contingent Identity	367
17.3	SI Again, and the Nature of Avatars	373
17.4	*Proofs of Theorems	376
17.5	History	382
17.6	Further Reading	382
17.7	Problems	382
18	Non-normal Modal Logics	384
18.1	Introduction	384
18.2	Non-normal Modal Logics and Matrices	384
18.3	Constant Domain Quantified L	385
18.4	Tableaux for Constant Domain L	386
18.5	Ringling the Changes	387
18.6	Identity	391
18.7	*Proofs of Theorems	393
18.8	History	397
18.9	Further Reading	397
18.10	Problems	397

19	Conditional Logics	399
19.1	Introduction	399
19.2	Constant and Variable Domain C	399
19.3	Extensions	403
19.4	Identity	408
19.5	Some Philosophical Issues	413
19.6	*Proofs of Theorems	415
19.7	History	419
19.8	Further Reading	419
19.9	Problems	419
20	Intuitionist Logic	421
20.1	Introduction	421
20.2	Existence and Construction	421
20.3	Quantified Intuitionist Logic	422
20.4	Tableaux for Intuitionist Logic 1	424
20.5	Tableaux for Intuitionist Logic 2	427
20.6	Mental Constructions	431
20.7	Necessary Identity	432
20.8	Intuitionist Identity	434
20.9	*Proofs of Theorems 1	437
20.10	*Proofs of Theorems 2	448
20.11	History	453
20.12	Further Reading	453
20.13	Problems	453
21	Many-valued Logics	456
21.1	Introduction	456
21.2	Quantified Many-valued Logics	456
21.3	\forall and \exists	457
21.4	Some 3-valued Logics	459
21.5	Their Free Versions	461
21.6	Existence and Quantification	462
21.7	Neutral Free Logics	465
21.8	Identity	467
21.9	Non-classical Identity	468
21.10	Supervaluations and Subvaluations	469

21.11	*Proofs of Theorems	471
21.12	History	473
21.13	Further Reading	474
21.14	Problems	474
22	First Degree Entailment	476
22.1	Introduction	476
22.2	Relational and Many-valued Semantics	476
22.3	Tableaux	479
22.4	Free Logics with Relational Semantics	481
22.5	Semantics with the Routley *	483
22.6	Identity	486
22.7	*Proofs of Theorems 1	489
22.8	*Proofs of Theorems 2	493
22.9	*Proofs of Theorems 3	499
22.10	History	502
22.11	Further Reading	502
22.12	Problems	502
23	Logics with Gaps, Gluts and Worlds	504
23.1	Introduction	504
23.2	Matrix Semantics Again	505
23.3	N_4	505
23.4	N_*	508
23.5	K_4 and K_*	510
23.6	Relevant Identity	512
23.7	Relevant Predication	515
23.8	Logics with Constructible Negation	517
23.9	Identity for Logics with Constructible Negation	521
23.10	*Proofs of Theorems 1	523
23.11	*Proofs of Theorems 2	527
23.12	*Proofs of Theorems 3	530
23.13	History	532
23.14	Further Reading	532
23.15	Problems	533
24	Relevant Logics	535
24.1	Introduction	535

24.2	Quantified B	535
24.3	Extensions of B	537
24.4	Restricted Quantification	541
24.5	Semantics vs Proof Theory	543
24.6	Identity	548
24.7	Properties of Identity	553
24.8	*Proofs of Theorems 1	555
24.9	*Proofs of Theorems 2	559
24.10	History	561
24.11	Further Reading	561
24.12	Problems	562
25	Fuzzy Logics	564
25.1	Introduction	564
25.2	Quantified Łukasiewicz Logic	564
25.3	Validity in $L_{\mathfrak{N}}$	565
25.4	Deductions	570
25.5	The Sorites Again	572
25.6	Fuzzy Identity	573
25.7	Vague Objects	576
25.8	*Appendix: Quantification and Identity in t -norm Logics	578
25.9	History	581
25.10	Further Reading	582
25.11	Problems	582
	Postscript: A Methodological Coda	584
	<i>References</i>	587
	<i>Index of Names</i>	603
	<i>Index of Subjects</i>	607

Preface to the First Edition

Around the turn of the twentieth century, a major revolution occurred in logic. Mathematical techniques of a quite novel kind were applied to the subject, and a new theory of what is logically correct was developed by Gottlob Frege, Bertrand Russell and others. This theory has now come to be called ‘classical logic’. The name is rather inappropriate, since the logic has only a somewhat tenuous connection with logic as it was taught and understood in Ancient Greece or the Roman Empire. But it is classical in another sense of that term, namely standard. It is now the logic that people normally learn when they take a first course in formal logic. They do not learn it in the form that Frege and Russell gave it, of course. Several generations of logicians have polished it up since then; but the logic is the logic of Frege and Russell none the less.

Despite this, many of the most interesting developments in logic in the last forty years, especially in philosophy, have occurred in quite different areas: intuitionism, conditional logics, relevant logics, paraconsistent logics, free logics, quantum logics, fuzzy logics, and so on. These are all logics which are intended either to supplement classical logic, or else to replace it where it goes wrong. The logics are now usually grouped under the title ‘non-classical logics’; and this book is an introduction to them.

The subject of non-classical logic is now far too big to permit the writing of a comprehensive textbook, so I have had to place some restrictions on what is covered.¹ For a start, the book is restricted to propositional logic. This is not because there are no non-classical logics that are essentially first-order (there are: free logic), but because the major interest in non-classical logics is *usually* at the propositional level. (Often, the quantifier

¹ For a brief introduction and overview of the field, see Priest (2005a).

extensions of these logics are relatively straightforward.) Within propositional logics, I have also restricted the logics considered here to ones which are relevant to the debate about conditionals ('if ... then ...' sentences). Again, this is not because this exhausts non-classical propositional logics (there is quantum logic, for example), but because taking the topic of conditionals as a *leitmotiv* gives the material a coherence that it might otherwise lack. And, of course, conditionals are about as central to logic as one can get.

The major semantical technique in non-classical logics is possible-world semantics. Most non-classical logics have such semantics. This is therefore the major semantical technique that I use in the book. In many ways, the book could be thought of as a set of variations on the theme of possible-world semantics. It should be mentioned that many of the systems discussed in the book have semantics other than possible-world semantics – notably, algebraic semantics of some form or other. Those, however, are an appropriate topic for a different book.

Choosing a kind of proof theory presents more options. Logic is about validity, what follows from what. Hence, the most natural proof theories for logic are natural deduction systems and sequent calculi. Most of the systems we will consider here can, in fact, be formulated in these ways. However, I have chosen not to use these techniques, but to use tableau methods instead (except towards the end of the book, where an axiomatic approach becomes necessary). One reason for this choice is that constructing tableau proofs, and so 'getting a feel' for what is, and what is not, valid in a logic, is very easy (indeed, it is algorithmic). Another is that the soundness and, particularly, completeness proofs for logics are very simple using tableaux. Since these areas are both ones where inexperienced students experience difficulty, tableaux have great pedagogical attractions. I first learned to do tableaux for modal logics, in the way that they are presented in the book, from my colleagues Rod Girle and the now greatly missed Ian Hinckfuss. The myriad variations they take on here are my own.

This book is not meant to provide a first course in logic. I assume that readers are familiar with the classical propositional calculus, though I review this material fairly swiftly in chapter 1. (I do not assume that students are familiar with tableaux, however.) Chapter 2 introduces the basic semantic technique of possible worlds, in the form of semantics for basic modal logic. Chapters 3 and 4 extend the techniques to other modal logics.

Chapter 3 looks at other normal systems of modal logic. Chapter 4 looks at non-normal worlds and their uses. Chapter 5 extends the semantic techniques, yet again, to so-called conditional logics. (The material in chapter 5 is significantly harder than anything else before the last couple of chapters of Part I.)

The non-classical logics up to this point are all most naturally thought of as extensions of classical logic. In the subsequent chapters of Part I, the logics are most naturally seen as rivals to it. Chapter 6 deals with intuitionism. Chapter 7 introduces many-valued logics, and the idea that there might be truth-value gaps (sentences that are *neither* true nor false) and gluts (sentences that are *both* true and false). Chapter 8 then describes first degree entailment, a central system of both relevant and paraconsistent logics. The semantic techniques of the final chapters fuse the techniques of both modal and many-valued logic. Non-normal worlds come into their own in chapter 9, where basic relevant logics are considered. Chapter 10 considers relevant logics more generally; and in chapter 11 fuzzy logic comes under the microscope. The chapters are broken up into sections and subsections. Their numeration is self-explanatory.

The major aim of this book is to explain the basic techniques of non-classical logics. However, these techniques do not float in mid-air: they engage with numerous philosophical issues, especially that of conditionality. The meanings of the techniques themselves also raise important philosophical issues. I therefore thought it important to include some philosophical discussion, usually towards the end of each chapter. The discussions are hardly comprehensive – quite the opposite; but they at least serve to elucidate the technical material, and may be used as a springboard for a more extended consideration for those who are so inclined.

Since proofs of soundness and completeness are such an integral part of modern logic, I have included them for the systems considered here, where possible. This technical material is relatively self-contained, however, and, even though the matter in the book is largely cumulative, can be skipped without prejudice by those who have no need, or taste, for it. For this reason, I have relegated the material to separate sections, marked with an asterisk. These sections also take for granted a little more mathematical sophistication on the part of the reader. Towards the end of each chapter there are also sections containing some historical details and giving suggestions for further reading. At the conclusion of each chapter is a section

containing a set of problems, exercises and questions. To understand the material in any but a relatively superficial way, there is no substitute for engaging with these. Questions that pertain to the sections marked with an asterisk are themselves marked with an asterisk, and can be ignored without prejudice.

I have taught a course based on the material in this book, or similar material, a number of times over the last ten years. I am grateful to the generations of students whose feedback has helped to improve both the content and the presentation. I have learned more from their questions than they would ever have been aware of. I am particularly grateful to the class of '99, who laboured under a draft of the book, picking up numerous typos and minor errors. I am grateful, too, to Aislinn Batstone, Stephen Read and some anonymous readers for comments which greatly improved the manuscript. I am sure that it could be improved in many other ways. But if one waited for perfection, one would wait for ever.

Preface to the Second Edition

The first edition of *Introduction to Non-Classical Logic* deals with just propositional logics. In 2004, Cambridge University Press and I decided to produce a second volume dealing with quantification and identity in non-classical logics. Late in the piece, it was decided to put the old and the new volumes together, and simply bring out one omnibus volume. The practical decision caused a theoretical problem. Was it the same book as the old *Introduction* or a different one? The answer – as befits a book on non-classical logic – was, of course, both. So the name of the book had to be the same and different. We decided to achieve this seeming impossibility by adding an appropriate sub-title to the book, ‘From If to Is’. Though there are many propositional operators and connectives, the conditional, ‘if’, is perhaps the most vexed. It is, at any rate, the focus around which the old *Introduction* moves. Whether or not ‘if’ is univocal is a contentious matter; but ‘is’ is certainly said in many ways. There is the ‘is’ of predication (‘Ponting is Australian’), the ‘is’ of existence (‘There is a spider in the bathtub’, ‘Socrates no longer is’), and the ‘is’ of identity (‘2 plus 2 is 4’). All of these are in play in first-order logic; they provide the focus around which the new part of the book moves.

On Part I

Though Part I of the present volume is essentially the old *Introduction to Non-Classical Logic*, I have taken the opportunity of revising its contents. With one exception, the revisions simply add new material. Some of the additions are made in the light of what is coming in Part II. Thus, there is a new section on equivalence relations and equivalence classes in the *Mathematical Prolegomenon*. But most of them comprise material that could usefully have been in the old *Introduction*, or that I would have put there had I thought to

do so. These are as follows:

- Chapter 3 now contains material on tense logic.
- Chapter 4 contains a section on the modal system $S0.5$, and related systems. This makes the bridge between non-normal logics and the impossible worlds of chapter 9 patent.
- In chapter 7, the section on supervaluations has been extended slightly.
- In chapter 8, a new section on relational semantics and tableaux for \mathcal{L}_3 and RM_3 has been added.
- Chapter 9 now contains a section on systems of ‘constructible negation’, making a connection with chapter 6 on intuitionist logic. I have renamed this chapter ‘Logics with Gaps, Gluts and Worlds’ to indicate better its contents. This allowed chapter 10 to be renamed simply ‘Relevant Logics’.
- I have added a technical appendix to chapter 11 on fuzzy logic. The Łukasiewicz logic of that chapter is, in fact, a special case of a more general construction. That construction is, perhaps, less likely to be of interest to philosophers. But I think that it is a good idea to have the material there, at least for the sake of reference.
- The appendix, chapter 11a, is a last-minute addition. In a paper I was writing in 2006 I wanted to refer to the general theory of many-valued modal logics. I could not find anything suitable in the literature, so I drafted one. I was persuaded by Stephen Read that this would be a helpful addition to the book.

If it was not already so before, the additions now make it entirely impossible to cover all of the material in Part I in a one-semester course. But it is better to have material there which a teacher can skip over, than no material on a topic which a teacher would like to cover.

The one place where material has not simply been added is in chapter 10 on relevant logic (with a few knock-on consequences in chapter 11). As 10.9 explains, the semantics given in that chapter are not the original Routley–Meyer semantics, but the ‘simplified semantics’ developed later (by Priest, Sylvan and Restall). It has now turned out that the original simplified semantics completeness proof is incorrect with respect to one of the axioms, $A \rightarrow ((A \rightarrow B) \rightarrow B)$ (A11 in the old *Introduction*) – though this does not affect the tableau completeness proof. In the context of the simplified semantics, the condition C11 of the old *Introduction* is too strong; and the extra strength, resuscitating, as it does, the Disjunctive Syllogism, is not of

a desirable kind. The condition can, however, be modified in such a way as to be complete. (See Restall and Roy (200+).) This modification is now employed in chapter 10, occasioning a new section on content inclusion and some more relevant logics whose semantics employ this notion.

In producing the present Part I, I have decided to leave the section and subsection numbering of the old *Introduction* unchanged. It was therefore necessary to accommodate new material in a way that does not disturb the numbering. I use letters to indicate interpolations that would otherwise do so. Thus, subsections between, e.g., 4.3.6 and 4.3.7 are 4.3.6a, 4.3.6b, etc.; and a section between 4.3 and 4.4 is 4.3a, so that its subsections become 4.3a.1, 4.3a.2, etc.

In writing the old *Introduction*, I decided, again as its preface explains, to employ tableaux, as far as possible. Systems of natural deduction have a great deal to recommend them, however. It is therefore very welcome that Fitch-style systems of natural deduction for all the logics of the old *Introduction* have been produced by Tony Roy. These (together with soundness and completeness proofs) can be found in Roy (2006).

Finally, in producing the new Part I, I have taken the opportunity to correct typos, as well as pedagogical and other minor infelicities. A number of people have pointed these out to me; these include Stephan Cursiefen, Rafał Gruszczyński, Maren Kruger, Jenny Louise, Tanja Osswald, Stephen Read, Wen-fang Wang, and the members of the Arché Logic Group at the University of St Andrews (see below). Kate Manne, Stephen Read and Elia Zardini provided helpful comments on the new material. Finally, correspondence with Petr Hájek was invaluable in writing the appendix to chapter 11. Warm thanks go to all of them.

On Part II

When I wrote the first edition of *Introduction to Non-Classical Logic*, I decided to restrict myself to propositional logic for the reasons explained in its preface. Someone who has mastered that material certainly has a good grasp of what non-classical logics are all about. But it cannot be denied that a book which leaves matters there is leaving the job half done. If any non-classical logic is to be applied, then quantifiers and, probably, identity, are going to be essential. And certainly the philosophical issues surrounding the technical constructions are as acute as anything in the propositional case. Hence it was (in a moment of weakness) that I decided to write a second volume

dealing with quantifiers and identity in non-classical logics. That volume would contain details of the behaviour of first-order quantifiers and identity in the logics of the old *Introduction*. As mentioned above, that material eventually became Part II of this volume.

Explaining the techniques of a large number of logics perspicuously and relatively briefly presents various exegetical challenges. So it was with Part I. Part II adds to these. The material in this is, by its nature, more difficult than that in Part I. (Although, by the time a student reaches this material, they are, one would hope, a little more sophisticated, so a little more may be expected of them – or required by them.) Most obviously the semantics of quantifiers are more intricate than those of the connectives. Less obviously, technical results, such as compactness and the Löwenheim–Skolem theorems, assume more importance. This book does not pretend to provide a comprehensive introduction to the metatheory of non-classical logics, important as that topic is. But those who are familiar with some of these matters from classical logic will naturally be curious to know how things stand with respect to the various non-classical logics. Fortunately, then, many of the elementary metatheoretic properties of a logic follow, in a relatively uniform way, from the fact that it has a sound and complete proof system (tableau, axiomatic, or whatever). I have covered the relevant matters for classical logic in chapter 12, and then simply pointed out that essentially the same considerations apply to all the other logics in the book – except for fuzzy logic in chapter 25, where completeness finally fails.

More difficult is the fact that the techniques used permit systematic independent variations. These can be applied in the case of many, if not most, of the logics covered in Part II. The result is a plethora of disparate systems. Attempting to cover all of them in the book would make it far too long, and would, I think, result in the danger of the reader losing the wood for the trees; it would also, I suspect, become tiresome. I therefore decided to explain the relevant variations in detail for certain logics, but to consider their applications to others only when there was some particular point to doing so. Thus, to give one example, the constants employed for the most part in the logics are rigid designators. But all the systems with world semantics can be augmented with non-rigid designators as well. How to do this is explained in the case of modal logic in chapters 16 and 17. I leave it (usually in problems) to those who want other systems of logic with non-rigid designators to extrapolate the techniques for themselves.

As in Part I, I assume that the reader is familiar with the relevant parts of classical logic. There is a review of the material in chapter 12. Free logic is necessary at various places in Part II. Chapter 13 presents this. Perhaps the most important of the aforementioned variations is that between constant domain semantics and variable domain semantics. Chapter 14 explains constant domain modal logic; chapter 15 explains variable domain modal logic. Another important variation is that between necessary identity and contingent identity. Chapter 16 spells out necessary identity in modal logic; chapter 17 spells out contingent identity in the same context. After that, all the fundamental techniques are in place, and the subsequent chapters correspond, one to one, to chapters 4 to 11 of Part I, covering non-normal modal logics, conditional logics, intuitionist logic, many-valued logics, First Degree Entailment, logics with semantics employing worlds and many-values, relevant logics and fuzzy logics. The reader is well advised to be familiar with (or refresh their memory of) the relevant chapter of Part I before passing on to the corresponding chapter of Part II. But, generally speaking, it is unnecessary to master the material after a chapter in Part I to understand material for the corresponding logic in Part II. Thus, for example, it is quite possible to read the material on modal logic in Part I, and then move on directly to the chapters on modal logic in Part II. There are a few notational changes between Part I and Part II. These are very minor, and will not hinder understanding (or usually even be noticed!).

Again as with Part I, the logics of this part inform and are informed by important philosophical considerations. Perhaps the most important of these concern existence and its various machinations. At the appropriate points I have therefore discussed these things. The discussions do little more than raise the relevant issues. But they at least show the reader what is at issue in the technical matters, and provide a certain amount of focusing for the diverse topics. And proofs of theorems and other technical matters are relegated to the starred appendices of each chapter, which can be omitted by uninterested readers.

There is, of course, much more to be said about non-classical logics than can be said here. For example – just to mention a few topics – all the logics in this part can be augmented with function symbols; they can all be extended to second-order logics; and all have algebraic semantics of various kinds. At one time I thought to include some of these topics in this book. But eventually I judged undesirable the additional complexity and length that

this would have involved. These topics can be covered in Part III – if anyone should care to write it; it won't be me.

The manuscript of this Part has been much improved by comments and suggestions from a number of people. I taught an honours logic course based on a draft of the manuscript at the University of Melbourne in the first half of 2006, where the students provided helpful feedback. My colleagues Allen Hazen and Greg Restall sat in on the class and provided many helpful suggestions. Kate Manne worked carefully through the whole draft and polished it considerably. Later that year, the Arché Logic Group at the University of St Andrews also worked through the manuscript and made a number of valuable suggestions: Philip Ebert, Andri Hjálmarsson, Ole Hjorthland, Ira Kiourti, Stephen Read, Marcus Rossberg, Andreas Stokke, and, most especially, Elia Zardini. Finally, correspondence with Petr Hájek was invaluable in writing the appendix to chapter 25. To all of them, my warmest thanks. These go, also, to Hilary Gaskin and the staff of Cambridge University Press for all they have done to make this volume possible – indeed, actual.

Book Website

All books contain errors, from the trivial typo, through infelicities of various degrees, to the serious screw-up. I hope that there aren't too many in this book – especially of the last kind! Details of any corrections that I am aware need to be made can be found on the website www.cambridge.org/priest. In due course, the website will also contain solutions to selected exercises.

Mathematical Prolegomenon

In expositions of modern logic, the use of some mathematics is unavoidable. The amount of mathematics used in this text is rather minimal, but it may yet throw a reader who is unfamiliar with it. In this section I will explain briefly three bits of mathematics that will help a reader through the text. The first is some simple set-theoretic notation and its meaning. The second is the notion of proof by induction. The third concerns the notion of equivalence relations and equivalence classes. It is not necessary to master the following before starting the book; the material can be consulted if and when required.

0.1 Set-theoretic Notation

0.1.1 The text makes use of standard set-theoretic notation from time to time (though never in a very essential way). Here is a brief explanation of it.

0.1.2 A set, X , is a collection of objects. If the set comprises the objects a_1, \dots, a_n , this may be written as $\{a_1, \dots, a_n\}$. If it is the set of objects satisfying some condition, $A(x)$, then it may be written as $\{x : A(x)\}$. $a \in X$ means that a is a *member* of the set X , that is, a is one of the objects in X . $a \notin X$ means that a is not a member of X .

0.1.3 *Examples:* The set of (natural) numbers less than 5 is $\{0, 1, 2, 3, 4\}$. Call this F . The set of even numbers is $\{x : x \text{ is an even natural number}\}$. Call this E . Then $3 \in F$, and $5 \notin E$.

0.1.4 Sets can have any number of members. In particular, for any a , there is a set whose only member is a , written $\{a\}$. $\{a\}$ is called a *singleton* (and is not to be confused with a itself). There is also a set which has no members, the *empty set*; this is written as ϕ .

0.1.5 *Examples:* $\{3\}$ is the set containing just the number three. It has one member. It is distinct from 3, which is a number, not a set at all, and so has no members.² $3 \notin \phi$.

0.1.6 A set, X , is a *subset* of a set, Y , if and only if every member of X is a member of Y . This is written as $X \subseteq Y$. The empty set is a subset of every set (including itself). $X \subset Y$ means that X is a *proper* subset of Y ; that is, everything in X is in Y , but there are some things in Y that are not in X . X and Y are identical sets, $X = Y$, if they have the same members, i.e., if $X \subseteq Y$ and $Y \subseteq X$. Hence, if X and Y are not identical, $X \neq Y$, either there are some members of X that are not in Y , or vice versa (or both).

0.1.7 *Examples:* Let N be the set of all natural numbers, and E be the set of even numbers. Then $\phi \subseteq N$ and $E \subseteq N$. Also, $E \subset N$, since $5 \in N$ but $5 \notin E$. If $X \subseteq N$ and $X \neq E$ then either some odd number is in X , or some even number is not in X (or both).

0.1.8 The *union* of two sets, X, Y , is the set containing just those things that are in X or Y (or both). This is written as $X \cup Y$. So $a \in X \cup Y$ if and only if $a \in X$ or $a \in Y$. The *intersection* of two sets, X, Y , is the set containing just those things that are in both X and Y . It is written $X \cap Y$. So $a \in X \cap Y$ if and only if $a \in X$ and $a \in Y$. The *relative complement* of one set, X , with respect to another, Y , is the set of all things in Y but not in X . It is written $Y - X$. Thus, $a \in Y - X$ if and only if $a \in Y$ but $a \notin X$.

0.1.9 *Examples:* Let N, E and O be the set of all numbers, all even numbers, and all odd numbers, respectively. Then $E \cup O = N$, $E \cap O = \phi$. Let $T = \{x : x \geq 10\}$. Then $E - T = \{0, 2, 4, 6, 8\}$.

0.1.10 An *ordered pair*, $\langle a, b \rangle$, is a set whose members occur in the order shown, so that we know which is the first and which is the second. Similarly for an ordered triple, $\langle a, b, c \rangle$, quadruple, $\langle a, b, c, d \rangle$, and, in general, n -tuple, $\langle x_1, \dots, x_n \rangle$. Given n sets X_1, \dots, X_n , their *cartesian product*, $X_1 \times \dots \times X_n$, is the set of all n -tuples, the first member of which is in X_1 , the second of which is in X_2 , etc. Thus, $\langle x_1, \dots, x_n \rangle \in X_1 \times \dots \times X_n$ if and only if $x_1 \in X_1$ and \dots and $x_n \in X_n$. A *relation*, R , between X_1, \dots, X_n is any subset of $X_1 \times \dots \times X_n$.

² In some reductions of number theory to set theory, 3 is identified with a certain set, and so may have members. But in the most common reduction, 3 has three members, not one.

$\langle x_1, \dots, x_n \rangle \in R$ is usually written as $Rx_1 \dots x_n$. If n is 3, the relation is a *ternary* relation. If n is 2, the relation is a *binary* relation, and Rx_1x_2 is usually written as x_1Rx_2 . A *function* from X to Y is a binary relation, f , between X and Y , such that for all $x \in X$ there is a unique $y \in Y$ such that xfy . More usually, in this case, we write: $f(x) = y$.

0.1.11 *Examples:* $\langle 2, 3 \rangle \neq \langle 3, 2 \rangle$, since these sets have the same members, but in a different order. Let N be the set of numbers. Then $N \times N$ is the set of all pairs of the form $\langle n, m \rangle$, where n and m are in N . If $R = \{\langle 2, 3 \rangle, \langle 3, 2 \rangle\}$ then $R \subseteq N \times N$ and is a binary relation between N and itself. If $f = \{\langle n, n^2 \rangle : n \in N\}$, then f is a function from numbers to numbers, and $f(n) = n^2$.

0.2 Proof by Induction

0.2.1 The method of proof by induction (or recursion) on the complexity of sentences is used heavily in the asterisked sections of the book. It is also used occasionally in other places, though these can usually be skipped without loss. What this method comes to is this. Suppose that all of the simplest formulas of some formal language (that is, those that do not contain any connectives or quantifiers) have some property, P . (Establishing this fact is usually called the *basis* (or *base*) *case*.) And suppose that whenever one constructs a more complex sentence – that is, one with an extra connective (or quantifier if such things are in the language) – out of formulas that have property P , the resulting formula also has the property P . (Establishing this is usually called the *induction case*.) Then it follows that all the formulas of the language have the property P . Thus, for example, suppose that the simple formulas p and q have property P , and that whenever formulas have that property, so do their negations, conjunctions, etc. Then it follows that $\neg p$, $p \wedge q$, $\neg p \wedge (p \wedge q)$, have the property, as do all sentences that we can construct from p and q using negation and conjunction.

0.2.2 The proof of the induction case normally breaks down into a number of different sub-cases, one for each of the connectives (and quantifiers if present) employed in the construction of more complex formulas. Thus, we assume that A has the property, then show that $\neg A$ has it; we assume that A and B have the property, then show that $A \wedge B$ has it; and so on for every connective (and quantifier). The assumption, in each case, is called the *induction hypothesis*.

0.2.3 Here is a simple example of a proof by induction. We show that every formula of the propositional calculus which is grammatical according to the rules of 1.2.2 has an even number of brackets. (This is a bit like cracking a nut with a sledgehammer; but it illustrates the method clearly.) The symbol ■ marks the end of a proof.

Proof:

BASIS CASE: First, we need to establish that this result holds for all of the simplest formulas, the propositional parameters. All such formulas have no (zero) brackets, and 0 is an even number. Hence, the result holds for propositional parameters.

INDUCTION CASE: Next we must establish that if the result holds for some formulas, and we construct other formulas out of those, the result holds for these too. So suppose that A and B have an even number of brackets. (This is the induction hypothesis.) We need to show that each of $\neg A$, $(A \vee B)$, $(A \wedge B)$, $(A \supset B)$ and $(A \equiv B)$ has an even number of brackets too. There is one case for each of the constructions in question.

For \neg : the number of brackets in $\neg A$ is the same as the number of brackets in A . Since this is even (by the induction hypothesis), the result follows. (We did not use the induction hypothesis concerning B in this case, but that does not matter.)

For \vee : suppose that the number of brackets in A is a , and the number of brackets in B is b . Then the number of brackets in $(A \vee B)$ is $a + b + 2$ (since the construction introduces two new brackets). But a and b are even, and so $a + b + 2$ is even. Hence, the number of brackets in $(A \vee B)$ is even, as required.

For \wedge , \supset , and \equiv : the arguments are exactly the same as for \vee . We have now established the basis case and the induction case. It follows from these that the result holds for all formulas; that is, all grammatical formulas have an even number of brackets. ■

0.3 Equivalence Relations and Equivalence Classes

0.3.1 The notion of an equivalence relation is one that is very useful on a number of occasions, especially when identity comes into play. An equivalence relation on a domain of objects is one, essentially, that chunks the domain into a collection of disjoint (i.e., non-overlapping) classes called *equivalence classes*. Thus, given a class of people, C , 'x has the same height

as y' is a relation that partitions them into classes of people with the same height. Suppose that C is:

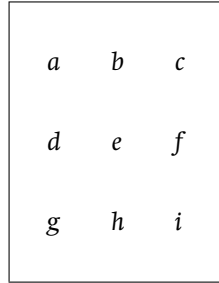

and that a, b, d and e , all have the same height, as do c, f and i , as do g and h . Then the equivalence classes are:

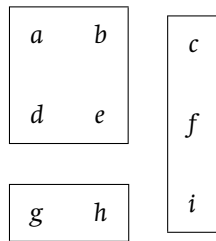

0.3.2 More precisely, if \sim is a binary relation on a collection of objects, C , it is an *equivalence relation* just if it is:

- reflexive: for all $x \in C$, $x \sim x$
- symmetric: for all $x, y \in C$, if $x \sim y$ then $y \sim x$
- transitive: for all $x, y, z \in C$, if $x \sim y$ and $y \sim z$ then $x \sim z$

If $x \in C$, its *equivalence class*, written $[x]$, is defined as $\{w \in C : w \sim x\}$.

0.3.3 The fundamental fact about equivalence classes is that every object in the domain is in exactly one. To see this, note, first, that for any $x \in C$, since $x \sim x$, $x \in [x]$; so x is in *some* equivalence class. Now let $X = [x]$ and $Y = [y]$. Suppose that, for some z , z is in both X and Y . Then $z \sim x$ and $z \sim y$. By symmetry and transitivity, $x \sim y$. For any $w \in X$, $w \sim x$. Since $x \sim y$, $w \sim y$. That is, $w \in Y$. Hence, $X \subseteq Y$. Similarly, $Y \subseteq X$. Hence, $X = Y$.

0.3.4 In constructions employing equivalence classes, it is common to specify a property of a class in terms of one of its members, thus:

$F([x])$ if and only if $G(x)$

Now suppose that $[x] = [y]$. Then the definition will go awry if we can have $G(x)$ but not $G(y)$. In such a definition it is therefore always important to establish that if $x \sim y$, $G(x)$ if and only if $G(y)$.

Part I

Propositional Logic

1 Classical Logic and the Material Conditional

1.1 Introduction

1.1.1 The first purpose of this chapter is to review classical propositional logic, including semantic tableaux. The chapter also sets out some basic terminology and notational conventions for the rest of the book.

1.1.2 In the second half of the chapter we also look at the notion of the conditional that classical propositional logic gives, and, specifically, at some of its shortcomings.

1.1.3 The point of logic is to give an account of the notion of validity: what follows from what. Standardly, validity is defined for inferences couched in a formal language, a language with a well-defined vocabulary and grammar, the *object language*. The relationship of the symbols of the formal language to the words of the vernacular, English in this case, is always an important issue.

1.1.4 Accounts of validity themselves are in a language that is normally distinct from the object language. This is called the *metalanguage*. In our case, this is simply mathematical English. Note that ‘iff’ means ‘if and only if’.

1.1.5 It is also standard to define two notions of validity. The first is *semantic*. A valid inference is one that *preserves truth*, in a certain sense. Specifically, every interpretation (that is, crudely, a way of assigning truth values) that makes all the premises true makes the conclusion true. We use the metalinguistic symbol ‘ \models ’ for this. What distinguishes different logics is the different notions of interpretation they employ.

1.1.6 The second notion of validity is *proof-theoretic*. Validity is defined in terms of some purely formal procedure (that is, one that makes reference only to the symbols of the inference). We use the metalinguistic symbol ‘ \vdash ’ for this notion of validity. In our case, this procedure will (mainly) be one employing tableaux. What distinguish different logics here are the different tableau procedures employed.

1.1.7 Most contemporary logicians would take the semantic notion of validity to be more fundamental than the proof-theoretic one, though the matter is certainly debatable. However, given a semantic notion of validity, it is always useful to have a proof-theoretic notion that corresponds to it, in the sense that the two definitions always give the same answers. If every proof-theoretically valid inference is semantically valid (so that \vdash entails \models) the proof-theory is said to be *sound*. If every semantically valid inference is proof-theoretically valid (so that \models entails \vdash) the proof-theory is said to be *complete*.

1.2 The Syntax of the Object Language

1.2.1 The symbols of the object language of the propositional calculus are an infinite number of propositional parameters:¹ p_0, p_1, p_2, \dots ; the connectives: \neg (negation), \wedge (conjunction), \vee (disjunction), \supset (material conditional), \equiv (material equivalence); and the punctuation marks: (,).

1.2.2 The (well-formed) formulas of the language comprise all, and only, the strings of symbols that can be generated recursively from the propositional parameters by the following rule:

If A and B are formulas, so are $\neg A$, $(A \vee B)$, $(A \wedge B)$, $(A \supset B)$, $(A \equiv B)$.

1.2.3 I will explain a number of important notational conventions here. I use capital Roman letters, A, B, C, \dots , to represent arbitrary formulas of the object language. Lower-case Roman letters, p, q, r, \dots , represent arbitrary,

¹ These are often called ‘propositional variables’.

but distinct, propositional parameters. I will always omit outermost parentheses of formulas if there are any. So, for example, I write $(A \supset (B \vee \neg C))$ simply as $A \supset (B \vee \neg C)$. Upper-case Greek letters, Σ, Π, \dots , represent arbitrary sets of formulas; the empty set, however, is denoted by the (lower case) ϕ , in the standard way. I often write a finite set, $\{A_1, A_2, \dots, A_n\}$, simply as A_1, A_2, \dots, A_n .

1.3 Semantic Validity

1.3.1 An *interpretation* of the language is a function, ν , which assigns to each propositional parameter either 1 (true), or 0 (false). Thus, we write things such as $\nu(p) = 1$ and $\nu(q) = 0$.

1.3.2 Given an interpretation of the language, ν , this is extended to a function that assigns every formula a truth value, by the following recursive clauses, which mirror the syntactic recursive clauses:²

- $\nu(\neg A) = 1$ if $\nu(A) = 0$, and 0 otherwise.
- $\nu(A \wedge B) = 1$ if $\nu(A) = \nu(B) = 1$, and 0 otherwise.
- $\nu(A \vee B) = 1$ if $\nu(A) = 1$ or $\nu(B) = 1$, and 0 otherwise.
- $\nu(A \supset B) = 1$ if $\nu(A) = 0$ or $\nu(B) = 1$, and 0 otherwise.
- $\nu(A \equiv B) = 1$ if $\nu(A) = \nu(B)$, and 0 otherwise.

1.3.3 Let Σ be any set of formulas (the premises); then A (the conclusion) is a *semantic consequence* of Σ ($\Sigma \models A$) iff there is no interpretation that makes all the members of Σ true and A false, that is, every interpretation that makes all the members of Σ true makes A true. ' $\Sigma \not\models A$ ' means that it is not the case that $\Sigma \models A$.

1.3.4 A is a *logical truth* (*tautology*) ($\models A$) iff it is a semantic consequence of the empty set of premises ($\phi \models A$), that is, every interpretation makes A true.

² The reader might be more familiar with the information contained in these clauses when it is depicted in the form of a table, usually called a *truth table*, such as the one for *conjunction* displayed:

\wedge	1	0
1	1	0
0	0	0

1.4 Tableaux

1.4.1 A *tree* is a structure that looks, generally, like this:³

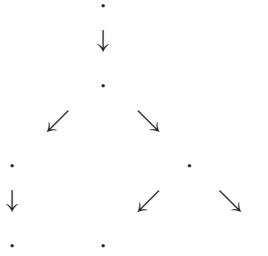

The dots are called *nodes*. The node at the top is called the *root*. The nodes at the bottom are called *tips*. Any path from the root down a series of arrows as far as you can go is called a *branch*. (Later on we will have trees with infinite branches, but not yet.)

1.4.2 To test an inference for validity, we construct a tableau which begins with a single branch at whose nodes occur the premises (if there are any) and the negation of the conclusion. We will call this the *initial list*. We then apply rules which allow us to extend this branch. The rules for the conditional are as follows:

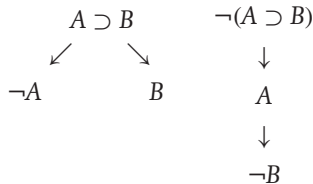

The rule on the right is to be interpreted as follows. If we have a formula $\neg(A \supset B)$ at a node, then every branch that goes through that node is extended with two further nodes, one for A and one for $\neg B$. The rule on the left is interpreted similarly: if we have a formula $A \supset B$ at a node, then every branch that goes through that node is split at its tip into two branches; one contains a node for $\neg A$; the other contains a node for B .

³ Strictly speaking, for those who want the precise mathematical definition, it is a partial order with a unique maximum element, x_0 , such that for any element, x_n , there is a unique finite chain of elements $x_n \leq x_{n-1} \leq \dots \leq x_1 \leq x_0$.

1.4.3 For example, to test the inference whose premises are $A \supset B$, $B \supset C$, and whose conclusion is $A \supset C$, we construct the following tree:

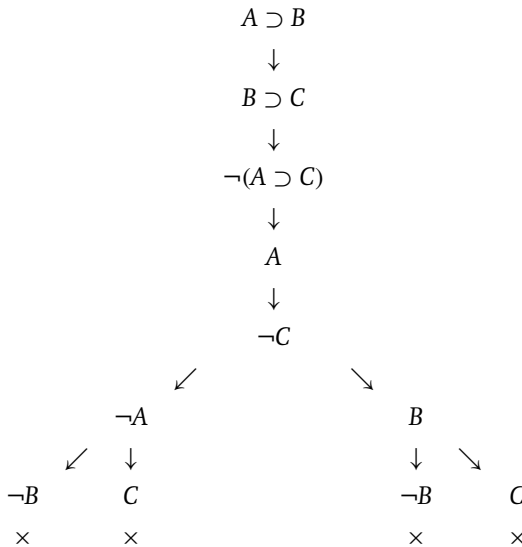

The first three formulas are the premises and negated conclusion. The next two formulas are produced by the rule for the negated conditional applied to the negated conclusion; the first split on the branch is produced by applying the rule for the conditional to the first premise; the next splits are produced by applying the same rule to the second premise. (Ignore the ‘ \times ’s: we will come back to those in a moment.)

1.4.4 The other connectives also have rules, which are as follows.

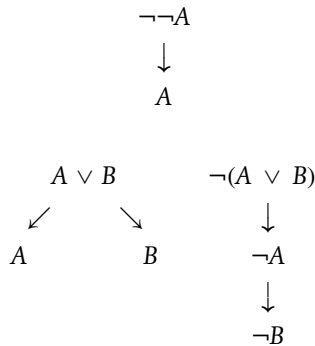

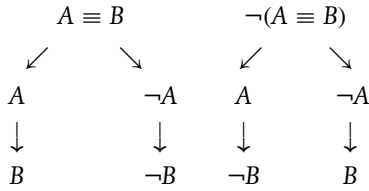
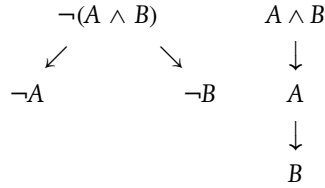

Intuitively, what a tableau means is the following. If we apply a rule to a formula, then if that formula is true in an interpretation, so are the formulas below on at least one of the branches that the rule generates. (Of course, there may be only one such branch.) This is a useful mnemonic for remembering the rules. It must be stressed, though, that officially the rules are purely formal.

1.4.5 A tableau is *complete* iff every rule that can be applied has been applied. By applying the rules over and over, we may always construct a complete tableau. In the present case, the branches of a completed tableau are always finite,⁴ but in the tableaux of some subsequent chapters they may be infinite.

1.4.6 A branch is *closed* iff there are formulas of the form A and $\neg A$ on two of its nodes; otherwise it is *open*. A closed branch is indicated by writing an \times at the bottom. A *tableau* itself is closed iff every branch is closed; otherwise it is open. Thus the tableau of 1.4.3 is closed: the leftmost branch contains A and $\neg A$; the next contains A and $\neg A$ (and C and $\neg C$); the next contains B and $\neg B$; the rightmost contains C and $\neg C$.

1.4.7 A is a proof-theoretic consequence of the set of formulas Σ ($\Sigma \vdash A$) iff there is a complete tree whose initial list comprises the members of Σ and the negation of A , and which is closed. We write $\vdash A$ to mean that $\phi \vdash A$,

⁴ This is not entirely obvious, though it is not difficult to prove.

that is, where the initial list of the tableau comprises just $\neg A$. ‘ $\Sigma \not\vdash A$ ’ means that it is not the case that $\Sigma \vdash A$.⁵

1.4.8 Thus, the tree of 1.4.3 shows that $A \supset B, B \supset C \vdash A \supset C$. Here is another, to show that $\vdash ((A \supset B) \wedge (A \supset C)) \supset (A \supset (B \wedge C))$. To save space, we omit arrows where a branch does not divide.

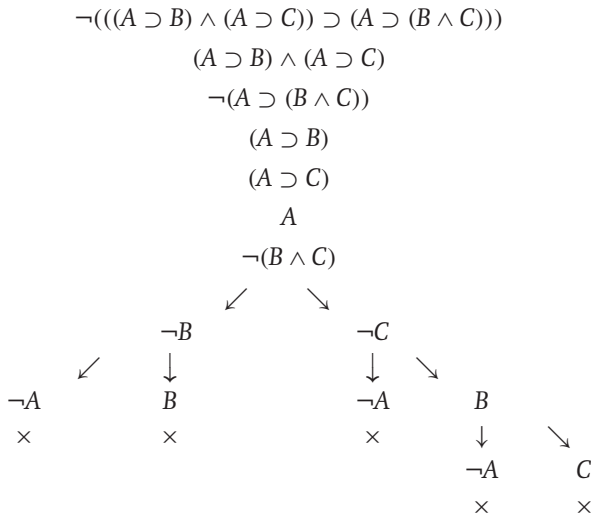

Note that when we find a contradiction on a branch, there is no point in continuing it further. We know that the branch is going to close, whatever else is added to it. Hence, we need not bother to extend a branch as soon as it is found to close. Notice also that, wherever possible, we apply rules that do not split branches before rules that split branches. Though this is not essential, it keeps the tableau simpler, and is therefore useful practically.

1.4.9 In practice, it is also a useful idea to put a tick at the side of a formula once one has applied a rule to it. Then one knows that one can forget about it.

⁵ There may, in fact, be several completed trees for an inference, depending upon the order of the premises in the initial list and the order in which rules are applied. Fortunately, they all give the same result, though this is not entirely obvious. See 1.14, problem 5.

1.5 Counter-models

1.5.1 Here is another example, to show that $(p \supset q) \vee (r \supset q) \not\vdash (p \vee r) \supset q$.

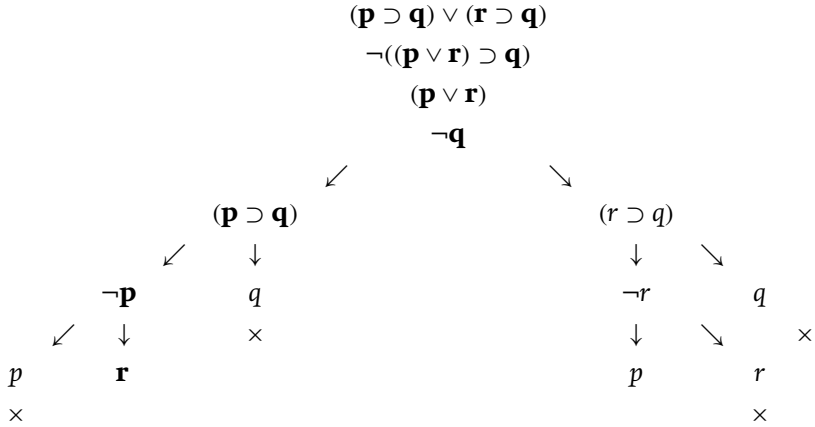

The tableau has two open branches. The leftmost one is emphasised in bold for future reference.

1.5.2 The tableau procedure is, in effect, a systematic search for an interpretation that makes all the formulas on the initial list true. Given an open branch of a tableau, such an interpretation can, in fact, be read off from the branch.⁶

1.5.3 The recipe is simple. If the propositional parameter, p , occurs at a node on the branch, assign it 1; if $\neg p$ occurs at a node on the branch, assign it 0. (If neither p nor $\neg p$ occurs in this way, it may be assigned anything one likes.)

1.5.4 For example, consider the tableau of 1.5.1 and its (bolded) leftmost open branch. Applying the recipe gives the interpretation, v , such that $v(r) = 1$, and $v(p) = v(q) = 0$. It is simple to check directly that $v((p \supset q) \vee (r \supset q)) = 1$ and $v((p \vee r) \supset q) = 0$. Since p is false, $p \supset q$ is true, as is $(p \supset q) \vee (r \supset q)$. Since r is true, $p \vee r$ is true; but q is false; hence, $(p \vee r) \supset q$ is false.

⁶ If one thinks of constructing a tableau as a search procedure for a counter-model, then the soundness and completeness theorems constitute, in effect, a proof that the procedure always gives the right result, that is, which *verifies* the algorithm in question.

1.5.4a Note that the tableau of 1.4.8 shows that *any* inference of the form in question is valid. That is, A , B and C can be *any* formulas. To show that an inference is invalid, we have to construct a counter-model, and this means assigning truth values to *particular* formulas. This is why the example just given uses ‘ p ’, ‘ q ’ and ‘ r ’, not ‘ A ’, ‘ B ’ and ‘ C ’. One may say that an inference expressed using schematic letters (‘ A ’s and ‘ B ’s) is invalid, but this must mean that there are some formulas that can be substituted for these letters to make it so. Thus, we may write $A \not\models B$, since $p \not\models q$. But note that this does not rule out the possibility that some inferences of that form are valid, e.g., $p \models q \vee \neg q$.

1.5.5 As one would hope, the tableau procedure we have been looking at is sound and complete with respect to the semantic notion of consequence, i.e., if Σ is a finite set of sentences, $\Sigma \vdash A$ iff $\Sigma \models A$. That is, the search procedure really works. If there is an interpretation that makes all the formulas on the initial list true, the tableau will have an open branch which, in effect, specifies one. And if there is no such interpretation, every branch will close. These facts are not obvious. The proof is in 1.11.⁷

1.6 Conditionals

1.6.1 In the remainder of this chapter, we look at the notion of conditionality that the above, classical, semantics give us, and at its inadequacy. But first, what is a conditional?

1.6.2 Conditionals relate some proposition (the *consequent*) to some other proposition (the *antecedent*) on which, in some sense, it depends. They are expressed in English by ‘if’ or cognate constructions:

If the bough breaks (then) the cradle will fall.

The cradle will fall if the bough breaks.

The bough breaks only if the cradle falls.

⁷ The restriction to finite Σ is due to the fact that tableaux have been defined only for finite sets of premises. It is possible to define tableaux for infinite sets of premises as well (not putting all the premises at the start, but introducing them, one by one, at regular intervals down the branches). If one does this, the soundness and completeness results generalise to arbitrary sets of premises. We will take up this matter again in Chapter 12 (Part II), where the matter assumes more significance.

If the bough were to break the cradle would fall.
 Were the bough to break the cradle would fall.

1.6.3 Note that the grammar of conditionals imposes certain requirements on the tense (past, present, future) and mood (indicative, subjunctive) of the sentences expressing the antecedent and consequent within it. These may be different when the antecedent and consequent stand alone. To see this, just consider the following applications of *modus ponens* (if A then B ; A ; hence B):

If he *takes* a plane he will get there quicker.
 He *will take* a plane.
 Hence, he will get there quicker.

If he *had come* in the window there *would have been* foot-marks.
 He *did come* in the window.
 So, there *are* foot-marks.

1.6.4 Note, also, that not all sentences using ‘if’ are conditionals; consider, for example, ‘If I may say so, you have a nice ear-ring’, ‘(Even) if he was plump, he could still run fast’, or ‘If you want a banana, there is one in the kitchen.’ A rough and ready test for ‘if A , B ’ to be a conditional is that it can be rewritten equivalently as ‘that A implies that B ’.

1.7 The Material Conditional

1.7.1 The connective \supset is usually called the *material conditional* (or *material implication*). As its truth conditions show, $A \supset B$ is logically equivalent to $\neg A \vee B$. It is true iff A is false or B is true. Thus, we have:

$$B \models A \supset B$$

$$\neg A \models A \supset B$$

These are sometimes called the ‘paradoxes of material implication’.

1.7.2 People taking a first course in logic are often told that English conditionals may be represented as \supset . There is an obvious objection to this claim, though. If it were correct, then the truth conditions of \supset would ensure the

truth of the following, which appear to be false:

If New York is in New Zealand then $2 + 2 = 4$.

If New York is in the United States then World War II ended in 1945.

If World War II ended in 1941 then gold is an acid.

1.7.3 It is possible to reply to this objection as follows. These examples are, indeed, true. They strike us as counterintuitive, though, for the following reason. Communication between people is governed by many pragmatic rules of conversation, for example ‘be relevant’, ‘assert the strongest claim you are in a position to make’. We often use the fact that these rules are in place to draw conclusions. Consider, for example, what you would infer from the following questions and replies: ‘How do you use this drill?’, ‘There’s a book over there.’ (It is a drill manual. *Relevance*.) ‘Who won the 3.30 at Ascot?’, ‘It was a horse named either Blue Grass or Red Grass.’ (The speaker does not know which. *Assert the strongest information*.) These inferences are inferences, not from the *content* of what has been said, but from the fact that *it has been said*. The process is often dubbed ‘conversational implicature’. Now, the claim goes, the examples of 1.7.2 strike us as odd since anyone who asserted them would be violating the rule *assert the strongest*, since, in each case, we are in a position to assert either the consequent or the negation of the antecedent (or both).

1.8 Subjunctive and Counterfactual Conditionals

1.8.1 A harder objection to the correctness of the material conditional is to the effect that there are pairs of conditionals which appear to have the same antecedent and consequent, but which clearly have different truth values. They cannot both, therefore, be material conditionals. Consider the examples:

- (1) If Oswald didn’t shoot Kennedy someone else did. (True)
- (2) If Oswald hadn’t shot Kennedy someone else would have. (False)

1.8.2 In response to this kind of example, it is not uncommon for philosophers to distinguish between two sorts of conditionals: conditionals in which the consequent is expressed using the word ‘would’ (called ‘subjunctive’ or ‘counterfactual’), and others (called ‘indicative’). Subjunctive conditionals, like (2), cannot be material: after all, (2) is false, though its

antecedent is false (assuming the results of the Warren Commission!). But indicative conditionals may still be material.

1.8.3 The claim that the English conditional is ambiguous between subjunctive and indicative is somewhat dubious, though. There appears to be no grammatical justification for it, for a start. In (1) and (2) the ‘if’s are grammatically identical; it is the tenses and/or moods of the verbs involved which make the difference.

1.8.4 What these differences seem to do is to get us to evaluate the truth values of conditionals from different points in time. Thus, we evaluate (1) as true from the present, where Kennedy has, in fact, been shot. The difference of tense and mood of (2) asks us to evaluate the conditional ‘If Oswald doesn’t shoot Kennedy, someone else will’ from the perspective of a time just before Kennedy was shot. It is, in a certain sense, the past tense of that conditional. Notice that no difference of the kind between (1) and (2) arises in the case of present-tense conditionals. There is no major difference between ‘If I shoot you, you will die’ and ‘If I were to shoot you, you would die.’

1.9 More Counter-examples

1.9.1 There are more fundamental objections against the claim that the indicative English conditional (even if it is distinct from the subjunctive) is material. It is easy to check that the following inferences are valid.

$$\begin{aligned} (A \wedge B) \supset C &\vdash (A \supset C) \vee (B \supset C) \\ (A \supset B) \wedge (C \supset D) &\vdash (A \supset D) \vee (C \supset B) \\ \neg(A \supset B) &\vdash A \end{aligned}$$

If the English indicative conditional were material, the following inferences would, respectively, be instances of the above, and therefore valid, which they are clearly not.

- (1) If you close switch x and switch y the light will go on. Hence, it is the case either that if you close switch x the light will go on, or that if you close switch y the light will go on. (Imagine an electrical circuit where switches x and y are in series, so that both are required for the light to go on, and both switches are open.)

- (2) If John is in Paris he is in France, and if John is in London he is in England. Hence, it is the case either that if John is in Paris he is in England, or that if he is in London he is in France.
- (3) It is not the case that if there is a good god the prayers of evil people will be answered. Hence, there is a god.

1.9.2 Notice that all these conditionals are indicative. Note, also, that appealing to conversational rules cannot explain why the conclusions appear odd, as in 1.7.3. For example, in the first, it is not the case that we already know which disjunct of the conclusion is true: *both* appear to be false.

1.9.3 It might be pointed out that the above arguments are valid if ‘if’ is understood as \supset . However, this just concedes the point: ‘if’ in English is not understood as \supset .

1.10 Arguments for \supset

1.10.1 The claim that the English conditional (or even the indicative conditional) is material is therefore hard to sustain. In the light of this it is worth asking why anyone ever thought this. At least in the modern period, a large part of the answer is that, until the 1960s, standard truth-table semantics were the only ones that there were, and \supset is the only truth function that looks an even remotely plausible candidate for ‘if’.

1.10.2 Some arguments have been offered, however. Here is one, to the effect that ‘If A then B ’ is true iff ‘ $A \supset B$ ’ is true.

1.10.3 First, suppose that ‘If A then B ’ is true. Either $\neg A$ is true or A is. In this first case, $\neg A \vee B$ is true. In the second case, B is true by *modus ponens*. Hence, again, $\neg A \vee B$ is true. Thus, in either case, $\neg A \vee B$ is true.

1.10.4 The converse argument appeals to the following plausible claim:

- (*) ‘If A then B ’ is true if there is some true statement, C , such that from C and A together we can deduce B .

Thus, we agree that the conditional ‘If Oswald didn’t kill Kennedy, someone else did’ is true because we can deduce that someone other than Oswald killed Kennedy from the fact that Kennedy was murdered and Oswald did not do it.

1.10.5 Now, suppose that $\neg A \vee B$ is true. Then from this and A we can deduce B , by the *disjunctive syllogism*: $A, \neg A \vee B \vdash B$. Hence, by (*), ‘If A then B ’ is true.

1.10.6 We will come back to this argument in a later chapter. For now, just note the fact that it uses the disjunctive syllogism.

1.11 *Proofs of Theorems

1.11.1 DEFINITION: Let ν be any propositional interpretation. Let b be any branch of a tableau. Say that ν is *faithful* to b iff for every formula, A , on the branch, $\nu(A) = 1$.

1.11.2 SOUNDNESS LEMMA: If ν is faithful to a branch of a tableau, b , and a tableau rule is applied to b , then ν is faithful to at least one of the branches generated.

Proof:

The proof is by a case-by-case examination of the tableau rules. Here are the cases for the rules for \supset . The other cases are left as exercises. Suppose that ν is faithful to b , that $\neg(A \supset B)$ occurs on b , and that we apply a rule to it. Then only one branch eventuates, that obtained by adding A and $\neg B$ to b . Since ν is faithful to b , it makes every formula on b true. In particular, $\nu(\neg(A \supset B)) = 1$. Hence, $\nu(A \supset B) = 0$, $\nu(A) = 1$, $\nu(B) = 0$, and so $\nu(\neg B) = 1$. Hence, ν makes every formula on b true. Next, suppose that ν is faithful to b , that $A \supset B$ occurs on b , and that we apply a rule to it. Then two branches eventuate, one extending b with $\neg A$ (the left branch); the other extending b with B (the right branch). Since ν is faithful to b , it makes every formula on b true. In particular, $\nu(A \supset B) = 1$. Hence, $\nu(A) = 0$, and so $\nu(\neg A) = 1$, or $\nu(B) = 1$. In the first case, ν is faithful to the left branch; in the second, it is faithful to the right. ■

1.11.3 SOUNDNESS THEOREM: For finite Σ , if $\Sigma \vdash A$ then $\Sigma \models A$.

Proof:

We prove the contrapositive. Suppose that $\Sigma \not\models A$. Then there is an interpretation, ν , which makes every member of Σ true, and A false - and hence makes $\neg A$ true. Now consider a completed tableau for the inference. ν is faithful to the initial list. When we apply a rule to the list, we can, by the

Soundness Lemma, find at least one of its extensions to which ν is faithful. Similarly, when we apply a rule to this, we can find at least one of its extensions to which ν is faithful; and so on. By repeatedly applying the Soundness Lemma in this way, we can find a whole branch, b , such that ν is faithful to every initial section of it. (An initial section is a path from the root down the branch, but not necessarily all the way to the tip.) It follows that ν is faithful to b itself, but we do not need this fact to make the proof work. Now, if b were closed, it would have to contain some formulas of the form B and $\neg B$, and these must occur in some initial section of b . But this is impossible since ν is faithful to this section, and so it would follow that $\nu(B) = \nu(\neg B) = 1$, which cannot be the case. Hence, the tableau is open, i.e., $\Sigma \not\vdash A$. ■

1.11.4 DEFINITION: Let b be an open branch of a tableau. The interpretation induced by b is any interpretation, ν , such that for every propositional parameter, p , if p is at a node on b , $\nu(p) = 1$, and if $\neg p$ is at a node on b , $\nu(p) = 0$. (And if neither, $\nu(p)$ can be anything one likes.) This is well defined, since b is open, and so we cannot have both p and $\neg p$ on b .

1.11.5 COMPLETENESS LEMMA: Let b be an open complete branch of a tableau. Let ν be the interpretation induced by b . Then:

- if A is on b , $\nu(A) = 1$
- if $\neg A$ is on b , $\nu(A) = 0$

Proof:

The proof is by induction on the complexity of A . If A is a propositional parameter, the result is true by definition. If A is complex, it is of the form $B \wedge C$, $B \vee C$, $B \supset C$, $B \equiv C$, or $\neg B$. Consider the first case, and suppose that $B \wedge C$ is on b . Since b is complete, the rule for conjunction has been applied to it. Hence, both B and C are on the branch. By induction hypothesis, $\nu(B) = \nu(C) = 1$. Hence, $\nu(B \wedge C) = 1$, as required. Next, suppose that $\neg(B \wedge C)$ is on b . Since the rule for negated conjunction has been applied to it, either $\neg B$ or $\neg C$ is on the branch. By induction hypothesis, either $\nu(B) = 0$ or $\nu(C) = 0$. In either case, $\nu(B \wedge C) = 0$, as required. The cases for the other binary connectives are similar. For \neg : suppose that $\neg B$ is on b . Then, since the result holds for B , by the induction hypothesis, $\nu(B) = 0$. Hence, $\nu(\neg B) = 1$. If $\neg\neg B$ is on b , then so is B , by the rule for double negation. By induction hypothesis, $\nu(B) = 1$, so $\nu(\neg B) = 0$. ■

1.11.6 COMPLETENESS THEOREM: For finite Σ , if $\Sigma \models A$ then $\Sigma \vdash A$.

Proof:

We prove the contrapositive. Suppose that $\Sigma \not\vdash A$. Consider a completed open tableau for the inference, and choose an open branch. The interpretation that the branch induces makes all the members of Σ true, and A false, by the Completeness Lemma. Hence, $\Sigma \not\models A$. ■

1.12 History

The propositional logic described in this chapter was first formulated by Frege in his *Begriffsschrift* (translated in Bynum, 1972) and Russell (1903). Semantic tableaux in the form described here were first given in Smullyan (1968). The issue of how to understand the conditional is an old one. Disputes about it can be found in the Stoics and in the Middle Ages. Some logicians at each of these times endorsed the material conditional. For an account of the history, see Sanford (1989). The defence of the material conditional in terms of conversational rules first seems to have been suggested by Ajdukiewicz (1956). The idea was brought to prominence by Grice (1989, chs. 1–4). The argument for distinguishing between the indicative and subjunctive conditionals was first given by Adams (1970). The examples of 1.9 are taken from a much longer list given by Cooper (1968). The argument of 1.10 was given by Faris (1968).

1.13 Further Reading

For an introduction to classical logic based on tableaux, see Jeffrey (1991), Howson (1997) or Restall (2006). For a number of good papers discussing the connection between material, indicative and subjunctive conditionals, see Jackson (1991). For further discussion of the examples of sec 1.9, see Routley, Plumwood, Meyer and Brady (1982, ch. 1).

1.14 Problems

1. Check the truth of each of the following, using tableaux. If the inference is invalid, read off a counter-model from the tree, and check directly that it makes the premises true and the conclusion false, as in 1.5.4.

- (a) $p \supset q, r \supset q \vdash (p \vee r) \supset q$
 (b) $p \supset (q \wedge r), \neg r \vdash \neg p$
 (c) $\vdash ((p \supset q) \supset q) \supset q$
 (d) $\vdash ((p \supset q) \wedge (\neg p \supset q)) \supset \neg p$
 (e) $p \equiv (q \equiv r) \vdash (p \equiv q) \equiv r$
 (f) $\neg(p \supset q) \wedge \neg(p \supset r) \vdash \neg q \vee \neg r$
 (g) $p \wedge (\neg r \vee s), \neg(q \supset s) \vdash r$
 (h) $\vdash (p \supset (q \supset r)) \supset (q \supset (p \supset r))$
 (i) $\neg(p \wedge \neg q) \vee r, p \supset (r \equiv s) \vdash p \equiv q$
 (j) $p \equiv \neg\neg q, \neg q \supset (r \wedge \neg s), s \supset (p \vee q) \vdash (s \wedge q) \supset p$
2. Give an argument to show that $A \models B$ iff $\models A \supset B$. (Hint: split the argument into two parts: left to right, and right to left. Then just apply the definition of \models . You may find it easier to prove the contrapositives. That is, assume that $\not\models A \supset B$, and deduce that $A \not\models B$; then vice versa.)
 3. How, if at all, could one defend or attack the arguments of 1.7, 1.8 and 1.9?
 4. *Check the details omitted in 1.11.2 and 1.11.5.
 5. *Use the Soundness and Completeness Lemmas to show that if one completed tableau for an inference is open, they all are. Infer that the result of a tableau test is indifferent to the order in which one lists the premises of the argument and applies the tableau rules.

2 Basic Modal Logic

2.1 Introduction

2.1.1 In this chapter, we look at the basic technique – possible-world semantics – variations on which will occupy us for most of the following chapters. (We will return to the subject of the conditional in chapter 4.)

2.1.2 This will take us into an area called *modal logic*. This chapter concerns the most basic modal logic, *K* (after Kripke).

2.2 Necessity and Possibility

2.2.1 Modal logic concerns itself with the *modes* in which things may be true/false, particularly their possibility, necessity and impossibility. These notions are highly ambiguous, a subject to which we will return in the next chapter.

2.2.2 The modal semantics that we will examine employ the notion of a *possible world*. Exactly what possible worlds are, we will return to later in this chapter. For the present, the following will suffice. We can all imagine that things might have been different. For example, you can imagine that things are exactly the same, except that you are a centimetre taller. What you are imagining here is a different situation, or possible world. Of course, the actual world is a possible world too, and there are indefinitely many others as well, where you are two centimetres taller, three centimetres taller, where you have a different colour hair, where you were born in another country, and so on.

2.2.3 The other intuitive notion that the semantics employs is that of *relative possibility*. Given how things are now, it is possible for me to be in New York

in a week's time, 26 January. Given how things will be in six days and twenty-three hours, it will no longer be possible. (I am writing in Brisbane.) Or, even if one countenances the possibility of some futuristic and exceptionally fast form of travel, assuming that I do not leave Brisbane in the next eight days, it will then be impossible for me to be in New York on 26 January. Hence, certain states of affairs are possible relative to some situations (worlds), but not others.

2.3 Modal Semantics

2.3.1 A propositional modal language augments the language of the propositional calculus with two monadic operators, \Box and \Diamond .¹ Intuitively, $\Box A$ is read as 'It is necessarily the case that A '; $\Diamond A$ as 'It is possibly the case that A '.

2.3.2 Thus, the grammar of 1.2.2 is augmented with the rule:

If A is a formula, so are $\Box A$ and $\Diamond A$.

2.3.3 An *interpretation* for this language is a triple $\langle W, R, \nu \rangle$. W is a non-empty set. Formally, W is an arbitrary set of objects. Intuitively, its members are possible worlds. R is a binary relation on W (so that, technically, $R \subseteq W \times W$). Thus, if u and v are in W , R may or may not relate them to each other. If it does, we will write uRv , and say that v is *accessible* from u . Intuitively, R is a relation of relative possibility, so that uRv means that, relative to u , situation v is possible. ν is a function that assigns a truth value (1 or 0) to each pair comprising a world, w , and a propositional parameter, p . We write this as $\nu_w(p) = 1$ (or $\nu_w(p) = 0$). Intuitively, this is read as 'at world w , p is true (or false)'.

2.3.4 Given an interpretation, ν , this is extended to assign a truth value to every formula at every world by a recursive set of conditions. The conditions for the truth functions (\neg , \wedge , \vee , etc.) are the same as those for propositional logic (1.3.2), except that things are relativised to worlds. Thus, for \neg , \wedge and \vee , the conditions go as follows. For any world $w \in W$:

$\nu_w(\neg A) = 1$ if $\nu_w(A) = 0$, and 0 otherwise.

$\nu_w(A \wedge B) = 1$ if $\nu_w(A) = \nu_w(B) = 1$, and 0 otherwise.

$\nu_w(A \vee B) = 1$ if $\nu_w(A) = 1$ or $\nu_w(B) = 1$, and 0 otherwise.

¹ Some logicians use L and M , respectively.

In other words, worlds play no essential role in the truth conditions for the non-modal operators.

2.3.5 They play an essential role in the truth conditions for the modal operators. For any world $w \in W$:

$\nu_w(\Diamond A) = 1$ if, for some $w' \in W$ such that wRw' , $\nu_{w'}(A) = 1$; and 0 otherwise.

$\nu_w(\Box A) = 1$ if, for all $w' \in W$ such that wRw' , $\nu_{w'}(A) = 1$; and 0 otherwise.

In other words, 'It is possibly the case that A ' is true at a world, w , if A is true at *some* world, possible relative to w . And 'It is necessarily the case that A ' is true at a world, w , if A is true at *every* world, possible relative to w .

2.3.6 Note that if w accesses no worlds, everything of the form $\Diamond A$ is false at w - if w accesses no worlds, it accesses no worlds at which A is true. And if w accesses no worlds, everything of the form $\Box A$ is true at w - if w accesses no worlds, then (vacuously) at all worlds that w accesses A is true.²

2.3.7 A finite interpretation (that is, where W is a finite set) can be perspicuously represented diagrammatically. For example, let $W = \{w_1, w_2, w_3\}$; w_1Rw_2 , w_1Rw_3 , w_3Rw_3 (and no other worlds are related by R); $\nu_{w_1}(p) = 0$, $\nu_{w_1}(q) = 0$; $\nu_{w_2}(p) = 1$, $\nu_{w_2}(q) = 1$; $\nu_{w_3}(p) = 1$, $\nu_{w_3}(q) = 0$. This interpretation can be represented as follows:

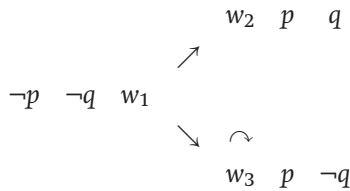

The arrows represent accessibility. In particular,



means that w_3 accesses itself.

² Recall that 'all Xs are Ys' is logically equivalent to 'there are no Xs that are not Ys'.

2.3.8 The truth conditions of 2.3.4 and 2.3.5 can be used to work out the truth values of compound sentences, and these can be marked on the diagram in the same way. For example, since p and q are true at w_2 , so is $p \wedge q$. But w_1Rw_2 ; hence, $\diamond(p \wedge q)$ is true at w_1 . At the only world that w_3 accesses (namely itself), p is true. Hence, $\square p$ is true at w_3 . But w_1 accesses w_3 , hence, $\diamond\square p$ is true at w_1 . w_2 accesses no world; hence, $\diamond q$ is false at w_2 , so $\neg\diamond q$ is true there. We can add these facts to the diagram in the obvious way:

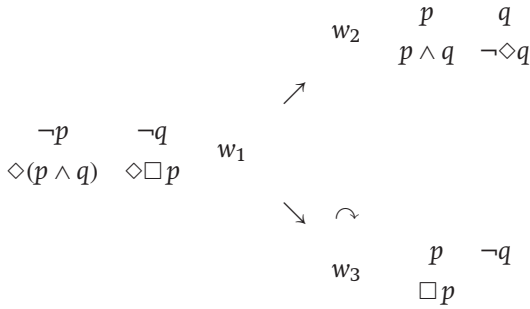

2.3.9 Observe that the truth value of $\neg\diamond A$ at any world, w , is the same as that of $\square\neg A$. For:

$$\begin{aligned}
 v_w(\neg\diamond A) = 1 & \quad \text{iff} \quad v_w(\diamond A) = 0 \\
 & \quad \text{iff} \quad \text{for all } w' \text{ such that } wRw', v_{w'}(A) = 0 \\
 & \quad \text{iff} \quad \text{for all } w' \text{ such that } wRw', v_{w'}(\neg A) = 1 \\
 & \quad \text{iff} \quad v_w(\square\neg A) = 1
 \end{aligned}$$

2.3.10 Similarly, the truth value of $\neg\square A$ at a world is the same as that of $\diamond\neg A$. The proof is left as an exercise.

2.3.11 An inference is valid if it is truth-preserving at all worlds of all interpretations. Thus, if Σ is a set of formulas and A is a formula, then semantic consequence and logical truth are defined as follows:

$$\begin{aligned}
 \Sigma \models A & \quad \text{iff for all interpretations } \langle W, R, v \rangle \text{ and all } w \in W: \text{ if } v_w(B) = 1 \text{ for all } \\
 & \quad B \in \Sigma, \text{ then } v_w(A) = 1. \\
 \models A & \quad \text{iff } \phi \models A, \text{ i.e., for all interpretations } \langle W, R, v \rangle \text{ and all } w \in W, v_w(A) = 1.
 \end{aligned}$$

2.4 Modal Tableaux

2.4.1 Tableaux for modal logic are similar to those for propositional logic (1.4), except for the following modifications. At every node of the tree there is either a formula and a natural number (0, 1, 2, ...), thus: A, i ; or something of the form irj , where i and j are natural numbers. Intuitively, different numbers indicate different possible worlds; A, i means that A is true at world i ; and irj means that world i accesses world j .³

2.4.2 Second, the initial list for the tableau comprises $A, 0$, for every premise, A (if there are any), and $\neg B, 0$, where B is the conclusion.

2.4.3 Third, the rules for the truth-functional connectives are the same as in non-modal logic, except that the number associated with any formula is also associated with its immediate descendant(s). Thus, the rule for disjunction, for example, is:

$$\begin{array}{ccc} & A \vee B, i & \\ \swarrow & & \searrow \\ A, i & & B, i \end{array}$$

2.4.4 There are four new rules for the modal operators:

$$\begin{array}{cc} \neg \Box A, i & \neg \Diamond A, i \\ \downarrow & \downarrow \\ \Diamond \neg A, i & \Box \neg A, i \\ \\ \Box A, i & \Diamond A, i \\ irj & \downarrow \\ \downarrow & irj \\ A, j & A, j \end{array}$$

In the rule for \Box (bottom left), both of the lines above the arrow must be present for the rule to be triggered (the lines do not have to occur in the order shown, and they do not have to be consecutive), and it is applied to *every* such j . In the rule for \Diamond (bottom right), the number j must be *new*. That is, it must not occur on the branch anywhere above.

³ I will avoid using r as a propositional parameter where this might lead to confusion.

2.4.5 Finally, a branch is closed iff for some formula, A , and number, i , A, i and $\neg A, i$ both occur on the branch. (It must be the same i in both cases.)⁴

2.4.6 Here are some examples of tableaux:

(i) $\Box(A \supset B) \wedge \Box(B \supset C) \vdash \Box(A \supset C)$.

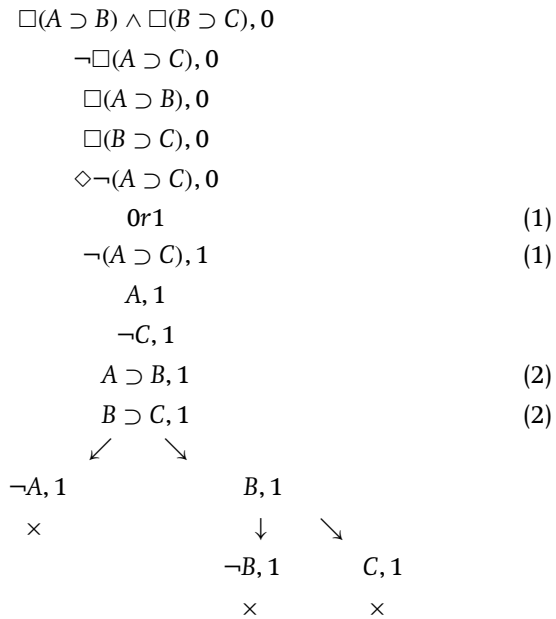

The lines marked (1) are obtained by applying the rule for \diamond to the line immediately above them. Note that in applying the rule for \diamond , a number new to the branch must be chosen. The lines marked (2) are the results of two applications of the rule for \Box to the conjuncts of the premise. Note that the rule for \Box is applied to numbers already on the branch.

(ii) $\vdash \diamond(A \wedge B) \supset (\diamond A \wedge \diamond B)$. The arrow at the bottom of a branch indicates that it continues on the next page.

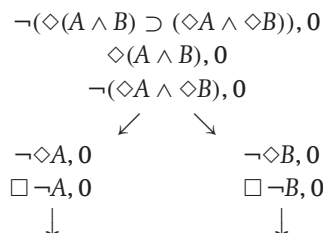

⁴ It is not obvious, but, as in the propositional case, every tableau of the kind we are dealing with here is finite.

of the same rule to the fifth line of the tableau. Note that, as the example shows, when we apply the rule for \diamond , we may have to go back and apply the rule for \square again, to the new world (number) that has been introduced. Thus, the line marked (3) results from a first application of the rule to line (1). Line (5) results from a second application. For this reason, if one is ticking nodes to show that one has finished with them, one should never tick a node of the form $\square A$, since one may have to come back and use it again.

2.4.7 Counter-models can be read off from an open branch of a tableau in a natural way. For each number, i , that occurs on the branch, there is a world, w_i ; $w_i R w_j$ iff irj occurs on the branch; for every propositional parameter, p , if p, i occurs on the branch, $\nu_{w_i}(p) = 1$, if $\neg p, i$ occurs on the branch, $\nu_{w_i}(p) = 0$ (and if neither, $\nu_{w_i}(p)$ can be anything one wishes).

2.4.8 Thus, the counter-model given by the open (and only) branch of the third example of 2.4.6 is as follows: $W = \{w_0, w_1, w_2, w_3, w_4\}$. $w_0 R w_1, w_1 R w_2, w_0 R w_3, w_3 R w_4$. There are no other worlds related by R . $\nu_{w_1}(p) = 1, \nu_{w_3}(q) = 0$; otherwise, ν is arbitrary. The interpretation can be depicted thus:

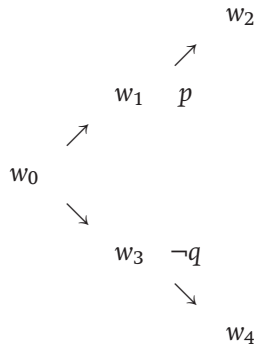

Using the truth conditions, one can check directly that the interpretation works. Since p is true at w_1 , $\diamond p$ is true at w_0 . Similarly, $\diamond \neg q$ is true at w_0 . Hence, the antecedent is true at w_0 . w_2 accesses no worlds; so $\diamond p$ is false at w_2 , and $\square \diamond p$ is false at w_1 . Similarly, $\square \diamond p$ is false at w_3 . Hence, there is no world which w_0 can access at which $\square \diamond p$ is true. Thus, $\diamond \square \diamond p$ is false at w_0 . It follows, then, that $(\diamond p \wedge \diamond \neg q) \supset \diamond \square \diamond p$ is false at w_0 .

2.4.9 The tableaux just described are sound and complete with respect to the semantics. The proof is given in 2.9.

2.5 Possible Worlds: Representation

2.5.1 In the rest of this chapter we look at the major philosophical question that modal semantics generate: what do they *mean*?

2.5.2 One might suggest that they do not mean anything. They are simply a mathematical apparatus – interpretations comprise just bunches of objects (W) furnished with some properties and relations – to be thought of purely instrumentally as delivering an appropriate notion of validity.

2.5.3 But there is something very unsatisfactory about this, as there is about all instrumentalisms. If a mathematical ‘black box’ gives what seem to be the right answers, one wants to know why. There must be some relationship between how it works and reality, which explains why it gets things right.

2.5.4 The most obvious explanation in this context is that the mathematical structures that are employed in interpretations *represent* something or other which underlies the correctness of the notion of validity.

2.5.5 In the same way, no one supposes that truth is simply the number 1. But that number, and the way that it behaves in truth-functional semantics, are able to represent truth, because the structure of their machinations corresponds to the structure of truth’s own machinations. This explains why truth-functional validity works (when it does).

2.5.6 So, the question arises: what exactly, in reality, does the mathematical machinery of possible worlds represent? Possible worlds, of course (what else?). But what are they?

2.6 Modal Realism

2.6.1 The simplest suggestion (usually termed ‘modal realism’) is that possible worlds are things exactly like the actual world. They are composed of physical objects like people, chairs and stars (if any exist in those worlds), in their own space and time (if there are such things in those worlds). These objects exist just as much as you and I do, just in a different place/time – though not ones in this world.

2.6.2 The thought is, no doubt, a little mind-boggling. But so are many of the developments in modern physics. And why should metaphysics not have the right to boggle the mind just as much as physics?

2.6.3 Many arguments may be put both for and against this proposal – as they may be for all the views that I will mention. Here is one argument against. What makes such a world a *different* possible world, and not simply part of this one? The natural answer is that the space, time and causation of that world are unconnected with the space, time and causation of this world. One cannot travel from here to there in space or time; nor can causal processes from here reach there, or vice versa.

2.6.4 But why should that make it a *different* world? Suppose that because of the spatial geometry of the inside of a black hole, one could travel thence down a worm hole into a part of the cosmos with its own space and time; and suppose, then, that the worm hole closed up. We would not think of that region, now causally isolated from the rest, as a different possible world: merely an inaccessible part of this one.

2.6.5 The point may be put in a different way. Why should we think that something is possible in *this* world merely because it is actually happening at another place/time? I do not, after all, think that it is possible to see kangaroos in Antarctica merely because they are seen in Australia.

2.7 Modal Actualism

2.7.1 Another possibility (frequently termed ‘modal actualism’) is that, though possible worlds exist, they are not the physical entities that the modal realist takes them to be. They are entities of a different kind: specifically, abstract entities (like numbers, assuming there to be such things).

2.7.2 What kind of abstract entities? There are several possible candidates here. A natural one is to take them to be sets of propositions, or other language-like entities. Crudely, a possible world is individuated by the set of things true at it, which is just the set of propositions it contains.

2.7.3 But a problem arises with this suggestion when one asks which sets are worlds? Clearly not all sets are possible worlds. For example, a set that contains two propositions but not their conjunction could not be a possible world.

2.7.4 For a set of propositions to form a world, it must at least be closed under valid inference. (If a proposition is true at a world, and it entails

another, then so is that.) But there's the rub. The machinery of worlds was meant to explain why certain inferences, and not others, are valid. But it now seems that the notion of validity is required to explain the notion of world – not the other way around.

2.7.5 A variation of actualism which avoids this problem is known as 'combinatorialism'. A possible world is merely the set of things in *this* world, rearranged in a different way. So in this world, my house is in Australia, and not China; but rearrange things, and it could be in China, and not Australia.

2.7.6 Combinatorialism is still a version of actualism, because an arrangement is, in fact, an abstract object. It is a *set* of objects with a certain structure. But it avoids the previous objection, since one may explain what combinations there are without invoking the notion of validity.

2.7.7 But combinatorialism has its own problems. For example, it would seem to be entirely possible that there is an object such that neither it nor any of its parts exist in this world. It is clear, though, that such an object could not exist in any world obtained simply by rearranging the objects in this world. Hence, there are possible worlds which cannot be delivered by combinatorialism.

2.8 Meinongianism

2.8.1 Both realism and actualism take possible worlds and their denizens, whatever they are, to exist, either as concrete objects or as abstract objects. Another possibility is to take them to be non-existent objects. (We know, after all, that such things do not really exist!)

2.8.2 We are all, after all, familiar with the thought that there are non-existent things, like fairies, Father Christmas (sorry) and phlogiston. Possible worlds are things of this kind.

2.8.3 The view that there are non-existent objects was espoused, famously, by Meinong. It had a very bad press for a long time in English-speaking philosophy, but it is fair to say that many of the old arguments against the possibility of there being non-existent objects are not especially cogent.

2.8.4 For example, one argument against such objects is that, since they cannot interact with us causally, we would have no way of knowing anything

about them. But exactly the same is true, of course, of possible worlds as both the realist and the actualist conceive them, so this can hardly count to their advantage against Meinongianism about worlds.

2.8.5 Moreover, it is very clear how we know facts about at least some non-existent objects: they are simply stipulated. Holmes lived in Baker Street – and not Oxford Street – because Conan Doyle decided it was so.

2.8.6 The preceding considerations hardly settle the matter of the nature of possible worlds. There are many other suggested answers (most of which are some variation on one or other of the themes that I have mentioned); and there are many objections to the suggestions I have raised, other than the ones that I have given, as well as possible replies to the objections I have raised; philosophers can have hours of fun with possible worlds. This will do for the present, though.

2.9 *Proofs of Theorems

2.9.1 The soundness and completeness proofs for K are essentially variations and extensions of the soundness and completeness proofs for propositional logic. We redefine faithfulness and the induced interpretation. The proofs are then much as in 1.11.

2.9.2 DEFINITION: Let $\mathcal{I} = \langle W, R, \nu \rangle$ be any modal interpretation, and b be any branch of a tableau. Then \mathcal{I} is *faithful* to b iff there is a map, f , from the natural numbers to W such that:

For every node A, i on b , A is true at $f(i)$ in \mathcal{I} .

If irj is on b , $f(i)Rf(j)$ in \mathcal{I} .

We say that f shows \mathcal{I} to be faithful to b .

2.9.3 SOUNDNESS LEMMA: Let b be any branch of a tableau, and $\mathcal{I} = \langle W, R, \nu \rangle$ be any interpretation. If \mathcal{I} is faithful to b , and a tableau rule is applied to it, then it produces at least one extension, b' , such that \mathcal{I} is faithful to b' .

Proof:

Let f be a function which shows \mathcal{I} to be faithful to b . The proof proceeds by a case-by-case consideration of the tableau rules. The cases for the propositional rules are essentially as in 1.11.2. Suppose, for example, that

$A \wedge B, i$ is on b , and that we apply the rule for conjunction to give an extended branch containing A, i and B, i . Since \mathcal{I} is faithful to b , $A \wedge B$ is true at $f(i)$. Hence, A and B are true at $f(i)$. Hence, \mathcal{I} is faithful to the extension of b . We will therefore consider only the modal rules in detail. Consider the rule for negated \diamond . Suppose that $\neg\diamond A, i$ occurs on b , and that we apply the rule to extend the branch with $\Box\neg A, i$. Since \mathcal{I} is faithful to b , $\neg\diamond A$ is true at $f(i)$. Hence, $\Box\neg A$ is true at $f(i)$ (by 2.3.9). Hence, \mathcal{I} is faithful to the extension of b . The rule for negated \Box is similar (invoking 2.3.10).

This leaves the rules for \Box and \diamond . Suppose that $\Box A, i$ is on b , and that we apply the rule for \Box . Since \mathcal{I} is faithful to b , $\Box A$ is true at $f(i)$. Moreover, for any i and j such that irj is on b , $f(i)Rf(j)$. Hence, by the truth conditions for \Box , A is true at $f(j)$, and so \mathcal{I} is faithful to the extension of the branch. Finally, suppose that $\diamond A, i$ is on b and we apply the rule for \diamond to get nodes of the form irj and A, j . Since \mathcal{I} is faithful to b , $\diamond A$ is true at $f(i)$. Hence, for some $w \in W$, $f(i)Rw$ and A is true at w . Let f' be the same as f except that $f'(j) = w$. Note that f' also shows that \mathcal{I} is faithful to b , since f and f' differ only at j ; this does not occur on b . Moreover, by definition, $f'(i)Rf'(j)$, and A is true at $f'(j)$. Hence, f' shows \mathcal{I} to be faithful to the extended branch. ■

2.9.4 SOUNDNESS THEOREM FOR K : For finite Σ , if $\Sigma \vdash A$ then $\Sigma \models A$.

Proof:

Suppose that $\Sigma \not\models A$. Then there is an interpretation, $\mathcal{I} = \langle W, R, \nu \rangle$, that makes every premise true, and A false, at some world, w . Let f be any function such that $f(0) = w$. This shows \mathcal{I} to be faithful to the initial list. The proof is now exactly the same as in the non-modal case (1.11.3). ■

2.9.5 DEFINITION: Let b be an open branch of a tableau. The interpretation, $\mathcal{I} = \langle W, R, \nu \rangle$, induced by b , is defined as in 2.4.7. $W = \{w_i : i \text{ occurs on } b\}$. $w_i R w_j$ iff irj occurs on b . If p, i occurs on b , then $\nu_{w_i}(p) = 1$; if $\neg p, i$ occurs on b , then $\nu_{w_i}(p) = 0$ (and otherwise $\nu_{w_i}(p)$ can be anything one likes).

2.9.6 COMPLETENESS LEMMA: Let b be any open complete branch of a tableau. Let $\mathcal{I} = \langle W, R, \nu \rangle$ be the interpretation induced by b . Then:

- if A, i is on b then A is true at w_i
- if $\neg A, i$ is on b then A is false at w_i

Proof:

The proof is by recursion on the complexity of A . If A is atomic, the result is true by definition. If A occurs on b , and is of the form $B \vee C$, then the rule for disjunction has been applied to $B \vee C, i$. Thus, either B, i or C, i is on b . By induction hypothesis, either B or C is true at w_i . Hence, $B \vee C$ is true at w_i , as required. The case for $\neg(B \vee C)$ is similar, as are the cases for the other truth functions. Next, suppose that A is of the form $\Box B$. If $\Box B, i$ is on b , then for all j such that irj is on b , B, j is on b . By construction and the induction hypothesis, for all w_j such that $w_i R w_j$, B is true at w_j . Hence, $\Box B$ is true at w_i , as required. If $\neg\Box A, i$ is on b , then $\Diamond\neg A, i$ is on b ; so, for some j , irj and $\neg A, j$ are on b . By induction hypothesis, $w_i R w_j$ and A is false at w_j . Hence, $\Box A$ is false at w_i as required. The case for \Diamond is similar. ■

2.9.7 COMPLETENESS THEOREM: For finite Σ , if $\Sigma \models A$ then $\Sigma \vdash A$.

Proof:

Suppose that $\Sigma \not\vdash A$. Given an open branch of the tableau, the interpretation that this induces makes all the premises true at w_0 and A false at w_0 by the Completeness Lemma. Hence, $\Sigma \not\models A$. ■

2.10 History

Modal logic is as old as logic. Aristotle himself gave an account of which modal syllogisms he took to be valid (see Kneale and Kneale, 1975, ch. 2, sect. 8). Modal logic and semantics were also discussed widely in the Middle Ages (see Knuuttila, 1982). In the modern period, the subject of modal logic was initiated by C. I. Lewis just before the First World War (see Lewis and Langford, 1931). Initially, it received a bad press, largely as a result of the criticisms of Quine – whose work also produced much of the unpopularity of Meinongianism. (On both, see the papers in Quine, 1963.) Things changed with the invention of possible-world semantics in the early 1960s. These are due to the work of a number of people, most notably that of Kripke (1963a). (For a history, see Copeland, 1996, pp. 8–15.)

The notion of a possible world is to be found in Leibniz (e.g., *Monadology*, sect. 53). Modal realism has been espoused most famously by D. Lewis (1986). Notable proponents of actualism include Plantinga and Stalnaker. Combinatorialism is espoused by Cresswell. See the papers by all three in Loux (1979). The idea that worlds are non-existent objects is proposed in

Routley (1980a) and defended in Priest (2005c). Kripke's own views on the nature of possible worlds can be found in Kripke (1977).

2.11 Further Reading

Perhaps the best introduction to modal logic is still Hughes and Cresswell (1996). The semantics of K are given in chapter 2. (Hughes and Cresswell use axiom systems rather than tableaux for their proof theory.) Chellas (1980) is also excellent, though a little more demanding mathematically. Tableaux for modal propositional logics can be found in chapters 2 and 3 of Girle (2000). A somewhat different form can be found in chapter 2 of Fitting and Mendelsohn (1999). A useful collection of essays on the nature of possible worlds is Loux (1979); chapter 15, 'The Trouble with Possible Worlds', by Lycan, is a good orientational survey. Read (1994, ch. 4) is also an excellent discussion.

2.12 Problems

1. Check the details of 2.3.10.
2. Show the following. Where the tableau does not close, use it to define a counter-model, and draw this, as in 2.4.8.

$$(a) \vdash (\Box A \wedge \Box B) \supset \Box(A \wedge B)$$

$$(b) \vdash (\Box A \vee \Box B) \supset \Box(A \vee B)$$

$$(c) \vdash \Box A \equiv \neg \Diamond \neg A$$

$$(d) \vdash \Diamond A \equiv \neg \Box \neg A$$

$$(e) \vdash \Diamond(A \wedge B) \supset (\Diamond A \wedge \Diamond B)$$

$$(f) \vdash \Diamond(A \vee B) \supset (\Diamond A \vee \Diamond B)$$

$$(g) \Box(A \supset B) \vdash \Diamond A \supset \Diamond B$$

$$(h) \Box A, \Diamond B \vdash \Diamond(A \wedge B)$$

$$(i) \vdash \Box A \equiv \Box(\neg A \supset A)$$

$$(j) \vdash \Box A \supset \Box(B \supset A)$$

$$(k) \vdash \neg \Diamond B \supset \Box(B \supset A)$$

$$(l) \not\vdash \Box(p \vee q) \supset (\Box p \vee \Box q)$$

$$(m) \Box p, \Box \neg q \not\vdash \Box(p \supset q)$$

$$(n) \Diamond p, \Diamond q \not\vdash \Diamond(p \wedge q)$$

$$(o) \not\vdash \Box p \supset p$$

$$(p) \not\vdash \Box p \supset \Diamond p$$

(q) $p \not\vdash \Box p$

(r) $\not\vdash \Box p \supset \Box \Box p$

(s) $\not\vdash \Diamond p \supset \Diamond \Diamond p$

(t) $\not\vdash p \supset \Box \Diamond p$

(u) $\not\vdash \Diamond p \supset \Box \Diamond p$

(v) $\not\vdash \Diamond(p \vee \neg p)$

3. How might one reply to the objections of 2.5–2.8, and what other objections are there to the views on the nature of possible worlds explained there? What other views could there be?
4. *Check the details omitted in 2.9.3 and 2.9.6.

3 Normal Modal Logics

3.1 Introduction

3.1.1 In this chapter we look at some well-known extensions of K , the system of modal logic that we considered in the last chapter.

3.1.2 We then look at the question of which systems of modal logic are appropriate for which notions of necessity.

3.1.3 We will end the chapter with a brief look at logics with more than one pair of modal operators, in the shape of tense logic. (This can be skipped without loss of continuity for Part I of the book.)

3.2 Semantics for Normal Modal Logics

3.2.1 There are many systems of modal logic. If there is any doubt as to which one is being considered in what follows, we subscript the turnstile (\models or \vdash) used. Thus, the consequence relation of K is written as \models_K .

3.2.2 The most important class of modal logics is the class of *normal* logics. The basic normal logic is the logic K .

3.2.3 Other normal modal logics are obtained by defining validity in terms of truth preservation in some special class of interpretations. Typically, the special class of interpretations is one containing all and only those interpretations whose accessibility relation, R , satisfies some constraint or other. Some important constraints are as follows:

ρ (rho), reflexivity: for all w , wRw .

σ (sigma), symmetry: for all w_1, w_2 , if w_1Rw_2 , then w_2Rw_1 .

τ (tau), transitivity: for all w_1, w_2, w_3 , if w_1Rw_2 and w_2Rw_3 , then w_1Rw_3 .

η (eta), extendability: for all w_1 , there is a w_2 such that w_1Rw_2 .

3.2.4 We term any interpretation in which R satisfies condition ρ a ρ -interpretation. We denote the logic defined in terms of truth preservation over all worlds of all ρ -interpretations, $K\rho$, and write its consequence relation as $\models_{K\rho}$. Thus, $\Sigma \models_{K\rho} A$ iff, for all ρ -interpretations $\langle W, R, \nu \rangle$, and all $w \in W$, if $\nu_w(B) = 1$ for all $B \in \Sigma$, then $\nu_w(A) = 1$. Similarly for σ , τ and η .

3.2.5 The conditions on R can be combined. Thus, for example, a $\rho\sigma$ -interpretation is one in which R is reflexive and symmetric; and the logic $K\sigma\tau$ is the consequence relation defined over all $\sigma\tau$ -interpretations. Historically, the systems $K\rho, K\eta, K\rho\sigma, K\rho\tau$ and $K\rho\sigma\tau$ are known as $T, D, B, S4$ and $S5$, respectively.

3.2.6 Note that if R is reflexive, it is extendable. (If a world accesses itself, it certainly accesses something.) But otherwise, with one exception, all the conditions on R are independent: one can mix and match at will. For example, here is a relation that is symmetric and reflexive, but not transitive:

$$\widehat{w}_1 \rightleftharpoons \widehat{w}_2 \rightleftharpoons \widehat{w}_3$$

The other combinations are left as an exercise (see 3.10, problem 1). The exception is that σ , τ and η , together, give ρ .¹

3.2.7 Every normal modal logic, \mathcal{L} , is an extension of K , in the sense that if $\Sigma \models_K A$ then $\Sigma \models_{\mathcal{L}} A$. For if truth is preserved at all worlds of all interpretations, *a fortiori* it is preserved at all worlds of any restricted class of interpretations.

3.2.8 This is an important kind of argument that we use a number of times, so let us pause over it for a moment. Consider the following diagram:

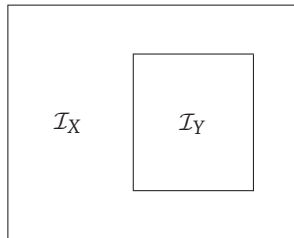

Suppose that the outer box contains all interpretations of a certain kind (in our case, all K interpretations), and that the inner box contains some more

¹ Consider any world, w . By η , wRw' for some w' . So, by σ , $w'Rw$, and, by τ , wRw .

restricted class of interpretations (in our case, those appropriate for the logic \mathcal{L}). Then if truth (from premise to conclusion) is preserved in all worlds of all interpretations in \mathcal{I}_X , then it is preserved in all worlds of all interpretations in \mathcal{I}_Y . Hence, the logic determined by the class of interpretations \mathcal{I}_Y is an extension of that determined by the class \mathcal{I}_X .

In other words, if \mathcal{V}_X and \mathcal{V}_Y are the sets of the inferences that are valid in the two logics, they are related as in the following diagram:

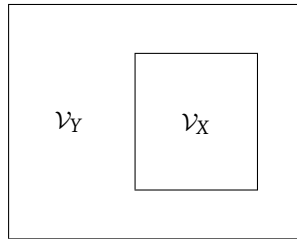

Note that the relationship between \mathcal{I}_X and \mathcal{I}_Y is *inverse* to that between \mathcal{V}_X and \mathcal{V}_Y : fewer interpretations, more inferences. (Or, to be more precise, no less. It is possible to have fewer interpretations with the same set of valid inferences. We will have an example of this in 3.5.4. Thus, \mathcal{V}_Y may be a degenerate (improper) extension of \mathcal{V}_X , namely \mathcal{V}_X itself.)

3.2.9 For exactly this reason, $K\rho\sigma$ is an extension of $K\rho$; $K\rho\sigma\tau$ is an extension of $K\rho\sigma$, and so on.

3.3 Tableaux for Normal Modal Logics

3.3.1 The tableau rules for K can be extended to work for other normal systems as well. Essentially, this is done by adding rules which introduce further information about r on branches. Since this information comes into play when the rule for \Box is applied, the effect of this is to increase the number of applications of that rule.

3.3.2 The rules for ρ , σ and τ are, respectively:

ρ	σ	τ
.	irj	irj
\downarrow	\downarrow	jrk
iri	jri	\downarrow
		irk

(We come to the rule for η in the next section.) The rule for ρ means that if i is any integer on the tableau, we introduce iri . It can therefore be applied to world 0 after the initial list, and, thereafter, after the introduction of any new integer. The other two rules are self-explanatory. Note that if the application of a rule would result in just repeating lines already on the branch, it is not applied. Thus, for example, if we apply the σ -rule to irj to get jri , we do not then apply it again to jri to get irj . The following three subsections give examples of tableaux for $K\rho$, $K\sigma$ and $K\tau$, respectively.

3.3.3 $\vdash_{K\rho} \Box p \supset p$:

$$\begin{array}{c} \neg(\Box p \supset p), 0 \\ 0r0 \\ \Box p, 0 \\ \neg p, 0 \\ p, 0 \\ \times \end{array}$$

The last line is obtained from $\Box p, 0$, since $0r0$. Since $\Box p \supset p$ is not valid in K (2.12, problem 2(o)), this shows that $K\rho$ is a *proper* extension of K . (That is, $K\rho$ is not exactly the same as K .)

3.3.4 $\vdash_{K\sigma} p \supset \Box \Diamond p$:

$$\begin{array}{c} \neg(p \supset \Box \Diamond p), 0 \\ p, 0 \\ \neg \Box \Diamond p, 0 \\ \Diamond \neg \Diamond p, 0 \\ 0r1 \\ \neg \Diamond p, 1 \\ 1r0 \\ \Box \neg p, 1 \\ \neg p, 0 \\ \times \end{array}$$

The last line follows from the fact that $\Box \neg p, 1$, since $1r0$. Since $p \supset \Box \Diamond p$ is not valid in K (2.12, problem 2(t)), this shows that $K\sigma$ is a *proper* extension of K .

3.3.5 $\vdash_{K\tau} \Box p \supset \Box\Box p$:

$$\begin{array}{l}
\neg(\Box p \supset \Box\Box p), 0 \\
\Box p, 0 \\
\neg\Box\Box p, 0 \\
\Diamond\neg\Box p, 0 \\
0r1 \\
\neg\Box p, 1 \\
\Diamond\neg p, 1 \\
1r2 \\
\neg p, 2 \\
0r2 \\
p, 2 \\
\times
\end{array}$$

When we add 1r2 to the tableau because of the \Diamond -rule, we already have 0r1; hence, we add 0r2. Since $\Box p$ holds at 0, an application of the rule for \Box immediately closes the tableau. Since $\Box p \supset \Box\Box p$ is not valid in K (2.12, problem 2(r)), this shows that $K\tau$ is a proper extension of K .

3.3.6 For ‘compound’ systems, all the relevant rules must be applied. There may be some interplay between them. To keep track of this, adopt the following procedure. New worlds are normally introduced by the \Diamond -rule. Apply this first. Then compute all the new facts about r that need to be added, and add them. Finally, backtrack if necessary and apply the \Box -rule wherever the new r facts require it. The procedure is illustrated in the following tableau, demonstrating that $\vdash_{K\sigma\tau} \Diamond p \supset \Box\Diamond p$. For brevity’s sake, we write more than one piece of information about r on the same line.

$$\begin{array}{l}
\neg(\Diamond p \supset \Box\Diamond p), 0 \\
\Diamond p, 0 \\
\neg\Box\Diamond p, 0 \\
0r1 \\
p, 1 \\
1r0, 1r1, 0r0 \\
\Diamond\neg\Diamond p, 0 \\
0r2 \\
\neg\Diamond p, 2 \\
\downarrow
\end{array}$$

$$\begin{array}{l}
2r0, 2r2, 1r2, 2r1 \\
\Box\neg p, 2 \\
\neg p, 2 \\
\neg p, 1 \\
\neg p, 0 \\
\times
\end{array}$$

The line $\Diamond\neg\Diamond p, 0$ requires the construction of a new world, 2, with an application of the \Diamond -rule. This is done on the next two lines. We then add all the new information about r that the creation of world 2 requires. $2r0$ is added because of symmetry; $2r2$ is added because of transitivity and the fact that we have $2r0$ and $0r2$; $1r2$ is added because of transitivity and the fact that we have $1r0$ and $0r2$; similarly, $2r1$ is added because of transitivity. Symmetry and transitivity require no other facts about r . In constructing a tableau, it may help to keep track of things if one draws a diagram of the world structure, as it emerges.

3.3.7 Counter-models read off from an open branch of a tableau incorporate the information about r in the obvious way. Thus, consider the following tableau, which shows that $\not\vdash_{K\rho\sigma} \Box p \supset \Box\Box p$.

$$\begin{array}{l}
\neg(\Box p \supset \Box\Box p), 0 \\
0r0 \\
\Box p, 0 \\
\neg\Box\Box p, 0 \\
p, 0 \\
\Diamond\neg\Box p, 0 \\
0r1 \\
\neg\Box p, 1 \\
1r1, 1r0 \\
p, 1 \\
\Diamond\neg p, 1 \\
1r2 \\
\neg p, 2 \\
2r2, 2r1
\end{array}$$

The counter-model is $\langle W, R, \nu \rangle$, where $W = \{w_0, w_1, w_2\}$, R is such that $w_0Rw_0, w_1Rw_1, w_2Rw_2, w_0Rw_1, w_1Rw_0, w_1Rw_2$ and w_2Rw_1 , and ν is such that

$\nu_{w_0}(p) = \nu_{w_1}(p) = 1, \nu_{w_2}(p) = 0$. In pictures:

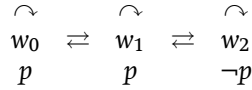

3.3.8 The tableau systems above are all sound and complete with respect to their respective semantics. The proof of this can be found in 3.7.

3.4 Infinite Tableaux

3.4.1 The tableau rule for η is as follows:

$$\begin{array}{c} \eta \\ \cdot \\ \downarrow \\ irj \end{array}$$

It is applied to any integer, i , on a branch, provided that there is not already something of the form irj on the branch, and the j in question must then be *new*.

3.4.2 Care must be taken in applying this rule. If it is applied every time as soon as it is possible to do so, we go off into an infinite regress from which we never return. For when we introduce j , we have (since j is new) to introduce a new k and add jrj , and then a new l , and add krj , and so on.

3.4.3 The rule is alright, however, provided that one does not apply it immediately, where to do so would prevent other rules from being applied. It must still be applied at some time, of course (unless the tableau closes first). Soundness and completeness for the rule are proved in 3.7.

3.4.4 The following tableau demonstrates that $\vdash_{K\eta} \Box p \supset \Diamond p$.

$$\begin{array}{l} \neg(\Box p \supset \Diamond p), 0 \\ \Box p, 0 \\ \neg \Diamond p, 0 \\ \Box \neg p, 0 \\ Or1 \\ p, 1 \\ \neg p, 1 \\ \times \end{array}$$

This inference is not valid in K (2.12, problem 2(p)). Hence, K_η is a proper extension of K .

3.4.5 Even with the rule applied in this way, though, if the tableau fails to close, it will be infinite, as the following tableau, demonstrating that $\not\vdash_{K_\eta} \Box p$, illustrates:

$$\begin{array}{c} \neg\Box p, 0 \\ \Diamond\neg p, 0 \\ 0r1 \\ \neg p, 1 \\ 1r2 \\ 2r3 \\ \vdots \end{array}$$

The tableau is infinite, but the (only) branch is still open. Hence, the inference is still invalid. The branch also specifies a counter-model, though this, too, is infinite. It may be depicted thus:

$$\begin{array}{c} \neg p \\ w_0 \rightarrow w_1 \rightarrow w_2 \rightarrow \dots \end{array}$$

3.4.6 This does not mean that the only counter-models to $\Box p$ in K_η are infinite. For example, the following will do, as may easily be checked:

$$\begin{array}{c} \curvearrowright \\ w_0 \\ \neg p \end{array}$$

If an inference is not valid in η , however, and it has a finite counter-model, the tableau procedure will not find it. Such models can be found by trial and error: make a guess; see if it works; if it does not, try making an appropriate change; see if it works; if it does not, try making an appropriate change; etc.

3.4.7 It is not only the system K_η that may give rise to infinite tableaux; even K_τ may give rise to them. Consider the tableau showing that $\not\vdash_{K_\tau} \neg(\Diamond p \wedge \Box\Diamond p)$:

$$\begin{array}{c} \neg\neg(\Diamond p \wedge \Box\Diamond p), 0 \\ \Diamond p \wedge \Box\Diamond p, 0 \\ \Diamond p, 0 \end{array}$$

$$\begin{array}{l}
 \Box \Diamond p, 0 \\
 0r1 \\
 p, 1 \\
 \Diamond p, 1 \\
 1r2 \\
 p, 2 \\
 0r2 \\
 \Diamond p, 2 \\
 2r3 \\
 p, 3 \\
 \vdots
 \end{array}$$

Every time we open a new world, i , transitivity gives us $0ri$. And since $\Box \Diamond p$ holds at 0, the \Box -rule requires us to write $\Diamond p, i$, which requires us to open a new world ...

3.4.8 Again, though, an infinite counter-model can be read off the open branch:

$$\begin{array}{ccccccc}
 & p & & p & & p & \\
 w_0 & \rightarrow & w_1 & \rightarrow & w_2 & \rightarrow & w_3 & \rightarrow & \dots
 \end{array}$$

This is a very simple example, however. In general, it is often very difficult to establish that a tableau is infinite and open, and an even more difficult task to read off the counter-model when it is.

3.4.9 It is usually much easier to find a simpler counter-model by trial and error. Thus, it is easy enough to establish that the following interpretation is a counter-model for the inference of 3.4.7:

$$\begin{array}{c}
 \curvearrowright \\
 w_0 \\
 p
 \end{array}$$

3.4.10 We conclude this section by noting the following. I did not choose the examples of 3.3.3, 3.3.4, 3.3.5 and 3.4.4 at random. The principles shown to hold in each case are, in a sense, the *characteristic* principles of the logics $K\rho$, $K\sigma$, $K\tau$ and $K\eta$.²

² And, technically, each, when added to some axiom system for K , gives a complete axiomatisation of the logic.

3.5 S5

3.5.1 The system S5 is special. To see how, let an ν -interpretation - ' ν ' (upsilon) for universal - be an interpretation in which R satisfies the following condition: for all w_1 and w_2 , $w_1 R w_2$ - everything relates to everything.

3.5.2 In an ν -interpretation, R drops out of the picture altogether, in effect. We can just as well define an ν -interpretation to be a pair $\langle W, \nu \rangle$, where the truth conditions for \Box are simply: $\nu_w(\Box A) = 1$ iff for all $w' \in W$, $\nu_{w'}(A) = 1$; and similarly for \Diamond .

3.5.3 Tableaux for $K\nu$ can also be formulated very simply: r is never mentioned. Applying the \Diamond -rule to $\Diamond A, i$ gives a new line of the form A, j (new j); and in applying the \Box -rule to $\Box A, i$, we add A, j for every j . For example, $\vdash_{K\nu} \Diamond A \supset \Box \Diamond A$:

$$\begin{array}{c}
 \neg(\Diamond A \supset \Box \Diamond A), 0 \\
 \quad \Diamond A, 0 \\
 \quad \neg \Box \Diamond A, 0 \\
 \quad \quad \Diamond \neg \Diamond A, 0 \\
 \quad \quad \quad A, 1 \\
 \quad \quad \quad \neg \Diamond A, 2 \\
 \quad \quad \quad \Box \neg A, 2 \\
 \quad \quad \quad \neg A, 0 \\
 \quad \quad \quad \neg A, 1 \\
 \quad \quad \quad \neg A, 2 \\
 \quad \quad \quad \times
 \end{array}$$

3.5.4 Now, $K\rho\sigma\tau$ and $K\nu$ are, in fact, equivalent, in the sense that $\Sigma \models_{K\rho\sigma\tau} A$ iff $\Sigma \models_{K\nu} A$. Half of this fact is obvious. It is easy to check that if a relationship satisfies the condition ν it satisfies the conditions ρ , σ and τ . Hence, if truth is preserved at all worlds of all $\rho\sigma\tau$ -interpretations, it is preserved at all worlds of all ν -interpretations. Hence, if $\Sigma \models_{K\rho\sigma\tau} A$, then $\Sigma \models_{K\nu} A$. The converse is not so obvious. (A proof can be found in 3.7.5.)

3.5.5 Because of the equivalence between $K\nu$ and $K\rho\sigma\tau$, the name S5 tends to be used, indifferently, for either of these systems.

3.5.6 There are many other normal modal logics. Some of these glorify in names such as $S4.2$. The number indicates that the system is between $S4$ and $S5$ in strength, but otherwise is not to be taken too seriously.

3.6 Which System Represents Necessity?

3.6.1 Let us now turn to a philosophical issue raised by the multiplicity of normal modal logics. Which system is correct? There is, in fact, no single answer to this question, since there are many different notions of necessity (and, correlatively, possibility and impossibility) and the first thing that one needs to do is distinguish among them.

3.6.2 Among the many notions, we can distinguish at least the following: logical, metaphysical, physical, epistemic, alethic and moral. How, exactly, to characterise each of these notions is a moot point; however, a rough characterisation will do for our purposes.

3.6.3 A standard way of defining logical necessity is in terms of analyticity. That is, A is logically necessary if its truth is determined solely by the meanings of the words it contains. We might argue about which sentences are analytic in this sense, but it would standardly be assumed that the following examples are: 'If it rains today then it rains today', ' $2 + 2 = 4$ '.

3.6.4 It is plausible to suppose that the appropriate system of modal logic for logical necessity is $S5$. Certainly, it would appear that logical truths satisfy the principles characteristic of $K\rho$, $K\sigma$ and $K\tau$. If A 's truth is analytic, A is certainly true ($\Box A \supset A$). If A 's truth is determined simply by the meanings of the words it contains, then so is the truth of the claim that A is analytic ($\Box A \supset \Box\Box A$). And if A is true (e.g., 'snow is white'), then $\neg A$ ('snow isn't white') is not analytically true, so $\neg\Box\neg A$ ('it is not analytically true that snow isn't white'), and this is so simply in virtue of the meanings of the words involved ($A \supset \Box\Diamond A$) (though one certainly might have one's doubts about this last claim).

3.6.5 Let us turn now to physical necessity and its cognates. Something is physically necessary if it is determined by the laws of nature, and physically possible if it is compatible with the laws of nature. Thus, it is physically impossible for me to jump thirty metres into the air (though this is not a logical impossibility).

3.6.6 Some also hold that there is a distinct notion of metaphysical necessity/possibility. Something is metaphysically necessary if it is determined by the laws of metaphysics. What are such laws like? According to Aristotle, at least, some of my properties are essential. That is, I could not lose them and continue to exist. Thus, I could lose the property of being 80kg and still exist, but I could not lose the property of being human and still exist. That is part of my essence. Hence, it is a metaphysical law that I am human. Note that given the laws of physics (and biology), it might well be physically impossible for me to grow another three metres taller, but this is not a metaphysical impossibility: height is not an essential property.

3.6.7 The modal logics of physical and metaphysical necessity are certainly at least as strong as $K\rho$: if A 's truth is determined by the laws of physics/metaphysics, then A is true. But it is not clear that they are stronger. For example, it is determined by the laws of physics that I do not accelerate through the speed of light. But why should this fact itself be determined by the laws of physics (as required by $K\tau$ and its extensions)? Similarly, I am not a frog, and so it is metaphysically possible that I am not a frog. But is *that* fact true because of the essence of something (as required by $K\sigma$ and its extensions)? The essence of possibility?

3.6.8 The fourth notion of necessity and its cognates is epistemic.³ Something is epistemically necessary if it is known to be true, and possible if it could be true for all we know. Thus, it is presently epistemically possible that the cosmos will start to contract in the future. But if there is not sufficient matter in the universe, this is, in fact, a physical impossibility.

3.6.9 If something is known to be true, it is certainly true. Hence, the principle $\Box A \supset A$ holds for epistemic necessity. The principles for $K\sigma$ and $K\tau$ are almost certainly false, however (though they are frequently assumed in the literature). For example, you can know something without believing that you know it. ('I didn't believe that I had really absorbed all that information, but when it came to the exam, I found that I had.') *A fortiori*, you can know

³ When applied in this way, ' \Box ' is usually written as ' K ', and the logic is called *epistemic logic*. Though it hardly corresponds to a standard notion of necessity, one may also interpret ' \Box ' as 'it is believed that'. When applied in this way, ' \Box ' is usually written as ' B ', and the logic is called *doxastic logic*.

something without knowing that you know it (assuming, as is standardly done, that knowledge entails belief).

3.6.10 For epistemic necessity, moreover, there is a real doubt about the adequacy of any extension of K . It is a feature of all normal logics that if $A \models B$ then $\Box A \models \Box B$. For if A is true at all worlds accessible from w , and A entails B , then B is true at all worlds accessible from w . But things that we know may well have all kinds of complex and recondite consequences of which we are unaware, and so do not know.

3.6.10a To understand the notion of alethic necessity, consider the fact that some predicates are vague, e.g., *is a (biological) child*, *is drunk*. (We will have a lot more to say about these in chapter 11.) Such predicates are definitely true of some things, definitely false of others, and for things in the borderline area, neither definitely true nor definitely false. Thus, a person of 4 is definitely a child; someone of 60 is definitely not; but for someone of 14, on the cusp of puberty, the matter may be indefinite. We can interpret \Box as 'It is definitely true that'.

3.6.10b It is natural to suppose that the appropriate modal logic for \Box in this sense is $S5$. Certainly, if something is definitely true, it is true ($K\rho$). If something is definitely true, say that a certain 4 year-old is a child, that judgment would itself seem to be definitely true ($K\tau$). And if something is definitely false, say that a certain 60 year-old is a child, then it is not definitely true; and that is definitely true ($\neg A \supset \Box \neg \Box A$, i.e., $\neg A \supset \Box \neg \Box \neg \neg A$, i.e., $\neg A \supset \Box \Diamond \neg A$) ($K\sigma$).

3.6.10c One might suspect the arguments for $K\tau$ and $K\sigma$, however. Suppose one thinks that in a borderline area something can be true or false, but not definitely so. Indeed, one might take this to be the criterion of being borderline. In this case, one can have $A \wedge \neg \Box A$. Suppose, also, that being definitely true is itself vague. Thus, it is not clear where, as someone grows up, it ceases to be definitely true that they are a child. Then we will have truths of the form $\Box A \wedge \neg \Box \Box A$. So the $K\tau$ principle will fail. Moreover, suppose that A is false. Then it follows that it is not definitely true, $\neg \Box A$. But there is no obvious reason why $\neg \Box A$ must itself be definitely true, as required by $K\sigma$.

3.6.11 Finally, moral necessity: something is morally necessary if it is required by the laws of morality (and again we might well disagree about

what is morally obligatory).⁴ Notoriously, $\Box A \supset A$ fails for this. Often, people do not bring about what they morally ought to. The principles of $K\sigma$ and $K\tau$ are also dubious. Suppose, for example, that you murder someone; then (arguably) you ought to be punished. But you ought not to have murdered them in the first place, so it ought not to be the case that you ought to be punished ($\Box A \supset \Box\Box A$ fails).

3.6.12 It is standardly assumed that the correct modal logic for moral necessity is $K\eta$, whose characteristic principle is that ‘ought implies may’ ($\Box A \supset \Diamond A$). One may doubt this too, though. It would appear that people sometimes face moral dilemmas, where they ought to bring it about that A , and they ought to bring about that $\neg A$ too. Maybe they give a solemn promise to each of two different parties. They are then obliged to bring about A , but they are also obliged to bring about $\neg A$. So $\Box A \supset \neg\Box\neg A$ fails.

3.6.13 Nearly all the claims of this section are disputable (and have been disputed). But these considerations will serve to illustrate some of the things at issue concerning disputes over the correct modal logic.

3.6a The Tense Logic K^t

3.6a.1 In the last two sections of this chapter, we will look at another interpretation of modal logics: tense logic.

3.6a.2 The semantics of a tense logic are exactly the same as those for a normal modal logic. Intuitively, though, one thinks of the worlds of an interpretation as times (or maybe states of affairs at times), and the relation $w_1 R w_2$ as ‘ w_1 is earlier than w_2 ’. Hence $\Box A$ means something like ‘at all later times, A ’, and $\Diamond A$ as ‘at some later time, A ’. For reasons that will become clear in a moment, we will now write \Box and \Diamond as $[F]$ and $\langle F \rangle$, respectively. (The F is for ‘future’.)

3.6a.3 What is novel about tense logic is that another pair of operators, $[P]$ and $\langle P \rangle$, is added to the language. (The P is for ‘past’).⁵ Their grammar is exactly the same as that for $[F]$ and $\langle F \rangle$. So we can write things such as $\langle P \rangle [F](p \wedge \neg [P]q)$.

⁴ When interpreted in this way, ‘ \Box ’ is usually written as ‘ O ’ (and ‘ \Diamond ’ as ‘ P ’), and the logic is called *deontic logic*

⁵ Traditionally, the operators $\langle F \rangle$, $[F]$, $\langle P \rangle$ and $[P]$, are written as F , G , P and H , respectively.

3.6a.4 The truth conditions for $\langle P \rangle$ and $[P]$ are exactly the same as those for $\langle F \rangle$ and $[F]$, except that the direction of R is reversed:

$$\begin{aligned} v_w(\langle P \rangle A) &= 1 \text{ iff for some } w' \text{ such that } w'Rw, v_{w'}(A) = 1 \\ v_w([P]A) &= 1 \text{ iff for all } w' \text{ such that } w'Rw, v_{w'}(A) = 1 \end{aligned}$$

3.6a.5 If, in an interpretation, R may be any relation, we have the tense-logic analogue of the modal logic, K , usually written as K^t .⁶

3.6a.6 Appropriate tableaux for K^t are easy. The rules for $\langle F \rangle$ and $[F]$ are exactly the same as those for \diamond and \square , and those for $\langle P \rangle$ and $[P]$ are the same with the order of r reversed appropriately. Thus, we have:

$$\begin{array}{cccc} [F]A, i & \langle F \rangle A, i & \neg[F]A, i & \neg \langle F \rangle A, i \\ irj & \downarrow & \downarrow & \downarrow \\ \downarrow & irj & \langle F \rangle \neg A, i & [F]\neg A, i \\ A, j & A, j & & \end{array}$$

$$\begin{array}{cccc} [P]A, i & \langle P \rangle A, i & \neg[P]A, i & \neg \langle P \rangle A, i \\ jri & \downarrow & \downarrow & \downarrow \\ \downarrow & jri & \langle P \rangle \neg A, i & [P]\neg A, i \\ A, j & A, j & & \end{array}$$

In the first rule of each four, this is for all j ; in the second, j is new.

3.6a.7 The main novelty in K^t is in the interaction between the future and past tense operators. Thus, for example, $A \vdash [P] \langle F \rangle A$:

$$\begin{array}{c} A, 0 \\ \neg[P] \langle F \rangle A, 0 \\ (P) \neg \langle F \rangle A, 0 \\ 1r0 \\ \neg \langle F \rangle A, 1 \\ [F]\neg A, 1 \\ \neg A, 0 \\ \times \end{array}$$

We have the last line, since $1r0$.

⁶ Generally speaking, modal logics with more than one pair of modal operators are called 'multimodal logics', and in an interpretation for such a logic there is an accessibility relation, R_X , for each pair of operators, $\langle X \rangle$ and $[X]$. In tense logic, however, it is unnecessary to give an independent specification of R_P , since this is just the converse of R_F . That is, $w_1 R_P w_2$ iff $w_2 R_F w_1$.

3.6a.8 Counter-models are read off from tableaux just as they are for K . For example, $\not\vdash p \supset ([F]p \vee [P]p)$. The tableau for this is:

$$\begin{array}{l}
 \neg(p \supset ([F]p \vee [P]p)), 0 \\
 \quad p, 0 \\
 \quad \neg([F]p \vee [P]p), 0 \\
 \quad \quad \neg[F]p, 0 \\
 \quad \quad \neg[P]p, 0 \\
 \quad \quad \langle F \rangle \neg p, 0 \\
 \quad \quad \langle P \rangle \neg p, 0 \\
 \quad \quad \text{Or1} \\
 \quad \quad \neg p, 1 \\
 \quad \quad 2r0 \\
 \quad \quad \neg p, 2
 \end{array}$$

This gives the counter-model which may be depicted as follows:

$$\begin{array}{ccccc}
 w_2 & \rightarrow & w_0 & \rightarrow & w_1 \\
 \neg p & & p & & \neg p
 \end{array}$$

3.6a.9 If A is any formula, call the formula obtained by writing all ‘ P ’s as ‘ F ’s, and vice versa, its *mirror image*. Thus, the mirror image of $[F]p \supset \neg \langle P \rangle q$ is $[P]p \supset \neg \langle F \rangle q$. Given any binary relation, R , let its converse, \check{R} , be the relation obtained by simply reversing the order of its arguments. Thus, $x\check{R}y$ iff yRx . It is clear that if we have any interpretation for K^t , the interpretation that is exactly the same, except that R is replaced by \check{R} , is just as good an interpretation. Moreover, in this interpretation, $\langle F \rangle$ and $[F]$ behave in exactly the same way as $\langle P \rangle$ and $[P]$ do in the original interpretation, and vice versa. Hence any inference is valid/invalid in K^t just if the inference obtained by replacing every formula by its mirror image is valid/invalid. So, for example, by 3.6a.7, $A \vdash [F] \langle P \rangle A$.

3.6b Extensions of K^t

3.6b.1 Extensions of K^t are obtained, as in the case of K , by adding conditions on the accessibility relation. In this way we obtain $K^t_\rho, K^t_{\rho\sigma}$, etc.

3.6b.2 Thought of in tense-logical terms, the conditions on R are constraints on the way in which the temporal relation ‘ x is before y ’ may

behave. Thus, the condition τ says that beforeness is transitive (if x is before y , and y is before z , then x is before z), which we normally suppose it to be. The condition η says that there is no last point in time, and its reversal, η' (for all x , there is a y such that yRx) says that there is no first point in time. These are, perhaps, more contentious, but still very natural. The conditions ρ and σ have, by contrast, little plausibility. The first says that every point in time is later than itself; the second says that if x is before y then y is before x .

3.6b.3 In the context of tense logic, some other constraints are very natural, however. Some notable ones are:

δ (delta), denseness: if xRy then for some z , xRz and zRy

φ (phi), forward convergence: if xRy and xRz then (yRz or $y = z$ or zRy)

β (beta), backward convergence: if yRx and zRx then (yRz or $y = z$ or zRy)

The first of these says that, for any two times, there is a time between them; the second says that time cannot branch forward, so that if y and z are both later than x , they cannot belong to distinct ‘futures’: if they are not the same, one must be before the other. Similarly, the third says that time cannot branch backwards. Note that φ and β are vacuously satisfied if y is z , or either is x . Hence, the conditions need apply only to distinct x , y and z .

3.6b.4 The tableau rules for ρ , τ , σ and η are as usual. That for η' is an obvious modification of that for η . The rule for δ is:

$$irj$$

$$\downarrow$$

$$irk$$

$$krj$$

where k is new to the branch. (If a branch fails to close, this rule makes it infinite, as does the rule for η .) In K_δ^t , we have $[F][F]A \vdash [F]A$ and its mirror image, $[P][P]A \vdash [P]A$ (neither of which is valid in K^t , as may easily be checked). Here, for example, is a tableau for the latter:

$$[P][P]A, 0$$

$$\neg[P]A, 0$$

$$\langle P \rangle \neg A, 0$$

$$\downarrow$$

$1r0$
 $\neg A, 1$
 $1r2, 2r0$
 $[P]A, 2$
 $A, 1$
 \times

The line $1r2, 2r0$ is generated by the rule for δ .

3.6b.5 To formulate tableau rules for φ and β , we have to complicate things a little. Lines concerning the accessibility relation are now allowed to be of the form $i = j$ as well as irj . There is a new rule (or to be precise, pair of rules) for $=$:

$\alpha(i)$	$\alpha(i)$
$i = j$	$j = i$
\downarrow	\downarrow
$\alpha(j)$	$\alpha(j)$

$\alpha(i)$ is a line of the tableau containing an ‘ i ’. $\alpha(j)$ is the same, with ‘ j ’ replacing ‘ i ’. Thus:

if $\alpha(i)$ is A, i , $\alpha(j)$ is A, j
 if $\alpha(i)$ is kri , $\alpha(j)$ is krj
 if $\alpha(i)$ is $i = k$, $\alpha(j)$ is $j = k$

In fact, in the first case, we never need to (or will) apply the rules to lines where A is anything other than a propositional parameter or the negation of one (though the rule works whatever A is). And obviously, we do not need to apply the rule if it would produce a line that is already there (counting $i = j$ as the same as $j = i$).

3.6b.6 The rules for φ and β are now, respectively:

irj		jri	
irk		kri	
\swarrow	\downarrow	\swarrow	\downarrow
jrk	$j = k$	jrk	$j = k$
krj		krj	

where i, j and k are distinct.

3.6b.7 In K_φ^t we have $\langle F \rangle p \wedge \langle F \rangle q \vdash \langle F \rangle (p \wedge q) \vee \langle F \rangle (p \wedge \langle F \rangle q) \vee \langle F \rangle (\langle F \rangle p \wedge q)$, which is not valid in K^t , as may easily be checked.⁷ (And the same for the mirror image of this in K_β^t .) Here is the tableau:

$$\begin{array}{c}
 \langle F \rangle p \wedge \langle F \rangle q, 0 \\
 \neg(\langle F \rangle (p \wedge q) \vee \langle F \rangle (p \wedge \langle F \rangle q) \vee \langle F \rangle (\langle F \rangle p \wedge q)), 0 \\
 \neg \langle F \rangle (p \wedge q), 0 \\
 \neg \langle F \rangle (p \wedge \langle F \rangle q), 0 \\
 \neg \langle F \rangle (\langle F \rangle p \wedge q), 0 \\
 [F] \neg(p \wedge q), 0 \\
 [F] \neg(p \wedge \langle F \rangle q), 0 \\
 [F] \neg(\langle F \rangle p \wedge q), 0 \\
 \langle F \rangle p, 0 \\
 \langle F \rangle q, 0 \\
 0r1 \\
 p, 1 \\
 0r2 \\
 q, 2 \\
 \swarrow \qquad \downarrow \qquad \searrow \\
 1r2 \qquad 1 = 2 \qquad 2r1 \\
 \neg(p \wedge \langle F \rangle q), 1 \quad \neg(p \wedge q), 1 \quad \neg(\langle F \rangle p \wedge q), 2 \\
 \swarrow \qquad \searrow \qquad \swarrow \qquad \searrow \qquad \swarrow \qquad \searrow \\
 \neg p, 1 \quad \neg \langle F \rangle q, 1 \quad \neg p, 1 \quad \neg q, 1 \quad \neg \langle F \rangle p, 2 \quad \neg q, 2 \\
 \times \quad [F] \neg q, 1 \quad \times \quad \neg q, 2 \quad [F] \neg p, 2 \quad \times \\
 \qquad \qquad \neg q, 2 \qquad \qquad \times \qquad \qquad \neg p, 1 \\
 \qquad \qquad \times \qquad \qquad \qquad \qquad \times
 \end{array}$$

The last formula on the right fork of the middle branch is obtained by the = rule.

3.6b.8 Reading off a counter-model from a tableau is the same as for K^t , except that whenever there is a bunch of lines of the form $i = j, j = k, \dots$, we choose only one of the numbers, say i , and ignore the others. (It does

⁷ Note that the conclusion is of the form $A \vee B \vee C$. Strictly speaking, this should be either $(A \vee B) \vee C$, or $A \vee (B \vee C)$. But the bracketing makes no difference. The two formulas have the same truth value (at every world), and in a tableau, both give the same three branches, one for each disjunct. Similarly, given $\neg(A \vee B \vee C)$ on a tableau, the effect is to give three lines, one for the negation of each disjunct.

not matter which we choose, because of the = rule.) For example, in K_φ^t , we have $\langle F \rangle p \not\models [F](p \wedge q)$. Here is the tableau:

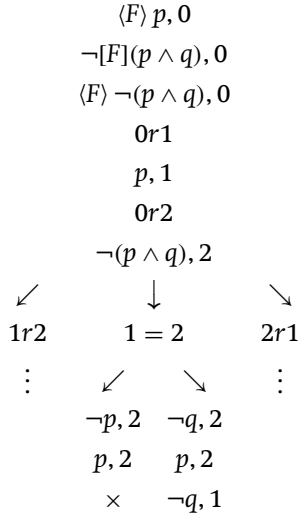

The last two lines on the open branch shown are obtained by applying the = rule. All other applications of the rule produce lines that are already present. In reading off the counter-model from the completed open branch, since $1 = 2$ occurs on the line, we can simply ignore all lines marked 2 to obtain:

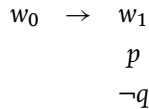

It is easy to check that the counter-model works.

3.6b.9 The tableaux for K^t and its various extensions are sound and complete with respect to their semantics. This is shown in 3.7.

3.6b.10 Some of the interesting philosophical issues related to tense logics concern the structure of time itself. For example, it is natural to suppose that the future is open in a way that the past is not. Let p describe some future event that it is within my power to make true, and within my power to make false. (So p might be ‘I will father a third child’ — well, with a little help from at least one other person!) Then there would seem to be different futures, in one of which p is true, and in the other of which it is not. The same is not the case for a q about the past (e.g., ‘I fathered at least two children’). I am not now able to render this either true or false at will. (It is

just true, and nothing I do can change this.) Thus, one might suppose, time satisfies the condition β of backward convergence, but not the condition φ of forward convergence.

3.6b.11 This is less than clear, though. Granted, there are two *possible* futures concerning p ; it does not follow that there are two *actual* futures. Certainly, $\diamond \langle F \rangle p \wedge \diamond \langle F \rangle \neg p$; but it is not clear that $\langle F \rangle p \wedge \langle F \rangle \neg p$. The first of these is quite compatible with future convergence. To establish this, however, requires a semantics for a language with both tense and modal operators. I leave details of this as a non-trivial exercise.

3.7 *Proofs of Theorems

3.7.1 THEOREM: The tableaux for $K\rho$, $K\sigma$, $K\tau$ and $K\eta$ are sound with respect to their semantics.

Proof:

The proof is as for K (2.9.2–2.9.4). All we need to do is check that the Soundness Lemma still works given the new rules. So suppose that f shows \mathcal{I} to be faithful to b and that we then apply one of the rules. For ρ : we get iri , but $f(i)Rf(i)$ since R is reflexive. For σ : since irj is on b , $f(i)Rf(j)$, but then $f(j)Rf(i)$ since R is symmetric, as required. For τ : since irj and jrk are on b , $f(i)Rf(j)$ and $f(j)Rf(k)$. Hence $f(i)Rf(k)$ since R is transitive, as required. For η : i occurs on b , and we apply the rule to get irj , where j is new. We know that for some $w \in W$, $f(i)Rw$. Let f' be the same as f except that $f'(j) = w$. Since j does not occur on b , f' shows that \mathcal{I} is faithful to b . Moreover, $f'(i)Rf'(j)$ by construction. Hence, f' shows that \mathcal{I} is faithful to the extended branch. ■

3.7.2 THEOREM: The tableaux for systems with any combination of ρ , σ , τ and η are sound with respect to their semantics.

Proof:

We just combine each of the individual arguments. ■

3.7.3 THEOREM: The tableaux for $K\rho$, $K\sigma$, $K\tau$ and $K\eta$ are complete with respect to their semantics.

Proof:

The proof is as for K (2.9.6–2.9.7). All we have to do, in addition, is check that the interpretation induced by the open branch, b , is of the required kind.

For ρ : for every $w_i \in W$, iri occurs on b (by the ρ -rule), hence, by definition of R , w_iRw_i . For σ : for $w_i, w_j \in W$, suppose that w_iRw_j . Then irj occurs on b ; but then jri occurs on b (by the σ -rule). Hence, w_jRw_i , as required. For τ : for $w_i, w_j, w_k \in W$, suppose that w_iRw_j and w_jRw_k . Then irj and jrk occur on b ; but then irk occurs on b (by the τ -rule). Hence, w_iRw_k , as required. For η : if $w_i \in W$ then for some j , irj is on b . Hence, for some j , w_iRw_j , as required. ■

3.7.4 THEOREM: The tableaux for systems with any combination of ρ , σ , τ and η are complete with respect to their semantics.

Proof:

We just combine each of the individual arguments. ■

3.7.5 THEOREM: $\Sigma \models_{K\rho\sigma\tau} A$ iff $\Sigma \models_{K\nu} A$.

Proof:

The proof from left to right is as in 3.5.4. From right to left, suppose that $\Sigma \not\models_{K\rho\sigma\tau} A$. Let $\mathcal{I} = \langle W, R, \nu \rangle$ be a $\rho\sigma\tau$ -interpretation, such that for some $w \in W$, all members of Σ are true at w , but A is not. R is an equivalence relation. Let W' be the equivalence class of w , $[w]$. Let $\mathcal{I}' = \langle W', R', \nu' \rangle$, where R' and ν' are the restrictions of R and ν to W' , respectively. Then \mathcal{I}' is a ν -interpretation. If, for any A and $w \in W'$, the truth value of A at w is the same in \mathcal{I} and \mathcal{I}' , the result follows. That this is so follows by a simple induction. The cases for propositional parameters and the extensional connectives are trivial. The case for \Box is as follows. That for \Diamond is similar:

$$\begin{aligned}
 \nu'_w(\Box A) = 1 & \text{ iff } \text{for all } x \in W' \text{ such that } wR'x, \nu'_x(A) = 1 \\
 & \text{ iff } \text{for all } x \in W' \text{ such that } wR'x, \nu_x(A) = 1 \quad \text{IH}^8 \\
 & \text{ iff } \text{for all } x \in W \text{ such that } wRx, \nu_x(A) = 1 \quad (*) \\
 & \text{ iff } \nu_w(\Box A) = 1
 \end{aligned}$$

The line (*) holds since wRx iff $x \in W'$ iff $wR'x$. ■

3.7.6 THEOREM: The tableaux for K^t are sound and complete with respect to its semantics.

Proof:

The proof of the soundness and completeness theorems are essentially the same as those for K . (2.9.3–2.9.4, 2.9.5–2.9.7). In the Soundness and

⁸ Induction Hypothesis

Completeness Lemmas, there are new cases to check for $[P]$ and $\langle P \rangle$. These are exactly the same as those for $[F]$ and $\langle F \rangle$ (i.e., \square and \diamond), with trivial modifications. ■

3.7.7 THEOREM: The tableaux for the extensions of K^t discussed are sound with respect to their semantics.

Proof:

If the rules for β or φ are employed, an extra clause has to be added to the definition of faithfulness:

If $i = j$ is on b then $f(i)$ is $f(j)$.

The proof is now the same as that for K^t . We merely have to check the extra cases for the new rules. The cases for ρ , σ , τ , η are as in the modal case (3.7.1). The case of η' is a trivial modification of that for η . The cases for the other rules are as follows.

- δ : Suppose that irj is on b , and that we apply the rule to get irk and krj , where k is new to the branch. Since \mathcal{I} is faithful to the branch, $f(i)Rf(j)$. By the denseness constraint, for some w , $f(i)Rw$ and $wRf(j)$. Let f' be the same as f , except that $f'(k) = w$. Since k does not occur on the branch, f' shows \mathcal{I} to be faithful to b .
- φ : Suppose that irj and irk are on b . Then $f(i)Rf(j)$ and $f(i)Rf(k)$. By the forward convergence constraint, $f(j)Rf(k)$ or $f(k)Rf(j)$ or $f(j) = f(k)$. So f shows at least one of the branches obtained by applying the rule to be faithful to b .
- β : the argument is the same.
- $=$: Suppose that $\alpha(i)$ and $i = j$ are on b , and that we apply the rule to get $\alpha(j)$. Since f shows \mathcal{I} to be faithful to b , $f(i) = f(j)$. If $\alpha(i)$ is A, i , then A is true at $f(i)$. Hence A is true at $f(j)$, as required. The other two possibilities for $\alpha(i)$ are similar. ■

3.7.8 THEOREM: The tableaux for the extensions of K^t discussed are complete with respect to their semantics.

Proof:

The proof is similar to that for K^t , though the induced interpretation is defined differently. Given a completed open branch of a tableau, b , let I be

the set of world numbers that occur on b . Define a relation on I as follows, $i \sim j$ iff:

$i = j$, or ' $i = j$ ' occurs on b , or ' $j = i$ ' occurs on b

\sim is obviously reflexive and symmetric. By the $=$ rule, it is also transitive. Hence, it is an equivalence relation. Let $[i]$ be the equivalence class of i . The induced interpretation is $\langle W, R, \nu \rangle$, where, $W = \{w_{[i]} : i \in I\}$; $w_{[i]}Rw_{[j]}$ iff irj is on b ; $\nu_{w_{[i]}}(p) = 1$ if p, i is on b , and $\nu_{w_{[i]}}(p) = 0$ if $\neg p, i$ is on b . Note that R and ν are well defined. For if $[i] = [i']$ and $[j] = [j']$: irj is on b iff $i'rj'$ is on b ; p, i is on b iff p, i' is on b ; and $\neg p, i$ is on b iff $\neg p, i'$ is on b ; all because of the $=$ rule.

The appropriate version of the Completeness Lemma now states:

if A, i is on b then A is true at $w_{[i]}$

if $\neg A, i$ is on b then A is false at $w_{[i]}$

In the proof of this, the basis case, and the cases for the extensional connectives are essentially as for K^t , with trivial modifications. The cases for $[F]$ are as follows. Those for $\langle F \rangle$, $[P]$ and $\langle P \rangle$ are left as exercises.

Suppose that $[F]B, i$ is on b . Then for all $j \in I$, such that irj is on b , B, j is on b . Hence, by construction and induction hypothesis, for all $w_{[j]}$ such that $w_{[i]}Rw_{[j]}$, B is true at $w_{[j]}$, as required. Suppose that $\neg[F]B, i$ is on b . Then $\langle F \rangle \neg B, i$ is on b , as, therefore, are irj and $\neg B, j$, for some j . By construction and induction hypothesis, $w_{[i]}Rw_{[j]}$ and B is false at $w_{[j]}$. Hence, $[F]B$ is false at $w_{[i]}$, as required.

It remains to be checked that the induced interpretation is of the appropriate kind if the corresponding tableau rule is used. The cases for ρ , τ , σ , η , η' and β are left as exercises. Here are the other two cases:

- δ : Suppose that $w_{[i]}Rw_{[j]}$. Then irj is on b . So by the δ -rule, there is some k such that irk and krj are on b . Hence for some k , $w_{[i]}Rw_{[k]}$ and $w_{[k]}Rw_{[j]}$, as required.
- φ : Suppose that $w_{[i]}Rw_{[j]}$ and $w_{[i]}Rw_{[k]}$ (where $[i]$, $[j]$ and $[k]$ are distinct). Then irj and irk are on b . Because the φ -rule has been applied, either jrj , krj , or $j = k$ is on b ; so either $w_{[j]}Rw_{[k]}$ or $w_{[k]}Rw_{[j]}$ or $j \sim k$. In the last case, $[j] = [k]$, so $w_{[j]} = w_{[k]}$. In all three cases, we therefore have what we need.

Note, finally, that if the rules for φ and β are not in operation in a tableau, then the relation \sim simply reduces to identity. So $[i] = \{i\}$. In this case, we may take W to be $\{w_i : i \in I\}$, and dispense with the equivalence classes entirely. ■

3.8 History

C. I. Lewis proposed five systems of modal logic, which he labelled $S1$ – $S5$ (see Lewis and Langford, 1931). We look at $S1$ – $S3$ in the next chapter. The system T was proposed by Feys. For its history, see Hughes and Cresswell (1996, p.50, n.7). The name B stands for ‘Brouwer’, the founder of intuitionism, because of a (somewhat tenuous) connection between the characteristic principle of B , $A \supset \Box \Diamond A$, and intuitionist logic (for details, see Hughes and Cresswell, 1996, p.70, n.5). D stands for ‘deontic’, a name given to the system by Lemmon and Scott (see Hughes and Cresswell, 1996, p.50, n.8).

The possibility of interpreting a modal logic as an epistemic logic or a deontic logic, was suggested by Von Wright (1951, 1957). The person who realised the similarity between tense and modality, and invented tense logic, was Prior (1957).

3.9 Further Reading

Hughes and Cresswell (1996, chs. 2–4) survey a number of systems of modal logic, including those discussed in this chapter. Girle (2000, chs. 2–3) contains tableau systems for the modal logics of this chapter.

For expositions of epistemic logic, see Hintikka (1962) and Meyer (2001); and on deontic logic, see Hilpinen (1981, 2001). For tense logic, see Burgess (1986) and Venema (2001). On the combination of tense and modal operators, see Thomason (1986).

Various notions of necessity are discussed in Lemmon (1959). The most famous defence of the notion of metaphysical necessity in contemporary philosophy is Kripke (1980). On the possibility of moral dilemmas, see Gowans (1987). For one approach to the modal logic of definite truth, see Williamson (1994).

3.10 Problems

1. This exercise concerns combinations of relations.
 - (a) For each of ρ , σ , τ and η , produce a relation which satisfies one of these but none of the others (except that ρ implies η , so this case is impossible).
 - (b) There are six pairs of these conditions: $\rho\sigma$, $\rho\tau$, $(\rho\eta)$, $\sigma\tau$, $\sigma\eta$ and $\tau\eta$. Since ρ entails η , the third of these is simply ρ . For each of the five

genuine compound pairs, produce a relation that satisfies this condition, but none of the others (except that any relation that is ρ must also be η).

- (c) Check the following. There are four triples of these conditions: $\rho\sigma\tau$, $(\rho\sigma\eta)$, $(\rho\tau\eta)$, $(\sigma\tau\eta)$. Because ρ entails η , the middle two are simply $\rho\sigma$ and $\rho\tau$. Moreover, for the same reason, and because $\sigma\tau\eta$ entails ρ (as we noted in 3.2.6), the first and last are identical. (And for good measure, $\rho\sigma\tau\eta$ is simply $\rho\sigma\tau$ as well.) Hence, there is only one genuine triple.
2. Which of the inferences of 2.12, problems 2(l)–(v) hold in $K\rho$, $K\sigma$, $K\tau$ and $K\eta$? Check with appropriate tableaux. If a tableau does not close, define and draw a counter-model.
3. Show the following in $K\rho$:
- $\vdash (\Box(A \supset B) \wedge \Box(B \supset C)) \supset (A \supset C)$
 - $\vdash (\Box(A \supset B) \wedge \Diamond(A \wedge C)) \supset \Diamond(B \wedge C)$
 - $\vdash (\Box A \wedge \Box B) \supset (A \equiv B)$
 - $\vdash \Diamond(A \supset B) \equiv (\Box A \supset \Diamond B)$
 - $\vdash (\Diamond\neg A \vee \Diamond\neg B) \vee \Diamond(A \vee B)$
 - $\vdash \Diamond(A \supset (B \wedge C)) \supset ((\Box A \supset \Diamond B) \wedge (\Box A \supset \Diamond C))$
4. Show the following in $K\rho\tau$:
- $\vdash (\Box A \vee \Box B) \equiv \Box(\Box A \vee \Box B)$
 - $\vdash \Box(\Box(A \equiv B) \supset C) \supset (\Box(A \equiv B) \supset \Box C)$
5. Show the following in $K\nu$:
- $\vdash \Diamond A \supset \Diamond\Diamond A$
 - $\vdash \Diamond A \supset \Box\Diamond A$
 - $\vdash \Box(\Box A \supset \Box B) \vee \Box(\Box B \supset \Box A)$
 - $\vdash \Box(\Diamond A \supset B) \equiv \Box(A \supset \Box B)$
6. Which of the following hold in $K\rho\tau$?
- $\vdash \Diamond\Box p \supset \Box\Diamond p$
 - $\vdash \Box(\Box p \supset q) \vee \Box(\Box q \supset p)$
 - $\vdash \Box(p \equiv q) \supset \Box(\Box p \equiv \Box q)$
 - $\vdash \Diamond\Box p \equiv \Box\Diamond p$
7. The following exercises concern the relationships between various normal modal logics.
- If R is reflexive (ρ), it is extendable (η). Hence, if truth is preserved at all worlds of all η -interpretations, it is preserved at all worlds of all ρ -interpretations. Consequently, the system $K\rho$ is an extension of

the system $K\eta$. Find an inference demonstrating that it is a proper extension.

- (b) Show that none of the systems $K\rho$, $K\sigma$ and $K\tau$ is an extension of any of the others (i.e., for each pair, find an inference that is valid in one but not the other, and then vice versa). (Hint: see 3.4.10.)
- (c) By combining the individual conditions, we obtain the systems $K\rho\sigma$, $K\rho\tau$, $K\sigma\tau$, $K\sigma\eta$ and $K\tau\eta$ (see problem 1(b)). $K\rho\sigma$ is an extension of $K\rho$ and $K\sigma$. Show that it is a proper extension of each of these. Do the same for the other four binary systems. Show that $K\rho\sigma$ is a proper extension of $K\eta\sigma$, and that $K\rho\tau$ is a proper extension of $K\eta\tau$. Show that none of the other binary systems is an extension of any other.
- (d) Combining three (or four) of the conditions, we obtain only the system $K\rho\sigma\tau$ (see problem 1(c)). Show that this is a proper extension of each of the binary systems of the last question.
8. Object to some of the arguments of 3.6.
9. Check the details omitted in 3.6b.4, 3.6b.7.
10. By constructing suitable tableaux, determine whether the following are valid in K^t . Where the inference is invalid, specify a counter-model.
- (a) $\vdash [F](p \supset q) \supset ([F]p \supset [F]q)$
- (b) $\vdash \langle F \rangle p \equiv \neg[F]\neg p$
- (c) $\vdash p \supset [F]\langle P \rangle p$
- (d) $[F]p \supset [F][F]p \vdash [P]p \supset [P][P]p$
- (e) $\vdash [F](p \supset q) \supset (\langle F \rangle p \supset \langle F \rangle q)$
- (f) $\langle F \rangle \langle F \rangle p \supset \langle F \rangle p \vdash \langle P \rangle \langle P \rangle p \supset \langle P \rangle p$
- (g) $\vdash ([P]p \vee [P]q) \supset [P](p \vee q)$
- (h) $\vdash \langle P \rangle (p \wedge q) \supset (\langle P \rangle p \wedge \langle P \rangle q)$
- (i) $\vdash (\langle F \rangle p \wedge \langle F \rangle q) \supset (((\langle F \rangle (p \wedge \langle F \rangle q)) \vee \langle F \rangle (p \wedge q)) \vee (\langle F \rangle (\langle F \rangle p \wedge q)))$
- (j) $\vdash (\langle P \rangle p \wedge \langle P \rangle q) \supset (((\langle P \rangle (p \wedge \langle P \rangle q)) \vee \langle P \rangle (p \wedge q)) \vee (\langle P \rangle (\langle P \rangle p \wedge q)))$
- (k) $\vdash [P](p \wedge q) \equiv ([P]p \wedge [P]q)$
- (l) $\vdash [P]p \supset \langle P \rangle p$
- (m) $\vdash (p \wedge [P]p) \supset \langle F \rangle [P]p$
- (n) $\vdash \langle P \rangle [F]p \supset p$
- (o) $\vdash [P]([P]p \supset p) \supset [P]p$
- (p) $\vdash \langle P \rangle [P]p \supset [P]\langle P \rangle p$
- (q) $\vdash \langle F \rangle [F]p \supset p$
- (r) $\vdash (\langle F \rangle p \wedge \langle F \rangle [F]\neg p) \supset \langle F \rangle ([P]\langle F \rangle p \wedge [F]\neg p)$

11. In the previous question, if the inference is invalid, repeat the question in K_t^t , K_s^t and K_ϕ^t .
12. Consider a tense logic in which the relation R is constrained by the following condition. There is an x such that: (i) for no y , xRy ; and (ii) for all y distinct from x , yRx . Show that $[F](A \wedge \neg A) \vee \langle F \rangle [F](A \wedge \neg A)$ is a logical truth.
13. If an inference is valid in K_t^t , does it follow that its mirror image is? What about K_s^t and K_ϕ^t ?
14. Are there different futures? Could there be different pasts?
15. *Fill in the details omitted in 3.7.
16. *Work out the details of the semantics and tableaux for a language with both modal and tense operators.
17. *Show that the tableaux for K_v , as described in 3.5.3, are sound and complete with respect to the semantics, as described in 3.5.2.
18. *Let α (anti-reflexivity) be the condition: for all w , it is not the case that wRw . Show that the logic K_α is the same as the logic K . (Hint: think about the interpretations produced by K -tableaux.)
19. *A relation, R , is *Euclidean* iff, if wRu and wRv then uRv (and also, of course, vRu). An ε -interpretation is one in which R is Euclidean. What tableau rules are sound and complete for K_ε ? Show that K_ε is distinct from K , K_ρ , K_σ , K_τ and K_η . (Hint: consider the formula $\diamond A \supset \square \diamond A$.)
20. *Show that if a relation is reflexive and Euclidean then it is (a) symmetric and (b) transitive. Infer that $K_{\rho\varepsilon}$, $K_{\rho\sigma\varepsilon}$, $K_{\rho\varepsilon\tau}$ and $K_{\varepsilon\rho\sigma\tau}$ are all the same. Infer also that $K_{\rho\tau}$ is a subsystem of $K_{\rho\varepsilon}$. Show that the converse is false.

4 Non-normal Modal Logics; Strict Conditionals

4.1 Introduction

4.1.1 In this chapter we look at some systems of modal logic weaker than K (and so non-normal). These involve so-called non-normal worlds. Non-normal worlds are worlds where the truth conditions of modal operators are different.

4.1.2 We are then in a position to return to the issue of the conditional, and have a look at an account of a modal conditional called the *strict* conditional.

4.2 Non-normal Worlds

4.2.1 Let us start by looking at the technicalities concerning non-normality. In due course we will be able to discuss what they mean.

4.2.2 A non-normal interpretation of a modal propositional language is a structure, $\langle W, N, R, \nu \rangle$, where W , R and ν are as in previous chapters, and $N \subseteq W$. Worlds in N are called *normal*. Worlds in $W - N$ (the worlds that are not normal) are called *non-normal*.

4.2.3 The truth conditions for the truth functions, \wedge , \vee , \neg , etc. are the same as before (2.3.4). The truth conditions for \Box and \Diamond at normal worlds are also as before (2.3.5). But if w is non-normal:

$$\nu_w(\Box A) = 0$$

$$\nu_w(\Diamond A) = 1$$

In a sense, at non-normal worlds, everything is possible, and nothing is necessary.

4.2.4 Note that at every world, w , $\neg\Box A$ and $\Diamond\neg A$ still have the same truth value, as do $\neg\Diamond A$ and $\Box\neg A$. We saw this to be the case for normal worlds in 2.3.9 and 2.3.10. It is easy to see that this is also true if w is non-normal.

4.2.5 Logical validity is defined in terms of truth preservation at *normal* worlds, thus:

$\Sigma \models A$ iff for all interpretations $\langle W, N, R, \nu \rangle$ and all $w \in N$: if $\nu_w(B) = 1$ for all $B \in \Sigma$ then $\nu_w(A) = 1$.

$\models A$ iff $\phi \models A$, i.e., iff for all $\langle W, N, R, \nu \rangle$ and all $w \in N$, $\nu_w(A) = 1$.

4.2.6 If the accessibility relation, R , may be any binary relation on W , the logic this construction gives will be called N .¹ As with normal modal logics, additional logics can be formed by placing constraints on R , such as reflexivity, transitivity, symmetry, etc. (as in 3.2). In fact, of course, how R behaves at non-normal worlds is irrelevant, since this plays no role in determining truth values. We use $N\rho$ to refer to the non-normal logic determined by the class of all interpretations where R is reflexive; $N\sigma\tau$, to refer to the non-normal logic determined by the class of all interpretations where R is symmetric and transitive, and so on. As for normal logics, $N\rho\tau$ is an extension of $N\rho$, which is an extension of N , etc.

4.2.7 Historically, $N\rho$ and $N\rho\tau$ are the Lewis systems $S2$ and $S3$ respectively. $N\rho\sigma\tau$ is the non-Lewis system $S3.5$.

4.2.8 Non-normal worlds were originally invented purely as a technical device to give a possible-world semantics for the Lewis systems weaker than $S4$. As we shall see in due course, though, they have a perfectly good philosophical meaning. For the record, Lewis thought that the correct system of modal logic for logical necessity was $S2$.

4.3 Tableaux for Non-normal Modal Logics

4.3.1 A tableau technique for N is obtained by modifying the technique for K as follows. If world i occurs on a branch of a tableau, call it \Box -inhabited if there is some node of the form $\Box B, i$ on the branch. The rule for $\Diamond A, i$ (2.4.4)

¹ The name is not standard, but is sensible enough. Note that N is also used for the normal worlds in an interpretation. Context, however, will disambiguate.

is activated only when $i = 0$ or i is \Box -inhabited. Otherwise, details are the same as for K .

4.3.2 The rationale for the new \Diamond -rule is, roughly, as follows. If $i = 0$, i must be a normal world (since the tableau is a search for a normal world where the premises are true and the conclusion is false), and so the \Diamond -rule is applied in the usual way. If $i > 0$, it can be assumed to be non-normal as long as the branch of the tableau is not \Box -inhabited. Nothing, then, needs to be done. But as soon as i is \Box -inhabited, it can no longer be non-normal (since nothing of the form $\Box A$ is true at a non-normal world), and so the standard rule for \Diamond must be applied. The next two subsections give example tableaux for N .

4.3.3 $\vdash_N \Box(A \supset B) \supset (\Box A \supset \Box B)$:

$$\begin{array}{c}
 \neg(\Box(A \supset B) \supset (\Box A \supset \Box B)), 0 \\
 \Box(A \supset B), 0 \\
 \neg(\Box A \supset \Box B), 0 \\
 \Box A, 0 \\
 \neg\Box B, 0 \\
 \Diamond\neg B, 0 \\
 Or1 \\
 \neg B, 1 \\
 A \supset B, 1 \\
 A, 1 \\
 \swarrow \quad \searrow \\
 \neg A, 1 \quad B, 1 \\
 \times \quad \times
 \end{array}$$

The \Diamond -rule is applied to $\Diamond\neg B, 0$, because we are dealing with world 0.

4.3.4 $\not\vdash_N \Box(p \supset \Box(q \supset q))$:

$$\begin{array}{c}
 \neg\Box(p \supset \Box(q \supset q)), 0 \\
 \Diamond\neg(p \supset \Box(q \supset q)), 0 \\
 Or1 \\
 \neg(p \supset \Box(q \supset q)), 1 \\
 p, 1 \\
 \neg\Box(q \supset q), 1 \\
 \Diamond\neg(q \supset q), 1
 \end{array}$$

On the (only) branch of the tableau, world 1 is not \Box -inhabited. Consequently, the \Diamond -rule is not applied to the last line, and the tableau ends open.

4.3.5 Bearing in mind the comments of 4.3.2, it is easy to see how a counter-model for an inference can be read off from an open tableau branch. The method is exactly the same as for K , except that world 0 is always normal, and all other worlds are non-normal, unless they are \Box -inhabited.

4.3.6 Thus, in the counter-model determined by the tableau of 4.3.4, $W = \{w_0, w_1\}$; $N = \{w_0\}$; w_0Rw_1 ; and v is such that $v_{w_1}(p) = 1$. If we indicate that a world is non-normal by putting it in a box, the interpretation can be depicted thus:

$$w_0 \rightarrow \begin{array}{c} p \\ \boxed{w_1} \end{array}$$

4.3.7 Tableaux for $N\rho$, $N\rho\tau$, etc. are obtained by adding the extra tableau rules for ρ , $\rho\tau$, etc., as for K (3.3).

4.3.8 The tableaux for N and its extensions are sound and complete with respect to their respective semantics. The proof can be found in 4.10.

4.4 The Properties of Non-normal Logics

4.4.1 A K -interpretation is simply a special case of an N -interpretation, namely, one where $W = N$. Hence, if truth is preserved at all worlds of all N -interpretations, it is preserved at all worlds of all K -interpretations. Hence, the logic K is an extension of N . (Another way of seeing this is to note that any tableau that closes under the rules for N must also close under the rules for K .)

4.4.2 The same is true for the corresponding extensions of K and N : $K\rho$ and $N\rho$, $K\rho\tau$ and $N\rho\tau$, etc.

4.4.3 But each K -logic is a proper extension of the corresponding N -logic. It is easy enough to check that $\vdash_K \Box(p \supset \Box(q \supset q))$ (and *a fortiori* any of K 's extensions), but as the tableau of 4.3.4 shows, it is not valid in N . Moreover, adding any of the rules for r to this tableau does not close it, either. None of the rules makes world 1 \Box -inhabited; hence, it remains open. Hence, this inference is not valid in any of the non-normal extensions of N either.

4.4.4 Note that $K\rho\sigma\tau(Kv)$ is the strongest of all the logics we have looked at: every normal system that we looked at is contained in $K\rho\sigma\tau$ (3.2.9), and every non-normal system that we looked at is contained in the corresponding normal system (4.4.1, 4.4.2). N is the weakest system we have met. It is contained in every non-normal system, and also in K , and so in every normal system.

4.4.5 It might be wondered what happens if we define a logic with non-normal semantics, and validity defined in terms of truth preservation at all worlds (normal *and* non-normal). This gives a sub-logic of the corresponding non-normal logic. (If truth is preserved at *all* worlds of an interpretation, it is preserved at all normal worlds.) In fact, it is a proper sub-logic. In any non-normal modal logic, for example, $\models \Box(A \vee \neg A)$. But since $\Box(A \vee \neg A)$ is not true at non-normal worlds, $\Box(A \vee \neg A)$ is not valid if logical truth is defined with reference to all worlds. Hence, this definition can be used to create logics weaker than N .²

4.4.6 Let us finally, now, return to the question of the meaning of non-normal worlds. For any normal system, \mathcal{L} , if $\models_{\mathcal{L}} A$ then $\models_{\mathcal{L}} \Box A$. (This is sometimes called the *Rule of Necessitation*.) For if $\models_{\mathcal{L}} A$ then A is true at all worlds of all \mathcal{L} -interpretations. Hence, if w is any such world, A is true at all worlds accessible from w . Hence, $\Box A$ is true at w . Thus, $\models_{\mathcal{L}} \Box A$.

4.4.7 The Rule of Necessitation fails in every non-normal logic, \mathcal{L} , however. Consider, for example, $A \vee \neg A$. This holds at all worlds, normal or non-normal. Hence, $\Box(A \vee \neg A)$ holds at all normal worlds, i.e., $\models_{\mathcal{L}} \Box(A \vee \neg A)$. But at any non-normal world, $\Box(A \vee \neg A)$ is false. Now consider an interpretation where there is a normal world that accesses such a world. Then $\Box\Box(A \vee \neg A)$ is false at that world. So, $\not\models_{\mathcal{L}} \Box\Box(A \vee \neg A)$.³

4.4.8 The failure of the Rule of Necessitation is, perhaps, the most distinctive feature of non-normal systems. And it fails, as we have just seen, because

² The logics which are the same as $S2$ and $S3$, except that validity is defined in terms of truth preservation at all worlds, are sometimes called $E2$ and $E3$.

³ Similarly, the principle that if $A \models B$ then $\Box A \models \Box B$, which holds in all normal logics, as we saw in 3.6.10, also fails in non-normal logics. If $\Box A$ is true at a normal world of an interpretation, it follows that A is true at all worlds in it; but it does not follow from this and $A \models B$ that B is true at all the worlds in it - only that it is true at all *normal* worlds in it.

logical truths may fail to hold at non-normal worlds. Non-normal worlds are, thus, worlds where ‘logic is not guaranteed to hold’. We come back to this insight in a later chapter.

4.4a S0.5

4.4a.1 Before we leave the topic of non-normal modal logics, there is one further (very small) family of such logics that is worth noting. I will call the basic system of this family L (after Lemmon). Let us call sentences of the form $\Box A$ and $\Diamond A$ *modal formulas*. In interpretations for L , modal formulas are assigned *arbitrary* truth values at non-normal worlds.

4.4a.2 Thus, interpretations for L are exactly the same as those for N , with one modification. In any interpretation for L , the evaluation function, ν , assigns each propositional parameter, p , a truth value at every world, as usual. But ν also assigns each modal formula a truth value at every *non-normal* world, as well.

4.4a.3 Tableaux for L are the same as those for N , except that there are no rules applying to modal formulas or their negations at worlds other than 0. That is, the rules of 2.4.4 apply at world 0 and world 0 only.

4.4a.4 Here are tableaux to show that $\vdash_L \Box(\Box A \vee \neg\Box A)$ and $\not\vdash_L \Box(\Box(p \supset p) \vee \Diamond(q \wedge \neg q))$:

$$\begin{array}{l}
 \neg\Box(\Box A \vee \neg\Box A), 0 \\
 \Diamond\neg(\Box A \vee \neg\Box A), 0 \\
 \text{Or1} \\
 \neg(\Box A \vee \neg\Box A), 1 \\
 \neg\Box A, 1 \\
 \neg\neg\Box A, 1 \\
 \times \\
 \\
 \neg\Box(\Box(p \supset p) \vee \Diamond(q \wedge \neg q)), 0 \\
 \Diamond\neg(\Box(p \supset p) \vee \Diamond(q \wedge \neg q)), 0 \\
 \text{Or1} \\
 \neg(\Box(p \supset p) \vee \Diamond(q \wedge \neg q)), 1 \\
 \neg\Box(p \supset p), 1 \\
 \neg\Diamond(q \wedge \neg q), 1
 \end{array}$$

The second tableau is now finished, since no modal rules are applicable at world 1.

4.4a.5 To read off a counter-model from an open branch of a tableau, the worlds and accessibility relation are read off as usual, $N = \{w_0\}$, the truth values of propositional parameters are read off in the usual way, and the truth values of modal formulas at non-normal worlds are read off in exactly the same way. Thus, if $i > 0$, and $\Box A, i$, is on the branch, $v_{w_i}(\Box A) = 1$; if $\neg\Box A, i$, is on the branch, $v_{w_i}(\Box A) = 0$; similarly for \Diamond .

4.4a.6 Hence, the counter-model given by the open tableau of 4.4a.4, is such that $W = \{w_0, w_1\}$; $N = \{w_0\}$; $w_0 R w_1$, $v_{w_1}(\Box(p \supset p)) = 0$, $v_{w_1}(\Diamond(q \wedge \neg q)) = 0$ (all other values of v being irrelevant). In a diagram:

$$w_0 \rightarrow \boxed{w_1} \quad \begin{array}{l} \neg\Box(p \supset p) \\ \neg\Diamond(q \wedge \neg q) \end{array}$$

4.4a.7 Extensions of L are obtained by adding constraints on the accessibility relation in the usual fashion, and adding the corresponding tableau rules. This gives the systems L_ρ , $L\sigma\tau$, etc. L is sometimes called $S0.5^0$. L_ρ is often called $S0.5$, and is stronger than $S0.5^0$, since $\vdash_{L_\rho} \Box A \supset A$. Though it is not immediately obvious, the addition of each of σ and τ has no effect on validity. Jointly, they have an effect on L , but not L_ρ . (See 4.10.6 and 4.13, problem 9.)

4.4a.8 The tableaux for L and its extensions are sound and complete with respect to their semantics. This is proved in 4.10.5.

4.4a.9 One further wrinkle should be noted here. In the earlier years of modal logic, it was common to take a modal language to contain only one modal operator, normally \Box . The other was then defined. The historical $S0.5^0$ and $S0.5$ are actually the \Diamond -free fragments of L and L_ρ respectively.

4.4a.10 The standard definition for ' $\Diamond A$ ' is ' $\neg\Box\neg A$ '. To take \Diamond to be defined in this way, instead of as primitive, has no effect on its behaviour in logics in the K family and N family. This is because $\Diamond A$ and $\neg\Box\neg A$ have the same truth value at every world (normal or non-normal). But this is not the case in the L family. Given the way in which I set things up, $\vdash_L \Diamond A \equiv \neg\Box\neg A$ (and $\vdash_L \Box A \equiv \neg\Diamond\neg A$). However, it does not follow that the formulas on each side of the biconditional have the same truth value in all

worlds, since at a non-normal world $\diamond A$ and $\Box \neg A$ can be assigned the same truth value.

4.4a.11 Because of this, defining \diamond does affect the inferences that involve it. For example, it is not difficult to check that:

$$(*) \neg \diamond (\diamond p \wedge \Box \neg p)$$

is not valid in L , but $\neg \diamond (\neg \Box \neg p \wedge \Box \neg p)$ is. Hence, $(*)$ is valid with a defined \diamond . If we wish to make \diamond behave in L as it does when it is defined, we have to add an extra constraint: for every world, w , $\nu_w(\diamond A) = \nu_w(\neg \Box \neg A)$ (that is, $\nu_w(\diamond A) = 1 - \nu_w(\Box \neg A)$). Clearly, this makes for a stronger system.

4.4a.12 It should be noted, though, that even this constraint does not ensure that $\Box A$ and $\neg \diamond \neg A$ have the same truth value at every world, since $\Box A$ and $\Box \neg \neg A$ (and so $\neg \neg \Box \neg \neg A$) may have different truth values at a non-normal world. Neither, for essentially the same reason, is $\neg \diamond (\Box p \wedge \diamond \neg p)$ logically valid, as is easy to check. This shows a displeasing lack of symmetry. It is clearly better to treat \Box and \diamond even-handedly, as I have done.

4.4a.13 Any N interpretation is an L interpretation (where ν makes \Box and \diamond behave in the appropriate fashion). Hence, N is an extension of L . It is a proper extension. We have just noted that $\neg \diamond (\Box p \wedge \diamond \neg p)$ is not valid in L . It is not difficult to check that it is valid in N . Similar comments apply to extensions of L and N formed by adding constraints on the accessibility relation. L is, thus, the weakest modal logic we have come across.

4.4a.14 The rule of Necessitation fails in L for essentially the same reason that it fails in N and its extensions (4.4.7). Indeed, that 'logic need not hold' at non-normal worlds in L is patent: if A is a logical truth, $\Box A$ can behave any old way at such a world.

4.4a.15 It is worth noting one final fact: $\Box A$ is valid in L (and L_ρ) iff A is a truth-functional tautology, or, more accurately, is valid in virtue of its truth-functional structure.⁴ The proof is in 4.10.7.

⁴ $\Box A \vee \neg \Box A$ is not, strictly speaking, a truth-functional tautology since it contains a \Box , but it is valid in virtue of its truth-functional structure.

4.5 Strict Conditionals

4.5.1 Now that we have covered material on modal logic, we can return to the question of the conditional.

4.5.2 Consider a true material conditional, such as ‘The sun is shining \supset Canberra is the federal capital of Australia’. One is inclined to reject this as a true conditional just because the truth of the material conditional is too contingent an affair. Things could have been quite otherwise, in which case the material conditional would have been false. This suggests defining the conditional, ‘if A then B ’ as $\Box(A \supset B)$, where \Box expresses an appropriate notion of necessity.

4.5.3 When Lewis created modern modal logic, he was not, in fact, concerned with modality as such. He was dissatisfied with the material conditional. He defined $A \rightarrow B$ as $\Box(A \supset B)$, and suggested this as a correct account of the conditional. \rightarrow is usually called the *strict conditional*.

4.5.4 It is easy enough to check that all the following are false in $K\rho\sigma\tau$, and so in all the normal and non-normal logics we have looked at.

$$\begin{aligned} B &\models A \rightarrow B \\ \neg A &\models A \rightarrow B \\ (A \wedge B) \rightarrow C &\models (A \rightarrow C) \vee (B \rightarrow C) \\ (A \rightarrow B) \wedge (C \rightarrow D) &\models (A \rightarrow D) \vee (C \rightarrow B), \\ \neg(A \rightarrow B) &\models A \end{aligned}$$

But these inferences are the basis of all the objections to the material account of the conditional that we looked at in 1.7–1.9. Hence, the strict conditional is not subject to any of the objections to which the material conditional is.

4.6 The Paradoxes of Strict Implication

4.6.1 Does it provide an adequate account of the conditional? Each system of modal logic gives \rightarrow different properties. Hence, before we can answer that question, we need to address the question of which system of modal logic it is that is at issue. Let me make two comments on this.

4.6.2 First, it is natural to suppose that any notion of necessity that is to be employed in defining a notion of conditionality must be at least as strong as $K\rho$ (or $L\rho$ if one is countenancing non-normal systems). This is because, without ρ , *modus ponens* fails: $A, A\rightarrow B \not\vdash B$. With it, it holds, as simple tableau tests verify.

4.6.3 Second, a further determination of this question is not very important for what follows. This is because the major objections to the claim that English conditionals are strict hinge on a feature that the strict conditional possesses in all systems of modal logic. In all systems of modal logic the following hold:

$$\begin{aligned}\Box B &\vdash A\rightarrow B \\ \neg\Diamond A &\vdash A\rightarrow B\end{aligned}$$

These facts are sometimes called the ‘paradoxes of strict implication’. A tableau test verifies that these hold in L , and so in all the normal and non-normal systems that we have looked at. Since, in all systems, we also have $\vdash \Box(B \vee \neg B)$ and $\vdash \neg\Diamond(A \wedge \neg A)$, this gives us as special cases:

$$\begin{aligned}\vdash A\rightarrow(B \vee \neg B) \\ \vdash (A \wedge \neg A)\rightarrow B\end{aligned}$$

4.7 ... and their Problems

4.7.1 If we read \rightarrow as the conditional, the paradoxes of strict implication are highly counterintuitive. For example, ‘There is an infinitude of prime numbers’ is a logical truth; yet:

If Brisbane is in Australia, there is an infinitude of prime numbers
If there is not an infinitude of prime numbers, Brisbane is in Germany

do not appear to be true.

4.7.2 This point is inconclusive, at least as far as indicative conditionals go, since one might just accept the paradoxes, and try to explain why the two preceding statements, and their kind, appear counterintuitive, by using the notion of conversational implicature (1.7.3). The conditionals are true enough, but simply unassertable, since we are in a position, in each case,

to assert stronger information: necessarily there is an infinitude of prime numbers; it is impossible that there is not.

4.7.3 It will not help for subjunctive conditionals, however. For asserting such a conditional does *not* conversationally imply that we do not know the status of the antecedent and consequent. (On the contrary, it often implies that we do.) It is not, therefore, linguistically odd. For example, it is logically impossible to square the circle (that is, construct a square with an area equal to that of a given circle by means of ruler and compasses). But even though we know this, it is not at all odd to assert that, none the less, if Hobbes (who thought he had succeeded in squaring the circle) had done so, he would have become a very famous mathematician. Moreover, there are clearly *false* subjunctive conditionals with impossible antecedents. For example, I can assure you that it is not the case that if you were to square the circle I would give you my life's savings.

4.7.4 Here is another objection against \rightarrow being the indicative conditional. Let A be 'There is an infinite number of prime numbers'. Since A is a necessary truth, $(A \vee \neg A) \rightarrow A$ is true. If the conditional were strict implication, the following would therefore be a sound argument: If $A \vee \neg A$ then A ; but $A \vee \neg A$; hence A . Now, imagine someone offering this as a proof for the infinitude of primes in a class on number theory. It is clear that it would not be acceptable.

4.7.5 This objection may also be challenged. For an argument to be acceptable, it must be more than just sound. In particular, it must not beg the question (assume what is at issue). And the only reason we have for supposing the conditional premise to be true is that the consequent is necessarily true. The proof at issue would therefore beg the question.

4.8 The Explosion of Contradictions

4.8.1 The toughest objections to a strict conditional, at least as an account of the indicative conditional, come from the fact that $\models (A \wedge \neg A) \rightarrow B$. If this were the case, then, by *modus ponens*, we would have $(A \wedge \neg A) \models B$. Contradictions would entail everything. Not only is this highly counterintuitive,

there would seem to be definite counter-examples to it. There appear to be a number of situations or theories which are inconsistent, yet in which it is manifestly incorrect to infer that everything holds. Here are three very different examples.

4.8.2 The first is a theory in the history of science: Bohr's theory of the atom (the 'solar system' model). This was internally inconsistent. To determine the behaviour of the atom, Bohr assumed the standard Maxwell electromagnetic equations. But he also assumed that energy could come only in discrete packets (quanta). These two things are inconsistent (as Bohr knew); yet both were integrally required for the account to work. The account was therefore essentially inconsistent. Yet many of its observable predictions were spectacularly verified. It is clear though that not everything was taken to follow from the account. Bohr did not infer, for example, that electronic orbits are rectangles.

4.8.3 Another example: pieces of legislation are often inconsistent. To avoid irrelevant historical details, here is an hypothetical example. Suppose that an (absent-minded) state legislator passes the following traffic laws. At an unmarked junction, the priority regulations are:

- (1) Any woman has priority over any man.
- (2) Any older person has priority over any younger person.

(We may suppose that clause 2 was meant to resolve the case where two men or two women arrive together, but the legislator forgot to make it subordinate to clause 1.) The legislation will work perfectly happily in three out of four combinations of sex and age. But suppose that Ms X, of age 30, approaches the junction at the same time as Mr Y, of age 40. Ms X has priority (by 1), but has not got priority (by 2 and the meaning of 'priority'). Hence, the situation is inconsistent. But, again, it would be stupid to infer from this that, for example, the traffic laws are *consistent*.

4.8.4 Third example: it is possible to have visual illusions where things appear contradictory. For example, in the 'waterfall effect', one's visual system is conditioned by constant motion of a certain kind, say a rotating spiral. If one then looks at a stationary situation, say a white wall, it appears to move in the opposite direction. But, a point in the visual field,

say at the top, does not appear to move, for example, to revolve around to the bottom. Thus, things appear to move without changing place: the perceived situation is inconsistent. But not everything perceivable holds in this situation. For example, it is not the case that the situation is red all over.⁵

4.9 Lewis' Argument for Explosion

4.9.1 Let us end by considering a final objection to \rightarrow as providing a correct account of the conditional. It is natural to object that this account cannot be correct, since a conditional requires some kind of connection between antecedent and consequent; yet a strict conditional requires no such connection. There is no connection in general, for example, between $A \wedge \neg A$ and B .

4.9.2 C. I. Lewis, who did accept \rightarrow as an adequate account of the conditional, thought that there was a connection, at least in this case. The connection is shown in the following argument:

$$\frac{\frac{A \wedge \neg A}{A} \quad \frac{A \wedge \neg A}{\neg A}}{A \quad \neg A \vee B} B$$

Premises are above lines; conclusions are below. The only ultimate premise is $A \wedge \neg A$; the only ultimate conclusion is B . The inferences that the argument uses are: inferring a conjunct from a conjunction; inferring a disjunction from a disjunct; and the disjunctive syllogism: $A, \neg A \vee B \vdash B$. Of course, all these are valid in the modal logics we have looked at. If contradictions do not entail everything, then one of these must be wrong. We will return to this point in a later chapter.

4.9.3 Lewis also argued that there is a connection in the case of the conditional $A \rightarrow (B \vee \neg B)$ as well. The connection is provided by the

⁵ A fourth kind of example is provided by certain fictional situations, in which contradictory states of affairs hold. This may well be the case without everything holding in the fictional situation.

following argument:

$$\frac{\frac{\frac{A}{(A \wedge B) \vee (A \wedge \neg B)}}{A \wedge (B \vee \neg B)}}{(B \vee \neg B)}$$

This argument is less convincing than that of 4.9.2, however, since the first step seems evidently to smuggle in the conclusion.

4.10 *Proofs of Theorems

4.10.1 THEOREM: The tableaux for N are sound with respect to their semantics.

Proof:

The proof is as for K (2.9.2–2.9.4) with a couple of minor amendments. First, we add a new clause to the definition of faithfulness, namely:

$$f(0) \in N$$

The proof of the Soundness Lemma proceeds as before, except for the cases for the modal rules. The negated rules are taken care of by 4.2.4. For the \diamond -rule: Suppose that f shows \mathcal{I} to be faithful to b , and that we apply the rule to $\diamond A, i$ to get A, j for a new j ; then either $i = 0$ or i is \square -inhabited. In either case, $f(i)$ is normal. (In the first case, this is obvious; in the second case, there is some node of the form $\square B, i$ on b ; and since f shows \mathcal{I} to be faithful to b , $\square B$ is true at $f(i)$; but $\square B$ is false at every non-normal world.) Hence there is a world, w , such that A is true at w . Let f' be the same as f , except that $f'(j) = w$. Then f' shows \mathcal{I} to be faithful to the extended branch, as in the corresponding case for K . For the \square -rule: suppose that f shows \mathcal{I} to be faithful to b , and that we apply the rule to $\square A, i$ and irj to get A, j . Since $\square A$ is true at $f(i)$, $f(i)$ must be normal; and since $f(i)Rf(j)$, it follows that A is true at $f(j)$.

In the proof of the Soundness Theorem proper, suppose that $\Sigma \not\models A$. Let $\mathcal{I} = \langle W, N, R, \nu \rangle$ and $w \in N$ be such that at w every member of Σ is true and A is false. Let $f(0) = w$. Then f shows \mathcal{I} to be faithful to the initial list. The argument then goes as for K . ■

4.10.2 THEOREM: The tableaux for extensions of N with ρ, τ , etc., and their various combinations, are sound with respect to their respective semantics.

Proof:

The argument is as for K (3.7.1–3.7.2). ■

4.10.3 THEOREM: The tableaux for N are complete with respect to their semantics.

Proof:

The proof is as for K (2.9.5–2.9.7) with a couple of minor amendments. First, given an open branch, b , we define the induced interpretation as for K , except that $i \in N$ iff $i = 0$ or i is \Box -inhabited on b .

The argument for the Completeness Lemma is the same as that for K , except the cases for the modal operators, which go as follows. Suppose that $\Diamond A, i$ is on b . If $i \notin N$ then $\Diamond A$ is true at w_i by definition. If $i \in N$ then the \Diamond -rule has been applied to it. Hence, for some new j , irj and A, j occur on b . By induction hypothesis, $w_i R w_j$, and A is true at w_j . Since w_i is normal, $\Diamond A$ is true at w_i , as required. If $\neg \Diamond A, i$ is on b then $\Box \neg A, i$ is on b . By definition, i is \Box -inhabited. Hence, for every j such that irj is on b , $\neg A, j$ is on b . By induction hypothesis, A is false at every w_j such that $w_i R w_j$; and since i is normal, $\Diamond A$ is false at w_i . The case for \Box is similar.

The proof of the Completeness Theorem proper is the same as that for K . ■

4.10.4 THEOREM: The tableaux for extensions of N with ρ, τ , etc., and their various combinations, are complete with respect to their respective semantics.

Proof:

The argument is as for K (3.7.3–3.7.4). ■

4.10.5 THEOREM: The tableau systems for L and its extensions are sound and complete with respect to the corresponding semantics.

Proof:

The soundness proofs are trivial modifications of 4.10.1, 4.10.2. The induced interpretation is defined as for other non-normal logics, except that $N = \{w_0\}$; and for $i > 0$, $v_{w_i}(\Box A) = 1$ if $\Box A, i$ is on the branch, and $v_{w_i}(\Box A) = 0$

if $\neg\Box A$, i is on the branch; similarly for \Diamond . The completeness proof is then a trivial modification of 4.10.3 and 4.10.4. ■

4.10.6 THEOREM: The addition of each of the constraints σ and τ to L and $L\rho$ do not produce proper extensions. The addition of both constraints to $L\rho$ does not give a proper extension.

Proof:

Consider a tableau for L (or $L\rho$) in which the τ rule may also be invoked. This will have lines of the form $0ri$, but since no world other than 0 is normal, the \Diamond rule is never applied at i , so we never obtain anything of the form irj . The transitivity rule is never, therefore, applied, and the tableau closes iff it closed without it.

Consider a tableau for L (or $L\rho$) in which the σ rule may also be invoked. This will have lines of the form $0ri$, and therefore $ir0$, but no other r -lines. But since the \Box rule is never applied at i , the lines of the form $ir0$ have no effect, and the tableau closes iff it closes without an application of the σ rule.

Consider a tableau for $L\rho$ in which both rules may be invoked. This will have lines of the form $0ri$, and therefore $ir0$, and so $0r0$ and iri . None of these lines have any further effect. ■

4.10.7 THEOREM: $\Box A$ is logically valid in L or $L\rho$ iff A is valid in virtue of its truth-functional structure.

Proof:

If A is valid in virtue of its truth-functional structure, then it is true in all worlds. Hence, $\Box A$ is a logical truth. For the converse, consider the tableau for $\Box A$. In two moves we arrive at a line of the form $\neg A, 1$. The only way for the tableau to close is for us to be able to obtain lines of the form $B, 1$ and $\neg B, 1$ by the application of the truth-functional rules to this. (No others get applied at this world – or any other.) In this case, the tableau for $\neg A$ closes by the tableau rules for the classical propositional calculus, which are sound and complete with respect to classical propositional inference (1.11.3, 1.11.6). ■

4.11 History

The notion of a non-normal world, and the semantics for $S2$ and $S3$, were invented by Kripke (1965a). The Lewis system $S1$ proved recalcitrant to a

semantical modelling. A suitable one was eventually given by Cresswell (1995). The semantics has non-normal worlds, but the behaviour of modal formulas at these requires more complex machinery. The logics $E2$ and $E3$ were proposed by Lemmon (1957). $S6$ and $S7$ (see 4.13, problem 8) were produced in the 1940s. For their history, see Hughes and Cresswell (1996, p. 207, n. 24). In axiomatic form $S0.5$ is due to Lemmon (1957). The semantics are due to Cresswell (1966).

The argument of 4.7.4 is due to Anderson and Belnap (1975, p. 17), the founders of relevant logic, which we will come to in later chapters. The Lewis argument that everything follows from a contradiction was known in the Middle Ages, for example, by Scotus. Its earliest known appearance in logic appears to be in the work of William of Soissons in the twelfth century. See Martin (1985).

4.12 Further Reading

For a good discussion of some of the history of Lewis' investigations of modal logic, and of non-normal systems, see Hughes and Cresswell (1996, ch. 11). For some philosophical discussion of non-normal worlds, see Cresswell (1967). Tableaux for non-normal logics can be found in Girle (2000, ch. 5).

For papers on either side of the debate about the adequacy of the strict conditional, see Bennett (1969) and Meyer (1971). For a discussion of whether contradictions entail everything, see Priest and Routley (1989b, pp. 483–98). Historical details of Bohr's theory of the atom and its inconsistency can be found in Brown (1993); and the waterfall effect is discussed in most psychology textbooks on perception, for example, Robinson (1972). For an essentially inconsistent fictional situation, see Priest (1997a).

4.13 Problems

1. Check the details omitted in 4.4.3, 4.4a.12, 4.4a.13, 4.5.4, 4.6.2 and 4.6.3.
2. Show the following for N :

$$(a) \vdash A \rightarrow A$$

$$(b) \vdash ((A \rightarrow B) \wedge (B \rightarrow C)) \rightarrow (A \rightarrow C)$$

$$(c) \vdash (A \rightarrow B) \rightarrow (\neg B \rightarrow \neg A)$$

$$(d) \vdash \Box \neg A \supset \Box \neg (A \wedge B)$$

3. Show the following for N . Specify a counter-model and draw a picture of it.
- (a) $\not\vdash \Box p \supset p$
 - (b) $\not\vdash \Box p \supset \Box \Box p$
 - (c) $\not\vdash \neg(p \supset p) \supset q$
 - (d) $\not\vdash \Box(p \supset p)$
 - (e) $\not\vdash (p \supset q) \supset (\Box p \supset \Box q)$
 - (f) $\not\vdash \Box \Box p \supset (\Box q \supset \Box \Box q)$
 - (g) $\not\vdash \Diamond \Diamond p$
 - (h) $\not\vdash \Box \Box(p \vee \neg p)$
4. Which of the above (in problem 3) hold in $S2$ ($N\rho$)? Which hold in $S3$ ($N\rho\tau$)?
5. Repeat 3.10, problem 7, with N instead of K . (Beware: in $N\tau$, $\Box p \supset \Box \Box p$ is *not* valid. A little ingenuity is required here.)
6. How might one object to the arguments of 4.7 and 4.8?
7. Show that $\vdash \Diamond \Diamond(p \wedge \neg p) \vee \Box(q \supset q)$, in both $S2$ and $S3$, but that neither disjunct is valid in either $S2$ or $S3$. (Note that there is nothing odd, in general, about having a logically valid disjunction, each disjunct of which is not logically valid – just consider $p \vee \neg p$. But it is odd for this to arise if the disjuncts have no propositional parameter in common.)
8. *Consider an interpretation for N . Call a world *standard* if it is both normal and accesses a non-normal world. A new notion of validity is obtained if we define it in terms of truth preservation at standard worlds. Show that according to this definition of validity, $\Diamond \Diamond A$ is valid. If, in addition, we insist that R be reflexive, or reflexive and transitive, we obtain the non-Lewis systems $S6$ and $S7$, respectively. These are extensions of $S2$ and $S3$, respectively, but, despite the numerology, they are not extensions of $S5$. Design tableau systems for $S6$ and $S7$ and prove them sound and complete.
9. *Show that $\not\vdash_L (\Box p \supset p) \vee \Box q$, but $\vdash_{L\sigma\tau} (\Box p \supset p) \vee \Box q$. Infer that $L\sigma\tau$ is a proper extension of L . By a tableau-theoretic argument, show that $L\rho$ is an extension of $L\sigma\tau$. (Hint: see 4.10.6.) Show that $\not\vdash_{L\sigma\tau} \Box p \supset p$, and infer that it is a proper extension.
10. *What effect does the addition of the constraint η have on L and its other extensions?

5 Conditional Logics

5.1 Introduction

5.1.1 In this chapter we look at what have come to be called ‘conditional logics’. These are a type of modal logic where there is a multiplicity of accessibility relations of a certain kind.

5.1.2 The logics also introduce us to some more problematic inferences concerning the conditional, and we discuss what to make of these.

5.2 Some More Problematic Inferences

5.2.1 Let us start with the inferences. It is easy enough to check that the following are all valid in classical logic:

Antecedent strengthening: $A \supset B \models (A \wedge C) \supset B$

Transitivity: $A \supset B, B \supset C \models A \supset C$

Contraposition: $A \supset B \models \neg B \supset \neg A$

It is also easy to check that the same is true if ‘ \supset ’ is replaced by ‘ \rightarrow ’. (The inferences all hold in L , and so in all modal systems.)

5.2.2 But now consider the three following arguments of the same respective forms:

- (1) If it does not rain tomorrow we will go to the cricket. Hence, if it does not rain tomorrow and I am killed in a car accident tonight then we will go to the cricket.
- (2) If the other candidates pull out, John will get the job. If John gets the job, the other candidates will be disappointed. Hence, if the other candidates pull out, they will be disappointed.

- (3) If we take the car then it won't break down *en route*. Hence, if the car does break down *en route*, we didn't take it.

If the conditional were either material or strict, then these inferences would be valid, which they certainly do not appear to be, since they may have true premises and a false conclusion. Hence, we have a new set of objections against the conditional being either material or strict. (And since the conditionals are indicative, they tell just as much against one who claims only that English indicative conditionals are material.)

5.2.3 What is one to say about these objections? It is often the case that, when one gives an argument, one does not mention explicitly some of the premises, perhaps because they are pretty obvious. Thus, I might say: this plane lands in Rome; therefore, this plane lands in Italy. Here I omit the fact that Rome is in Italy. Arguments where premises are omitted in this way are traditionally called *enthymemes*. Just as arguments can be enthymematic, so can conditionals. Thus, suppose that I say: if this plane lands in Rome, it lands in Italy. Strictly speaking, one may say, the conditional is false. It is an enthymeme of the true conditional: if this plane lands in Rome, and Rome is in Italy, then this plane lands in Italy.

5.2.4 Now consider the first argument of 5.2.2. A natural thing to say is that the inference *is* valid. It is just that the premise is not, strictly speaking, true. What we are assenting to, when we assent to the premise, is really the conditional: if it does not rain tomorrow *and* I am not killed in a car accident tonight, then we will go to the cricket tomorrow. The premise is an enthymematic form of that. Similar comments can be made about the other arguments of 5.2.2. Thus, the second premise of the second argument is, strictly speaking, false. What is true is that if John gets the job *and* the other candidates do not pull out, they will be disappointed. Thus, one may defuse these counter-examples.

5.2.5 This move is essentially right, but it is a bit too swift, though. Come back to the premise of the first argument. If the conditional 'if it does not rain tomorrow, we will go to the cricket' is not true, then neither is the conditional 'if it does not rain tomorrow and I am not killed in a car accident tonight, we will go to the cricket'. I might be killed in a domestic accident, all means of transport may break down tomorrow, we might be invaded by Martians, etc. The list of conditions is, arguably, open-ended and indefinite. So no conditional of this kind that we could formulate explicitly is true!

5.2.6 Fortunately, though, we can capture all the open-ended conditions in a catch-all clause. We can say: ‘if it does not rain tomorrow then, other things being equal, we will go to the cricket’ or ‘if it does not rain tomorrow and everything else relevant remains unchanged, we will go to the cricket’. The Latin for ‘other things being equal’ is *ceteris paribus*, so we can call this a *ceteris paribus* clause. It is the conditional with the *ceteris paribus* clause that we are really assenting to when we assent to the premise of the first argument. Similarly for the other arguments.

5.2.7 A conditional of this kind is of the form ‘if A and C_A then B ’, where C_A is the *ceteris paribus* clause. How does this clause function? It is no ordinary conjunct. For a start, as we have seen, it captures an open-ended set of conditions. It also depends very much on A . (That is what the subscript A is there to remind you of.) If A is ‘it does not rain tomorrow’, then C_A includes the condition that we are not invaded by Martians. If A is ‘flying saucers arrive from Mars’, it does not.

Finally, it is context-dependent. For example, suppose that I am driving, and am stuck behind a truck. A is ‘I overtake now’. From where I sit, I can see that there is a car coming the other way. This is part of my C_A . Hence, I can truly assert ‘If I overtake now, there will be an accident.’ You, on the other hand, are sitting in the passenger seat and cannot see the oncoming traffic. You do know, however, that I am a safe driver. That is part of your C_A . Hence you can truly assert ‘If Graham overtakes now, there will not be an accident’.

5.2.8 Let us write $A > B$ for a conditional with a *ceteris paribus* clause. Suppose one accepts a strict account of the conditional. Then a conditional $A \rightarrow B$ is true (at a world) if $A \supset B$ is true at every (accessible) world; that is, if B is true at every (accessible) world at which A is true. Thus, the conditional $A > B$ is true (at a world) if B is true at every (accessible) world at which $A \wedge C_A$ is true. How do we spell out this idea more precisely?

5.3 Conditional Semantics

5.3.1 First, we extend our formal language with the connective $>$. Thus, if A and B are formulas of the extended language, so is $A > B$. Let the set of formulas of the language be \mathcal{F} .

5.3.2 To keep things simple, we assume that the logic of the modal operators is K_v . In this way, we need not worry about an accessibility relation for the modal operators in an interpretation. (It is possible, of course, for the modal operators to behave in a more complicated way. For example, they could behave as in some other normal modal logic, in which case, an interpretation would need an extra component, the modal accessibility relation, R .)

5.3.3 An interpretation for the extended language is a structure of the form $\langle W, \{R_A : A \in \mathcal{F}\}, v \rangle$. W and v are as for K_v . The middle component, $\{R_A : A \in \mathcal{F}\}$, is a collection of binary relations on W , R_A , one for every formula, A . Intuitively, $w_1 R_A w_2$ means that A is true at w_2 , which is, *ceteris paribus*, the same as w_1 .

5.3.4 Given an interpretation, v is extended to give a truth value to every formula at every world. The conditions for the truth functions, and for \Box and \Diamond , are as for the modal logic K_v . For $>$ the condition is:

$$v_w(A > B) = 1 \text{ iff for all } w' \text{ such that } w R_A w', v_{w'}(B) = 1$$

One may look at the situation like this: every formula, A , gives rise to a corresponding necessity operator, \Box_A . $A > B$ is then just $\Box_A B$.¹

5.3.5 A little bit of notation will make many of the following details easier to follow. Let us write the set of worlds accessible to w under R_A as $f_A(w)$. Thus, $f_A(w) = \{x \in W : w R_A x\}$. R and f are, in fact, interdefinable, since $w R_A w'$ iff $w' \in f_A(w)$. Thus, we may couch any discussion in terms of R or f indifferently. Next, let $[A]$ be the class of worlds where A is true, $\{w : v_w(A) = 1\}$. With these conventions, the truth conditions of $A > B$ can be stated very simply: $A > B$ is true at w iff $f_A(w) \subseteq [B]$. Note also that $A \rightarrow B$ is true at w iff $[A] \subseteq [B]$. (Since we are operating in K_v , the truth value of $A \rightarrow B$ does not depend on w .)

5.3.6 Validity is defined as truth preservation over all worlds of all interpretations, as in normal modal logics. We will call this conditional logic C .² Since no constraints are placed on the relations R_A , C is the analogue for conditional logics of the modal logic K .

¹ See the footnote at 3.6a.5.

² In the notation we are employing, C is also used as a variable for formulas. But the context will always disambiguate.

5.4 Tableaux for C

5.4.1 Tableaux for C are obtained simply by modifying those for K . Nodes may now be of the form A, i or ir_{Aj} . The rules for the truth-functional and modal connectives are as in Kv . The rules for $>$ are as follows:

$$\begin{array}{ccc}
 A > B, i & & \neg(A > B), i \\
 ir_{Aj} & & \downarrow \\
 \downarrow & & ir_{Aj} \\
 B, j & & \neg B, j
 \end{array}$$

In the first rule, this is applied for every ir_{Aj} on the branch. In the second, j has to be new. (The first rule is just like the rule for \square ; the second rule is just like the rule for \diamond , given that $\neg\square C$ is equivalent to $\diamond\neg C$.)

5.4.2 Here is an example tableau, demonstrating that $A > B \vdash_C A > (B \vee C)$:

$$\begin{array}{c}
 A > B, 0 \\
 \neg(A > (B \vee C)), 0 \\
 Or_A 1 \\
 \neg(B \vee C), 1 \\
 \neg B, 1 \\
 \neg C, 1 \\
 B, 1 \\
 \times
 \end{array}$$

The third and fourth lines are obtained from the second by the rule for negated $>$. The last line is obtained from the first and third by the rule for $>$.

5.4.3 Here is another to show that $p > r \not\vdash_C (p \wedge q) > r$:

$$\begin{array}{c}
 p > r, 0 \\
 \neg((p \wedge q) > r), 0 \\
 Or_{p \wedge q} 1 \\
 \neg r, 1
 \end{array}$$

Note that we cannot apply the rule for $>$ to the first line, to close off the tableau. For this, we would need $Or_p 1$, which we do not have. It is easy enough to check that the other inferences corresponding to the arguments

of 5.2.2 are invalid, as is to be expected: $p > q$, $q > r \not\vdash_C p > r$, $p > q \not\vdash_C \neg q > \neg p$. Details are left as an exercise.

5.4.4 Counter-models are read off from the tableau in a natural way. If there is something of the form $A > B$ or $\neg(A > B)$ on the branch, then R_A is as the information about r_A on the branch specifies. Otherwise, R_A may be arbitrary. Thus, in the counter-model given by 5.4.3, $W = \{w_0, w_1\}$; $w_0 R_{p \wedge q} w_1$ (and those are the only things that $R_{p \wedge q}$ relates); R_p relates nothing to anything; for every other formula, A , R_A can be anything one likes; and v is such that $v_{w_1}(r) = 0$. In pictures:

$$\begin{array}{ccc} w_0 & \xrightarrow{p \wedge q} & w_1 \\ & & \neg r \end{array}$$

It is easy to check directly that this makes the premise true and the conclusion false at w_0 . r is true at every world accessible to w_0 via R_p . (There are none.) Hence, $p > r$ is true at w_0 . And at some world accessible to w_0 via $R_{p \wedge q}$, r is false. Hence, $(p \wedge q) > r$ is false at w_0 .

5.4.5 The tableaux for C are sound and complete with respect to their semantics. The proof of this can be found in 5.9.

5.5 Extensions of C

5.5.1 Just as with K , one can extend C by adding constraints on the accessibility relations. A couple of these are mandated by the very intuition explained in 5.2.8. No doubt, the reader will have been wanting to point out for some time now that there is nothing in the semantics, so far, that requires A to be true at w' if $w R_A w'$. Thus the following condition is very natural:

$$(1) f_A(w) \subseteq [A]$$

Moreover, if the world, w , is already such that A is true there, then, presumably, the worlds that are essentially the same as w , except that A is true there, must include w itself. This motivates the condition:

$$(2) \text{ If } w \in [A], \text{ then } w \in f_A(w)$$

It is difficult to get any other conditions uncontentionally out of the motivating conditions of 5.2.8.

5.5.2 We call the logic in which validity is defined in terms of truth preservation at all worlds of all interpretations where, for every formula A , R_A satisfies conditions (1) and (2), C^+ . For the usual reasons, C^+ is an extension of C .

5.5.3 Tableaux for C^+ are obtained by modifying the rule for negated $>$ to:

$$\begin{array}{c} \neg(A > B), i \\ \downarrow \\ ir_A j \\ A, j \\ \neg B, j \end{array}$$

(where j is new). This takes care of (1). For (2), we have to apply the following rule:

$$\begin{array}{ccc} & \cdot & \\ \swarrow & & \searrow \\ \neg A, i & & A, i \\ & & ir_A i \end{array}$$

for every integer, i , occurring on the branch, and every A which is the antecedent of a conditional or negated conditional at a node.

5.5.4 Here is an example, to show that $A, A > B \vdash_{C^+} B$ (*modus ponens* for $>$):

$$\begin{array}{ccc} A, 0 & & \\ A > B, 0 & & \\ \neg B, 0 & & \\ \swarrow & & \searrow \\ \neg A, 0 & A, 0 & \\ \times & Or_A 0 & \\ & B, 0 & \\ & \times & \end{array}$$

It is not difficult to check that *modus ponens* for $>$ fails in C . C^+ is therefore a proper extension of C .

5.5.5 Here is another tableau to show that $p > r \not\vdash_{C^+} p > (r \wedge q)$:

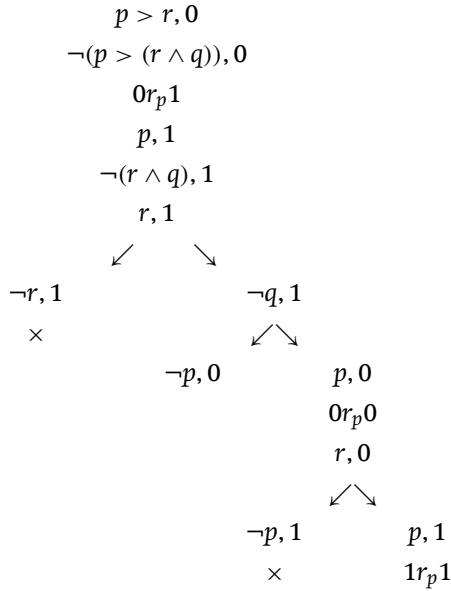

Only the first and third branches from the left close.

5.5.6 Counter-models can be read off from an open branch of a tableau as before. If A does not occur as the antecedent of a conditional or negated conditional at a node, we can no longer allow R_A to be arbitrary, however, since it must satisfy (1) and (2). The simplest trick is to let $f_A(w) = [A]$ (for every w).³ With this definition, (1) and (2) are clearly satisfied.

5.5.7 Thus, in the counter-model for the tableau of 5.5.5, read off from the rightmost branch, $W = \{w_0, w_1\}$; $w_0 R_p w_0$, $w_0 R_p w_1$ and $w_1 R_p w_1$; for all other A , $f_A(w) = [A]$; $v_{w_0}(p) = v_{w_0}(r) = v_{w_1}(r) = v_{w_1}(p) = 1$, and $v_{w_1}(q) = 0$. In pictures:

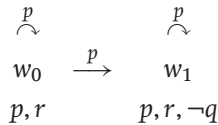

³ This is legitimate, since f_A is not required to define the truth value of A at a world. To evaluate the truth value of A at a world, one needs to know only f_B for those B that occur as the antecedents of conditionals within A .

5.5.8 As is probably clear, the tableaux for C^+ branch very rapidly. It may often, therefore, be easier to construct counter-models directly, by trial and error. Thus, one might construct the interpretation depicted in 5.5.7 directly. (Or even a simpler one. Details are left as an exercise.)

5.5.9 Soundness and completeness proofs for the C^+ tableaux can be found in 5.9.

5.6 Similarity Spheres

5.6.1 There are many other conditions that one might impose on each R_A , and so create extensions of C . Perhaps the most important constraints of this kind arise in the following way.

5.6.2 The founders of conditional logic (Stalnaker and Lewis⁴) suggested that the worlds accessible to w via R_A – that is, the worlds essentially the same as w , except that A is true there – should be thought of as the worlds *most similar* to w at which A is true. How to understand similarity in this context is a difficult question. It is clear, though, at least, that similarity is something that comes by degrees. We will return to what to make of the notion philosophically later.

5.6.3 A way of making the notion precise formally is as follows. We suppose that each world, w , comes with a system of ‘spheres’. All the worlds in a sphere are more similar to w than any world outside that sphere. We may depict the idea thus. (The spheres are depicted as rectangles here for typographical reasons.)

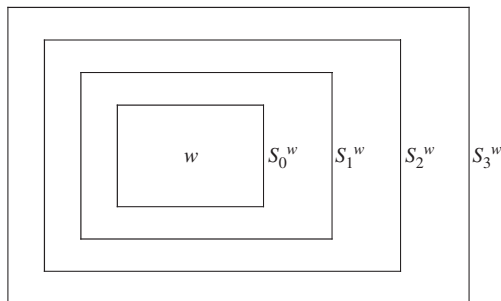

⁴ This is David Lewis, not to be confused with C. I. Lewis. All references to Lewis in this chapter are to David.

All the worlds in S_0^w are more similar to w than the worlds in S_1^w that are not in S_0^w ($S_1^w - S_0^w$). All the worlds in S_1^w are more similar than the worlds in $S_2^w - S_1^w$, etc.

5.6.4 Technically, for any world, w , there is a set of subsets of W , $\{S_0^w, S_1^w, \dots, S_n^w\}$ (for some n), such that $w \in S_0^w \subseteq S_1^w \subseteq \dots \subseteq S_n^w = W$. We omit the superscript when no confusion can arise as to which world's spheres it is that are at issue.

5.6.5 $f_A(w)$ may now be defined as follows. If $[A]$ is empty, then $f_A(w)$ is empty. Otherwise, there is a smallest of w 's spheres whose intersection with $[A]$ is not empty, S_i , and $f_A(w)$ is $S_i \cap [A]$. In terms of the motivation of 5.2.8, the sphere S_i can be thought of as containing exactly those worlds at which the *ceteris paribus* clause, C_A , is true. To help picture the situation, consider the following diagram; $f_A(w)$ is the area marked with crosses.⁵

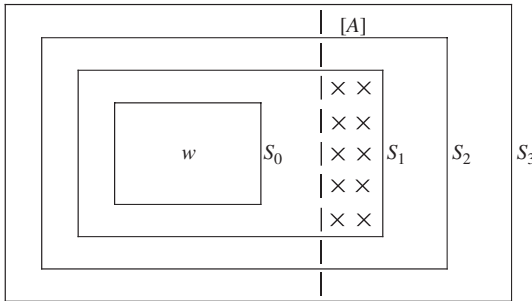

5.6.6 It is clear that this conception verifies conditions (1) and (2). For (1): if $f_A(w) = \phi$, then $f_A(w) \subseteq [A]$; and if $f_A(w) = S_i \cap [A]$, then again, $f_A(w) \subseteq [A]$. For (2): if $w \in [A]$, then $[A]$ is not empty, and since $w \in S_0$, S_0 is the smallest sphere with a non-empty intersection with $[A]$. So $w \in S_0 \cap [A] = f_A(w)$.

⁵ We have assumed, for simplicity, that the system of spheres is finite. This is not necessary, but infinite systems give rise to certain complications. In particular, if there is an infinite number of spheres, there may be no smallest sphere with a non-empty intersection with $[A]$. (Suppose that there is a world, w_x , at every point on the real line, x ; that A holds at w_x iff $x > 0$; and that the spheres around w_0 are of the Zenonian kind $\{w_x : |x| < 1\}$, $\{w_x : |x| < 1/2\}$, $\{w_x : |x| < 1/4\}, \dots$) The non-existence of a smallest sphere can be accommodated by changing the truth conditions of $>$ to: $A > B$ is true at w iff there is some sphere around w , S , such that $S \cap [A] \neq \phi$ and $S \cap [A] \subseteq [B]$, which is equivalent to the construction of the text if there is a finite number of spheres.

5.6.7 The conception also verifies further constraints on R ; for example, by definition, if there are any worlds at which A is true, $f_A(w)$ is non-empty, i.e.:

(3) If $[A] \neq \phi$, then $f_A(w) \neq \phi$

5.6.8 The sphere conception also verifies the following two conditions:

(4) If $f_A(w) \subseteq [B]$ and $f_B(w) \subseteq [A]$, then $f_A(w) = f_B(w)$

(5) If $f_A(w) \cap [B] \neq \phi$, then $f_{A \wedge B}(w) \subseteq f_A(w)$

The arguments are given in 5.6.9, and can be skipped if desired.

5.6.9 For (4): suppose, for *reductio*, the antecedent and the negation of the consequent. Then either there is some $x \in f_A(w)$ such that $x \notin f_B(w)$, or vice versa. Consider the first case (the second is the same). Let $f_A(w) = S_i \cap [A]$, S_i being the smallest sphere for which this intersection is non-empty. By the first conjunct of the antecedent, $x \in [B]$. And since $x \notin f_B(w)$, and $f_B(w) \neq \phi$, by (3), there must be some $S_j \subset S_i$ such that $f_B(w) = S_j \cap [B]$. Let $y \in f_B(w)$. Then $y \in [A]$, by the second conjunct of the antecedent. But this is impossible, since $S_j \cap [A] = \phi$.

For (5): suppose that $f_A(w) \cap [B]$ is non-empty. Then $f_A(w)$ is non-empty. Let $f_A(w) = S_i \cap [A]$, S_i being the smallest sphere for which this intersection is non-empty. Hence, $S_i \cap [A] \cap [B] = S_i \cap [A \wedge B]$ is non-empty. Indeed, S_i is the smallest sphere such that the intersection is non-empty. (If $S_j \subset S_i$, then $S_j \cap [A] = \phi$.) Hence, $f_{A \wedge B}(w) = S_i \cap [A \wedge B] \subseteq S_i \cap [A] = f_A(w)$.

5.6.10 Let us call the system where validity is defined in terms of all interpretations where f satisfies conditions (1)–(5), S . S is clearly an extension of C^+ .

5.6.11 It is, in fact, a proper extension. For example, the following inference is not valid in C^+ , as may be checked with a tableau, or directly:

$$p > q, q > p \vdash (p > r) \equiv (q > r)$$

But it is valid in S . Suppose that the premise is true at world w , i.e., $f_p(w) \subseteq [q]$ and $f_q(w) \subseteq [p]$. Then, by condition (4), $f_p(w) = f_q(w)$. Hence, $f_p(w) \subseteq [r]$ iff $f_q(w) \subseteq [r]$, i.e., $(p > r)$ is true at w iff $(q > r)$ is true at w , i.e., $(p > r) \equiv (q > r)$ is true at w .

5.6.12 There are presently no known tableau systems of the kind used in this book for S (and its extensions that we will meet in the next section). Hence, demonstrations that an inference is valid have to be given directly, as in 5.6.11.

5.6.13 And demonstrations that an inference is invalid in S must be performed by constructing a counter-model directly. An easy way to do this is to construct an appropriate sphere structure. Here is an example to show that $(p \vee q) > r \not\vdash_S p > r$. To invalidate this inference, we need a sphere model with a world, w_0 say, such that at the nearest worlds to w_0 where $p \vee q$ is true, so is r ; but at the nearest world where p is true, r is not. Here is a simple example.

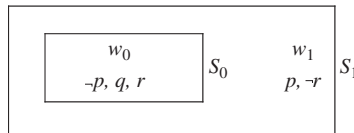

$f_{p \vee q}(w_0) = \{w_0\} \subseteq [r]$; hence, $(p \vee q) > r$ is true at w_0 ; but $f_p(w_0) = \{w_1\} \not\subseteq [r]$; hence, $p > r$ is false at w_0 . We know that all sphere models satisfy the conditions (1)–(5) of S . Hence, the inference is invalid in S .

5.6.14 Notice that if inferences involve nested conditionals, then demonstrations of validity or invalidity may have to take into account the systems of spheres around more than one world. Here, for example, is a counter-model demonstrating that $\not\vdash_S p > (q > (p \wedge q))$:

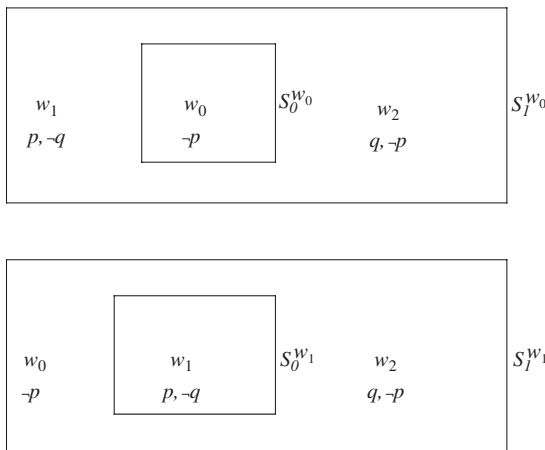

The top diagram shows the system of spheres around w_0 ; the bottom diagram depicts the system of spheres around w_1 . $q > (p \wedge q)$ is false at w_1 , since at some of the nearest worlds to w_1 where q is true (w_2), $p \wedge q$ is false. Hence, $p > (q > (p \wedge q))$ is false at w_0 , since at a nearest world to w_0 where p is true (w_1), $q > (p \wedge q)$ is false. Note that the worlds in the two diagrams must be the same, as must the truth values of every formula at each world. It is only the system of spheres that may vary from picture to picture.

5.6.15 One final matter: (1) and (4) together entail that for all w :

$$(P) \text{ If } [A] = [B], \text{ then } f_A(w) = f_B(w)$$

For suppose that $[A] = [B]$. Then, by (1), $f_A(w) \subseteq [A] = [B]$, and $f_B(w) \subseteq [B] = [A]$. Hence, by (4), $f_A(w) = f_B(w)$.

5.6.16 Now, the truth value of $A > B$ at a world, w , depends on $f_A(w)$. But if condition (P) holds, then $f_A(w)$ is determined completely by $[A]$. Hence, the truth value of $A > B$ depends, not on the formula A , but on the set of worlds at which A is true. (Some philosophers think of this as the *proposition* expressed by A .) If this is the case, then an interpretation can be formulated as a structure of the form $\langle W, \{R_X : X \subseteq W\}, \nu \rangle$, where truth conditions are the same as before, except that for $>$:

$$\nu_w(A > B) = 1 \text{ iff } f_{[A]}(w) \subseteq [B]$$

where $f_X(w) = \{w' : wR_X w'\}$.⁶

5.6.17 Constraints on f can then be couched in the same terms. Thus, (1) becomes $f_{[A]}(w) \subseteq [A]$, or more generally, $f_X(w) \subseteq X$, and so on.

5.7 C_1 and C_2

5.7.1 Perhaps the two best-known conditional logics are obtained from S , each by adding one further constraint. A natural thought is that, for any world, w , if there are any worlds at which A is true, then there is a *unique* world closest to w at which A is true (condition (3) guarantees that there is

⁶ This is legitimate, since A is a part (proper subformula) of $A > B$, and hence $[A]$ is determined *before* the truth value of $A > B$.

at least one world), i.e.:

(6) If $x \in f_A(w)$ and $y \in f_A(w)$, then $x = y$

5.7.2 The system which is the same as S , except that in its interpretations f satisfies condition (6), is often called C_2 .⁷ What is distinctive about C_2 is that it verifies *Conditional Excluded Middle*: $(A > B) \vee (A > \neg B)$. (This is not logically valid in S ; details are left as an exercise.) *Proof*: Either $[A] = \phi$ or not. In the first case, for any w , $f_A(w) = \phi$ (by (1)), and so $f_A(w) \subseteq [B]$ and $f_A(w) \subseteq [\neg B]$. Hence, the disjunction is true at w . In the second case, let $f_A(w) = \{x\}$. (It has only one member, by (6).) Either B is true at x or it is false at x . In the first case, $f_A(w) \subseteq [B]$. In the second case, $f_A(w) \subseteq [\neg B]$. In either case, the disjunction is therefore true at w .

5.7.3 One may object to condition (6) – as did Lewis – on the ground that there is no reason to believe that the nearest world to w where something holds must be unique. There may be different worlds where something holds which are symmetrical with respect to w , so that neither is nearer than the other. Consider, for example, Bizet and Verdi. These were contemporaries, but the first was French and the second was Italian. There would appear to be no unique world most similar to ours in which the two are compatriots. In some, they are both French, and in some they are both Italian. (Any world in which they are both, say, German, would be even less similar to ours.)

5.7.4 Conditional Excluded Middle is, in any case, problematic. Both of the following conditionals would appear to be false: if it will either rain tomorrow or it won't, then it will rain tomorrow; if it will either rain tomorrow or it won't, then it won't rain tomorrow.

5.7.5 In response to this, Lewis suggested dropping (6), but replacing it with:

(7) If $w \in [A]$ and $w' \in f_A(w)$, then $w = w'$

If A is true at w , then the most similar worlds at which A is true comprise just w itself. (Any world is more similar to itself than any other world.) (6), together with (2), obviously implies (7), but not vice versa.

⁷ Stalnaker, whose system C_2 is, makes $f_A(w)$ a singleton for every A . He does this by having, in addition to all the usual worlds, one 'absurd world', where everything holds. This is the unique world in $f_A(w)$ if A is true at no ordinary worlds. Because everything holds at the absurd world, the net effect of this is the same.

5.7.6 If this replacement is made, we get a system often called C_1 . C_1 does not verify Conditional Excluded Middle (see 5.7.9), but (like C_2) it does verify the inference: $A \wedge B \models A > B$. (The inference is not valid in S ; details are left as an exercise.) *Proof:* Suppose that $A \wedge B$ is true at w . Then A and B are true at w . Moreover, by (7), there is only one world in $f_A(w)$, and that is w . Hence $f_A(w) \subseteq [B]$.

5.7.7 This inference is itself problematic, however. Suppose that you go to a fake fortune-teller, who says that you will come in to a large sum of money. And suppose that, purely by accident, you do. The conditional ‘If the fortune-teller says that you will come into a large sum of money, you will’ would still appear to be false, though both antecedent and consequent are true. Or suppose that food x is normal, but food y is poisoned; and that, as a matter of fact, you will eat both and consequently become ill. According to this account, the conditional ‘If you eat food x you will become ill’ is true. But this seems false: it is y that will make you ill.

5.7.8 Invalidity in C_1 and C_2 may be shown in the same way as for S in 5.6.13. We just need to construct a sphere model which verifies either (6) or (7). It is easy to see that a sphere model will verify (7) if S_0 is a singleton (has just one member). For S_0 is the smallest sphere containing w , so if $w \in [A]$, $f_A(w) = \{w\}$. Similarly, a sphere model will verify (6) if S_0 is a singleton and for every other S_i , $S_i - S_{i-1}$ is also a singleton. For then if S_i is the smallest sphere such that $S_i \cap [A] \neq \emptyset$, $S_i \cap [A]$ must be a singleton.⁸

5.7.9 Thus, the interpretation depicted in 5.6.13 shows that the inference in question there is also invalid in C_1 and C_2 . And the following depicts a counter-model to $(p > q) \vee (p > \neg q)$ in C_1 :

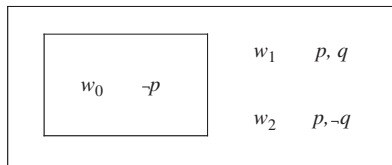

At some of the worlds nearest to w_0 where p is true, q is true; at some, it is false. Hence, neither $p > q$ nor $p > \neg q$ is true at w_0 .

⁸ Note that these conditions are sufficient to verify conditions (6) and (7), but they are not necessary.

5.7.10 To summarise all the systems of conditional logic that we have met in this chapter: the following are systems of properly increasing strength: C, C^+, S, C_1, C_2 .⁹

5.8 Further Philosophical Reflections

5.8.1 Let us finish by picking up a couple of philosophical loose ends. We start with the notion of similarity between worlds. The sphere models assume that there is a sensible notion of this kind, but is there? Presumably, how similar two worlds are will depend on what holds in each of these. But how can one define similarity in terms of these things?

5.8.2 One certainly cannot define it in terms of the *number* of propositions over which the worlds differ. For if there are any differences at all, there will be an infinite number. For example, if A is true at w_1 and false at w_2 , then for any B false at w_2 , $A \vee B$ will be true at w_1 and false at w_2 . (Since there is an infinite number of sentences, and ‘half’ of these are false at w_2 , there will be an infinite number of such B .)

5.8.3 Clearly, some changes are more important than others. The world coming to an end now, for example, would appear to be a bigger difference than my raising my arm. But how can one give an account of such importance?

5.8.4 Moreover, even if one can, is the account one that will validate the sphere models? These require of any two worlds that they have either the same degree of similarity to the actual world, or that one is more similar than the other. (All worlds are comparable in their similarity.) But why should this be the case? Consider two worlds: one is the same as ours, except that snow is green; the other is the same as ours, except that coal is green. Are these equally similar, or is one more similar than the other? I have no idea.

5.8.5 Even if there is some story to be told here, the analysis of conditionals in terms of similarity seems to be vulnerable to a more fundamental

⁹ It should be noted that the postulates characteristic of some of the stronger systems render some of the postulates characteristic of weaker systems redundant. For example, (1), (4) and (6) together entail (5). For suppose that $f_A(w) \cap [B] \neq \phi$. By (1), $f_{A \wedge B}(w) \subseteq [A \wedge B] = [A] \cap [B] \subseteq [A]$. And since $f_A(w)$ is a singleton (by (6)), $f_A(w) \subseteq [B]$. Since $f_A(w) \subseteq [A]$ (by (1)), $f_A(w) \subseteq [A] \cap [B] = [A \wedge B]$. By (4), $f_A(w) = f_{A \wedge B}(w)$.

objection. Consider worlds which are like ours, except that, during the Cuban Missile blockade, President Kennedy pushed the button. In some of these, a nuclear holocaust occurred; in others, something happened to prevent this (maybe a circuit short-circuited), and life continued much as we know it. On almost any understanding of similarity, the second scenario is more similar to the actual world than the first. Hence, according to the similarity account, the conditional ‘If Kennedy had pushed the button, something would have happened to prevent a nuclear holocaust’ is true; but it seems plainly false.

5.8.6 These considerations cast doubt on any theory of the behaviour of the *ceteris paribus* clause that is motivated by similarity considerations; but not C^+ , which does not depend on these. This brings us to the second issue. How does the theory of C^+ fare?

5.8.7 First, consider any interpretation for Kv . Turn this into a conditional-logic interpretation by setting $f_A(w) = [A]$. It is easy to see that this is a C^+ interpretation, since conditions (1) and (2) are satisfied. Moreover, in this interpretation $>$ is just \rightarrow . Hence, if any inference is invalid in Kv , it is invalid in C^+ when ‘ $>$ ’ is substituted for ‘ \rightarrow ’. Thus, this theory does not reintroduce the problems of the material conditional, since \rightarrow is free of these (4.5).

5.8.8 But, on the other hand, it does nothing to avoid the problems of the strict conditional, on which it piggy-backs. For $\Box B \models A > B$ and $\Box \neg A \models A > B$ in C^+ , as may easily be checked. In particular, $\models (A \wedge \neg A) > B$. So we still face the problems that we discussed in 4.7 and 4.8, especially the problem of explosion.

5.9 *Proofs of Theorems

5.9.1 THEOREM: C is sound and complete with respect to its semantics.

Proof:

The soundness argument is essentially the same as that for K (2.9.2–2.9.4). The definition of faithfulness is modified in the obvious way. Thus, ‘if irj is on b , then $f(i)Rf(j)$ in \mathcal{I} ’ is replaced by:

for every formula, A , if ir_{Aj} is on b , then $f(i)R_A f(j)$ in \mathcal{I} .¹⁰

¹⁰ In this proof and the next, f is always used for the function that shows a branch to be faithful to an interpretation. It is never used as the world selection function, $f_A(w)$.

In the Soundness Lemma, the cases for the truth functions, \square and \diamond , are as for Kv (3.10, problem 17). For $>$: suppose that f shows that \mathcal{I} is faithful to b , and that we apply the rule for $>$ to $A > B, i$ and ir_{Aj} to get B, j . By faithfulness, $A > B$ is true at $f(i)$ and $f(i)R_A f(j)$. Hence, B is true at $f(j)$, as required. Suppose, on the other hand, that we apply the rule for negated $>$ to $\neg(A > B), i$ to get ir_{Aj} , and $\neg B, j$ (j new). By faithfulness, $A > B$ is false at $f(i)$. Hence, there is some w such that $f(i)R_A w$ and B is false at w . Let f' be the same as f , except that $f'(j) = w$. Then, as in the normal case for \diamond , f' shows that \mathcal{I} is faithful to b . The rest of the proof of the Soundness Theorem is the same.

The completeness argument is also a modification of that for K (2.9.5–2.9.7). In the induced interpretation, W and ν are defined in the same way. And, for every A :

- if A occurs as the antecedent of a conditional or negated conditional at a node of b , then $w_i R_A w_j$ iff ir_{Aj} is on b ;
- otherwise, $w_i R_A w_j$ iff A is true at w_j .

Two comments should be made on this definition. First, the second clause is, in fact, irrelevant to the following argument. If A is not an antecedent on b , then how R_A behaves is completely irrelevant to the inference in question. We give the definition in this form, however, since the second clause is required for the completeness proof for C^+ in the next theorem. Secondly, note that the clause is well defined. The definition of A 's truth at a world requires the definition of R_B only for those B that are proper subformulas of A .

In the Completeness Lemma, the cases for the truth functions, and for \square and \diamond , are as for Kv (3.10, problem 17). For $>$: suppose that $A > B, i$ is on b . Then for every j such that ir_{Aj} is on b , B, j is on b . By the definition of the induced interpretation, and induction hypothesis, for every w_j such that $w_i R_A w_j$, B is true at w_j . Hence $A > B$ is true at w_i . Finally, suppose that $\neg(A > B), i$ is on b . Then there is a j such that ir_{Aj} and $\neg B, j$ is on b . By the definition of the induced interpretation, and induction hypothesis, there is a w_j such that $w_i R_A w_j$, and B is false at w_j . Hence $A > B$ is false at w_i . The Completeness Theorem then goes through as before. ■

5.9.2 THEOREM: C^+ is sound and complete with respect to its semantics.

Proof:

The proof is a modification of that for C . For soundness, we merely have to check the cases for the rules of 5.5.3 in the Soundness Lemma. The argument for the first of these is the same as that for the rule for negated $>$ in C , except that we have an extra A, i to worry about. But since $f(i)R_A f(j)$, $v_{f(j)}(A) = 1$ by condition (1), as required. For the second, suppose that we apply the rule to obtain one branch containing $\neg A, i$, and one containing $ir_A i$ and A, i . Condition (2) tells us that either $v_{f(i)}(A) = 0$, or $v_{f(i)}(A) = 1$ and $f(i)R_A f(i)$. In the first case, f shows \mathcal{I} to be faithful to the left branch; in the second case, it shows \mathcal{I} to be faithful to the right branch.

For the Completeness Theorem, we have to check, in addition, only that the induced interpretation satisfies conditions (1) and (2). There are two cases, depending on whether or not A occurs as an antecedent on b . If it does not, the result holds simply by the definition of R_A (5.9.1). In the other case, let us consider the two conditions in turn. For (1), suppose that $w_i R_A w_j$; then $ir_A j$ occurs on b . The only way for this to occur is for the node to be the result of an application of one of two rules. But in each of them, when we introduce this node, we also add a node of the form A, j on the same branch. By the Completeness Lemma, $v_{w_j}(A) = 1$, as required. For (2), suppose that $v_{w_i}(A) = 1$. Then, since the second rule has been applied, either $\neg A, i$ or $ir_A i$ is on the branch. But by the Completeness Lemma, it cannot be the first. Hence, $w_i R_A w_i$, as required. ■

5.10 History

The first conditional logic was proposed by Stalnaker (1968), who thought it adequate for both indicative and subjunctive conditionals. His system is essentially C_2 . C_1 was proposed by Lewis (1973a,b), who took it to be appropriate for subjunctive conditionals (the indicative conditional being \supset). C_1 is also called VC in the literature. Some care is required when reading the literature, since both C_1 and C_2 get formulated in slightly different ways. The versions given here are taken, essentially, from Nute (1984). The notion of sphere semantics is also due to Lewis (1973a,b). Sphere semantics not only provide a modelling for selection-function semantics for conditional logics, but, in a sense, are intertranslatable with them. In particular, the systems S , C_1 and C_2 are sound and complete with respect to appropriate versions of the sphere semantics. Details for C_1 and C_2 can be found in Lewis (1971). The

first person to realise that conditional logics could be seen as modal logics with accessibility relations indexed by formulas (or propositions) appears to have been Chellas (1975), who invented the system C . (Strictly speaking, what he calls C is what I have called C plus condition (P) of 5.6.15.) C^+ and S are not standard names. Tableaux for conditional logics of a kind very different from those used in this chapter were given by de Swart (1983) and Gent (1992). The argument of 5.8.5 is due to Fine. It is discussed in Lewis (1979).

5.11 Further Reading

A good survey of conditional logics is Nute (1984). See also Nute (1980). A systematic account of many conditional logics, seen as indexed modal logics, can be found in Segerberg (1989). A debate between Stalnaker and Lewis on C_1 versus C_2 can be found in papers collected in Harper, Stalnaker and Pearce (1981), which also contains a number of other useful papers on conditionals and conditional logics. A discussion of the Lewis–Stalnaker semantics can be found in Read (1994, ch.3).

5.12 Problems

- Complete the details left open in 5.2.1, 5.4.3, 5.5.4, 5.5.8, 5.6.11, 5.7.2, 5.7.6 and 5.8.8.
- Show that the following are true in C :
 - $\Box(A \equiv B) \vdash (C > A) \equiv (C > B)$
 - $A > (B \wedge C) \vdash (A > B) \wedge (A > C)$
 - $(A > B) \wedge (A > C) \vdash A > (B \wedge C)$
 - $A > (B \supset C) \vdash (A > B) \supset (A > C)$
 - $\vdash A > (B \vee \neg B)$
- Show the following are false in C , but true in C^+ . Specify a C counter-model.
 - $\vdash p > p$
 - $p, p > q \vdash q$
 - $p \neg q \vdash p > q$
 - $p \wedge \neg q \vdash \neg(p > q)$
- Show that the following are false in C^+ . Specify a counter-model, either by constructing a tableau, or directly.

- (a) $p > q \models (p \wedge r) > q$
 (b) $p > q \models \neg q > \neg p$
 (c) $p > q, q > r \models p > r$
5. Show that the following fail in C , but hold provided we add the condition on f indicated.
- (a) $(p \vee q) > r \models (p > r) \wedge (q > r)$
 $f_p(w) \cup f_q(w) \subseteq f_{p \vee q}(w)$
 (b) $(p > r) \wedge (q > r) \models (p \vee q) > r$
 $f_{p \vee q}(w) \subseteq f_p(w) \cup f_q(w)$
 (c) $p > q, q > r \models (p \wedge q) > r$
 If $f_p(w) \subseteq [q]$, then $f_{p \wedge q}(w) \subseteq f_q(w)$
6. Show that the following fail in C^+ , but hold in S :
- (a) $\diamond p \models \neg(p > (q \wedge \neg q))$
 (b) $p > q, \neg(p > \neg r) \models (p \wedge r) > q$
 (c) $\Box(p \equiv q) \models (p > r) \equiv (q > r)$
7. By constructing a suitable sphere model, show that the inferences of problem 4 also fail in C_2 . Show that the following is also false in C_2 : $(p \vee q) > r \models (p > r) \wedge (q > r)$.
8. Determine whether the following hold in each of C_1 and C_2 :
- (a) $p > (q \vee r) \models (p > q) \vee (p > r)$
 (b) $p > q, \neg q \models \neg q > \neg p$
 (c) $\diamond p, p > q \models \neg(p > \neg q)$
 (d) $p > (p > q) \models p > q$
 (d) $p > (q > r) \models q > (p > r)$
9. It seems natural to suppose that the inference from $(s \vee t) > r$ to $s > r$ ought to be valid. (For example. 'If you have a broken arm or you have a broken leg, you can claim the allowance. Hence, if you have a broken arm, you can claim the allowance.') Now, suppose that $p > r$. Since $\models \Box(p \equiv ((p \wedge q) \vee (p \wedge \neg q)))$, it follows in S - and, in fact, any logic satisfying the condition (P) - that $((p \wedge q) \vee (p \wedge \neg q)) > r$. (See problem 6 (c).) If the form of inference in question were valid, then, it would follow that $(p \wedge q) > r$. But we know that the inference from $p > r$ to $(p \wedge q) > r$ is invalid. Discuss.

6 Intuitionist Logic

6.1 Introduction

6.1.1 In this chapter, we look at another logic that has a natural possible-world semantics: intuitionist logic, a logic that arose originally out of certain views in the philosophy of mathematics called *intuitionism*.

6.1.2 We will also look briefly at the philosophical foundations of intuitionism, and at the distinctive account of the conditional that intuitionist logic provides.

6.2 Intuitionism: The Rationale

6.2.1 Let us start with a look at the original rationale for intuitionism. Consider the sentence ‘Granny had led a sedate life until she decided to start pushing crack on a small tropical island just south of the Equator.’ You can understand this, and indefinitely many other sentences that you have never (I presume) heard before. How is this possible?

6.2.2 We can understand a sentence of this kind because we understand its individual parts and the way they are put together; the meaning of a sentence is determined by the meanings of its parts, and of the grammatical construction which composes these. This fact is called *compositionality*.

6.2.3 An orthodox view, usually attributed to Frege, is that the meaning of a statement is given by the conditions under which it is true, its *truth conditions*. Thus, by compositionality, the truth conditions of a statement must be given in terms of the truth conditions of its parts. Thus, for example, $\neg A$ is true iff A is not true; $A \wedge B$ is true iff A is true and B is true; and so on.

6.2.4 Now, truth, as commonly conceived, is a relationship between language and an extra-linguistic reality. Thus, ‘Brisbane is in Australia’ is true because of certain objective social and geographical arrangements that obtain in the southern hemisphere of our planet. But many have found the notion of an objective extra-linguistic reality problematic – for mathematics, in particular.

6.2.5 What is the extra-linguistic reality that corresponds to the truth of ‘ $2+3 = 5$ ’? Some (mathematical *realists*) have suggested that there are objectively existing mathematical objects, like 3 and 5. To others, such a view has just seemed like mysticism. These include mathematical intuitionists, who rejected the common conception of truth, as applied to mathematics, for just this reason.

6.2.6 But in this case, how is meaning to be expressed? The intuitionist answer is that the meaning of a sentence is to be given, not by the conditions under which it is true, where truth is conceived as a relationship with some external reality, but by the conditions under which it is proved, its *proof conditions* – where a proof is a (mental) construction of a certain kind.

6.2.7 Thus, supposing that we know what counts as a proof of the simplest sentences (propositional parameters), the proof conditions for sentences constructed using the usual propositional connectives are as follows. In the following sections, it will make matters easier if we use new symbols for negation and the conditional. Hence, we will now write these as \rightarrow and \sqsupset , respectively.

A proof of $A \wedge B$ is a pair comprising a proof of A and a proof of B .

A proof of $A \vee B$ is a proof of A or a proof of B .

A proof of $\rightarrow A$ is a proof that there is no proof of A .

A proof of $A \sqsupset B$ is a construction that, given any proof of A , can be applied to give a proof of B .

6.2.8 Note that these conditions fail to verify a number of standard logical principles – most notoriously, some instances of the law of excluded middle: $A \vee \rightarrow A$. For example, a famous mathematical conjecture whose status is currently undecided is the *twin prime conjecture*: there is an infinite number of pairs of primes, two apart, like 3 and 5, 11 and 13, 29 and 31. Call this claim A . Then there is presently no proof of A ; nor is there a proof that there is no proof of A . Hence, there is no proof of $A \vee \rightarrow A$, which

claim is not, therefore, acceptable. Thus, intuitionism generates a quite distinctive logic.

6.3 Possible-world Semantics for Intuitionism

6.3.1 To obtain a better understanding of this logic, intuitionist logic, let us look at a possible-world semantics which, arguably, captures the above ideas.

6.3.2 The language of propositional intuitionist logic is a language whose only connectives are \wedge , \vee , \rightarrow and \Box .

6.3.3 An intuitionist interpretation for the language is a structure, $\langle W, R, \nu \rangle$, which is the same as an interpretation for the normal modal logic $K_{\rho\tau}$ (so that R is reflexive and transitive) apart from one further constraint, namely that for every propositional parameter, p :

$$\text{for all } w \in W, \text{ if } \nu_w(p) = 1 \text{ and } wRw', \nu_{w'}(p) = 1$$

This is called the *heredity condition*.

6.3.4 The assignment of values to molecular formulas is given by the following conditions:

$$\nu_w(A \wedge B) = 1 \text{ if } \nu_w(A) = 1 \text{ and } \nu_w(B) = 1; \text{ otherwise it is } 0.$$

$$\nu_w(A \vee B) = 1 \text{ if } \nu_w(A) = 1 \text{ or } \nu_w(B) = 1; \text{ otherwise it is } 0.$$

$$\nu_w(\rightarrow A) = 1 \text{ if for all } w' \text{ such that } wRw', \nu_{w'}(A) = 0; \text{ otherwise it is } 0.$$

$$\nu_w(A \Box B) = 1 \text{ if for all } w' \text{ such that } wRw', \text{ either } \nu_{w'}(A) = 0 \text{ or } \nu_{w'}(B) = 1; \text{ otherwise it is } 0.$$

Note that $\rightarrow A$ is, in effect, $\Box \neg A$, and $A \Box B$ is, in effect, $\Box(A \supset B)$.¹

6.3.5 Given these truth conditions, the heredity condition holds, as a matter of fact, not just for propositional parameters, but for all formulas. The proof is relegated to a footnote, which can be skipped if desired.²

¹ Sometimes, the language is taken to contain a propositional constant, \perp , which is true at no world. The truth conditions of $\rightarrow A$ then reduce to those of $A \Box \perp$.

² The proof is by induction on the construction of formulas. Suppose that the result holds for A and B . We show that it holds for $\rightarrow A$, $A \wedge B$, $A \vee B$ and $A \Box B$. For $\rightarrow A$: we prove the contrapositive. Suppose that wRw' , and $\rightarrow A$ is false at w' . Then for some w'' such that $w'Rw''$, A is true at w'' . But then wRw'' , by transitivity. (cont. on next page)

6.3.6 Before we complete the definition of validity, let us see how an intuitionist interpretation arguably captures the intuitionist ideas of the previous section. Think of a world as a state of information at a certain time; intuitively, the things that hold at it are those things which are proved at this time. uRv is thought of as meaning that v is a possible extension of u , obtained by finding some number (possibly zero) of further proofs. Given this understanding, R is clearly reflexive and transitive. (For τ : any extension of an extension is an extension.) And the heredity condition is also intuitively correct. If something is proved, it stays proved, whatever else we prove.

6.3.7 Given the provability conditions of 6.2.7, the recursive conditions of 6.3.4 are also very natural. $A \wedge B$ is proved at a time iff A is proved at that time, and so is B ; $A \vee B$ is proved at a time iff A is proved at that time, or B is. If $\neg A$ is proved at some time, then we have a proof that there is no proof of A . Hence, A will be proved at no possible later time. Conversely, if $\neg A$ is not proved at some time, then it is at least possible that a proof of A will turn up, so A will hold at some possible future time. Finally, if $A \sqsupset B$ is proved at a time, then we have a construction that can be applied to any proof of A to give a proof of B . Hence, at any future possible time, either there is no proof of A , or, if there is, this gives us a proof of B . Conversely, if $A \sqsupset B$ is not proved at a time, then it is at least possible that at a future time, A will be proved, and B will not be. That is, A holds and B fails at some possible future time.

6.3.8 Back to validity: this is defined as truth preservation over all worlds of all interpretations, in the usual way. We will write intuitionist logical consequence as \models_I , when necessary.

6.3.9 Observe that if an intuitionist interpretation has just one world, the recursive conditions for the connectives of 6.3.4 just reduce to the standard classical conditions. A one-world intuitionist interpretation is, in

Hence, $\neg A$ is false at w . For $A \wedge B$: suppose that $A \wedge B$ is true at w , and that wRw' . Then A and B are true at w . By induction hypothesis, A and B are true at w' . Hence, $A \wedge B$ is true at w' . For $A \vee B$: the argument is similar. For $A \sqsupset B$: we again prove the contrapositive. Suppose that wRw' and $A \sqsupset B$ is false at w' . Then for some w'' such that $w'Rw''$, A is true and B is false at w'' . But, by transitivity, wRw'' . Hence $A \sqsupset B$ is false at w .

effect, therefore, a classical interpretation. Thus, if truth is preserved at all worlds of all intuitionist interpretations, it is preserved in all classical interpretations. If an inference is intuitionistically valid, it is therefore classically valid (when \rightarrow and \Box are replaced with \neg and \supset , respectively). The converse is not true, as we shall see. Hence, intuitionist logic is a sub-logic of classical logic.³

6.3.10 Note, finally, that logics stronger than intuitionist logic, but still weaker than classical logic, can be obtained by putting further constraints on the accessibility relation, R . These are usually known as *intermediate logics*. Perhaps the best known of these is a logic called *LC*, obtained by insisting that R be a linear order, that is, by adding the constraint that for all $w_1, w_2 \in W$, $w_1 R w_2$ or $w_2 R w_1$ or $w_1 = w_2$.

6.4 Tableaux for Intuitionist Logic

6.4.1 To obtain tableaux for intuitionist logic, we modify those for normal modal logics. The first modification is that a node on the tableau is now of the form $A, +i$ or $A, -i$. The first means, intuitively, that A is true at world i ; the second means that A is false at i . For previous modal logics, the fact that A was false at a world was indicated by $\neg A, i$. But now, A may be false at a world without $\neg A$ being true there.

6.4.2 The initial list of a tableau for a given inference now comprises $B, +0$, for every premise, B , and $A, -0$, where A is the conclusion.

³ This is not true of intuitionist mathematics in general. Intuitionist mathematics endorses some mathematical principles which are not endorsed in classical mathematics; in fact, they are inconsistent classically. But because intuitionist logic is weaker than classical logic, the principles are intuitionistically consistent. For the record, it is worth noting that there is a certain way of seeing classical logic as a part of intuitionist logic too. For it can be shown that if $\Sigma \vdash A$ in classical logic, then $\rightarrow \rightarrow \Sigma \vdash_I \rightarrow \rightarrow A$, when all occurrences of \neg and \supset are replaced by \rightarrow and \Box , and $\rightarrow \rightarrow \Sigma = \{\rightarrow \rightarrow A : A \in \Sigma\}$. (The converse is obviously the case, given that intuitionist logic is a sub-logic of classical logic, and the law of double negation holds for the latter.) This was proved by V. Glivenko in 1929. It also follows (unobviously) that the logical truths of classical logic, expressible using only \wedge and \neg , are identical with those of intuitionist logic (when \neg is replaced by \rightarrow). Every sentence of classical propositional logic is logically equivalent to one employing only \wedge and \neg . On these matters, see Kleene (1952, pp. 492-3).

6.4.3 Closure of a branch occurs just when we have nodes of the form $A, +i$ and $A, -i$.

6.4.4 The rules of the tableau for the connectives are as follows:

$$\begin{array}{cc}
 A \wedge B, +i & A \wedge B, -i \\
 \downarrow & \swarrow \quad \searrow \\
 A, +i & A, -i \quad B, -i \\
 B, +i &
 \end{array}$$

$$\begin{array}{cc}
 A \vee B, +i & A \vee B, -i \\
 \swarrow \quad \searrow & \downarrow \\
 A, +i \quad B, +i & A, -i \\
 & B, -i
 \end{array}$$

$$\begin{array}{cc}
 A \sqsupset B, +i & A \sqsupset B, -i \\
 \quad \quad \quad \textit{irj} & \downarrow \\
 \swarrow \quad \searrow & \textit{irj} \\
 A, -j \quad B, +j & A, +j \\
 & B, -j
 \end{array}$$

$$\begin{array}{cc}
 \rightarrow A, +i & \rightarrow A, -i \\
 \quad \quad \quad \textit{irj} & \downarrow \\
 \quad \quad \quad \downarrow & \textit{irj} \\
 A, -j & A, +j
 \end{array}$$

$$\begin{array}{c}
 p, +i \\
 \quad \quad \quad \textit{irj} \\
 \quad \quad \quad \downarrow \\
 p, +j
 \end{array}$$

The rules for \wedge and \vee are self-explanatory. The first rule for each of \sqsupset and \rightarrow is applied for every j on the branch. In the second, for each, the j is new. The rules are easier to remember if one recalls that $A \sqsupset B$ means, in effect, $\sqsupset(A \supset B)$, and $\rightarrow A$ means, in effect, $\sqsupset\neg A$. Note that, in particular, we can never ‘tick off’ any node of the form $A \sqsupset B, +i$ or $\rightarrow A, +i$, since we may have to come back and reapply the rule if anything of the form \textit{irj} turns up. The final rule is applied only to propositional parameters, and, again, to

every j (distinct from i). The rule is required by the heredity condition, and we will refer to it as the *heredity rule*. Note that there is no corresponding rule for $p, -i$.

6.4.5 We also have the rules ρ and τ (of 3.3.2), as required for the reflexivity and transitivity of R .

6.4.6 As an example, here is a tableau to show that $\vdash_I p \Box \rightarrow \rightarrow p$:

$p \Box \rightarrow \rightarrow p, -0$	(1)
$0r0$	
$0r1$	(2)
$p, +1$	(3)
$\rightarrow \rightarrow p, -1$	(4)
$1r1$	
$1r2$	(5)
$\rightarrow p, +2$	(6)
$2r2, 0r2$	
$p, -2$	(7)
$p, +2$	(8)
\times	

(2)-(4) are obtained from (1) by the rule for false \Box . (5) and (6) are obtained from (4) by the rule for false \rightarrow . (7) is obtained from (6) by the rule for true \rightarrow (and the fact that $2r2$). Finally, (8) is obtained from (3) by the heredity rule (and the fact that $1r2$).⁴

6.4.7 Here is another example to demonstrate that $p \Box q \not\vdash_I \rightarrow p \vee q$. (Since the inference is classically valid - when \Box and \rightarrow are replaced by \supset and

⁴ Note a distinctive feature of intuitionist tableaux. Suppose that we had constructed the tableau using, not a propositional parameter, p , but an arbitrary formula, A . Then we could not apply the heredity rule to close off the tableau in the same way. But since anything of the form $A \Box \rightarrow \rightarrow A$ is logically true, and the tableau system is complete, tableaux for all such formulas will close, though not in a uniform way. (That is, for each sentence that A represents, the tableau will continue to closure in a different way.) This could be changed by making the heredity rule apply to all formulas, not just propositional parameters. And since heredity does hold for arbitrary formulas (6.3.5), this rule is sound. But this complicates tableaux enormously, and, by completeness, is unnecessary anyway.

\neg – this shows that intuitionist logic is a proper sub-logic of classical logic.)

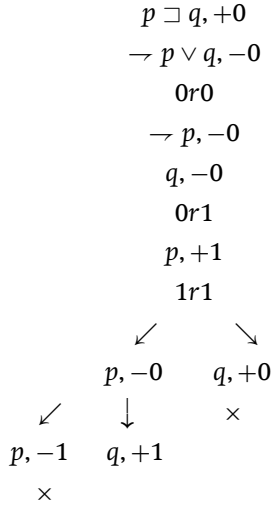

The sixth and seventh lines are given by the rule for false \rightarrow , applied to the fourth line. Both splits are caused by an application of the rule for true \sqsupset to the first line, to worlds 0 and 1, respectively. Note that there are no possible applications of the heredity rule.

6.4.8 Counter-models are read off from an open branch of a tableau in a natural way. The worlds and accessibility relation are as the branch of the tableau specifies. If a node of the form $p, +i$ occurs on the branch, p is set to true at w_i ; otherwise, p is false at w_i . (In particular, if a node of the form $p, -i$ occurs on the branch, p is set to false at w_i .) Thus, reading from the open branch of the tableau of 6.4.7, $W = \{w_0, w_1\}$; w_0Rw_0 , w_0Rw_1 and w_1Rw_1 ; $v_{w_0}(p) = v_{w_0}(q) = 0$ and $v_{w_1}(p) = v_{w_1}(q) = 1$.

6.4.9 In pictures:

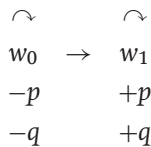

We indicate the fact that p is true (at a world) by $+p$, and the fact that it is false by $-p$. It is a simple matter to check directly that the interpretation is a counter-model. At every world accessible from w_0 , p is false or q is true.

Hence, $p \sqsupset q$ is true at w_0 . p is true at w_1 ; hence $\neg p$ is false at w_0 . But q is also false there. Hence, $\neg p \vee q$ is false there.

6.4.10 The tableaux are sound and complete with respect to the semantics. This is demonstrated in 6.7.

6.4.11 Note that, as for $K_{\rho\tau}$, open tableaux for intuitionist logic may be infinite. Here, for example, is the start of a tableau which establishes that $\not\vdash_{I} \neg\neg p \sqsupset p$:

$$\begin{array}{l}
 \neg\neg p \sqsupset p, -0 \\
 0r0 \\
 0r1 \\
 \neg\neg p, +1 \\
 p, -1 \\
 1r1 \\
 \neg p, -1 \\
 1r2 \\
 p, +2 \\
 2r2, 0r2 \\
 \neg p, -2 \\
 2r3 \\
 \vdots
 \end{array}$$

Every time we open a new world, i , the fourth line (and transitivity) requires us to write $\neg p, -i$ there; but this requires us to open a new world, j , such that $i r j$ and $p, +j$, and so on.

6.4.12 Again, as with $K_{\rho\tau}$, in such cases it is usually easier to construct counter-models directly. Thus, for $\neg\neg p \sqsupset p$, the following will work:

$$\begin{array}{ccc}
 \curvearrowright & & \curvearrowright \\
 w_0 & \rightarrow & w_1 \\
 -p & & +p
 \end{array}$$

Since p is true at w_1 , $\neg p$ is false at w_0 and w_1 . Hence, $\neg\neg p$ is true at w_0 . Since p is false there, $\neg\neg p \sqsupset p$ is false at w_0 .

6.5 The Foundations of Intuitionism

6.5.1 So much for formal details: in this section we look a little further into the foundations of intuitionism.

6.5.2 The intuitionist critique of classical logic described in 6.2, is not, as a matter of fact, very persuasive. For even if one rejects a realm of independently existing mathematical objects, one might simply say that, for atomic sentences, truth is to be considered as provability. Yet once truth is defined in this way for atomic sentences, truth conditions for connectives are given as in classical logic. Thus, if we are dealing with arithmetic, something like ‘ $2 + 3 = 5$ ’ is true if the numerical algorithm for addition verifies it. Then, for any sentence, A , $\neg A$ is true iff A is not true, and so on. Thus, classical logic is not impugned.

6.5.3 A much more subtle but radical argument for intuitionism has been elaborated in recent years by a number of people, but most notably by Dummett, based on quite different considerations. *In nuce*, it goes as follows. Someone who understands the meaning of a sentence must be able to demonstrate that they grasp its meaning, or we would not be able to recognise that they understood it (nor, the argument sometimes continues, would we ever be able to learn the meaning of the sentence from others). In particular, we demonstrate our understanding of the meaning of a sentence by being prepared to assert it in those conditions under which it obtains (and just those). But if classical truth conditions were employed, this would be impossible. For such conditions allow for the possibility that a sentence could be true, even though we could never recognise this. For example, the sentence ‘It is not the case that there are unicorn-like creatures somewhere in space and time’ might be true, even though we could never establish this. Hence, meanings must be specified in terms of something which we can recognise as obtaining, namely the conditions under which a sentence is shown to be true, that is, *verified*.

6.5.4 Clearly, Dummett’s argument applies to all language, not just to mathematical language. Intuitionist claims about mathematics are just a special case, proof being mathematical verification. If this critique is right, then, intuitionist logic would be correct quite generally.

6.5.5 But one may have doubts about Dummett’s argument for several reasons. For a start, why must it always be necessary to be able to manifest

a grasp of meaning? Some aspects of meaning might simply be innate, or hard-wired into us. We do not need to learn them; nor do we need an *a posteriori* guarantee that a speaker possesses them. (Chomsky has argued that our grammar is innate in just this way.)

6.5.6 But even granting that the grasp of meaning must be manifestable, why does it have to be manifestable in a way as strong as the argument requires? Why is it not sufficient simply to assent to a sentence when the state of affairs it describes *is* manifest, and not when it isn't?

6.5.7 It might be suggested that such a manifestation would not be adequate. There will be cases where people assent to the same sentence, but do not mean the same thing by it, as would be demonstrated by some situation that will never, as a matter of fact, come to light, but in which they would differ. Thus, for example, you and I might agree that standard objects are red, but yet mean different things by the word, as would be exposed by a disagreement about the redness of some totally novel object that will, as a matter of fact, never come to light.

6.5.8 This may be so. But if people not only agree on given cases, but also manifest a disposition to agree on novel cases when they do arise, this is sufficient to show (if not, perhaps, conclusively, then at least beyond reasonable doubt) that they are operating with the notion in question in the same way. (This is essentially what following an appropriate rule comes to, in Wittgensteinian terms.)

6.6 The Intuitionist Conditional

6.6.1 Setting aside the intuitionist critique in general, let us finish by considering the intuitionist conditional in its own right. All the claims about \models_I in the following subsections can be checked by suitable tableaux, and are left as exercises.

6.6.2 The intuitionist conditional has an unusual mixture of properties. It validates the paradoxes of the material conditional, $q \models p \supset q$, $\neg p \models p \supset q$, and so is liable to the objections of 1.7 (which, as we saw there, are not conclusive). However, the following are false:

$$\begin{aligned} (p \wedge q) \supset s &\not\models (p \supset s) \vee (q \supset s) \\ (p \supset q) \wedge (s \supset t) &\not\models (p \supset t) \vee (s \supset q) \\ \neg (p \supset q) &\not\models p \end{aligned}$$

So the conditional does not fall to the more damaging objections of 1.9.

6.6.3 The following hold in intuitionist logic:

$$\begin{aligned} p \sqsupset q &\models \neg q \sqsupset \neg p \\ p \sqsupset q, q \sqsupset s &\models p \sqsupset s \\ p \sqsupset s &\models (p \wedge q) \sqsupset s \end{aligned}$$

Hence, the intuitionist conditional is not suitable as an account of a conditional with an enthymematic *ceteris paribus* clause, for reasons that we saw in 5.2.

6.6.4 Most importantly, the intuitionist conditional also validates the strict paradox: $\models (p \wedge \neg p) \sqsupset q$, and so is not suitable as an account of the ordinary conditional, for reasons that we saw in 4.8.

6.6.5 Intuitionist logic also validates the strict paradox $\sqsupset q \models p \sqsupset q$ - or, at least, obviously would do so if the language were augmented with the modal operator. But it does not validate the classical instance: $\models p \sqsupset (q \vee \neg q)$. The reason for this is that $q \vee \neg q$ is not a logical truth: there are situations in which something of the form $q \vee \neg q$ may fail. This thought takes us into the next chapter.

6.7 *Proofs of Theorems

6.7.1 The soundness and completeness proofs for intuitionist tableaux are modifications of those for normal modal logics. We start by redefining faithfulness.

6.7.2 DEFINITION: Let $\mathcal{I} = \langle W, R, v \rangle$ be any intuitionist interpretation, and b be any branch of a tableau. Then \mathcal{I} is *faithful* to b iff there is a map, f , from the natural numbers to W such that:

- for every node A , $+i$ on b , A is true at $f(i)$ in \mathcal{I} .
- for every node A , $-i$ on b , A is false at $f(i)$ in \mathcal{I} .
- if irj is on b , $f(i)Rf(j)$ in \mathcal{I} .

6.7.3 SOUNDNESS LEMMA: Let b be any branch of a tableau, and $\mathcal{I} = \langle W, R, v \rangle$ be any intuitionist interpretation. If \mathcal{I} is faithful to b , and a tableau rule is applied to b , then this produces at least one extension, b' , such that \mathcal{I} is faithful to b' .

Proof:

Let f be a function which shows \mathcal{I} to be faithful to b . The proof proceeds by a case-by-case consideration of the tableau rules. The cases for the rules ρ and τ are as 3.7.1. The propositional rules for \wedge and \vee are straightforward. For \sqsupset : suppose that $A \sqsupset B, +i$ and irj are on b , and that we apply the rule, splitting the branch, to get $A, -j$ on one branch and $B, +j$, on the other. Then $A \sqsupset B$ is true at $f(i)$, and $f(i)Rf(j)$; hence, either A is false at $f(j)$ and \mathcal{I} is faithful to the first branch, or B is true at $f(j)$ and it is faithful to the second. Suppose that $A \sqsupset B, -i$ is on b , and that we apply the rule to get $irj, A, +j$ and $B, -j$, where j is new. Then $A \sqsupset B$ is false at $f(i)$. Hence, there is a w such that $f(i)Rw$, A is true at w , and B is false at w . Let f' be the same as f , except that $f'(j) = w$. Then f' shows that \mathcal{I} is faithful to the extended branch, as usual. For \rightarrow : suppose that $\rightarrow A, +i$ and irj are on b , and that we apply the rule to get $A, -j$. Then $\rightarrow A$ is true at $f(i)$, and $f(i)Rf(j)$; hence, A is false at $f(j)$, as required. Suppose that $\rightarrow A, -i$ is on b , and that we apply the rule to get $irj, A, +j$, where j is new. Then $\rightarrow A$ is false at $f(i)$. Hence, there is a w such that $f(i)Rw$, and A is true at w . Let f' be the same as f , except that $f'(j) = w$. Then f' shows that \mathcal{I} is faithful to the extended branch, as usual. This leaves the heredity rule. Suppose that $p, +i$ and irj are on b , and that we apply the rule to get $p, +j$. Since p is true at $f(i)$ and $f(i)Rf(j)$, p is true at $f(j)$, by the heredity condition. ■

6.7.4 SOUNDNESS THEOREM: For finite Σ , if $\Sigma \vdash_I A$ then $\Sigma \models_I A$.

Proof:

This follows from the Soundness Lemma in the usual way. ■

6.7.5 DEFINITION: Let b be an open branch of a tableau. The interpretation, $\mathcal{I} = \langle W, R, v \rangle$, induced by b , is defined as in 6.4.8. $W = \{w_i : i \text{ occurs on } b\}$. w_iRw_j iff irj occurs on b . $v_{w_i}(p) = 1$ iff $p, +i$ occurs on b .

6.7.6 LEMMA: If b is an open branch of a tableau, and \mathcal{I} is the interpretation it induces, \mathcal{I} is an intuitionist interpretation.

Proof:

First, R satisfies the conditions ρ and τ , as in 3.7.3. For the heredity condition, suppose that p is true at w_i and w_iRw_j . Then $p, +i$ and irj occur on b . Since the heredity rule has been applied, $p, +j$ is on b , and hence p is true at w_j in \mathcal{I} , as required. ■

6.7.7 COMPLETENESS LEMMA: Let b be any open completed branch of a tableau. Let $\mathcal{I} = \langle W, R, \nu \rangle$ be the interpretation induced by b . Then:

if $A, +i$ is on b , then A is true at w_i

if $A, -i$ is on b , then A is false at w_i

Proof:

The proof is by recursion on the complexity of A . If A is atomic, the result is true by definition, and the fact that b is open. If $B \vee C, +i$ is on b , then either $B, +i$ or $C, +i$ is on b . By induction hypothesis, either B or C is true at w_i . So $B \vee C$ is true at w_i . If $B \vee C, -i$ is on b , then $B, -i$ and $C, -i$ are on b . By induction hypothesis, B and C are false at w_i . Hence, $B \vee C$ is false at w_i . The argument for $B \wedge C$ is similar. If $B \sqsupset C, +i$ is on b , then for every j such that irj is on b , either $B, -j$ or $C, +j$ is on b . Hence, by construction and induction hypothesis, for every w_j such that $w_i R w_j$, either B is false at w_j or C is true at w_j . Thus, $B \sqsupset C$ is true at w_i . If $B \sqsupset C, -i$ is on b , then for some $j, irj, B, +j$ and $C, -j$ are on b . By construction and induction hypothesis, there is a w_j such that $w_i R w_j$, B is true at w_j , and C is false at w_j . Hence, $B \sqsupset C$ is false at w_i . Finally, if $\neg B, +i$ is on b , then for every j such that irj is on $b, B, -j$ is on b . By construction and induction hypothesis, for every w_j such that $w_i R w_j$, B is false at w_j . Thus, $\neg B$ is true at w_i . If $\neg B, -i$ is on b , then for some j, irj and $B, +j$ are on b . By construction and induction hypothesis, there is a w_j such that $w_i R w_j$ and B is true at w_j . Hence, $\neg B$ is false at w_i . ■

6.7.8 COMPLETENESS THEOREM: For finite Σ , if $\Sigma \models_I A$ then $\Sigma \vdash_I A$.

Proof:

The result follows from the previous two lemmas in the usual fashion. ■

6.8 History

Intuitionism was first advocated by the Dutch mathematician Brouwer in a number of papers from just before the First World War until the early 1950s. (The name ‘intuitionism’ comes from the fact that Brouwer took himself to be endorsing the Kantian claim that arithmetic is the pure form of temporal intuition.) Intuitionist logic was formulated first (as an axiom system) by the Dutch logician Heyting in 1930. For a history of the intuitionist movement, see Fraenkel, Bar-Hillel and Levy (1973, ch. 4). The close connection between intuitionist logic and $K\rho\tau$ was observed (before the advent

of possible-world semantics) by Gödel (1933a) and later, in a different way, by McKinsey and Tarski (1948). (See 6.10, problem 11.) The possible-world semantics for intuitionist logic were first given by Kripke (1965b). The logic *LC* was first formulated by Dummett (1959). Frege expressed the view that meaning is determined by truth conditions in section 32 of volume 1 of his *Grundgesetze der Arithmetik*. Dummett advocated intuitionist logic in a number of places starting in the mid-1970s (see the next section). The innateness of grammar was advocated by Chomsky (1971). Innateness was advocated in semantics by Fodor (1975). Cryptic remarks on rule-following can be found in Wittgenstein (1953, esp. sects. 201–40).

6.9 Further Reading

A gentle introduction to intuitionism can be found in Haack (1974, ch. 5). A more technical introduction can be found in Fraenkel, Bar-Hillel and Levy (1973, ch. 4). A systematic account of intuitionist logic, mathematics and philosophy can be found in Dummett (1977). His argument for intuitionism is spelled out there in 7.1, and also in Dummett (1975a). It is generalised to all language in Dummett (1976). A critique of Dummett's position can be found in Wright (1987). For a readable introduction to constructivism in general, see Read (1994, ch. 8). On intermediate logics, see van Dalen (2006), section 5.

6.10 Problems

1. Verify the claims made about intuitionist validity, left as exercises in 6.6.
2. Show that in an intuitionist interpretation, $\rightarrow A$ is true at a world, w , iff for all w' such that wRw' , there is a w'' such that $w'Rw''$ and A is true at w'' .
3. Show the following in intuitionist logic:
 - (a) $\vdash (p \wedge (\rightarrow p \vee q)) \supset q$
 - (b) $\vdash \rightarrow (p \wedge \rightarrow p)$
 - (c) $\rightarrow p \vee q \vdash p \supset q$
 - (d) $\rightarrow (p \vee q) \vdash \rightarrow p \wedge \rightarrow q$
 - (e) $\rightarrow p \wedge \rightarrow q \vdash \rightarrow (p \vee q)$
 - (f) $\rightarrow p \vee \rightarrow q \vdash \rightarrow (p \wedge q)$

(g) $p \sqsupset (p \sqsupset q) \vdash p \sqsupset q$

(h) $\vdash \neg\neg (p \vee \neg p)$

4. Either using tableaux, or by constructing counter-models directly, show each of the following. In each case, define the interpretation and draw a picture of it. (For simplicity, omit the extra arrows required by transitivity. Take them as read.) Check that the interpretation works.

(a) $\not\models p \vee \neg p$

(b) $\neg p \sqsupset p \not\models p$

(c) $\neg (p \wedge q) \not\models p \vee \neg q$

(d) $\neg p \sqsupset \neg q \not\models q \sqsupset p$

(e) $p \sqsupset (q \vee r) \not\models (p \sqsupset q) \vee (p \sqsupset r)$

5. Show that if $\models A \vee B$ then $\models A$ or $\models B$. (Hint: take counter-models for A and B ; let A fail in the first at w_A , and B fail in the second at w_B . Construct a counter-model for $A \vee B$ by putting the two together in an appropriate way, adding a new world, w , such that wRw_A and wRw_B .) Show that it is not the case that if $\models \neg(A \wedge B)$ then $\models \neg A$ or $\models \neg B$. (Hint: consider the formula $\neg(p \wedge \neg p)$.)
6. Show that in intuitionist logic $\not\models (p \sqsupset q) \vee (q \sqsupset p)$. Show that this is valid in *LC*. (Hint: suppose that it is not, and argue by *reductio*.)
7. How else might one manifest an understanding of the meaning of a sentence, other than by asserting it when it becomes manifest that the situation described obtains?
8. * Consider the following tableau rule:

$$\begin{array}{c} p, \neg j \\ irj \\ \downarrow \\ p, \neg i \end{array}$$

Show that if this rule is added to tableaux for intuitionist logic, they are still sound. Use the completeness of intuitionist tableaux to infer that the rule is redundant.

9. *Call a *strong intuitionist interpretation* one where R satisfies the additional condition: for all $x, y \in W$, if xRy and yRx , then $x = y$. (This makes R a partial order.) If an inference is intuitionistically valid, it is obviously truth-preserving in all worlds of strong intuitionist interpretations. Show the converse. (Hint: Consider the interpretation induced by an open branch of a tableau for an invalid inference.)

10. * Construct a tableau system for *LC*. (Hint: look at 3.6b.) Prove that this is sound and complete with respect to the semantics.
11. * The McKinsey–Tarski *translation* is a map, M , from the sentences of intuitionist propositional logic into the language of $K_{\rho\tau}$, defined, by recursion, thus:

$$\begin{aligned}
 p^M &= \Box p \\
 (A \wedge B)^M &= A^M \wedge B^M \\
 (A \vee B)^M &= A^M \vee B^M \\
 (A \supset B)^M &= \Box(A^M \supset B^M) \\
 (\neg A)^M &= \Box \neg A^M
 \end{aligned}$$

Given an intuitionist interpretation (which is also, of course, a $K_{\rho\tau}$ interpretation), show by recursion on the construction of sentences that A is true at a world, w , iff A^M is true at w . Let $\Sigma^M = \{A^M : A \in \Sigma\}$. Infer that if $\Sigma^M \models_{K_{\rho\tau}} A^M$, then $\Sigma \models_I A$. Suppose that $\Sigma^M \not\models_{K_{\rho\tau}} A^M$ (and hence that $\Sigma^M \not\models_{K_{\rho\tau}} A^M$), and consider the interpretation induced by an open branch of the tableau. Show that this satisfies the heredity condition, and hence infer the converse.

7 Many-valued Logics

7.1 Introduction

7.1.1 In this chapter, we leave possible-world semantics for a time, and turn to the subject of propositional many-valued logics. These are logics in which there are more than two truth values.

7.1.2 We have a look at the general structure of a many-valued logic, and some simple but important examples of many-valued logics. The treatment will be purely semantic: we do not look at tableaux for the logics, nor at any other form of proof procedure. Tableaux for some many-valued logics will emerge in the next chapter.

7.1.3 We also look at some of the philosophical issues that have motivated many-valued logics, how many-valuedness affects the issue of the conditional, and a few other noteworthy issues.

7.2 Many-valued Logic: The General Structure

7.2.1 Let us start with the general structure of a many-valued logic. To simplify things, we take, henceforth, $A \equiv B$ to be defined as $(A \supset B) \wedge (B \supset A)$.

7.2.2 Let \mathcal{C} be the class of connectives of classical propositional logic $\{\wedge, \vee, \neg, \supset\}$. The classical propositional calculus can be thought of as defined by the structure $\langle \mathcal{V}, \mathcal{D}, \{f_c; c \in \mathcal{C}\} \rangle$. \mathcal{V} is the set of truth values $\{1, 0\}$. \mathcal{D} is the set of *designated* values $\{1\}$; these are the values that are preserved in valid inferences. For every connective, c , f_c is the truth function it denotes. Thus, f_{\neg} is a one-place function such that $f_{\neg}(0) = 1$ and $f_{\neg}(1) = 0$; f_{\wedge} is a two-place function such that $f_{\wedge}(x, y) = 1$ if $x = y = 1$, and $f_{\wedge}(x, y) = 0$ otherwise; and so

on. These functions can be (and often are) depicted in the following ‘truth tables’.

f_{\neg}	
1	0
0	1

f_{\wedge}	1	0
1	1	0
0	0	0

7.2.3 An interpretation, ν , is a map from the propositional parameters to \mathcal{V} . An interpretation is extended to a map from all formulas into \mathcal{V} by applying the appropriate truth functions recursively. Thus, for example, $\nu(\neg(p \wedge q)) = f_{\neg}(\nu(p \wedge q)) = f_{\neg}(f_{\wedge}(\nu(p), \nu(q)))$. (So if $\nu(p) = 1$ and $\nu(q) = 0$, $\nu(\neg(p \wedge q)) = f_{\neg}(f_{\wedge}(1, 0)) = f_{\neg}(0) = 1$.) Finally, an inference is semantically valid just if there is no interpretation that assigns all the premises a value in \mathcal{D} , but assigns the conclusion a value not in \mathcal{D} .

7.2.4 A many-valued logic is a natural generalisation of this structure. Given some propositional language with connectives \mathcal{C} (maybe the same as those of the classical propositional calculus, maybe different), a logic is defined by a structure $\langle \mathcal{V}, \mathcal{D}, \{f_c; c \in \mathcal{C}\} \rangle$. \mathcal{V} is the set of truth values: it may have any number of members (≥ 1). \mathcal{D} is a subset of \mathcal{V} , and is the set of designated values. For every connective, c , f_c is the corresponding truth function. Thus, if c is an n -place connective, f_c is an n -place function with inputs and outputs in \mathcal{V} .

7.2.5 An interpretation for the language is a map, ν , from propositional parameters into \mathcal{V} . This is extended to a map from all formulas of the language to \mathcal{V} by applying the appropriate truth functions recursively. Thus, if c is an n -place connective, $\nu(c(A_1, \dots, A_n)) = f_c(\nu(A_1), \dots, \nu(A_n))$. Finally, $\Sigma \models A$ iff there is no interpretation, ν , such that for all $B \in \Sigma$, $\nu(B) \in \mathcal{D}$, but $\nu(A) \notin \mathcal{D}$. A is a logical truth iff $\phi \models A$, i.e., iff for every interpretation $\nu(A) \in \mathcal{D}$.

7.2.6 If \mathcal{V} is finite, the logic is said to be *finitely many-valued*. If \mathcal{V} has n members, it is said to be an n -valued logic.

7.2.7 For any finitely many-valued logic, the validity of an inference with finitely many premises can be determined, as in the classical propositional calculus, simply by considering all the possible cases. We list all the possible combinations of truth values for the propositional parameters employed.

Then, for each combination, we compute the value of each premise and the conclusion. If, in any of these, the premises are all designated and the conclusion is not, the inference is invalid. Otherwise, it is valid. We will have an example of this procedure in the next section.

7.2.8 This method, though theoretically adequate, is often impractical because of exponential explosion. For if there are m propositional parameters employed in an inference, and n truth values, there are n^m possible cases to consider. This grows very rapidly. Thus, if the logic is 4-valued and we have an inference involving just four propositional parameters, there are already 256 cases to consider!

7.3 The 3-valued Logics of Kleene and Łukasiewicz

7.3.1 In what follows, we consider some simple examples of the above general structure. All the examples that we consider are 3-valued logics. The language, in every case, is that of the classical propositional calculus.

7.3.2 A simple example of a 3-valued logic is as follows. $\nu = \{1, i, 0\}$. 1 and 0 are to be thought of as *true* and *false*, as usual. i is to be thought of as *neither true nor false*. \mathcal{D} is just $\{1\}$. The truth functions for the connectives are depicted as follows:

f_{\neg}	
1	0
i	i
0	1

f_{\wedge}	1	i	0
1	1	i	0
i	i	i	0
0	0	0	0

f_{\vee}	1	i	0
1	1	1	1
i	1	i	i
0	1	i	0

f_{\supset}	1	i	0
1	1	i	0
i	1	i	i
0	1	1	1

Thus, if $\nu(p) = 1$ and $\nu(q) = i$, $\nu(\neg p) = 0$ (top row of f_{\neg}), $\nu(\neg p \vee q) = i$ (bottom row, middle column of f_{\vee}), etc.

7.3.3 Note that if the inputs of any of these functions are classical (1 or 0), the output is exactly the same as in the classical case. We compute the other entries as follows. Take $A \wedge B$ as an example. If A is false, then, whatever B is, this is (classically) sufficient to make $A \wedge B$ false. In particular, if B is neither true nor false, $A \wedge B$ is false. If A is true, on the other hand, and B is neither true nor false, there is insufficient information to compute the (classical) value of $A \wedge B$; hence, $A \wedge B$ is neither true nor false. Similar reasoning justifies all the other entries.

7.3.4 The logic specified above is usually called the (strong) Kleene 3-valued logic, often written K_3 .¹

7.3.5 The following table verifies that $p \supset q \models_{K_3} \neg q \supset \neg p$:

p	q	$p \supset q$	$\neg q \supset \neg p$
1	1	1	0
1	i	i	i
1	0	0	0
i	1	1	1
i	i	i	i
i	0	i	1
0	1	1	1
0	i	1	1
0	0	1	1

In the last three columns, the first number is the value of $\neg q$; the last number is that of $\neg p$, and the central number (printed in bold) is the value of the whole formula. As can be seen, there is no interpretation where the premise is designated, that is, has the value 1, and the conclusion is not.

7.3.6 In checking for validity, it may well be easier to work backwards. Consider the formula $p \supset (q \supset p)$. Suppose that this is undesignated. Then it has either the value 0 or the value i . If it has the value 0, then p has the value 1 and $q \supset p$ has the value 0. But if p has the value 1, so does $q \supset p$. This situation is therefore impossible. If it has the value i , there are three possibilities:

p	$q \supset p$
1	i
i	i
i	0

The first case is not possible, since if p has the value 1, so does $q \supset p$. Nor is the last case, since if p has the value i , $q \supset p$ has value either i or 1. But the

¹ Weak Kleene logic is the same as K_3 , except that, for every truth function, if any input is i , so is the output.

second case is possible, namely when both p and q have the value i . Thus, $v(p) = v(q) = i$ is a counter-model to $p \supset (q \supset p)$, as a truth-table check confirms. So $\not\models_{K_3} p \supset (q \supset p)$.

7.3.7 A distinctive thing about K_3 is that the law of excluded middle is not valid: $\not\models_{K_3} p \vee \neg p$. (Counter-model: $v(p) = i$.) However, K_3 is distinct from intuitionist logic. As we shall see in 7.10.8, intuitionist logic is not the same as any finitely many-valued logic.

7.3.8 In fact, K_3 has no logical truths at all (7.14, problem 3)! In particular, the law of identity is not valid: $\not\models_{K_3} p \supset p$. (Simply give p the value i .) This may be changed by modifying the middle entry of the truth function for \supset , so that f_{\supset} becomes:

f_{\supset}	1	i	0
1	1	i	0
i	1	1	i
0	1	1	1

(The meaning of $A \supset B$ in K_3 can still be expressed by $\neg A \vee B$, since this has the same truth table, as may be checked.) Now, $A \supset A$ always takes the value 1.

7.3.9 The logic resulting from this change is one originally given by Łukasiewicz, and is often called L_3 .

7.4 LP and RM_3

7.4.1 Another 3-valued logic is the one often called *LP*. This is exactly the same as K_3 , except that $\mathcal{D} = \{1, i\}$.

7.4.2 In the context of *LP*, the value i is thought of as *both true and false*. Consequently, 1 and 0 have to be thought of as *true and true only*, and *false and false only*, respectively. This change does not affect the truth tables, which still make perfectly good sense under the new interpretation. For example, if A takes the value 1 and B takes the value i , then A and B are both true; hence, $A \wedge B$ is true; but since B is false, $A \wedge B$ is false. Hence, the value of $A \wedge B$ is i . Similarly, if A takes the value 0, and B takes the value i , then A

and B are both false, so $A \wedge B$ is false; but only B is true, so $A \wedge B$ is not true. Hence, $A \wedge B$ takes the value 0.

7.4.3 However, the change of designated values makes a crucial difference. For example, $\models_{LP} p \vee \neg p$. (Whatever value p has, $p \vee \neg p$ takes either the value 1 or i . Thus it is always designated.) This fails in K_3 , as we saw in 7.3.7.

7.4.4 On the other hand, $p \wedge \neg p \not\models_{LP} q$. Counter-model: $v(p) = i$ (making $v(p \wedge \neg p) = i$), $v(q) = 0$. But $p \wedge \neg p$ can never take the value 1 and so be designated in K_3 . Thus, the inference is valid in K_3 .

7.4.5 A notable feature of LP is that *modus ponens* is invalid: $p, p \supset q \not\models_{LP} q$. (Assign p the value i , and q the value 0.)

7.4.6 One way to rectify this is to change the truth function for \supset to the following:

f_{\supset}	1	i	0
1	1	0	0
i	1	i	0
0	1	1	1

(As in 7.3.8, the meaning of $A \supset B$ in LP can still be expressed by $\neg A \vee B$.) Now, if A and $A \supset B$ have designated values (1 or i), so does B , as a moment checking the truth table verifies.

7.4.7 This change gives the logic often called RM_3 .

7.5 Many-valued Logics and Conditionals

7.5.1 Further details of the properties of \wedge , \vee and \neg in the logics we have just met will emerge in the next chapter. For the present, let us concentrate on the conditional.

7.5.2 In past chapters, we have met a number of problematic inferences concerning conditionals. The following table summarises whether or not they hold in the various logics we have looked at. (A tick means *yes*; a cross means *no*.)

	K_3	L_3	LP	RM_3
(1) $q \models p \supset q$	✓	✓	✓	×
(2) $\neg p \models p \supset q$	✓	✓	✓	×
(3) $(p \wedge q) \supset r \models (p \supset r) \vee (q \supset r)$	✓	✓	✓	✓
(4) $(p \supset q) \wedge (r \supset s) \models (p \supset s) \vee (r \supset q)$	✓	✓	✓	✓
(5) $\neg(p \supset q) \models p$	✓	✓	✓	✓
(6) $p \supset r \models (p \wedge q) \supset r$	✓	✓	✓	✓
(7) $p \supset q, q \supset r \models p \supset r$	✓	✓	×	✓
(8) $p \supset q \models \neg q \supset \neg p$	✓	✓	✓	✓
(9) $\models p \supset (q \vee \neg q)$	×	×	✓	×
(10) $\models (p \wedge \neg p) \supset q$	×	×	✓	×

(1) and (2) we met in 1.7, and (3)–(5) we met in 1.9, all in connection with the material conditional. (6)–(8) we met in 5.2, in connection with conditional logics. (9) and (10) we met in 4.6, in connection with the strict conditional. The checking of the details is left as a (quite lengthy) exercise. For K_3 , a generally good strategy is to start by assuming that the premises take the value 1 (the only designated value), and recall that, in K_3 , if a conditional takes the value 1, then either its antecedent takes the value 0 or the consequent takes the value 1. For L_3 , it is similar, except that a conditional with value 1 may also have antecedent and consequent with value i . For LP , a generally good strategy is to start by assuming that the conclusion takes the value 0 (the only undesigned value), and recall that, in LP , if a conditional takes the value 0, then the antecedent takes the value 1 and the consequent takes the value 0. For RM_3 , it is similar, except that if a conditional has value 0, the antecedent and consequent may also take the values 1 and i , or i and 0, respectively. And recall that classical inputs (1 or 0) always give the classical outputs.

7.5.3 As can be seen from the number of ticks, the conditionals do not fare very well. If one's concern is with the ordinary conditional, and not with conditionals with an enthymematic *ceteris paribus* clause, then one may ignore lines (6)–(8). But all the logics suffer from some of the same problems as the material conditional. K_3 and L_3 also suffer from some of the problems that the strict conditional does. In particular, even though (10) tells us that $(p \wedge \neg p) \supset q$ is not valid in these logics, contradictions still entail everything, since $p \wedge \neg p$ can never assume a designated value. By contrast, this is not

true of *LP* (as we saw in 7.4.4), but this is so only because *modus ponens* is invalid, since $(p \wedge \neg p) \supset q$ is valid, as (10) shows. (*Modus ponens* is valid for the other logics, as may easily be checked.) About the best of the bunch is *RM*₃.

7.5.4 But there are quite general reasons as to why the conditional of any finitely many-valued logic is bound to be problematic. For a start, if disjunction is to behave in a natural way, the inference from *A* (or *B*) to $A \vee B$ must be valid. Hence, we must have:

(i) if *A* (or *B*) is designated, so is $A \vee B$

Also, $A \equiv A$ ought to be a logical truth. (Even if *A* is neither true nor false, for example, it would still seem to be the case that if *A* then *A*, and so, that *A* iff *A*.) Hence:

(ii) if *A* and *B* have the same value, $A \equiv B$ must be designated (since $A \equiv A$ is).

Note that both of these conditions hold for all the logics that we have looked at, with the exception of *K*₃, for which (ii) fails.

7.5.5 Now, take any *n*-valued logic that satisfies (i) and (ii), and consider $n + 1$ propositional parameters, p_1, p_2, \dots, p_{n+1} . Since there are only *n* truth values, in any interpretation, two of these must receive the same value. Hence, by (ii), for some *j* and *k*, $p_j \equiv p_k$ must be designated. But then the disjunction of all biconditionals of this form must also be designated, by (i). Hence, this disjunction is logically valid.

7.5.6 But this seems entirely wrong. Consider $n + 1$ propositions such as ‘John has 1 hair on his head’, ‘John has 2 hairs on his head’, . . . , ‘John has $n + 1$ hairs on his head’. Any biconditional relating a pair of these would appear to be false. Hence, the disjunction of all such pairs would also appear to be false – certainly not logically true.

7.6 Truth-value Gluts: Inconsistent Laws

7.6.1 Let us now turn to the issue of the philosophical motivations for many-valued logics and, in particular, the 3-valued logics we have met. Typically, the motivations for those logics that treat *i* as both true and false (a *truth-value glut*), like *LP* and *RM*₃, are different from those that treat *i* as neither true nor false (a *truth-value gap*), like *K*₃ and *L*₃. Let us start

with the former. We will look at two reasons for supposing that there are truth-value gluts.²

7.6.2 The first concerns inconsistent laws, and the rights and obligations that agents have in virtue of these. We have already had an example of this in 4.8.3 concerning inconsistent traffic regulations.

7.6.3 Here is another example. Suppose that in a certain (entirely hypothetical) country the constitution contains the following clauses:

- (1) No aborigine shall have the right to vote.
- (2) All property-holders shall have the right to vote.

We may suppose that when the law was made, the possibility of an aboriginal property-holder was so inconceivable as not to be taken seriously. Despite this, as social circumstances change, aborigines do come to hold property. Let one such be John. John, it would appear, both does and does not have the right to vote.

7.6.4 Of course, if a situation of this kind comes to light, the law is likely to be changed to resolve the contradiction. The fact remains, though, that until the law is changed the contradiction is true.

7.6.5 One way that one might object to this conclusion is as follows. The law contains a number of principles for resolving apparent contradictions, for example *lex posterior* (that a later law takes precedence over an earlier law), or that constitutional law takes precedence over statute law, which takes precedence over case law. One might insist that all contradictions are only apparent, and can be defused by applying one or other of these principles.

7.6.6 It is clear, however, that there could well be cases where none of these principles are applicable. Both laws are made at the same time; they are both laws of the same rank, and so on. Hence, though some legal contradictions may be only apparent, this need not always be the case.

² Other examples of truth-value gluts that have been suggested include the state of affairs realised at an instant of change; statements about some object in the border-area of a vague predicate; contradictory statements in the dialectical tradition of Hegel and Marx; statements with predicates whose criteria of application are over-determined; and certain statements about micro-objects in quantum mechanics.

7.7 Truth-value Gluts: Paradoxes of Self-reference

7.7.1 A second argument for the existence of truth-value gluts concerns the paradoxes of self-reference. There are many of these; some very old; some very modern. Here are a couple of well-known ones.

7.7.2 THE LIAR PARADOX: Consider the sentence ‘this sentence is false’. Suppose that it is true. Then what it says is the case. Hence it is false. Suppose, on the other hand, that it is false. That is just what it says, so it is true. In either case – one of which must obtain by the law of excluded middle – it is both true and false.

7.7.3 RUSSELL'S PARADOX: Consider the set of all those sets which are not members of themselves, $\{x; x \notin x\}$. Call this r . If r is a member of itself, then it is one of the sets that is not a member of itself, so r is not a member of itself. On the other hand, if r is not a member of itself, then it is one of the sets in r , and hence it is a member of itself. In either case – one of which must obtain by the law of excluded middle – it is both true and false.

7.7.4 These (and many others like them) are both *prima facie* sound arguments, and have conclusions of the form $A \wedge \neg A$. If the arguments are sound, the conclusions are true, and hence there are truth-value gluts.

7.7.5 Many people have claimed that the arguments are not, despite appearances, sound. The reasons given are many and complex; let us consider, briefly, just a couple.

7.7.6 Some have argued that any sentence which is self-referential, like the liar sentence, is meaningless. (Hence, such sentences can play no role in logical arguments at all.) This, however, is clearly false. Consider: ‘this sentence has five words’, ‘this sentence is written on page 129 of Part I of *An Introduction to Non-Classical Logic*’, ‘this sentence refers to itself’.

7.7.7 The most popular objection to the argument is that the liar sentence is neither true nor false. In this case, we can no longer appeal to the law of excluded middle, and so the arguments to contradiction are broken. (Thus, the paradoxes of self-reference are sometimes used as an argument for the existence of truth-value gaps, too.)

7.7.8 This suggestion does not avoid contradiction, however, because of ‘extended paradoxes’.³ Consider the sentence ‘This sentence is either false or neither true nor false.’ If it is true, it is either false or neither. In both cases it is not true. If, on the other hand, it is either false or neither (and so not true), then that is exactly what it claims, and so it is true. In either case, therefore, it is both true and not true.

7.8 Truth-value Gaps: Denotation Failure

7.8.1 Let us now turn to the question of why one might suppose there to be truth-value gaps. One reason for this, we saw in the last chapter. If one identifies truth with verification then, since there may well be sentences, A , such that neither A nor $\neg A$ can be verified, there may well be truth-value gaps. Intuitionism can be thought of as a particular case of this.⁴ Since we discussed intuitionism in the last chapter, we will say no more about this argument here. Instead, we will look at two different arguments.⁵

7.8.2 The first concerns sentences that contain noun phrases that do not appear to refer to anything, like names such as ‘Sherlock Holmes’, and descriptions such as ‘the largest integer’ (there is no largest).

7.8.3 It was suggested by Frege that all sentences containing such terms are neither true nor false.⁶ This seems unduly strong. Think, for example, of ‘Sherlock Holmes does not really exist’, or ‘either 2 is even or the greatest prime number is’.

7.8.4 Still, there are some sentences containing non-denoting terms that can plausibly be taken as neither true nor false. One sort of example

³ Moreover, and in any case, not all of the paradoxical arguments invoke the law of excluded middle. Berry’s paradox, for example, does not.

⁴ Though, note, in the Kripke semantics for intuitionist logic, every formula takes the value of either 1 or 0 at every world.

⁵ Other examples of truth-value gaps that are sometimes given include category mistakes. Such as ‘The number 3 is thinking about Sydney’, and other ‘nonsense’ statements; statements in the border-area of some vague predicate; and cases of presupposition failure.

⁶ Though he also thought that denotation failure ought not to arise in a properly constructed language. Non-denoting terms should be assigned an arbitrary reference.

concerns ‘truths of fiction’. It is natural to suppose that ‘Holmes lived in Baker Street’ is true, because Conan Doyle says so; ‘Holmes’ friend, Watson, was a lawyer’ is false, since Doyle tells us that Watson was a doctor; and ‘Holmes had three maiden aunts’ is neither true nor false, since Doyle tells us nothing about Holmes’ aunts or uncles.

7.8.5 This reason is not conclusive, though. An alternative view is that *all* such sentences are simply false. A fictional truth is really a shorthand for the truth of a sentence prefixed by ‘In the play/novel/film (etc.), it is the case that’. Thus, in Doyle’s stories (it is the case that) Holmes lived in Baker Street. Fictional falsities are similar. Thus, in Doyle’s stories it is not the case that Watson was a lawyer. And a fictional truth-value gap, *A*, is just something where neither *A* nor $\neg A$ holds in the fiction. Thus, it is not the case in Doyle’s stories that Holmes had three maiden aunts; and it is not the case that he did not.

7.8.6 Another sort of example of a sentence that can plausibly be seen as neither true nor false is a subject/predicate sentence containing a non-denoting description, like ‘the greatest integer is even’. (Maybe not every predicate, though: ‘The greatest integer exists’ would seem to be false. But existence is a contentious notion anyway.)⁷

7.8.7 But again, this view is not mandatory. One may simply take such sentences to be false (so that their negations are true, etc.). This was, essentially, Russell’s view.

7.8.8 And Russell’s view would seem to work better than a truth-value gap view in many cases. Thus, let ‘Father Christmas’ be short for the description ‘the old man with a white beard who comes down the chimney at Christmas bringing presents’. Then the following would certainly appear to be false: ‘The Greeks worshipped Father Christmas’ and ‘Julius Caesar thought about Father Christmas.’

7.8.9 Note, though, that even Russell’s view appears to be in trouble with some similar examples. For example, it appears to be true that the Greeks

⁷ A related suggestion concerns names that may denote objects, but not objects that exist in the world or situation at which truth is being evaluated. Thus, Aristotle exists in this world, but consider some world at which he does not exist. It may be suggested that ‘Aristotle is a philosopher’ is neither true nor false at that world.

worshipped the gods who lived on Mount Olympus, and that little Johnny does think about Father Christmas on 24 December.

7.8.10 Thus, though non-denotation does give some reason for supposing there to be truth-value gaps, the view has its problems, as do most views concerning non-denotation.⁸

7.9 Truth-value Gaps: Future Contingents

7.9.1 The second argument for the existence of truth-value gaps concerns certain statements about the future – future contingents. The suggestion is that statements such as ‘The first pope in the twenty-second century will be Chinese’ and ‘It will rain in Brisbane some time on 6/6/2066’ are now neither true nor false. The future does not yet exist; there are therefore, presently, no facts that makes such sentences true or false.

7.9.2 It might be replied that such sentences *are* either true or false; it’s just that we do not know which yet. But there is a very famous argument, due to Aristotle, to the effect that this cannot be the case. It can be put in different ways; here is a standard version of it.

7.9.3 Let S be the sentence ‘The first pope in the twenty-second century will be Chinese.’ If S were true now, then it would necessarily be the case that the first pope in the twenty-second century will be Chinese. If S were false now, then it would necessarily be the case that the first pope in the twenty-second century will not be Chinese. Hence, if S were either true or false now, then whatever the state of affairs concerning the first pope in the twenty-second century, it will arise of necessity. But this is impossible, since what happens then is still a contingent matter. Hence, it is neither true nor false now.

7.9.4 One might say much about this argument, but a standard, and very plausible, response to it is that it hinges on a fallacy of ambiguity. Statements of the form ‘if A then necessarily B ’ are ambiguous between ‘if A , then, it necessarily follows that B ’ – $\Box(A \supset B)$ – and ‘if A , then B is true of necessity’ – $A \supset \Box B$. Moreover, neither of these entails the other (even in $K\upsilon$).

⁸ We will meet the topic of denotation-failure again in chapter 21 (Part II).

7.9.5 Now, consider the sentence ‘If S were true now, then it would necessarily be the case that the first pope in the twenty-second century will be Chinese’, which is employed in the argument. If this is interpreted in the first way ($\Box(A \supset B)$), it is true, but the argument is invalid. (Since $A, \Box(A \supset B) \not\models \Box B$.) If we interpret it in the second way ($A \supset \Box B$), the argument is certainly valid, but now there is no reason to believe the conditional to be true (or, if there is, this argument does not provide it). Similar considerations apply to the second part of the argument. Aristotle’s argument does not, therefore, appear to work.⁹

7.10 Supervaluations, Modality and Many-valued Logic

7.10.1 Let us finish with two other matters that arise in connection with Aristotle’s argument of the previous section, though they have wider implications.

7.10.2 First, those who have taken future contingents to be neither true nor false, like Aristotle, have not normally taken all statements about the future to be truth-valueless – only statements about states of affairs that are as yet undetermined have that status. In particular, instances of the law of excluded middle, $S \vee \neg S$, are usually endorsed, even if S is a future contingent. Since this is not valid in K_3 or L_3 , these logics do not appear to be the appropriate ones for future statements.

7.10.3 A logic better in this regard can be obtained by a technique called *supervaluation*. Let ν be any K_3 interpretation. Define $\nu \leq \nu'$ to mean that ν' is a classical interpretation that is the same as ν , except that wherever $\nu(p)$ is i , $\nu'(p)$ is either 0 or 1. (So ν' ‘fills in all the gaps’ in ν .) Call ν' a *resolution* of ν . Define the supervaluation of ν , ν^+ , to be the map such that for every formula, A :

$$\begin{aligned} \nu^+(A) &= 1 \text{ iff for all } \nu' \text{ such that } \nu \leq \nu', \nu'(A) = 1 \\ \nu^+(A) &= 0 \text{ iff for all } \nu' \text{ such that } \nu \leq \nu', \nu'(A) = 0 \\ \nu^+(A) &= i \text{ otherwise} \end{aligned}$$

The thought here is that A is true on the supervaluation of ν ; just in case however its gaps were to get resolved (and, in the case of future contingents,

⁹ I will have more to say about the argument in 11a.7.

will get resolved), it would come out true. We can now define a notion of validity as something like ‘truth preservation come what may’, $\Sigma \models^S A$ (*supervalidity*), as follows:

$\Sigma \models^S A$ iff for every ν , if $\nu^+(B)$ is designated for all $B \in \Sigma$, $\nu^+(A)$ is designated (where the designated values here are as for K_3).

7.10.4 A fundamental fact is that $\Sigma \models^S A$ iff A is a classical consequence of Σ . (In particular, therefore, $\models^S A \vee \neg A$ even though A may be neither true nor false!) The argument for this is as follows. First, suppose that the inference is not classically valid; then there is a classical interpretation that makes all the members of Σ true and A false. But the only resolution of ν is ν itself. So every resolution of ν makes all the premises true and the conclusion false. That is, for all $B \in \Sigma$, $\nu^+(B) = 1$, and $\nu^+(A) = 0$. Hence, $\Sigma \not\models^S A$.¹⁰ Conversely, suppose that $\Sigma \not\models^S A$. Then there is a ν such that for all $B \in \Sigma$, $\nu^+(B) = 1$ and $\nu^+(A) \neq 1$. Consequently, there is some resolution $\mu \geq \nu$ such that $\mu(A) = 0$, but for all $B \in \Sigma$, $\mu(B) = 1$. Since μ is a classical interpretation, the inference is not classically valid.

7.10.5 The alignment between classical validity and supervaluation validity is not, in fact, as clean as 7.10.4 makes it appear. For any logic, including classical logic, one can define a natural notion of multiple-conclusion validity. For this, the conclusions, like the premises, may be an arbitrary set of formulas (not just a single formula) and the inference is valid iff every interpretation (of the kind appropriate for the logic) that makes *every* premise true makes *some* conclusion true. Thus, in classical logic (and ignoring set braces for the conclusions as well as the premises), $A \vee B \models A, B$. This inference is not valid for \models^S . To see this, just consider an interpretation, ν , such that $\nu(p) = i$. Then $\nu^+(p \vee \neg p) = 1$, but $\nu^+(p) = \nu^+(\neg p) = i$.

7.10.5a A slightly different way of proceeding avoids this consequence. Define an inference to be valid iff, for every K_3 interpretation, ν , every resolution of ν that makes every premise true makes some (or, in the single conclusion case, the) conclusion true. Since the class of resolutions of all K_3

¹⁰ In certain contexts, there may be reason to suppose that not all resolutions of an evaluation are ‘genuine possibilities’. In that case, one may wish to restrict the supervaluation of an evaluation to an appropriate subclass of its resolutions. If one does so, this half of the proof may break down, and the inferences that are supervaluation valid may actually *extend* the classically valid inferences.

interpretations is exactly the set of classical evaluations, this gives exactly classical logic (single or multiple conclusion, as appropriate).¹¹

7.10.5b It is worth noting that there is a technique dual to supervaluation for the logic LP . Given any LP interpretation, define \leq and validity exactly as in 7.10.3 (remembering that the designated values have now changed). In this context, it is usual to use the term *subvaluation* rather than *supervaluation*; correspondingly, we will use \models_S instead of \models^S (and call this *subvalidity*). This time, $A \models_S \Sigma$ iff the multiple conclusion inference from A to Σ is classically valid (and *a fortiori* for single conclusion inferences). The argument for this is as follows. First, suppose that the inference is not classically valid; then there is a classical interpretation that makes A true and every member of Σ false. But the only resolution of v is v itself. So every resolution of v makes the premise true and all the conclusions false. That is, for all $B \in \Sigma$, $v^+(B) = 0$, and $v^+(A) = 1$. Hence, $A \not\models_S \Sigma$.¹² Conversely, suppose that $A \not\models_S \Sigma$. Then there is a v such that $v^+(A) \neq 0$, and for all $B \in \Sigma$, $v^+(B) = 0$. Consequently, there is some resolution $\mu \geq v$ such that $\mu(A) = 1$, but for all $B \in \Sigma$, $\mu(B) = 0$. Since μ is a classical interpretation, the inference is not classically valid.

7.10.5c The result does not extend to multiple-premise inferences. Thus, in classical logic, $A, B \models A \wedge B$. This inference is not valid for \models_S . Just consider an interpretation, v , such that $v(p) = i$. Then $v^+(p) = v^+(\neg p) = i$, but $v^+(p \wedge \neg p) = 0$. However, if validity is defined as in 7.10.5a, replacing K_3 with LP , then it coincides with classical validity, for the same reason.

7.10.5d Clearly, applying the super/subvaluation technique provides a number of different notions of validity. In deciding whether or not to apply the technique, and if so how, one has to decide what one wishes one's notion

¹¹ Note that supervaluation techniques can be applied to the logic \mathcal{L}_3 , but are less appropriate. Supervaluation is essentially a gap-filling exercise. It should not destabilise things that already have a determinate truth. A resolution of a K_3 interpretation preserves classical truth values in the appropriate way. That is, if $v \leq v'$, and $v(A)$ is 0 or 1, $v'(A)$ has the same value. The same is not true of \mathcal{L}_3 . Similarly, subvaluations (about to be defined) do not destabilise classical values in LP , but they may do so in RM_3 . See 7.14, problem 4.

¹² Again, if one restricts the subvaluation to an appropriate class of its resolutions, this half of the proof may break down, and subvaluation validity may extend the classically valid inferences.

of validity to preserve: designated value under an interpretation, designated value under a super/subvaluation, or designated value under a resolution. In the case of future contingents, for example, are we interested in preserving actual truth value, truth value we can ‘predict now’, or ‘eventual’ truth value? Quite possibly, the answer may depend on why, exactly, gaps/gluts are supposed to arise in the application at hand. Conceivably, the answer may be different for different applications (e.g., future contingents and vagueness¹³).

7.10.6 Let us now turn to the second matter. This concerns the connection between modality and many-valued logic. Notwithstanding the issue concerning the law of excluded middle that we have just discussed, Łukasiewicz was motivated to construct his logic \mathcal{L}_3 by the problem about future contingents. According to him, statements about the past and present are now unalterable in truth value. If they are true, they are necessarily true; if they are false, they are necessarily false. But future contingents, those things taking the value i , are merely possible. Things that are true are also possible, of course. He therefore augmented the language with a modal possibility operator, \diamond , and gave it the following truth table:

f_\diamond	
1	1
i	1
0	0

Defining $\Box A$ in the standard way, as $\neg\diamond\neg A$, gives it the truth table:

f_\Box	
1	1
i	0
0	0

7.10.7 These definitions give a modal logic that, in the light of modern modal logic, has some rather strange properties. For example, it is easy to check that $p \models_{\mathcal{L}_3} \Box p$. (This is *not* the Rule of Necessitation.) Given the Aristotelian motivation, this may be acceptable. But there are other consequences that are certainly not. For example, it is easy to check that

¹³ For vagueness, see 11.3.7.

$\diamond A, \diamond B \models_{L_3} \diamond(A \wedge B)$. This is not acceptable – even to an Aristotelian. It is possible that the first pope in the twenty-second century will be Chinese and possible that she will not. But it is not possible that she both will and will not be.

7.10.8 In fact, none of the modal logics that we have looked at (nor conditional logics, nor intuitionist logic) is a finitely many-valued logic. The proof of this is essentially a version of the argument of 7.5.4, 7.5.5. The proof is given in 7.11.1–7.11.3.

7.10.9 There is a certain sense in which every logic can be thought of as an infinitely many-valued logic, however. A *uniform substitution* of a set of formulas is the result of replacing each propositional parameter uniformly with some formula or other (maybe itself). Thus, for example, a uniform substitution of the set $\{p, p \supset (p \vee q)\}$ is $\{r \wedge s, (r \wedge s) \supset ((r \wedge s) \vee q)\}$. A logic is *closed under uniform substitution* when any inference that is valid is also valid for every uniform substitution of the premises and conclusion. All standard logics are closed under uniform substitution.¹⁴

7.10.10 Now, it can be shown that every logical consequence relation, \vdash , closed under uniform substitution, is weakly complete with respect to a many-valued semantics. That is, $\vdash A$ iff A is logically valid in the semantics. This is proved in 7.11.5. The semantics is somewhat fraudulent, though, since it involves taking every formula as a truth value. Moreover, the result can be extended to strong completeness (that is, to inferences with arbitrary sets of premises – not just empty ones) only under certain conditions.¹⁵

7.11 *Proofs of Theorems

7.11.1 DEFINITION: Let $A \varepsilon \exists B$ be $(A \rightarrow B) \wedge (B \rightarrow A)$, and let $A \sqsubset \sqsupset B$ be $(A \sqsubset B) \wedge (B \sqsubset A)$. Let D_{n+1} be the disjunction of all sentences of the form $p_j \varepsilon \exists p_k$ (if

¹⁴ The general reason is as follows. Suppose that some substitution instance of an inference is invalid. Then there is some interpretation, \mathcal{I} (appropriate for the logic in question), which makes the premises true and the conclusion untrue (at some world). Now consider the interpretation that is exactly the same as \mathcal{I} , except that it assigns to every parameter (at a world) the value of whatever formula was substituted for it (at that world) in \mathcal{I} . It is not difficult to check that the truth value of every formula (at every world) is the same in this interpretation as its substitution instance was in \mathcal{I} . Hence, the inference is invalid also.

¹⁵ See Priest (2005b).

we are dealing with a modal logic), or $p_j \Box \Box p_k$ (if we are dealing with intuitionist logic), for $1 \leq j < k \leq n + 1$.

7.11.2 LEMMA: For no n is D_{n+1} a logical truth of any modal logic weaker than K_V or of intuitionist logic.

Proof:

The proof is by constructing counter-models in K_V and I , either directly or with the aid of tableaux. Details are left as an exercise. ■

7.11.3 THEOREM: No modal logic between L and K_V is a finitely many-valued logic.

Proof:

Suppose that it were, and that it had n truth values. Since $A \models_L A \vee B$:

(i) whenever $A \in \mathcal{D}$, $A \vee B \in \mathcal{D}$

Since $A \wedge B \models_L A$:

(ii) whenever $A \wedge B \in \mathcal{D}$, $A \in \mathcal{D}$

(and the same for B in both cases). Moreover, since $\models_L p \rightarrow \neg p$:

(iii) for any $x \in \mathcal{V}$, $f_{\rightarrow}(x, x) \in \mathcal{D}$

Now, consider any interpretation, v . Since there are only n truth values, for some $1 \leq j < k \leq n + 1$, $v(p_j) = v(p_k)$. Hence, $v(p_j \rightarrow p_k) \in \mathcal{D}$ and $v(p_k \rightarrow p_j) \in \mathcal{D}$, by (iii), $v(p_j \rightarrow \neg p_k) \in \mathcal{D}$, by (ii), and $v(D_{n+1}) \in \mathcal{D}$, by (i). Thus, D_{n+1} is logically valid, which it is not, by the preceding lemma. ■

7.11.4 THEOREM: Intuitionist logic is not a finitely many-valued logic. Nor is any logic that extends intuitionist logic or any of the modal logics above with extra connectives. In particular, no conditional logic is a finitely many-valued logic.

Proof:

The proof for intuitionist logic is exactly the same, replacing \rightarrow with $\Box \Box$. The argument for any linguistic extension of the logics in question is also exactly the same. ■

7.11.5 THEOREM: Any logical consequence relation, \vdash , closed under uniform substitution, is weakly complete with respect to a many-valued semantics.

Proof:

We define the components of a many-valued logic as follows. Let \mathcal{V} be the set of formulas of the language. Let $\mathcal{D} = \{A : \vdash A\}$. For every n -place connective, c , let $f_c(A_1, \dots, A_n) = c(A_1, \dots, A_n)$. Now, suppose that $\vdash A$. Consider any interpretation, ν . Then it is easy to check that $\nu(A)$ is simply the formula A with every propositional parameter, p , replaced by $\nu(p)$. Call this A_ν . Since \vdash is closed under uniform substitution, $\vdash A_\nu$. That is, $\nu(A) \in \mathcal{D}$. Conversely, suppose that $\not\vdash A$. Consider the interpretation, ν , which maps every propositional parameter to itself. It is easy to check that $\nu(A) = A$. Hence, $\nu(A) \notin \mathcal{D}$. ■

7.12 History

The first many-valued logic was \mathcal{L}_3 . This, and its generalisation to n -valued logics, \mathcal{L}_n , were invented by the Polish logician Łukasiewicz (pronounced Woo/ka/syey/vitz) around 1920. See Łukasiewicz (1967). (This paper also discusses future contingents and Łukasiewicz's modal logic.) At about the same time, the US mathematician Post (1921) was also constructing a many-valued logic. (Post's system has no simple philosophical motivation, though.) The logic \mathcal{K}_3 was invented by Kleene (1952, sect. 64). He was brought to it by considering partial functions, that is, functions that may have no value for certain inputs (such as division when this is by 0). An expression such as $3/0$ can be thought of as an instance of denotation failure. Some, such as Kripke (1975), have argued that i should be thought of as a lack of truth value, rather than as a third truth value; but this is a subtle distinction to which it is hard to give substance. *LP* (which stands for 'Logic of Paradox') was given by Priest (1979). RM_3 is one of a family of n -valued logics, RM_n , related to the logic *RM* (*R* Mingle), which we will meet in chapter 10. See Anderson and Belnap (1975, pp. 470f.).

The view that there are true contradictions, *dialetheism*, had a number of historical adherents; but, in its modern form, is relatively recent. For its history, see Priest (1998a). Kripke (1975) gave an influential account of the liar sentence as neither true nor false. Frege's views on non-denotation can be found in Frege (1970). A more nuanced defence of the same idea is in Strawson (1950). Russell's account of descriptions appeared in Russell (1905). Aristotle's argument for truth-value gaps is to be found in *De Interpretatione*, chapter 9.

Supervaluations were invented by van Fraassen (1969). For subvaluations see Varzi (2000). The proof that intuitionist logic is not many-valued was first given by Gödel (1933b). The idea was applied to modal logic by Dugunji (1940). The proof that every logic is weakly characterised by a many-valued logic is due to Lindenbaum (see Rescher 1969, p. 157).

7.13 Further Reading

For an excellent overview of many-valued logics, including their history, see Rescher (1969). Urquhart (1986) and Malinowski (2001) are shorter and also very good. The literature on the paradoxes of self-reference is enormous, but reasonable places to start are Haack (1979, ch. 8), Sainsbury (1995, ch. 5) and Priest (1987, chs. 1 and 2). Chapter 13 of the last of these also contains a discussion of inconsistent laws. The literature on non-denotation is also enormous. A suitable place to start is Haack (1979, ch. 5). A good discussion of Aristotle's argument for truth-value gaps, and its employment by Łukasiewicz, is Haack (1974, ch. 4). Many of the possible examples of truth-value gluts are discussed in Priest and Routley (1989a,b). Many of the possible examples of truth-value gaps are discussed in Blamey (1986, sect. 2). For multiple-conclusion logic, see Shoesmith and Smiley (1978).

7.14 Problems

1. Check all the details omitted in 7.5.2.
2. Call a many-valued logic in the language of the classical propositional calculus *normal* if, amongst its truth values are two, 1 and 0, such that 1 is designated, 0 is not, and for every truth function corresponding to a connective, the output for those inputs is the same as the classical output. (K_3 , L_3 , LP and RM_3 are all normal.) Show that every normal many-valued logic is a sub-logic of classical logic (i.e., that every inference valid in the logic is valid in classical logic).
3. Observe that in K_3 if an interpretation assigns the value i to every propositional parameter that occurs in a formula, then it assigns the value i to the formula itself. Infer that there are no logical truths in K_3 . Are there any logical truths in L_3 ?

4. Let ν_1 and ν_2 be any interpretations of K_3 or LP . Write $\nu_1 \leq \nu_2$ to mean that for every propositional parameter, p :

if $\nu_1(p) = 1$, then $\nu_2(p) = 1$; and if $\nu_1(p) = 0$, then $\nu_2(p) = 0$

Show by induction on the way that formulas are constructed, that if $\nu_1 \leq \nu_2$, then the displayed condition is true for all formulas. Does the result hold for L_3 and RM_3 ?

5. By problem 2, if $\models_{LP} A$, then A is a classical logic truth. Use problem 4 to show the converse. (Hint: Suppose that ν is an LP interpretation such that $\nu(A) = 0$. Consider the interpretation, ν' , which is the same as ν , except that if $\nu(p) = i$, $\nu'(p) = 0$.)
6. What is the truth value of ‘this sentence is true’?
7. Tolkien tells us in *The Hobbit* that Bilbo Baggins is a hobbit, and all hobbits are short. Graham Priest is 6’4”. What is the truth value of ‘Graham Priest is taller than Bilbo Baggins’, and why?
8. Under what conditions is it appropriate to apply a super/subvaluation technique, and what determines the appropriate form to apply?
9. * Fill in the details omitted in 7.11.2.

8 First Degree Entailment

8.1 Introduction

8.1.1 In this chapter we look at a logic called *first degree entailment (FDE)*. This is formulated, first, as a logic where interpretations are *relations* between formulas and standard truth values, rather than as the more usual *functions*. Connections between *FDE* and the many-valued logics of the last chapter will emerge.

8.1.2 We also look at an alternative possible-world semantics for *FDE*, which will introduce us to a new kind of semantics for negation.

8.1.3 Finally, we look at the relation of all this to the explosion of contradictions, and to the disjunctive syllogism.

8.2 The Semantics of *FDE*

8.2.1 The language of *FDE* contains just the connectives \wedge , \vee and \neg . $A \supset B$ is defined, as usual, as $\neg A \vee B$.

8.2.2 In the classical propositional calculus, an interpretation is a function from formulas to the truth values 0 and 1, written thus: $v(A) = 1$ (or 0). Packed into this formalism is the assumption (usually made without comment in elementary logic texts) that every formula is either true or false; never neither, and never both.

8.2.3 As we saw in the last chapter, there are reasons to doubt this assumption. If one does, it is natural to formulate an interpretation, not as a function, but as a relation between formulas and truth values. Thus, a formula may relate to 1; it may relate to 0; it may relate to both; or it may relate to neither. This is the main idea behind the following semantics for *FDE*.

8.2.4 Note that it is now very important to distinguish between being false in an interpretation and not being true in it. (There is, of course, no difference in the classical case.) The fact that a formula is false (relates to 0) does not mean that it is untrue (it may also relate to 1). And the fact that it is untrue (does not relate to 1) does not mean that it is false (it may not relate to 0 either).

8.2.5 An *FDE* interpretation is a relation, ρ^1 between propositional parameters and the values 1 and 0. (In mathematical notation, $\rho \subseteq \mathcal{P} \times \{1, 0\}$, where \mathcal{P} is the set of propositional parameters.) Thus, $p\rho 1$ means that p relates to 1, and $p\rho 0$ means that p relates to 0.

8.2.6 Given an interpretation, ρ , this is extended to a relation between all formulas and truth values by the recursive clauses:

$$A \wedge B\rho 1 \text{ iff } A\rho 1 \text{ and } B\rho 1$$

$$A \wedge B\rho 0 \text{ iff } A\rho 0 \text{ or } B\rho 0$$

$$A \vee B\rho 1 \text{ iff } A\rho 1 \text{ or } B\rho 1$$

$$A \vee B\rho 0 \text{ iff } A\rho 0 \text{ and } B\rho 0$$

$$\neg A\rho 1 \text{ iff } A\rho 0$$

$$\neg A\rho 0 \text{ iff } A\rho 1$$

Note that these are exactly the same as the classical truth conditions, stripped of the assumption that truth and falsity are exclusive and exhaustive. Thus, a conjunction is true (under an interpretation) if both conjuncts are true (under that interpretation); it is false if at least one conjunct is false, etc.

8.2.7 As an example of how these conditions work, consider the formula $\neg p \wedge (q \vee r)$. Suppose that $p\rho 1$, $p\rho 0$, $q\rho 1$ and $r\rho 0$, and that ρ relates no parameter to anything else. Since p is true, $\neg p$ is false; and since p is false, $\neg p$ is true. Thus $\neg p$ is both true and false. Since q is true, $q \vee r$ is true; and since q is not false, $q \vee r$ is not false. Thus, $q \vee r$ is simply true. But then, $\neg p \wedge (q \vee r)$ is true, since both conjuncts are true; and false, since the first conjunct is false. That is, $\neg p \wedge (q \vee r)\rho 1$ and $\neg p \wedge (q \vee r)\rho 0$.

¹ Not to be confused with the reflexive ρ of normal modal logics.

8.2.8 Semantic consequence is defined, in the usual way, in terms of truth preservation, thus:

$$\Sigma \models A \text{ iff for every interpretation, } \rho, \text{ if } B \rho 1 \text{ for all } B \in \Sigma \text{ then } A \rho 1$$

and:

$$\models A \text{ iff } \phi \models A, \text{ i.e., for all } \rho, A \rho 1$$

8.3 Tableaux for FDE

8.3.1 Tableaux for FDE can be obtained by modifying those for the classical propositional calculus as follows.

8.3.2 Each entry of the tableau is now of the form $A, +$ or $A, -$. Intuitively, $A, +$ means that A is true, $A, -$ means that it isn't. As we noted in 8.2.4, and as with intuitionist logic (6.4.1), $\neg A, +$ no longer means the same, intuitively, as $A, -$.

8.3.3 To test the claim that $A_1, \dots, A_n \vdash B$, we start with an initial list of the form:

$$\begin{array}{c} A_1, + \\ \vdots \\ A_n, + \\ B, - \end{array}$$

8.3.4 The tableaux rules are as follows:

$$\begin{array}{cc} A \wedge B, + & A \wedge B, - \\ \downarrow & \swarrow \quad \searrow \\ A, + & A, - \quad B, - \\ B, + & \end{array}$$

$$\begin{array}{cc} A \vee B, + & A \vee B, - \\ \swarrow \quad \searrow & \downarrow \\ A, + \quad B, + & A, - \\ & B, - \end{array}$$

$$\begin{array}{cc} \neg(A \wedge B), + & \neg(A \wedge B), - \\ \downarrow & \downarrow \\ \neg A \vee \neg B, + & \neg A \vee \neg B, - \end{array}$$

$$\begin{array}{cc}
 \neg(A \vee B), + & \neg(A \vee B), - \\
 \downarrow & \downarrow \\
 \neg A \wedge \neg B, + & \neg A \wedge \neg B, - \\
 \\
 \neg\neg A, + & \neg\neg A, - \\
 \downarrow & \downarrow \\
 A, + & A, -
 \end{array}$$

The first two rules speak for themselves: if $A \wedge B$ is true, A and B are true; if $A \wedge B$ is not true, then one or other of A and B is not true. Similarly for the rules for disjunction. The other rules are also easy to remember, since $\neg(A \wedge B)$ and $\neg A \vee \neg B$ have the same truth values in *FDE*, as do $\neg(A \vee B)$ and $\neg A \wedge \neg B$, and $\neg\neg A$ and A . (De Morgan's laws and the law of double negation, respectively.)

8.3.5 Finally, a branch of a tableau closes if it contains nodes of the form $A, +$ and $A, -$.

8.3.6 For example, the following tableau demonstrates that $\neg(B \wedge \neg C) \wedge A \vdash (\neg B \vee C) \vee D$:

$$\begin{array}{c}
 \neg(B \wedge \neg C) \wedge A, + \\
 (\neg B \vee C) \vee D, - \\
 \neg(B \wedge \neg C), + \\
 A, + \\
 \neg B \vee \neg\neg C, + \\
 \neg B \vee C, - \\
 D, - \\
 \neg B, - \\
 C, - \\
 \swarrow \quad \searrow \\
 \neg B, + \quad \neg\neg C, + \\
 \times \quad C, + \\
 \quad \quad \times
 \end{array}$$

The third and fourth lines come from the first, by the rule for true conjunctions. The next line comes from the third by De Morgan's laws. The next two lines come from the second by the rule for untrue disjunctions, which is then applied again, to get the next two lines. The branching arises because of the rule for true disjunctions, applied to line five. The left

branch is now closed because of $\neg B, -$ and $\neg B, +$; an application of double negation then closes the righthand branch.

8.3.7 Here is another example, to show that $p \wedge (q \vee \neg q) \not\vdash r$:

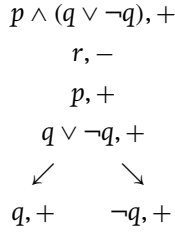

8.3.8 Counter-models can be read off from open branches in a simple way. For every parameter, p , if there is a node of the form $p, +$, set $p\rho 1$; if there is a node of the form $\neg p, +$, set $p\rho 0$. No other facts about ρ obtain.

8.3.9 Thus, the counter-model defined by the righthand branch of the tableau in 8.3.7 is the interpretation ρ , where $p\rho 1$ and $q\rho 0$ (and no other relations hold). It is easy to check directly that this interpretation makes the premises true and the conclusion untrue.

8.3.10 The tableaux are sound and complete with respect to the semantics. This is proved in 8.7.1-8.7.7.

8.4 FDE and Many-valued Logics

8.4.1 Given any formula, A , and any interpretation, ρ , there are four possibilities: A is true and not also false, A is false and not also true, A is true and false, A is neither true nor false. If we write these possibilities as 1, 0, b and n , respectively, this makes it possible to think of FDE as a 4-valued logic.

8.4.2 The truth conditions of 8.2.6 give the following truth tables:

f_{-}	
1	0
b	b
n	n
0	1

f_{\wedge}	1	b	n	0
1	1	b	n	0
b	b	b	0	0
n	n	0	n	0
0	0	0	0	0

f_{\vee}	1	b	n	0
1	1	1	1	1
b	1	b	1	b
n	1	1	n	n
0	1	b	n	0

The details are laborious, but easy enough to check. Thus, suppose that A is n and B is b . Then it is not the case that A and B are both true; hence, $A \wedge B$ is not true. But B is false; hence, $A \wedge B$ is false. Thus, $A \wedge B$ is false but not true, 0. Since B is true, $A \vee B$ is true; and since A and B are not both false, $A \vee B$ is not false. Hence, $A \vee B$ is true and not false, 1. The other cases are left as an exercise.

8.4.3 An easy way to remember these values is with the following diagram, the ‘diamond lattice’:

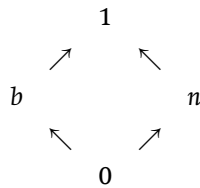

The conjunction of any two elements, x and y , is their greatest lower bound, that is, the greatest thing from which one can get to both x and y going up the arrows. Thus, for example, $b \wedge n = 0$ and $b \wedge 1 = b$. The disjunction of two elements, x and y , is the least upper bound, that is, the least thing from which one can get to both x and y going down the arrows. Thus, for example, $b \vee n = 1$, $b \vee 1 = 1$. Negation toggles 0 and 1, and maps each of n and b to itself.²

8.4.4 Since validity in *FDE* is defined in terms of truth preservation, the set of designated values is $\{1, b\}$ (true only, and both true and false).

8.4.5 This is not one of the many-valued logics that we met in the last chapter, but two of the ones that we did meet there are closely related to *FDE*.

8.4.6 Suppose that we consider an *FDE* interpretation that satisfies the constraint:

Exclusion: for no p , $p\rho 1$ and $p\rho 0$

² In fact, this structure is more than a mnemonic. The lattice is one of the most fundamental of a group of structures called ‘De Morgan lattices’, which can be used to give a different semantics for *FDE*.

i.e., no propositional parameter is both true and false. Then it is not difficult to check that the same holds for every sentence, A .³ That is, nothing takes the value b .

8.4.7 The logic defined in terms of truth preservation over all interpretations satisfying this constraint is, in fact, K_3 . For if we take the above matrices, and ignore the rows and columns for b , we get exactly the matrices for K_3 (identifying n with i). (In K_3 , $A \supset B$ can be defined as $\neg A \vee B$, as we observed in 7.3.8.)

8.4.8 K_3 is sound and complete with respect to the tableaux of the previous section, augmented by one extra closure rule: a branch closes if it contains nodes of the form $A, +$ and $\neg A, +$. (This is proved in 8.7.8.) Here, for example, is a tableau showing that $p \wedge \neg p \vdash_{K_3} q$. (The tableau is open in *FDE*.)

$$\begin{array}{c}
 p \wedge \neg p, + \\
 q, - \\
 p, + \\
 \neg p, + \\
 \times
 \end{array}$$

Counter-models are read off from open branches of tableaux in exactly the same way as in *FDE*.

8.4.9 Suppose, on the other hand, that we consider an *FDE* interpretation that satisfies the constraint:

Exhaustion: for all p , either $p\rho 1$ or $p\rho 0$

i.e., every propositional parameter is either true or false – and maybe both. Then it is not difficult to check that, again, the same holds for every sentence, A .⁴ That is, nothing takes the value n .

³ *Proof:* The proof is by an induction over the complexity of sentences. Suppose that it is true for A and B ; we show that it is true for $\neg A$, $A \wedge B$ and $A \vee B$. Suppose that $\neg A\rho 1$ and $\neg A\rho 0$; then $A\rho 0$ and $A\rho 1$, contrary to supposition. Suppose that $A \wedge B\rho 1$ and $A \wedge B\rho 0$; then $A\rho 1$ and $B\rho 1$, and either $A\rho 0$ or $B\rho 0$; hence, either $A\rho 1$ and $A\rho 0$, or the same for B . Both cases are false, by assumption. The argument for $A \vee B$ is similar.

⁴ *Proof:* The proof is by an induction over the complexity of sentences. Suppose that it is true for A and B ; we show that it is true for $\neg A$, $A \wedge B$ and $A \vee B$. Suppose that either $A\rho 1$ or $A\rho 0$; then either $\neg A\rho 0$ or $\neg A\rho 1$. Since $A\rho 1$ or $A\rho 0$, and $B\rho 1$ or $B\rho 0$, then either $A\rho 1$ and $B\rho 1$, and so $A \wedge B\rho 1$; or $A\rho 0$ or $B\rho 0$, and so $A \wedge B\rho 0$. The argument for $A \vee B$ is similar.

8.4.10 The logic defined by truth preservation over all interpretations satisfying this constraint is, in fact, *LP*. For if we take the matrices of 8.4.2 and ignore the rows and columns for n , we get exactly the matrices for *LP* (identifying b with i). (Again, in *LP*, $A \supset B$ can be defined as $\neg A \vee B$, as we observed in 7.4.6.)

8.4.11 *LP* is sound and complete with respect to the tableaux of the previous section, augmented by one extra closure rule: a branch closes if it contains nodes of the form A, \neg and $\neg A, -$. (This is proved in 8.7.9.) Here, for example, is a tableau showing that $p \vdash_{LP} q \vee \neg q$. (The tableau is open in *FDE*.)

$$\begin{array}{c}
 p, + \\
 q \vee \neg q, - \\
 q, - \\
 \neg q, - \\
 \times
 \end{array}$$

Counter-models are read off from open branches of tableaux by employing the following rule: if $p, -$ is not on the branch (and so, in particular, if $p, +$ is), set $p\rho 1$; and if $\neg p, -$ is not on the branch (and so, in particular, if $\neg p, +$ is), set $p\rho 0$.

8.4.12 Finally, and of course, if an interpretation satisfies both *Exclusion* and *Exhaustion*, then for every p , $p\rho 0$ or $p\rho 1$, but not both, and the same follows for arbitrary A . In this case, we have what is, in effect, an interpretation for classical logic. Adding the closure rules for K_3 and *LP* to those of *FDE*, therefore gives us a new tableau procedure for classical logic.

8.4.13 Since all K_3 interpretations are *FDE* interpretations, and all *LP* interpretations are *FDE* interpretations, *FDE* is a sub-logic of K_3 and *LP*. It is a proper sub-logic of each, as the tableaux of 8.4.8 and 8.4.11 show.

8.4a Relational Semantics and Tableaux for L_3 and RM_3

8.4a.1 Before we move on to a different kind of semantics for *FDE*, it is worth noting that the semantics for L_3 and RM_3 can be reformulated in a relational fashion as well. The only difference from K_3 and *LP* (respectively) concerns the appropriate conditional.

8.4a.2 For L_3 , we consult the truth table of 7.3.8, and recall that i is n – that is, neither true (relates to 1) nor false (relates to 0). It is not difficult to check that:

$A \supset B \rho 1$ iff $A \rho 0$ or $B \rho 1$ or (none of $A \rho 1, A \rho 0, B \rho 1, B \rho 0$)

$A \supset B \rho 0$ iff $A \rho 1$ and $B \rho 0$

8.4a.3 For LP , we consult the truth table of 7.4.6, and recall that i is b – that is, both true (relates to 1) and false (relates to 0). It is not difficult to check that:

$A \supset B \rho 1$ iff it is not the case that $A \rho 1$ or it is not the case that $B \rho 0$ or ($A \rho 1$ and $A \rho 0$ and $B \rho 1$ and $B \rho 0$)

$A \supset B \rho 0$ iff $A \rho 1$ and $B \rho 0$

8.4a.4 In virtue of these truth conditions, it is straightforward to give tableaux systems for the two logics. The tableaux for L_3 are the same as those for K_3 , with the additional rules for \supset :

$$\begin{array}{ccc}
 A \supset B, + & & A \supset B, - \\
 \swarrow \quad \downarrow \quad \searrow & & \swarrow \quad \searrow \\
 \neg A, + \quad B, + \quad A \vee \neg A, - & & A, + \quad \neg B, + \\
 & & B, - \quad \neg A, - \\
 & & B \vee \neg B, -
 \end{array}$$

$$\begin{array}{ccc}
 \neg(A \supset B), + & & \neg(A \supset B), - \\
 \downarrow & & \swarrow \quad \searrow \\
 A, + & & A, - \quad \neg B, - \\
 \neg B, + & &
 \end{array}$$

8.4a.5 The tableaux for RM_3 are the same as those for LP , with the additional rules for \supset :

$$\begin{array}{ccc}
 A \supset B, + & & A \supset B, - \\
 \swarrow \quad \downarrow \quad \searrow & & \swarrow \quad \searrow \\
 A, - \quad \neg B, - \quad A \wedge \neg A, + & & A, + \quad \neg B, + \\
 & & B, - \quad \neg A, - \\
 & & B \wedge \neg B, +
 \end{array}$$

$$\begin{array}{ccc}
 \neg(A \supset B), + & & \neg(A \supset B), - \\
 \downarrow & & \swarrow \quad \searrow \\
 A, + & & A, - \quad \neg B, - \\
 \neg B, + & &
 \end{array}$$

8.4a.6 The tableau systems are sound and complete with respect to the appropriate semantics. (See 8.10, problem 11.)

8.5 The Routley Star

8.5.1 We now have two equivalent semantics for *FDE*, a relational semantics and a many-valued semantics.⁵ For reasons to do with later chapters, we should have a third. This is a two-valued possible-world semantics, which treats negation as an intensional operator; that is, as an operator whose truth conditions require reference to worlds other than the world at which truth is being evaluated.

8.5.2 Specifically, we assume that each world, w , comes with a mate, w^* , its *star world*, such that $\neg A$ is true at w if A is false, not at w , but at w^* . If $w = w^*$ (which may happen), then these conditions just collapse into the classical conditions for negation; but if not, they do not. The star operator is often described with a variety of metaphors; for example, it is sometimes described as a reversal operator; but it is hard to give it and its role in the truth conditions for negation a satisfying intuitive interpretation.

8.5.3 Formally, a *Routley interpretation* is a structure $\langle W, *, \nu \rangle$, where W is a set of worlds, $*$ is a function from worlds to worlds such that $w^{**} = w$, and ν assigns each propositional parameter either the value 1 or the value 0 at each world. ν is extended to an assignment of truth values for all formulas by the conditions:

$$\nu_w(A \wedge B) = 1 \text{ if } \nu_w(A) = 1 \text{ and } \nu_w(B) = 1; \text{ otherwise it is } 0.$$

$$\nu_w(A \vee B) = 1 \text{ if } \nu_w(A) = 1 \text{ or } \nu_w(B) = 1; \text{ otherwise it is } 0.$$

$$\nu_w(\neg A) = 1 \text{ if } \nu_{w^*}(A) = 0; \text{ otherwise it is } 0.$$

⁵ At least, they are equivalent given the standard set-theoretic reasoning employed in the reformulation. Such reasoning employs classical logic, however, and in a set theory based on a paraconsistent logic it may fail. See Priest (1993).

Note that $v_{w^*}(\neg A) = 1$ iff $v_{w^{**}}(A) = 0$ iff $v_w(A) = 0$. In other words, given a pair of worlds, w and w^* , each of A and $\neg A$ is true exactly once. Validity is defined in terms of truth preservation over all worlds of all interpretations.

8.5.4 Appropriate tableaux for these semantics are easy to construct. Nodes are now of the form $A, +x$ or $A, -x$, where x is either i or $i^\#$, i being a natural number. (In fact, i will always be 0, but we set things up in a slightly more general way for reasons to do with later chapters.) Intuitively, $i^\#$ represents the star world of i . Closure occurs if we have a pair of the form $A, +x$ and $A, -x$. The initial list comprises a node $B, +0$ for every premise, B , and $A, -0$, where A is the conclusion. The tableau rules are as follows, where x is either i or $i^\#$, and whichever of these it is, \bar{x} is the other.

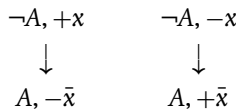
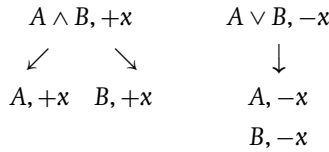
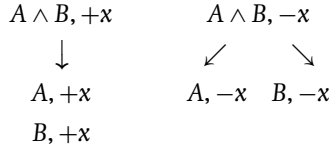

8.5.5 Here are tableaux demonstrating that $\neg(B \wedge \neg C) \wedge A \vdash (\neg B \vee C) \vee D$ and $p \wedge (q \vee \neg q) \not\vdash r$:

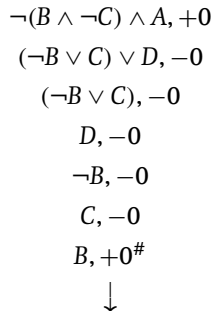

$$\begin{array}{c}
 \neg(B \wedge \neg C), +0 \\
 A, +0 \\
 B \wedge \neg C, -0^\# \\
 \swarrow \quad \searrow \\
 B, -0^\# \quad \neg C, -0^\# \\
 \times \quad C, +0 \\
 \quad \quad \times
 \end{array}$$

Line two is pursued as far as possible. Then line one is pursued to produce closure.

$$\begin{array}{c}
 p \wedge (q \vee \neg q), +0 \\
 r, -0 \\
 p, +0 \\
 q \vee \neg q, +0 \\
 \swarrow \quad \searrow \\
 q, +0 \quad \neg q, +0 \\
 \quad \quad q, -0^\#
 \end{array}$$

8.5.6 To read off a counter-model from an open branch: $W = \{w_0, w_{0^\#}\}$ (there are only ever two worlds); $w_0^* = w_{0^\#}$ and $(w_{0^\#})^* = w_0$. (W and $*$ are always the same, no matter what the tableau.) ν is such that if $p, +x$ occurs on the branch, $\nu_{w_x}(p) = 1$, and if $p, -x$ occurs on the branch, $\nu_{w_x}(p) = 0$. Thus, the counter-model defined by the righthand open branch of the second tableau of 8.5.5 has $\nu_{w_0}(p) = 1$, $\nu_{w_0}(r) = 0$ and $\nu_{w_{0^\#}}(q) = 0$. It is easy to check directly that this interpretation does the job. Since q is false at $w_{0^\#}$, $\neg q$ is true at w_0 , as, therefore, is $q \vee \neg q$; but p is true at w_0 , hence $p \wedge (q \vee \neg q)$ is true at w_0 . But r is false at w_0 , as required.

8.5.7 The soundness and completeness of this tableau procedure is proved in 8.7.10–8.7.16.

8.5.8 It is not at all obvious that the $*$ semantics are equivalent to the relational semantics, but it is not too difficult to establish this. Essentially, it is because a relational interpretation, ρ , is equivalent to a pair of worlds, w and w^* . Specifically, the relation and the worlds do exactly the same job when they are related by the condition:

$$\begin{array}{l}
 \nu_w(p) = 1 \text{ iff } p\rho 1 \\
 \nu_{w^*}(p) = 0 \text{ iff } p\rho 0
 \end{array}$$

for all parameters, p . The proof of the equivalence is given in 8.7.17 and 8.7.18.

8.6 Paraconsistency and the Disjunctive Syllogism

8.6.1 As we have seen (8.4.8 and 8.4.11), both of the following are false in *FDE*: $p \models q \vee \neg q, p \wedge \neg p \models q$. This is essentially because there are truth-value gaps (for the former) and truth-value gluts (for the latter). In particular, then, *FDE* does not suffer from the problem of explosion (4.8).

8.6.2 A logic in which the inference from p and $\neg p$ to an arbitrary conclusion is not valid is called *paraconsistent*. *FDE* is therefore paraconsistent, as is *LP* (7.4.4).

8.6.3 It is not only explosion that fails in *FDE* (and *LP*). The disjunctive syllogism (*DS*) is also invalid: $p, \neg p \vee q \not\models_{FDE} q$. (Relational counter-model: $p\rho 1$ and $p\rho 0$, but just $q\rho 0$.)

8.6.4 This is a significant plus. We have seen the *DS* involved in two problematic arguments: the argument for the material conditional of 1.10, and the Lewis argument for explosion of 4.9.2. We can now see that these arguments do not work, and (at least one reason) why.⁶

8.6.5 Note, also, that the *DS* is just *modus ponens* for the material conditional. Since this fails, we have another argument against the adequacy of the material conditional to represent the real conditional.

8.6.6 The failure of the *DS* has also been thought by some to be a significant minus. First, it is claimed that the *DS* is intuitively valid. For if $\neg p \vee q$ is true, either $\neg p$ or q is true. But, the argument continues, if p is true, this rules out the truth of $\neg p$. Hence, it must be q that is true. But once one countenances the possibility of truth-value gluts, this argument is patently wrong. The truth of p does not rule out the truth of $\neg p$: both may hold. From this perspective, the inference is intuitively invalid.

8.6.7 A more persuasive objection is that we frequently use, and seem to need to use, the *DS* to reason, and we get the right results. Thus, we know

⁶ For good measure, the argument of 4.9.3 for the validity of the inference from A to $B \vee \neg B$ is also invalid in *FDE*, since $p \not\models (p \wedge q) \vee (p \wedge \neg q)$, as may be checked.

that you are either at home or at work. We ascertain that you are not at home, and infer that you are at work – which you are. If the *DS* is invalid, this form of reasoning would seem to be incorrect.

8.6.8 If the *DS* fails, then the inference about being at home or work is not deductively valid. It may be perfectly legitimate to use it, none the less. There are a number of ways of spelling this idea out in detail, but at the root of all of them is the observation that when the *DS* fails, it does so because the premise p involved is a truth-value glut. If the situation about which we are reasoning is consistent – as it is, presumably, in this case – the *DS* cannot lead us from truth to untruth. So it is legitimate to use it. This fact will underwrite its use in most situations we come across, since consistency is, arguably, the norm.

8.6.9 In the same way, if we have some collection, X , one cannot infer from the fact that some other collection, Y , is a proper subset of X that it is smaller.⁷ But provided that we are working with collections that are finite, this inference is perfectly legitimate: violations can occur only when infinite sets are involved.

8.6.10 Thus, this objection can also be set aside.

8.7 *Proofs of Theorems

8.7.1 The soundness and completeness proofs for the relational semantics for *FDE* modify those for classical logic (1.11).

8.7.2 DEFINITION: Let ρ be any relational interpretation. Let b be any branch of a tableau. ρ is *faithful to b* iff for every node, A , $+$, on the branch, $A\rho 1$, and for every node, A , $-$, on the branch, it is not the case that $A\rho 1$.

8.7.3 SOUNDNESS LEMMA: If ρ is faithful to a branch of a tableau, b , and a tableau rule is applied to b , then ρ is faithful to at least one of the branches generated.

⁷ For example, the set of all natural numbers is the same size as the set of all even numbers, as can be seen by making the following correlation:

0	1	2	3	4	...
↕	↕	↕	↕	↕	
0	2	4	6	8	...

Proof:

The proof is by a case-by-case examination of the tableau rules. First, the rules for \wedge . Suppose that we apply the rule for $A \wedge B, +$; then since ρ is faithful to the branch, $A \wedge B \rho 1$. Hence, $A \rho 1$ and $B \rho 1$. Hence, ρ is faithful to the extended branch. Next, suppose that we apply the rule for $A \wedge B, -$; then since ρ is faithful to the branch, it is not the case that $A \wedge B \rho 1$. Hence, either it is not the case that $A \rho 1$ or it is not the case that $B \rho 1$. Hence, ρ is faithful to either the left branch or the right branch. The argument for \vee is similar. For the other rules, it is easy to check that in *FDE*, $\neg(A \wedge B)$ is true under an evaluation iff $\neg A \vee \neg B$ is true; the same goes for $\neg(A \vee B)$ and $\neg A \wedge \neg B$, and $\neg\neg A$ and A . (Details are left as an exercise.) The cases for the other rules follow simply from these facts. ■

8.7.4 SOUNDNESS THEOREM FOR *FDE*: For finite Σ , if $\Sigma \vdash A$ then $\Sigma \models A$.

Proof:

The proof follows from the Soundness Lemma in the usual way. ■

8.7.5 DEFINITION: Let b be an open branch of a tableau. The interpretation *induced* by b is the interpretation, ρ , such that for every propositional parameter, p :

$$\begin{aligned} p \rho 1 &\text{ iff } p, + \text{ occurs on } b \\ p \rho 0 &\text{ iff } \neg p, + \text{ occurs on } b \end{aligned}$$

8.7.6 COMPLETENESS LEMMA: Let b be an open completed branch of a tableau. Let ρ be the interpretation induced by b . Then:

$$\begin{aligned} \text{if } A, +, \text{ occurs on } b, &\text{ then } A \rho 1 \\ \text{if } A, - \text{ occurs on } b, &\text{ then it is not the case that } A \rho 1 \\ \text{if } \neg A, +, \text{ occurs on } b, &\text{ then } A \rho 0 \\ \text{if } \neg A, - \text{ occurs on } b, &\text{ then it is not the case that } A \rho 0 \end{aligned}$$

Proof:

The proof is by an induction on the complexity of A . If A is a propositional parameter, p : if $p, +$ occurs on b , then $p \rho 1$ by definition. If $p, -$ occurs on b , then $p, +$ does not occur on b , since it is open. Hence, by definition, it is not the case that $p \rho 1$. The cases for 0 are similar. For $B \wedge C$: if $B \wedge C, +$ occurs on b , then $B, +$ and $C, +$ occur on b . By induction hypothesis, $B \rho 1$ and $C \rho 1$. Hence, $B \wedge C \rho 1$ as required. The argument for $B \wedge C, -$ is similar. If $\neg(B \wedge C), +$

occurs on b , then by applications of a De Morgan rule and a disjunction rule, either $\neg B, +$ or $\neg C, +$ are on b . By induction hypothesis, either $B\rho 0$ or $C\rho 0$. In either case, $B \wedge C\rho 0$. The case for $\neg(B \wedge C), -$ is similar. The argument for \vee is symmetric. This leaves negation. Suppose that $\neg B, +$ occurs on b . Since the result holds for B , $B\rho 0$. Hence, $\neg B\rho 1$, as required. Similarly for $\neg B, -$. If $\neg\neg B, +$ is on b , $B, +$ is on b . Hence, by induction hypothesis, $B\rho 1$, and so $\neg\neg B\rho 1$ as required. The case for $\neg\neg B, -$ is similar. ■

8.7.7 COMPLETENESS THEOREM FOR *FDE*: For finite Σ , if $\Sigma \models A$ then $\Sigma \vdash A$.

Proof:

The proof follows from the Completeness Lemma in the usual way. ■

8.7.8 THEOREM: The tableau rules of 8.4.8 are sound and complete for K_3 .

Proof:

The soundness proof is exactly the same as that for *FDE*. (If the rules are sound with respect to *FDE* interpretations, they are sound with respect to K_3 interpretations, which are a special case.) The completeness proof is also essentially the same. All we have to check, in addition, is that the induced interpretation is a K_3 interpretation. It cannot be the case that $p\rho 1$ and $p\rho 0$, for then we would have both $p, +$ and $\neg p, +$ on b . But this is impossible, or b would be closed by the new closure rule. ■

8.7.9 THEOREM: The tableau rules of 8.4.11 are sound and complete for *LP*.

Proof:

The soundness proof is exactly the same as that for *FDE*. (If the rules are sound with respect to *FDE* interpretations, they are sound with respect to *LP* interpretations, which are a special case.) In the completeness proof, the induced interpretation is defined slightly differently, thus:

$$\begin{aligned} p\rho 1 &\text{ iff } p, - \text{ is not on } b \\ p\rho 0 &\text{ iff } \neg p, - \text{ is not on } b \end{aligned}$$

Note that this makes ρ an *LP* interpretation. By the new closure rule, either $p, -$ or $\neg p, -$ is not on b . Hence, either $p\rho 1$ or $p\rho 0$. In the Completeness Lemma, the new definition makes the argument for the basis case different. If $p, +$ occurs on b , then $p, -$ does not occur on b , by the *FDE* closure rule, so $p\rho 1$. If $p, -$ occurs on b , then it is not the case that $p\rho 1$, by definition. The

argument for $\neg p$ is the same. The rest of the Completeness Lemma, and the proof of the Completeness Theorem itself, are as usual. ■

8.7.10 The soundness and completeness proofs for the $*$ semantics are variations on those for intuitionist tableaux (6.7). We start off, as usual, with a redefinition of faithfulness.

8.7.11 DEFINITION: Let $\mathcal{I} = \langle W, *, \nu \rangle$ be any Routley interpretation, and b be any branch of a tableau. Then \mathcal{I} is faithful to b iff there is a map, f , from the natural numbers to W , such that:

- for every node $A, +x$ on b , A is true at $f(x)$ in \mathcal{I} ,
- for every node $A, -x$ on b , A is false at $f(x)$ in \mathcal{I} ,

where $f(i^\#)$ is, by definition, $f(i)^*$.

8.7.12 SOUNDNESS LEMMA: Let b be any branch of a tableau, and $\mathcal{I} = \langle W, *, \nu \rangle$ be any Routley interpretation. If \mathcal{I} is faithful to b , and a tableau rule is applied, then it produces at least one extension, b' , such that \mathcal{I} is faithful to b' .

Proof:

Let f be a function which shows \mathcal{I} to be faithful to b . The proof proceeds by a case-by-case consideration of the tableau rules. Suppose we apply the rule to $A \wedge B, +x$, then, by assumption $A \wedge B$ is true at $f(x)$. Thus, A and B are both true at $f(x)$, and so f shows that \mathcal{I} is faithful to b' . If we apply the rule to $A \wedge B, -x$, then, by assumption, $A \wedge B$ is false at $f(x)$. Consequently, A is false at $f(x)$ or B is false at $f(x)$, i.e., f shows that \mathcal{I} is faithful to either the left branch or the right branch. The arguments for the rules for disjunction are also similar. This leaves the rules for negation. Suppose that we apply the rule to $\neg A, +i$. Then, by assumption, $\neg A$ is true at $f(i)$. Hence, A is false at $f(i)^*$, as required. If we apply the rule to $\neg A, +i^\#$, then we know that $\neg A$ is true at $f(i)^*$. Hence, A , is false at $f(i)$, as required. The argument for the other negation rule is similar. ■

8.7.13 SOUNDNESS THEOREM: For finite Σ , if $\Sigma \vdash A$ then $\Sigma \models A$.

Proof:

This follows from the Soundness Lemma in the usual way. ■

8.7.14 DEFINITION: Let b be an open branch of a tableau. The interpretation, $\mathcal{I} = \langle W, *, \nu \rangle$, induced by b , is defined as in 8.5.6. $W = \{w_0, w_{0^\#}\}$. $w_0^* = w_{0^\#}$, $(w_{0^\#})^* = w_0$. ν is such that:

$$\begin{aligned} \nu_{w_x}(p) &= 1 \text{ if } p, +x \text{ is on } b \\ \nu_{w_x}(p) &= 0 \text{ if } p, -x \text{ is on } b \end{aligned}$$

(where x is either 0 or $0^\#$). Since the branch is open, this is well defined. Note also that, by the definition of $*$, $w_x^{**} = w_x$, i.e., the induced interpretation is a Routley interpretation.

8.7.15 COMPLETENESS LEMMA: Let b be any open completed branch of a tableau. Let $\mathcal{I} = \langle W, *, \nu \rangle$ be the interpretation induced by b . Then:

$$\begin{aligned} &\text{if } A, +x \text{ is on } b, A \text{ is true at } w_x \\ &\text{if } A, -x \text{ is on } b, A \text{ is false at } w_x \end{aligned}$$

Proof:

This is proved by induction on the complexity of A . If A is atomic, the result is true by definition. If $B \wedge C$, $+x$ occurs on b , then $B, +x$ and $C, +x$ occur on b . By induction hypothesis, B and C are true at w_x . Hence, $B \wedge C$ is true at w_x . If $B \wedge C$, $-x$ occurs on b , then either $B, -x$, or $C, -x$ occurs on b . By induction hypothesis, B is false at w_x or C is false at w_x . Hence, $B \wedge C$ is false at w_x as required. The cases for disjunction are similar. For negation: if $\neg B$, $+x$ occurs on b , then $B, -\bar{x}$ occurs on b . By induction hypothesis, B is false at $w_{\bar{x}}$; hence, by the definition of $*$, B is false at w_x^* , that is, $\neg B$ is true at w_x , as required. The other negation rule is the same. ■

8.7.16 COMPLETENESS THEOREM: For finite Σ , if $\Sigma \models A$ then $\Sigma \vdash A$.

Proof:

The result follows from the Completeness Lemma in the usual fashion. ■

8.7.17 THEOREM: If $\Sigma \models A$ under the relational semantics, $\Sigma \models A$ under the Routley semantics.

Proof:

We prove the contrapositive. Suppose that there is a Routley interpretation, $\langle W, *, \nu \rangle$, and a world $w \in W$, which makes all the members of Σ true and

A false (i.e., untrue). Define a relational interpretation, ρ , by the following conditions:

$$\begin{aligned} p\rho 1 &\text{ iff } v_W(p) = 1 \\ p\rho 0 &\text{ iff } v_{W^*}(p) = 0 \end{aligned}$$

If it can be shown that the displayed conditions hold for all formulas, then the result follows. This is proved by induction on the construction of A . If A is a propositional parameter, the result holds by definition. Suppose that the result holds for B and C . $B \wedge C\rho 1$ iff $B\rho 1$ and $C\rho 1$; iff $v_W(B) = 1$ and $v_W(C) = 1$, by induction hypothesis; iff $v_W(B \wedge C) = 1$. $B \wedge C\rho 0$ iff $B\rho 0$ or $C\rho 0$; iff $v_{W^*}(B) = 0$ or $v_{W^*}(C) = 0$, by induction hypothesis; iff $v_{W^*}(B \wedge C) = 0$, as required. The cases for disjunction are similar. $\neg A\rho 1$ iff $A\rho 0$; iff $v_{W^*}(A) = 0$, by induction hypothesis; iff $v_W(\neg A) = 1$. $\neg A\rho 0$ iff $A\rho 1$; iff $v_W(A) = 1$, by induction hypothesis; iff $v_{W^*}(\neg A) = 0$, as required. ■

8.7.18 THEOREM: If $\Sigma \models A$ under the Routley semantics, $\Sigma \models A$ under the relational semantics.

Proof:

We prove the contrapositive. Suppose that there is a relational interpretation, ρ , which makes all the members of Σ true and A untrue. Define a Routley interpretation, $\langle W, *, v \rangle$, where $W = \{a, b\}$, $a^* = b$ and $b^* = a$, and v is defined by the conditions:

$$\begin{aligned} v_a(p) &= 1 \text{ iff } p\rho 1 \\ v_b(p) &= 1 \text{ iff it is not the case that } p\rho 0 \end{aligned}$$

If it can be shown that the displayed condition holds for all formulas, then the result follows. This is proved by induction on the construction of A . If A is a propositional parameter, the result holds by definition. Suppose that the result holds for B and C . $v_a(B \wedge C) = 1$ iff $v_a(B) = 1$ and $v_a(C) = 1$; iff $B\rho 1$ and $C\rho 1$, by induction hypothesis; iff $B \wedge C\rho 1$. $v_b(B \wedge C) = 1$ iff $v_b(B) = 1$ and $v_b(C) = 1$; iff it is not the case that $B\rho 0$ and it is not the case that $C\rho 0$, by induction hypothesis; iff it is not the case that $B \wedge C\rho 0$. The cases for disjunction are similar. $v_a(\neg B) = 1$ iff $v_{a^*}(B) = 0$; iff $v_b(B) = 0$; iff $B\rho 0$ by induction hypothesis; iff $\neg B\rho 1$. $v_b(\neg B) = 1$ iff $v_{b^*}(B) = 0$; iff $v_a(B) = 0$; iff it is not the case that $B\rho 1$, by induction hypothesis; iff it is not the case that $\neg B\rho 0$. ■

8.8 History

The logic *FDE* is the core of a family of relevant logics (which we will meet in later chapters), developed by the US logicians Anderson and Belnap, starting at the end of the 1950s. (Strictly speaking, $A \models_{FDE} B$ iff $A \rightarrow B$ is valid in their system of first degree entailment.) See Anderson and Belnap (1975, esp. ch. 3). The relational semantics were discovered by Dunn in the 1960s as a spin-off from his algebraic semantics for *FDE* (on which, see Anderson and Belnap 1975, sect. 18). He published them only later, however, by which time they had been discovered by others too. The Routley semantics for *FDE* were first given by Richard Routley (later Sylvan) and Val Routley (later Plumwood) in Routley and Routley (1972). There are many paraconsistent logics. *FDE*, *LP* and the relevant logics that we will meet in later chapters constitute one kind. Paraconsistent logics of different kinds were developed by the Polish logician Jaśkowski in 1948 (see Jaśkowski 1969) and the Brazilian logician da Costa in the 1960s (see da Costa 1974). A general history and survey of paraconsistent logics can be found in Priest (2002a).

8.9 Further Reading

On the various semantics for *FDE* covered in this chapter, see Priest (2002a, sects. 4.6 and 4.7); and for a much more detailed account, see Routley, Plumwood, Meyer and Brady (1982, sects. 3.1 and 3.2). For the Routleys' own discussion of the meaning of the star operator, see Routley and Routley (1985). For a defence of the Routley star, see Restall (1999). Discussions of the disjunctive syllogism can be found in Burgess (1983), Mortensen (1983) and Priest (1987, ch. 8).

8.10 Problems

- Using the tableau procedure of 8.3, determine whether or not the following are true in *FDE*. If the inference is invalid, specify a relational counter-model.
 - $p \wedge q \vdash p$
 - $p \vdash p \vee q$
 - $p \wedge (q \vee r) \vdash (p \wedge q) \vee (p \wedge r)$
 - $p \vee (q \wedge r) \vdash (p \vee q) \wedge (p \vee r)$

- (e) $p \vdash \neg\neg p$
- (f) $\neg\neg p \vdash p$
- (g) $(p \wedge q) \supset r \vdash (p \wedge \neg r) \supset \neg q$
- (h) $p \wedge \neg p \vdash p \vee \neg p$
- (i) $p \wedge \neg p \vdash q \vee \neg q$
- (j) $p \vee q \vdash p \wedge q$
- (k) $p, \neg(p \wedge \neg q) \vdash q$
- (l) $(p \wedge q) \supset r \vdash p \supset (\neg q \vee r)$

2. For the inferences of problem 1 that are invalid, determine which ones are valid in K_3 and LP , using the appropriate tableaux.
3. Check all the details omitted in 8.4.2.
4. By checking the truth tables of 8.4.2, note that if A and B have truth value n , then so do $A \vee B, A \wedge B$ and $\neg A$. Infer that if A is any formula all of whose propositional parameters take the value n , it, too, takes the value n . Hence infer that there is no formula, A , such that $\models_{FDE} A$.
5. Similarly, show that if A is a formula all of whose propositional parameters take the value b , then A takes the value b . Hence, show that if A and B have no propositional parameters in common, $A \not\models_{FDE} B$. (Hint: Assign all the parameters in A the value b , and all the parameters in B the value n .)
6. Repeat problem 1 with the $*$ semantics and tableaux of 8.5.
7. Using the $*$ semantics, show that if $A \models_{FDE} B$, then $\neg B \models_{FDE} \neg A$. (Hint: Assume that there is a counter-model for the consequent.) Why is this not obvious with the many-valued or the relational semantics? (Note that contraposition of this kind does not extend to multiple-premise inferences: $p, q \models_{FDE} p$, but $p, \neg p \not\models_{FDE} \neg q$.)
8. Test the validity of the inferences in 7.5.2 using the tableau of this chapter.
9. Under what conditions is it legitimate to employ a deductively invalid inference?
10. *Check the details omitted in 8.7.3.
11. *Show that the tableaux of 8.4a.4 and 8.4a.5 are sound and complete with respect to the semantics of L_3 and RM_3 . (Hint: consult 8.7.8 and 8.7.9.)

9 Logics with Gaps, Gluts and Worlds

9.1 Introduction

9.1.1 In this chapter, we will see how the techniques of modal logic and many-valued logic can be combined. More specifically, we will look at logics that add some kind of strict conditional with world semantics on top of a many-valued base-logic, specifically, *FDE*.¹

9.1.2 The non-normal worlds of chapter 4 will also make a reappearance, giving us some basic relevant logics. This will allow us to discuss further what, exactly, non-normal worlds are.

9.1.3 We will end the chapter with a brief look at so called logics of constructible negation, which have close connections with intuitionist logic; and an even briefer look at connexive logics.

9.2 Adding \rightarrow

9.2.1 *FDE* has no conditional operator. The material conditional, $A \supset B$, does not even satisfy *modus ponens*, as we saw in 8.6.5. In any case, as we have seen, using possible-world semantics provides a much more promising approach to the logic of conditional operators. Thus, an obvious thing to do is to build a possible-world semantics on top of the relational semantics of *FDE*.

9.2.2 To effect this, let us add a new binary connective, \rightarrow , to the language of *FDE* to represent the conditional. By analogy with $K\cup$, a relational

¹ The most obvious combination of the two techniques is in the construction of simple many-valued modal logics. Since this material breaks the main sequence of development of the book, I cover it in the appendix, chapter 11a.

interpretation for such a language is a pair $\langle W, \rho \rangle$, where W is a set of worlds, and for every $w \in W$, ρ_w is a relation between propositional parameters and the values 1 and 0.

9.2.3 The truth and falsity conditions for the extensional connectives (\wedge , \vee and \neg) are exactly those of 8.2.6, except that they are relativised to each world, w . Thus, for example, the truth and falsity conditions for conjunction are:

$$A \wedge B \rho_w 1 \text{ iff } A \rho_w 1 \text{ and } B \rho_w 1$$

$$A \wedge B \rho_w 0 \text{ iff } A \rho_w 0 \text{ or } B \rho_w 0$$

9.2.4 For the truth and falsity conditions for \rightarrow , recall that the truth and falsity conditions for \neg in K_V come to this: $v_w(A \neg B) = 1$ if for all w' such that $v_{w'}(A) = 1$, $v_{w'}(B) = 1$; and $v_w(A \neg B) = 0$ if for some w' , $v_{w'}(A) = 1$ and $v_{w'}(B) = 0$. Making the obvious generalisation:

$$A \rightarrow B \rho_w 1 \text{ iff for all } w' \in W \text{ such that } A \rho_{w'} 1, B \rho_{w'} 1$$

$$A \rightarrow B \rho_w 0 \text{ iff for some } w' \in W, A \rho_{w'} 1 \text{ and } B \rho_{w'} 0$$

9.2.5 Semantic consequence is defined in terms of truth preservation at all worlds of all interpretations:

$$\Sigma \models A \text{ iff for every interpretation, } \langle W, \rho \rangle, \text{ and all } w \in W: \text{ if } B \rho_w 1 \text{ for all } B \in \Sigma, A \rho_w 1$$

9.2.6 A natural name for this logic would be K_{V_4} . We will call it, more simply, K_4 .

9.3 Tableaux for K_4

9.3.1 A tableau system for K_4 can be obtained by modifying the system for *FDE* of 8.3, in the same way that the tableau system for classical propositional logic is modified in order to obtain one for K_V (3.5.3).

9.3.2 A node now has the form $A, +i$ or $A, -i$, where i is a natural number. The initial list comprises a node of the form $B, +0$ for every premise, B , and $A, -0$, where A is the conclusion. A branch closes if it contains a pair of the form $A, +i$ and $A, -i$.

9.3.3 The rules for the extensional connectives are exactly the same as those of 8.3.4 for *FDE*, except that i is carried through each rule.

Thus, for example, the rules for \wedge are:

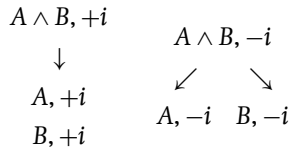

9.3.4 The rules for the conditional are as follows:

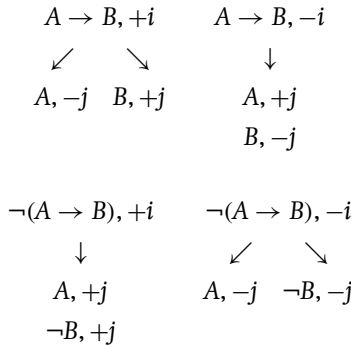

In the rules that split the branch, j is every number that occurs on the branch. In the other two rules, j is a new number.

9.3.5 Example: $A \rightarrow B, B \rightarrow C \vdash A \rightarrow C$:

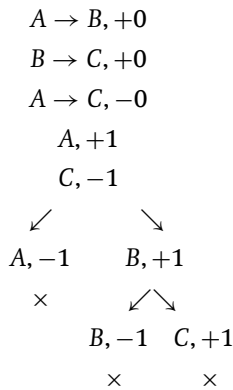

The fourth and fifth lines are obtained by applying the rule for untrue \rightarrow to the third line. The two splits are then obtained by applying the rule for true \rightarrow to the first and second lines respectively.

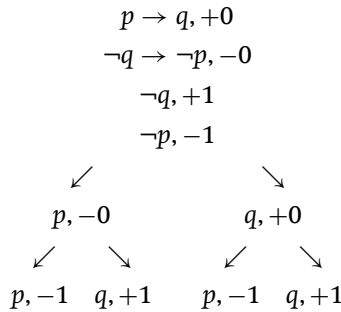
9.3.6 Example: $p \rightarrow q \not\vdash \neg q \rightarrow \neg p$:

9.3.7 Counter-models are read off from open branches of tableaux in the natural way. There is a world w_i for each i on the branch; for propositional parameters, p , if $p, +i$ occurs on the branch, set $p\rho_{w_i}1$; if $\neg p, +i$ occurs on the branch, set $p\rho_{w_i}0$. ρ relates no parameter to anything else. Thus, the counter-model defined by the leftmost branch of the tableau of 9.3.6 may be depicted thus:

w_0	w_1
$\neg p$	$\neg p$
	$\neg\neg p$
	$+\neg q$

($+A$ indicates that A is true; $-A$ indicates that it is untrue.) At every world, p is untrue. Hence, $p \rightarrow q$ is true at w_0 . But $\neg q$ is true at w_1 , and $\neg p$ is not true there. Hence, $\neg q \rightarrow \neg p$ is not true at w_0 .

9.3.8 The tableaux are sound and complete with respect to the semantics. This is proved in 9.8.1–9.8.7.

9.4 Non-normal Worlds Again

9.4.1 As is to be expected, and is not difficult to check, the following do not hold in \mathcal{K}_4 : $\models p \rightarrow (q \vee \neg q)$, $\models (p \wedge \neg p) \rightarrow q$. The conditional of \mathcal{K}_4 does not, therefore, suffer from these paradoxes of the strict conditional.

9.4.2 But, as is also easy to see, it is still the case that if $\models A$ then $\models B \rightarrow A$. (If A is true at all worlds of all interpretations, it is true at all worlds of all

interpretations where B is true).² In particular, for example, since $\models q \rightarrow q$, $\models p \rightarrow (q \rightarrow q)$.

9.4.3 This may well be felt to be unsatisfactory. $q \rightarrow q$ is an instance of the law of identity. Yet the following conditional would hardly seem to be true: if every instance of the law of identity failed, then, if cows were black, cows would be black. If every instance of the law failed, then it would precisely *not* be the case that if cows were black, they would be black.

9.4.4 Clearly, if we are thinking in terms of worlds, to do justice to this conditional, we need to countenance worlds where the laws of logic are different, and so where laws of logic, like the law of identity, may fail. This is exactly what non-normal worlds are, as we saw in 4.4.8 and 4.4a.14. Hence, it is natural to augment the semantic machinery with appropriate non-normal worlds.

9.4.5 Now, it is exactly conditionals – which guarantee truth preservation from antecedent to consequent at all worlds – that express laws of logic. (A conditional such as ‘If it does not rain, we will go to the cricket’ does not express a law of logic, of course. But, as we noted in 5.2.4, such a conditional is not, arguably and strictly speaking, true.) Hence, we need to consider worlds where formulas of the form $A \rightarrow B$ may take values different from the values they may take in K_4 .

9.4.6 How different? If logical laws may change, then there would seem to be no *a priori* bound on how this may happen. Hence, at a non-normal world $A \rightarrow B$ might be able to take on any sort of value. It therefore behaves in exactly the same way as do modal formulas in the logic L of 4.4a.

9.4.7 A way of making these ideas precise is to take an interpretation to be a structure $\langle W, N, \rho \rangle$, where W is a set of worlds, $N \subseteq W$ is the set of normal worlds (so that $W - N$ is the set of non-normal worlds), and ρ does two things. For every w , ρ_w is a relation between propositional parameters and the truth values 1 and 0, in the usual way. But also, for every *non-normal* world, w , ρ_w is a relation between formulas of the form $A \rightarrow B$ and truth values.

² The dual (if $\models \neg A$ then $\models A \rightarrow B$) does not hold. For example, even though $\models \neg\neg(p \rightarrow p)$, $\not\models \neg(p \rightarrow p) \rightarrow q$, as may be checked.

9.4.8 The truth conditions for all the connectives are exactly as in K_4 (9.2.4), except that at non-normal worlds, the truth values of \rightarrow formulas are not determined recursively: they are already determined by ρ .

9.4.9 Validity is defined in terms of truth preservation at all normal worlds of all interpretations, as in 4.2.5. (After all, we are interested in what follows from what in the worlds where logic is *not* different.) Call this logic N_4 .³

9.5 Tableaux for N_4

9.5.1 Tableaux for N_4 can be obtained by modifying those for K_4 . Specifically, the rules are exactly the same as those for K_4 , except that the rules for \rightarrow apply at world 0 only. (It turns out that we never need to assume that there is *more* than one normal world in a counter-model.)

9.5.2 For example: $\not\vdash \neg(p \rightarrow p) \rightarrow (q \rightarrow q)$:

$$\begin{array}{l} \neg(p \rightarrow p) \rightarrow (q \rightarrow q), -0 \\ \neg(p \rightarrow p), +1 \\ (q \rightarrow q), -1 \end{array}$$

The tableau finishes there! (In K_4 an application of the rule for untrue \rightarrow to the last line would immediately close it.)

9.5.3 We read off a counter-model from an open branch exactly as for K_4 (9.3.7), except that the only normal world is w_0 – all others are non-normal – and the recipe for determining ρ is applied to propositional parameters at all worlds, and to any formula of the form $A \rightarrow B$ at *non-normal* worlds. Thus, in the tableau of the previous paragraph, $W = \{w_0, w_1\}$; $N = \{w_0\}$ and $p \rightarrow p \rho_{w_1} 0$, there being no other facts about ρ . Since $\neg(p \rightarrow p)$ is true at w_1 , and $q \rightarrow q$ is not true at w_1 , $\neg(p \rightarrow p) \rightarrow (q \rightarrow q)$ is not true at w_0 .

9.5.4 Since interpretations for K_4 are special cases of interpretations for N_4 (namely, when $W - N = \emptyset$), N_4 is a sub-logic of K_4 , but not the other way around, as this example shows.

³ Since the logic is conceptually much closer to the non-normal modal logic L than N , ‘ L_4 ’ would be a more appropriate name. (Similarly for N_* in 9.6.) However, ‘ N_4 ’ was the name used in the first edition of this book, and it would seem to cause less confusion to stick with this.

9.5.5 The tableaux for N_4 are sound and complete with respect to the semantics. This is proved in 9.8.8–9.8.9.

9.6 Star Again

9.6.1 Before we move on to consider some of the implications of the preceding, let us pause to note that exactly the same sorts of construction can be performed with respect to the $*$ semantics.

9.6.2 Let $\langle W, *, v \rangle$ be any Routley interpretation (8.5.3). This becomes an interpretation for the augmented language when we add the following truth condition for \rightarrow :

$$v_w(A \rightarrow B) = 1 \text{ iff for all } w' \in W \text{ such that } v_{w'}(A) = 1, v_{w'}(B) = 1$$

Call the logic that this generates, K_* .

9.6.3 Tableaux for K_* can be obtained by adding to the rules of 8.5.4, these rules for \rightarrow :

$$\begin{array}{ccc} A \rightarrow B, +x & & A \rightarrow B, -x \\ \swarrow & \searrow & \downarrow \\ A, -y & B, +y & A, +j \\ & & B, -j \end{array}$$

where x is either i or $i^\#$; y is anything of the form j or $j^\#$, where one or other (or both) of these is on the branch;⁴ and in the second rule, j must be new. (Note that we do not need rules for negated \rightarrow . The $*$ rules take care of that.)

9.6.4 Here is a tableau to show that $p \wedge \neg q \not\vdash \neg(p \rightarrow q)$:

$$\begin{array}{c} p \wedge \neg q, +0 \\ \neg(p \rightarrow q), -0 \\ p, +0 \\ \neg q, +0 \\ q, -0^\# \\ \downarrow \end{array}$$

⁴ So for a completed tableau, if either j or $j^\#$ occurs on the branch, the rule needs to be applied to both j and $j^\#$.

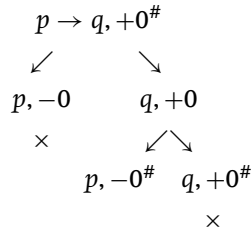

The splits are caused by applying the rule for $\text{true} \rightarrow$ to the line immediately before the first split. There are two worlds, 0 and $0^\#$, so the rule has to be applied to both of them.

9.6.5 Counter-models are read off as is done without \rightarrow (8.5.6), except that there may be more than two worlds now. Thus, W is the set of worlds which contains w_x for every x and \bar{x} that occurs on the branch. For all i , $w_i^* = w_{i^\#}$ and $w_{i^\#}^* = w_i$. v is such that if $p, +x$ occurs on the branch, $v_x(p) = 1$, and if $p, -x$ occurs on the branch, $v_x(p) = 0$. Thus, the counter-model from the open branch of the tableau of 9.6.4 may be depicted thus:

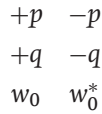

Since q is not true at w_0^* , $\neg q$ is true at w_0 , as, then, is $p \wedge \neg q$. But at every world where p is true, q is true. Hence, $p \rightarrow q$ is true at w_0^* , and so $\neg(p \rightarrow q)$ is false (untrue) at w_0 .

9.6.6 As in K_4 , in K_* , $\models p \rightarrow (q \rightarrow q)$, as may easily be checked. To change this, we may add non-normal worlds in the same way. An interpretation is a structure $\langle W, N, *, v \rangle$, where $N \subseteq W$; for all $w \in W$, $w^{**} = w$; v assigns a truth value to every parameter at every world, and to every formula of the form $A \rightarrow B$ at every non-normal world. The truth conditions are exactly the same as for K_* , except that the truth conditions for \rightarrow apply only at normal worlds; at non-normal worlds, they are already given by v . Validity is defined in terms of truth preservation at normal worlds. Call this logic N_* .

9.6.7 The tableaux for N_* are the same as those for K_* , except that the rules for \rightarrow (9.6.3) are applied only at 0 . Counter-models are also read off in the same way. Again, only w_0 is normal.

9.6.8 Soundness and completeness for the tableaux for K_* and N_* are proved in 9.8.10–9.8.13.

9.6.9 It should be noted that although the relational semantics and the $*$ semantics are equivalent for *FDE*, as we saw in 8.5.8, this equivalence no longer obtains once we add \rightarrow . For a start, the $*$ systems (K and N) validate contraposition: $p \rightarrow q \models \neg q \rightarrow \neg p$. (Details are left as an exercise.) The relational systems do not. (We saw that this is not valid in K_4 , and *a fortiori* N_4 , in 9.3.6.)⁵

9.6.10 More fundamentally, because of the falsity conditions for \rightarrow , the relation semantics (normal and non-normal) verify $p \wedge \neg q \models \neg(p \rightarrow q)$. (Details are left as an exercise.) But this inference fails in K_* (and *a fortiori* N_*), as we saw in 9.6.4.

9.7 Impossible Worlds and Relevant Logic

9.7.1 We are now in a position to make some comments on the import of the previous constructions.

9.7.2 As we saw (9.4.4–9.4.6), non-normal worlds of the kind we have employed in this chapter are worlds where the laws of logic are different. Let us call these ‘logically impossible worlds’.

9.7.3 There seems to be no reason why there should not be logically impossible worlds, in whatever sense there are possible worlds. Physically impossible worlds, where the laws of physics are different, are entirely routine (see 3.6.5). And just as there are worlds where the laws of physics are different, there must be worlds where the laws of logic are different.

9.7.4 After all, we seem to envisage just such worlds when we evaluate conditionals such as ‘if intuitionist logic were correct, the law of double negation would fail’ (true), ‘if intuitionist logic were correct, the law of

⁵ This may be changed by redefining the truth conditions of \rightarrow (at normal worlds) in the relational semantics, as:

$$A \rightarrow B \rho_W 1 \text{ iff for all } w' \in W \text{ (if } A \rho_{w'} 1 \text{ then } B \rho_{w'} 1, \text{ and if } B \rho_{w'} 0 \text{ then } A \rho_{w'} 0).$$

Or, more simply, and equivalently, defining a new conditional $A \Rightarrow B$ as $(A \rightarrow B) \wedge (\neg B \rightarrow \neg A)$, and working with this.

identity would fail' (false). Even if one is a modal realist (2.6), why should there not be such worlds?

9.7.5 One might suggest that there can be no worlds at which logical laws fail: by definition, logical laws hold at *all* possible worlds. Maybe so. But it is precisely *impossible* worlds that we are dealing with here. Or one might say: take a world in which it is a logical law that $A \rightarrow (B \wedge \neg B)$ and in which A is also true. It would follow that $B \wedge \neg B$ is true at that world, which cannot be the case. This argument is hardly likely to persuade someone who accepts the possibility of truth-value gluts. But in any case, it is fallacious. For who says that *modus ponens* holds at that world? In the semantics we have looked at, it is entirely possible to have both A and $A \rightarrow C$ holding at a non-normal world, without C holding there.

9.7.6 Note that one might take 'logically impossible world' to mean something other than 'world where the laws of logic are different'. One might equally take it to mean 'world where the logically impossible happens'. This need not be the same thing. If this is not clear, just consider physically impossible worlds. The fact that the laws of physics are different does not necessarily mean that physically impossible things happen there (though the converse is true). For example, even if the laws of physics were to permit things to accelerate past the speed of light, it does not follow that anything actually would. Things at that world might be accelerating very slowly, and the world might not last long enough for any of them to reach super-luminal speeds.

9.7.7 But logically impossible worlds, in the sense that these occur in the semantics we have been looking at, may be logically impossible in the second sense as well. For example, there are, as has just been noted, worlds where A and $A \rightarrow C$ are true, but C is not.⁶

9.7.8 A propositional logic is *relevant* iff whenever $A \rightarrow B$ is logically valid, A and B have a propositional parameter in common. Obviously, any conditional that suffers from paradoxes of implication (material implication,

⁶ There are no worlds at which $A \wedge B$ is true, but A is not, or at which $\neg\neg A$ is true, but A is not. But it is conditionals that express the laws of logic, not conjunctions or negations. That is why it is their behaviour (and only theirs) that changes at non-normal worlds.

strict implication, the intuitionist conditional) is not relevant. Neither are K_4 and K_* relevant, as we have seen (9.4.2 and 9.6.6).

9.7.9 But N_4 is a relevant logic. This can be seen by modifying the argument of 8.10, problem 5. Suppose that A and B share no propositional parameters, and consider an interpretation $\langle W, N, \rho \rangle$, where $W = \{w_0, w_1\}$; $N = \{w_0\}$; if D is a propositional parameter or a conditional in A , $D\rho_{w_1} 1$ and $D\rho_{w_1} 0$; if D is a propositional parameter or a conditional in B , neither $D\rho_{w_1} 1$ nor $D\rho_{w_1} 0$. (D cannot occur in both, since A and B have no parameters in common.) It is easy to check that $A\rho_{w_1} 1$ and $A\rho_{w_1} 0$, but neither $B\rho_{w_1} 1$ nor $B\rho_{w_1} 0$.⁷ In particular, A is true at w_1 and B is not. Hence $A \rightarrow B$ is not true at w_0 .

9.7.10 A similar argument shows that N_* is a relevant logic. Take a $*$ interpretation $\langle W, N, *, \nu \rangle$, where $W = \{w_0, w_1, w_2\}$; $N = \{w_0\}$, $w_0^* = w_0$, $w_1^* = w_2$, $w_2^* = w_1$; for every propositional parameter or conditional, D , in A , $\nu_{w_1}(D) = 1$ and $\nu_{w_2}(D) = 0$; for every propositional parameter or conditional, D , in B , $\nu_{w_1}(D) = 0$ and $\nu_{w_2}(D) = 1$. One can check that $\nu_{w_1}(A) = 1$, and $\nu_{w_1}(B) = 0$. Hence $\nu_{w_0}(A \rightarrow B) = 0$. Details are left as an exercise.

9.7.11 It is a natural thought that for a conditional to be true there must be some connection between its antecedent and consequent. It was precisely this idea that led to the development of relevant logic. A sensible notion of connection is not so easy to spell out, however (as we saw, in effect, in 4.9.2). The parameter-sharing condition of 9.7.8 gives some content to the idea.

9.7.12 There are some approaches to relevant logic where a conditional is taken to be valid iff it is classically valid *and* satisfies some extra constraint, for example that antecedent and consequent share a parameter. (These are

⁷ *Proof:* For the first, what we show is that every formula made up from the propositional parameters occurring in A – and so, in particular, A – the result holds. Similarly for B . This is proved by induction on the construction of sentences, but an induction slightly different from the normal kind. Note that every formula can be built up from conditionals and parameters using the extensional connectives. Hence, the result may be proved by induction, with parameters and conditionals as the basis case, and induction cases for the extensional connectives. The basis case is true by definition. The induction cases are as in the notes to 8.4.6 and 8.4.9.

sometimes called *filter logics*, since the extra constraint filters out ‘undesirables’.) Characteristically, such approaches give rise to relevant logics of a kind different from those considered in this book. For example, if the parameter-sharing filter is used, $(p \wedge (\neg p \vee q)) \rightarrow q$ is valid, which it is not in the relevant logics of this, and subsequent, chapters. Typically (though not invariably), a feature of filter logics is the failure of the principle of transitivity: if $A \models B$ and $B \models C$ then $A \models C$ (thus breaking the argument of 4.9.2).

9.7.13 In the present approach, relevance is not some extra condition imposed *on top* of classical validity. Rather, relevance, in the form of parameter sharing, falls out of something more fundamental, namely the taking into account of a suitably wide range of situations.

9.7.14 One final comment: one might hold that truth – real truth, not just truth in some world – has some special properties; that unlike truth in an arbitrary world, truth itself can have no gaps or gluts. To accommodate this view, one could take an interpretation to include a distinguished normal world, @ (for actuality), such that truth (*simpliciter*) is truth at @. Validity would then be defined as truth preservation at @ in all interpretations.⁸ The special properties of truth would be reflected in semantic constraints on @. Thus, if it be held that there are no truth-value gluts in @, one would impose the constraint that $\rho_{@}$ satisfy the condition *Exclusion* of 8.4.6. If it be held that there are no truth-value gaps in @, then one would impose the constraint that $\rho_{@}$ satisfy the condition *Exhaustion* of 8.4.9.⁹ Or in a * interpretation, one might require that @ = @*, which rules out gaps and gluts. But from the present

⁸ One could, in fact, set up all the possible-world semantics that we have had till now in this way. But since these semantics contain nothing to distinguish @ from any other normal world, this would have had no effect on validity.

⁹ Strictly speaking, these conditions are not sufficient. To rule out truth-value gluts and gaps with formulas containing $\rightarrow s$, we need to make another change as well. Specifically, to rule out truth-value gaps, the falsity conditions for $A \rightarrow B$ at @ have to read:

$A \rightarrow B \rho_{@} 0$ iff (for some w' , $A \rho_{w'} 1$ and $B \rho_{w'} 0$) or (it is not the case that $A \rightarrow B \rho_{w'} 1$)
and to rule out truth-value gluts, they have to read:

$A \rightarrow B \rho_{@} 0$ iff (for some w' , $A \rho_{w'} 1$ and $B \rho_{w'} 0$) and (it is not the case that $A \rightarrow B \rho_{w'} 1$).

perspectives, these conditions would require justification by some novel considerations.

9.7a Logics of Constructible Negation

9.7a.1 Let us end this chapter with a brief look at a few other notable logics in the same ballpark as the ones we have already considered. These are obtained, essentially, by taking positive intuitionist logic – that is, the negation-free part of intuitionist logic – and grafting on a different account of negation. The logics are often called logics of constructible negation. The mark of these logics is that, unlike intuitionist logic, they treat truth and falsity even-handedly.

9.7a.2 Consider interpretations of the form (W, R, ρ) , where W is the usual set of worlds, R is a reflexive and transitive binary relation on W , and for every $w \in W$, and propositional parameter, p , ρ_w relates p to 1, 0, both or neither, subject to the heredity constraints:

$$\begin{aligned} &\text{if } p\rho_w 1 \text{ and } wRw', \text{ then } p\rho_{w'} 1 \\ &\text{if } p\rho_w 0 \text{ and } wRw', \text{ then } p\rho_{w'} 0 \end{aligned}$$

The truth conditions in 9.7a.3 then ensure that these conditions hold for all formulas, not just propositional parameters. (See 9.11, problem 9.)

9.7a.3 The truth/falsity conditions for the connectives are as follows. I write the conditional as \sqsupset , to make the connection with intuitionist logic clear.

$$\begin{aligned} A \wedge B\rho_w 1 &\text{ iff } A\rho_w 1 \text{ and } B\rho_w 1 \\ A \wedge B\rho_w 0 &\text{ iff } A\rho_w 0 \text{ or } B\rho_w 0 \end{aligned}$$

$$\begin{aligned} A \vee B\rho_w 1 &\text{ iff } A\rho_w 1 \text{ or } B\rho_w 1 \\ A \vee B\rho_w 0 &\text{ iff } A\rho_w 0 \text{ and } B\rho_w 0 \end{aligned}$$

$$\begin{aligned} \neg A\rho_w 1 &\text{ iff } A\rho_w 0 \\ \neg A\rho_w 0 &\text{ iff } A\rho_w 1 \end{aligned}$$

$$\begin{aligned} A \sqsupset B\rho_w 1 &\text{ iff for all } w' \text{ such that } wRw', \text{ either it is not the case that } A\rho_{w'} 1 \text{ or } \\ &B\rho_{w'} 1 \\ A \sqsupset B\rho_w 0 &\text{ iff } A\rho_w 1 \text{ and } B\rho_w 0 \end{aligned}$$

An inference is valid if it is truth-preserving in all worlds of all interpretations, as in K_4 . Call this logic I_4 .¹⁰

9.7a.4 Tableaux for I_4 are the same as those for K_4 , except that the rules for the conditional are:

$$\begin{array}{cc}
 A \sqsupset B, +i & A \sqsupset B, -i \\
 \text{irj} & \downarrow \\
 \swarrow \quad \searrow & \text{irj} \\
 A, -j \quad B, +j & A, +j \\
 & B, -j
 \end{array}$$

In the first rule, j is any number on the branch. In the second, j is new to the branch.

$$\begin{array}{cc}
 \neg(A \sqsupset B), +i & \neg(A \sqsupset B), -i \\
 \downarrow & \swarrow \quad \searrow \\
 A, +i & A, -i \quad \neg B, -i \\
 \neg B, +i &
 \end{array}$$

We also have the rules for reflexivity and transitivity of r (3.3.2), and the heredity rules:

$$\begin{array}{cc}
 p, +i & \neg p, +i \\
 \text{irj} & \text{irj} \\
 \downarrow & \downarrow \\
 p, +j & \neg p, +j
 \end{array}$$

where p is any propositional parameter.

A tableau closes if we have lines of the form $A, +i$ and $A, -i$.

9.7a.5 Here are tableaux to show that $\vdash \neg\neg A \sqsupset A$, and $\not\vdash (p \wedge \neg p) \sqsupset q$:

$$\begin{array}{c}
 \neg\neg A \sqsupset A, -0 \\
 0r0 \\
 0r1, 1r1 \\
 \neg\neg A, +1 \\
 A, -1 \\
 A, +1 \\
 \times
 \end{array}$$

¹⁰ The reason that the logic is called one of constructible negation is that - unlike intuitionist logic - for a conditional to be false, its antecedent must be true and its consequent must be false. That is, we must be able to construct a counter-example to it.

The last line is obtained by the rule for double negation.

$$\begin{array}{c}
 (p \wedge \neg p) \sqsupset q, -0 \\
 \text{Or } 0 \\
 \text{Or } 1, 1r1 \\
 p \wedge \neg p, +1 \\
 q, -1 \\
 p, +1 \\
 \neg p, +1
 \end{array}$$

9.7a.6 Counter-models are read off from open branches as for K_4 (9.3.7), except that details about R are read off as in tableaux for modal logics. Thus, the counter-model given by the tableau of 9.7a.5 is as follows:

$$\begin{array}{c}
 \widehat{w}_0 \rightarrow \widehat{w}_1 \\
 +p \\
 +\neg p \\
 -q
 \end{array}$$

9.7a.7 A standard variant of I_4 is obtained by adding the appropriate version of the Exclusion Constraint of 8.4.6:

$$\text{for no } p \text{ and } w, p\rho_w 1 \text{ and } p\rho_w 0$$

This ensures the corresponding statement for all formulas.¹¹ Call the logic I_3 . Appropriate tableaux are obtained by adding the extra closure rule:

$$\begin{array}{c}
 A, +i \\
 \neg A, +i \\
 \times
 \end{array}$$

Clearly, the open tableau of 9.7a.5 closes in I_3 , so $\vdash (p \wedge \neg p) \sqsupset q$.

9.7a.8 It is not difficult to see that for sentences that do not contain negation, an inference is valid in I_4 (and I_3) iff it is valid in intuitionist logic, I . To see this, note that any intuitionist interpretation, $\langle W, R, v \rangle$, corresponds to an I_4 (or I_3) interpretation $\langle W, R, \rho \rangle$, where $v_w(p) = 1$ iff $p\rho_w 1$; and vice

¹¹ The proof is essentially as in the footnote of 8.4.6, except for the case for \sqsupset , which goes as follows. Suppose that $A \sqsupset B\rho_w 1$ and $A \sqsupset B\rho_w 0$. Then, by the second, $A\rho_w 1$ and $B\rho_w 0$. Moreover, by the first, $B\rho_w 1$. This is impossible, by induction hypothesis.

versa. A short argument by induction (for connectives other than negation) then shows that for every formula, A , $v_w(A) = 1$ iff $A\rho_w 1$. (Details are left as an exercise.) In other words, the two sorts of interpretation are essentially the same.

9.7a.9 Clearly, I_4 (and I_3) differ from I in the behaviour of negation, however, as 9.7a.5 shows.

9.7a.10 In the context of a discussion of conditionals, a further variation is worth noting. Suppose that in I_4 we change the falsity conditions for \sqsupset to:

$A \sqsupset B\rho_w 0$ iff $A \sqsupset \neg B\rho_w 1$ (i.e., for all w' such that wRw' , either it is not the case that $A\rho_{w'} 1$ or $B\rho_{w'} 0$).

The corresponding tableau rule for negated conditionals is simply:

$$\begin{array}{c} \neg(A \sqsupset B), \underline{+}i \\ \downarrow \\ A \sqsupset \neg B, \underline{+}i \end{array}$$

where the $\underline{+}$ can be disambiguated consistently either way.

Call this logic W (for Wansing).¹²

9.7a.11 The change makes no difference to the negation-free inferences, but it does affect the inferences involving negation. In particular, it is not difficult to check that both of the following are valid:

Aristotle $\neg(A \sqsupset \neg A)$

Boethius $(A \sqsupset B) \sqsupset \neg(A \sqsupset \neg B)$

The principles are so named because they are endorsed, arguably, by the philosophers in question. In modern logic, their holding characterises a logic as a *connexive* logic. There are many such logics. W is one of the simplest and most natural.

9.7a.12 One reason why connexive logics are important is the following. All the propositional logics we will meet in this book, other than connexive logics, are sub-logics of classical logic (when the various negation

¹² A similar modification of I_3 does not quite work. The Exclusion Constraint of 9.7a.7 is not sufficient to ensure that all formulas are not both true and false. $A \sqsupset B$ may be so, even though A and B are not (for example, if A is true at no worlds).

and conditional symbols are identified): any inference valid in the logic is valid in classical logic. **Aristotle** and **Boethius** are not valid in classical logic (when \sqsupset is identified with \supset). Indeed, they have instances that are classical contradictions. For example, $\models (p \wedge \neg p) \sqsupset \neg(p \wedge \neg p)$ in classical logic (and even in most relevant logics).¹³ So connexive logics are very distinctive.

9.7a.13 **Aristotle** and **Boethius** are highly heterodox principles of conditionality. However, they do have a certain intuitive appeal. This makes connexive logics particularly interesting in the context of discussions of the conditional.

9.7a.14 Another notable feature of W is that its class of logical truths is inconsistent. It is not difficult to show that $(p \wedge \neg p) \sqsupset \neg(p \wedge \neg p)$ is valid. (Details are left as an exercise.) This contradicts **Aristotle**. W is the only propositional logic we will meet in this book with this property.¹⁴

9.7a.15 The tableaux of this section are sound and complete with respect to their semantics. The proofs of this can be found in 9.8.

9.8 *Proofs of Theorems

9.8.1 Soundness and completeness proofs for K_4 and N_4 can be obtained by modifying the proofs for FDE , as the proofs for classical logic were modified for normal and non-normal logics, respectively. Let us start with K_4 .

9.8.2 DEFINITION: Let $\mathcal{I} = \langle W, \rho \rangle$ be any relational interpretation, and b be any branch of a tableau. Then \mathcal{I} is faithful to b iff there is a map, f , from the natural numbers to W such that:

for every node A , $+i$ on b , $A\rho_{f(i)}1$ in \mathcal{I} .

for every node A , $-i$ on b , it is not the case that $A\rho_{f(i)}1$ in \mathcal{I} .

9.8.3 SOUNDNESS LEMMA: Let b be any branch of a tableau, and $\mathcal{I} = \langle W, \rho \rangle$ be any K_4 interpretation. If \mathcal{I} is faithful to b , and a tableau rule is applied to it, then it produces at least one extension, b' , such that \mathcal{I} is faithful to b' .

¹³ In such logics, $\models (p \wedge \neg p) \rightarrow p$. By contraposition, $\models \neg p \rightarrow \neg(p \wedge \neg p)$, so $\models (p \wedge \neg p) \rightarrow \neg(p \wedge \neg p)$.

¹⁴ Most connexive logics in the literature are, in fact, consistent. This is because conjunction is usually taken to behave in a non-standard fashion.

Proof:

Let f be a function which shows \mathcal{I} to be faithful to b . The proof proceeds by a case-by-case consideration of the tableau rules. The cases for the extensional rules are essentially as for *FDE* (8.7.3). We simply rewrite ρ as $\rho_{f(i)}$. For the rules for \rightarrow : suppose that we apply the rule to $A \rightarrow B, +i$. Then by assumption, $A \rightarrow B$ is true at $f(i)$. Hence, for any j on the branch, either A is not true at $f(j)$ or B is true at $f(j)$. In the first case, f shows \mathcal{I} to be faithful to the lefthand branch; in the second, it shows \mathcal{I} to be faithful to the righthand branch. Next, suppose that we apply the rule to $A \rightarrow B, -i$. Then $A \rightarrow B$ is not true at $f(i)$. Hence, there is some w such that A is true at w and B is not. Let f' be the same as f , except that $f'(j) = w$. Then f' shows \mathcal{I} to be faithful to the extended branch, as usual. The cases for $\neg(A \rightarrow B), +i$ and $\neg(A \rightarrow B), -i$ are similar. ■

9.8.4 SOUNDNESS THEOREM FOR K_4 : For finite Σ , if $\Sigma \vdash A$ then $\Sigma \models A$.

Proof:

This follows from the Soundness Lemma in the usual way. ■

9.8.5 DEFINITION: Let b be an open branch of a tableau. The interpretation, $\mathcal{I} = \langle W, \rho \rangle$, induced by b , is defined as in 9.3.7. $W = \{w_i : i \text{ occurs on } b\}$. For every parameter, p :

$$\begin{aligned} p\rho_{w_i}1 &\text{ iff } p, +i \text{ occurs on } b \\ p\rho_{w_i}0 &\text{ iff } \neg p, +i \text{ occurs on } b \end{aligned}$$

9.8.6 COMPLETENESS LEMMA: Let b be any open completed branch of a tableau. Let $\mathcal{I} = \langle W, \rho \rangle$ be the interpretation induced by b . Then:

$$\begin{aligned} \text{if } A, +i \text{ is on } b, &\text{ then } A \text{ is true at } w_i \\ \text{if } A, -i \text{ is on } b, &\text{ then it is not the case that } A \text{ is true at } w_i \\ \text{if } \neg A, +i \text{ is on } b, &\text{ then } A \text{ is false at } w_i \\ \text{if } \neg A, -i \text{ is on } b, &\text{ then it is not the case that } A \text{ is false at } w_i \end{aligned}$$

Proof:

The proof is by recursion on the complexity of A . If A is atomic, the result is true by definition, and the fact that b is open. The cases for the extensional connectives are essentially the same as for *FDE* (8.7.6). We merely rewrite ρ as ρ_{w_i} . This leaves the cases for \rightarrow . Suppose that $B \rightarrow C, +i$ is on b . Then for all j , either $B, -j$ or $C, +j$ is on b . By induction hypothesis, either B is not

true at w_j or C is true at w_j . Thus, $B \rightarrow C$ is true at w_i . Suppose that $B \rightarrow C, -i$ is on b . Then there is a j , such that $B, +j$ and $C, -j$ are on b . By induction hypothesis, B is true at w_j and C is not true at w_j . Thus, $B \rightarrow C$ is not true at w_j . The cases for negated \rightarrow are similar. ■

9.8.7 COMPLETENESS THEOREM FOR K_4 : For finite Σ , if $\Sigma \models A$ then $\Sigma \vdash A$.

Proof:

The result follows from the Completeness Lemma in the usual fashion. ■

9.8.8 SOUNDNESS THEOREM FOR N_4 : The tableau system for N_4 is sound with respect to its semantics.

Proof:

The proof is exactly the same as for K_4 , except that in the definition of faithfulness, we add the clause: $f(0) \in N$. In the Soundness Lemma, the rules for \rightarrow are applied only at $f(0)$; and this is normal. ■

9.8.9 COMPLETENESS THEOREM FOR N_4 : The tableau system for N_4 is complete with respect to its semantics.

Proof:

The induced interpretation is now defined as follows (as in 9.5.3). $W = \{w_i: i \text{ occurs on } b\}$. $N = \{w_0\}$. For every parameter, p :

$$\begin{aligned} p\rho_{w_i}1 &\text{ iff } p, +i \text{ occurs on } b \\ p\rho_{w_i}0 &\text{ iff } \neg p, +i \text{ occurs on } b \end{aligned}$$

and for every formula $A \rightarrow B$, and $i > 0$:

$$\begin{aligned} A \rightarrow B\rho_{w_i}1 &\text{ iff } A \rightarrow B, +i \text{ occurs on } b \\ A \rightarrow B\rho_{w_i}0 &\text{ iff } \neg(A \rightarrow B), +i \text{ occurs on } b \end{aligned}$$

The proof of the Completeness Theorem is then as for K_4 . Only the induction cases for \rightarrow in the Completeness Lemma are different. In these, if w_i is normal, the arguments are exactly the same as before. If w_i is non-normal, the result holds simply by definition. ■

9.8.10 Soundness and completeness proofs for K_* and N_* can be obtained by modifying those for the $*$ semantics for FDE (8.7.10–8.7.16).

9.8.11 SOUNDNESS THEOREM: K_* is sound with respect to its semantics.

Proof:

The proof is exactly the same as that for *FDE*. All we need to check, in addition, are the new rules for \rightarrow in the Soundness Lemma. So suppose that we apply the rule to $A \rightarrow B, +x$, then, by assumption, $A \rightarrow B$ is true at some world. Hence, for any y , either A is not true at $f(y)$, in which case f shows \mathcal{I} to be faithful to the left branch, or B is true at $f(y)$, in which case f shows \mathcal{I} to be faithful to the right branch. If we apply the rule to $A \rightarrow B, -x$, then $A \rightarrow B$ is false at some world. Hence, there is a world, w , at which A is true and B is false. Consider an f' which is the same as f , except that $f'(j) = w$. Then the result follows as usual. ■

9.8.12 COMPLETENESS THEOREM: K_* is complete with respect to its semantics.

Proof:

The interpretation induced by an open branch is defined in exactly the same way as in *FDE* (8.7.14), except that there may be more than two worlds. Thus, $W = \{w_x: x \text{ or } \bar{x} \text{ occurs on } b\}$, and for all i , $w_i^* = w_{i\#}$ and $w_{i\#}^* = w_i$. The only things that need additional checking are the cases for \rightarrow in the Completeness Lemma. So suppose that $A \rightarrow B, +x$ occurs on b ; then for all y either $A, -y$ or $B, +y$ occurs on b . By induction hypothesis and the definition of W , for all $w \in W$, either A is false at w or B is true at w . Hence $A \rightarrow B$ is true at w_x . Suppose, on the other hand, that $A \rightarrow B, -x$ occurs on b . Then for some j , $A, +j$ and $B, -j$ occur on b . By induction hypothesis, A is true at w_j and B is false at w_j . Hence, $A \rightarrow B$ is false at w_x , as required. The rest of the proof is the same. ■

9.8.13 SOUNDNESS AND COMPLETENESS FOR N_* : N_* is sound and complete with respect to its tableaux.

Proof:

The proof modifies the proof for K_* , as that for N_4 modifies that for K_4 . Details are left as an exercise. ■

9.8.14 THEOREM: The tableaux for I_4 are sound and complete with respect to their semantics.

Proof:

The proof extends that for K_4 (9.8.2–9.8.7). In the definition of faithfulness, a new clause is added:

if irj is on b then $f(i)Rf(j)$.

In the Soundness Lemma, the cases for conjunction, disjunction and negation are as for K_4 . The arguments for the conditional, the rules for r , and the two heredity rules are as in intuitionist logic (6.7.3). This leaves the cases for negated conditionals. These go as follows.

Suppose that we apply the rule for $\neg(A \sqsupset B)$, $+i$. By assumption, $A \sqsupset B$ is false at $f(i)$. Hence, A is true at $f(i)$, and B is false there. So f shows \mathcal{I} to be faithful to the extended branch. Suppose that we apply the rule to $\neg(A \sqsupset B)$, $-i$. Then, by assumption, $A \sqsupset B$ is not false at $f(i)$. Either A is not true at $f(i)$ or $\neg B$ is not true at $f(i)$. So f shows \mathcal{I} to be faithful to one branch or the other.

The Soundness Theorem follows in the usual way.

The induced interpretation is defined as in 9.8.5, except that, in addition: w_iRw_j iff irj is on the branch. Given the rules for r on the tableau, it is easy to see that this is an I_4 interpretation. In the Completeness Lemma, the cases for conjunction, disjunction and negation are as for K_4 . The cases for the conditional are as for intuitionist logic (6.7.7). This leaves the cases for the negated conditional, which go as follows.

Suppose that $\neg(A \sqsupset B)$, $+i$ is on the branch. Then A , $+i$, and $\neg B$, $+i$ are on the branch. By induction hypothesis, A is true at w_i , and B is false there. Hence, $\neg(A \sqsupset B)$ is true at w_i . Suppose that $\neg(A \sqsupset B)$, $-i$ is on the branch. Then either A , $-i$ is on the branch or $\neg B$, $-i$ is. By induction hypothesis, either A is not true at w_i or B is not false there. Hence, $A \sqsupset B$ is not false at w_i .

The Completeness Theorem follows in the usual way. ■

9.8.15 THEOREM: The tableaux for I_3 are sound and complete with respect to their semantics.

Proof:

The proof is exactly the same as that for I_4 . The only additional fact that needs to be checked is that the induced interpretation is an I_3 interpretation. For any parameter, p , p , $+i$ and $\neg p$, $+i$ cannot both be on the

branch, by the new closure rule. Hence we cannot have $p \rho_{w_i} 1$ and $p \rho_{w_i} 0$, as required. ■

9.8.16 THEOREM: The tableaux for the connexive logic W are sound and complete with respect to their semantics.

Proof:

The proof is as for I_4 . All that changes are the cases for negated conditionals in the Soundness and Completeness Lemmas. For Soundness, suppose that we apply the rule to $\neg(A \sqsupset B)$, $+i$. By assumption, $A \sqsupset B$ is false at $f(i)$. Hence $A \sqsupset \neg B$ is true at $f(i)$, as required. The case for $-$ is similar. For Completeness, suppose that $\neg(A \sqsupset B)$, $+i$ is on the branch. Then so is $A \sqsupset \neg B$, $+i$. Hence, for every j such that irj is on the branch, either A , $-j$ or $\neg B$, $+j$ is on the branch. By construction and induction hypothesis, for all w_j such that $w_i R w_j$, either A is not true at w_j or B is false there. Hence, $\neg(A \sqsupset B)$ is true at w_i . The case for $-$ is similar. ■

9.9 History

The terminology of degrees (as in ‘first degree entailment’) comes from Anderson and Belnap (1975, p. 150). The degree of a formula is the largest number of nestings of \rightarrow within it. So the logics of this chapter have arbitrarily high degree. The logics K_4 , K_* , N_4 and N_* , though natural enough, are not to be found in the literature. The idea of giving conditionals arbitrary truth values at some worlds was first used (inspired by the semantics of S0.5) by Routley and Loparić (1978) in connection with a certain family of paraconsistent logics. The analysis of these worlds as worlds where logic is different comes from Priest (1992). The notion of an impossible world, as such, started to appear in the literature in the 1980s. On filter logics, see Priest (2000a, sects. 4.1 and 5.1).

The system I_3 is originally due to Nelson (1949), though not with these semantics. The semantics were given by Thomason (1969). I_4 appeared in Almukdad and Nelson (1984). There are many more logics in the family. Some of these are surveyed in Dunn (2000). Another can be found in Priest (1987), ch. 7. The history of connexive logics in Ancient and Medieval logic can be found in Routley (2000). Connexivism was introduced into modern logic by Angell. See the discussion by McCall in section

29.8 of Anderson and Belnap (1975). The connexive logic here is due to Wansing (2005).

9.10 Further Reading

Discussions of impossible worlds can be found in Yagisawa (1988), Stalnaker (1996), and all the papers in Priest (1997b). The editor's introduction to the third of these is a useful orientation. An argument that truth proper has no gaps is mounted in Priest (1987, ch. 4) and (2006, ch. 4). A discussion of the Nelson systems can be found in Wansing (2001). (Note that I_3 and I_4 go by various different names in the literature. Wansing calls them N_3 and N_4 , respectively.) A survey of connexive logics can be found in Wansing (2006).

9.11 Problems

1. Complete the details left as exercises in 9.4.1, 9.4.2, 9.6.6, 9.6.9, 9.6.10 and 9.7.10.
2. Show the following in K_4 (where $A \leftrightarrow B$ is $(A \rightarrow B) \wedge (B \rightarrow A)$):
 - (a) $\vdash A \rightarrow A$
 - (b) $\vdash A \leftrightarrow \neg\neg A$
 - (c) $\vdash (A \wedge B) \rightarrow A$
 - (d) $\vdash A \rightarrow (A \vee B)$
 - (e) $\vdash (A \wedge (B \vee C)) \leftrightarrow ((A \wedge B) \vee (A \wedge C))$
 - (f) $A \rightarrow B, A \rightarrow C \vdash A \rightarrow (B \wedge C)$
 - (g) $A \rightarrow C, B \rightarrow C \vdash (A \vee B) \rightarrow C$
 - (h) $A \rightarrow C \vdash (A \wedge B) \rightarrow C$
 - (i) $\vdash ((A \rightarrow B) \wedge (A \rightarrow C)) \rightarrow (A \rightarrow (B \wedge C))$
 - (j) $\vdash ((A \rightarrow C) \wedge (B \rightarrow C)) \rightarrow ((A \vee B) \rightarrow C)$
 - (k) $A \rightarrow B \vdash (B \rightarrow C) \rightarrow (A \rightarrow C)$
 - (l) $A \rightarrow B \vdash (C \rightarrow A) \rightarrow (C \rightarrow B)$
 - (m) $A \rightarrow B, B \rightarrow C \vdash A \rightarrow C$
3. Show that the following are not true in K_4 , and specify a counter-model.
 - (a) $\vdash (p \wedge (\neg p \vee q)) \rightarrow q$
 - (b) $(p \wedge q) \rightarrow r \vdash p \rightarrow (\neg q \vee r)$
 - (c) $\vdash p \rightarrow (q \vee \neg q)$
 - (d) $\vdash (p \wedge \neg p) \rightarrow q$
 - (e) $\vdash (p \rightarrow q) \rightarrow (\neg q \rightarrow \neg p)$

4. Determine which of the inferences in problem 2 are valid in N_4 . Where invalid, specify a counter-model for an instance.
5. Repeat problems 2–4 with K_* and N_* .
6. In the semantics for N_4 and N_* , there may be many normal worlds, but the tableaux show us that it suffices to suppose that there is only one normal world. Why is this?
7. What reasons might there be against supposing that there are logically impossible worlds?
8. Suppose that we add the modal operators \Box and \Diamond to the language. What are the most appropriate truth/falsity conditions for them in the non-normal semantics, and why? (Should the truth of $\Box A$ at a normal world depend on the truth of A at all worlds, or just at normal worlds? What truth conditions are appropriate at non-normal worlds? How does this bear on the question of relevance?)
9. Show by induction that in any interpretation, $\langle W, R, \rho \rangle$, for I_4 , I_3 or W , for any formula, A :
 - if $A \rho_w 1$ and wRw' , then $A \rho_{w'} 1$
 - if $A \rho_w 0$ and wRw' , then $A \rho_{w'} 0$
10. Determine the truth of the following inferences in I_4 , I_3 , and the connexive logic W . Where the inference is invalid, give a counter-model.
 - (a) $\vdash \neg(p \wedge q) \supset (\neg p \vee \neg q)$
 - (b) $\vdash \neg(p \vee q) \supset (\neg p \wedge \neg q)$
 - (c) $\vdash (p \supset q) \supset (\neg q \supset \neg p)$
 - (d) $\vdash p \vee \neg p$
 - (e) $\vdash (\neg p \supset p) \supset p$
 - (f) $\vdash \neg(p \supset q) \supset (p \supset \neg q)$
 - (g) $\vdash (p \supset q) \vee (p \supset \neg q)$
 - (h) $\vdash \neg((p \wedge \neg p) \supset (p \vee \neg p))$
11. Work out the details omitted in 9.7a.8, 9.7a.11, and 9.7a.14.
12. Show that in I_3 and I_4 :
 - (a) if $\models A \vee B$ then $\models A$ or $\models B$. (Hint: see 6.10, problem 5.)
 - (b) if $\models \neg(A \wedge B)$ then $\models \neg A$ or $\models \neg B$.
13. Find an inference that is valid in I_4 , but not in intuitionist logic. Find an inference that is valid in intuitionist logic, but not in I_3 . (Hint: see 9.6.9.)

14. Discuss the plausibility of **Aristotle** and **Boethius**, as principles concerning the conditional.
15. * Fill in the details omitted in 9.8.
16. * Design tableaux for the systems of 9.7.14, and prove them sound and complete.

10 Relevant Logics

10.1 Introduction

10.1.1 In this chapter we look at logics in the family of mainstream relevant logics. These are obtained by employing a ternary relation to formulate the truth conditions of \rightarrow . In the most basic logic, there are no constraints on the relation. Stronger logics are obtained by adding constraints.

10.1.2 We also see how these semantics can be combined with the semantics of conditional logics of chapter 5 to give an account of *ceteris paribus* enthymemes.

10.2 The Logic B

10.2.1 N_4 and N_* are relevant logics, but, as relevant logics go, they are relatively weak. Many proponents of relevant logic have thought that the relevant logics of the last chapter are too weak, on the ground that there are intuitively correct principles concerning the conditional that they do not validate. A way to accommodate such principles within a possible-world semantics is to use a relation on worlds to give the truth conditions of conditionals at non-normal worlds. Unlike the binary relation of modal logic, xRy , though, this relation is a ternary, that is, three-place, relation, $Rxyz$.¹

10.2.2 Intuitively, the ternary relation $Rxyz$ means something like: for all A and B , if $A \rightarrow B$ is true at x , and A is true at y , then B is true at z . What philosophical sense to make of this, we will come back to later.

¹ Using a binary relation would produce irrelevance, since $p \rightarrow p$ would be true at all worlds, and hence, $q \rightarrow (p \rightarrow p)$ would be logically valid.

10.2.3 The technique can be applied to both the relational semantics and the $*$ semantics. As we noted in 9.6.9 and 9.6.10, these semantics diverge once we add \rightarrow to the language. Though the ternary relation *relational* semantics are perfectly good, it is, as a matter of historical fact, the logics with the ternary relation $*$ semantics that occur in the literature. Hence, we look only at those.

10.2.4 A ternary ($*$) interpretation is a structure $\langle W, N, R, *, \nu \rangle$, where $W, N, *$ and ν are as in the semantics for N_* (9.6.6), and R is any ternary relation on worlds. (So, technically, $R \subseteq W \times W \times W$.)

10.2.5 With one exception, the truth conditions for all connectives are as for N_* . In particular, at normal worlds, the truth conditions for \rightarrow are:

$$\nu_w(A \rightarrow B) = 1 \text{ iff for all } x \in W \text{ such that } \nu_x(A) = 1, \nu_x(B) = 1$$

The exception is that if w is a non-normal world:

$$\nu_w(A \rightarrow B) = 1 \text{ iff for all } x, y \in W \text{ such that } Rwx y, \text{ if } \nu_x(A) = 1, \text{ then } \nu_y(B) = 1$$

10.2.6 Validity is defined as truth preservation over all normal worlds, as in N_* .

10.2.7 The logic generated in this way is usually called B (for basic).² Clearly, B is a sub-logic of K_* (since any K_* interpretation is a B interpretation, with $W - N = \emptyset$). Moreover, any B interpretation, \mathcal{I} , is equivalent to an N_* interpretation. We just take that N_* interpretation which is the same as \mathcal{I} , except that it assigns to each conditional at each non-normal world, w , whatever value it has at w in \mathcal{I} . Hence, N_* is a sub-logic of B .

10.2.8 The bipartite truth conditions of \rightarrow can be simplified if one thinks of R as *defined* at normal worlds. Specifically, if w is normal, we specify R by the following condition:

$$Rwx y \text{ iff } x = y$$

Call this the *normality condition*. If we define R at normal worlds in this way, we may take the ternary truth conditions to govern conditionals at *all* worlds. For, given this condition, the ternary truth conditions:

$$\text{for all } x, y \in W \text{ such that } Rwx y, \text{ if } \nu_x(A) = 1, \text{ then } \nu_y(B) = 1$$

² We continue to use B as a letter for formulas, too. Context will disambiguate.

become:

for all $x, y \in W$ such that $x = y$, if $v_x(A) = 1$, then $v_y(B) = 1$

And given the standard properties of $=$, this is logically equivalent to:

for all $x \in W$ such that $v_x(A) = 1$, $v_x(B) = 1$

which gives the standard truth conditions of \rightarrow at normal worlds. We adopt this simplification in what follows.

10.2.9 Notice that the normality condition falls apart into two halves. From left to right:

if $Rwxy$ then $x = y$

and from right to left, since $x = x$:

$Rwxx$.

10.3 Tableaux for B

10.3.1 Tableaux for B are the same as those for N_* (9.6.7), except that nodes may now be of the form $A, +x$, or $A, -x$ (where x is i or $i^\#$), or of the form $rxyz$; the tableaux rules for the conditional are:

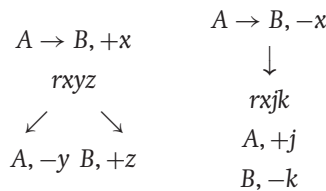

In the first rule, y and z are anything of the form j or $j^\#$, where either of these occurs on the branch. In the second rule, j and k are new. Moreover, in this, if x is 0, j and k must be the same, as required by one half of the normality condition. For the other half, we need one further rule:



where x is either j or $j^\#$, where either of these occurs on the branch – and, as usual, $r0xx$ is not already on the branch. We will call this the *normality rule*. It is simplest to apply it as soon as conveniently possible on a branch.

10.3.2 Example: $(A \rightarrow B) \vdash_B (B \rightarrow C) \rightarrow (A \rightarrow C)$:

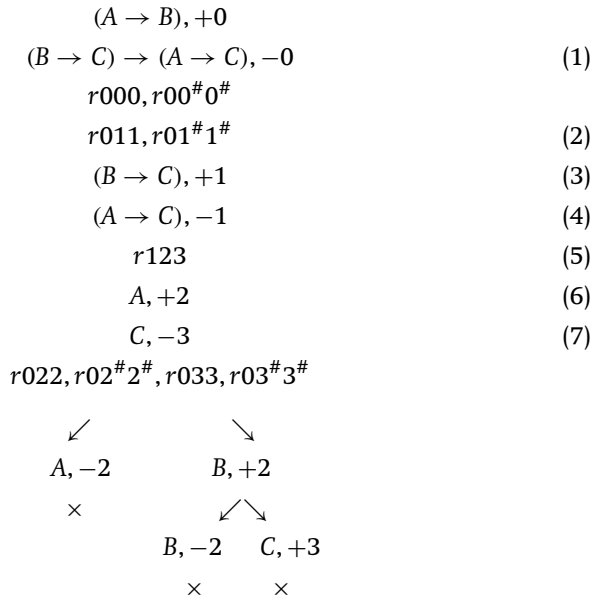

Line (1) and the normality rule give lines (2)-(4). Line (4) gives lines (5)-(7). The first line of the tableau, and the fact that $r022$, give the first split; and line (3), plus the fact that $r123$, give the second.

10.3.3 In practice, it is simplest to omit the lines of the form $r0xx$ in a tableau for B , since they cause much clutter – as long as one remembers that they are there for the purpose of applying a rule to something of the form $A \rightarrow B, +0$. Another example: $\vdash_B p \rightarrow ((p \rightarrow q) \rightarrow q)$.

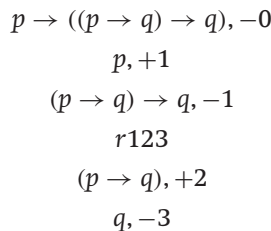

The rule for true conditionals never gets applied in this tableau, since the only true conditional holds at world 2, and we have nothing of the form $r2xy$.

10.3.4 Counter-models are read off open branches as in N_* (9.6.7), except that the information about R is now included. Thus, in the counter-model given by the tableau of 10.3.3, $W = \{w_0, w_1, w_2, w_3, w_{0\#}, w_{1\#}, w_{2\#}, w_{3\#}\}$; $N = \{w_0\}$; $w_i^* = w_{i\#}$ and $w_{i\#}^* = w_i$; $Rw_1w_2w_3$, and for all $w \in W$, Rw_0ww ; v is such that $v_{w_1}(p) = 1$, and $v_{w_3}(q) = 0$. The interpretation may be depicted thus:

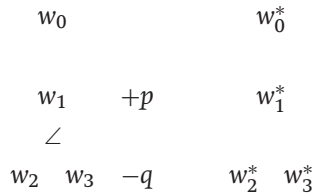

The configuration:

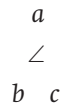

is a way of representing the relation $Rabc$. The accessibility relations involving w_0 have been omitted. These are taken for granted. Since all worlds except w_0 are non-normal, there is also no need to indicate non-normal worlds by putting them in boxes. In the depicted interpretation, $p \rightarrow q$ is true at w_2 (since it accesses nothing); hence, $(p \rightarrow q) \rightarrow q$ is false at w_1 . But then, $p \rightarrow ((p \rightarrow q) \rightarrow q)$ is false at w_0 .

10.3.5 The tableaux are sound and complete with respect to the semantics. This is proved in 10.8.1.

10.3.6 One may check that all formulas of the following form are logically valid in B :

- (A1) $A \rightarrow A$
- (A2) $A \rightarrow (A \vee B)$ (and $B \rightarrow (A \vee B)$)
- (A3) $(A \wedge B) \rightarrow A$ (and $(A \wedge B) \rightarrow B$)
- (A4) $A \wedge (B \vee C) \rightarrow ((A \wedge B) \vee (A \wedge C))$
- (A5) $((A \rightarrow B) \wedge (A \rightarrow C)) \rightarrow (A \rightarrow (B \wedge C))$

$$(A6) \quad ((A \rightarrow C) \wedge (B \rightarrow C)) \rightarrow ((A \vee B) \rightarrow C)$$

$$(A7) \quad \neg\neg A \rightarrow A$$

And that the following also hold in B :

$$(R1) \quad A, A \rightarrow B \vdash B$$

$$(R2) \quad A, B \vdash A \wedge B$$

$$(R3) \quad A \rightarrow B \vdash (C \rightarrow A) \rightarrow (C \rightarrow B)$$

$$(R4) \quad A \rightarrow B \vdash (B \rightarrow C) \rightarrow (A \rightarrow C)$$

$$(R5) \quad A \rightarrow \neg B \vdash B \rightarrow \neg A$$

R4 is verified in 10.3.2. Details of the others are left as an exercise. All save A5, A6, R3 and R4 hold in N_* . (Again, details are left as an exercise.) Hence, the logic B is a proper extension of N_* . It is, in fact, R3 (*prefixing*) and R4 (*suffixing*) that are most distinctive about B . Together, these are referred to as *affixing*. Hence, the family of logics that we are currently concerned with are sometimes called *affixing relevant logics*.

10.3.7 The most common proof-theoretic treatment of the affixing logics in the literature is not tableau-theoretic, but axiomatic. An axiom system for B is obtained by taking every formula of the form of A1–A7 as an axiom, and every inference of the form R1–R5 as a rule.

10.3.8 In an axiom system, \vdash is defined differently from the way in which it is defined in a tableau system. Specifically, $\Sigma \vdash A$ iff there is a sequence of formulas, A_1, \dots, A_n such that A is A_n , and every formula in the sequence is either an axiom, or a member of Σ , or follows from some prior members of the sequence by one of the rules. Such a sequence is called a *deduction*.

10.3.9 Here, for example, is a deduction of $C \rightarrow \neg\neg C$ in B (which is why this half of double negation is not needed as an axiom). The justification for each step is explained in the righthand column. Line numbers in the lefthand column assist this.

$$(1) \quad \neg C \rightarrow \neg C \quad A1$$

$$(2) \quad C \rightarrow \neg\neg C \quad (1) \text{ and R5}$$

Note that (1) is an instance of A1, since $\neg C \rightarrow \neg C$ is of the form $A \rightarrow A$. Similarly, $\neg C \rightarrow \neg C \vdash C \rightarrow \neg\neg C$ is an instance of R5, since it is of the form $A \rightarrow \neg B \vdash B \rightarrow \neg A$. Here is another example to establish that $A \rightarrow B, B \rightarrow C \vdash_B A \rightarrow C$ (*transitivity*).

- (1) $A \rightarrow B$ assumption
 (2) $B \rightarrow C$ assumption
 (3) $(B \rightarrow C) \rightarrow (A \rightarrow C)$ (1) and R4
 (4) $A \rightarrow C$ (2), (3) and R1

10.4 Extensions of B

10.4.1 As with the modal logic K and its extensions, stronger relevant logics can be obtained by adding constraints on the relation R (which constraints may also involve $*$).

10.4.2 Now, there are many constraints that one might impose on the ternary R . But the most significant ones are much more complex than those in modal logic. We will look at a number of the more notable ones in this section and the next. The diagram attached to each condition may make it easier to visualise. The odd numbering will make more sense in a moment. In each case, the condition is for all worlds in W (normal *and* non-normal), a, b, c, d :

(C8) If $Rabc$ then Rac^*b^*

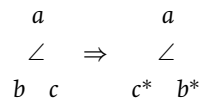

(C9) If there is an $x \in W$ such that $Rabx$ and $Rxcd$, then there is a $y \in W$ such that $Racy$ and $Rbyd$

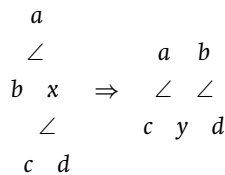

(C10) If there is an $x \in W$ such that $Rabx$ and $Rxcd$, then there is a $y \in W$ such that $Rbcy$ and $Rayd$

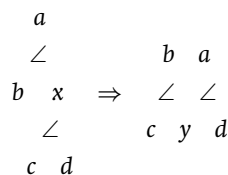

(C11) If $Rabc$ then for some $x \in W$, $Rabx$ and $Rxbc$

$$\begin{array}{ccc}
 & & a \\
 a & & \angle \\
 \angle & \Rightarrow & b \ x \\
 b \ c & & \angle \\
 & & b \ c
 \end{array}$$

10.4.3 The tableau rules corresponding to the above conditions are not difficult to guess. They are, respectively, as follows, where j is always new to the branch (recall that if x is i , \bar{x} is $i^\#$, and if x is $i^\#$, \bar{x} is i):

(T8)

$$\begin{array}{c}
 rxyz \\
 \downarrow \\
 rx\bar{z}\bar{y}
 \end{array}$$

(T9)

$$\begin{array}{c}
 rxyz \\
 rzuv \\
 \downarrow \\
 rxuj, ryjv
 \end{array}$$

(T10)

$$\begin{array}{c}
 rxyz \\
 rzuv \\
 \downarrow \\
 ryuj, rxjv
 \end{array}$$

(T11)

$$\begin{array}{c}
 rxyz \\
 \downarrow \\
 rxyj, rjyz
 \end{array}$$

10.4.4 The addition of the new rules adds a further complication. Because of the normality condition, we need to ensure that whenever $r0xy$ occurs on a branch, x and y are ‘the same’. (This was not necessary before, since the only rules that introduced information of the form $r0xy$ required x and y to be identical. But this need no longer be the case.) The easiest way to achieve this is to allow lines on the tableau to have an additional form,

$x = y$ (where x and y are of the form i or $i^\#$), and to add the identity rules:

$$\begin{array}{ccc}
 . & i^\# = j^\# & x = y \\
 \downarrow & \downarrow & \alpha(x) \\
 x = x & i = j & \downarrow \\
 & & \alpha(y)
 \end{array}$$

where $\alpha(x)$ is any node on the branch containing x , and $\alpha(y)$ is the same with some occurrences of x replaced by y , cancelling out any double occurrences of $\#$. The normality condition can now be effected by the rule:

$$\begin{array}{c}
 r0xy \\
 \downarrow \\
 x = y
 \end{array}$$

10.4.5 The tableaux for extensions of B , though sound and complete (as is proved in 10.8.2) are very unwieldy, and, in any but the simplest cases, are too complex to be reasonably done by humans (though they can be mechanised easily enough). To make matters worse, open tableaux are normally infinite (because of the existential quantifiers in many of the conditions on R). In practice, other techniques for establishing validity and invalidity may be more viable, as we will see in a moment.

10.4.6 Each of the constraints on R is sufficient to make formulas of a certain form, which are not valid in B , logically valid. These are as follows (where the numbers correspond):

- (A8) $(A \rightarrow \neg B) \rightarrow (B \rightarrow \neg A)$
- (A9) $(A \rightarrow B) \rightarrow ((B \rightarrow C) \rightarrow (A \rightarrow C))$
- (A10) $(A \rightarrow B) \rightarrow ((C \rightarrow A) \rightarrow (C \rightarrow B))$
- (A11) $(A \rightarrow (A \rightarrow B)) \rightarrow (A \rightarrow B)$

We will show this for A11. The others are left as an exercise.

10.4.7 We may show that $(p \rightarrow (p \rightarrow q)) \rightarrow (p \rightarrow q)$ is not logically valid in B by constructing a tableau, or by giving a counter-model directly. The

following counter-model will do, where w_0 is the only normal world:

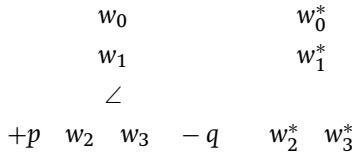

w_3 accesses no worlds; hence, $p \rightarrow q$ holds at w_3 . Thus, $p \rightarrow (p \rightarrow q)$ is true at w_1 . But $p \rightarrow q$ is false at w_1 . Hence, $(p \rightarrow (p \rightarrow q)) \rightarrow (p \rightarrow q)$ is false at w_0 .

10.4.8 We establish the validity of A11 by the following argument. Consider any normal world of any interpretation, w_0 . We need to show that if Rw_0xx , then if $A \rightarrow (A \rightarrow B)$ is true at x , $A \rightarrow B$ is true at x . To show the latter, we need to show that if $Rxyz$ and A is true at y , B is true at z . In diagrammatic form:

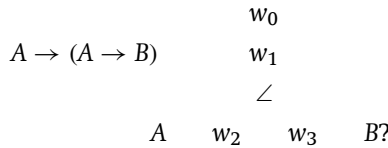

By C11, we know that there is an x such that Rw_1w_2x , and Rxw_2w_3 . And by the truth conditions for \rightarrow at w_1 , $A \rightarrow B$ is true at x . In pictures:

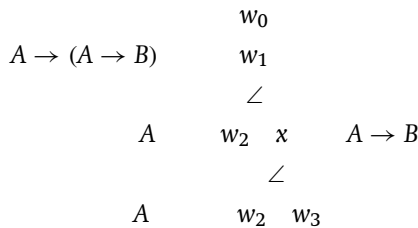

By the truth conditions of \rightarrow at x , B is true at w_3 , as required.

10.4a Content Inclusion

10.4a.1 There are other constraints that play an important role in relevant logics. However, to state these, we need a little more machinery. We add an extra component, \sqsubseteq , to interpretations (so that an interpretation is now of

the form $(W, N, R, *, \sqsubseteq, \nu)$. \sqsubseteq is a reflexive and transitive binary relation on worlds.³ Intuitively, $w_1 \sqsubseteq w_2$ means that everything true at w_1 is true at w_2 . The relationship satisfies the following constraints. If $w \sqsubseteq w'$ then:

1. if $\nu_w(p) = 1$ then $\nu_{w'}(p) = 1$
2. $w'^* \sqsubseteq w^*$
3. if $Rw'w_1w_2$ then $(w \in N$ and $w_1 \sqsubseteq w_2)$ or $(w \notin N$ and $Rww_1w_2)$

Note that the identity relation, $=$, satisfies these conditions. Any interpretation without \sqsubseteq can therefore be extended to one with it, simply by taking \sqsubseteq to be $=$.

10.4a.2 Clause 1 is a version of the heredity condition, familiar from intuitionist and related logics. The other conditions are sufficient to ensure that this condition holds for all sentences (not just propositional parameters). This is proved in 10.8.2a.

10.4a.3 For appropriate tableaux, we now need to be able to express the ordering; the third constraint on \sqsubseteq also requires us to be able to express the normality of a world explicitly. So we now assume that there can be lines of the form $i \leq j$, $\$i$, and $\bar{\$}i$. Intuitively, $i \leq j$ means that $w_i \sqsubseteq w_j$, $\$i$ means that w_i is normal, and $\bar{\$}i$ means that w_i is non-normal. The following are the new tableau rules.

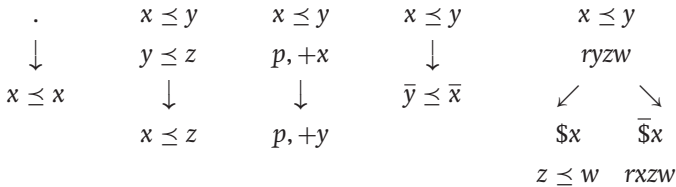

The rules for normality of 10.3.1 and 10.4.4 also have to be revised to:

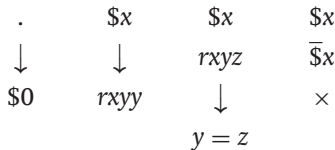

³ Note that for present purposes reflexivity and transitivity are not, strictly speaking, necessary. However, they are for the application we will make of \sqsubseteq in Part II (24.4) concerning restricted quantification.

The old normality rules are special cases.

10.4a.4 We can now state some of the interesting constraints that involve \sqsubseteq :

(C12) If $Rabc$ then, for some x such that $a \sqsubseteq x$, $Rbxc$

$$\begin{array}{ccc} a & & b \\ \angle & \Rightarrow & \angle \\ b \ c & & a \sqsubseteq x \ c \end{array}$$

(C13) If $a \in N$, $a^* \sqsubseteq a$.

(C14) If $a \in N$, $a^* \sqsubseteq a$; and if $a \in W - N$, Raa^*a .

(C15) If $Rabc$ then $a \sqsubseteq c$:

$$\begin{array}{ccc} a & & a \\ \angle & \Rightarrow & \angle \\ b \ c & & b \ c \sqsupseteq a \end{array}$$

(C16) If $Rabc$ then $a \sqsubseteq c$ or $b \sqsubseteq c$:

$$\begin{array}{ccc} a & & a & & a \\ \angle & \Rightarrow & \angle & \text{or} & \angle \\ b \ c & & b \ c \sqsupseteq a & & b \ c \sqsupseteq b \end{array}$$

10.4a.5 The corresponding tableau rules are, as one would expect:

(T12)

$$\begin{array}{c} rxyz \\ \downarrow \\ x \preceq j \\ ryjz \end{array}$$

where j is new to the branch.

(T13)

$$\begin{array}{c} \$x \\ \downarrow \\ \bar{x} \preceq x \end{array}$$

(T14)

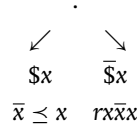

(T15)

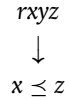

(T16)

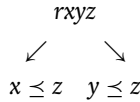

10.4a.6 As an example, here is a tableau to show that, given T14, $\vdash (p \rightarrow \neg p) \rightarrow \neg p$:

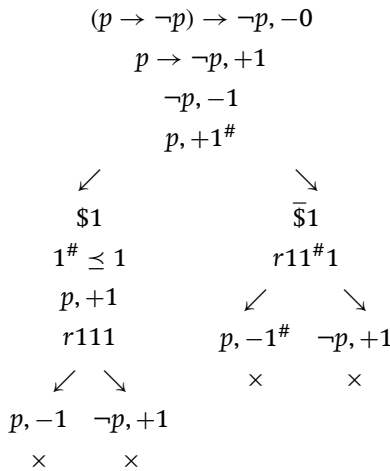

The first split in the tableau is due to T14. Down the left branch, $p, +1$ then follows by the heredity rule, and $r111$ by one of the normality rules. The next split on each branch is obtained by applying line 2, given the information about r on the branch.

10.4a.7 Given an open branch of a tableau, a counter-model can be read off in a natural way. Since open tableaux are complex to construct, this is not a very practical way of finding counter-models. The tableaux are,

nonetheless, sound and complete. This is proved in 10.8.2b–2d, where the recipe for reading off a counter-model from an open branch is spelled out.

10.4a.8 Each of the constraints suffices to make formulas of a certain form, that are not valid in B , logically valid. These are as follows, where the numbers correspond:⁴

(A12) $A \rightarrow ((A \rightarrow B) \rightarrow B)$

(A13) $A \vee \neg A$

(A14) $(A \rightarrow \neg A) \rightarrow \neg A$

(A15) $A \rightarrow (B \rightarrow A)$

(A16) $A \rightarrow (A \rightarrow A)$

I will show this for (A12). The others are left as exercises.

10.4a.9 To show that A12 is not valid in B , the following will do, where w_0 is the only normal world, and \sqsubseteq is =:

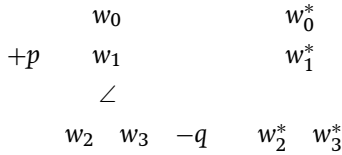

Since w_2 accesses nothing, $p \rightarrow q$ is true there. It quickly follows that $p \rightarrow ((p \rightarrow q) \rightarrow q)$ is not true at w_0 .

10.4a.10 To establish that A12 is valid, given C12, suppose that in an interpretation $w_0 \in N$ and Rw_0aa . We need to show that if A is true at a , so is $(A \rightarrow B) \rightarrow B$. So suppose that $Rabc$, and that $A \rightarrow B$ is true at b ; we need to

⁴ In the first edition of the book, A11 and A12 were numbered in reverse, as were their associated paraphernalia. In that edition, the constraint corresponding to A12 was given as the simpler: if $Rabc$ then $Rbac$. For the original Routley–Meyer semantics this condition is correct. In the simplified semantics that are being employed here, and in the context of other constraints, the condition is sound but it is not complete. For, if w_0 is normal, then the normality constraint gives us that for any w , Rw_0ww . By C11, there is an x such that Rw_0wx and $Rxww$. By normality, $x = w$, so $Rwww$. In particular, $Rw_0^*w_0^*w_0^*$. By C8, $Rw_0^*w_0^*w_0$. The old condition now gives, $Rw_0w_0^*w_0$, and so, by normality, $w_0 = w_0^*$. This suffices to validate the disjunctive syllogism: $A, \neg A \vee B \models B$, as is easy to check. Note that this does not show that the tableau completeness proof of the first edition is incorrect; what was incorrect was the original completeness proof for the axiom system of the simplified semantics.

show that B is true at c . That is:

$$\begin{array}{c}
 w_0 \\
 \\
 A \quad a \\
 \quad \quad \angle \\
 A \rightarrow B \quad b \quad c \quad B?
 \end{array}$$

By the constraint, we have:

$$\begin{array}{c}
 A \rightarrow B \quad b \\
 \quad \quad \quad \angle \\
 A \quad a \sqsubseteq d \quad c
 \end{array}$$

Since $a \sqsubseteq d$, A is true at d , and so B is true at c , as required.

10.4a.11 The axioms of B can be augmented by any combination of A8–A16 to give a stronger logic. The axiom systems are sound and complete with respect to the corresponding combinations of conditions on R , though we will not prove this here.

10.4a.12 The stronger logics have no very systematic nomenclature. Some names to be found in the literature are as follows:

$$\begin{array}{l}
 BX = B + A13 \\
 DW = B + A8 \\
 DWX = DW + A13 [= BX + A8] \\
 TW = DW + A9 + A10 \\
 TWX = TW + A13 [= DWX + A9 + A10] \\
 T = TW + A11 + A14 [= TWX + A11 + A14] \\
 RW = TW + A12 \\
 R = RW + A11 [= T + A12] \\
 RWK = RW + A15 \\
 RM = R + A16
 \end{array}$$

RW and RWK are sometimes called C (not to be confused with the basic conditional logic) and CK , respectively.⁵ The relationships between the various

⁵ The favourite system of Anderson and Belnap (1975) is called E . This is obtained from T by adding $(A \rightarrow C) \rightarrow ((A \rightarrow C) \rightarrow B) \rightarrow B$ (that is, the special case of A12 with A replaced by $A \rightarrow C$) and $N(A) \wedge N(B) \rightarrow N(A \wedge B)$, where $N(C)$ is $(C \rightarrow C) \rightarrow C$. E does have a ternary relation semantics, though of a more complicated kind.

systems can be seen most perspicuously in the following diagram:

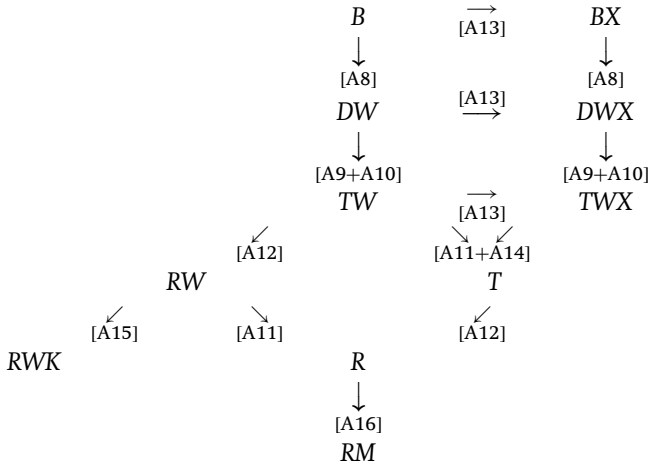

10.4a.13 Note that there are essentially two routes to T . In only one of these $A13$ gets added. This axiom becomes redundant once one has $A14$. See the deduction in 10.5.4. There are also essentially two routes to R . In only one of these $A14$ gets added. This is because, in the context of the other axioms, it is redundant. See the deduction in 10.5.3.

10.4a.14 Note also that in the stronger systems, some of the other axioms and rules also become redundant. $A8$ clearly makes $R5$ redundant, and $A9$ and $A10$ render $R3$ and $R4$ redundant. Not so obviously, given $A12$, $A9$ and $A10$ collapse into each other, because of permutation. (See 10.5.2.)

10.4a.15 Finally, R (and so all its subsystems) are relevant logics. That is, whenever $\vDash A \rightarrow B$, A and B share a propositional parameter. We will see a proof of this in 10.5.7. Not all systems with ternary-relation semantics are relevant logics, though. CK is not. An instance of $A15$ is $(p \rightarrow p) \rightarrow (q \rightarrow (p \rightarrow p))$. By $A1$ and $R1$, $q \rightarrow (p \rightarrow p)$. CK is not classical logic, though. For example, $A11$ is not valid in it, as we will see in 11.5.7.

10.4a.16 Less obviously, RM is not a relevant logic, since $\vdash_{RM} (p \wedge \neg p) \rightarrow \neg(q \wedge \neg q)$. For the proof, see 10.11, question 6.

10.5 The System R

10.5.1 Perhaps the most important of the above extensions of B is R (not to be confused with the ternary accessibility relation!). It is certainly the best

known of these. Establishing what is valid in R , and what is not, is often a very hard matter. (It is known that there is no decision procedure for the logic.) For the sake of definiteness, in what follows we will take R to be axiomatised by A1-A12, R1 and R2.

10.5.2 Sometimes, semantic arguments are relatively straightforward. For example, in this way one may establish the validity of *permutation*: $A \rightarrow (B \rightarrow C) \models_R B \rightarrow (A \rightarrow C)$. (To grasp the following reasoning, it is helpful to draw a diagram as the argument proceeds, as in 10.4.8.) Suppose that in an interpretation $A \rightarrow (B \rightarrow C)$ is true at a normal world, w . We show that $B \rightarrow (A \rightarrow C)$ is true there. So suppose that Rwx , and that B is true at x . We need to show that $A \rightarrow C$ is true at x . To this end, suppose that $Rxyz$, and A is true at y . We need to show that C is true at z . By C12, there is a u such that $x \sqsubseteq u$ and $Ryuz$. Since $Rwyy$ and A is true at y , $B \rightarrow C$ is true at y . Since B is true at x , it is true at u . Hence, C is true at z , as required.

10.5.3 Sometimes it is easier to deduce things from others we already know to be valid. For example, *consequentia mirabilis*: $\vdash_R (A \rightarrow \neg A) \rightarrow \neg A$.

- | | |
|--|------------------|
| (1) $(A \rightarrow \neg A) \rightarrow (A \rightarrow \neg A)$ | A1 |
| (2) $A \rightarrow ((A \rightarrow \neg A) \rightarrow \neg A)$ | (1), permutation |
| (3) $((A \rightarrow \neg A) \rightarrow \neg A) \rightarrow (A \rightarrow \neg(A \rightarrow \neg A))$ | A8 |
| (4) $A \rightarrow ((A \rightarrow \neg A) \rightarrow \neg A) \rightarrow (A \rightarrow (A \rightarrow \neg(A \rightarrow \neg A)))$ | (3), R3 |
| (5) $A \rightarrow (A \rightarrow \neg(A \rightarrow \neg A))$ | (2), (4) and R1 |
| (6) $(A \rightarrow (A \rightarrow \neg(A \rightarrow \neg A))) \rightarrow (A \rightarrow \neg(A \rightarrow \neg A))$ | A12 |
| (7) $A \rightarrow \neg(A \rightarrow \neg A)$ | (5), (6) and R1 |
| (8) $(A \rightarrow \neg A) \rightarrow \neg A$ | (7), R5 |

10.5.4 The following shows that the law of excluded middle also holds in R .

- | | |
|---|-------------------------------|
| (1) $A \rightarrow (A \vee \neg A)$ | A2 |
| (2) $(A \vee \neg A) \rightarrow \neg\neg(A \vee \neg A)$ | double negation (10.3.9) |
| (3) $A \rightarrow \neg\neg(A \vee \neg A)$ | (1), (2) and transitivity |
| (4) $\neg(A \vee \neg A) \rightarrow \neg A$ | (3), R5 |
| (5) $\neg A \rightarrow (A \vee \neg A)$ | A2 |
| (6) $\neg(A \vee \neg A) \rightarrow (A \vee \neg A)$ | (4), (5) and transitivity |
| (7) $\neg(A \vee \neg A) \rightarrow \neg\neg(A \vee \neg A)$ | (6), (2) and transitivity |
| (8) $(\neg(A \vee \neg A) \rightarrow \neg\neg(A \vee \neg A)) \rightarrow \neg\neg(A \vee \neg A)$ | <i>consequentia mirabilis</i> |
| (9) $\neg\neg(A \vee \neg A)$ | (7), (8) and R1 |
| (10) $\neg\neg(A \vee \neg A) \rightarrow (A \vee \neg A)$ | A7 |
| (11) $A \vee \neg A$ | (9), (10) and R1 |

In fact, it can be shown that all classical tautologies (expressed in terms of \vee , \wedge , \neg and \supset) are logically valid in R .⁶

10.5.5 Establishing that inferences are invalid in R is even harder, since some kind of counter-model must be constructed. A useful technique is to employ a suitable many-valued logic.⁷ For example, it is laborious, but not difficult, to check that every axiom of R takes a designated value in the many-valued logic RM_3 of 7.4, and that the rules of R preserve that property. (Details are left as an exercise.) It follows that R is a sub-logic of RM_3 . Hence, if something is not valid in RM_3 , it is not valid in R . This suffices to establish some facts about invalidity in R . For example, as we saw in 7.5.2, RM_3 avoids the standard paradoxes of both the material conditional and the strict conditional. Hence, the same is true of R . (Exactly the same considerations apply to logic RM .)

10.5.6 A more complex many-valued logic can be used to establish the relevance of R (and *a fortiori*, of any of the weaker systems that we have met in this chapter). The truth values of the logic are $\{1, 0, b, n, 1', 0', b', n'\}$. The designated values are those with the primes. To compute the negation of a value, add or take away the prime, as appropriate. To compute the truth value of conjunctions and disjunctions, consider the following diagram:

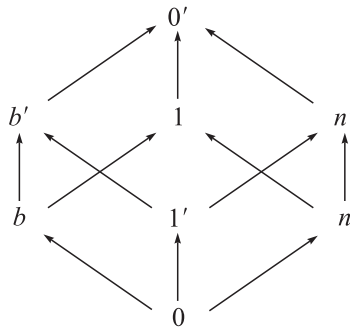

⁶ The proof, in essence, is as follows. Let A be anything logically valid in classical logic, and let A' be its disjunctive normal form. In classical logic, this follows from the law of excluded middle by laws about conjunction, disjunction and negation, which also hold in R . Hence, A' holds in R . In classical logic, A' entails A by laws concerning conjunction, disjunction and negation, which also hold in R . Hence, A holds in R .

⁷ Perhaps the most useful many-valued logic, in this context, is the one given in 10.11, problem 8.

Note that this is just the diamond lattice of 8.4.3, with an inverted copy pasted on top, and connected by vertical lines for corresponding elements. Conjunction is greatest lower bound; disjunction is least upper bound. Thus, for example, $b' \wedge n' = 1'$, $1 \wedge 1' = 0$, etc.⁸ The truth function for \rightarrow is as follows:

	0'	n'	b'	1'	1	b	n	0
0'	0'	0	0	0	0	0	0	0
n'	0'	n'	0	0	n	0	n	0
b'	0'	0	b'	0	b	b	0	0
1'	0'	n'	b'	1'	1	b	n	0
1	0'	0	0	0	1'	0	0	0
b	0'	0	b'	0	b'	b'	0	0
n	0'	n'	0	0	n'	0	n'	0
0	0'	0'	0'	0'	0'	0'	0'	0'

It is complex but mundane to check that all the axioms of R are valid in this logic, that the rules preserve this property, and hence that R is also a sub-logic of the logic. (Details are left as an exercise for masochists.)

10.5.7 Now, consider any formula of the form $B \rightarrow C$, where B and C share no parameter. Assign to every parameter in B the value b or b' ; assign to every parameter in C the value n or n' . It is then easy to check that B has the value b or b' , and C has the value n or n' . But in that case, checking the table for \rightarrow suffices to show that $B \rightarrow C$ has the value 0, and so is not logically valid in the many-valued logic, and so in R .

10.6 The Ternary Relation

10.6.1 Let us now turn to some philosophical issues. In particular, what does the ternary relation mean, and why might it be reasonable to employ it in stating the truth conditions of a conditional?

10.6.2 It is difficult to give a satisfactory answer to this question. The most promising sort of answer seems to be to tie up the relation with the notion of information. Suppose, for example, that we think of a world as

⁸ The structure is another example of a De Morgan lattice. Most mainstream relevant logics also have algebraic semantics based on such lattices.

a state of information (as we did with intuitionist logic in 6.3.6). Then we may read $Rxyz$ as meaning that z contains all the information obtainable by pooling the information x and y . This makes sense of the truth conditions of \rightarrow . For if $A \rightarrow B$ holds in the information x , and A holds in the information y , we should certainly expect B to hold in the information obtained by pooling x and y . Conversely, if $A \rightarrow B$ does not hold in the information x , then it would certainly seem possible that we might add the information that A without thereby obtaining the information that B . Hence, there would seem to be a state of information, y , such that A holds in y , but B does not hold in the information obtained by pooling x and y .

10.6.3 The problem with this interpretation is that it seems to justify too much. For example, it justifies the claim that if $Rxyz$ and A is true at y it is also true at z . But if this were the case, $A \rightarrow A$ would be true at every world, and hence, for any B , $B \rightarrow (A \rightarrow A)$ would be logically valid, which it cannot be if the logic is to be relevant.

10.6.4 Another possibility for interpreting R is to suppose that worlds are not themselves states of information, but that they may act as conduits for information in some way. Thus, a situation that contains a fossilised footprint allows information to flow from the situation in which it was made, to the situation in which it is found. $Rxyz$ is now interpreted as saying that the information in y is carried to z by x . If we think of $A \rightarrow B$ as recording the information carried, this makes some sense of the ternary truth conditions. For if A is information at y , and x allows the flow of information $A \rightarrow B$ from y to z , then we would expect the information B to be available at z . Conversely, if x does not allow the information flow $A \rightarrow B$, then it must be possible for there to be situations, y and z , where A is available at y , but B is not available at z .

10.6.5 The problem now is to make sense of the metaphor of information flow – hardly a transparent one. Moreover, it is not at all clear that, when articulated, it will provide what is needed. For example, if a situation carries any information at all, it would appear to carry the information that there is some source from which information is coming. Call this statement S . If this is the case, then the inference from $A \rightarrow B$ to $A \rightarrow S$ would appear to

be valid. But this would seem to give a violation of relevance, since A itself may have nothing to do with S .

10.6.6 The ternary relation semantics, and the study of information flow are both very new; and it may be the case that a satisfactory analysis of the two together will eventually arise. But if the ternary relation semantics is ultimately to provide anything more than a model-theoretic device for establishing various formal facts about various relevant logics, this is a task that must be discharged successfully. In particular, if the ternary relation semantics is to *justify* the fact that some inferences concerning conditionals are valid and some are not, then there must be some acceptable account of the connection between the meaning of the relation and the truth conditions of conditionals.

10.7 *Ceteris Paribus* Enthymemes

10.7.1 Setting this issue aside, let us return to the question of the conditional itself. Any relevant logic of the kind that we have met avoids the standard paradoxes of the material and strict conditionals, as we saw in 10.5.5. It also avoids the inferences of 1.9.1. (See 10.11, problem 9.) Hence, it is an excellent candidate for the conditional. A natural question at this point is whether it is possible to give an account of conditionals with a *ceteris paribus* clause in relevant logic. (The inferences of 5.2.1 are all valid in N_* , and *a fortiori*, all the relevant logics we have met. Details are left as an exercise.)

10.7.2 It is, and we will now see how. In fact, all we have to do is reproduce the techniques of chapter 5 in a relevant possible-world semantics. (Note that the connective $>$ of chapter 5 is not a relevant connective. For example, in all the logics of that chapter, $\models p > (q \vee \neg q)$; 5.12, problem 2(e).) We illustrate this with respect to the logic B , but it should be clear that it can be applied to any of the relevant logics that we have met.

10.7.3 Start by adding a new connective, $>$, to the language. Let \mathcal{I} be an interpretation for B . To obtain a semantics for the extended language, we add the collection of accessibility relations, $\{R_A: A \text{ is a formula of the language}\}$, to \mathcal{I} . Alternatively, and equivalently, we can add a set of selection functions, f_A . (See 5.3.5.)

10.7.4 The truth conditions for the old connectives are as for B . The conditions for $>$ are:⁹

$$v_w(A > B) = 1 \text{ iff } f_A(w) \subseteq [B]$$

10.7.5 Validity is defined in terms of truth preservation at all normal worlds. Let us call this system C_B . Tableaux for C_B can be obtained simply by adding the following rules to those of 10.3.1.

$$\begin{array}{cc} A > B, +x & A > B, -x \\ \downarrow \text{ } xr_{Ay} & \downarrow \\ \downarrow & xr_{Aj} \\ B, +y & B, -j \end{array}$$

In the second rule, j is a new number. Soundness and completeness proofs can be found in 10.8.3.

10.7.6 Extensions of C_B can be obtained by adding further conditions on f . Again, we simply illustrate this. Corresponding to the conditions for C^+ , we have, for any $w \in N$:

- (1) $f_A(w) \subseteq [A]$
- (2) if $w \in [A]$ then $w \in f_A(w)$

(Why the conditions are for only normal w , we will come back to in a moment.) Call the system obtained in this way C_B^+ . Tableaux for C_B^+ can be obtained by modifying the rule for false $>$, when (and only when) x is 0, to become:

$$\begin{array}{c} A > B, -0 \\ \downarrow \\ Or_{Aj} \\ A, +j \\ B, -j \end{array}$$

⁹ In the case of the relational relevant logics, the natural conditions are:

$$\begin{array}{l} A > B\rho_w 1 \text{ iff } f_A(w) \subseteq [B] \\ A > B\rho_w 0 \text{ iff } f_A(w) \cap [\neg B] \neq \phi \end{array}$$

and adding the rule:

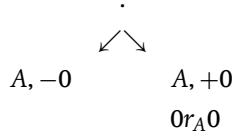

where A is the antecedent of any conditional or negated conditional on the branch. Soundness and completeness proofs are to be found in 10.8.4.

10.7.7 Here, for example, is a tableau to show that $\not\vdash_{C_B^+} (p \wedge \neg p) > q$:

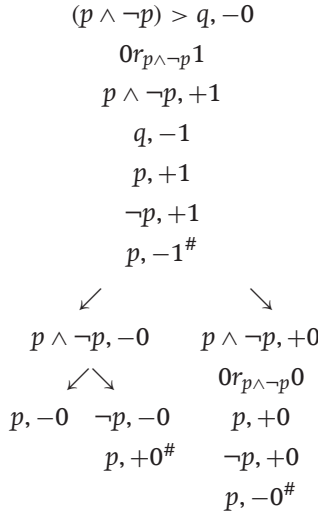

The counter-model determined by the lefthand branch may be depicted thus:

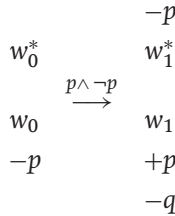

10.7.8 If we restrict our interpretations to those where $W = N$ and for all $w, w^* = w$, then we have, essentially, just interpretations for C^+ . Hence C_B^+ is a sub-logic of C^+ . In particular, all the inferences of 5.2.1 fail (5.12, problem 4).

10.7.9 On the other hand, if we consider interpretations where $W = N$ and $f_A(w) = [A]$ (which condition satisfies both (1) and (2)), then $>$ behaves just like \rightarrow in K_* . In particular, for any inference involving \rightarrow that fails in K_* , the corresponding inference for $>$ fails in C_B^+ . Hence, C_B^+ is not subject to the standard paradoxes of strict implication. In fact, $>$ is a relevant connective. (For the proof of this, see 10.11, problem 12.)

10.7.10 Note, finally, that if condition (1) were not restricted to normal worlds, irrelevance would arise. For then, $A > A$ would be true at all worlds, and so $B > (A > A)$ would be valid.

10.7.11 Thus, the semantics of relevant logics can provide plausible candidates not only for the conditional, but also for *ceteris paribus* enthymemes.

10.7.12 The existence of such conditionals provides for a different answer to the question of why it is sometimes permissible to use the DS (see 8.6). This is because, in the context in question, one may take the conditional $(p \wedge \neg(p \vee q)) > q$ to be true, since the worlds accessible under $R_{p \wedge \neg(p \vee q)}$ are all consistent.

10.8 *Proofs of Theorems

10.8.1 THEOREM: The tableaux for B are sound and complete with respect to their semantics.

Proof:

The proofs are modifications of those for N_* (9.8.13). The definition of faithfulness is modified by the addition of the clause:

if $rxyz$ is on b , then $Rf(x)f(y)f(z)$ in \mathcal{I}

In the Soundness Lemma, we merely need to check the new rules. So suppose that we apply a rule to $A \rightarrow B, +x$ and $rxyz$. By assumption, $A \rightarrow B$ is true at $f(x)$, and $Rf(x)f(y)f(z)$. By the truth conditions of \rightarrow , either A is false at $f(y)$ or B is true at $f(z)$, as required. If, on the other hand, we apply the rule to $A \rightarrow B, -x$, then $A \rightarrow B$ is false at $f(x)$. Hence, there are worlds, u, v , such that $Rf(x)uv$, A is true at u , and B is not true at v ; and if x is 0, u is v , since $f(0) \in N$. Let f' be the same as f , except that $f'(j) = u$ and $f'(k) = v$. Then the result follows in the usual way. For the normality rule, since $f(0) \in N$, $Rf(0)f(x)f(x)$, by the normality condition, as required.

In the Completeness Lemma, the induced interpretation is defined as for N_* (so, in particular, only w_0 is normal), and $Rw_xw_yw_z$ iff $rxyz$ occurs at a node on b . The interpretation, so defined, is a B -interpretation. In particular, by the normality rule, for all x , $r0xx$ occurs on the tableau, so $Rw_0w_xw_x$. And if $r0xy$ occurs on the tableau, it must have got there by an application of either the normality rule or the rule for false \rightarrow s. In either case, x is y . Hence, if $Rw_0w_xw_y$, $w_x = w_y$. It remains to check the clauses for \rightarrow in the Completeness Lemma. So suppose that $A \rightarrow B, +x$ occurs on the branch. Then for all y and z such that $rxyz$ occurs on the branch, either $A, -y$ or $B, +z$ occurs on the branch. By induction hypothesis, for all worlds w_y, w_z such that $Rw_xw_yw_z$, if A is true at w_y, B is true at w_z . That is, $A \rightarrow B$ is true at w_x . Suppose, on the other hand, that $A \rightarrow B, -x$ occurs on the branch. Then for some j and k , $rxjk, A, +j$ and $B, -k$ occur on the branch. By induction hypothesis, for some worlds w_j, w_k , such that $Rw_xw_jw_k$, A is true at w_j and B is false at w_k . That is, $A \rightarrow B$ is false at w_x . ■

10.8.2 THEOREM: The tableaux of 10.4 for $B + C8-C11$ are sound and complete.

Proof:

The proofs are extensions of those for B . The definition of faithfulness is now extended with the clause:

if $x = y$ occurs on b then $f(x) = f(y)$

For the Soundness Lemma, we have to check the rules for identity, and the rules T8-T11. The three rules for identity proper are straightforward, any deletion of double #s being justified by the fact that $w = w^{**}$. For the fourth rule, suppose that $r0xy$ is on the branch; then, by assumption, $Rf(0)f(x)f(y)$. Since $f(0) \in N, f(x) = f(y)$, as required. It remains to check T8-T11. This is routine, and left as an exercise.

For completeness, the induced interpretation is defined slightly differently. Define $x \sim y$ to mean that ' $x = y$ ' occurs on the branch. It is easy to check that \sim is an equivalence relation. Let $[x]$ be the equivalence class of x . The worlds of the interpretation are now $w_{[x]}$, for every x on the branch. $w_{[x]}^* = w_{[\bar{x}]}$. (This definition makes sense, since if $x = y$ is on b , so is $\bar{x} = \bar{y}$, as may easily be checked. And $w^{**} = w$, since $\bar{\bar{x}} = x$.) The rest of the definition is the same, with ' x ' replaced by ' $[x]$ ' (and makes sense, since any two members of an equivalence class behave in exactly the same way on a branch,

by the substitutivity rule).

The Completeness Lemma is now formulated as:

if $A, +x$ occurs on b then A is true at $w_{[x]}$
 if $A, -x$ occurs on b then A is false at $w_{[x]}$

and its proof goes through, essentially as usual.

It remains to check that the induced interpretation has the appropriate properties. Since, for any x , $r0xx$ is on the branch, we have $Rw_{[0]}w_{[x]}w_{[x]}$. Moreover, suppose that $Rw_{[0]}w_{[x]}w_{[y]}$. Then $r0xy$ is on the branch, as, then, is $x = y$. It follows that $x \sim y$, and $[x] = [y]$, as required. Checking that each of the constraints C8–C11 is satisfied, given that the appropriate rule is in force, is routine, and details are left as an exercise. ■

10.8.2a THEOREM: In any interpretation with a content ordering, if $w \sqsubseteq w'$ then, for any A , if $v_w(A) = 1$, $v_{w'}(A) = 1$.

Proof:

The proof is by induction on the structure of A . The basis case is true by Clause 1 of 10.4a.1. For the other connectives:

$$\begin{aligned} v_w(A \wedge B) = 1 &\Rightarrow v_w(A) = 1 \text{ and } v_w(B) = 1 \\ &\Rightarrow v_{w'}(A) = 1 \text{ and } v_{w'}(B) = 1 \quad \text{IH} \\ &\Rightarrow v_{w'}(A \wedge B) = 1 \end{aligned}$$

The case for \vee is similar.

$$\begin{aligned} v_w(\neg A) = 1 &\Rightarrow v_{w^*}(A) = 0 \\ &\Rightarrow v_{w'^*}(A) = 0 \quad \text{Clause 2} \\ &\Rightarrow v_{w'}(\neg A) = 1 \end{aligned}$$

For \rightarrow : Suppose that $v_w(A \rightarrow B) = 1$. We need to show that $v_{w'}(A \rightarrow B) = 1$, i.e., that for all x, y such that $Rw'xy$, if $v_x(A) = 1$, then $v_y(B) = 1$. Suppose that $Rw'xy$ and $v_x(A) = 1$.

Case 1, $w \in N$: Then for all u , if $v_u(A) = 1$ then $v_u(B) = 1$. So $v_x(B) = 1$. By Clause 3, $x \sqsubseteq y$, so by induction hypothesis, $v_y(B) = 1$, as required.

Case 2, $w \in W - N$: Then for all x, y such that $Rwxy$, if $v_x(A) = 1$, then $v_y(B) = 1$. By Clause 3, $Rwxy$, and so $v_y(B) = 1$, as required. ■

10.8.2b THEOREM: The tableaux of 10.4a.3 for content-inclusion are sound with respect to their semantics.

Proof:

The proof extends that of 10.8.2. The definition of faithfulness is now extended with the clauses:

- if $\$x$ occurs on b then $f(x) \in N$
- if $\bar{\$}x$ occurs on b then $f(x) \in W - N$
- if $x \leq y$ occurs on the branch then $f(x) \sqsubseteq f(y)$

In the proof of the Soundness Lemma, we need to check the new rules of 10.4a.3, including the new normality rules (except the new closure rule). These are straightforward, and left as an exercise. The proof of the Soundness Theorem then proceeds as usual.

10.8.2c THEOREM: The tableaux of 10.4a.3 for content-inclusion are complete with respect to their semantics. ■

Proof:

The proof modifies that of 10.8.2. I spell out the induced interpretation in detail. Given an open branch, b , this is the structure $\langle W, N, R, *, \sqsubseteq, \nu \rangle$ defined as follows. Let $x \sim y$ mean that ' $x = y$ ' is on b . This is an equivalence relation. $W = \{w_{[x]}: x \text{ or } \bar{x} \text{ is on } b\}$. $w_{[x]} \in N$ iff $\$x$ is on b (so if $\bar{\$}x$ is on b , $w_{[x]} \in W - N$ by the closure rule for $\$$). $Rw_{[x]}w_{[y]}w_{[z]}$ iff $rxyz$ is on b . R satisfies the normality constraint because of the new normality rules. $w_{[x]}^* = w_{[\bar{x}]}$. $w^{**} = w$ since $\bar{\bar{x}} = x$. $\nu_{w_{[x]}}(p) = 1$ iff $p, +x$ is on b . $w_{[x]} \sqsubseteq w_{[y]}$ iff $x \leq y$ is on b . \sqsubseteq is reflexive, transitive, and satisfies the constraints of 10.4a.1 because of the corresponding tableau rules of 10.4a.3. (Finally, all the definitions that make use of equivalence classes are well defined because of the identity rules.)

The proof of the Completeness Lemma, and so Theorem, now proceed in the usual way.

10.8.2d THEOREM: The tableaux obtained by adding the rules T8–T16 to those for content inclusion are sound and complete with respect to conditions C8–C16, respectively. ■

Proof:

The proofs extend those for the tableaux for content-inclusion (10.8.2b and 10.8.2c) in the usual way. In the Soundness Lemma, the cases for T8–T11 are as in 10.8.2. The cases for T12–T16 are as follows:

T12: Suppose that $Rf(x)f(y)f(z)$. Then for some w , $f(x) \sqsubseteq w$ and $Rf(y)wf(z)$. Let f' be the same as f , except that $f'(j) = w$. Then f' shows \mathcal{I} to be faithful to b .

T13: Given that $f(x)$ is normal, $f(x)^* \sqsubseteq f(x)$, as required.

T14: $f(x)$ is either normal or non-normal. In the first case f shows \mathcal{I} to be faithful to the left branch; in the second it shows \mathcal{I} to be faithful to the right branch.

T15: Suppose that $Rf(x)f(y)f(z)$. Then $f(x) \sqsubseteq f(z)$, as required.

T16 Suppose that $Rf(x)f(y)f(z)$. Then $f(x) \sqsubseteq f(z)$ or $f(y) \sqsubseteq f(z)$, as required.

In the Completeness Lemma, we have to check that the induced interpretation has the right property in each case. This is straightforward, and left as an exercise. ■

10.8.3 THEOREM: The tableaux for C_B are sound and complete with respect to their semantics.

Proof:

The proof extends that for B . The definition of faithfulness is extended by the same clause as that required for C :

if xr_Ay is on b , then $f(x)R_Af(y)$ in \mathcal{I}

In the proof of the Soundness Lemma, we have to check only the rules for $>$; and these are as for C in 5.9.1, with appropriate modifications.

The induced interpretation is defined as for B , except that for each formula, A , R_A is defined as for C (5.9.1). The rest of the argument is then routine. ■

10.8.4 THEOREM: The tableaux for C_B^+ are sound and complete with respect to its semantics.

Proof:

The proof extends that for C_B . In the Soundness Lemma, we have to check the cases for the revised rules. The argument is as for C^+ (5.9.2), with the appropriate modifications.

In the Completeness Theorem, we have to check that the induced interpretation is a C_B^+ -interpretation, and in particular, that w_0 satisfies conditions (1) and (2). The argument is as for C^+ (5.9.2). ■

10.9 History

The earliest known relevant logic is an axiomatisation of R by the Russian logician Orlov in 1928; see Došen (1992). This went largely unnoticed, however. After that, relevant logics or fragments thereof were published by Church in 1951 and Ackermann in 1956. The project was taken up and much developed in the 1960s by the US logicians Anderson and Belnap, together with a number of their students, including Meyer and Dunn (who developed the algebraic semantics for relevant logics). The result was Anderson and Belnap's *Entailment* (1975), which can also be consulted for a discussion of Church and Ackermann. Volume II of *Entailment* appeared later, as Anderson, Belnap, and Dunn (1992). The work of Anderson, Belnap and their school concentrated on the strong relevant logics, T , R and E , the last of these being their preferred logic. The model of R in 10.11, problem 8, is due to Meyer (1970).

The ternary relation semantics for relevant logics was developed by Routley (Sylvan) and Meyer (by that time in Australia), building on the earlier invention of the Routley $*$. The results appeared in a number of papers in the 1970s, starting with Routley and Meyer (1973). Further work by Routley, Meyer and their students, including Brady, was published in Routley, Plumwood, Meyer and Brady (1982), and Brady (2003). The semantics made it clear that the basic affixing relevant logic was B , and that there were many interesting logics between B and the strong American systems. Much of the work of the Australians concentrated on the weaker systems – especially those not containing *contraction* (A11) – which are much better for a number of applications, such as the theory of truth (see Priest 2002a, sect. 8). The Americans called the subject *relevance* logic, since they took themselves to be giving an analysis of (amongst other things) relevance. Routley argued that the logics did not really provide an analysis of relevance; though, in these logics, the antecedent is relevant to the consequent in logical truths of the form $A \rightarrow B$. He therefore preferred the name *relevant* logic, a usage that is followed by most Australian logicians.

The original Routley/Meyer ternary relation semantics was somewhat more complex than the ones used in this chapter. The simplified version employed here was given for B by Priest and Sylvan (1992), and extended to stronger systems by Restall (1993). These works can be consulted for the soundness and completeness proofs for the various systems of relevant logics formulated axiomatically.¹⁰ For the mistake discussed in the footnote of 10.4a.8, see Restall and Roy (200+).

The relevant logics based on relational semantics for negation are a somewhat different family of logics from the one considered in this chapter, though some of these can be given relational semantics by employing various devices. See Priest and Sylvan (1992), Routley (1984) and Restall (1995a).

The suggestion of 10.6.2 to interpret the ternary relation in terms of information comes from Urquhart (1972), which contains a slightly different semantics for some relevant logics. Urquhart also proved the undecidability of the stronger relevant logics, including R . (The weaker members of the family are decidable.) The suggestion of 10.6.4, that the ternary relation can be thought of in terms of information flow, arose out of the similarities between relevant logic and situation semantics, and is due to Restall (1995b) and Mares (1996). The debate on the question of whether the Routley/Meyer semantics has any philosophical significance has become quite heated at times. See Copeland (1979), Routley, Routley, Meyer and Martin (1982) and Copeland (1983).

The fact that the techniques of conditional logic could be applied just as well to relevant logics was first noted by Routley (1989a, sect. 8), and later by Mares and Fuhrmann (1995). The suggestion concerning the DS of 10.7.12 is due to Mares (2004), ch. 7.

10.10 Further Reading

Perhaps the gentlest introductions to mainstream relevant logic are Mares and Meyer (2001), Read (1988) and Mares (2004). Dunn (1986)

¹⁰ As the semantics are formulated in those papers, there is only one normal world. This, in fact, makes no difference. The soundness and completeness arguments work just as well if there is more than one normal world. And in fact, the completeness argument shows that one never needs to assume that there is more than one normal world.

is a good reference work for the stronger relevant systems (including their undecidability). For the more technical reader, Restall (2000) is an excellent investigation of relevant logics, and the broader family of substructural logics to which they belong. There are many kinds of relevant logics outside the mainstream area. For an orientation, see Routley (1989b).

10.11 Problems

1. Fill in the details left as exercises in 10.3.6, 10.4.6, 10.4a.8, 10.5.5, 10.5.6 and 10.7.1.
2. Show that the following fail in B :
 - (a) $(p \wedge q) \rightarrow r \vdash p \rightarrow (q \rightarrow r)$
 - (b) $p \rightarrow (q \rightarrow r) \vdash (p \wedge q) \rightarrow r$
 - (c) $\vdash ((p \rightarrow q) \wedge (q \rightarrow r)) \rightarrow (p \rightarrow r)$
 - (d) $\vdash (p \rightarrow q) \rightarrow ((p \wedge r) \rightarrow (q \wedge r))$
 - (e) $(p \wedge q) \rightarrow r \vdash (p \wedge \neg r) \rightarrow \neg q$
3. Show that $(p \wedge (p \rightarrow q)) \rightarrow q$ is not logically valid in B . Show that it is if we require every world, w , of every interpretation to satisfy the condition $Rwww$.
4. Give deductions for the following in R :
 - (a) $\vdash \neg A \rightarrow \neg(A \wedge B)$
 - (b) $\vdash \neg(A \wedge \neg A)$
 - (c) $A \rightarrow B, A \rightarrow \neg B \vdash \neg A$
5. Show that in R , A12 may be replaced by permutation: $(A \rightarrow (B \rightarrow C)) \rightarrow (B \rightarrow (A \rightarrow C))$. Show that in R , A11 may be replaced by A14. (Hint for the second: take $(A \rightarrow \neg A) \rightarrow \neg A$, and prefix the antecedent and consequent with $\neg B$. Then use permutation on the antecedent.)
6. Show that $\vdash_{RM} (p \wedge \neg p) \rightarrow \neg(q \wedge \neg q)$. This is non-trivial. Start by showing that in $R \vdash (A \vee \neg A) \leftrightarrow \neg(A \wedge \neg A)$, $\vdash (A \wedge \neg A) \leftrightarrow \neg(A \vee \neg A)$, and $\vdash (A \rightarrow B) \rightarrow (\neg B \rightarrow \neg A)$ (contraposition). (Use any appropriate method.) Now formalise the following deduction. Let A be $(p \wedge \neg p) \vee (q \wedge \neg q)$. A16 gives $A \rightarrow (A \rightarrow A)$; so by contraposition and permutation $\neg A \rightarrow (A \rightarrow \neg A)$. Substituting for A , we have:

$$\begin{aligned} &\neg((p \wedge \neg p) \vee (q \wedge \neg q)) \rightarrow \\ &\quad ((p \wedge \neg p) \vee (q \wedge \neg q)) \rightarrow \neg((p \wedge \neg p) \vee (q \wedge \neg q)) \end{aligned}$$

But the antecedent is equivalent to the conjunction of two instances of Excluded Middle. Hence we can detach the consequent. This is equivalent to $((p \wedge \neg p) \vee (q \wedge \neg q)) \rightarrow (\neg(p \wedge \neg p) \wedge \neg(q \wedge \neg q))$. $(p \wedge \neg p) \rightarrow \neg(q \wedge \neg q)$ follows.

7. Show that if all the worlds of an interpretation are normal, the constraints C8–C11 hold. Infer that any logic obtained by adding to B any of A8–A11 is a sublogic of K_* . Show that the same is not true of A12. Is it true of A13?
8. (Another exercise for masochists.) Show that all the axioms of R are valid in the following many-valued logic, and that all the rules of R preserve validity; hence, that R is a sub-logic of the logic. The values of the logic are the integers, together with a new object, ∞ . All but 0 are designated. The logical operators are defined as follows:

$$\neg 0 = \infty; \neg \infty = 0; \neg a = -a \text{ otherwise}$$

$$0 \wedge a = a \wedge 0 = 0; \infty \wedge a = a \wedge \infty = a$$

$$0 \vee a = a \vee 0 = a; \infty \vee a = a \vee \infty = \infty$$

$$0 \rightarrow a = a \rightarrow \infty = \infty; \text{ if } a \neq 0, a \rightarrow 0 = 0, \text{ if } a \neq \infty, \infty \rightarrow a = 0$$

if a and b are positive integers, then:

$$\text{if } a \text{ divides } b, a \rightarrow b = b/a; \text{ otherwise, } a \rightarrow b = 0$$

$$a \wedge b \text{ is the greatest common divisor of } a \text{ and } b$$

$$a \vee b \text{ is the least common multiple of } a \text{ and } b$$

if a and b are negative integers, then:

$$a \wedge b = -(-a \vee -b)$$

$$a \vee b = -(-a \wedge -b)$$

$$a \rightarrow b = -b \rightarrow -a$$

if a is a negative integer and b is a positive integer, then:

$$a \rightarrow b = 0; b \rightarrow a = b.a$$

$$a \wedge b = b \wedge a = b$$

$$a \vee b = b \vee a = a$$

9. Use the result of the previous problem to show that the following do not hold in R :

$$(a) \models p \rightarrow (p \rightarrow p)$$

$$(b) \models p \rightarrow (q \rightarrow (p \wedge q))$$

$$(c) (p \wedge q) \rightarrow r \models (p \rightarrow r) \vee (q \rightarrow r)$$

- (d) $(p \rightarrow q) \wedge (r \rightarrow s) \models (p \rightarrow s) \vee (r \rightarrow q)$
 (e) $\neg(p \rightarrow q) \models p$
10. Show that the following are valid in C_B^+ :
- (a) $\vdash A > A$
 (b) $\vdash (A > \neg\neg A) \wedge (\neg\neg A > A)$
 (c) $\vdash (A \wedge B) > A$
 (d) $A > B, A > C \vdash A > (B \wedge C)$
 (e) $A, A > B \vdash B$
 (f) $A \rightarrow B \vdash A > B$
11. This exercise gives a proof of the relevance of the logic B.
- (a) Let \perp and \perp^* be a pair of non-normal worlds such that every propositional parameter is true at \perp and false at \perp^* . Suppose that $R\perp\perp\perp, R\perp^*\perp\perp^*$, and that each world accesses no other worlds. Show that every formula is true at \perp and false at \perp^* .
- (b) Let w and w^* be a pair of non-normal worlds such that $Rw\perp w$ and $Rw^*\perp w^*$. Using part (a), show that: (i) if every parameter in A is true at w and false at w^* , the same is true of A ; (ii) if every parameter in B is false at w and true at w^* , the same is true of B .
- (c) Use this to show that if $\vdash_B A \rightarrow C$, A and C share a propositional parameter.
12. By defining suitable accessibility relations for $>$, modify the proof of the previous question to show the same for $>$ in C_B^+ . (Hint: For every non-normal world, w , set $f_A(w) = \{w\}$.)
13. Let $D(n)$ be the disjunction of all formulas of the form $p_i \leftrightarrow p_j$ for all i and j , such that $0 \leq i < j \leq n$. Using the interpretation of problem 8, show that for all n , $D(n)$ is not logically valid in R . Hence, show that neither R nor any weaker relevant logic is finitely-many valued. (Hint: See the similar proofs for modal and intuitionist logics, 7.11.1–7.11.4.)
14. What is it to carry information? And what (ternary) properties does information flow have?
15. *Check the details omitted in 10.8.

11 Fuzzy Logics

11.1 Introduction

11.1.1 In this chapter we look at fuzzy logic, that is, logic in which sentences can take as a truth value any real number between 0 and 1.

11.1.2 We look at one of the major motivations for such a logic: vagueness. We also show some of the connections between fuzzy logic and relevant logics.

11.1.3 Finally, fuzzy logic gives a very distinctive account of the conditional, since *modus ponens* may fail. The chapter examines what fuzzy conditionals are like.

11.2 Sorites Paradoxes

11.2.1 Suppose that Mary is aged five, and hence is a child. If someone is a child, they are a child one second later: there is no second at which a person turns from a child to an adult. (We are talking about biological childhood here, not legal childhood. The latter does terminate at the instant someone turns eighteen, in many jurisdictions.) So in one second's time, Mary will still be a child. Hence, one second after that, she will still be a child; and one second after *that*; and one second after *that* . . . Hence, Mary will be a child after any number of seconds have elapsed. But this is, of course, absurd. After an appropriate number of seconds have elapsed, so have thirty years, by which time Mary is thirty-five, and so certainly not a child.

11.2.2 The argument of 11.2.1 is known as a *sorites* paradox. It arises because the predicate 'is a child' is vague in a certain sense. Specifically, very small changes to an object (in this case, a person) seem to have no effect on the applicability of the predicate.

11.2.3 In fact, most of the predicates we commonly use are vague in this sense: ‘is tall’, ‘is drunk’, ‘is red’, ‘appears red’, ‘is a heap of sand’ (‘sorites’ comes from the Greek *soros* meaning ‘heap’) – even ‘is dead’ (dying takes time: one nanosecond makes no difference). One can construct sorites arguments for all such predicates.

11.2.4 Sorites arguments can often be put in the form of a sequence of *modus ponens* inferences. Thus, if M_i is the sentence ‘Mary is a child after i seconds’, then the sorites of 11.2.1 is just:

$$\frac{M_0 \quad M_0 \rightarrow M_1}{M_1 \quad M_1 \rightarrow M_2} \\ M_2 \\ \vdots \\ \frac{M_{k-1} \quad M_{k-1} \rightarrow M_k}{M_k}$$

where k is some very large number.

11.3 ... and Responses to Them

11.3.1 Various, very different, responses to the sorites paradox have been given. To see what some of these are, consider the sequence: M_0, M_1, \dots, M_k . M_0 is definitely true; M_k is definitely false. What is one to say about what goes on in between?

11.3.2 If we suppose that every sentence is either simply true or simply false, and given that the change from child to adult is not reversible, then there must be a unique i such that M_i is true, and M_{i+1} is false. In this case, the conditional $M_i \rightarrow M_{i+1}$ is false, and the sorites argument is broken. The problem with this supposition is obvious, however: the discrete nature of the change (that is, the jump from truth to falsity) would seem to be incompatible with the relatively continuous nature of the change from being a child to being an adult.

11.3.3 Some have bitten the bullet, and accepted that there is, indeed, such a point. The most notable defence of this line (given by *epistemicists*) attempts to argue that we find the existence of the point counterintuitive because,

as a matter of principle, we cannot know where it is; and we cannot know this for the following reason.

11.3.4 If you know something, this has to be on some evidential basis. Thus, if you know something about a situation, you must know the same thing about any situation that is evidentially the same. Now suppose that you know that M_i . Since, M_{i+1} is evidentially the same (you could not tell the difference), you would have to know M_{i+1} too. But you cannot, since M_{i+1} is false.

11.3.5 Whatever one makes of this argument itself, it cannot really serve to explain why we find the existence of a semantic discontinuity counterintuitive. For it is not just the fact that we do not *know* where the cut-off point is that is odd; it is the very possibility of a cut-off point at all: the changes involved in one second of a person's life just do not seem to be of the kind that could ground a difference between childhood and adulthood.

11.3.6 Some philosophers have suggested that vagueness requires us to reject a simple dichotomy between truth and falsity. In a sorites transition, there is a middle ground: some sentences in the middle of the transition are neither true nor false – or, perhaps, both true and false – something symmetric between truth and falsity, anyway.

11.3.7 Thus, a popular suggestion is that K_3 (7.3), possibly in conjunction with some supervaluation technique (7.10.3–7.10.5a), is an appropriate logic for vagueness. In this case, there is some i , such that M_i is true and M_{i+1} is neither true nor false. Again, $M_i \rightarrow M_{i+1}$ is not true, and so the sorites argument fails.

11.3.8 The problem with any 3-valued approach is obvious, however. The existence, in a sorites progression, of a discrete boundary between truth and the middle value is just as counterintuitive as that of one between truth and falsity.

11.3.9 Moreover, the existence of relatively continuous change along a sorites progression would seem to be incompatible with any discrete boundaries. It is natural to suppose, therefore, that truth values must themselves change continuously. Thus, we must consider a logic in which truth comes

in continuous degrees. This is fuzzy logic, and will concern us for the rest of this chapter.¹

11.3.10 It should be noted, though, that even fuzzy logic is not entirely unproblematic. For if truth comes by degrees, there must be some point in a sorites transition where the truth value changes from *completely true* to *less than completely true*. The existence of such a point would itself seem to be intuitively problematic.

11.4 The Continuum-valued Logic L

11.4.1 A natural way to construct a fuzzy logic is as a many-valued logic with a continuum of truth values. Let the truth values, \mathcal{V} , be the set of real numbers (decimals) between 0 and 1, $\{x: 0 \leq x \leq 1\}$. This is often written as $[0,1]$. 1 is completely true; 0 is completely false; 0.5 is half true; etc.

11.4.1a What are the semantic functions that correspond to the connectives \wedge , \vee , \neg and \rightarrow ? There are various ways to answer this question, based on the general notion of something called a *t*-norm. Details can be found in the technical appendix to this chapter, 11.7a. For the rest of this chapter, we will concentrate on the oldest and, perhaps, most interesting answer for philosophical purposes.

11.4.2 According to this:

$$f_{\neg}(x) = 1 - x$$

$$f_{\wedge}(x, y) = \text{Min}(x, y)$$

$$f_{\vee}(x, y) = \text{Max}(x, y)$$

$$f_{\rightarrow}(x, y) = x \odot y$$

where *Min* means ‘the minimum (lesser) of’; *Max* means ‘the maximum (greater) of’; and $x \odot y$ is a function defined as follows:

$$\text{if } x \leq y, \text{ then } x \odot y = 1$$

$$\text{if } x > y, \text{ then } x \odot y = 1 - (x - y) \quad (= 1 - x + y)$$

¹ There are, in fact, sorites progressions where each step is clearly discrete: for example, the addition of a single grain of sand. So, in principle, one could use a finitely-many valued logic for these. But the continuum-valued semantics is more general, and can be applied to all sorites paradoxes, giving, what is clearly desirable, a uniform account.

Note that we could say ' $x \geq y$ ' instead of ' $x > y$ ' in the second clause, since if $x = y$, $1 - (x - y) = 1$. Note, also, that we could define $x \ominus y$ equivalently as $\text{Min}(1, 1 - x + y)$.

11.4.3 The truth functions for negation, conjunction and disjunction are fairly natural. As the truth value of 'Mary is a child' goes down, the truth value of 'Mary is not a child' would seem to go up coordinately. A conjunction would seem to be just as good as its least true conjunct; and a disjunction would seem to be just as good as its most true. The truth function for \rightarrow is anything but obvious. Here is its rationale. Consider $A \rightarrow B$. If A is less true (or, better, no more true) than B , then the truth value of $A \rightarrow B$ is 1. That's how it works, after all, with the standard 2-valued material conditional. If A is more true than B , then there is something faulty about the conditional: its truth value must be less than 1. How much less? The amount that the truth value falls in going from A to B . In particular, if it falls all the way from 1 to 0, then the value of $A \rightarrow B$ is 0. All this is exactly what \ominus means.²

11.4.4 Note that:

$$\text{if } x \leq y, \text{ then } y \ominus z \leq x \ominus z$$

$$\text{if } x \leq y, \text{ then } z \ominus x \leq z \ominus y$$

For the first of these, suppose that $x \leq y$ (and so, that $-y \leq -x$): if $x \leq z$, then $x \ominus z = 1$, so the result follows. If $z < x \leq y$, then $y \ominus z = 1 - y + z \leq 1 - x + z = x \ominus z$. The second conditional is left as an exercise.

11.4.5 Notice that if we restrict ourselves to just the values 1 and 0, then the truth functions of 11.4.2 are exactly the same as those of classical truth tables. It is less obvious, but is easy to check, that if we restrict ourselves to just the values 1, 0.5 and 0, then the truth functions are exactly the same as those of L_3 (7.3.2 and 7.3.8), thinking of \rightarrow as \supset , and 0.5 as i . In this sense, the logic is a generalisation of both classical propositional logic, and Łukasiewicz' 3-valued logic.

² Fuzzy logic should not be confused with probability theory. Though fuzzy truth values and probability values are both real numbers in $[0, 1]$, fuzzy truth values are truth functional – that is, the value of a compound is determined by the values of its components – whilst probabilities are not. Given a die, let A be 'you roll 1, 2, or 3', and B be 'you roll 4, 5, or 6'. Then if $P(A)$ is the probability of A , $P(A \wedge A) = P(A) = 0.5$, but $P(A \wedge B) = 0$, even though $P(A) = P(B)$.

11.4.6 What of the designated values of the logic? In general, things do not have to be completely true to be acceptable. If I ask for a red apple, and you give me one with a very small patch of green (so that ‘this is red’ is, say, 0.95 true), that’s probably good enough. *How* true something has to be to be acceptable will depend on the context. If you buy a new car, you expect it not to have been driven at all. (So ‘this is a new car’ needs to have truth value 1.) But you would still describe it as a new car to a friend, even if you had bought it and driven it around for a few weeks. (So in this context, ‘this is a new car’ need have truth value only 0.95, say.) But at any rate, if A is acceptable as true, and B is truer than A , then B is acceptable as true as well. What all this means is that any context will determine a number, ε , somewhere between 0 and 1, such that the things that are acceptable are exactly those things with truth value x , where $x \geq \varepsilon$.

11.4.7 Correspondingly, for every such ε , taking the set of designated values, \mathcal{D}_ε , to be $\{x: x \geq \varepsilon\}$, will define a notion of validity. Thus $\Sigma \models_\varepsilon A$ iff for all interpretations, ν , if $\nu(B) \geq \varepsilon$ for all $B \in \Sigma$, then $\nu(A) \geq \varepsilon$.

11.4.8 Each logic defined in this way is a perfectly good many-valued logic. But in logic, it makes sense to abstract from context and consider a notion of validity that is context-independent. Hence, it is natural to define the central notion of logical consequence as follows:

$$\Sigma \models A \text{ iff for all } \varepsilon, \text{ where } 0 \leq \varepsilon \leq 1, \Sigma \models_\varepsilon A$$

We will call this logic L .

11.4.9 A set of truth values, X , may have no least member. (Consider, for example, $\{0.41, 0.401, 0.4001, 0.40001, \dots\}$.) But there will always be a greatest number that is less than or equal to every number in the set. (In this case, the number is 0.4.) This is called the *greatest lower bound* of X ($Glb(X)$). If the set is finite, then the Glb of the set is, of course, its least member. Notice that, by definition, if $x \in X$, $x \geq Glb(X)$; and if for all $x \in X$, $x \geq y$, then $Glb(X) \geq y$.

11.4.10 \models has, in fact, a very simple characterisation. If Σ is a set of formulas, let $\nu[\Sigma]$ be $\{\nu(B): B \in \Sigma\}$. Then:

$$\Sigma \models A \text{ iff for all } \nu, Glb(\nu[\Sigma]) \leq \nu(A)$$

Proof: Suppose that $\Sigma \not\models A$. Then there is some ε , such that $\Sigma \not\models_{\varepsilon} A$. That is, for some ν , and for all $B \in \Sigma$, $\nu(B) \geq \varepsilon$, and $\nu(A) < \varepsilon$. But if every member of $\nu[\Sigma]$ is $\geq \varepsilon$, $\text{Glb}(\nu[\Sigma]) \geq \varepsilon$. Hence, for this ν , it is not the case that $\text{Glb}(\nu[\Sigma]) \leq \nu(A)$. Conversely, suppose that for some ν , $\text{Glb}(\nu[\Sigma]) > \nu(A)$. Let $\varepsilon = \text{Glb}(\nu[\Sigma])$. Then for all $B \in \Sigma$, $\nu(B) \geq \varepsilon$, but $\nu(A) < \varepsilon$. That is, $\Sigma \not\models_{\varepsilon} A$. Hence, $\Sigma \not\models A$.

11.4.11 For a finite set, the *Glb* is its minimum. So if $\Sigma = \{B_1, \dots, B_n\}$, then $\Sigma \models A$ iff for all ν , $\text{Min}(\nu(B_1), \dots, \nu(B_n)) \leq \nu(A)$ iff $\nu(B_1 \wedge \dots \wedge B_n) \leq \nu(A)$.³ A little thought concerning \odot suffices to show that $\nu(C) \leq \nu(A)$ iff $\nu(C \rightarrow A) = 1$. Hence:

$$\{B_1, \dots, B_n\} \models A \text{ iff for all } \nu, \nu((B_1 \wedge \dots \wedge B_n) \rightarrow A) = 1$$

Thus (for a finite number of premises), validity amounts to the logical truth of the appropriate conditional when the set of designated values is just $\{1\}$, that is, the logical truth of the conditional in \models_1 . The logic with just 1 as a designated value is usually written as \mathcal{L}_{\aleph} , and called Łukasiewicz' continuum-valued logic. Hence, to investigate \mathcal{L} further, we may investigate \mathcal{L}_{\aleph} .⁴

11.5 Axioms for \mathcal{L}_{\aleph}

11.5.1 There is presently no tableau system of the kind used in this book for \mathcal{L}_{\aleph} .⁵ Hence, we will use a suitable axiomatic notion of proof. The best known axiom system has the sole rule of inference *modus ponens*, and the following axioms:

$$\begin{aligned} (A \rightarrow B) \rightarrow ((B \rightarrow C) \rightarrow (A \rightarrow C)) \\ A \rightarrow (B \rightarrow A) \\ (A \rightarrow \neg B) \rightarrow (B \rightarrow \neg A) \\ ((A \rightarrow B) \rightarrow B) \rightarrow ((B \rightarrow A) \rightarrow A) \\ ((A \rightarrow B) \rightarrow B) \leftrightarrow (A \vee B) \\ (A \wedge B) \leftrightarrow \neg(\neg A \vee \neg B) \end{aligned}$$

³ Strictly speaking, the conjuncts should be bracketed in some way, since conjunction is a binary connective. But, however one inserts brackets, the value of the iterated conjunction is the same: the minimum of the values of the conjuncts. It therefore does no harm to omit the brackets.

⁴ \aleph is the Hebrew letter *aleph*, and, following Cantor, is used by logicians to denote a size of infinity.

⁵ Tableaux of a slightly different kind can be found in Hänle (1999) and Olivetti (2003).

(Often only the first four axioms are given, and $A \vee B$ and $A \wedge B$ are *defined* as $(A \rightarrow B) \rightarrow B$ and $\neg(\neg A \vee \neg B)$, respectively.) The axiom system is hardly perspicuous. This is reflected in the fact that the proofs of completeness for it are mathematically hard.⁶

11.5.2 Something that is a little more perspicuous can be obtained with the help of the logic CK of 10.4a.12. Here, as a reminder, is an axiom system for it (with the numbers used in chapter 10). A10 is redundant, as we observed in 10.4a.14.

- (A1) $A \rightarrow A$
- (A2) $A \rightarrow (A \vee B)$ (and $B \rightarrow (A \vee B)$)
- (A3) $(A \wedge B) \rightarrow A$ (and $(A \wedge B) \rightarrow B$)
- (A4) $A \wedge (B \vee C) \rightarrow ((A \wedge B) \vee (A \wedge C))$
- (A5) $((A \rightarrow B) \wedge (A \rightarrow C)) \rightarrow (A \rightarrow (B \wedge C))$
- (A6) $((A \rightarrow C) \wedge (B \rightarrow C)) \rightarrow ((A \vee B) \rightarrow C)$
- (A7) $\neg\neg A \rightarrow A$
- (A8) $(A \rightarrow \neg B) \rightarrow (B \rightarrow \neg A)$
- (A9) $(A \rightarrow B) \rightarrow ((B \rightarrow C) \rightarrow (A \rightarrow C))$
- (A12) $A \rightarrow ((A \rightarrow B) \rightarrow B)$
- (A15) $A \rightarrow (B \rightarrow A)$
- (R1) $A, A \rightarrow B \vdash B$
- (R2) $A, B \vdash A \wedge B$

11.5.3 CK is a sub-logic of L_{\aleph} . We can show this by showing that in every interpretation, each axiom takes the value 1, and that the rules preserve this property. It then follows that everything provable (that is, deducible from the empty set of assumptions) takes the value 1. The proofs of some of these facts are elementary. For example, since $v(A) \leq v(A \vee B)$, $v(A \rightarrow (A \vee B)) = 1$, giving A2. And if $v(A \rightarrow B) = 1$, $v(A) \leq v(B)$; so if $v(A) = 1$, as well, $v(B) = 1$, giving R1. Others require more detailed argument. In the next three sections we show three of these, A5, A9 and A15. The others are left as exercises. One piece of notation will be convenient: we write $v(A)$ as a , $v(B)$ as b , etc.

11.5.4 For A5: suppose that $b \leq c$. (The other possibility, that $b \geq c$, is similar.) Then, $a \odot b \leq a \odot c$, by 11.4.4. Moreover, $\text{Min}(b, c) = b$, so

⁶ The axiom system is sound and complete with respect to logical truths - i.e., with respect to the empty set of premises. (And also with respect to finite sets of premises. See 11.7a.17.) There is no axiom system that is sound and complete with respect to arbitrary sets of premises. See 11.10, question 9.

$a \odot \text{Min}(b, c) = a \odot b = \text{Min}(a \odot b, a \odot c)$; that is, $v((A \rightarrow B) \wedge (A \rightarrow C)) = v(A \rightarrow (B \wedge C))$. So A5 takes the value 1.

11.5.5 For A9: suppose that $a \leq b$. Then, by 11.4.4, $b \odot c \leq a \odot c$, so $(B \rightarrow C) \rightarrow (A \rightarrow C)$ takes the value 1, as, then, does the whole formula. So suppose that $a > b$. If $c \geq a$, then $A \rightarrow C$ takes the value 1, as, then, does the whole formula. So suppose that $c < a$. There are now two cases: $a > c \geq b$ and $a > b \geq c$. The value of the consequent is $(b \odot c) \odot (a \odot c)$. In the first case, this is $1 - 1 + a \odot c = 1 - a + c \geq 1 - a + b$, which is the value of the antecedent. In the second case, $(b \odot c) \odot (a \odot c) = 1 - (1 - b + c) + (1 - a + c) = 1 - a + b$, which is the value of the antecedent. Hence, in both cases, the result follows.

11.5.6 For A15, we argue by *reductio*. Suppose, for some v , that $A \rightarrow (B \rightarrow A)$ does not take the value 1. Then $a > b \odot a$. It must therefore be the case that $b > a$. But then $a > 1 - b + a$. That is, $b > 1$, which is impossible.

11.5.7 Notice that the other axiom of R, A11 - $(A \rightarrow (A \rightarrow B)) \rightarrow (A \rightarrow B)$ - is not valid in these semantics. (Hence, $\mathcal{L}_{\mathbb{N}}$ is not a sub-logic of R.) To see this, let $v(A) = 0.9$ and $v(B) = 0.6$. Then $v(A \rightarrow B) = v(A) \odot v(B) = 0.7$. But $v(A \rightarrow (A \rightarrow B)) = 0.9 \odot 0.7 = 0.8$. Hence, $v(A \rightarrow (A \rightarrow B)) > v(A \rightarrow B)$. For similar reasons, $\not\models (A \wedge (A \rightarrow B)) \rightarrow B$. Given the same v , this formula evaluates to 0.9.

11.5.8 CK is nearly $\mathcal{L}_{\mathbb{N}}$, but not quite. To obtain $\mathcal{L}_{\mathbb{N}}$, we have to add one further axiom - the rather odd-looking:

$$(A17) \quad ((A \rightarrow B) \rightarrow B) \rightarrow (A \vee B)$$

This axiom is also valid in $\mathcal{L}_{\mathbb{N}}$. For if $a \leq b$, $(a \odot b) \odot b = 1 - 1 + b = b \leq \text{Max}(a, b)$; and if $a > b$, $a \odot b = 1 - a + b$. This is greater than b . Hence, $(a \odot b) \odot b = 1 - (1 - a + b) + b = a \leq \text{Max}(a, b)$.

11.5.9 Hence, this axiom system is sound. To show that it is complete, it suffices to show that it can prove all the axioms of 11.5.1. Since these are complete, we know that every logical truth can be proved from them (using R1). The first three axioms and the last are easy. If we can prove the fifth, the fourth follows from $(A \vee B) \rightarrow (B \vee A)$, which is easily proved. This leaves the fifth. From left to right, this is obvious. From right to left, this is left as an exercise.

11.6 Conditionals in \mathcal{L}

11.6.1 The most distinctive feature of the conditional in \mathcal{L} is the failure of *modus ponens*. It is true that $A, A \rightarrow B \models_1 B$. What this means is that whenever the premises take value 1, so does the conclusion. But recall (11.4.11) that $A, A \rightarrow B \models B$ iff $\models_1 (A \wedge (A \rightarrow B)) \rightarrow B$. And this, as we saw (11.5.7), fails.

11.6.2 Given that a sorites argument is simply a sequence of *modus ponens* inferences, the failure of *modus ponens* is hardly surprising. Suppose, for example, that the truth values of a sorites sequence, M_0, M_1, \dots, M_9 , are as follows:

M_0	M_1	M_2	M_3	M_4	M_5	M_6	M_7	M_8	M_9
1	1	1	0.8	0.6	0.4	0.2	0	0	0

Then the value of every conditional $M_i \rightarrow M_{i+1}$ is greater than or equal to 0.8. Hence, it is possible to make every conditional acceptable by setting the level of acceptability as 0.8. Since all the premises of the sorites are then acceptable, and the conclusion is not, *modus ponens* must fail.

11.6.3 The failure of *modus ponens* may still be thought counterintuitive. It should be remembered, however, that the inference is truth-preserving as long as all the formulas involved are completely true or false. It fails only when we trespass into the fuzzy.⁷

11.6.4 Turning to other properties of the conditional in \mathcal{L} , it is easy to see that $\not\models_1 (A \wedge \neg A) \rightarrow B$, i.e., $A \wedge \neg A \not\models B$ (set $v(A) = 0.5$, and $v(B) = 0$). Hence, \models is paraconsistent. For similar reasons, $\not\models A \rightarrow (B \vee \neg B)$.

11.6.5 However, \mathcal{L} is not a relevant logic. It has virtually all of the problematic features of the material conditional. In particular, all of the following hold:

$$\begin{aligned}
 &A \models B \rightarrow A \\
 &\neg A \models A \rightarrow B \\
 &(A \wedge B) \rightarrow C \models (A \rightarrow C) \vee (B \rightarrow C) \\
 &(A \rightarrow B) \wedge (C \rightarrow D) \models (A \rightarrow D) \vee (C \rightarrow B) \\
 &\neg(A \rightarrow B) \models A
 \end{aligned}$$

⁷ One also has *modus ponens* in the form $\models (A \circ (A \rightarrow B)) \rightarrow B$, where \circ is the ‘strong conjunction’ of 11.7a.

Most of these are easy to check. We will do the hardest, the fourth of these, with the others being left as an exercise. If $a \leq d$ or $c \leq b$, then the conclusion takes the value 1. So suppose that $a > d$ and $c > b$. If $a \leq b$, then we have $c > b \geq a > d$, and the first conjunct of the premise takes the value 1. Hence, if the inference fails, the value of the second conjunct must be greater than those of both disjuncts of the conclusion. In particular, because of the first disjunct, we must have $1 - c + d = c \odot d > a \odot d = 1 - a + d$, i.e., $a > c$, which it is not. If $c \leq d$, the argument is similar. The only other combination is $a > b$ and $c > d$. In this case, both conjuncts of the premise must have values greater than both disjuncts of the conclusion. In particular, because of the first conjunct, we must have $1 - a + b = a \odot b > a \odot d = 1 - a + d$ and $1 - a + b = a \odot b > c \odot b = 1 - c + b$, i.e., $b > d$ and $c > a$. Hence, we have $c > a > b > d$. But, by the second conjunct of the premise, we must also have $1 - c + d = c \odot d > a \odot d = 1 - a + d$ and $1 - c + d = c \odot d > c \odot b = 1 - c + b$, i.e., $a > c$ and $d > b$, both of which are impossible.

11.7 Fuzzy Relevant Logic

11.7.1 Although \mathcal{L} is not a relevant logic, we can construct a fuzzy relevant logic by combining the techniques of relevant logic and of \mathcal{L} . I will explain how to ‘fuzzify’ the relevant logic B . It should be clear that exactly the same technique will work for other relevant logics.

11.7.2 A fuzzy- B interpretation is a structure $(W, N, R, *, \nu)$, where W, R, N and $*$ are as in B (10.2.4) – and we assume that R has been defined at normal worlds (10.2.8). For every $w \in W$, and every propositional parameter, p , $\nu_w(p) \in [0, 1]$. Truth conditions for the connectives are:⁸

$$\begin{aligned} \nu_w(\neg A) &= 1 - \nu_w^*(A) \\ \nu_w(A \wedge B) &= \text{Min}(\nu_w(A), \nu_w(B)) \\ \nu_w(A \vee B) &= \text{Max}(\nu_w(A), \nu_w(B)) \\ \nu_w(A \rightarrow B) &= \text{Glb}\{\nu_x(A) \odot \nu_y(B) : Rwx\} \end{aligned}$$

Given the truth conditions of B and \mathcal{L} , the truth conditions for negation, conjunction and disjunction speak for themselves. In the truth conditions for \rightarrow , the universal quantification over worlds, of B , has been replaced by a corresponding greatest lower bound. Notice that if all formulas have truth

⁸ Where X is given by a set abstract, I omit the brackets in $\text{Glb}(X)$ to reduce clutter.

value 1 or 0, all these conditions just reduce to those for B . The least obvious is the case for \rightarrow . For this, note that when things are 2-valued, the value of a universally quantified sentence is, in effect, the minimum of those of its instances.

11.7.3 The definition of validity is also a natural generalisation of that for \mathcal{L} (11.4.10). Specifically:

$$\Sigma \models A \text{ iff for every normal world, } w, \text{ of every interpretation,} \\ \text{Glb}(\nu_w[\Sigma]) \leq \nu_w(A)$$

Notice, again, that if every truth value is either 1 or 0, this condition collapses into the definition of validity for B .

11.7.4 Call this logic FB (Fuzzy B). Since every B -interpretation is an FB -interpretation – namely, one where every formula takes either the value 1 or the value 0 at every world – FB is a sub-logic of B . That is, if $\Sigma \models_{FB} A$, then $\Sigma \models_B A$. In particular, then, if $\models_{FB} A$, then $\models_B A$; so FB is a relevant logic.

11.7.5 The relationship in the opposite direction is more complex. One may check that all the axioms of B (10.3.6) are logically true in FB , and all the rules of B preserve this property. It follows that if $\models_B A$ then $\models_{FB} A$. The next two sections verify some of the details; the others are left as an exercise. We write $\nu_w(A)$ as a_w , $\nu_w(A \vee B)$ as $(a \vee b)_w$, $\nu_w(A \rightarrow B)$ as $(a \rightarrow b)_w$, etc.

11.7.6 For $A2$: at any world of an interpretation, x , $a_x \leq (a \vee b)_x$; so $a_x \odot (a \vee b)_x = 1$. So for every normal world, w , $\text{Glb}\{a_x \odot (a \vee b)_x: Rwx\} = 1$. For $A5$: suppose that in an interpretation, $Rxyz$. Suppose that $b_y \leq c_z$. Then, $a_y \odot b_z \leq a_y \odot c_z$, by 11.4.4. Moreover, $(b \wedge c)_z = b_z$, so $a_y \odot (b \wedge c)_z = a_y \odot b_z = \text{Min}(a_y \odot b_z, a_y \odot c_z)$. If, on the other hand, $c_z \leq b_z$, the same result follows by a similar argument. Hence:⁹

$$\begin{aligned} ((a \rightarrow b) \wedge (a \rightarrow c))_x &= \text{Min}((a \rightarrow b)_x, (a \rightarrow c)_x) \\ &= \text{Min}(\text{Glb}\{a_y \odot b_z: Rxyz\}, \text{Glb}\{a_y \odot c_z: Rxyz\}) \\ &\leq \text{Glb}\{\text{Min}(a_y \odot b_z, a_y \odot c_z): Rxyz\} \\ &= \text{Glb}\{a_y \odot (b \wedge c)_z: Rxyz\} \\ &= (a \rightarrow (b \wedge c))_x \end{aligned}$$

⁹ For the third step, note that $\text{Min}(\text{Glb}\{x_i: i \in I\}, \text{Glb}\{y_i: i \in I\}) \leq \text{Glb}\{\text{Min}(x_i, y_i): i \in I\}$. *Proof:* Suppose that $m = \text{Glb}\{x_i: i \in I\} \leq \text{Glb}\{y_i: i \in I\}$. (The argument in the other case is similar.) Then, for all $i \in I$, $m \leq x_i, y_i$. Hence, for all $i \in I$, $m \leq \text{Min}(x_i, y_i)$. So $m \leq \text{Glb}\{\text{Min}(x_i, y_i): i \in I\}$.

Hence, for normal w , $\text{Glb}\{((a \rightarrow b) \wedge (a \rightarrow c))_x \odot (a \rightarrow (b \wedge c))_x; Rwx\} = 1$, as required.

11.7.7 For R1: suppose that w is normal, and that a_w and $(a \rightarrow b)_w$ are both 1. Then, for all x such that Rwx , $a_x \leq b_x$. Since $Rwww$, the result follows. For R4: suppose that w is normal, and $(a \rightarrow b)_w = 1$. Then, for all y , $a_y \leq b_y$. It follows that $b_y \odot c_z \leq a_y \odot c_z$ by 11.4.4. Hence, $\text{Glb}\{b_y \odot c_z : Rxyz\} \leq \text{Glb}\{a_y \odot c_z; Rxyz\}$. That is, $(b \rightarrow c)_x \leq (a \rightarrow c)_x$. Hence, $\text{Glb}\{(b \rightarrow c)_x \odot (a \rightarrow c)_x; Rwx\} = 1$, as required.

11.7.8 Although all logical truths of B are logical truths of FB , it is not the case that $\Sigma \models_B A$ entails $\Sigma \models_{FB} A$ for arbitrary Σ . *Modus ponens*, for example, fails, as is to be expected given the fuzzification. Thus, consider the interpretation where $W = N = \{w\}$, $Rwww$, $w^* = w$, $\nu_w(p) = 0.9$, $\nu_w(q) = 0.6$. Then $\nu_w(p \rightarrow q) = 0.7$, so $p, p \rightarrow q \not\models q$.

11.7.9 A suitable proof theory (axiom system or tableau system) for the consequence relation of FB is, at the time of writing, an open question.

11.7.10 Finally, consider the inferences that we met in 5.2, in connection with the *ceteris paribus* clause:

$$\begin{aligned} p \rightarrow r &\models (p \wedge q) \rightarrow r \\ p \rightarrow q, q \rightarrow r &\models p \rightarrow r \\ p \rightarrow q &\models \neg q \rightarrow \neg p \end{aligned}$$

The second of these fails. (Just consider a model with one normal world, w , where $\nu_w(p) = 1$, $\nu_w(q) = 0.9$ and $\nu_w(r) = 0.8$.) The first and third hold, however. For the first: take any interpretation, and any world, x , of that interpretation. $(p \wedge q)_x \leq p_x$; hence, by 11.4.4, $p_x \odot r_x \leq (p \wedge q)_x \odot r_x$; hence, at all normal worlds, w , $\nu_w((p \wedge q) \rightarrow r) \geq \nu_w(p \rightarrow r)$. The third is left as an exercise.

11.7.11 One may construct a theory of enthymematic fuzzy relevant conditionals by adding a selection function to the semantics, and giving the appropriate truth conditionals, in exactly the same way that this was done for the non-fuzzy relevant conditional in 10.7. The details are complex, but involve no novelties, and are left to the reader.

11.7a *Appendix: t-norm Logics

11.7a.1 The logic $L_{\mathbb{N}}$ is one of a class of logics with degrees of truth in the interval $[0, 1]$. In this appendix, I describe some features of the general family. I omit proofs; some of these are assigned as exercises (11.7, question 10).¹⁰

11.7a.2 The fundamental notion concerned is that of a *t-norm* (triangular norm). A *t-norm* is a commutative, associative, order-preserving, binary operation, \bullet , on real numbers in $[0, 1]$. That is:¹¹

$$\begin{aligned}x \bullet y &= y \bullet x \\(x \bullet y) \bullet z &= x \bullet (y \bullet z) \\ \text{if } x \leq y &\text{ then } x \bullet z \leq y \bullet z\end{aligned}$$

1 and 0 also have their standard multiplicative properties with respect to \bullet :

$$\begin{aligned}1 \bullet x &= x \\ 0 \bullet x &= 0\end{aligned}$$

11.7a.3 In semantic terms, a *t-norm* is the interpretation for a certain kind of conjunction, \circ , the symbol for which we add to the language. (So \circ is not \wedge .) That is, $f_{\circ}(x, y) = x \bullet y$. It is also useful to take the language to contain a logical constant, $\mathbf{0}$, which denotes 0.

11.7a.4 Provided that \bullet is a continuous function we can define f_{\rightarrow} in terms of \bullet . Thus, we define:

$$f_{\rightarrow}(x, y) = \text{Lub}\{z : x \bullet z \leq y\}$$

Continuity ensures that $\{z : x \bullet z \leq y\}$ has a greatest member, so that this is its *Lub*. The definition guarantees the following:

1. $f_{\circ}(x, y) \leq z$ iff $y \leq f_{\rightarrow}(x, z)$
2. $f_{\rightarrow}(x, y) = 1$ iff $x \leq y$

So, since $f_{\rightarrow}(x, z) \leq f_{\rightarrow}(x, z)$, it follows (by 1) that $f_{\circ}(x, f_{\rightarrow}(x, z)) \leq z$, and then (by 2) that $f_{\rightarrow}(f_{\circ}(x, f_{\rightarrow}(x, z)), z) = 1$.

¹⁰ All proofs can be found in the references cited in 11.9, especially Hájek (2000).

¹¹ Note that the first and third of these deliver the preservation of order to the left as well:

$$\text{if } x \leq y \text{ then } z \bullet x \leq z \bullet y$$

11.7a.5 f_{\rightarrow} , f_{\vee} , and f_{\wedge} can also be defined:

$$\begin{aligned} f_{\rightarrow}(x) &= f_{\rightarrow}(x, 0) \\ f_{\wedge}(x, y) &= f_{\circ}(x, f_{\rightarrow}(x, y)) \\ f_{\vee}(x, y) &= f_{\wedge}(f_{\rightarrow}(f_{\rightarrow}(x, y), y), f_{\rightarrow}(f_{\rightarrow}(y, x), x)) \end{aligned}$$

It can be shown that $f_{\wedge}(x, y) = \text{Min}(x, y)$, and $f_{\vee}(x, y) = \text{Max}(x, y)$.

11.7a.6 Taking the set of designated values to be $\{1\}$, any continuous t -norm, \bullet , then defines a continuum-valued logic, $L(\bullet)$.

11.7a.7 The logic defined by the following axiom system is called *BL* (Basic Logic). Any theorem of this is logically true in all $L(\bullet)$.

Axioms:

1. $(A \rightarrow B) \rightarrow ((B \rightarrow C) \rightarrow (A \rightarrow C))$
2. $(A \circ B) \rightarrow A$
3. $(A \circ B) \rightarrow (B \circ A)$
4. $(A \circ (A \rightarrow B)) \rightarrow (B \circ (B \rightarrow A))$
5. $(A \rightarrow (B \rightarrow C)) \rightarrow ((A \circ B) \rightarrow C)$
6. $((A \circ B) \rightarrow C) \rightarrow (A \rightarrow (B \rightarrow C))$
7. $((A \rightarrow B) \rightarrow C) \rightarrow (((B \rightarrow A) \rightarrow C) \rightarrow C)$
8. $\underline{0} \rightarrow A$

The only rule of inference is *modus ponens*; and \neg , \wedge , and \vee are defined as one would expect in virtue of 11.7a.5:

$$\begin{aligned} \neg A &\text{ is } A \rightarrow \underline{0} \\ A \wedge B &\text{ is } A \circ (A \rightarrow B) \\ A \vee B &\text{ is } ((A \rightarrow B) \rightarrow B) \wedge ((B \rightarrow A) \rightarrow A) \end{aligned}$$

11.7a.8 In fact, the theorems of *BL* are exactly the things that are logically true in all $L(\bullet)$ s.

11.7a.9 There are three special cases of t -norms that are worth noting. In the first of these, $x \bullet y = \text{Max}(0, x + y - 1)$. This is called the Łukasiewicz t -norm. It is not difficult to check that:

$$\begin{aligned} f_{\rightarrow}(x, y) &= 1 && \text{if } x \leq y \\ &= 1 - x + y && \text{if } x > y \end{aligned}$$

and $f_{\rightarrow}(x) = 1 - x$. This logic is therefore L_{\aleph} (with the additional syntactic connective, \circ).

11.7a.10 If we add to *BL* the axiom:

$$\neg\neg A \rightarrow A$$

we obtain an axiom system that is theoremwise sound and complete with respect to the Łukasiewicz *t*-norm.

11.7a.11 The second *t*-norm is the Product *t*-norm, so called because $x \bullet y = x \times y$. (The norm is sometimes also called the Goguen *t*-norm.) For this norm:

$$\begin{aligned} f_{\rightarrow}(x, y) &= 1 && \text{if } x \leq y \\ &= y/x && \text{if } x > y \end{aligned}$$

and:

$$\begin{aligned} f_{\neg}(x) &= 1 && \text{if } x = 0 \\ &= 0 && \text{if } x > 0 \end{aligned}$$

11.7a.12 If we add to *BL* the axioms:

$$\begin{aligned} \neg\neg C &\rightarrow (((A \circ C) \rightarrow (B \circ C)) \rightarrow (A \rightarrow B)) \\ (A \wedge \neg A) &\rightarrow \underline{0} \end{aligned}$$

we obtain an axiom system that is theoremwise sound and complete with respect to the product *t*-norm.

11.7a.13 The third *t*-norm is called the Gödel *t*-norm. For this, $x \bullet y = \text{Min}(x, y)$, and we have:

$$\begin{aligned} f_{\rightarrow}(x, y) &= 1 && \text{if } x \leq y \\ &= y && \text{if } x > y \end{aligned}$$

and:

$$\begin{aligned} f_{\neg}(x) &= 1 && \text{if } x = 0 \\ &= 0 && \text{if } x > 0 \end{aligned}$$

In this logic, \circ collapses into \wedge .

11.7a.14 If we add to *BL* the axiom:

$$A \rightarrow (A \circ A)$$

we obtain an axiom system that is sound and complete (for arbitrary sets of premises) with respect to the Gödel t -norm.

11.7a.15 In fact, this logic turns out to give the same valid inferences as the intermediate logic LC of 6.3.10. It can also be axiomatised by adding the ‘linearity axiom’, $(A \rightarrow B) \vee (B \rightarrow A)$, to an axiom system for intuitionist logic. It is sometimes called ‘fuzzy intuitionist logic’.

11.7a.16 All continuous t -norms can be constructed out of these three special cases, in the following sense. If \bullet is any continuous t -norm then the unit square $[0, 1]^2$ is decomposable into a countable number of disjoint sets, $\{X_i: i \text{ is a natural number}\}$, such that, for each X_i , \bullet restricted to X_i is either the Łukasiewicz, Product, or Gödel norm.

11.7a.17 The logics for the Łukasiewicz and Product norms are, in fact, sound and complete with respect to finite sets of premises.

11.7a.18 As we noted in 11.7a.14, the axiom system for the Gödel norm is sound and complete with respect to arbitrary sets of premises. But compactness fails for the other two logics, and so they have no axiom system that is sound and complete in this way. (See 11.10, questions 8, 9.)

11.7a.19 The logic BL has an algebraic semantics in terms of structures closely related to t -norms, called BL -algebras. Special cases of these, MV -algebras, Π -algebras, and G -algebras, provide algebraic semantics for (respectively) the logics of the Łukasiewicz, Product and Gödel norms. Each logic is, moreover, sound and complete with respect to the corresponding algebraic semantics, for arbitrary sets of premises. (It follows that compactness holds for these semantics.)

11.8 History

The sorites paradox goes back to the Megarian logician Eubulides. After that, the problem of vagueness was largely neglected historically. It has become something of a growth area in the last thirty years, however. Epistemicism has been defended, most notably by Williamson (1994). A supervaluational account has been defended by many, including Fine (1975). The possibility

of a 3-valued account, where the middle value is *both true and false* is defended in Hyde (1997). A fuzzy account of vagueness has been defended by many, including Machina (1976).

Continuum-valued logics were first proposed by Łukasiewicz and Tarski in 1930, though not with the application of vagueness in mind. The truth conditions of 11.4.2 are also due to them. The axiom system of 11.5.1 was proved complete by Wajsberg, though the proof was lost and never published, owing to the Second World War. The first published completeness proof was given by Rose and Rosser (1958). This was a combinatorial number-theoretic proof. The second was given by Chang (1959). This was an algebraic proof. There is a readable summary of the whole situation in Rosser (1960). Fuzzy relevant logic is developed in Priest (2002b).

The phrase ‘*t*-norm’ was coined by Menger (1942) in the context of the theory of statistical metrics. A version of the triangular inequality held in his structures – hence the ‘triangular’. What is now called a *t*-norm is a variation of this, and was first defined by Schweizer and Sklar (1960), though not in the context of fuzzy logic. The application of a *t*-norm to fuzzy logic appears in Pavelka (1970) and Dubois (1980). The definition of the product norm appeared in Goguen (1968–69). Gödel (1933b) has an infinite hierarchy of finite-valued logics. The logic with the Gödel *t*-norm is the infinitary generalisation of these. For the equivalence of this with *LC*, see Beckmann and Preining (2007). The logic *BL* is due to Hájek (1998).

11.9 Further Reading

Good short introductions to the problem of vagueness are chapter 7 of Read (1994) and chapter 2 of Sainsbury (1995). Williamson (1994) is a more extended account, and Keefe and Smith (1996) is an excellent collection of readings in the area. A brief technical discussion of continuum-valued logic can be found in Rescher (1969); a longer one is given in Urquhart (1972). A survey of results concerning continuum-valued logic with different sets of designated values can be found in Chang (1963). An account of continuum-valued logic and its connection with fuzzy-set theory, with an eye on the application of both, is given in Klir and Yuan (1995).

For an account of the variety of fuzzy logics, and of the general theory of t -norms, see Hájek (1998), Novák, Perfilieva, and Močkoř (2000), and Gottwald (2001). For the proof of the result of 11.7a.8, see Cignoli *et al.* (2000). Hájek and Novák (2003) contains a discussion of the sorites paradox in t -norm logics.

11.10 Problems

1. Construct a sorites argument for each of the predicates mentioned in 11.2.3.
2. Check the details omitted in 11.4.4, 11.4.5, 11.5.3, 11.5.9, 11.6.5, 11.7.5 and 11.7.10.
3. Show the following in $\mathcal{L}_{\mathbb{N}}$ (either by giving a deduction or by showing that whenever the premises have the value 1, so does the conclusion):
 - (a) $\models (A \rightarrow B) \vee (B \rightarrow A)$
 - (b) $\models (A \rightarrow (B \rightarrow C)) \rightarrow (B \rightarrow (A \rightarrow C))$
 - (c) $A \rightarrow B \models (A \wedge C) \rightarrow B$
 - (d) $A \rightarrow B \models \neg B \rightarrow \neg A$
4. By constructing appropriate counter-models, show the following in $\mathcal{L}_{\mathbb{N}}$:
 - (a) $\not\models p \vee \neg p$
 - (b) $\not\models (p \wedge (\neg p \vee q)) \rightarrow q$
 - (c) $\not\models ((p \rightarrow q) \rightarrow q) \rightarrow q$
 - (d) $\not\models ((p \rightarrow q) \wedge (q \rightarrow r)) \rightarrow (p \rightarrow r)$
 - (e) $\not\models (p \rightarrow \neg p) \rightarrow \neg p$
5. Show the following in FB:
 - (a) $A \rightarrow B, A \rightarrow C \models A \rightarrow (B \wedge C)$
 - (b) $A \rightarrow C, B \rightarrow C \models (A \vee B) \rightarrow C$
 - (c) $p \rightarrow q, q \rightarrow r \not\models p \rightarrow r$
6. Give the semantics of the *ceteris paribus* clause for fuzzy relevant logic (see 11.7.11), and investigate the properties of enthymematic conditionals.
7. Discuss the problem raised in 11.3.10.
8. A notion of semantic consequence, \models , is said to be *compact* just if whenever $\Sigma \models A$ there some finite $\Sigma' \subseteq \Sigma$ such that $\Sigma' \models A$. Let \vdash be the deducibility relationship of any axiom system. Since proofs are finite,

then whenever $\Sigma \vdash A$ there is some finite $\Sigma' \subseteq \Sigma$ such that $\Sigma' \vdash A$. Show that if \vdash is sound and complete with respect to \models , \models is compact.

9. Let $A * B$ be $\neg A \rightarrow B$. Show that, given any interpretation of \mathcal{L}_{\aleph} , $\nu(A * B) = \text{Min}(1, \nu(A) + \nu(B))$. Let A^1 be A , and A^{n+1} be $A^n * A$. Let $\Sigma = \{\neg p \rightarrow q\} \cup \{p^n \rightarrow q : n \geq 1\}$. Show that, in \mathcal{L}_{\aleph} , $\Sigma \models q$. (Hint: if $\nu(p) = 0$, the first conditional gives q . If $\nu(p) > 0$ then we can make $\nu(p^n)$ as close to 1 as we please by taking n to be large enough.) Show that if Σ' is any finite subset of Σ , $\Sigma' \not\models q$. (Hint: there must be a largest n such that $p^n \rightarrow q$ is in Σ' . Choose a ν such that $\nu(p) < 1/n$.) Infer, from the last question, that \mathcal{L}_{\aleph} has no axiom system that is sound and complete (with respect to arbitrary sets of premises).
10. *Check the details omitted in 11.7a.4, 11.7a.5, 11.7a.7, 11.7a.9, 11.7a.10 (show that the axiom system is equivalent to the one in 11.5.1 or 11.5.2), 11.7a.11, 11.7a.12 (soundness only), 11.7a.13 and 11.7a.14 (soundness only).

11a Appendix: Many-valued Modal Logics

11a.1 Introduction

11a.1.1 In standard modal logics, the worlds are two-valued, in the following sense: there are two values (*true* and *false*) that a sentence may take at a world. Technically, however, there is no reason why this has to be the case: the worlds could be many-valued. This chapter looks at many-valued modal logics.

11a.1.2 We will start with the general structure of a many-valued modal logic. To illustrate the general structure, we will look briefly at modal logic based on Łukasiewicz continuum-valued logic.

11a.1.3 We will then look at one particular many-valued modal logic in more detail, modal First Degree Entailment (*FDE*), and its special cases, modal K_3 and modal *LP*. In particular, tableau systems for these logics will be given.

11a.1.4 Modal many-valued logics engage with a number of philosophical issues. The final part of the chapter will illustrate by returning to the issue of future contingents.

11a.2 General Structure

11a.2.1 As we observed in 7.2, semantically, a propositional many-valued logic is characterised by a structure $\langle \mathcal{V}, \mathcal{D}, \{f_c : c \in C\} \rangle$, where \mathcal{V} is the set of semantic values, $\mathcal{D} \subseteq \mathcal{V}$ is the set of designated values, and for each connective, c , f_c is the truth function it denotes. An interpretation, ν , assigns values in \mathcal{V} to propositional parameters; the values of all formulas can

then be computed using the f_c s; and a valid inference is one that preserves designated values in every interpretation.

11a.2.2 It is standard for \mathcal{V} to come with an ordering, \leq . We will assume in what follows that this is so. We also assume that every subset of the values has a greatest lower bound (*Glb*) and least upper bound (*Lub*) in the ordering.

11a.2.3 The language of a many-valued modal logic is the same as that of the many-valued logic, except that it is augmented by the monadic operators, \Box and \Diamond in the usual way.

11a.2.4 An interpretation for a many-valued modal logic is a structure $\langle W, R, S_L, \nu \rangle$, where W is a non-empty set of worlds, R is a binary accessibility relation on W , S_L is a structure for a many-valued logic, L , and for each propositional parameter, p , and world, w , ν assigns the parameter a value, $\nu_w(p)$, in \mathcal{V} .

11a.2.5 The truth conditions for the many-valued connectives at a world simply deploy the functions f_c . Thus, if c is an n -place connective $\nu_w(c(A_1, \dots, A_n)) = f_c(\nu_w(A_1), \dots, \nu_w(A_n))$. (So if c is conjunction, $\nu_w(A \wedge B) = f_\wedge(\nu_w(A), \nu_w(B))$.)

11a.2.6 The natural generalisation of the two-valued truth conditions for the modal operators is as follows:¹

$$\begin{aligned}\nu_w(\Box A) &= \text{Glb}\{\nu_{w'}(A) : wRw'\} \\ \nu_w(\Diamond A) &= \text{Lub}\{\nu_{w'}(A) : wRw'\}\end{aligned}$$

11a.2.7 Validity is naturally defined as follows:

$$\Sigma \models A \text{ iff for every interpretation, } \langle W, R, S_L, \nu \rangle, \text{ and for every } w \in W, \\ \text{whenever } \nu_w(B) \in \mathcal{D} \text{ for every } B \in \Sigma, \nu_w(A) \in \mathcal{D}.$$

11a.2.8 This gives the analogue of the two-valued modal logic K . Call it K_L . Stronger logics can be obtained by the addition of constraints on the accessibility relation, such as reflexivity (ρ), symmetry (σ), transitivity (τ), giving the logics $K_L\rho$, $K_L\sigma$, $K_L\rho\tau$, etc. (See ch. 3.)

¹ Semantically, \Box and \Diamond are forms of (respectively) universal and particular quantifiers over worlds. The following truth conditions are the obvious analogues of the truth conditions for these quantifiers in many-valued logic. (See Part II, 21.3.)

11a.3 Illustration: Modal Łukasiewicz Logic

11a.3.1 The previous section gives the general structure of a many-valued modal logic. Let us illustrate with respect to the continuum-valued logic of Łukasiewicz, L_N . As we saw in 11.4, the connectives of this are \neg , \wedge , \vee , and \rightarrow . \mathcal{V} is the set of real numbers between 0 and 1, $[0, 1]$. The truth functions corresponding to the connectives are:

$$\begin{aligned} f_{\neg}(x) &= 1 - x \\ f_{\wedge}(x, y) &= \text{Min}(x, y) \\ f_{\vee}(x, y) &= \text{Max}(x, y) \\ f_{\rightarrow}(x, y) &= x \odot y \end{aligned}$$

11a.3.2 In K_{L_N} , the modal logic based on L_N , if $\vDash A$ then $\vDash \Box A$, and $\vDash \Box(A \rightarrow B) \rightarrow (\Box A \rightarrow \Box B)$. (These are the characteristic modal properties of the two-valued modal logic, K .)

11a.3.3 For the first of these, suppose that $\not\vDash \Box A$. Then there is some interpretation, and some world in that interpretation, w , such that $\nu_w(\Box A) \neq 1$. Thus, for some w' such that wRw' , $\nu_{w'}(A) \neq 1$. Hence $\not\vDash A$.

11a.3.4 For the second, it suffices to show that in any interpretation, $\nu_w(\Box(A \rightarrow B)) \leq \nu_w(\Box A \rightarrow \Box B)$, i.e., that: $\text{Glb}\{\nu_{w'}(A) \odot \nu_{w'}(B) : wRw'\} \leq \text{Glb}\{\nu_{w'}(A) : wRw'\} \odot \text{Glb}\{\nu_{w'}(B) : wRw'\}$. Let $X = \{w' : wRw'\}$, and let a_x and b_x be $\nu_x(A)$ and $\nu_x(B)$, respectively. We need to show that:

$$(*) \text{Glb}\{a_x \odot b_x : x \in X\} \leq \text{Glb}\{a_x : x \in X\} \odot \text{Glb}\{b_x : x \in X\}$$

Suppose, that $\text{Glb}\{a_x : x \in X\} \leq \text{Glb}\{b_x : x \in X\}$. Then the righthand side of (*) is 1, and we have the result. Conversely, suppose that $\text{Glb}\{a_x : x \in X\} > \text{Glb}\{b_x : x \in X\}$. Then for some $x \in X$, $a_x > b_x$. Let $X' = \{x \in X : a_x > b_x\}$. Then:

$$\begin{aligned} \text{Glb}\{a_x \odot b_x : x \in X\} &= \text{Glb}\{a_x \odot b_x : x \in X'\} \\ &= \text{Glb}\{1 - a_x + b_x : x \in X'\} \\ &= 1 + \text{Glb}\{b_x - a_x : x \in X'\} \\ &= 1 + \text{Glb}\{b_x - a_x : x \in X\} \end{aligned}$$

Consequently, what needs to be shown is that:

$$1 + \text{Glb}\{b_x - a_x : x \in X\} \leq 1 + \text{Glb}\{b_x : x \in X\} - \text{Glb}\{a_x : x \in X\}$$

That is:

$$\text{Glb}\{b_x - a_x : x \in X\} \leq \text{Glb}\{b_x : x \in X\} - \text{Glb}\{a_x : x \in X\}$$

We show this as follows.

$$\text{For any } x \in X, \quad b_x - a_x \leq b_x - a_x$$

$$\text{Hence} \quad \text{Glb}\{b_x - a_x : x \in X\} \leq b_x - a_x$$

$$\text{So} \quad \text{Glb}\{b_x - a_x : x \in X\} \leq b_x - \text{Glb}\{a_x : x \in X\}$$

$$\text{That is,} \quad \text{Glb}\{b_x - a_x : x \in X\} + \text{Glb}\{a_x : x \in X\} \leq b_x$$

$$\text{And so} \quad \text{Glb}\{b_x - a_x : x \in X\} + \text{Glb}\{a_x : x \in X\} \leq \text{Glb}\{b_x : x \in X\}$$

$$\text{That is,} \quad \text{Glb}\{b_x - a_x : x \in X\} \leq \text{Glb}\{b_x : x \in X\} - \text{Glb}\{a_x : x \in X\}$$

11a.3.5 In K_{L_N} none of the following hold:

$$\vDash \Box A \rightarrow A$$

$$\vDash A \rightarrow \Box \Diamond A$$

$$\vDash \Box A \rightarrow \Box \Box A$$

This follows from the fact that none of these is valid in K , and a K counter-model is (a special case of) a K_{L_N} counter-model. (One where only the values 1 and 0 are taken by formulas.)

11a.3.6 However, the additions of the constraints ρ , σ , and τ suffice, respectively, to make the three hold. I continue to write a_w for $\nu_w(A)$.

- For the first, if wRw , $\nu_w(\Box A) = \text{Glb}\{a_{w'} : wRw'\} \leq a_w$, as required.
- For the second, suppose that wRw' . If R is symmetric, $a_w \leq \text{Lub}\{a_{w''} : w'Rw''\} = \nu_{w'}(\Diamond A)$. So $a_w \leq \text{Glb}\{\nu_{w'}(\Diamond A) : wRw'\}$, i.e., $a_w \leq \nu_w(\Box \Diamond A)$, as required.
- For the third, suppose that wRw' . Since R is transitive, $\{w'' : w'Rw''\} \subseteq \{w'' : wRw''\}$. So $\{a_{w''} : w'Rw''\} \subseteq \{a_{w''} : wRw''\}$. Thus, $\text{Glb}\{a_{w''} : wRw''\} \leq \text{Glb}\{a_{w''} : w'Rw''\}$. So $\text{Glb}\{a_{w''} : wRw''\} \leq \text{Glb}\{\text{Glb}\{a_{w''} : w'Rw''\} : wRw'\}$, i.e., $\nu_w(\Box A) \leq \nu_w(\Box \Box A)$, as required.

11a.4 Modal FDE

11a.4.1 Let us now look at one many-valued modal logic in more detail. The many-valued logic in question is *FDE*. The language for this has three connectives: \wedge , \vee and \neg . (Recall that $A \supset B$ is defined as $\neg A \vee B$.)

11a.4.2 As we saw in chapter 8, *FDE* can be formulated as a four-valued logic. $\nu = \{1, 0, b, n\}$ – true (only), false (only), both and neither. $\mathcal{D} = \{1, b\}$. The values are ordered as follows:

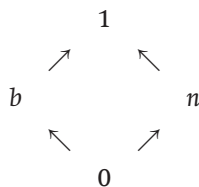

f_{\wedge} is the meet on this lattice; f_{\vee} is the join; f_{-} maps 1 to 0, vice versa, and each of b and n to itself.

11a.4.3 K_{FDE} is obtained by the general construction described. If we ignore the value n in the non-modal case (that is, we insist that formulas take one of the values in $\{1, b, 0\}$) we get the logic *LP*. In the modal case, we get K_{LP} . If we ignore the value b in the non-modal case, we get the logic K_3 . In the modal case, we get K_{K_3} .

11a.4.4 As we also saw in chapter 8, *FDE* can be formulated equivalently as a logic in which, instead of an evaluation function, ν , there is a relation, ρ (not to be confused with the constraint on the accessibility relation), which relates a formula, A , to the values 1 (true) and 0 (false) as follows:

- $\nu(A) = 1$ iff $A\rho 1$ and it is not the case that $A\rho 0$
- $\nu(A) = b$ iff $A\rho 1$ and $A\rho 0$
- $\nu(A) = n$ iff it is not the case that $A\rho 1$ and it is not the case that $A\rho 0$
- $\nu(A) = 0$ iff it is not the case that $A\rho 1$ and $A\rho 0$

The appropriate truth/falsity conditions for the connectives are:

- $A \wedge B\rho 1$ iff $A\rho 1$ and $B\rho 1$
- $A \wedge B\rho 0$ iff $A\rho 0$ or $B\rho 0$
- $A \vee B\rho 1$ iff $A\rho 1$ or $B\rho 1$
- $A \vee B\rho 0$ iff $A\rho 0$ and $B\rho 0$
- $\neg A\rho 1$ iff $A\rho 0$
- $\neg A\rho 0$ iff $A\rho 1$

Validity is defined in terms of the preservation of relating to 1.

11a.4.5 K_{FDE} can be formulated in the same way. The facts of 11a.4.4 carry over with a subscript w to the ν s and ρ s. What of the truth/falsity conditions

of the modal operators if *FDE* is formulated in this way? They may be given, in a very natural way, as follows:

- $\Box A \rho_w 1$ iff for all w' such that wRw' , $A \rho_{w'} 1$
- $\Box A \rho_w 0$ iff for some w' such that wRw' , $A \rho_{w'} 0$
- $\Diamond A \rho_w 1$ iff for some w' such that wRw' , $A \rho_{w'} 1$
- $\Diamond A \rho_w 0$ iff for all w' such that wRw' , $A \rho_{w'} 0$

11a.4.6 The argument for this is as follows. Consider $v_w(\Box A)$, that is $Glb\{v_{w'}(A) : wRw'\}$. This has four possible values.

- 1:** In this case, for all w' such that wRw' the value of $v_{w'}(A)$ is 1. So for all w' such that wRw' , $A \rho_{w'} 1$ and it is not the case that $A \rho_{w'} 0$. In this case, the truth/falsity conditions give that $\Box A \rho_w 1$ and it is not the case that $\Box A \rho_w 0$, as required.
- b:** In this case, for all w' such that wRw' , the value of $v_{w'}(A)$ is 1 or b , and at least one is b . That is, for all w' such that wRw' , $A \rho_{w'} 1$ and for at least one such w' , $A \rho_{w'} 0$. In this case, the truth/falsity conditions give that $\Box A \rho_w 1$ and $\Box A \rho_w 0$, as required.
- n:** In this case, for all w' such that wRw' , the value of $v_{w'}(A)$ is 1 or n , and at least one is n . That is, for all w' such that wRw' , it is not the case that $A \rho_{w'} 0$ and for at least one such w' , it is not the case that $A \rho_{w'} 1$. In this case, the truth/falsity conditions give that it is not the case that $\Box A \rho_w 1$ and it is not the case that $\Box A \rho_w 0$, as required.
- 0:** In this case, either there is some w' such that wRw' and $v_{w'}(A) = 0$, or there are w' and w'' , such that wRw' , wRw'' , $v_{w'}(A) = b$ and $v_{w''}(A) = n$. In the first case, for all w' such that wRw' , $A \rho_{w'} 0$ and it is not the case that $A \rho_{w'} 1$. In the second case, $A \rho_{w'} 1$ and $A \rho_{w''} 0$, and neither $A \rho_{w'} 1$ nor $A \rho_{w''} 0$. In either case, the truth/falsity conditions give that $\Box A \rho_w 0$ and it is not the case that $\Box A \rho_w 1$, as required.

The case for \Diamond is similar, and is left as an exercise.

11a.4.7 In the context of the relational semantics, *LP* is obtained by requiring that, for all p , either $p \rho 1$ or $p \rho 0$. (See 8.4.9.) The same is true with the appropriate subscript w on ρ for K_{LP} .

11a.4.8 In the context of the relational semantics, K_3 is obtained by requiring that, for all p , not both $p \rho 1$ and $p \rho 0$. (See 8.4.6.) The same is true with the appropriate subscript w on ρ for K_{K_3} .

11a.4.9 If we add both conditions in the non-modal case, we get classical logic. In the modal case, we get the classical modal logic K .

11a.4.10 All the many-valued modal logics may be extended by adding the constraints on the accessibility relation ρ , σ and τ , to give $K_{FDE}\rho$, $K_{LP}\rho\tau$, $K_{K_3}\sigma$, etc.

11a.4.11 Note that K_{FDE} , K_{K_3} , and all their normal extensions have no logical truths. To see this, just consider the interpretation with one world, w , such that wRw , and for all p , neither $p\rho_w 1$ nor $p\rho_w 0$. An easy induction shows the same to be true for all formulas. (Details are left as an exercise.)

11a.4.12 Note also that interpretations for any logic in the family we are considering is monotonic, in the following sense. Let $\mathcal{I}_1 \leq \mathcal{I}_2$ iff the two interpretations have the same worlds and accessibility relation, and, in addition, for all propositional parameters, p , and all worlds, w :

$$\begin{aligned} &\text{if } p\rho_{1w} 1 \text{ then } p\rho_{2w} 1 \\ &\text{if } p\rho_{1w} 0 \text{ then } p\rho_{2w} 0 \end{aligned}$$

where ρ_1 and ρ_2 are the evaluation relations of \mathcal{I}_1 and \mathcal{I}_2 , respectively. If $\mathcal{I}_1 \leq \mathcal{I}_2$, the displayed conditions obtain for an arbitrary formula, A . The proof is by a simple induction, which is left as an exercise.

11a.4.13 A corollary is that $\vDash_K A$ iff $\vDash_{K_{LP}} A$ (and similarly for $K\rho$ and $K_{LP}\rho$, etc.). From right to left, the result is straightforward, since any interpretation of K is an interpretation of K_{LP} . For the converse, suppose that $\not\vDash_{K_{LP}} A$. Then there is an interpretation, \mathcal{I}_2 , such that A does not hold at some world, w_0 , in \mathcal{I}_2 (i.e., it is not the case that $A\rho_{w_0} 1$). Let \mathcal{I}_1 be any classical interpretation obtained from \mathcal{I}_2 simply by resolving contradictory propositional parameters one way or the other. That is, when $p\rho_{2w} 1$ and $p\rho_{2w} 0$, only one of these holds for ρ_{1w} . Then $\mathcal{I}_1 \leq \mathcal{I}_2$. By monotonicity, A does not hold at w_0 in \mathcal{I}_1 ; and \mathcal{I}_1 is an interpretation for K .

11a.5 Tableaux

11a.5.1 We may obtain tableau systems for the logics we have been looking at, by modifying the tableau system for FDE in the same way that the tableau system for classical propositional logic is modified to obtain those for the modal logics K , $K\rho$, etc.

11a.5.2 Thus, for K_{FDE} , tableau lines are of the form $A, +i$, $A, -i$ or irj . The first indicates that A holds at world i (that is, relates to 1); the second that A fails at world i (that is, does not relate to 1); the third indicates that world i relates to world j . We start with a line of the form $B, +0$ for every premise, B ; and a line of the form $A, -0$, where A is the conclusion. A branch of the tableau closes if it contains lines of the form $A, +i$ and $A, -i$. The tableau is closed if all branches close.

11a.5.3 The rules for the extensional connectives are as given in 8.3.4:

$$\begin{array}{cc} A \wedge B, +i & A \wedge B, -i \\ \downarrow & \swarrow \quad \searrow \\ A, +i & A, -i \quad B, -i \\ B, +i & \end{array}$$

$$\begin{array}{cc} A \vee B, +i & A \vee B, -i \\ \swarrow \quad \searrow & \downarrow \\ A, +i \quad B, +i & A, -i \\ & B, -i \end{array}$$

$$\begin{array}{ccc} \neg(A \vee B), \pm i & \neg(A \wedge B), \pm i & \neg\neg A, \pm i \\ \downarrow & \downarrow & \downarrow \\ \neg A \wedge \neg B, \pm i & \neg A \vee \neg B, \pm i & A, \pm i \end{array}$$

The \pm can be disambiguated uniformly as either $+$ or $-$.

11a.5.4 The rules for the modal operators are as follows:

$$\begin{array}{cccc} \Box A, +i & \Box A, -i & \Diamond A, +i & \Diamond A, -j \\ irj & \downarrow & \downarrow & irj \\ \downarrow & irj & irj & \downarrow \\ A, +j & A, -j & A, +j & A, -j \end{array}$$

In the middle two rules, j is new to the branch. In the other two, the rule is applied whenever something of the form irj is on the branch. In addition, we have the ‘commuting rules’:

$$\begin{array}{cc} \neg\Box A, \pm i & \neg\Diamond A, \pm i \\ \downarrow & \downarrow \\ \Diamond\neg A, \pm j & \Box\neg A, \pm i \end{array}$$

11a.5.5 Here are tableaux to show that $\Box A \wedge \neg \Box B \vdash_{K_{FDE}} \Diamond(A \wedge \neg B)$ and $\Box(p \supset q), \Diamond p \not\vdash_{K_{FDE}} \Diamond q$.

$$\begin{array}{c}
 \Box A \wedge \neg \Box B, +0 \\
 \Diamond(A \wedge \neg B), -0 \\
 \Box A, +0 \\
 \neg \Box B, +0 \\
 \Diamond \neg B, +0 \\
 \text{Or1} \\
 \neg B, +1 \\
 A, +1 \\
 A \wedge \neg B, -1 \\
 \swarrow \quad \searrow \\
 A, -1 \quad \neg B, -1 \\
 \times \quad \times
 \end{array}$$

$$\begin{array}{c}
 \Box(p \supset q), +0 \\
 \Diamond p, +0 \\
 \Diamond q, -0 \\
 \text{Or1} \\
 p, +1 \\
 q, -1 \\
 p \supset q, +1 \\
 \swarrow \quad \searrow \\
 \neg p, +1 \quad q, +1 \\
 \times
 \end{array}$$

11a.5.6 To read off a counter-model from an open branch, b , of a tableau, we let $W = \{w_i : \text{a line of the form } A, \pm i \text{ occurs in } b\}$; $w_i R w_j$ iff irj occurs on b ; for every propositional parameter, p , $p \rho_{w_i} 1$ iff $p, +i$ is on b ; $p \rho_{w_i} 0$ iff $\neg p, +i$ is on b . Thus, in the counter-model determined by the open branch of the last tableau, $W = \{w_0, w_1\}$, $w_0 R w_1$ (and no other R relations hold), $p \rho_{w_1} 1$ and $p \rho_{w_1} 0$ (and no other ρ relationships hold). In a diagram:

$$\begin{array}{c}
 w_0 \rightarrow w_1 \\
 +p \\
 +\neg p \\
 -q
 \end{array}$$

Since p holds at w_1 , $\diamond p$ holds at w_0 . Since $\neg p$ holds at w_1 , $p \supset q$ holds at w_1 , so $\Box(p \supset q)$ holds at w_0 . But q fails at w_1 ; hence $\diamond q$ fails at w_0 .

11a.6 Variations

11a.6.1 For K_{K_3} we add the extra closure rule:

$$\begin{array}{c} A, +i \\ \neg A, +i \\ \times \end{array}$$

11a.6.2 For K_{LP} we add the extra closure rule:

$$\begin{array}{c} A, -i \\ \neg A, -i \\ \times \end{array}$$

11a.6.3 To obtain the systems corresponding to the semantic conditions ρ , σ , and τ , we add the rules:

$$\begin{array}{ccc} \cdot & irj & irj \\ \downarrow & \downarrow & jrk \\ iri & jri & \downarrow \\ & & irk \end{array}$$

respectively.

11a.6.4 Here are tableaux to show that $\Box A \vdash_{K_{K_3} \tau} \Box \Box A$ and $\Box p \not\vdash_{K_{LP} \rho} \Box \Box p$.

$$\begin{array}{c} \Box A, +0 \\ \Box \Box A, -0 \\ Or1 \\ \Box A, -1 \\ 1r2 \\ A, -2 \\ Or2 \\ A, +2 \\ \times \end{array}$$

$$\begin{array}{c} \Box p, +0 \\ \Box \Box p, -0 \\ 0r0 \\ 0r1, 1r1 \\ \Box p, -1 \\ 1r2, 2r2 \\ p, -2 \end{array}$$

11a.6.5 Counter-models are read off from open branches as in 11a.5.6, except that for K_{LP} and its extensions, $p \rho_{w_i} 1$ iff $p, -i$ is *not* on the branch, and $\neg p \rho_{w_i} 0$ iff $\neg p, -i$ is *not* on the branch. Thus, the counter-model given by the last tableau may be depicted by:

$$\begin{array}{ccccc} \curvearrowright & & \curvearrowright & & \curvearrowright \\ w_0 & \rightarrow & w_1 & \rightarrow & w_2 \\ +p & & +p & & -p \\ +\neg p & & +\neg p & & +\neg p \end{array}$$

Since p holds at w_1 , $\Box p$ holds at w_0 . Since p fails at w_2 , $\Box p$ fails at w_1 , and $\Box \Box p$ fails at w_0 .

11a.6.6 The tableau systems for all the logics we have considered are sound and complete. This is proved in the technical appendix, 11a.9.

11a.7 Future Contingents Revisited

11a.7.1 Many-valued modal logics engage with a number of philosophical controversies. Let me illustrate with respect to Aristotle's argument concerning future contingents, which we met in 7.9. In *De Interpretatione*, ch. 9, Aristotle argued famously that if contingent statements about the future were now either true or false, fatalism would follow. He therefore denied that contingent statements about the future are true or false.

11a.7.2 The argument that the law of excluded middle entails fatalism is worth quoting in detail:²

... if a thing is white now, it was true before to say that it would be white, so that of anything that has taken place, it was always true to say 'it is' or 'it

² *De Int.* 18^b 10–16. Translation from Vol. 1 of Ross (1928).

will be'. But if it was always true to say that a thing is or will be, it is not possible that it should not be or not come to be, and when a thing cannot not come to be, it is impossible that it should not come to be, and when it is impossible that it should not come to be, it must come to be. All then, that is about to be must of necessity take place. It results from this that nothing is uncertain or fortuitous, for if it were fortuitous it would not be necessary.

11a.7.3 One way to read the passage is as follows. Let q be any statement about a future contingent event. Let T_q be the statement that it is (or was) true that q . Then $\Box(T_q \supset q)$. Hence $T_q \supset \Box q$. And since $\Box q$ is not true, neither is T_q . A similar argument can be run for $\neg q$. So neither T_q nor $T_{\neg q}$ holds. Read in this way, the reasoning contains a modal fallacy (passing from $\Box(A \supset B)$ to $(A \supset \Box B)$). Many commentators have read the passage thus (see 7.9).

11a.7.4 But this may not do Aristotle justice. It is clear that he thinks that the past and present are fixed (unchangeable, now inevitable). So if s is a statement about the past or present, $s \supset \Box s$. Hence, $T_q \supset \Box T_q$, and since $\Box(T_q \supset q)$, so that $\Box T_q \supset \Box q$, it follows that $T_q \supset \Box q$. There is no fallacy here.

11a.7.5 In fact, we can simplify the argument. Neither T_q nor the conditional is playing an essential role. We may run the argument as follows. If q were true, this would be a present fact, and so fixed; that is, it would be necessarily true, that is: $q \models \Box q$. Similarly, if it were false, it would be necessarily false: $\neg q \models \Box \neg q$. Since neither $\Box q$ nor $\Box \neg q$ holds, neither q nor $\neg q$ holds.

11a.7.6 To do justice to Aristotle's argument, we must take seriously the thought that some things might be neither true nor false. Since Aristotle does not countenance violations of the 'Law of Non-Contradiction', an appropriate logic is K_{K_3} - or one of its normal extensions - not K_{FDE} or K_{LP} .

11a.7.7 Think of the accessibility statement wRw' as meaning that w' may be obtained from w by some number (possibly zero) of further things happening. Clearly, R is reflexive and transitive. According to Aristotle, once something is true/false, it stays so. We may capture the idea by the heredity condition: for every propositional parameter, p , and world, w :

If $p \rho_w 1$ and wRw' , $p \rho_{w'} 1$

If $p \rho_w 0$ and wRw' , $p \rho_{w'} 0$

Call this the *Persistence Constraint*. The displayed conditions follow for all unmodalised formulas, as may be shown by an easy induction. (Details are left as an exercise.)

11a.7.8 They do not hold for modalised formulas, however; nor would one expect them to. Let s be the sentence ‘It rains in St Andrews on 1/1/2100’. $\diamond s$ and $\diamond \neg s$ are both true. But there is a possible world (indeed, a probable one!) in which s is true, and so $\Box s$ is true, and $\diamond \neg s$ is false.

11a.7.9 Call $K_{3\rho\tau}$ augmented by the Persistence Constraint, \mathfrak{A} (for Aristotle). In this logic $p \models \Box p$ and $\neg p \models \Box \neg p$. Aristotle’s argument therefore works. But, of course, in \mathfrak{A} , $p \vee \neg p$ may fail to be true. Here is a simple counter-model (I omit the arrows of reflexivity):

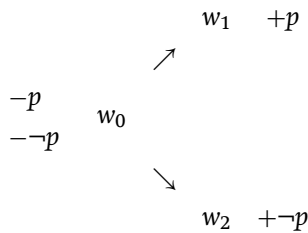

Aristotle is vindicated.³

11a.7.10 Matters are a little more difficult than this, however, as we noted in 7.10.2. Later in the same chapter Aristotle says:⁴

A sea fight must either take place tomorrow, or not; but it is not necessary that it should take place tomorrow, neither is it necessary that it should not take place, yet it is necessary that it either should or should not take place tomorrow.

He is saying that, for the appropriate p , we have neither $\Box p$ nor $\Box \neg p$. We still have $\Box(p \vee \neg p)$, however. As is easy to see, $\Box(p \vee \neg p)$ is not valid in \mathfrak{A} .

³ Though one might object: the Persistence Constraint should hold only for those things that are *genuinely* about the present (w). (A sentence can be grammatically present but essentially about the future – such as the sentence ‘it will rain’ is true’.) Enforcing the Persistence Constraint for those p that are covertly about the future *may* therefore be thought to be question-begging.

⁴ *De Int.* 19^a30–32.

11a.7.11 The matter may be remedied by modifying the truth conditions for \Box . Though neither p nor $\neg p$ may be true at a world, w , it is natural to suppose on the Aristotelian picture that the truth value of p will eventually be decided. We may therefore view things ‘from the end of time’, when everything undetermined has been resolved. Call a world *complete* if every propositional parameter is either true or false. A natural way of giving the truth conditions for \Box is as follows:

$\Box A \rho_w 1$ iff for all complete w' such that wRw' , $A \rho_{w'} 1$

$\Box A \rho_w 0$ iff for some complete w' such that wRw' , $A \rho_{w'} 0$

The truth/falsity conditions for \Diamond are the same with ‘some’ and ‘all’ interchanged. $\Box A$ may naturally be seen as expressing the idea that A is inevitable. It is not difficult to show that, for any complete world, w , Persistence holds for all formulas. It follows that at such a world, A is true iff $\Box A$ is, and that all formulas are either true or false. (Details are left as an exercise.)

11a.7.12 With the revised truth/falsity conditions for \Box , $p \models \Box p$, $\neg p \models \Box \neg p$ (so Aristotle’s argument still works), $\models \Box(p \vee \neg p)$, but not $\models \Box p \vee \Box \neg p$. For the first of these, if p is true at w then, by the Persistence Constraint, p holds at any complete world accessed by w . Hence $\Box p$ is true at w . The argument for the second is similar. For the third, in any complete world accessed by w , either p or $\neg p$ holds. Hence $p \vee \neg p$ holds, and $\Box(p \vee \neg p)$ is true at w . (Indeed, the same holds for an arbitrary formula, A .) For the last, consider the interpretation of 11a.7.9. We may suppose that all the parameters other than p also take a classical value at w_1 and w_2 , and hence that these worlds are complete. Neither $\Box p$ nor $\Box \neg p$ is true at w_0 .⁵

11a.8 A Glimpse Beyond

11a.8.1 Many-valued modal logics are relevant to many other philosophical debates. I give just one example.

11a.8.2 It is natural to ask what happens to issues about essentialism in the context of vagueness. Can vague predicates express essential properties?

⁵ What one loses on this account is, of course, the validity of the inference from $\Box A$ to A , even though the accessibility relation is reflexive. The inference is guaranteed to preserve truth only at complete worlds.

Can vague objects, assuming there to be some, have essential properties? To investigate such questions, one clearly needs a modal logic.

11a.8.3 But, it is often argued, a logic of vagueness is many-valued: it is either some continuum-valued logic, or it is some 3-valued logic with or without a supervaluation technique. (See 11.3.) If this is so, the investigation of such questions requires a many-valued modal logic.

11a.8.4 In fact, since the matter involves predication and identity, what is required is a first-order many-valued modal logic. I leave the construction of such logics as a long but relatively routine exercise in the application of the techniques of Part II.⁶

11a.9 *Proofs of Theorems

11a.9.1 In this section we prove soundness and completeness for all the tableau systems mentioned in the chapter. The proofs simply amalgamate those of chapters 2, 3 and 8.

11a.9.2 DEFINITION: Let $\mathcal{I} = \langle W, R, S_{FDE}, \rho \rangle$ be any K_{FDE} interpretation, and b any branch of a tableau. Then \mathcal{I} is *faithful* to b iff there is a map, f , from the natural numbers to W such that:

- If $A, +i$ is on b , $A\rho_{f(i)}1$ in \mathcal{I}
- If $A, -i$ is on b , then it is not the case that $A\rho_{f(i)}1$ in \mathcal{I}
- If irj is on b , $f(i)Rf(j)$

11a.9.3 SOUNDNESS LEMMA FOR K_{FDE} : Let b be any branch of a tableau and \mathcal{I} any interpretation. If \mathcal{I} is faithful to b , and a tableau rule is applied, then it produces at least one extension, b' , such that \mathcal{I} is faithful to b' .

Proof:

We merely have to check the rules, one by one. The rules for the extensional connectives are as in 8.7.3. Here are the cases for the rules for \Box . Those for

⁶ **History and Further Reading:** The earliest paper on a many-valued modal logic appears to have been Segerberg (1967), which specifies some 3-valued modal logics. More general approaches were later provided by Thomason (1978) and Ostermann (1988). Fitting (1992a, 1992b) generalises to allow even the accessibility relation to be many-valued. Hájek (1998), 8.3, discusses fuzzy modal logic. Ostermann (1990) gives a first-order many-valued modal logic.

\diamond are similar. The rules in question are:

$$\begin{array}{ccc}
 \Box A, +i & \Box A, -i & \neg\Box A, \pm i \\
 \downarrow \text{irj} & \downarrow & \downarrow \\
 A, +j & A, -j & \diamond\neg A, \pm i
 \end{array}$$

For the first, suppose that f shows \mathcal{I} to be faithful to a branch containing the premises. Then $\Box A$ holds at $f(i)$ and $f(i)Rf(j)$. Hence A is true at $f(j)$, as required. For the second, suppose that f shows \mathcal{I} to be faithful to a branch containing the premise. Then $\Box A$ fails at $f(i)$. There must therefore be a w such that $f(i)Rw$ and A fails at w . Let f' be the same as f except that $f'(j) = w$. Then f' shows \mathcal{I} to be faithful to b . For the third, here is the case for $+$. That for $-$ is similar. Suppose that f shows \mathcal{I} to be faithful to a branch containing the premise. Then $\neg\Box A$ is true at $f(i)$. So for some w such that $f(i)Rw$, A is false at w . So $\neg A$ is true at w , and $\diamond\neg A$ holds at $f(i)$. ■

11a.9.4 SOUNDNESS THEOREM FOR K_{FDE} : For finite Σ , if $\Sigma \vdash A$ then $\Sigma \vDash A$.

Proof:

This follows from the Soundness Lemma in the usual way. ■

11a.9.5 DEFINITION: Given an open branch, b , of a tableau for FDE , the interpretation \mathcal{I} induced by b is the structure where $W = \{w_i : i \text{ occurs on } b\}$; $w_i R w_j$ iff irj occurs on b ; for every propositional parameter, p , $p \rho_{w_i} 1$ iff $p, +i$ is on b ; $p \rho_{w_i} 0$ iff $\neg p, +i$ is on b .

11a.9.6 COMPLETENESS LEMMA FOR K_{FDE} : Let b be a complete open branch of a tableau (i.e., one where every rule that can be applied has been applied). Then:

If $A, +i$ is on b , $A \rho_{w_i} 1$

If $A, -i$ is on b , it is not the case that $A \rho_{w_i} 1$

If $\neg A, +i$ is on b , $A \rho_{w_i} 0$

If $\neg A, -i$ is on b , it is not the case that $A \rho_{w_i} 0$

Proof:

This is proved by induction on A . It is true by definition (and the fact that b is open) when A is atomic. The induction cases for the extensional connectives are as in 8.7.6. Here are the cases for \Box . The cases for \Diamond are similar.

Suppose that $\Box B, +i$ is on b . Then for every w_i such that $w_i R w_j$, $B, +j$ is on b . By induction hypothesis, B is true at w_j . Hence $\Box B$ is true at w_i .

Suppose that $\Box B, -i$ is on b . Then for some j such that $w_i R w_j$, $B, -j$ is on b . By induction hypothesis, B is not true at w_j . Hence, $\Box B$ is not true at w_i .

Suppose that $\neg\Box B, +i$ is on b . Then $\Diamond\neg B, +i$ is on b . So for some w_i such that $w_i R w_j$, $\neg B, +j$ is on b . By induction hypothesis, B is false at w_j . Hence $\Box B$ is false at w_i .

Finally, suppose that $\neg\Box B, -i$ is on b . Then $\Diamond\neg B, -i$ is on b . Hence, for all j such that $w_i R w_j$, $\neg B, -j$ is on b . By induction hypothesis, B is not false at w_j . So $\Box B$ is not false at w_i . ■

11a.9.7 COMPLETENESS THEOREM FOR K_{FDE} : For finite Σ , if $\Sigma \models A$ then $\Sigma \vdash A$.

Proof:

This follows from the Completeness Lemma in the usual way. ■

11a.9.8 SOUNDNESS AND COMPLETENESS THEOREM FOR K_{K_3} AND K_{LP} : The tableau systems for K_{K_3} and K_{LP} are sound and complete.

Proof:

The proof for K_{K_3} is exactly the same as for K_{FDE} . In the Completeness Lemma we merely have to check that the induced interpretation is an interpretation for K_{K_3} . This follows from the fact that the K_3 closure rule is in operation. The proof for K_{LP} is the same, except that in the induced interpretation, ρ is defined slightly differently: for every propositional parameter, p , $p\rho_{w_i} 1$ iff $p, -i$ is not on b ; $p\rho_{w_i} 0$ iff $\neg p, -i$ is not on b . This is an interpretation for K_{LP} because of the LP closure rule. The new definition makes the basis case of the Completeness Lemma slightly different. If $p, +i$ is on b then, by closure, $p, -i$ is not on b . So $p\rho_{w_i} 1$. If $p, -i$ is on b , it is not the case that $p\rho_{w_i} 1$. The cases for 0 are similar. ■

11a.9.9 SOUNDNESS AND COMPLETENESS THEOREMS FOR THE EXTENSIONS OF THESE LOGICS OBTAINED BY ADDING CONSTRAINTS ON THE ACCESSIBILITY RELATION: The addition of the rules for ρ , σ and τ are sound and complete with respect to the corresponding semantics.

Proof:

In the Soundness Lemma, we merely have to check the cases for the additional rules. In the Completeness Lemma, we have to check that the induced interpretation is appropriate. This is all straightforward. (See 3.7.1–3.7.4.) ■

Postscript: An Historical Perspective on Conditionals

Part I of the book has explored, in various ways, a relevant account of conditionals. Such an account seems to me to be better than any of the other accounts that we have traversed in the course of Part I. This is, naturally, a contentious view.¹ Logic is a contentious subject, and the conditional has been particularly so since the earliest years of the discipline. It was the Stoic logicians who first discussed conditionals explicitly, and they had at least four competing accounts. These accounts survived – one way or another – and others were added throughout the Middle Ages. Consensus might have been reached locally, but only locally.²

The changes in logic at the beginning of the twentieth century were revolutionary. The power of the mathematical techniques employed by the founders of modern logic made anything before obsolete. (Which is not to say that there is not now a good deal to be learned from it – just that whatever is of value in it must be seen through radically new eyes.) It is perhaps not surprising, then, that their work established a very general consensus over the conditional. The view of the conditional as material became highly orthodox – though never universal, as C. I. Lewis bears witness.

Digesting the results of the revolution occupied logicians in the first half of the century. But the second half was quite different. It has become clear that the mathematical machinery deployed by Frege and Russell is of a relatively simple kind, and that there is much more sophisticated machinery available, which can be used to do many exciting things. This has made it possible to challenge many of the assumptions built into ‘classical logic’. In particular, the machinery has made it possible to construct a galaxy of ‘non-standard’ logics; and I think it fair to say that there is less consensus now over many questions in logic than there has been for a long time.

¹ Some defence of it can be found in Priest (2007).

² For an excellent discussion of all this, see Sylvan (2000).

One of these questions is surely that of the conditional. In the light of the new developments, the account of the conditional as material must appear a crude one; and the consensus of the earlier part of the twentieth century concerning it, would seem to be entirely an artifact of the limited logical technology then available.

The relevant account of conditionality draws on many of the most notable developments in logic in the second half of the century, and would not have been possible without them: possible worlds, impossible worlds, truth-value gaps and gluts, *ceteris paribus* clauses, degrees of truth. What will happen to this account in the future, and what consensus, if any, will emerge in the twenty-first century, only time will tell.

Part II

Quantification and Identity

12 Classical First-order Logic

12.1 Introduction

12.1.1 In this chapter we will review the semantics and tableaux for classical first-order logic (without function symbols). We will start by assuming that identity is not part of the language. We will then look at its addition.

12.1.2 Next, we will look at some of the philosophical problems of the machinery.

12.1.3 Finally, I will discuss briefly some more technical matters concerning first-order logic.

12.2 Syntax

12.2.1 The vocabulary of the language of first-order logic comprises:

- variables: v_0, v_1, v_2, \dots
- constants: k_0, k_1, k_2, \dots
- for every natural number $n > 0$, n -place predicate symbols: $P_n^0, P_n^1, P_n^2, \dots$
- connectives: $\wedge, \vee, \neg, \supset, \equiv$
- quantifiers: \forall, \exists
- brackets: $(,)$

We will call \forall and \exists the *universal* and *particular* quantifiers, respectively. (\exists is often called the *existential* quantifier. I will return to the nomenclature in the next chapter.)

12.2.2 I will use x, y, z for arbitrary variables, and a, b, c for arbitrary constants (possibly with primes or subscripts in each case). I will use P_n, Q_n, S_n

for arbitrary n -place predicates.¹ I will omit the subscript in cases where it can be read off from the context. I will use A, B, C for arbitrary formulas, and Σ, Π for arbitrary sets of formulas.

12.2.3 The grammar of the language is as follows.

- Any constant or variable is a *term*.

(In general, languages may have other terms as well. We will meet some more in later chapters.) The formulas are specified recursively as follows.

- If t_1, \dots, t_n are any terms and P is any n -place predicate, $Pt_1 \dots t_n$ is an (atomic) formula.
- If A and B are formulas, so are the following: $(A \wedge B)$, $(A \vee B)$, $\neg A$, $(A \supset B)$, $(A \equiv B)$.
- If A is any formula, and x is any variable, then $\forall xA$, $\exists xA$ are formulas.

I will omit outermost brackets in formulas.

12.2.4 An occurrence of a variable, x , in a formula, is said to be *bound* if it occurs in a context of the form $\exists x \dots x \dots$ or $\forall x \dots x \dots$. If it is not bound, it is *free*. A formula with no free variables is said to be *closed*. $A_x(c)$ is the formula obtained by substituting c for each free occurrence of x in A .

12.3 Semantics

12.3.1 An *interpretation* of the language is a pair, $\mathcal{I} = \langle D, \nu \rangle$. D is a non-empty set (the domain of quantification); ν is a function such that:

- if c is a constant, $\nu(c)$ is a member of D
- if P is an n -place predicate, $\nu(P)$ is a subset of D^n

(D^n is the set of all n -tuples of members of D , $\{\langle d_1, \dots, d_n \rangle: d_1, \dots, d_n \in D\}$. By convention, $\langle d \rangle$ is just d , and so D^1 is D .)

12.3.2 Given an interpretation, truth values are assigned to all *closed* formulas. To state the truth conditions, we extend the language to ensure that every member of the domain has a name. For all $d \in D$, we add a

¹ I will not use 'R', to avoid any confusion with the modal accessibility relation.

constant to the language, k_d , such that $v(k_d) = d$. The extended language is the *language of* \mathcal{I} , and written $L(\mathcal{I})$. The truth conditions for (closed) atomic sentences are:

$$v(Pa_1 \dots a_n) = 1 \text{ iff } (v(a_1), \dots, v(a_n)) \in v(P) \text{ (otherwise it is 0)}$$

The truth conditions for the connectives are as in the propositional case (1.3.2). For the quantifiers:

$$v(\forall xA) = 1 \text{ iff for all } d \in D, v(A_x(k_d)) = 1 \text{ (otherwise it is 0)}$$

$$v(\exists xA) = 1 \text{ iff for some } d \in D, v(A_x(k_d)) = 1 \text{ (otherwise it is 0)}$$

12.3.3 Validity is a relationship between premises and conclusions that are *closed* formulas, and is defined in terms of the preservation of truth in all interpretations, thus: $\Sigma \models A$ iff every interpretation that makes all the members of Σ true makes A true.

12.3.4 Note that in any interpretation, we have the following:

$$\begin{aligned} v(\neg\exists xA) &= v(\forall x\neg A) \\ v(\neg\forall xA) &= v(\exists x\neg A) \\ v(\neg\exists x(Px \wedge A)) &= v(\forall x(Px \supset \neg A)) \\ v(\neg\forall x(Px \supset A)) &= v(\exists x(Px \wedge \neg A)) \end{aligned}$$

For the first of these, suppose that $v(\neg\exists xA) = 1$. Then $v(\exists xA) = 0$. So for all d in the domain of the interpretation, $v(A_x(k_d)) = 0$, i.e., $v(\neg A_x(k_d)) = 1$. So, $v(\forall x\neg A) = 1$. Conversely, suppose that $v(\forall x\neg A) = 1$. Then for all d in the domain of the interpretation $v(\neg A_x(k_d)) = 1$, that is, $v(A_x(k_d)) = 0$. Hence, $v(\exists xA) = 0$, and $v(\neg\exists xA) = 1$. The other three cases are left as exercises.

12.3.5 Note also the following. If C is some set of constants such that every object in the domain has a name in C , then:

$$v(\forall xA) = 1 \text{ iff for all } c \in C, v(A_x(c)) = 1 \text{ (otherwise it is 0)}$$

$$v(\exists xA) = 1 \text{ iff for some } c \in C, v(A_x(c)) = 1 \text{ (otherwise it is 0)}$$

The proof is a simple corollary of the Denotation Lemma, and is given in 12.8.4. As we will see, counter-models read off from the open branch of a tableau are of this kind. Since appropriate versions of the Denotation Lemma can be proved for all the logics we will be concerned with in this

part of the book, the same is true for all of them. I will not keep mentioning the fact.²

12.4 Tableaux

12.4.1 Tableaux for first-order logic are the same as those for propositional logic (1.4), except that we have four new rules:

$$\begin{array}{cccc}
 \neg\exists xA & \neg\forall xA & \forall xA & \exists xA \\
 \downarrow & \downarrow & \downarrow & \downarrow \\
 \forall x\neg A & \exists x\neg A & A_x(a) & A_x(c)
 \end{array}$$

The third and fourth rules are called universal and particular *instantiation* (UI and PI), respectively; the constant in each case is said to *instantiate* the quantifier. c is a constant that does not occur so far on the branch. a is any constant on the branch. (If there aren't any, we select one at will.) If one is checking lines to note that one has finished with them, then one can never check a line of the form $\forall xA$, since it is possible that a new constant will be introduced on the branch (by PI), and hence that we will have to come back and apply UI to the new constant. (A useful trick is, instead of checking the line, to write beside it all the constants with which it has been instantiated.)

12.4.2 Note that the tableaux rules are applied only to whole lines, not to parts thereof. Thus, consider the following:

$$\begin{array}{c}
 \neg(A \wedge \forall xB) \\
 \downarrow \\
 \neg(A \wedge B_x(a))
 \end{array}$$

(for any a on the branch). This is *not* an application of UI.

12.4.3 If Σ is finite, I will write $\Sigma \vdash A$ to mean that there is a closed tableau whose initial list comprises the members of Σ together with the negation

² If C is the set of the constants in the original language (that is, unaugmented by the special constants, k_d , of 12.3.2) and the truth conditions of quantifiers are given as in 12.3.5, we obtain a notion of quantification different from the more standard one employed here, and usually called *substitutional quantification*. It is a feature of substitutional quantification, that something in the domain can be in $v(P)$, and yet $\exists xPx$ is not true, just because the object in question has no name in the interpretation. In principle, all the logics we will meet in this book could be formulated with substitution quantification but we will not pursue this.

of A . (We will come to tableaux where Σ is infinite later.) Note that all the formulas on a tableau are closed.

12.4.4 It is true, though not entirely obvious, that the order in which one applies the rules does not matter. If the tableau closes it will close in whatever order the rules are applied, provided that every rule that can be applied is applied. Similarly if the tableau is open. This is, in fact, a simple corollary of the Soundness and Completeness Lemmas (see 12.8.10), and holds for all tableaux for which appropriate versions of these lemmas can be proved. This includes all the tableau systems that we will meet in this part of the book. Again, I will not keep mentioning the fact.

12.4.5 Here is a tableau to show that $\forall x(Px \supset Qx), \forall x(Qx \supset Sx) \vdash \forall x(Px \supset Sx)$.

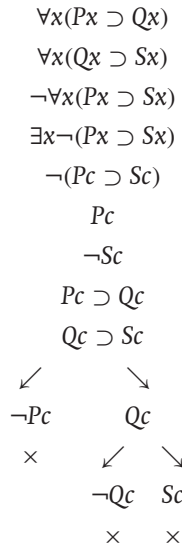

12.4.6 Here is another to show that $\vdash \forall xA \supset \exists xA$.

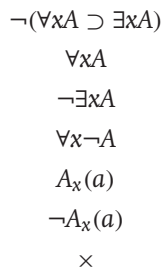

a is any constant that occurs in A , if there is one, or a new one if there isn't.

12.4.7 Here is a tableau to show that $\exists x(Px \supset Qx) \not\vdash \forall x\neg Qx$.

$$\begin{array}{c}
 \exists x(Px \supset Qx) \\
 \neg \forall x\neg Qx \\
 Pc \supset Qc \\
 \exists x\neg\neg Qx \\
 \neg\neg Qa \\
 Qa \\
 \swarrow \quad \searrow \\
 \neg Pc \quad Qc
 \end{array}$$

12.4.8 To read off a counter-model from an open branch, we take a domain which contains a distinct object, ∂_b , for every constant, b , on the branch. $v(b)$ is ∂_b . $v(P)$ is the set of n -tuples $\langle \partial_{b_1}, \dots, \partial_{b_n} \rangle$ such that $Pb_1 \dots b_n$ occurs on the branch. Of course, if $\neg Pb_1 \dots b_n$ is on the branch, $\langle \partial_{b_1}, \dots, \partial_{b_n} \rangle \notin v(P)$, since the branch is open. (If a predicate or constant does not occur on the branch, the value given to it by v is a *don't care* condition: it can be anything one likes.)³ Thus, in the example of 12.4.7, the counter-model given by the leftmost open branch is an interpretation (D, v) , such that $D = \{\partial_c, \partial_a\}$; $v(c) = \partial_c$, $v(a) = \partial_a$. For predicates, $v(P) = \emptyset$, $v(Q) = \{\partial_a\}$; we may depict these in the following table:

	∂_c	∂_a
P	\times	\times
Q	\times	\checkmark

The tick means that the object in the column is in the extension of the predicate in the row. A cross means that it is not.

12.4.9 As is clear, every object in the domain has a name on the branch. To check that a formula of the form $\exists xA$ is true in the interpretation, it therefore suffices to show that some sentence of the form $A_x(b)$ is true, where b is some constant on the branch. Similarly, to check that a formula

³ This is not the only interpretation compatible with the information on the branch. What is, in fact, required is that $\langle \partial_{b_1}, \dots, \partial_{b_n} \rangle \in v(P)$ if $Pb_1 \dots b_n$ is on the branch, and $\langle \partial_{b_1}, \dots, \partial_{b_n} \rangle \notin v(P)$ if $\neg Pb_1 \dots b_n$ is on the branch. Other members of $v(P)$ are, strictly speaking, *don't cares*. For other sorts of tableau that we will meet in this part of the book, however, the absence of a piece of information on a branch does not mean that it is a *don't care* condition. For uniformity, then, we will stick with the recipe given in the text.

of the form $\forall xA$ is true in the interpretation, it suffices to show that $A_x(b)$ is true, for every b on the branch. (See 12.3.5.) Bearing this in mind, it is easy to check that the following hold in the interpretation of 12.4.8 (running down each column):

$$\begin{array}{ll} \neg Pc & \neg\neg Qa \\ Pc \supset Qc & \exists x\neg\neg Qx \\ \exists x(Px \supset Qx) & \neg\forall x\neg Qx \end{array}$$

This shows that the interpretation is indeed a counter-model.

12.4.10 Note that an open branch of a tableau may well be infinite. Thus, consider the following tableau, which shows that $\not\vdash \exists x\forall ySxy$.

$$\begin{array}{l} \neg\exists x\forall ySxy \\ \forall x\neg\forall ySxy \\ \neg\forall ySay \\ \exists y\neg Say \\ \neg Sab \\ \neg\forall ySby \\ \exists y\neg Sby \\ \neg Sbc \\ \neg\forall yScy \\ \vdots \end{array}$$

At the fifth line the particular quantifier is instantiated with the new constant b . But then we have to go back and instantiate the universal quantifier at line two; and this starts the procedure all over again. The tableau never closes, and goes on to infinity. In this case it is easy to read off the counter-model. The domain comprises $\partial_a, \partial_b, \partial_c, \dots$; and the denotation of S (which is a set of ordered pairs) looks like this:

S	∂_a	∂_b	∂_c	∂_d	\dots
∂_a	×				
∂_b		×			
∂_c			×		
\vdots				\ddots	

Given the recipe of 12.4.8, the blank squares also contain crosses, but it is the ones shown that are essential. Given them, we have the following:

$$\begin{array}{rcl}
 \neg Sab & \text{so} & \neg \forall y Say \\
 \neg Sbc & \text{so} & \neg \forall y Sby \\
 \vdots & & \vdots \\
 & & \text{so} \\
 & & \neg \exists x \forall y Sxy
 \end{array}$$

12.4.11 In many cases where a tree is infinite (though not all) a simple finite counter-model can be found by intelligent guesswork. Thus, for 12.4.10 the following will do, as can be checked:

$$\begin{array}{ccc}
 S & \partial_a & \partial_b \\
 \partial_a & \checkmark & \times \\
 \partial_b & \times & \checkmark
 \end{array}$$

Neither ∂_a nor ∂_b relates to everything via S .

12.4.12 To make sure that a tableau does not close, it is necessary to ensure that all the rules that can be applied have been applied, that is, that every branch is *complete*. (A completed branch is not necessarily finite.) It is not entirely obvious for first-order tableaux, and for all the other tableaux with which we will be concerned in this part of the book, that complete branches can always be constructed. A simple algorithm (not necessarily the most efficient) for ensuring that every rule that can be applied is applied is as follows. (1) For each branch in turn (there is only a finite number at any stage of the construction), we run down the formulas on the branch, applying any rule that generates something not already on the branch. (In the case of a rule such as UI, which has multiple applications, we make all the applications possible at this stage.) (2) We then go back and repeat the process. (Needless to say, it is only a few rules – UI in the case of classical first order logic – where repeating the process with formulas already traversed in this process may produce something new on a branch.)

12.4.13 The tableaux are sound and complete with respect to the semantics. This is proved in 12.8.

12.4.14 In understanding the behaviour of quantifiers in a logic, perhaps the most important thing is to know how they interact with the propositional operators. In classical logic, the interactions are as follows.

' $A \dashv\vdash B$ ' means ' $A \vdash B$ and $B \vdash A$ '. C is any closed formula. A^* at the end of a line indicates that the converse does not hold, in the sense that there are instances that are not valid. (So, for example, in the first line for Negation, if A is Px , we have $\neg\forall xPx \not\vdash \forall x\neg Px$.) Where the converse does not hold, there is often a restricted version involving a closed formula that does. Where this exists, it is given on the next line. Verification of all these facts is left as an exercise.

1. No Operators

$$(a) \forall xC \dashv\vdash C$$

$$(b) \exists xC \dashv\vdash C$$

2. Negation

$$(a) \forall x\neg A \vdash \neg\forall xA^*$$

$$(b) \neg\forall xC \vdash \forall x\neg C$$

$$(c) \neg\exists xA \vdash \exists x\neg A^*$$

$$(d) \exists x\neg C \vdash \neg\exists xC$$

$$(e) \neg\exists xA \dashv\vdash \forall x\neg A$$

$$(f) \neg\forall xA \dashv\vdash \exists x\neg A$$

3. Disjunction

$$(a) \forall xA \vee \forall xB \vdash \forall x(A \vee B)^*$$

$$(b) \forall x(A \vee C) \vdash \forall xA \vee C$$

$$(c) \exists xA \vee \exists xB \dashv\vdash \exists x(A \vee B)$$

$$(d) \forall xA \vee \forall xB \vdash \exists x(A \vee B)^*$$

$$(e) \forall x(A \vee B) \vdash \exists xA \vee \exists xB^*$$

4. Conjunction

$$(a) \forall xA \wedge \forall xB \dashv\vdash \forall x(A \wedge B)$$

$$(b) \exists x(A \wedge B) \vdash \exists xA \wedge \exists xB^*$$

$$(c) \exists xA \wedge C \vdash \exists x(A \wedge C)$$

$$(d) \forall xA \wedge \forall xB \vdash \exists x(A \wedge B)^*$$

$$(e) \forall x(A \wedge B) \vdash \exists xA \wedge \exists xB^*$$

5. Conditional

$$(a) \forall x(A \supset B) \vdash \forall xA \supset \forall xB^*$$

$$(b) C \supset \forall xB \vdash \forall x(C \supset B)$$

$$(c) \exists xA \supset \exists xB \vdash \exists x(A \supset B)^*$$

$$(d) \exists x(C \supset B) \vdash C \supset \exists xB$$

$$(e) \forall x(A \supset B) \vdash \exists xA \supset \exists xB^*$$

$$(f) \exists xA \supset C \vdash \forall x(A \supset C)$$

(g) $\forall xA \supset \forall xB \vdash \exists x(A \supset B)$ *

(h) $\exists x(A \supset C) \vdash \forall xA \supset C$

Most of the logics we will be considering in this book agree with classical logic in cases 1–4, though 1 breaks down in free logic, and there are some very significant differences in cases 2 and 3 (negation and disjunction) for intuitionist logic. In case 5, however – as one might expect in the light of Part I – nearly all the logics diverge (for the appropriate conditional (\neg , \supset , \rightarrow , etc.)).

12.5 Identity

12.5.1 In this section we consider the behaviour of the identity predicate. We can take this to be one of the binary predicates, say P_2^0 . It is normally written as $=$, and written between its arguments, not to the left of them, thus: $a_1 = a_2$. I will follow this convention. $a_1 \neq a_2$ is an alternative notation for $\neg a_1 = a_2$.

12.5.2 In any interpretation, $\langle D, v \rangle$, $v(=)$ is $\{\langle d, d \rangle : d \in D\}$. That is, $\langle d, e \rangle$ is in the denotation of the identity predicate, just if d is e .

12.5.3 The tableau rules that need to be added to handle $=$ are as follows:

$$\begin{array}{ccc}
 & & a = b \\
 & \downarrow & \\
 & & A_x(a) \\
 a = a & & \downarrow \\
 & & A_x(b)
 \end{array}$$

The first rule says that we can always add a line of the form $a = a$. In the second, which is called the *Substitutivity of Identicals* (SI), A is any atomic sentence distinct from $a = b$. (It could be *any* sentence, but this is enough, and makes for more manageable tableaux.) As usual, the two lines above the arrow can occur in any order, and do not have to be consecutive.

12.5.4 SI says, in effect, that when we have a line of the form $a = b$ we can substitute b for any number of occurrences of a in any line (above or below) with an atomic formula. Thus, suppose that the line is of the form Saa . This is $(Sxa)_x(a)$, $(Sax)_x(a)$, and $(Sxx)_x(a)$. Hence, we can apply the rule to get, respectively, $(Sxa)_x(b)$, $(Sax)_x(b)$, and $(Sxx)_x(b)$; that is, Sba , Sab , and Sbb . Note that one cannot check a line of the form $a = b$ to indicate that

one has finished with it, since one may have to come back and apply it to a new formula of the form $A_x(a)$. But, as for UI, one can keep track of the lines to which it has been applied.

12.5.5 The first identity rule has two functions. The first is to close any branch with a line of the form $a \neq a$. The second is to allow us, given an identity, to interchange a and b :

$$\begin{array}{c} a = b \\ a = a \\ \downarrow \\ b = a \end{array}$$

(The last line is obtained by substituting b for the first occurrence of a in the second line.) This allows us to close any tableau with lines of the form $a = b$ and $b \neq a$, and also to apply SI substituting a for b , instead of the other way around. In practice it is simplest to forget the lines of the form $a = a$, but to close all branches that contain a line of the form $a \neq a$, or lines of the form $a = b$ and $b \neq a$, and to apply SI to the constants on both sides of an identity. I will follow this procedure.

12.5.6 We will meet tableau for identity many times in this book. The comments of 12.5.4 and 12.5.5, in the appropriate form, should be taken as carrying over to all of these.

12.5.7 Here is a tableau to show that $\vdash a = b \supset (\exists xSxa \supset (a = a \wedge \exists xSxb))$.

$$\begin{array}{c} \neg(a = b \supset (\exists xSxa \supset (a = a \wedge \exists xSxb))) \\ a = b \\ \neg(\exists xSxa \supset (a = a \wedge \exists xSxb)) \\ \exists xSxa \\ \neg(a = a \wedge \exists xSxb) \\ Sca \\ \swarrow \quad \searrow \\ \neg a = a \quad \neg \exists xSxb \\ \times \quad \forall x \neg Sxb \\ \quad \neg Scb \\ \quad Scb \\ \quad \times \end{array}$$

The last line on the right branch is obtained by SI, with the identity on line two being applied to line six.

12.5.8 Here is another example to show that $a = b \not\vdash \forall x\exists y(Py \wedge x = y)$.

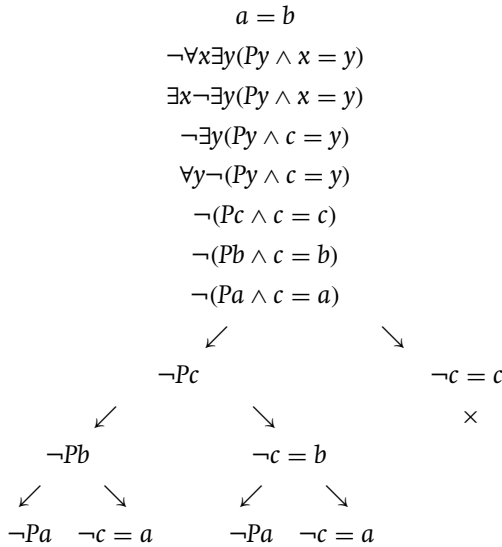

Since there are no atomic formulas other than $a = b$ on any branch, there are no applications of SI to be made.

12.5.9 To read off a counter-model from an open branch, we proceed as before, except that whenever we have a bunch of lines of the form $a = b$, $b = c$, etc., we choose one of the constants, say, a , and let all the constants in the bunch denote ∂_a . It does not matter which constant was chosen from those said to be identical, since SI has been applied as often as possible.

12.5.10 Thus, in the interpretation given by the leftmost open branch of the tableau in 12.5.8, $D = \{\partial_a, \partial_c\}$, $v(a) = v(b) = \partial_a$, $v(c) = \partial_c$, and $v(P)$ is given by the following table:

	∂_a	∂_c
P	\times	\times

so that $v(P) = \phi$. I leave it as an exercise to check that this counter-model works.

12.5.11 The soundness and completeness of the tableaux are proved in 12.9.

12.6 Some Philosophical Issues

12.6.1 The semantics we have been considering, though orthodox, are not without their problems. In this section, we will consider some.

12.6.2 It is standard to read $\exists x$ as ‘There exists an x such that’, in which case $\exists xA$ expresses the fact that there exists something that satisfies A . Since the domain of quantification is non-empty, $\exists x(A \vee \neg A)$ is a logical truth, and expresses the fact that there exists something which satisfies either A or its negation – or simply that something exists. This hardly seems to be a logical truth. It would seem entirely possible that there should be nothing. To avoid this, we could allow the domain of quantification to be empty, but we would then be unable to assign constants any denotation. Perhaps the natural remedy for this is to allow ν to be a partial function (so that it may have no value for some constants). We will return to this matter in chapter 21, when we consider logics with truth value gaps.

12.6.3 The fact that the denotation function is always defined also makes the following inference valid:

$$A_x(a) \models \exists xA$$

Now, presumably, it is true that Pegasus does not exist. But the conclusion that there exists something that does not exist is certainly false.

12.6.4 One might suspect that something funny is going on in this example, on the ground that existence is not a real predicate. But there seem to be other true sentences containing names that do not denote existent objects, which have nothing to do with existence, and where it is wrong to generalise existentially. Thus, consider the following:

1. Sherlock Holmes lived in Baker St.
2. Sherlock Holmes is a character in a work of fiction.
3. I am thinking about Sherlock Holmes.

In the case of the first of these, one might claim that it is not really true. What is true is that:

In the novels by Arthur Conan Doyle, Sherlock Holmes lived in Baker St.

But this still gives us a true sentence about Sherlock Holmes, so the problem has not been solved. In the second and third cases, not even this move seems available.

12.6.5 The semantics of first-order logic also validates the general law of the substitutivity of identicals (see 12.9.2):

$$a = b, A_x(a) \vDash A_x(b)$$

(I will also abbreviate this general form as SI.) There are a number of apparent counter-examples to this, such as the following:

$$a = b, 'a' \text{ is the first letter of the alphabet; so } 'b' \text{ is the first letter of the alphabet.}$$

The standard response to this is to say that the context

$$'...'$$
 is the first letter of the alphabet

and similar quotational contexts, are not predicates in the sense of first-order logic. That is, the claim that 'a' is the first letter of the alphabet is not about a at all. " 'a' " simply refers to the letter 'a'; the referent of 'a' itself is irrelevant.

12.6.6 Other examples are not so easily defused. Thus, suppose that I show you a picture of a baby. Let us call the person involved a . I then show you a picture of an adult. Let us call the person involved b . Suppose that, as a matter of fact, a and b are the same person (at different stages of her life). Then $a = b$ and a is a baby; but it is not true that b is a baby.

12.6.7 It is natural to try to solve this problem by bringing time into the matter explicitly. There are two obvious ways this can be done, depending on whether we understand the sentence 'a is a baby' as:

$$a\text{-at-time-}t \text{ is a baby}$$

or as

$$a \text{ is a-baby-at-time-}t$$

(where t is the time when the photograph was taken). Some deep metaphysical issues hang on this difference, but these need not concern us here. In either case SI can now be admitted: $b\text{-at-time-}t$ is a baby, and b is a-baby-at-time- t .

12.6.8 There are cases where even this move is not available, however. Substitution into intentional contexts (that is, contexts containing predicates for certain kinds of mental states) causes problems of the following kind. The real name of the novelist George Eliot was 'Mary Anne Evans'. For many years I knew that George Eliot was a novelist; I had no idea that Mary Anne Evans was a novelist. And I knew that George Eliot was George Eliot; I had no idea that George Eliot was Mary Anne Evans. And from time to time I thought about George Eliot, but I was not thinking about Mary Anne Evans.

12.6.9 We will return to a number of these problems in subsequent chapters.

12.7 Some Final Technical Comments

12.7.1 Before we finish, let me comment on a few topics of a more technical nature. These remarks can be omitted without loss of continuity.

12.7.2 We have dealt so far with tableaux for finite sets of premises. The tableau technique can be extended to apply to arbitrary sets of premises. If there are any premises at all, we form them into a (possibly infinite) list.⁴ We start the tableau with just the negation of the conclusion. Then at regular intervals in applying the rules – say, at the end of every cycle in the algorithm described in 12.4.12 – we add to each open branch of the tableau the first premise on the list that has not so far been used. In this way, every premise gets added to every open branch sooner or later. When applying PI in tableaux constructed in this way, it is important that the constant employed be not just new to the branch, but new to all the premises, as well. Since it is possible for all of the constants in the language to occur in an infinite number of premises, we may have to augment the language with a set of new constants, c_i , for every natural number i , to make the construction of the tableaux possible.

12.7.3 Note that when the number of premises is finite, constructing the tableau in this way gives exactly the same result as constructing it the usual way. All that might be affected is the order in which rules get applied, and, as we know from 12.4.4, this does not matter.

⁴ It is not entirely obvious that this can be done, but that it can be follows from a few elementary facts about cardinality.

12.7.4 The proofs of soundness and completeness for the finite case carry over with only very minor modifications to the new construction.

12.7.5 The *Compactness Theorem* states that whenever $\Sigma \models A$ then there is a finite subset of Σ , Σ' , such that $\Sigma' \models A$. This is an almost immediate consequence of the Soundness and Completeness Theorems.

12.7.6 The *Löwenheim–Skolem Theorem* (in one form) states that any invalid inference has a counter-model with a countable domain. That is, the members of the domain can be made into a list of the form d_1, d_2, d_3, \dots (possibly containing repetitions). This is, again, almost an immediate corollary of the Soundness and Completeness Theorems.

12.7.7 The proofs of all of the above facts are spelled out in 12.10.

12.7.8 It should be noted that the comments in this section apply quite generally to all the systems of logic we will be concerned with in this part of the book which have sound and complete tableau systems.⁵ I will not reiterate the points for each system we deal with.

12.8 *Proofs of Theorems 1

12.8.1 In this section, we prove the soundness and completeness of the tableaux without identity. In the next section, this is extended by the addition of identity. Some important corollaries are inferred in the section after this. We start with a couple of important lemmas.

12.8.2 LEMMA (LOCALITY): Let $\mathcal{J}_1 = \langle D, v_1 \rangle$, $\mathcal{J}_2 = \langle D, v_2 \rangle$ be two interpretations. Since they have the same domain, the language of the two is the same. Call this L . If A is any closed formula of L such that v_1 and v_2 agree on the denotations of all the predicates and constants in it then:

$$v_1(A) = v_2(A)$$

Proof:

The result is proved by recursion on formulas. For atomic formulas:

$$\begin{aligned} v_1(Pa_1 \dots a_n) = 1 & \text{ iff } \langle v_1(a_1), \dots, v_1(a_n) \rangle \in v_1(P) \\ & \text{ iff } \langle v_2(a_1), \dots, v_2(a_n) \rangle \in v_2(P) \\ & \text{ iff } v_2(Pa_1 \dots a_n) = 1 \end{aligned}$$

⁵ The same is true of logics with sound and complete axiom systems, though in this case the Löwenheim–Skolem Theorem is harder to prove.

The induction cases for the connectives are straightforward, and are left as exercises. The case for the universal quantifier is as follows. That for the particular quantifier is similar.

$$\begin{aligned} v_1(\forall xB) = 1 & \text{ iff } \text{for all } d \in D, v_1(B_x(k_d)) = 1 \\ & \text{ iff } \text{for all } d \in D, v_2(B_x(k_d)) = 1 \quad (*) \\ & \text{ iff } v_2(\forall xB) = 1 \end{aligned}$$

The line marked (*) follows from the induction hypothesis (IH), and the fact that $v_1(k_d) = v_2(k_d) = d$. ■

12.8.3 LEMMA (DENOTATION): Let $\mathcal{J} = \langle D, v \rangle$ be any interpretation. Let A be any formula of $L(\mathcal{J})$ with at most one free variable, x (though it can have multiple occurrences), and a and b be any two constants such that $v(a) = v(b)$. Then:

$$v(A_x(a)) = v(A_x(b))$$

Proof:

The proof is by recursion on formulas. For atomic formulas (I assume that the formula has one occurrence of ' a ', distinct from each a_i , for the sake of illustration):

$$\begin{aligned} v(Pa_1 \dots a \dots a_n) = 1 & \text{ iff } \langle v(a_1), \dots, v(a), \dots, v(a_n) \rangle \in v(P) \\ & \text{ iff } \langle v(a_1), \dots, v(b), \dots, v(a_n) \rangle \in v(P) \\ & \text{ iff } v(Pa_1 \dots b \dots a_n) = 1 \end{aligned}$$

The argument for connectives is straightforward. The case for the universal quantifier is as follows. That for the particular quantifier is similar. Let A be of the form $\forall yB$. If x is the same variable as y then A has no free occurrences of x . Hence, $A_x(a)$ and $A_x(b)$ are just A , and the result is trivial. So suppose that x and y are distinct variables. Note that, in this case, $(\forall yB)_x(c)$ is the same as $\forall y(B_x(c))$. (It does not matter whether you take B , make the substitution, and then stick the quantifier on the front, or do these things in the reverse order. The result is the same.) Similarly, $(B_x(c))_y(a)$ is the same as $(B_y(a))_x(c)$. (Each is the result of substituting c for x and a for y . The order in which one

does this does not matter.) So:

$$\begin{aligned}
 v((\forall yB)_x(a)) = 1 & \text{ iff } v(\forall y(B_x(a))) = 1 \\
 & \text{ iff for all } d \in D, v((B_x(a))_y(k_d)) = 1 \\
 & \text{ iff for all } d \in D, v((B_y(k_d))_x(a)) = 1 \\
 & \text{ iff for all } d \in D, v((B_y(k_d))_x(b)) = 1 \quad (\text{IH}) \\
 & \text{ iff for all } d \in D, v((B_x(b))_y(k_d)) = 1 \\
 & \text{ iff } v(\forall y(B_x(b))) = 1 \\
 & \text{ iff } v((\forall yB)_x(b)) = 1
 \end{aligned}$$

■

12.8.4 COROLLARY: Let \mathfrak{I} be any interpretation. Let C be any set of constants such that every object in the domain of quantification has a name in C . Then:

$$\begin{aligned}
 v(\forall xA) = 1 & \text{ iff for all } c \in C, v(A_x(c)) = 1 \\
 v(\exists xA) = 1 & \text{ iff for some } c \in C, v(A_x(c)) = 1
 \end{aligned}$$

Proof:

Here is the proof for \forall . The proof for \exists is similar.

Suppose that $v(\forall xA) = 1$. Then for all d in the domain of quantification, $v(A_x(k_d)) = 1$. Consider any $c \in C$. For some d in the domain $v(c) = d = v(k_d)$. By the Lemma, $v(A_x(c)) = 1$.

Conversely, suppose that $v(\forall xA) = 0$. Then for some d in the domain, $v(A_x(k_d)) = 0$. By assumption, there is a $c \in C$ such $v(c) = d = v(k_d)$. By the Lemma, $v(A_x(c)) = 0$. ■

12.8.5 SOUNDNESS LEMMA: Consider any initial segment of a branch of a tableau. Suppose that some interpretation, $\mathfrak{I} = \langle D, v \rangle$, makes every formula on the branch true. If we apply a rule of inference to the branch then it produces at least one extension of the branch such that there is an interpretation, \mathfrak{I}' , which makes all the formulas on that extension true.

Proof:

To prove this, we consider each rule in turn. The cases for the connectives are the same as in the propositional case (1.11.2), and \mathfrak{I}' can simply be taken to be \mathfrak{I} . Hence, we need consider only the rules for quantifiers. Suppose that

we apply the rule:

$$\begin{array}{c} \neg\forall xA \\ \downarrow \\ \exists x\neg A \end{array}$$

\mathcal{I} makes $\neg\forall xA(x)$ true. Hence, \mathcal{I} makes $\forall xA(x)$ false. So there is some $d \in D$ such that $A_x(k_d)$ is false. That is, $\neg A_x(k_d)$ is true. So \mathcal{I} makes $\exists x\neg A$ true. We can therefore take \mathcal{I}' to be \mathcal{I} . The argument for the other rule concerning negation is the same.

Suppose we apply the rule:

$$\begin{array}{c} \forall xA \\ \downarrow \\ A_x(a) \end{array}$$

Since \mathcal{I} makes $\forall xA$ true, for all $d \in D$, \mathcal{I} makes $A_x(k_d)$ true. Let d be such that $v(a) = v(k_d)$. By the Denotation Lemma, \mathcal{I} makes $A_x(a)$ true. Hence we can take \mathcal{I}' to be \mathcal{I} .

Suppose that we apply the rule:

$$\begin{array}{c} \exists xA \\ \downarrow \\ A_x(c) \end{array}$$

\mathcal{I} makes $\exists xA$ true. Hence there is some $d \in D$ such that \mathcal{I} makes $A_x(k_d)$ true. Let $\mathcal{I}' = \langle D, v' \rangle$ be the same as \mathcal{I} , except (if necessary) that $v'(c) = d$. Since c does not occur in $A_x(k_d)$, \mathcal{I}' makes $A_x(k_d)$ true, by the Locality Lemma. Since $v'(c) = d = v'(k_d)$, \mathcal{I}' makes $A_x(c)$ true, by the Denotation Lemma. And since c does not occur in any other formula on the branch, \mathcal{I}' makes all other relevant formulas true as well, by the Locality Lemma. ■

12.8.6 SOUNDNESS THEOREM: For finite Σ , if $\Sigma \vdash A$ then $\Sigma \models A$.

Proof:

Suppose that $\Sigma \not\models A$. Then there is an interpretation, \mathcal{I} , which makes all members of Σ true and A false. Consider any completed tableau for the inference. \mathcal{I} makes all the formulas on the initial list of the tableau true. When we apply a rule to the list, we can, by the Soundness Lemma, find at least one of its extensions such that there is an interpretation, \mathcal{I}' , which makes every formula on the extension true. Similarly, when we apply a rule

to this, we can find at least one of *its* extensions, and an interpretation, \mathcal{I}'' , which makes all the formulas on it true; and so on. By repeatedly applying the Soundness Lemma in this way, we can find a whole branch, \mathcal{B} , such that for every initial section of it (and so the whole branch itself if this is finite) there is an interpretation which makes every formula on the section true. Now, if \mathcal{B} were closed, it would have to contain some formulas of the form B and $\neg B$, and these must occur in some initial section of \mathcal{B} . But this is impossible, since we would then have an interpretation where $v(B) = v(\neg B) = 1$, which cannot be the case. Hence, the tableau is open, i.e., $\Sigma \not\vdash A$. ■

12.8.7 DEFINITION: Suppose that we have a tableau with an open branch, \mathcal{B} . Let C be the set of all constants on \mathcal{B} . The interpretation *induced* by \mathcal{B} is the interpretation $\langle D, v \rangle$, defined as follows: $D = \{\partial_a : a \in C\}$.⁶ For all constants, a , on \mathcal{B} , $v(a) = \partial_a$. For every n -place predicate on \mathcal{B} , $\langle \partial_{a_1}, \dots, \partial_{a_n} \rangle \in v(P)$ iff $Pa_1 \dots a_n$ is on \mathcal{B} . (If a constant or predicate is not on \mathcal{B} , its denotation does not matter, by the Locality Lemma.)

12.8.8 COMPLETENESS LEMMA: Given the interpretation specified in 12.8.7, for every formula A :

if A is on \mathcal{B} then $v(A) = 1$
 if $\neg A$ is on \mathcal{B} then $v(A) = 0$

Proof:

The proof is by recursion on formulas. For atomic formulas:

$$\begin{aligned} Pa_1 \dots a_n \text{ is on } \mathcal{B} &\Rightarrow \langle \partial_{a_1}, \dots, \partial_{a_n} \rangle \in v(P) \\ &\Rightarrow \langle v(a_1), \dots, v(a_n) \rangle \in v(P) \\ &\Rightarrow v(Pa_1 \dots a_n) = 1 \end{aligned}$$

$$\begin{aligned} \neg Pa_1 \dots a_n \text{ is on } \mathcal{B} &\Rightarrow Pa_1 \dots a_n \text{ is not on } \mathcal{B} \quad (\mathcal{B} \text{ open}) \\ &\Rightarrow \langle \partial_{a_1}, \dots, \partial_{a_n} \rangle \notin v(P) \\ &\Rightarrow \langle v(a_1), \dots, v(a_n) \rangle \notin v(P) \\ &\Rightarrow v(Pa_1 \dots a_n) = 0 \end{aligned}$$

⁶ Note that this must be non-empty. If the formulas on the initial list contain no constants, they must contain quantifiers. And when we get around to applying the quantifier rules to these, they will introduce at least one new constant, whether the quantifiers are universal or particular.

For the propositional connectives, the argument is as in the propositional case (1.11.5). Here is the case for \exists . The case for \forall is similar. Suppose that $\exists xA$ is on the branch. Then for some c , $A_x(c)$ is on the branch. By IH, $v(A_x(c)) = 1$. For some $d \in D$, $v(c) = d$. But $v(k_d) = d$. Hence, $v(A_x(k_d)) = 1$, by the Denotation Lemma. That is, $v(\exists xA) = 1$. Suppose that $\neg\exists xA$ is on the branch. Then so is $\forall x\neg A$. So for all $c \in C$, $\neg A_x(c)$ is on the branch and so $v(A_x(c)) = 0$ (by IH). If $d \in D$, then for some $c \in C$, $v(c) = v(k_d)$. Hence, $v(A_x(k_d)) = 0$, by the Denotation Lemma. Thus, $v(\exists xA) = 0$. ■

12.8.9 COMPLETENESS THEOREM: For finite Σ , if $\Sigma \models A$ then $\Sigma \vdash A$.

Proof:

Suppose that $\Sigma \not\vdash A$. Construct a tableau for the inference. Define the interpretation as in 12.8.7. By the Completeness Lemma, this makes all the members of Σ true and A false. Hence, $\Sigma \not\models A$. ■

12.8.10 COROLLARY: Given a tableau for an inference, it does not matter in what order you apply the rules; the result will always be the same.

Proof:

Suppose, for *reductio*, that you have two tableaux for the inference, T_1 and T_2 , such that T_1 is open and T_2 is closed. Choose an open branch of T_1 . Let \mathfrak{J} be the interpretation it induces. By the Completeness Lemma, this makes all the premises and the negation of the conclusion true. Now take \mathfrak{J} , and apply it to T_2 , as in the argument of the proof of the Soundness Theorem. It follows that T_2 is open. Contradiction. ■

12.9 *Proofs of Theorems 2

12.9.1 We now extend the results of the previous section to incorporate identity. First, note that the proofs of the Locality and Denotation Lemmas are unaffected by taking one of the predicates in the language to be identity. These lemmas therefore continue to hold.

12.9.2 COROLLARY OF DENOTATION LEMMA:

$$a = b, A_x(a) \models A_x(b)$$

Proof:

Suppose that $a = b$ and $A_x(a)$ are both true in an interpretation, $\langle D, \nu \rangle$. Then $\nu(a) = \nu(b)$. By the Denotation Lemma, $\nu(A_x(a)) = \nu(A_x(b))$. Hence, $A_x(b)$ is true in the interpretation. ■

12.9.3 SOUNDNESS THEOREM: For finite Σ , if $\Sigma \vdash A$ then $\Sigma \models A$.

Proof:

The Soundness Lemma is proved as in 12.8.5. There are two new cases, one for each of the identity rules. For the first, $\langle \nu(a), \nu(a) \rangle \in \nu(=)$. So $a = a$ is true in every interpretation, and we may simply take \mathcal{J}' to be \mathcal{J} . For SI: suppose that $a = b$ and $A_x(a)$ are both true in \mathcal{J} . Then $A_x(b)$ is true in \mathcal{J} , by 12.9.2. Hence, we can take \mathcal{J}' to be \mathcal{J} .

The Soundness Theorem follows from the Soundness Lemma as in 12.8.6. ■

12.9.4 DEFINITION: Given any completed open branch, \mathcal{B} , of a tableau with identity, the interpretation induced by it, $\langle D, \nu \rangle$, is defined as follows. Let C be the set of constants on the branch. Let $a \sim b$ iff ' $a = b$ ' is on \mathcal{B} . It is easy to check that \sim is an equivalence relation. Let $[a]$ be the equivalence class of a .

$$D = \{[a] : a \in C\}$$

$$\nu(a) = [a]$$

(So in the construction of 12.5.9, $[a]$ is playing the role of ∂_a .) For any predicate, P , other than identity:

$$\langle [a_1], \dots, [a_n] \rangle \in \nu(P) \text{ iff the formula } Pa_1 \dots a_n \text{ occurs on } \mathcal{B}.$$

(The interpretation of the identity predicate needs no specification, since it is always the same.) Note that $\nu(P)$ is well defined. For if, say, $[a] = [c]$, then $a \sim c$; so $Pa_1 \dots a \dots a_n$ occurs on the branch iff $Pa_1 \dots c \dots a_n$ does, because of SI.

12.9.5 COMPLETENESS THEOREM: For finite Σ , if $\Sigma \models A$ then $\Sigma \vdash A$.

Proof:

We prove the Completeness Lemma using the notion of induced interpretation of 12.9.4. The proof is exactly the same as before (12.8.8), except for the basis cases. (For the quantifiers, note that every object in the domain, $[a]$, still has a name on the branch – in fact, multiple names: every member

of the equivalence class.) The basis cases now go as follows. If P is not the identity predicate:

$$\begin{aligned}
 Pa_1 \dots a_n \text{ is on } \mathcal{B} &\Rightarrow \langle [a_1], \dots, [a_n] \rangle \in v(P) \\
 &\Rightarrow \langle v(a_1), \dots, v(a_n) \rangle \in v(P) \\
 &\Rightarrow v(Pa_1 \dots a_n) = 1 \\
 \\
 \neg Pa_1 \dots a_n \text{ is on } \mathcal{B} &\Rightarrow Pa_1 \dots a_n \text{ is not on } \mathcal{B} \quad (\mathcal{B} \text{ open}) \\
 &\Rightarrow \langle [a_1], \dots, [a_n] \rangle \notin v(P) \\
 &\Rightarrow \langle v(a_1), \dots, v(a_n) \rangle \notin v(P) \\
 &\Rightarrow v(Pa_1 \dots a_n) = 0
 \end{aligned}$$

For the identity predicate:

$$\begin{aligned}
 a_1 = a_2 \text{ is on } \mathcal{B} &\Rightarrow a_1 \sim a_2 \\
 &\Rightarrow [a_1] = [a_2] \\
 &\Rightarrow v(a_1) = v(a_2) \\
 &\Rightarrow v(a_1 = a_2) = 1 \\
 \\
 \neg a_1 = a_2 \text{ is on } \mathcal{B} &\Rightarrow a_1 = a_2 \text{ is not on } \mathcal{B} \quad (\mathcal{B} \text{ open}) \\
 &\Rightarrow \text{it is not the case that } a_1 \sim a_2 \\
 &\Rightarrow [a_1] \neq [a_2] \\
 &\Rightarrow v(a_1) \neq v(a_2) \\
 &\Rightarrow v(a_1 = a_2) = 0
 \end{aligned}$$

The Completeness Theorem follows from the Completeness Lemma, as in 12.8.9. ■

12.10 *Proofs of Theorems 3

12.10.1 THEOREM: The tableaux for arbitrary sets of premises (with or without identity) given in 12.7.2 are sound and complete with respect to inferences with arbitrary sets of premises.

Proof:

The proof of completeness is exactly the same as in the finite case. The proof of soundness requires a minor modification. We reformulate the Soundness Lemma (the additions are italicised):

Consider any initial segment of a branch of a tableau. Suppose that some interpretation, $\mathfrak{I} = \langle D, v \rangle$, makes every member of Σ and every formula on the

branch true. If we *add a member of Σ to a branch* or apply a rule of inference to the branch then it produces at least one extension of the branch such that there is an interpretation, \mathcal{J}' , which makes *every member of Σ and all the formulas on that extension true*.

The proof is as in 12.8.5. There is one extra case to consider, namely when we add a member of Σ to the branch. In this case, we can just take \mathcal{J}' to be \mathcal{J} .

The Soundness Theorem now follows from the Soundness Lemma exactly as in 12.8.6. ■

12.10.2 COMPACTNESS THEOREM: If $\Sigma \models A$ then there is a finite subset of Σ , Σ' , such that $\Sigma' \models A$.

Proof:

Draw up the tableau for the inference. Since the inference is valid the tableau will close. Each branch closes after a finite number of steps. By König's Lemma, the whole tableau will close after a finite number of steps.⁷ In particular, only a finite subset of members of Σ , Σ' , will have been used. This shows that $\Sigma' \vdash A$, that is, $\Sigma' \models A$ by the Soundness Theorem. ■

12.10.3 LÖWENHEIM-SKOLEM THEOREM: If $\Sigma \not\models A$ the inference has a counter-model where the domain is countable.

Proof:

Since the tableau does not close, it has an open branch. Define the counter-model as in the Completeness Lemma. We can list all the constants on the branch in the following way. We start with all the constants in the first formula on the branch. We then add any new constants in the second formula, and so on. Suppose this list is: a_0, a_1, a_2, \dots (If we run out of constants, we can merely recycle one an infinite number of times.) The list

⁷ König's Lemma says that a tableau with an infinite number of nodes has a branch with an infinite number of nodes (and conversely, if every branch is finite, so is the whole tableau).

The proof of König's Lemma goes as follows. Suppose that the tableau is infinite. Consider the first node, n_0 . This must have an infinite number of nodes below it. If it has one immediate descendant, this must have an infinite number of nodes below it. If it has two immediate descendants, at least one of them must have an infinite number of nodes below it. In either case, there is an immediate descendent with an infinite number of nodes below it, n_1 . Repeat the argument for n_1 , and so on. In this way we obtain a sequence of nodes n_0, n_1, n_2, \dots . This is an infinite branch.

$v(a_0), v(a_1), v(a_2), \dots$ is a list of all the objects in the domain (whether or not the tableau contains identity). ■

12.11 History

Quantifiers were invented by Frege in his *Begriffsschrift* (translated in Bynum, 1972), and at about the same time by C. S. Peirce (see Berry, 1952), though Peirce's work had little impact at the time. Before that, what we would now think of as quantifier phrases were treated quite differently. In Medieval logic, they were handled by something called the theory of supposition and related notions (see Read, 2006). Quantifiers that can stand in object places, as in this chapter, are called 'first-order'; so the logics containing them are called 'first-order logics'. Frege's system also had quantifiers that could stand in predicate places, thus: $\exists X Xa$. Such quantifiers are called 'second-order', and the logics containing them are called 'second-order logics'.

Reasoning employing identity can be found in Ancient Greek geometry (e.g., 'things equal to the same thing are equal to one another', 'if equals are added to equals the wholes are equal', Euclid, Book I, common notions 1 and 2); but identity did not come to be a part of logic until about the time of Leibniz, who endorsed both SI and its converse, thus: $a = b \equiv \forall X(Xa \equiv Xb)$. (On the logic of Leibniz, see Kneale and Kneale, 1975, V.2 and V.3.) This equivalence can be used to provide a *definition* of identity in classical second-order logic, and is, in fact, how Frege handled identity. The treatment of identity in this chapter, as a self-standing notion, is due to Hilbert and his school. (See Hilbert and Ackermann, 1928.)

Versions of the Löwenheim–Skolem Theorem were produced by Löwenheim (1915) and Skolem (1920). The Compactness Theorem was first proved by Gödel (1930). For the record, it is so called because the compactness theorem for classical propositional logic is equivalent to the compactness theorem – in the topological sense – for Stone Spaces. (Both the Löwenheim–Skolem and the Compactness theorems fail for standard second-order logic.)

12.12 Further Reading

For treatments of first-order logic based on tableaux, see Jeffrey (1991), Howson (1996), or Restall (2006). For a brief philosophical discussion of

quantification, identity, and some of their philosophical problems, see Priest (2000), chs. 3 and 9.

12.13 Problems

1. Check the details omitted in 12.3.4, 12.4.11 and 12.5.10.
2. By constructing appropriate tableaux, show the following:
 - (a) $\forall xPx \vdash \forall yPy$
 - (b) $\exists x\exists ySxy \vdash \exists y\exists xSxy$
 - (c) $\neg\exists xA \vdash \forall x(A \supset B)$
 - (d) $\forall xC \vdash \forall x(A \supset (B \vee C))$
3. Construct tableaux to check the following. If the tableau does not close, construct a counter-model from the open branch and check that it works. If the tableau is infinite, see if you can find a simple finite counter-model by trial and error.
 - (a) $\forall x(Px \supset Qx), \exists x\neg Px \vdash \forall x\neg Qx$
 - (b) $\forall x(Px \supset \exists ySxy) \vdash \forall x\exists y(Px \supset Sxy)$
 - (c) $\forall xPx \supset \forall yQy \vdash \forall x(Px \supset \forall yQy)$
 - (d) $\exists x(Px \supset \forall yQy) \vdash \exists xPx \supset \forall yQy$
 - (e) $\vdash \forall x\exists ySxy \supset \exists xSxx$
 - (f) $\exists x\neg\exists ySxy \vdash \exists x\forall ySxy$
4. Check all the facts in 12.4.14.
5. Show the following:
 - (a) $\vdash a = a$
 - (b) $\vdash a = b \supset b = a$
 - (c) $\vdash ((a = b) \wedge (b = c)) \supset (a = c)$
 - (d) $\forall x(x = a \supset Px) \vdash Pa$
 - (e) $Pa \vdash \forall x(x = a \supset Px)$
 - (f) $\exists x(x = a \wedge Px) \vdash Pa$
 - (g) $Pa \vdash \exists x(x = a \wedge Px)$
6. Determine the truth of the following. If the inference is invalid, use an open branch to specify a counter-model for the inference.
 - (a) $\exists xPx, \forall x\forall y((Px \wedge Py) \supset x = y) \vdash \exists x(Px \wedge \forall y(Py \supset x = y))$
 - (b) $\forall x(Px \supset (x = a \vee x = b)), a = b \vee b = c \vee c = a \vdash Pc$
 - (c) $\exists x(Px \wedge \forall y(Py \supset x = y)) \vdash \exists x\forall y(Py \equiv x = y)$
 - (d) $\exists x(\forall zSxz \wedge \forall y(\forall zSyzy \supset x = y)) \vdash \exists x\exists y(\neg Sxy \wedge \neg Syx)$
 - (e) $\exists x\forall y(Py \equiv x = y) \vdash \exists xPx \wedge \forall x\forall y((Px \wedge Py) \supset x = y)$

7. How might one reply to the objections of 12.6.2–12.6.4 and 12.6.8?
8. Show that $\vdash \exists x(\exists yPy \supset Px)$ and $\vdash \exists x(Px \supset \forall yPy)$. Reading ‘ \supset ’ as ‘if... then’, evaluate the plausibility of these inferences.
9. *Check the details omitted in 12.8, 12.9 and 12.10.
10. *Show that $a = b, A_x(a) \vdash A_x(b)$. (Hint: use 12.9.2 and the Soundness and Completeness Theorems.)
11. *In the proof of the Soundness Theorem, given any open branch, we construct a sequence of interpretations, $\mathfrak{J}, \mathfrak{J}', \mathfrak{J}'', \dots$, such that for any initial section of the branch, a member of the sequence makes all the formulas on it true. Use the sequence to define a single interpretation that makes every formula on the whole branch true.

13 Free Logics

13.1 Introduction

13.1.1 The family of *free logics* is a family of systems of logic that dispense with a number of the existential assumptions of classical logic.

13.1.2 In this chapter, we will look at the semantics of, and tableau systems for, various free logics.

13.1.3 We will then discuss how these logics handle some issues concerning existence.

13.1.4 Until further notice, we assume that the language does not contain the identity predicate. In the final part of the chapter, we will see how its addition affects matters.

13.2 Syntax and Semantics

13.2.1 The vocabulary of free logic is the same as that of classical first-order logic, except that we single out one of the one-place predicates for special treatment. Let this be P_1^0 . We will write this as \mathfrak{E} , and think of it as an existence predicate. Thus, $\mathfrak{E}a$ can be thought of as ‘ a exists’.

13.2.2 An interpretation for the language is a triple $\langle D, E, \nu \rangle$, where D is a non-empty set, and E (the ‘inner domain’) is a (possibly empty) subset of D . One can think of D as the set of all objects, and E as the set of all existent objects. Thus, one might think of D as containing objects such as Sherlock Holmes, Pegasus and Julius Caesar. Only the last of these would be in E .

13.2.3 As in classical logic, ν assigns every constant in the language a member of D , and every n -place predicate a subset of D^n . In any interpretation, $\nu(\mathfrak{E}) = E$.

13.2.4 The truth conditions for closed sentences in the language of an interpretation, \mathcal{J} , are given in exactly the same way as in classical logic (12.3), except for those of the quantifiers, which are as follows:

$$\begin{aligned} \nu(\forall xA) &= 1 \text{ iff for all } d \in E, \nu(A_x(k_d)) = 1 \text{ (otherwise it is 0)} \\ \nu(\exists xA) &= 1 \text{ iff for some } d \in E, \nu(A_x(k_d)) = 1 \text{ (otherwise it is 0)} \end{aligned}$$

13.2.5 An inference is semantically valid if it is truth-preserving in all interpretations, as in classical logic.

13.2.6 Note that we have the free analogue of 12.3.5. If C is some set of constants such that every object in D has a name in C , then:

$$\begin{aligned} \nu(\forall xA) &= 1 \text{ iff for all } c \in C \text{ such that } \nu(\mathcal{E}c) = 1, \nu(A_x(c)) = 1 \text{ (otherwise it is 0)} \\ \nu(\exists xA) &= 1 \text{ iff for some } c \in C \text{ such that } \nu(\mathcal{E}c) = 1, \nu(A_x(c)) = 1 \text{ (otherwise} \\ &\quad \text{it is 0)} \end{aligned}$$

The proof is, again, a simple corollary of the Denotation Lemma, and is given in 13.7.14. The result carries over to all logics with a domain of quantification circumscribed by an existence predicate, and I will not keep mentioning the fact.

13.3 Tableaux

13.3.1 The tableaux for free logic are the same as those for classical logic, except that the rules of universal and particular instantiation are now formulated as follows:

$$\begin{array}{ccc} \forall xA & & \exists xA \\ \swarrow \searrow & & \downarrow \\ \neg \mathcal{E}a & A_x(a) & \mathcal{E}c \\ & & A_x(c) \end{array}$$

a is any constant on the branch (choosing a new constant only if there are none there already); c is a constant new to the branch.

13.3.2 Here is a tableau to demonstrate that $\forall xPx, \exists xQx \vdash \exists x(Px \wedge Qx)$.

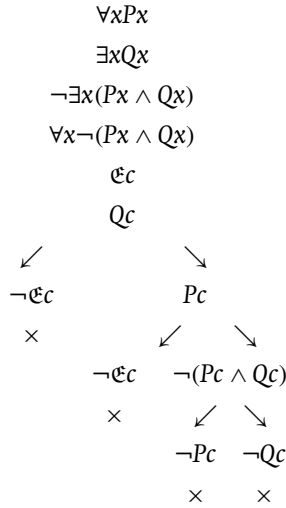

The new rule for particular instantiation is applied at lines five and six. The new rule for universal instantiation is applied the first two times the tableau splits.

13.3.3 Here are two more tableaux, showing that $Pa \not\vdash \exists xPx$, and $\not\vdash \exists x(Px \vee \neg Px)$.

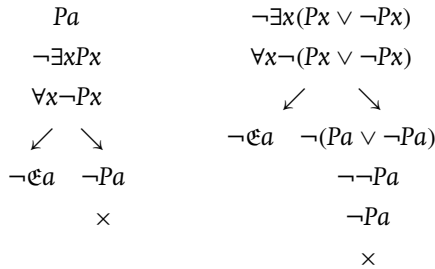

13.3.4 To read off a counter-model from an open branch of a tableau, the procedure is exactly as for classical logic, and $E = \nu(\mathfrak{E})$. Since every object in D has a name in the interpretation, and given the definition of E , 13.2.6 assures us that to check that $\nu(\exists xA) = 1$, we just have to show that $\nu(A_x(c)) = 1$ for some c such that $\mathfrak{E}c$ is on the branch; and to check that $\nu(\forall xA) = 1$, we just have to show that $\nu(A_x(c)) = 1$ for every constant, c , such that $\mathfrak{E}c$ is on the branch.

13.3.5 The counter-model determined by the open branch of the first tableau of 13.3.3 is as follows: $D = \{\partial_a\} = v(P)$, $E = \phi = v(\mathfrak{E})$, and $v(a) = \partial_a$. In the counter-model determined by the open branch of the second tableau, $D = \{\partial_a\}$, $E = \phi = v(\mathfrak{E})$, $v(a) = \partial_a$, and $v(P) = \phi$. It is easy to check that these work. Details are left as an exercise.

13.4 Free Logics: Positive, Negative and Neutral

13.4.1 As we saw in 12.6.1–12.6.4, if the particular quantifier is interpreted as expressing existence, classical first-order logic shows to be valid inferences that are intuitively not so. We saw in 13.3.3 that free logic does not have the same problematic consequences: particular generalisation fails, since a constant can denote a non-existent object; and the logic is not committed to the logical truth that something exists, for there are interpretations where E is the empty set.

13.4.2 The semantics we have been considering allow for non-existent objects to have positive properties (that is, they may satisfy Px , Qxy , or other atomic formulas). Thus, for example, it is not hard to construct an interpretation that makes $\neg \mathfrak{E}a \wedge Pa$ true. Free logics of this kind are called *positive* free logics. Some have felt it intuitively implausible that a non-existent object can have positive properties. One can see or kick or run past an existent object, but one cannot see or kick or run past a non-existent object. The condition that non-existent objects have no positive properties can be enforced by adding the following constraint on all interpretations. For any n , and n -place predicate, P :

(*) If $\langle d_1, \dots, d_n \rangle \in v(P)$ then $d_1 \in v(\mathfrak{E})$, and ...and $d_n \in v(\mathfrak{E})$

We will call (*) the *Negativity Constraint*. Logics that impose this constraint are called *negative* free logics.

13.4.3 To obtain tableaux for negative free logics, we add the rule:

$$\begin{array}{c} Pa_1 \dots a_n \\ \downarrow \\ \mathfrak{E}a_1 \\ \vdots \\ \mathfrak{E}a_n \end{array}$$

which we will call the *Negativity Constraint Rule* (NCR). This gives the characteristic inference of negative free logics, $Pa_1 \dots a_i \dots a_n \vdash \exists x Pa_1 \dots x \dots a_n$:

$$\begin{array}{c}
 Pa_1 \dots a_i \dots a_n \\
 \neg \exists x Pa_1 \dots x \dots a_n \\
 \mathfrak{E}a_i \\
 \forall x \neg Pa_1 \dots x \dots a_n \\
 \swarrow \quad \searrow \\
 \neg \mathfrak{E}a_i \quad \neg Pa_1 \dots a_i \dots a_n \\
 \times \quad \quad \times
 \end{array}$$

The NCR is applied at line three.

13.4.4 Here is another to show that $\not\vdash (Qab \wedge \neg Sac) \supset \mathfrak{E}c$:

$$\begin{array}{c}
 \neg((Qab \wedge \neg Sac) \supset \mathfrak{E}c) \\
 Qab \wedge \neg Sac \\
 \neg \mathfrak{E}c \\
 Qab \\
 \neg Sac \\
 \mathfrak{E}a \\
 \mathfrak{E}b
 \end{array}$$

The last two lines are given by the NCR. We read off a counter-model as before. Thus, $D = \{\partial_a, \partial_b, \partial_c\}$, $E = \{\partial_a, \partial_b\} = \nu(\mathfrak{E})$, $\nu(Q) = \{\langle \partial_a, \partial_b \rangle\}$, and $\nu(S) = \emptyset$. It is routine to check that this interpretation satisfies the Negativity Constraint, and that it is a counter-model.

13.4.5 The tableaux for positive and negative free logics are sound and complete with respect to their semantics (as proved in 13.7).

13.4.6 Negative free logics are not without their philosophical problems. In 12.6.4 we noted some apparent counter-examples to the Negativity Constraint. One was ‘I am thinking about Sherlock Holmes’. Others of the same kind are: ‘Homer worshipped Zeus’, ‘Little Johnny fears Gollum (whom he believes to exist)’. From this perspective, the verbs ‘kicks’ and ‘runs past’ of 13.4.2 look like special cases.

13.4.7 It has been suggested by some that sentences (in particular, atomic sentences) that contain names that do not refer to existent objects should not be uniformly false, but uniformly neither true nor false. Logics which enforce this idea are often referred to as *neutral* free logics. To do justice to the idea one needs a logic with truth value gaps; we will return to the matter in chapter 21.

13.5 Quantification and Existence

13.5.1 Free logics of the kind at which we have been looking contain names for non-existent objects, but they do not allow us to quantify over them. This may be thought somewhat arbitrary, especially given the semantics. Why not allow quantifiers to range over all objects? Thus, we might add another kind of quantifier whose truth conditions are exactly the same as those in classical logic, with domain of quantification D . In tableaux, these quantifiers would function, of course, just as do quantifiers in classical logic.

13.5.2 Let us call such quantifiers *outer quantifiers*, as opposed to the quantifiers with domain E , which are *inner quantifiers*. If we use \exists and \forall for the outer quantifiers, then we need a different notation for inner quantifiers. For the rest of this section (only) I will use \exists^E and \forall^E for them (the superscript ‘ E ’ indicating existential loading).

13.5.3 Of course, if one proceeds in this fashion, one must precisely not read the outer particular quantifier, $\exists xA$, as ‘there exists an x such that A ’. That is how one reads $\exists^E xA$. ‘Some x is such that A ’ will do nicely as a reading. Thus, ‘ $\exists x x$ is a cat’ can be read as ‘Some x is such that x is a cat’, or more simply, ‘Something is a cat’. The outer universal quantifier, $\forall xA$, note, can still be read as ‘Every x is such that A ’. It is the inner quantifier $\forall^E xA$ that now needs to have its standard reading changed to ‘Every existent x is such that A ’. What of the locution ‘there is an x such that A ’? Conceivably, one might use this for either inner or outer particular quantification: we can, after all, use words to mean whatever we wish, provided that it is clear to all concerned what we are doing. My own inclination, however, is to use it only for inner quantification. Doing otherwise invites us to draw a distinction

between *exists* and *is* (existence and being), and to impute to non-existent objects some different – usually some second-class – kind of existence.¹ But if an object is non-existent, it is non-existent. End of story.

13.5.4 The founding fathers of classical logic, Frege and Russell, certainly read the quantifier \exists as ‘there exists’, and Quine famously took the quantifier to be *definitional* of existence, in his slogan: ‘to be (= to exist) is to be the value of a bound variable’. But it is not easy to find *arguments* that natural language quantifiers ought always to be understood as existentially loaded, and there are many places in English where this appears not to be the case. Suppose, for example, that I dreamed of an ugly monster last week, and I dreamed of it again last night. Then it would be quite natural to say that I dreamed about something last night which I dreamed about last week, even though that thing does not exist.

13.5.5 A historically influential argument for reading \exists as ‘there exists’ is based on the claim that existence is not a genuine predicate (in some sense of ‘genuine’). If this is right, then it would seem that the only mechanism we have for expressing existence is the quantifier. (Of course, since even free logics with only inner quantifiers use an existence predicate, this is just as much an objection to these.) At root, the basis for this claim is the thought that to predicate *anything* of an object, it must be *there*, in some sense, to be available for predication. Maybe there is some sense in this thought, but identifying *being there* with *existing* is simply question-begging against someone who takes it that non-existent objects can have properties. And natural language would seem to have obvious counter-examples to the claim that an object must exist for one to be able to predicate something of it. Sherlock Holmes can be thought of without existing, and Zeus can be worshipped without existing.²

¹ A view, incidentally, often attributed – fallaciously – to Meinong. It was an early view of Russell.

² A more sophisticated argument against the claim that existence is a genuine predicate is to the effect that, if it were, the Ontological Argument for the existence of God – and of pretty much anything else – would be sound. But this does not follow. To run the Argument one needs not only an existence predicate; one needs also the principle that an object characterised in a certain way has its characterising properties (the Characterisation Principle). No one can accept this, whether or not existence is a predicate.

13.5.6 Two final comments. First, note that inner quantifiers can be defined in terms of outer quantifiers and the existence predicate. It is easy to check that the following pairs of sentences have the same truth values:

$$\begin{aligned}\exists^E x A & \quad \exists x(\mathcal{E}x \wedge A) \\ \forall^E x A & \quad \forall x(\mathcal{E}x \supset A)\end{aligned}$$

Thus, in a free logic with outer quantifiers, we can dispense with inner quantifiers altogether. There is no way of defining outer quantifiers in terms of inner quantifiers.

13.5.7 Second, if one interprets the quantifiers as outer quantifiers, the inference of 12.6.3, from $A_x(a)$ to $\exists x A$, seems quite unproblematic. The fate of the inference of 12.6.2 is less clear. One cannot now object to the logical truth of $\exists x(A \vee \neg A)$ on the ground that it makes the existence of something a logical truth. It is less obvious that the logical truth of ‘something satisfies either A or $\neg A$ ’ is objectionable.

13.6 Identity in Free Logic

13.6.1 Let us now consider how the addition of the identity predicate affects free logic. The situation is the same whether the language has outer quantifiers or merely inner quantifiers. The simplest and most natural treatment of identity in free logic is exactly the same as in classical logic. In any interpretation, $\nu(=) = \{\langle d, d \rangle : d \in D\}$. The tableau rules for it are then exactly the same as in classical logic. In particular, identity has exactly the same properties as it does in classical logic.

13.6.2 In a thoroughgoing negative free logic, however, this approach will not be satisfactory. For we will need to apply the Negativity Constraint of 13.4.2 to all predicates, including identity. Thus, $a = b$ will be false if either a or b does not exist. In particular, $a = a$ will be false if a does not exist.

13.6.3 The semantic and tableau rules for identity must therefore be changed to make this possible. In particular, the extension of identity must be restricted to those things in E ; so $\nu(=) = \{\langle d, d \rangle : d \in E\}$.³ For the

³ Thus, the new relation $x = y$ could be defined in terms of the old one as follows:
 $x = y \wedge \mathcal{E}x \wedge \mathcal{E}y$ (or just $x = y \wedge \mathcal{E}x$).

corresponding tableaux, the first identity rule must be changed to:

$$\begin{array}{c} \mathfrak{E}a \\ \downarrow \\ a = a \end{array}$$

(One can call this rule the Self-Identity of Existents, SIE.) The other, SI, remains the same. We cannot now close a branch simply if we find a line of the form $a \neq a$. But we can, if we find a line of the form $\mathfrak{E}a$ as well. So, in practice, we may close a branch under those conditions. Note that we can still establish the symmetry of identity, as follows:

$$\begin{array}{c} a = b \\ \mathfrak{E}a \\ a = a \\ b = a \end{array}$$

The second line is the NCR.

13.6.4 To illustrate the new rules, consider the following tableaux, which demonstrate that $\neg\mathfrak{E}a \vdash \neg a = b$ and $\not\vdash (\mathfrak{E}a \vee a = a) \wedge (\neg\mathfrak{E}a \vee a = a)$:

$$\begin{array}{ccc} \neg\mathfrak{E}a & \neg((\mathfrak{E}a \vee a = a) \wedge (\neg\mathfrak{E}a \vee a = a)) & \\ \neg\neg a = b & \swarrow & \searrow \\ a = b & \neg(\mathfrak{E}a \vee a = a) & \neg(\neg\mathfrak{E}a \vee a = a) \\ \mathfrak{E}a & \neg\mathfrak{E}a & \neg\neg\mathfrak{E}a \\ \times & a \neq a & a \neq a \\ & & \mathfrak{E}a \\ & & \times \end{array}$$

In the first tableau, line four is obtained by applying the NCR to line three. In the second tableau, the right branch closes, but the left branch, which would have closed with the classical rules for identity, remains open.

13.6.5 Given an open branch of a tableau of this kind, one reads off a counter-model by combining the procedures for negative free logic (13.4.4) with those for identity (12.5.8). In particular, given a bunch of identities, $a = b, b = c, \dots$ on a branch, one chooses a single object for all the constants in the bunch to denote. For every predicate, P , excluding identity (but

including \mathfrak{E} , $\langle \partial_{a_1}, \dots, \partial_{a_n} \rangle \in \nu(P)$ iff $Pa_1 \dots a_n$ is on the branch; $E = \nu(\mathfrak{E})$; and $\nu(=)$ comprises the set of all pairs $\langle d, d \rangle$, where d is any object in E . The left-hand branch of the second tableau of 13.6.4 gives the interpretation where $D = \{\partial_a\}$, $E = \nu(\mathfrak{E}) = \phi = \nu(=)$, and $\nu(a) = \partial_a$. It is not difficult to check that this interpretation makes the whole formula false, since it makes the left conjunct false.

13.6.6 The tableaux for identity, with and without the NCR, are sound and complete with respect to the appropriate semantics. This is proved in 13.7.

13.6.7 It should be noted that applying the Negativity Constraint to identity gives rise to further apparent counter-examples of the kind that we have already met in 13.4.6. It would certainly seem to be false that Sherlock Holmes = Pegasus. But it would seem to be true that Father Christmas = Santa Claus – or even that Santa Claus = Santa Claus.

13.6.8 It should also be noted that whichever treatment of identity one employs, the Substitutivity of Identicals is still valid. Hence, moving to a free logic does nothing to alleviate the problems about identity noted in 12.6.5–12.6.8.

13.6.9 Let me finish with a couple of observations about the relationship between classical logic and free logic. With just outer quantifiers, free logic is just classical logic plus a distinguished predicate for existence. And in positive free logic, even this predicate satisfies no special semantic conditions. The only difference is therefore simply one of informal interpretation.

13.6.10 With just inner quantifiers, consider a free logic interpretation – positive or negative, with or without identity – where $D = E$; this is a classical interpretation. Hence, any inference (not involving \mathfrak{E}) that is valid in the logic is valid in classical logic. (See 3.2.8.) The converse is not the case, as we have had several occasions to note.

13.6.11 However, there is a limited relationship in the other direction. Let the inference with premises Σ and conclusion A be valid in classical logic. Let C be the set of constants that occur in A and all members of Σ , and let $\Pi = \{\mathfrak{E}c : c \in C\} \cup \{\exists x \mathfrak{E}x\}$. (The quantified sentence is redundant if $C \neq \phi$.) Then $\Pi \cup \Sigma \models A$. This is proved in 13.7.13. Note that the quantified member of Π is necessary. For $\forall x Px \not\models \exists x Px$ (as may be checked using tableaux), but this is classically valid.

13.7 *Proofs of Theorems

13.7.1 In this section, we prove a number of metatheorems for free logic, in particular, the appropriate soundness and completeness results. Since these are variations on the classical arguments, this is mainly just a matter of noting differences. Let us start with positive free logic with only inner quantifiers, and no identity.

13.7.2 LEMMA (LOCALITY): Let $\mathfrak{I}_1 = \langle D, E, \nu_1 \rangle$, $\mathfrak{I}_2 = \langle D, E, \nu_2 \rangle$ be two interpretations. Since they have the same domain, the language of the two is the same. Call this L . If A is any closed formula of L such that ν_1 and ν_2 agree on the denotations of all the predicates and constants in it then:

$$\nu_1(A) = \nu_2(A)$$

Proof:

The proof is as in 12.8.2. The only things that have changed are the truth conditions of the quantifiers. In the induction cases for these, ' $d \in D$ ' is simply replaced by ' $d \in E$ '. ■

13.7.3 LEMMA (DENOTATION): Let $\mathfrak{I} = \langle D, E, \nu \rangle$ be any interpretation. Let A be any formula of $L(\mathfrak{I})$ with at most one free variable, x , and a and b be any two constants such that $\nu(a) = \nu(b)$ then:

$$\nu(A_x(a)) = \nu(A_x(b))$$

Proof:

The proof is as in 12.8.3. Again, the only things that have changed are the truth conditions of the quantifiers. In the induction cases for these, ' $d \in D$ ' is simply replaced by ' $d \in E$ '. ■

13.7.4 COROLLARY: Let \mathfrak{I} be any interpretation. Let C be any set of constants such that every object in D has a name in C . Then:

$$\begin{aligned} \nu(\forall xA) &= 1 \text{ iff for all } c \in C \text{ such that } \nu(\mathfrak{E}c) = 1, \nu(A_x(c)) = 1 \text{ (otherwise it is 0)} \\ \nu(\exists xA) &= 1 \text{ iff for some } c \in C \text{ such that } \nu(\mathfrak{E}c) = 1, \nu(A_x(c)) = 1 \text{ (otherwise} \\ &\text{it is 0)} \end{aligned}$$

Proof:

Here is the proof for \forall . The proof for \exists is similar.

Suppose that $v(\forall xA) = 1$. Then for all $d \in E$, $v(A_x(k_d)) = 1$. That is, for all $d \in D$ such that $v(\mathfrak{E}k_d) = 1$, $v(A_x(k_d)) = 1$. Consider any $c \in C$, and suppose that $v(\mathfrak{E}c) = 1$. Let $v(c) = d$. Then, by the Lemma, $v(\mathfrak{E}k_d) = 1$, so $v(A_x(k_d)) = 1$. That is, again by the Lemma, $v(A_x(c)) = 1$.

Conversely, suppose that $v(\forall xA) = 0$. Then for some $d \in E$, $v(A_x(k_d)) = 0$. That is, for some d such that $v(\mathfrak{E}k_d) = 1$, $v(A_x(k_d)) = 0$. Let $v(c) = d$. Then, by the Lemma, $v(\mathfrak{E}c) = 1$ and $v(A_x(c)) = 0$. So it is not the case that for all $c \in C$ such that $v(\mathfrak{E}c) = 1$, $v(A_x(c)) = 1$. ■

13.7.5 THEOREM: The tableaux for free logic are sound with respect to their semantics.

Proof:

The proof is as in the classical case, 12.8.5–12.8.7. The only differences are in the cases for the quantifier rules in the Soundness Lemma. The changes in the rules involving negation are entirely trivial. (Again, ‘ $d \in D$ ’ simply replaces ‘ $d \in E$.’) For universal and particular instantiation, we have the following.

Suppose that $\mathfrak{J} = \langle D, E, v \rangle$ makes $\forall xA$ and all other formulas on the branch true. Then for all $d \in D$, either $d \notin E$, or $A_x(k_d)$ is true. Let c be the instantiating constant, and let $v(c) = d$. In the first case, \mathfrak{J} makes $\neg\mathfrak{E}k_d$ true (and so $\neg\mathfrak{E}c$ true, by the Denotation Lemma); in the second, it makes $A_x(k_d)$ true (and so $A_x(c)$ true, by the Denotation Lemma). Hence \mathfrak{J} makes the next formula on one or other branch true, and we may take \mathfrak{J}' to be \mathfrak{J} .

Suppose that \mathfrak{J} makes $\exists xA$ and all other formulas on the branch true. Then for some d , $\mathfrak{E}k_d$ and $A_x(k_d)$ are true. Let c be the instantiating constant, and let $\mathfrak{J}' = \langle D, E, v' \rangle$ be the same as \mathfrak{J} , except that $v'(c) = d$. By the Locality Lemma, $\mathfrak{E}k_d$ and $A_x(k_d)$ are both true in \mathfrak{J}' ; and by the Denotation Lemma, $\mathfrak{E}c$ and $A_x(c)$ are both true in \mathfrak{J}' . By the Locality Lemma, \mathfrak{J}' makes all the other relevant formulas true. Hence, we have what we need. ■

13.7.6 THEOREM: The tableaux for free logic are complete with respect to their semantics.

Proof:

The induced interpretation is defined as in 12.8.7, except that, in addition, $E = v(\mathfrak{E})$. The rest of the proof proceeds as in 12.8.8 and 12.8.9. The only differences concern the quantifier cases in the Completeness Lemma. Here

is the case for \exists . The case for \forall is similar. C is the set of constants on the branch.

Suppose that $\exists xA$ is on the branch. Then for some $c \in C$, $\mathfrak{E}c$ and $A_x(c)$ are on the branch. By IH, $\nu(\mathfrak{E}c) = 1$ and $\nu(A_x(c)) = 1$. For some $d \in D$, $\nu(c) = d$. Hence, $\nu(A(k_d)) = \nu(\mathfrak{E}k_d) = 1$, by the Denotation Lemma. That is, for some $d \in E$, $\nu(A(k_d)) = 1$. So $\nu(\exists xA) = 1$.

Suppose that $\neg\exists xA$ is on the branch. Then so is $\forall x\neg A$. So for all $c \in C$, either $\neg\mathfrak{E}c$ or $\neg A_x(c)$ is on the branch. By IH, $\nu(\mathfrak{E}c) = 0$ or $\nu(A_x(c)) = 0$. Suppose that $d \in E$. Then $\nu(\mathfrak{E}k_d) = 1$. Let $\nu(c) = d$. By the Denotation Lemma $\nu(\mathfrak{E}c) = 1$, so $\nu(A_x(c)) = 0$. That is, by the Lemma again, $\nu(A_x(k_d)) = 0$. Thus, $\nu(\exists xA) = 0$. ■

13.7.7 THEOREM: The addition of the Negativity Constraint Rule produces tableaux that are sound and complete with respect to the semantics with the Negativity Constraint added.

Proof:

The arguments simply add to those of 13.7.5 and 13.7.6. In the Soundness Lemma, it must be checked that the Negativity Constraint Rule has the appropriate property. This is immediate. For completeness, it needs to be checked that the induced interpretation satisfies the Negativity Constraint. This is almost immediate.

13.7.8 As already observed (13.6.9), outer quantifiers are just classical quantifiers. The soundness and completeness arguments for them are therefore the classical ones.

13.7.9 We now turn to the addition of identity. ■

13.7.10 THEOREM: The addition of the classical rules for identity to those of positive free logic produces a tableau system that is sound and complete with respect to the semantics.

Proof:

We simply modify the above arguments for soundness and completeness as the classical case was modified for identity in 12.9. ■

13.7.11 THEOREM: The addition of the rules of 13.6.7 to those for negative free logic give a tableau system that is sound and complete with respect to the semantics.

Proof:

The proof for negative free logic without identity (13.7.7) is modified as follows. In the Soundness Lemma we have to check the new identity rule, SIE:

$$\begin{array}{c} \mathfrak{E}a \\ \downarrow \\ a = a \end{array}$$

Verifying this is easy, and left as an exercise.

For the completeness proof, we define the interpretation induced by an open branch, \mathcal{B} , slightly differently. The relation \sim is defined as follows:

$a \sim b$ iff 'a' and 'b' are the same constant, or ' $a = b$ ' occurs on \mathcal{B} .

It is not difficult to check that this is an equivalence relation. (If $\mathfrak{E}a$ is not on the branch, then neither is anything of the form $a = b$, by the NCR. Hence, $[a] = \{a\}$.) $E = \nu(\mathfrak{E}) = \{[a]: \mathfrak{E}a \text{ is on } \mathcal{B}\}$; $\nu(=) = \{\langle d, d \rangle: d \in E\}$. The rest of the definition is as in 12.9.4. The argument for the Completeness Lemma is as in the classical case (12.9.5), except the case for identity, which now goes as follows:

$$\begin{aligned} a_1 = a_2 \text{ is on } \mathcal{B} &\Rightarrow a_1 \sim a_2 \\ &\Rightarrow [a_1] = [a_2] \\ &\Rightarrow \nu(a_1) = \nu(a_2) \\ &\text{and } \mathfrak{E}(a_1) \text{ and } \mathfrak{E}a_2 \text{ are on } \mathcal{B} \quad (\text{NCR}) \\ &\Rightarrow \nu(a_1 = a_2) = 1 \end{aligned}$$

If $\neg a_1 = a_2$ is on \mathcal{B} , there are two cases, depending on whether both of $\mathfrak{E}a_1$ and $\mathfrak{E}a_2$ are on \mathcal{B} , or one is not. In the first case:

$$\begin{aligned} \neg a_1 = a_2 \text{ is on } \mathcal{B} &\Rightarrow \text{(i) } a_1 = a_2 \text{ is not on } \mathcal{B}, \text{ and } \quad (\mathcal{B} \text{ open}) \\ &\quad \text{(ii) } a_1 \text{ and } a_2 \text{ are distinct terms } \quad (\mathcal{B} \text{ open, SIE}) \\ &\Rightarrow \text{it is not the case that } a_1 \sim a_2 \\ &\Rightarrow [a_1] \neq [a_2] \\ &\Rightarrow \nu(a_1) \neq \nu(a_2) \\ &\Rightarrow \nu(a_1 = a_2) = 0 \end{aligned}$$

In the second case, suppose that $\mathfrak{E}a_1$ is not on the branch. (The case for a_2 is similar.) Then $v(a_1) = [a_1] \notin E$. So $\langle v(a_1), v(a_2) \rangle \notin v(=)$, and $v(a_1 = a_2) = 0$, as required. ■

13.7.12 Finally, let us prove the result mentioned in 13.6.11:

13.7.13 THEOREM: Let the inferences with premises Σ and conclusion A be valid in classical logic. Let C be the set of constants that occur in A and all members of Σ , and let $\Pi = \{\mathfrak{E}c:c \in C\} \cup \{\exists x\mathfrak{E}x\}$. Then $\Pi \cup \Sigma \models A$.

Proof:

Suppose that $\Pi \cup \Sigma \not\models A$. Let $\mathfrak{J} = \langle D, E, v \rangle$ be an interpretation (positive or negative) that makes all the premises true and the conclusion false. In particular, $v(\mathfrak{E}) \neq \phi$. Let d be some member of $v(\mathfrak{E})$, and let \mathfrak{J}' be the interpretation $\langle D, E, v' \rangle$, which is the same as \mathfrak{J} , except that if $c \notin C$, $v'(c) = d$. By the Locality Lemma, \mathfrak{J}' makes every member of Σ true, and A false. Let $\mathfrak{J} = \langle E, \mu \rangle$, where μ is the same as v' , except that for any n -place predicate, P , $\mu(P) = v'(P) \cap E^n$. This is a classical interpretation (even if the logic is negative and identity is present). We show that if B is any sentence of $L(\mathfrak{J})$, then B has the same truth value in \mathfrak{J}' and \mathfrak{J} . The result follows. The proof is by induction on B . The basis case, and the cases for the connectives are entirely trivial. The cases for the quantifiers are nearly so. For \exists :

$$\begin{aligned} \mu(\exists xA) = 1 & \text{ iff } \text{for some } d \in E, \mu(A_x(k_d)) = 1 \\ & \text{ iff } \text{for some } d \in E, v'(A_x(k_d)) = 1 \quad (\text{IH}) \\ & \text{ iff } v'(\exists xA) = 1 \end{aligned}$$

The case for \forall is similar. ■

13.8 History

The name ‘free logic’ is applied to a variety of systems in the literature. I have concentrated on the most general kind. The first paper about these was Leonard (1956). The subject was developed by a number of people in the subsequent decades, but most notably by Leonard’s student, Lambert, in a series of papers such as 1963, 1967. The most forceful advocate of outer quantifiers was Routley (1980a).

In Ancient and Medieval logic, it was not assumed that names had to denote existent objects. And in Medieval logic, sentences of the form ‘...

some P s ...', (e.g., 'Some P s may be Q s'), were not necessarily taken to entail the existence of things satisfying P . (See Read (2006), sect. 4.) The view that some objects do not exist was also endorsed by writers in the late nineteenth century by the phenomenological school of Brentano, most notably, Meinong (1904).

The inventor of quantifiers, Frege, read $\exists x$ as 'there is/exists' an x such that' (see his 'Function and Concept' and 'Concept and Object', pp. 21–41 and 42–55 of Geach and Black (1960), or pp. 130–48 and 181–93 of Beaney (1997)). This reading got taken up by Russell (1905) (and later by Quine), in his analysis of existence. Earlier, Russell had subscribed to the view that some objects do not exist, though, unlike Meinong, he held that all objects have some kind of being. (See Priest (2005c), ch. 5.)

The view that existence is not a predicate is usually laid at the door of Kant in his analysis of the Ontological Argument (*Critique of Pure Reason*, A598 = B626 ff.). For a brief discussion of the Ontological Argument, the existence predicate, and the Characterisation Principle, see Priest (2000), ch. 4.

13.9 Further Reading

Good places to go for surveys of free logics are Bencivenga (1986) and Lambert (2001). The canonical defence of reading $\exists x$ as 'there exists' is Quine (1948). This should be read in conjunction with the reply by Routley (1982). See also Priest (2005), ch. 5. In that book, I use \mathfrak{S} and \mathfrak{A} – fractur 'S' (some) and 'A' (all) – for outer quantifiers, and \exists and \forall for inner quantifiers (since the habit of reading \exists as 'there exists' is now so entrenched).

13.10 Problems

1. Check the details omitted in 13.3.5, 13.4.4 and 13.5.6.
2. By constructing appropriate tableaux, determine the truth of the following in positive free logic, where the quantifiers are inner. If the inference is invalid, read off a counter-model from an open branch of the tableau, and check that it works.

(a) $\forall x(Px \supset Qx), \exists xPx \vdash \exists xQx$

(b) $\forall xPx \supset \exists yQy \vdash \exists y(\forall xPx \supset Qy)$

- (c) $\vdash \exists x \forall y Rxy \supset \forall y \exists x Rxy$
 (d) $\exists x Px, \exists x Qx \vdash \forall x (Px \wedge Qx)$
 (e) $\vdash \forall x Px \supset Pa$
 (f) $\vdash (\forall x Px \wedge \mathcal{E}a) \supset Pa$
 (g) $\vdash Pa \supset \exists x Px$
 (h) $\vdash (Pa \wedge \mathcal{E}a) \supset \exists x Px$
 (i) $\forall x Px \vdash \exists x Px$
3. Show the following in a free logic if C is closed and the quantifiers are inner. (Hint: recall that E can be empty.)
- (a) $C \models \forall x C$
 (b) $\forall x C \not\models C$
 (c) $\exists x C \models C$
 (d) $C \not\models \exists x C$
4. Determine the truth of the following in negative free logic, where the quantifiers are inner. When the inference is invalid, read off a counter-model from an open branch, and check that it works.
- (a) $Pa \vee Sab \vdash \mathcal{E}a$
 (b) $\neg \exists x Sxa \vdash \mathcal{E}a$
5. Repeat the previous question for negative free logic where the quantifiers are outer.
6. Determine the truth of the following in positive free logic, where the quantifiers are inner. If the inference is invalid, read off a counter-model from an open branch, and check that it works.
- (a) $\vdash \forall x x = x$
 (b) $\vdash \exists x x = x$
 (c) $\vdash Pa \supset \exists x x = a$
 (d) $\vdash \forall x \forall y ((x = y \wedge \mathcal{E}x) \supset \mathcal{E}y)$
7. Repeat the previous question for negative free logic, where the quantifiers are inner. Does it make any difference if the quantifiers are outer?
8. Show that in free logic with outer quantifiers and the Negativity Constraint, $\models \forall x (\mathcal{E}x \equiv x = x)$ and $\models \forall x (\mathcal{E}x \equiv \exists y x = y)$. Infer that the existence predicate can be defined in this logic.
9. Assuming that Father Christmas does not exist (still sorry), is the sentence 'Father Christmas = Father Christmas' true, false, or neither?

10. *Check the details omitted in 13.7.
11. *For the various systems of logic in this chapter, formulate tableaux for inferences with arbitrary sets of premises. Prove the Soundness and Completeness Theorems. Infer the Compactness and Löwenheim-Skolem Theorems.

14 Constant Domain Modal Logics

14.1 Introduction

14.1.1 In this chapter we will start to look at quantified normal modal logics. These come in two varieties: constant domain (where the domain of quantification is the same in all worlds), and variable domain (where the domain may vary from world to world).

14.1.2 Where it is necessary to distinguish between the two, I will use the following notation. If S is any system of propositional modal logic, CS will denote the constant domain quantified version, and VS will denote the variable domain quantified version.

14.1.3 In this chapter we will look at the semantics and tableaux for constant domain logics, saving variable domains for the next.

14.1.4 For these two chapters we will take it that identity is not part of the language. We will turn to the topic of identity in modal logic in chapter 16.

14.1.5 We will also take a quick look at one of the major philosophical issues to which quantified modal logic gives rise: the issue of essentialism.

14.1.6 The chapter ends by showing how the semantic and tableau techniques of normal modal logic extend to tense logic.

14.2 Constant Domain K

14.2.1 The syntax of quantified modal logic augments the language of first-order classical logic (12.2) with the operators \Box and \Diamond , as propositional modal logic extends classical propositional logic (2.3.1, 2.3.2).

14.2.2 An interpretation for the language is a quadruple $\langle D, W, R, \nu \rangle$. W is a (non-empty) set of worlds, and R is a binary accessibility relation on W , as in the propositional case (2.3.3). D is the non-empty domain of quantification, as in classical first-order logic (12.3.1). ν assigns each constant, c , of the language a member, $\nu(c)$, of D , and each pair comprising a world, w , and an n -place predicate, P , a subset of D^n . I will write this as $\nu_w(P)$. Intuitively, $\nu_w(P)$ is the set of n -tuples that satisfy P at world w – which may change from world to world. (Thus, $\langle \text{Caesar}, \text{Brutus} \rangle$ is in the extension of ‘was murdered by’ at this world, but in a world where Brutus was not persuaded to join the conspirators, it is not.) The language of an interpretation, \mathcal{L} , is obtained by adding a constant to the language for every member of D , as in 12.3.2.

14.2.3 Each closed formula, A , is now assigned a truth value, $\nu_w(A)$, at each world, w . The truth conditions for atomic formulas are as follows:

$$\nu_w(Pa_1 \dots a_n) = 1 \text{ iff } \langle \nu(a_1), \dots, \nu(a_n) \rangle \in \nu_w(P) \text{ (otherwise it is 0)}$$

The truth conditions for the connectives and modal operators are as in the propositional case (2.3.4, 2.3.5). The truth conditions for the quantifiers are as in first-order logic (12.3.2). Thus, for every world, w :

$$\begin{aligned} \nu_w(\forall xA) &= 1 \text{ iff for all } d \in D, \nu_w(A_x(k_d)) = 1 \text{ (otherwise it is 0)} \\ \nu_w(\exists xA) &= 1 \text{ iff for some } d \in D, \nu_w(A_x(k_d)) = 1 \text{ (otherwise it is 0)} \end{aligned}$$

14.2.4 An inference is valid if it is truth-preserving in all worlds of all interpretations.

14.2.5 The above semantics define the constant domain modal logic CK , corresponding to the propositional logic K (and not to be confused with the propositional logic of the same name in 10.4a.12).

14.3 Tableaux for CK

14.3.1 Tableaux for CK are obtained by augmenting the tableaux for K (2.4) with the rules one would expect for quantifiers. The rules are essentially

those of classical logic with a world parameter added:

$$\begin{array}{cccc}
 \neg\exists xA, i & \neg\forall xA, i & \forall xA, i & \exists xA, i \\
 \downarrow & \downarrow & \downarrow & \downarrow \\
 \forall x\neg A, i & \exists x\neg A, i & A_x(a), i & A_x(c), i
 \end{array}$$

a is any constant on the branch (choosing a new one only if there are none already available). c is a constant new to the branch.

14.3.2 Here are tableaux showing that:

$$\begin{array}{l}
 \vdash \exists x\Diamond A \supset \Diamond\exists xA \\
 \vdash \forall x\Box A \supset \Box\forall xA
 \end{array}$$

a is a constant that does not occur in A .

$$\begin{array}{l}
 \neg(\exists x\Diamond A \supset \Diamond\exists xA), 0 \\
 \quad \exists x\Diamond A, 0 \\
 \quad \neg\Diamond\exists xA, 0 \\
 \quad \Diamond A_x(a), 0 \\
 \quad \text{Or 1} \\
 \quad A_x(a), 1 \\
 \quad \Box\neg\exists xA, 0 \\
 \quad \neg\exists xA, 1 \\
 \quad \forall x\neg A, 1 \\
 \quad \neg A_x(a), 1 \\
 \quad \times
 \end{array}$$

$$\begin{array}{l}
 \neg(\forall x\Box A \supset \Box\forall xA), 0 \\
 \quad \forall x\Box A, 0 \\
 \quad \neg\Box\forall xA, 0 \\
 \quad \Diamond\neg\forall xA, 0 \\
 \quad \text{Or 1} \\
 \quad \neg\forall xA, 1 \\
 \quad \exists x\neg A, 1 \\
 \quad \neg A_x(a), 1 \\
 \quad \Box A_x(a), 0 \\
 \quad A_x(a), 1 \\
 \quad \times
 \end{array}$$

14.3.3 Here is a tableau showing that $\not\vdash \diamond\exists xPx \supset \diamond\exists x(Px \wedge Qb)$:

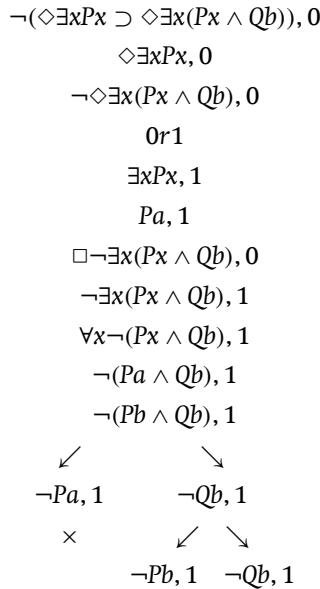

14.3.4 A counter-model is read off from an open branch by combining the techniques of modal propositional logic and first-order logic. Thus, for the righthand branch of the tableau of 14.3.3, $W = \{w_0, w_1\}$, w_0Rw_1 , $D = \{a, b\}$, $v(a) = \partial_a$, $v(b) = \partial_b$, and for predicates, the values of v are as shown by the following tables:

w_0	\rightarrow	w_1																		
<table style="width: 100%; text-align: center;"> <tr> <td></td> <td>∂_a</td> <td>∂_b</td> </tr> <tr> <td>P</td> <td>\times</td> <td>\times</td> </tr> <tr> <td>Q</td> <td>\times</td> <td>\times</td> </tr> </table>		∂_a	∂_b	P	\times	\times	Q	\times	\times		<table style="width: 100%; text-align: center;"> <tr> <td></td> <td>∂_a</td> <td>∂_b</td> </tr> <tr> <td>P</td> <td>\checkmark</td> <td>\times</td> </tr> <tr> <td>Q</td> <td>\times</td> <td>\times</td> </tr> </table>		∂_a	∂_b	P	\checkmark	\times	Q	\times	\times
	∂_a	∂_b																		
P	\times	\times																		
Q	\times	\times																		
	∂_a	∂_b																		
P	\checkmark	\times																		
Q	\times	\times																		

It is easy to check that the counter-model works. Pa is true at w_1 ; hence $\exists xPx$ is true at w_1 . (As in the case of classical first-order logic, since every object in the domain has a name, in evaluating the truth of quantified formulas, we need to take into account only the behaviour of the constants

on the branch.) Since $w_0 R w_1$, $\diamond \exists x P x$ is true at w_0 . $P a \wedge Q b$, and $P b \wedge Q b$ are both false at w_1 . Hence, $\exists x (P x \wedge Q b)$ is false at w_1 . Since w_1 is the only world that w_0 accesses, $\diamond \exists x (P x \wedge Q b)$ is false at w_0 .

14.3.5 Because of the quantifiers, tableaux in *CK*, unlike tableaux in *K*, can be infinite. Thus, consider the following tableau, showing that $\Box \exists x P x \not\vdash \exists x \Box P x$:

$$\begin{array}{l}
 \Box \exists x P x, 0 \\
 \neg \exists x \Box P x, 0 \\
 \forall x \neg \Box P x, 0 \\
 \neg \Box P a, 0 \\
 \diamond \neg P a, 0 \\
 \text{Or1} \\
 \neg P a, 1 \\
 \exists x P x, 1 \\
 P b, 1 \\
 \neg \Box P b, 0 \\
 \diamond \neg P b, 0 \\
 \text{Or2} \\
 \neg P b, 2 \\
 \exists x P x, 2 \\
 P c, 2 \\
 \neg \Box P c, 0 \\
 \diamond \neg P c, 0 \\
 \text{Or3} \\
 \neg P c, 3 \\
 \vdots
 \end{array}$$

Every time a new world is opened, we have to go back and apply the \Box rule for line one to it. This gives us a new particular quantifier to instantiate. The universal quantifier at line three must then be instantiated with the constant this provides, which gives a new \diamond , requiring the opening of a new world.

14.3.6 The counter-model determined by the tableau can be depicted as follows:

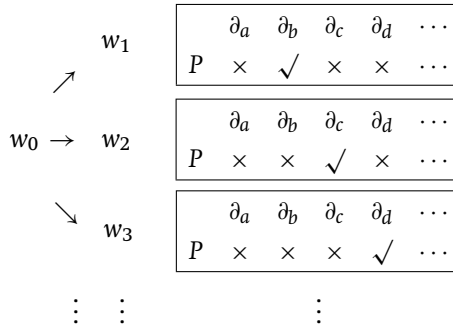

I leave it as an exercise to check that this counter-model works.

14.3.7 As usual, a finite interpretation to do the same job can often be found by trial and error. For the inference of 14.3.5, the interpretation depicted as follows will do the job.

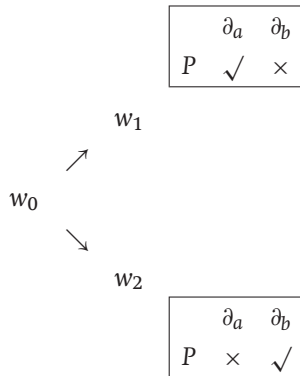

$\exists xPx$ is true at w_1 and w_2 . So, $\Box\exists xPx$ is true at w_0 . Pb fails at w_1 and Pa fails at w_2 , so $\exists x\Box Px$ fails at w_0 .

14.3.8 There is one final subtlety to observe here. If we are testing an inference whose sentences contain no constant symbols, then it is possible for

the whole tableau to contain no constant symbols, since the quantifiers may be embedded within modal operators, and so the quantifier rules never get to be applied. Thus, consider the tableau to determine whether $\vdash \Diamond \exists x Px$. This goes as follows:

$$\begin{array}{l} \neg \Diamond \exists x Px, 0 \\ \square \neg \exists x Px, 0 \end{array}$$

There are no further rules that can be applied, and the tableau finishes open. In this case, when reading off a counter-model, we have to set the domain, D , to be $\{\partial\}$ for some arbitrary object, ∂ . ∂ is not in the extension of any predicate at any world. Thus, in the counter-model in question, $W = \{w_0\}$, $D = \{\partial\}$, it is not the case that $w_0 R w_0$, and $v_{w_0}(P) = \phi$. (This observation will apply to a number of the logics with world semantics that we will be looking at in subsequent chapters as well.)

14.4 Other Normal Modal Logics

14.4.1 In the propositional case, modal logics stronger than K are obtained semantically by adding constraints on the accessibility relation, R , and proof-theoretically by adding the corresponding tableau rules. (See chapter 3.) Exactly the same is true in the quantified case.

14.4.2 Here, as an illustration, is a tableau to show that $\vdash_{CK\rho} \exists x \square Px \supset \exists x Px$. (It is not valid in CK : as should be clear, the CK -tableau does not close.)

$$\begin{array}{l} \neg(\exists x \square Px \supset \exists x Px), 0 \\ Or 0 \\ \exists x \square Px, 0 \\ \neg \exists x Px, 0 \\ \square Pa, 0 \\ Pa, 0 \\ \forall x \neg Px, 0 \\ \neg Pa, 0 \\ \times \end{array}$$

14.4.3 Here is another to show that $\exists xSxb \not\vdash_{CK\nu} \forall x\Box\Diamond Sxb$. (For tableaux for $K\nu$, see 3.5.)

$$\begin{aligned} & \exists xSxb, 0 \\ & \neg\forall x\Box\Diamond Sxb, 0 \\ & \quad Sab, 0 \\ & \exists x\neg\Box\Diamond Sxb, 0 \\ & \quad \neg\Box\Diamond Scb, 0 \\ & \quad \quad \Diamond\neg\Diamond Scb, 0 \\ & \quad \quad \neg\Diamond Scb, 1 \\ & \quad \quad \Box\neg Scb, 1 \\ & \quad \quad \neg Scb, 0 \\ & \quad \quad \neg Scb, 1 \end{aligned}$$

14.4.4 Counter-models are read off in the obvious way. Thus, the interpretation determined by the tableau of 14.4.3 is as follows: $W = \{w_0, w_1\}$. (In $CK\nu$ we may dispense with the accessibility relation.) $D = \{\partial_a, \partial_b, \partial_c\}$. $\nu(a) = \partial_a$, $\nu(b) = \partial_b$, $\nu(c) = \partial_c$, $\nu_{w_0}(S) = \{\langle\partial_a, \partial_b\rangle\}$, $\nu_{w_1}(S) = \emptyset$. We may depict the interpretation as follows.

	w_0				w_1			
	S	∂_a	∂_b	∂_c	S	∂_a	∂_b	∂_c
∂_a	×	×	✓	×	∂_a	×	×	×
∂_b	×	×	×	×	∂_b	×	×	×
∂_c	×	×	×	×	∂_c	×	×	×

$\exists xSxb$ is true in w_0 . Scb is false at both worlds. So $\Diamond Scb$ is false at both worlds, as is $\Box\Diamond Scb$. Hence, $\forall x\Box\Diamond Sxb$ is false at w_0 .

14.4.5 All the tableau systems discussed so far in this chapter are sound and complete with respect to their semantics. Proofs of these facts can be found in 14.7.

14.5 Modality *De Re* and *De Dicto*

14.5.1 Consider a sentence of the form $\Box Pa$. There are two ways of understanding this. First, one may understand it as saying that the proposition expressed by ‘ Pa ’ is a necessary truth. Conceived of in this way, the modality

is attached to the *dictum* (saying), *Pa*, and so is called *de dicto*. Alternatively, one may understand the sentence as saying that the object *a* has the property of necessarily being *P* (of being necessarily *P*). Conceived of in this way, the modality is attached to the object (*res*), *a*, and so it is called *de re*. (The Latin tags bespeak the origin of the distinction in Medieval logic, where it goes by several different names.) There is no way of forcing a sentence to express *de re* (or *de dicto*) modality without quantifiers, but once these are available the situation changes. The sentence $\exists x \Box Px$ expresses the claim that there is some object which has the property expressed by $\Box Px$. It is therefore unavoidably *de re*.

14.5.2 Some modern philosophers, notably Quine, have expressed scepticism about *de re* modality. Necessity, the claim goes, cannot attach to things in themselves; only in the way that we describe them. One argument supposed to show this is as follows.

14.5.3 Suppose that it makes sense to speak about objects *per se* having necessary properties. A poet must necessarily have a sense of metaphor, but a poet need not be analytical. A mathematician, by contrast, must necessarily be analytical, but a mathematician need not have a sense of metaphor. Now consider Alice, who is both a poet and a mathematician. She necessarily has a sense of metaphor, and does not necessarily have a sense of metaphor (similarly for being analytical). The contradiction is untenable. Alice, *qua* poet, necessarily has a sense of metaphor; Alice, *qua* mathematician, is necessarily analytical.

14.5.4 What to make of this argument? A sentence of that form ‘As are necessarily Bs’ is, in fact, triply ambiguous. It can mean $\Box \forall x (Ax \supset Bx)$, $\forall x \Box (Ax \supset Bx)$, or $\forall x (Ax \supset \Box Bx)$. The argument of 14.5.3 can therefore be understood in three ways (assuming that ‘need not’ expresses the negation of the modality). With the obvious symbolism:

1. $\Box \forall x (Px \supset Mx), \neg \Box \forall x (Px \supset Ax), Pa$. So $\Box Ma \wedge \neg \Box Aa$
2. $\forall x \Box (Px \supset Mx), \forall x \neg \Box (Px \supset Ax), Pa$. So $\Box Ma \wedge \neg \Box Aa$
3. $\forall x (Px \supset \Box Mx), \forall x (Px \supset \neg \Box Ax), Pa$. So $\Box Ma \wedge \neg \Box Aa$

The premises of inferences 1 and 2 are plausible, but the inferences are invalid, even in the strongest normal system, *Kv*, as may be checked. Inference 3 is valid, but there is no reason to suppose the premises to be true.

Take the first. Someone may be a poet in this world, but it does not follow that they have a sense of metaphor in every world: they need not be a poet in every world.

14.5.5 Either way, then, the argument is unsound, and it may be plausibly seen as a fallacy of ambiguity (one sense being necessary to make the premises true; another to make the inference valid).

14.5.6 If an object has (*de re*) a property necessarily, this is often expressed by saying that the object has the property *essentially* (or as part of its *essence*); and the view that there are such properties is called *essentialism*. The semantics of modal logic, if correct, deliver a certain kind of essentialism. Given a sentence, A , with one free variable, x , this expresses a necessary property of the object denoted by a , just if $A_x(a)$ is true in all worlds, and there are a number of logical truths of the form $\Box A_x(a)$, e.g., $\Box(Pa \vee \neg Pa)$.¹

14.5.7 The essentialism is of a very limited kind, though. For provided A contains no constant symbols, $\Box A_x(a)$ is a logical truth iff $\Box A_x(b)$ is. To see this, just take a closed tableau for $\Box A_x(a)$ and go through it replacing a everywhere with b . The result is a closed tableau for $\Box A_x(b)$.² Thus, the only essential properties that modal logic delivers are ones that all things have.

14.5.8 Are there essential properties of a stronger kind, not shared by all things? If there are, this will doubtless depend on the kind of thing in question. It might be suggested that the origin of something is essential to it. In that case, it is true of me that I necessarily had the parents I did. No other parents could have engendered me (however much like me their progeny might be). Or it may be suggested that the constitution of something is essential to it. Thus, it is true of me that I necessarily have the genetic structure that I do. A creature with a different genetic structure could not be me.

14.5.9 Different intuitions tend to pull in different directions on these matters. For example, it certainly seems possible to imagine that I should have

¹ Strictly speaking, an essential property of an object is one that it has at every world *where it exists*, so P is an essential property of a iff $\Box(\exists a \supset Pa)$ is true. However, existence is not on the agenda in this chapter.

² This is no longer true if names are allowed to occur in A . Thus, take for A the formula $\Box(Pa \vee \neg Px)$. $\Box(Pa \vee \neg Pa)$ is a logical truth, but $\Box(Pa \vee \neg Pb)$ is not.

been born to parents in the Middle Ages. But even if someone had been born in 1234 with all my physical and mental properties, 6' 4", brown eyes, a penchant for philosophy, what would have made that person *me*, rather than some *doppelgänger*?

14.6 Tense Logic

14.6.1 The extensions of the semantic and tableau techniques of this chapter to tense logic are routine. As in 3.6a, we now write \square and \diamond as $[F]$ and $\langle F \rangle$, respectively, and add the corresponding past tense operators, $[P]$ and $\langle P \rangle$, to the language. An interpretation for the basic constant domain tense logic, CK^t , is the same as that for CK . The truth conditions for the tense operators are as in 3.6a.4, and for the quantifiers as in 14.2.3.³

14.6.2 For tableaux, we simply add the quantifier rules of 14.3.1 to the tableau rules of propositional tense logic (3.6a.6). Here, for example, is a tableau to show that $\vdash \exists x Qx \supset [P]\exists x \langle F \rangle Qx$:

$$\begin{array}{c}
 \neg(\exists x Qx \supset [P]\exists x \langle F \rangle Qx), 0 \\
 \exists x Qx, 0 \\
 \neg[P]\exists x \langle F \rangle Qx, 0 \\
 Qa, 0 \\
 \langle P \rangle \neg \exists x \langle F \rangle Qx, 0 \\
 1r0 \\
 \neg \exists x \langle F \rangle Qx, 1 \\
 \forall x \neg \langle F \rangle Qx, 1 \\
 \neg \langle F \rangle Qa, 1 \\
 [F]\neg Qa, 1 \\
 \neg Qa, 0 \\
 \times
 \end{array}$$

Counter-models are read off from open branches as they are for CK .

14.6.3 Extensions of CK^t are obtained by adding constraints on the accessibility relation, R , as in 3.6b. Appropriate tableaux, and the techniques

³ When dealing with tense logic, I will avoid using 'P' to represent predicates, for obvious reasons.

for reading off counter-models from open branches, are obtained by modifying those of CK^t , also as in 3.6b. (Soundness and completeness proofs can be found in 14.7.) Here, for example, is a tableau to show that $\not\vdash (\exists x \langle F \rangle Sx \wedge \exists x \langle F \rangle Qx) \supset [P]Sc$ in CK_\emptyset^t :

$$\begin{array}{c}
 \neg((\exists x \langle F \rangle Sx \wedge \exists x \langle F \rangle Qx) \supset [P]Sc), 0 \\
 \exists x \langle F \rangle Sx \wedge \exists x \langle F \rangle Qx, 0 \\
 \neg[P]Sc, 0 \\
 \exists x \langle F \rangle Sx, 0 \\
 \exists x \langle F \rangle Qx, 0 \\
 \langle F \rangle Sa, 0 \\
 \langle F \rangle Qb, 0 \\
 Or1 \\
 Sa, 1 \\
 Or2 \\
 Qb, 2 \\
 \langle P \rangle \neg Sc, 0 \\
 3r0 \\
 \neg Sc, 3 \\
 \swarrow \quad \downarrow \quad \searrow \\
 1r2 \quad 1 = 2 \quad 2r1 \\
 Sa, 2 \\
 Qb, 1
 \end{array}$$

The last two lines in the middle branch are given by applying the identity $1 = 2$. The final lines about r on the other two branches give rise to no further applications of rules. The interpretation determined by the middle branch may be depicted as follows:

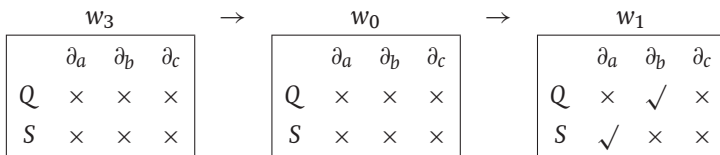

I leave it as an exercise to check that this works.

14.7 *Proofs of Theorems

14.7.1 In this section, we will prove soundness and completeness for constant domain modal logics. We will start with CK and then consider modifications required for other normal systems. The proofs are essentially those for classical logic in 12.7, augmented by the modal techniques of 2.9 and 3.7. Finally, we do the same for constant domain tense logics.

14.7.2 LEMMA (LOCALITY): Let $\mathfrak{J}_1 = \langle D, W, R, v_1 \rangle$, $\mathfrak{J}_2 = \langle D, W, R, v_2 \rangle$ be two CK interpretations. Since they have the same domain, the language of the two is the same. Call this L . If A is any closed formula of L such that v_1 and v_2 agree on the denotations of all the predicates and constants in it, then for all $w \in W$:

$$v_{1w}(A) = v_{2w}(A)$$

Proof:

The result is proved by recursion on formulas. For atomic formulas:

$$\begin{aligned} v_{1w}(Pa_1 \dots a_n) = 1 & \text{ iff } \langle v_1(a_1), \dots, v_1(a_n) \rangle \in v_{1w}(P) \\ & \text{ iff } \langle v_2(a_1), \dots, v_2(a_n) \rangle \in v_{2w}(P) \\ & \text{ iff } v_{2w}(Pa_1 \dots a_n) = 1 \end{aligned}$$

The induction cases for the truth functional connectives are straightforward, and are left as exercises. The case for the universal quantifier is as follows. The case for the particular quantifier is similar.

$$\begin{aligned} v_{1w}(\forall xA) = 1 & \text{ iff for all } d \in D, v_{1w}(A_x(k_d)) = 1 \\ & \text{ iff for all } d \in D, v_{2w}(A_x(k_d)) = 1 \quad (*) \\ & \text{ iff } v_{2w}(\forall xA) = 1 \end{aligned}$$

The line marked (*) follows from the induction hypothesis (IH), and the fact that $v_{1w}(k_d) = v_{2w}(k_d) = d$.

The induction case for \Box is as follows. The case for \Diamond is similar.

$$\begin{aligned} v_{1w}(\Box A) = 1 & \text{ iff for all } w' \text{ such that } wRw', v_{1w'}(A) = 1 \\ & \text{ iff for all } w' \text{ such that } wRw', v_{2w'}(A) = 1 \quad (\text{IH}) \\ & \text{ iff } v_{2w}(\Box A) = 1 \end{aligned}$$

■

14.7.3 LEMMA (DENOTATION): Let $\mathfrak{J} = \langle D, W, R, v \rangle$ be any CK interpretation. Let A be any formula of $L(\mathfrak{J})$ with at most one free variable, x , and a and b be any two constants such that $v(a) = v(b)$. Then for any $w \in W$:

$$v_w(A_x(a)) = v_w(A_x(b))$$

Proof:

The proof is by recursion on formulas. (For atomic formulas I assume that there is one occurrence of 'a' for the sake of illustration.)

$$\begin{aligned} v_w(Pa_1 \dots a \dots a_n) = 1 & \text{ iff } \langle v(a_1), \dots, v(a), \dots, v(a_n) \rangle \in v_w(P) \\ & \text{ iff } \langle v(a_1), \dots, v(b), \dots, v(a_n) \rangle \in v_w(P) \\ & \text{ iff } v_w(Pa_1 \dots b \dots a_n) = 1 \end{aligned}$$

The argument for the truth functional connectives is straightforward. The case for the universal quantifier is as follows. The case for the particular quantifier is similar. Let A be of the form $\forall yB$. If x is the same variable as y then $A_x(a)$ and $A_x(b)$ are just A , so the result is trivial. So suppose that x and y are distinct variables. In this case, $(\forall yB)_x(c)$ is the same as $\forall y(B_x(c))$, and $(B_x(c))_y(a)$ is the same as $(B_y(a))_x(c)$.

$$\begin{aligned} v_w((\forall yB)_x(a)) = 1 & \text{ iff } v_w(\forall y(B_x(a))) = 1 \\ & \text{ iff for all } d \in D, v_w((B_x(a))_y(k_d)) = 1 \\ & \text{ iff for all } d \in D, v_w((B_y(k_d))_x(a)) = 1 \\ & \text{ iff for all } d \in D, v_w((B_y(k_d))_x(b)) = 1 \quad (\text{IH}) \\ & \text{ iff for all } d \in D, v_w((B_x(b))_y(k_d)) = 1 \\ & \text{ iff } v_w(\forall y(B_x(b))) = 1 \\ & \text{ iff } v_w((\forall yB)_x(b)) = 1 \end{aligned}$$

The argument for \Box is as follows. The case for \Diamond is similar.

$$\begin{aligned} v_w(\Box A_x(a)) = 1 & \text{ iff for all } w' \text{ such that } wRw', v_{w'}(A_x(a)) = 1 \\ & \text{ iff for all } w' \text{ such that } wRw', v_{w'}(A_x(b)) = 1 \\ & \text{ iff } v_w(\Box A_x(b)) = 1 \end{aligned}$$

■

14.7.4 DEFINITION: Let $\mathfrak{J} = \langle D, W, R, v \rangle$ be an interpretation for CK, and \mathcal{B} be any branch of a tableau. Then \mathfrak{J} is *faithful* to \mathcal{B} iff there is a map, f , from

the natural numbers to W , such that:

For every node, A, i on \mathcal{B} , A is true at $f(i)$ in \mathcal{J} .

If irj is on \mathcal{B} , $f(i)Rf(j)$ in \mathcal{J} .

We say that f shows \mathcal{J} to be faithful to \mathcal{B} .

14.7.5 SOUNDNESS LEMMA: Let \mathcal{B} be any branch of a tableau, and let $\mathcal{J} = \langle D, W, R, \nu \rangle$ be any interpretation. If \mathcal{J} is faithful to \mathcal{B} , and a tableau rule is applied to it, then there is an $\mathcal{J}' = \langle D, W, R, \nu' \rangle$ and an extension of \mathcal{B} , \mathcal{B}' , such that \mathcal{J}' is faithful to \mathcal{B}' .

Proof:

The proof for the connectives and modal operators is as in the propositional case (2.9.3). In each case, \mathcal{J}' is just \mathcal{J} . The cases for the quantifiers are as follows. Let f be a function that shows \mathcal{J} to be faithful to \mathcal{B} . Suppose that we apply the rule:

$$\begin{array}{c} \neg\forall xA, i \\ \downarrow \\ \exists x\neg A, i \end{array}$$

\mathcal{J} makes $\neg\forall xA(x)$ true at $f(i)$. Hence, \mathcal{J} makes $\forall xA(x)$ false at $f(i)$. So there is some $d \in D$ such that $A_x(k_d)$ is false at $f(i)$. That is, $\neg A_x(k_d)$ is true at $f(i)$. So \mathcal{J} makes $\exists x\neg A$ true at $f(i)$. We can therefore take \mathcal{J}' to be \mathcal{J} . The argument for the other rule concerning negation is similar.

Suppose we apply the rule:

$$\begin{array}{c} \forall xA, i \\ \downarrow \\ A_x(a), i \end{array}$$

Since \mathcal{J} makes $\forall xA$ true at $f(i)$, \mathcal{J} makes $A_x(k_d)$ true at $f(i)$, for all $d \in D$. Let d be such that $\nu(a) = \nu(k_d)$. By the Denotation Lemma, \mathcal{J} makes $A_x(a)$ true at $f(i)$. Hence we can take \mathcal{J}' to be \mathcal{J} .

Suppose that we apply the rule:

$$\begin{array}{c} \exists xA, i \\ \downarrow \\ A_x(c), i \end{array}$$

\mathcal{J} makes $\exists xA$ true at $f(i)$. Hence there is some $d \in D$ such that \mathcal{J} makes $A_x(k_d)$ true at $f(i)$. Let $\mathcal{J}' = \langle D, W, R, \nu' \rangle$ be the same as \mathcal{J} except that $\nu'(c) = d$. Since c does not occur in $A_x(k_d)$, \mathcal{J}' makes $A_x(k_d)$ true at $f(i)$, by the Locality Lemma. Since $\nu'(c) = d = \nu'(k_d)$, \mathcal{J}' makes $A_x(c)$ true at $f(i)$, by the Denotation Lemma. And since c does not occur in any other formula on the branch, \mathcal{J}' makes all other formulas on the branch true at their respective worlds as well, by the Locality Lemma. ■

14.7.6 SOUNDNESS THEOREM: For finite Σ , if $\Sigma \vdash A$ then $\Sigma \models A$.

Proof:

Suppose that $\Sigma \not\models A$. Then there is an interpretation, $\mathcal{J} = \langle D, W, R, \nu \rangle$, which makes all members of Σ true, and A false, at some $w_0 \in W$. Let f be any function such that $f(0) = w_0$. Consider any completed tableau for the inference. f shows \mathcal{J} to be faithful to the initial list. When we apply a rule to some formula on the list, we can, by the Soundness Lemma, find at least one of its extensions such that there is an interpretation, \mathcal{J}' , which is faithful to it. Similarly, when we apply a rule to a formula on this, we can find at least one of its extensions, and an interpretation \mathcal{J}'' , which is faithful to it; and so on. By repeatedly applying the Soundness Lemma in this way, we can find a whole branch, \mathcal{B} , such that, for every initial section of it, there is an interpretation and a function f such that for every line of \mathcal{B} of the form A, i , A is true at $f(i)$. Now, if \mathcal{B} were closed, it would have to contain some lines of the form B, i and $\neg B, i$, and these must occur in some initial section of \mathcal{B} . But this is impossible, since we would then have an interpretation where for some $w \in W$, $\nu_w(B) = \nu_w(\neg B) = 1$, which cannot be the case. Hence, the tableau is open, i.e., $\Sigma \not\models A$. ■

14.7.7 DEFINITION: Suppose that we have a tableau with an open branch, \mathcal{B} . Let C be the set of all constants on \mathcal{B} . The interpretation *induced* by \mathcal{B} is the interpretation $\langle D, W, R, \nu \rangle$ defined as follows. $W = \{w_i: i \text{ occurs on } \mathcal{B}\}$. $w_i R w_j$ iff irj occurs on \mathcal{B} . $D = \{\partial_a: a \in C\}$ (or if C is empty, $D = \{\partial\}$, for some arbitrary ∂). For all constants, a , on \mathcal{B} , $\nu(a) = \partial_a$. For every n -place predicate on \mathcal{B} , $\langle \partial_{a_1}, \dots, \partial_{a_n} \rangle \in \nu_{w_i}(P)$ iff $Pa_1 \dots a_n, i$ is on \mathcal{B} . (∂ is not in the extension of anything.)

14.7.8 COMPLETENESS LEMMA: Given the interpretation specified in 14.7.7, for every formula A :

if A, i is on \mathcal{B} then $\nu_{w_i}(A) = 1$
 if $\neg A, i$ is on \mathcal{B} then $\nu_{w_i}(A) = 0$

Proof:

This is proved by recursion on formulas. For atomic formulas:

$$\begin{aligned} Pa_1 \dots a_n, i \text{ is on } \mathcal{B} &\Rightarrow \langle \partial_{a_1}, \dots, \partial_{a_n} \rangle \in \nu_{w_i}(P) \\ &\Rightarrow \langle \nu(a_1), \dots, \nu(a_n) \rangle \in \nu_{w_i}(P) \\ &\Rightarrow \nu_{w_i}(Pa_1 \dots a_n) = 1 \end{aligned}$$

$$\begin{aligned} \neg Pa_1 \dots a_n, i \text{ is on } \mathcal{B} &\Rightarrow Pa_1 \dots a_n, i \text{ is not on } \mathcal{B} \quad (\mathcal{B} \text{ is open}) \\ &\Rightarrow \langle \partial_{a_1}, \dots, \partial_{a_n} \rangle \notin \nu_{w_i}(P) \\ &\Rightarrow \langle \nu(a_1), \dots, \nu(a_n) \rangle \notin \nu_{w_i}(P) \\ &\Rightarrow \nu_{w_i}(Pa_1 \dots a_n) = 0 \end{aligned}$$

For the truth-functional and modal connectives, the argument is as in the propositional case (2.9.6). Here is the case for \exists . The case for \forall is similar.

Suppose that $\exists xA, i$ is on the branch. Then for some c , $A_x(c), i$ is on the branch. By IH, $\nu_{w_i}(A_x(c)) = 1$. For some $d \in D$, $\nu(c) = d$. But $\nu(k_d) = d$. Hence, $\nu_{w_i}(A(k_d)) = 1$, by the Denotation Lemma. That is, $\nu_{w_i}(\exists xA) = 1$.

Suppose that $\neg \exists xA, i$ is on the branch. Then so is $\forall x \neg A, i$. So for all $c \in C$, $\neg A_x(c), i$ is on the branch and so $\nu_{w_i}(A_x(c)) = 0$ (by IH). If $d \in D$ then, for some $c \in C$, $\nu(c) = \nu(k_d)$. Hence, $\nu_{w_i}(A_x(k_d)) = 0$, by the Denotation Lemma. Thus, $\nu_{w_i}(\exists xA) = 0$. ■

14.7.9 COMPLETENESS THEOREM: For finite Σ , if $\Sigma \models A$ then $\Sigma \vdash A$.

Proof:

Suppose that $\Sigma \not\vdash A$. Construct a tableau for the inference. Define the interpretation as in 14.7.7. By the Completeness Lemma, this makes all the members of Σ true and A false. Hence, $\Sigma \not\models A$. ■

14.7.10 THEOREM: The tableau systems for normal modal logics stronger than CK are sound and complete with respect to their tableaux.

Proof:

To extend the above proofs to constant-domain normal modal systems stronger than CK , only minor modifications are necessary. In the proof of the Soundness Lemma, there are extra cases corresponding to the relevant rules for r . These are as in 3.7.1. In the proof of the Completeness Theorem, we have to check that the induced interpretation is an interpretation appropriate for the logic in question. This is as in 3.7.3. ■

14.7.11 THEOREM: The tableaux for CK^t are sound and complete with respect to their semantics.

Proof:

The proofs for CK extend to CK^t very simply. In the Locality, Denotation, Soundness, and Completeness Lemmas, there are new cases for $[P]$ and $\langle P \rangle$, but these are trivial modifications of those for $[F]$ and $\langle F \rangle$. ■

14.7.12 THEOREM: The tableaux for extensions of CK^t are sound and complete with respect to their semantics.

Proof:

The proofs modify those for CK^t . In the Soundness Lemma, there are extra cases to be checked for the new rules concerning r . These are as in the propositional case (3.7.7). For completeness, the induced interpretation is defined as for CK^t , except that the accessibility relation is defined in terms of the equivalence relation determined by the information about $=$ on the branch, as in 3.7.8. In the Completeness Lemma, the cases for atomic sentences and quantifiers are as for CK^t . The Completeness Theorem is then proved as in the propositional case (3.7.8). ■

14.8 History

Reasoning with modal notions and what we would now call quantifier phrases goes back to Aristotle (modal syllogistic), and was also much

discussed in Medieval logic. (See Kneale and Kneale (1975), ch. 2. sect. 8, and Knuuttilla (1982).) The modern founder of modal logic, C. I. Lewis, did make a few remarks about quantified modal logic (Lewis (1918), pp. 320–4, Lewis and Langford (1932), ch. 9); but the first systematic presentation of it was by Ruth Barcan – later, Barcan-Marcus – (1946). Quantified modal logic came in for an even tougher time at the hands of Quine than did propositional modal logic. But the situation changed with the invention of the world semantics for quantified modal logic by Kripke (see Kripke (1959) and (1963b)). Quantified tense logic was introduced by the founder of modern tense logic, Prior. (See Prior (1967), esp. ch. 8.)

The first person to espouse a form of essentialism was Aristotle, in the *Metaphysics* and elsewhere. (For a discussion of his form of it, see Guthrie (1981), ch. 11.) Quine’s attack on quantified modal logic, and especially its essentialism, can be found in Quine (1953a), (1953b), (1960). The argument of 14.5.3 comes from the last of these (section 41). Parsons (1967), (1969) was an early commentator on Quine’s arguments. Kripke initiated contemporary defences of essentialism on the basis of his modal semantics in Kripke (1972). Another stout defender has been Plantinga (1974).

14.9 Further Reading

On quantified modal logic, Hughes and Cresswell (1996) is now rather dated (since, for example, it uses axiom systems rather than tableaux or natural deduction), but is still a classic. For constant domain modal logic, see chs. 13, 14. Fitting and Mendelsohn (1998) is an excellent text book on quantified modal logic, containing semantics, tableaux, and much interesting philosophical discussion. For a survey of quantified modal logic, see Garson (1984) and Cresswell (2001). There is now an enormous literature on essentialism. One good collection is Schwartz (1972).

For more on quantified tense logic, see McArthur (1976) and Cocchiarella (1984). For an overview of the history of tense logic, and philosophical disputes to which it is relevant, see Øhrstrøm and Hasle (1995).

14.10 Problems

1. Check the details omitted in 14.3.6, 14.5.4 and 14.6.3.
2. Show the following in CK:
 - (a) $\vdash \forall x \Box A \equiv \Box \forall x A$
 - (b) $\vdash \exists x \Diamond A \equiv \Diamond \exists x A$
 - (c) $\vdash \Diamond \forall x A \supset \forall x \Diamond A$
 - (d) $\vdash \exists x \Box A \supset \Box \exists x A$
 - (e) $\vdash \forall x \Box (A \wedge B) \supset \Box \forall x A$
 - (f) $\vdash \Box \Diamond \exists x A \supset \Box \exists x \Diamond (A \vee B)$
3. Show the following in CK. Read off a counter-model from an open branch of a tableau, and check that it works. If the counter-model is infinite, find a finite one by trial and error.
 - (a) $\not\vdash \forall x \Diamond Px \supset \Diamond \forall x Px$
 - (b) $\not\vdash \Box \exists x Px \supset \exists x \Box Px$
 - (c) $\not\vdash \forall x \Box (Px \vee Qx) \supset \Box \forall x Px$
 - (d) $\not\vdash \exists x \Box \Diamond Px \supset \exists x \Diamond \Box Px$
4. Check the following in each of $CK\rho$, $CK\sigma\tau$ and $CK\nu$. Where the inference is invalid, read off a counter-model from an open branch, and check that it works. If the counter-model is infinite, find a finite counter-model by trial and error.
 - (a) $\vdash \forall x \Box Px \supset \exists x Px$
 - (b) $\vdash \exists x \Diamond \Diamond Qx \supset \Diamond \exists x Qx$
 - (c) $\vdash \Box \Box \forall x Px \equiv \Diamond \forall x \Box Px$
5. Check the validity of the inferences in 12.4.14, no. 5, for CK, when ‘ \supset ’ is replaced by ‘ \rightarrow ’. Are things different in $CK\nu$?
6. Determine the truth of the following in CK^t . If the inference is invalid, give a counter-model and check that it works. Are the results different in (a) CK_τ^t , (b) CK_ϕ^t ?
 - (a) $\vdash \langle F \rangle \exists x Qx \wedge [F] \forall x (Qx \supset Sx) \supset \langle F \rangle \exists x Sx$
 - (b) $\vdash \langle P \rangle \exists x Qx \supset \exists x \langle P \rangle Qx$
 - (c) $\vdash \exists x [P] Qx \supset [P] \exists x Qx$
7. Could I have been born to different parents in 1234?
8. *Temporal essentialism* is the view that there are some properties that objects have at all times that they exist. Discuss temporal essentialism.
9. *Check the details omitted in 14.7.

10. *In the proof of the Soundness Theorem, given any open branch, we construct a sequence of interpretations, $\mathcal{I}, \mathcal{I}', \mathcal{I}'', \dots$, such that for any initial section of the branch, a member of the sequence is faithful to it. Use the sequence to define a single interpretation that is faithful to the whole branch.
11. *For the various systems of logic in this chapter, formulate tableaux for inferences with arbitrary sets of premises. Prove the Soundness and Completeness Theorems. Infer the Compactness and Löwenheim-Skolem Theorems.

15 Variable Domain Modal Logics

15.1 Introduction

15.1.1 In this chapter we will look at the other variety of semantics for quantified modal (and tense) logic: variable domain.

15.1.2 We will start with K and its normal extensions. Next we observe how matters can be extended to tense logic.

15.1.3 There are then some comments on other extensions of the logics involved.

15.1.4 The chapter ends with a brief discussion of two major philosophical issues that variable domain semantics throw into prominence: the question of existence across worlds, and the connection (or lack thereof) between existence and the particular quantifier.

15.2 Prolegomenon

15.2.1 Perhaps the most obvious objection to constant domain semantics is as follows. Just as the properties of objects may vary from world to world, what exists at a world, it is natural to suppose, may vary from world to world. Thus, I exist at this world, but in a world where my parents never met, I do not exist. Or, at this world, Sherlock Holmes does not exist, but in a world that realises the stories of Arthur Conan Doyle, he does.

15.2.2 Another way of making the point is as follows. Consider the following formulas:

BF: $\forall x \Box A \supset \Box \forall x A$

CBF: $\Box \forall x A \supset \forall x \Box A$

These are usually called the *Barcan Formula* and the *Converse Barcan Formula*, respectively. Both of these are valid in *CK* (and *a fortiori* stronger constant domain logics), as may be checked. But intuitively they are invalid. For the Barcan Formula: Suppose that $\forall x \Box Px$ holds (at this world). Then every object that exists satisfies P at every (accessible) world. It does not follow that $\Box \forall x Px$ is true. For other worlds may contain objects that do not exist at this world, and they may not satisfy P . Conversely, suppose that $\Box \forall x Px$ is true. Then at every (accessible) world, every object that exists (there) satisfies P . It does not follow that $\forall x \Box Px$. For this world might contain objects that do not exist at another world, and there is no reason to suppose that they satisfy P at such worlds.

15.2.3 The natural response to this sort of criticism is to construct a semantics in which the domain of quantification varies from world to world. This presents a problem, however. Suppose that $\forall x Px$ is true at a world. Then for every object, a , at that world, Pa is true. But suppose that b does not exist at the world. There is no reason to suppose that Pb is true. Universal instantiation will therefore fail.¹

15.2.4 The simplest and most robust solution to this problem is to base the modal logic, not on classical logic, but on free logic. Thus, as in chapter 13, we will take one of the monadic predicates in the language to be a distinguished existence predicate, \mathfrak{E} .²

15.3 Variable Domain K and its Normal Extensions

15.3.1 Bearing this in mind, a variable domain interpretation is a quadruple $\langle D, W, R, \nu \rangle$. D, W, R and ν are the same as in the constant domain case, with the exception that for every $w \in W$, ν maps w to a subset of D , that is,

¹ It is worth noting that if an axiomatic version of quantified modal logic is based on a classical logic using free variables, the CBF is provable in quantified K , and the BF is provable in quantified $K\sigma$. See Hughes and Cresswell (1996), ch. 13.

² It is more usual, perhaps, to formulate variable domain modal logics without an existence predicate in the language. However, its presence is distinctly useful, and has no effect on the validity of inferences employing only sentences which do not contain it (by the Locality Lemma (15.9.3)).

$\nu(w) \subseteq D$. $\nu(w)$ is the domain at world w . I will write it as D_w . Note that for any n -place predicate, P , $\nu_w(P) \subseteq D^n$ (not D_w^n), and $\nu_w(\mathfrak{E})$ is always D_w .³

15.3.2 The truth conditions for atomic sentences, truth-functional and modal operators, are as in the constant domain case (14.2.3). Those for the quantifiers (as is to be expected) are:

$$\begin{aligned} \nu_w(\exists xA) &= 1 \text{ iff for some } d \in D_w, \nu_w(A_x(k_d)) = 1 \\ \nu_w(\forall xA) &= 1 \text{ iff for all } d \in D_w, \nu_w(A_x(k_d)) = 1 \end{aligned}$$

15.3.3 Semantic validity is defined in terms of truth preservation at all worlds of all interpretations, as in the constant domain case.

15.3.4 These semantics give the variable domain version of the propositional logic K , VK .

15.3.5 Adding constraints on the accessibility relation produces the extensions $VK\rho$, $VK\rho\sigma$, etc.

15.4 Tableaux for VK and its Normal Extensions

15.4.1 The tableaux for VK are exactly the same as those for CK , except that the quantifier instantiation rules are replaced with the corresponding free logic rules:

$$\begin{array}{ccc} \forall xA, i & & \exists xA, i \\ \swarrow \searrow & & \downarrow \\ \neg\mathfrak{E}a, i & A_x(a), i & \mathfrak{E}c, i \\ & & A_x(c), i \end{array}$$

with the usual conditions on a and c .

³ Using ν to specify the domain of world w in this way is entirely artificial, but it allows constant and variable domain interpretations to have a common form. In some contexts there are good reasons to keep ν separate from the rest of the structure. In that case, we have to add an extra component, δ , to an interpretation, such that $\delta(w)$ is the domain of world w . Alternatively, we can take D itself to be a function from worlds to sets, so that $D(w)$ is now the domain of world w . This means that we lose D in the old sense though. We still have a set $D' = \bigcup\{D(w) : w \in W\}$. But if this replaces our old D , it ensures that every object exists at some world. Better not to build this extra assumption into the semantics.

15.4.2 Here is a tableaux to show that $\vdash \Box\forall x(A \supset B) \supset (\Box\forall xA \supset \Box\forall xB)$.

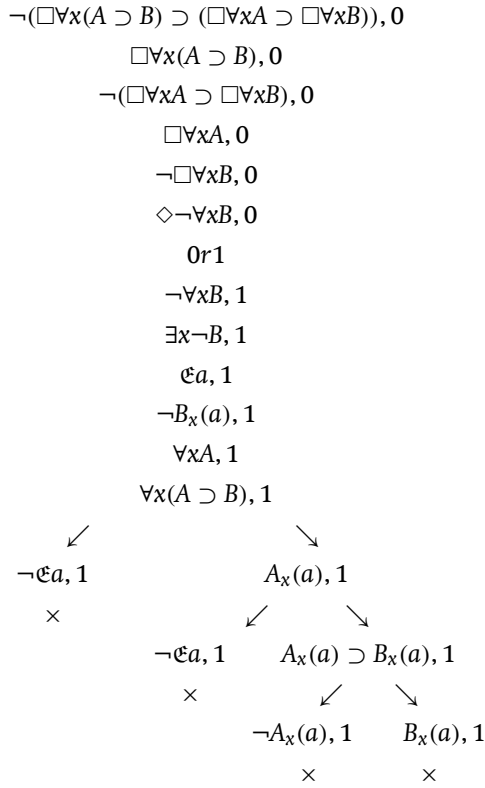

15.4.3 And here are tableaux to show that the Barcan Formula and its converse fail:

$$\not\vdash \forall x\Box Px \supset \Box\forall xPx$$

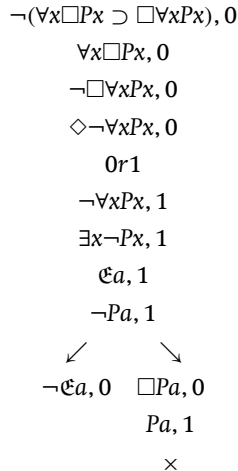

$$\not\vdash \Box \forall x Px \supset \forall x \Box Px$$

$$\begin{array}{c} \neg(\Box \forall x Px \supset \forall x \Box Px), 0 \\ \Box \forall x Px, 0 \\ \neg \forall x \Box Px, 0 \\ \exists x \neg \Box Px, 0 \\ \mathfrak{E}a, 0 \\ \neg \Box Pa, 0 \\ \diamond \neg Pa, 0 \\ Or1 \\ \neg Pa, 1 \\ \forall x Px, 1 \\ \swarrow \quad \searrow \\ \neg \mathfrak{E}a, 1 \quad Pa, 1 \\ \times \end{array}$$

15.4.4 Given an open branch, \mathcal{B} , of a tableau, a counter-model is read off as in the constant domain case, as modified by free logic. In particular, $D_{w_i} = \nu_{w_i}(\mathfrak{E}) = \{\partial_a : \mathfrak{E}a, i \text{ occurs on } \mathcal{B}\}$. Thus, for the counter-model determined by the open branch of the first tableau in 15.4.3, $W = \{w_0, w_1\}$, $w_0 R w_1$, $D = \{\partial_a\}$, $\nu(w_0) = D_{w_0} = \nu_{w_0}(\mathfrak{E}) = \emptyset$, $\nu(w_1) = D_{w_1} = \nu_{w_1}(\mathfrak{E}) = \{\partial_a\}$, $\nu_{w_0}(P) = \nu_{w_1}(P) = \emptyset$, and $\nu(a) = \partial_a$. We can depict this as:

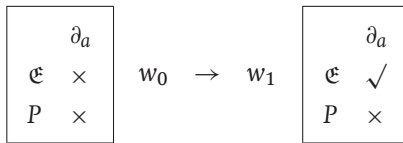

All objects in the domain of w_0 satisfy $\Box Px$. (There aren't any.) So $\forall x \Box Px$ is true there. And at w_1 , the only world accessible from w_0 , some object in its domain does not satisfy Px . Hence, $\Box \forall x Px$ is false at w_0 .

The counter-model determined by the open branch of the second tableau in 15.4.3 may be depicted as follows:

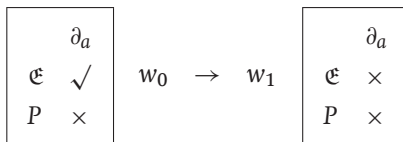

It is easy to check that this makes $\Box \forall x Px$ true at w_0 and $\forall x \Box Px$ false there.

15.4.5 Note that the counter-model for the Barcan Formula in 15.4.4 has an empty domain at some world, but the failure of the Barcan Formula does not depend on the possibility of empty domains. The interpretation depicted as follows refutes the Barcan Formula too:

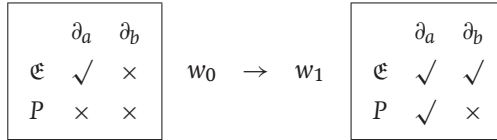

It is easy to check that this makes $\forall x \Box Px$ true at w_0 and $\Box \forall x Px$ false there.

A similar comment applies to the Converse Barcan Formula (and its demonstration is left as an exercise).

15.4.6 Tableaux for $VK\rho$, $VK\rho\tau$, etc. are obtained by adding the corresponding rules for r . Here, for example, is a tableau to show that $\Diamond \exists x Px \not\vdash_{VK\sigma} \exists x \Diamond Px$.

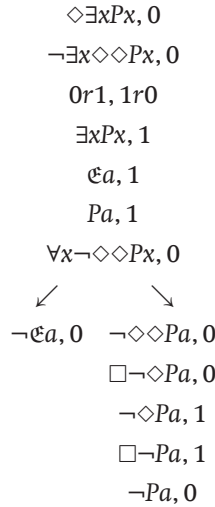

The counter-model given by the righthand branch may be depicted as follows.

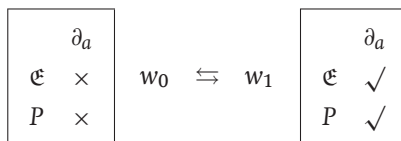

I leave it as an exercise to check that this works.

15.4.7 Since every interpretation for CK is an interpretation for VK (with $D_w = D$ for all $w \in W$), every inference that is valid in VK is valid in CK , though not vice versa. (See the examples of 15.4.3.) The same is true of CK_ρ and VK_ρ , and all the other normal extensions of CK . (The inferences of 15.4.3 are invalid in even the strongest normal variable domain logic, VK_ν . I leave this as an exercise.)

15.5 Variable Domain Tense Logic

15.5.1 Given the preceding remarks, the construction of variable domain tense logics is almost trivial. An interpretation for VK^t is the same as for VK , the truth conditions for the quantifiers are as in 15.3.2, and those for the tense operators are as in the propositional case (3.6a.4). Extensions are obtained by putting the appropriate constraints on R .

15.5.2 Tableaux for the systems are obtained by changing the classical quantifier rules of 14.3.1 to the free rules of 15.4.1.

15.5.3 Here are a couple of examples of tableaux:

$\vdash_{VK^t_\tau} \langle P \rangle \langle P \rangle \exists x Qx \supset \langle P \rangle \exists x(Qx \vee Sx)$:

$$\begin{array}{c} \neg(\langle P \rangle \langle P \rangle \exists x Qx \supset \langle P \rangle \exists x(Qx \vee Sx)), 0 \\ \langle P \rangle \langle P \rangle \exists x Qx, 0 \\ \neg \langle P \rangle \exists x(Qx \vee Sx), 0 \\ 1r0 \\ \langle P \rangle \exists x Qx, 1 \\ 2r1, 2r0 \\ \exists x Qx, 2 \\ \mathfrak{C}a, 2 \\ Qa, 2 \\ [P] \neg \exists x(Qx \vee Sx), 0 \\ \neg \exists x(Qx \vee Sx), 2 \\ \forall x \neg(Qx \vee Sx), 2 \\ \swarrow \quad \searrow \\ \neg \mathfrak{C}a, 2 \quad \neg(Qa \vee Sa), 2 \\ \times \quad \neg Qa, 2 \\ \quad \neg Sa, 2 \\ \times \end{array}$$

$\not\vdash_{VK^{\dagger\tau}} (\exists x \langle P \rangle Qx \wedge \exists x Qx) \supset \exists x \langle F \rangle Qx$:

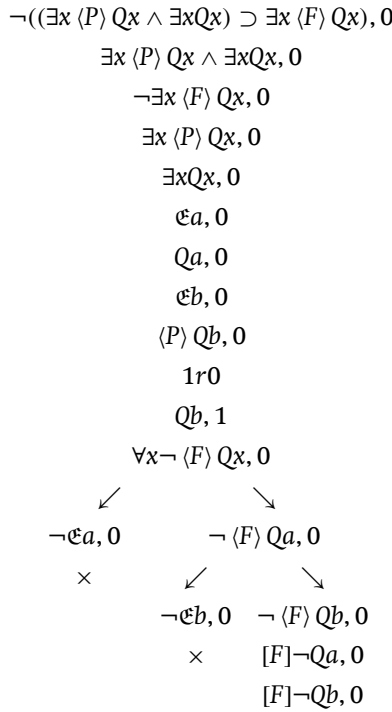

15.5.4 The counter-model determined by the open branch of the second tableau may be depicted as follows.

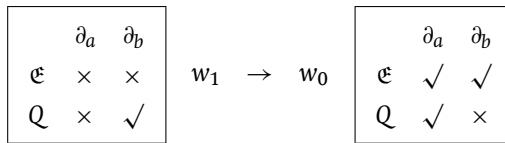

I leave it as an exercise to check that this works.

15.5.5 The comments of 15.4.7 apply, in analogous form, to variable and constant domain tense logics.

15.6 Extensions

15.6.1 In this section, we will consider a few possible extensions of the logics we have been considering.

15.6.2 The presence of variable domains and accessibility relations makes possible the addition of some hybrid constraints. A simple one is the domain-increasing condition:

$$\text{if } wRw' \text{ then } D_w \subseteq D_{w'}$$

The corresponding tableau rule is the obvious:

$$\begin{array}{c} irj \\ \mathfrak{E}a, i \\ \downarrow \\ \mathfrak{E}a, j \end{array}$$

15.6.3 Such constraints can certainly have an effect on which inferences are valid. Thus, the domain-increasing condition validates the Converse Barcan Formula in VK. To see this, look at the second tableau of 15.4.3, and note that an application of the rule for the domain-increasing condition to line five closes the lefthand branch.

15.6.4 In the context of both modal logic and tense logic, the domain-increasing constraint has little plausibility, however. As is easy to check, it validates the claim that if a exists, it exists necessarily/for all future times. These claims seem obviously false. (We will meet the claim again in chapter 20, in connection with intuitionist logic, where it has more plausibility.)

15.6.5 The logics we have been dealing with are all positive free logics, where objects that do not exist at a world may yet have positive properties there. Each logic can be extended to a corresponding negative one. We merely add the constraint that says that an object cannot be in the extension of a predicate at a world unless it exists there:

$$\text{If } \langle d_1, \dots, d_n \rangle \in \nu_{w_i}(P) \text{ then } d_1 \in \nu_{w_i}(\mathfrak{E}), \text{ and } \dots \text{ and } d_n \in \nu_{w_i}(\mathfrak{E})$$

and, for the tableaux, the corresponding rule (NCR):

$$\begin{array}{c} Pa_1 \dots a_n, i \\ \downarrow \\ \mathfrak{E}a_1, i \\ \vdots \\ \mathfrak{E}a_n, i \end{array}$$

15.6.6 Here is a tableau to show that $\vdash \Diamond Pa \supset \Diamond \exists x Px$ in the negative version of VK.

$$\begin{array}{c}
 \neg(\Diamond Pa \supset \Diamond \exists x Px), 0 \\
 \Diamond Pa, 0 \\
 \neg \Diamond \exists x Px, 0 \\
 \text{Or } 1 \\
 Pa, 1 \\
 \Box \neg \exists x Px, 0 \\
 \neg \exists x Px, 1 \\
 \forall x \neg Px, 1 \\
 \swarrow \quad \searrow \\
 \neg \mathcal{E}a, 1 \quad \neg Pa, 1 \\
 \mathcal{E}a, 1 \quad \times \\
 \times
 \end{array}$$

The left branch closes because of a final application of the NCR to line five.

15.6.7 Counter-models are read off from open branches of tableaux in the obvious way.

15.6.8 Adding the Negativity Constraint to any variable domain logic also produces a proper extension. The formula of 15.6.6 is not provable in any of the positive logics we have met. (Details are left as an exercise.)

15.6.9 The Negativity Constraint can, in fact, be added to any of the logics with world-semantics and an existence predicate that we will look at in this part of the book. Its addition is almost trivial – at least when identity is not present; the semantics and tableaux are modified essentially in the same way as we have modified the logics of this chapter (or, when identity is present, as we will modify them in the next chapter). I will not mention this explicitly in the following chapters unless there is some particular point to doing so.

15.6.10 The incorporation of world-machinery does nothing to change the counter-intuitiveness of the Negativity Constraint that we noted in 13.4.6 and 13.6.7, however. Indeed, it produces many new apparent counter-examples of the same kind. Thus, it can be true (at *this* world) that Sherlock Holmes has the property *lives in Baker St in some non-actual world, w*, though Holmes does not exist (at this world). (And, arguably, neither does *w*.)

15.6.11 All the systems we have looked at in this chapter are sound and complete with respect to their tableaux. This is proved in 15.9.

15.7 Existence Across Worlds

15.7.1 Let us now turn to a couple of philosophical issues to which variable domain semantics give rise. The first of these is an argument to the effect that domains in modal logic not only *may* vary, but *must* vary, since no object – at least no concrete object – can exist in more than one world.

15.7.2 One might argue this for a couple of reasons. One is by analogy with places. No object can have different physical locations; similarly, no object can have more than one world-location. For the second argument, let a exist at a world; we may suppose that it is red. Let b exist at another; we may suppose that it is not red. If $a = b$ then, by SI, a , that is, b , is both red and not red. Hence $a \neq b$.

15.7.3 The consequences of this view for quantified modal logic, at least in conjunction with the Negativity Constraint, would appear to be pretty draconian though. Let a be any object that exists at a world, w . Then at any other world, since a does not exist there, Pa is false there. It follows that $\diamond Pa$ is false at w , unless wRw , in which case $\diamond Pa$ is true at w iff Pa is. Taking w to be the actual world, and assuming that this accesses itself, we have, therefore, some kind of fatalism: the only things that can be true are the things that actually are true.

15.7.4 To avoid this problem, David Lewis suggested that although each object exists at only one world, at other worlds it may have *counterparts*. An object is a counterpart if it is a thing that is sufficiently similar, and nothing at that world is more similar. (So the unique counterpart of any object at a world is itself.) Then if A is a formula that contains one free variable, x , and no names, $\diamond A_x(a)$ is true at a world, w , iff for some accessible world, w' , and some counterpart of a at w' , b , $A_x(b)$ is true at w' . And $\square A_x(a)$ is true at w iff for all accessible worlds and all counterparts of a at w' , b , $A_x(b)$ is true at w .⁴

⁴ More generally, if A contains more than one constant, the recipe must be applied to all of these. Thus, $\diamond Pab$ is true at a world iff at some accessible world, w , for some counterparts of a and b at w , a' and b' , respectively, $Pa'b'$ is true there. And $\square Pab$ is true

15.7.5 The counterpart of an object at a world may not be unique: there may be two things that are sufficiently, and equally, similar. Nor need an object have a counterpart at all: there may be nothing sufficiently similar. Nor need the counterpart relation be symmetric or transitive. Given a in w_1 , the thing most (and sufficiently) similar in w_2 may be b . But the thing most (and sufficiently) similar to b in w_1 may be c . Similarly, given a in w_1 , the thing most (and sufficiently) similar in w_2 may be b . And the thing most (and sufficiently) similar to b in w_3 may be c . A different object, d , in w_3 may yet be more similar to a than c . We might depict these two situations as follows, where the degree of similarity between objects is represented by the distance between the corresponding letters:

$w_1:$	a	c	$w_1:$	a
$w_2:$	b		$w_2:$	b
			$w_3:$	d c

15.7.6 How to understand the notion of similarity between objects across worlds is as problematic an issue as how to understand the notion of similarity between worlds. (See the discussion of similarity in 5.8.) But harder to come to terms with is the fact that the features of the similarity relation play some havoc with the propositional properties of modal logic. For example, even in $VK\upsilon$, $\Box Pa \supset \Box \Box Pa$ fails. Thus, in the second scenario of 15.7.5, suppose that the worlds and objects depicted are the only ones there are, and that P is true of a , b , and d at their respective worlds, but not c . Then $\Box Pa$ is true at w_1 . But at w_2 , $\Box Pb$ is false, since b 's counterpart at w_3 is c ; and since b is the counterpart of a in w_2 , $\Box \Box Pa$ is false at w_1 . Similarly, $Pa \supset \Box \Diamond Pa$ fails.

15.7.7 Fortunately, then, the arguments of 15.7.2 to the effect that something cannot exist in more than one world may be resisted. The argument that appeals to SI may be defused by taking properties to be world-indexed. So a and b are both red-at-one-world and not red-at-the-other. (See 12.6.6, 12.6.7.) And though we are inclined to consider it impossible for an object to exist at two different places, we are not inclined to suppose it impossible

at a world iff at every accessible world, w , for every counterpart of a and b at w , a' and b' , $Pa'b'$ is true there.

for an object to exist at two different times. Worlds, we may suppose, are more like times than places.⁵

15.7.8 This does raise the question of what it is that makes an object the same object at different worlds, however. (This is often known as the problem of *transworld identity*.) What makes an object, such as my bike, the same object at different times, is, presumably, some kind of causal continuity. There can be no continuity of this kind across worlds.

15.7.9 The situation is exacerbated by the fact that objects can change their properties radically. Thus, it would seem, there is a world in which I am a woman, Chinese, 4' tall, etc. Why is it still *me*?

15.7.10 One answer might be that I cannot change all my properties. I retain, by definition, my essential properties. If the essential properties of an object uniquely identify it, then this solves the problem. (Essential properties that uniquely identify an object are sometimes called *haecceities*, from the Latin 'haec', meaning *this*.) Thus, one might argue, the property of being identical with *a* is an essential property of *a* and nothing else.

15.8 Existence and Wide-Scope Quantifiers

15.8.1 Finally, let us return to the argument for domain variation given in 15.2.1. It gets its punch from identifying the things in the domain at a world with the things that exist there. (Indeed, in the semantics for variable domains, the domain of a world just is the extension of the existence predicate at that world.) But the very semantics of variable domains appears to force us to countenance objects whose existence changes from world to world and which may well, therefore, not exist at the actual world – mere *possibilia*. We even quantify over them: some of these objects do not exist (at the actual world).

15.8.2 This suggests that we should take our quantifiers to be existentially unloaded; in which case, there seems to be little point in not taking the domain of each world to be the same – comprising all objects – and

⁵ If worlds are abstract objects – in the last instance, certain sets – as the modal actualist claims (2.7), there is no problem about seeing how an object can be in more than one world. Clearly, an object can be in different sets.

expressing the change of existential status with the existence predicate. If we do this, then, as we saw in 13.5.6, the existentially loaded, i.e., domain relative, quantifiers can be defined in terms of the outer quantifiers. We might just as well, therefore, settle for constant domain semantics plus an existence predicate.

15.8.3 It might be replied that we can surely imagine a possible world with just one thing in the domain, a possible world with just two things in the domain, etc. It must therefore be possible for the domain to change. We can certainly imagine a domain with one existing thing, two existing things, etc. These domains could still contain all objects. And given that we are countenancing non-existent objects, what would it be like for one of these not to be in the domain of quantification at a world? If I can refer to, and quantify over, Sherlock Holmes and other things that do not exist at this world, why cannot the denizen of another possible world do the same?

15.8.4 Hard-liners about the particular quantifier expressing existence, such as (David) Lewis, would resist the suggestion of 15.8.2. The particular quantifier does express existence, and the predicate \mathcal{E} has then to be interpreted as a *local* existence predicate, ‘exists at this world’, cf. ‘exists in the twenty-first century’ or ‘exists in Scotland’.) But even they hold that we can quantify over objects, whether or not they exist at this world. The hard line, therefore, provides no argument against constant domain semantics.

15.9 *Proofs of Theorems

15.9.1 In this section, we will prove the soundness and completeness of the tableau systems given in this chapter. We will start with VK and its extensions. Next we consider tense logics. Finally, we consider the domain-inclusion and negativity constraints.

15.9.2 The proofs are essentially the same as those for constant domain semantics (14.7), as modified by those for free logic (13.7). We start with the appropriate versions of the Locality and Denotation Lemmas for VK.

15.9.3 LEMMA (LOCALITY): Let $\mathfrak{J}_1 = \langle D, W, R, \nu_1 \rangle$, $\mathfrak{J}_2 = \langle D, W, R, \nu_2 \rangle$ be two VK interpretations. Since they have the same domain, the language of the two is the same. Call this L . If A is any closed formula of L such that ν_1 and ν_2 agree on the denotations of all the predicates and constants in it, then, for

all $w \in W$:

$$\nu_{1w}(A) = \nu_{2w}(A)$$

Proof:

The proof is essentially as in 14.7.2. The only variation is in the cases for the quantifiers. In these, clauses of the form ' $d \in D$ ' are replaced by ones of the form ' $d \in D_w$ '. ■

15.9.4 LEMMA (DENOTATION): Let $\mathfrak{J} = \langle D, W, R, \nu \rangle$ be any VK interpretation. Let A be any formula of $L(\mathfrak{J})$ with at most one free variable, x , and a and b be any two constants such that $\nu(a) = \nu(b)$. Then for any $w \in W$:

$$\nu_w(A_x(a)) = \nu_w(A_x(b))$$

Proof:

Again, the proof is essentially as in 14.7.3. The only variation is in the cases for the quantifiers. In these, clauses of the form ' $d \in D$ ' are replaced by ones of the form ' $d \in D_w$ '. ■

15.9.5 SOUNDNESS THEOREM: The tableaux for VK are sound with respect to their semantics.

Proof:

The proof is as for the constant domain case (14.7.4–14.7.6). The only difference is in the cases of the Soundness Lemma for the quantifier rules. The modifications for the rules concerning negated quantifiers are trivial. For particular and universal instantiation, the cases are as follows. Let f be a function that shows \mathfrak{J} to be faithful to \mathcal{B} .

Suppose we apply the rule:

$$\begin{array}{c} \forall x A, i \\ \swarrow \searrow \\ \neg \mathcal{E} a, i \quad A_x(a), i \end{array}$$

Since \mathfrak{J} makes $\forall x A$ true at $f(i)$, \mathfrak{J} makes $A_x(k_d)$ true at $f(i)$, for all $d \in D_{f(i)}$; so, for any $d \in D$, \mathfrak{J} makes either $\neg \mathcal{E} k_d$ or $A_x(k_d)$ true at $f(i)$. Let d be such that $\nu(a) = \nu(k_d)$. By the Denotation Lemma, \mathfrak{J} makes either $\neg \mathcal{E} a$ or $A_x(a)$ true at $f(i)$. Hence, \mathfrak{J} is faithful to one branch or the other, and we can take \mathfrak{J}' to be \mathfrak{J} .

Suppose that we apply the rule:

$$\begin{array}{c} \exists xA, i \\ \downarrow \\ \mathfrak{E}c, i \\ A_x(c), i \end{array}$$

\mathfrak{I} makes $\exists xA$ true at $f(i)$. Hence, for some $d \in D_{f(i)}$, \mathfrak{I} makes $A_x(k_d)$ true at $f(i)$. That is, \mathfrak{I} makes $\mathfrak{E}k_d$ and $A_x(k_d)$ true at $f(i)$. Let $\mathfrak{I}' = \langle D, W, R, v' \rangle$ be the same as \mathfrak{I} except that $v'(c) = d$. Since c does not occur in $A_x(k_d)$, \mathfrak{I}' makes $\mathfrak{E}k_d$ and $A_x(k_d)$ true at $f(i)$, by the Locality Lemma. Since $v'(c) = d = v'(k_d)$, \mathfrak{I}' makes $\mathfrak{E}c$ and $A_x(c)$ true at $f(i)$, by the Denotation Lemma. And since c does not occur in any other formula on the branch, \mathfrak{I}' makes all other formulas on the branch true at $f(i)$ as well, by the Locality Lemma. ■

15.9.6 COMPLETENESS THEOREM: The tableaux for VK are complete with respect to their semantics.

Proof:

The proof is a small modification of that for CK . The induced interpretation is defined in the same way as 14.7.7, except that, in addition, $D_{w_i} = v(w_i) = v_{w_i}(\mathfrak{E}) = \{\partial_a: \mathfrak{E}a, i \text{ occurs on } \mathcal{B}\}$. The proof of the Completeness Lemma is as in 14.7.8, except for the cases for quantified sentences. Here is the case for \exists . The case for \forall is similar. Recall that C is the set of constants on the branch.

Suppose that $\exists xA, i$ is on the branch. Then, for some $c \in C$, $\mathfrak{E}c, i$ and $A_x(c), i$ are on the branch. By IH, $v_{w_i}(\mathfrak{E}c) = 1$ and $v_{w_i}(A_x(c)) = 1$. For some $d \in D$, $v(c) = d = v(k_d)$. Hence, $v_{w_i}(\mathfrak{E}k_d) = v_{w_i}(A_x(k_d)) = 1$, by the Denotation Lemma. That is, $v_{w_i}(\exists xA) = 1$.

Suppose that $\neg\exists xA, i$ is on the branch. Then so is $\forall x\neg A, i$. So for all $c \in C$, either $\neg\mathfrak{E}c, i$ or $\neg A_x(c), i$ is on the branch. Since the branch is open, then, for all $c \in C$, if $\mathfrak{E}c, i$ is on the branch, so is $\neg A_x(c)$; that is, by IH, if $v_{w_i}(\mathfrak{E}c) = 1$, $v_{w_i}(A_x(c)) = 0$. If $d \in D$, then for some $c \in C$, $v(c) = v(k_d)$. Hence, for all $d \in D$, such that $v_{w_i}(\mathfrak{E}k_d) = 1$, i.e., such that $d \in D_{w_i}$, $v_{w_i}(A_x(k_d)) = 0$, by the Denotation Lemma. Thus, $v_{w_i}(\exists xA) = 0$.

The Completeness Theorem follows from the Completeness Lemma in the usual way (14.7.9). ■

15.9.7 THEOREM: The tableaux for the extensions of VK are sound and complete with respect to their semantics.

Proof:

The proof extends the soundness and completeness proof for VK , just by checking that the constraints on R verify the corresponding tableau rules, and the tableau rules induce an interpretation of the right kind. Details are as in 14.7.10. ■

15.9.8 THEOREM: The tableaux for VK^t and its extensions are sound and complete with respect to their semantics.

Proof:

The proofs modify those of VK , as the proofs for CK^t modify those for CK (4.7.11, 4.7.12). Details are left as an exercise. ■

15.9.9 THEOREM: In any of the logics we have considered, the addition of the domain-increasing rule of 15.6.2 produces a system that is sound and complete with respect to the corresponding semantics.

Proof:

In the proof of the relevant Soundness Lemma, we have to check an extra case for the new rule. Suppose that f shows \mathcal{J} to be faithful to a branch, \mathcal{B} , containing irj and $\mathfrak{E}a, i$. Then $f(i)Rf(j)$ and $v(a) \in v_{w_i}(\mathfrak{E}) = D_{w_i}$. By the constraint, $D_{f(i)} \subseteq D_{f(j)}$, so $v(a) \in D_{w_j} = v_{w_j}(\mathfrak{E})$. That is, $\mathfrak{E}a$ is true at $f(j)$, and we can take \mathcal{J}' to be \mathcal{J} .

In the relevant Completeness Theorem, we have to check that the induced interpretation satisfies the constraint. Suppose that w_iRw_j . Then irj is on the branch. Suppose that $\partial_a \in D_{w_i}$. Then $\mathfrak{E}a, i$ is on the branch, as is $\mathfrak{E}a, j$. Hence $\partial_a \in D_{w_j}$. ■

15.9.10 THEOREM: In any of the logics considered, the addition of the Negativity Constraint Rule is sound and complete with respect to the corresponding semantics.

Proof:

In the proof of the relevant Soundness Lemma, we have to check an extra case for the new rule. Suppose that f shows \mathcal{J} to be faithful to a branch, \mathcal{B} , containing $Pa_1 \dots a_n, i$. Then $\langle v(a_1), \dots, v(a_n) \rangle \in v_{f(i)}(P)$. By the Negativity

Constraint, $v(a_1), \dots, v(a_n) \in v_{f(i)}(\mathcal{E})$. So $\mathcal{E}a_1, \dots, \mathcal{E}a_n$ are all true at $f(i)$. So we may take \mathfrak{J}' to be \mathfrak{J} .

In the relevant Completeness Theorem, we have to check that the induced interpretation satisfies the Constraint. So suppose that $\langle \partial_{a_1}, \dots, \partial_{a_n} \rangle \in v_{w_i}(P)$. $Pa_1 \dots a_n, i$ is on the branch, and so, then, are $\mathcal{E}a_1, i, \dots, \mathcal{E}a_n, i$. That is, $\partial_{a_1}, \dots, \partial_{a_n} \in v_{w_i}(\mathcal{E})$. ■

15.10 History

Variable domain quantified logic goes back to the work of Kripke. (See the references in 14.8.) The Barcan Formula was introduced by Barcan(-Marcus) (1946). The problems with it were apparent early. They are pointed out in Prior (1957). Barcan (1962) provides an early defence of it, in terms of substitutional quantification. Kripke (1963b) uses a version of classical logic without free variables to avoid deriving the Barcan Formula (see the footnote to 15.2.3), though he indicates in a footnote that an existence predicate could be employed. Hughes and Cresswell (1996), ch. 13, employ the domain-increasing condition. This allows them to sidestep the problem of non-denoting terms. Using free logic to formulate variable domain semantics seems to have been folklore for quite a long time before anyone put details into print.

Counterpart theory was put forward and defended by David Lewis (1968) and (1986), ch. 4. Aristotle did not subscribe to haecceities. A number of Medieval philosophers, notably Duns Scotus, did, however (see Cross (2006)). Haecceities have been defended in contemporary philosophy by various people including Plantinga (1974), ch. 6. For Kripke's own response to the problem of transworld identity, see Kripke (1971).

15.11 Further Reading

For variable domain modal logic, see the references for quantified modal logic by Hughes and Cresswell, Garson, Fitting and Mendelsohn, and Cresswell in 14.9. For variable domain tense logics, see the reference to McArthur in 14.9. See also Cocchiarella (1984) for a number of the philosophical issues to which quantified modal and tense logic gives rise. It is worth noting that there is a rather different kind of semantics for modal logics ('neighbourhood semantics') that verifies neither the Barcan Formula nor the Converse

Barcan Formula, even with constant domains. See, e.g., Waagbø (1992). An argument that, contrary to what one might expect, all objects exist necessarily (and so for constant domain semantics) can be found in Williamson (2002).

A number of good essays on the issue of transworld identity and other matters can be found in Loux (1979). See also Adams (1979). For a discussion of *possibilia*, see Yagisawa (2006). On outer quantifiers in modal logic, see Priest (2005c), chs. 1 and 3.

15.12 Problems

1. Check the details omitted in 15.2.2, 15.4.4, 15.4.5, 15.4.6, 15.4.7, 15.5.4, 15.6.4 and 15.6.8.
2. Show the following in VK .
 - (a) $\vdash (\Box\forall xA \wedge \Box\forall xB) \supset \Box\forall x(A \wedge B)$
 - (b) $\vdash \Diamond\exists xA \supset \Diamond\exists x(A \vee B)$
 - (c) $\vdash (\forall x\Box A \wedge \mathcal{E}a) \supset \Box A_x(a)$
3. Show the following in VK . Read off an interpretation from an open branch of the tableau, and show that it works. If the counter-model is infinite, try to find a finite counter-model by trial and error.
 - (a) $\not\vdash \forall x\Diamond A \supset \Diamond\forall xA$
 - (b) $\not\vdash \Diamond\exists xA \supset \exists x\Diamond A$
 - (c) $\not\vdash \Diamond\forall xA \supset \forall x\Diamond A$
 - (d) $\not\vdash \exists x\Box A \supset \Box\exists xA$
 - (e) $\not\vdash \Box Pa \supset \exists x\Box Px$
 - (f) $\not\vdash \exists x\Diamond Px \supset \exists x\Diamond\Diamond Px$
 - (g) $\not\vdash \forall xPx \supset \exists x\Box\Diamond Px$
 - (h) $\not\vdash \forall x\Diamond\mathcal{E}x$
4. Does anything change if you repeat the previous question with (a) $VK\rho$, (b) $VK\nu$?
5. Determine the truth of the following in VK^t . Where invalid, give a counter-model.
 - (a) $\vdash [P]\forall xQx \supset \forall x[P]Qx$
 - (b) $\vdash \forall x[P]Qx \supset [P]\forall xQx$
 - (c) $\vdash \langle F \rangle \exists xQx \supset \langle P \rangle \langle F \rangle \langle F \rangle \exists xQx$
 - (d) $\vdash \langle \langle P \rangle \exists xQx \wedge [P]\forall x(Qx \supset Sx) \rangle \supset \langle P \rangle \exists xSx$
 - (e) $\vdash \exists x[P] \langle F \rangle Qx \supset \exists xQx$

6. Are the answers to the previous question any different in (a) VK_{δ}^t , (b) VK_{φ}^t ?
7. Do the following hold in the negative version of VK_{ρ} ? Justify your answer.
 - (a) $\vdash \Box \exists x P x \supset \Box \exists x \mathcal{E} x$
 - (b) $\vdash \Box \exists x P x \supset \exists x \Box \mathcal{E} x$
8. Determine whether the following hold in VK with the domain-increasing condition:
 - (a) $\vdash \exists x \mathcal{E} x \supset \Box \exists x \mathcal{E} x$
 - (b) $\vdash \Diamond \exists x \mathcal{E} x \supset \exists x \mathcal{E} x$
9. The domain-decreasing condition is: if wRw' then $D_w \supseteq D_{w'}$. Check the examples of the previous question with respect to this condition.
10. Can an object exist in more than one possible world? If so, what makes it the same object?
11. Do *possibilia* exist?
12. *Check the details omitted in 15.9.
13. *Formulate an appropriate tableau rule for the domain-decreasing constraint of question 9, and prove that its addition to the rules for VK gives a tableau system that is sound and complete with respect to the semantics for VK with the constraint added. Extend this to stronger normal modal logics.
14. *For the various systems of logic in this chapter, formulate tableaux for inferences with arbitrary sets of premises. Prove the Soundness and Completeness Theorems. Infer the Compactness and Löwenheim-Skolem Theorems.

16 Necessary Identity in Modal Logic

16.1 Introduction

16.1.1 In this chapter we will start to look at the behaviour of identity in modal logic. (Henceforth, I use ‘modal logic’ to include tense logic.) There are, in fact, two kinds of semantics for identity in modal logic: necessary and contingent.¹

16.1.2 Where it is necessary to distinguish between the two notions of identity, I will use the following notation. If S is any system of logic without identity, $S(NI)$ will denote the system augmented by necessary identity, and $S(CI)$ will denote the system of logic augmented by contingent identity. In this chapter we will deal with necessary identity, which is simpler; in the next chapter, we will turn to contingent identity.

16.1.3 We will assume, first, that the Negativity Constraint is not in operation. We will then see how its addition affects matters.

16.1.4 Next, we will look at the distinction between rigid and non-rigid designators, and see how non-rigid designators can be added to the logic.

¹ The terminology is not entirely happy. The distinction turns on whether identity statements can have different truth values at different worlds. For this reason, it might be more appropriate to call the identities world-invariant and world-variant. Later in the book, we will be concerned not only with possible worlds, but with impossible worlds of various kinds. It is therefore entirely possible for identity statements to change their truth values, but only at impossible worlds. If this is the case, then true identity statements can still be necessarily true (i.e., true at all possible worlds) even though identity is world-variant. However, since the terminology is standard, I employ it.

16.1.5 Finally, there is a short philosophical discussion of how this distinction applies to names and descriptions in a natural language such as English.

16.2 Necessary Identity

16.2.1 Assume that we are dealing with any quantified (constant or variable domain) normal modal logic (without the Negativity Constraint). As in the classical case (12.5.1), we now distinguish one of the binary predicates as the identity predicate.

16.2.2 The denotation of the identity predicate is the same in every world, w , of an interpretation: $v_w(=) = \{\langle d, d \rangle : d \in D\}$.

16.2.3 There are three tableau rules for identity. The first two are exactly as in the classical case (12.5.3), modulo an appropriate world parameter:

$$\begin{array}{ccc} \cdot & a = b, i & \\ \downarrow & A_x(a), i & \\ a = a, i & \downarrow & \\ & A_x(b), i & \end{array}$$

– where, recall, A is any atomic sentence other than $a = b$. Note that in SI, the world index on every line is the same, so substitution is licensed only *within* a world. The third rule is the following:

$$\begin{array}{c} a = b, i \\ \downarrow \\ a = b, j \end{array}$$

where j is any world parameter on the branch distinct from i . I will call this the *Identity Invariance Rule (IIR)*.

16.2.4 Here are tableaux to demonstrate that $\vdash_{VK(NI)} \forall x \forall y (x = y \supset \Box x = y)$, and $\vdash_{VK(NI)} \forall x \forall y (x \neq y \supset \Box x \neq y)$. Clearly, the tableaux work in a similar way in $VK^t(NI)$, when \Box is replaced by $[F]$ or $[P]$. Since the variable domain logics are sub-logics of the corresponding constant domain logics (15.4.7, 15.5.5), these inferences are valid in all constant and variable domain quantified modal logics. It is the validity of these formulas that give this notion of identity its name: all true statements of identity or difference are necessarily

true (true for all future/past times). For future reference, we will call the formula $\forall x\forall y(x = y \supset \Box x = y)$ NI (*Necessary Identity*).

$$\begin{aligned}
 &\neg\forall x\forall y(x = y \supset \Box x = y), 0 \\
 &\exists x\neg\forall y(x = y \supset \Box x = y), 0 \\
 &\quad \mathfrak{E}a, 0 \\
 &\neg\forall y(a = y \supset \Box a = y), 0 \\
 &\exists y\neg(a = y \supset \Box a = y), 0 \\
 &\quad \mathfrak{E}b, 0 \\
 &\neg(a = b \supset \Box a = b), 0 \\
 &\quad a = b, 0 \\
 &\quad \neg\Box a = b, 0 \\
 &\quad \diamond\neg a = b, 0 \\
 &\quad \text{Or1} \\
 &\quad \neg a = b, 1 \\
 &\quad a = b, 1 \\
 &\quad \times
 \end{aligned}$$

The last line is obtained by applying the IIR from line eight.

$$\begin{aligned}
 &\neg\forall x\forall y(x \neq y \supset \Box x \neq y), 0 \\
 &\exists x\neg\forall y(x \neq y \supset \Box x \neq y), 0 \\
 &\quad \mathfrak{E}a, 0 \\
 &\neg\forall y(a \neq y \supset \Box a \neq y), 0 \\
 &\exists y\neg(a \neq y \supset \Box a \neq y), 0 \\
 &\quad \mathfrak{E}b, 0 \\
 &\neg(a \neq b \supset \Box a \neq b), 0 \\
 &\quad a \neq b, 0 \\
 &\quad \neg\Box a \neq b, 0 \\
 &\quad \diamond\neg a \neq b, 0 \\
 &\quad \text{Or1} \\
 &\quad \neg a \neq b, 1 \\
 &\quad a = b, 1 \\
 &\quad a = b, 0 \\
 &\quad \times
 \end{aligned}$$

Again, the last line is obtained by applying the IIR.

16.2.5 Here is another tableau to show that $\not\models_{CK(NI)} \Box \forall x \forall y ((Sax \wedge Say) \supset x \neq y)$:

$$\begin{array}{l}
 \neg \Box \forall x \forall y ((Sax \wedge Say) \supset x \neq y), 0 \\
 \diamond \neg \forall x \forall y ((Sax \wedge Say) \supset x \neq y), 0 \\
 \text{Or } 1 \\
 \neg \forall x \forall y ((Sax \wedge Say) \supset x \neq y), 1 \\
 \exists x \neg \forall y ((Sax \wedge Say) \supset x \neq y), 1 \\
 \neg \forall y ((Sab \wedge Say) \supset b \neq y), 1 \\
 \exists y \neg ((Sab \wedge Say) \supset b \neq y), 1 \\
 \neg ((Sab \wedge Sac) \supset b \neq c), 1 \\
 Sab \wedge Sac, 1 \\
 \neg b \neq c, 1 \\
 Sab, 1 \\
 Sac, 1 \\
 b = c, 1 \\
 b = c, 0
 \end{array}$$

16.2.6 Counter-models are read off from open branches as usual. In particular, where there is a bunch of lines of the form $a = b, 0$, $b = c, 0$, etc., a single denotation is provided for all the constants, as in 12.5.9 and 13.6.5. (The 0 could, in fact, be any line number, because of the IIR.)

16.2.7 Thus, in the counter-model given by the tableau of 16.2.5, $W = \{w_0, w_1\}$, $w_0 R w_1$, $D = \{\partial_a, \partial_b\}$, $v(a) = \partial_a$, $v(b) = v(c) = \partial_b$, and $v_{w_1}(S) = \{\langle \partial_a, \partial_b \rangle\}$. In a picture:

<table style="border-collapse: collapse; margin: auto;"> <tr><td style="padding: 2px 10px;">S</td><td style="padding: 2px 10px;">∂_a</td><td style="padding: 2px 10px;">∂_b</td></tr> <tr><td style="padding: 2px 10px;">∂_a</td><td style="padding: 2px 10px; text-align: center;">\times</td><td style="padding: 2px 10px; text-align: center;">\times</td></tr> <tr><td style="padding: 2px 10px;">∂_b</td><td style="padding: 2px 10px; text-align: center;">\times</td><td style="padding: 2px 10px; text-align: center;">\times</td></tr> </table>	S	∂_a	∂_b	∂_a	\times	\times	∂_b	\times	\times	$w_0 \rightarrow w_1$	<table style="border-collapse: collapse; margin: auto;"> <tr><td style="padding: 2px 10px;">S</td><td style="padding: 2px 10px;">∂_a</td><td style="padding: 2px 10px;">∂_b</td></tr> <tr><td style="padding: 2px 10px;">∂_a</td><td style="padding: 2px 10px; text-align: center;">\times</td><td style="padding: 2px 10px; text-align: center;">\checkmark</td></tr> <tr><td style="padding: 2px 10px;">∂_b</td><td style="padding: 2px 10px; text-align: center;">\times</td><td style="padding: 2px 10px; text-align: center;">\times</td></tr> </table>	S	∂_a	∂_b	∂_a	\times	\checkmark	∂_b	\times	\times
S	∂_a	∂_b																		
∂_a	\times	\times																		
∂_b	\times	\times																		
S	∂_a	∂_b																		
∂_a	\times	\checkmark																		
∂_b	\times	\times																		

I leave it as an exercise to check that this interpretation works.

16.3 The Negativity Constraint

16.3.1 In this section, we will see how the addition of the Negativity Constraint affects matters.

16.3.2 In the presence of the constraint, non-existent objects cannot be in the extension of the identity predicate. Hence, $v_w(=) = \{\langle d, d \rangle : d \in v_w(\mathcal{E})\}$.

16.3.3 For the corresponding tableaux, the identity rules become:

$$\begin{array}{ccc}
 \mathcal{E}a, i & a = b, i & a = b, i \\
 \downarrow & A_x(a), i & \mathcal{E}a, j \text{ (or } \mathcal{E}b, j) \\
 a = a, i & \downarrow & \downarrow \\
 & A_x(b), i & a = b, j
 \end{array}$$

(where $A_x(a)$ is any atomic formula except $a = b$). Note the comments of 13.6.3 about the tableau rules for identity in free logic, which apply equally here.

16.3.4 Here is a tableau to show that $\vdash a = b \supset \Box(\mathcal{E}a \supset a = b)$ in $VK(NI)$, the weakest normal quantified modal logic. (Clearly, a similar tableau works in $VK^t(NI)$, when \Box is replaced by $[F]$ or $[P]$.)

$$\begin{array}{c}
 \neg(a = b \supset \Box(\mathcal{E}a \supset a = b)), 0 \\
 a = b, 0 \\
 \neg\Box(\mathcal{E}a \supset a = b), 0 \\
 \mathcal{E}a, 0 \\
 \mathcal{E}b, 0 \\
 \diamond\neg(\mathcal{E}a \supset a = b), 0 \\
 Or1 \\
 \neg(\mathcal{E}a \supset a = b), 1 \\
 \mathcal{E}a, 1 \\
 \neg a = b, 1 \\
 a = b, 1 \\
 \times
 \end{array}$$

The last line follows from the appropriate applications of IIR.

16.3.5 NI does not hold in $VK(NI)$ (or $VK^t(NI)$) with the Negativity Constraint. The tableau is as for the first one of 16.2.4, except that the last line is missing. We cannot infer $a = b, 1$, since we have neither $\mathcal{E}a, 1$ nor $\mathcal{E}b, 1$.

16.3.6 To read off a counter-model from an open branch of a tableau when the Negativity Constraint is in operation, we give constants the same denotation provided they are said to be the same at *some* world. Thus, for

example, if we have $a = b, i$ and $b = c, j$, we give a, b and c the same denotation.² The first tableau of 16.2.4 (truncated before the last line) then gives the interpretation depicted as follows:

$$\boxed{\begin{array}{c} \partial_a \\ \mathfrak{E} \quad \checkmark \end{array}} \quad w_0 \quad \rightarrow \quad w_1 \quad \boxed{\begin{array}{c} \partial_a \\ \mathfrak{E} \quad \times \end{array}}$$

Both a and b denote ∂_a . I leave it as an exercise to show that this counter-model works.

16.4 Rigid and Non-rigid Designators

16.4.1 Let us now consider a standard objection to quantified modal logic. Beethoven wrote nine symphonies. Therefore $9 = \beta$, where β is ‘the number of symphonies that Beethoven wrote’. Given NI, $\vdash \forall x \forall y (x = y \supset \Box x = y)$, it follows that $\Box 9 = \beta$; that is, necessarily the number of Beethoven symphonies is nine – which is false, since Beethoven could have died immediately after writing the eighth.

16.4.2 It might be suggested that the failure of NI in necessary identity systems with the Negativity Constraint provides an answer to the problem, but it does not. As we saw in 16.3.4, even with the Negativity Constraint, $a = b \supset \Box(\mathfrak{E}a \supset a = b)$. Since $9 = \beta$, it still follows that $\Box(\mathfrak{E}9 \supset 9 = \beta)$, and so $\Box \mathfrak{E}9 \supset \Box 9 = \beta$. But a Platonist about numbers ought to be able to hold that 9 is a necessary existent, without being driven into this absurd conclusion.

16.4.3 What has gone wrong with the argument is, in fact, that the noun-phrase β , ‘the number of symphonies written by Beethoven’ is a noun phrase that may change its denotation from world to world. In some worlds, Beethoven wrote eight symphonies, in some two, in some 147.

16.4.4 The constants we have been using so far all have a world-invariant denotation. (Thus, we write $\nu(c)$, not $\nu_w(c)$. Compare predicates, where

² In fact, if we have lines of the form $a = b, i$ and $b = c, j$, then there is a line of the form $\mathfrak{E}b, j$ (by the NCR) and $a = b, j$ (by the IIR). Hence, the worlds at issue can always be taken to be the same.

extensions may change from world to world, and we write $v_w(P)$, not $v(P)$.) Constants of this kind are called *rigid designators*. Constants like β are, by contrast, *non-rigid designators*. How do such constants behave logically?

16.4.5 Let us augment the language with a collection of new constants: $\alpha_0, \alpha_1, \alpha_2, \dots$ and call these *descriptor constants*, or just *descriptors*. I will use $\alpha, \beta, \gamma, \dots$ for arbitrary descriptors. I will call our old constants *rigid constants*. The terms of the language now comprise descriptors, rigid constants and variables.

16.4.6 In an interpretation, v assigns each descriptor a denotation, $v_w(\alpha)$, at each world w . If we define $v_w(a)$ to be $v(a)$ for all rigid constants, a , we can write the truth conditions of closed atomic sentences uniformly as:

$$v_w(Pt_1 \dots t_n) = 1 \text{ iff } \langle v_w(t_1), \dots, v_w(t_n) \rangle \in v_w(P)$$

In all other ways, the semantics remain the same. In particular, the truth conditions of the quantifiers are still given in terms of the canonical constants, k_d , which are rigid.

16.4.7 To obtain tableaux for the extended language, the identity rules (whatever they are) are extended to include all closed terms, descriptors or rigid constants, except that the IIR applies *only if both terms are rigid constants*. All of the other rules remain the same. In particular, the rules of universal and particular instantiation (and the NCR if it is present) apply *only to rigid constants*. There is, in addition, one further rule:

$$\begin{array}{c} \cdot \\ \downarrow \\ c = \alpha, i \end{array}$$

c is a constant new to the branch. The rule is applied to every descriptor, α , on the branch, and every i on the branch, for which there is not already a line of this form.³

³ The effect of applying the other rules to descriptors, where this is legitimate, is obtained by applying this rule. Thus, consider UI, for example. Given $\forall xPx, i$, we have a line of the form $c = \alpha, i$, so we can infer Pc, i by UI, and $P\alpha, i$ by SI.

16.4.8 Here is a tableau to show that $\forall x \Box Px \vdash \Box P\alpha$ in $CK(NI)$.

$$\begin{array}{l}
 \forall x \Box Px, 0 \\
 \neg \Box P\alpha, 0 \\
 \diamond \neg P\alpha, 0 \\
 Or1 \\
 \neg P\alpha, 1 \\
 a = \alpha, 0 \\
 b = \alpha, 1 \\
 \Box Pb, 0 \\
 Pb, 1 \\
 P\alpha, 1 \\
 \times
 \end{array}$$

Lines six and seven apply the new rule, and the last line is obtained by SI from line seven.

16.4.9 Here is a tableau to show that $\not\vdash a = \alpha \supset \Box a = \alpha$ in the same system.

$$\begin{array}{l}
 \neg(a = \alpha \supset \Box a = \alpha), 0 \\
 a = \alpha, 0 \\
 \neg \Box a = \alpha, 0 \\
 \diamond \neg a = \alpha, 0 \\
 Or1 \\
 \neg a = \alpha, 1 \\
 b = \alpha, 1
 \end{array}$$

The last line is provided by the new rule, but its addition has no further consequences.

16.4.10 We read off a counter-model from an open branch of a tableau as before. In addition, if there is a line of the form $c = \beta, i$ on the tableau, we set $\nu_{w_i}(\beta)$ to $\nu(c)$. (Note that if we have lines of the form $c_1 = \beta, i$ and $c_2 = \beta, i$, then we have a line of the form $c_1 = c_2, i$, by SI, so $\nu(c_1) = \nu(c_2)$.)

16.4.11 Thus, in the counter-model given by the tableau of 16.4.9, $W = \{w_0, w_1\}$, $D = \{\partial_a, \partial_b\}$, $w_0 R w_1$, $\nu(a) = \partial_a$, $\nu(b) = \partial_b$, $\nu_{w_0}(\alpha) = \partial_a$, $\nu_{w_1}(\alpha) = \partial_b$.

That is:

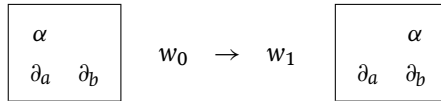

The descriptor is written above the object that it denotes at each world. $v_{w_0}(a) = v(a) = \partial_a = v_{w_0}(\alpha)$. Hence, $a = \alpha$ is true at w_0 . But $v_{w_1}(a) = v(a) = \partial_a \neq \partial_b = v(b) = v_{w_1}(\alpha)$. Hence, $a = \alpha$ is false at w_1 , so $\Box a = \alpha$ is false at w_0 .

16.4.12 Note that various quantifier inferences that hold for rigid constants may fail for descriptors. Thus, $\Box P\alpha \not\vdash_{CK} \exists x\Box Px$. The tableau for this is infinite. Here is a finite counter-model:

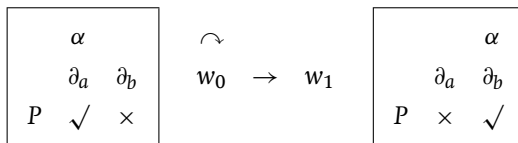

I leave it as an exercise to check that this works.

16.4.13 All the tableau systems described in this chapter are sound and complete with respect to the appropriate semantics. This is proved in 16.6 and 16.7.

16.5 Names and Descriptions

16.5.1 Given the distinction between rigid and non-rigid designators, it may reasonably be asked of various noun-phrases in a natural language, such as English, which kind they are. Definite descriptions, of the form ‘the so and so’ are naturally taken to be non-rigid, as we have already observed, in effect, with the description ‘the number of symphonies composed by Beethoven’. (Though we might want to make exceptions for descriptions such as ‘the least natural number’ which, at least arguably, refers to the same object in all worlds, namely, 0.)

16.5.2 The situation is less clear with respect to proper names, such as ‘Aristotle’. Some have suggested that proper names are really covert descriptions, such as ‘the teacher of Alexander the Great’. But if so, the sentence:

Aristotle is the teacher of Alexander the Great

would mean the same as:

The teacher of Alexander the Great is the teacher of Alexander the Great

and this is not false at any world (at least, at any world in which Alexander's teacher exists). But this does not seem to be the case: in a possible world in which Aristotle whiled away his life in Stagira as a minor local official, and Alexander was taught by someone else, the claim would be false.

16.5.3 It is therefore plausible to suppose that proper names in a natural language (at least when appropriately disambiguated to a particular object) are rigid designators. Thus, they latch on to the object they denote, not via some implicit descriptive content, but by a more direct mechanism.

16.5.4 One account of the mechanism has been suggested by Kripke. The person who coins a name, selects a particular object, x . They then baptise x with that name, which refers to it rigidly – at all worlds. (They may single x out with a certain description, but if they do, in any other world the name still refers to x , not to whatever satisfies the description at that world.) When other speakers learn to use the name – ultimately from the baptiser – the reference goes with it. This is sometimes called the *causal theory of reference*, because of the causal interaction between speakers which transmits the use of the name. (Note that the account is quite compatible with speakers, generally, having false beliefs about what it is the name refers to.)

16.5.5 The theory is not without its problems. For example, folklore has it that certain Africans used the name 'Madagascar' for part of the African mainland. Some European explorers wished to know the name of a certain island off the coast of Eastern Africa. Their African informants, misunderstanding their question, told them that it was Madagascar, the name by which the island is now known. Clearly, the reference did not transfer between speakers on this occasion.

16.6 *Proofs of Theorems 1

16.6.1 In the following sections I will prove the soundness and completeness of the tableau systems for identity discussed in this chapter. We will turn to descriptors in the next section. In this section, we ignore them.

16.6.2 So suppose that we are dealing with constant or variable domain semantics for some normal modal (including tense) logic. Selecting the identity predicate for special treatment does nothing to affect the proofs of the Locality and Denotation Lemmas, which therefore still hold.

16.6.3 **THEOREM:** Given any system of modal logic of the previous chapters, without the Negativity Constraint, the tableaux obtained by adding the rules for necessary identity (16.2.3) are sound with respect to their semantics.

Proof:

The proof simply extends that for the corresponding logic without identity. We need only check the new cases for the identity rules in the relevant Soundness Lemma. The first is trivial. The second is SI. For the sake of illustration, we suppose that there is only one occurrence of the term to be substituted. Then the rule is as follows:

$$\begin{array}{c} a = b, i \\ Pa_1 \dots a \dots a_n, i \\ \downarrow \\ Pa_1 \dots b \dots a_n, i \end{array}$$

Suppose that f shows that \mathfrak{J} is faithful to a branch with the two premises on it. Then $v(a) = v(b)$ and $\langle v(a_1), \dots, v(a), \dots, v(a_n) \rangle \in v_{w_i}(P)$. Hence, $\langle v(a_1), \dots, v(b), \dots, v(a_n) \rangle \in v_{w_i}(P)$, and $Pa_1 \dots b \dots a_n, i$ is true at \mathfrak{J} . We may therefore take \mathfrak{J}' to be \mathfrak{J} .

For the Identity Invariance Rule: if $a = b$ is true at $f(i)$, then $v(a) = v(b)$, so $a = b$ is true at $f(j)$, and we may just take \mathfrak{J}' to be \mathfrak{J} . ■

16.6.4 **THEOREM:** Given any system of modal logic of the previous chapters, without the Negativity Constraint, the tableaux obtained by adding the rules for necessary identity are complete with respect to their semantics.

Proof:

The proofs modify the relevant identity-free cases, using the technique of the classical completeness proof for identity (12.9.4–12.9.5). We define the induced interpretation as follows. Let C be the set of (rigid) constants on the branch, \mathcal{B} . Define $a \sim b$ to mean that $a = b, 0$ is on the branch. This is

an equivalence relation, as may easily be checked. $D = \{[a] : a \in C\}$ (or, if $C = \phi$, $D = \{\partial\}$ for an arbitrary ∂). $W = \{w_i : i \text{ occurs on } \mathcal{B}\}$, $w_i R w_j$ iff irj occurs on \mathcal{B} . (For extensions of $CK^t(NI)$ and $VK^t(NI)$, this definition of R is modified as in 3.7.8.) $v(a) = [a]$, and if P is any n -place predicate other than identity, $\langle [a_1], \dots, [a_n] \rangle \in v_{w_i}(P)$ iff $Pa_1 \dots a_n, i$ is on \mathcal{B} . (This is well defined because of IIR and SI.) For the variable domain case, $D_{w_i} = v_{w_i}(\mathcal{E})$. The cases in the Completeness Lemma for the connectives and quantifiers are as without identity, and the atomic cases are the obvious modifications of the classical case (12.9.5):

If P is not the identity predicate:

$$\begin{aligned} Pa_1 \dots a_n, i \text{ is on } \mathcal{B} &\Rightarrow \langle [a_1], \dots, [a_n] \rangle \in v_{w_i}(P) \\ &\Rightarrow \langle v(a_1), \dots, v(a_n) \rangle \in v_{w_i}(P) \\ &\Rightarrow v_{w_i}(Pa_1 \dots a_n) = 1 \end{aligned}$$

$$\begin{aligned} \neg Pa_1 \dots a_n, i \text{ is on } \mathcal{B} &\Rightarrow Pa_1 \dots a_n, i \text{ is not on } \mathcal{B} && (\mathcal{B} \text{ open}) \\ &\Rightarrow \langle [a_1], \dots, [a_n] \rangle \notin v_{w_i}(P) \\ &\Rightarrow \langle v(a_1), \dots, v(a_n) \rangle \notin v_{w_i}(P) \\ &\Rightarrow v_{w_i}(Pa_1 \dots a_n) = 0 \end{aligned}$$

For the identity predicate:

$$\begin{aligned} a = b, i \text{ is on } \mathcal{B} &\Rightarrow a \sim b && (\text{IIR}) \\ &\Rightarrow [a] = [b] \\ &\Rightarrow v(a) = v(b) \\ &\Rightarrow v_{w_i}(a = b) = 1 \end{aligned}$$

$$\begin{aligned} \neg a = b, i \text{ is on } \mathcal{B} &\Rightarrow a = b, 0 \text{ is not on } \mathcal{B} && (\text{IIR, } \mathcal{B} \text{ is open}) \\ &\Rightarrow \text{it is not the case that } a \sim b \\ &\Rightarrow [a] \neq [b] \\ &\Rightarrow v(a) \neq v(b) \\ &\Rightarrow v_{w_i}(a = b) = 0 \end{aligned}$$

The Completeness Theorem then follows in the usual fashion. ■

16.6.5 We look next at the variations that need to be made if the Negativity Constraint is present.

16.6.6 THEOREM: Adding the NCR and modifying the identity rules as in 16.3.3 gives tableaux that are sound with respect to the corresponding semantics.

Proof:

In the Soundness Lemma, we have to check the cases for the NCR and the new identity rules. Here is one example. Suppose we apply IIR:

$$\begin{array}{c} a = b, i \\ \mathfrak{E}a, j \\ \downarrow \\ a = b, j \end{array}$$

and that f shows \mathfrak{J} to be faithful to a branch containing the first two formulas. Then $v(a) = v(b)$, and $v(a), v(b) \in v_{f(\mathfrak{J})}(\mathfrak{E})$. Hence, $v_{f(\mathfrak{J})}(a = b) = 1$, and we can take \mathfrak{J}' to be \mathfrak{J} .

The others are straightforward, and left as exercises. The Soundness Theorem follows in the usual fashion. ■

16.6.7 THEOREM: Adding the NCR and modifying the identity rules as in 16.3.3 gives tableaux that are complete with respect to the corresponding semantics.

Proof:

The proof is a variation of 16.6.4, using the free logic construction of 13.7.11. For the induced interpretation, $a \sim b$ is defined to mean that a and b are the same constant, or for some i , $a = b, i$ is on \mathcal{B} . This is still an equivalence relation. Reflexivity is obvious; for symmetry, see 13.6.3. For transitivity, suppose that $a \sim b$ and $b \sim c$. Then, ignoring the trivial case where some of these constants are identical, for some i and j , $a = b, i$ and $b = c, j$ are on \mathcal{B} . By the NCR, $\mathfrak{E}b, j$ is on \mathcal{B} . Hence, $a = b, j$ is on \mathcal{B} , by the IIR. Whence, $a = c, j$ is on \mathcal{B} , by SI. The rest of the interpretation is then defined as in 16.6.4. The Completeness Lemma is proved as before, except that the case for identity

is a variant of that for negative free logics as in 13.7.11:

$$\begin{aligned}
 a = b, i \text{ is on } \mathcal{B} &\Rightarrow a \sim b \\
 &\text{and } \mathfrak{E}a, i \text{ and } \mathfrak{E}b, i \text{ are on } \mathcal{B} \quad (\text{NCR}) \\
 &\Rightarrow [a] = [b] \\
 &\text{so } v(a) = v(b) \\
 &\text{and } v(a), v(b) \in v_{w_i}(\mathfrak{E}) \\
 &\Rightarrow v_{w_i}(a = b) = 1
 \end{aligned}$$

If $\neg a = b, i$ is on \mathcal{B} , there are two cases, depending on whether both of $\mathfrak{E}a, i$ and $\mathfrak{E}b, i$ are on \mathcal{B} , or one is not. In the first case:

$$\begin{aligned}
 \neg a = b, i \text{ is on } \mathcal{B} &\Rightarrow \text{(i) for no } j, a = b, j \text{ on } \mathcal{B} \quad (\text{IIR, } \mathcal{B} \text{ open}) \\
 &\text{and (ii) } a \text{ and } b \text{ are distinct terms } \quad (\mathcal{B} \text{ open}) \\
 &\Rightarrow \text{it is not the case that } a \sim b \\
 &\Rightarrow [a] \neq [b] \\
 &\Rightarrow v(a) \neq v(b) \\
 &\Rightarrow v_{w_i}(a = b) = 0
 \end{aligned}$$

In the second case, suppose that $\mathfrak{E}a, i$ is not on the branch. (The case for b is similar.) Then $v(a) = [a] \notin v_{w_i}(\mathfrak{E})$. So $\langle v(a), v(b) \rangle \notin v_{w_i}(=)$, and $v_{w_i}(a = b) = 0$, as required. ■

16.7 *Proofs of Theorems 2

16.7.1 In this section we consider the addition of descriptors to the language. We assume that the Negativity Constraint is not present. The case for descriptors plus the Negativity Constraint is left as an exercise. (See 16.10, problem 10.) The proofs of the Locality and Denotation Lemmas are as usual. The extension of the language does nothing to change them essentially. (We merely rewrite anything of the form $\mu(t)$ as $\mu_w(t)$.) In the Denotation Lemma, it is important that the co-referring constants are rigid. Substituting descriptors that co-refer at a world is not guaranteed to preserve truth values at all worlds. It is easy enough to construct an interpretation where $v_w(\alpha) = v_w(\beta) = v_w(a)$, $v_w(\Box P\alpha) = 1$, but $v_w(\Box P\beta) = v_w(\Box Pa) = 0$.

16.7.2 THEOREM: For all the logics we have been dealing with, the tableaux for descriptors are sound with respect to their semantics.

Proof:

We have merely to check that the relevant Soundness Lemma continues to work with the rules that involve descriptors. These are just the identity rules of 16.4.7. The only one of these that involves any novelty is the last:

$$\begin{array}{c} \cdot \\ \downarrow \\ c = \alpha, i \end{array}$$

where c is new to the branch. For this: Suppose that f shows \mathfrak{J} to be faithful to the branch, \mathcal{B} , to which we apply the rule. At world $f(i)$, α has some denotation, d . Hence, $v(k_d) = v_{f(i)}(\alpha)$. Let \mathfrak{J}' be the same as \mathfrak{J} , except that $v'(c) = d$. $v'(c) = d = v(k_d) = v_{f(i)}(\alpha)$. So $c = \alpha$ is true at $f(i)$ in \mathfrak{J}' . And since c does not occur in any formula on \mathcal{B} , f shows \mathfrak{J}' to be faithful to the rest of the branch, by the Locality Lemma. ■

16.7.3 THEOREM: For all the logics we have been dealing with, the tableaux for descriptors are complete with respect to their semantics.

Proof:

For the proof of this, we extend the definition of the relevant induced interpretation to descriptors, and check that the relevant Completeness Lemma continues to hold. Given any descriptor, α , on the branch, and any world i , on the tableau, there is a line of the form $a = \alpha, i$. Take any one such a (it does not matter which, because of SI), and let this be \widehat{a} . For any rigid designator, b , let \widehat{b} just be b itself. In the induced interpretation, we define $v_{w_i}(\alpha)$ to be $[\widehat{a}]$. The only cases in the Completeness Lemma that need to be checked are the atomic ones. These modify the argument of 16.6.4 as follows.

$$\begin{aligned} Pt_1 \dots t_n, i \text{ is on } \mathcal{B} &\Rightarrow P\widehat{t}_1 \dots \widehat{t}_n, i \text{ is on } \mathcal{B} && \text{(SI)} \\ &\Rightarrow \langle [\widehat{t}_1], \dots, [\widehat{t}_n] \rangle \in v_{w_i}(P) \\ &\Rightarrow \langle v_{w_i}(t_1), \dots, v_{w_i}(t_n) \rangle \in v_{w_i}(P) \\ &\Rightarrow v_{w_i}(Pt_1 \dots t_n) = 1 \end{aligned}$$

$$\begin{aligned} \neg Pt_1 \dots t_n, i \text{ is on } \mathcal{B} &\Rightarrow P\widehat{t}_1 \dots \widehat{t}_n, i \text{ is not on } \mathcal{B} && \text{(SI, } \mathcal{B} \text{ open)} \\ &\Rightarrow \langle [\widehat{t}_1], \dots, [\widehat{t}_n] \rangle \notin v_{w_i}(P) \\ &\Rightarrow \langle v_{w_i}(t_1), \dots, v_{w_i}(t_n) \rangle \notin v_{w_i}(P) \\ &\Rightarrow v_{w_i}(Pt_1 \dots t_n) = 0 \end{aligned}$$

For the identity predicate:

$$\begin{aligned}
 t_1 = t_2, i \text{ is on } \mathcal{B} &\Rightarrow \widehat{t}_1 = \widehat{t}_2, i \text{ is on } \mathcal{B} && \text{(SI)} \\
 &\Rightarrow \widehat{t}_1 = \widehat{t}_2, 0 \text{ is on } \mathcal{B} && \text{(IIR)} \\
 &\Rightarrow \widehat{t}_1 \sim \widehat{t}_2 \\
 &\Rightarrow [\widehat{t}_1] = [\widehat{t}_2] \\
 &\Rightarrow \nu_{w_i}(t_1) = \nu_{w_i}(t_2) \\
 &\Rightarrow \nu_{w_i}(t_1 = t_2) = 1
 \end{aligned}$$

$$\begin{aligned}
 \neg t_1 = t_2, i \text{ is on } \mathcal{B} &\Rightarrow \widehat{t}_1 = \widehat{t}_2, i \text{ is not on } \mathcal{B} && \text{(SI, } \mathcal{B} \text{ open)} \\
 &\Rightarrow \widehat{t}_1 = \widehat{t}_2, 0 \text{ is not on } \mathcal{B} && \text{(IIR, } \mathcal{B} \text{ open)} \\
 &\Rightarrow \text{it is not the case that } \widehat{t}_1 \sim \widehat{t}_2 \\
 &\Rightarrow [\widehat{t}_1] \neq [\widehat{t}_2] \\
 &\Rightarrow \nu_{w_i}(t_1) \neq \nu_{w_i}(t_2) \\
 &\Rightarrow \nu_{w_i}(t_1 = t_2) = 0
 \end{aligned}$$

■

16.8 History

There are a few comments concerning identity and modal notions in Lewis and Langford (1932), ch. 10, but the first account of necessary identity in modal logic (in fact, of identity in modal logic) was Barcan (1947). The argument of 16.4.1 was part of Quine's attack on modal logic in (1953). The analysis of 16.4.3, was given by Smullyan (1948), which was one of the first papers about descriptions in modal logic. The view that proper names have a sense which is something like a definite description, and which fixes its referent, goes back to Frege in 'Sense and Reference' (translated as pp. 56–78 of Geach and Black (1970) or pp. 151–71 of Beaney (1997)). The term 'rigid designator' is due to Kripke, as is the argument of 16.5.2. This, other arguments for the same conclusion, and the causal theory of reference, can be found in Kripke (1972). Kripke (1971) defends the truth of *NI*. The argument of 16.5.5 is given by Evans (1973), where it is discussed further.

16.9 Further Reading

Discussions of identity in modal logic can be found in Garson (1984) and Cresswell (2001). Hughes and Cresswell (1996), ch. 17, contains a discussion

of identity and descriptions. Fitting and Mendelsohn (1998) has a good discussion of necessary identity (ch. 7) and descriptions (ch. 12). Kripke's work on modality and reference generated an enormous literature. For an introduction to this, see Devitt and Sterelny (1987), part 2.

16.10 Problems

1. Check the details omitted in 16.2.7, 16.3.6 and 16.4.12.
2. Determine the truth of the following in $CK(NI)$ (without the Negativity Constraint). If the inference is invalid, read off a counter-model from an open branch, and check that it works.
 - (a) $\Box Pa \vdash \exists x(x = a \wedge Px)$
 - (b) $\Diamond \exists x(x = a \wedge Px) \vdash \exists x \Diamond Px$
 - (c) $\Box \exists x x = a \vdash \exists x \Box x = a$
3. Repeat question 2 with $VK(NI)$.
4. Determine the truth of the following in $VK(NI)$ with the Negativity Constraint. If the inference is invalid, read off a counter-model from an open branch, and check that it works.
 - (a) $\Diamond Pa \vdash \Diamond \exists x(x = a \wedge Px)$
 - (b) $\Diamond a \neq b \vdash \Box a \neq b$
5. Determine the truth of the following in $CK(NI)$ (without the Negativity Constraint). If the inference is invalid, read off a counter-model from an open branch, and check that it works.
 - (a) $\alpha = \beta, \Diamond P\alpha \vdash \Diamond P\beta$
 - (b) $\vdash \Diamond P\alpha \supset \exists x \Diamond Px$
 - (c) $\vdash \forall x \Diamond Px \supset \Diamond P\alpha$
 - (d) $\vdash \Box \forall x Px \supset \Box P\alpha$
6. Determine the truth of the following in $VK^t(NI)$ (without the Negativity Constraint). If the inference is invalid, read off a counter-model from an open branch, and check that it works.
 - (a) $\vdash [P]a = b \supset [F]a = b$
 - (b) $\vdash a = b \supset [P] \langle P \rangle \langle F \rangle a = b$
 - (c) $\vdash \exists x \exists y \langle P \rangle x = y \supset \exists x \exists y \langle F \rangle x = y$
 - (d) $\vdash [P][G]\alpha = \beta \supset \alpha = \beta$
 - (e) $\vdash \langle F \rangle \alpha = \beta \supset [P][F]\alpha = \beta$
7. How is the denotation of an English proper name fixed?
8. *Check the details omitted in 16.6 and 16.7.

9. *Show that in any modal logic with necessary identity, $a = b, A_x(a) \models A_x(b)$. (Hint: see 12.9.2.) Show that in such logics, $a = \alpha, \Box Pa \not\models \Box P\alpha$.
10. *Prove that the tableaux for descriptors plus the Negativity Constraint are sound and complete. (Hint: modify the arguments of 16.6.6 and 16.6.7 in the way that 16.7.2 and 16.7.3 modify the arguments of 16.6.3 and 16.6.4.)
11. *For the various systems of logic in this chapter, formulate tableaux for inferences with arbitrary sets of premises. Prove the Soundness and Completeness Theorems. Infer the Compactness and Löwenheim-Skolem Theorems.

17 Contingent Identity in Modal Logic

17.1 Introduction

17.1.1 In this chapter we will look at the behaviour of contingent identity in modal logic.¹ We assume that the logic to which identity is being added is any quantified normal modal logic, constant or variable domain, without the Negativity Constraint.² Recall that if L is any logic $L(CI)$ is L augmented by contingent identity.

17.1.2 First, we will take all constants to be rigid designators. We then look at the addition of descriptors.

17.1.3 Finally, we will take up briefly two important philosophical issues concerning identity, tense and modality.

17.2 Contingent Identity

17.2.1 In 16.4.1 we looked at a problem concerning SI. Later in 16.4 we saw how the distinction between rigid and non-rigid designators solves the problem. But there would appear to be a more virulent form of it. The Morning Star is the planet Venus, as is the Evening Star, $m = v = e$. But arguably, these noun phrases are rigid. So it follows by NI that $\Box m = e$; and this would seem not to be true. It would seem to be a contingent matter that the heavenly object that appears in the sky around dawn, and christened by the Ancients ‘the Morning Star’, turned out to be identical with the heavenly body that appears in the sky around dusk, and christened by the

¹ As in the previous chapter, this includes tense logic. So \Box and \Diamond may be read as $[F]$ and $\langle F \rangle$.

² The addition of the Negativity Constraint is left as an exercise. See 17.7, question 11.

Ancients ‘the Evening Star’. The latter, for example, could have turned out to be Mercury.

17.2.2 To obtain a system of identity in modal logic in which NI fails, we proceed as follows. An interpretation is a fivetuple $\langle D, H, W, R, \nu \rangle$. W and R are as usual. H is a set of objects that for the moment we will call *avatars*. (What, exactly, these are, we will return to in due course.) D is the non-empty domain of quantification, but now its members have internal structure: they are functions from W to H . If $d \in D$ and $w \in W$, we may think of $d(w)$ as the avatar of d at w . I will write $d(w)$ as $|d|_w$. For every (rigid) constant, c , $\nu(c) \in D$. But for every world, w , and n -place predicate, P , $\nu_w(P)$ is a subset of H^n , not D^n . $\nu_w(=)$ is the world-invariant set $\{\langle h, h \rangle : h \in H\}$. If the interpretation is a variable domain interpretation $\nu(w) = D_w = \{d \in D : |d|_w \in \nu_w(\mathfrak{E})\}$.

The truth conditions for atomic sentences, including identity, are now as follows:

$$\nu_w(Pa_1 \dots a_n) = 1 \text{ iff } \langle |v(a_1)|_w, \dots, |v(a_n)|_w \rangle \in \nu_w(P)$$

For the connectives and quantifiers, the truth conditions are as usual. In particular, the truth conditions for the quantifiers are, note:

$$\begin{aligned} \nu_w(\forall xA) &= 1 \text{ iff for all } d \in D \text{ (or } D_w), \nu_w(A_x(k_d)) = 1 \\ \nu_w(\exists xA) &= 1 \text{ iff for some } d \in D \text{ (or } D_w), \nu_w(A_x(k_d)) = 1 \end{aligned}$$

Validity is defined as usual, in terms of truth preservation at all worlds.

17.2.3 The tableaux for contingent identity are exactly the same as those for necessary identity, except that the Identity Invariance Rule of 16.2.3 is dropped.

17.2.4 Here is a tableau to demonstrate that $\vdash_{CK(CI)} \forall x \forall y \Box(x = y \supset (Px \supset Py))$.

$$\begin{aligned} &\neg \forall x \forall y \Box(x = y \supset (Px \supset Py)), 0 \\ &\exists x \neg \forall y \Box(x = y \supset (Px \supset Py)), 0 \\ &\neg \forall y \Box(a = y \supset (Pa \supset Py)), 0 \\ &\exists y \neg \Box(a = y \supset (Pa \supset Py)), 0 \\ &\neg \Box(a = b \supset (Pa \supset Pb)), 0 \\ &\diamond \neg(a = b \supset (Pa \supset Pb)), 0 \\ &\quad \downarrow \end{aligned}$$

$$\begin{array}{c}
\text{Or1} \\
\neg(a = b \supset (Pa \supset Pb)), 1 \\
a = b, 1 \\
\neg(Pa \supset Pb), 1 \\
Pa, 1 \\
\neg Pb, 1 \\
Pb, 1 \\
\times
\end{array}$$

The last line is obtained by SI.

17.2.5 And to show that this is not a system of necessary identity:

$\not\vdash_{CK\nu(CI)} \forall x \forall y (x = y \supset \Box x = y)$:

$$\begin{array}{c}
\neg \forall x \forall y (x = y \supset \Box x = y), 0 \\
\exists x \neg \forall y (x = y \supset \Box x = y), 0 \\
\neg \forall y (a = y \supset \Box a = y), 0 \\
\exists y \neg (a = y \supset \Box a = y), 0 \\
\neg (a = b \supset \Box a = b), 0 \\
a = b, 0 \\
\neg \Box a = b, 0 \\
\diamond \neg a = b, 0 \\
\neg a = b, 1
\end{array}$$

The tableau is finished. Without the Identity Invariance Rule, the tableau fails to close. Since $CK\nu(CI)$ ($CK^t\nu(CI)$) is the strongest system of quantified normal modal logic, this shows that NI is not valid in any such logic.

17.2.6 To read off a counter-model from an open branch, W and R are defined as usual. $D = \{\partial_a : a \text{ occurs on the branch}\}$. For every constant, c , $\nu(c) = \partial_c$. To determine H , start with a set of distinct elements of the form \mathbf{a}_i , where a is a constant on the branch and i is a world on the branch. If there is a bunch of identities of the form $a = b, i$, $b = c, i$, etc., on the branch, choose one of \mathbf{a}_i , \mathbf{b}_i , \mathbf{c}_i , etc. – say \mathbf{a}_i – and throw the others away. Then $|\partial_a|_{w_i} = |\partial_b|_{w_i} = |\partial_c|_{w_i} = \dots = \mathbf{a}_i$, and H is what remains after the discarding. For every $w_i \in W$, if P is any n -place predicate other than identity (which always has the same extension) $\langle |\partial_{a_1}|_{w_i}, \dots, |\partial_{a_n}|_{w_i} \rangle \in \nu_{w_i}(P)$ iff

$Pa_1 \dots a_n, i$ is on the branch. Note that we deploy the *avatars* corresponding to the constants. Note, also, that it does not matter which avatar is chosen for a constant to denote at a world, since SI has been applied within worlds. This definition does not say under what conditions an n -tuple containing an avatar that is not of the form $|\partial_a|_{w_i}$ is in $\nu_{w_i}(P)$. This is, in fact, a *don't care* condition. The simplest thing is to say that all such n -tuples are not in $\nu_{w_i}(P)$.³

17.2.7 Thus, in the counter-model defined by the tableau of 17.2.5, $W = \{w_0, w_1\}$, $D = \{\partial_a, \partial_b\}$. $H = \{\mathbf{a}_0, \mathbf{a}_1, \mathbf{b}_1\}$, where $|\partial_a|_{w_0} = |\partial_b|_{w_0} = \mathbf{a}_0$, $|\partial_a|_{w_1} = \mathbf{a}_1$, and $|\partial_b|_{w_1} = \mathbf{b}_1$.

Checking that this works: $|\nu(a)|_{w_0} = |\partial_a|_{w_0} = \mathbf{a}_0 = |\partial_b|_{w_0} = |\nu(b)|_{w_0}$. But $\langle \mathbf{a}_0, \mathbf{a}_0 \rangle \in \nu_{w_0}(=)$, so $a = b$ is true at w_0 . $|\nu(a)|_{w_1} = |\partial_a|_{w_1} = \mathbf{a}_1 \neq \mathbf{b}_1 = |\partial_b|_{w_1} = |\nu(b)|_{w_1}$. But $\langle \mathbf{a}_1, \mathbf{b}_1 \rangle \notin \nu_{w_1}(=)$, so $a = b$ is not true at w_1 , and $\Box a = b$ is not true at w_0 . Hence $\forall x \forall y (x = y \supset \Box x = y)$ is not true at w_0 .

17.2.8 Here is another example. $\not\vdash_{CK(CI)} \forall x \forall y ((\Diamond x = y \wedge Px) \supset Py)$:

$$\begin{aligned}
 & \neg \forall x \forall y ((\Diamond x = y \wedge Px) \supset Py), 0 \\
 & \exists x \neg \forall y ((\Diamond x = y \wedge Px) \supset Py), 0 \\
 & \neg \forall y ((\Diamond a = y \wedge Pa) \supset Py), 0 \\
 & \exists y \neg ((\Diamond a = y \wedge Pa) \supset Py), 0 \\
 & \neg ((\Diamond a = b \wedge Pa) \supset Pb), 0 \\
 & \quad \Diamond a = b \wedge Pa, 0 \\
 & \quad \neg Pb, 0 \\
 & \quad \Diamond a = b, 0 \\
 & \quad Pa, 0 \\
 & \quad Or 1 \\
 & \quad a = b, 1
 \end{aligned}$$

³ There is no requirement in the semantics that avatars cannot occur in more than one world; that is, that for all $f, g \in D$, if $|f|_{w_1} = |g|_{w_2}$ then $w_1 = w_2$. Imposing this constraint obviously gives a logic that is at least as strong. In the counter-models given by the recipe, this constraint is satisfied. (See also the proof of 17.4.5.) Hence, the logic with this constraint imposed has exactly the same strength. In other words, whether or not the avatars at distinct worlds must themselves be distinct has no effect on the logic.

The counter-model determined by the tableau may be depicted as follows:

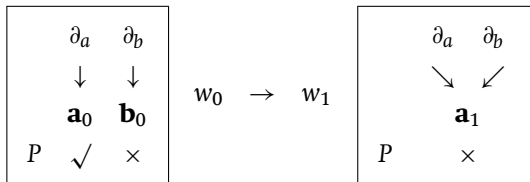

At each world, the members of D are listed at the top, the arrows indicate their avatars, and whether or not P applies to these is indicated by the ticks and crosses below. I leave it as an exercise to check that this interpretation works.

17.2.9 Since the tableau rules for contingent identity are all rules for necessary identity, any inference valid in a logic with contingent identity is valid in the corresponding logic with necessary identity. The converse, as we have seen (17.2.5), is not true.

17.2.10 A couple of observations. First, NI breaks down in Lewis' counterpart theory of 15.7.4–15.7.6. Suppose that $a = b$ at this world, but that in world w , a (that is, b) has multiple counterparts, c and d . Then at w it is not true that $c = d$. Hence, $\Box a = b$ is not true. Hence, it might be thought that the avatars of an object at different worlds behave as do counterparts for Lewis. But they do not. Most obviously, as we saw, the counterpart relation need be neither symmetric nor transitive; and as we also saw, this fact makes a mess of modal propositional inferences. But the relationship between the different avatars of an object is an equivalence relation, and so symmetric and transitive; neither does the machinery of avatars interfere with the underlying propositional logic.

17.2.11 Secondly, and for future reference: in a contingent identity system, the members of D are functions from worlds to avatars, but D does not have to comprise all such functions. This might seem rather arbitrary. What happens if we insist that in every interpretation it does? The answer is that in such a system the following is valid: $\Box \exists x Px \supset \exists x \Box Px$. It is clear that this is not desirable. (Though see 17.3.12.) Given a fair game, it is necessarily the

case that someone wins it; but it is not the case that there is someone who necessarily wins it.⁴

17.2.12 Finally in this section, let us note that we can add descriptors to contingent identity logic, just as we added them to necessary identity logic (16.4). In the semantics, each descriptor simply denotes a member of D at each world – possibly changing from world to world. In particular, for atomic sentences the truth conditions are:

$$v_w(Pt_1 \dots t_n) = 1 \text{ iff } (|v_w(t_1)|_w, \dots, |v_w(t_n)|_w) \in v_w(P)$$

where, if t is a rigid constant, $v_w(t)$ is just $v(t)$. Tableaux are obtained as in the necessary identity case.

17.2.13 It might be wondered where the difference between descriptors and rigid constants lies, if the business end of the denotation of a rigid constant may change from world to world. The answer is in the behaviour of the quantifiers. These work normally for rigid constants, but not for descriptors. Thus, in $CK(CI)$, for example, $\Box Pa \vdash \exists x \Box Px$, but $\Box Pa \not\vdash \exists x \Box Px$, as the following tableaux show:

$\Box Pa, 0$	$\Box P\alpha, 0$
$\neg \exists x \Box Px, 0$	$\neg \exists x \Box Px, 0$
$\forall x \neg \Box Px, 0$	$\forall x \neg \Box Px, 0$
$\neg \Box Pa, 0$	$a = \alpha, 0$
$\diamond \neg Pa, 0$	$\neg \Box Pa, 0$
$0r1$	$\diamond \neg Pa, 0$
$\neg Pa, 1$	$0r1$
$Pa, 1$	$\neg Pa, 1$
\times	$b = \alpha, 1$
	$\neg \Box Pb, 0$
	\vdots

The second tableau is infinite and does not close. Counter-models are read off from an open branch of a tableau as in 17.2.6, with the denotations of

⁴ Just for the record, if, in an interpretation, D is required to be the set of all functions from W to H , this effectively gives the logic the power of second-order non-modal logic. Second-order non-modal logic has no sound and complete tableau system. For similar reasons, neither does this logic. See Garson (1984), 3.4.

descriptors then being assigned as in 16.4.10. I leave it as an exercise to read off the counter-model from the second tableau.

17.2.14 A finite counter-model to the open tableau of 17.2.13 may be depicted as follows:

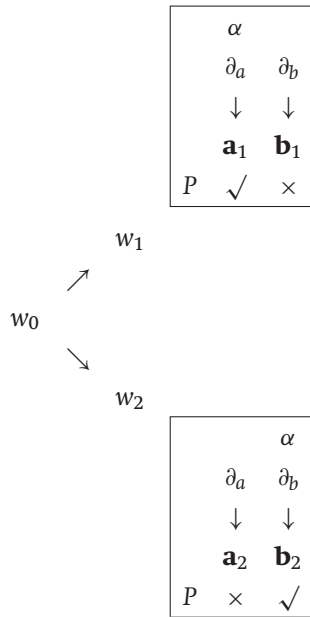

I leave it as an exercise to show that this interpretation works.

17.2.15 The tableaux for contingent identity are sound and complete with respect to their semantics. This is proved in 17.4.

17.3 SI Again, and the Nature of Avatars

17.3.1 Let us start our philosophical considerations by returning to the argument of 17.2.1. Let us assume that ‘Morning Star’ and ‘Evening Star’ are rigid designators (as argued in 16.5). Is it possible that the Morning Star might not be the Evening Star? If the names are rigid designators, then to say that the Morning Star is the Evening Star would appear to be saying no more than that a certain object (viz., Venus) has the property of being self-identical. This is a necessary truth, and it is not possible that it is false. The argument of 17.2.1 is therefore suspect.

17.3.2 In virtue of this, it might be suggested that we can dispense with systems of contingent identity altogether. But there are other possible objections to NI. Let us start with the case of tense logic. Consider an amoeba, Alf. At some time, Alf divides into two amoebas, Ben and Con. Now, Ben and Con did not come into existence at the time of fission. Prior to that, they were both Alf. Hence, it was the case that Ben and Con were identical. Now they are distinct.

17.3.3 There are modal analogues of the temporal example. Consider the zygote that was to become me. Consider a world in which this split at the appropriate time, and my mother gave birth to identical twins, Graham₁ and Graham₂. In that world, I am two people; and in this world, they are one person. So the fact that two things are distinct does not entail that they are necessarily distinct.

17.3.4 A different sort of example is provided by the following considerations. Consider a lump of clay, l . At a certain time, t_1 , this is fashioned into a statue of the Buddha, b . At a later time, t_2 , the statue is destroyed by squashing the clay back into an amorphous lump. Now, between t_1 and t_2 it would appear that $l = b$; but at t_1 , it was the case that $l \neq b$; after all, l existed, but b did not. Similarly, at t_2 , it will be the case that $l \neq b$.

17.3.5 Again, there is a modal analogue. Between t_1 and t_2 , $l = b$. But it is possible for this to be false. After all, before t_1 it was false, and the statue might never have been made.

17.3.6 One may certainly argue about these examples. But there are others which seem harder to dispute. As was observed in 3.6.8, one possible interpretation of necessity is as epistemic necessity. To say that something is necessary in this sense, is to say that it is known to be true; and to say that it is possible is to say that it is not known to be false. Now, at least as far as the Ancients knew, the Morning Star and the Evening Star might have been different celestial bodies. (Maybe they even believed that they were.) Hence, NI appears to fail for epistemic necessity.

17.3.7 This brings us back to the examples of 12.6.5–12.6.8 concerning SI. In necessary identity systems, $a = b, A_x(a) \vDash A_x(b)$ (16.10, question 9), but

in contingent identity systems, this does not hold.⁵ (For example, $a = b$, $\Box a = a \not\equiv \Box a = b$. I leave it as an exercise to check this.) Now, the hardest of the problems we met was that concerning George Eliot and Mary Anne Evans. I knew that George Eliot was a novelist; I did not know that Mary Anne Evans was. The argument here precisely applies SI within the context of an epistemic operator. Appealing to a system of contingent identity therefore solves this problem.

17.3.8 It does not solve the other problem of 12.6.8, though. Even in contingent identity systems: $g = m$, $Tpg \equiv Tpm$. (Substitutivity breaks down only in modal contexts.) Hence, if Priest was thinking about George Eliot, it still follows that he was thinking about Mary Anne Evans.

17.3.9 Maybe, then, we should just accept the conclusion. I was thinking about Mary Anne Evans; I just did not know that I was. Of course, I knew that I was thinking about George Eliot, and Mary Anne Evans is George Eliot. But it does not follow that I knew that I was thinking about Mary Anne Evans. That inference requires SI within an epistemic operator.

17.3.10 Since we need to take systems of contingent identity seriously, we therefore need to face the question of what, exactly, the members of H , the avatars, are. If we interpret the modal operators as tense operators – as we did in reasoning about the amoeba example of 17.3.2 – worlds are naturally thought of as states of affairs at certain times. Now, a physical object extended over space obviously has spatial parts. In the same way, we may suppose, a physical object extended over time has temporal parts. We may therefore take the members of H to be such parts. An object is the sum of its temporal parts (in the appropriate order), and a member of D is just a function from worlds (times) to parts, which effectively arranges the parts in the right order.

17.3.11 If we think of the worlds as worlds proper (and not times), it is less clear that the analogous move is plausible. An object, we may suppose, has different ‘modal’ parts at different worlds. But what is it that makes them

⁵ Though one does have this if x is not in the scope of a modal operator. See 17.7, question 10.

parts of one and the same object? In the temporal case, there is, presumably, some kind of temporal or causal continuity that ties the parts together into a single whole. There would seem to be nothing analogous in the modal case. (Since the parts are different objects, one cannot even appeal to the haecceities of 15.7.10.)

17.3.12 There is an extreme solution here: any combination of parts can be taken to form a whole. What this amounts to is that D should comprise *all* functions from worlds to parts. But as we noted in 17.2.11, this would appear to produce an unacceptably strong modal logic.⁶ It would seem, then, that objects composed of trans-world parts must be held together by some kind of non-arbitrary metaphysical glue. What this might be is opaque.

17.3.13 A quite different suggestion is to give up the idea that the members of H are parts, and take the notion of an avatar more literally. Objects may have different (or the same) colours at different worlds, different (or the same) locations at different worlds, and so on. Let us suppose that they may also have different (or the same) *identities* at different worlds. Thus, in the actual world, George Eliot and Mary Anne Evans had the same identity; but as far as my epistemic state before I learned this fact goes, there were worlds where they had quite different identities. We might, then, take the members of H to be identities. Each object may be mapped to its identity at each world; or, as a matter of convenience, we may simply identify the object with the map.

17.4 *Proofs of Theorems

17.4.1 In the following section I will prove the technical results mentioned in this chapter. We suppose that we are dealing with constant or variable domain semantics for some normal modal logic, first without descriptors.

17.4.2 The statement of the Locality and Denotation Lemmas are as in 14.7.2 and 14.7.3 (except that the interpretation has one new component, H).

⁶ Some philosophers have suggested interpreting the members of D as individual concepts, i.e., concepts that pick out individuals, such as *the tallest mountain*. Its avatar at a world is then simply the individual that it picks out there. Thought of in this way, the logic may not be too strong. If it is necessarily the case that someone wins the game, then, arguably, there is someone who necessarily wins, viz., *the winner*. However, if our quantifiers are to range over objects, not concepts, the point remains.

17.4.3 THEOREM: The Denotation and Locality Lemmas hold in contingent identity semantics.

Proof:

The proofs are as in 14.7.2 and 14.7.3 (15.9.3 and 15.9.4 for the variable domain case), except for the basis cases, which now go as follows.

Locality:

$$\begin{aligned} v_{1w}(Pa_1 \dots a_n) = 1 & \text{ iff } \langle |v_1(a_1)|_w, \dots, |v_1(a_n)|_w \rangle \in v_{1w}(P) \\ & \text{ iff } \langle |v_2(a_1)|_w, \dots, |v_2(a_n)|_w \rangle \in v_{2w}(P) \quad (*) \\ & \text{ iff } v_{2w}(Pa_1 \dots a_n) = 1 \end{aligned}$$

Line (*) follows, since $v_1(a_1) = v_2(a_1)$, etc.

Denotation:

$$\begin{aligned} v_w(Pa_1 \dots a \dots a_n) = 1 & \text{ iff } \langle |v(a_1)|_w, \dots, |v(a)|_w, \dots, |v(a_n)|_w \rangle \in v_w(P) \\ & \text{ iff } \langle |v(a_1)|_w, \dots, |v(b)|_w, \dots, |v(a_n)|_w \rangle \in v_w(P) \quad (*) \\ & \text{ iff } v_w(Pa_1 \dots b \dots a_n) = 1 \end{aligned}$$

Line (*) follows, since $v(a) = v(b)$. ■

17.4.4 THEOREM: The tableaux for contingent identity are sound with respect to their semantics.

Proof:

The proof is as in the necessary identity case (16.6.3), except that the Identity Invariance Rule has now disappeared, and the proofs for the other identity rules require minor and straightforward modifications. Thus, for SI, given that $|v(a)|_{w_i} = |v(b)|_{w_i}$ and $\langle |v(a_1)|_{w_i}, \dots, |v(a)|_{w_i}, \dots, |v(a_n)|_{w_i} \rangle \in v_{w_i}(P)$, we may infer that $\langle |v(a_1)|_{w_i}, \dots, |v(b)|_{w_i}, \dots, |v(a_n)|_{w_i} \rangle \in v_{w_i}(P)$. ■

17.4.5 THEOREM: The tableaux for contingent identity are complete with respect to their semantics.

Proof:

We define the induced interpretation, and prove the Completeness Lemma. The Completeness Theorem then follows as usual. Given an open branch of a tableau, the induced interpretation is defined as follows. $W = \{w_i: i \text{ occurs on } \mathcal{B}\}$. $w_i R w_j$ iff irj occurs on \mathcal{B} (modified as in 3.7.8 for tense logic if

necessary). $D = \{\partial_a : a \text{ occurs in a formula on } \mathcal{B}\}$.⁷ The ∂_a are now functions, defined as follows. Define the relation $a \sim_i b$ to mean that $a = b, i$ occurs on \mathcal{B} . \sim_i is an equivalence relation. Let $[a]_i$ be the equivalence class of a under \sim_i . $H = \{[a]_i : \text{for all } a, i \text{ on } \mathcal{B}\}$. For $w_i \in W$, we define:⁸

$$|\partial_a|_{w_i} = [a]_i$$

For each constant, a , $v(a) = \partial_a$. For each n -place predicate, P , other than identity:

$$\langle [a_1]_i, \dots, [a_n]_i \rangle \in v_{w_i}(P) \text{ iff } Pa_1 \dots a_n, i \text{ is on } \mathcal{B}$$

(Any n -tuple that contains an avatar that is not of the form $[a]_i$ is not in $v_{w_i}(P)$.) As usual, it does not matter which member of an equivalence class we chose, because of SI. If the interpretation is a variable domain interpretation, $D_{w_i} = \{d \in D : |d|_{w_i} \in v_{w_i}(\mathcal{E})\}$.

The cases in the Completeness Lemma are as in the non-identity case (14.7.8 and 15.9.6 - or in the case of tense logic proper, 14.7.11, 14.7.12 and 15.9.8). The atomic cases are as follows:

If P is not the identity predicate:

$$\begin{aligned} Pa_1 \dots a_n, i \text{ is on } \mathcal{B} &\Rightarrow \langle [a_1]_i, \dots, [a_n]_i \rangle \in v_{w_i}(P) \\ &\Rightarrow \langle |\partial_{a_1}|_{w_i}, \dots, |\partial_{a_n}|_{w_i} \rangle \in v_{w_i}(P) \\ &\Rightarrow \langle |v(a_1)|_{w_i}, \dots, |v(a_n)|_{w_i} \rangle \in v_{w_i}(P) \\ &\Rightarrow v_{w_i}(Pa_1 \dots a_n) = 1 \end{aligned}$$

$$\begin{aligned} \neg Pa_1 \dots a_n, i \text{ is on } \mathcal{B} &\Rightarrow Pa_1 \dots a_n, i \text{ is not on } \mathcal{B} && (\mathcal{B} \text{ open}) \\ &\Rightarrow \langle [a_1]_i, \dots, [a_n]_i \rangle \notin v_{w_i}(P) \\ &\Rightarrow \langle |\partial_{a_1}|_{w_i}, \dots, |\partial_{a_n}|_{w_i} \rangle \notin v_{w_i}(P) \\ &\Rightarrow \langle |v(a_1)|_{w_i}, \dots, |v(a_n)|_{w_i} \rangle \notin v_{w_i}(P) \\ &\Rightarrow v_{w_i}(Pa_1 \dots a_n) = 0 \end{aligned}$$

⁷ In the odd case where there are no constants on the branch, $D = \{\partial\}$, for an arbitrary ∂ ; $H = \{h\}$, for an arbitrary h ; and for every w , $|\partial|_w = h$.

⁸ If we wanted to ensure that the avatars are different at different worlds, we could take H to be $\{\langle i, [a]_i \rangle : \text{for all } a, i \text{ on } \mathcal{B}\}$. $|\partial_a|_{w_i}$ is then $\langle i, [a]_i \rangle$.

For the identity predicate:

$$\begin{aligned}
 a = b, i \text{ is on } \mathcal{B} &\Rightarrow a \sim_i b \\
 &\Rightarrow [a]_i = [b]_i \\
 &\Rightarrow |\partial_a|_{w_i} = |\partial_b|_{w_i} \\
 &\Rightarrow |v(a)|_{w_i} = |v(b)|_{w_i} \\
 &\Rightarrow v_{w_i}(a = b) = 1
 \end{aligned}$$

$$\begin{aligned}
 \neg a = b, i \text{ is on } \mathcal{B} &\Rightarrow a = b, i \text{ is not on } \mathcal{B} && (\mathcal{B} \text{ open}) \\
 &\Rightarrow \text{it is not the case that } a \sim_i b \\
 &\Rightarrow [a]_i \neq [b]_i \\
 &\Rightarrow [\partial_a]_{w_i} \neq [\partial_b]_{w_i} \\
 &\Rightarrow |v(a)|_{w_i} \neq |v(b)|_{w_i} \\
 &\Rightarrow v_{w_i}(a = b) = 0
 \end{aligned}$$

■

17.4.6 Next, we consider the addition of descriptors, and the tableaux therefor. The Locality and Denotation Lemmas are proved as in 16.7.1. The soundness and completeness arguments are modifications of the corresponding arguments for the necessary identity case (16.7.2, 16.7.3).

17.4.7 THEOREM: The tableaux for descriptors are sound with respect to their semantics.

Proof:

We have to check that the Soundness Lemma continues to work with the new rules for descriptors. The first rule is:

$$\begin{array}{c}
 \cdot \\
 \downarrow \\
 \alpha = \alpha, i
 \end{array}$$

The proof for this is simple, and is left as an exercise. The second rule is SI (we assume that there is only one occurrence of t for the sake of illustration):

$$\begin{array}{c}
 t = t', i \\
 Pt_1 \dots t \dots t_n, i \\
 \downarrow \\
 Pt_1 \dots t' \dots t_n, i
 \end{array}$$

where t and t' are any terms. Suppose that f shows \mathfrak{J} to be faithful to the branch, \mathcal{B} , on which the two premises lie. Then $|v_{f(i)}(t)|_{f(i)} = |v_{f(i)}(t')|_{f(i)}$ and $\langle |v_{f(i)}(t_1)|_{f(i)}, \dots, |v_{f(i)}(t)|_{f(i)}, \dots, |v_{f(i)}(t_n)|_{f(i)} \rangle \in v_{f(i)}(P)$. Thus, $\langle |v_{f(i)}(t_1)|_{f(i)}, \dots, |v_{f(i)}(t')|_{f(i)}, \dots, |v_{f(i)}(t_n)|_{f(i)} \rangle \in v_{f(i)}(P)$, and $Pt_1 \dots t' \dots t_n$ is true at $f(i)$. We may therefore take \mathfrak{J}' to be \mathfrak{J} .

The final rule of inference is:

$$\begin{array}{c} \cdot \\ \downarrow \\ a = \alpha, i \end{array}$$

where a is new to the branch. Suppose that f shows \mathfrak{J} to be faithful to the branch, \mathcal{B} , to which we apply the rule. At $f(i)$, α has some denotation, $d \in D$. Then $|v(k_d)|_{f(i)} (= |v_{f(i)}(k_d)|_{f(i)}) = |v_{f(i)}(\alpha)|_{f(i)}$. Let \mathfrak{J}' be the same as \mathfrak{J} , except that $v(a) = d$. $|v(a)|_{f(i)} = |d|_{f(i)} = |v(k_d)|_{f(i)} = |v_{f(i)}(\alpha)|_{f(i)}$. So $a = \alpha$ is true at $f(i)$. And since a does not occur in any formula on \mathcal{B} , f shows \mathfrak{J}' to be faithful to the rest of the branch, by the Locality Lemma. ■

17.4.8 THEOREM: The tableaux for descriptors are complete with respect to their semantics.

Proof:

We define the induced interpretation as in 17.4.5. We extend the induced interpretation to apply to descriptors, and check that the Completeness Lemma holds. Given any descriptor, α , on the branch, and any world i , on the tableau, there is a line of the form $a = \alpha, i$. Take any one such a (it does not matter which, because of SI), and let this be \hat{a} . For any rigid designator, b , let \hat{b} be b itself. In the induced interpretation, we define:

$$v_{w_i}(\alpha) = \partial_{\hat{a}}$$

(For rigid designators, a , we already had $v_{w_i}(a) = \partial_{\hat{a}}$.)

If P is not the identity predicate:

$$\begin{aligned} Pt_1 \dots t_n, i \text{ is on } \mathcal{B} &\Rightarrow P\hat{t}_1 \dots \hat{t}_n, i \text{ is on } \mathcal{B} && \text{(SI)} \\ &\Rightarrow \langle [\hat{t}_1]_i, \dots, [\hat{t}_n]_i \rangle \in v_{w_i}(P) \\ &\Rightarrow \langle |\partial_{\hat{t}_1}|_{w_i}, \dots, |\partial_{\hat{t}_n}|_{w_i} \rangle \in v_{w_i}(P) \\ &\Rightarrow \langle |v_{w_i}(t_1)|_{w_i}, \dots, |v_{w_i}(t_n)|_{w_i} \rangle \in v_{w_i}(P) \\ &\Rightarrow v_{w_i}(Pt_1 \dots t_n) = 1 \end{aligned}$$

$$\begin{aligned}
\neg Pt_1 \dots t_n, i \text{ is on } \mathcal{B} &\Rightarrow Pt_1 \dots t_n, i \text{ is not on } \mathcal{B} && (\mathcal{B} \text{ open}) \\
&\Rightarrow P\widehat{t}_1 \dots \widehat{t}_n, i \text{ is not on } \mathcal{B} && (\text{SI}, \mathcal{B} \text{ open}) \\
&\Rightarrow \langle [\widehat{t}_1]_i, \dots, [\widehat{t}_n]_i \rangle \notin \nu_{w_i}(P) \\
&\Rightarrow \langle |\partial_{\widehat{t}_1}|_{w_i}, \dots, |\partial_{\widehat{t}_n}|_{w_i} \rangle \notin \nu_{w_i}(P) \\
&\Rightarrow \langle |\nu_{w_i}(t_1)|_{w_i}, \dots, |\nu_{w_i}(t_n)|_{w_i} \rangle \notin \nu_{w_i}(P) \\
&\Rightarrow \nu_{w_i}(Pt_1 \dots t_n) = 0
\end{aligned}$$

For the identity predicate:

$$\begin{aligned}
t_1 = t_2, i \text{ is on } \mathcal{B} &\Rightarrow \widehat{t}_1 = \widehat{t}_2, i \text{ is on } \mathcal{B} && (\text{SI}) \\
&\Rightarrow \widehat{t}_1 \sim_i \widehat{t}_2 \\
&\Rightarrow [\widehat{t}_1]_i = [\widehat{t}_2]_i \\
&\Rightarrow |\partial_{\widehat{t}_1}|_{w_i} = |\partial_{\widehat{t}_2}|_{w_i} \\
&\Rightarrow |\nu_{w_i}(t_1)|_{w_i} = |\nu_{w_i}(t_2)|_{w_i} \\
&\Rightarrow \nu_{w_i}(t_1 = t_2) = 1
\end{aligned}$$

$$\begin{aligned}
\neg t_1 = t_2, i \text{ is on } \mathcal{B} &\Rightarrow t_1 = t_2, i \text{ is not on } \mathcal{B} && (\mathcal{B} \text{ open}) \\
&\Rightarrow \widehat{t}_1 = \widehat{t}_2, i \text{ is not on } \mathcal{B} && (\text{SI}, \mathcal{B} \text{ open}) \\
&\Rightarrow \text{it is not the case that } \widehat{t}_1 \sim_i \widehat{t}_2 \\
&\Rightarrow [\widehat{t}_1]_i \neq [\widehat{t}_2]_i \\
&\Rightarrow |\partial_{\widehat{t}_1}|_{w_i} \neq |\partial_{\widehat{t}_2}|_{w_i} \\
&\Rightarrow |\nu_{w_i}(t_1)|_{w_i} \neq |\nu_{w_i}(t_2)|_{w_i} \\
&\Rightarrow \nu_{w_i}(t_1 = t_2) = 0
\end{aligned}$$

■

17.4.9 Finally, we prove the result announced in 17.2.11.

17.4.10 THEOREM: If in contingent identity interpretations we require that D be the set of all functions from W to H , then $\models \Box \exists x Px \supset \exists x \Box Px$.

Proof:

Suppose that in an interpretation, $\langle D, H, W, R, \nu \rangle$, $\nu_w(\Box \exists x Px) = 1$. Then for every w' such that wRw' , $\nu_{w'}(\exists x Px) = 1$; so for some $d \in D$, $\nu_{w'}(Pk_d) = 1$; that is, $|d|_{w'} \in \nu_{w'}(P)$. For each w' , choose one such d (by the Axiom of Choice). Let f be a function such that for all the w' in question, $|f|_{w'} = |d|_{w'}$; for all other w , $|f|_w$ can be anything one likes. This is in D , since D contains all functions from W to H . By construction, for all w' such that wRw' , $\nu_{w'}(Pk_f) = 1$, so $\nu(\Box Pk_f) = 1$. That is, $\nu(\exists x \Box Px) = 1$. ■

17.5 History

Problems about substitutivity in intensional contexts go back to Aristotle. They were discussed by a number of the great Medieval logicians. (For discussion and references, see Priest (2005c), 3.7.) The problems were put on the map in the contemporary period by Frege in ‘Sense and Reference’ (translated as pp. 56–78 of Geach and Black (1970) or pp. 151–71 of Beaney (1997)). Contingent identity semantics developed in a series of works, starting with Kanger (1957), and running through Hughes and Cresswell (1968), ch. 11, Parks and Smith (1974), and Parks (1974). In the last of these it assumes essentially the form given here.

Intensional concepts were advocated by Carnap (1947). The splitting example of 17.3.2 is discussed by Prior (1968); the example of the statue of 17.3.4 is discussed by Gibbard (1975).

17.6 Further Reading

For contingent identity modal logics (including discussions of intensional concepts), see Hughes and Cresswell (1996), ch. 18, Garson (1984), and Cresswell (2001). For a discussion of various philosophical issues surrounding contingent identity, see Priest (2005), ch. 2, and the essays in Part 2 of Kim and Sosa (1999).

17.7 Problems

1. Check the details omitted in 17.2.8, 17.2.13, 17.2.14 and 17.3.5.
2. Determine the truth of the following in $CK(CI)$. If the inference is invalid, read off a counter-model from the open branch, and check that it works.
 - (a) $\diamond a = b \vdash a = b$
 - (b) $\vdash \forall x \forall y (x \neq y \supset \Box x \neq y)$
 - (c) $\diamond \exists x (x = a \wedge Px) \vdash \diamond \exists x Px$
 - (d) $a = b, \diamond Pa \vdash \diamond Pb$
 - (e) $\Box Pa \vdash \exists x (x = a \wedge Px)$
 - (f) $\diamond \exists x (x = a \wedge Px) \vdash \exists x \diamond Px$
3. Repeat question 2 with $VK(CI)$.

4. Determine the truth of the following in $CK(CI)$. If the inference is invalid, read off a counter-model from the open branch, and check that it works.

$$(a) \alpha = \beta, \diamond P\alpha \vdash \diamond P\beta$$

$$(b) \vdash \Box P\alpha \supset \exists x \Box Px$$

$$(c) \vdash \forall x \diamond Px \supset \diamond P\alpha$$

5. Repeat question 4 with $VK(CI)$.

6. Determine the truth of the following in $CK^t(CI)$. Where invalid, give a counter-model.

$$(a) \vdash \langle F \rangle a = b \wedge \langle F \rangle Qa \supset \langle F \rangle Qb$$

$$(b) \vdash \langle F \rangle a = b \wedge [F]Qa \supset \langle F \rangle Qb$$

$$(c) \vdash \langle P \rangle a = b \supset [F] \langle P \rangle a = b$$

7. Is it possible for one object to be two?

8. What is the best understanding of the nature of the members of H in the semantics of contingent identity modal logic?

9. *Check the details omitted in 17.4.

10. *Show that if x is not in the scope of a modal operator, $a = b, A_x(a) \models A_x(b)$. (Hint: Show by induction that if $|v(a)|_w = |v(b)|_w$ then, for any A of this form, $A_x(a)$ and $A_x(b)$ have the same truth value at w . Note that formulas of this form are made up from atomic formulas, and formulas of the form $\Box A$ and $\diamond A$ in which x does not occur free, by means of truth-functional connectives and quantifiers.)

11. *Formulate the semantics and appropriate tableaux for systems with contingent identity and the Negativity Constraint. Prove that they are sound and complete.

12. *For the various systems of logic in this chapter, formulate tableaux for inferences with arbitrary sets of premises. Prove the Soundness and Completeness Theorems. Infer the Compactness and Löwenheim-Skolem Theorems.

18 Non-normal Modal Logics

18.1 Introduction

18.1.1 The techniques concerning quantification and identity in normal modal logics carry over in a natural way to other logics which have possible-world semantics. In this chapter we will look at one of these, non-normal modal logics.¹

18.1.2 We will ignore identity to start with, and look at the constant and variable domain versions of non-normal modal logics (without descriptors).

18.1.3 We will then look at the addition of identity to these logics.

18.1.4 Non-normal worlds are important since, being worlds where logical truths may fail (as we saw in 4.4.7), they are harbingers of the impossible worlds of relevant logics (9.7). But the addition of quantifiers and identity to non-normal worlds appears to raise no novel philosophical issues. There is therefore no philosophical discussion in this chapter.

18.2 Non-normal Modal Logics and Matrices

18.2.1 In a non-normal modal logic, formulas of the form $\Box A$ and $\Diamond A$ are assigned truth values at non-normal worlds in a way that does not depend on the value of A . When quantification is involved, employing this strategy in the simple-minded way may cause a problem. Most obviously, $\Box Pa$ and $\Box Pb$ may be assigned different values at a world, even though $a = b$ is true there. (More generally, the Denotation Lemma, which is integral to the correct functioning of quantifiers, breaks down.)

¹ There are, in principle, non-normal tense logics, though no one, as far as I am aware, has ever bothered to formulate them. We will not concern ourselves with them here.

18.2.2 To overcome this problem, we have to treat formulas of the form $\Box A$ and $\Diamond A$, with n free variables, effectively as n -place predicates. However, we want to count, e.g., $\Box Px$ and $\Box Py$ as the same predicate, even though x and y are different variables. So the first thing we have to do is a bit of standardisation.

18.2.3 Call any formula of the form $\Box A$ or $\Diamond A$ a *modal formula*. Given any closed modal formula, A , of the language, we obtain its *matrix* as follows. Recall that the variables are v_0, v_1, \dots . Let m be the least number greater than every n such that v_n occurs bound in A . Starting on the left of A , and moving right, we replace every occurrence of an individual constant with $v_m, v_{m+1}, v_{m+2}, \dots$, in that order. Note, in particular, that if a constant occurs more than once, different variables will be used to replace it on each occasion. The following table illustrates.

Formula	Matrix
$\Box(Sab \vee Pc)$	$\Box(Sv_0v_1 \vee Pv_2)$
$\Diamond \forall v_6 S av_6 b$	$\Diamond \forall v_6 S v_7 v_6 v_8$
$\Box \exists v_3 S v_3 v_3$	$\Box \exists v_3 S v_3 v_3$
$\Diamond (\neg Pa \supset \forall v_0 S v_0 a)$	$\Diamond (\neg P v_1 \supset \forall v_0 S v_0 v_2)$

Clearly, we can obtain the original formula from its matrix by making the reverse substitution. We will call a formula itself a matrix if it is the matrix of some closed formula or other.

18.2.4 Some useful notation: let x_1, \dots, x_n be any variables. We will write $A_{x_1, \dots, x_n}(a_1, \dots, a_n)$ for A with x_1 replaced by a_1 , and \dots , and x_n replaced by a_n . If we write the sequence x_1, \dots, x_n , as \vec{x} , this can be written more simply as $A_{\vec{x}}(a_1, \dots, a_n)$. (We could write it, more tersely, as $A_{\vec{x}}(\vec{a})$, but it will often be useful to display the a s individually.)

18.3 Constant Domain Quantified L

18.3.1 We are now in a position to specify the semantics for quantified non-normal modal logics. We start with the constant domain version of the logic L of 4.4a, *CL*.

18.3.2 An interpretation is a structure $\langle D, W, N, R, \nu \rangle$. D is the domain of quantification; W, N , and R are as in the propositional case (4.2); ν is as in

the case of normal modal logics, except that, in addition, if M is any matrix with free variables x_1, \dots, x_n , and w is any non-normal world, $v_w(M) \subseteq D^n$. By convention, we take D^0 to be the set whose only member is the empty sequence, $\langle \cdot \rangle$.² (So its subsets are just $\{\langle \cdot \rangle\}$ and ϕ .)

18.3.3 The truth conditions for the truth-functional connectives and quantifiers are as for normal modal logics (14.2.3). The truth conditions for \Box and \Diamond are the same as usual for normal worlds (2.3.5). But now consider any closed modal formula of the form $M_{\vec{x}}(a_1, \dots, a_n)$, where M is a matrix. The truth conditions are:

$$v_w(M_{\vec{x}}(a_1, \dots, a_n)) = 1 \text{ iff } \langle v(a_1), \dots, v(a_n) \rangle \in v_w(M)$$

Note that if M contains no free variables, $\langle v(a_1), \dots, v(a_n) \rangle$ is simply the empty sequence, $\langle \cdot \rangle$. So M is true at w just if $\langle \cdot \rangle \in v_w(M)$.

18.3.4 Validity is defined in terms of truth preservation at all normal worlds of all interpretations, as in 4.2.5.

18.4 Tableaux for Constant Domain L

18.4.1 To obtain appropriate tableaux for CL , we simply augment the propositional tableau rules of 4.4a.3 (where, in particular, no modal rules apply at worlds other than 0) with the quantifier rules of 14.3.1.

18.4.2 Here are tableaux to show that $\vdash \forall x \Box A \supset \Box A_x(a)$, and $\not\vdash \Box(\exists x \Diamond(Px \wedge Qx)) \supset \exists x \Diamond Px$:

$$\begin{array}{l} \neg(\forall x \Box A \supset \Box A_x(a)), 0 \\ \quad \forall x \Box A, 0 \\ \quad \neg \Box A_x(a), 0 \\ \quad \Diamond \neg A_x(a), 0 \\ \quad \text{Or } 1 \\ \quad \neg A_x(a), 1 \\ \quad \Box A_x(a), 0 \\ \quad A_x(a), 1 \\ \quad \times \end{array}$$

² We have not, in fact, defined what this is. For our purposes, it does not really matter. We can take it simply to be Aristotle.

$$\begin{aligned}
 &\neg \Box (\exists x \Diamond (Px \wedge Qx) \supset \exists x \Diamond Px), 0 \\
 &\Diamond \neg (\exists x \Diamond (Px \wedge Qx) \supset \exists x \Diamond Px), 0 \\
 &\text{Or } 1 \\
 &\neg (\exists x \Diamond (Px \wedge Qx) \supset \exists x \Diamond Px), 1 \\
 &\quad \exists x \Diamond (Px \wedge Qx), 1 \\
 &\quad \neg \exists x \Diamond Px, 1 \\
 &\quad \Diamond (Pa \wedge Qa), 1 \\
 &\quad \forall x \neg \Diamond Px, 1 \\
 &\quad \neg \Diamond Pa, 1
 \end{aligned}$$

In the second tableau, world 1 is non-normal, and no further modal rules can be applied; hence the tableau remains open.

18.4.3 To read off a counter-model from an open branch, we proceed exactly as in the constant domain case for a normal modal logic, except that all worlds other than 0 are non-normal; and if $i > 0$ and M is a matrix, $\langle a_1, \dots, a_n \rangle \in v_{w_i}(M)$ iff $M_{\vec{x}}(a_1, \dots, a_n), i$ is on the branch.

18.4.4 Thus, in the counter-model given by the open tableau of 18.4.2, we have $W = \{w_0, w_1\}, N = \{w_0\}, w_0 R w_1, D = \{\partial_a\}, v(a) = \partial_a$, the extension of P and Q at both worlds is ϕ , $v_{w_1}(\Diamond(Pv_0 \wedge Qv_1)) = \{\{\partial_a, \partial_a\}\}$ and $v_{w_1}(\Diamond Pv_0) = \phi$. We may depict it thus:

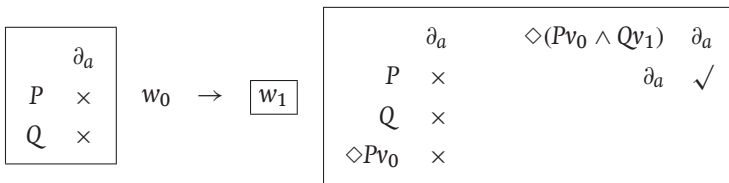

(The rightmost table in the box for w_1 indicates the extension of $\Diamond(Pv_0 \wedge Qv_1)$ there). The box around w_1 indicates that it is non-normal. I leave it as a straightforward exercise to show that the interpretation does the required job.

18.5 Ringing the Changes

18.5.1 Constant domain L can be varied or extended in all the standard ways. For a start, it is easy enough to give variable domain semantics, VL. Interpretations are exactly the same as variable domain semantics for normal modal logics (see 15.3.1), except that there is a class of non-normal

worlds, $W - N$, as well. At these, the interpretation function, v , assigns each matrix an extension, which is employed in giving the truth conditions of its substitution instances, as in 18.3.3. The tableaux for VL are the same as those for CL, except that the classical quantifier rules are replaced by those of free logic, as in 15.4.1.

18.5.2 Here is a tableau showing that $\not\vdash_{VL} \Box(\exists x\Box Px \supset \Box\exists xPx)$:

$$\begin{array}{l}
 \neg\Box(\exists x\Box Px \supset \Box\exists xPx), 0 \\
 \diamond\neg(\exists x\Box Px \supset \Box\exists xPx), 0 \\
 \text{Or } 1 \\
 \neg(\exists x\Box Px \supset \Box\exists xPx), 1 \\
 \quad \exists x\Box Px, 1 \\
 \quad \neg\Box\exists xPx, 1 \\
 \quad \quad \mathfrak{E}a, 1 \\
 \quad \quad \Box Pa, 1
 \end{array}$$

18.5.3 Counter-models are read off from an open branch as in the constant domain case, except that the information about the domains is read off as in the variable domain case for normal modal logics (that is, from the extension of the existence predicate). (See 15.4.4.) Thus, in the counter-model given by the tableau of 18.5.2: $W = \{w_0, w_1\}$, $N = \{w_0\}$, w_0Rw_1 , $D = \{\partial_a\}$, $v(a) = \partial_a$, $D_{w_0} = v_{w_0}(\mathfrak{E}) = \phi$, $D_{w_1} = v_{w_1}(\mathfrak{E}) = \{\partial_a\}$, the extension of P at both worlds is ϕ , $v_{w_1}(\Box\exists xPx) = \phi$, and $v_{w_1}(\Box Pv_0) = \{\partial_a\}$. In a diagram:

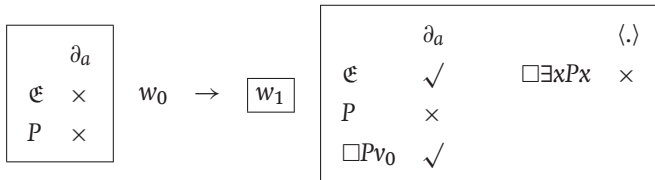

Checking:

- $\langle \partial_a \rangle \in v_{w_1}(\Box Pv_0)$, so $\Box Pa$ is true at w_1 as, then, is $\exists x\Box Px$
- $\langle \cdot \rangle \notin v_{w_1}(\Box\exists xPx)$, so $\Box\exists xPx$ is false at w_1

Verifying the facts about the other relevant formulas is routine, and left as an exercise.

18.5.4 Next, we may produce the constant and variable domain versions of non-normal modal propositional logics stronger than L . Thus, CN and VN

are formed by adding the constraint that for all $w \in W - N$, and all matrices $\Box A$ and $\Diamond A$, with n free variables:

$$\begin{aligned} v_w(\Box A) &= \phi \\ v_w(\Diamond A) &= D^n \end{aligned}$$

This has the effect of making every substitution instance of $\Box A$ (and so every closed formula of that form) false at w , and every substitution instance of $\Diamond A$ true. In particular, then, $\neg\Box A$ and $\Diamond\neg A$ have the same truth value at w , as do $\neg\Diamond A$ and $\Box\neg A$.

18.5.5 The tableaux for CN and VN are the same as those for CL and VL , respectively, except that the rules for the modal operators of N (4.3.1) are applied, instead of those for L . (So the rules for \Box , $\neg\Box$, and $\neg\Diamond$ are applied at all worlds; the rule for \Diamond is applied only at world 0 and \Box -inhabited worlds.)

18.5.6 Here is a tableau to show that $\not\vdash \forall x\Box\Box Px \supset \forall x\Box(Qx \vee \Box\Box Qx)$ in CN :

$$\begin{aligned} &\neg(\forall x\Box\Box Px \supset \forall x\Box(Qx \vee \Box\Box Qx)), 0 \\ &\quad \forall x\Box\Box Px, 0 \\ &\quad \neg\forall x\Box(Qx \vee \Box\Box Qx), 0 \\ &\quad \exists x\neg\Box(Qx \vee \Box\Box Qx), 0 \\ &\quad \neg\Box(Qa \vee \Box\Box Qa), 0 \\ &\quad \Diamond\neg(Qa \vee \Box\Box Qa), 0 \\ &\quad \quad 0r1 \\ &\quad \neg(Qa \vee \Box\Box Qa), 1 \\ &\quad \quad \neg Qa, 1 \\ &\quad \quad \neg\Box\Box Qa, 1 \\ &\quad \quad \Diamond\neg\Box Qa, 1 \\ &\quad \quad \Box\Box Pa, 0 \\ &\quad \quad \Box Pa, 1 \\ &\quad \quad \quad 1r2 \\ &\quad \quad \neg\Box Qa, 2 \\ &\quad \quad \Diamond\neg Qa, 2 \\ &\quad \quad Pa, 2 \end{aligned}$$

The rule for \Diamond is applied to the formula at line 11, because world 1 is \Box -inhabited due to line 13. It is not applied to the formula at line 16, since world 2 is not \Box -inhabited.

18.5.7 Counter-models are read off from open branches of tableaux as for *CL* and *VL*, except that (i) the normal worlds are world 0 and any world that is \Box -inhabited (as in 4.3.5), and (ii) for all $w \in W - N$, and all matrices of the form $\Box A$ and $\Diamond A$, with n free variables, $\nu_w(\Box A) = \phi$ and $\nu_w(\Diamond A) = D^n$. Thus, for the counter-model determined by the tableau of 18.5.6, $W = \{w_0, w_1, w_2\}$, $N = \{w_0, w_1\}$, w_0Rw_1 and w_1Rw_2 ; $D = \{\partial_a\}$, $\nu(a) = \partial_a$. All extensions are empty, except that $\nu_{w_2}(P) = \{\partial_a\}$. In a picture:

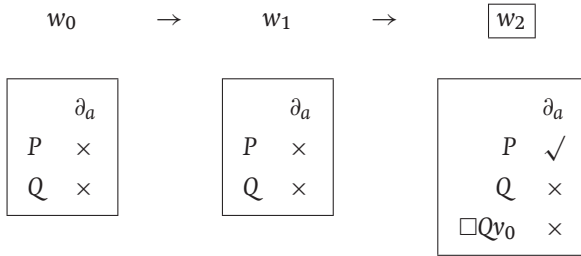

I leave it as an exercise to check that this counter-model works.

18.5.8 The quantified versions of *L* and *N* can also be extended by adding constraints on the accessibility relation, to give *CL* $_{\rho}$, *VN* $_{\rho}$, etc. Appropriate tableaux are obtained by adding the corresponding rule for r . Counter-models are read off in the obvious way.

18.5.9 Here is an example to show that $\not\models \Box(\Diamond\exists xPx \supset \neg\Diamond\exists xQx)$ in *CL* $_{\rho}$:

$$\begin{aligned}
 &\neg\Box(\Diamond\exists xPx \supset \neg\Diamond\exists xQx), 0 \\
 &\quad 0r0 \\
 &\Diamond\neg(\Diamond\exists xPx \supset \neg\Diamond\exists xQx), 0 \\
 &\quad 0r1, 1r1 \\
 &\neg(\Diamond\exists xPx \supset \neg\Diamond\exists xQx), 1 \\
 &\quad \Diamond\exists xPx, 1 \\
 &\quad \neg\Diamond\exists xQx, 1 \\
 &\quad \quad \Diamond\exists xQx, 1
 \end{aligned}$$

In the counter-model, $W = \{w_0, w_1\}$, $N = \{w_0\}$, $w_0Rw_0, w_0Rw_1, w_1Rw_1$, $D = \{\partial\}$. (This is one of the odd cases where there are no constants on the completed tableau.) The extension of P and Q at both worlds is ϕ ; $\nu_{w_1}(\Diamond\exists xPx) = \nu_{w_1}(\Diamond\exists xQx) = \{\langle \cdot \rangle\}$. Checking that this works is straightforward and is left as an exercise.

18.5.10 As a matter of fact, in the case of N and its extensions, the use of matrices can be avoided. Things work just as well if we take ν to assign truth values to closed statements of the form $\Box A$ and $\Diamond A$ at a non-normal world, w , as follows:

$$\begin{aligned} \nu_w(\Box A) &= 0 \\ \nu_w(\Diamond A) &= 1 \end{aligned}$$

This is proved in 18.7.8.

18.6 Identity

18.6.1 In this section, we look at the addition of identity to the non-normal logics we have so far considered.

18.6.2 For necessary identity, we take the extension of the identity predicate at all worlds, normal and non-normal, to be $\{\langle x, x \rangle : x \in D\}$.³ (At non-normal worlds, ν assigns extensions to all matrices – including ones containing identity.) For the tableaux, we simply add the identity rules of 16.2.3, except that, in the rule SI, $A_x(a)$ may also be a modal formula if i is non-normal (that is, in L and its extensions, if $i > 0$; and in N and its extensions, if $i > 0$ and is not \Box -inhabited).

18.6.3 Here, for example, are tableaux to show that $\vdash_{CL(NI)} \forall x \forall y \Box(x = y \supset (\Box Px \supset \Box Py))$ and $\not\vdash_{CL(NI)} \Box(a = b \supset (\Box Pa \supset \Diamond Pb))$:

$$\begin{aligned} &\neg \forall x \forall y \Box(x = y \supset (\Box Px \supset \Box Py)), 0 \\ &\exists x \neg \forall y \Box(x = y \supset (\Box Px \supset \Box Py)), 0 \\ &\neg \forall y \Box(a = y \supset (\Box Pa \supset \Box Py)), 0 \\ &\exists y \neg \Box(a = y \supset (\Box Pa \supset \Box Py)), 0 \\ &\neg \Box(a = b \supset (\Box Pa \supset \Box Pb)), 0 \\ &\quad \Diamond \neg(a = b \supset (\Box Pa \supset \Box Pb)) \\ &\quad \text{Or } 1 \\ &\quad \neg(a = b \supset (\Box Pa \supset \Box Pb)), 1 \\ &\quad \quad a = b, 1 \\ &\quad \quad \neg(\Box Pa \supset \Box Pb), 1 \\ &\quad \quad \downarrow \end{aligned}$$

³ When the Negativity Constraint is in operation, this has to be restricted to those x that exist at the world.

$$\begin{aligned} &\Box Pa, 1 \\ &\neg\Box Pb, 1 \\ &\Box Pb, 1 \\ &\times \end{aligned}$$

In the last line, SI is applied to a modal formula at world 1, which is non-normal.

$$\begin{aligned} &\neg\Box(a = b \supset (\Box Pa \supset \Diamond Pb)), 0 \\ &\Diamond\neg(a = b \supset (\Box Pa \supset \Diamond Pb)), 0 \\ &\text{Or 1} \\ &\neg(a = b \supset (\Box Pa \supset \Diamond Pb)), 1 \\ &\quad a = b, 1 \\ &\quad \neg(\Box Pa \supset \Diamond Pb), 1 \\ &\quad a = b, 0 \\ &\quad \Box Pa, 1 \\ &\quad \neg\Diamond Pb, 1 \\ &\quad \Box Pb, 1 \end{aligned}$$

Again, at the last line, SI is applied to a modal formula. There being no other rules (modal or identity) applicable, the tableau is open.

18.6.4 Counter-models are read off from open branches as in the case where identity is not present, except that whenever we have a bunch of formulas of the form $a = b, 0, b = c, 0, \dots$ on a branch, one single object is chosen for all of the constants to denote (as in 16.2.6). Thus, in the interpretation determined by the open tableau of 18.6.3, we have $W = \{w_0, w_1\}, N = \{w_0\}, w_0Rw_1, D = \{\partial_a\}, v(a) = v(b) = \partial_a$, the extension of P at both worlds is ϕ , $v_{w_0}(\Box Pv_0) = \{\partial_a\}$ and $v_{w_1}(\Diamond Pv_0) = \phi$. In a picture:

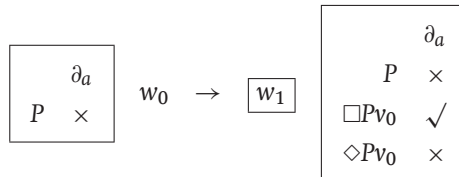

I leave it as an exercise to check that this works.

18.6.5 The non-normal logics can also be extended with contingent identity. The semantic techniques are exactly the same as those used for normal systems; and the appropriate tableaux are as for necessary identity, but

with the Identity Invariance Rule dropped. Details are left as an exercise. (See 18.11, question 9.)

18.6.6 All the non-normal systems of logic in this chapter are sound and complete with respect to their appropriate semantics. This is proved in 18.7.

18.6.7 Finally, note that all the systems of logic we have dealt with in the chapter can be modified by the addition of the Negativity Constraint and/or descriptors. The reader will no doubt be relieved to learn that I will not go into these matters here. (But see 18.11, questions 7 and 8.)

18.7 *Proofs of Theorems

18.7.1 In this section I will give the soundness and completeness proofs for the tableau systems of this chapter. We will start by considering the logics without identity.

18.7.2 LEMMA (LOCALITY): Let $\mathcal{J}_1 = \langle D, W, N, R, v_1 \rangle$, $\mathcal{J}_2 = \langle D, W, N, R, v_2 \rangle$ be two non-normal interpretations (constant or variable domain). Since they have the same domain, the language of the two is the same. Call this L . If A is any closed formula of L such that v_1 and v_2 agree on the denotations of all the predicates, constants *and matrices* deployed in it, then for all $w \in W$:

$$v_{1w}(A) = v_{2w}(A)$$

Proof:

The proof is exactly the same as in the normal case, except for the induction case for modal formulas at non-normal worlds. Suppose that w is non-normal, and that M is a matrix.

$$\begin{aligned} v_{1w}(M_{\vec{x}}(a_1, \dots, a_n)) = 1 & \text{ iff } \langle v_1(a_1), \dots, v_1(a_n) \rangle \in v_{1w}(M) \\ & \text{ iff } \langle v_2(a_1), \dots, v_2(a_n) \rangle \in v_{2w}(M) \\ & \text{ iff } v_{2w}(M_{\vec{x}}(a_1, \dots, a_n)) = 1 \end{aligned}$$

■

18.7.3 LEMMA (DENOTATION): Let $\mathcal{J} = \langle D, W, N, v, R \rangle$ be any non-normal interpretation (constant or variable domain). Let A be any formula of $L(\mathcal{J})$ with at most one free variable, x , and a and b be any two constants such that

$v(a) = v(b)$. Then for any $w \in W$:

$$v_w(A_x(a)) = v_w(A_x(b))$$

Proof:

The proof is the same as in the normal case, with the exception of the inductive case for modal formulas at non-normal worlds. Suppose that w is non-normal, that M is a matrix, and, for the sake of illustration, that a is substituted for only one free variable in it.

$$\begin{aligned} v_w(M_{\vec{x}}(a_1, \dots, a, \dots, a_n)) = 1 & \text{ iff } \langle v(a_1), \dots, v(a), \dots, v(a_n) \rangle \in v_w(M) \\ & \text{ iff } \langle v(a_1), \dots, v(b), \dots, v(a_n) \rangle \in v_w(M) \\ & \text{ iff } v_w(M_{\vec{x}}(a_1, \dots, b, \dots, a_n)) = 1 \end{aligned}$$

■

18.7.4 SOUNDNESS THEOREM FOR CL AND VL: The tableaux for *CL* and *VL* are sound with respect to their semantics.

Proof:

The Soundness Lemmas are proved as in the normal case (14.7.5 and 15.9.5). This is entirely straightforward: there are fewer cases to consider. (No rules apply to modal formulas at non-normal worlds.) The Soundness Theorem follows in the standard way (14.7.6, 15.9.5). ■

18.7.5 COMPLETENESS THEOREM FOR CL AND VL: The tableaux for *CL* and *VL* are complete with respect to their semantics.

Proof:

The induced interpretation is defined as in the normal case (14.7.7, 15.9.6), with the following modifications. $N = \{w_0\}$; for every $w_i \in W - N$, and every n -place matrix, M , with instantiations on the branch, $\langle \partial_{a_1}, \dots, \partial_{a_n} \rangle \in v_{w_i}(M)$ iff $M_{\vec{x}}(a_1, \dots, a_n), i$ is on \mathcal{B} . The Completeness Lemma is then proved in the usual way (14.7.8, 15.9.6). There is only one new case, that for modal formulas at non-normal worlds. This is the same as for atomic formulas, given the definition of the extension of matrices at non-normal worlds. The Completeness Theorem follows as usual (14.7.9, 15.9.6). ■

18.7.6 SOUNDNESS AND COMPLETENESS THEOREMS FOR CN AND VN: The tableaux for *CN* and *VN* are sound and complete with respect to their semantics.

Proof:

The proofs are simple modifications of the arguments for L just given. In the Soundness Lemma, there are extra cases for modal rules applied at non-normal worlds. The arguments here are as in the propositional case (4.10.1).

For completeness, the induced interpretation is defined as for L , except that the normal worlds are w_0 and all the \Box -inhabited worlds (as in 4.10.3); for any matrix, $\Box A$, and non-normal world, w_i , $\nu_{w_i}(\Box A) = \phi$; for any matrix $\Diamond A$, with n -free variables, and non-normal world, w_i , $\nu_{w_i}(\Diamond A) = D^n$. (In particular, then, any formula of the form $\Box A_{\vec{x}}(a_1, \dots, a_n)$ is false at such a world, and any formula of the form $\Diamond A_{\vec{x}}(a_1, \dots, a_n)$ is true.) It is clear that this is an N interpretation. The cases for modal formulas in the Completeness Lemma now proceed as in the propositional case (4.10.3). ■

18.7.7 SOUNDNESS AND COMPLETENESS THEOREMS FOR EXTENSIONS: The logics obtained by extending the quantified versions of L and N by adding constraints on the accessibility relation are sound and complete with respect to their tableaux.

Proof:

This is just a matter of checking the cases for the rules concerning r in the Soundness Lemma, and checking that the appropriate constraints are in place in the induced interpretation. This is all straightforward. ■

18.7.8 As observed in 18.5.10, in N and its extensions, we can dispense with matrices and give the truth values of modal formulas directly. In this case, the Locality and Denotation Lemmas can be enunciated as in the normal modal case. The induction case for modal formulas in the Locality Lemma is trivial (if w is non-normal, $\nu_{1w}(\Box A) = 0 = \nu_{2w}(\Box A)$, and similarly for \Diamond), as it is in the Denotation Lemma (if w is non-normal, $\nu_w(\Box A_x(a)) = 0 = \nu_w(\Box A_x(b))$, and similarly for \Diamond). The Soundness and Completeness arguments are trivial modifications of the ones already given for N and its extensions.

18.7.9 We now suppose that necessary identity is added to the language. The proofs of the Locality and Denotation Lemmas of 18.7.2 and 18.7.3 are unaffected. These Lemmas therefore continue to hold.

18.7.10 SOUNDNESS THEOREMS FOR NECESSARY IDENTITY: The tableau systems for all the quantified non-normal logics with necessary identity are sound.

Proof:

The Soundness Theorem for each logic follows from the Soundness Lemma in the usual way. The only novelty in the proof of this concerns the rules for identity. These are handled as in the normal case (16.6.3), except that we need to consider the case for SI where a substitution is made in a modal formula at a non-normal world, thus:

$$\begin{array}{c} a = b, i \\ M_{\vec{x}}(a_1, \dots, a, \dots, a_n), i \\ \downarrow \\ M_{\vec{x}}(a_1, \dots, b, \dots, a_n), i \end{array}$$

i is non-normal, M is a matrix, and we suppose for the sake of illustration that a is substituted for only one of the variables in it. Suppose that f shows that \mathcal{I} is faithful to a branch with the two premises on it. Then $v(a) = v(b)$ and $\langle v(a_1), \dots, v(a), \dots, v(a_n) \rangle \in v_{f(i)}(M)$. Hence, $\langle v(a_1), \dots, v(b), \dots, v(a_n) \rangle \in v_{f(i)}(M)$, $M_{\vec{x}}(a_1, \dots, b, \dots, a_n)$ is true at $f(i)$, and we may take \mathcal{I}' to be \mathcal{I} . ■

18.7.11 For each logic, given an open branch, \mathcal{B} , of a tableau, the induced interpretation is defined as in the normal case (16.6.4), with the addition that the class of normal worlds is defined in the standard way (just 0 for L and its extensions; just 0 and \Box -inhabited worlds for N and its extensions); and for non-normal worlds, w_i , and any matrix, M , with n -free variables, $\langle [a_1], \dots, [a_n] \rangle \in v_{w_i}(M)$ iff $M_{\vec{x}}(a_1, \dots, a_n), i$ is on \mathcal{B} . This is well-defined since SI has been applied to matrices at non-normal worlds.

18.7.12 COMPLETENESS THEOREMS FOR NECESSARY IDENTITY: The tableau systems for all the quantified non-normal logics with necessary identity are complete with respect to their semantics.

Proof:

The Completeness Theorem for each logic follows from the appropriate version of the Completeness Lemma. This is proved as for normal modal logics (16.6.4). There is one extra case, namely that for modal formulas at non-normal worlds. Thus, suppose that i is non-normal, and that M is a

matrix.

$$\begin{aligned}
 M_{\vec{\chi}}(a_1, \dots, a_n), i \text{ is on } \mathcal{B} &\Rightarrow \langle [a_1], \dots, [a_n] \rangle \in \nu_{w_i}(M) \\
 &\Rightarrow \langle v(a_1), \dots, v(a_n) \rangle \in \nu_{w_i}(M) \\
 &\Rightarrow \nu_{w_i}(M_{\vec{\chi}}(a_1, \dots, a_n)) = 1
 \end{aligned}$$

$$\begin{aligned}
 \neg M_{\vec{\chi}}(a_1, \dots, a_n), i \text{ is on } \mathcal{B} &\Rightarrow M_{\vec{\chi}}(a_1, \dots, a_n), i \text{ is not on } \mathcal{B} \quad (\mathcal{B} \text{ open}) \\
 &\Rightarrow \langle [a_1], \dots, [a_n] \rangle \notin \nu_{w_i}(M) \\
 &\Rightarrow \langle v(a_1), \dots, v(a_n) \rangle \notin \nu_{w_i}(M) \\
 &\Rightarrow \nu_{w_i}(M_{\vec{\chi}}(a_1, \dots, a_n)) = 0
 \end{aligned}$$

■

18.8 History

Quantified non-normal logics were formulated by Barcan (1946) and Feys (1965), sect. 12. The semantics in the form given in 18.5.10 were provided by Routley (1978). Matrix semantics were first deployed (as far as I know) in Priest (2005c), chs. 1 and 2; ch. 2 uses contingent identity.

18.9 Further Reading

There is no significant literature on quantified non-normal logics, and therefore nothing much more to read than the works cited in 18.8.

18.10 Problems

1. Check the details omitted in 18.4.4, 18.5.3, 18.5.7 and 18.5.9.
2. Determine the truth of the following in *CL*. If the inference is invalid, read off a counter-model and check that it works.
 - (a) $\vdash \Box \exists x Px \supset \exists x \Box Px$
 - (b) $\vdash \Diamond \Box (\forall x Px \supset \exists x Px)$
 - (c) $\vdash \Diamond (\exists x \Box Px \wedge \exists x \Box \neg Px)$
 - (d) $\vdash \Box \exists x (Px \wedge \Box Px)$
3. Repeat question 2 for each of *CL* ρ , *VL*, *VL* ρ , *CN*, *CN* ρ , *VN* and *VN* ρ .
4. Determine the truth of the following in *CL(NI)*. If the inference is invalid, read off a counter-model and check that it works.

$$(a) \vdash \diamond a = b \supset \Box a = b$$

$$(b) \vdash \forall x \forall y (\Box x = y \supset \Box \Box x = y)$$

$$(c) \vdash \forall x \forall y (\diamond (Px \wedge \neg Py) \supset x \neq y)$$

$$(d) \vdash (\Box \Box a = b \wedge \Box \Box b = c) \supset \Box \Box a = c$$

5. Repeat question 4 for $CN(NI)$.
6. *Check the details omitted in the proofs of 18.7.
7. *Add the Negativity Constraint to $VL(NI)$; specify the appropriate tableau rules, and prove them to be sound and complete. Do the same for $VN(NI)$.
8. *Add descriptors to $CL(NI)$; specify the appropriate tableau rules, and prove them to be sound and complete. Do the same for $CN(NI)$.
9. *Formulate the semantics for contingent identity systems $CL(CI)$ and $CN(CI)$. Construct appropriate tableaux, and prove them sound and complete.
10. *For the various systems of logic in this chapter, formulate tableaux for inferences with arbitrary sets of premises. Prove the Soundness and Completeness Theorems. Infer the Compactness and Löwenheim-Skolem Theorems.

19 Conditional Logics

19.1 Introduction

19.1.1 In this chapter we will look at another family of logics which have possible-world semantics: conditional logics.

19.1.2 We will ignore identity to start with, and look at the constant and variable domain versions of conditional logics. We will then turn to the addition of identity to such logics.¹

19.1.3 We finish by looking at a couple of philosophical issues concerning conditionals, quantification and identity.

19.2 Constant and Variable Domain C

19.2.1 Let us start with the constant domain version of the basic conditional logic C , CC .

19.2.2 The language of first-order modal logic is augmented by the binary connective, $>$. An interpretation, \mathfrak{J} , for this language is a structure $\langle D, W, \{R_A: A \in \mathcal{F}\}, \nu \rangle$. \mathcal{F} is the set of formulas of the language of \mathfrak{J} ; D is the domain of quantification; ν is as in normal modal logics (14.2.2); W and $\{R_A: A \in \mathcal{F}\}$ are as in the propositional case (5.3.3); and, as there, we will assume for the sake of simplicity that the underlying modal logic is $K\nu$ (see 5.3.2).

¹ As in the last chapter, we ignore the Negativity Constraint and descriptors, and relegate them to exercises.

19.2.3 The truth conditions for the quantifiers are as in the modal case, 14.2.3, and those for the propositional operators are as in 5.3.4. In particular, for $>$:

$$v_w(A > B) = 1 \text{ iff } f_A(w) \subseteq [B]$$

where $f_A(w) = \{w' \in W : wR_A w'\}$ and $[A] = \{w : v_w(A) = 1\}$. Validity is defined in terms of truth preservation at all worlds of all interpretations.

19.2.4 There is one further condition on interpretations: for all formulas, A , and constants in the language of \mathcal{J} , a and b :

$$\text{if } v(a) = v(b) \text{ then } R_{A_x(a)} = R_{A_x(b)}$$

(or equivalently, if $v(a) = v(b)$ then $f_{A_x(a)} = f_{A_x(b)}$). Let us call this the *Accessibility Denotation Constraint* (ADC). What goes wrong without it is most easily seen by considering identity. Suppose that $v(a) = v(b)$. Consider the conditionals $Pa > A$ and $Pb > A$. These are true at w if $f_{Pa}(w) \subseteq [A]$ and $f_{Pb}(w) \subseteq [A]$, respectively. Unless $f_{Pa} = f_{Pb}$ (that is, $R_{Pa} = R_{Pb}$), then one may be true, but not the other. (In more general terms, without this constraint, the Denotation Lemma, crucial to the behaviour of quantification, will fail. We met a similar situation with respect to non-normal modal logic in 18.2.1.)

19.2.5 Tableaux for CC are obtained by adding the quantifier rules of constant domain modal logic (14.3.1) to those for propositional C (5.4.1).

19.2.6 Here is an example to show that $A > B_x(a) \vdash A > \exists xB$.

$$\begin{array}{l} A > B_x(a), 0 \\ \neg(A > \exists xB), 0 \\ \text{Or}_A 1 \\ \neg \exists xB, 1 \\ \forall x \neg B, 1 \\ \neg B_x(a), 1 \\ B_x(a), 1 \\ \times \end{array}$$

The last line follows from the first, since $\text{Or}_A 1$. (Note that it is the propositional rules for C that are being applied, not those for C^+ .) Here is another

tableau to show that $\forall x(Px > Qx) \not\vdash \forall xPx > \forall xQx$:

$$\begin{aligned} & \forall x(Px > Qx), 0 \\ & \neg(\forall xPx > \forall xQx), 0 \\ & \quad 0r_{\forall xPx} 1 \\ & \quad \neg\forall xQx, 1 \\ & \quad \exists x\neg Qx, 1 \\ & \quad \neg Qa, 1 \\ & \quad Pa > Qa, 0 \end{aligned}$$

There being no information of the form $0r_{pai}$, no further rules are applicable.

19.2.7 Given an open branch of a tableau, for a counter-model, the worlds and accessibility relations are read off as in the propositional case (5.4.4). The domain and the information about the extensions of the predicates at each world are read off as in the case of constant domain (normal) modal logic (14.3.4). Note that reading the counter-model off from an open branch of the tableau in this way guarantees that the ADC is automatically satisfied: if a and b are constants on the tableau, and $\nu(a) = \nu(b)$, a and b must be the same constant, so $A_x(a)$ is $A_x(b)$.²

19.2.8 Thus, for the open tableau of 19.2.6, $W = \{w_0, w_1\}$, $w_0R_{\forall xPx}w_1$, $D = \{\partial_a\}$, $\nu(a) = \partial_a$, and the extension of every predicate at every world is empty. In a diagram:

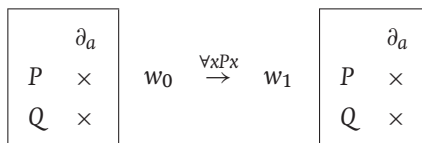

Since w_0 accesses no world along R_{Pa} , $Pa > Qa$ is true at w_0 , as, then, is $\forall x(Px > Qx)$. $\forall xQx$ is false at w_1 , and since w_0 accesses w_1 along $R_{\forall xPx}$, $\forall xPx > \forall xQx$ is false at w_0 .

² Strictly speaking, this is less than required, since the constraint must be satisfied for all constants in the language of the interpretation, including the various k_d s for $d \in D$. However, if $d = \partial_a$, we can simply define $R_{A_x(k_d)}$ to be $R_{A_x(a)}$. So the result will hold for these too.

19.2.9 Variable domain C , VC , is obtained by modifying CC in the natural way. In particular, in an interpretation, for every $w \in W$, $v(w) = D_w = v_w(\mathfrak{E})$; and the truth conditions of a quantified sentence at a world, w , are given in terms of the objects in D_w . (See 15.3.1 and 15.3.2.) The tableaux are obtained from the tableaux for CC by replacing the classical quantifier rules by those for free logic, as in 15.4.1.

19.2.10 Here are a couple of tableaux for VC showing that $\forall x(A > B) \vdash \forall x(A > (B \vee C))$ and $\forall x(Px > Sx) \not\vdash \forall x((Px \wedge Qx) > Sx)$:

$$\begin{array}{c}
 \forall x(A > B), 0 \\
 \neg \forall x(A > (B \vee C)), 0 \\
 \exists x \neg(A > (B \vee C)), 0 \\
 \mathfrak{E}a, 0 \\
 \neg(A_x(a) > (B_x(a) \vee C_x(a))), 0 \\
 \text{Or}_{A_x(a)} 1 \\
 \neg(B_x(a) \vee C_x(a)), 1 \\
 \neg B_x(a), 1 \\
 \neg C_x(a), 1 \\
 \swarrow \quad \searrow \\
 \neg \mathfrak{E}a, 0 \quad A_x(a) > B_x(a), 0 \\
 \times \quad B_x(a), 1 \\
 \quad \quad \quad \times
 \end{array}$$

The last line in the right branch is obtained in virtue of the information about the accessibility relation at line 6.

$$\begin{array}{c}
 \forall x(Px > Sx), 0 \\
 \neg \forall x((Px \wedge Qx) > Sx), 0 \\
 \exists x \neg((Px \wedge Qx) > Sx), 0 \\
 \mathfrak{E}a, 0 \\
 \neg((Pa \wedge Qa) > Sa), 0 \\
 \text{Or}_{Pa \wedge Qa} 1 \\
 \neg Sa, 1 \\
 \swarrow \quad \searrow \\
 \neg \mathfrak{E}a, 0 \quad Pa > Sa, 0 \\
 \times
 \end{array}$$

Since we have no information about r_{Pa} (at world 0) no further rules can be applied.

19.2.11 We read off a counter-model from an open branch as in the constant domain case, except that we use the information about what exists to determine the domain at each world (as in the variable domain modal case, 15.4.4). Thus, the counter-model determined by the open branch of the tableau in 19.2.10 may be depicted by the following diagram:

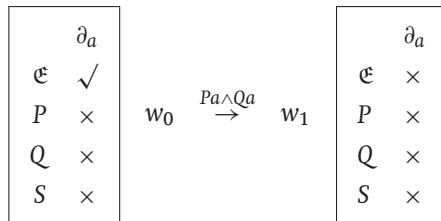

Since w_0 accesses nothing under R_{Pa} , $Pa > Sa$ is true there, as, then, is $\forall x(Px > Sx)$ (since a is the only thing that exists there). And since Sa is false at w_1 , $(Pa \wedge Qa) > Sa$ is false at w_0 , as is $\forall x((Px \wedge Qx) > Sx)$.

19.3 Extensions

19.3.1 The basic quantified conditional logics are, in fact, very weak. None of the following, for example, holds:

1. $\vdash \forall xPx > Pa$
2. $\vdash (\forall xPx \wedge \forall xQx) > \forall x(Px \wedge Qx)$
3. $Pa, \forall x(Px > Qx) \vdash Qa$
4. $\forall x \Box(Px \supset Qx) \vdash \forall x(Px > Qx)$

Details are left as exercises.

19.3.2 The logics can be extended in the same way that the propositional logics are, by adding constraints on the accessibility relations. Perhaps the most basic extension is obtained by adding constraints (1) and (2) of 5.5.1:

- (1) $f_A(w) \subseteq [A]$
- (2) if $w \in [A]$ then $w \in f_A(w)$

The corresponding tableau rules are as in 5.5.3. This gives the constant and variable domain systems CC^+ and VC^+ .

19.3.3 Each of 1–4 of 19.3.1 then holds generally in these systems (that is, we may replace Px and Qx with arbitrary formulas, A and B , respectively) – though in the case of variable domains, an extra premise to the effect that a exists is necessary in 1 and 3. Here are tableaux to demonstrate that $\mathcal{E}a, A_x(a), \forall x(A > B) \vdash_{VC+} B_x(a)$, and $\forall x \Box(A \supset B) \vdash_{CC+} \forall x(A > B)$. The others are left as exercises.

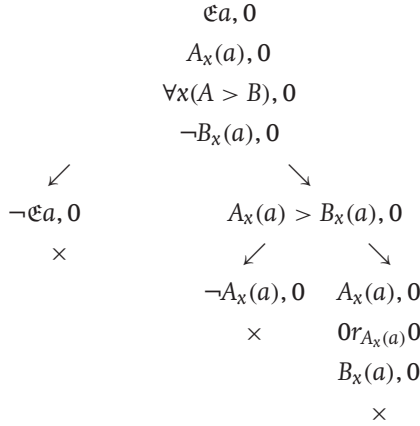

Note that the rule corresponding to constraint (2) (which causes the second split) needs to be applied only to *closed* formulas that are the antecedent of a conditional or negated conditional on the branch.

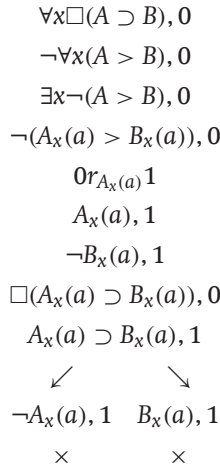

Line 9 holds by the \Box rule for Kv .

19.3.4 If a tableau does not close, we read off the counter-model from an open branch as for CC or VC . Thus, consider the following tableau, showing that $\forall xQx \not\vdash_{CC^+} \forall x(Px > Qx)$:

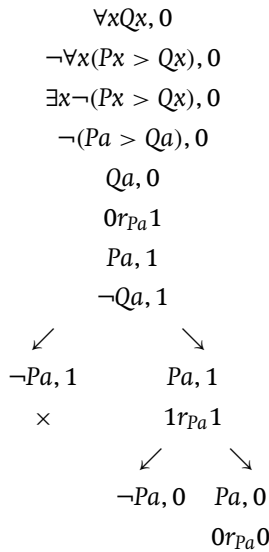

In the counter-model given by the righthand open branch, $W = \{w_0, w_1\}$, $w_0R_{Pa}w_0$, $w_1R_{Pa}w_1$, and $w_0R_{Pa}w_1$ (and for all other A and w , $f_A(w) = [A]$), $D = \{\partial_a\}$, $v(a) = \partial_a$, $v_{w_0}(P) = v_{w_1}(P) = v_{w_0}(Q) = \{\partial_a\}$, $v_{w_1}(Q) = \phi$. In a diagram:

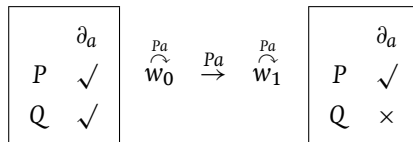

This is a CC^+ interpretation: at every world that w_0 and w_1 access under R_{Pa} , Pa holds; Pa holds at w_0 and w_1 , and each world accesses itself under R_{Pa} . All the other instances of the constraints for C^+ are taken care of by the default definition of f . (The ADC is automatically satisfied, as we noted in 19.2.7.) $\forall xQx$ clearly holds at w_0 . $\neg Qa$ holds at w_1 and $w_0R_{Pa}w_1$; hence $Pa > Qa$ fails at w_0 , as, then, does $\forall x(Px > Qx)$.

19.3.5 More complex constraints on f can be obtained with the sphere semantics of 5.6. Thus, we may augment an interpretation with a set of

spheres for each world. f is then defined in terms of these as in 5.6.5: $f_A(w) = S_i \cap [A]$, where S_i is the smallest sphere that intersects with $[A]$ (or if $[A] = \phi$, $f_A(w) = \phi$). This gives the constant or variable domain version of the propositional system S . (See 5.6.) Adding constraint (6) or constraint (7) of 5.7 gives the constant or variable domain version of C_2 and C_1 respectively.

19.3.6 In the sphere semantics, the ADC is automatically satisfied, so we do not have to worry about it. For suppose that $\nu(a) = \nu(b)$. Then $\nu_w(A_x(a)) = \nu_w(A_x(b))$. But then $[A_x(a)] = [A_x(b)]$, so the smallest sphere intersecting each of these is the same. Hence, $f_{A_x(a)} = f_{A_x(b)}$.³

19.3.7 These semantic systems have (at the time of writing) no corresponding tableau systems of the kind in use here. Validity therefore has to be shown by giving a direct argument. Thus, we may demonstrate that:

$$\exists xPx, \forall x(Px \supset Qx) \models \exists xQx$$

in CS as follows.

Take any interpretation that makes the premises true at world w . Then for some $d \in D$, Pk_d and $Pk_d \supset Qk_d$ are true at w , so $w \in [Pk_d]$ and $f_{Pk_d}(w) \subseteq [Qk_d]$. If we can show that Qk_d holds at w , then we are home. $[Pk_d]$ is non-empty, so $f_{Pk_d}(w) = S_i \cap [Pk_d]$, where S_i is the smallest sphere containing w which has a non-empty intersection with $[Pk_d]$. Hence, $w \in f_{Pk_d}(w)$. It follows that $w \in [Qk_d]$, as required.

(This particular inference happens also to be valid in CC^+ . So an alternative way to proceed in this case is to show the inference to be valid in CC^+ using tableaux. We may then infer that it is valid in CS (constant domain S), since CC^+ is a subsystem of CS . Of course, this procedure will not be available in general.)

19.3.8 To show that an inference is not valid, a counter-model has to be constructed by intelligent trial and error, and checked to be a counter-model in the usual way. Let us show, as an example, that:

$$\neg \exists x(Px \wedge Qx) \not\models \forall x(Px \supset Qx)$$

³ Strictly speaking, this is a proof by joint recursion. We show that for all w :

1. if $\nu(a) = \nu(b)$ then $\nu_w(A_x(a)) = \nu_w(A_x(b))$
2. if $\nu(a) = \nu(b)$ then $f_{A_x(a)} = f_{A_x(b)}$

by induction on A . The argument in the text deals with case (2); case (1) is straightforward.

in CC_2 . As observed in 5.7.8, an interpretation is guaranteed to be a C_2 interpretation if each of $S_0, S_1 - S_0, S_2 - S_1$, etc., is a singleton. So let us look for an interpretation of this kind. Let w be some world in the interpretation. We wish to make the premise true there, and the conclusion false. To keep things simple, let us see if we can get away with supposing that D is a singleton, $\{d\}$. To make the premise true at w , we need to ensure that either Pk_d or Qk_d is false at w . Now, to make $\forall x(Px > Qx)$ false at w we have to make $Pk_d > Qk_d$ false there. So at the world nearest to w where Pk_d is true Qk_d must be false. If Pk_d is true at w , this can just be w itself. If it is false, then we need to ensure that there is a nearest world where Pk_d is true, and that Qk_d is false there. Hence, either of the interpretations depicted in the following diagrams will do. I draw the spheres with broken lines to differentiate them from the contents of worlds.

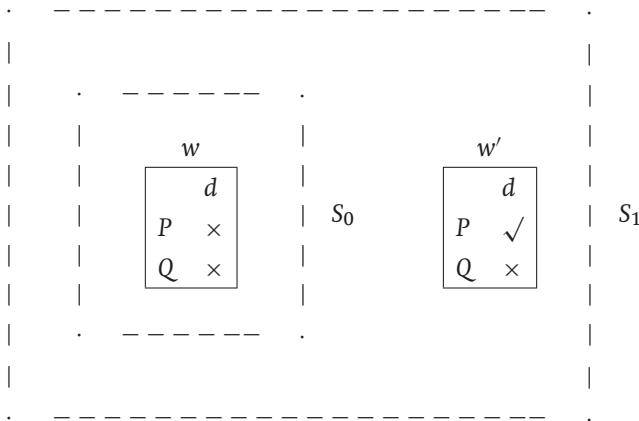
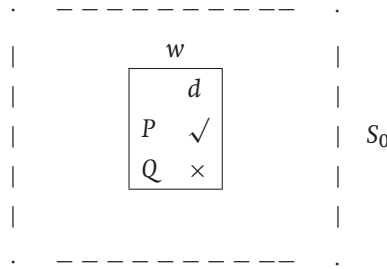

I leave it as an exercise to check that the interpretations depicted are indeed counter-models.

19.4 Identity

19.4.1 We now consider the addition of identity to the language, starting with necessary identity.

19.4.2 For necessary identity, we simply take the extension of the identity predicate at all worlds to be $\{(x, x) : x \in D\}$.⁴ For the tableaux for C and C^+ with identity, we add the identity rules of 16.2.3 to the respective sets of rules. There is also one further rule, required by the ADC (see 19.2.4), namely:

$$\begin{array}{c} a = b, 0 \\ ir_{A_x(a)j} \\ \downarrow \\ ir_{A_x(b)j} \end{array}$$

Call this the *Accessibility Denotation Rule* (ADR).

19.4.3 Here, for example, are tableaux to show that $a = b, Pa > Qc \vdash_{CC(NI)} Pb > Qc$ and $\vdash_{CC^+(NI)} \forall x \forall y (x = y > (Px > Py))$:

$$\begin{array}{c} a = b, 0 \\ Pa > Qc, 0 \\ \neg(Pb > Qc), 0 \\ Or_{Pb}1 \\ \neg Qc, 1 \\ Or_{Pa}1 \\ Qc, 1 \\ \times \end{array}$$

The penultimate line is given by the ADR. The last line then follows from line 2.

$$\begin{array}{c} \neg \forall x \forall y (x = y > (Px > Py)), 0 \\ \exists x \neg \forall y (x = y > (Px > Py)), 0 \\ \neg \forall y (a = y > (Pa > Py)), 0 \\ \exists y \neg (a = y > (Pa > Py)), 0 \\ \neg (a = b > (Pa > Pb)), 0 \\ Or_{a=b}1 \\ a = b, 1 \\ \neg (Pa > Pb), 1 \\ 1r_{Pa}2 \\ \downarrow \end{array}$$

⁴ Unless the Negativity Constraint is in operation, in which case it has to be restricted to those x that exist at the world.

$Pa, 2$
 $\neg Pb, 2$
 $a = b, 2$
 $Pb, 2$
 \times

The last line is obtained by SI, and the one preceding it is obtained by the Identity Invariance Rule. (Note that this inference is invalid in $CC(NI)$ since lines 7 and 10 are missing in that case.)

19.4.4 Given an open branch of a tableau, a counter-model is read off as in the case without identity, except that if we have lines of the form $a = b, 0, b = c, 0, \dots$ we choose a single object for all the constants to denote (as in 16.2.6). Thus, consider the following tableau, which demonstrates that $\not\vdash_{VC(NI)} \forall x \forall y \forall z (x = y \supset (y = z \supset x = z))$.

$\neg \forall x \forall y \forall z (x = y \supset (y = z \supset x = z)), 0$
 $\exists x \neg \forall y \forall z (x = y \supset (y = z \supset x = z)), 0$
 $\mathfrak{E}a, 0$
 $\neg \forall y \forall z (a = y \supset (y = z \supset a = z)), 0$
 $\exists y \neg \forall z (a = y \supset (y = z \supset a = z)), 0$
 $\mathfrak{E}b, 0$
 $\neg \forall z (a = b \supset (b = z \supset a = z)), 0$
 $\exists z \neg (a = b \supset (b = z \supset a = z)), 0$
 $\mathfrak{E}c, 0$
 $\neg (a = b \supset (b = c \supset a = c)), 0$
 $Or_{a=b} 1$
 $\neg (b = c \supset a = c), 1$
 $1r_{b=c} 2$
 $a \neq c, 2$

There being no further rules applicable, the tableau is finished, and it is open. The counter-model is depicted as follows.

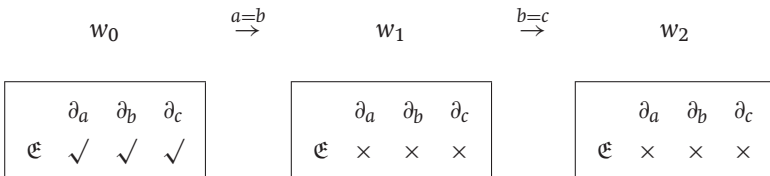

At w_2 , $a = c$ is false; so at w_1 , $b = c \supset a = c$ is false; so at w_0 , $a = b \supset (b = c \supset a = c)$ is false. Since all three things exist at w_0 , $\forall x \forall y \forall z (x = y \supset (y = z \supset x = z))$ is false at w_0 .

19.4.5 An interpretation for a contingent identity conditional logic is a structure $\langle D, W, H, \{R_A: A \in \mathcal{F}\}, \nu \rangle$, where D, H, W and ν are as in the case of a contingent identity (normal) modal logic, and the R_A s are as usual for conditional logics. The truth conditions are as for constant or variable domain normal modal logic (17.2.2) – $K\nu$, for the sake of simplicity – except those for the conditional, which are as in 19.2.3.

19.4.6 The tableau systems for contingent identity C and C^+ are the same as those for the corresponding necessary identity system, except that the Identity Invariance Rule and, perhaps surprisingly, the ADR are dropped.

19.4.7 Thus, the following tableau shows that $\vdash \forall x \forall y (\Box Px > (x = y > Py))$ in $CC^+(CI)$:

$$\begin{array}{l}
 \neg \forall x \forall y (\Box Px > (x = y > Py)), 0 \\
 \exists x \neg \forall y (\Box Px > (x = y > Py)), 0 \\
 \neg \forall y (\Box Pa > (a = y > Py)), 0 \\
 \exists y \neg (\Box Pa > (a = y > Py)), 0 \\
 \neg (\Box Pa > (a = b > Pb)), 0 \\
 \quad \text{Or } \Box Pa \ 1 \\
 \quad \quad \Box Pa, 1 \\
 \quad \quad \neg (a = b > Pb), 1 \\
 \quad \quad \quad 1r_{a=b} 2 \\
 \quad \quad \quad a = b, 2 \\
 \quad \quad \quad \neg Pb, 2 \\
 \quad \quad \quad Pa, 2 \\
 \quad \quad \quad Pb, 2 \\
 \quad \quad \quad \times
 \end{array}$$

19.4.8 To read off a counter-model from an open branch of a tableau, we proceed as for a normal modal logic with contingent identity (17.2.6), modified by reading off the information about the accessibility relation as in the case for propositional conditional logic. Thus, consider the following tableau, which shows that $\not\vdash_{CC(CI)} a = b > (Pa > Pb)$:

$$\begin{array}{l}
 \neg (a = b > (Pa > Pb)), 0 \\
 \quad \text{Or } a=b \ 1 \\
 \quad \quad \neg (Pa > Pb), 1 \\
 \quad \quad \quad 1r_{Pa} 2 \\
 \quad \quad \quad \neg Pb, 2
 \end{array}$$

The counter-model can be depicted thus:

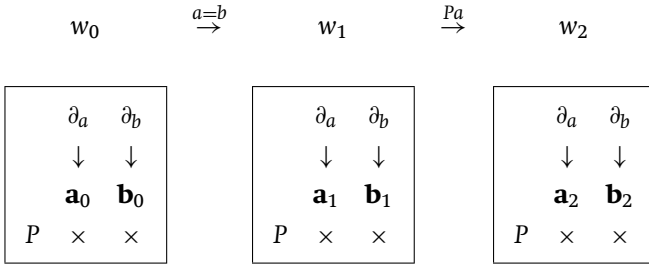

$Pa > Pb$ is false at w_1 , so $a = b > (Pa > Pb)$ is false at w_0 .

19.4.9 In the interpretation depicted, the ADC is satisfied. This is because every constant has a different denotation. (∂_a and ∂_b have different avatars at every world.) Hence the constraint is satisfied, as in 19.2.7. But this need not be the case in an interpretation induced by an open branch. If, on a branch, we have $a = b, i$ for every i , then ∂_a and ∂_b will have the same avatar at every world, and hence be identical. But $ir_{A_x(a)}j$ may be on the branch whilst $ir_{A_x(b)}j$ is not. In such cases we can rectify the matter with an artifice. Normally in set theory a function, ∂_a , is taken to be a set of ordered pairs, $\langle input, output \rangle$, but we can take it equally well to be a set of ordered triples, $\langle a, input, output \rangle$. This ensures that if a and b are distinct constants, ∂_a and ∂_b are distinct. (One can perform the same trick in a normal modal logic.)

19.4.10 In the systems with sphere semantics, to establish the validity of an inference, a direct argument must be given. Thus, to establish that:

$$\forall x \forall y (Px > x = y) \models \forall x \forall y (Px > Py)$$

in $CS(NI)$, we argue as follows. Consider any interpretation where $\forall x \forall y (Px > x = y)$ holds at a world, w . Then, for all $d, e \in D, Pk_d > k_d = k_e$ there. Hence, $f_{Pk_d}(w) \subseteq [k_d = k_e]$. We need to show that $\forall x \forall y (Px > Py)$ is true at w . Suppose not, for *reductio*. Then, for some $d, e \in D, Pk_d > Pk_e$ is false at w . So $f_{Pk_d}(w) \not\subseteq [Pk_e]$. Let $w' \in f_{Pk_d}(w)$ and $w' \notin [Pk_e]$. Then $w' \in [k_d = k_e]$ and $w' \in [Pk_d]$ (since in $S, f_A(w) \subseteq [A]$). Thus, $k_d = k_e$ and Pk_d are true at w' , and Pk_e is true at w' . Contradiction.

19.4.11 Similarly, to show that an inference is invalid, we have to construct a counter-model directly. Let us show, as an example, that in $CC_1(CI)$:

$$Pa > a = b \not\models (Pa \wedge Qb) > a = b$$

As observed in 5.7.8, an interpretation is guaranteed to be a C_1 interpretation if S_0 is a singleton. So let us look for a counter-model of this kind. We need $Pa > a = b$ to be true at some world, w . That is, at the nearest worlds to w where Pa is true, $a = b$ is true. We may as well try taking w to be the unique such world. Hence, Pa is true at w , and ∂_a and ∂_b need to have the same avatars there. We require $(Pa \wedge Qb) > a = b$ to be false at w . That is, at a nearest world where $Pa \wedge Qb$ is true, $a = b$ is false. This clearly cannot be w . So we should arrange for a nearest world to w where $Pa \wedge Qb$ is true to be some other world, w' . (In particular, then, Qb must be false at w . And ∂_a and ∂_b must have different avatars at w'). An interpretation having these properties may be depicted thus:

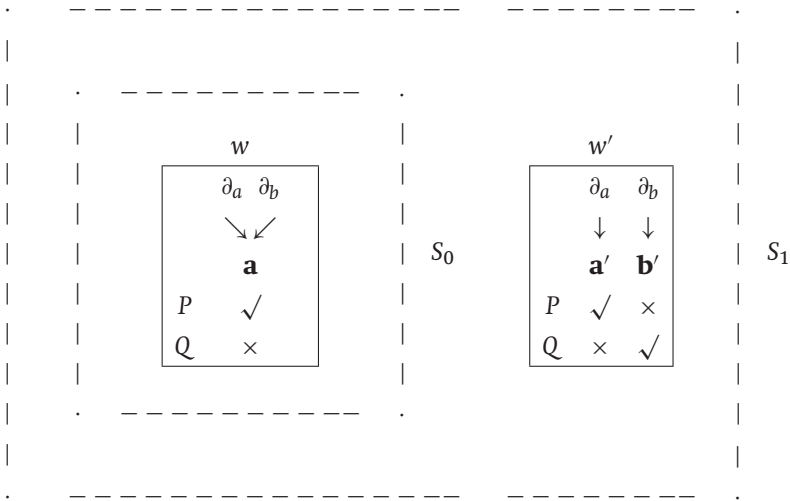

I leave it as an exercise to check that this works.

19.4.12 Note that, for all systems with necessary identity, $a = b, A_x(a) \models A_x(b)$. (This follows from the Denotation Lemma (19.6.2) in the obvious way.) For contingent identity, this is not the case. Thus, for example, $a = b, Pa > Pa \not\models Pa > Pb$ in $CC_2(CI)$ (the strongest contingent identity conditional logic that we have met). The construction of a counter-model is left as an exercise.

19.4.13 All the tableau systems of this chapter are sound and complete with respect to their corresponding semantics. This is proved in 19.6.

19.5 Some Philosophical Issues

19.5.1 We end this chapter with a few comments on some philosophical issues.

19.5.2 First, if we assume that $>$ represents English conditionals – or at least, subjunctive conditionals – should one prefer a constant domain conditional logic or a variable domain one? It is not too difficult to see that one should prefer a variable domain logic – or at least a constant domain logic in which the extension of the existence predicate varies from world to world (see 15.8.2). Just consider, for example:

If Father Christmas does exist, we are all very mistaken (about his existence).
If Father Christmas were to exist, we would not have to buy the kids presents at Christmas.

These conditionals appear to be true. To evaluate them, we have to look at worlds that are, *ceteris paribus*, the same as ours, except that Father Christmas exists. Hence, we have to consider worlds where what exists is different.

19.5.3 Do we have any reason to prefer constant domain semantics with an existence predicate to variable domain semantics? Consider the following conditional: If any non-existent thing did exist then (*ceteris paribus*) there would be fewer things in the world. That is:

(0) For any non-existent x , if x were to exist then there would be fewer things in existence.

This certainly looks false. If something non-existent were to exist, then, *ceteris paribus*, there would be *more* things in existence. Now, if we can quantify only over existent things (0) is vacuously true. To evaluate the conditional, we need to take something in this world that does not exist, and consider a world where things are the same except that that thing exists. (And in that world, there would be more things.) Hence, we need to quantify over things that do not exist (at this world).

19.5.4 What about identity? Do conditionals give us any reason for preferring contingent identity over necessary identity? It would appear so.

Consider the conditional:

If the Morning Star is not the Evening Star, modern astronomy is badly mistaken.

This seems true enough. To evaluate it, we have to look at worlds where the Morning Star is not the Evening Star. This requires contingent identity. It might be replied that we should stick to necessary identity. The antecedent expresses the thought that a certain object is not self-identical, and the conditional is vacuously true. But if the object is not self-identical, it is not modern astronomy that is badly mistaken: it is modern logic. So the conditional should be false.

19.5.5 Here is another example. Consider the conditional:

(1) If I were Rupert Murdoch, I would have more than a million dollars in my bank account.

This seems true. But to evaluate it we have to consider a world in which Murdoch and I are one, which we are not at this world. So it looks as though we need to consider a contingent identity conditional logic.

19.5.6 But things are not straightforward. What of the conditional:

(2) If Rupert Murdoch were I, he would have less than a million dollars in his bank account.

That seems true too. But how can this be true as well (and why do we not conclude that if Murdoch and I were one, we would have both more and less than a million dollars in our bank account)?

19.5.7 The answer is that what counts as *ceteris paribus* depends on the context (see 5.2.7). In a context where I am wondering what it would be like to be Murdoch, then I (that is he) am/is wealthy. In a context where I am wondering what Murdoch would do if he were a penurious philosopher, he (that is I) is/am not wealthy. (1) is true in the first context; (2) in the second. (The antecedents of the two conditionals are logically equivalent, but the different order of the terms suggests the different contexts.)

19.5.8 Having got that straight, whichever context we are in, in evaluating the conditional, we have to consider a world in which two things which are, as a matter of fact, distinct, are identical. Hence, we require a contingent identity logic.

19.6 *Proofs of Theorems

19.6.1 In this section I will establish soundness and completeness for the tableau systems of this chapter. We assume, for a start, that identity is not in the language.

19.6.2 LOCALITY AND DENOTATION LEMMAS FOR CONDITIONAL LOGICS: The Locality and Denotation Lemmas are stated in the natural way:

(Locality) Let $\mathcal{J}_1 = \langle D, W, \{R_A: A \in \mathcal{F}\}, \nu_1 \rangle$, $\mathcal{J}_2 = \langle D, W, \{R_A: A \in \mathcal{F}\}, \nu_2 \rangle$ be two interpretations. Since they have the same domain, the language of the two is the same. Call this L . If A is any closed formula of L such that ν_1 and ν_2 agree on the denotations of all the predicates and constants in it, then for all $w \in W$:

$$\nu_{1w}(A) = \nu_{2w}(A)$$

(Denotation) Let $\mathcal{J} = \langle D, W, \{R_A: A \in \mathcal{F}\}, \nu \rangle$ be any interpretation. Let A be any formula of $L(\mathcal{J})$ with at most one free variable, x , and a and b be any two constants such that $\nu(a) = \nu(b)$. Then for any $w \in W$:

$$\nu_w(A_x(a)) = \nu_w(A_x(b))$$

Proof:

The proofs are as for normal modal logics, with the addition of a case for the conditional connective. The cases go as follows. For Locality:

$$\begin{aligned} \nu_{1w}(A > B) = 1 & \quad \text{iff} \quad \text{for all } w' \text{ such that } wR_{A'}w', \nu_{1w'}(B) = 1 \\ & \quad \text{iff} \quad \text{for all } w' \text{ such that } wR_{A'}w', \nu_{2w'}(B) = 1 \\ & \quad \text{iff} \quad \nu_{2w}(A > B) = 1 \end{aligned}$$

For Denotation:

$$\begin{aligned} \nu_w(A_x(a) > B_x(a)) = 1 & \quad \text{iff} \quad \text{for all } w' \text{ such that } wR_{A_x(a)}w', \nu_{w'}(B_x(a)) = 1 \\ & \quad \text{iff} \quad \text{for all } w' \text{ such that } wR_{A_x(b)}w', \nu_{w'}(B_x(b)) = 1 \\ & \quad \text{iff} \quad \nu_w(A_x(b) > B_x(b)) = 1 \end{aligned}$$

The second line, in each case, is by IH, and, for Denotation, the ADC of 19.2.4. ■

19.6.3 SOUNDNESS THEOREM FOR C : The tableaux for CC and VC are sound with respect to the relevant semantics.

Proof:

The proofs modify the arguments for constant and variable domain K (14.7.5, 14.7.6, 15.9.5) in the same way that the argument for propositional C modifies the argument for propositional K (5.9.1). ■

19.6.4 COMPLETENESS THEOREM FOR C : The tableaux for CC and VC are complete with respect to the relevant semantics.

Proof:

The proofs modify the arguments for constant and variable domain K (14.7.7, 14.7.8, 15.9.6) in the same way that the argument for propositional C modifies the argument for propositional K (5.9.1). There is only one special point to note: checking that the induced interpretation satisfies the ADC. Suppose that in the induced interpretation $v(a) = v(b)$. Then a and b are the same constants. (Unless identity is involved, all constants have distinct denotations.) Hence, for any A , $A_x(a)$ and $A_x(b)$ are identical, as then are $R_{A_x(a)}$ and $R_{A_x(b)}$. ■

19.6.5 SOUNDNESS AND COMPLETENESS THEOREM FOR C^+ : The tableaux for CC^+ and VC^+ are sound and complete with respect to the relevant semantics.

Proof:

The proofs extend the arguments for C in the same way that the argument for propositional C^+ extends that for propositional C (5.9.2). ■

19.6.6 Turning to identity, suppose that we add this to constant or variable domain C or C^+ . Consider, first, the necessary identity case. The proofs of the Locality and Denotation Lemmas of 19.6.2 are unaffected. These Lemmas therefore continue to hold.

19.6.7 SOUNDNESS THEOREM FOR NECESSARY IDENTITY: The tableau systems for all the logics in question are sound.

Proof:

The Soundness Theorem for each logic follows from the Soundness Lemma in the usual way. To extend the proof of the Lemma without identity to include it, we have only to consider the cases for the identity rules. Except

for the ADR, these are as in 16.6.3. For the ADR, suppose that we apply the rule:

$$\begin{array}{c} a = b, 0 \\ ir_{A_x(a)}j \\ \downarrow \\ ir_{A_x(b)}j \end{array}$$

and that f shows \exists to be faithful to the branch. Then $a = b$ is true at $f(0)$, so $v(a) = v(b)$, and $f(i)R_{A_x(a)}f(j)$. By the ADC, $R_{A_x(a)} = R_{A_x(b)}$. Hence, $f(i)R_{A_x(b)}f(j)$, and we may take \exists' to be \exists . ■

19.6.8 COMPLETENESS THEOREM FOR NECESSARY IDENTITY: The tableau systems for all the logics in question are complete.

Proof:

For every logic in question, given an open branch, \mathcal{B} , of a tableau, the induced interpretation is defined as for normal modal logics (16.6.4), except that R_A is defined as follows. Say that A and A' are *coidenticals* if for some a and b such that $a \sim b$, A is of the form $B_x(a)$ and A' is of the form $B_x(b)$. It is not difficult to check that being coidenticals is an equivalence relation. Say that A is *engaged* if something coidentical to A is the antecedent of a conditional or negated conditional on \mathcal{B} . Note that if A and A' are coidenticals, the one is engaged iff the other is. Now the definition of R_A :

if A is engaged, $w_i R_A w_j$ iff $ir_{A'}j$ is on \mathcal{B} for some coidentical, A' , of A ;
otherwise, $w_i R_A w_j$ iff A is true at w_j .

We need to check that the interpretation, thus defined, satisfies the ADC. So suppose that $v(a) = v(b)$. Then $a = b, 0$ is on \mathcal{B} . Case (i): $A_x(a)$ is engaged. Then $w_i R_{A_x(a)} w_j$ iff $ir_{A_x(c)}j$ is on \mathcal{B} , where $A_x(c)$ is some coidentical of $A_x(a)$. $w_i R_{A_x(b)} w_j$ iff $ir_{A_x(d)}j$ is on \mathcal{B} , where $A_x(d)$ is some coidentical of $A_x(b)$. Since $a = c, 0$ and $b = d, 0$ are on \mathcal{B} , so is $c = d, 0$. The result follows by the ADR. Case (ii): $A_x(a)$ is not engaged. Then $w_i R_{A_x(a)} w_j$ iff $w_j \in [A_x(a)]$ iff $w_j \in [A_x(b)]$ (by the Denotation Lemma) iff $w_i R_{A_x(b)} w_j$.

The Completeness Theorem for each logic follows from the appropriate version of the Completeness Lemma. This is proved as for normal modal logics (16.6.4), except where $>$ is concerned. The cases for this go as follows. Suppose that $A > B, i$ is on \mathcal{B} , and $w_i R_A w_j$. A is engaged. So for some coidentical, A' , of A , $ir_{A'}j$ is on \mathcal{B} . By the ADR, $ir_{A'}j$ is on \mathcal{B} . So B, j is on \mathcal{B} ,

and B is true at w_j by IH, as required. Suppose that $\neg(A > B)$, i is on \mathcal{B} . Then for some j , $ir_A j$ and B, j are on \mathcal{B} . Since A is engaged, $w_i R_A w_j$, and the result follows by IH.

It remains to check the constraints (1) and (2) of 5.5.1 when the corresponding rules are present. If A is not engaged, the result holds by the definition of R_A . So suppose that A is engaged. For (1): suppose that $w_i R_A w_j$. Then for some coincidental of A , A' , $ir_{A'} j$ occurs on \mathcal{B} . The only way for this to happen is for $ir_{A'} j$ to have been introduced by the rules corresponding to (1) and (2), where A'' is some coincidental of A' (and so of A). But in each case, when we introduce this node, we introduce one of the form A'', j . By the Completeness Lemma, $w_j \in [A'']$, and so $w_j \in [A]$, by the Denotation Lemma. For (2), suppose that $\nu_{w_i}(A) = 1$. Then since the rule for (2) has been applied, either $\neg A, i$ or $ir_A i$ is on \mathcal{B} . By the Completeness Lemma, it cannot be the first; and so $w_i R_A w_i$. ■

19.6.9 Now suppose, instead, that we are dealing with contingent identity. The appropriate Locality and Denotation Lemmas are stated as for the necessary identity case. The proofs are as for normal modal logics with contingent identity (17.4.3), with one new case for $>$, which is as in 19.6.2.

19.6.10 SOUNDNESS THEOREM FOR CONTINGENT IDENTITY: The tableaux for all systems considered are sound.

Proof:

The Soundness Theorem for each logic follows from the Soundness Lemma in the usual way. The Soundness Lemma is proved as in the case for normal modal logics with contingent identity (17.4.4), except that there are extra cases for $>$. These are as in 19.6.3. ■

19.6.11 COMPLETENESS THEOREM FOR CONTINGENT IDENTITY: The tableaux for all systems considered are complete.

Proof:

For every logic in question, given an open branch, \mathcal{B} , of a tableau, the induced interpretation is defined as in the case of normal modal logic (17.4.5), except that the information concerning the various R_A s is read off from the information on the branch as in the propositional case (5.9.1). To ensure that the ADC is satisfied, ensure that each constant has] a different

denotation by taking functions to be ordered triples, as explained in 19.4.9. The ADC then follows as in the case without identity, 19.6.4.

The Completeness Theorem for each logic follows from the appropriate version of the Completeness Lemma. This is proved as for normal modal logics (17.4.5), with the addition of the case for $>$, which is the same as in the propositional case (5.9.1). ■

19.7 History

Given quantified modal logic, how to extend propositional conditional logics to include quantifiers and identity is pretty obvious – at least in principle. Perhaps for this reason, no one seems to have bothered to do it before.

19.8 Further Reading

There is a very brief discussion of quantified conditional logics, involving descriptors and counterpart theory, in Lewis (1973b), 1.9.

19.9 Problems

1. Fill in the details omitted in 19.3.1, 19.3.3, 19.3.6, 19.3.8, 19.4.11 and 19.4.12.
2. Determine the truth of the following in CC . Where the inference is invalid, read off a counter-model from an open branch and check that it works.
 - (a) $\forall x(Px > Qx) \vdash \forall xPx \supset \forall xQx$
 - (b) $\vdash Pa > \exists xPx$
 - (c) $Pa, \forall x(Px > Qx) \vdash \exists xQx$
 - (d) $\neg\exists x(Px \wedge Qx) \vdash \forall x(Px > \neg Qx)$
3. Repeat question 2 for CC^+ , VC , and VC^+ .
4. Determine whether each inference of question 2 holds in CC_2 . If it does, give a direct argument for its validity. (A tableau system is not available.) If it does not, find a counter-model by intelligent trial and error, and show that it works.
5. Find two examples of inferences involving quantification that are valid in CC_1 or CC_2 that are not valid in CC^+ .
6. Check the validity of the inferences in 12.4.14, question 5, for CC , when ' \supset ' is replaced by ' $>$ '. Are things different in CC^+ ?

7. Determine the truth of the following in $CC^+(NI)$. Where the inference is invalid, read off a counter-model from an open branch and check that it works.
- (a) $\vdash \forall x(Px \supset x = x)$
 - (b) $\vdash \forall x\forall y(x = y \supset y = x)$
 - (c) $\vdash \forall x\forall y\forall z((x = y \wedge y = z) \supset x = z)$
 - (d) $\vdash \forall x(x = a \supset ((Pa \supset Qa) \supset (Px \supset Qx)))$
 - (e) $\vdash \forall x(x = a \supset ((Pa \supset Qa) \supset (Px \supset Qx)))$
 - (f) $\vdash a = b \supset (Pa \supset Pb)$
8. Repeat question 7 for $VC^+(NI)$, $CC^+(CI)$ and $VC^+(CI)$.
9. Determine whether each inference of question 7 holds in (i) $CC_2(NI)$, (ii) $CC_2(CI)$. If the inference is valid, give a direct argument for its truth. (A tableau system is not available.) If it does not, find a counter-model by intelligent trial and error, and show that it works.
10. Object to some of the arguments of 19.5.
11. *Write out one (or more!) of the soundness and completeness proofs of 19.6 in full detail.
12. *Add the Negativity Constraint to $VC(NI)$; specify the appropriate tableau rules, and prove them to be sound and complete.
13. *Add descriptors to $CC(NI)$; specify the appropriate tableau rules, and prove them to be sound and complete. Do the same for $VC(NI)$.
14. *For the various systems of logic in this chapter, formulate tableaux for inferences with arbitrary sets of premises. Prove the Soundness and Completeness Theorems. Infer the Compactness and Löwenheim-Skolem Theorems.

20 Intuitionist Logic

20.1 Introduction

20.1.1 In this chapter we will look at one more logic with possible-world semantics: intuitionist logic.

20.1.2 After a brief prolegomenon, we will look at the semantics for this. We will then look at two tableau systems. The first is close to the tableau system for variable domain modal logic of chapter 15. The second is slightly more complicated to formulate, but produces simpler tableaux.

20.1.3 All this without identity, which is thrown into play in the second half of the chapter.

20.1.4 *En route*, we will also look at some philosophical issues concerning existence, construction and identity.

20.2 Existence and Construction

20.2.1 Mathematical Platonists think of mathematical objects as existing in some objective realm, just like (we normally think that) stones and stars do; it is just a realm that is out of causal contact with us – or anything else. As we observed (6.2.5) mathematical intuitionists reject this view.

20.2.2 So what, according to them, does it mean to say that a mathematical object exists? It means that we are able to *construct* it; that is, that there is some recipe we can follow to produce it. Obviously, the entity constructed is not a physical entity; we may call it a mental (or maybe social) entity. Thus, mathematical objects have no cognition-independent existence.

20.2.3 As we also observed (6.2.6), an intuitionist needs to give the proof conditions for sentences (where a proof is something that can be recognised as such). So, assuming that we think of \exists as meaning ‘there exists’, what proof conditions are to be given for sentences of the form $\exists xA$? Bearing in mind what I have just said, the natural ones are:

$\exists xA$ is proved if there is a construction which gives an object, a , plus a proof that $A_x(a)$

A construction here is something like an algorithm, or procedure that can be effectively followed, to give the required result.

20.2.4 What of the proof conditions for sentences of the form $\forall xA$? The natural thought is that this is proved if, for any object we can construct, call it a , we can prove $A_x(a)$. But this is not quite good enough. As knowledge develops, we not only prove new things to be true, we construct new objects as well. We don’t want to count $\forall xA$ as proved unless we are sure that any object that we have *or that we may come up with* will satisfy A . Thus, the proof conditions need to be given as follows:

$\forall xA$ is proved if there is a construction that can be applied to any object we may come up with, a , to give us a proof that $A_x(a)$

20.2.5 Bearing these things in mind, we can now specify the semantics of quantified intuitionist logic.

20.3 Quantified Intuitionist Logic

20.3.1 The language of quantified intuitionist logic has the same connectives as propositional intuitionist logic (6.3.2); it also has the quantifiers, \forall and \exists (thought of as existentially loaded). Until 20.5, we will also take the language to contain an existence predicate, \mathfrak{E} .

20.3.2 Interpretations for the language are a species of variable domain modal logic interpretation. Specifically, they are of the form $\langle D, W, R, \nu \rangle$, as in 15.3.1. R is reflexive and transitive, as in the propositional case.

20.3.3 We require two further constraints. For all $w \in W$, if wRw' then:

1. $\nu_w(P) \subseteq \nu_{w'}(P)$
2. $D_w \subseteq D_{w'}$

The first of these is essentially the heredity constraint of 6.3.3. The second is the domain-increasing constraint of 15.6.2. In the present context, it may be seen as expressing the thought that whatever gets discovered/invented remains discovered/invented. In fact, given that we have an existence predicate, and that for every $w \in W$, $D_w = \nu_w(\mathcal{E})$, 2 is just a special case of 1.

20.3.4 The truth conditions for atomic sentences are what one would expect. If w is a world, and P is an n -place predicate:

$$\nu_w(Pa_1 \dots a_n) = 1 \text{ if } \langle \nu(a_1), \dots, \nu(a_n) \rangle \in \nu_w(P); \text{ otherwise, it is } 0.$$

The truth conditions for the connectives at a world are as in 6.3.4, and the truth conditions for the quantifiers are:

$$\begin{aligned} \nu_w(\exists xA) &= 1 \text{ if for some } d \in D_w, \nu_w(A_x(k_d)) = 1; \text{ otherwise it is } 0 \\ \nu_w(\forall xA) &= 1 \text{ if for all } w' \text{ such that } wRw', \text{ and all } d \in D_{w'}, \nu_{w'}(A_x(k_d)) = 1; \\ &\text{ otherwise it is } 0 \end{aligned}$$

(So one can think of the intuitionist $\forall xA$ essentially as the variable-domain modal $\Box\forall xA$.) As in the propositional case, truth conditions ensure that whenever w_1Rw_2 and $\nu_{w_1}(A) = 1$, $\nu_{w_2}(A) = 1$. The proof is relegated to a footnote, and can be skipped if desired.¹

20.3.5 Note that the truth-at-a-world conditions plausibly capture the intuitive proof conditions for quantifiers. Given that D_w contains the things that can be constructed at stage w , this is pretty obvious for \exists . For \forall : if there is a construction that can be applied to any object that we come up with, then whatever object we construct at a later time, there will be a proof that it satisfies A . Conversely, if there is no such construction, then there is a possible development in which we find an object for which there is no such proof.

20.3.6 Validity is defined in the usual way: $\Sigma \models A$ iff for every world, w , of every interpretation, if every member of Σ is true at w , so is A .

¹ The proof is by induction on A . The basis case is given by 20.3.3. The cases for the connectives are as in 6.3.5. For the quantifiers: suppose that $\exists xA$ is true at w_1 . Then for some $d \in D_{w_1}$, $A_x(k_d)$ is true at w_1 . By IH, this is true at w_2 . By 20.3.4, $\exists xA$ is true at w_2 . For $\forall xA$, we prove the contrapositive. Suppose that $\forall xA$ is not true at w_2 . Then for some w such that w_2Rw , and some $d \in D_w$, $A_x(k_d)$ is not true at w . By transitivity w_1Rw , and $\forall xA$ is not true at w_1 .

20.3.7 There is one further wrinkle. Let us call interpretations, as I have just specified them, *free intuitionist interpretations* (or just *free interpretations*), and the logic they determine *free intuitionist logic*. Standard intuitionist logic is not a free logic. To obtain intuitionist interpretations, properly speaking, we have to add the further constraint that:

for every constant, a (in our original language), and every $w \in W$, $v(a) \in D_w$

Note that this entails that for every $w \in W$, $D_w \neq \emptyset$, since the (original) language contains some constants. Note also that the constraint does not apply to all the constants in the language of the interpretation. In this language, each object, d , in D has a name, k_d , and clearly some of these names will denote objects that may not exist at every world.

20.3.8 Sometimes, a further constraint is placed on intuitionist interpretations, namely, that predicates can be true at a world only of things that exist there: for all w and n -place P , $v_w(P) \subseteq D_w^n$ (not D^n). (This is the Negativity Constraint of 13.4.2.) Because of the domain-increasing constraint, however, this extra condition makes no difference to which inferences are valid. (See 20.13, question 12.)

20.3.9 Finally, as in the propositional case (6.3.9), note that a one-world intuitionist interpretation is, in effect, an interpretation for classical first-order logic. Hence, anything valid in intuitionistic first-order logic is valid in classical first-order logic. The converse is not true, as we shall see.²

20.4 Tableaux for Intuitionist Logic 1

20.4.1 To obtain tableaux for quantified intuitionist logic, start with the rules for propositional intuitionist logic (including the rules ρ and τ) (6.4).

² It is also worth noting that the Glivenko ‘double negation’ translation of classical propositional logic (6.3.9, fn. 3) fails in the case of quantified intuitionistic logic. $\forall x(Px \vee \neg Px)$ is valid in classical logic, but $\neg\neg \forall x(Px \vee \neg Px)$ is not valid in intuitionistic logic. See 20.13, question 4(e). The same example shows that something can be consistent in first-order intuitionist logic, but not in first-order classical logic. This cannot happen in the propositional case.

The Heredity Rule now has to be formulated for atomic sentences, thus:

$$\begin{array}{c}
 Pa_1 \dots a_n, +i \\
 \text{irj} \\
 \downarrow \\
 Pa_1 \dots a_n, +j
 \end{array}$$

Note that a special case of this is when P is the existence predicate, \exists . We then add the appropriate versions of the quantifier rules for variable domain modal logic (15.4.1). These are as follows. (Note that there are no rules for negated quantifiers, since there is a separate rule for negation.)

$$\begin{array}{cc}
 \exists xA, +i & \forall xA, -i \\
 \downarrow & \downarrow \\
 \exists c, +i & \text{irj} \\
 A_x(c), +i & \exists c, +j \\
 & A_x(c), -j
 \end{array}$$

$$\begin{array}{cc}
 \exists xA, -i & \forall xA, +i \\
 \swarrow \quad \searrow & \text{irj} \\
 \exists a, -i \quad A_x(a), -i & \swarrow \quad \searrow \\
 & \exists a, -j \quad A_x(a), +j
 \end{array}$$

c is a constant new to the branch. a is any constant on the branch. In the top right rule, j is a world-number new to the branch; in the bottom right, the rule applies whenever something of the form irj is on the branch. If one is ticking off lines to show that one is finished with them, then, when applying the bottom two rules, we cannot tick off the formulas involved since we may later introduce a new constant to which the rules must be applied.

Because of the considerations explained in 20.3.7, we also have to include in the initial list a line of the form $\exists a, +0$, for every constant, a , in a premise or conclusion, or one of the form $\exists c, +0$ if there are none.

20.4.2 Here are tableaux to show that $\vdash \forall xPx \sqsupset Pa$ and $\not\vdash \exists x(Px \vee \rightarrow Px)$:

$$\begin{array}{c}
 \mathfrak{E}a, +0 \\
 \forall xPx \sqsupset Pa, -0 \\
 \text{Or}0 \\
 \text{Or}1, 1r1 \\
 \forall xPx, +1 \\
 Pa, -1 \\
 \swarrow \quad \searrow \\
 \mathfrak{E}a, -1 \quad Pa, +1 \\
 \mathfrak{E}a, +1 \quad \times \\
 \times
 \end{array}$$

On the left branch, the last line is obtained by the Heredity Rule applied to line 1.

$$\begin{array}{c}
 \mathfrak{E}c, +0 \\
 \exists x(Px \vee \rightarrow Px), -0 \\
 \text{Or}0 \\
 \swarrow \quad \searrow \\
 \mathfrak{E}c, -0 \quad Pc \vee \rightarrow Pc, -0 \\
 \times \quad Pc, -0 \\
 \rightarrow Pc, -0 \\
 \text{Or}1, 1r1 \\
 Pc, +1 \\
 \mathfrak{E}c, +1
 \end{array}$$

20.4.3 Given an open branch of a tableau, we read off a counter-model as in the propositional case (6.4.8), the quantificational structure being handled as in variable domain modal logic (15.4.4). For any predicate, P (including existence), $\langle \partial_{a_1}, \dots, \partial_{a_n} \rangle \in v_{w_i}(P)$ iff $Pa_1 \dots a_n, +i$ is on the branch. The interpretation defined in this way is, strictly speaking, a free interpretation, since some of the constants may denote things that do not exist at all worlds. But all the objects denoted by constants in the premises and conclusion do exist at all worlds (because of the initial list and applications of the Heredity Rule). The other constants can simply be thought of as the appropriate k_d s. This makes it an intuitionist interpretation proper.

20.4.4 The counter-model determined by the open branch of the second tableau of 20.4.2 may be depicted as follows.

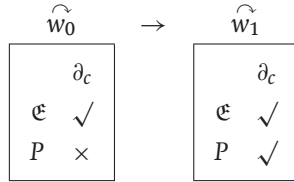

Clearly, Pc fails at w_0 ; but since Pc holds at w_1 , $\neg Pc$ fails at w_0 . Hence, $Pc \vee \neg Pc$ fails at w_0 . Since c is the only thing that exists there, $\exists x(Px \vee \neg Px)$ fails at w_0 .

20.5 Tableaux for Intuitionist Logic 2

20.5.1 We will call tableaux of the kind described in the last section *tableaux of kind 1*. Tableaux of kind 1 are perspicuous, but can be rather unwieldy, due to the branching delivered by the second pair of quantifier rules. Moreover, intuitionist logic is not normally formulated with an existence predicate in the language. It is worth noting, then, that with a bit of extra book-keeping, we can both simplify the tableaux, and eliminate the use of the existence predicate. The main function of the existence predicate in tableaux of kind 1 is to keep track of the domains. We can do this directly. Any constant either occurs in a premise or the conclusion, or else it is introduced by a quantifier rule. We can use this information (plus information about the accessibility relation) to determine the domains of the various worlds directly. I will call tableaux of the following kind *tableaux of kind 2*.

20.5.2 In tableaux of kind 2, the propositional rules (including heredity, as formulated in tableaux of kind 1) are augmented by the following quantifier rules. The first two are easy.

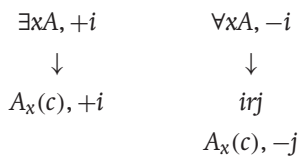

c and (in the second rule) j are new to the branch.

20.5.3 To state the other two quantifier rules, we need a little new jargon. If a constant, a , occurs on a branch, then, running down from the top, there will be a first line in which the constant occurs. If this is of the form $A, +i$ or $A, -i$ we will call i the *entry number* of a . Intuitively, if the entry line of a is i , then a denotes something in w_i , and so in every w_j such that $w_i R w_j$, because of the domain-increasing condition. Let us say that a *belongs to* i , if kri is on the branch, where k is the entry number of a . Note that if the entry number of a is i then, since iri will be on the branch (unless it closes beforehand), a will belong to i .

20.5.4 The other two rules may now be stated as follows:

$$\begin{array}{ccc} \exists xA, -i & & \forall xA, +i \\ \downarrow & & \downarrow \\ A_x(a), -i & & A_x(a), +j \end{array}$$

In the first of these, a is any constant belonging to i ; in the second, a is any constant belonging to j .

20.5.5 One further wrinkle. If there are any constants in the premises or conclusion, then we are guaranteed a constant with entry number 0. If not, we need to ensure this. (Note that deploying the rule for $\forall xA, -0$ does not give us a constant with entry number 0.) We could just remember that in such cases there is a constant which has, by fiat, entry number zero, and which must be employed in the appropriate instantiations. But it's easy to forget this. So what we will do in these circumstances is add a dummy line of the form $c = c, +0$ at the start of the initial list. (Though identity is not in the language at this point, we may count $c = c$ as true at every world of every interpretation simply by convention.)

20.5.6 Here is a tableau demonstrating that $\forall x \rightarrow A \vdash \exists xA$. a is a constant that does not occur in A . If there are no constants in A , then there should also be a line of the form $c = c, +0$ at the start. But I shall omit mention of such a line here and in what follows if it plays no role in the closure of a tableau.

$$\begin{array}{c} \forall x \rightarrow A, +0 \\ \rightarrow \exists xA, -0 \\ \downarrow \end{array}$$

belong to 0 since $1r0$ is not on the branch.³) The last line on the lefthand open branch is obtained from the Heredity Rule (which produces nothing new on the righthand open branch).

20.5.8 We read off a counter-model from an open branch as for tableaux of kind 1 (20.4.3), except that D_{w_i} is the set of things, ∂_a , such that a belongs to i . Thus, the counter-model given by the leftmost open branch of the tableau of 20.5.7 is as follows. $W = \{w_0, w_1\}$; $w_0Rw_0, w_0Rw_1, w_1Rw_1$; $D_{w_0} = \{\partial_a\}$, $D_{w_1} = \{\partial_a, \partial_b\}$; $v(a) = \partial_a, v(b) = \partial_b$; $v_{w_0}(P) = \phi, v_{w_0}(Q) = \{\partial_a\}, v_{w_1}(P) = \{\partial_a\}, v_{w_1}(Q) = \{\partial_a\}$. The † next to an object indicates that it does not exist at the world in question.

\curvearrowright	\rightarrow	\curvearrowright												
w_0		w_1												
<table style="width: 100%; border-collapse: collapse;"> <tr> <td style="padding: 5px;">∂_a</td> <td style="padding: 5px;">$\dagger \partial_b$</td> </tr> <tr> <td style="padding: 5px;">P</td> <td style="padding: 5px;">$\times \quad \times$</td> </tr> <tr> <td style="padding: 5px;">Q</td> <td style="padding: 5px;">$\checkmark \quad \times$</td> </tr> </table>	∂_a	$\dagger \partial_b$	P	$\times \quad \times$	Q	$\checkmark \quad \times$		<table style="width: 100%; border-collapse: collapse;"> <tr> <td style="padding: 5px;">∂_a</td> <td style="padding: 5px;">∂_b</td> </tr> <tr> <td style="padding: 5px;">P</td> <td style="padding: 5px;">$\checkmark \quad \times$</td> </tr> <tr> <td style="padding: 5px;">Q</td> <td style="padding: 5px;">$\checkmark \quad \times$</td> </tr> </table>	∂_a	∂_b	P	$\checkmark \quad \times$	Q	$\checkmark \quad \times$
∂_a	$\dagger \partial_b$													
P	$\times \quad \times$													
Q	$\checkmark \quad \times$													
∂_a	∂_b													
P	$\checkmark \quad \times$													
Q	$\checkmark \quad \times$													

$Pa \vee Qa$ hold at w_0 ; $Pa \vee Qa$ and $Pa \vee Qb$ hold at w_1 . Hence $\forall x(Pa \vee Qx)$ holds at w_0 . But Pa fails at w_0 , and $\forall xQx$ fails at w_0 (since Qb fails at w_1). Hence, $Pa \vee \forall xQx$ fails at w_0 .

20.5.9 Here are a couple of final examples to illustrate the use of the dummy line $c = c, +0$. We show that $\vdash \forall xPx \sqcap \exists xPx$ and $\not\vdash \forall xPx$:

$c = c, +0$	
$\forall xPx \sqcap \exists xPx, -0$	
$0r0$	
$0r1, 1r1$	
$\forall xPx, +1$	$c \quad 0$
$\exists xPx, -1$	
$Pc, -1$	
$Pc, +1$	
\times	

³ Note that if we applied Universal Instantiation to $(b, 0)$ the tableau would close. (We would have a line of the form $Pa \vee Qb, +0$. When the rule for \vee is applied to this, the lefthand branch closes immediately, and an application of the Heredity Rule closes the righthand branch.) This shows that if were we to insist that all domains be the same, this inference would be valid.

Since c belongs to 1, the quantifiers at lines 5 and 6 can be instantiated with it.

$$\begin{array}{l}
 c = c, +0 \\
 \forall xPx, -0 \\
 0r0 \\
 0r1, 1r1 \\
 Pa, -1
 \end{array}
 \quad
 \begin{array}{|c|c|}
 \hline
 c & 0 \\
 \hline
 a & 1 \\
 \hline
 \end{array}$$

The counter-model given by the tableau can be depicted as follows.

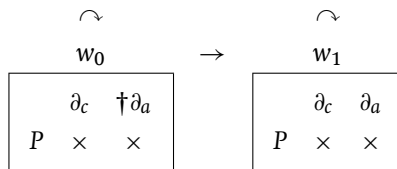

20.5.10 Note, finally, that it is quite possible for an open tableau for quantified intuitionist logic (of kind 1 or kind 2) to be infinite. When it is, a finite counter-model can often (though not always) be found by intelligent trial and error.

20.6 Mental Constructions

20.6.1 Before we pass on to identity, let us note one of the problems with the intuitionist claim that mathematical objects are mental constructions.

20.6.2 There are some things that do not exist in concrete reality, and which obviously are mental constructions in some sense. These are fictional objects, such as Sherlock Holmes and Bilbo Baggins.

20.6.3 Mathematical objects appear to behave nothing like these. I would seem to be able to make up facts about a fictional object at will. I cannot make up the facts about the number 3 at will. And if Tolkien says that Bilbo did this or that, there is no sense in which he could get it wrong. Whereas if I say that $3 + 3 = 7$, I clearly have got it wrong.

20.6.4 Moreover, different people can make up different stories about Bilbo, and both stories are equally good, in the sense that it would be silly to say

that one got it right and one got it wrong, even if the stories contradict one another. But people can't go around saying different things about the number 3. If one person says one thing, and someone else contradicts them, then they can't both be equally right.

20.6.5 The trouble, then, is that even if mathematical objects are not denizens of some abstract realm, they seem to have an objectivity that genuine mental constructions lack. Whence?

20.7 Necessary Identity

20.7.1 The simplest way of adding identity to intuitionist logics is as necessary identity. So, in an interpretation, the extension of the identity predicate at any world is the set $\{\langle x, x \rangle : x \in D\}$.

20.7.2 To obtain tableaux of kind 2 for necessary identity, we simply add the appropriate rules:

$$\begin{array}{ccc}
 . & a = b, +i & a = b, +i \\
 \downarrow & A_x(a), +i & \downarrow \\
 a = a, +i & \downarrow & a = b, +j \\
 & A_x(b), +i &
 \end{array}$$

where A is any atomic sentence other than $a = b$, and i and j are any natural numbers. The last rule is the intuitionist version of the Identity Invariance Rule. (As usual, we omit lines of the form $a = a, +i$, and close tableaux with lines of the form $a = a, -i$.)⁴ Tableaux of kind 1 for necessary identity are obtained in the same way, but in what follows we will consider only tableaux of kind 2.

20.7.3 Here is an example showing that $\vdash a = b \sqsupset (b = c \sqsupset a = c)$:

$$\begin{array}{c}
 a = b \sqsupset (b = c \sqsupset a = c), -0 \\
 0r0 \\
 0r1, 1r1 \\
 \downarrow
 \end{array}$$

⁴ In SI, we could equally have $A_x(a), -i$ and $A_x(b), -i$, but this would be redundant. The same, for that matter, is true of the formulation of the IIR with $-$ instead of $+$.

$$\begin{array}{c}
 a = b, +1 \\
 b = c \sqsupset a = c, -1 \\
 1r2, 2r2, 0r2 \\
 b = c, +2 \\
 a = c, -2 \\
 a = b, +2 \\
 a = c, +2 \\
 \times
 \end{array}$$

The penultimate line is obtained from line 4 by either the Identity Invariance Rule or the Heredity Rule applied to identity. (There is overkill here.) The last line is then SI.

20.7.4 To read off a counter-model from an open branch of a tableau, we proceed as in the case without identity, but for every bunch of lines of the form $a = b, +0, b = c, +0 \dots$ on the branch, we choose one object for the constants all to denote (as in 16.2.6). The object is in D_{w_i} iff any of the constants in the bunch belongs to i .⁵ Thus, consider the following tableau, which shows that $\not\vdash (a = b \vee b = c) \sqsupset a = c$:

$$\begin{array}{c}
 (a = b \vee b = c) \sqsupset a = c, -0 \\
 0r0 \\
 0r1, 1r1 \\
 a = b \vee b = c, +1 \\
 a = c, -1 \\
 \swarrow \quad \searrow \\
 a = b, +1 \quad b = c + 1 \\
 a = b, +0 \quad b = c + 0
 \end{array}$$

There being no other rules applicable, the tableau is finished. The counter-model determined by the left branch is as follows. $W = \{w_0, w_1\}$, w_0Rw_0 , w_0Rw_1 , w_1Rw_1 , $D_{w_0} = D_{w_1} = \{\partial_a, \partial_c\}$, $v(a) = v(b) = \partial_a$ and $v(c) = \partial_c$. I leave it as an exercise to check that this works.

⁵ For tableaux of kind 1, the object is in D_{w_i} iff $\mathcal{E}a, +i$ is on the branch.

20.8 Intuitionist Identity

20.8.1 Intuitionist identity is not necessary identity, however. Consider the following tableau:

$$\begin{array}{c}
 a = b \vee \neg a = b, -0 \\
 0r0 \\
 a = b, -0 \\
 \neg a = b, -0 \\
 0r1, 1r1 \\
 a = b, +1 \\
 a = b, +0 \\
 \times
 \end{array}$$

The last line is an application of the Identity Invariance Rule. This shows that the Law of Excluded Middle holds for identity statements if identity is necessary identity. The Law of Excluded Middle is not valid in intuitionist logic. It could of course be that identity is a special case, and that the Law should be valid for it. But it is not.

20.8.2 To see this, suppose that I have two real numbers in the closed interval $[0,1]$. One is 1 itself; the other is a number, n , given to me by an algorithm that generates its decimal expansion. Using this, I can calculate the first decimal place, the second, the third, and so on. Now suppose that I start to compute, and I find that I keep getting 9s. So the initial sequence of n is 0.99999. Is n equal to 1 or is it not? If it happened to have a 9 in every decimal place, then it would be equal to 1, but I have no way of proving that this is the case. If it had some other number in a decimal place, then it would not be 1, but however far along the expansion I go, if such a number has not turned up, I have no way of knowing whether or not it will. In short, I can prove neither that $n = 1$ nor that it is not. Hence, $n = 1 \vee \neg n = 1$ fails.

20.8.3 The appropriate identity for intuitionist logic is, in fact, contingent identity. At a certain world (state of information) I may not be able to prove that $a = b$. So this is not true. But at a later time I may come up with a proof of this statement, so at that world (state of information) it is true.

20.8.4 Thus, a free interpretation for quantified intuitionist logic with identity is a structure $\langle D, H, W, R, \nu \rangle$, as in contingent identity modal logic (17.2.2). $\langle D, W, R, \nu \rangle$ is a free interpretation for quantified intuitionist logic,

and for any $w \in W$ and $d \in D$, $|d|_w \in H$. $v_w(=) = \{\langle h, h \rangle : h \in H\}$. Note that the heredity constraint applies to identity statements. What this comes to is:

$$\text{if } wRw' \text{ and } |d|_w = |e|_w \text{ then } |d|_{w'} = |e|_{w'}$$

Once two things are established to be identical, they remain so. An interpretation proper is a free interpretation that satisfies the condition for constants in 20.3.7.

20.8.5 Tableaux for the semantics are as for necessary identity, except that the Identity Invariance Rule is dropped. Note, however, that we still have:

$$\begin{array}{c} a = b, +i \\ irj \\ \downarrow \\ a = b, +j \end{array}$$

This is an instance of the Heredity Rule.

20.8.6 Here is a tableau to show that $\vdash \forall x \forall y (x = y \supset (Px \supset Py))$:

$$\begin{array}{c} \forall x \forall y (x = y \supset (Px \supset Py)), -0 \\ Or0 \\ Or1, 1r1 \\ \forall y (a = y \supset (Pa \supset Py)), -1 \\ 1r2, 2r2, Or2 \\ a = b \supset (Pa \supset Pb), -2 \\ 2r3, 3r3, Or3, 1r3 \\ a = b, +3 \\ Pa \supset Pb, -3 \\ 3r4, 4r4, Or4, 1r4, 2r4 \\ Pa, +4 \\ Pb, -4 \\ a = b, +4 \\ Pb, +4 \\ \times \end{array}$$

The last two lines are applications of the Heredity Rule and SI, respectively.

20.8.7 We read off a counter-model from an open branch as in the case of quantified intuitionist logic, as modified, where necessary, by the techniques of contingent identity modal logic. Specifically, W and R are as in the

propositional case, $D = \{\partial_a: a \text{ occurs on the tableau}\}$. $D_{w_i} = \{\partial_a: a \text{ belongs to } i\}$.⁶ For every constant, a , $v(a) = \partial_a$. Wherever there are lines of the form $a = b, +i, b = c, +i, \dots$ we put a distinct object, \mathbf{a}_i , in H , and $\partial_a, \partial_b, \dots$ all have that avatar at world i . $\langle \{\partial_{a_1}|_{w_i}, \dots, \{\partial_{a_n}|_{w_i}\} \in v_{w_i}(P) \text{ iff } Pa_1 \dots a_n, +i \text{ is on } \mathcal{B}$.

Thus, consider the following tableau, showing that $\not\vdash \forall x \forall y (x = y \vee \rightarrow x = y)$.

$c = c, +0$							
$\forall x \forall y (x = y \vee \rightarrow x = y), -0$							
0r0							
0r1, 1r1							
$\forall y (a = y \vee \rightarrow a = y), -1$	<table style="border-collapse: collapse; width: 100%; text-align: center;"> <tr><td style="padding: 2px;">c</td><td style="padding: 2px;">0</td></tr> <tr><td style="padding: 2px;">a</td><td style="padding: 2px;">1</td></tr> <tr><td style="padding: 2px;">b</td><td style="padding: 2px;">2</td></tr> </table>	c	0	a	1	b	2
c		0					
a		1					
b		2					
1r2, 2r2, 0r2							
$a = b \vee \rightarrow a = b, -2$							
$a = b, -2$							
$\rightarrow a = b, -2$							
2r3, 3r3, 0r3, 1r3							
$a = b, +3$							

The counter-model delivered by the tableau may be depicted as follows. (I omit the arrows for reflexivity and transitivity.)

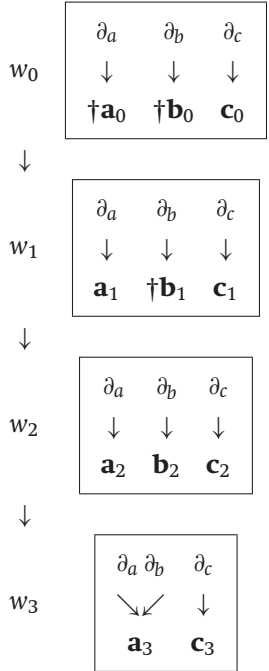

⁶ For tableaux of kind 1, $D_{w_i} = \{\partial_a: \mathfrak{C}a, +i \text{ is on the branch}\}$

$a = b$ holds at w_3 , so $\rightarrow a = b$ fails at w_2 , but $a = b$ fails at w_2 , so $a = b \vee \rightarrow a = b$ fails at w_2 , and $\forall x \forall y (x = y \vee \rightarrow x = y)$ fails at w_0 .

20.8.8 Note the following. Since intuitionist identity is a contingent identity, one might expect the full substitutivity of identicals to fail. But because of the heredity conditions involved, it does not: $a = b, A_x(a) \models A_x(b)$. This is proved in 20.10.10.

20.8.9 All the tableau systems of this chapter are sound and complete with respect to their semantics. This is proved in the following technical appendices.

20.9 *Proofs of Theorems 1

20.9.1 In this section we will prove soundness and completeness for both kinds of tableaux we have considered (without identity, which is reserved for the next section). We start, as usual, with the appropriate Locality and Denotation Lemmas. We prove soundness and completeness for tableaux of kind 1, and then for tableaux of kind 2.

20.9.2 LEMMA (LOCALITY): Let $\mathcal{J}_1 = \langle D, W, R, \nu_1 \rangle$, $\mathcal{J}_2 = \langle D, W, R, \nu_2 \rangle$ be two free interpretations. Since they have the same domain, the language of the two is the same. Call this L . If A is any closed formula of L such that ν_1 and ν_2 agree on the denotations of all the predicates and constants in it, then, for all $w \in W$:

$$\nu_{1w}(A) = \nu_{2w}(A)$$

Proof:

The result is proved by recursion on formulas. For atomic formulas:

$$\begin{aligned} \nu_{1w}(Pa_1 \dots a_n) = 1 & \text{ iff } \langle \nu_1(a_1), \dots, \nu_1(a_n) \rangle \in \nu_{1w}(P) \\ & \text{ iff } \langle \nu_2(a_1), \dots, \nu_2(a_n) \rangle \in \nu_{2w}(P) \\ & \text{ iff } \nu_{2w}(Pa_1 \dots a_n) = 1 \end{aligned}$$

The case for negation is as follows.

$$\begin{aligned} \nu_{1w}(\rightarrow B) = 1 & \text{ iff for all } w' \text{ such that } wRw', \nu_{1w'}(B) = 0 \\ & \text{ iff for all } w' \text{ such that } wRw', \nu_{2w'}(B) = 0 \quad (\text{IH}) \\ & \text{ iff } \nu_{2w}(\rightarrow B) = 1 \end{aligned}$$

The cases for the other connectives are straightforward, and are left as exercises. The cases for the quantifiers are as follows.

$$\begin{aligned} \nu_{1w}(\exists xB) = 1 & \text{ iff for some } d \in D_w, \nu_{1w}(B_x(k_d)) = 1 \\ & \text{ iff for some } d \in D_w, \nu_{2w}(B_x(k_d)) = 1 \quad (*) \\ & \text{ iff } \nu_{2w}(\exists xB) = 1 \end{aligned}$$

$$\begin{aligned} \nu_{1w}(\forall xB) = 1 & \text{ iff for all } w' \text{ such that } wRw' \text{ and all } d \in D_{w'}, \\ & \quad \nu_{1w'}(B_x(k_d)) = 1 \\ & \text{ iff for all } w' \text{ such that } wRw' \text{ and all } d \in D_{w'}, \\ & \quad \nu_{2w'}(B_x(k_d)) = 1 \quad (*) \\ & \text{ iff } \nu_{2w}(\forall xB) = 1 \end{aligned}$$

The lines marked (*) follow from the induction hypothesis (IH), and the fact that $\nu_1(k_d) = \nu_2(k_d) = d$. ■

20.9.3 LEMMA (DENOTATION): Let $\mathcal{J} = \langle D, W, R, \nu \rangle$ be any free interpretation. Let A be any formula of $L(\mathcal{J})$ with at most one free variable, x , and a and b be any two constants such that $\nu(a) = \nu(b)$. Then, for all $w \in W$:

$$\nu_w(A_x(a)) = \nu_w(A_x(b))$$

Proof:

The proof is by recursion on formulas. For atomic formulas I assume that the formula has one occurrence of 'a' for the sake of illustration:

$$\begin{aligned} \nu_w(Pa_1 \dots a \dots a_n) = 1 & \text{ iff } \langle \nu(a_1), \dots, \nu(a), \dots, \nu(a_n) \rangle \in \nu_w(P) \\ & \text{ iff } \langle \nu(a_1), \dots, \nu(b), \dots, \nu(a_n) \rangle \in \nu_w(P) \\ & \text{ iff } \nu_w(Pa_1 \dots b \dots a_n) = 1 \end{aligned}$$

The case for negation is as follows:

$$\begin{aligned} \nu_w(\neg B_x(a)) = 1 & \text{ iff for all } w' \text{ such that } wRw', \nu_{w'}(B_x(a)) = 0 \\ & \text{ iff for all } w' \text{ such that } wRw', \nu_{w'}(B_x(b)) = 0 \quad (\text{IH}) \\ & \text{ iff } \nu_w(\neg B_x(b)) = 1 \end{aligned}$$

The cases for the other connectives are straightforward, and are left as exercises. The cases for the quantifiers are as follows. Let A be of the form $\forall yB$ or $\exists yB$. If x is the same variable as y then $A_x(a)$ and $A_x(b)$ are just A , so

the result is trivial. So suppose that x and y are distinct variables.

$$\begin{aligned}
 \nu_w((\exists yB)_x(a)) = 1 & \text{ iff } \nu_w(\exists y(B_x(a))) = 1 \\
 & \text{ iff for some } d \in D_w, \nu_w((B_x(a))_y(k_d)) = 1 \\
 & \text{ iff for some } d \in D_w, \nu_w((B_y(k_d))_x(a)) = 1 \\
 & \text{ iff for some } d \in D_w, \nu_w((B_y(k_d))_x(b)) = 1 \quad (\text{IH}) \\
 & \text{ iff for some } d \in D_w, \nu_w((B_x(b))_y(k_d)) = 1 \\
 & \text{ iff } \nu_w(\exists y(B_x(b))) = 1 \\
 & \text{ iff } \nu_w((\exists yB)_x(b)) = 1
 \end{aligned}$$

$$\begin{aligned}
 \nu_w((\forall yB)_x(a)) = 1 & \text{ iff } \nu_w(\forall y(B_x(a))) = 1 \\
 & \text{ iff for all } w' \text{ such that } wRw', \text{ and all } d \in D_{w'}, \\
 & \quad \nu_{w'}((B_x(a))_y(k_d)) = 1 \\
 & \text{ iff for all } w' \text{ such that } wRw', \text{ and all } d \in D_{w'}, \\
 & \quad \nu_{w'}((B_y(k_d))_x(a)) = 1 \\
 & \text{ iff for all } w' \text{ such that } wRw', \text{ and all } d \in D_{w'}, \\
 & \quad \nu_{w'}((B_y(k_d))_x(b)) = 1 \quad (\text{IH}) \\
 & \text{ iff for all } w' \text{ such that } wRw', \text{ and all } d \in D_{w'}, \\
 & \quad \nu_{w'}((B_x(b))_y(k_d)) = 1 \\
 & \text{ iff } \nu_w(\forall y(B_x(b))) = 1 \\
 & \text{ iff } \nu_w((\forall yB)_x(b)) = 1
 \end{aligned}$$

■

20.9.4 DEFINITION: Let $\mathcal{J} = \langle D, W, R, \nu \rangle$ be any free interpretation, and \mathcal{B} be any branch of a tableau. Then \mathcal{J} is *faithful to* \mathcal{B} iff there is a map, f , from the natural numbers to W such that:

- for every node A , $+i$ on \mathcal{B} , A is true at $f(i)$ in \mathcal{J}
- for every node A , $-i$ on \mathcal{B} , A is false at $f(i)$ in \mathcal{J}
- if irj is on \mathcal{B} then $f(i)Rf(j)$ in \mathcal{J}

20.9.5 SOUNDNESS LEMMA, TABLEAUX OF KIND 1: Let \mathcal{B} be any branch of a tableau. Let $\mathcal{J} = \langle D, W, R, \nu \rangle$ be any free interpretation. If \mathcal{J} is faithful to \mathcal{B} , and we apply a tableau rule of kind 1 to a formula on \mathcal{B} , there is an interpretation, $\mathcal{J}' = \langle D, W, R, \nu' \rangle$, and an extension of \mathcal{B} , \mathcal{B}' , such that \mathcal{J}' is faithful to \mathcal{B}' .

Proof:

The proof for the connectives is essentially as in the propositional case. The case for the Heredity Rule is the obvious modification of that for the propositional case. (See 6.7.3. In each case, we may take \mathfrak{I}' to be \mathfrak{I} .) This leaves the cases for the quantifiers. Let f be a function that shows \mathfrak{I} to be faithful to \mathcal{B} . There are four rules to consider.

$$(i) \quad \begin{array}{c} \exists xA, +i \\ \downarrow \\ \mathfrak{E}c, +i \\ A_x(c) \end{array}$$

$\exists xA$ is true at $f(i)$. So, for some $d \in D_{f(i)}$, $A_x(k_d)$ is true at $f(i)$. Also, $\mathfrak{E}k_d$ is true at $f(i)$. Let \mathfrak{I}' be the free interpretation that is the same as \mathfrak{I} , except that $v(c) = d$. Then, by the Denotation Lemma, $A_x(c)$ and $\mathfrak{E}c$ are true at $f(i)$ in \mathfrak{I}' . Since c does not occur in any other formula on the branch, \mathfrak{I}' makes all the other formulas on the branch true/false at their respective worlds too, by the Locality Lemma.

$$(ii) \quad \begin{array}{c} \forall xA, -i \\ \downarrow \\ i'j \\ \mathfrak{E}c, +j \\ A_x(c), -j \end{array}$$

$\forall xA$ is false at $f(i)$. So, for some w such that $f(i)Rw$ and some $d \in D_w$, $A_x(k_d)$ is false at w . Also, $\mathfrak{E}k_d$ is true at w . Let f' be the same as f except that $f'(j) = w$. Since j does not occur on any line on \mathcal{B} , f' shows \mathfrak{I} to be faithful to \mathcal{B} , and, moreover, $f'(i)Rf'(j)$. Now, let \mathfrak{I}' be the free interpretation that is the same as \mathfrak{I} , except that $v(c) = d$. Then, by the Denotation Lemma, $\mathfrak{E}c$ is true and $A_x(c)$ is false at $f'(j)$ in \mathfrak{I}' . Since c does not occur in any other formula on the branch, \mathfrak{I}' makes all the other formulas on the branch true/false at the appropriate worlds, by the Locality Lemma. Hence, f' shows that \mathfrak{I}' is faithful to all the formulas on the extended branch.

$$(iii) \quad \begin{array}{c} \exists xA, -i \\ \swarrow \quad \searrow \\ \mathfrak{E}a, -i \quad A_x(a), -i \end{array}$$

$\exists xA$ is false at $f(i)$. So, for all $d \in D_{f(i)}$, $A_x(k_d)$ is false at $f(i)$. So, for any $d \in D$, either $\mathfrak{E}k_d$ is false at $f(i)$ or $A_x(k_d)$ is false at $f(i)$. Let $v(a) = d$. Then, by the

Denotation Lemma, either $\mathfrak{C}a$ is false at $f(i)$ or $A_x(a)$ is false at $f(i)$. In the first case, f shows \mathfrak{J} to be faithful to the left branch; in the second, it shows it to be faithful to the right. In either case, we may take \mathfrak{J}' to be \mathfrak{J} .

$$(iv) \quad \begin{array}{c} \forall xA, +i \\ irj \\ \swarrow \quad \searrow \\ \mathfrak{C}a, -j \quad A_x(a), +j \end{array}$$

$\forall xA$ is true at $f(i)$ and $f(i)Rf(j)$. Hence, for all $d \in D_{f(j)}$, $A_x(k_d)$ is true at $f(j)$. So, for all $d \in D$, either $\mathfrak{C}k_d$ is false at $f(j)$ or $A_x(k_d)$ is true at $f(j)$. Let $v(a) = d$. Then, by the Denotation Lemma, either $\mathfrak{C}a$ is false at $f(j)$ or $A_x(a)$ is true at $f(j)$. In the first case, f shows \mathfrak{J} to be faithful to the left branch; in the second, it shows it to be faithful to the right. In either case, we may take \mathfrak{J}' to be \mathfrak{J} . ■

20.9.6 SOUNDNESS THEOREM, TABLEAUX OF KIND 1: Tableaux of kind 1 are sound with respect to the semantics.

Proof:

Suppose that $\Sigma \not\models A$. Then given a tableau for the inference there is an interpretation, \mathfrak{J} , which makes all members of Σ true and A false at some world, w . For every constant, c , of the original language, $v(c) \in D_w$. Hence, every formula of the form $\mathfrak{C}c$ at the start of the initial list is true at w . So \mathfrak{J} is faithful to the original list. (Let $f(0) = w$.) By repeatedly applying the Soundness Lemma as usual we can find a whole branch, \mathcal{B} , such that for every initial section of it there is a free interpretation which makes every formula on the section true. Again as usual, it follows that the branch is open. So $\Sigma \not\models A$. ■

20.9.7 DEFINITION OF INDUCED INTERPRETATION, TABLEAUX OF KIND 1: Suppose that we have a completed tableau with an open branch, \mathcal{B} . Let C be the set of all constants on \mathcal{B} . The free interpretation *induced* by \mathcal{B} is the interpretation $\langle D, W, R, v \rangle$ defined as follows: $W = \{w_i: i \text{ is a world number on } \mathcal{B}\}$; w_iRw_j iff irj occurs on the branch; $D = \{\partial_a: a \in C\}$. $D_{w_i} = \{\partial_a: \mathfrak{C}a, +i \text{ is on } \mathcal{B}\}$; for all constants, a , $v(a) = \partial_a$; $\langle \partial_{a_1}, \dots, \partial_{a_n} \rangle \in v_{w_i}(P)$ iff $Pa_1 \dots a_n, +i$ occurs on \mathcal{B} .

One may check that the structure is a free interpretation. As in the propositional case, the rules for r ensure that R is reflexive and transitive. Because

all applications of the Heredity Rule have been made, the structure satisfies the heredity constraint (and so the domain-increasing condition).

20.9.8 COMPLETENESS LEMMA, TABLEAUX OF KIND 1: Given the free interpretation specified in 20.9.7, for every formula A :

if $A, +i$ is on \mathcal{B} then $\nu_{w_i}(A) = 1$

if $A, -i$ is on \mathcal{B} then $\nu_{w_i}(A) = 0$

Proof:

This is proved by recursion on formulas. For atomic formulas:

$$\begin{aligned} Pa_1 \dots a_n, +i \text{ is on } \mathcal{B} &\Rightarrow \langle \partial_{a_1}, \dots, \partial_{a_n} \rangle \in \nu_{w_i}(P) \\ &\Rightarrow \langle v(a_1), \dots, v(a_n) \rangle \in \nu_{w_i}(P) \\ &\Rightarrow \nu_{w_i}(Pa_1 \dots a_n) = 1 \end{aligned}$$

$$\begin{aligned} Pa_1 \dots a_n, -i \text{ is on } \mathcal{B} &\Rightarrow Pa_1 \dots a_n, +i \text{ is not on } \mathcal{B} \quad (\mathcal{B} \text{ open}) \\ &\Rightarrow \langle \partial_{a_1}, \dots, \partial_{a_n} \rangle \notin \nu_{w_i}(P) \\ &\Rightarrow \langle v(a_1), \dots, v(a_n) \rangle \notin \nu_{w_i}(P) \\ &\Rightarrow \nu_{w_i}(Pa_1 \dots a_n) = 0 \end{aligned}$$

For negation:

$$\begin{aligned} \neg A, +i \text{ is on } \mathcal{B} &\Rightarrow \text{for all } j \text{ such that } irj \text{ is on } \mathcal{B}, A, -j \text{ is on } \mathcal{B} \\ &\Rightarrow \text{for all } w_j \text{ such that } w_i R w_j, \nu_{w_j}(A) = 0 \quad (\text{IH}) \\ &\Rightarrow \nu_{w_i}(\neg A) = 1 \end{aligned}$$

$$\begin{aligned} \neg A, -i \text{ is on } \mathcal{B} &\Rightarrow \text{for some } j \text{ such that } irj \text{ is on } \mathcal{B}, A, +j \text{ is on } \mathcal{B} \\ &\Rightarrow \text{for some } w_j \text{ such that } w_i R w_j, \nu_{w_j}(A) = 1 \quad (\text{IH}) \\ &\Rightarrow \nu_{w_i}(\neg A) = 0 \end{aligned}$$

The cases for the other connectives are similar, and are left as an exercise.

For the quantifiers:

$$\begin{aligned} \exists x A, +i \text{ is on } \mathcal{B} &\Rightarrow \text{for some } a, \mathcal{E}a, +i \text{ and } A_x(a), +i \text{ are on } \mathcal{B} \\ &\Rightarrow \text{for some } a \text{ with denotation in } D_{w_i}, \\ &\quad \nu_{w_i}(A_x(a)) = 1 \quad (\text{IH}) \\ &\Rightarrow \text{for some } d \in D_{w_i}, \nu_{w_i}(A_x(k_d)) = 1 \quad (*) \\ &\Rightarrow \nu_{w_i}(\exists x A) = 1 \end{aligned}$$

(*) holds by the Denotation Lemma. The asterisks below mean the same.

$\exists xA, -i$ is on $\mathcal{B} \Rightarrow$ for every a such that $\mathfrak{C}a, +i$ is on \mathcal{B} ,
 $A_x(a), -i$ is on \mathcal{B} (\mathcal{B} open)
 \Rightarrow for every a with denotation in D_{w_i} ,
 $\nu_{w_i}(A_x(a)) = 0$ (IH)
 \Rightarrow for every $d \in D_{w_i}, \nu_{w_i}(A_x(k_d)) = 0$ (*)
 $\Rightarrow \nu_{w_i}(\exists xA) = 0$

$\forall xA, +i$ is on $\mathcal{B} \Rightarrow$ for all j such that irj and $\mathfrak{C}a, +j$ are
on $\mathcal{B}, A_x(a), +j$ is on \mathcal{B} (\mathcal{B} open)
 \Rightarrow for all w_j such that w_iRw_j , and all a
with denotation in $D_{w_j}, \nu_{w_j}(A_x(a)) = 1$ (IH)
 \Rightarrow for all w_j such that w_iRw_j ,
and all $d \in D_{w_j}, \nu_{w_j}(A_x(k_d)) = 1$ (*)
 $\Rightarrow \nu_{w_i}(\forall xA) = 1$

$\forall xA, -i$ is on $\mathcal{B} \Rightarrow$ for some j and a , such that irj and
 $\mathfrak{C}a, +j$ are on $\mathcal{B}, A_x(a), -j$ is on \mathcal{B}
 \Rightarrow for some w_j such that w_iRw_j , and a
with denotation in $D_{w_j}, \nu_{w_j}(A_x(a)) = 0$ (IH)
 \Rightarrow for some w_j such that w_iRw_j ,
and some $d \in D_{w_j}, \nu_{w_j}(A_x(k_d)) = 0$ (*)
 $\Rightarrow \nu_{w_i}(\forall xA) = 0$

■

20.9.9 COMPLETENESS THEOREM, TABLEAUX OF KIND 1: Tableaux of kind 1 are complete with respect to their semantics.

Proof:

Suppose that $\Sigma \not\vdash A$. Construct a tableau for the inference. Define the free interpretation, \mathfrak{J} , as in 20.9.7. By the Completeness Lemma, this makes all the members of Σ true and A false at w_0 . This is not quite what we want, since \mathfrak{J} may not be an interpretation proper. By construction, any constant occurring in the initial list denotes something in D_{w_0} , and hence D_w for all $w \in W$ (by applications of the Heredity Rule). But for constants, a , that have been introduced by applications of the quantifier rules, this may not be the case. Let $\mathfrak{C}c$ be the first line of the tableau. Let \mathfrak{J}' be an interpretation (properly so called) that is the same as \mathfrak{J} , except that for all

these a , $v(a) = v(c)$. By the Locality Lemma, \mathcal{J}' makes all members of Σ true and A false at w_0 .⁷ Hence, $\Sigma \not\models A$. ■

20.9.10 SOUNDNESS LEMMA, TABLEAUX OF KIND 2: We will say that a free interpretation *respects the constants in C* iff $v(a) \in D_w$, for every $a \in C$ and $w \in W$. Let \mathcal{B} be any branch of a tableau with premises Σ and conclusion A , and let $\mathcal{J} = \langle D, W, R, v \rangle$ be any free interpretation that respects all the constants in the initial list. If \mathcal{J} is faithful to \mathcal{B} , and a tableau rule of kind 2 is applied to it, then there is a free interpretation, $\mathcal{J}' = \langle D, W, R, v' \rangle$, that respects the constants in the formulas on the initial list, and an extension of \mathcal{B} , \mathcal{B}' , such that \mathcal{J}' is faithful to \mathcal{B}' .

Proof:

The proof for the connectives is essentially as in the propositional case. The case for the Heredity Rule is the obvious modification of that for the propositional case. (See 6.7.3. In each case, we may take \mathcal{J}' to be \mathcal{J} .) This leaves the cases for the quantifiers. Let f be a function that shows \mathcal{J} to be faithful to \mathcal{B} . There are four rules to consider.

$$(i) \quad \begin{array}{c} \exists xA, +i \\ \downarrow \\ A_x(c), +i \end{array}$$

Suppose that $\exists xA$ is true at $f(i)$. Then for some $d \in D_{f(i)}$, $A_x(k_d)$ is true at $f(i)$. Let \mathcal{J}' be the free interpretation that is the same as \mathcal{J} , except that $v(c) = d$. Then, by the Denotation Lemma, $A_x(c)$ is true at $f(i)$ in \mathcal{J}' . Since c does not occur in any other formula on the branch, \mathcal{J}' makes all the other formulas on the branch true/false at their respective worlds too, by the Locality Lemma. If \mathcal{J} respects all the constants in formulas on the initial list, so does \mathcal{J}' . Note that the denotation of c is in $D_{f(i)}$, where i is its entry number.

$$(ii) \quad \begin{array}{c} \forall xA, -i \\ \downarrow \\ i'j \\ A_x(c), -j \end{array}$$

⁷ Note that there is no guarantee that the interpretation will satisfy the conditions of the Completeness Lemma for other lines of the tableau.

Suppose that $\forall xA$ is false at $f(i)$. Then for some w such that $f(i)Rw$ and some $d \in D_w$, $A_x(k_d)$ is false at $f(i)$. Let f' be the same as f except that $f'(j) = w$. Since j does not occur on any formula on \mathcal{B} , f' shows \mathfrak{I} to be faithful to \mathcal{B} , and, moreover, $f'(i)Rf'(j)$. Now, let \mathfrak{I}' be the free interpretation that is the same as \mathfrak{I} , except that $\nu(c) = d$. Then, by the Denotation Lemma, $A_x(c)$ is false at $f'(j)$ in \mathfrak{I}' . Since c does not occur in any other formula on the branch, \mathfrak{I}' makes all the other formulas on the branch true/false at the appropriate worlds, by the Locality Lemma. Hence, f' shows that \mathfrak{I}' is faithful to all the formulas on the extended branch. If \mathfrak{I} respects all constants in formulas on the initial list, so does \mathfrak{I}' . Note that the denotation of c is in $D_{f(j)}$, where j is its entry number.

$$\begin{array}{l} \text{(iii)} \qquad \qquad \qquad \exists xA, -i \\ \qquad \qquad \qquad \qquad \qquad \downarrow \\ \qquad \qquad \qquad \qquad \qquad A_x(a), -i \end{array}$$

where a is any constant that belongs to i . Suppose that it has entry number k ; then kri is on the branch. We have it that $\exists xA$ is false at $f(i)$ and $f(k)Rf(i)$. So, for all $d \in D_{f(i)}$, $A_x(k_d)$ is false at $f(i)$. a is either a constant in a formula on the initial list or is introduced by one of the previous two quantifier rules. In the first case, the denotation of a is in $D_{f(i)}$ since the interpretation respects all these constants. In the second case, the denotation of a is in $D_{f(k)}$. By the domain-increasing condition, $D_{f(k)} \subseteq D_{f(i)}$, so the denotation of a is in $D_{f(i)}$ as well. Hence, in both cases, for some $d \in D_{f(i)}$, a and k_d have the same denotation. It follows by the Denotation Lemma that $A_x(a)$ is false at $f(i)$. Hence, we can take \mathfrak{I}' to be \mathfrak{I} .

$$\begin{array}{l} \text{(iv)} \qquad \qquad \qquad \forall xA, +i \\ \qquad \qquad \qquad \qquad \qquad irj \\ \qquad \qquad \qquad \qquad \qquad \downarrow \\ \qquad \qquad \qquad \qquad \qquad A_x(a), +j \end{array}$$

where a is any constant that belongs to j . Suppose that it has entry number k ; then krj is on the branch. We have it that $\forall xA$ is true at $f(i)$ and $f(i)Rf(j)$. So, for all w such that $f(i)Rw$ – in particular, for $f(j)$ – and for all $d \in D_w$, $A_x(k_d)$ is true at w . As in the previous case, for some $d \in D_{f(j)}$, a and k_d have the same denotation. Hence, $A_x(a)$ is true at $f(j)$, by the Denotation Lemma. We can therefore take \mathfrak{I}' to be \mathfrak{I} . ■

20.9.11 SOUNDNESS THEOREM, TABLEAUX OF KIND 2: Tableaux of kind 2 are sound with respect to the semantics.

Proof:

Suppose that $\Sigma \not\models A$. Then given a tableau for the inference, there is an interpretation, \mathcal{J} , which is faithful to all the members of the original list (including the line $c = c, +0$ if there is one). Let C be the set of constants in formulas on the original list. \mathcal{J} respects all the constants in C . (It respects *all* the constants in the original language.) By repeatedly applying the Soundness Lemma as usual, we can find a whole branch, \mathcal{B} , such that for every initial section of it there is a free interpretation (that respects all the constants in C) which makes every formula on the section true. Again as usual, it follows that the branch is open. So $\Sigma \not\models A$. ■

20.9.12 DEFINITION OF INDUCED INTERPRETATION, TABLEAUX OF KIND 2: The interpretation induced by a branch of a tableau of kind 2 is defined as for a tableau of kind 1, except that $D_{w_i} = \{a : a \text{ belongs to } i\}$. As for kind 1 tableaux, the structure defined is a free interpretation. For the domain-increasing condition: suppose that $a \in D_{w_i}$ and $w_i R w_j$. Then if the entry number of a is k , kri is on the branch. But irj is also on the branch, so by the τ rule, kri is on the branch, and $a \in D_{w_j}$.

20.9.13 COMPLETENESS LEMMA, TABLEAUX OF KIND 2: This is stated as for kind 1 tableaux.

Proof:

This proof is as for tableaux of kind 1, except for the cases for the quantifiers. For these, we have the following:

$$\begin{aligned}
 \exists xA, +i \text{ is on } \mathcal{B} &\Rightarrow \text{for some } a \text{ with entry number } i, \\
 &A_x(a), +i \text{ is on } \mathcal{B} \\
 &\Rightarrow \text{for some } a \text{ that belongs to } i, \\
 &\nu_{w_i}(A_x(a)) = 1 \quad \text{(IH)} \\
 &\Rightarrow \text{for some } d \in D_{w_i}, \nu_{w_i}(A_x(k_d)) = 1 \quad (*) \\
 &\Rightarrow \nu_{w_i}(\exists xA) = 1
 \end{aligned}$$

(*) holds by the Denotation Lemma. The asterisks below mean the same.

$$\begin{aligned}
\exists xA, -i \text{ is on } \mathcal{B} &\Rightarrow \text{for every } a \text{ that belongs to } i, \\
&\quad A_x(a), -i \text{ is on } \mathcal{B} \\
&\Rightarrow \text{for every } a \text{ that belongs to } i, \\
&\quad \nu_{w_i}(A_x(a)) = 0 \quad (\text{IH}) \\
&\Rightarrow \text{for every } d \in D_{w_i}, \nu_{w_i}(A_x(k_d)) = 0 \quad (*) \\
&\Rightarrow \nu_{w_i}(\exists xA) = 0
\end{aligned}$$

$$\begin{aligned}
\forall xA, +i \text{ is on } \mathcal{B} &\Rightarrow \text{for all } j \text{ such that } irj \text{ is on } \mathcal{B}, \text{ and every } a \\
&\quad \text{that belongs to } j, A_x(a), +j \text{ is on } \mathcal{B} \\
&\Rightarrow \text{for all } w_j \text{ such that } w_iRw_j, \text{ and every } a \\
&\quad \text{that belongs to } j, \nu_{w_j}(A_x(a)) = 1 \quad (\text{IH}) \\
&\Rightarrow \text{for all } w_j \text{ such that } w_iRw_j, \\
&\quad \text{and all } d \in D_{w_j}, \nu_{w_j}(A_x(k_d)) = 1 \quad (*) \\
&\Rightarrow \nu_{w_i}(\forall xA) = 1
\end{aligned}$$

$$\begin{aligned}
\forall xA, -i \text{ is on } \mathcal{B} &\Rightarrow \text{for some } j \text{ such that } irj \text{ is on } \mathcal{B}, \text{ and some } a \\
&\quad \text{with entry number } j, A_x(a), -j \text{ is on } \mathcal{B} \\
&\Rightarrow \text{for some } w_j \text{ such that } w_iRw_j, \text{ and} \\
&\quad \text{some } a \text{ that belongs to } j, \nu_{w_j}(A_x(a)) = 0 \quad (\text{IH}) \\
&\Rightarrow \text{for some } w_j \text{ such that } w_iRw_j, \\
&\quad \text{and some } d \in D_{w_j}, \nu_{w_j}(A_x(k_d)) = 0 \quad (*) \\
&\Rightarrow \nu_{w_i}(\forall xA) = 0
\end{aligned}$$

■

20.9.14 COMPLETENESS THEOREM, TABLEAUX OF KIND 2: Tableaux of kind 2 are complete with respect to their semantics.

Proof:

Suppose that $\Sigma \not\vdash A$. Construct a tableau for the inference. Define the free interpretation, \mathcal{J} , as in 20.9.12. By the Completeness Lemma, this makes all the members of Σ true and A false at w_0 . This is not quite what we want, since it may not be an interpretation proper. Any constant, a , occurring in the initial list has entry number 0. And since for every world, i , on the branch $0ri$ occurs on it, a belongs to i ; so $\nu(a) \in D_{w_i}$ for every i . But for constants, a , that have been introduced by the quantifier rules, this may

not be true. Choose any constant, c , with entry number 0. (We know that there is at least one.) Let \mathcal{J}' be an interpretation that is the same as \mathcal{J} , except that for all these, $v(a) = v(c)$. As in 20.9.9, \mathcal{J}' makes all members of Σ true and A false at w_0 . Hence, $\Sigma \not\models A$. ■

20.10 *Proofs of Theorems 2

20.10.1 We now turn to the soundness and completeness theorems for the tableaux of kind 2 with identity. (Tableaux of kind 1 are left as an exercise. See 20.13, question 14.) We start with necessary identity.

20.10.2 The Locality and Denotation Lemmas are stated and proved as in the case without identity (20.9.2, 20.9.3).

20.10.3 **SOUNDNESS THEOREM FOR NECESSARY IDENTITY:** The tableaux for intuitionist logic with necessary identity are sound with respect to their semantics.

Proof:

The Soundness Theorem follows from the appropriate Soundness Lemma, as in the case without identity (20.9.11). In the proof of the Lemma, we need to consider the new cases for the identity rules of 20.7.2. These are straightforward, and are left as exercises. ■

20.10.4 **DEFINITION:** Given an open branch, \mathcal{B} , of a tableau, the induced interpretation is defined as in the case without identity (20.9.12), except for the following. If a and b are constants on the branch, let $a \sim b$ iff $a = b, +0$ is on \mathcal{B} . As usual, this is an equivalence relation. $D = \{[a] : a \text{ occurs on } \mathcal{B}\}$. $D_{w_i} = \{x \in D : \text{for some } a \in x, a \text{ belongs to } i\}$.⁸ $v(a) = [a]$, and for n -place predicates other than identity $\langle [a_1], \dots, [a_n] \rangle \in v_{w_i}(P)$ iff $Pa_1 \dots a_n, +i$ is on \mathcal{B} . As usual, this is well defined. As in the case without identity, the induced structure is a free interpretation. For the domain-increasing condition: suppose that $x \in D_{w_i}$ and $w_i R w_j$. Then, for some $a \in x$, a belongs to i . Let k be the entry number of a ; then kri is on the branch. But irj is also on the branch, so by the τ rule, $k r j$ is on the branch. That is, a belongs to j , i.e., $x \in D_{w_j}$.

⁸ The definition for tableaux of kind 1 is the same, except that $D_{w_i} = \{[a] : \mathcal{C}a, +i \text{ is on } \mathcal{B}\}$.

20.10.5 COMPLETENESS THEOREM FOR NECESSARY IDENTITY: The tableaux with necessary identity are complete with respect to their semantics.

Proof:

The proof of the Completeness Theorem follows from the appropriate Completeness Lemma in the usual way. The cases of the Completeness Lemma are as follows. For identity sentences:

$$\begin{aligned}
 a = b, +i \text{ is on } \mathcal{B} &\Rightarrow a = b, +0 \text{ is on } \mathcal{B} \quad (\text{IIR}) \\
 &\Rightarrow a \sim b \\
 &\Rightarrow [a] = [b] \\
 &\Rightarrow v(a) = v(b) \\
 &\Rightarrow v_{w_i}(a = b) = 1
 \end{aligned}$$

$$\begin{aligned}
 a = b, -i \text{ is on } \mathcal{B} &\Rightarrow a = b, +i \text{ is not on } \mathcal{B} \quad (\mathcal{B} \text{ open}) \\
 &\Rightarrow a = b, +0 \text{ is not on } \mathcal{B} \quad (\text{IIR, } \mathcal{B} \text{ open}) \\
 &\Rightarrow \text{it is not the case that } a \sim b \\
 &\Rightarrow [a] \neq [b] \\
 &\Rightarrow v(a) \neq v(b) \\
 &\Rightarrow v_{w_i}(a = b) = 0
 \end{aligned}$$

For other atomic sentences:

$$\begin{aligned}
 Pa_1 \dots a_n, +i \text{ is on } \mathcal{B} &\Rightarrow \langle [a_1], \dots, [a_n] \rangle \in v_{w_i}(P) \\
 &\Rightarrow \langle v(a_1), \dots, v(a_n) \rangle \in v_{w_i}(P) \\
 &\Rightarrow v_{w_i}(Pa_1 \dots a_n) = 1
 \end{aligned}$$

$$\begin{aligned}
 Pa_1 \dots a_n, -i \text{ is on } \mathcal{B} &\Rightarrow Pa_1 \dots a_n, +i \text{ is not on } \mathcal{B} \quad (\mathcal{B} \text{ open}) \\
 &\Rightarrow \langle [a_1], \dots, [a_n] \rangle \notin v_{w_i}(P) \\
 &\Rightarrow \langle v(a_1), \dots, v(a_n) \rangle \notin v_{w_i}(P) \\
 &\Rightarrow v_{w_i}(Pa_1 \dots a_n) = 0
 \end{aligned}$$

The cases for the connectives and quantifiers are as in the case without identity (20.9.13). ■

20.10.6 We now turn to intuitionist (contingent) identity. We start, as usual, by establishing the Locality and Denotation Lemmas. In fact, it will be useful to establish something a bit stronger than the latter.

20.10.7 LEMMA (LOCALITY): Let $\mathfrak{J}_1 = \langle D, H, W, R, \nu_1 \rangle$, $\mathfrak{J}_2 = \langle D, H, W, R, \nu_2 \rangle$ be two free interpretations. Since they have the same domain, the language of the two is the same. Call this L . If A is any closed formula of L such that ν_1 and ν_2 agree on the denotations of all the predicates and constants in it, then, for all $w \in W$:

$$\nu_{1w}(A) = \nu_{2w}(A)$$

Proof:

The result is proved by recursion on formulas. For atomic formulas:

$$\begin{aligned} \nu_{1w}(Pa_1 \dots a_n) = 1 & \text{ iff } \langle |\nu_1(a_1)|_w, \dots, |\nu_1(a_n)|_w \rangle \in \nu_{1w}(P) \\ & \text{ iff } \langle |\nu_2(a_1)|_w, \dots, |\nu_2(a_n)|_w \rangle \in \nu_{2w}(P) \\ & \text{ iff } \nu_{2w}(Pa_1 \dots a_n) = 1 \end{aligned}$$

The cases for the connectives and quantifiers are as in the non-identity case (20.9.2). ■

20.10.8 LEMMA: Let $\mathfrak{J} = \langle D, H, W, R, \nu \rangle$ be any free interpretation. Let A be any formula of $L(\mathfrak{J})$ with at most one free variable, x , and w, a and b be such that $|\nu(a)|_w = |\nu(b)|_w$. Then for all $w' \in W$:

$$\text{if } wRw' \text{ then } \nu_{w'}(A_x(a)) = \nu_{w'}(A_x(b))$$

Proof:

The proof is by recursion on formulas. Suppose that wRw' . For atomic formulas I assume that the formula has one occurrence of a for the sake of illustration:

$$\begin{aligned} \nu_{w'}(Pa_1 \dots a \dots a_n) = 1 & \text{ iff } \langle |\nu(a_1)|_{w'}, \dots, |\nu(a)|_{w'}, \dots, |\nu(a_n)|_{w'} \rangle \in \nu_{w'}(P) \\ & \text{ iff } \langle |\nu(a_1)|_{w'}, \dots, |\nu(b)|_{w'}, \dots, |\nu(a_n)|_{w'} \rangle \in \nu_{w'}(P) \quad (*) \\ & \text{ iff } \nu_{w'}(Pa_1 \dots b \dots a_n) = 1 \end{aligned}$$

Line (*) holds by the heredity constraint applied to identity (see 20.8.4).

The case for negation is as follows:

$$\begin{aligned} \nu_{w'}(\neg B_x(a)) = 1 & \text{ iff for all } w'' \text{ such that } w'Rw'', \nu_{w''}(B_x(a)) = 0 \\ & \text{ iff for all } w'' \text{ such that } w'Rw'', \nu_{w''}(B_x(b)) = 0 \quad (*) \\ & \text{ iff } \nu_{w'}(\neg B_x(b)) = 1 \end{aligned}$$

Line (*) follows from the IH and the fact that wRw'' (since wRw' and $w'Rw''$). The cases for the other connectives are straightforward, and are left as exercises.

The case for the universal quantifier is as follows. The case for the particular quantifier is left as an exercise. Let A be of the form $\forall yB$. If x is the same variable as y then $A_x(a)$ and $A_x(b)$ are just A , so the result is trivial. So suppose that x and y are distinct variables.

$$\begin{aligned}
 \nu_{w'}((\forall yB)_x(a)) = 1 & \text{ iff } \nu_{w'}(\forall y(B_x(a))) = 1 \\
 & \text{ iff for all } w'' \text{ such that } w'Rw'', \text{ and all } d \in D_{w'',} \\
 & \quad \nu_{w''}((B_x(a))_y(k_d)) = 1 \\
 & \text{ iff for all } w'' \text{ such that } w'Rw'', \text{ and all } d \in D_{w'',} \\
 & \quad \nu_{w''}((B_y(k_d))_x(a)) = 1 \\
 & \text{ iff for all } w'' \text{ such that } w'Rw'', \text{ and all } d \in D_{w'',} \\
 & \quad \nu_{w''}((B_y(k_d))_x(b)) = 1 \tag{*} \\
 & \text{ iff for all } w'' \text{ such that } w'Rw'', \text{ and all } d \in D_{w'',} \\
 & \quad \nu_{w''}((B_x(b))_y(k_d)) = 1 \\
 & \text{ iff } \nu_{w'}(\forall y(B_x(b))) = 1 \\
 & \text{ iff } \nu_{w'}((\forall yB)_x(b)) = 1
 \end{aligned}$$

Line (*) follows from the IH and the transitivity of R , as for negation. ■

20.10.9 COROLLARY 1 (DENOTATION LEMMA): Let $\mathcal{I} = \langle D, H, W, R, \nu \rangle$ be any free interpretation. Let A be any formula of $L(\mathcal{I})$ with at most one free variable, x , and a and b be any two constants such that $\nu(a) = \nu(b)$. Then for all $w \in W$:

$$\nu_w(A_x(a)) = \nu_w(A_x(b))$$

Proof:

Immediate. ■

20.10.10 COROLLARY 2 (SI): $a = b, A_x(a) \models A_x(b)$.

Proof:

Let w be any world of any interpretation where $\nu_w(a = b) = \nu_w(A_x(a)) = 1$. Then $|\nu(a)|_w = |\nu(b)|_w$. By the lemma, it follows that $\nu_w(A_x(b)) = 1$. ■

20.10.11 SOUNDNESS THEOREM FOR CONTINGENT IDENTITY: The tableaux for intuitionist logic with contingent identity are sound with respect to their semantics.

Proof:

The proof is as in the case without identity. There are new cases for the identity rules of 20.8.5. These are straightforward, and left as exercises. ■

20.10.12 DEFINITION: Given an open branch, \mathcal{B} , of a tableau, the induced interpretation is the structure $\langle W, H, R, D, \nu \rangle$. W and R are as in the propositional case. If a and b are constants on the branch, let $a \sim_i b$ iff $a = b$, $+i$ is on \mathcal{B} . As usual, this is an equivalence relation. $D = \{\partial_a : a \text{ occurs on } \mathcal{B}\}$. $D_{w_i} = \{\partial_a : a \text{ belongs to } i\}$.⁹ $H = \{[a]_i : \text{for all } i \text{ and } a \text{ on } \mathcal{B}\}$ (where $[a]_i$ is the equivalence class of a under \sim_i). For all $w_i \in W$, $|\partial_a|_{w_i} = [a]_i$. $\nu(a) = \partial_a$ and $\langle [a_1]_i, \dots, [a_n]_i \rangle \in \nu_{w_i}(P)$ iff $Pa_1 \dots a_n$, $+i$ is on \mathcal{B} . (Any n -tuple that contains an avatar that is not of the form $[a]_i$ is not in $\nu_{w_i}(P)$.) As usual, this is well defined; and it is not difficult to check that this is a free interpretation.

20.10.13 COMPLETENESS THEOREM FOR CONTINGENT IDENTITY: The tableaux for intuitionist logic with contingent identity are complete with respect to their semantics.

Proof:

The proof of the Completeness Theorem follows from the appropriate Completeness Lemma in the usual way. The cases of the Completeness Lemma are as follows. For identity sentences:

$$\begin{aligned}
 a = b, +i \text{ is on } \mathcal{B} &\Rightarrow a \sim_i b \\
 &\Rightarrow [a]_i = [b]_i \\
 &\Rightarrow |\partial_a|_{w_i} = |\partial_b|_{w_i} \\
 &\Rightarrow |\nu(a)|_{w_i} = |\nu(b)|_{w_i} \\
 &\Rightarrow \nu_{w_i}(a = b) = 1
 \end{aligned}$$

$$\begin{aligned}
 a = b, -i \text{ is on } \mathcal{B} &\Rightarrow a = b, +i \text{ is not on } \mathcal{B} && (\mathcal{B} \text{ open}) \\
 &\Rightarrow \text{it is not the case that } a \sim_i b \\
 &\Rightarrow [a]_i \neq [b]_i \\
 &\Rightarrow |\partial_a|_{w_i} \neq |\partial_b|_{w_i} \\
 &\Rightarrow |\nu(a)|_{w_i} \neq |\nu(b)|_{w_i} \\
 &\Rightarrow \nu_{w_i}(a = b) = 0
 \end{aligned}$$

⁹ The definition for tableaux of kind 1 is the same, except that $D_{w_i} = \{\partial_a : \mathfrak{C}a, +i \text{ is on } \mathcal{B}\}$.

For other atomic sentences:

$$\begin{aligned}
 Pa_1 \dots a_n, +i \text{ is on } \mathcal{B} &\Rightarrow \langle [a_1]_i, \dots, [a_n]_i \rangle \in \nu_{w_i}(P) \\
 &\Rightarrow \langle |\partial_{a_1}|_{w_i}, \dots, |\partial_{a_n}|_{w_i} \rangle \in \nu_{w_i}(P) \\
 &\Rightarrow \langle |\nu(a_1)|_{w_i}, \dots, |\nu(a_n)|_{w_i} \rangle \in \nu_{w_i}(P) \\
 &\Rightarrow \nu_{w_i}(Pa_1 \dots a_n) = 1
 \end{aligned}$$

$$\begin{aligned}
 Pa_1 \dots a_n, -i \text{ is on } \mathcal{B} &\Rightarrow Pa_1 \dots a_n, +i \text{ is not on } \mathcal{B} && (\mathcal{B} \text{ open}) \\
 &\Rightarrow \langle [a_1]_i, \dots, [a_n]_i \rangle \notin \nu_{w_i}(P) \\
 &\Rightarrow \langle |\partial_{a_1}|_{w_i}, \dots, |\partial_{a_n}|_{w_i} \rangle \notin \nu_{w_i}(P) \\
 &\Rightarrow \langle |\nu(a_1)|_{w_i}, \dots, |\nu(a_n)|_{w_i} \rangle \notin \nu_{w_i}(P) \\
 &\Rightarrow \nu_{w_i}(Pa_1 \dots a_n) = 0
 \end{aligned}$$

The cases for the connectives and quantifiers are as in the case without identity (20.9.13). ■

20.11 History

For a history of intuitionism and intuitionist logic, see 6.8. The comments there apply just as much to quantified intuitionist logic, which was formulated by Heyting in the same year that he formulated propositional intuitionistic logic.

20.12 Further Reading

Again, for further reading, see 6.9. For some of Brouwer's papers, see part 1 of Mancosu (1998). Heyting (1956), ch. 1, contains a nice discussion of the intuitionist position on mathematical existence. For further details of intuitionist logic one can consult Fitting (1969), van Dalen (1986, 2001), Mints (2000), and Bell, DeVidi and Solomon (2001), ch. 5 (5.3.3 has a brief discussion of intuitionist identity.) For a discussion of the issues of 20.6 (though not in the context of intuitionism), see Priest (2005c), 7.7.

20.13 Problems

1. Check the details omitted in 20.5.7 and 20.7.4.
2. Using tableaux of kind 1, show the following:

$$(a) \exists x \rightarrow Px \vdash \forall x Px$$

- (b) $\rightarrow \exists xPx \vdash \forall x \rightarrow Px$
- (c) $\forall x \rightarrow Px \vdash \rightarrow \exists xPx$
- (d) $\exists x(Px \vee Qx) \vdash \exists xPx \vee \exists xQx$
- (e) $\exists xPx \vee \exists xQx \vdash \exists x(Px \vee Qx)$
- (f) $\exists x(Px \wedge Qx) \vdash \exists xPx \wedge \exists xQx$
- (g) $\forall x(Px \wedge Qx) \vdash \forall xPx \wedge \forall xQx$
- (h) $\forall xPx \wedge \forall xQx \vdash \forall x(Px \wedge Qx)$
- (i) $\forall xPx \vee \forall xQx \vdash \forall x(Px \vee Qx)$

3. Repeat the previous question with tableaux of kind 2.
4. By constructing appropriate counter-models and checking that they have the right properties, show the following. Use whichever kind of tableau you like (or none). Note that some of the relevant tableaux may be infinite.

- (a) $\exists xPx \wedge \exists xQx \not\models \exists x(Px \wedge Qx)$
- (b) $\forall x(Px \vee Qx) \not\models \forall xPx \vee \forall xQx$
- (c) $\rightarrow \forall xPx \not\models \exists x \rightarrow Px$
- (d) $\forall x(Px \vee \rightarrow Px), \rightarrow \forall x \rightarrow Px \not\models \exists xPx$
- (e) $\not\models \rightarrow \rightarrow \forall x(Px \vee \rightarrow Px)$

5. Check the validity of the inferences in 12.4.14, question 5, when ‘ \supset ’ is replaced by ‘ \sqsupset ’.
6. Show that the following hold in intuitionistic logic (with contingent identity). Use tableaux of kind 2.

- (a) $\vdash \forall x x = x$
- (b) $\vdash \forall x \forall y (x = y \sqsupset y = x)$
- (c) $\vdash \forall x \forall y ((x = y \wedge y = z) \sqsupset x = z)$
- (d) $\vdash \forall x \forall y ((x = y \wedge Px) \sqsupset Py)$
- (e) $\vdash \forall x \forall y ((Px \wedge \rightarrow Py) \sqsupset \rightarrow x = y)$

7. Show the following in intuitionist logic (with contingent identity). Provide appropriate counter-models and show that they work.

- (a) $\not\models \exists x \rightarrow x = x$
- (b) $\not\models \forall x \exists y \rightarrow x = y$
- (c) $\not\models \forall x \forall y ((Px \wedge \rightarrow x = y) \sqsupset \rightarrow Py)$
- (d) $\not\models \forall x \forall y \forall z (x = y \vee y = z \vee z = x)$
- (e) $\not\models \forall x \forall y (Qxy \sqsupset \rightarrow x = y)$

8. Discuss the objection of 20.6.
9. According to the proof conditions of 20.2.3, $\exists xA$ is proved if there is a construction of a certain kind. But what does it mean to say ‘there is’

in this context? Constructions are naturally thought of as mathematical objects of a certain kind. An intuitionist obviously cannot say that for there to be such an object is for it to be an independently existing abstract object. Nor can they say that for there to be such an object someone has *actually* to have constructed it. That would make mathematics far too contingent an affair. So what can they say?

10. *Check the details omitted in 20.9 and 20.10.
11. *Extend the McKinsey–Tarski translation of intuitionist propositional logic (6.10, question 11) to predicate logic, and show the equivalence of the logic to an appropriate version of $VK_{\rho\tau}$.
12. *Let $\langle D, W, R, v_1 \rangle$ and $\langle D, W, R, v_2 \rangle$ be two free interpretations such that for all n -place predicates, P , and all $w \in W$, $v_{1w}(P) \cap D_w = v_{2w}(P) \cap D_w$. Show that for every formula, A , and every $w \in W$, if every constant in A denotes something in D_w :

$$v_{1w}(A) = v_{2w}(A)$$

(Hint: argue by induction on A ; for the cases concerning \rightarrow , \square and \forall , use the domain-increasing constraint.) Infer that in an interpretation (where all constants denote objects at every world), whether or not something that does not exist at a world is in the extension of a predicate there is irrelevant, and that we may always, therefore, suppose that $v_w(P) \subseteq D_w^n$ for every n -place predicate, P .

13. *Formulate the semantics for a quantified version of the intermediate logic LC . Formulate an appropriate tableau system and prove it to be sound and complete. (See 6.10, question 10.)
14. *Prove that the tableaux of kind 1 with (i) necessary identity and (ii) contingent identity are sound and complete.
15. *For the various systems of logic in this chapter, formulate tableaux for inferences with arbitrary sets of premises. Prove the Soundness and Completeness Theorems. Infer the Compactness and Löwenheim–Skolem Theorems.

21 Many-valued Logics

21.1 Introduction

21.1.1 In this chapter we leave world-semantics for the time being, and turn to many-valued logics.

21.1.2 We will start with a brief look at the general situation concerning many-valued logics, before turning to the special cases of the 3-valued logics of chapter 7 for more detailed consideration.

21.1.3 Free versions of these logics are next on the agenda – in particular, now that we have the machinery of truth value gaps at our finger tips, the neutral free logics mentioned in 13.4.7. This will occasion a discussion of the behaviour of the existence predicate in a many-valued logic, and the question of whether it might make good philosophical sense for a statement of existence to have a non-classical value.

21.1.4 Next, we turn to the behaviour of identity in many-valued logics, and particularly the 3-valued logics of chapter 7. This will occasion a discussion of whether identity statements may plausibly be taken to have non-classical values.

21.1.5 We will finish with a few comments on supervaluations and subvaluations in the context of quantificational logic.

21.2 Quantified Many-valued Logics

21.2.1 As we saw in 7.2.2, a propositional many-valued logic is characterised by a structure $\langle \mathcal{V}, \mathcal{D}, \{f_c : c \in C\} \rangle$, where \mathcal{V} is the set of truth values, $\mathcal{D} \subseteq \mathcal{V}$ is the set of designated values, and for each connective, c, f_c is the truth function it denotes. An interpretation, ν , assigns values to propositional parameters;

the values of all formulas can then be computed using the f_c s; and a valid inference is one that preserves designated values in every interpretation.

21.2.2 A quantified many-valued logic is characterised by a structure of the form $\langle D, \mathcal{V}, \mathcal{D}, \{f_c: c \in C\}, \{f_q: q \in Q\} \rangle$. \mathcal{V} , \mathcal{D} , and $\{f_c: c \in C\}$ are as before. D is a non-empty domain of quantification, and if Q is the set of quantifiers in the language, for every $q \in Q$, f_q is a map from subsets of \mathcal{V} into \mathcal{V} . (In a free many-valued logic, there is an extra component, the inner domain, E , and $E \subseteq D$.)

21.2.3 Given this structure, an evaluation, ν , assigns every constant a member of D and every n -place predicate an n -place function from the domain into the truth values. (So if P is any predicate, $\nu(P)$ is a function with inputs in D and an output in \mathcal{V} .) Given an evaluation, every formula, A , is then assigned a value, $\nu(A)$, in \mathcal{V} recursively, as follows. If P is any n -place predicate:

$$\nu(Pa_1 \dots a_n) = \nu(P)(\nu(a_1), \dots, \nu(a_n))$$

For each n -place propositional connective, c :

$$\nu(c(A_1, \dots, A_n)) = f_c(\nu(A_1), \dots, \nu(A_n))$$

as in the propositional case. And for each quantifier, q :

$$\nu(qxA) = f_q(\{\nu(A_x(k_d)): d \in D\})$$

(In a free many-valued logic, ‘ D ’ is replaced by ‘ E ’.) For example, $\nu(\forall xA) = f_{\forall}(\{\nu(A_x(k_d)): d \in D\})$. Thus, the value of qxA is determined by the set of the values of substitution instances of A formed using the names of all members of the domain of quantification.

21.2.4 As in the propositional case, an inference is valid if it preserves designated values. Thus, $\Sigma \models A$ iff for every interpretation, whenever $\nu(B) \in \mathcal{D}$, for all $B \in \Sigma$, $\nu(A) \in \mathcal{D}$.

21.3 \forall and \exists

21.3.1 Of course, the main quantifiers in which we are interested (in this book, anyway) are the universal and particular quantifiers. So, given a many-valued logic, how would one expect f_{\forall} and f_{\exists} to behave?

21.3.2 In classical logic, the universal quantifier acts essentially like a conjunction over all the members of the domain. So $\forall xA$ is something like $A_x(k_{d_1}) \wedge A_x(k_{d_2}) \wedge \dots$, where d_1, d_2, \dots are all the members of the domain. Of course, if the domain is infinite, the conjunction is infinite, so one cannot actually express this in the language. (Though there are formal languages that permit infinite conjunctions and disjunctions.) But the sense is intuitively clear enough. Dually, the particular quantifier is something like a disjunction over all members of the domain: $\exists xA$ is $A_x(k_{d_1}) \vee A_x(k_{d_2}) \vee \dots$. It is natural to suppose that the two quantifiers should work the same way in a many-valued logic.

21.3.3 Taking this idea as our guide: in most many-valued logics, the truth values, ν , are ordered in a certain way; when this is the case, $\nu(A \wedge B)$ is naturally taken to be the greatest lower bound (*Glb*) of $\nu(A)$ and $\nu(B)$, that is, the greatest value that is less than or equal to $\nu(A)$ and $\nu(B)$ (see 11.4.9). If one of $\nu(A)$ and $\nu(B)$ is less than the other, then this is just the lesser of the two. But if neither is less than the other (which may happen if the order is not a linear one), then the *Glb* will be distinct from both of them. Thus, as we saw in 8.4, First Degree Entailment may be formulated as a four-valued logic, where the values are not linearly ordered. In *FDE*, if $\nu(A) = n$ and $\nu(B) = b$, then $\nu(A \wedge B) = 0$. Generalising this to the infinite case, it is natural to define $f_{\forall}(X)$ as *Glb*(X), so that $\nu(\forall xA)$ is the greatest lower bound of $\{\nu(A_x(k_d)) : d \in D\}$. Dually, in most logics with an ordering, $\nu(A \vee B)$ is naturally taken to be the least upper bound (*Lub*) of $\nu(A)$ and $\nu(B)$, that is, the least value greater than or equal to $\nu(A)$ and $\nu(B)$. So we may define $f_{\exists}(X)$ as *Lub*(X), and $\nu(\exists xA)$ is the least upper bound of $\{\nu(A_x(k_d)) : d \in D\}$.

21.3.4 There is a rub. In some orderings, some sets may have no *Glb* or *Lub*. Thus, consider the integers ordered in the usual way: $\dots, -2, -1, 0, 1, 2, \dots$. Any finite set of these has a *Glb* and a *Lub*, the least and the greatest member of the set, respectively. But the set of positive numbers has no upper bound at all, and *a fortiori*, no least upper bound. And the set of negative numbers has no lower bound, and *a fortiori*, no greatest lower bound. In cases where sets of semantic values may not have a *Glb* or a *Lub*, then, we cannot proceed in the way suggested. Fortunately, for the logics of concern in the present book, this is not something we will have to worry about.¹

¹ Interactions between the ordering and the set of designated values can also produce odd consequences. For example, if, in the ordering, there are undesigned values higher

21.4 Some 3-valued Logics

21.4.1 Let us apply these observations to the 3-valued logics we met in 7.3 and 7.4 (K_3 , L_3 , LP and RM_3). In these logics, the natural ordering of \mathcal{V} is the following: $0 < i < 1$. And it is not difficult to check the truth tables of 7.3 to see that conjunction and disjunction behave in the appropriate way with respect to this ordering. So $v(\forall xA) = \text{Glb}(\{v(A_x(k_d)) : d \in D\})$; and because this set is finite (it can have at most three members), and the values are linearly ordered, the greatest lower bound is the minimum (*Min*) of these values. Similarly, $v(\exists xA)$ is the maximum (*Max*) of the values in the set. Thus, $\forall xA$ takes the value 1 if all instantiations with the constants k_d take the value 1; it takes the value 0 if some instantiation takes the value 0; otherwise it takes the value i . Dually, $\exists xA$ takes the value 1 if some instantiation with a constant k_d takes the value 1; it takes the value 0 if all instantiations take the value 0; otherwise it takes the value i .

21.4.2 In each of the logics at hand, \mathcal{D} , \mathcal{V} , and the various f s are fixed, so a semantic structure can simply be taken to be of the form $\langle D, \nu \rangle$, where D is the domain of quantification, and ν assigns a denotation to each constant and predicate.

21.4.3 In this chapter we will not be concerned with tableau systems for these logics. Tableau systems for some of them will emerge in the next chapter. For the present, to establish that an inference is valid, one has to argue directly.

21.4.4 So, for example, here is an argument to show that

$$\forall x(Px \supset Qx) \vDash \exists xPx \supset \exists xQx$$

holds in K_3 and L_3 . (You will find it useful to have the truth tables of 7.3.2 and 7.3.8 in front of you.) Consider any interpretation, and suppose that the premise is designated, that is, has the value 1. Then, for every $d \in D$, $Pk_d \supset Qk_d$ takes the value 1. Now, suppose, for *reductio*, that $\exists xPx \supset \exists xQx$ is

than designated values, then it is possible for $v(\forall xA)$ to be designated whilst $v(A_x(a))$ is not. In this case, universal instantiation will fail to be valid. Consequences of this kind will also not feature in any of the particular many-valued logics with which we will be concerned in this book

not designated. There are four possible cases in K_3 :

$\exists xPx$	$\exists xQx$
1	i
1	0
i	0
i	i

In L_3 only the first three are possible. In the first two, there is a $d \in D$ such that Pk_d takes the value 1. Since $Pk_d \supset Qk_d$ takes the value 1, so does Qk_d , and so, contrary to supposition, does $\exists xQx$. In the third (and second), for every $d \in D$, Qk_d takes the value 0. Since $Pk_d \supset Qk_d$ takes the value 1, Pk_d takes the value 0. Hence, contrary to supposition, so does $\exists xPx$. In the last case (for K_3 only), there must be some $d \in D$ such that Pk_d takes the value i . But since $Pk_d \supset Qk_d$ takes the value 1, Qk_d takes the value 1, as then does $\exists xQx$, contrary to supposition.

21.4.5 Here is an argument to show that the same inference holds in LP and RM_3 . (Again, have the tables of 7.3.2 and 7.4.6 in front of you.) We argue by contraposition. Suppose that the conclusion is not designated. Then it takes the value 0. There are three cases for RM_3 :

$\exists xPx$	$\exists xQx$
1	0
1	i
i	0

and just the first for LP . In the first, there is a $d \in D$ such that Pk_d takes the value 1 and Qk_d takes the value 0. In this case, $Pk_d \supset Qk_d$ takes the value 0, as, then, does $\forall x(Px \supset Qx)$. In the second case, there is a $d \in D$ such that Pk_d takes the value 1, and for every $d \in D$, Qk_d takes the value of either i or 0. But then $Pk_d \supset Qk_d$ takes the value 0, as does $\forall x(Px \supset Qx)$. For the final case, for every $d \in D$, Qk_d takes the value 0, and for every $d \in D$, Pk_d takes the value 0 or i , with at least one taking that value. For this d , $Pk_d \supset Qk_d$ takes the value 0, as does $\forall x(Px \supset Qx)$.

21.4.6 To show that an inference is invalid, we have to construct a counter-model by trial and error. Thus, we show that

$$\exists xPx \wedge \exists xQx \not\equiv \exists x(Px \wedge Qx)$$

in the four logics in question as follows. We need an interpretation in which $\exists xPx$ and $\exists xQx$ are both designated. An easy way of obtaining this (in all the logics) is to suppose that there are $d_1, d_2 \in D$, such that Pk_{d_1} and Qk_{d_2} take the value 1. We also need $\exists x(Px \wedge Qx)$ to be undesignated. An easy way to obtain that is just to ensure that whenever Pk_d takes the value 1, Qk_d takes the value 0, and vice versa. Thus, a simple counter-model is the following: $D = \{a, b\}$, $v(a) = a$, $v(b) = b$, $v(P)$ and $v(Q)$ are the functions depicted as follows:

	$v(P)$	$v(Q)$
a	1	0
b	0	1

It is easy to see that (in all the logics at hand) in this interpretation the premise takes the value 1, and the conclusion takes the value 0. Hence, the inference is invalid.

21.5 Their Free Versions

21.5.1 It is not difficult to check that in all the 3-valued logics in our compass

$$Pa \models \exists xPx$$

$$\forall xPx \models Pa$$

Thus, for the first, if Pa is designated in an interpretation then $v(P)(v(a)) \in \mathcal{D}$, in which case $v(\exists xPx) \in \mathcal{D}$. But one might well have reservations about these inferences, as we have already observed in 12.6. And just as one can formulate a free version of classical logic, as we did in chapter 13, one can formulate free versions of many-valued logics.

21.5.2 We take the language to contain an existence predicate, \mathfrak{E} . An interpretation is a triple $\langle D, E, v \rangle$. D is the domain of all objects, and $E \subseteq D$ contains those that are thought of as existent. For every constant, c , $v(c) \in D$. For every n -place predicate, P , $v(P)$ is a function such that if $d_1, \dots, d_n \in D$, $v(P)(d_1, \dots, d_n) \in \mathcal{V}$. $v(\mathfrak{E})$ is such that:

$$v(\mathfrak{E})(d) \in \mathcal{D} \text{ iff } d \in E$$

Truth conditions are as in the non-free case, except that for the quantifiers $v(\forall xA) = \text{Min}(\{A_x(k_d) : d \in E\})$ (not D), and $v(\exists xA) = \text{Max}(\{A_x(k_d) : d \in E\})$.

21.5.3 It is now not difficult to construct counter-models to the inferences of 21.5.1. Details are left as an exercise.

21.5.4 To establish the validity or invalidity of inferences in the free version of a many-valued logic, we may proceed as in the non-free case. But note the special case of a free interpretation where $D = E$ is a non-free interpretation. Hence, anything valid in any many-valued free logic is valid in the corresponding non-free logic. Conversely, suppose that the inference with premises Σ and conclusion A is valid in one of our 3-valued logics. Let C be the set of constants that occur in A and all members of Σ , and let $\Pi = \{\mathcal{E}c : c \in C\} \cup \{\exists x\mathcal{E}x\}$. (The quantified sentence is redundant if $C \neq \emptyset$.) Then $\Pi \cup \Sigma \models A$ in the corresponding free logic (where quantifiers are inner). (This is true even when the language contains the identity predicate, and is proved in 21.11.6.)

21.6 Existence and Quantification

21.6.1 As with the two-valued case, in the free 3-valued logics we have been talking about, one can have outer quantifiers, ranging over the whole of D . The definability of the inner (existentially loaded) quantifiers in terms of the outer quantifiers and the existence predicate is, however, more problematic. If, as in 13.5.3, we write the outer quantifiers as \forall and \exists , and use a superscript E to indicate the existentially loaded quantifiers, what we require is:

1. $v(\exists^E xA) = v(\exists x(\mathcal{E}x \wedge A))$
2. $v(\forall^E xA) = v(\forall x(\mathcal{E}x \supset A))$

We know that $v(\mathcal{E}k_d) \in \mathcal{D}$ iff $d \in E$. If \mathcal{E} is a classical predicate, in the sense that for all $d \in D$, $v(\mathcal{E}k_d) = 1$ or $v(\mathcal{E}k_d) = 0$, these equations hold. The details are straightforward, and left as an exercise. (Check that if the lefthand side is 1, so is the righthand side. Then check the opposite direction. Do the same thing for 0. The case for i then follows.) If, however, existential statements may take the value i , things may go wrong. Consider an interpretation with

two members, d and e , as follows:

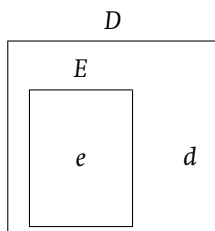

If ν is as follows:

	$\nu(\mathfrak{E})$	$\nu(P)$
d	i	1
e	1	0

this is a K_3 and L_3 interpretation. It is not difficult to check that $\nu(\exists^E xPx) = 0$, but $\nu(\mathfrak{E}k_d \wedge Pk_d) = i = \nu(\exists x(\mathfrak{E}x \wedge Px))$.

If ν is as follows:

	$\nu(\mathfrak{E})$	$\nu(P)$
d	0	0
e	i	1

this is an LP and RM_3 interpretation. It is not difficult to check that $\nu(\exists^E xPx) = 1$, but $\nu(\mathfrak{E}k_e \wedge Pk_e) = i = \nu(\exists x(\mathfrak{E}x \wedge Px))$. Hence, if the existence predicate is allowed to take non-classical values, inner quantifiers will have to be taken as primitive.

21.6.2 Arranging for this is a simple matter, and left as an exercise. However, it does raise the question of whether it makes sense for the existence predicate to have a non-classical value, the answer to which is not so obvious.

21.6.3 Suppose that we are in a logic where i is interpreted as *neither true nor false*. Could a sentence of the form $\mathfrak{E}a$ take this value? The answer depends on what sorts of thing one takes to be neither true nor false; but on certain views about this, the answer could be ‘yes’.

21.6.4 Some have argued that a sentence containing a non-denoting name has no truth value (see 7.8). If this is the case, and a does not denote anything,

$\mathcal{E}a$ has no truth value. But the claim about non-denotation is not very plausible as far as the existence predicate goes. Supposing that the name ‘Sherlock Holmes’ does not denote anything, it would seem that ‘Sherlock Holmes exists’ is false, not truth-valueless.

21.6.5 Aristotle argued that statements about a future state of affairs that is not, as yet, determined are neither true nor false (see 7.9). If this is correct then, arguably, ‘The first Pope of the 25th century will exist (but does not yet)’ or ‘Hilary will exist’ – where ‘Hilary’ rigidly designates the first Pope of the 25th century – is neither true nor false. But this seems wrong. If there is such a Pope, this is true.

21.6.6 Better arguments can be found if one subscribes to verificationism of some kind. This might be a philosophy of mathematics which identifies mathematical truth with provability; or it might be a philosophy of science which identifies truth with empirical verifiability. If one subscribes to such a view, and one can verify neither ‘ a exists’ nor its negation, for some suitable a , then this statement is neither true nor false. Thus, for example, ‘The author of the *Dao De Ching* in fact existed’, or ‘Laozi in fact existed’ might be of this kind.

21.6.7 As another example: some have argued that statements about the borderline range of some vague predicate are neither true nor false (see 11.3.6, 11.3.7). Thus, ‘Dana is an adult’, said of Dana around puberty, might be thought to be neither true nor false. But can existence be a vague predicate? Certainly: when people die they go out of existence (let us suppose). But dying can be a gradual process. Bodily functions do not normally all cease at once; there can therefore be a grey area where it is vague as to whether or not someone exists.

21.6.8 What of a logic where i is interpreted as *both true and false*. Could a sentence of the form $\mathcal{E}a$ be both true and false? Some have suggested that the statements about the borderline range of some vague predicate are both true and false. What intuition tells us, after all, is that the statement in question seems to be as true as it is false, as false as it is true; and, as far as that goes, the symmetric positions, *both* and *neither*, would seem to be as good as each other. Hence, borderline cases of existence might deliver existence statements that are both true and false.

21.6.9 One final example. Some have argued that paradoxical sentences generated by the paradoxes of self-reference are both true and false (see 7.7). Some of these can be existence statements, as in Berry's paradox, which is as follows. Consider all those (whole) numbers that can be specified in English by a (context-independent) description with less than, say, 100 words. There is a finite number of these, so there are many numbers that cannot be so specified. There must therefore be a least. But there cannot be such a number, since if it did exist it would be specified by the description 'the least (whole) number that cannot be specified in English by a description with less than 100 words'. The least whole number that cannot be specified in English by a description with less than 100 words both does and does not, therefore, exist. So paradoxes of self-reference may deliver existence statements that are both true and false.

21.7 Neutral Free Logics

21.7.1 In 13.4 we noted that free logics can be classified as positive, negative, or neutral. In positive free logics, applying a predicate to a non-existent object can result in any semantic value. In negative logics, it always results in the value *false* (0). In a neutral logic it is always *neither true nor false* (*i*). We looked at positive and negative free logics in chapter 13. We are now in a position to see what a neutral free logic is like.

21.7.2 A neutral free logic is a logic with a value which may be thought of as neither true nor false, such as *i* in K_3 or \mathcal{L}_3 (or the value *n* in *FDE* – see the next chapter), which satisfies the condition that for any *n*-place predicate:

$$\text{if, for some } 1 \leq j \leq n, d_j \notin E, \text{ then } v(P)(d_1, \dots, d_n) = i.$$

Call this the *Neutrality Constraint*. (Depending on the context, the converse condition might also be plausible: if $v(P)(d_1, \dots, d_n) = i$ then, for some $1 \leq j \leq n, d_j \notin E$. Only non-existent objects give rise to truth value gaps.) Note that the Negativity Constraint can be added just as much to a many-valued logic as it can be to a two-valued logic, giving rise to a many-valued negative free logic.

21.7.3 Neutral free logics can be formulated in a different, but equivalent, way. We may dispense with the ‘outer domain’ altogether. The only domain we need is E . Instead of taking the denotation function for names, v , to be a *total* function, we let it be *partial*. That is, for some inputs the output may just not be defined – just as division is not defined if the divisor is zero. (Division is, in fact, a partial function.) The appropriate truth conditions for atomic sentences are then:

$$\begin{aligned} &\text{if } v(a_1) = d_1, \dots, v(a_n) = d_n \text{ then } v(Pa_1 \dots a_n) = v(P)(d_1 \dots d_n) \\ &\text{if any of } v(a_1), \dots, v(a_n) \text{ is undefined, } v(Pa_1 \dots a_n) = i. \end{aligned}$$

It is not difficult to see that the truth value of any sentence comes out the same under this policy. (The truth conditions make this clear for atomic sentences. For other formulas, this follows by a simple induction.)

21.7.4 Note that we can follow the same strategy with respect to negative free logics as well. The denotation function for names is taken to be partial, and the truth conditions of atomic sentences are given as in 21.7.3, replacing ‘= i ’ with ‘ $\neq 1$ ’.²

21.7.5 The Neutrality Constraint gives rise to valid inferences that are not valid in a positive free logic. For example, as is easy to check, $Pa_1 \dots a_n \models \mathcal{E}a_1 \wedge \dots \wedge \mathcal{E}a_n$ and $\neg Pa_1 \dots a_n \models \mathcal{E}a_1 \wedge \dots \wedge \mathcal{E}a_n$. Negative free logics make the first of these valid, but not the second.

21.7.6 Neutral free logics are usually motivated by examples such as ‘The greatest prime number is even’ and ‘The King of France is bald’. But note that one would seem to have to make exceptions for the existence predicate itself. For it would seem that ‘The greatest prime number exists’ and ‘The King of France exists’ are both false, not neither true nor false. And once one has made an exception for one predicate, it seems somewhat arbitrary not to admit other exceptions, such as those we noted in connection with negative free logics in 13.4.6.

² An even stronger constraint replaces ‘= i ’ with ‘= 0’. But this constraint, equivalent in a classical context, is less natural in a many-valued context. The intuition behind the Negativity Constraint is simply that atomic sentences containing names that do not refer to (existent) objects cannot be true.

21.7.7 Hence, though some sentences with non-denoting terms may be neither true nor false, not all would seem to be; the most appropriate free logic, even in a many-valued context, would appear to be a positive one.

21.8 Identity

21.8.1 If we now suppose that one of the predicates in the language is the identity predicate, then the natural truth conditions for this are:

$$v(=)(d_1, d_2) \in \mathcal{D} \text{ iff } d_1 = d_2$$

21.8.2 It is not difficult to check that $\models a = a$ and $a = b, Pa \models Pb$. Thus, for the second of these, suppose that in an interpretation $a = b$ is designated. Then $v(a) = v(b)$. So $v(P)(v(a)) \in \mathcal{D}$ iff $v(P)(v(b)) \in \mathcal{D}$.

21.8.3 Similarly, it is not difficult to check that $a = b \models b = a$ and $a = b, b = c \models a = c$. More generally, $a = b, A_x(a) \models A_x(b)$; for the proof of this, see 21.11.4. Note that this fact in no way depends on identities taking only classical values. Identities may well take the value i in LP or RM_3 (or b in FDE).

21.8.4 If we are in a logic where i is thought of as *neither true nor false*, and we enforce the neutrality constraint, then the truth conditions for identity become:

$$\begin{aligned} \text{if } v(a) \in E \text{ and } v(b) \in E \text{ then } v(=)(a, b) \in \mathcal{D} \text{ iff } v(a) = v(b) \\ \text{if } v(a) \notin E \text{ or } v(b) \notin E \text{ then } v(=)(a, b) = i \end{aligned}$$

(which makes sense provided that $i \notin \mathcal{D}$). Or, if we dispense with the outer domain, and take the denotation function to be a partial function:

$$\begin{aligned} \text{if } v(a) \text{ and } v(b) \text{ are defined then } v(=)(a, b) \in \mathcal{D} \text{ iff } v(a) = v(b) \\ \text{if either } v(a) \text{ or } v(b) \text{ is not defined then } v(=)(a, b) = i \end{aligned}$$

21.8.5 It is clear that it will not now be the case that $\models a = a$. (Take $v(a)$ to be not in E , or undefined.) However it is still the case that $a = b, Pa \models Pb$. If the first premise is true, then $v(a)$ and $v(b)$ are both in E (or defined), and the argument then proceeds as in 21.8.2. Indeed, more generally, $a = b, A_x(a) \models A_x(b)$. The proof is to be found in 21.11.4.

21.8.6 Note that, given the neutrality constraint, $a = b \models \mathfrak{E}a \wedge \mathfrak{E}b$ and $\mathfrak{E}a \models a = a$, as is easy to check.

21.9 Non-classical Identity

21.9.1 This raises the question of whether it is plausible to suppose that identity statements may take non-classical values, that is, values other than 0 and 1.

21.9.2 The considerations of 21.6 about existence statements and non-classical truth values seem to apply just as much to identity statements. I leave the reader to think about plausible candidates for non-classical identity statements in the sorts of situation discussed there.

21.9.3 I will just take up one of them in more detail: vagueness. Suppose that I have two motorbikes, a and b . Suppose that I dismantle a and, over a period of time, replace each part of b with the corresponding part of a . At the start, the machine is b ; at the end, it is a . Let us call the object somewhere in the middle of the transition c . Is it true that $c = a$ (or $c = b$)? It is not clear; we would seem to be in a borderline situation, so the identity predicate can be a vague one. And if one takes vague predicates to have a non-classical value (*both true and false* or *neither true nor false*) when applied to borderline cases, then there are identity statements that take such values.

21.9.4 There is a well-known argument (due to Gareth Evans) against this possibility, however. Let us say that an identity is *indeterminate* if the statement expressing it takes the value i . The argument goes as follows. Suppose that it is indeterminate whether $a = b$. It is determinately true that $a = a$, so a and b have different properties, and thus, $a \neq b$. Thus, the identity is not indeterminate: it is false. There are therefore no indeterminate identities.

21.9.5 To analyse this argument, let us suppose that we are using one of our 3-valued logics; let us write ∇ for ‘it is indeterminate that’, and suppose that:

$$\begin{aligned} v(\nabla A) \in \mathcal{D} & \text{ if } v(A) = i \\ v(\nabla A) = 0 & \text{ otherwise} \end{aligned}$$

Then the argument is simply:

$$\begin{aligned} \text{Suppose that } & \nabla a = b & (1) \\ \text{Then since } & \neg \nabla a = a & (2) \\ \text{It follows that } & a \neq b & (3) \end{aligned}$$

The inference is a contraposed form of SI; SI itself we know to be valid.

21.9.6 Now it is clear that as an argument against the possibility of indeterminate identities, the argument must fail. It is quite possible for identity statements to take the value i in all these logics. What, however, is wrong with it?

21.9.7 That depends. Suppose, for a start, that we are in a logic with truth value gaps. Then the inference from (1) and (2) to (3) is invalid. Consider the K_3 or \mathcal{L}_3 evaluation in which:

$$\begin{aligned} v(=)(d, e) &= 1 \text{ if } v(d) = v(e) \\ v(=)(d, e) &= i \text{ if } v(d) \neq v(e) \end{aligned}$$

Let a and b denote distinct objects. Then $a = b$ has the value i , so $\nabla a = b$ has the value 1. $a = a$ has the value 1, so $\neg \nabla a = a$ has the value 1. But $a = b$ and so its negation, has the value i .

21.9.8 In LP and RM_3 , the inference is valid, even without the second premise. Suppose that the value of $\nabla a = b$ is designated. Then the value of $a = b$ is i . So the value of the conclusion, $a \neq b$, is also designated. But this does not rule out indeterminate identity statements. Consider an LP or RM_3 interpretation in which:

$$\begin{aligned} v(=)(d, e) &= i \text{ if } v(d) = v(e) \\ v(=)(d, e) &= 0 \text{ if } v(d) \neq v(e) \end{aligned}$$

Let a and b denote the same object, then (1), (2) and (3) are all designated. Yet $a = b$ has the value i .

21.10 Supervaluations and Subvaluations

21.10.1 Let us end by noting how the techniques of supervaluations and subvaluations extend to first-order logic. For propositional logic, see 7.10.3–7.10.5d. (I deal only with the non-free cases. Analogous considerations apply in the free cases.) I will consider supervaluations in detail, and leave subvaluations largely as an exercise.

21.10.2 Let $\mathfrak{J} = \langle D, v \rangle$ and $\mathfrak{J}' = \langle D, v' \rangle$ be any K_3 interpretations. Define $\mathfrak{J} \leq \mathfrak{J}'$ to mean that \mathfrak{J}' is a classical interpretation which is the same as \mathfrak{J} , except that for any n -place predicate, P , and every $d_1, \dots, d_n \in D$, such that $v(P)(d_1, \dots, d_n) = i$, $v'(P)(d_1, \dots, d_n)$ is either 1 or 0. Call \mathfrak{J}' a *resolution* of \mathfrak{J} .

21.10.3 Given any interpretation, \mathcal{I} , let the supervaluation of a formula, A , be a map, v^+ such that:

$$\begin{aligned} v^+(A) = 1 & \quad \text{iff for all } \mathcal{I}', \text{ such that } \mathcal{I} \leq \mathcal{I}', v'(A) = 1 \\ v^+(A) = 0 & \quad \text{iff for all } \mathcal{I}', \text{ such that } \mathcal{I} \leq \mathcal{I}', v'(A) = 0 \\ v^+(A) = i & \quad \text{otherwise} \end{aligned}$$

Now define a notion of supervaluation validity (*supervalidity*), $\Sigma \models^S A$, in the natural way:

$$\Sigma \models^S A \text{ iff for every interpretation } \mathcal{I}, \text{ if } v^+(B) = 1 \text{ for all } B \in \Sigma, v^+(A) = 1$$

21.10.4 Then $\Sigma \models^S A$ iff the inference is classically valid. For suppose that the inference is not classically valid. Let \mathcal{I} be a classical interpretation that makes all the premises true and the conclusion false. Then \mathcal{I} is a K_3 interpretation, and it is the only resolution of itself. Hence, the inference is not supervalid.³ Conversely, suppose that the inference is not supervalid. Then there is a K_3 interpretation, \mathcal{I} , such that for every premise $B \in \Sigma$, $v^+(B) = 1$, and $v^+(A) \neq 1$. Hence, there is a resolution of \mathcal{I} , \mathcal{I}' , which makes the conclusion false and the premises true. Hence, the inference is not classically valid.

21.10.5 Just as in the propositional case (7.10.5), one can formulate a multiple-conclusion version of classical first-order logic (and most other first-order logics). An inference is valid if every interpretation that makes every premise true makes some conclusion true. And as in the propositional case, the equivalence between classical validity and supervalidity breaks down here, since the classically valid $A \vee B \models A, B$ is not supervalid. (Details are left as an exercise.)

21.10.6 But, again as in the propositional case (7.10.5a), define an inference to be valid iff for every K_3 interpretation, every resolution that makes every premise true makes some (or the, in the single conclusion case) conclusion true. Since the set of resolutions of K_3 interpretations is exactly the set of classical interpretations, this notion of validity is equivalent to classical validity.

³ As in the propositional case (7.10.4), it may make sense to define the supervaluation of an interpretation over some subset of its resolutions. In this case, this half of the argument may fail.

21.10.7 As we saw in 7.10.5b and 7.10.5c, the supervaluation technique for propositional K_3 can be dualised to LP to give subvaluations. Exactly the same is true in the first-order case. The details are routine, and left as an exercise. (See 21.4, question 13.)

21.11 *Proofs of Theorems

21.11.1 In this appendix, we prove the technical claims made in the chapter.

21.11.2 LEMMA (LOCALITY): Let $\langle D, (E,)\mathcal{V}, \mathcal{D}, \{f_c: c \in C\}, \{f_q: q \in Q\}, \nu_1 \rangle$ and $\langle D, (E,)\mathcal{V}, \mathcal{D}, \{f_c: c \in C\}, \{f_q: q \in Q\}, \nu_2 \rangle$ be two many-valued interpretations. Since they have the same domain, the language of the two is the same. Call this L . If A is any closed formula of L such that ν_1 and ν_2 agree on the denotations of all the predicates and constants in it then:

$$\nu_1(A) = \nu_2(A)$$

Proof:

The result is proved by recursion on formulas. For atomic formulas:

$$\begin{aligned} \nu_1(Pa_1 \dots a_n) &= \nu_1(P)(\nu_1(a_1), \dots, \nu_1(a_n)) \\ &= \nu_2(P)(\nu_2(a_1), \dots, \nu_2(a_n)) \\ &= \nu_2(Pa_1 \dots a_n) \end{aligned}$$

For any n -place connective, c :

$$\begin{aligned} \nu_1(c(A_1, \dots, A_n)) &= f_c(\nu_1(A_1), \dots, \nu_1(A_n)) \\ &= f_c(\nu_2(A_1), \dots, \nu_2(A_n)) \quad \text{IH} \\ &= \nu_2(c(A_1, \dots, A_n)) \end{aligned}$$

For every quantifier, q :

$$\begin{aligned} \nu_1(qxB) &= f_q(\{\nu_1(A_x(k_d)): d \in D\}) \\ &= f_q(\{\nu_2(A_x(k_d)): d \in D\}) \quad (*) \\ &= \nu_2(qxB) \end{aligned}$$

The line marked (*) follows from IH, and the fact that $\nu_1(k_d) = \nu_2(k_d) = d$. In the case of a free logic, D is replaced by E . ■

21.11.3 LEMMA (DENOTATION): Let $\mathcal{J} = \langle D, (E, \nu, \mathcal{D}, \{f_c: c \in C\}, \{f_q: q \in Q\}, \nu) \rangle$ be any interpretation. Let A be any formula of $L(\mathcal{J})$ with at most one free variable, x , and a and b be any two constants such that $\nu(a) = \nu(b)$. Then:

$$\nu(A_x(a)) = \nu(A_x(b))$$

Proof:

The proof is by recursion on formulas. For atomic formulas I assume that the formula has one occurrence of 'a' for the sake of illustration:

$$\begin{aligned} \nu(Pa_1 \dots a \dots a_n) &= \nu(P)(\nu(a_1), \dots, \nu(a), \dots, \nu(a_n)) \\ &= \nu(P)(\nu(a_1), \dots, \nu(b), \dots, \nu(a_n)) \\ &= \nu(Pa_1 \dots b \dots a_n) \end{aligned}$$

If c is any n -place connective:

$$\begin{aligned} \nu(c(A_{1x}(a), \dots, A_{nx}(a))) &= f_c(\nu(A_{1x}(a)), \dots, \nu(A_{nx}(a))) \\ &= f_c(\nu(A_{1x}(b)), \dots, \nu(A_{nx}(b))) \quad \text{IH} \\ &= \nu(c(A_{1x}(b), \dots, A_{nx}(b))) \end{aligned}$$

And if q is any quantifier, let A be of the form qyB . If x is the same variable as y then $A_x(a)$ and $A_x(b)$ are just A , so the result is trivial. So suppose that x and y are distinct variables.

$$\begin{aligned} \nu((qyB)_x(a)) &= \nu(qy(B_x(a))) \\ &= f_q(\{\nu((B_x(a))_y(k_d)): d \in D\}) \\ &= f_q(\{\nu((B_y(k_d))_x(a)): d \in D\}) \\ &= f_q(\{\nu((B_y(k_d))_x(b)): d \in D\}) \quad \text{IH} \\ &= f_q(\{\nu((B_x(b))_y(k_d)): d \in D\}) \\ &= \nu(qy(B_x(b))) \\ &= \nu((qyB)_x(b)) \end{aligned}$$

In the case of a free logic, D is replaced by E . ■

21.11.4 LEMMA (SI): In any many-valued logic, $a = b, A_x(a) \vDash A_x(b)$ (even if the Neutrality or Negativity Constraints are in operation).

Proof:

Consider any interpretation in which $\nu(a = b), \nu(A_x(a)) \in \mathcal{D}$. Then $\nu(a) = \nu(b)$, and so $\nu(A_x(b)) \in \mathcal{D}$ by the Denotation Lemma.

21.11.5 Finally, the proof of the fact mentioned in 21.5.4. ■

21.11.6 THEOREM: Suppose that the inference with premises Σ and conclusion A is valid in one of our 3-valued logics. Let C be the set of constants that occur in A or in any member of Σ , and let $\Pi = \{\mathfrak{C}c: c \in C\} \cup \{\exists x\mathfrak{C}x\}$. (The quantified sentence is redundant if $C \neq \phi$.) Then $\Pi \cup \Sigma \models A$ in the corresponding free logic (where quantifiers are inner).

Proof:

Suppose that $\Pi \cup \Sigma \not\models A$. Let $\mathfrak{J} = \langle D, E, v \rangle$ be any free many-valued interpretation that designates all the premises but not the conclusion. In particular, $E \neq \phi$. Let d be some member of E , and let \mathfrak{J}' be the interpretation $\langle D, E, v' \rangle$, which is the same as \mathfrak{J} , except that if $c \notin C$, $v'(c) = d$. By the Locality Lemma, the truth values of A and the members of Σ are the same in \mathfrak{J}' . Let $\mathfrak{J} = \langle E, \mu \rangle$, where μ is the same as v' , except that for any n -place predicate, P , $\mu = v' \upharpoonright E$ (the restriction of v' to the members of E). This is a classical interpretation (even if the logic is neutral or negative, and identity is present). We show that if B is any sentence of $L(\mathfrak{J})$, then B has the same truth value in \mathfrak{J}' and \mathfrak{J} . The result follows. The proof is by induction on B . The basis case and the cases for the connectives are entirely trivial. The cases for the quantifiers are nearly so. For \exists :

$$\begin{aligned} \mu(\exists xA) &= \text{Max}(\{\mu(A_x(k_d)): d \in E\}) \\ &= \text{Max}(\{v'(A_x(k_d)): d \in E\}) \quad \text{IH} \\ &= v'(\exists xA) \end{aligned}$$

The case for \forall is similar. ■

21.12 History

The earliest papers on quantified many-valued logics seem to have been Rosser (1939), Rosser and Turquette (1948) and (1951), and Turquette (1958). Another early paper is Mostowski (1961). There has been a sporadic literature on quantified many-valued logic since then. For the history of quantified continuum-valued logic, see 25.9. Very little of a systematic nature seems to have been written on identity in many-valued logics.

For the history of the views described in 21.6, See 7.12 and 11.8. The first of these also describes the history of the notion of supervaluation (and subvaluation). For the history of free logic, see 13.8. The argument of 21.9.4 appeared in Evans (1978).

21.13 Further Reading

There are sections or chapters on quantified many-valued logics in Rescher (1969), Urquhart (1986), Blamey (1986) and Malinowski (1993).

For further reading on the issues in 21.6, see 7.13 and 11.9. On vagueness, gaps and gluts, see Hyde (1997); on identity sorites arguments, see Priest (1998). For an overview of free logic, see Lambert (1981), and also the essays in Lambert (1991) (chapter 4 by van Fraassen, ‘Singular Terms, Truthvalue Gaps, and Free Logic’, is a classical statement of a neutral free logic employing supervaluations). Evans’ argument generated a number of discussions. These are surveyed in section 5 of the introduction to Keefe and Smith (1997).

21.14 Problems

1. Check the details omitted in 21.5.3, 21.6.1, 21.6.2, 21.8.6, 21.9.2 and 21.10.5.
2. Determine whether the following hold in (the non-free versions of) K_3 , L_3 , LP and RM_3 . If the inference is valid give an argument to this effect; if it is invalid, specify a counter-model.
 - (a) $\forall xPx \models \exists xPx$
 - (b) $\models \forall xPx \supset \exists xPx$
 - (c) $\neg\exists xPx \models \forall x\neg Px$
 - (d) $\neg\forall xPx \models \exists x\neg Px$
 - (e) $\forall x(Px \vee Qx) \models Px \vee \forall xQx$
 - (f) $\forall x(Px \supset Qx) \models \exists x\neg Px \vee \exists xQx$
 - (g) $\forall x(\neg Px \vee Qx) \models \exists xPx \supset \exists xQx$
3. Does moving to the free version of each logic make any difference to the inferences in question 2?
4. Check the facts of 12.4.14, question 5, in the logics K_3 , L_3 , LP and RM_3 . (Hint: test the statement with corresponding conjunctions and disjunctions first. Thus, for example, if you are examining the inference from $\exists x(A \supset C)$ to $\forall xA \supset C$, have a look at the inference from $(A \supset C) \vee (B \supset C)$ to $(A \wedge B) \supset C$ first.)
5. Are there any logical truths in each of quantified (non-free) K_3 , L_3 , LP , and RM_3 ? Give an example or explain why not.
6. Assuming that some sentences have non-classical truth values, is there any reason for supposing that statements of existence cannot be amongst them?

7. Consider a statement about the borderline area of a vague predicate. What considerations, intrinsic to the situation, might lead one to suppose that its value was a truth value gap, rather than a glut, or vice versa?
8. Let L be the positive free logic based on K_3 or L_3 . Let Neg and Neu be the corresponding negative and neutral free logics. (That is, the logics obtained by adding the Negativity or Neutrality Constraints, respectively.) L is a sub-logic of each of these. (Why?) Give inferences to show that each is a proper extension of L . Give inferences to show that neither is an extension of the other.
9. Check to see which of the following hold in K_3 , L_3 , LP , and RM_3 (without the Neutrality or Negativity Constraints). If the inference is valid show it to be so by giving an appropriate argument. If it is invalid, give a counter-model.
- (a) $a = b \vDash Pa \supset Pb$
 (b) $\vDash (a = b \wedge Pa) \supset Pb$
 (c) $\vDash a = b \supset (Pa \supset Pb)$
10. Does the addition of the Neutrality Constraint in the case of K_3 and L_3 make any difference?
11. Let $\mathfrak{I}_1 = \langle D, v_1 \rangle$ and $\mathfrak{I}_2 = \langle D, v_2 \rangle$ be any K_3 or LP interpretations. Write $\mathfrak{I}_1 \preceq \mathfrak{I}_2$ to mean that for every n -place predicate, and $d_1, \dots, d_n \in D$:

$$\begin{aligned} &\text{if } v_1(P)(d_1, \dots, d_n) = 0 \text{ then } v_2(P)(d_1, \dots, d_n) = 0 \\ &\text{if } v_1(P)(d_1, \dots, d_n) = 1 \text{ then } v_2(P)(d_1, \dots, d_n) = 1 \end{aligned}$$

Show by induction that if $\mathfrak{I}_1 \preceq \mathfrak{I}_2$ then the displayed conditions hold for all formulas in the language of the interpretations. Does the same hold for L_3 and RM_3 ?

12. Show that something is a logical truth in classical logic with identity iff it is a logical truth in LP . (Hint: see 7.14, question 5.)
13. Work out the details of subvaluations for first-order LP . (Go through the details of supervaluations in 21.10, and modify appropriately.)

22 First Degree Entailment

22.1 Introduction

22.1.1 The present chapter is devoted to another many-valued logic, one that will lead us into a discussion of relevant logic: First Degree Entailment (*FDE*).

22.1.2 We start with the relational semantics for *FDE*, and see that this is equivalent to a many-valued semantics.

22.1.3 We will then look at tableaux for quantified *FDE*, in the process obtaining tableau systems for the 3-valued logics of the last chapter.

22.1.4 A quick look at free logics in the context of relational semantics is next on the agenda.

22.1.5 After that, we move on to the $*$ semantics and tableaux for *FDE*, and note their equivalence with the relational semantics.

22.1.6 Finally, we will look at the behaviour of identity in both semantics for *FDE*.

22.1.7 The philosophical issues that tend to be raised by quantification and identity in *FDE* are much the same as those which we met in connection with the three-valued logics of the last chapter. There is therefore no new philosophical discussion in this chapter.

22.2 Relational and Many-valued Semantics

22.2.1 An interpretation for quantified *FDE* is a structure $\langle D, \nu \rangle$, where D is the non-empty domain of quantification. For every constant in the language, c , $\nu(c) \in D$, and for every n -place predicate, P , $\nu(P)$ is a pair $\langle \mathcal{E}, \mathcal{A} \rangle$, where \mathcal{E}

and \mathcal{A} are subsets of D^n . \mathcal{E} is the *extension* of P (the set of things of which P is true); \mathcal{A} is the *anti-extension* (the set of things of which it is false). We will write these as $v^{\mathcal{E}}(P)$ and $v^{\mathcal{A}}(P)$, respectively.

22.2.2 Given an interpretation, we define a relationship, ρ , between formulas and truth values (1 and 0) recursively as follows:

$$\begin{aligned} Pa_1 \dots a_n \rho 1 & \text{ iff } \langle v(a_1), \dots, v(a_n) \rangle \in v^{\mathcal{E}}(P) \\ Pa_1 \dots a_n \rho 0 & \text{ iff } \langle v(a_1), \dots, v(a_n) \rangle \in v^{\mathcal{A}}(P) \end{aligned}$$

The truth and falsity conditions for the connectives are as in the propositional case (8.2.6). For the quantifiers:

$$\begin{aligned} \forall x A \rho 1 & \text{ iff for all } d \in D, A_x(k_d) \rho 1 \\ \forall x A \rho 0 & \text{ iff for some } d \in D, A_x(k_d) \rho 0 \\ \exists x A \rho 1 & \text{ iff for some } d \in D, A_x(k_d) \rho 1 \\ \exists x A \rho 0 & \text{ iff for all } d \in D, A_x(k_d) \rho 0 \end{aligned}$$

22.2.3 As in the propositional case, validity is defined in terms of preservation of truth: $\Sigma \models A$ iff for every interpretation where $B \rho 1$, for all $B \in \Sigma$, $A \rho 1$.

22.2.4 Given any interpretation, negation and the quantifiers behave in the familiar fashion:

$$\begin{aligned} \neg \exists x A \rho 1 [0] & \text{ iff } \forall x \neg A \rho 1 [0] \\ \neg \forall x A \rho 1 [0] & \text{ iff } \exists x \neg A \rho 1 [0] \end{aligned}$$

For the 1-case of the first:

$$\begin{aligned} \neg \exists x A \rho 1 & \text{ iff } \exists x A \rho 0 \\ & \text{ iff for every } d \in D, A_x(k_d) \rho 0 \\ & \text{ iff for every } d \in D, \neg A_x(k_d) \rho 1 \\ & \text{ iff } \forall x \neg A \rho 1 \end{aligned}$$

The other cases are left as exercises.

22.2.5 As in the propositional case of 8.4, a relational interpretation for FDE can be reformulated as a many-valued interpretation with the values *true* (only), *false* (only), *both* and *neither* – 1, 0, b , n – and designated values $\{1, b\}$. In particular, what corresponds to a relational evaluation, v , is a many-valued

evaluation, μ , such that for any m -place predicate, P , $\mu(P)(d_1, \dots, d_m)$ is:

- 1 iff $\langle d_1, \dots, d_m \rangle \in v^{\mathcal{E}}(P)$ and $\langle d_1, \dots, d_m \rangle \notin v^{\mathcal{A}}(P)$
- b iff $\langle d_1, \dots, d_m \rangle \in v^{\mathcal{E}}(P)$ and $\langle d_1, \dots, d_m \rangle \in v^{\mathcal{A}}(P)$
- n iff $\langle d_1, \dots, d_m \rangle \notin v^{\mathcal{E}}(P)$ and $\langle d_1, \dots, d_m \rangle \notin v^{\mathcal{A}}(P)$
- 0 iff $\langle d_1, \dots, d_m \rangle \notin v^{\mathcal{E}}(P)$ and $\langle d_1, \dots, d_m \rangle \in v^{\mathcal{A}}(P)$

The truth conditions of the connectives deliver the truth tables of 8.4.2, and the truth conditions of the quantifiers deliver the fact that the value of $\forall xA$ is the *Glb* of the values of the formulas $A_x(k_d)$, for $d \in D$, in the lattice of 8.4.3; and that the value of $\exists xA$ is the *Lub* of the values of the formulas $A_x(k_d)$, for $d \in D$.

Consider the *Glb* of the values of formulas in the set $\{A_x(k_d) : d \in D\}$. There are four possible values for this:

- 1:** In this case, for all $d \in D$ the value of $A_x(k_d)$ is 1. So for all $d \in D$, $A_x(k_d)$ is true and not false, so $\forall xA$ is true and not false; that is, the value of $\forall xA$ is 1.
- b:** In this case, for all $d \in D$ the value of $A_x(k_d)$ is 1 or b , and at least one is b . That is, for all $d \in D$, $A_x(k_d)$ is true, and at least one is false. Hence, $\forall xA$ is true and false; that is, the value of $\forall xA$ is b .
- n:** In this case, for all $d \in D$ the value of $A_x(k_d)$ is 1 or n , and at least one is n . That is, for all $d \in D$, $A_x(k_d)$ is not false, and at least one is not true. Hence, $\forall xA$ is neither true nor false; that is, the value of $\forall xA$ is n .
- 0:** In this case, either there is some $d \in D$ such that the value of $A_x(k_d)$ is 0, or this is not the case, but there are $d, e \in D$, such that the value of $A_x(k_d)$ is b and that of $A_x(k_e)$ is n . In the first case, $A_x(k_d)$ is false and not true, so $\forall xA$ is false and not true; that is, its value is 0. In the second case, $A_x(k_d)$ is both true and false, and $A_x(k_e)$ is neither. So $\forall xA$ is false but not true; that is, its value is 0.

The case for \exists is similar, and is left as an exercise.

22.2.6 Finally, consider the following constraints:

- Exclusion:* for every m -place predicate, P , and $d_1, \dots, d_m \in D$, $\langle d_1, \dots, d_m \rangle \notin v^{\mathcal{E}}(P) \cap v^{\mathcal{A}}(P)$ (or, in the many-valued formulation, $v(P)(d_1, \dots, d_m) \neq b$).
- Exhaustion:* for every m -place predicate, P , and $d_1, \dots, d_m \in D$, $\langle d_1, \dots, d_m \rangle \in v^{\mathcal{E}}(P) \cup v^{\mathcal{A}}(P)$ (or, in the many-valued formulation, $v(P)(d_1, \dots, d_m) \neq n$).

If we impose the first of these, then clearly no atomic formula is both true and false (or, in the many-valued case, takes the value b). The same follows for all formulas, as a simple induction shows. (The cases for the connectives are as in 8.4.6, and the cases for the quantifiers are left as an exercise.) In this case we obtain quantified K_3 . Dually, if we impose the second constraint, then no formula is neither true nor false (or, in the many-valued case, takes the value n). (The induction cases for the connectives are as in 8.4.9, and the cases for the quantifiers are left as an exercise.) In this case we obtain quantified LP . If we impose both constraints, we have classical logic.

22.3 Tableaux

22.3.1 Tableaux for quantified FDE are obtained by adding the appropriate quantifier rules to the propositional rules of 8.3.4. These are:

$$\begin{array}{ccc}
 \forall xA, + & \forall xA, - & \neg\forall xA, \pm \\
 \downarrow & \downarrow & \downarrow \\
 A_x(a), + & A_x(c), - & \exists x\neg A, \pm \\
 \\
 \exists xA, + & \exists xA, - & \neg\exists xA, \pm \\
 \downarrow & \downarrow & \downarrow \\
 A_x(c), + & A_x(a), - & \forall x\neg A, \pm
 \end{array}$$

where a is any constant on the branch, or a new one if there is none; c is a constant new to the branch; and \pm can be disambiguated consistently either way.

22.3.2 Here is a tableau to show that $\forall x(A \wedge B) \vdash \forall xA \wedge \forall xB$. c is a constant new to the branch.

$$\begin{array}{cc}
 \forall x(A \wedge B), + & \\
 \forall xA \wedge \forall xB, - & \\
 \swarrow & \searrow \\
 \forall xA, - & \forall xB, - \\
 A_x(c), - & B_x(c), - \\
 A_x(c) \wedge B_x(c), + & A_x(c) \wedge B_x(c), + \\
 A_x(c), + & A_x(c), + \\
 B_x(c), + & B_x(c), + \\
 \times & \times
 \end{array}$$

22.3.3 Here is another to show that $\forall xPx, \forall x(Px \supset Qx) \not\vdash \forall xQx$. (Recall that $A \supset B$ is just $\neg A \vee B$.)

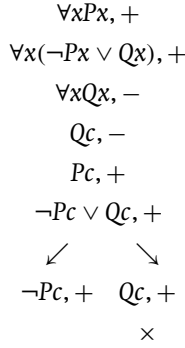

22.3.4 To read off a counter-model from an open branch, we set $D = \{\partial_a : a \text{ is a constant on the branch}\}$, and $v(a) = \partial_a$. The extension of a predicate, P , comprises just those things that will make $Pa_1 \dots a_n$ true if $Pa_1 \dots a_n, +$ occurs on the branch, and the anti-extension comprises just those things that will make $Pa_1 \dots a_n$ false if $\neg Pa_1 \dots a_n, +$ occurs. (Note that we look at the pluses, not the minuses.)

22.3.5 Thus, in the counter-model determined by the open branch of the tableau of 22.3.3, $D = \{\partial_c\}$, $v(c) = \partial_c$, $v^E(P) = v^A(P) = \{\partial_c\}$, $v^E(Q) = v^A(Q) = \emptyset$. The interpretation may be depicted thus:

	$v^E(P)$	$v^A(P)$	$v^E(Q)$	$v^A(Q)$
∂_c	✓	✓	×	×

It is not difficult to see that Pc and $\neg Pc \vee Qc$ are true, as, therefore, are $\forall xPx$ and $\forall x(\neg Px \vee Qx)$; but Qc is not true, so $\forall xQx$ is not true.

22.3.6 A many-valued interpretation can be read off from an open branch in the obvious way. Thus, for the interpretation of 22.3.5, the corresponding many-valued interpretation is the same, except that $v(P)(\partial_c) = b$ and $v(Q)(\partial_c) = n$.

22.3.7 As in 8.4, to obtain tableaux for K_3 and LP we add the appropriate closure rules, which are, respectively:

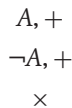

and

$$\begin{array}{c} A, - \\ \neg A, - \\ \times \end{array}$$

Counter-models are read off from open branches of tableaux as in the propositional case (8.4.8, 8.4.11), with atomic formulas replacing propositional parameters.

22.3.8 Quantified L_3 and RM_3 can also be reformulated as relational logics, with appropriate tableaux. The propositional details of 8.4a are extended in the natural way. Details are left as an exercise. (See 22.12, question 13.)

22.4 Free Logics with Relational Semantics

22.4.1 A relational interpretation for free FDE is a structure $\langle D, E, \nu \rangle$, where everything is the same as for FDE , except that $E \subseteq D$ and, in the truth conditions for the quantifiers, D is replaced by E . For the existence predicate, we require that:

$$\nu^{\mathcal{E}}(\mathcal{E}) = E$$

The anti-extension of the existence predicate can be any subset of D .

22.4.2 The observations of 22.2.4 and 22.2.5 carry over to the free case, with ‘ D ’ replaced by ‘ E ’. In particular, free FDE can be formulated as a free many-valued logic.

22.4.3 Tableaux for free FDE are obtained by adding the free versions of the quantifier rules to those for propositional FDE . These are as follows:

$$\begin{array}{ccc} \forall xA, + & \forall xA, - & \neg\forall xA, \pm \\ \swarrow \quad \searrow & \downarrow & \downarrow \\ \mathcal{E}a, - \quad A_x(a), + & \mathcal{E}c, + & \exists x\neg A, \pm \\ & A_x(c), - & \\ \\ \exists xA, + & \exists xA, - & \neg\exists xA, \pm \\ \downarrow & \swarrow \quad \searrow & \downarrow \\ \mathcal{E}c, + & \mathcal{E}a, - \quad A_x(a), - & \forall x\neg A, \pm \\ A_x(c), + & & \end{array}$$

with the same restrictions as in 22.3.1.

22.4.4 Here is a tableau showing that $\forall x(A \wedge B) \vdash \forall xA \wedge \forall xB$ in free FDE. c is a constant new to the branch.

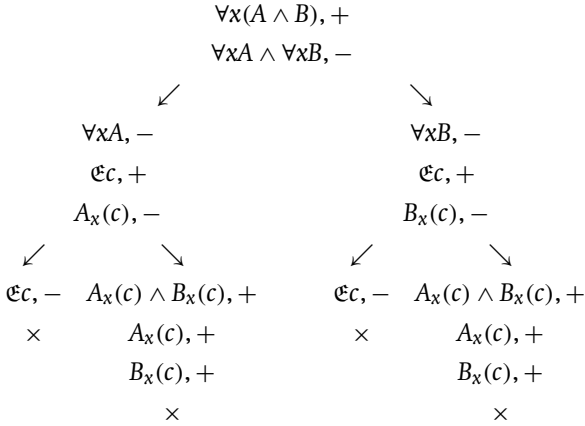

22.4.5 Here is another to show that $\forall xPx, \forall x(Px \supset Qx) \not\vdash \forall xQx$.

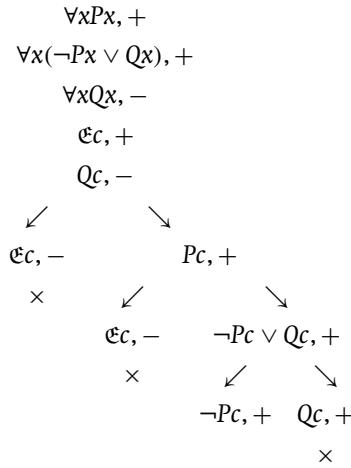

Counter-models are read off from open branches as for FDE (22.3.4), with the addition that $E = v^{\mathfrak{E}}(\mathfrak{E})$. Thus, the counter-model given by the open branch of this tableau can be depicted as follows:

	$v^{\mathfrak{E}}(P)$	$v^{\mathfrak{A}}(P)$	$v^{\mathfrak{E}}(Q)$	$v^{\mathfrak{A}}(Q)$	$v^{\mathfrak{E}}(\mathfrak{E})$	$v^{\mathfrak{A}}(\mathfrak{E})$
∂_c	✓	✓	×	×	✓	×

I leave it as an exercise to check that this works.

22.4.6 Three final observations. First, the constraints of 22.2.6 can be added to give the free versions of K_3 and LP . Tableaux are obtained as in 22.3.7.

22.4.7 Next, the appropriate form of the Neutrality and Negativity Constraints for the free logics of this section are as follows:

Neu If $\langle d_1, \dots, d_n \rangle \in \nu^{\mathcal{E}}(P)$ or $\langle d_1, \dots, d_n \rangle \in \nu^{\mathcal{A}}(P)$ then $\nu(d_i) \in E$ (for all $1 \leq i \leq n$).

Neg If $\langle d_1, \dots, d_n \rangle \in \nu^{\mathcal{E}}(P)$ then $\nu(d_i) \in E$ (for all $1 \leq i \leq n$).

The relevant tableau rules are:

$$\begin{array}{ccc} Pa_1, \dots, a_n, + & & \neg Pa_1, \dots, a_n, + \\ \downarrow & & \downarrow \\ \mathfrak{E}a_i, + & & \mathfrak{E}a_i, + \end{array}$$

We need both in the case of **Neu**, and just the first in the case of **Neg**.

22.4.8 Finally, we can add inner quantifiers in all the free logics we have considered, but these have to be added separately, since they cannot be defined in terms of \mathfrak{E} and truth functions, as they can in two-valued logic. The reasons are as for 21.6.1.

22.5 Semantics with the Routley *

22.5.1 As for the propositional case, quantified FDE can also be given a constant domain world-semantics employing the Routley * to handle negation. A Routley interpretation is a structure $\langle D, W, *, \nu \rangle$. D is the non-empty domain of quantification, W and $*$ are as in the propositional case (8.5.3), for every constant, c , $\nu(c) \in D$, and for every n -place predicate, P , and $w \in W$, $\nu_w(P) \subseteq D^n$.¹

22.5.2 Given an interpretation, all formulas are assigned a truth value (1 or 0) by the conditions:

$$\nu_w(Pa_1, \dots, a_n) = 1 \text{ iff } \langle \nu(a_1), \dots, \nu(a_n) \rangle \in \nu_w(P)$$

¹ A variable domain semantics can also be given, as usual; but this is not particularly significant in the present case, so I will leave it as an exercise for the reader. (See 22.12, question 6.)

The conditions for the connectives are as in the propositional case (8.5.3). In particular, for negation:

$$\nu_W(\neg A) = 1 \text{ iff } \nu_{W^*}(A) = 0$$

For the quantifiers:

$$\nu_W(\forall xA) = 1 \text{ iff for all } d \in D, \nu_W(A_x(k_d)) = 1$$

$$\nu_W(\exists xA) = 1 \text{ iff for some } d \in D, \nu_W(A_x(k_d)) = 1$$

22.5.3 As in the propositional case, validity is defined in terms of truth preservation at all worlds of all interpretations.

22.5.4 Tableaux for the $*$ semantics are the same as those in the propositional case (8.5.4) with the addition of the appropriate rules for the quantifiers:

$$\begin{array}{cccc} \forall xA, +\alpha & \forall xA, -\alpha & \exists xA, +\alpha & \exists xA, -\alpha \\ \downarrow & \downarrow & \downarrow & \downarrow \\ A_x(a), +\alpha & A_x(c), -\alpha & A_x(c), +\alpha & A_x(a), -\alpha \end{array}$$

a is any constant on the branch (choosing a new one if there is none), c is a constant new to the branch, and α is either a natural number or a natural number with the superscript #.²

22.5.5 Here is a tableau to show that $\forall x\neg A \vdash \neg\exists xA$. c is a constant new to the branch.

$$\begin{array}{c} \forall x\neg A, +0 \\ \neg\exists xA, -0 \\ \exists xA, +0^\# \\ A_x(c), +0^\# \\ \neg A_x(c), +0 \\ A_x(c), -0^\# \\ \times \end{array}$$

² In Part I, I use 'x' instead of ' α '. In the case of first-order logic, a different kind of letter is obviously desirable.

22.5.6 Here is another to show that $\exists x(Px \wedge \neg Qx) \not\vdash \forall x(Px \wedge \neg Qx)$:

$$\begin{array}{c}
 \exists x(Px \wedge \neg Qx), +0 \\
 \forall x(Px \wedge \neg Qx), -0 \\
 Pa \wedge \neg Qa, +0 \\
 Pa, +0 \\
 \neg Qa, +0 \\
 Qa, -0^\# \\
 Pb \wedge \neg Qb, -0 \\
 \swarrow \quad \searrow \\
 Pb, -0 \quad \neg Qb, -0 \\
 \quad \quad Qb, +0^\#
 \end{array}$$

22.5.7 To read off a counter-model from an open branch, $W = \{w_0, w_{0^\#}\}$ (there are only ever two worlds), $w_0^* = w_{0^\#}$ and $w_{0^\#}^* = w_0$. $D = \{\partial_c : c \text{ is a constant on the branch}\}$. $v(c) = \partial_c$. Where α is either 0 or $0^\#$, $\langle \partial_{a_1}, \dots, \partial_{a_n} \rangle \in v_\alpha(P)$ iff $Pa_1 \dots a_n, +\alpha$ occurs on the branch. Thus, the counter-model given by the righthand branch of the tableau in 22.5.6 may be depicted as follows:

	w_0		w_0^*
	P	Q	
∂_a	✓	×	∂_a
∂_b	×	×	∂_b
	×	×	✓

$Pa \wedge \neg Qa$ is true at w_0 , as, then, is $\exists x(Px \wedge \neg Qx)$. $\neg Qb$ fails at w_0 , as, therefore, do $Pb \wedge \neg Qb$ and $\forall x(Px \wedge \neg Qx)$.

22.5.8 As in the propositional case (8.5.8), the * semantics for FDE are equivalent to the relational (non-free) semantics. A relational evaluation, μ , is equivalent to a pair of worlds, w and w^* , related by the conditions:

$$\begin{array}{l}
 \langle d_1, \dots, d_n \rangle \in v_w(P) \text{ iff } \langle d_1, \dots, d_n \rangle \in \mu^{\mathcal{E}}(P) \\
 \langle d_1, \dots, d_n \rangle \notin v_{w^*}(P) \text{ iff } \langle d_1, \dots, d_n \rangle \in \mu^{\mathcal{A}}(P)
 \end{array}$$

The proof is given in 22.8.10 and 22.8.11.

22.6 Identity

22.6.1 We now add identity to the language, starting with the relational semantics.³ In an interpretation, $\langle D, \nu \rangle$, $\nu^{\mathcal{E}}(=) = \{\langle d, d \rangle : d \in D\}$. The anti-extension of $=$ can be any subset of D^2 . Note that it is the extension of $=$ that does all the work with respect to its usual properties.

22.6.2 The appropriate tableau rules are:

$$\begin{array}{rcl}
 & & a = b, + \\
 & \downarrow & \\
 & & A_x(a), + \\
 a = a, + & & \downarrow \\
 & & A_x(b), +
 \end{array}$$

In SI, A is any atomic sentence or its negation, other than $a = b$.⁴

22.6.3 Here are tableaux to show that $a = b, b = c, Pa \vdash Pc$ and $\vdash \forall x x = x$.

$$\begin{array}{rcl}
 a = b, + & & \forall x x = x, - \\
 b = c, + & & a = a, - \\
 Pa, + & & \times \\
 Pc, - & & \\
 Pb, + & & \\
 Pc, + & & \\
 \times & &
 \end{array}$$

22.6.4 Here is another to show that $a = b, b = c, Pa, \neg Pc \not\vdash a \neq c$:

$$\begin{array}{r}
 a = b, + \\
 b = c, + \\
 Pa, + \\
 \neg Pc, + \\
 \neg a = c, - \\
 a = c, + \\
 Pb, + \\
 Pc, + \\
 \neg Pb, + \\
 \neg Pa, +
 \end{array}$$

³ We consider only the non-free case. The free case – possibly with the Negativity and Neutrality Constraints – is left as an exercise. See 22.12, question 9.

⁴ It would also be okay to change the plus signs in $A_x(a), +$ and $A_x(b), +$ to minuses. But this form of the rule is redundant.

Note that the last two lines use SI for a negated atomic formula.

22.6.5 To read off a counter-model from an open branch of a tableau, we take any bunch of lines of the form $a = b, b = c, \dots$, and select one object, say ∂_a , for the constants all to denote. $\langle \partial_{a_1}, \dots, \partial_{a_n} \rangle \in v^{\mathcal{E}}(P)$ iff $Pa_1 \dots a_n, +$ is on the branch; and $\langle \partial_{a_1}, \dots, \partial_{a_n} \rangle \in v^{\mathcal{A}}(P)$ iff $\neg Pa_1 \dots a_n, +$ is on the branch. This recipe applies to the anti-extension of identity formulas too. (The extension is always the same, $\{\langle d, d \rangle : d \in D\}$.) So, in the counter-model given by the tableau of 22.6.4, $D = \{\partial_a\}$, $v(a) = v(b) = v(c) = \partial_a$, $v^{\mathcal{E}}(P) = v^{\mathcal{A}}(P) = \{\partial_a\}$, and $v^{\mathcal{A}}(=) = \phi$. It is easy to check that $a = b, b = c, Pa, \neg Pc$ are all true, and since $\langle v(a), v(c) \rangle \notin v^{\mathcal{A}}(=)$, $\neg a = c$ is not true.

22.6.6 In the $*$ semantics, I will deal only with the necessary identity case. $v_w(=)$ is the world-invariant set $\{\langle d, d \rangle : d \in D\}$. (One can formulate contingent identity semantics in a natural way; I leave this as an exercise (see 22.12, question10).)

22.6.7 The corresponding tableau rules are:

$$\begin{array}{ccc}
 . & a = b, +\alpha & a = b, +\alpha \\
 \downarrow & A_x(a), +\alpha & \downarrow \\
 a = a, +\alpha & \downarrow & a = b, +\beta \\
 & A_x(b), +\alpha &
 \end{array}$$

where α and β are natural numbers with or without a superscript #. A is any atomic sentence other than $a = b$. The last rule is the appropriate version of the Identity Invariance Rule.

22.6.8 Here is a tableau to show that $a = b \wedge \neg Pa \vdash \neg Pb$:

$$\begin{array}{l}
 a = b \wedge \neg Pa, +0 \\
 \neg Pb, -0 \\
 a = b, +0 \\
 \neg Pa, +0 \\
 Pa, -0^\# \\
 a = b, +0^\# \\
 Pb, +0^\# \\
 Pa, +0^\# \\
 \times
 \end{array}$$

Line 6 is the Identity Invariance Rule. At the last line, SI is applied at world $0^\#$.

22.6.9 Here is a tableau to show that $a = b \vee b = c \not\vdash a = c$:

$$\begin{array}{c}
 a = b \vee b = c, +0 \\
 a = c, -0 \\
 \swarrow \quad \searrow \\
 a = b, +0 \quad b = c, +0
 \end{array}$$

Counter-models are read off from an open branch as in the case without identity (22.5.7), except that whenever we have a bunch of lines of the form $a = b, +0, b = c, +0, \dots$, we choose a single object, say ∂_a , for all the constants in the bunch to denote. (The extension of the identity predicate is always predefined.) So in the interpretation given by the lefthand branch of this tableau, $W = \{w_0, w_{0\#}\}$, $w_0^* = w_{0\#}$ and $w_{0\#}^* = w_0$, $D = \{\partial_a, \partial_c\}$. $v(a) = v(b) = \partial_a$ and $v(c) = \partial_c$. Clearly, $v(a) = v(b)$, so $a = b$ is true at w_0 , but $v(a) \neq v(c)$, so $a = c$ is not true at w_0 .

22.6.10 Note that in both the relational semantics and the $*$ semantics, $a = b, A_x(a) \vDash A_x(b)$. (The proof of this is in 22.9.3.)

22.6.11 Note also that once identity is in the language the equivalence between the relational and the $*$ semantics breaks down.⁵ For example, in the $*$ semantics, $\vdash a = b \vee \neg a = b$:

$$\begin{array}{c}
 a = b \vee \neg a = b, -0 \\
 a = b, -0 \\
 \neg a = b, -0 \\
 a = b, +0^\# \\
 a = b, +0 \\
 \times
 \end{array}$$

But this is not valid in the relational semantics. Counter-model: $D = \{\partial_a, \partial_b\}$, $v(a) = \partial_a$, $v(b) = \partial_b$, $v^A(=) = \emptyset$.

22.6.12 All the tableau systems of this chapter are sound and complete with respect to their semantics. This is proved in the following technical appendices.

⁵ But see 22.12, question 11.

22.7 *Proofs of Theorems 1

22.7.1 In this section we establish the appropriate soundness and completeness theorems for relation semantics (without identity). I bundle the free and non-free cases together. We start, in the usual way, with the appropriate Locality and Denotation Lemmas.

22.7.2 LEMMA (LOCALITY): Let $\mathcal{J}_1 = \langle D, (E,) v_1 \rangle$, $\mathcal{J}_2 = \langle D, (E,) v_2 \rangle$ be two interpretations (with corresponding relations ρ_1 and ρ_2). Since they have the same domain, the language of the two is the same. Call this L . If A is any closed formula of L such that v_1 and v_2 agree on the denotations of all the predicates and constants in it then:

$$\begin{aligned} A\rho_1 1 &\text{ iff } A\rho_2 1 \\ A\rho_1 0 &\text{ iff } A\rho_2 0 \end{aligned}$$

Proof:

The result is proved by recursion on formulas. Here are the cases for 1. The cases for 0 are similar. For atomic formulas:

$$\begin{aligned} Pa_1 \dots a_n \rho_1 1 &\text{ iff } \langle v_1(a_1), \dots, v_1(a_n) \rangle \in v_1^{\mathcal{E}}(P) \\ &\text{ iff } \langle v_2(a_1), \dots, v_2(a_n) \rangle \in v_2^{\mathcal{E}}(P) \\ &\text{ iff } Pa_1 \dots a_n \rho_2 1 \end{aligned}$$

For negation:

$$\begin{aligned} \neg A\rho_1 1 &\text{ iff } A\rho_1 0 \\ &\text{ iff } A\rho_2 0 \quad (\text{IH}) \\ &\text{ iff } \neg A\rho_2 1 \end{aligned}$$

The cases for the other connectives are left as exercises. The case for the universal quantifier is as follows. That for the particular quantifier is similar.

$$\begin{aligned} \forall x B\rho_1 1 &\text{ iff for all } d \in D[E], B_x(k_d)\rho_1 1 \\ &\text{ iff for all } d \in D[E], B_x(k_d)\rho_2 1 \quad (\text{IH}) \\ &\text{ iff } \forall x B\rho_2 1 \end{aligned}$$

■

22.7.3 LEMMA (DENOTATION): Let $\mathcal{J} = \langle D, (E,) v \rangle$ be any interpretation. Let A be any formula of $L(\mathcal{J})$ with at most one free variable, x , and a and b be any

two constants such that $v(a) = v(b)$ then:

$$A_x(a)\rho 1 \text{ iff } A_x(b)\rho 1$$

$$A_x(a)\rho 0 \text{ iff } A_x(b)\rho 0$$

Proof:

The proof is by recursion on formulas. Here are the cases for 1. The cases for 0 are similar. (For atomic formulas I assume that the formula has one occurrence of a for the sake of illustration.)

$$Pa_1 \dots a \dots a_n \rho 1 \text{ iff } \langle v(a_1), \dots, v(a), \dots, v(a_n) \rangle \in v^{\mathcal{E}}(P)$$

$$\text{iff } \langle v(a_1), \dots, v(b), \dots, v(a_n) \rangle \in v^{\mathcal{E}}(P)$$

$$\text{iff } Pa_1 \dots b \dots a_n \rho 1$$

For negation:

$$\neg A_x(a)\rho 1 \text{ iff } A_x(a)\rho 0$$

$$\text{iff } A_x(b)\rho 0 \quad (\text{IH})$$

$$\text{iff } \neg A_x(b)\rho 1$$

The cases for the other connectives are similar. The case for the universal quantifier is as follows. That for the particular quantifier is similar. Let A be of the form $\forall yB$. If x is the same variable as y then $A_x(a)$ and $A_x(b)$ are just A , so the result is trivial. So suppose that x and y are distinct variables.

$$(\forall yB)_x(a)\rho 1 \text{ iff } \forall y(B_x(a))\rho 1$$

$$\text{iff for all } d \in D[E], (B_x(a))_y(k_d)\rho 1$$

$$\text{iff for all } d \in D[E], (B_y(k_d))_x(a)\rho 1$$

$$\text{iff for all } d \in D[E], (B_y(k_d))_x(b)\rho 1 \quad (\text{IH})$$

$$\text{iff for all } d \in D[E], (B_x(b))_y(k_d)\rho 1$$

$$\text{iff } \forall y(B_x(b))\rho 1$$

$$\text{iff } (\forall yB)_x(b)\rho 1$$

■

22.7.4 DEFINITION: Let $\mathfrak{J} = \langle D, (E, \cdot) v \rangle$ be any relational interpretation. Let \mathcal{B} be any branch of a tableau. \mathfrak{J} is faithful to \mathcal{B} iff:

for every node A , + on \mathcal{B} , $A\rho 1$

for every node A , - on \mathcal{B} , it is not the case that $A\rho 1$

22.7.5 SOUNDNESS LEMMA: If \mathfrak{J} is faithful to a branch of a tableau, \mathcal{B} , and a tableau rule is applied to \mathcal{B} , then there is an interpretation, \mathfrak{J}' , that is faithful to at least one of the branches generated.

Proof:

The cases of the Lemma for connective rules are as in the propositional case (8.7.3). The quantifier rules concerning negation are taken care of by 22.2.4 and 22.4.2. (We can just take \mathfrak{J}' to be \mathfrak{J} .) Here are the cases for the free quantifier rules. The non-free cases are left as an exercise.

$$(i) \quad \begin{array}{c} \forall xA, + \\ \swarrow \quad \searrow \\ \mathfrak{E}a, - \quad A_x(a), + \end{array}$$

Suppose that $\forall xA\rho 1$. Then for all $d \in E$, $A_x(k_d)\rho 1$. Let $v(a) = d$. If $d \notin E$ then it is not the case that $\mathfrak{E}k_d\rho 1$, and so not the case that $\mathfrak{E}a\rho 1$, by the Denotation Lemma; \mathfrak{J} is faithful to the left branch. If $d \in E$ then $A_x(a)\rho 1$ by the Denotation Lemma; \mathfrak{J} is faithful to the right branch.

$$(ii) \quad \begin{array}{c} \forall xA, - \\ \downarrow \\ \mathfrak{E}c, + \\ A_x(c), - \end{array}$$

Suppose that it is not the case that $\forall xA\rho 1$. Then for some $d \in E$, it is not the case that $A_x(k_d)\rho 1$. For this d , $\mathfrak{E}k_d\rho 1$. Let \mathfrak{J}' be the same as \mathfrak{J} , except that $v(c) = d$. By the Denotation Lemma, $\mathfrak{E}c\rho 1$ and it is not the case that $A_x(c)\rho 1$, in \mathfrak{J}' . Since c is a new constant, the Locality Lemma does the rest of the job.

$$(iii) \text{ and } (iv) \quad \begin{array}{cc} \exists xA, + & \exists xA, - \\ \downarrow & \swarrow \quad \searrow \\ \mathfrak{E}c, + & \mathfrak{E}a, - \quad A_x(a), - \\ A_x(c), + & \end{array}$$

These cases are similar, and are left as exercises. ■

22.7.6 COROLLARY SOUNDNESS THEOREM: The tableaux for *FDE* and free *FDE* are sound.

Proof:

This follows from the Soundness Lemma in the usual way. ■

22.7.7 DEFINITION: Suppose that we have a tableau with an open branch, \mathcal{B} . Let C be the set of all constants on \mathcal{B} . The interpretation induced by \mathcal{B} , $\langle D, (E,) v \rangle$, is defined as follows: $D = \{\partial_a : a \in C\}$. For all constants, a , on \mathcal{B} ,

$v(a) = \partial_a$. For every n -place predicate:

$$\begin{aligned} \langle \partial_{a_1}, \dots, \partial_{a_n} \rangle \in v^{\mathcal{E}}(P) &\text{ iff } Pa_1 \dots a_n, + \text{ is on } \mathcal{B} \\ \langle \partial_{a_1}, \dots, \partial_{a_n} \rangle \in v^{\mathcal{A}}(P) &\text{ iff } \neg Pa_1 \dots a_n, + \text{ is on } \mathcal{B} \end{aligned}$$

(And if the interpretation is free, E is $v^{\mathcal{E}}(\mathcal{E})$.)

22.7.8 COMPLETENESS LEMMA: Given the interpretation specified in 22.7.7, for every formula A :

- if $A, +$ is on \mathcal{B} then $A\rho 1$
- if $A, -$ is on \mathcal{B} then it is not the case that $A\rho 1$
- if $\neg A, +$ is on \mathcal{B} then $A\rho 0$
- if $\neg A, -$ is on \mathcal{B} then it is not the case that $A\rho 0$

Proof:

The proof is by recursion on formulas. For atomic formulas:

$$\begin{aligned} Pa_1 \dots a_n, + \text{ is on } \mathcal{B} &\Rightarrow \langle \partial_{a_1}, \dots, \partial_{a_n} \rangle \in v^{\mathcal{E}}(P) \\ &\Rightarrow \langle v(a_1), \dots, v(a_n) \rangle \in v^{\mathcal{E}}(P) \\ &\Rightarrow Pa_1 \dots a_n\rho 1 \end{aligned}$$

$$\begin{aligned} Pa_1 \dots a_n, - \text{ is on } \mathcal{B} &\Rightarrow Pa_1 \dots a_n, + \text{ is not on } \mathcal{B} && (\mathcal{B} \text{ open}) \\ &\Rightarrow \langle \partial_{a_1}, \dots, \partial_{a_n} \rangle \notin v^{\mathcal{E}}(P) \\ &\Rightarrow \langle v(a_1), \dots, v(a_n) \rangle \notin v^{\mathcal{E}}(P) \\ &\Rightarrow \text{it is not the case that } Pa_1 \dots a_n\rho 1 \end{aligned}$$

The cases for 0 are similar.

The cases for the connectives are as in 8.7.6. Here are the cases for the quantifiers for the free logic. The non-free cases are left as an exercise. The cases for \exists are as follows. Those for \forall are similar.

(i) Suppose that $\exists xB, +$ is on \mathcal{B} . Then, for some c , $B_x(c), +$ and $\mathcal{E}c, +$ are on \mathcal{B} . By IH, $B_x(c)\rho 1$ and $\mathcal{E}c\rho 1$. Let $v(c) = d$. By the Denotation Lemma, $B_x(k_d)\rho 1$ and $\mathcal{E}k_d\rho 1$, and so $d \in E$. Hence, $\exists xB\rho 1$.

(ii) Suppose that $\exists xB, -$ is on \mathcal{B} . Then, for every constant c , either $\mathcal{E}c, -$ or $B_x(c), -$ is on \mathcal{B} . By IH, for every constant, c , either it is not the case that $\mathcal{E}c\rho 1$ or it is not the case that $B_x(c)\rho 1$. By the Denotation Lemma, for every $d \in D$, either it is not the case that $\mathcal{E}k_d\rho 1$ or it is not the case that $B_x(k_d)\rho 1$. So for all $d \in D$ such that $\mathcal{E}k_d\rho 1$, it is not the case that $B_x(k_d)\rho 1$; i.e., for all $d \in E$, it is not the case that $B_x(k_d)\rho 1$. That is, it is not the case that $\exists xB\rho 1$.

(iii) If $\neg\exists xB$, $+$ is on \mathcal{B} then $\forall x\neg B$, $+$ is on \mathcal{B} . Hence, for every constant, c , either $\mathcal{E}c$, $-$ or $\neg B_x(c)$, $+$ is on \mathcal{B} . By IH, either it is not the case that $\mathcal{E}c\rho 1$ or $B_x(c)\rho 0$. Now let $d \in D$. Then by the Denotation Lemma, either it is not the case that $\mathcal{E}k_d\rho 1$ or $B_x(k_d)\rho 0$; that is, either it is not the case that $d \in E$ or $B_x(k_d)\rho 0$. So for all $d \in E$, $B_x(k_d)\rho 0$. That is, $\exists xB\rho 0$.

(iv) If $\neg\exists xB$, $-$ is on \mathcal{B} then $\forall x\neg B$, $-$ is on \mathcal{B} . So for some constant, c , $\mathcal{E}c$, $+$ and $\neg B_x(c)$, $-$ are on \mathcal{B} . By IH, $\mathcal{E}c\rho 1$ and it is not the case that $B_x(c)\rho 0$. By the Denotation Lemma, for some $d \in D$, $\mathcal{E}k_d\rho 1$ and it is not the case that $B_x(k_d)\rho 0$. That is, for some $d \in E$, it is not the case that $B_x(k_d)\rho 0$. So it is not the case that $\exists xB\rho 0$. ■

22.7.9 COROLLARY COMPLETENESS THEOREM: The tableaux for *FDE* and free *FDE* are complete.

Proof:

This follows from the Completeness Lemma in the usual way. ■

22.7.10 THEOREM: The addition of the closure rules of 22.3.7 to those for *FDE* or free *FDE* produce tableaux that are sound and complete with respect to K_3 and *LP*.

Proof:

The argument is as in the propositional case (8.7.8, 8.7.9), with atomic formulas replacing propositional parameters. ■

22.7.11 THEOREM: The addition of the tableau rules of 22.4.7 to those of free *FDE* (K_3 or *LP*) produce tableaux that are sound and complete with respect to the Negativity Constraint and the Neutrality Constraint.

Proof:

We need (i) to check the relevant rules in the Soundness Lemmas, and (ii) to check that the relevant induced interpretations have the appropriate properties. Details are straightforward, and are left as exercises. ■

22.8 *Proofs of Theorems 2

22.8.1 In this section we establish soundness and completeness for the * semantics (without identity), and the equivalence between the * semantics and the relational semantics.

22.8.2 LEMMA (LOCALITY): Let $\mathfrak{J}_1 = \langle D, W, *, v_1 \rangle$, $\mathfrak{J}_2 = \langle D, W, *, v_2 \rangle$ be two interpretations. Since they have the same domain, the language of the two is the same. Call this L . If A is any closed formula of L such that v_1 and v_2 agree on the denotations of all the predicates and constants in it, then, for all $w \in W$:

$$v_{1w}(A) = v_{2w}(A)$$

Proof:

The result is proved by recursion on formulas. The arguments for all cases are as in the corresponding cases in constant domain modal logic (14.7.2), except the one for negation, which is as follows:

$$\begin{aligned} v_{1w}(\neg B) = 1 & \quad \text{iff} \quad v_{1w^*}(B) = 0 \\ & \quad \text{iff} \quad v_{2w^*}(B) = 0 \quad (\text{IH}) \\ & \quad \text{iff} \quad v_{2w}(\neg B) = 1 \end{aligned}$$

■

22.8.3 LEMMA (DENOTATION): Let $\mathfrak{J} = \langle D, W, *, v \rangle$ be any interpretation. Let A be any formula of $L(\mathfrak{J})$ with at most one free variable, x , and a and b be any two constants such that $v(a) = v(b)$. Then for any $w \in W$:

$$v_w(A_x(a)) = v_w(A_x(b))$$

Proof:

The proof is by recursion on formulas. The cases are all the same as the corresponding cases in constant domain modal logic (14.7.3), except the one for negation, which is as follows.

$$\begin{aligned} v_w(\neg B_x(a)) = 1 & \quad \text{iff} \quad v_{w^*}(B_x(a)) = 0 \\ & \quad \text{iff} \quad v_{w^*}(B_x(b)) = 0 \quad (\text{IH}) \\ & \quad \text{iff} \quad v_w(\neg B_x(b)) = 1 \end{aligned}$$

■

22.8.4 DEFINITION: Let $\mathfrak{J} = \langle D, W, *, v \rangle$ be an interpretation, and \mathcal{B} be any branch of the tableau. Then \mathfrak{J} is faithful to \mathcal{B} iff there is a map, f , from the natural numbers to W , such that:

- for every node $A, +\alpha$ on \mathcal{B} , A is true at $f(\alpha)$ in \mathfrak{J}
- for every node $A, -\alpha$ on \mathcal{B} , A is false at $f(\alpha)$ in \mathfrak{J}

where, by definition, $f(i^\#)$ is $f(i)^*$.

22.8.5 SOUNDNESS LEMMA: Let \mathcal{B} be any branch of a tableau, and let $\mathcal{J} = \langle D, W, *, \nu \rangle$ be any interpretation. If \mathcal{J} is faithful to \mathcal{B} , and a tableau rule is applied to it, then there is an $\mathcal{J}' = \langle D, W', *, \nu' \rangle$ and an extension of \mathcal{B} , \mathcal{B}' , such that \mathcal{J}' is faithful to \mathcal{B}' .

Proof:

The proof is by a case-by-case consideration of the rules. The cases for the propositional rules are as in the propositional case (8.7.12). The cases for the rules for \forall are as follows. Those for \exists are similar, and are left as exercises.

$$(i) \quad \begin{array}{c} \forall xA, +\alpha \\ \downarrow \\ A_x(a), +\alpha \end{array}$$

Suppose that $\forall xA$ is true at $f(\alpha)$ in \mathcal{J} . Then, for every $d \in D$, $A_x(k_d)$ is true at $f(\alpha)$. Let $\nu(a) = d$. Then, by the Denotation Lemma, $A_x(a)$ is true at $f(\alpha)$, and we may take \mathcal{J}' to be \mathcal{J} .

$$(ii) \quad \begin{array}{c} \forall xA, -\alpha \\ \downarrow \\ A_x(c), -\alpha \end{array}$$

Suppose that $\forall xA$ is false at $f(\alpha)$ in \mathcal{J} . Then, for some $d \in D$, $A_x(k_d)$ is false at $f(\alpha)$ in \mathcal{J} . Let \mathcal{J}' be the interpretation that is the same as \mathcal{J} , except that $\nu(c) = d$. Since c is a new constant, the same is true of \mathcal{J}' by the Locality Lemma. By the Denotation Lemma, $A_x(c)$ is false at $f(\alpha)$ in \mathcal{J}' . And since c does not occur anywhere else on the branch, f shows the rest of the branch to be faithful to \mathcal{J}' too, by the Locality Lemma. ■

22.8.6 SOUNDNESS THEOREM: The tableaux for the $*$ semantics are sound with respect to them.

Proof:

This follows from the Soundness Lemma in the usual way. ■

22.8.7 DEFINITION: Given an open branch of a tableau, \mathcal{B} , the induced interpretation is defined as follows. $W = \{w_0, w_{0\#}\}$ (there are only ever two worlds), $w_0^* = w_{0\#}$ and $w_{0\#}^* = w_0$. $D = \{\partial_c : c \in C\}$, where C is the set of constants on the branch. $\nu(c) = \partial_c$. $\langle \partial_{a_1}, \dots, \partial_{a_n} \rangle \in \nu_\alpha(P)$ iff $Pa_1 \dots a_n, +\alpha$ is on \mathcal{B} , where α is either i or $i^\#$. (In the present case, i is always 0.)

22.8.8 COMPLETENESS LEMMA: In the interpretation induced by an open branch, \mathcal{B} , for every formula A :

if $A, +\alpha$ is on \mathcal{B} then $v_{w_\alpha}(A) = 1$

if $A, -\alpha$ is on \mathcal{B} then $v_{w_\alpha}(A) = 0$

where α is either i or $i^\#$. (In the present case, i is always 0.)

Proof:

This is proved by recursion on formulas. For atomic formulas:

$$\begin{aligned} Pa_1 \dots a_n, +\alpha \text{ is on } \mathcal{B} &\Rightarrow \langle \partial_{a_1}, \dots, \partial_{a_n} \rangle \in v_{w_\alpha}(P) \\ &\Rightarrow \langle v(a_1), \dots, v(a_n) \rangle \in v_{w_\alpha}(P) \\ &\Rightarrow v_{w_\alpha}(Pa_1 \dots a_n) = 1 \end{aligned}$$

$$\begin{aligned} Pa_1 \dots a_n, -\alpha \text{ is on } \mathcal{B} &\Rightarrow Pa_1 \dots a_n, +\alpha \text{ is not on } \mathcal{B} \quad (\mathcal{B} \text{ open}) \\ &\Rightarrow \langle \partial_{a_1}, \dots, \partial_{a_n} \rangle \notin v_{w_\alpha}(P) \\ &\Rightarrow \langle v(a_1), \dots, v(a_n) \rangle \notin v_{w_\alpha}(P) \\ &\Rightarrow v_{w_\alpha}(Pa_1 \dots a_n) = 0 \end{aligned}$$

The cases for the truth functions are as in the propositional case (8.7.15). Here are the cases for \exists . The cases for \forall are similar.

Suppose that $\exists xA, +\alpha$ is on the branch. Then, for some $c \in C$, $A_x(c), +\alpha$ is on the branch. By IH, $v_{w_\alpha}(A_x(c)) = 1$. For some $d \in D$, $v(c) = d$. Hence, $v_{w_\alpha}(A(k_d)) = 1$, by the Denotation Lemma. That is, $v_{w_\alpha}(\exists xA) = 1$.

Suppose that $\exists xA, -\alpha$ is on the branch. Then, for all $c \in C$, $A_x(c), -\alpha$ is on the branch and so $v_{w_\alpha}(A_x(c)) = 0$ (by IH). If $d \in D$, then for some $c \in C$, $v(c) = d$. Hence, $v_{w_\alpha}(A_x(k_d)) = 0$, by the Denotation Lemma. Thus, $v_{w_\alpha}(\exists xA) = 0$. ■

22.8.9 COMPLETENESS THEOREM: The tableaux for the $*$ semantics are complete with respect to them.

Proof:

This follows from the Completeness Lemma in the usual way. ■

22.8.10 THEOREM: If $\Sigma \models A$ in the relational semantics for FDE, $\Sigma \models A$ in the $*$ semantics.

Proof:

We prove the contrapositive. Suppose that there is a $*$ interpretation, $\mathfrak{I} = \langle D, W, *, v \rangle$, and a $w \in W$ which makes all the members of Σ true, and A false. Define a relational interpretation, $\langle D, \mu \rangle$ where, for every constant, c , $\mu(c) = v(c)$, and for any n -place predicate, P :

$$\langle d_1, \dots, d_n \rangle \in \mu^{\mathcal{E}}(P) \text{ iff } \langle d_1, \dots, d_n \rangle \in v_w(P)$$

$$\langle d_1, \dots, d_n \rangle \in \mu^{\mathcal{A}}(P) \text{ iff } \langle d_1, \dots, d_n \rangle \notin v_w^*(P)$$

We show that for any A in the language of \mathfrak{I} :

$$A\rho 1 \text{ iff } v_w(A) = 1$$

$$A\rho 0 \text{ iff } v_w^*(A) = 0$$

The theorem follows.

The result is proved by recursion. For atomic formulas:

$$\begin{aligned} Pa_1 \dots a_n \rho 1 & \text{ iff } \langle \mu(a_1), \dots, \mu(a_n) \rangle \in \mu^{\mathcal{E}}(P) \\ & \text{ iff } \langle v(a_1), \dots, v(a_n) \rangle \in v_w(P) \\ & \text{ iff } v_w(Pa_1 \dots a_n) = 1 \end{aligned}$$

$$\begin{aligned} Pa_1 \dots a_n \rho 0 & \text{ iff } \langle \mu(a_1), \dots, \mu(a_n) \rangle \in \mu^{\mathcal{A}}(P) \\ & \text{ iff } \langle v(a_1), \dots, v(a_n) \rangle \notin v_w^*(P) \\ & \text{ iff } v_w^*(Pa_1 \dots a_n) = 0 \end{aligned}$$

The cases for the connectives are as in propositional case (8.7.17). The cases for \forall are as follows. Those for \exists are similar.

$$\begin{aligned} \forall x A \rho 1 & \text{ iff for all } d \in D, A_x(k_d) \rho 1 \\ & \text{ iff for all } d \in D, v_w(A_x(k_d)) = 1 \quad (\text{IH}) \\ & \text{ iff } v_w(\forall x A) = 1 \end{aligned}$$

$$\begin{aligned} \forall x A \rho 0 & \text{ iff for some } d \in D, A_x(k_d) \rho 0 \\ & \text{ iff for some } d \in D, v_w^*(A_x(k_d)) = 0 \quad (\text{IH}) \\ & \text{ iff } v_w^*(\forall x A) = 0 \end{aligned}$$

■

22.8.11 THEOREM: If $\Sigma \models A$ in the $*$ semantics for FDE, $\Sigma \models A$ in the relational semantics.

Proof:

We prove the contrapositive. Suppose that there is a relational interpretation $\mathfrak{J} = \langle D, v \rangle$, which makes all the members of Σ true and A not true. Define a $*$ interpretation, $\langle D, W, *, \mu \rangle$, where $W = \{w_0, w_1\}$, $w_1^* = w_0$, $w_0^* = w_1$, for every constant, c , $\mu(c) = v(c)$, and for every n -place predicate, P :

$$\langle d_1, \dots, d_n \rangle \in \mu_{w_0}(P) \text{ iff } \langle d_1, \dots, d_n \rangle \in v^{\mathcal{E}}(P)$$

$$\langle d_1, \dots, d_n \rangle \in \mu_{w_1}(P) \text{ iff } \langle d_1, \dots, d_n \rangle \notin v^{\mathcal{A}}(P)$$

We show that for every A in the language of \mathfrak{J} :

$$\mu_{w_0}(A) = 1 \text{ iff } A\rho 1$$

$$\mu_{w_1}(A) = 1 \text{ iff it is not the case that } A\rho 0$$

The theorem follows.

The result is proved by recursion. For the atomic case:

$$\begin{aligned} \mu_{w_0}(Pa_1 \dots a_n) = 1 & \text{ iff } \langle \mu(a_1), \dots, \mu(a_n) \rangle \in \mu_{w_0}(P) \\ & \text{ iff } \langle v(a_1), \dots, v(a_n) \rangle \in v^{\mathcal{E}}(P) \\ & \text{ iff } Pa_1 \dots a_n\rho 1 \end{aligned}$$

$$\begin{aligned} \mu_{w_1}(Pa_1 \dots a_n) = 1 & \text{ iff } \langle \mu(a_1), \dots, \mu(a_n) \rangle \in \mu_{w_1}(P) \\ & \text{ iff } \langle v(a_1), \dots, v(a_n) \rangle \notin v^{\mathcal{A}}(P) \\ & \text{ iff it is not the case that } Pa_1 \dots a_n\rho 0 \end{aligned}$$

The cases for the connectives are as in the propositional case (8.7.18). The cases for \forall are as follows. Those for \exists are similar.

$$\begin{aligned} \mu_{w_0}(\forall xA) = 1 & \text{ iff for all } d \in D, \mu_{w_0}(A_x(k_d)) = 1 \\ & \text{ iff for all } d \in D, A_x(k_d)\rho 1 \quad \text{(IH)} \\ & \text{ iff } \forall xA\rho 1 \end{aligned}$$

$$\begin{aligned} \mu_{w_1}(\forall xA) = 1 & \text{ iff for all } d \in D, \mu_{w_1}(A_x(k_d)) = 1 \\ & \text{ iff for all } d \in D, \text{ it is not the case that } A_x(k_d)\rho 0 \quad \text{(IH)} \\ & \text{ iff it is not the case that, for some } d \in D, A_x(k_d)\rho 0 \\ & \text{ iff it is not the case that } \forall xA\rho 0 \end{aligned}$$

■

22.9 *Proofs of Theorems 3

22.9.1 Finally, we establish soundness and completeness with identity for both forms of semantics (with necessary identity in the $*$ case).

22.9.2 The addition of identity to the language does not affect the statements and proofs of the Locality and Denotation Lemmas (22.7.2, 22.7.3, 22.8.2, 22.8.3).

22.9.3 COROLLARY: In both the relational and the $*$ semantics, $a = b, A_x(a) \models A_x(b)$.

Proof:

This follows from the Denotation Lemma in the usual way. ■

22.9.4 SOUNDNESS THEOREM: The tableaux for identity, for both the relational and the $*$ semantics, are sound with respect to their semantics.

Proof:

The Soundness Theorems follow from the appropriate Soundness Lemmas. The proofs of these simply extend the proofs for the cases without identity (22.7.5, 22.8.5), by adding the appropriate cases for the identity rules (22.6.2, 22.6.7). These are straightforward, and left as exercises. ■

22.9.5 COMPLETENESS THEOREM (RELATIONAL SEMANTICS): The tableaux for identity are complete.

Proof:

Given any completed open branch, \mathcal{B} , of a tableau, the interpretation induced by it, $\langle D, (E,) \nu \rangle$, is defined as follows. Let C be the set of constants on the branch. Let $a \sim b$ iff $a = b, +$ is on \mathcal{B} . As usual, \sim is an equivalence relation. $D = \{[a] : a \in C\}$. $\nu(a) = [a]$. For any predicate, P , except identity (including \mathcal{E} , if it is present, defining E), $\langle [a_1], \dots, [a_n] \rangle \in \nu^{\mathcal{E}}(P)$ iff $Pa_1 \dots a_n, +$ occurs on \mathcal{B} ; $\langle [a_1], \dots, [a_n] \rangle \in \nu^A(P)$ iff $\neg Pa_1 \dots a_n, +$ occurs on \mathcal{B} . This is well defined because of SI. $\nu^{\mathcal{E}}(=)$ needs no specification; $\nu^A(=)$ is defined in the same way as the anti-extension of all other predicates.

The Completeness Lemma is stated as in 22.7.8, and proved by recursion. For predicates other than identity:

$$\begin{aligned} Pa_1 \dots a_n, + \text{ is on } \mathcal{B} &\Rightarrow \langle [a_1], \dots, [a_n] \rangle \in v^{\mathcal{E}}(P) \\ &\Rightarrow \langle v(a_1), \dots, v(a_n) \rangle \in v^{\mathcal{E}}(P) \\ &\Rightarrow Pa_1 \dots a_n \rho 1 \end{aligned}$$

$$\begin{aligned} Pa_1 \dots a_n, - \text{ is on } \mathcal{B} &\Rightarrow Pa_1 \dots a_n, + \text{ is not on } \mathcal{B} && (\mathcal{B} \text{ open}) \\ &\Rightarrow \langle [a_1], \dots, [a_n] \rangle \notin v^{\mathcal{E}}(P) \\ &\Rightarrow \langle v(a_1), \dots, v(a_n) \rangle \notin v^{\mathcal{E}}(P) \\ &\Rightarrow \text{it is not the case that } Pa_1 \dots a_n \rho 1 \end{aligned}$$

$$\begin{aligned} \neg Pa_1 \dots a_n, + \text{ is on } \mathcal{B} &\Rightarrow \langle [a_1], \dots, [a_n] \rangle \in v^{\mathcal{A}}(P) \\ &\Rightarrow \langle v(a_1), \dots, v(a_n) \rangle \in v^{\mathcal{A}}(P) \\ &\Rightarrow Pa_1 \dots a_n \rho 0 \end{aligned}$$

$$\begin{aligned} \neg Pa_1 \dots a_n, - \text{ is on } \mathcal{B} &\Rightarrow \neg Pa_1 \dots a_n, + \text{ is not on } \mathcal{B} && (\mathcal{B} \text{ open}) \\ &\Rightarrow \langle [a_1], \dots, [a_n] \rangle \notin v^{\mathcal{A}}(P) \\ &\Rightarrow \langle v(a_1), \dots, v(a_n) \rangle \notin v^{\mathcal{A}}(P) \\ &\Rightarrow \text{it is not the case that } Pa_1 \dots a_n \rho 0 \end{aligned}$$

For the identity predicate:

$$\begin{aligned} a_1 = a_2, + \text{ is on } \mathcal{B} &\Rightarrow a_1 \sim a_2 \\ &\Rightarrow [a_1] = [a_2] \\ &\Rightarrow v(a_1) = v(a_2) \\ &\Rightarrow a_1 = a_2 \rho 1 \end{aligned}$$

$$\begin{aligned} a_1 = a_2, - \text{ is on } \mathcal{B} &\Rightarrow a_1 = a_2, + \text{ is not on } \mathcal{B} && (\mathcal{B} \text{ open}) \\ &\Rightarrow \text{it is not the case that } a_1 \sim a_2 \\ &\Rightarrow [a_1] \neq [a_2] \\ &\Rightarrow v(a_1) \neq v(a_2) \\ &\Rightarrow \text{it is not the case that } a_1 = a_2 \rho 1 \end{aligned}$$

$$\begin{aligned} \neg a_1 = a_2, + \text{ is on } \mathcal{B} &\Rightarrow \langle [a_1], [a_2] \rangle \in v^{\mathcal{A}}(=) \\ &\Rightarrow \langle v(a_1), v(a_2) \rangle \in v^{\mathcal{A}}(=) \\ &\Rightarrow a_1 = a_2 \rho 0 \end{aligned}$$

$$\begin{aligned} \neg a_1 = a_2, - \text{ is on } \mathcal{B} &\Rightarrow \neg a_1 = a_2, + \text{ is not on } \mathcal{B} && (\mathcal{B} \text{ open}) \\ &\Rightarrow \langle [a_1], [a_2] \rangle \notin v^{\mathcal{A}}(=) \\ &\Rightarrow \langle v(a_1), v(a_2) \rangle \notin v^{\mathcal{A}}(=) \\ &\Rightarrow \text{it is not the case that } a_1 = a_2 \rho 0 \end{aligned}$$

The cases for the connectives and quantifiers are as without identity (22.7.8).

The Completeness Theorem follows from the Completeness Lemma in the usual way. ■

22.9.6 COMPLETENESS THEOREM (* SEMANTICS): The tableaux for identity are complete.

Proof:

Given an open branch, \mathcal{B} , of a tableau, the induced interpretation, $\langle D, W, *, v \rangle$, is defined as follows. W and $*$ are as in the case without identity (22.8.7). Define $a \sim b$ to mean that $a = b, 0$ is on \mathcal{B} . As usual, this is an equivalence relation. $D = \{[a] : a \in C\}$ (where C is the set of constants on the branch); $v(a) = [a]$. If α is 0 or $0^\#$, and P is any predicate other than identity then $\langle [a_1], \dots, [a_n] \rangle \in v_{w_\alpha}(P)$ iff $Pa_1 \dots a_n, +\alpha$ occurs on \mathcal{B} . (The interpretation of the identity predicate needs no specification.)

The Completeness Lemma is stated as in 22.8.8, and proved by recursion. The cases for the atomic sentences are as follows.

If P is not the identity predicate:

$$\begin{aligned} Pa_1 \dots a_n, +\alpha \text{ is on } \mathcal{B} &\Rightarrow \langle [a_1], \dots, [a_n] \rangle \in v_{w_\alpha}(P) \\ &\Rightarrow \langle v(a_1), \dots, v(a_n) \rangle \in v_{w_\alpha}(P) \\ &\Rightarrow v_{w_\alpha}(Pa_1 \dots a_n) = 1 \end{aligned}$$

$$\begin{aligned} Pa_1 \dots a_n, -\alpha \text{ is on } \mathcal{B} &\Rightarrow Pa_1 \dots a_n, +\alpha \text{ is not on } \mathcal{B} \quad (\mathcal{B} \text{ open}) \\ &\Rightarrow \langle [a_1], \dots, [a_n] \rangle \notin v_{w_\alpha}(P) \\ &\Rightarrow \langle v(a_1), \dots, v(a_n) \rangle \notin v_{w_\alpha}(P) \\ &\Rightarrow v_{w_\alpha}(Pa_1 \dots a_n) = 0 \end{aligned}$$

For the identity predicate:

$$\begin{aligned} a_1 = a_2, +\alpha \text{ is on } \mathcal{B} &\Rightarrow a_1 = a_2, +0 \text{ is on } \mathcal{B} \quad (\text{IIR}) \\ &\Rightarrow a_1 \sim a_2 \\ &\Rightarrow [a_1] = [a_2] \\ &\Rightarrow v(a_1) = v(a_2) \\ &\Rightarrow v_{w_\alpha}(a_1 = a_2) = 1 \end{aligned}$$

$$\begin{aligned} a_1 = a_2, -\alpha \text{ is on } \mathcal{B} &\Rightarrow a_1 = a_2, +0 \text{ is not on } \mathcal{B} \quad (\text{IIR, } \mathcal{B} \text{ open}) \\ &\Rightarrow \text{it is not the case that } a_1 \sim a_2 \\ &\Rightarrow [a_1] \neq [a_2] \\ &\Rightarrow v(a_1) \neq v(a_2) \\ &\Rightarrow v_{w_\alpha}(a_1 = a_2) = 0 \end{aligned}$$

The cases for the connectives and quantifiers are as in 22.8.8.

The Completeness Theorem follows in the usual fashion. ■

22.10 History

The earliest paper on quantified *FDE* is Belnap (1967). The semantics used there are algebraic semantics, not any of the kinds used in this chapter. Quantified $*$ semantics were first given by Routley (1979). Quantified relational/many-valued semantics are given by Priest (1987), ch. 5. That chapter also describes the behaviour of identity in *LP* (and *FDE*). However, most of the discussion of identity in relevant logic has gone on in the context of full relevant logics. For references, see 24.10.

22.11 Further Reading

For further reading on quantification and identity in relevant logics, see 24.11.

22.12 Problems

1. Check the details omitted in 22.2.4, 22.2.5, 22.2.6 and 22.4.5.
2. Determine whether the following are true in *FDE*. If the inference is not valid, read off a counter-model from an open branch, and check that it works. Convert this into a many-valued counter-model.
 - (a) $\forall xPx \vdash Pa$
 - (b) $\forall x(Px \vee Qx) \vdash \forall xPx \vee \forall xQx$
 - (c) $\exists x(Px \wedge Qx) \vdash \exists xPx \wedge \exists xQx$
 - (d) $\exists xPx \wedge \exists xQx \vdash \exists x(Px \wedge Qx)$
 - (e) $\forall x(Px \supset Qx) \vdash \forall xPx \supset \forall xQx$
 - (f) $\forall x(Px \supset Qx) \vdash \exists xPx \supset \exists xQx$
 - (g) $\forall x\neg(Px \wedge Qx) \vdash \forall x(\neg Px \vee \neg Qx)$
 - (h) $\exists x\neg(Px \vee Qx) \vdash \exists x(\neg Px \wedge \neg Qx)$
 - (i) $\exists x(Px \wedge \neg Px) \vdash \forall xQx$
 - (j) $\forall xQx \vdash \exists x(Px \vee \neg Px)$
3. Repeat question 2 with K_3 and *LP*.
4. Repeat question 2 in free *FDE*.
5. Repeat question 2 with the $*$ semantics and tableaux for *FDE*.

6. Formulate the variable domain version of the * semantics for *FDE*, and write down the appropriate tableau rules.
7. Determine whether the following are true in the relational semantics for *FDE* with identity. If the inference is not valid, read off a counter-model from an open branch, and check that it works.

(a) $\vdash a = a$

(b) $a = b \vdash b = a$

(c) $a = b, b = c \vdash a = c$

(d) $a = b \wedge Pa \vdash Pb$

(e) $\vdash (a = b \wedge Pa) \supset Pb$

(f) $\vdash a = b \supset (Pa \supset Pb)$

(g) $a = b, \neg b = c \vdash \neg a = c$

(h) $a = b \wedge \neg Pa \vdash \neg Pb$

8. Repeat the previous question with the * semantics.
9. Formulate the semantics for identity in free *FDE*. Write down the appropriate tableau rules. Modify these to accommodate the Negativity and Neutrality Constraints. (See 22.4.7.)
10. Formulate the contingent identity version of the * semantics, and write down the appropriate tableau rules. Give an inference that is invalid in these semantics, but valid in the necessary identity semantics. (Hint: this must involve negation. Why?)
11. Show that, for *FDE*, the relational semantics with identity and the * semantics with contingent identity are equivalent. (Hint: modify the argument of 22.5.8.)
12. *Check the details omitted in 22.7, 22.8, 22.9.
13. *Formulate the tableaux for quantified \mathcal{L}_3 and *RM*. (See 22.3.8.) Prove that they are sound and complete.
14. *Prove soundness and completeness for the tableau systems of questions 6, 9 and 10.
15. *For the various systems of logic in this chapter, formulate tableaux for inferences with arbitrary sets of premises. Prove the Soundness and Completeness Theorems. Infer the Compactness and Löwenheim-Skolem Theorems.

23 Logics with Gaps, Gluts and Worlds

23.1 Introduction

23.1.1 This chapter brings together the techniques of previous chapters, to look at a variety of logics that they may generate. The chapter also acts as a bridge between the basic system of relevant logic of the last chapter, First Degree Entailment, and the full relevant logics of the next.

23.1.2 By this stage of the book we have many independent techniques that may be employed in constructing the semantics of a logic: normal and non-normal worlds, constant and variable domains, different numbers of truth values, negation using many values and the * semantics, necessary and contingent identity. These techniques can be combined to produce a vast variety of logics, far too many to consider here. We will consider only some of the more notable ones.

23.1.3 We begin with the basic relevant logics N_4 and N_* , starting with the former. This will require an application of the matrix semantics employed for non-normal modal logics in chapter 18. The logics K_4 and K_* are then obtained as special cases. We will look only at the constant domain versions of the logics.

23.1.4 Identity for the logics in question is next on the agenda. We will concern ourselves only with necessary identity, though the behaviour of identity at non-normal worlds gives it something of the flavour of contingent identity.

23.1.5 There is then a philosophical interlude concerning one application of identity in relevant logic: relevant predication.

23.1.6 Finally, we turn to logics of constructible negation. To make the comparison with intuitionist logic as clear as possible, we consider only

the case where the world structure is the same as that of intuitionist logic. For the same reason, we (then) consider only contingent identity for the logics.

23.2 Matrix Semantics Again

23.2.1 The language of the systems we will deal with first adds a conditional operator, \rightarrow , to be thought of as a conditional of entailment strength, to the language of *FDE*.

23.2.2 In the propositional logics N_4 and N_* , conditionals of this kind are assigned arbitrary truth values at non-normal worlds. If we do exactly this in the quantificational extensions, we encounter the same problems as we encountered with non-normal modal logics in 18.2. Thus, for example, $Pa \rightarrow Qa$ may be assigned the value true at a world, though $Pb \rightarrow Qb$ isn't – even though a and b have the same denotation. (And more generally, the Denotation Lemma, fundamental to the well-functioning of quantification, will fail.)

23.2.3 The solution to the problem is also as in 18.2. Given any closed conditional formula, $A \rightarrow B$, we define its matrix exactly as we defined the matrices of modal formulas in 18.2.3. As there, any conditional formula can be obtained from its matrix by making the appropriate substitutions of constants for variables. In the semantics for N_4 and N_* , matrices behave just like atomic sentences at non-normal – that is, impossible – worlds.¹ We take over the notational conventions of 18.2 and 18.3.

23.3 N_4

23.3.1 Thus, an interpretation for N_4 extends the relational semantics of *FDE*, employing matrices at non-normal worlds. Specifically, an interpretation is a structure of the form $\langle D, W, N, \nu \rangle$. D is the non-empty domain of quantification. W is a set (of worlds), and $N \subseteq W$ is the set of normal worlds. For every constant, c , $\nu(c) \in D$; for every n -place predicate, and world, w , ν assigns P an extension and anti-extension, $\langle \nu_w^E(P), \nu_w^A(P) \rangle$; for

¹ As observed in 9.4.9, it would therefore be more appropriate to call these logics L_4 and L_* , respectively.

every conditional matrix, M , and every non-normal world, w , v also assigns M an extension and anti-extension, $(v_w^{\mathcal{E}}(M), v_w^{\mathcal{A}}(M))$.

23.3.2 Given an interpretation, a relation, ρ , determining the truth/falsity values of each formula at a world, is defined as follows. For any n -place predicate, P :

$$\begin{aligned} Pa_1 \dots a_n \rho_w 1 & \text{ iff } \langle v(a_1), \dots, v(a_n) \rangle \in v_w^{\mathcal{E}}(P) \\ Pa_1 \dots a_n \rho_w 0 & \text{ iff } \langle v(a_1), \dots, v(a_n) \rangle \in v_w^{\mathcal{A}}(P) \end{aligned}$$

The conditions for the extensional connectives are as in 9.2.3. For the conditional, if w is a normal world:

$$\begin{aligned} A \rightarrow B \rho_w 1 & \text{ iff for all } w' \in W \text{ such that } A \rho_{w'} 1, B \rho_{w'} 1 \\ A \rightarrow B \rho_w 0 & \text{ iff for some } w' \in W, A \rho_{w'} 1 \text{ and } B \rho_{w'} 0 \end{aligned}$$

But if w is non-normal and $A \rightarrow B$ is any closed formula of the form $M_{\vec{x}}(a_1, \dots, a_n)$, where M is a matrix:

$$\begin{aligned} M_{\vec{x}}(a_1, \dots, a_n) \rho_w 1 & \text{ iff } \langle v(a_1), \dots, v(a_n) \rangle \in v_w^{\mathcal{E}}(M) \\ M_{\vec{x}}(a_1, \dots, a_n) \rho_w 0 & \text{ iff } \langle v(a_1), \dots, v(a_n) \rangle \in v_w^{\mathcal{A}}(M) \end{aligned}$$

The conditions for the quantifiers are:

$$\begin{aligned} \forall x A \rho_w 1 & \text{ iff for all } d \in D, A_x(k_d) \rho_w 1 \\ \forall x A \rho_w 0 & \text{ iff for some } d \in D, A_x(k_d) \rho_w 0 \\ \exists x A \rho_w 1 & \text{ iff for some } d \in D, A_x(k_d) \rho_w 1 \\ \exists x A \rho_w 0 & \text{ iff for all } d \in D, A_x(k_d) \rho_w 0 \end{aligned}$$

23.3.3 Validity is defined in terms of truth preservation at normal worlds of all interpretations. That is, $\Sigma \models A$ iff for every interpretation $\mathcal{J} = \langle D, W, N, v \rangle$, and every $w \in N$, if $B \rho_w 1$ for all $B \in \Sigma$, $A \rho_w 1$.

23.3.4 Tableaux are the same as in the propositional case (that is, as in 9.3, as modified for N_4 in 9.5.1 – specifically, the rules for conditionals are applied only when $i = 0$) with the addition of the quantifier rules:

$$\begin{array}{ccc} \forall x A, +i & \forall x A, -i & \neg \forall x A, \underline{+i} \\ \downarrow & \downarrow & \downarrow \\ A_x(a), +i & A_x(c), -i & \exists x \neg A, \underline{+i} \end{array}$$

$$\begin{array}{ccc}
 \exists xA, +i & \exists xA, -i & \neg\exists xA, \underline{+i} \\
 \downarrow & \downarrow & \downarrow \\
 A_x(c), +i & A_x(a), -i & \forall x\neg A, \underline{+i}
 \end{array}$$

a is any constant on the branch, or a new one if there is none; c is a constant new to the branch; and $\underline{+}$ can be disambiguated uniformly either way.

23.3.5 Here is a tableau to show that $\forall x(A \rightarrow B) \vdash \exists xA \rightarrow \exists xB$. c is a constant new to the branch.

$$\begin{array}{c}
 \forall x(A \rightarrow B), +0 \\
 \exists xA \rightarrow \exists xB, -0 \\
 \exists xA, +1 \\
 \exists xB, -1 \\
 A_x(c), +1 \\
 B_x(c), -1 \\
 A_x(c) \rightarrow B_x(c), +0 \\
 \swarrow \quad \searrow \\
 A_x(c), -1 \quad B_x(c), +1 \\
 \times \quad \times
 \end{array}$$

23.3.6 Here is another to show that $\not\vdash \forall x(Px \rightarrow Qx) \rightarrow (\forall xPx \rightarrow \forall xQx)$:

$$\begin{array}{c}
 \forall x(Px \rightarrow Qx) \rightarrow (\forall xPx \rightarrow \forall xQx), -0 \\
 \forall x(Px \rightarrow Qx), +1 \\
 \forall xPx \rightarrow \forall xQx, -1 \\
 Pa \rightarrow Qa, +1
 \end{array}$$

No further rules are applicable, since the only remaining information about conditionals is at worlds other than 0.

23.3.7 To read off a counter-model from an open branch of a tableau, W and D are defined as usual. $N = \{w_0\}$. For every constant, a , $v(a) = \partial_a$, and for every n -place predicate, P :

$$\begin{array}{ll}
 \langle \partial_{a_1}, \dots, \partial_{a_n} \rangle \in v_{w_i}^{\mathcal{E}}(P) & \text{iff } Pa_1 \dots a_n, +i \text{ is on the branch} \\
 \langle \partial_{a_1}, \dots, \partial_{a_n} \rangle \in v_{w_i}^{\mathcal{A}}(P) & \text{iff } \neg Pa_1 \dots a_n, +i \text{ is on the branch}
 \end{array}$$

Extensions and anti-extensions for every conditional matrix, M , at non-normal worlds are determined in the same way. (If there are no constants on the branch, D is simply $\{\partial\}$, and ∂ is not the extension or anti-extension of any predicate.)

23.3.8 Thus, in the counter-model determined by the tableau of 23.3.6, $W = \{w_0, w_1\}$, $N = \{w_0\}$, $D = \{\partial_a\}$, $v(a) = \partial_a$, $v_{w_1}^\mathcal{E}(Pv_0 \rightarrow Qv_1) = \{\{\partial_a, \partial_a\}\}$, $v_{w_1}^\mathcal{E}(\forall xPx \rightarrow \forall xQx) = \phi$. All anti-extensions are empty. The interpretation may be depicted as follows. I display only the extensions; anti-extensions play no role. Recall that if A is a closed sentence, its extension – or anti-extension – is either ϕ or $\{\langle \cdot \rangle\}$.

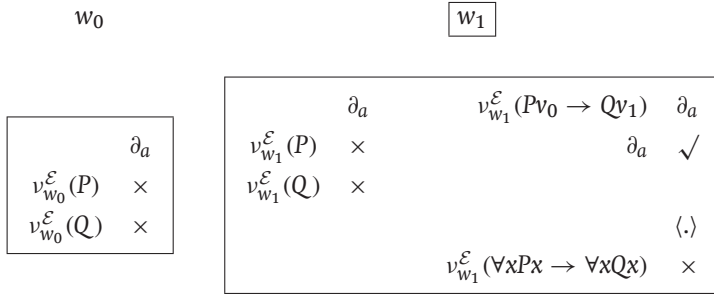

It is not difficult to see that $\forall x(Px \rightarrow Qx)$ is true at w_1 , whilst $\forall xPx \rightarrow \forall xQx$ is not. Hence the whole conditional is not true at w_0 .

23.4 N_*

23.4.1 Turning to N_* , an interpretation is a structure of the form $\langle D, W, N, *, v \rangle$. D , W , and $*$ are as in the $*$ semantics for FDE (22.5.1). $N \subseteq W$ is the set of normal worlds. For every constant, c , $v(c) \in D$; for every n -place predicate, P , and world, w , $v_w(P) \subseteq D^n$, and for every conditional matrix, M , and every non-normal world, w , $v_w(M) \subseteq D^n$. (Interpretations are 2-valued, and hence we do not need to worry about anti-extensions, as we do in N_4 .)

23.4.2 Given an interpretation, truth values are assigned to formulas at worlds as for FDE (22.5.2), with the addition that, for the conditional, if w is a normal world:

$$v_w(A \rightarrow B) = 1 \quad \text{iff} \quad \text{for all } w' \in W \text{ such that } v_{w'}(A) = 1, v_{w'}(B) = 1$$

and if w is a non-normal world, and $A \rightarrow B$ is any closed formula of the form $M_{\rightarrow}^x(a_1, \dots, a_n)$, where M is a matrix:

$$v_w(M_{\rightarrow}^x(a_1, \dots, a_n)) = 1 \quad \text{iff} \quad \langle v(a_1), \dots, v(a_n) \rangle \in v_w(M)$$

23.4.3 Validity is defined in terms of truth preservation at all normal worlds of all interpretations.

23.4.4 Tableaux are the same as in the propositional case (that is, as in 9.6.3, as modified for N_* in 9.6.7 – specifically, the rules for conditionals are applied only when $i = 0$) with the addition of the quantifier rules:

$$\begin{array}{cc} \forall xA, +i & \forall xA, -i \\ \downarrow & \downarrow \\ A_x(a), +i & A_x(c), -i \end{array}$$

$$\begin{array}{cc} \exists xA, +i & \exists xA, -i \\ \downarrow & \downarrow \\ A_x(c), +i & A_x(a), -i \end{array}$$

a is any constant on the branch, or a new one if there is none; c is a constant new to the branch.

23.4.5 Here is a tableau to show that $\forall x(A \rightarrow B) \vdash \exists x\neg B \rightarrow \exists x\neg A$. c is a constant new to the branch.

$$\begin{array}{c} \forall x(A \rightarrow B), +0 \\ \exists x\neg B \rightarrow \exists x\neg A, -0 \\ \exists x\neg B, +1 \\ \exists x\neg A, -1 \\ \neg B_x(c), +1 \\ B_x(c), -1^\# \\ \neg A_x(c), -1 \\ A_x(c), +1^\# \\ A_x(c) \rightarrow B_x(c), +0 \\ \swarrow \quad \searrow \\ A_x(c), -1^\# \quad B_x(c), +1^\# \\ \times \quad \times \end{array}$$

23.4.6 Here is another to show that $\not\vdash \forall x(Px \rightarrow Qx) \rightarrow (\exists x\neg Qx \rightarrow \exists x\neg Px)$:

$$\begin{array}{c} \forall x(Px \rightarrow Qx) \rightarrow (\exists x\neg Qx \rightarrow \exists x\neg Px), -0 \\ \forall x(Px \rightarrow Qx), +1 \\ \exists x\neg Qx \rightarrow \exists x\neg Px, -1 \\ Pa \rightarrow Qa, +1 \end{array}$$

No further rules are applicable, since the only remaining information about conditionals is at worlds other than 0.

23.4.7 Counter-models are read off from an open branch as for *FDE* (22.5.7), with the addition that all worlds other than w_0 are non-normal, and conditional matrices are treated as atomic formulas at non-normal worlds. Thus, the counter-model determined by the tableau of 23.4.6 may be depicted as follows. All extensions other than those explicitly depicted are empty.

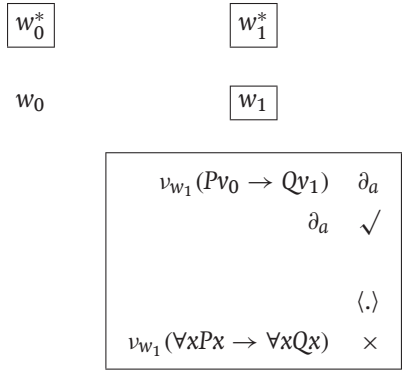

I leave it as an exercise to check that this interpretation works.

23.4.8 Note that as long as we stay away from negation, the tableaux for N_4 and N_* are the same, showing that the positive (i.e., negation free) parts of the two logics are the same.

23.4.9 We can, of course, have variable domain semantics for these logics. In such logics, the inner-domain quantifiers cannot be defined in terms of the outer-domain quantifiers plus a connective, for the same reasons as we noted in connection with *FDE* in 22.4.8. Hence, if we have both inner and outer quantifiers, both have to be taken as primitive. (Note also that even if \mathcal{E} is a classical predicate, we cannot define $\forall^E Px$ as $\forall x(\mathcal{E}x \rightarrow Px)$.) For the first of these to be true at a world, w , Pk_d must be true at w , for every $d \in D_w$. But for the second to be true at a normal world, w , Pk_d must be true at every world, w' , and every $d \in D_{w'}$. This is obviously a lot stronger. If \mathcal{E} is a classical predicate we can, however, define $\forall^E Px$ as $\forall x(\mathcal{E}x \supset Px)$.

23.5 K_4 and K_*

23.5.1 Interpretations for the logics K_4 and K_* are the same as those for N_4 and N_* , respectively, except that the class of non-normal worlds is empty. That is, $N = W$. The use of matrices therefore drops out of the picture altogether.

23.5.5 Counter-models are read off as for N_4 and N_* , except that we no longer have to worry about non-normal worlds or matrices. Thus, the counter-model given by the rightmost branch of the tableau of 23.5.4 may be depicted as follows.

w_0	w_0^*	w_1	w_1^*																																																
<table style="width: 100%; border-collapse: collapse;"> <thead> <tr> <th style="border: none;"></th> <th style="border: none;">P</th> <th style="border: none;">Q</th> </tr> </thead> <tbody> <tr> <td style="border: none;">∂_a</td> <td style="border: none;">×</td> <td style="border: none;">×</td> </tr> <tr> <td style="border: none;">∂_b</td> <td style="border: none;">×</td> <td style="border: none;">×</td> </tr> <tr> <td style="border: none;">∂_c</td> <td style="border: none;">×</td> <td style="border: none;">✓</td> </tr> </tbody> </table>		P	Q	∂_a	×	×	∂_b	×	×	∂_c	×	✓	<table style="width: 100%; border-collapse: collapse;"> <thead> <tr> <th style="border: none;"></th> <th style="border: none;">P</th> <th style="border: none;">Q</th> </tr> </thead> <tbody> <tr> <td style="border: none;">∂_a</td> <td style="border: none;">×</td> <td style="border: none;">×</td> </tr> <tr> <td style="border: none;">∂_b</td> <td style="border: none;">×</td> <td style="border: none;">×</td> </tr> <tr> <td style="border: none;">∂_c</td> <td style="border: none;">×</td> <td style="border: none;">✓</td> </tr> </tbody> </table>		P	Q	∂_a	×	×	∂_b	×	×	∂_c	×	✓	<table style="width: 100%; border-collapse: collapse;"> <thead> <tr> <th style="border: none;"></th> <th style="border: none;">P</th> <th style="border: none;">Q</th> </tr> </thead> <tbody> <tr> <td style="border: none;">∂_a</td> <td style="border: none;">✓</td> <td style="border: none;">×</td> </tr> <tr> <td style="border: none;">∂_b</td> <td style="border: none;">×</td> <td style="border: none;">×</td> </tr> <tr> <td style="border: none;">∂_c</td> <td style="border: none;">×</td> <td style="border: none;">✓</td> </tr> </tbody> </table>		P	Q	∂_a	✓	×	∂_b	×	×	∂_c	×	✓	<table style="width: 100%; border-collapse: collapse;"> <thead> <tr> <th style="border: none;"></th> <th style="border: none;">P</th> <th style="border: none;">Q</th> </tr> </thead> <tbody> <tr> <td style="border: none;">∂_a</td> <td style="border: none;">×</td> <td style="border: none;">×</td> </tr> <tr> <td style="border: none;">∂_b</td> <td style="border: none;">×</td> <td style="border: none;">✓</td> </tr> <tr> <td style="border: none;">∂_c</td> <td style="border: none;">×</td> <td style="border: none;">✓</td> </tr> </tbody> </table>		P	Q	∂_a	×	×	∂_b	×	✓	∂_c	×	✓
	P	Q																																																	
∂_a	×	×																																																	
∂_b	×	×																																																	
∂_c	×	✓																																																	
	P	Q																																																	
∂_a	×	×																																																	
∂_b	×	×																																																	
∂_c	×	✓																																																	
	P	Q																																																	
∂_a	✓	×																																																	
∂_b	×	×																																																	
∂_c	×	✓																																																	
	P	Q																																																	
∂_a	×	×																																																	
∂_b	×	✓																																																	
∂_c	×	✓																																																	

$Pc \rightarrow Qc$ holds at w_0 , as therefore does $\exists x(Px \rightarrow Qx)$. At w_1 , $\exists xPx$ holds, but at w_1^* , $\exists xQx$ holds, so $\neg\exists xQx$ fails at w_1 . Hence, $\exists xPx \rightarrow \neg\exists xQx$ fails at w_0 .

23.5.6 Note that the comments of 23.4.8 and 23.4.9 concerning N_4 and N_* apply equally to K_4 and K_* .

23.6 Relevant Identity

23.6.1 We now turn to identity. The straightforward way of adding identity to the logics we have been dealing with is simply to set the extension of $=$ at every world, w , ($\nu_w^E(=)$ in the relational semantics, and $\nu_w(=)$ in the $*$ semantics) to be the set of all pairs of the form $\langle d, d \rangle$ for $d \in D$.

23.6.2 This would appear to give the wrong results, however – at least in the case of N_4 and N_* , which are relevant logics. (See 9.7.9, 9.7.10.) It is not difficult to check that this would deliver the result that:

$$a = b \models A \rightarrow a = b$$

(In particular, $\models A \rightarrow a = a$; and there is no intuitive connection between an arbitrary formula and an instance of the law of identity.) If $\nu(a) = \nu(b)$, then $a = b$ is true at every world, so $A \rightarrow a = b$ is true at every normal world. This is a special case of the inference from B to $A \rightarrow B$, which fails in relevant logics. True, it is just as a special case, but from a relevant perspective it would seem to be just as dubious as the general case. There is no connection of relevance between an arbitrary A and a true identity.

23.6.3 What has gone wrong is clear, though. Non-normal, that is, impossible, worlds, are worlds where logical truths may fail. $a = a$ is a logical truth, so one should expect there to be worlds where it fails. In particular, the extension of identity at an impossible world should not be $\{(d, d) : d \in D\}$. What should it be? In N_4 and N_* logical truths of the form $A \rightarrow B$ are effectively assigned arbitrary truth values at non-normal worlds. (For a discussion of the rationale of this, see 9.4.) This suggests that the extension of $=$ should also be arbitrary at such worlds. (In the relational semantics for FDE , the anti-extension is already arbitrary.)

23.6.4 Thus, we adopt the following policy. In any interpretation, the extension of $=$ (that is, $v_w^E(=)$ in the relational semantics, and $v_w(=)$ in the $*$ semantics) is a subset of D^2 , subject only to the constraint that if $w \in N$, it is $\{(d, d) : d \in D\}$. (Of course, normal worlds are the only worlds in K_4 and K_* .)

23.6.5 The corresponding tableau rules are, for the relational semantics:

$$\begin{array}{rcl}
 & & a = b, +0 \\
 & & \downarrow \\
 & & A_x(a), +i \\
 a = a, +0 & & \downarrow \\
 & & A_x(b), +i
 \end{array}$$

where A is any atomic sentence or its negation (and we do not count the line $a = b, +0$). In the case of N_4 , if $i > 0$, A may also be any conditional sentence or its negation.

In the $*$ semantics, the rules are:

$$\begin{array}{rcl}
 & & a = b, +0 \\
 & & \downarrow \\
 & & A_x(a), +\alpha \\
 a = a, +0 & & \downarrow \\
 & & A_x(b), +\alpha
 \end{array}$$

where A is any atomic sentence (and we do not count the line $a = b, +0$), and α is anything of the form i or $i^\#$. Again, in the case of N_* , if $i > 0$, A may also be any conditional sentence. Note that in both cases, SI legitimises substitution in worlds *other* than that in which the identity holds.

In the case of K_4 and K_* , we also need a version of the identity invariance rule:

$$\begin{array}{c} a = b, +i [\alpha] \\ \downarrow \\ a = b, +j [\beta] \end{array}$$

As in the cases without identity (23.4.8, 23.5.6), as long as we stick to negation-free inferences, tableaux with identity for the relational semantics and the $*$ semantics are the same.

23.6.6 Here is a tableau to show that $a = b \vdash Pa \rightarrow Pb$ in N_4 and N_* :

$$\begin{array}{c} a = b, +0 \\ Pa \rightarrow Pb, -0 \\ Pa, +1 \\ Pb, -1 \\ Pa, -1 \\ \times \end{array}$$

Here is another to show that $a = b \not\vdash Pc \rightarrow a = b$ in the same logics:

$$\begin{array}{c} a = b, +0 \\ Pc \rightarrow a = b, -0 \\ Pc, +1 \\ a = b, -1 \end{array}$$

Without any analogue of the identity invariance rule, the tableau goes no further, and remains open.

23.6.7 We read off a counter-model from an open branch as is usual in the case of necessary identity. Whenever we have a bunch of lines of the form $a = b, +0, b = c, +0, \dots$ we select one object for all of the constants to denote, say ∂_a . At normal worlds (that is, all worlds in the K -logics, and just 0 in the N -logics) the extension of $=$ is predetermined. At non-normal worlds $=$ is treated as any other predicate, and its extension is read off accordingly (as is its anti-extension at all worlds in the relational semantics).

23.6.8 Thus, for the open tableau of 23.6.6, the N_4 counter-model is as follows: $W = \{w_0, w_1\}$, $N = \{w_0\}$, $D = \{\partial_a, \partial_c\}$, $\nu(a) = \nu(b) = \partial_a$, $\nu(c) = \partial_c$, $\nu_{w_1}^E(P) = \{\partial_c\}$ and $\nu_{w_1}^E(=) = \emptyset$. All anti-extensions are empty. In a picture

(omitting anti-extensions):

w_0	w_1															
<table style="margin: auto;"> <tr><td style="padding: 5px;">$v^{\mathcal{E}}(P)$</td></tr> <tr><td style="padding: 5px;">$\partial_a \times$</td></tr> <tr><td style="padding: 5px;">$\partial_c \times$</td></tr> </table>	$v^{\mathcal{E}}(P)$	$\partial_a \times$	$\partial_c \times$	<table style="margin: auto;"> <tr> <td style="padding: 5px;">$v^{\mathcal{E}}(=)$</td> <td style="padding: 5px;">∂_a</td> <td style="padding: 5px;">∂_c</td> <td style="padding: 5px;">$v^{\mathcal{E}}(P)$</td> </tr> <tr> <td style="padding: 5px;">∂_a</td> <td style="padding: 5px;">\times</td> <td style="padding: 5px;">\times</td> <td style="padding: 5px;">$\partial_a \times$</td> </tr> <tr> <td style="padding: 5px;">∂_c</td> <td style="padding: 5px;">\times</td> <td style="padding: 5px;">\times</td> <td style="padding: 5px;">$\partial_c \checkmark$</td> </tr> </table>	$v^{\mathcal{E}}(=)$	∂_a	∂_c	$v^{\mathcal{E}}(P)$	∂_a	\times	\times	$\partial_a \times$	∂_c	\times	\times	$\partial_c \checkmark$
$v^{\mathcal{E}}(P)$																
$\partial_a \times$																
$\partial_c \times$																
$v^{\mathcal{E}}(=)$	∂_a	∂_c	$v^{\mathcal{E}}(P)$													
∂_a	\times	\times	$\partial_a \times$													
∂_c	\times	\times	$\partial_c \checkmark$													

For N_* it is the same, except that $W = \{w_0, w_0^*, w_1, w_1^*\}$ and $v^{\mathcal{E}}$ is replaced by v . I leave it as an exercise to check that this model works.

23.6.9 It is quite possible to formulate a contingent-identity semantics for the relevant logics we are dealing with here, as in chapter 17. Such semantics will also invalidate the inference from $a = b$ to $A \rightarrow a = b$, even without non-normal worlds: the fact that the avatars of a and b are the same at w_0 does not mean that they are the same at all other worlds. However, the semantics also invalidate the inference from $a = b$ to $Pa \rightarrow Pb$. a and b can have the same avatar at w_0 , but at some other world the avatar of a there may satisfy P whilst the avatar of b does not.

23.6.10 As we saw in 17.3, it is possible to find plausible examples of the failure of SI in modal contexts. It is much harder to find plausible examples of the failure of SI in the context of a relevant conditional.

23.6.11 In the necessary-identity semantics given, $a = b, A_x(a) \models A_x(b)$. This is proved in 23.11.3.

23.7 Relevant Predication

23.7.1 As is not difficult to check, Pa is logically equivalent to $\forall x(x = a \rightarrow Px)$ in classical logic. In relevant logics this is not the case. The latter implies the former but not vice versa. So in N_4 and N_* , we have:

$\forall x(x = a \rightarrow Px), +0$	$Pa, +0$
$Pa, -0$	$\forall x(x = a \rightarrow Px), -0$
$a = a \rightarrow Pa, +0$	$b = a \rightarrow Pb, -0$
$\swarrow \quad \searrow$	$b = a, +1$
$a = a, -0 \quad Pa, +0$	$Pb, -1$
$\times \quad \times$	

The N_4 counter-model given by the second tableau is as follows. (All anti-extensions are empty, and not depicted.)

w_0	w_1																					
<table style="width: 100%; border-collapse: collapse;"> <tr> <td style="width: 50%;"></td> <td style="width: 50%;">$\nu^{\mathcal{E}}(P)$</td> </tr> <tr> <td>∂_a</td> <td style="text-align: center;">✓</td> </tr> <tr> <td>∂_b</td> <td style="text-align: center;">×</td> </tr> </table>		$\nu^{\mathcal{E}}(P)$	∂_a	✓	∂_b	×	<table style="width: 100%; border-collapse: collapse;"> <tr> <td style="width: 25%;">$\nu^{\mathcal{E}}(=)$</td> <td style="width: 10%;">∂_a</td> <td style="width: 10%;">∂_b</td> <td style="width: 50%;"></td> <td style="width: 25%;">$\nu^{\mathcal{E}}(P)$</td> </tr> <tr> <td>∂_a</td> <td style="text-align: center;">×</td> <td style="text-align: center;">×</td> <td>∂_a</td> <td style="text-align: center;">×</td> </tr> <tr> <td>∂_b</td> <td style="text-align: center;">✓</td> <td style="text-align: center;">×</td> <td>∂_b</td> <td style="text-align: center;">×</td> </tr> </table>	$\nu^{\mathcal{E}}(=)$	∂_a	∂_b		$\nu^{\mathcal{E}}(P)$	∂_a	×	×	∂_a	×	∂_b	✓	×	∂_b	×
	$\nu^{\mathcal{E}}(P)$																					
∂_a	✓																					
∂_b	×																					
$\nu^{\mathcal{E}}(=)$	∂_a	∂_b		$\nu^{\mathcal{E}}(P)$																		
∂_a	×	×	∂_a	×																		
∂_b	✓	×	∂_b	×																		

Generally, Pa says simply that P is true of a ; whereas $\forall x(x = a \rightarrow Px)$ says, loosely, that x 's being a is relevant to its being P : a 's being P is no accident.

23.7.2 Let us write $\forall x(x = a \rightarrow Px)$ as $[Px](a)$, and, if this is true, say that P is *relevantly predicable* of a . The square brackets thus indicate a notion of relevant (monadic) predication. In a similar way, we may write $\forall x\forall y((x = a \wedge y = b) \rightarrow Sxy)$ as $[Sxy](a, b)$. The square brackets indicate relevant (relational) predication.

23.7.3 There are many places in philosophy where it is natural to appeal to the idea that a property of an object is, in some sense, inherent to it. Thus, suppose that Albert is thinking about the Moon. This seems to be a property inherent to Albert in a way that it is not inherent to the Moon. If Albert ceased thinking about the Moon, he would change, but the Moon certainly would not. This asymmetry is not captured by the simple predication Tam , which treats both constants even-handedly. How should one express it?

23.7.4 One cannot use the machinery of modal logic to do this. Though the property of thinking about the Moon is inherent to Albert, it is not a necessary truth about Albert that he is thinking of the Moon. In other worlds, he is not.

23.7.5 A natural thought is that one can deploy the notion of relevant predication to express the idea. For we may have $[Txm](a)$ but not $[Tax](m)$. These are, respectively:

$$\begin{aligned} &\forall x(x = a \rightarrow Txm) \\ &\forall x(x = m \rightarrow Tax) \end{aligned}$$

Though these are logically equivalent in classical logic, they are not equivalent in relevant logic. (Details are left as an exercise.)

23.7.6 In a similar way, at many places in philosophy it is plausible to suppose that some relationships are inherent to a pair of objects, and some are not. That a is in London and b is in St Andrews, Sab , determines no real relationship between a and b . If a moved, b could still be in St Andrews. By contrast, if a and b are married (to each other), Mab , a could not cease to be married without b ceasing to be married too. The mere relational form does not distinguish between the two situations.

23.7.7 Again, a natural thought is that the difference between the two can be captured by the fact that being married is a relevant relation, whilst the other is not. That is, $[Rxy](a, b)$ is not true, but $[Mxy](a, b)$ is:

$$\begin{aligned} & \neg \forall x \forall y ((x = a \wedge y = b) \rightarrow Sxy) \\ & \forall x \forall y ((x = a \wedge y = b) \rightarrow Mxy) \end{aligned}$$

23.7.8 The notion of relevant predication may well, therefore, be a useful philosophical tool.

23.8 Logics with Constructible Negation

23.8.1 In the remainder of this chapter, we will look at logics with constructible negation (9.7a). These are logics whose positive (negation-free) parts are the same as intuitionist logic, but which employ a different treatment of negation. The language for these logics is the same as that for the logics we have considered in previous sections of this chapter, except that we write the conditional as \Box . We ignore identity in this section, reserving it for the next.

23.8.2 We start with I_4 . An interpretation is a structure $\langle D, W, R, \nu \rangle$. D, W and R are as for intuitionist logic. So, in particular, R is reflexive and transitive, and if wRw' then $D_w \subseteq D_{w'}$. ν is as for K_4 . Specifically, for every world, w , and n -place predicate, P , $\nu_w^E(P)$ and $\nu_w^A(P)$ are subsets of D^n ; and we have the appropriate version of the heredity condition:

$$\text{if } wRw' \text{ then } \nu_w^E(P) \subseteq \nu_{w'}^E(P) \text{ and } \nu_w^A(P) \subseteq \nu_{w'}^A(P)$$

As in the case of intuitionist logic, for every constant, c (in the original language, not the language of the interpretation), and world, w , $\nu(c) \in D_w$.

23.8.3 The truth/falsity conditions for atomic sentences are as for K_4 (23.3.2). The conditions for the propositional connectives are as in the propositional case (9.7a.3). For the quantifiers:

$$\begin{aligned} \exists xA\rho_w 1 & \text{ iff for some } d \in D_w, A_x(k_d)\rho_w 1 \\ \forall xA\rho_w 1 & \text{ iff for all } w' \text{ such that } wRw', \text{ and all } d \in D_{w'}, A_x(k_d)\rho_{w'} 1 \\ \exists xA\rho_w 0 & \text{ iff for all } w' \text{ such that } wRw', \text{ and all } d \in D_{w'}, A_x(k_d)\rho_{w'} 0 \\ \forall xA\rho_w 0 & \text{ iff for some } d \in D_w, A_x(k_d)\rho_w 0 \end{aligned}$$

Note that the falsity conditions are the reverse of what one might initially expect. If this were not the case, the heredity conditions would not hold for all formulas, as they do. (See 23.15, problem 11.)

23.8.4 Validity is defined, as in K_4 , in terms of truth preservation at all worlds of all interpretations.

23.8.5 In the tableaux for I_4 the propositional rules are the same as in the propositional case (9.7a.4), except that the heredity rules are applied to atomic formulas and their negations:

$$\begin{array}{ccc} Pa_1 \dots a_n, +i & \neg Pa_1 \dots a_n, +i & \\ \text{irj} & \text{irj} & \\ \downarrow & \downarrow & \\ Pa_1 \dots a_n, +j & \neg Pa_1 \dots a_n, +j & \end{array}$$

The positive rules for the quantifiers are as for intuitionist logic, tableaux of kind 2 (20.5.2–20.5.4):²

$$\begin{array}{cccc} \exists xA, +i & \exists xA, -i & \forall xA, +i & \forall xA, -i \\ \downarrow & \downarrow & \text{irj} & \downarrow \\ A_x(c), +i & A_x(a), -i & \downarrow & \text{irj} \\ & & A_x(a), +j & A_x(c), -j \end{array}$$

The negative rules are:

$$\begin{array}{cccc} \neg \exists xA, +i & \neg \exists xA, -i & \neg \forall xA, +i & \neg \forall xA, -i \\ \text{irj} & \downarrow & \downarrow & \downarrow \\ \downarrow & \text{irj} & \neg A_x(c), +i & \neg A_x(a), -i \\ \neg A_x(a), +j & \neg A_x(c), -j & & \end{array}$$

c is a constant new to the branch, and a is every constant that belongs to i or j (whichever is to be found on the bottom line of the rule at issue). (For the definition of *belonging*, see 20.5.3.) As for intuitionist logic, we also need to

² It is also possible to have tableaux of kind 1. Details are left as an exercise.

ensure that there is at least one constant with entry number 0. So if there are no constants in the premises and conclusion, we add a line of the form $c = c, +0$.

23.8.6 Here are tableaux to show that $\exists x(\neg Px \wedge \neg Qx) \vdash \neg \forall x(Px \vee Qx)$ and $\forall x(Px \sqsupset Qx) \not\vdash \neg \forall x Px \vee \forall x Qx$. (The small table next to the second tableau shows the entry number of each constant.)

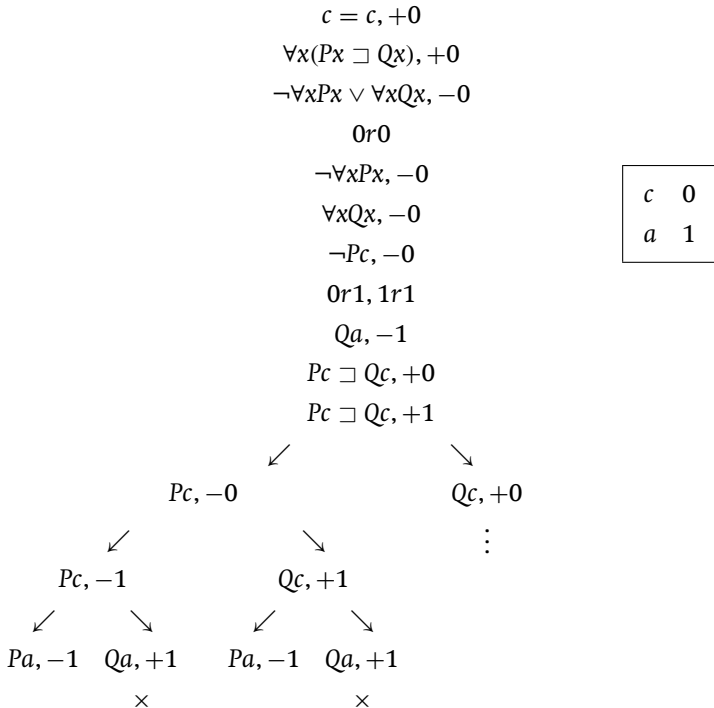
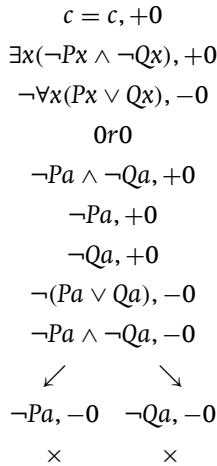

Note that the second split is over-determined. It is produced by both the lines $Pc \sqsupset Qc, +0$ and $Pc \sqsupset Qc, +1$.

23.8.7 To read off a counter-model from an open branch, W , R , and each D_w are as in the case of intuitionistic logic (20.5.8), $v(a) = \partial_a$, and:

$$\begin{aligned} \langle \partial_{a_1}, \dots, \partial_{a_n} \rangle \in v_{w_i}^{\mathcal{E}}(P) & \text{ iff } Pa_1 \dots a_n, +i \text{ is on the branch} \\ \langle \partial_{a_1}, \dots, \partial_{a_n} \rangle \in v_{w_i}^{\mathcal{A}}(P) & \text{ iff } \neg Pa_1 \dots a_n, +i \text{ is on the branch} \end{aligned}$$

Thus, the counter-model determined by the lefthand open branch of the open tableau of 23.8.6 is as follows. (The \dagger by an object indicates that it does not exist at the world in question.)

\curvearrowright		\curvearrowright																																				
w_0	\rightarrow	w_1																																				
<table style="width: 100%; border-collapse: collapse;"> <tr> <td style="padding: 5px;">$v^{\mathcal{E}}$</td> <td style="padding: 5px;">∂_c</td> <td style="padding: 5px;">$\dagger \partial_a$</td> </tr> <tr> <td style="padding: 5px;">P</td> <td style="padding: 5px; text-align: center;">\times</td> <td style="padding: 5px; text-align: center;">\times</td> </tr> <tr> <td style="padding: 5px;">Q</td> <td style="padding: 5px; text-align: center;">\times</td> <td style="padding: 5px; text-align: center;">\times</td> </tr> <tr> <td style="padding: 5px;">$v^{\mathcal{A}}$</td> <td style="padding: 5px;">∂_c</td> <td style="padding: 5px;">$\dagger \partial_a$</td> </tr> <tr> <td style="padding: 5px;">P</td> <td style="padding: 5px; text-align: center;">\times</td> <td style="padding: 5px; text-align: center;">\times</td> </tr> <tr> <td style="padding: 5px;">Q</td> <td style="padding: 5px; text-align: center;">\times</td> <td style="padding: 5px; text-align: center;">\times</td> </tr> </table>	$v^{\mathcal{E}}$	∂_c	$\dagger \partial_a$	P	\times	\times	Q	\times	\times	$v^{\mathcal{A}}$	∂_c	$\dagger \partial_a$	P	\times	\times	Q	\times	\times		<table style="width: 100%; border-collapse: collapse;"> <tr> <td style="padding: 5px;">$v^{\mathcal{E}}$</td> <td style="padding: 5px;">∂_c</td> <td style="padding: 5px;">∂_a</td> </tr> <tr> <td style="padding: 5px;">P</td> <td style="padding: 5px; text-align: center;">\times</td> <td style="padding: 5px; text-align: center;">\times</td> </tr> <tr> <td style="padding: 5px;">Q</td> <td style="padding: 5px; text-align: center;">\times</td> <td style="padding: 5px; text-align: center;">\times</td> </tr> <tr> <td style="padding: 5px;">$v^{\mathcal{A}}$</td> <td style="padding: 5px;">∂_c</td> <td style="padding: 5px;">∂_a</td> </tr> <tr> <td style="padding: 5px;">P</td> <td style="padding: 5px; text-align: center;">\times</td> <td style="padding: 5px; text-align: center;">\times</td> </tr> <tr> <td style="padding: 5px;">Q</td> <td style="padding: 5px; text-align: center;">\times</td> <td style="padding: 5px; text-align: center;">\times</td> </tr> </table>	$v^{\mathcal{E}}$	∂_c	∂_a	P	\times	\times	Q	\times	\times	$v^{\mathcal{A}}$	∂_c	∂_a	P	\times	\times	Q	\times	\times
$v^{\mathcal{E}}$	∂_c	$\dagger \partial_a$																																				
P	\times	\times																																				
Q	\times	\times																																				
$v^{\mathcal{A}}$	∂_c	$\dagger \partial_a$																																				
P	\times	\times																																				
Q	\times	\times																																				
$v^{\mathcal{E}}$	∂_c	∂_a																																				
P	\times	\times																																				
Q	\times	\times																																				
$v^{\mathcal{A}}$	∂_c	∂_a																																				
P	\times	\times																																				
Q	\times	\times																																				

At every world accessible to w_0 , every object that exists there satisfies $Px \sqsupset Qx$. Hence, $\forall x(Px \sqsupset Qx)$ is true at w_0 . But $\forall xPx$ is not false at w_0 , and $\forall xQx$ is not true. Hence, $\neg \forall xPx \vee \forall xQx$ is not true at w_0 .

23.8.8 Quantified I_3 is obtained from I_4 by adding the Exclusion Constraint to the semantics, and the corresponding tableau rule, as in 9.7a.7. (It is not difficult to extend the proof that no formula relates to both 1 and 0 and a world – see the footnote of 9.7a.7. Details are left as an exercise.) The connexive logic W is obtained by changing the falsity condition for \sqsupset , and modifying the corresponding tableau rule, as in 9.7a.10.

23.8.9 Again as for the propositional case, for sentences that do not contain negation, an inference is valid in I_4 (or I_3) iff it is valid in intuitionist logic, I . The argument is as in the propositional case (9.7a.8).

23.9 Identity for Logics with Constructible Negation

23.9.1 The semantics for I_4 with (contingent) identity are obtained by modifying the semantics for I_4 in the same way that the semantics for intuitionist logic are modified to give intuitionist logic with identity (20.8.4). In particular, members of D are now functions from worlds to avatars, and extensions and anti-extensions of predicates comprise the appropriate n -tuples of avatars.

23.9.2 The corresponding tableau rules are:

$$\begin{array}{rcl}
 & & a = b, +i \\
 & & \downarrow \\
 & & A_x(a), +i \\
 a = a, +i & & \downarrow \\
 & & A_x(b), +i
 \end{array}$$

where, in SI, $A_x(a)$ is an atomic sentence or its negation. (We also have the heredity rule for identities and their negations.)

23.9.3 Here are tableaux to show that $a = b \vdash \neg Pa \sqcap \neg Pb$ and $\not\vdash \forall x \forall y (x = y \vee \neg x = y)$:

$$\begin{array}{l}
 c = c, +0 \\
 a = b, +0 \\
 \neg Pa \sqcap \neg Pb, -0 \\
 \text{Or0} \\
 \text{Or1, 1r1} \\
 \neg Pa, +1 \\
 \neg Pb, -1 \\
 a = b, +1 \\
 \neg Pb, +1 \\
 \times
 \end{array}$$

The penultimate line is obtained by applying the heredity rule to line 1.

$$\begin{array}{l}
 c = c, +0 \\
 \forall x \forall y (x = y \vee \neg x = y), -0 \\
 \text{Or0} \\
 \text{Or1, 1r1} \\
 \forall y (a = y \vee \neg a = y), -1 \\
 \text{1r2, 2r2, Or2} \\
 a = b \vee \neg a = b, -2 \\
 a = b, -2 \\
 \neg a = b, -2
 \end{array}$$

23.9.4 Counter-models are read off from open branches as in intuitionist logic (20.8.7), except that extensions and anti-extensions for predicates are obtained as for K_4 . Specifically, for all n -place predicates, P , other than identity:

$$\begin{aligned} \langle |\partial_{a_1}|_{w_i}, \dots, |\partial_{a_n}|_{w_i} \rangle \in v_{w_i}^{\mathcal{E}}(P) & \text{ iff } Pa_1 \dots a_n, +i \text{ is on } \mathcal{B} \\ \langle |\partial_{a_1}|_{w_i}, \dots, |\partial_{a_n}|_{w_i} \rangle \in v_{w_i}^{\mathcal{A}}(P) & \text{ iff } \neg Pa_1 \dots a_n, +i \text{ is on } \mathcal{B} \end{aligned}$$

The extension of identity is given. The anti-extension of identity is read off as for any other predicate.

Thus, the counter-model given by the open tableau of 23.9.3 may be depicted as follows. I omit the arrows for reflexivity and transitivity, and also the extensions of $=$

$w_0 \qquad \qquad \rightarrow \qquad \qquad w_1 \qquad \qquad \rightarrow \qquad \qquad w_2$

<table style="width: 100%; border-collapse: collapse;"> <tr> <td style="width: 10%;"></td> <td style="width: 10%; text-align: center;">∂_c</td> <td style="width: 10%; text-align: center;">∂_a</td> <td style="width: 10%; text-align: center;">∂_b</td> </tr> <tr> <td></td> <td style="text-align: center;">↓</td> <td style="text-align: center;">↓</td> <td style="text-align: center;">↓</td> </tr> <tr> <td style="vertical-align: top;">$v^A(=)$</td> <td style="text-align: center;">c₀</td> <td style="text-align: center;">a₀</td> <td style="text-align: center;">b₀</td> </tr> <tr> <td style="text-align: center;">c₀</td> <td style="text-align: center;">×</td> <td style="text-align: center;">×</td> <td style="text-align: center;">×</td> </tr> <tr> <td style="text-align: center;">†a₀</td> <td style="text-align: center;">×</td> <td style="text-align: center;">×</td> <td style="text-align: center;">×</td> </tr> <tr> <td style="text-align: center;">†b₀</td> <td style="text-align: center;">×</td> <td style="text-align: center;">×</td> <td style="text-align: center;">×</td> </tr> </table>		∂_c	∂_a	∂_b		↓	↓	↓	$v^A(=)$	c₀	a₀	b₀	c₀	×	×	×	†a₀	×	×	×	†b₀	×	×	×	<table style="width: 100%; border-collapse: collapse;"> <tr> <td style="width: 10%;"></td> <td style="width: 10%; text-align: center;">∂_c</td> <td style="width: 10%; text-align: center;">∂_a</td> <td style="width: 10%; text-align: center;">∂_b</td> </tr> <tr> <td></td> <td style="text-align: center;">↓</td> <td style="text-align: center;">↓</td> <td style="text-align: center;">↓</td> </tr> <tr> <td style="vertical-align: top;">$v^A(=)$</td> <td style="text-align: center;">c₁</td> <td style="text-align: center;">a₁</td> <td style="text-align: center;">b₁</td> </tr> <tr> <td style="text-align: center;">c₁</td> <td style="text-align: center;">×</td> <td style="text-align: center;">×</td> <td style="text-align: center;">×</td> </tr> <tr> <td style="text-align: center;">a₁</td> <td style="text-align: center;">×</td> <td style="text-align: center;">×</td> <td style="text-align: center;">×</td> </tr> <tr> <td style="text-align: center;">†b₁</td> <td style="text-align: center;">×</td> <td style="text-align: center;">×</td> <td style="text-align: center;">×</td> </tr> </table>		∂_c	∂_a	∂_b		↓	↓	↓	$v^A(=)$	c₁	a₁	b₁	c₁	×	×	×	a₁	×	×	×	†b₁	×	×	×	<table style="width: 100%; border-collapse: collapse;"> <tr> <td style="width: 10%;"></td> <td style="width: 10%; text-align: center;">∂_c</td> <td style="width: 10%; text-align: center;">∂_a</td> <td style="width: 10%; text-align: center;">∂_b</td> </tr> <tr> <td></td> <td style="text-align: center;">↓</td> <td style="text-align: center;">↓</td> <td style="text-align: center;">↓</td> </tr> <tr> <td style="vertical-align: top;">$v^A(=)$</td> <td style="text-align: center;">c₂</td> <td style="text-align: center;">a₂</td> <td style="text-align: center;">b₂</td> </tr> <tr> <td style="text-align: center;">c₂</td> <td style="text-align: center;">×</td> <td style="text-align: center;">×</td> <td style="text-align: center;">×</td> </tr> <tr> <td style="text-align: center;">a₂</td> <td style="text-align: center;">×</td> <td style="text-align: center;">×</td> <td style="text-align: center;">×</td> </tr> <tr> <td style="text-align: center;">b₂</td> <td style="text-align: center;">×</td> <td style="text-align: center;">×</td> <td style="text-align: center;">×</td> </tr> </table>		∂_c	∂_a	∂_b		↓	↓	↓	$v^A(=)$	c₂	a₂	b₂	c₂	×	×	×	a₂	×	×	×	b₂	×	×	×
	∂_c	∂_a	∂_b																																																																							
	↓	↓	↓																																																																							
$v^A(=)$	c₀	a₀	b₀																																																																							
c₀	×	×	×																																																																							
†a₀	×	×	×																																																																							
†b₀	×	×	×																																																																							
	∂_c	∂_a	∂_b																																																																							
	↓	↓	↓																																																																							
$v^A(=)$	c₁	a₁	b₁																																																																							
c₁	×	×	×																																																																							
a₁	×	×	×																																																																							
†b₁	×	×	×																																																																							
	∂_c	∂_a	∂_b																																																																							
	↓	↓	↓																																																																							
$v^A(=)$	c₂	a₂	b₂																																																																							
c₂	×	×	×																																																																							
a₂	×	×	×																																																																							
b₂	×	×	×																																																																							

I leave it as an exercise to check that this works.

23.9.5 I_3 and W with (contingent) identity, are obtained from I_4 as in the case without identity (23.8.8). And as without identity, a negation-free inference is valid in I_4 (or I_3) with (contingent) identity iff it is valid in I with (contingent) identity (23.8.9).

23.9.6 In all these logics, full SI is valid: $a = b, A_x(a) \vDash A_x(b)$. This is proved in 23.12.11.

23.9.7 The tableaux for all the systems mentioned in the chapter are sound and complete with respect to their semantics. This is proved in the technical appendices that follow.

23.10 *Proofs of Theorems 1

23.10.1 In this section, we establish appropriate soundness and completeness theorems for the tableaux for N_4 and K_4 , and N_* and K_* , starting with the former pair.

23.10.2 LEMMA (LOCALITY): Let $\mathfrak{J}_1 = \langle D, W, (N,) v_1 \rangle$, $\mathfrak{J}_2 = \langle D, W, (N,) v_2 \rangle$ be two N_4 or K_4 interpretations (with corresponding relations ρ_1 and ρ_2). Since they have the same domain, the language of the two is the same. Call this L . If A is any closed formula of L such that v_1 and v_2 assign the same object to each constant in A , the same extension and anti-extension at every world to each predicate in A , and the same extension and anti-extension at every non-normal world to every matrix occurring in A , then, for all $w \in W$:

$$\begin{aligned} A\rho_{1w}1 & \text{ iff } A\rho_{2w}1 \\ A\rho_{1w}0 & \text{ iff } A\rho_{2w}0 \end{aligned}$$

Proof:

The result is proved as in FDE (22.7.2). We simply add the subscript ‘ w ’ at appropriate points in the proof. There is only one essentially new case: that for \rightarrow . Here are the cases for 1; the cases for 0 are similar. If w is normal:

$$\begin{aligned} A \rightarrow B\rho_{1w}1 & \text{ iff for all } w' \in W \text{ where } A\rho_{1w'}1, B\rho_{1w'}1 \\ & \text{ iff for all } w' \in W \text{ where } A\rho_{2w'}1, B\rho_{2w'}1 \quad (\text{IH}) \\ & \text{ iff } A \rightarrow B\rho_{2w}1 \end{aligned}$$

If w is non-normal, and $A \rightarrow B$ is of the form $M_{\vec{x}}(a_1, \dots, a_n)$, where M is a matrix:

$$\begin{aligned} M_{\vec{x}}(a_1, \dots, a_n)\rho_{1w}1 & \text{ iff } \langle v_1(a_1), \dots, v_1(a_n) \rangle \in v_{1w}^{\mathcal{E}}(M) \\ & \text{ iff } \langle v_2(a_1), \dots, v_2(a_n) \rangle \in v_{2w}^{\mathcal{E}}(M) \\ & \text{ iff } M_{\vec{x}}(a_1, \dots, a_n)\rho_{2w}1 \end{aligned}$$

Of course, only the first case is relevant in the case of K_4 . ■

23.10.3 LEMMA (DENOTATION): Let $\mathfrak{J} = \langle D, W, (N,) v \rangle$ be any N_4 or K_4 interpretation. Let A be any formula of $L(\mathfrak{J})$ with at most one free variable, x , and a and b be any two constants such that $v(a) = v(b)$. Then for all $w \in W$:

$$\begin{aligned} A_x(a)\rho_w1 & \text{ iff } A_x(b)\rho_w1 \\ A_x(a)\rho_w0 & \text{ iff } A_x(b)\rho_w0 \end{aligned}$$

Proof:

The result is proved as for *FDE* (22.7.3). We simply add the subscript ‘w’ at appropriate points in the proof. There is only one essentially new case: that for \rightarrow . Here are the cases for 1; the cases for 0 are similar. If w is normal:

$$\begin{aligned} (A \rightarrow B)_x(a)\rho_w 1 & \text{ iff for all } w' \in W \text{ where } A_x(a)\rho_{w'} 1, B_x(a)\rho_{w'} 1 \\ & \text{ iff for all } w' \in W \text{ where } A_x(b)\rho_{w'} 1, B_x(b)\rho_{w'} 1 \quad (\text{IH}) \\ & \text{ iff } (A \rightarrow B)_x(b)\rho_w 1 \end{aligned}$$

If w is non-normal, and $A \rightarrow B$ is of the form $M_{\vec{x}}(a_1, \dots, a, \dots, a_n)$, where M is a matrix (and we assume only one occurrence of a , for simplicity):

$$\begin{aligned} M_{\vec{x}}(a_1, \dots, a, \dots, a_n)\rho_w 1 & \text{ iff } \langle v(a_1), \dots, v(a), \dots, v(a_n) \rangle \in v_w^{\mathcal{E}}(M) \\ & \text{ iff } \langle v(a_1), \dots, v(b), \dots, v(a_n) \rangle \in v_w^{\mathcal{E}}(M) \\ & \text{ iff } M_{\vec{x}}(a_1, \dots, b, \dots, a_n)\rho_w 1 \end{aligned}$$

Of course, only the first case is relevant in the case of K_4 . ■

23.10.4 DEFINITION: Let $\mathcal{J} = \langle D, W, (N,) v \rangle$ be any N_4 or K_4 interpretation. Let \mathcal{B} be any branch of a tableau. \mathcal{J} is *faithful to* \mathcal{B} iff there is a map, f , from the natural numbers to W such that:

- for every node $A, i+$ on \mathcal{B} , $A\rho_{f(i)} 1$
- for every node $A, i-$ on \mathcal{B} , it is not the case that $A\rho_{f(i)} 1$
- $f(0) \in N$

(The last clause has a bite only for N_4 .)

23.10.5 SOUNDNESS LEMMA: If \mathcal{J} is faithful to a branch of an N_4 or K_4 tableau, \mathcal{B} , and a tableau rule is applied to \mathcal{B} , then there is an interpretation, \mathcal{J}' , that is faithful to at least one of the branches generated.

Proof:

The proof is on a case-by-case basis for the rules. For all the rules other than those for the conditionals, the arguments are essentially as for *FDE* (22.7.5). We merely add the appropriate world parameter. Here, for example, is the case for one of the quantifier rules:

$$\begin{array}{c} \exists x A, i+ \\ \downarrow \\ A_x(c), i+ \end{array}$$

Suppose that $\exists x A \rho_{f(i)} 1$. Then, for some $d \in D$, $A_x(k_d) \rho_{f(i)} 1$. Let \mathcal{J}' be the same as \mathcal{J} , except that $v(c) = d$. By the Denotation Lemma, $A_x(c) \rho_{f(i)} 1$. Since c is a new constant, the Locality Lemma does the rest of the job.

The arguments for the conditionals are as in the propositional case (9.8.3, 9.8.8). ■

23.10.6 COROLLARY (cf 22.7.6) SOUNDNESS THEOREM: The tableaux for N_4 and K_4 are sound. This follows from the Soundness Lemma in the usual way.

23.10.7 DEFINITION: Suppose that we have a tableau with an open branch, \mathcal{B} . Let C be the set of all constants on \mathcal{B} . The interpretation induced by \mathcal{B} , $\langle D, W, (N,) v \rangle$, is defined as follows. $W = \{w_i : i \text{ occurs on } \mathcal{B}\}$. For N_4 , $N = \{w_0\}$. $D = \{\partial_a : a \in C\}$. For all constants, a , on \mathcal{B} , $v(a) = \partial_a$. For every n -place predicate, P :

$$\begin{aligned} \langle \partial_{a_1}, \dots, \partial_{a_n} \rangle \in v_{w_i}^{\mathcal{E}}(P) & \text{ iff } Pa_1 \dots a_n, +i \text{ is on } \mathcal{B} \\ \langle \partial_{a_1}, \dots, \partial_{a_n} \rangle \in v_{w_i}^{\mathcal{A}}(P) & \text{ iff } \neg Pa_1 \dots a_n, +i \text{ is on } \mathcal{B} \end{aligned}$$

And, in the case of N_4 , for every conditional matrix, M , and $i > 0$:

$$\begin{aligned} \langle \partial_{a_1}, \dots, \partial_{a_n} \rangle \in v_{w_i}^{\mathcal{E}}(M) & \text{ iff } M_{\vec{x}}(a_1, \dots, a_n), +i \text{ is on } \mathcal{B} \\ \langle \partial_{a_1}, \dots, \partial_{a_n} \rangle \in v_{w_i}^{\mathcal{A}}(M) & \text{ iff } \neg M_{\vec{x}}(a_1, \dots, a_n), +i \text{ is on } \mathcal{B} \end{aligned}$$

(If $C = \phi$, $D = \{\partial\}$, and ∂ is not in any extension or anti-extension.)

23.10.8 COMPLETENESS LEMMA: Given the interpretation specified in 23.10.7, for every formula A :

$$\begin{aligned} \text{if } A, +i \text{ is on } \mathcal{B} \text{ then } A \rho_{w_i} 1 \\ \text{if } A, -i \text{ is on } \mathcal{B} \text{ then it is not the case that } A \rho_{w_i} 1 \\ \text{if } \neg A, +i \text{ is on } \mathcal{B} \text{ then } A \rho_{w_i} 0 \\ \text{if } \neg A, -i \text{ is on } \mathcal{B} \text{ then it is not the case that } A \rho_{w_i} 0 \end{aligned}$$

Proof:

The proof is as for FDE (22.7.8). We merely insert the appropriate world parameter. Here, for example, is one case for \exists :

Suppose that $\exists x B, +i$ is on \mathcal{B} . Then, for some c , $B_x(c), +i$ is on \mathcal{B} . By IH, $B_x(c) \rho_{w_i} 1$. Let $v(c) = d$. By the Denotation Lemma, $B_x(k_d) \rho_{w_i} 1$. Hence, $\exists x B \rho_{w_i} 1$.

The only essentially new cases are those for \rightarrow . These are as in the propositional case (9.8.6, 9.8.9). ■

23.10.9 COROLLARY COMPLETENESS THEOREM: The tableaux for N_4 and K_4 are complete. This follows from the Completeness Lemma in the usual fashion.

23.10.10 We now turn to N_* and K_* .

23.10.11 LEMMAS (LOCALITY AND DENOTATION): These are stated as in the case for *FDE* (22.8.2, 22.8.3). In the case of N_* there is an extra component, N , in an interpretation, and for the Locality Lemma we have to add the clause that the two interpretations agree at non-normal worlds on all the conditional matrices occurring in the formula. The proof is also as for *FDE*. There is only one new case: that for \rightarrow . This goes as follows.

For Locality: if w is normal:

$$\begin{aligned} v_{1w}(A \rightarrow B) = 1 & \text{ iff for all } w' \text{ such that } v_{1w'}(A) = 1, v_{1w'}(B) = 1 \\ & \text{ iff for all } w' \text{ such that } v_{2w'}(A) = 1, v_{2w'}(B) = 1 \quad (\text{IH}) \\ & \text{ iff } v_{2w}(A \rightarrow B) = 1 \end{aligned}$$

If w is non-normal (not relevant in the case for K_*) and $A \rightarrow B$ is of the form $M_{\vec{x}}(a_1, \dots, a_n)$, where M is a matrix:

$$\begin{aligned} v_{1w}(M_{\vec{x}}(a_1, \dots, a_n)) = 1 & \text{ iff } \langle v_1(a_1), \dots, v_1(a_n) \rangle \in v_{1w}(M) \\ & \text{ iff } \langle v_2(a_1), \dots, v_2(a_n) \rangle \in v_{2w}(M) \\ & \text{ iff } v_{2w}(M_{\vec{x}}(a_1, \dots, a_n)) = 1 \end{aligned}$$

For Denotation: if w is normal:

$$\begin{aligned} v_w(A \rightarrow B)_x(a) = 1 & \text{ iff for all } w' \in W, \text{ if } v_{w'}(A_x(a)) = 1, \\ & v_{w'}(B_x(a)) = 1 \\ & \text{ iff for all } w' \in W, \text{ if } v_{w'}(A_x(b)) = 1, \\ & v_{w'}(B_x(b)) = 1 \quad (\text{IH}) \\ & \text{ iff } v_w(A \rightarrow B)_x(b) = 1 \end{aligned}$$

If w is non-normal, and $A \rightarrow B$ is of the form $M_{\vec{x}}(a_1, \dots, a, \dots, a_n)$, where M is a matrix (and we assume only one occurrence of a , for simplicity):

$$\begin{aligned} v_w(M_{\vec{x}}(a_1, \dots, a, \dots, a_n)) = 1 & \text{ iff } \langle v(a_1), \dots, v(a), \dots, v(a_n) \rangle \in v_w(M) \\ & \text{ iff } \langle v(a_1), \dots, v(b), \dots, v(a_n) \rangle \in v_w(M) \\ & \text{ iff } v_w(M_{\vec{x}}(a_1, \dots, b, \dots, a_n)) = 1 \end{aligned}$$

23.10.12 **SOUNDNESS THEOREM:** The tableaux for N_* and K_* are sound with respect to their semantics.

Proof:

The proof is as for *FDE* (22.8.4–22.8.6), with some minor modifications. In the definition of faithfulness, we have to add the clause that $f(0) \in N$ for the logic N_* . There are new cases for \rightarrow in the Soundness Lemma. These are as in the propositional case (9.8.11, 9.8.13). ■

23.10.13 **COMPLETENESS THEOREM:** The tableaux for N_* and K_* are complete.

Proof:

The proof is essentially the same as that for *FDE* (22.8.7–22.8.9), with some minor modifications. In the induced interpretation, there may now be more than two worlds: $W = \{w_i: i \text{ or } i^\# \text{ occurs on } \mathcal{B}\} \cup \{w_{i^\#}: i \text{ or } i^\# \text{ occurs on } \mathcal{B}\}$; for all i , $w_i^* = w_{i^\#}$ and $w_{i^\#}^* = w_i$. In the case of N_* , $N = \{w_0\}$; and for every conditional matrix, M , and $\alpha \neq 0$:

$$\langle \partial_{a_1}, \dots, \partial_{a_n} \rangle \in v_\alpha(M) \quad \text{iff} \quad M_{\vec{x}}(a_1 \dots a_n), +\alpha \text{ is on } \mathcal{B}$$

where α is either i or $i^\#$. (If there are no constants on the branch, $D = \{\partial\}$, and ∂ is not in any extension or anti-extension.) In the proof of the Completeness Lemma, there are extra cases for \rightarrow . These are essentially as in the propositional case (9.8.12, 9.8.13). ■

23.11 *Proofs of Theorems 2

23.11.1 We now turn to soundness and completeness for tableaux for identity in the logics of the previous section.

23.11.2 For a start, the addition of identity does nothing to affect the Locality and Denotation Lemmas. These, therefore, continue to hold.

23.11.3 **COROLLARY:** In all the logics in question, $a = b, A_x(a) \models A(b)$. This follows from the relevant Denotation Lemmas in the usual way.

23.11.4 **SOUNDNESS THEOREMS:** All the logics we are concerned with are sound with respect to their corresponding semantics.

Proof:

The proofs extend the corresponding ones without identity. The extension merely requires us to check the cases for the identity rules in the appropriate soundness lemmas. These are straightforward, and are left as exercises. ■

23.11.5 COMPLETENESS THEOREM FOR RELATIONAL SEMANTICS: The tableaux for N_4 and K_4 with identity are complete.

Proof:

Given an open branch of a tableau, \mathcal{B} , the induced interpretation is defined as follows. W and N are as in the case without identity (23.10.7). Let C be the set of constants on the branch. Let $a \sim b$ iff $a = b$, $+0$ is on \mathcal{B} . As usual, \sim is an equivalence relation. $D = \{[a]: a \in C\}$. (If $C = \emptyset$, then $D = \{\emptyset\}$.) $v(a) = [a]$. For any predicate, P , except identity, $\langle [a_1], \dots, [a_n] \rangle \in v_{w_i}^{\mathcal{E}}(P)$ iff $Pa_1 \dots a_n, +i$ occurs on \mathcal{B} ; $\langle [a_1], \dots, [a_n] \rangle \in v_{w_i}^A(P)$ iff $\neg Pa_1 \dots a_n, +i$ occurs on \mathcal{B} . This is well defined because of SI. At normal worlds, w , $v_w^{\mathcal{E}}(=)$ needs no specification; at non-normal worlds, $v_w^{\mathcal{E}}(=)$ is defined in the same way as for all other predicates. For all w , $v_w^A(=)$ is defined in the same way as the anti-extension of all other predicates. The extension and anti-extension of conditional matrices at non-normal worlds are defined similarly.

We now prove the Completeness Lemma. The Completeness Theorem then follows in the usual fashion. The Lemma is proved as without identity (23.10.8). The only cases that are different are the atomic cases (and the cases for conditionals at non-normal worlds, which are essentially the same). These are as follows.

For predicates, P , other than the identity predicate:

$$\begin{aligned} Pa_1 \dots a_n, +i \text{ is on } \mathcal{B} &\Rightarrow \langle [a_1], \dots, [a_n] \rangle \in v_{w_i}^{\mathcal{E}}(P) \\ &\Rightarrow \langle v(a_1), \dots, v(a_n) \rangle \in v_{w_i}^{\mathcal{E}}(P) \\ &\Rightarrow Pa_1 \dots a_n \rho_{w_i} 1 \end{aligned}$$

$$\begin{aligned} Pa_1 \dots a_n, -i \text{ is on } \mathcal{B} &\Rightarrow Pa_1 \dots a_n, +i \text{ is not on } \mathcal{B} && (\mathcal{B} \text{ open}) \\ &\Rightarrow \langle [a_1], \dots, [a_n] \rangle \notin v_{w_i}^{\mathcal{E}}(P) \\ &\Rightarrow \langle v(a_1), \dots, v(a_n) \rangle \notin v_{w_i}^{\mathcal{E}}(P) \\ &\Rightarrow \text{it is not the case that } Pa_1 \dots a_n \rho_{w_i} 1 \end{aligned}$$

The cases for 0 are similar, and left as exercises.

The argument for identity at non-normal worlds is the same. For identity at normal worlds, w_i :

$$\begin{aligned}
 a = b, +i \text{ is on } \mathcal{B} &\Rightarrow a \sim b && (*) \\
 &\Rightarrow [a] = [b] \\
 &\Rightarrow v(a) = v(b) \\
 &\Rightarrow a = b\rho_{w_i}1
 \end{aligned}$$

For line (*): for N_4 , the only normal world is 0; for K_4 , the line uses the Identity Invariance Rule. Similar comments apply to the next argument.

$$\begin{aligned}
 a = b, -i \text{ is on } \mathcal{B} &\Rightarrow \text{it is not the case that } a \sim b && (\mathcal{B} \text{ open, } *) \\
 &\Rightarrow [a] \neq [b] \\
 &\Rightarrow v(a) \neq v(b) \\
 &\Rightarrow \text{it is not the case that } a = b\rho_{w_i}1
 \end{aligned}$$

■

23.11.6 COMPLETENESS THEOREM FOR * SEMANTICS: The tableaux for N_* and K_* with identity are complete.

Proof:

Given an open branch of a tableau, \mathcal{B} , the induced interpretation is defined as follows. W and N are as in the case without identity (23.10.13). Let $a \sim b$ mean that $a = b, +0$ is on \mathcal{B} . If the set of constants on the branch is C , $D = \{[a] : a \in C\}$. (If $C = \emptyset$, then $D = \{\emptyset\}$.) $v(a) = [a]$. If α is anything of the form i or $i^\#$, P is any predicate other than identity, and w is any world, $\langle \partial_{a_1}, \dots, \partial_{a_n} \rangle \in v_{w_\alpha}(P)$ iff $Pa_1 \dots a_n, +\alpha$ occurs on the branch. Identity at a non-normal world is treated the same way. (The interpretation of the identity predicate at normal worlds needs no specification.) In N_* , the extensions of conditional matrices at non-normal worlds are defined similarly.

We now prove the Completeness Lemma. The Completeness Theorem then follows in the usual fashion. The Lemma is proved as without identity (23.10.13). The only different cases are the atomic ones (and the cases for conditionals at non-normal worlds, which are essentially the same). These are as follows.

For every predicate, P , other than identity:

$$\begin{aligned} Pa_1 \dots a_n, +\alpha \text{ is on } \mathcal{B} &\Rightarrow \langle [a_1], \dots, [a_n] \rangle \in v_{w_\alpha}(P) \\ &\Rightarrow \langle v(a_1), \dots, v(a_n) \rangle \in v_{w_\alpha}(P) \\ &\Rightarrow v_{w_\alpha}(Pa_1 \dots a_n) = 1 \end{aligned}$$

$$\begin{aligned} Pa_1 \dots a_n, -\alpha \text{ is on } \mathcal{B} &\Rightarrow Pa_1 \dots a_n, +\alpha \text{ is not on } \mathcal{B} \quad (\mathcal{B} \text{ open}) \\ &\Rightarrow \langle [a_1], \dots, [a_n] \rangle \notin v_{w_\alpha}(P) \\ &\Rightarrow \langle v(a_1), \dots, v(a_n) \rangle \notin v_{w_\alpha}(P) \\ &\Rightarrow v_{w_\alpha}(Pa_1 \dots a_n) = 0 \end{aligned}$$

The arguments for identity at non-normal worlds are the same. For identity at normal worlds, w_α :

$$\begin{aligned} a = b, +\alpha \text{ is on } \mathcal{B} &\Rightarrow a \sim b && (*) \\ &\Rightarrow [a] = [b] \\ &\Rightarrow v(a) = v(b) \\ &\Rightarrow v_{w_\alpha}(a = b) = 1 \end{aligned}$$

For line (*): for N_* , the only normal world is 0; for K_* , the line uses the Identity Invariance Rule. Similar comments apply to the next argument.

$$\begin{aligned} a = b, -\alpha \text{ is on } \mathcal{B} &\Rightarrow \text{it is not the case that } a \sim b \quad (\mathcal{B} \text{ open, } *) \\ &\Rightarrow [a] \neq [b] \\ &\Rightarrow v(a) \neq v(b) \\ &\Rightarrow v_{w_\alpha}(a = b) = 0 \end{aligned}$$

■

23.12 *Proofs of Theorems 3

23.12.1 In this section, we prove soundness and completeness for the logics with constructible negation of this chapter, first without identity, and then with. Details are mostly left as exercises, since the proofs are essentially as for intuitionist logic, as modified by the relational techniques of K_4 required for negation.

23.12.2 LOCALITY AND DENOTATION LEMMAS FOR QUANTIFIED I_4 : These are stated as for K_4 (23.10.2, 23.10.3; there are no non-normal worlds). Except for negation, the proofs in the 1 cases are as for intuitionist logic (20.9.2, 20.9.3), and the proofs for the 0 cases are straightforward and are left as exercises. Negation is handled as for K_4 .

23.12.3 SOUNDNESS THEOREM FOR QUANTIFIED I_4 : An interpretation, \mathcal{J} , is faithful to a branch, \mathcal{B} , iff:

- for every node A , $+i$ on \mathcal{B} , $A \rho_{f(i)} 1$
- for every node A , $-i$ on \mathcal{B} , it is not the case that $A \rho_{f(i)} 1$
- if irj is on \mathcal{B} then $f(i)Rf(j)$

The Soundness Lemma is then stated as for intuitionist logic (20.9.10). In the proof of this, the arguments for the connectives are as in the propositional case (9.8.14). The arguments for the positive quantifier rules are as for intuitionist logic (20.9.10) (reading ‘equals 1’ and ‘equals 0’ as ‘relates to 1’ and ‘does not relate to 1’, respectively). The arguments for the negative quantifier rules are similar, and left as exercises. The Soundness Theorem follows from the Lemma as for intuitionist logic (20.9.11).

23.12.4 COMPLETENESS THEOREM FOR QUANTIFIED I_4 : Given an open branch of an interpretation, the induced interpretation is defined as for intuitionist tableaux of kind 2 (20.9.12), except for the extensions and anti-extensions of predicates, which are as given in 23.8.7. The Completeness Lemma is as stated for K_4 (23.10.8). In the proof of this, the cases for the connectives are as in the propositional case (9.8.14), and cases for quantified formulas are as for intuitionist logic (20.9.13) (reading ‘equals 1’ as ‘relates to 1’, and ‘equals 0’ as ‘does not relate to 1’). The cases for negated quantified formulas are similar, and left as exercises. The Completeness Theorem follows from the Lemma as for intuitionist logic (20.9.14).

23.12.5 SOUNDNESS AND COMPLETENESS THEOREMS FOR QUANTIFIED I_3 AND W : These modify the arguments for I_4 as in the propositional case. (9.8.15, 9.8.16).

23.12.6 Finally, we turn to (contingent) identity for these logics.

23.12.7 LOCALITY AND DENOTATION LEMMAS FOR QUANTIFIED I_4 WITH IDENTITY: These are stated as for intuitionism (20.10.7–20.10.9), except that instead of saying that two formulas have the same truth value, we say that each relates to 1 or 0 iff the other does. Except for negation, the proofs in the 1 cases are as for intuitionist logic (20.10.7–20.10.9), and the proofs for the 0 cases are straightforward and left as exercises. Negation is handled as for K_4 .

23.12.8 SOUNDNESS THEOREM FOR QUANTIFIED I_4 WITH IDENTITY: The argument here is as without identity. We merely need to check the cases for the identity rules of 23.9.2. These are straightforward.

23.12.9 COMPLETENESS THEOREM FOR QUANTIFIED I_4 WITH IDENTITY: The induced interpretation is defined as for intuitionist logic (20.10.12) except that the extension and anti-extension of each predicate is read off as in 23.9.4. The Completeness Lemma is stated as in the case without identity, and the proof is the same, except in the atomic cases. The positive atomic cases are as for intuitionist logic (20.10.13) (reading ‘equals 1’ as ‘relates to 1’, and ‘equals 0’ as ‘does not relate to 1’). The negative ones are straightforward, and left as exercises. (We do not have to distinguish between identity and other predicates in the negative cases.)

23.12.10 SOUNDNESS AND COMPLETENESS THEOREMS FOR QUANTIFIED I_3 AND W WITH CONTINGENT IDENTITY. These modify the arguments for I_4 as in the propositional case. (9.8.15, 9.8.16).

23.12.11 SUBSTITUTIVITY OF IDENTICALS: In all the logics in question, $a = b, A_x(a) \models A_x(b)$. This follows as for intuitionist logic (20.10.10).

23.13 History

The semantics for quantified N_4 , N_* , K_4 and K_* given in this chapter do not appear in the literature; but systems in the same broad family appear in Routley (1978), Priest (1987), ch. 6, and Priest (2005c), ch. 1. Chapter 2 of the last of these also has a brief discussion of identity in non-normal worlds, as well as an account of contingent identity. Relevant predication was introduced by Dunn (1987, 1990a, 1990b). Quantified I_3 and I_4 were introduced in Nelson (1949) and Almuqdad and Nelson (1984), respectively, though not with world semantics. Constant domain semantics were developed by Thomason (1984). Almuqdad and Nelson (1984) mention that the systems are complete with respect to the corresponding variable domain semantics, but do no more.

23.14 Further Reading

There is little reading on these matters in the literature, other than that already mentioned in the previous section, except on a few topics. For

relevant identity see 24.10 and 24.11; for relevant predication, Anderson, Belnap and Dunn (1992), section 74, and Kremer (1997). Quantified connexive logic can be found in Wansing (2005).

23.15 Problems

1. Check the details omitted in 23.4.7, 23.6.8, 23.7.5, 23.8.8 and 20.9.4.
2. Determine the validity of each of the following in N_4 . Where the inference is invalid, use an open branch to determine a counter-model, and check that it works.
 - (a) $\forall x(Px \rightarrow Qx) \vdash \exists xPx \rightarrow \exists xQx$
 - (b) $\vdash \forall x(Px \rightarrow Qx) \rightarrow (\exists xPx \rightarrow \exists xQx)$
 - (c) $\vdash (\forall xPx \wedge \forall xQx) \rightarrow \forall x(Px \wedge Qx)$
 - (d) $\vdash \forall xPx \rightarrow Pa$
 - (e) $\vdash Pa \rightarrow \exists xPx$
 - (f) $\vdash \forall x(Pa \vee Qx) \rightarrow (Pa \vee \forall xQx)$
 - (g) $\forall x(Px \rightarrow Qa) \vdash \exists xPx \rightarrow Qa$
 - (h) $\exists xPx \wedge Qa \vdash \exists x(Px \wedge Qa)$
 - (i) $Pa \wedge \neg Qa \vdash \exists x\neg(Px \rightarrow Qx)$
 - (j) $\forall x(Px \rightarrow Qx) \vdash \neg\exists x(Px \wedge \neg Qx)$
3. Repeat question 2 with N_* .
4. Check the validity of the inferences in 12.4.14, question 5, when \supset is replaced by \rightarrow in N_4 (and N_*).
5. Repeat question 2 with K_4 and K_* .
6. Determine the validity of each of the following in N_4 . Where the inference is invalid, use an open branch to determine a counter-model, and check that it works.
 - (a) $\vdash a = a$
 - (b) $a = b \vdash b = a$
 - (c) $a = b, b = c \vdash a = c$
 - (d) $\vdash a = b \rightarrow b = a$
 - (e) $\vdash (a = b \wedge b = c) \rightarrow a = c$
 - (f) $\vdash a = b \rightarrow (b = c \rightarrow a = c)$
 - (g) $a = b, Pa \vdash Pb$
 - (h) $a = b \vdash Pa \rightarrow Pb$
 - (i) $Pa \vdash a = b \rightarrow Pb$
 - (j) $\vdash (a = b \wedge Pa) \rightarrow Pb$

(k) $\vdash a = b \rightarrow (Pa \rightarrow Pb)$

(l) $\vdash Pa \rightarrow (a = b \rightarrow Pb)$

7. Repeat question 6 with N_* .
8. Repeat question 6 with K_4 and K_* .
9. Can you think of a plausible intuitive example of a failure of SI in the context of a relevant conditional?
10. How might one object to the application of the notion of relevant predication in the contexts described in 23.7?
11. Show that in an interpretation for I_4 , I_3 or W , if wRw' , then for any A , if $A\rho_w 1$ then $A\rho_{w'} 1$, and if $A\rho_w 0$ then $A\rho_{w'} 0$. (Hint: show this by induction on A . For the propositional case, see 9.11, problem 9.)
12. Repeat question 2 with I_4 and W . (Replace \rightarrow with \sqsupset .)
13. Repeat question 6 with I_4 and W . (Replace \rightarrow with \sqsupset .)
14. *Check the details omitted in 23.10, 23.11, and 23.12.
15. *Formulate the semantics for variable domain N_4 . State the appropriate tableau rules, and prove that they are sound and complete.
16. *Formulate the semantics for (constant domain) N_4 with contingent identity. State the appropriate tableau rules, and prove that they are sound and complete.
17. *For the various systems of logic in this chapter, formulate tableaux for inferences with arbitrary sets of premises. Prove the Soundness and Completeness Theorems. Infer the Compactness and Löwenheim-Skolem Theorems.

24 Relevant Logics

24.1 Introduction

24.1.1 In this chapter we will look at quantification (constant domain) and identity (necessary) in mainstream relevant logics.

24.1.2 We will start with quantification in the basic relevant logic, B , and then look quickly at its extensions. The next section takes up the question of restricted quantification in relevant logics.

24.1.3 After this, we turn to the topic of identity.

24.1.4 Along the way, we will look at some issues of a more philosophical nature that are thrown up by the material. In particular, we will look at the issue of the primacy of semantics over proof theory, and the way one should expect a relevant theory of identity to behave.

24.2 Quantified B

24.2.1 An interpretation for quantified B is a structure $\langle D, W, N, R, *, v \rangle$. D is a non-empty domain of quantification. W, N, R and $*$ are as in the propositional case (10.2). v assigns every constant, c , a denotation, $v(c) \in D$, and every n -place predicate, P , an extension $v_w(P) \subseteq D^n$, at each world, w .

24.2.2 The truth conditions for atomic sentences are:

$$v_w(Pa_1 \dots a_n) = 1 \text{ iff } \langle v(a_1), \dots, v(a_n) \rangle \in v_w(P)$$

The truth conditions for the connectives are as in the propositional case (10.2). For the quantifiers:

$$v_w(\exists xA) = 1 \text{ iff for some } d \in D, v_w(A_x(k_d)) = 1$$

$$v_w(\forall xA) = 1 \text{ iff for all } d \in D, v_w(A_x(k_d)) = 1$$

24.2.3 Validity is defined in terms of truth preservation at all normal (possible) worlds, as in 10.2.6.

24.2.4 Tableaux for quantified B are as for propositional B (10.3), with the addition of rules for the quantifiers:

$$\begin{array}{cc}
 \forall xA, +i & \forall xA, -i \\
 \downarrow & \downarrow \\
 A_x(a), +i & A_x(c), -i \\
 \exists xA, +i & \exists xA, -i \\
 \downarrow & \downarrow \\
 A_x(c), +i & A_x(a), -i
 \end{array}$$

where a is any constant on the branch, or a new one if there is none; c is a constant new to the branch.

24.2.5 Here is a tableau to show that $\forall x(A \rightarrow B) \vdash \exists xA \rightarrow \exists xB$. c is a constant new to the tableau.

$$\begin{array}{c}
 \forall x(A \rightarrow B), +0 \\
 \exists xA \rightarrow \exists xB, -0 \\
 r000, r00\#0\# \\
 r011, r01\#1\# \\
 \exists xA, +1 \\
 \exists xB, -1 \\
 A_x(c), +1 \\
 B_x(c), -1 \\
 A_x(c) \rightarrow B_x(c), +0 \\
 \swarrow \quad \searrow \\
 A_x(c), -1 \quad B_x(c), +1 \\
 \times \quad \times
 \end{array}$$

As in the propositional case, I will omit entries of the form $r0\alpha\alpha$ in future tableaux.

24.2.6 Here is a tableau to show that $\not\vdash \forall x(Px \supset Qx) \rightarrow \forall x(Px \rightarrow Qx)$.

$$\begin{array}{c}
 \forall x(Px \supset Qx) \rightarrow \forall x(Px \rightarrow Qx), -0 \\
 \forall x(Px \supset Qx), +1 \\
 \forall x(Px \rightarrow Qx), -1 \\
 Pa \rightarrow Qa, -1 \\
 r123 \\
 \downarrow
 \end{array}$$

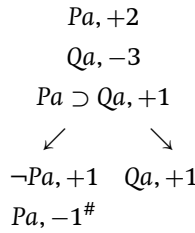

24.2.7 We read off a tableau from an open branch as in the propositional case (10.3.4), with the addition that: $D = \{\partial_c : c \text{ is a constant on the branch}\}$; $\nu(c) = \partial_c$; $\langle \partial_{a_1}, \dots, \partial_{a_n} \rangle \in \nu_{w_\alpha}(P)$ iff $Pa_1 \dots a_n, +\alpha$ is on the branch.

24.2.8 Thus, for the lefthand open branch of the tableau in 24.2.6: $W = \{w_0, w_1, w_2, w_3, w_0^\#, w_1^\#, w_2^\#, w_3^\#\}$, $N = \{w_0\}$, $w_i^* = w_{i^\#}$ and $w_{i^\#}^* = w_i$ (for $0 \leq i \leq 3$). For all $w \in W$, Rw_0ww , and $Rw_1w_2w_3$. $D = \{\partial_a\}$, $\nu_{w_2}(P) = \{\partial_a\}$, and all other extensions are empty.

24.2.9 In a picture (I omit the information about P and Q at worlds where it plays no role):¹

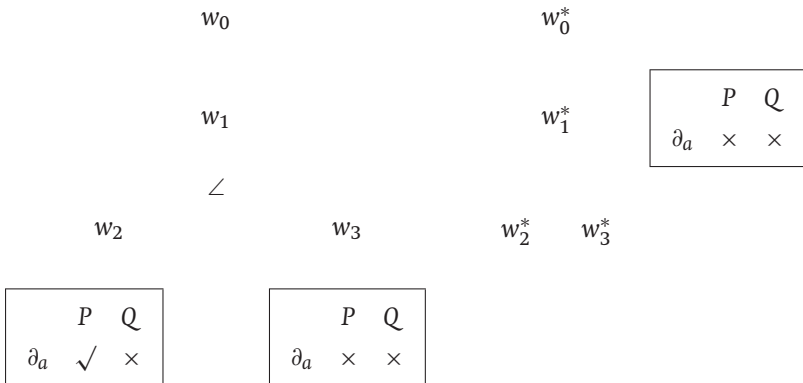

Pa fails at w_1^* , so $\neg Pa$ holds at w_1 . Thus, $Pa \supset Qa$, and so $\forall x(Px \supset Qx)$, are true at w_1 . But $Pa \rightarrow Qa$ fails at w_1 (because of w_2 and w_3). Hence, $\forall x(Px \rightarrow Qx)$ fails at w_1 . Thus, $\forall x(Px \supset Qx) \rightarrow \forall x(Px \rightarrow Qx)$ fails at w_0 .

24.3 Extensions of B

24.3.1 Quantified logics stronger than B may be obtained by adding the constraints C8–C11 of 10.4. Appropriate tableaux are obtained as in the propositional case (10.4).

¹ In the diagrams of this chapter, I will omit the box around a non-normal world, to avoid clutter.

24.3.2 The semantics of B may also be augmented by the content ordering, \sqsubseteq , of 10.4a. The ordering is governed by the constraints 1–3 of 10.4a.1 – except that the heredity condition (condition 1) applies to atomic formulas, not propositional parameters. The truth conditions for the connectives and quantifiers then suffice to ensure that it holds for all formulas. This is proved in 24.8.7. Appropriate tableaux are obtained by modifying the tableaux as in the propositional case (10.4a).

24.3.3 With the semantics thus augmented, quantified logics stronger than B can then also be obtained by adding the constraints C12–C16 of 10.4a. Appropriate tableaux are obtained by adding the corresponding rules (10.4a).

24.3.4 As in the propositional case, the tableaux for the extensions of B are often horribly complex and, when open, infinite. Often, the easiest way to show that a quantifier principle holds in an extension of B is to show that it holds in B itself. (The interaction between quantifiers and iterated \rightarrow -principles is not insignificant, as we will note in the next section, but in cases of practical importance is usually not great.)

24.3.5 To show that a principle of inference holds in an extension of B , one can always give a direct argument. Here, for example, is one to show that $\models (Pa \rightarrow \exists x\neg Qx) \rightarrow (\forall xQx \rightarrow \neg Pa)$ in the logic DW (that is, B plus the constraint $Rabc \Rightarrow Rac^*b^*$; see 10.4a.12). Suppose, *for reductio*, that it fails at a normal world, w_0 , in some interpretation. Then, there must be a w_1 at which $Pa \rightarrow \exists x\neg Qx$ holds and $\forall xQx \rightarrow \neg Pa$ fails. The latter requires there to be worlds, w_2 and w_3 , such that $Rw_1w_2w_3$, $\forall xQx$ holds at w_2 and $\neg Pa$ fails at w_3 . Thus, we have the following situation:

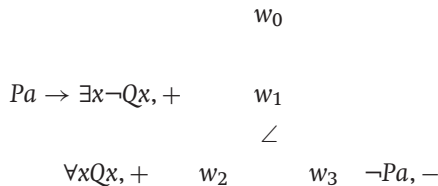

(The ‘+’ indicates that a formula holds at a world; the ‘-’ that it fails.) It follows that Pa holds at w_3^* . Now, since, $Rw_1w_2w_3$, $Rw_1w_3^*w_2^*$. Hence, by the information at w_1 , $\exists x\neg Qx$ holds at w_2^* . That is, for some $d \in D$, $\neg Qkd$

holds at w_2^* , and so Qk_a fails at w_2 . This is impossible, given the information about w_2 .

24.3.6 To show that an inference is invalid, one can construct a counter-model by intelligent trial and error. For example, suppose we wish to show that $\exists x(Px \rightarrow Qx) \rightarrow (\exists xPx \rightarrow \exists xQx)$ is not valid in DW . We need an interpretation where it fails at some normal world, w_0 . Hence, at some world, w_1 :

1. $\exists x(Px \rightarrow Qx)$ holds at w_1
2. $\exists xPx \rightarrow \exists xQx$ fails at w_1

Supposing that w_1 and all other worlds are non-normal gives us most flexibility. Because of 2, there must be worlds, w_2 and w_3 , such that $Rw_1w_2w_3$, something, ∂_a , is P at w_2 , and nothing is Q at w_3 . Because of 1 (and the fact that nothing can be Q at w_3), something, ∂_b , must be such that it fails to be P at w_2 . So we have:

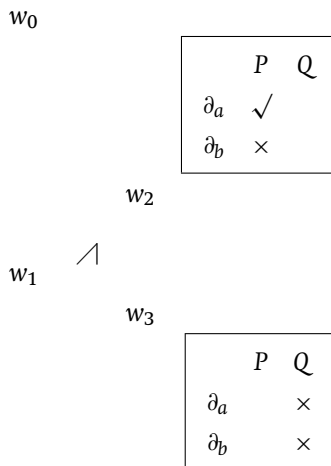

Now we have to worry about the constraints on R . Since w_0 (and only w_0) is normal, we require that Rw_0xy iff $x = y$. The constraint proper to DW is: if $Rwxy$ then Rwy^*x^* . This requires us to look at the $*$ worlds. Since, for any w , Rw_0ww , the constraint is satisfied automatically at w_0 . The accessibility relation at w_2 and w_3 is playing no role. We can simply assume that these worlds access nothing; this will satisfy the constraint. We do have to worry

about w_1 , though. Since $Rw_1w_2w_3$, we need $Rw_1w_3^*w_2^*$. And 1 requires that ∂_b either fails to be P at w_3^* or is Q at w_2^* . Choosing the former, we have:

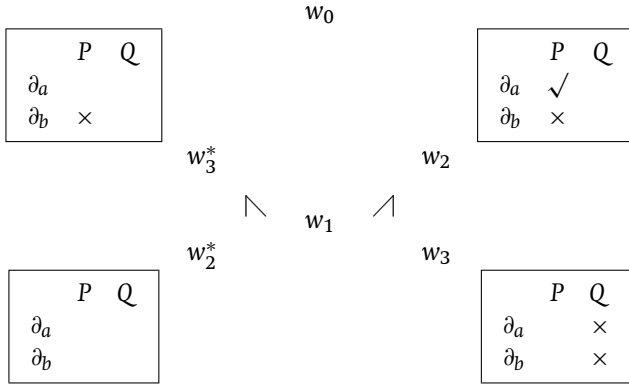

Again, we can suppose that w_2^* and w_3^* access no worlds. Adding the extra worlds does not disturb the argument, and we can let w_0^* and w_1^* be anything we like. This will do the trick. I leave it as an exercise to check that the interpretation does the required job. The blanks represent *don't care* conditions.

24.3.7 The more semantic constraints on the logic, the harder, of course, is the job of finding a counter-model. Let us do an example for the relevant logic with the greatest number of constraints which we have met, R . Suppose we wish to show that $Pa \rightarrow \exists xQx \not\equiv \exists x(Pa \rightarrow Qx)$ in this logic. Then we need a normal world of an interpretation, w_0 , where $Pa \rightarrow \exists xQx$ holds and $\exists x(Pa \rightarrow Qx)$ fails. So at every world, either Pa must fail or $\exists xQx$ must hold. And for every object in the domain, there must be a world where Pa holds, but it fails to be Q . An interpretation of the following form will do the job:

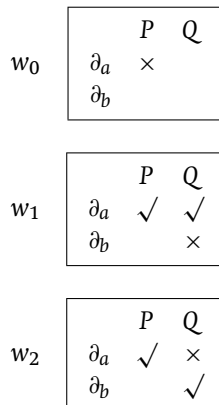

The hard thing is to define $*$, R and \sqsubseteq in such a way that the appropriate constraints hold. As observed in 10.4a.1, we can take \sqsubseteq to be $=$. This will ensure that it satisfies the conditions for a content ordering. Since negation is not involved in this example, we can take w^* to be w . This leaves R . The normality constraint is easy to implement. Given the definitions of \sqsubseteq and $*$, the other constraints (see 10.4 and 10.4a) become:

(C8) If $Rabc$ then $Racb$

(C9) If $Rabx$ and $Rxcd$, for some x , then, for some y , $Racy$ and $Rbyd$

(C11) If $Rabc$ then, for some x , $Rabx$ and $Rxbc$

(C12) If $Rabc$ then $Rbac$

(C10 is redundant, as I observed in 10.4a.14.)

In the present case, the following triples will work – where 000 is $\langle w_0, w_0, w_0 \rangle$, etc. (It took me a couple of hours to find this!)

000	011	022			
101	110	111	112	121	122
202	220	222	221	212	211

Verifying that all the conditions hold is straightforward, but laborious. I leave the details to any person with the inclination and the time to devote to it!

24.3.8 Finally on the subject of extensions, I note that the relevant conditional logic of 10.7 can be extended to a constant domain quantified logic, in exactly the same way that the straight relevant logic is. The details are straightforward, and I leave them as an exercise for those who are interested.

24.4 Restricted Quantification

24.4.1 Turning to a different matter, it is worth considering the behaviour of the restricted quantifiers, ‘Some P s are Q s’ and ‘All P s are Q s’, in the context of relevant logics. In classical logic, these are naturally parsed as $\exists x(Px \wedge Qx)$ and $\forall x(Px \supset Qx)$, respectively. In the context of a relevant logic, the restricted particular quantifier can be understood in the same way, but the restricted universal quantifier cannot, at least without the failure of

some very natural inferences. The inference ‘ a is a P ; all P s are Q s; hence a is a Q ’ seems quite correct. But in any relevant logic: $Pa, \forall x(Px \supset Qx) \not\vdash Qa$. The inference is just a quantified version of the disjunctive syllogism. Neither does it help much to parse ‘All P s are Q s’ as $\forall x(Px \rightarrow Qx)$. The inference in question is then valid, but the equally natural inference ‘Everything is Q ; hence everything that is P is Q ’ is not valid: $\forall xQx \not\vdash \forall x(Px \rightarrow Qx)$. (It is easy to check this in B .) The connection between P and Q when $\forall x(Px \rightarrow Qx)$ is true is much tighter than would seem to be required by a truth of the form ‘All P s are Q s’.

24.4.2 A solution here is to make use of the content ordering, \sqsubseteq . Recall that if w and w' are worlds, $w \sqsubseteq w'$ means, in effect, that everything true at w is true at w' . Let us define $R'ww_1w_2$ as:

$$Rww_1w_2 \text{ and } w \sqsubseteq w_2$$

So $R'ww_1w_2$ requires the truth content of w to be preserved at w_2 . We may now add a new connective to the language, \mapsto , and give it the truth conditions:

$$\begin{aligned} \nu_w(A \mapsto B) = 1 \text{ iff for all } w_1, w_2 \in W \text{ such that } R'ww_1w_2, \text{ when } \nu_{w_1}(A) = 1, \\ \nu_{w_2}(B) = 1 \end{aligned}$$

It is not difficult to show that the language, thus augmented, satisfies the heredity constraint for all formulas (see 24.8.7).

24.4.3 Tableaux for the extended language are obtained in the natural way. We simply add the rules:

$$\begin{array}{ccc} A \mapsto B, +\alpha & & A \mapsto B, -\alpha \\ r\alpha\beta\gamma & & \downarrow \\ \alpha \leq \gamma & & r\alpha ij, \alpha \leq j \\ \swarrow \quad \searrow & & A, +i \\ A, -\beta \quad B, +\gamma & & B, -j \end{array}$$

In the second rule, i and j are numbers new to the branch.

24.4.4 It is now simple to check that $Pa, \forall x(Px \mapsto Qx) \vdash Qa$ and $\forall xQx \vdash \forall x(Px \mapsto Qx)$ in B (and so all stronger logics):

$Pa, +0$	$\forall xQx, +0$
$\forall x(Px \mapsto Qx), +0$	$\forall x(Px \mapsto Qx), -0$
$Qa, -0$	$\$0, 0 \leq 0$
$\$0, 0 \leq 0$	$Pa \mapsto Qa, -0$
$Pa \mapsto Qa, +0$	$Qa, +0$
$\swarrow \quad \searrow$	$r012, 0 \leq 2$
$Pa, -0 \quad Qa, +0$	$Pa, +1$
$\times \quad \times$	$Qa, -2$
	$Qa, +2$
	\times

For the split in the first tableau, generated by line five, recall that there is a line of the form $r000$ implicitly present. The last line of the second tableau is obtained by the heredity rule for \leq .

24.4.5 It should be noted that, though we have $\forall xQx \vdash \forall x(Px \mapsto Qx)$, we do not have $\forall x\neg Px \vDash \forall x(Px \mapsto Qx)$. A counter-model for B can be depicted as follows. Only w_0 is normal; for all w , $w \sqsubseteq w$ and Rw_0ww ; no other facts about R obtain.

<table style="width: 100%; border-collapse: collapse;"> <tr><td style="padding: 2px 10px;">P</td><td style="padding: 2px 10px;">Q</td></tr> <tr><td style="padding: 2px 10px;">∂_a</td><td style="padding: 2px 10px;">$\times \quad \times$</td></tr> </table>	P	Q	∂_a	$\times \quad \times$	$w_0 \sqsubseteq w_1$	<table style="width: 100%; border-collapse: collapse;"> <tr><td style="padding: 2px 10px;">P</td><td style="padding: 2px 10px;">Q</td></tr> <tr><td style="padding: 2px 10px;">∂_a</td><td style="padding: 2px 10px;">$\checkmark \quad \times$</td></tr> </table>	P	Q	∂_a	$\checkmark \quad \times$
P	Q									
∂_a	$\times \quad \times$									
P	Q									
∂_a	$\checkmark \quad \times$									
<table style="width: 100%; border-collapse: collapse;"> <tr><td style="padding: 2px 10px;">P</td><td style="padding: 2px 10px;">Q</td></tr> <tr><td style="padding: 2px 10px;">∂_a</td><td style="padding: 2px 10px;">$\times \quad \times$</td></tr> </table>	P	Q	∂_a	$\times \quad \times$	$w_0^* \sqsupseteq w_1^*$	<table style="width: 100%; border-collapse: collapse;"> <tr><td style="padding: 2px 10px;">P</td><td style="padding: 2px 10px;">Q</td></tr> <tr><td style="padding: 2px 10px;">∂_a</td><td style="padding: 2px 10px;">$\times \quad \times$</td></tr> </table>	P	Q	∂_a	$\times \quad \times$
P	Q									
∂_a	$\times \quad \times$									
P	Q									
∂_a	$\times \quad \times$									

I leave it as an exercise to check that this counter-model (including the conditions of 10.4a.1 on \sqsubseteq) works.

24.5 Semantics vs Proof Theory

24.5.1 When the founders of relevant logic, and especially Anderson and Belnap, formulated relevant logic, they did so purely axiomatically. That is, they wrote down axioms that gave the properties of \rightarrow that were wanted,

but did not give those that were not. The world semantics for the logics that they formulated and the other logics in the same family – since the semantics made it clear that there was a large family of logics here – came later.

24.5.2 When Anderson and Belnap formulated quantified relevant logics, there were still no semantics, and so they proceeded in the same way – axiomatically. They added the sort of principles that take one from classical propositional logic to classical first-order logic, and which seemed to give those things one might reasonably expect. Their axioms and rules of inference can be formulated in various equivalent ways, but a reasonably succinct set, given that conjunction and the particular quantifier can be defined in the usual fashion, is as follows:

1. $\vdash \forall x A \rightarrow A_x(a)$
2. $\vdash \forall x(A \rightarrow B) \rightarrow (A \rightarrow \forall x B)$
3. $\vdash \forall x(B \rightarrow A) \rightarrow (\exists x B \rightarrow A)$
4. $\vdash \forall x(A \vee B) \rightarrow (A \vee \forall x B)$
5. If $\vdash A_x(a)$ then $\vdash \forall x A$

In 2, 3 and 4 x is not free in A . Note that the rule of inference 5 is validity-preserving, but not truth-preserving.

24.5.3 Once the ternary-relation propositional semantics appeared, the natural constant domain quantificational extensions (namely, the ones we have been looking at) were pretty obvious. The axiom systems that had been formulated were sound with respect to the relevant semantics, and the weaker systems, such as B , turned out to be complete. But the stronger systems, notably those containing $(A \rightarrow B) \rightarrow ((B \rightarrow C) \rightarrow (A \rightarrow C))$ (A9 of 10.4.6), such as R , were found to be incomplete.

24.5.4 In particular, Fine showed that the following formula is semantically valid, but is not provable in the axiom system. I write p for Pa , and q for Qa :

$$\begin{aligned} & ((p \rightarrow \exists x Ex) \wedge \forall x((p \rightarrow Fx) \vee (Gx \rightarrow Hx))) \rightarrow \\ & ((\forall x((Ex \wedge Fx) \rightarrow q) \wedge \forall x((Ex \rightarrow q) \vee Gx)) \rightarrow (\exists x Hx \vee (p \rightarrow q))) \end{aligned}$$

We could construct a tableau for this, but an intuitive argument is probably easier to follow. Assume, for *reductio*, that this fails in an interpretation at

w_0 (a normal world). Then it is not difficult to see that the semantic situation depicted as follows must arise.

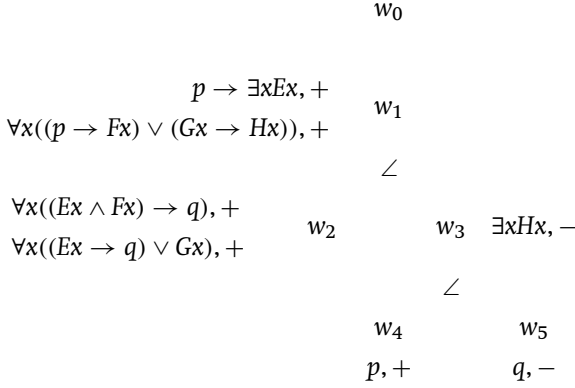

Given that R satisfies condition (C9) of 10.4, we have the following. (Ignore the bolded lines for the moment.):

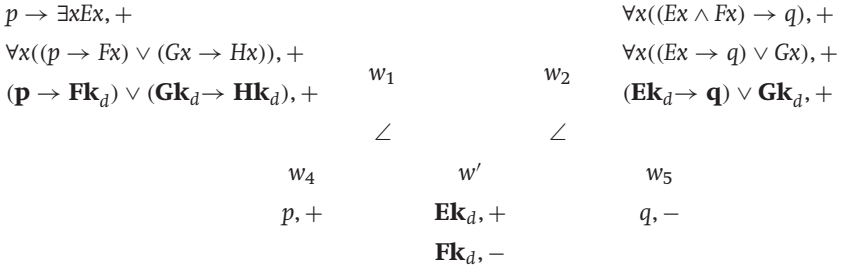

From the information about w_1 and w_4 , we can infer that at w' , $\exists xEx$, and so for some $d \in D$, Ek_d holds (shown in bold). Then from the information about w_2 , w_5 and w' , we can infer that Fk_d does not hold at w' (shown in bold). We now instantiate the second formulas at w_1 and w_2 to get the formulas bolded in the diagram at those worlds. The first disjunct of the formula at w_1 is ruled out by the failure of Fk_d at w' . The first disjunct of the formula at w_2 is ruled out by the failure of q at w_5 . Hence, the second disjunct of each must hold. Feeding this information back into the pertinent worlds of the first diagram, we have:

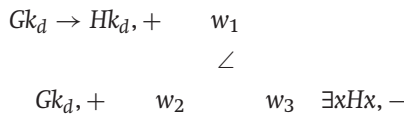

This is obviously impossible, since the information at w_1 and w_2 entails that Hk_d holds at w_3 .

The proof that this formula is not a consequence of the axioms is less straightforward, and I forgo it here.

24.5.5 In virtue of the incompleteness of these axiom systems, much effort has gone into finding a semantics with respect to which they are complete. A semantics has been found (by Fine himself), but it is complex and not particularly natural. The search continues for simpler semantics that will do the job.

24.5.6 Interesting though the technical project is, I think that this is the wrong response to the situation. If the axiom systems do not match up with the semantics, it is the semantics that should be given priority. The inferences are valid in virtue of the meanings of the connectives and quantifiers involved, and it is the semantics that are most naturally taken to give these. The axioms have no privileged status in this regard. They were, after all, formulated in an improvised way, and they have simply turned out to be incomplete.

24.5.7 This argument assumes that if the semantics and the proof theory do not line up, it is the semantics that should take conceptual priority. One may disagree with this perspective, as some logicians do. But all agree that an arbitrary set of rules and axioms cannot be guaranteed to characterise notions with sense. To see this, merely consider the connective, \dagger ('tonk'), governed by the rules of inference $\frac{A}{A\dagger B}$ and $\frac{A\dagger B}{B}$ (premises go above the line; conclusions below). Given the transitivity of deducibility, this gives $\frac{A}{B}$: everything follows from everything, which cannot be maintained.

24.5.8 Logicians who have taken proof theory to be privileged in the specification of meaning have formulated their proof theories in such a way as to satisfy certain constraints, which rule out \dagger -like connectives. In particular, some sort of natural deduction system is favoured, which has an introduction and elimination rule for each connective. It is the introduction rule that characterises the meaning of the connective. The elimination rule allows one to extract from the formula whatever was put into it, but no more. The rules are, in a certain sense, 'in harmony'. Thus, consider the

natural rules for \wedge :

$$\frac{A \quad B}{A \wedge B} \quad \frac{A \wedge B}{A} \quad \frac{A \wedge B}{B}$$

The harmony of these rules is shown by the following. Suppose that, in an argument, we have an application of the introduction rule immediately followed by an elimination rule, thus:

$$\frac{\Sigma \quad \Pi}{\frac{A \quad B}{A \wedge B}} \\ A \\ \Delta$$

(capital Greek letters here indicate the parts of the argument before and after the inferences in question). We can simply bypass the detour through conjunction, and obtain:

$$\Sigma \\ A \\ \Delta$$

Clearly, this cannot be done with \dagger :

$$\Sigma \\ A \\ \frac{A \dagger B}{B} \\ \Delta$$

24.5.9 Now, it is not clear that relevant logics have proof theories that can ground an account of meaning in this way.² But even if they do, axiom systems of the kind that Anderson and Belnap provided for relevant logics are

² The most elegant proof theories for relevant logics are of the substructural kind, where there are rules for the individual connectives, and then a bunch of so-called structural rules, which allow us to manipulate the structure of the premises and conclusions themselves. There are certainly formulations of this kind where the rules for the connectives can be thought of as having the appropriate kind of harmony. But it is not at all clear how the substructural rules feed into the story about meaning or vice versa.

clearly not of this form. Considerations based on them can hardly, therefore, be used to override the natural semantics.

24.5.10 Let us finish with a few comments about variable domain semantics. The Fine formula of 24.5.4 is not valid in simple variable domain semantics. (It is easy to check that the argument of 24.5.4 fails if domains may vary.) One might take this as an argument against constant domain semantics.

24.5.11 However, in variable domain semantics, axiom 4 of 24.5.2 is not valid either – essentially for the same reason that it is not valid in intuitionist logic (see 20.5.7). So simply moving to variable domains is not going to provide the required semantics.

24.5.12 Of course, one may decide that there are independent reasons, in the context of a relevant logic, why constant domain semantics are incorrect, and so why axiom 4 *ought* to be given up. One argument for this is as follows. In any constant domain interpretation with domain D , $\forall xA$ has the same truth value at any world, intuitively speaking, as the possibly infinite conjunction $\bigwedge_{d \in D} A_x(k_d)$. Hence, at any normal world, $\forall xA \leftrightarrow \bigwedge_{d \in D} A_x(k_d)$ is true. This is objectionable. The conditional from left to right is fine, but from right to left this should not hold, at least if \rightarrow marks some kind of logical sufficiency. For the conjunction is not logically sufficient for the universally quantified formula. We need, in addition, the claim that the k_d s exhaust all the members of the domain.

24.5.13 The argument is not conclusive, however; one may reply as follows. Within the context of that particular interpretation, the conjunction is sufficient for the quantified sentence. This should not be confused with the question of *logical* sufficiency. Even given some kind of infinite conjunction, there is no set of constants, C , such that it is a constant domain logical truth that $\bigwedge_{c \in C} A_x(c) \rightarrow \forall xA$. (In any such interpretation, there may well be members of the domain that have no name in C .)

24.6 Identity

24.6.1 In this section, we will add identity to the above systems. As for the relevant logics of the previous chapter, we will be concerned only with

necessary identity. Taking our cue from 23.6.4, $v_w(=)$ is a subset of D^2 , subject to the constraint that if $w \in N$, it is $\{(d, d) : d \in D\}$. Appropriate tableau rules are:

$$\begin{array}{l} \cdot \quad a = b, +0 \\ \downarrow \quad A_x(a), +\alpha \\ a = a, +0 \quad \downarrow \\ \quad \quad \quad A_x(b), +\alpha \end{array}$$

where A is any atomic sentence (we except $a = b, +0$), and α is anything of the form i or $i^\#$.

For those extensions which employ the content ordering (and so where we cannot assume that 0 is the only normal world), we also need the *Normality Invariance Rule*:

$$\begin{array}{l} a = b, +\alpha \\ \$\alpha \\ \$\beta \\ \downarrow \\ a = b, +\beta \end{array}$$

24.6.2 Here are tableaux to show that $a = b \vdash Pa \rightarrow Pb$ and $\not\vdash Pa \rightarrow (a = b \rightarrow Pb)$ in B :

$$\begin{array}{l} a = b, +0 \\ Pa \rightarrow Pb, -0 \\ Pa, +1 \\ Pb, -1 \\ Pb, +1 \\ \times \\ Pa \rightarrow (a = b \rightarrow Pb), -0 \\ Pa, +1 \\ a = b \rightarrow Pb, -1 \\ r123 \\ a = b, +2 \\ Pb, -3 \end{array}$$

There are no applications of SI, since the only information about identity is not at world 0.

24.6.3 We read off a counter-model from an open branch as in the case without identity, except that when we have a bunch of lines of the form

$a = b, +0, b = c, +0$, we choose a single object for all the constants involved to denote. Thus, in the case of the second tableau of 24.6.2, the counter-model may be depicted as follows. (I ignore the * worlds since they are doing no work. Only w_0 is normal.)

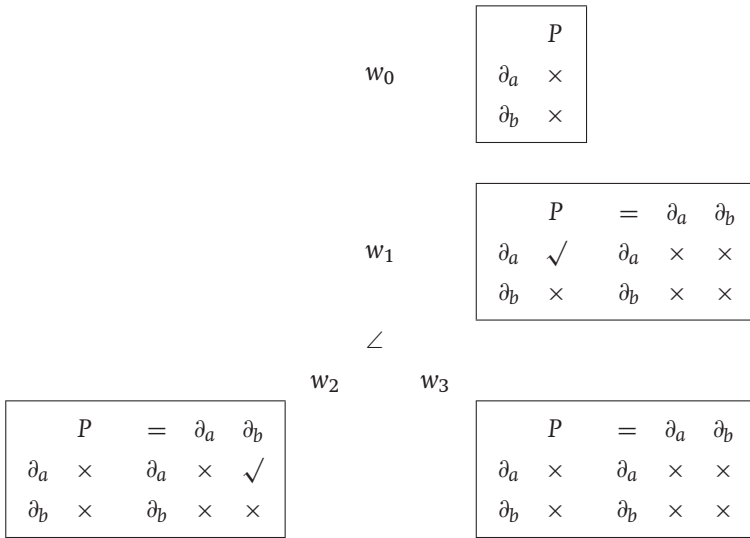

The interpretation of $=$ at w_0 is predetermined. (Recall that the information about the domain is read off from the information about identity at w_0 .) I leave it as an exercise to check that this interpretation works.

24.6.4 In the semantics described, identity behaves like an arbitrary binary predicate at non-normal worlds. One can constrain its behaviour further. One constraint worth noting is this: for $w \in W - N, \nu_w(=) \subseteq \{\langle d, d \rangle : d \in D\}$. Call this the *Subset Constraint*. The corresponding tableau rule is a version of the identity invariance rule:

$$\begin{array}{c}
 a = b, +\alpha \\
 \downarrow \\
 a = b, +0
 \end{array}$$

This makes information about identity flow backward into w_0 ; there is no flow in the other direction.

24.6.5 Logically impossible worlds are, intuitively, ones where logical truths may fail. Since $a = a$ is a logical truth, there may be (impossible) worlds where it fails (and so, because of the behaviour of *, worlds where $\neg a = a$

holds). This is quite compatible with the Subset Constraint. Note, also, that the addition of the Constraint validates neither of:

$$a = b \models Pc \rightarrow a = b$$

$$a \neq b \models a = b \rightarrow Pc$$

which would certainly wreck relevance. (It is easy to check that these both fail in B .)

24.6.6 The Subset Constraint nonetheless has an effect on the validity of inferences concerning identity. Without it, $(a = b \wedge Pa) \rightarrow Pb$ is not logically valid in B . (Details are left as an exercise.) With it, it is, as the following tableau shows.

$$\begin{array}{l} (a = b \wedge Pa) \rightarrow Pb, -0 \\ a = b \wedge Pa, +1 \\ Pb, -1 \\ a = b, +1 \\ Pa, +1 \\ a = b, +0 \\ Pb, +1 \\ \times \end{array}$$

The penultimate line is given by the Subset Constraint rule. The last line is then SI.

24.6.7 The constraint is not sufficient to generate the whole classical theory of identity, though. For example, $\not\models a = b \rightarrow (Pa \rightarrow Pb)$ in B :

$$\begin{array}{l} a = b \rightarrow (Pa \rightarrow Pb), -0 \\ a = b, +1 \\ Pa \rightarrow Pb, -1 \\ a = b, +0 \\ r123 \\ Pa, +2 \\ Pb, -3 \\ Pb, +2 \end{array}$$

24.6.8 The counter-model this gives may be depicted as follows. Again, I ignore the * worlds since they are doing no work. Only w_0 is normal.

$$v(a) = v(b) = \partial_a.$$

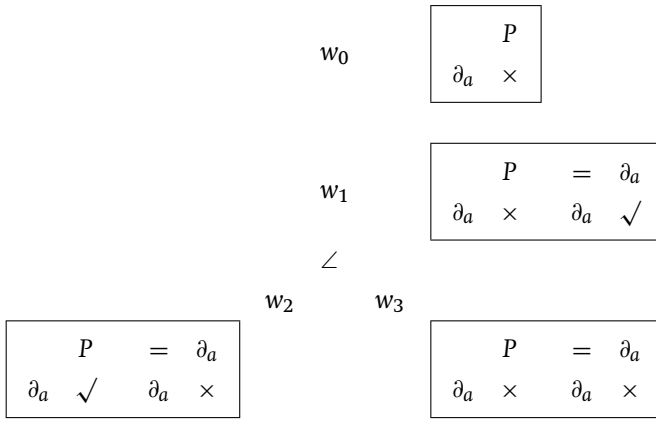

I leave it as an exercise to check that this works.

24.6.9 With or without the Subset Constraint, tableaux that do not close in extensions of B , such as R , are complex and often infinite. Often the easiest way to show that an identity principle holds in an extension of B is to show that it holds in B itself (again the interaction between identity and iterated \rightarrow -principles is not major), or by giving a direct argument. For a direct argument, a counter-model is found by intelligent trial and error. For example, $Pa \not\vdash a = b \rightarrow Pb$ fails in R , with or without the Subset Constraint. An interpretation of the following form shows this. w_0 alone is normal, and $v(a) = v(b) = \partial_a$.

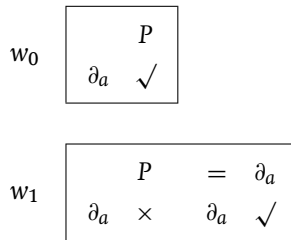

Again, the hard thing is defining $*$, R and \sqsubseteq . As in 24.3.7, taking w^* to be w , \sqsubseteq to be $=$, and R to be characterised by the following triples, will do the job.

- 000 011
- 101 110 111

Detailed checking is left as an exercise.

24.7 Properties of Identity

24.7.1 In relevant logics, there are various versions of SI, not all equivalent, that are worth noting. Consider the following.

1. $\models a = b \rightarrow (A_x(a) \rightarrow A_x(b))$
2. $\models (a = b \wedge A_x(a)) \rightarrow A_x(b)$
3. $a = b \models A_x(a) \rightarrow A_x(b)$
4. $a = b, A_x(a) \models A_x(b)$

24.7.2 Versions 3 and 4 are, in fact, equivalent, even in B . From 3 to 4, the inference is just *modus ponens*. Conversely, 4 gives us: $a = b, A_x(a) \rightarrow A_x(a) \models A_x(a) \rightarrow A_x(b)$. Since the second premise is a logical truth, the result follows.

24.7.3 In all relevant logics, version 1 fails. In 24.6.7, we saw that it fails in B – even with the Subset Constraint. Given 24.6.9 and the properties of R it is not difficult to show that it fails in R . (Details are left as an exercise.) Nor should one expect it to hold. Just take a case where A does not contain x free. Then it gives $a = b \rightarrow (A \rightarrow A)$. This is surely wrong. There is no relevant connection between an arbitrary identity and an arbitrary $A \rightarrow A$.

24.7.4 Without the Subset Constraint, version 2 fails. For example, it is easy to check that $\not\models (a = b \wedge Pa) \rightarrow Pb$ in B . (Details are left as an exercise.) But with the constraint it holds. We saw this for the special case just mentioned in 24.6.6. The proof of the general claim can be found in 24.9.2. The principle has a good deal of *a priori* plausibility, and is not subject to the same kind of objection as version 1: the logical truth of $(a = b \wedge A) \rightarrow A$ is not an intuitive violation of relevance.

24.7.5 One might still object that it is too strong. Let a, b and m be, respectively, ‘almond ice cream’, ‘banana ice cream’ and ‘my favourite ice cream’. Version 2 delivers:

$$(a = m \wedge (b = m \rightarrow b = m)) \rightarrow (b = m \rightarrow b = a)$$

Assuming that almond is my favourite ice cream, the antecedent is true. Hence, *modus ponens* delivers ‘If banana ice cream is my favourite ice cream then banana ice cream is almond ice cream’. This would seem to have little to recommend it. There are certainly possible worlds in which my favourite ice cream is banana. Yet banana and almond ice cream are as distinct there as they are here. Let us return to this objection in a moment.

24.7.6 In all relevant logics (as formulated here) version 4 holds. (This is proved in 24.9.2.) One may object to it in the same way. Where a , b and m are as before, version 4 delivers:

$$a = m, b = m \rightarrow b = m \models b = m \rightarrow b = a$$

This is just as bad.

24.7.7 There is an obvious reply to both of these arguments, however. ‘My favourite ice cream’ is not a rigid designator. As we saw in 16.4, one cannot apply SI to non-rigid designators in trans-world contexts. True, we now have impossible worlds to deal with as well as possible ones, but the point remains the same. \rightarrow is a trans-world operator, and the denotation of ‘ m ’ may slide around between worlds.

24.7.8 This suggests trying to run the argument with rigid designators. Let ‘ a ’, ‘ b ’, and ‘ m ’ be three different names, that is, rigid designators – say, of a confidence trickster. As before, we infer that:

$$b = m \rightarrow b = a$$

But this no longer seems so problematic. If these are rigid designators, the antecedent just says of a certain object that she is self-identical. The consequent says exactly the same (see 17.3.1).

24.7.9 We can perform a similar trick with version 3. This delivers $a = b \models a = a \rightarrow b = b$. And once again, it might be thought that the conclusion is a failure of relevance. But if ‘ a ’ and ‘ b ’ are rigid designators, both antecedent and consequent say of a certain object that it is self-identical, and any proposition is relevant to itself.

24.7.10 As we saw in 17.3, there are certainly examples that suggest that SI breaks down in some contexts. Entailment contexts were not amongst them, however; and it is difficult to think of analogous examples for it. (We did have apparent examples of the failure of SI in the context of an ordinary conditional in 19.5.4–19.5.8. However, one can handle these just as well with a relevant identity – at least, provided that we do not have the Subset Constraint. In each case, the consequent may fail at an impossible world where the antecedent is true.) If one were to become persuaded that SI breaks down, even in forms 3 and 4, then what would be required is clearly contingent-identity logic. We have not considered this sort of identity in the

present chapter, but one may construct a contingent-identity relevant logic in the same way that a contingent-identity modal logic was constructed in chapter 17. Since the present chapter is already quite long enough, I leave the details to the interested reader.

24.7.11 Finally on the properties of identity, it is easy to check that in B without the Subset Constraint we have $\vDash a = a$, $a = b \vDash b = a$, and $a = b \wedge b = c \vDash a = c$. We do not have $\vDash a = b \rightarrow b = a$ and $\vDash (a = b \wedge b = c) \rightarrow a = c$. The Subset Constraint delivers both of these.

24.7.12 All the tableaux of this chapter are sound and complete with respect to the corresponding semantics. This is proved in the following technical appendices.

24.8 *Proofs of Theorems 1

24.8.1 In this section we prove the relevant soundness and completeness results, starting with B , then moving to its extensions. The addition of identity is considered in the next section.

24.8.2 LEMMA (LOCALITY): Let $\mathfrak{J}_1 = \langle D, W, N, R, *, \nu_1 \rangle$ and $\mathfrak{J}_2 = \langle D, W, N, R, *, \nu_2 \rangle$ be two B interpretations. Since they have the same domain, the language of the two is the same. Call this L . If A is any closed formula of L such that ν_1 and ν_2 agree on the denotations of all the predicates and constants in it then, for all $w \in W$:

$$\nu_{1w}(A) = \nu_{2w}(A)$$

Proof:

The proof is as for *FDE* (22.8.2), with the addition of a new case for the conditional. This goes as follows:

$$\begin{aligned} \nu_{1w}(A \rightarrow B) = 1 & \text{ iff } \text{for all } w_1 \text{ and } w_2 \text{ such that } Rww_1w_2, \\ & \text{when } \nu_{1w_1}(A) = 1, \nu_{1w_2}(B) = 1 \\ & \text{iff } \text{for all } w_1 \text{ and } w_2 \text{ such that } Rww_1w_2, \\ & \text{when } \nu_{2w_1}(A) = 1, \nu_{2w_2}(B) = 1 \quad (\text{IH}) \\ & \text{iff } \nu_{2w}(A \rightarrow B) = 1 \end{aligned}$$

■

24.8.3 LEMMA (DENOTATION): Let $\mathcal{J} = \langle D, W, N, R, *, \nu \rangle$ be any B interpretation. Let A be any formula of $L(\mathcal{J})$ with at most one free variable, x , and a and b be any two constants such that $\nu(a) = \nu(b)$. Then, for any $w \in W$:

$$\nu_w(A_x(a)) = \nu_w(A_x(b))$$

Proof:

The proof is as for FDE (22.8.3) with one extra case for \rightarrow . This goes as follows:

$$\begin{aligned} \nu_w(A_x(a) \rightarrow B_x(a)) = 1 & \text{ iff for all } w_1 \text{ and } w_2 \text{ such that } Rww_1w_2, \\ & \text{ when } \nu_{w_1}(A_x(a)) = 1, \nu_{w_2}(B_x(a)) = 1 \\ \text{iff for all } w_1 \text{ and } w_2 \text{ such that } Rww_1w_2, & \\ & \text{ when } \nu_{w_1}(A_x(b)) = 1, \nu_{w_2}(B_x(b)) = 1 \quad (\text{IH}) \\ \text{iff } \nu_w(A_x(b) \rightarrow B_x(b)) = 1 & \end{aligned}$$

■

24.8.4 SOUNDNESS THEOREM: The tableaux for B are sound with respect to their semantics.

Proof:

The proof is as for N_* (23.10.12), with some minor modifications. The definition of faithfulness is modified by the addition of the clause:

$$\text{if } r\alpha\beta\gamma \text{ is on } \mathcal{B}, \text{ then } Rf(\alpha)f(\beta)f(\gamma) \text{ in } \mathcal{J}$$

In the Soundness Lemma the cases for \rightarrow are different, and are as in the propositional case (10.8.1). The Soundness Theorem then follows in the usual way. ■

24.8.5 COMPLETENESS THEOREM: The tableaux for B are complete.

Proof:

The proof is essentially the same as that for N_* (23.10.13), with some minor modifications. In particular, in the induced interpretation:

$$Rw_\alpha w_\beta w_\gamma \text{ iff } r\alpha\beta\gamma \text{ is on the branch.}$$

As in the propositional case (10.8.1), the structure defined is a B interpretation. In the Completeness Lemma the cases for \rightarrow are different. These are as in the propositional case too (10.8.1). The Completeness Theorem then follows as usual. ■

24.8.6 THEOREM: The soundness and completeness results carry over to the extensions of B obtained by adding constraints C8–C11 of 10.4 on the ternary R .

Proof:

The argument here is exactly as in the propositional case (10.8.2). ■

24.8.7 THEOREM: In any interpretation with a content ordering, for all w and w' such that $w \sqsubseteq w'$, if $\nu_w(A) = 1$ then $\nu_{w'}(A) = 1$, for every A . (This is true even if the connective \mapsto is in the language.)

Proof:

The proof is by recursion on A , as in the propositional case (10.8.2a). There are additional cases for the quantifiers. Here is the case for \forall . The case for \exists is similar.

$$\begin{aligned} \nu_w(\forall xA) = 1 &\Rightarrow \text{for all } d \in D, \nu_w(A_x(k_d)) = 1 \\ &\Rightarrow \text{for all } d \in D, \nu_{w'}(A_x(k_d)) = 1 \quad \text{IH} \\ &\Rightarrow \nu_{w'}(\forall xA) = 1 \end{aligned}$$

The case for \mapsto is as follows. Suppose that:

- (1) $\nu_w(A \mapsto B) = 1$
- (2) $w \sqsubseteq w'$

We need to show that $\nu_{w'}(A \mapsto B) = 1$, i.e.: for all w_1, w_2 such that $Rw'w_1w_2$ and $w' \sqsubseteq w_2$, if $\nu_{w_1}(A) = 1$ then $\nu_{w_2}(B) = 1$.

So suppose that:

- (3) $Rw'w_1w_2$
- (4) $w' \sqsubseteq w_2$
- (5) $\nu_{w_1}(A) = 1$

Case 1, $w \in N$: By (3) and condition 3 (10.4a.1), $w_1 \sqsubseteq w_2$. So by (5) and IH, $\nu_{w_2}(A) = 1$. By (1), since w is normal, for all u such that $w \sqsubseteq u$, if $\nu_u(A) = 1$, $\nu_u(B) = 1$. By (2), (4), and the transitivity of \sqsubseteq , $w \sqsubseteq w_2$. So $\nu_{w_2}(B) = 1$, as required.

Case 2, $w \in W - N$: By (3) and condition 3 (10.4a.1), Rww_1w_2 . By (2), (4), and the transitivity of \sqsubseteq , $w \sqsubseteq w_2$. So by (1) and (5), $\nu_{w_2}(B) = 1$, as required. ■

24.8.8 THEOREM: The tableaux for content-inclusion are sound and complete with respect to their semantics.

Proof:

The proofs extend the propositional proofs of 10.8.2b and 10.8.2c. In the Soundness Lemma, we have to check the new cases for the quantifier rules. These are as for B . In the completeness proof, the induced interpretation is defined as in the propositional case. In addition, D and the extensions of predicates are defined as for B . The Completeness Lemma is now proved as for B . ■

24.8.9 THEOREM: The tableaux obtained by adding the rules T8–T16 to those for content inclusion are sound and complete with respect to conditions C8–C16, respectively.

Proof:

The proof is as in the propositional case (10.8.2d). ■

24.8.10 THEOREM: The addition of the connective \mapsto of 24.4.2 preserves the above soundness and completeness results.

Proof:

The proof is just a matter of going through the soundness and completeness proofs for the quantified logics with \sqsubseteq , and adding the new cases for \mapsto . The new cases in the Locality and Denotation Lemmas are trivial modifications of the case for \rightarrow , and are left as an exercise.

There are two new cases in the Soundness Lemma:

$$\begin{array}{c}
 A \mapsto B, +\alpha \\
 r\alpha\beta\gamma \\
 \alpha \preceq \gamma \\
 \swarrow \quad \searrow \\
 A, -\beta \quad B, +\gamma
 \end{array}$$

Suppose that \mathfrak{J} is faithful to a branch containing the premises. Then $A \mapsto B$ is true at $f(\alpha)$, $Rf(\alpha)f(\beta)f(\gamma)$ and $f(\alpha) \sqsubseteq f(\gamma)$. By the truth conditions for \mapsto ,

either A fails at $f(\beta)$ or B holds at $f(\gamma)$. In either case, we may take \mathfrak{J}' to be \mathfrak{J} .

$$\begin{array}{c}
 A \mapsto B, -\alpha \\
 \downarrow \\
 r\alpha ij, \alpha \leq j \\
 A, +i \\
 B, -j
 \end{array}$$

Suppose that \mathfrak{J} is faithful to a branch containing the premises. Then $A \mapsto B$ fails at $f(\alpha)$. By the truth conditions for \mapsto , there are worlds, w_1 and w_2 , such that $R'f(\alpha)w_1w_2$, $v_{w_1}(A) = 1$, and $v_{w_2}(B) = 0$. Let f' be the same as f except that $f'(i) = w_1$ and $f'(j) = w_2$. Since i and j are new to the branch, f' shows \mathfrak{J} to be faithful to the extended branch, and we may take \mathfrak{J}' to be \mathfrak{J} .

In the Completeness Lemma, there are two new cases for \mapsto . Suppose that $A \mapsto B, +\alpha$ occurs on the branch. Then, since the first rule for \mapsto has been applied, for any worlds, w_β and w_γ , such that $Rw_\alpha w_\beta w_\gamma$ and $w_\alpha \sqsubseteq w_\gamma$, either A is false (0) at w_β or B is true (1) at w_γ (by IH). Hence, $A \mapsto B$ is true at w_α . Now suppose that $A \mapsto B, -\alpha$ occurs on the branch. Then there are lines of the form $r\alpha ij, \alpha \leq j, A, +i$ and $B, -j$ on the branch. By IH, there are worlds, w_i and w_j such that $R'w_\alpha w_i w_j$, A is true at w_i , and B is false at w_j . Hence, $A \mapsto B$ is false at w_α . ■

24.9 *Proofs of Theorems 2

24.9.1 In this section, we extend the soundness and completeness arguments for all the logics of the previous section to identity.

24.9.2 The arguments for the Locality and Denotation Lemmas are unaffected. $a = b, A_x(a) \models A_x(b)$ then follows from the Denotation Lemma in the usual way. Given the Subset Constraint, the validity of $(a = b \wedge A_x(a)) \rightarrow A_x(b)$ also follows. To see this, suppose that the antecedent holds in some world, w . Then $\langle v(a), v(b) \rangle \in v_w(=)$. Hence, $v(a) = v(b)$, and the result follows by the Denotation Lemma.

24.9.3 THEOREM: The tableaux for identity are sound.

Proof:

The proof of the Soundness Lemma requires us to check the rules for identity. These are straightforward (including the rule for the Subset Constraint,

if it is present), and are left as exercises. The Soundness Theorem follows in the usual way. ■

24.9.4 THEOREM: The tableaux for identity are complete.

Proof:

The induced interpretation is defined as in the case without identity, except that the domain is defined as in N_* (23.11.6), $v(a) = [a]$, and for any n -place predicate, P , except identity, and for identity at non-normal worlds, $\langle [a_1], \dots, [a_n] \rangle \in v_{w_\alpha}(P)$ iff $Pa_1 \dots a_n, +\alpha$ is on the branch. As usual, this is well defined, because of the applications of SI. The Completeness Theorem follows from the Completeness Lemma in the usual way. The proof of the Lemma is as without identity, except for atomic cases. Unless the content ordering is present, these are as for N_* (23.11.6). If the content ordering is present, then there may be more than one normal world. The cases for identity at normal worlds therefore have to be revised as follows. In both cases, the first line holds in virtue of the Normality Invariance Rule and the fact that $\$0$ and $\$\alpha$ are on the branch.

$$\begin{aligned}
 a = b, +\alpha \text{ is on } \mathcal{B} &\Rightarrow a \sim b \\
 &\Rightarrow [a] = [b] \\
 &\Rightarrow v(a) = v(b) \\
 &\Rightarrow v_{w_\alpha}(a = b) = 1
 \end{aligned}$$

$$\begin{aligned}
 a = b, -\alpha \text{ is on } \mathcal{B} &\Rightarrow \text{it is not the case that } a = b, +0 \text{ is on } \mathcal{B} \quad (\mathcal{B} \text{ open}) \\
 &\Rightarrow \text{it is not the case that } a \sim b \\
 &\Rightarrow [a] \neq [b] \\
 &\Rightarrow v(a) \neq v(b) \\
 &\Rightarrow v_{w_\alpha}(a = b) = 0
 \end{aligned}$$

If the Subset Constraint is present, we need to show that the induced interpretation satisfies it. If w_α is normal, the constraint is automatically satisfied. So suppose that w_α is not normal, and that $\langle [a], [b] \rangle \in v_{w_\alpha}(=)$. Then $a = b, +\alpha$ is on the branch used to induce the interpretation. But, then, $a = b, +0$ is on the branch, by the Subset Constraint rule. It follows that $a \sim b$, and so $[a] = [b]$, and $\langle [a], [b] \rangle \in v_{w_0}(=)$. ■

24.10 History

Quantified relevant logics were first formulated (in axiomatic form) by Anderson (1959) and Belnap (1960, 1967). Constant domain world semantics for them were formulated by Routley and Meyer (1973). Routley established the completeness of the axiom system for B in a somewhat circuitous way in (1980b) (from which the axiom system of 24.5.2 comes). The incompleteness of systems containing $A9$ was established by Fine (1989). Fine's semantics, with respect to which the strong systems, and notably R , are complete, appeared in Fine (1988). The treatment of restricted quantification in 24.4 comes from Beall, Brady, Hazen, Priest and Restall (2006).

That systems of proof have to answer to semantics, rather than vice versa, is fairly orthodox in the history of contemporary logic. It was challenged, particularly by logicians of an intuitionist persuasion such as Dummett and Prawitz, in the 1970s. (For a discussion and references, see Sundholm (1986).) The connective *tonk* was introduced by Prior (1960) to challenge a very simple version of the view that rules of inference always determine a meaningful connective. Natural-deduction style proof theory for relevant logics that satisfies the appropriate version of harmony (cut-elimination) can be found in Restall (2000), ch. 6. The argument of 24.5.12 comes from Fine (1988, 1989).

Semantics for identity in relevant logic, though in the context of Fine's semantics, were produced by Mares (1992). The arguments of 24.7.5 and 24.7.6 are due to Mares (2004), 6.13. The Subset Constraint is due to Priest (1987, 2nd edn), 19.8.

24.11 Further Reading

There is a brief discussion of the semantics of quantified relevant logic in Dunn (1986, 2nd edn), and a much longer discussion in Anderson, Belnap, and Dunn (1992), sects. 52 and 53. For discussions of harmony in a proof-theoretic account of meaning, see Dummett (1991), Prawitz (1977, 1994), and Read (2000). On the issue of the primacy of proof theory or semantics, see Dummett (1975b) and Priest (2006), ch. 11. Some further discussion of identity in relevant logic can be found in Mares (2004), ch. 6.

24.12 Problem

1. Check the details omitted in 24.3.6, 24.3.7, 24.4.1, 24.4.5, 24.6.5, 24.6.6, 24.6.8, 24.6.9, 24.7.3 and 24.7.4.
2. By constructing appropriate tableaux, show the following in B :
 - (a) $\vdash \forall xA \rightarrow A_x(a)$
 - (b) $\vdash A_x(a) \rightarrow \exists xA$
 - (c) $\vdash \forall x(A \wedge B) \rightarrow (\exists xA \wedge \exists xB)$
 - (d) $\vdash \forall x(B \vee A) \rightarrow (B \vee \forall xA)$ (x not free in B)
 - (e) $\vdash \neg\exists xA \rightarrow \forall x\neg A$
 - (f) $\vdash \neg\forall xA \rightarrow \exists x\neg A$
3. Check the validity of the inferences in 12.4.14, question 5, for B , when ‘ \supset ’ is replaced by ‘ \rightarrow ’.
4. By constructing an appropriate interpretation, show the following in R :
 - (a) $\not\models \forall x(Px \vee Qx) \rightarrow (\forall xPx \vee \forall xQx)$
 - (b) $\not\models \exists x(Px \wedge \neg Px) \rightarrow \exists xQx$
 - (c) $\not\models \forall xPx \rightarrow \forall y(Qy \rightarrow Qy)$
5. Show in B that:
 - (a) $\forall x(Px \mapsto Qx), \forall x(Qx \mapsto Sx) \vdash \forall x(Px \mapsto Sx)$
 - (b) $\forall x(Px \mapsto \neg Qx) \not\models \neg\exists x(Px \wedge \neg Qx)$
 - (c) $\forall x(Px \mapsto \neg Qx), \forall x(Px \vee \neg Px) \vdash \neg\exists x(Px \wedge \neg Qx)$
 - (d) $\forall x(Px \mapsto Qx) \not\models \forall x(\neg Qx \mapsto \neg Px)$
6. Construct a tableau for TW showing that the Fine formula of 24.5.4 is logically valid.
7. Suppose that one has a semantics for a logic, and a system of proof (e.g., tableau system, axiom system, or system of natural deduction), which is sound but not complete with respect to it. Under what conditions is it methodologically correct to revise the proof system; under what conditions is it correct to revise the semantics?
8. Repeat question 6 of 23.15 for identity in B (a) without the Subset Constraint and (b) with it.
9. Show the following in R , without the Subset Constraint. Does the addition of the Constraint make any difference?
 - (a) $\not\models (Pa \wedge \neg Pb) \rightarrow \neg a = b$
 - (b) $\not\models (a = b \wedge \neg Pa) \rightarrow \neg Pb$
 - (c) $\not\models a = b \rightarrow (Pa \rightarrow Pb)$
10. Should one accept the Subset Constraint?

11. *Check the details omitted in 24.8 and 24.9.
12. *Formulate semantics and tableaux for (constant domain) quantified B , extended with a *ceteris paribus* conditional, as in 10.7. Prove soundness and completeness.
13. *Formulate semantics and tableaux for the variable domain version of B . (Use the techniques of free logic, as in chapter 15.) Prove soundness and completeness.
14. *Using the content ordering on worlds, one can give intuitionist-style truth conditions for the quantifiers in variable domain semantics, as follows:

$$\begin{aligned} \nu_w(\exists xA) = 1 & \quad \text{iff} \quad \text{for some } d \in D_w, \nu_w(A_x(k_d)) = 1 \\ \nu_w(\forall xA) = 1 & \quad \text{iff} \quad \text{for all } w' \text{ such that } w \sqsubseteq w', \\ & \quad \text{and all } d \in D_{w'}, \nu_{w'}(A_x(k_d)) = 1 \end{aligned}$$

What effect does this have on the valid inferences? (Don't forget negation.)

15. *Formulate semantics and tableaux for quantified B with contingent identity. Prove soundness and completeness. What versions of SI hold in the semantics?
16. *For the various systems of logic in this chapter, formulate tableaux for inferences with arbitrary sets of premises. Prove the Soundness and Completeness Theorems. Infer the Compactness and Löwenheim-Skolem Theorems.

25 Fuzzy Logics

25.1 Introduction

25.1.1 In this chapter, we will look at the addition of quantifiers to the Łukasiewicz continuum-valued logic.

25.1.2 We will then look at the behaviour of identity in this logic.

25.1.3 This will occasion a discussion of some philosophical issues concerning fuzzy identity, connected, in particular, with the sorites paradox and with vague objects.

25.1.4 A technical appendix describes the addition of quantifiers and identity to the general class of t -norm logics.

25.2 Quantified Łukasiewicz Logic

25.2.1 In the language we are concerned with, the set of connectives, C , is $\{\wedge, \vee, \neg, \rightarrow\}$, and the set of quantifiers, Q , is $\{\forall, \exists\}$. ($A \leftrightarrow B$ can be taken as defined as $(A \rightarrow B) \wedge (B \rightarrow A)$.)

25.2.2 As we saw in 21.2, an interpretation for a quantified many-valued logic is a structure $\langle D, \mathcal{V}, \mathcal{D}, \{f_c : c \in C\}, \{f_q : q \in Q\}, \nu \rangle$. D is a non-empty domain of quantification. For every constant, c , $\nu(c) \in D$, and for every n -place predicate, P , $\nu(P)$ is an n -place function that maps members of D into the truth values, \mathcal{V} . In Łukasiewicz continuum-valued logic, $\mathcal{V} = [0, 1]$, the set of real numbers between 0 and 1, ordered in the usual way. f_\vee, f_\wedge, f_\neg and f_\rightarrow are as in the propositional case (11.4.2). f_\exists is *Lub* and f_\forall is *Glb*, as in 21.3. So, given any interpretation:

$$\nu(Pa_1 \dots a_n) = \nu(P)(\nu(a_1), \dots, \nu(a_n))$$

and then the various f s are applied to determine the truth values of other formulas. In particular:

$$\nu(\exists xA) = \text{Lub}(\{\nu(A_x(k_d)) : d \in D\})$$

$$\nu(\forall xA) = \text{Glb}(\{\nu(A_x(k_d)) : d \in D\})$$

In what follows, an interpretation can be thought of simply as a pair, $\langle D, \nu \rangle$, since all the other components of the interpretation are fixed.

25.2.3 An inference is valid if it preserves designated values. That is, $\Sigma \models A$ iff in every interpretation, when $\nu(B) \in \mathcal{D}$, for every $B \in \Sigma$, $\nu(A) \in \mathcal{D}$. As in 11.4.6–11.4.7, every set of the form $\{x: \varepsilon \leq x \leq 1\}$, where $0 \leq \varepsilon \leq 1$, makes perfectly good philosophical sense as a set of designated values. We write the consequence relation with this set of designated values as \models_ε .

25.2.4 Again as in the propositional case (11.4.8), it makes sense to define an absolute notion of validity, one that preserves designated value, whatever ε is. So we may define the absolute notion of consequence as follows:

$$\Sigma \models A \text{ iff for all } 0 \leq \varepsilon \leq 1, \Sigma \models_\varepsilon A$$

25.2.5 Defining $\nu[\Sigma]$ as $\{\nu(B) : B \in \Sigma\}$, one can then show that $\Sigma \models A$ iff for every interpretation, $\text{Glb}(\nu[\Sigma]) \leq \nu(A)$. And if $\Sigma = \{B_1, \dots, B_n\}$:

$$\Sigma \models A \text{ iff } \models_1 (B_1 \wedge \dots \wedge B_n) \rightarrow A$$

The proof is exactly as in the propositional case (11.4.10, 11.4.11). The logic whose consequence relation is \models_1 is standardly known as \mathcal{L}_\aleph . In what follows we consider this logic.

25.3 Validity in \mathcal{L}_\aleph

25.3.1 As we observed in 11.5.1, there is no axiom system for \mathcal{L}_\aleph that is sound and complete with respect to arbitrary sets of premises, but there is one that is sound and complete with respect to logical truths. Perhaps rather surprisingly, even this does not exist in the quantified case.¹ (This

¹ Indeed, for any rational $\varepsilon > 0$, the set of logical truths of \models_ε is not axiomatisable. However, let $\models_{\varepsilon-}$ be the consequence relation where the designated values are all x such that $\varepsilon < x \leq 1$. (Note the *greater than*.) The set of logical truths of $\models_{\varepsilon-}$ is axiomatisable iff ε is a recursive real number – that is, if there is an algorithm which generates its decimal expansion. (See Chang (1963).) Further on technical matters: since compactness

was proved by Scarpellini; the proof is too difficult to give here.) To show that something is valid, we therefore have to argue directly.

25.3.2 To verify some important inferences, one requires the Denotation Lemma. This lemma is to the effect that if two constants have the same denotation, one may be replaced by the other in a formula without affecting its truth value. (This was proved in 21.11.3.) Given the Lemma, we may verify that the following are logical truths:

1. $\forall xA \rightarrow A_x(a)$
2. $A_x(a) \rightarrow \exists xA$

The argument for 1 is as follows. $v(\forall xA) = \text{Glb}\{v(A_x(k_d)) : d \in D\} \leq v(A_x(k_d)) = v(A_x(a))$, where $v(a) = d$ (by the Denotation Lemma). The result follows. The argument for 2 is similar, and is left as an exercise.²

25.3.3 To verify other inferences, some facts about *Lub* and *Glb* are helpful. In particular, let r, a_x, b_x be real numbers in the interval $[0, 1]$, then:

1. $\text{Glb}\{x \pm r : x \in X\} = \text{Glb } X \pm r$
2. $\text{Lub}\{x \pm r : x \in X\} = \text{Lub } X \pm r$
3. $\text{Glb}\{-x : x \in X\} = -\text{Lub } X$
4. $\text{Lub}\{-x : x \in X\} = -\text{Glb } X$
5. $\text{Lub}\{r - x : x \in X\} = r - \text{Glb } X$
6. $\text{Glb}\{r - x : x \in X\} = r - \text{Lub } X$
7. If, for all $x \in X$, $a_x \leq b_x$ then $\text{Lub}\{a_x : x \in X\} \leq \text{Lub}\{b_x : x \in X\}$
8. $\text{Glb}\{\text{Max}(r, x) : x \in X\} = \text{Max}(r, \text{Glb } X)$
9. $\text{Glb}\{r \odot x : x \in X\} = r \odot \text{Glb } X$
10. $\text{Lub}\{a_x : x \in X\} \odot \text{Lub}\{b_x : x \in X\} \leq \text{Lub}\{a_x \odot b_x : x \in X\}$

Proof:

1. If $x \in X$ then $\text{Glb } X \leq x$. So $\text{Glb } X \pm r \leq x \pm r$. That is, $\text{Glb } X \pm r$ is a lower bound of $\{x \pm r : x \in X\}$. Suppose that for all $x \in X$, $y \leq x \pm r$, that is, $y \mp r \leq x$. Then $y \mp r \leq \text{Glb } X$; that is, $y \leq \text{Glb } X \pm r$. So $\text{Glb } X \pm r$ is the greatest lower bound.
2. The proof is similar, and left as an exercise.

fails for propositional \mathcal{L}_{\aleph} (11.10, question 9) it certainly fails for quantified \mathcal{L}_{\aleph} . However, the Löwenheim-Skolem Theorem holds. (See Chang and Keisler (1966), sect. 4.3.)

² I omit the brackets in $\text{Glb}(X)$ to reduce clutter.

3. If $x \in X$ then $x \leq \text{Lub } X$. So $-\text{Lub } X \leq -x$. That is, $-\text{Lub } X$ is a lower bound of $\{-x: x \in X\}$. Suppose that for all $x \in X, y \leq -x$; then $-y \geq x$. So $-y \geq \text{Lub } X$ and $y \leq -\text{Lub } X$. So $-\text{Lub } X$ is the greatest lower bound.
4. The proof is similar, and left as an exercise.
5. $\text{Lub}\{r - x: x \in X\} = r + \text{Lub}\{-x: x \in X\}$ (by 2) $= r - \text{Glb } X$ (by 4).
6. The proof is similar, and left as an exercise.
7. Suppose that for all $x \in X, a_x \leq b_x$. Then for any $x \in X, a_x \leq b_x \leq \text{Lub}\{b_x: x \in X\}$. Hence, $\text{Lub}\{a_x: x \in X\} \leq \text{Lub}\{b_x: x \in X\}$.
8. If $x \in X$ then $\text{Glb } X \leq x$. Hence, $\text{Max}(r, \text{Glb } X) \leq \text{Max}(r, x)$; and so $\text{Max}(r, \text{Glb } X)$ is a lower bound of $\{\text{Max}(r, x): x \in X\}$. Suppose that for all $x \in X, y \leq \text{Max}(r, x)$. Case 1: for all $x \in X, r \leq x$. Then $r \leq \text{Glb } X$, and $\text{Max}(r, x) \leq \text{Max}(r, \text{Glb } X)$. Hence, $y \leq \text{Max}(r, \text{Glb } X)$. Case 2: for some $x \in X, x < r$. Then for that $x, \text{Max}(r, x) = r = \text{Max}(r, \text{Glb } X)$. Hence, $y \leq \text{Max}(r, \text{Glb } X)$. In either case, $\text{Max}(r, \text{Glb } X)$ is the greatest lower bound.
9. Case 1: $r \leq \text{Glb } X$. In this case, the righthand side is 1. But also, if $x \in X, r \leq x$, so $r \odot x = 1$, and the lefthand side is also 1. Case 2: $r > \text{Glb } X$. Then there must be an $x \in X$ such that $r > x$. Let $X' = \{x \in X: r > x\}$. Clearly, $\text{Glb } X' = \text{Glb } X$. So

$$\begin{aligned}
 r \odot \text{Glb } X &= r \odot \text{Glb } X' \\
 &= 1 - r + \text{Glb}\{x: x \in X'\} \\
 &= \text{Glb}\{1 - r + x: x \in X'\} \quad (\text{by 1}) \\
 &= \text{Glb}\{r \odot x: x \in X'\} \\
 &= \text{Glb}\{r \odot x: x \in X\} \quad (*)
 \end{aligned}$$

(*) follows from the fact that if $x \in X - X', r \odot x = 1$.

10. Case 1: for some $x \in X, a_x < b_x$. In that case, the righthand side is 1, and the result follows. Case 2: for all $x \in X, a_x \geq b_x$. In that case, $\text{Lub}\{a_x: x \in X\} \geq \text{Lub}\{b_x: x \in X\}$ (by 7), so what we need to show is that:

$$\begin{aligned}
 &1 - \text{Lub}\{a_x: x \in X\} + \text{Lub}\{b_x: x \in X\} \leq \text{Lub}\{1 + b_x - a_x: x \in X\} \\
 \text{i.e., } &1 - \text{Lub}\{a_x: x \in X\} + \text{Lub}\{b_x: x \in X\} \leq 1 + \text{Lub}\{b_x - a_x: x \in X\} \quad (\text{by 2}) \\
 \text{i.e., } &\text{Lub}\{b_x: x \in X\} - \text{Lub}\{a_x: x \in X\} \leq \text{Lub}\{b_x - a_x: x \in X\}
 \end{aligned}$$

To show this we may reason as follows:

$$\begin{aligned}
 & a_x \leq \text{Lub}\{a_x : x \in X\} \\
 \text{So } & b_x - \text{Lub}\{a_x : x \in X\} \leq b_x - a_x \\
 \text{and } & \text{Lub}\{b_x - \text{Lub}\{a_x : x \in X\} : x \in X\} \\
 & \leq \text{Lub}\{a_x - b_x : x \in X\} \quad (\text{by 7}) \\
 \text{i.e., } & \text{Lub}\{b_x : x \in X\} - \text{Lub}\{a_x : x \in X\} \\
 & \leq \text{Lub}\{a_x - b_x : x \in X\} \quad (\text{by 2})
 \end{aligned}$$

25.3.4 We can use these facts to demonstrate the logical truth of various formulas in L_N . For example:

1. $\forall x \neg A \leftrightarrow \neg \exists x A$
2. $\exists x \neg A \leftrightarrow \neg \forall x A$
3. $\forall x (A \vee B) \leftrightarrow (A \vee \forall x B)$
4. $\forall x (A \rightarrow B) \leftrightarrow (A \rightarrow \forall x B)$
5. $(\exists x A \rightarrow \exists x B) \rightarrow \exists x (A \rightarrow B)$

In 3 and 4, x is not free in A . (And if the biconditionals in 1 and 2 are valid, the conditionals in each direction certainly are.) Proofs go as follows, where the ν in question is that of any interpretation. Numbered references are to the facts of 25.3.3.

Proof:

$$\begin{aligned}
 1. \quad & \nu(\forall x \neg A) = \text{Glb}\{\nu(\neg A_x(k_d)) : d \in D\} \\
 & = \text{Glb}\{1 - \nu(A_x(k_d)) : d \in D\} \\
 & = 1 - \text{Lub}\{\nu(A_x(k_d)) : d \in D\} \quad (\text{by 6}) \\
 & = 1 - \nu(\exists x A) \\
 & = \nu(\neg \exists x A)
 \end{aligned}$$

The result follows.

2. This is similar, using 5, and left as an exercise.

$$\begin{aligned}
 3. \quad & \nu(\forall x (A \vee B)) = \text{Glb}\{\text{Max}(\nu(A), \nu(B_x(k_d))) : d \in D\} \\
 & = \text{Max}\{\nu(A), \text{Glb}\{\nu(B_x(k_d)) : d \in D\}\} \quad (\text{by 8}) \\
 & = \nu(A \vee \forall x B)
 \end{aligned}$$

The result follows.

$$\begin{aligned}
4. \quad \nu(\forall x(A \rightarrow B)) &= \text{Glb}\{\nu(A) \odot \nu(B_x(k_d)): d \in D\} \\
&= \nu(A) \odot \text{Glb}\{\nu(B_x(k_d)): d \in D\} \quad (\text{by 9}) \\
&= \nu(A \rightarrow \forall xB)
\end{aligned}$$

The result follows.

$$\begin{aligned}
5. \quad \nu(\exists xA \rightarrow \exists xB) &= \text{Lub}\{\nu(A_x(k_d)): d \in D\} \odot \text{Lub}\{\nu(B_x(k_d)): d \in D\} \\
&\leq \text{Lub}\{\nu(A_x(k_d)) \odot \nu(B_x(k_d)): d \in D\} \quad (\text{by 10}) \\
&= \nu(\exists x(A \rightarrow B))
\end{aligned}$$

The result follows.

25.3.5 To show the invalidity of an inference, one must construct a counter-model by intelligent trial and error. Here is a counter-model to show that $\not\models (\exists xPx \wedge \exists xQx) \rightarrow \exists x(Px \wedge Qx)$. Consider an interpretation in which $D = \{\partial_a, \partial_b\}$, $\nu(a) = \partial_a$, $\nu(b) = \partial_b$, and ν has the following values:

	P	Q
∂_a	1	0
∂_b	0	1

It is not difficult to check that $\nu(\exists xPx) = \nu(\exists xQx) = \nu(\exists xPx \wedge \exists xQx) = 1$, whilst $\nu(Pa \wedge Qa) = \nu(Pb \wedge Qb) = \nu(\exists x(Px \wedge Qx)) = 0$. So the whole conditional takes the value 0.

25.3.6 Note that this interpretation is, in effect, a classical interpretation. Any classical interpretation is a special case of a Łukasiewicz interpretation (where all the atomic formulas, and so all the formulas, take the value 1 or 0). Hence, any formula that is invalid in classical logic is invalid in $\mathcal{L}_{\mathbb{N}}$ as well. So all formulas valid in $\mathcal{L}_{\mathbb{N}}$ are valid in classical logic.

25.3.7 Another example: $\not\models (\exists xPx \wedge \forall x(Px \rightarrow Qx)) \rightarrow \exists xQx$. Consider an interpretation where $D = \{\partial_a, \partial_b\}$, $\nu(a) = \partial_a$, $\nu(b) = \partial_b$, and ν has the following values:

	P	Q
∂_a	0.9	0.6
∂_b	0.6	0.3

Then $\nu(\exists xPx) = 0.9$, $\nu(Pa \rightarrow Qa) = \nu(Pb \rightarrow Qb) = \nu(\forall x(Px \rightarrow Qx)) = 0.7$. But $\nu(\exists xQx) = 0.6$. So the truth value of the whole conditional is 0.9.

25.3.8 The invalidity of this formula is due, essentially, to the invalidity of the corresponding propositional formula, $(p \wedge (p \rightarrow q)) \rightarrow q$. In nearly all cases of significance, when a formula is classically valid but not valid in \mathcal{L}_K , the invalidity is due to the properties of the underlying propositional logic. (See 25.11 question 4.)

25.4 Deductions

25.4.1 Another way of showing that something is valid in \mathcal{L}_K is by showing that it follows from things already known to be valid, using rules that are known to be validity-preserving, such as *modus ponens*. We can do this for the propositional logic, too, of course. Here, for example, are propositional deductions showing the validity of two forms of contraposition:

$$\begin{aligned} &\models (A \rightarrow B) \rightarrow (\neg B \rightarrow \neg A) \\ &\models (\neg B \rightarrow \neg A) \rightarrow (A \rightarrow B) \end{aligned}$$

One preliminary comment: in the axiomatisation of \mathcal{L}_K (11.5.2), axiom 9 is:

$$(A9)(A \rightarrow B) \rightarrow ((B \rightarrow C) \rightarrow (A \rightarrow C))$$

(suffixing). As observed in 11.5.2, we also have the redundant:

$$(A10)(A \rightarrow B) \rightarrow ((C \rightarrow A) \rightarrow (C \rightarrow B))$$

(prefixing).

In what follows, the lefthand column contains line numbers. The righthand column supplies the justification for each line, with reference to the line numbers employed. The bracketed references in that column are to the axioms and rules of propositional \mathcal{L}_K , which, of course, hold just as much in quantified \mathcal{L}_K too. (See 11.5.2.)

- | | | |
|----|--|------------------|
| 1. | $\neg B \rightarrow \neg B$ | (A1) |
| 2. | $B \rightarrow \neg\neg B$ | 1,(A8),(R1) |
| 3. | $(A \rightarrow B) \rightarrow (A \rightarrow \neg\neg B)$ | 2,(A10),(R1) |
| 4. | $(A \rightarrow \neg\neg B) \rightarrow (\neg B \rightarrow \neg A)$ | (A8) |
| 5. | $(A \rightarrow B) \rightarrow (\neg B \rightarrow \neg A)$ | 3,4,(A9/10),(R1) |

1. $(\neg B \rightarrow \neg A) \rightarrow (A \rightarrow \neg\neg B)$ (A8)
2. $\neg\neg B \rightarrow B$ (A7)
3. $(A \rightarrow \neg\neg B) \rightarrow (A \rightarrow B)$ 2,(A10), (R1)
4. $(\neg B \rightarrow \neg A) \rightarrow (A \rightarrow B)$ 1,3,(A9/10), (R1)

25.4.2 A quantificational rule that preserves validity is Universal Generalisation (UG): if the constant a does not occur in A , then if $\models A_x(a)$, $\models \forall xA$.³ This can be employed to effect in quantificational arguments. A couple of examples follow.

25.4.3 $\models \forall x(A \rightarrow B) \rightarrow (\forall xA \rightarrow \forall xB)$. a is a constant that does not occur in the formula.

1. $\forall x(A \rightarrow B) \rightarrow (A_x(a) \rightarrow B_x(a))$ [25.3.2, 1]
2. $\forall xA \rightarrow A_x(a)$ [25.3.2, 1]
3. $(A_x(a) \rightarrow B_x(a)) \rightarrow (\forall xA \rightarrow B_x(a))$ 2, (A9), (R1)
4. $\forall x(A \rightarrow B) \rightarrow (\forall xA \rightarrow B_x(a))$ 1, 3, (A9/10), (R1)
5. $\forall x(\forall x(A \rightarrow B) \rightarrow (\forall xA \rightarrow B))$ 4,UG
6. $\forall x(A \rightarrow B) \rightarrow \forall x(\forall xA \rightarrow B)$ 5,[25.3.4, 4], (R1)
7. $\forall x(\forall xA \rightarrow B) \rightarrow (\forall xA \rightarrow \forall xB)$ [25.3.4, 4]
8. $\forall x(A \rightarrow B) \rightarrow (\forall xA \rightarrow \forall xB)$ 6,7,(A9/10), (R1)

25.4.4 $\models \forall x(A \rightarrow B) \rightarrow (\exists xA \rightarrow B)$, where x is not free in B .

1. $(A_x(a) \rightarrow B) \rightarrow (\neg B \rightarrow \neg A_x(a))$ Contraposition
2. $\forall x((A \rightarrow B) \rightarrow (\neg B \rightarrow \neg A))$ 1,UG
3. $\forall x(A \rightarrow B) \rightarrow \forall x(\neg B \rightarrow \neg A)$ 2, [25.4.3], (R1)
4. $\forall x(\neg B \rightarrow \neg A) \rightarrow (\neg B \rightarrow \forall x\neg A)$ [25.3.4, 4]
5. $\forall x(A \rightarrow B) \rightarrow (\neg B \rightarrow \forall x\neg A)$ 3,4,(A9/10), (R1)
6. $\forall x\neg A \rightarrow \neg\exists xA$ [25.3.4, 1]
7. $(\neg B \rightarrow \forall x\neg A) \rightarrow (\neg B \rightarrow \neg\exists xA)$ 6,(A10), (R1)
8. $(\neg B \rightarrow \neg\exists xA) \rightarrow (\exists xA \rightarrow B)$ Contraposition
9. $(\neg B \rightarrow \forall x\neg A) \rightarrow (\exists xA \rightarrow B)$ 7,8,(A9/10), (R1)
10. $\forall x(A \rightarrow B) \rightarrow (\exists xA \rightarrow B)$ 5,9,(A9/10), (R1)

³ The proof is as follows. Suppose that $\forall xA$ is not logically valid. Then in some interpretation, there is a $d \in D$ such that $v_{(A_x(k_d))} \neq 1$. Consider the interpretation that is the same, except that $v(a) = d$. By the Locality Lemma (21.11.2), in this interpretation, $v_{(A_x(k_d))} \neq 1$ (since a does not occur in A); and by the Denotation Lemma (21.11.3), in this interpretation, $v_{(A_x(a))} \neq 1$.

25.4.5 Finally, before we turn to identity, I note that the fuzzy relevant logic of 11.7 can be extended to a quantificational logic in the natural way. I leave the details to any interested reader.

25.5 The Sorites Again

25.5.1 Let us now turn to identity in $\mathcal{L}_\mathcal{N}$. As we saw in 21.8.1–21.8.3, a natural way of handling identity in the context of a many-valued logic is to take $\nu(=)$ to satisfy the condition that:

$$\nu(=)(d_1, d_2) \in \mathcal{D} \text{ iff } d_1 = d_2$$

where \mathcal{D} is the set of designated values – in the case we are dealing with, $\{1\}$.

25.5.2 As we noted there, this suffices to guarantee that $a = b, A_x(a) \models_1 A_x(b)$. It does not mean that $a = b, A_x(a) \models A_x(b)$, however. For this we need it to be the case that $\models_1 (a = b \wedge A_x(a)) \rightarrow A_x(b)$. To determine whether or not this is so, we need more information about identity. Specifically, we need to know what $\nu(=)(d_1, d_2)$ is in the other cases.

25.5.3 A natural thought is that if d_1 and d_2 are not the same, $\nu(=)$ should map the pair to 0. It is not difficult to check that this makes it true that $\models_1 (a = b \wedge A_x(a)) \rightarrow A_x(b)$. (If a and b denote the same thing, the antecedent and consequent have the same truth value. If they denote distinct things, the antecedent has value 0.)

25.5.4 This strategy makes identity a nice crisp predicate. In the context of vagueness, however, there are reasons to suppose that identity is a fuzzy predicate; that is, that identity statements may take values other than 1 and 0. For example, suppose that I have two cars of the same model, a and b . Each day I take a part from car a and replace it by the corresponding part of car b . When the process starts, the object is car a , that is, it has the property of being identical with a ; when the process finishes, it is car b , so it does not have the property of being identical with a . But there would seem to be no exact point at which the object ceases to have the property of being identical to a . Having this property just seems to fade out.

In other words, the identity predicate behaves just like any other vague predicate.

25.5.5 Unsurprisingly, we can turn this into a sorites-style argument. Suppose that the change takes place over $n + 1$ days, and that we name the object on the successive days $a_0 (= a)$, $a_1, \dots, a_n (= b)$. Now, if we have a car, and we change a part, say the carburettor, it is still the same car. So it would seem that $a_i = a_{i+1}$ (for $0 \leq i \leq n$). We now have the following sorites argument:

$$\begin{array}{c} \frac{a = a_0 \quad a_0 = a_1}{a = a_1 \quad a_1 = a_2} \\ a = a_2 \\ \vdots \\ \frac{a = a_{n-1} \quad a_{n-1} = a_n}{a = a_n \quad a_n = b} \\ a = b \end{array}$$

25.5.6 As we saw in 11.2.4, standard sorites arguments use the single form of inference *modus ponens*. Here we have another kind of sorites argument that uses a different form of inference: the transitivity of identity. In 11.6, we noted that one may attempt to solve the sorites paradox in fuzzy logic by denying the validity of *modus ponens*. It is therefore natural to expect a solution to the identity sorites to deny the validity of the transitivity of identity. To make the parallel between the two cases even more obvious: the premises of a standard sorites can, equally, be formulated as biconditionals. (The conditionals in the other direction are not contentious.) And biconditionality, with respect to formulas, is very much like identity, with respect to names.

25.6 Fuzzy Identity

25.6.1 If identity is a vague predicate, then it will need to take values other than 0 and 1. How is this best done? One way is as follows.

25.6.2 A *distance metric* is a function that one may think of as measuring the distance between objects. Thus, it is a function, δ , that maps every pair

of objects to a real number greater than or equal to 0. Standardly, metrics satisfy the following conditions:

$$\delta(x, y) = 0 \text{ iff } x \text{ is } y$$

$$\delta(x, y) = \delta(y, x)$$

$$\delta(x, z) \leq \delta(x, y) + \delta(y, z)$$

The last condition is sometimes called ‘the triangle inequality’. It represents the fact that going around two sides of a triangle takes you at least as far as going straight along the third side.

25.6.3 Example: if we are dealing with real numbers, and we define $|z|$ in the usual way (as z , if $z \geq 0$, and $-z$, if $z < 0$), then it is not difficult to check that $|x - y|$ is a distance metric.

25.6.4 Measurements of distance have an element of the conventional about them. We can always change the scale. One may, for example, arrange for the metric to be such that the maximum distance between any two objects is 1. (For example, if our objects are real numbers ≥ 1 , we may define $\delta(x, y)$ as $|1/x - 1/y|$. I leave it as an exercise to check that the definition determines a metric.) This is exactly what we will assume in the present case. So for all x and y , $0 \leq \delta(x, y) \leq 1$.

25.6.5 If the objects in our domain come with a distance metric of this kind, the metric may be used to define a fuzzy identity predicate in a natural way: $v(=)(x, y)$ is $1 - \delta(x, y)$. When x and y are identical, this is 1. As they get further and further apart, the δ term will get bigger and bigger, so the degree of truth drops further and further.

25.6.6 As an illustration, suppose that our objects are themselves real numbers between 2 and 3, and that $\delta(x, y) = |x - y|$. Then the identity $2 = 2$ has the value 1; the identity $2 = 2.1$ has the value 0.9; $2 = 2.2$ has the value 0.8; $2 = 3$ has the value 0. So the identity $2 = 2.1$ isn’t quite as true as $2 = 2$, but it is truer than $2 = 2.2$, etc.

25.6.7 To make all this formally precise, we now think of an interpretation as a triple, $\langle D, \delta, v \rangle$. D and v are as before; δ is a metric on D , and:

$$v(=)(d_1, d_2) = 1 - \delta(d_1, d_2)$$

25.6.8 It is not difficult to see that $\models a = a$. For $v(a = a) = 1 - \delta(v(a), v(a)) = 1$. And since $\delta(v(a), v(b)) = \delta(v(b), v(a))$, $v(a = b) = v(b = a)$.

Hence, $\models_1 a = b \rightarrow b = a$. However, $\not\models_1 (a = b \wedge b = c) \rightarrow a = c$. To see this, take an interpretation where $D = [2, 3]$, $\delta(x, y) = |x - y|$, and let a , b , and c denote 2, 2.1 and 2.2, respectively. Then $\nu(a = b) = \nu(b = c) = 0.9$, but $\nu(a = c) = 0.8$. So $\nu((a = b \wedge b = c) \rightarrow a = c) = 0.9$, which is not designated.

25.6.9 However, the triangle inequality ensures that the truth value of $a = c$ can't be too far from those of $a = b$ and $b = c$. Where $\nu(a) = x$, $\nu(b) = y$, and $\nu(c) = z$, we have:

$$\begin{aligned} \delta(x, z) &\leq \delta(x, y) + \delta(y, z) \\ \text{So } -\delta(x, y) - \delta(y, z) &\leq -\delta(x, z) \\ \text{and } 1 - \delta(x, y) + 1 - \delta(y, z) - 1 &\leq 1 - \delta(x, z) \end{aligned}$$

Thus:

$$\nu(a = b) + \nu(b = c) - 1 \leq \nu(a = c)$$

If, for example, $\nu(a = b) = 0.8$ and $\nu(b = c) = 0.7$, $\nu(a = c)$ must be at least 0.5.

25.6.10 The transitivity of identity is a special case of the substitutivity of identicals, $(a = b \wedge A_x(a)) \rightarrow A_x(b)$, so this is going to fail in general too. For example, consider an interpretation in which $D = [0, 1]$; $\delta(x, y) = |x - y|$; $\nu(P)(x) = 1$ if $x \leq 0.5$, and 0 if $x > 0.5$; $\nu(a) = 0.4$, and $\nu(b) = 0.6$. Then $\nu(a = b) = 0.8$, $\nu(Pa) = 1$ and $\nu(Pb) = 0$. So $\nu((a = b \wedge Pa) \rightarrow Pb) = 0.2$.

25.6.11 In this interpretation, P is a crisp predicate, and makes a jump at 0.5. Vague predicates are not like this. They are tolerant with respect to small changes. That is, a small change in the value of x will make only a small change in the value of $\nu(P)(x)$. If we write $\nu(P)$ as p , this means that p is a continuous function, in an appropriate sense. We might demand more than this, however. For tolerant predicates of this kind it is natural to suppose that the value of $p(x)$ can change no faster than x does. That is:

$$|p(x) - p(y)| \leq \delta(x, y)$$

i.e., $p(x)$ must be at least as like $p(y)$ as x is like y . Let us call predicates satisfying this constraint *smooth*.

25.6.12 Now consider the inference from $a = b$ and Pa to Pb , where P is smooth. Let $\nu(a) = x$ and $\nu(b) = y$. If $p(x) \geq p(y)$, the constraint gives us that $p(x) - p(y) \leq \delta(x, y)$. That is, $p(x) - \delta(x, y) \leq p(y)$. If, on the other hand,

$p(x) \leq p(y)$, this still obtains. So in either case, $p(x) + 1 - \delta(x, y) - 1 \leq p(y)$. That is:

$$v(Pa) + v(a = b) - 1 \leq v(Pb)$$

So the amount that truth can fall in the inference is bounded in exactly the same way as in the transitivity of identity (25.6.9).

25.6.13 For good measure, consider the inference from A and $A \rightarrow B$ to B . If $v(A) \geq v(B)$ then $v(A \rightarrow B) = 1 - v(A) + v(B)$. That is, $v(A \rightarrow B) + v(A) - 1 = v(B)$. So certainly:

$$v(A \rightarrow B) + v(A) - 1 \leq v(B)$$

And if $v(A) \leq v(B)$, this relationship holds anyway (since $v(A \rightarrow B) = 1$). Again, the amount that truth can fall is bounded in exactly the same way.

25.6.14 What we have seen, then, is this. The inferences *modus ponens*, the transitivity of identity, and the substitutivity of identicals for smooth predicates, may allow for a drop of truth values. (They are not valid.) However, if, in an application of one of these rules, truth does drop, its drop is bounded. The degree of truth of the conclusion must be at least as great as the sum of the degrees of truth of the premises minus 1. In particular, if the premises have truth values close to one, so will the conclusion.

25.6.15 The treatment of fuzzy identity we have been looking at therefore treats the *modus ponens* sorites and the identity sorites in exactly the same way. The inference involved in each is invalid. But it is of a kind that is often practically correct. If our premises are ‘true enough’ (close enough to 1) the conclusion will be so too. This, perhaps, is why we find the inferences attractive, even though they are invalid.

25.7 Vague Objects

25.7.1 So far, we have been discussing vague predicates. Let us now turn to vague objects. *Prima facie*, at least, there are vague objects in the world: the Australian outback or Mount Everest, for example. If one starts in/on either of these and keeps going, then one will eventually be out of the outback or off the mountain (if one does not die first). But there is no definite point where the outback or the mountain finish.

25.7.2 And for such vague objects, identity statements may behave fuzzily. When the first Europeans arrived on the shores of the land now called ‘Australia’, they named it ‘New Holland’. But exactly how much of the place was New Holland was a vague matter. It certainly did not include New Zealand. But it is unclear whether it included, for example, Tasmania (which is a part of Australia). So it’s not definitely true that New Holland = Australia, and it’s not definitely false.

25.7.3 The theory of identity we have been looking at can be thought of as providing a theory of vague objects. The objects in the domain, together with the identity criteria given by the metric, seem exactly to be objects of this kind. In the example of 25.6.6, the number 2 behaves vaguely. It’s definitely equal to itself. It’s sort of equal to 2.1 as well, and 2.2, but less so. It’s definitely not equal to 3.

25.7.4 At any rate, we see that vague objects require fuzzy identity conditions. If, therefore, it were possible to show that fuzzy identity conditions are ruled out, so would vague objects be.

25.7.5 We can now return to the Evans argument of 21.9.4 and 21.9.5, which purports to show that all identities are determinate identities. Recall that we read ∇ as ‘it is indeterminate that’. The argument then goes as follows:

Suppose that $\nabla a = b$ (1)

Then since $\neg \nabla a = a$ (2)

It follows that $a \neq b$ (3)

25.7.6 To see what happens to this argument on the present approach, we need to decide how ∇ functions. A natural thought is that:

$$\begin{aligned} v(\nabla A) &= 0 && \text{if } v(A) = 1 \text{ or } v(A) = 0 \\ v(\nabla A) &= 1 && \text{otherwise} \end{aligned}$$

This makes ∇ a crisp operator. It is not difficult to see that the inference in Evans’ argument is now invalid. Just consider an interpretation where $D = [0, 1]$ and $\delta(x, y) = |x - y|$. Let $v(a) = 0.8$, and $v(b) = 0.5$. Then $v(\nabla a = b) = v(\neg \nabla a = a) = 1$; but $v(a \neq b) = 0.3$. Hence, the value of $(\nabla a = b \wedge \neg \nabla a = a) \rightarrow a \neq b$ is 0.3.

25.7.7 It might be thought that we are cheating by taking ∇ to be a crisp operator. But, in fact, this is inessential to the example. We can smooth it out by letting $v(\nabla A) = 4v(A) \times (1 - v(A))$. (It is not difficult to check that $v(\nabla A)$ is 0 when $v(A)$ is 0, grows to a maximum of 1 when $v(A)$ is 0.5, and then falls to 0 when $v(A)$ is 1.) Making just this change, and doing the arithmetic, we can see that we have $v(\nabla a = b) = 0.84$, $v(\neg\nabla a = a) = 1$, and $v(a \neq b) = 0.3$. So $(\nabla a = b \wedge \neg\nabla a = a) \rightarrow a \neq b$ has the value 0.46.

25.7.8 Hence, on this account, Evans' argument is fallacious. There can be indeterminate identities, and so vague objects.

25.7.9 It might be objected at this point that the objects we have been dealing with are not really vague. In the semantics, the identity relation is the standard crisp one. This shows that we are really dealing with crisp objects. The identity relation of the object language is not really identity. This is a fair point, but since it raises much more general methodological issues, I will take it up in the postscript to this part of the book.

25.8 *Appendix: Quantification and Identity in t -norm Logics

25.8.1 In 11.7a, we saw that the logic $L_{\mathbb{N}}$ is one of a general family of logics, t -norm logics. In this appendix, I describe briefly the features of quantification and identity in these logics. I omit proofs; some of these are assigned as exercises (25.11, question 11).⁴

25.8.2 As we saw in 11.7a.2–11.7a.6, any continuous t -norm, \bullet , defines a continuum-valued propositional logic $L(\bullet)$. An interpretation for the corresponding predicate logic, $QL(\bullet)$, adds to this a domain of quantification, D , and takes f_{\exists} and f_{\forall} to be Lub and GlB , respectively. Validity is defined in terms of the preservation of the value 1 in all interpretations.

25.8.3 The logic QBL adds to the axioms and rules of propositional BL (11.7a.7) the following. Here, and for the rest of this appendix, C is any closed formula. In particular, x is not free in C .

1. $\vdash \forall x A \rightarrow A_x(a)$
2. $\vdash A_x(a) \rightarrow \exists x A$

⁴ Proofs can be found in the references cited in 25.9 and 25.10.

3. $\vdash \forall x(C \rightarrow A) \rightarrow (C \rightarrow \forall xA)$
4. $\vdash \forall x(A \rightarrow C) \rightarrow (\exists xA \rightarrow C)$
5. $\vdash \forall x(C \vee A) \rightarrow (C \vee \forall xA)$
6. If $\vdash A_x(a)$ then $\vdash \forall xA$

These are exactly the same as the quantifier axioms and rules for relevant logic of 24.5.2, except that axiom 2 has been added. If $\exists xA$ is defined in the standard way (as $\neg\forall x\neg A$), 2 follows from 1 in relevant logics with the * semantics for negation. In the present context, we are taking both quantifiers to be primitive, since the definition does not work in all *t*-norm logics.

25.8.4 All the theorems of *QBL* are true in any *t*-norm logic.

25.8.5 Unlike the propositional case (11.7a.8), however, the theorems of *QBL* are not exactly the things that are logically valid in all $QL(\bullet)$. This set of formulas is, in fact, unaxiomatisable.

25.8.6 The following can be deduced in *QBL*, and so hold in all $QL(\bullet)$.

1. $\forall x(C \rightarrow A) \leftrightarrow (C \rightarrow \forall xA)$
2. $\forall x(A \rightarrow C) \leftrightarrow (\exists xA \rightarrow C)$
3. $\exists x(C \rightarrow A) \rightarrow (C \rightarrow \exists xA)$
4. $\exists x(A \rightarrow C) \rightarrow (\forall xA \rightarrow C)$
5. $\forall x(A \rightarrow B) \rightarrow (\forall xA \rightarrow \forall xB)$
6. $\forall x(A \rightarrow B) \rightarrow (\exists xA \rightarrow \exists xB)$
7. $\exists xA \rightarrow \neg\forall x\neg A$
8. $\neg\exists xA \leftrightarrow \forall x\neg A$

25.8.7 None of the following hold in *QBL*, in the sense that there are instances that fail. For example, for *C* take *Pa*, and for *A* take *Qx*. (Note that 1, 2 and 3 are the converses of 3, 4 and 7 of 25.8.6.)

1. $(C \rightarrow \exists xA) \rightarrow \exists x(C \rightarrow A)$
2. $(\forall xA \rightarrow C) \rightarrow \exists x(A \rightarrow C)$
3. $\neg\forall x\neg A \rightarrow \exists xA$
4. $\exists x(\exists xA \rightarrow A)$
5. $\exists x(A \rightarrow \forall xA)$

25.8.8 The logic obtained by adding the axioms and rules of 25.8.3 to the propositional axioms and rules of 11.7a.12 is sound and complete (for arbitrary sets of premises) with respect to quantified Gödel logic. The logic can also be axiomatised by taking an axiom system for quantified intuitionist logic, and adding the linearity axiom $(A \rightarrow B) \vee (B \rightarrow A)$ (as in the propositional case 11.7a.15) and the ‘confinement principle’, $\forall x(C \vee A) \rightarrow (C \vee \forall xA)$, which one does not have in intuitionist logic, because of the variable domains (20.5.7).

25.8.9 None of the formulas of 25.8.7 are valid in quantified Gödel logic.

25.8.10 As observed in 25.3.1, there is no axiom system that is theoremwise sound and complete with respect to quantified L_N .

25.8.11 In quantified L_N , all the formulas of 25.8.7 hold.

25.8.12 There is also no axiom system that is theoremwise sound and complete with respect to quantified Product logic.

25.8.13 In quantified Product logic, 1 and 4 of 25.8.7 are logically valid, but not the others.

25.8.14 Quantified *BL*, Łukaciewicz, Product and Gödel logics have algebraic semantics in terms of *BL* algebras, *MV*-algebras, Π -algebras and *G*-algebras, respectively. If the algebras are required to be linearly ordered, the axiom system obtained by adding the axioms of 25.8.3 to the appropriate propositional axioms is, in each case, sound and complete (for arbitrary sets of premises) with respect to these. If the algebras are not required to be linearly ordered, axiom 5 of 25.8.3 is dropped for the same result.

25.8.15 All of the logics we have been dealing with may be augmented by the treatment of identity in terms of a distance metric given in 25.6.

25.8.16 Alternatively, the truth conditions of the identity predicate can be given in terms of a *similarity function*. This is a binary function s , with values in $[0, 1]$, which satisfies the following conditions:

$$\begin{aligned} s(d_1, d_2) &= 1 \text{ iff } d_1 \text{ is } d_2 \\ s(d_1, d_2) &= s(d_2, d_1) \\ s(d_1, d_2) \bullet s(d_2, d_3) &\leq s(d_1, d_3) \end{aligned}$$

for all $d_1, d_2, d_3 \in D$.

25.8.17 In these semantics, identity will satisfy the following conditions:

$$\begin{aligned} &\models \forall x x = x \\ &\models \forall x \forall y (x = y \rightarrow y = x) \\ &\models \forall x \forall y \forall z ((x = y \circ y = z) \rightarrow x = z) \end{aligned}$$

25.8.18 It will not necessarily satisfy SI, but if $v(P)$ satisfies the condition:

$$s(d_1, e_1) \bullet \dots \bullet s(d_n, e_n) \bullet v(P)(d_1 \dots d_n) \leq v(P)(e_1 \dots e_n)$$

SI will hold in the form $a_1 = b_1 \circ \dots \circ a_n = b_n \rightarrow (Pa_1 \dots a_n \rightarrow Pb_1 \dots b_n)$. The corresponding formula for \wedge will not hold in general – except in Gödel logic, where \circ is just \wedge .

25.8.19 In an interpretation for quantified \mathcal{L}_{\aleph} , if we define $\delta(d, e)$ as $1 - s(d, e)$, then δ is a distance metric, satisfying the conditions of 25.6.2, and such that $\delta(d, e) \leq 1$. (Conversely, given any distance metric, δ , the function, s , defined by this condition is a similarity function.) Similarity functions may therefore be used to generate the theory of fuzzy identity of 25.6.

25.9 History

Early works on quantified \mathcal{L}_{\aleph} were Skolem (1957), Rosser (1960) and Rutledge (1960). The first proof of the unaxiomatisability of the logic appeared in Scarpellini (1962). The generalisation of this to the logic \models_{ε} , for $0 < \varepsilon \leq 1$, is due to Chang. The result of 25.3.1 about $\models_{\varepsilon-}$ is due to Belluce (1964) (drawing on Hay (1959) and Mostowski (1961)).

The example of 25.5.4 is a variation of the problem of the Ship of Theseus. This, and the fact that it gives rise to philosophical problems, are first reported by Plutarch (Life of Theseus, 23). (See Perrin (1967), p. 49.) The theory of fuzzy identity in 25.6 is due to Priest (1998b). For the history of the Evans argument of 25.7 see 21.12.

Quantified logics based explicitly on what is, in effect, a t -norm appeared in Goguen (1968–9) and Novák (1987). Quantified Gödel logic was first formulated (in terms of Heyting algebras) by Horn (1969) and (as a fuzzy logic) by Takeuti and Titani (1984). The two approaches were proved equivalent by Takano (1987). For the result of 25.8.5, and a general discussion of the complexity of quantified fuzzy logics, see Hájek (2005). For the results of 25.8.14, see Esteva, Godo, Hájek and Montagna (2003). Similarity as fuzzy equality was proposed by Zadeh (1971) and Trillas and Valverde (1984).

25.10 Further Reading

Accounts of quantified L_N are, generally speaking, mathematically complex, and merge quickly into a discussion of t-norm logics. For details, see Hájek (1998), Novák, Perfilieva and Močkoř (2000), and Gottwald (2001). A number of results about axiomatisability are surveyed in Rosser (1960). For more on Gödel logic and its various features, see Baaz, Preining and Zach (2007). Further reading concerning the Evans argument can be found in 21.13.

25.11 Problems

1. Check the details omitted in 25.3.2, 25.3.3, 25.3.4, 25.6.3, 25.6.4 and 25.7.7.
2. Show that each of the following is valid in L_N , either by giving a direct semantic argument or by deducing it from things known to be valid. C is a formula that does not contain x free.
 - (a) $\exists x(C \rightarrow A) \leftrightarrow (C \rightarrow \exists xA)$
 - (b) $\exists x(A \rightarrow C) \leftrightarrow (\forall xA \rightarrow C)$
 - (c) $\forall x(A \rightarrow B) \rightarrow (\exists xA \rightarrow \exists xB)$
 - (d) $(\forall xA \wedge \exists xB) \rightarrow \exists x(A \wedge B)$
 - (e) $(\exists xA \wedge C) \leftrightarrow \exists x(A \wedge C)$
 - (f) $\exists xA \leftrightarrow \neg \forall x \neg A$
 - (g) $\forall xA \leftrightarrow \neg \exists x \neg A$
3. By constructing an appropriate counter-model, show that the following are not valid in L_N :
 - (a) $(\forall xPx \vee \exists xQx) \rightarrow \exists x(Px \wedge Qx)$
 - (b) $(\forall xPx \wedge \exists x \neg Px) \rightarrow \exists xQx$
 - (c) $\forall x(Px \rightarrow (Px \rightarrow \exists xQx)) \rightarrow (\forall xPx \rightarrow \exists xQx)$
4. Verify that all the facts of 12.4.14 hold for L_N , when ‘ \supset ’ is replaced by ‘ \rightarrow ’.
5. By constructing an appropriate counter-model, show that the following are not valid in L_N (with fuzzy identity):
 - (a) $(a \neq b \wedge b \neq c) \rightarrow a \neq c$
 - (b) $(a = b \wedge b \neq c) \rightarrow a \neq c$
 - (c) $a = b \rightarrow (Pa \rightarrow Pb)$
 - (d) $\forall x \forall y ((x = y \wedge \neg Px) \rightarrow \neg Py)$
 - (e) $\forall x \forall y ((Px \wedge \neg Py) \rightarrow x \neq y)$

6. Is $a = b \rightarrow (b = c \rightarrow a = c)$ valid in $L_{\mathbb{N}}$ (with fuzzy identity)?
7. Suppose that p and q are smooth functions. Let $f(x) = 1 - p(x)$, $g(x) = \text{Min}(p(x), q(x))$, $h(x) = \text{Max}(p(x), q(x))$, $i(x) = p(x) \odot q(x)$. Which of f , g , h and i are smooth?
8. What reason might there be for supposing that a *modus ponens* sorites and an identity sorites have different kinds of solutions?
9. 'There can be no vagueness in reality itself. Everything is *exactly* what it is, and not another thing. The only vagueness there can be is in how our concepts apply to that reality.' Discuss.
10. Discuss the objection of 25.7.9.
11. *Check the details of 25.8.4, 25.8.6, 25.8.7 (hint: see 25.8.9), 25.8.9, 25.8.11, 25.8.13 and 25.8.19.

Postscript: A Methodological Coda

I conclude with a few comments of a methodological nature concerning the investigations of this book.

Let us start by returning to the objection to the theory of vague objects voiced in 25.7.9. The point there, recall, was that the theory given was not really a theory about vague objects at all. In the semantics of the language, the identity relation is the standard crisp one. What this shows is that the objects we are dealing with are really crisp objects. The identity relation of the object language is not really identity, just some sort of similarity relation.

There is something wrong about this objection, and something right. It is certainly the case that the identity relation of the object language and the identity relation of the metalanguage (in which the semantics are expressed) are different. It does not follow that it is the relation of the object language that is not the real notion. It is open to someone who holds that there are genuine vague objects to maintain that it is the identity relation of the metalanguage that is not really identity. To claim otherwise in this context would be to beg the question.

It remains the case, however, that the identity relation of the object language and the metalanguage are out of kilter. There is therefore something *prima facie* awry in the situation. Someone who holds that it is the object-language notions that are the correct ones would be better off specifying the semantics of the object language using *those* notions – or, at the very least, showing how the notions of the metalanguage can be made sense of in terms of those notions, and in such a way that the specification of the semantics that these provide makes perfectly good sense.

We do not, after all, have to give the semantics of a language in the very same terms that the language uses. The semantics of modal logics,

for example, are not given in terms of modal operators: they are given in terms of quantification over worlds. In that case, however, the philosophical plausibility of this is apparent. Though one may be able to tell a satisfactory philosophical story in the case of fuzzy identity, how to do this is certainly not immediately evident.

The point is a quite general one. Semantics do not come free. The notions employed need to be intelligible in their own right, and their deployment in the framing of a semantics similarly so. This is true, of course, whether we are dealing with classical or a non-classical logic. But it tends to pose a particular question if the logic is non-classical, as are the logics we have been concerned with in this book.

It may fairly be asked what logic I have been using to specify and reason about the semantics of the various logics we have been dealing with. The procedures employed have not been formal ones, of course. Like most mathematics, matters have been left at an informal level. They could be formalised in a standard set theory, such as Zermelo Fraenkel set theory, based on classical logic. But to someone, such as an intuitionist or paraconsistent logician, who takes such reasoning not to be correct, at least in part, things cannot be left like this. The classical ladder must, so to speak, be kicked away.

One possibility is to reshape the informal procedures in such a way that they can be codified in an acceptable logic. Thus, for example, we may try to develop the world-semantics of intuitionist logic using only those modes of reasoning that are intuitionistically acceptable.¹

Another possibility is to show that the apparently classical reasoning can be understood in a way that is perfectly acceptable in terms of the logic in question. Thus, for example, we may try to develop a paraconsistent account of why classical reasoning is acceptable in certain contexts, of which the metatheoretic context is one.²

The details of strategies for realising projects of these kinds, let alone analyses of their viability, far exceed anything that can be attempted

¹ An account of the semantics of intuitionist logic in a metatheory itself using intuitionist logic can be found in Dummett (1977), ch. 5.

² For a way of interpreting classical metatheory for paraconsistent logic in a paraconsistently acceptable way, see Priest (1987, 2nd edn), ch. 18.

here. It will have to suffice to say that this is one of the important technico-philosophical issues to which non-classical logics give rise. Since non-classical logics have lived off the philosophical challenges which they have brought against classical logic, this is one that they should, in their turn, be keen to take on.

References

- Adams, E. W. (1970), 'Subjunctive and Indicative Conditionals', *Foundations of Language* 6: 89–94.
- Adams, R. M. (1979), 'Primitive Thisness and Primitive Identity', *Journal of Philosophy* 76: 5–26.
- Ajdukiewicz, K. (1956), 'Conditional Statement and Material Implication', *Studia Logica*, 17: 117–34; reprinted as ch. 14 of J. Giedymin, ed., *The Scientific World-Perspective and other Essays (1931–63)* (Reidel: Dordrecht, 1978).
- Akmukdad, A., and Nelson, D. (1984), 'Constructible Falsity and Inexact Predicates', *Journal of Symbolic Logic* 49: 231–3.
- Anderson, A. (1959), 'Completeness Theorems for the Systems *E* of Entailment and *EQ* of Entailment with Quantification', *Zeitschrift für Mathematische Logik und Grundlagen der Mathematik* 6: 201–16.
- Anderson, A. and Belnap, N. D. (1975), *Entailment: The Logic of Relevance and Necessity* (Princeton: Princeton University Press), vol. I.
- Anderson, A., Belnap, N. D. and Dunn, J. M. (1992), *Entailment: The Logic of Relevance and Necessity* (Princeton: Princeton University Press), vol. II.
- Baaz, M., Preining, N. and Zach, R. (2007), 'First-Order Gödel Logics', *Annals of Pure and Applied Logic* 147: 23–47.
- Barcan (Barcan Marcus), R. (1946), 'A Functional Calculus Based on Strict Implication', *Journal of Symbolic Logic* 11: 1–16.
- (1947), 'The Identity of Individuals in a Strict Functional Calculus of Second Order', *Journal of Symbolic Logic* 12: 1–16.
- (1961), 'Modalities and Intensional Languages', *Synthese* 13: 303–22; reprinted as ch. 1 of *Modalities: Philosophical Essays* (Oxford: Oxford University Press, 1993).
- Beall, J.C., Brady, R., Hazen, A., Priest, G. and Restall, G. (2006), 'Restricted Quantification in Relevant Logic', *Journal of Philosophical Logic*, 35: 587–98.
- Beaney, M. (1997), ed., *The Frege Reader* (Oxford: Blackwell).

- Beckmann, A. and Preining, N. (2007), 'Linear Kripke Frames and Gödel Logics', *Journal of Symbolic Logic*, 71: 26–44.
- Bell, J. L., DeVidi, D. and Soloman, G. (2001), *Logical Options: An Introduction to Classical and Alternative Logics* (Peterborough, ON: Broadview Press).
- Belluce, L. P. (1964), *The Theory of Infinite Valued Predicate Logic*, PhD thesis, University of California, Los Angeles.
- Belnap, N. (1960), 'EQ and the First Order Functional Calculus', *Zeitschrift für Mathematische Logik und Grundlagen der Mathematik* 6: 217–18.
- (1967), 'Intentional Models for First Degree Formulas', *Journal of Symbolic Logic*, 32: 1–22.
- Bencivenga, E. (1986), 'Free Logics', in Gabbay and Guenther (1983–9), vol. 3, ch. 6; and (2001–), vol. 5.
- Bennett, J. (1969), 'Entailment', *Philosophical Review* 78: 197–236.
- Berry, G. D. W. (1952), 'Peirce's Contributions to the Logic of Statements and Quantifiers', in P. Wiener and F. Young, eds., *Studies in the Philosophy of Charles S. Peirce* (Cambridge, MA: Harvard University Press).
- Blamey, S. (1986), 'Partial Logic', in Gabbay and Guenther (1983–9), vol. 1, ch. 1; and (2001–), vol. 5.
- Brady, R. T. (2003), ed., *Relevant Logics and their Rivals*, vol. 2 (Aldershot: Ashgate).
- Brown, B. (1993), 'Old Quantum Theory: A Paraconsistent Approach', *Proceedings of the Philosophy of Science Association* 2: 397–441.
- Burgess, J. (1983), 'Common Sense and Relevance', *Notre Dame Journal of Formal Logic* 24: 41–53.
- (1986), 'Basic Tense Logic', in Gabbay and Guenther (1983–9), vol. 2, ch. 2; and (2001–), vol. 7.
- Bynum, T. W. (1972), ed., *Conceptual Notation and Related Articles* (Oxford: Clarendon Press).
- Carnap, R. (1947), *Meaning and Necessity* (Chicago: Chicago University Press).
- Chang, C. C. (1959), 'A New Proof of the Completeness Theorem of the Łukasiewicz Axioms', *Transactions of the American Mathematical Society* 93: 74–80.
- (1963), 'Logic with Positive and Negative Truth Values', *Acta Philosophica Fennica* 14: 19–39.
- Chang, C. C. and Keisler, J. (1966), *Continuous Model Theory* (Princeton: Princeton University Press).
- Chellas, B. (1975), 'Basic Conditional Logic', *Journal of Philosophical Logic* 4: 133–53.
- (1980), *Modal Logic: An Introduction* (Cambridge: Cambridge University Press).

- Chomsky, N. (1971), 'Recent Contributions to the Theory of Innate Ideas', in J.R. Searle, ed., *The Philosophy of Language* (Oxford: Oxford University Press), pp. 121–9.
- Cignoli, R., Esteva, F., Godo, L. and Torrens, A. (2000), 'Basic Fuzzy Logic is the Logic of Continuous t -norms and their Residua', *Soft Computing* 4: 106–12.
- Cocchiarella, N. B. (1984), 'Philosophical Perspectives in Tense and Modal Logic', in Gabbay and Guenther (1983–9), vol. 2, ch. 6; and (2001–), vol. 7.
- Cooper, W. S. (1968), 'The Propositional Logic of Ordinary Discourse', *Inquiry* 11: 295–320.
- Copeland, B. J. (1979), 'On When a Semantics is Not a Semantics; Some Reasons for Disliking the Routley–Meyer Semantics for Relevance Logic', *Journal of Philosophical Logic* 8: 399–413.
- (1983), 'Pure and Applied Semantics', *Topoi* 2: 197–204.
- (1996), 'Prior's Life and Legacy', in B. J. Copeland, ed., *Logic and Reality: Essays on the Legacy of Arthur Prior* (Oxford: Clarendon Press), pp. 1–40.
- Cresswell, M. (1966), 'The Completeness of $S0.5$ ', *Logique et Analyse* 9: 263–6.
- (1967), 'The Interpretation of Some Lewis Systems of Modal Logic', *Australasian Journal of Philosophy* 45: 198–205.
- (1995), 'S1 is not so Simple', in E. Sinnott-Armstrong, D. Raffman, and N. Asher (eds.), *Modality, Morality and Belief: Essays in Honor of Ruth Barcan Marcus* (Cambridge: Cambridge University Press), ch. 3.
- (2001), 'Modal Logic', in Goble (2001), ch. 7.
- Cross, R. (2006), 'Medieval Theories of Haecceity', *Stanford Encyclopedia of Philosophy*, <http://plato.stanford.edu/entries/medieval-haecceity/>.
- da Costa, N. C. A. (1974), 'On the Theory of Inconsistent Formal Systems', *Notre Dame Journal of Formal Logic* 15: 497–510.
- Dalen, D. van (1986), 'Intuitionist Logic', in Gabbay and Guenther (1983–9), vol. 3, ch. 4; and (2001–), vol. 5.
- Dalen, D. van (2001), 'Intuitionist Logic', in Goble (2001), ch. 11.
- de Swart, H. C. M. (1983), 'A Gentyzen- or Beth-Type System, a Practical Decision Procedure and a Constructive Completeness Proof for the Counterfactual Logics VC and VCS', *Journal of Symbolic Logic* 48: 1–20.
- Devitt, M. and Sterelny, K. (1987), *Language and Reality* (Oxford: Basil Blackwell).
- Došen, K. (1992), 'The First Axiomatization of Relevant Logic', *Journal of Philosophical Logic* 21: 339–56.
- Dubois, D. (1980), 'Triangular Norms for Fuzzy Sets', *Proceedings of the Second International Seminar on Fuzzy Set Theory (Linz)*, pp. 39–68.
- Dugunji, J. (1940), 'Note on a Property of Matrices for Lewis and Langford's Calculi of Propositions', *Journal of Symbolic Logic* 5: 150–1.

- Dummett, M. (1959), 'A Propositional Calculus with a Denumerable Matrix', *Journal of Symbolic Logic* 24: 97–106.
- (1975a), 'The Philosophical Basis of Institutionist Logic', in H.E. Rose and J.C. Shepherdson, eds., *Logic Colloquium* '73 (Amsterdam: North Holland), pp. 5–40; reprinted as chapter 14 of Dummett (1978).
- (1975b), 'The Justification of Deduction', *Proceedings of the British Academy* 59, 201–32; reprinted as ch. 17 of Dummett (1978).
- (1976), 'What is a Theory of Meaning? (II)', in G. Evans and J. McDowell, eds., *Truth and Meaning* (Oxford: Clarendon Press), ch. 4.
- (1977), *Elements of Intuitionism* (Oxford: Oxford University Press).
- (1978), *Truth and Other Enigmas* (London: Duckworth).
- (1991), *The Logical Basis of Metaphysics* (Harvard, MA: Harvard University Press).
- Dunn, J. M. (1986), 'Relevance Logic and Entailment', in Gabbay and Guenther (1983–9), vol. 3, ch 3: and (2001–), vol. 6 (rewritten with G. Restall as 'Relevant Logic').
- (1987), 'Relevant Predication, I: the Formal Theory', *Journal of Philosophical Logic* 16: 347–81.
- (1990a), 'Relevant Predication, II: Intrinsic Properties and Internal Relations', *Philosophical Studies* 60: 177–206.
- (1990b), 'Relevant Predication, III: Essential Properties', in J. M. Dunn and A. Gupta, eds., *Truth or Consequences* (Dordrecht: Kluwer), pp. 77–95.
- (2000), 'Partiality and its Dual', *Studia Logica* 66: 5–40.
- Esteva, F., Godo, L., Hájek, P. and Montagna, F. (2003), 'Hoops and Fuzzy Logic', *Soft Computing* 13: 532–55.
- Evans, G. (1973), 'The Causal Theory of Names', *Proceedings of the Aristotelian Society, Supplementary Volume* 47: 187–208; reprinted as ch. 1 of Evans (1985).
- (1978), 'Can There be Vague Objects?', *Analysis* 38: 208; reprinted as ch. 6 of Evans (1985) and ch. 17 of Keefe and Smith (1996).
- (1985), *Collected Papers* (Oxford: Clarendon Press).
- Faris, J. A. (1968), 'Interderivability of " \supset " and "If"', in G. Iseminger, ed., *Logic and Philosophy: Selected Readings* (New York: Appleton-Century-Crofts), ch. 17.
- Feys, R. (1965), *Modal Logics* (Louvain: E. Nauwelaerts).
- Fine, K. (1975), 'Vagueness, Truth and Logic', *Synthese* 30: 265–300; reprinted in Keefe and Smith (1996), ch. 9.
- (1988), 'Semantics for Quantified Relevance Logic', *Journal of Philosophical Logic* 17: 27–59.
- (1989), 'Incompleteness for Quantified Relevance Logic', in Norman and Sylvan (1989), pp. 205–25.

- Fitting, M. (1969), *Intuitionistic Logic Model Theory and Forcing* (Amsterdam: North-Holland).
- (1992a), 'Many-Valued Modal Logics', *Fundamenta Informaticae* 15: 235–54.
- (1992b), 'Many-Valued Modal Logics, II', *Fundamenta Informaticae* 17: 55–73.
- Fitting, M. and Mendelsohn, R. (1999), *First Order Modal Logic* (Dordrecht: Kluwer).
- Fodor, J. (1975), *The Language of Thought* (New York: Cromwell).
- Fraenkel, A., Bar-Hillel, Y. and Levy, A. (1973), eds., *Foundations of Set Theory* (Amsterdam: North-Holland).
- Frege, G. (1970), 'On Sense and Reference', in Geach and Black (1970), pp. 56–98. Also in M. Beaney (1997), pp. 151–71.
- Gabbay, D. and Guenther, F. (1983–1989), (eds.), *Handbook of Philosophical Logic* (Dordrecht: Kluwer Academic Publishers).
- (2001–), *Handbook of Philosophical Logic*, second edition (Dordrecht: Kluwer Academic Publishers).
- Garson, J. W. (1984), 'Quantification in Modal Logic', in Gabbay and Guenther (1983–9), vol. 2, ch. 5; and (2001–), vol. 3.
- Geach, P., and Black, M. (1970), eds. and trs., *Translations from the Philosophical Writings of Gottlob Frege* (Oxford: Basil Blackwell).
- Gent, I. P. (1992), 'A Sequent- or Tableau-Style System for Lewis's Counterfactual Logic VC', *Notre Dame Journal of Formal Logic* 33: 369–82.
- Gibbard, A. (1975), 'Contingent Identity', *Journal of Philosophical Logic* 4: 187–222; reprinted as ch. 9 of Kim and Sosa (1999).
- Girle, R. (2000), *Elementary Modal Logic* (London: Acumen).
- Goble, L. (ed.) (2001), *The Blackwell Guide to Philosophical Logic* (Oxford: Blackwell).
- Gödel, K. (1930), 'Die Vollständigkeit der Axiome des logischen Funktionenkalküls', *Monatshefte für Mathematik und Physik* 28: 173–98; reprinted in English translation as 'The completeness of the axioms of the functional calculus of logic', in Heijenoort (1967), pp. 582–91.
- (1933a), 'Eine Interpretation des intuitionistischen Aussagenkalküls', *Ergebnisse eines mathematischen Kolloquiums* 4: 39–40 (translated into English in J. Hintikka, ed., *The Philosophy of Mathematics* (Oxford: Oxford University Press), ch. 7.
- (1933b), 'Zum intuitionistischen Aussagenkalkül', *Ergebnisse eines mathematischen Kolloquiums* 4: 40.
- Goguen, J. A. (1968–9), 'The Logic of Inexact Concepts', *Synthese* 19: 325–73.
- Gottwald, S. (2001), *A Treatise on Many-Valued Logics* (Baldock: Research Studies Press Ltd.).
- Gowans, C. (1987), ed., *Moral Dilemmas* (Oxford: Oxford University Press).

- Grice, P. (1989), *Studies in the Way of Words* (Cambridge, MA: Harvard University Press).
- Guthrie, W. C. K. (1981), *A History of Greek Philosophy, Vol. IV: Aristotle, an Encounter* (Cambridge: Cambridge University Press).
- Haack, S. (1974), *Deviant Logic* (Cambridge: Cambridge University Press).
- Hájek, P. (1998), *Metamathematics of Fuzzy Logic* (Dordrecht: Kluwer).
- (2005), 'Arithmetical Complexity of Fuzzy Predicate Logics - a Survey', *Soft Computing* 9: 935–41.
- Hájek, P. and Novák, V. (2003), 'The Sorites Paradox and Fuzzy Logic', *International Journal of General Systems* 32: 373–83.
- Hähnle, R. (1999), 'Tableaux for Many-Valued Logics', in M. D'Agostino, D. M. Gabbay, R. Hähnle, and J. Posegga, *Handbook of Tableaux Methods* (Dordrecht: Kluwer), pp. 529–80.
- Harper, W. L., Stalnaker, R. and Pearce, G. (1981), eds., *Ifs* (Dordrecht: Reidel).
- Hay, L. S. (1959), *An Axiomatisation of the Infinitely Many-Valued Calculus*, MA thesis, Cornell University.
- Heijenoort, J. van (1967), *From Frege to Gödel* (Cambridge, MA: Harvard University Press).
- Heyting, A. (1956), *Intuitionism: An Introduction* (Amsterdam: North-Holland).
- Hilbert, D. and Ackermann, W. (1928), *Grundzüge der theoretischen Logik* (Berlin: Springer).
- Hilpinen, R. (2001), 'Deontic Logic', in Goble (2001), ch. 8.
- (1981), ed., *Deontic Logic: Introductory and Systematic Readings*, 2nd edn. (Dordrecht: Reidel).
- Hintikka, J. (1962), *Knowledge and Belief: An Introduction to the Logic of the Two Notions* (Ithaca: Cornell University Press).
- Horn, A. (1969), 'Logic with Truth Values in a Linearly Ordered Heyting Algebra', *Journal of Symbolic Logic* 34: 395–409.
- Hughes, G. and Cresswell, M. (1968), *An Introduction to Modal Logic* (London: Methuen).
- (1996), *A New Introduction to Modal Logic* (London: Routledge). This is essentially a second edition of Hughes and Cresswell (1968). It is worth noting that though the material has been updated, there is material in the first edition, especially of historical interest, that has been omitted from the second edition.
- Howson, C. (1997), *Logic with Trees* (London: Routledge).
- Hyde, D. (1997), 'From Heaps and Gaps to Heaps of Gluts', *Mind* 106: 641–60.

- Hyde, D. and Priest, G. (2000), eds., *Sociative Logics and their Applications: Essays by the Late Richard Sylvan* (Aldershot: Ashgate).
- Jackson, F. (1991), ed., *Conditionals* (Oxford: Oxford University Press).
- Jaśkowski, S. (1969), 'Propositional Calculus for Contradictory Deductive Systems', *Studia Logica* 24: 143–57.
- Jeffrey, R. (1991), *Formal Logic: Its Scope and its Limits*, 3rd edn (New York: McGraw-Hill).
- Kanger, S. (1957), 'The Morning Star Paradox', *Theoria* 23: 1–11.
- Kim, J. and Sosa, E. (1999), *Metaphysics, an Anthology* (Oxford: Blackwell).
- Keefe, R. and Smith, P. (1996), *Vagueness: A Reader* (Cambridge, MA: MIT Press).
- Kleene, S. C. (1952), *Introduction to Metamathematics* (Amsterdam: North-Holland).
- Klir, G. L. and Yuan, B. (1995), *Fuzzy Sets and Fuzzy Logic: Theory and Applications* (Upper Saddle River, NJ: Prentice Hall).
- Kneale, W. and Kneale, M. (1975), *The Development of Logic*, 2nd edn (Oxford: Clarendon Press).
- Knuuttila, S. (1982), 'Modal Logic', in N. Kretzmann, A. Kenny, J. Pinborg and E. Stump, eds., *The Cambridge History of Later Medieval Philosophy* (Cambridge: Cambridge University Press), ch. 17.
- Kremer, P. (1997), 'Dunn's Relevant Predication, Real Properties and Identity', *Erkenntnis* 47: 37–65.
- Kripke, S. (1959), 'A Completeness Theorem in Modal Logic', *Journal of Symbolic Logic* 24: 1–15.
- (1963a), 'Semantical Analysis of Modal Logic, I: Normal Propositional Calculi', *Zeitschrift für Mathematische Logik und Grundlagen der Mathematik* 8: 113–16.
- (1963b), 'Semantical Considerations in Modal Logic', *Acta Philosophica Fennica* 16: 83–94.
- (1965a), 'Semantical Analysis of Modal Logic, II: Non-Normal Modal Propositional Calculi', in J. W. Addison, L. Henkin and A. Tarski, eds., *The Theory of Models* (Amsterdam: North-Holland), pp. 202–20.
- (1965b), 'Semantical Analysis of Intuitionistic Logic, I', in J. Crossley and M. Dummett, eds., *Formal Systems and Recursive Functions* (Amsterdam: North-Holland), pp. 92–130.
- (1971), 'Identity and Necessity', M. Munitz, ed., *Identity and Individuation* (New York, NY: New York University Press) pp. 135–64; reprinted as ch. 2 of Schwartz (1972).
- (1972), 'Naming and Necessity', in D. Davidson and G. Harman, eds., *Semantics of Natural Language* (Dordrecht: Kluwer), pp. 253–355; reprinted as *Naming and Necessity* (Oxford: Blackwell, 1980).
- (1975), 'Outline of a Theory of Truth', *Journal of Philosophy* 72: 690–716.

- (1977), 'Identity and Necessity', in S. P. Schwartz, ed., *Naming, Necessity and Natural Kinds* (Ithaca: Cornell University Press), ch. 2.
- (1980), *Naming and Necessity* (Cambridge, MA: Harvard University Press).
- Lambert, K. (1963), 'Existential Import Revisited', *Notre Dame Journal of Formal Logic* 4: 288–92.
- (1967), 'Free Logics and the Concept of Existence', *Notre Dame Journal of Formal Logic* 8: 133–44.
- (1981), 'The Philosophical Foundations of Free Logic', *Inquiry* 24: 147–203; a revised version appears as ch. 8 of *Free Logic: Selected Essays* (Cambridge: Cambridge University Press, 2003).
- (1991), ed., *Philosophical Applications of Free Logic* (Oxford: Oxford University Press).
- (2001), 'Free Logic', in Goble (2001), ch. 12.
- Lemmon, E. J. (1957), 'New Foundations for the Lewis Modal Systems', *Journal of Symbolic Logic* 22: 176–86.
- (1959), 'Is There Only One Correct System of Modal Logic?', *Proceedings of the Aristotelian Society, Supplementary Volume* 33: 23–40.
- Leonard, H. S. (1956), 'The Logic of Existence', *Philosophical Studies* 9: 49–64.
- Lewis, C. I. (1918), *A Survey of Symbolic Logic* (Berkeley, CA: University of California Press).
- Lewis, C. I. and Langford, C. H. (1931), *Symbolic Logic* (New York: Dover).
- Lewis, D. (1968), 'Counterpart Theory and Quantified Modal Logic', *Journal of Philosophy* 65: 113–36; reprinted with a new appendix as ch. 3 of *Philosophical Papers*, Vol. I (Oxford: Oxford University Press, 1983).
- (1971), 'Completeness and Decidability of Three Logics of Counterfactuals', *Theoria* 37: 74–85.
- (1973a), 'Counterfactuals and Comparative Possibility', *Journal of Philosophical Logic* 2: 418–46; reprinted in Harper, Stalnaker and Pearce (1981), pp. 57–85.
- (1973b), *Counterfactuals* (Oxford: Basil Blackwell).
- (1979), 'Counterfactual Dependence and Time's Arrow', *Noûs* 13, 455–76.
- (1986), *On the Plurality of Worlds* (Oxford: Basil Blackwell).
- Loux, M. J. (1979), ed., *The Possible and the Actual* (Ithaca: Cornell University Press).
- Löwenheim, L. (1915), 'Über Möglichkeiten im Relativkalkül', *Mathematische Annalen* 16: 447–70; reprinted in English translation as 'On the possibilities of the calculus of relatives', in Heijenoort (1967), pp. 228–51.
- Łukasiewicz, J. (1967), 'Philosophical Remarks on Many-Valued Systems of Propositional Logic', in S. McCall, ed., *Polish Logic, 1920–1939* (Oxford: Clarendon Press), ch. 3.

- Machina, K. (1976), 'Truth, Belief and Vagueness', *Journal of Philosophical Logic* 5: 47-78; reprinted in Keefe and Smith (1996), ch. 11.
- Malinowski, G. (1993), *Many-Valued Logics* (Oxford: Oxford University Press).
(2001), 'Many-Valued Logic', in Goble (2001), ch. 14.
- Mancosu, P. (1998), *From Brouwer to Hilbert* (Oxford: Oxford University Press).
- Mares, E. (1992), 'Semantics for Relevance Logics with Identity', *Studia Logica* 51: 1-20.
(1996), 'Relevant Logic and the Theory of Information', *Synthese* 109: 345-60.
(2004), *Relevant Logic: A Philosophical Interpretation* (Cambridge: Cambridge University Press).
- Mares, E. and Fuhrmann, A. (1995), 'A Relevant Theory of Conditionals', *Journal of Philosophical Logic* 24: 645-65.
- Mares, E. and Meyer, R. K. (2001), 'Relevant Logics', in Goble (2001), ch. 13.
- Martin, C. (1985), 'William's Machine', *Journal of Philosophy* 83: 564-72.
- McArthur, R. P. (1978), *Tense Logic* (Dordrecht: D. Reidel Publishing Co.).
- McKinsey, J. C. C. and Tarski, A. (1948), 'Some Theorems about the Sentential Calculi of Lewis and Heyting', *Journal of Symbolic Logic* 13: 1-15.
- Meinong, A. (1904), 'Gegenstandstheorie', in A. Meinong, ed., *Untersuchungen zur Gegenstandstheorie und Psychologie* (Leipzig); translated into English as 'The Theory of Objects' in R. Chisholm, ed., *Realism and the Background to Phenomenology* (London: Allen and Unwin, 1960), ch. 4.
- Menger, K. (1942), 'Statistical Metrics', *Proceedings of the National Academy of Science U.S.A.*, 8: 535-7.
- Meyer, J. J. (2001), 'Epistemic Logic', in Goble (2001), ch. 9.
- Meyer, R. K. (1970), 'RI - the Bounds of Finitude', *Zeitschrift für Mathematische Logik und Grundlagen der Mathematik* 16: 385-7.
(1971), 'Entailment', *Journal of Philosophy* 68: 808-18.
- Mints, G. (2000), *A Short Introduction to Intuitionist Logic* (Dordrecht: Kluwer).
- Mortensen, C. (1983), 'The Validity of the Disjunctive Syllogism is not so Easily Proven', *Notre Dame Journal of Formal Logic* 24: 35-40.
- Mostowski, A. (1961), 'Axiomatizability of Some Many-Valued Predicate Calculi', *Fundamenta Mathematicae* 50: 165-90.
- Nelson, D. (1949), 'Constructible Falsity', *Journal of Symbolic Logic* 14: 14-26.
- Norman, J. and Sylvan, R. (1989), eds., *Directions in Relevant Logic* (Dordrecht: Kluwer).
- Novák, V. (1987), 'First Order Fuzzy Logic', *Studia Logica* 46: 87-109.
- Novák, V., Perfilieva, I. and Močkoř, J. (2000), *Mathematical Principles of Fuzzy Logic* (Dordrecht: Kluwer).
- Nute, D. (1980), *Conditional Logic* (Dordrecht: Reidel).

- (1984), 'Conditional Logic', in Gabbay and Guenther (1983–1989), vol. 2, ch. 8; and (2001–), vol. 4.
- Øhrstrøm, P. and Hasle, P. F. V. (1995), *Temporal Logic: From Ancient Ideas to Artificial Intelligence* (Dordrecht: Kluwer).
- Olivetti, N. (2003), 'Tableaux for Łukasiewicz Infinite-Valued Logic', *Studia Logica* 73: 81–111.
- Ostermann, P. (1988), 'Many-Valued Modal Propositional Calculi', *Zeitschrift für mathematische Logik und Grundlagen der Mathematik* 34: 342–54.
- (1990), 'Many-Valued Modal Logics: Uses and Predicate Calculus', *Zeitschrift für mathematische Logik und Grundlagen der Mathematik*, 20: 401–11.
- Parks, Z. (1974), 'Semantics for Contingent Identity Systems', *Notre Dame Journal of Formal Logic* 15: 333–4.
- Parks, Z. and Smith, T. L. (1974), 'The Inadequacy of Hughes and Cresswell's Semantics for the CI Systems', *Notre Dame Journal of Formal Logic* 15: 331–2.
- Parsons, T. (1967), 'Grades of Essentialism in Quantified Modal Logic', *Nous* 1: 181–91.
- (1969), 'Essentialism and Quantified Modal Logic', *Philosophical Review* 78: 35–52.
- Pavelka, J. (1979), 'On Fuzzy Logic, I, II, III', *Zeitschrift für mathematische Logik und Grundlagen der Mathematik* 25: 45–52, 119–34, 447–64.
- Perrin, B. (1967), ed. and trs., *Plutarch's Lives*, Vol. I (London: William Heinemann Ltd.).
- Plantinga, A. (1974), *The Nature of Necessity* (Oxford: Clarendon Press).
- Post, E. (1921), 'Introduction to the General Theory of Elementary Propositions', *American Journal of Mathematics* 43: 163–85; reprinted in J. van Heijenoort, ed., *From Frege to Gödel: A Source Book in Mathematical Logic, 1879–1931* (Cambridge, MA: Harvard University Press), pp. 264–83.
- Prawitz, D. (1977), 'Meaning and Proofs: On the Conflict between Intuitionist and Classical Logic', *Theoria* 43: 2–40.
- (1994), 'Review of M. Dummett *The Logical Basis of Metaphysics*', *Mind* 103: 373–6.
- Priest, G. (1979), 'Logic of Paradox', *Journal of Philosophical Logic* 8: 219–41.
- (1987), *In Contradiction: A Study of the Transconsistent* (The Hague: Martinus Nijhoff). Second (extended) edition, Oxford: Oxford University Press, 2006.
- (1992), 'What is a Non-Normal World?', *Logique et Analyse* 35: 291–302.
- (1993), 'Can Contradictions be True?, II', *Proceedings of the Aristotelian Society, Supplementary Volume* 68: 35–54.
- (1997a), 'Sylvan's Box: A Short Story and Ten Morals', in Priest (1997b), pp. 573–82; reprinted as an appendix to ch. 6, Priest (2005c).

- (1997b), guest ed., *Notre Dame Journal of Formal Logic* 38, no. 4 (Special Issue on Impossible Worlds).
- (1998a), 'Dialetheism', *Stanford Internet Encyclopedia of Philosophy*, <http://plato.stanford.edu/entries/dialetheism/>
- (1998b), 'Fuzzy Identity and Local Validity', *Monist* 81: 331–40.
- (2000), *Logic: a Very Short Introduction* (Oxford: Oxford University Press).
- (2002a), 'Paraconsistent Logic', in Gabbay and Guenther (2001–), vol. 6.
- (2002b), 'Fuzzy Relevant Logic', ch. 11 of W. Carnielli, M. E. Coniglio and I. M. L. D'Ottaviano (eds.), *Paraconsistency: the Logical Way to the Inconsistent* (New York: Marcel Dekker).
- (2005a), 'Logic, Non-Classical', in D. Borchet, ed., *Encyclopedia of Philosophy*, 2nd edn (New York: Macmillan).
- (2005b), 'Many-Valued Logics', in D. Borchet, ed., *Encyclopedia of Philosophy*, 2nd ed. (New York: Macmillan).
- (2005c), *Towards Non-Being* (Oxford: Oxford University Press).
- (2006), *Doubt Truth to be a Liar* (Oxford: Oxford University Press).
- (2007), 'Conditionals: a Debate with Jackson', in I. Ravenscroft, ed., *Minds, Worlds and Conditionals: Themes from the Philosophy of Frank Jackson* (Oxford: Oxford University Press).
- Priest, G. and Routley, R. (1989a), 'Applications of Paraconsistent Logic', in Priest, Routley and Norman (1989), ch. 13.
- (1989b), 'The Philosophical Significance and Inevitability of Paraconsistency', in Priest, Routley and Norman (1989), ch. 18.
- Priest, G., Routley, R. and Norman, J. (1989), eds., *Paraconsistent Logic: Essays on the Inconsistent* (Munich: Philosophia Verlag).
- Priest, G. and Sylvan, R. (1992), 'Simplified Semantics for Basic Relevant Logics', *Journal of Philosophical Logic* 21: 217–32.
- Prior, A. (1957), *Time and Modality* (Oxford: Clarendon Press).
- (1960), 'The Runabout Inference-Ticket', *Analysis* 21, 38–9; reprinted in P. Strawson (ed.), *Philosophical Logic* (Oxford: Oxford University Press, 1967), pp. 129–31.
- (1967), *Past, Present and Future* (Oxford: Clarendon Press).
- (1968), 'Time, Existence, and Identity', in *Papers on Tense and Time* (Oxford: Clarendon Press), ch. 8.
- Quine, W. V. O. (1948), 'On What There is', *Review of Metaphysics* 48: 21–38; reprinted as ch. 1 of Quine (1963).
- (1953a), 'Reference and Modality', in *From a Logical Point of View* (Cambridge, MA: Harvard University Press), ch.8; revised slightly in Quine (1963).

- (1953b), 'Three Grades of Modal Involvement', *Proceedings of the XIth International Congress of Philosophy*, vol. 14 (Amsterdam: North-Holland); reprinted as ch. 13 of *The Ways of Paradox* (New York, NY: Random House, 1966).
- (1960), *Word and Object* (Cambridge, MA: MIT Press).
- (1963), *From a Logical Point of View*, 2nd edn (New York: Harper and Row).
- Read, S. (1988), *Relevant Logic* (Oxford: Basil Blackwell).
- (1994), *Thinking About Logic: An Introduction to the Philosophy of Logic* (Oxford: Oxford University Press).
- (2000), 'Harmony and Autonomy in Classical Logic', *Journal of Philosophical Logic* 29: 123–54.
- (2006), 'Medieval Theories: Properties of Terms', *Stanford Encyclopedia of Philosophy*, <http://plato.stanford.edu/entries/medieval-terms/>.
- Rescher, N. (1969), *Many-Valued Logic* (New York: McGraw-Hill).
- Restall, G. (1993), 'Simplified Semantics for Relevant Logics (and Some of Their Rivals)', *Journal of Philosophical Logic* 22: 481–511.
- (1995a), 'Four-Valued Semantics for Relevant Logics (and Some of Their Rivals)', *Journal of Philosophical Logic*: 24: 139–60.
- (1995b), 'Information Flow and Relevant Logic', in J. Selligman and D. Westerståhl, eds., *Logic, Language and Computation: the 1994 Moraga Proceedings* (Stanford: CSLI Press), pp. 463–477.
- (1999), 'Negation in Relevant Logics (How I Stopped Worrying and Learned to Love the Routley Star)', in D. Gabbay and H. Wansing, eds., *What is Negation?* (Dordrecht: Kluwer), pp. 53–76.
- (2000), *An Introduction to Substructural Logic* (London: Routledge).
- (2006), *Logic: An Introduction* (London: Routledge).
- Restall, G. and Roy, T. (200+), 'On Permutation in Simplified Semantics', forthcoming. See <http://consequently.org/writing/>
- Robinson, J. O. (1972), *The Psychology of Visual Illusion* (London: Hutchinson).
- Rose, R. and Rosser, J. B. (1958), 'Fragments of Many Valued Statement Calculi', *Transactions of the American Mathematical Society* 87: 1–53.
- Ross, W. D. (1928), ed., *The Works of Aristotle* (Oxford: Oxford University Press).
- Rosser, J. B. (1939) 'The Introduction of Quantification into a Three-Valued Logic', slated to appear in *Erekenntnis*, vol. 9, which never came out; abstracted in the *Journal of Symbolic Logic* 1939: 170.
- (1960), 'Axiomatization of Infinite Valued Logics', *Logique et Analyse* 3: 137–53.
- Rosser, J. B. and Turquette, A. R. (1948), 'Axiom Schemes for m -Valued Functional Calculi of First Order, Part I. Definition of Axiom Schemes and Proof of Plausibility', *Journal of Symbolic Logic* 13: 177–92.

- (1951), 'Axiom Schemes for m -Valued Functional Calculi of First Order, Part II. Deductive Completeness', *Journal of Symbolic Logic* 16: 122–34.
- Routley, R. (1978), 'Constant Domain Semantics for Quantified Non-Normal Modal Logics and for Certain Quantified Quasi-Entailment Logics', *Reports on Mathematical Logic* 10: 103–21.
- (1979), 'Alternative Semantics for Quantified First Degree Relevant Logic', *Studia Logica* 38: 211–31.
- (1980a), *Exploring Meinong's Jungle, and Beyond* (Canberra: Research School of Social Sciences, Australian National University).
- (1980b), 'Problems and Solutions in the Semantics of Quantified Relevant Logics, I', in A. Arruda, R. Chaqui, and N. da Costa, eds., *Mathematical Logic in North America* (Amsterdam: North-Holland Publishing Co.) pp. 305–40.
- (1982), 'On What There Isn't', *Philosophy and Phenomenological Research* 43: 151–78; also in Routley (1980a), ch. 3.
- (1984) 'The American Plan Completed: Alternative Classical Style Semantics, without Stars, for Relevant and Paraconsistent Logics', *Studia Logica* 43: 131–58.
- (1989a), 'Philosophical and Linguistic Inroads: Multiply Intensional Relevant Logics', in Norman and Sylvan (1989), ch. 19.
- (1989b), 'Routes in Relevant Logic', in Norman and Sylvan (1989), ch. 1.
- (2000), 'A Preliminary Western History of Sociative Logics', in Hyde and Priest (2000), ch. 5.
- Routley, R. and Loparić, A. (1978), 'Semantical Analysis of Arruda-da Costa P Systems and Adjacent Non-Replacement Relevant Systems', *Studia Logica* 37: 301–22.
- Routley, R. and Meyer, R. K. (1973), 'The Semantics of Entailment', in H. Leblanc, ed., *Truth, Syntax and Modality* (Amsterdam: North-Holland), ch.11.
- Routley, R., Plumwood, V., Meyer, R. K. and Brady, R. (1982), *Relevant Logics and their Rivals* (Atascadero, CA: Ridgeview), vol. I.
- Routley, R. and Routley, V. (1972), 'The Semantics of First Degree Entailment', *Noûs* 6: 335–95.
- (1985), 'Negation and Contradiction', *Rivista Columbiana de Matemáticas* 19: 201–31.
- Routley, R., Routley, V., Meyer, R. K. and Martin, E. (1982), 'On the Philosophical Bases of Relevant Logic Semantics', *Journal of Non-Classical Logic* 1: 71–102.
- Roy, T. (2006), 'Natural Derivations for Priest', *Introduction to Non-Classical Logic*, *Australasian Journal of Logic* 4, www.philosophy.unimelb.edu.au/ajl/.
- Russell, B. (1903), *The Principles of Mathematics* (Cambridge: Cambridge University Press).

- (1905), 'On Denoting', *Mind* 14: 479–93.
- Rutledge, J. D. (1960) 'On the Definition of an Infinitely-Valued Predicate Calculus', *Journal of Symbolic Logic* 25: 212–16.
- Sainsbury, M. (1995), *Paradoxes*, 2nd edn (Cambridge: Cambridge University Press).
- Sanford, D. (1989), *If P then Q: Conditionals and the Foundations of Reasoning* (London: Routledge).
- Scarpellini, B. (1962), 'Die Nichtaxiomatisierbarkeit des unendlichwertigen Prädikatenkalküls von Łukasiewicz', *Journal of Symbolic Logic* 27: 159–70.
- Schwartz, S. P. (1972), *Naming, Necessity and Natural Kinds* (Ithaca, NY: Cornell University Press).
- Schweizer, B., and Sklar, A. (1960), 'Statistical Metric Spaces', *Pacific Journal of Mathematics* 10: 313–34.
- Seegerberg, K. (1967), 'Some Modal Logics Based on a Three-Valued Logic', *Theoria* 33: 53–71.
- (1989), 'Notes on Conditional Logic', *Studia Logica* 48: 157–68.
- Shoemith, D. J. and Smiley, T. J. (1978), *Multiple Conclusion Logic* (Cambridge: Cambridge University Press).
- Skolem, T. (1920), 'Logisch-kombinatorische Untersuchungen über die Erfüllbarkeit oder Beweisbarkeit mathematischer Sätze nebst einem Theorem über dichte Mengen', *Videnskapsselskapets Skrifter, I. Mathem.-naturv. Klasse 4*; reprinted in English translation as 'Logico-combinatorial investigations in the satisfiability or provability of mathematical propositions: A simplified proof of a theorem by L. Löwenheim and generalizations of the theorem', of Heijenoort (1967), pp. 252–63.
- (1957), 'Bemerkungen zum Komprehensionaxiom', *Zeitschrift für mathematische Logik und Grundlagen der Mathematik* 3: 1–17.
- Smullyan, A. F. (1948), 'Modality and Description', *Journal of Symbolic Logic* 13: 31–7; reprinted as ch. 2 of L. Linsky, ed., *Reference and Modality* (Oxford: Oxford University Press, 1971).
- Smullyan, R. (1968), *First Order Logic* (Berlin: Springer Verlag).
- Stalnaker, R. (1968), 'A Theory of Conditionals', in *Studies in Logical Theory*, American Philosophical Quarterly Monograph Series, no. 2 (Oxford: Basil Blackwell); reprinted in Harper, Stalnaker and Pearce (1981), pp. 41–55.
- (1996), 'Impossibilities', *Philosophical Topics* 24: 193–204.
- Strawson, P. (1950), 'On Referring', *Mind* 59: 320–44.
- Sundholm, G. (1986), 'Proof Theory and Meaning', in Gabbay and Guenther (1983–9), vol. 3, ch. 8; and (2001–), vol. 9.

- Sylvan, R. (2000), 'A Preliminary Western History of Sociative Logics', in Hyde and Priest (2000), ch. 5.
- Takano, M. (1987), 'Another Proof of the Strong Completeness of Intuitionist Fuzzy Logic', *Tsukuba Journal of Mathematics* 11: 101–5.
- Takeuti, G. and Titani, S. (1984), 'Intuitionist Fuzzy Logic and Intuitionist Fuzzy Set Theory', *Journal of Symbolic Logic* 49: 851–66.
- Thomason, R. (1969), 'A Semantical Study of Constructible Falsity', *Zeitschrift für mathematische Logik und Grundlagen der Mathematik* 15: 247–57.
- (1984), 'Combinations of Tense and Modality' in Gabbay and Guentner (1983–9), vol. 2, ch. 3; and (2001–), vol. 7.
- Thomason, S. K. (1978), 'Possible Worlds and Many-Values', *Studia Logica* 37: 195–204.
- Trillas, E. and Valverde, L. (1984), 'An Inquiry on *t*-Indistinguishable Operator', in H. Skala, S. Termini, and E. Trillas, eds., *Aspects of Vagueness* (Dordrecht: Reidel) pp. 231–56.
- Turquette, A. R. (1958), 'Simplified Axioms for Many-Valued Quantification Theory', *Journal of Symbolic Logic* 23: 139–48.
- Urquhart, A. (1972), 'Semantics for Relevant Logics', *Journal of Symbolic Logic* 37: 159–69.
- (1986), 'Many-Valued Logic', in Gabbay and Guentner (1983–1989), vol. 3, ch. 2; and (2001–), vol. 2 (slightly revised as 'Basic Many-Valued Logic').
- van Fraassen, B. (1969), 'Presuppositions, Supervaluations and Free Logic', in K. Lambert, ed., *The Logical Way of Doing Things* (New Haven: Yale University Press) ch. 4.
- Varzi, A. (2000), 'Supervaluationism and Paraconsistency', in D. Batens, C. Mortensen, G. Priest and J-P. Van Bendegem, eds., *Frontiers of Paraconsistent Logic* (Baldock: Research Studies Press), pp. 279–97.
- Venema, Y. (2001), 'Temporal Logic', in Goble (2001), ch. 10.
- Von Wright, G. H. (1951), *An Essay in Modal Logic* (Amsterdam: North-Holland).
- (1957), 'Deontic Logic', *Logical Studies* (London: Routledge & Kegan Paul), ch. 4.
- Waagbø, G. (1992), 'Quantified Modal Logic with Neighbourhood Semantics', *Zeitschrift für mathematische Logik und Grundlagen der Mathematik* 38: 491–99.
- Wansing, H. (2001), 'Negation', in Goble (2001), ch. 19.
- (2005), 'Connexive Modal Logic', *Advances in Modal Logic*, 5: 367–83.
- (2006) 'Connexive Logic', *Stanford Encyclopedia of Philosophy*, <http://plato.stanford.edu/entries/logic-connexive/>.
- Williamson, T. (1994), *Vagueness* (London: Routledge).

- (2002), 'Necessary Existents', in A. O'Hear, ed., *Logic, Thought and Language* (Cambridge: Cambridge University Press), pp. 233–51.
- Wittgenstein, L. (1953), *Philosophical Investigations* (Oxford: Basil Blackwell).
- Wright, C. (1987), 'Anti-Realism and Revisionism', in *Realism, Meaning and Truth* (Oxford: Basil Blackwell), ch. 10.
- Yagisawa, T. (1988), 'Beyond Possible Worlds', *Philosophical Studies* 53: 175–204.
- (2006), 'Possible Objects', *Stanford Encyclopedia of Philosophy*, <http://plato.stanford.edu/entries/possible-objects/>.
- Zadeh, L. (1975), 'Similarity Relations and Fuzzy Orderings', *Information Sciences* 3: 177–200.

Index of Names

- Ackermann, W., 287
Adams, E., 18
Adams, W., 347
Ajdukiewicz, K., 18
Almukdad, A., 184, 532
Anderson, A., 80, 139, 161, 184,
185, 202, 216, 533, 543, 544,
547, 561
Aristotle, 33, 47, 131, 132, 133, 251,
252, 253, 326, 346, 382

Baaz, M., 582
Barcan (Barcan Marcus), R., 326, 346,
364, 397
Bar-Hillel, Y., 116, 117
Batstone, A., xx
Beall, J.C., 561
Beaney, M., 305, 364, 382
Beckmann, A., 238
Bell, J.L., 453
Belluce, L.P., 581
Belnap, N.D., 80, 139, 161, 184,
185, 202, 216, 502, 533, 543,
544, 547, 561
Bencivenga, E., 305
Bennett, J., 80
Berry, G.D.W., 588
Black, M., 305, 364, 382
Blamey, S., 140, 474
Brady, R.T., 18, 161, 216, 561
Brouwer, L., 116, 453
Brown, B., 80
Burgess, J., 60, 161
Bynum, T.W., 18, 287

Cantor, G., 227
Carnap, R., 382
Chang, C.C., 238, 565, 566, 581
Chellas, B., 34, 101
Chomsky, N., 113, 117
Church, A., 216
Cignoli, R., 239
Cocchiarella, N.B., 326, 346
Cooper, W.S., 18
Copeland, B.J., 33, 217
Cresswell, M., 33, 34, 60, 80, 326, 330,
346, 364, 382
Cross, R., 346

da Costa, N.C.A., 161
Dalen, D. van, 117, 453
de Swart, H.C.M., 101
DeVidi, D., 453
Devitt, M., 365
Došen, K., 216
Dubois, D., 238
Dugunji, J., 140
Dummett, M., 112, 117, 561, 585
Dunn, J.M., 161, 184, 216, 217, 532,
533, 561

Esteva, F., 581
Eubulides, 237
Evans, G., 364, 468, 473, 474, 577, 578,
581, 582

Faris, J.A., 18
Feys, R., 60, 397

- Fine, K., 101, 237, 544, 546, 548, 561, 562
 Fitting, M., 34, 255, 326, 346, 365, 453
 Fodor, J., 117
 Fraenkel, A., 116, 117
 Frege, G., xvii, 18, 103, 117, 130, 139,
 259, 287, 296, 305, 364, 382
 Fuhrmann, A., 217

 Garson, J.W., 326, 346, 364, 372, 382
 Geach, P., 305, 364, 382
 Gent, I.P., 101
 Gibbard, A., 282
 Girle, R., xviii, 34, 60, 80
 Gödel, K., 117, 140, 238, 287
 Godo, L., 581
 Goguen, J.A., 238, 251
 Gottwald, S., 239, 582
 Gowans, C., 60
 Grice, P., 18
 Guthrie, W.C.K., 326

 Haack, S., 117, 140
 Hájek, P., xxiii, xxvi, 234, 238, 239, 255,
 581, 582
 Hänle, R., 227
 Harper, W.L., 101
 Hasle, P.F.V., 326
 Hay, L.S., 581
 Hazen, A., 561
 Hegel, G., 128
 Heyting, A., 116, 453, 581
 Hilbert, D., 287
 Hilpinen, R., 60
 Hinckfuss, I., xviii
 Hintikka, J., 60
 Horn, A., 581
 Howson, C., 18, 287
 Hughes, G., 34, 60, 80, 326, 330, 346,
 364, 382
 Hyde, D., 238, 474

 Jackson, F., 18
 Jaśkowski, S., 161
 Jeffrey, R., 18, 287

 Kanger, S., 382
 Keefe, R., 238, 474
 Keisler, J., 566
 Kim, J., 382
 Kleene, S.C., 107, 122, 123, 139
 Klir, G.L., 238
 Kneale, W., 33, 287, 326
 Knuuttila, S., 33
 Kremer, P., 533
 Kripke, S., 33, 34, 60, 79, 117, 130,
 139, 326, 346, 358, 364, 365

 Lambert, K., 304, 305, 474
 Langford, C.H., 33, 60, 326, 364
 Leibniz, G., 33, 287
 Lemmon, E.J., 60, 69, 80
 Leonard, H.S., 304
 Levy, A., 116, 117
 Lewis, C.I., 33, 60, 72, 76, 79, 80,
 90, 95, 154, 259, 326, 364, 371
 Lewis, D., 33, 90, 100, 101, 339, 342,
 346, 419
 Lindenbaum, A., 140
 Loparić, A., 184
 Loux, M.J., 33, 34, 347
 Löwenheim, L., 287
 Łukasiewicz, J., 122, 124, 136, 139,
 140, 238, 564
 Lycan, W., 34

 Machina, K., 238
 Malinowski, G., 140, 474
 Mancosu, P., 453
 Mares, E., 217, 561
 Martin, C., 80, 217
 Martin, E., 217
 Marx, K., 128
 McArthur, R.P., 326, 346
 McKinsey, J.C.C., 117
 Meinong, A., 30, 296, 305
 Mendelsohn, R., 34, 326, 346, 365, 453
 Menger, K., 238
 Meyer, J.J., 60

- Meyer, R.K., 18, 80, 161, 216,
217, 561
- Mints, G., 453
- Močkoř, J., 239, 582
- Montagna, F., 581
- Mortensen, C., 161
- Mostowski, A., 473, 581
- Nelson, D., 184, 185, 532
- Novák, V., 239, 581, 582
- Nute, D., 100, 101
- Øhrstrøm, P., 326
- Olivetti, N., 227
- Orlov, I., 216
- Ostermann, P., 255
- Parks, Z., 382
- Parsons, T., 326
- Pavelka, J., 238
- Pearce, G., 101
- Perfilieva, I., 239, 582
- Perrin, B., 581
- Plantinga, A., 33, 326, 346
- Plumwood (Routley), V., 18, 161,
216, 217
- Post, E., 139
- Prawitz, D., 561
- Preining, N., 238, 582
- Priest, G., xvii, 22, 34, 80, 137, 139, 140,
151, 161, 184, 185, 216, 217, 238,
259, 288, 305, 347, 382, 397, 453,
474, 502, 532, 561, 581, 585
- Prior, A., 60, 326, 346, 382, 561
- Quine, W.V.O., 33, 296, 305, 316, 326, 364
- Read, S., xx, xxii, xxiii, xxvi, 34, 117, 217,
238, 287, 305, 561
- Rescher, N., 140, 238, 474
- Restall, G., xxiii, xxvi, 18, 22, 161, 217,
218, 561
- Robinson, J.O., 80
- Rose, R., 238
- Ross, W.D., 251
- Rosser, J.B., 238, 473, 581, 582
- Routley, R., *see* Sylvan
- Routley, V., *see* Plumwood
- Roy, T., xxiii, 217, 218
- Russell, B., xvii, 18, 131, 139, 259, 296, 305
- Rutledge, J.D., 581
- Sainsbury, M., 140, 238
- Sanford, D., 18
- Scarpellini, B., 566, 581
- Schwartz, S.P., 326
- Schweizer, B., 238
- Scott, D., 60
- Scotus, Duns, 80, 346
- Segeberg, K., 101, 255
- Shoesmith, D.J., 140
- Sklar, A., 238
- Skolem, T., 287, 581
- Smiley, T.J., 140
- Smith, P., 238, 474
- Smith, T.L., 382
- Smullyan, A.F., 18
- Smullyan, R., 364
- Soisson, William of, 80
- Soloman, G., 453
- Sosa, E., 382
- Stalnaker, R., 33, 90, 95, 100, 101, 185
- Sterelny, K., 365
- Strawson, P., 139
- Sundholm, G., 561
- Sylvan (Routley), R., 18, 22, 34, 80, 140,
151, 161, 184, 216, 217, 259,
304, 305, 397, 502, 532, 561
- Takano, M., 581
- Takeuti, G., 581
- Tarski, A., 117
- Thomason, R., 60, 184, 532
- Thomason, S.K., 255
- Titani, S., 581
- Trillas, E., 581
- Turquette, A.R., 473

Urquhart, A., 140, 217, 238, 474

Valverde, L., 581

van Fraassen, B., 140, 474

Varzi, A., 140

Venema, Y., 60

Von Wright, G.H., 60

Waagbø, G., 347

Wansing, H., 178, 185, 533

Wajsberg, M., 238

Williamson, T., 60, 237, 238, 347

Wittgenstein, L., 113, 117

Wright, C., 117

Yagisawa, T., 185, 347

Yuan, B., 238

Zach, R., 582

Zadeh, L., 581

Index of Subjects

- accessibility denotation constraint (ADC)
 - 400, 401, 406, 408, 411
- accessibility relation
 - binary 21
 - ternary 206–208
- Aristotle and Boethius 179
- avatars 368, 370
- axiom systems xviii, 544
 - continuum valued logic 224–231
 - modal logic 34
 - relevant logic 193, 202, 216

- B* ($K\sigma$) (the modal logic) 37, 60
- B* (the relevant logic) 188–190
 - extensions 194–203, 537–541
 - history 561
 - identity 548–552
 - quantified 535–537
 - restricted quantification 541–543
 - semantics vs proof theory 543–548
 - soundness and completeness
 - 555–560
 - tableaux for 190–194
- Barcan formula 330
- Bohr's theory of atom 75

- C* (conditional logic) 85
 - extensions 403–408
 - history 419
 - identity 408–412
 - philosophical issues 413–414
 - quantified 399–408
 - soundness and completeness 415–419

- C^+ 87–90
- C_1 (VC) 94–97
- C_2 94–97
- category mistakes 130
- C_B 209
- CC (constant domain C) 399–401
- ceteris paribus* clauses 84, 114, 208–211,
 - 260, 413
- change, instant of 128
- CK 228, 309–314, 320
- CL 385–386, 388, 389
- classical propositional logic 3–19
 - counter-models 10–11
 - history 18
 - object language 4–5
 - semantic validity 5
 - soundness and completeness 4, 16–18
 - tableaux 6–9
- CN 388, 389
- combinatorialism 30
- compactness theorem 278, 286, 287
- completeness 8, 17–18
 - see also* soundness and completeness
- compositionality 103
- conditional logics
 - extensions 87–90
 - history 100–101
 - identity in 408–413
 - quantified 399–407
 - semantics 84–85
 - similarity spheres 90–94
 - tableaux 86–87
- conditionals 11–12, 82, 259–260
 - consequentia mirabilis* 204

- conditionals (cont.)
 - contraction 216
 - enthymematic 208–211
 - fuzzy logic 230–231
 - intuitionist 113–114
 - many-valued 125–127
 - material 12–13
 - strict 72
 - subjunctive and counterfactual 13–15
- constant domain modal logics
 - history 325–326
 - normal modal logics 314–315
 - soundness and completeness 320–325
 - tableaux for CK 309–314
 - tense logic 318–319
- constructible negation 175–179, 517–523
- contingent identity modal logic 367–373
 - history 382
 - SI and nature of avatars 373–376
 - soundness and completeness 376–381
- converse Barcan formula 330, 337
- counter-model *see* tableaux

- De Morgan lattices 147
- De Morgan's laws 145
- de re* and *de dicto* 315–318
- degrees of truth 224, 234, 260
- denotation, failure of 130–132
- deontic logic 49
- designated values 226, 227
- dialectics 128
- dialetheism 136
 - see also* truth-value gluts
- disjunctive syllogism 16, 154–155
- distance metric 573–574
- doxastic logic 47

- E 216
- enthymeme 83
- epistemic logic 47
- epistemicism 237
- equivalence relations xxx–xxxii
- essentialism 317, 326
- excluded middle
 - law 95, 124, 129, 133, 136, 204, 205
- exclusion and exhaustion 147
- existence 275–277, 295–297, 339–342, 413, 421–422, 462–465
- explosion of contradictions
 - Lewis argument for 76–77, 154
 - see also* paraconsistency

- FB 232
- FDE (first degree entailment) 163–164, 244–247
- disjunctive syllogism 154–155
- free logics
 - with relational semantics 481–483
- history 161, 502
- identity 485–488
- and many-valued logics 146–149
- paraconsistency 154–155
- Routley star 151–154, 483–485
- semantics 142–144
 - many-valued 476–479
 - relational 476–479
- soundness and completeness 155–160, 491
- tableaux 144–146, 479–481
- fiction, truths of 131
- first-order logic, classical
 - history 287
 - identity 272–274
 - philosophical issues 275–277
 - semantics 264–266
 - soundness and completeness 278–287
 - syntax 263–264
 - tableaux 266–272
 - technical comments 277–288
- free logics
 - history 304–305
 - identity in 297–299
 - intuitionist logic 424
 - negative 293–294
 - neutral 295
 - positive 293, 294
 - quantification and existence 295–297
 - with relational semantics 481–483
 - soundness and completeness 300–304

- syntax and semantics 290–291
 - tableaux 291–293
- future contingents 132–133, 251–253
- fuzzy logic
 - continuum-valued logic \mathcal{L} 224–231
 - conditionals in 230–231
 - deductions 570–572
 - history 237–238, 581
 - identity 573–576
 - quantified 564–565
 - \mathcal{L}_{\aleph} 227–229, 565–570
 - identity in 572
 - relevant logic 231–233
 - sorties paradox 221–224, 572–573
 - responses to 222–224
 - t*-norm logics 234–237
 - quantification and identity in 578–581
 - vague objects 576–578
- Gödel logic 580, 581
- heredity rule 105, 108–109, 425, 426
- I see intuitionist logic*
- I_3 183–184
- I_4 176, 182–183
- identity invariance rule (IIR) 350, 432, 434, 487
- identity, substitutivity of 272, 276–77, 299, 350–352, 367–376, 413–415, 432–437, 468–469, 512–515, 548–555, 573–578, 581
- impossible worlds 260
 - and relevant logic 171–179
- initial list, of tableau 6
- interpretations *see* semantics
- intuitionist logic 103–105, 112–113, 130, 138, 171, 175, 189, 207, 209, 231, 580
 - conditional 113–114
 - existence and construction 421–422
 - history 116–117, 453
 - identity 434–437
 - mental constructions 431–432
 - necessary identity 432–433
 - quantified logic 422–424
 - semantics 105–107
 - soundness and completeness 114–116, 437
 - tableaux for 107–111
 - of kind 1 424–427
 - of kind 2 427–431
- K 20–28
 - constant domain 308–309
 - history 33–34
 - modal semantics 21–23
 - modal tableaux 24–27
 - necessity and possibility 20–21
 - representation 28
 - soundness and completeness 31–33
 - variable domain 330–331
- K_3 122–124, 139, 148, 223, 460, 469
- K_4 and K_* 164–166, 169, 179–181, 182, 189, 510–512
- Kleene 3-valued logic *see* K_3
- K^t 49–51
 - extensions 51–56
- K_v *see* S_5
- $K\rho$, $K\sigma$, $K\tau$ etc. 36
- L , L_ρ etc. 69–71
 - quantified, 385–391
- \mathcal{L} 224–231
 - axioms for \mathcal{L}_{\aleph} 227–229
 - conditionals in 230–231
- \mathcal{L}_3 124, 139, 149–151, 225, 460, 469
- laws, inconsistent 127–128
- Lewis argument, for explosion of contradictions 76–77
- Lewis' systems of modal logic 60, 82
 - see also* S_1 – S_5
- logic
 - classical xvii, 3–19, 142, 149, 225
 - free xvii
 - with gaps, gluts and worlds 505
 - modal 20, 36, 133
 - non-normal modal 64–81, 384

- logic (cont.)
 conditional 82–101, 204, 216,
 259–260, 399
 contingent identity modal 367
 intuitionist 103, 130, 138, 207, 421
 many-valued 120, 146–149, 224,
 226, 456
 medieval 316
 non-classical xvii
 quantum xviii
 logic (cont.)
 fuzzy 230–231
 paraconsistent 184
 relevant 163, 188, 231–233, 535
 Stoic 259
 substructural 218
 see also individual entries
 logical truth *see* validity and
 logical truth
 Löwenheim–Skolem Theorem 278,
 286, 287
 LP 124–125, 139, 149, 150, 460, 469
 Łukasiewicz 3-valued logic *see* \mathcal{L}_3
 Łukasiewicz logic, modal 243–244
 modal logic 136
 quantified 564–565
 \mathcal{L}_N 227–229, 234, 235, 565–570
 identity in 572

 many-valued logics
 3-valued logics 122–125, 147–151,
 459–461
 conditionals 125–127
 existence and quantification
 462–465
 free versions 461–462
 general structure 120–122
 history 139–140, 473
 identity 467
 K_3 122–124
 \mathcal{L}_3 124
 LP 124–125
 modal logic
 FDE 244–247
 general structure 241–242
 Łukasiewicz logic 243–244
 tableaux 247–250
 neutral free logic 465–467
 non-classical identity 468–469
 quantified many-valued logics 456–458
 RM_3 125
 soundness and completeness 137–139,
 255–258
 supervaluations and subvaluations
 133–137, 469–471
 material conditional 12–13
 mathematical induction (recursion)
 xxix–xxx
 matrices 384–385, 505
 meinongianism 30–31
 metatheory, non-classical 584–586
 modal actualism 29–30, 33
 modal logic, K (after Kripke) *see* K
 modal logics
 many valued 241–255
 see non-normal modal logics, normal
 modal logics
 modal realism 28–29, 33
 modal semantics 21–23
modus ponens 12, 15, 73, 74, 88, 125, 154,
 233, 235, 553, 570, 573, 576
 multimodal logics 50

 N, N_ρ , N_σ etc. 65
 N_4 , N_* 168–169, 170, 173, 179–180, 181,
 182, 189, 505–508, 508–510
 necessary identity in modal logic
 349–352
 history 364
 names and descriptions 357–358
 negativity constraint 352–354
 rigid and non-rigid designators 354–357
 soundness and completeness 358–364
 necessitation, rule of 68
 necessity and possibility 20–21, 46–49, 132
 negation
 relevant/paraconsistent 151
 see also Routley star
 negativity constraint rule 293–294, 299,
 302, 338, 352–354

- non-normal modal logics
 constant domain quantified L 385–386
 tableaux for 386–387
 history 79–80, 397
 identity 391–393
 matrices 384–385
 non-normal worlds 64–65
 $S0.5$ 69–71
 soundness and completeness 77–79,
 393–397
 tableaux 65–67
- non-normal world 166–168
- normal modal logics 20–28, 36–60,
 314–315
 history 60
 necessity 46–49
 quantified 308–315, 329–331
 $S5$ 45–46
 semantics 36–38
 soundness and completeness 56–59
 tableaux 38–42
 infinite 42–44
 tense logic 49–56
- normality constraint/rule 189–191, 195,
 196, 199, 201, 211, 214
- normality invariance rule 549
- object-language
 syntax 4–5
- object, vague 276–278
- paraconsistency *see under* logic
- paradox(es)
 Berry's 130, 465
 liar 129
 Russell's 129
 of self-reference 129–130
 sorties 221–224, 572–573
 of strict implication 72–74
- parameter sharing 173, 174
- permutation 203, 204, 218
- possibility *see* necessity and possibility
- quantum mechanics 128
- R 189, 203–206, 216
- relevant logics
ceteris paribus enthymemes 208–211
 content ordering 197–200
 fuzzy 231–233
 history 216–217
 identity 548–552
 logic B 188–190
 extensions for 194–203
 tableaux for 190–194
 predication 515–517
 properties of identity 553–555
 quantified 535–537
 restricted quantification 541–543
 semantics vs proof theory 543–548
 soundness and completeness 211–216,
 555–560
 ternary relation 206–208
see also worlds
- rigid and non-rigid designators 354–357
- RM (R -Mingle) 139, 202–203
- RM_3 125, 139, 149–151, 205, 460, 469
- Routley star 151–154, 216, 483–485
see also semantics; star
- RW 202
- $S0.5$ 69–71
- $S1$ 79
- $S2$ ($N\rho$) 65
- $S3$ ($N\rho\tau$) 65
- $S3.5$ ($N\rho\sigma\tau$) 65
- $S4$ ($K\rho\tau$) 65
- $S5$ ($K\rho\sigma\tau$, $K\nu$) 45–46
 equivalence between $K\rho\sigma\tau$ and
 $K\nu$ 45, 57
- $S6$ and $S7$ 80
- semantics (interpretations) 3, 392,
 584–585
 algebraic xviii, 161, 206, 216, 237
 for conditional logics 84–85
 FDE 142–144, 147, 151–154, 476
 first-order logic 264–266, 276
 free logics 290–291
 fuzzy 223, 224, 229, 233, 234, 237, 238

semantics (interpretations) (cont.)

- for L_3 149–151
 - many-valued 224, 476–479
 - matrix 505
 - paraconsistent 154–155, 161
 - relational 163, 171, 476–479
 - for RM_3 149–151
 - star 169, 171, 189, 483–498, 493–498
 - validity and logical truth 3–4, 5
 - world xviii
 - fuzzy relevant logic 233
 - for intuitionist logic 105–107
 - for normal modal logics 21, 28, 36–38
 - relevant logic 163, 188
- sequent calculi xviii
- set theory
- basic concepts and notation xxvii–xxix
 - Zermelo Fraenkel 585
- similarity spheres 90–94
- situation semantics 217
- sorties paradox 221–224, 237, 572–573
- responses to 222–224
- soundness and completeness xix
- for B 202, 211–212, 556–560
 - for B 's extension 196
 - for C and C^+ 415–416
 - for C_B 215–216
 - for CL and VL 394
 - for classical propositional logic 4, 16–18
 - for CN and VN 394–395
 - constant domain modal logics 320–325
 - for contingent identity 377, 418–419, 451–453
 - for FDE , K_3 and LP 146, 149, 152, 157, 491–493
 - first-order logic 278–287
 - free logics 300–304
 - fuzzy logic 565–570
 - for intuitionist logic 114–116
 - for K_4 and K_* 179–181, 182, 183
 - for L_N 229
 - for K_* and K_4 524–526
 - many-valued modal logics 255–258
 - for N_4 and N_* 181, 182, 524–527
 - necessary identity 358–364, 396–397, 416–418, 448–451

- for non-normal modal logics 77–79
 - for normal modal logics 31–33, 56–59
 - for quantified I_4 531–532
 - for relational semantics 528–529
 - relevant logics 211–216
 - for star semantics 493–498, 529–530
 - for intuitionist tableaux
 - of kind 1 439–444
 - of kind 2 444–448
 - variable domain modal logics 342–346
- star 169–171, 189
- see also* Routley star
- strict conditionals 72
- paradoxes, of strict implication 72–74
- substitution, uniform 137
- substitutional quantification 266
- substitutivity of identicals *see* identity, substitutivity of
- supervaluation 133–137, 223, 237
- T 202, 203
- tableaux xviii
- for basic modal logics 24–27
 - for CK 309–314
 - for CL 386–387
 - for classical propositional logic 6–9
 - for conditional logics 86–87
 - for FDE 144–146, 479–481
 - for first-order logic 266–272
 - for free logic 291–293
 - for intuitionist logic 107–111
 - for K_4 and K_* 164–166, 169
 - of kind 1 (intuitionist) 424–427
 - of kind 2 (intuitionist) 427–431
 - for many-valued modal logics 247–250
 - for N_4 and N_* 168–169, 170
 - for non-normal modal logics 65–67
 - for normal modal logic 38–42
 - infinite 42–44
 - relevant logic 176, 183, 184, 190–194
 - for VK 331–335
- tense logic 49–56, 318–319, 335–336
- see also* K^t
- ternary relation 206–208

- t-norm logic 234–237
 - quantification and identity in 578–581
- tonk 546–547
- transworld identity 341
- tree 6
- triangle inequality 574, 575
- truth conditions 168, 170, 171, 175, 242, 254, 264–265, 291, 309, 331, 368, 372, 386, 423, 466, 478, 535, 580
- truth preservation 164, 167, 168, 174, 176, 209, 477, 484
 - see also* validity and logical truth
- truth table 5, 121
- truth-value gaps 127, 148, 154
 - denotation, failure of 130–132
 - future contingents 132–133
- truth-value gluts 127–128, 149, 154, 172, 174, 185, 260
 - paradoxes of self-reference 129–130
- TW 202

- undecidability of strong relevant logic 217

- vagueness 128, 130, 223, 237, 238, 575, 576–578, 584
- validity and logical truth 368, 386, 400, 423, 477
 - proof-theoretic 4
 - see also* axiom systems; tableaux
 - semantic 3–4, 5
 - see also* semantics
- variable domain modal logics
 - existence across worlds 339–341
 - existence and wide scope quantifiers 341–342
 - history 346
 - K variable domain and normal extensions 330–331
 - soundness and completeness 342–346
 - tableaux for VK and normal extensions 331–335
 - tense logic 335–336
 - VC (variable domain C) 402–403
 - VK 331–335, 342–345
 - VL 388, 389
 - VN 388, 389

- waterfall effect 75–76
- worlds 64–65, 339–341
 - with constructible negation 517–520
 - identity 521–522
 - FDE 163–164
 - fuzzy 231, 233
 - history 184–185, 532
 - identity 512–515
 - impossible worlds 260
 - and relevant logic 171–179
 - K_4, K_* 510–512
 - N_4, N_* 505–508, 508–510
 - non-normal world 64–65, 166–168
 - possible (normal) 20, 28, 36–38, 64
 - soundness and completeness 179–184, 523–531
 - star 169–171
 - tableaux
 - for K_4 164–166
 - for N_4 168–169