

48783

Radio - HI-TECH CONSUMER'S GUIDE TO BATTERIES

MARCH 1990

# Electronics®

TECHNOLOGY - VIDEO - STEREO - COMPUTERS - SERVICE

## BUILD THIS LABORATORY POWER SUPPLY

Two fully floating variable 50-volt, 5-ampere supplies and one fixed 5-volt, 3-ampere supply fulfills all your benchtop needs

## BUILD AN ION METER

Keep track of the levels of negative and positive ions in your environment

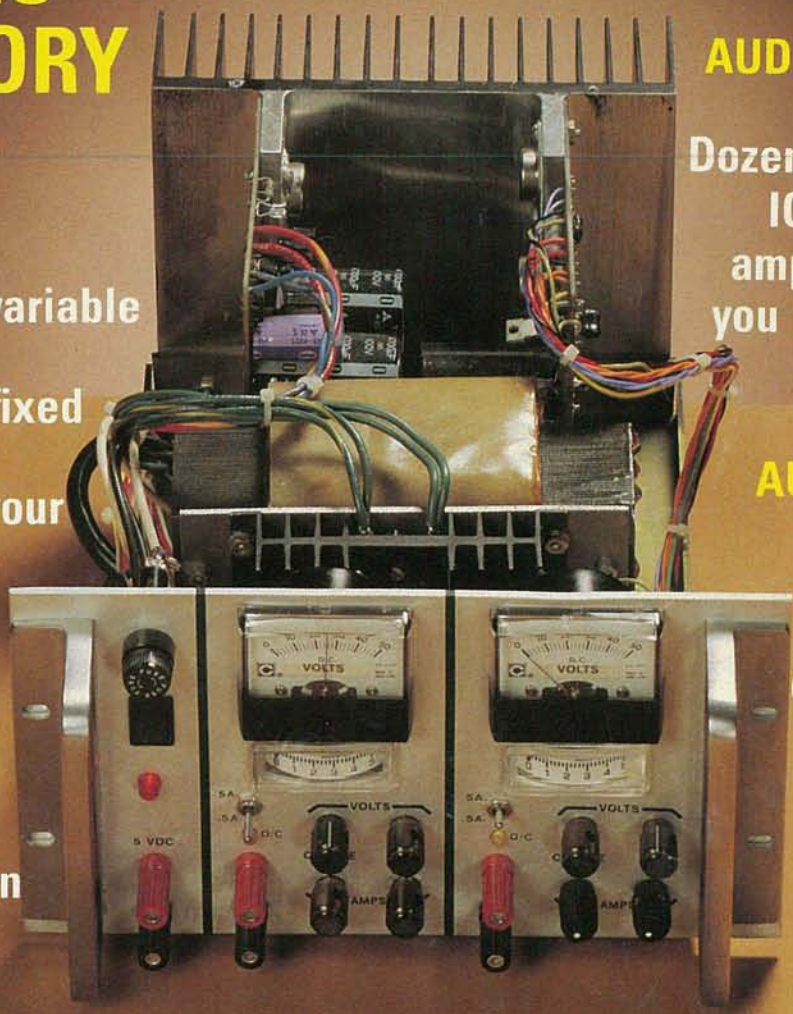

## AUDIO AMPLIFIER COOKBOOK

Dozens of practical IC audio power amplifier designs you can try today!

## BUILD AN AUDIO LIMITER

Eliminate distortion caused by overdriving or underdriving audio amplifiers

## COMPUTER DIGEST

Build a keyless entry system based on the 68705 microcontroller



\$2.50 U.S.  
\$2.95 CAN

**GERNSBACK**  
PUBLICATION

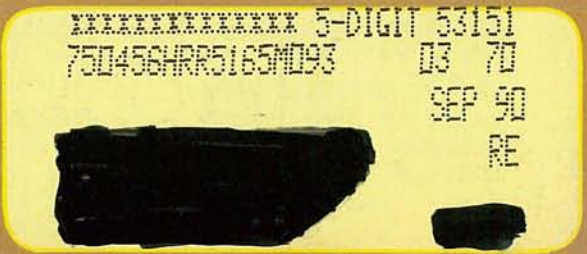



**FLUKE**



**PHILIPS**



# Great Choice.

**More professionals in more industries make Fluke their first choice in multimeters.**

Fluke DMMs. Reliable. Accurate. Powerful. Tough. Versatile. Easy to use and simple to operate. Backed by the longest, most comprehensive warranty in the business. Made in the U.S.A. In short, Fluke makes meters you can bet your reputation on.

**More choice.** No matter what the job, there's a Fluke to handle it.

There's the new 80 Series—the most powerful, most complete test and measurement system available in a handheld package.

The popular 70 Series—simply put, the most requested DMM in the world, with nearly 2 million units in service since 1984. And the Fluke 21 and 23—70 Series simplicity in high-visibility yellow.

The Fluke 25 and 27—the most rugged meters ever built, totally sealed against water, dust and other contaminants.

And the precise 8060 Series—with the versatility of a test lab, the accuracy of a bench instrument, and the convenience of a handheld.

**Smart choice.** Compare Fluke DMMs with any other handheld. No one else gives you as much meter for your money. And no other meter costs less to own.

**Your choice.** For the name of your nearest Fluke distributor, call toll-free **1-800-44-FLUKE, ext. 33.** And make a great choice.

John Fluke Mfg. Co., Inc. P.O. Box C9090 M/S 250C Everett, WA 98206. U.S.: (206) 356-5400. Canada: (416) 890-7600. Other Countries: (206) 356-5500. © 1989 John Fluke Mfg. Co., Inc. All rights reserved. Ad No. 0491-F70

FROM THE WORLD LEADER  
IN DIGITAL MULTIMETERS

**FLUKE**

CIRCLE 121 ON FREE INFORMATION CARD



## BUILD THIS

- 31 UNIVERSAL LABORATORY POWER SUPPLY**  
A flexible, high performance supply for your workbench.  
**Reinhard Metz**
- 35 ION METER**  
Now you can keep track of negative and positive ions in your environment.  
**Peter A. Lovelock**
- 39 AUDIO VOLUME LIMITER**  
Improve the performance of low-cost audio amps.  
**Lowell D. Johnson**

## TECHNOLOGY

- 42 ALL ABOUT BATTERIES**  
How to select the best power source for your equipment...or your next project!  
**Josef Bernard**

## COMPUTERS

- 71 BUILD A DIGITAL KEYLESS ENTRY SYSTEM**  
Use the 68705 microcontroller to improve your security.  
**Steven Avritch**

## CIRCUITS

- 52 WORKING WITH AUDIO POWER OP-AMP IC's**  
A circuit cookbook with scores of practical circuits.  
**Ray Marston**

## DEPARTMENTS

- 6 VIDEO NEWS**  
What's new in this fast-changing field.  
**David Lachenbruch**
- 18 EQUIPMENT REPORTS**  
Jameco Electronics  
Wishmaker II Prototyping System  
Beckman Industrial FG3A 2-MHz Sweep/Function generator
- 58 HARDWARE HACKER**  
Synchronous demodulation.  
**Don Lancaster**
- 77 AUDIO UPDATE**  
Do we hear things differently?  
**Larry Klein**
- 71 EDITOR'S WORKBENCH**  
Booting from a PROM  
**Jeff Holtzman**

## COMPUTER DIGEST

**DIGITAL KEYLESS ENTRY SYSTEM**  
**EDITOR'S WORKBENCH**

**Next Issue**  
The digital keyless entry system is a new security device that uses a microcontroller to control a lock. It is a simple, reliable, and easy-to-use system that can be installed in a few minutes. The system is made up of a microcontroller, a lock, and a key. The key is a small plastic device that is inserted into the lock. The microcontroller sends a signal to the lock, which then unlocks the door. The system is very secure and can be used in a variety of applications.

**Next Issue**  
The Editor's Workbench is a section that provides readers with a variety of projects and articles. This issue features a project on building a digital keyless entry system, a project on building a digital clock, and a project on building a digital thermometer. The Editor's Workbench is a great source of information for anyone interested in electronics.

PAGE 71

**TECHNOLOGY**  
**ALL ABOUT BATTERIES**

**Next Issue**  
The All About Batteries section is a comprehensive guide to the world of batteries. This issue covers a wide range of battery types, including alkaline, lithium, and nickel-cadmium. It provides detailed information on how to select the right battery for your application, how to use batteries safely, and how to maintain them. The section is a must-read for anyone who uses batteries in their projects.

PAGE 42

## AND MORE

- 96 Advertising and Sales Offices**
- 96 Advertising Index**
- 8 Ask R-E**
- 97 Free Information Card**
- 14 Letters**
- 79 Market Center**
- 22 New Products**
- 4 What's News**



## ON THE COVER



If you're looking for a power supply that combines high voltage, high current, and adjustability, then your search has ended. This month's cover project offers two fully floating, adjustable 50-volt, 5-amp supplies, along with a fixed 5-volt 3-amp supply.

The price of the supply is a steal when compared to commercially available units. Even better, a modular design allows you to build in only the features you need, keeping costs down even more. For all the technical and construction details, turn to page 31.

## COMING NEXT MONTH

### THE APRIL ISSUE GOES ON SALE MARCH 1

#### **BUILD THE MORSE DETECTOR**

This sophisticated project decodes morse code and RTTY signals.

#### **BUILD A SOLID-STATE WIPER CONTROL**

Beat those April showers with this easy-to-build project.

#### **ONE-CHIP FREQUENCY CONVERTER**

An in-depth look at the Signetics NE602.

#### **GLITCHES IN THE POWER LINE**

Everyone involved in electronics should understand the causes of and cures for power-line disturbances.

#### **AUDIO-AMP COOKBOOK**

Automotive applications for power op-amp IC's.

As a service to readers, RADIO-ELECTRONICS publishes available plans or information relating to newsworthy products, techniques and scientific and technological developments. Because of possible variances in the quality and condition of materials and workmanship used by readers, RADIO-ELECTRONICS disclaims any responsibility for the safe and proper functioning of reader-built projects based upon or from plans or information published in this magazine.

Since some of the equipment and circuitry described in RADIO-ELECTRONICS may relate to or be covered by U.S. patents, RADIO-ELECTRONICS disclaims any liability for the infringement of such patents by the making, using, or selling of any such equipment or circuitry, and suggests that anyone interested in such projects consult a patent attorney.

RADIO-ELECTRONICS, (ISSN 0033-7862) March 1990. Published monthly by Gernsback Publications, Inc., 500-B Bi-County Boulevard, Farmingdale, NY 11735 Second-Class Postage paid at Farmingdale, NY and additional mailing offices. Second-Class mail registration No. 9242 authorized at Toronto, Canada. One-year subscription rate U.S.A. and possessions \$17.97, Canada \$23.97, all other countries \$26.97. All subscription orders payable in U.S.A. funds only, via international postal money order or check drawn on a U.S.A. bank. Single copies \$2.50. © 1990 by Gernsback Publications, Inc. All rights reserved. Printed in U.S.A.

**POSTMASTER:** Please send address changes to RADIO-ELECTRONICS, Subscription Dept., Box 55115, Boulder, CO 80321-5115.

A stamped self-addressed envelope must accompany all submitted manuscripts and/or artwork or photographs if their return is desired should they be rejected. We disclaim any responsibility for the loss or damage of manuscripts and/or artwork or photographs while in our possession or otherwise.

## Radio Electronics®

Hugo Gernsback (1884-1967) founder  
M. Harvey Gernsback,  
editor-in-chief, emeritus

**Larry Steckler**, EHF, CET,  
editor-in-chief and publisher

#### **EDITORIAL DEPARTMENT**

**Brian C. Fenton**, editor  
**Marc Spiwak**, associate editor  
**Daniel Goodman**, technical editor  
**Teri Scaduto**, assistant editor  
**Jeffrey K. Holtzman**  
computer editor  
**Robert Grossblatt**, circuits editor  
**Larry Klein**, audio editor  
**David Lachenbruch**  
contributing editor  
**Don Lancaster**  
contributing editor  
**Richard D. Fitch**  
contributing editor  
**Kathy Campbell**, editorial assistant

#### **ART DEPARTMENT**

**Andre Duzant**, art director  
**Injae Lee**, illustrator  
**Russell C. Truelson**, illustrator

#### **PRODUCTION DEPARTMENT**

**Ruby M. Yee**, production director  
**Robert A. W. Lowndes**,  
editorial production  
**Karen S. Tucker**  
advertising production  
**Marcella Amoroso**  
production assistant

#### **CIRCULATION DEPARTMENT**

**Jacqueline P. Cheeseboro**  
circulation director  
**Wendy Alanko**  
circulation analyst  
**Theresa Lombardo**  
circulation assistant  
**Michele Torrillo**, reprint bookstore

Typography by Mates Graphics  
Cover photo by Diversified Photo  
Services

**Radio-Electronics** is indexed in  
*Applied Science & Technology Index*  
and *Readers Guide to Periodical Literature*.

Microfilm & microfiche editions are  
available. Contact circulation department  
for details.

**Advertising Sales Offices listed  
on page 96.**

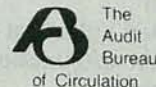



Now electronics technicians can get into VCR Servicing quickly and easily

# Learn professional VCR servicing at home or in your shop with exclusive videotaped demonstrations

Today, there are more than 10 million VCRs in use, with people standing in line to have them serviced. You can bring this profitable business into your shop with NRI professional training in VCR servicing. This top-level training supports the industry's claim that the best technicians today are those who service VCRs.

## Integrated Three-Way Self-Teaching Program

In one integrated program, NRI gives you a study guide, 9 instructional units, 2 hours of video training tapes accompanied by a 32-page workbook that pulls it all together. At home or in your shop, you'll cover all the basic concepts of video recording, mechanical and electronic systems analyses, and the latest troubleshooting techniques. Your workbook and instructional units also contain an abundance of diagrams, data, and supplementary material that makes them valuable additions to your servicing library.

## The "How-To" Videotape

Your NRI Action Videocassette uses every modern communications technique to make learning fast and easy. You'll enjoy expert lectures and see animation and video graphics that make every point crystal-clear. You'll follow the camera eye into the heart of the VCR as step-by-step servicing techniques are shown. Both electronic and mechanical troubleshooting are covered . . . including everything from complete replacement and adjustment of the recording heads to diagnosing micro-processor control faults.

## Plus Training On All The New Video Systems

Although your course concentrates on VCRs covering Beta, VHS, and 3/4" U-Matic commercial VCRs, NRI also brings you up to speed in other key areas. You'll get training in capacitance and optical video disc players, projection TV, and video cameras. All are included to make you the complete video technician. There's even an optional final examination for NRI's VCR Professional Certificate.



Covers Beta and VHS systems with actual instruction on videotape.

## The Best Professional Training

This exclusive self-study course has been developed by the professionals at NRI. NRI has trained more television technicians than any other electronics school! In fact, NRI has consistently led the way in developing troubleshooting techniques for servicing virtually every piece of home entertainment equipment as it appears in the marketplace.

## Satisfaction Guaranteed . . . 15-Day No-Risk Examination

Send today for the new NRI Self-Study Course in VCR Servicing for

Professionals. Examine it for 15 full days, look over the lessons, sample the videotape. If you're not fully satisfied that this is the kind of training you and your people need to get into the profitable VCR servicing business, return it for a prompt and full refund, including postage. Act now, and start adding new business to your business.

## Special Introductory Offer

This complete VCR training course with two hour videotape is being offered for a limited time only, on orders received from this ad, at our low introductory price of \$179.95. Save \$20 by acting now!

NRI Training For Professionals  
McGraw-Hill Continuing Education Center  
4401 Connecticut Ave Washington, DC 20008

**YES!** Get me started in profitable VCR servicing. Rush me my NRI self-study course in VCR Servicing for Professionals. I understand I may return it for a full refund within 15 days if not completely satisfied.



NRI Training For Professionals  
McGraw-Hill Continuing Education Center  
4401 Connecticut Avenue  
Washington, DC 20008

PLEASE SPECIFY TAPE FORMAT DESIRED  VHS  BETA

Name (please print) \_\_\_\_\_

Company \_\_\_\_\_

Street \_\_\_\_\_

City/State/Zip \_\_\_\_\_

Enclosed is my  check  money order for \$179.95 (D.C. residents add 6% tax) Make check payable to NRI

Charge to  VISA  MasterCard \_\_\_\_\_

Interbank Number \_\_\_\_\_

Card Number \_\_\_\_\_ Expiration Date \_\_\_\_\_

Signature \_\_\_\_\_

(required for credit card sales)

2600-030

MARCH 1990



# WHAT'S NEWS

## New path for computer electronics?

A team of IBM researchers led by Dr. Mordehai Heiblum have demonstrated that fast-moving "ballistic" electrons can be focused and steered as they travel at very low temperatures through gallium arsenide—a semiconductor material that holds promise for use in future computers. The result of studies at the Thomas J. Watson Research Center in Yorktown Heights, NY (where the same research group previously demonstrated that ballistic electrons can travel through ultra-thin layers of gallium arsenide at speeds greater than 1,000,000 mph), the discovery raises the possibility that 21st-century computer architects might possibly be able to use directed beams of electrons in computer-chip circuitry.

Normally, electrons moving through a semiconductor travel only a very short distance—known as the "mean free path"—before they collide with atoms, other electrons, or impurities. That causes the electrons to scatter and, in the process, to lose energy and change direction. The mean free path in those experiments is lengthened by reducing the temperature to  $-450^{\circ}\text{F}$ , which greatly reduces the normal motion of atoms in the semiconductor material, thus reducing the chance of collision with electrons. That allows the electrons to travel "ballistically"—in other words, without scattering.

The experimental setup was a type of microelectronic switch that involved "injecting" high-energy electrons on one side of a 2-micron region of semiconductor ma-

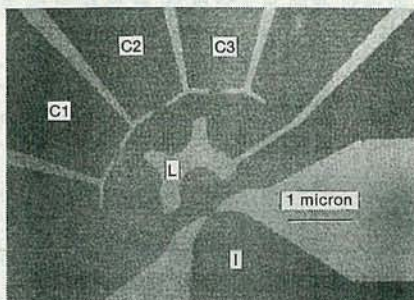

**TO FOCUS AND STEER BALLISTIC** electrons, traveling through a tiny region of the semiconductor material gallium arsenide, scientists "injected" them through an injector (I), focused the electron beam with a tiny metal lens (L), and "collected" the electrons in three areas (C1, C2, and C3).

terial, and "collecting" them at the other side. The electrons traveled ballistically through a "two-dimensional electron gas," a region free of impurities that might cause energy-wasting collisions.

The scientists applied a voltage to a curved lens as the electrons passed underneath it, causing the electrons to slow down and be focused.

To demonstrate that the path of travel could be controlled, they applied a differential voltage across tiny metal gates as they injected the electrons into the semiconductor. They were able to steer the electrons about 60 degrees off the original path over a distance as long as two microns. (One micron equals 1/25,000th of an inch.)

Substantial development hurdles would still have to be crossed before the controlled electron beams could find any practical application in future computer technology.

## Satellite capabilities coming down to earth?

The first field trial of fiber-optic networks for broadcast television began in December 1989 with

ABC's transmission of live television from New York to seven cities across the country. The first of five consecutive trials coordinated by Bellcore (Livingston, NJ) used

coast-to-coast fiber-optic links to determine how efficiently network television studios can broadcast programming to affiliate stations using a land-based alternative to satellites, which are now used almost exclusively by major broadcasters to distribute and collect programming.

Besides ABC, CBS, FOX, NBC, and PBS are participating—along with some 50 television stations, manufacturers, suppliers, interexchange carriers, and exchange carriers. The trial networks, established between Atlanta, Boston, Indianapolis, Los Angeles, Minneapolis, New York, St. Louis, and Washington, transmit conventional television signals at 45 megabits per second (DS3 rate). The signals travel over a two-way, tree-branch-like network that permits broadcasters to distribute programming simultaneously to any number of affiliate stations and to receive programming from those stations individually. Eight Bell operating companies and five interexchange carriers are providing the fiber-optic networks for the trials, and several suppliers are providing equipment ranging from video and audio codecs to a new multi-cast switch.

Various factors have combined to make the tests possible, including the declining cost of a DS3 channel and the availability of fiber optics (about 300 cities are connected by fiber optics and are capable of transmitting video at the DS3 rate). Space is limited on satellites, which are also subject to the problems of aging. Further, fiber networks offer near-instantaneous customizing of a program's destinations, lack of signal interference, security from unauthorized receivers, multiple simultaneous audio-channel capability, and the flexibility to make every network affiliate a program source.

R-E



# 5 WAYS TO STOP WASTING TIME IN ELECTRONICS.

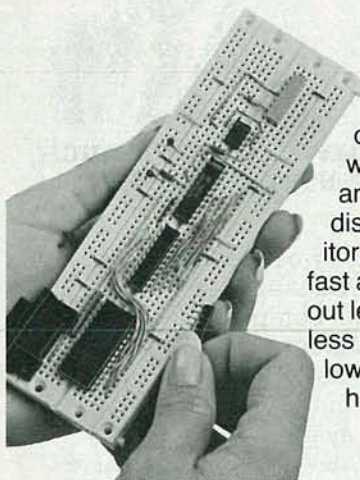

**Stop wasting your time soldering.** Save hours of soldering, desoldering, resoldering with Quick Test™ sockets and bus strips. Connect/disconnect resistors, capacitors, transistors, ICs, etc. as fast as you can push in/pull out leads. Interlock for limitless expandability. Priced as low as \$1.60, you'll wonder how you've done without them!

5-color coded binding posts and 17 sockets, for over 4,560 contact points. Lifetime guarantee. American-made. Affordably priced.

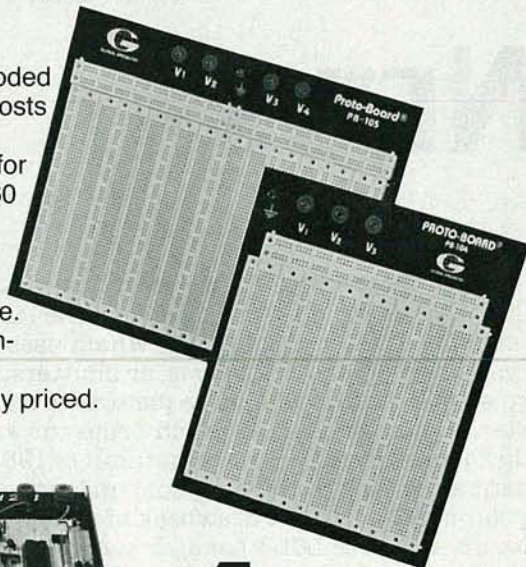

## 2. Stop wasting your time breadboarding.

Here are three popular PROTO BOARD® Brand solderless breadboarding systems that meet any budget or time schedule. First the diminutive PB-10's 840 contact points and 3-color binding posts. PB-102 has 1,240 tie points, accepting up to 12 16-pin ICs. Finally, PB-103, with 2,250 contact points, and up to 24 16-pin capacity. They're affordable, American-made, lifetime guaranteed. You'll soon see why PROTO BOARD Brand is Today's Standard for Quality in Breadboarding.



## 3. Stop wasting your time jury-rigging

**large numbers of circuits.** Here are two oversized PROTO BOARDS Brand, with expanded area, tie points, and more to keep your ideas together. PB-104 features 3,060 tie points, which can handle to 32 16-pin ICs with ease. Four color coded binding posts, and roomy 9.2" x 8" metal panel make it big...but simple. The humungous PB-105 lets you load up to 48 16-pin ICs, and much more onto its



## 5. NEW!

**Stop wasting time designing computer circuits.** Now you can use your solderless breadboard concepts for designing accessory circuits. PROTOCARD® is a PROTO BOARD Brand which fits any standard slot in your IBM, PC/XT or PC/AT computer. Some modules even include built-in basic decoder circuits for memory and I/O addressing. Breadboard areas up to 3,360 contact points. Buffered versions eliminate loading of pc buses.

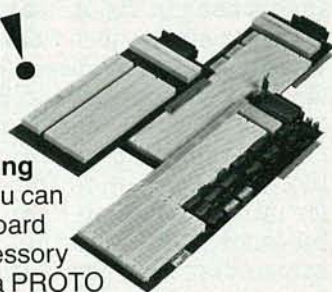

## 4. Stop wasting your time plugging-in external power.

We've added the power to the breadboard. And, what power! Up to triple voltage power, +5V, +12V, -12V, regulated/current limited and DC. Up to 2,250 tie points, with 24 IC capacity and 14 pin DIPs. Now you can create, test and modify TTL, CMOS, Op-Amps and even microprocessor circuits. Plus, there is the standard Global Lifetime Guarantee on the sockets. And, wait 'til you see the modest prices!



**GLOBAL SPECIALTIES**

*Easy does it!*



Call toll-free for details  
**1-800-572-1028**

Global Specialties. An Interplex Electronics Company.  
70 Fulton Terrace. New Haven, CT 06512.  
Telephone: (203) 624-3103. © Interplex Electronics 1989.  
All Global Specialties breadboarding products made in USA.

CIRCLE 193 ON FREE INFORMATION CARD

A0011

MARCH 1990

5



---

---

# VIDEO NEWS



**DAVID LACHENBRUCH,**  
CONTRIBUTING EDITOR

• **LCD projectors.** Some technologies advance slowly, some rapidly. An example of the latter seems to be LCD projection TV, which uses liquid-crystal devices as light valves, or shutters. Those projectors can throw a large picture on an external screen. The first such projector to be marketed, introduced in the autumn of 1988 by Eastman Kodak (now being sold under the Seiko Epson name), had the drawback of a very coarse picture. Its three LCD's (one for each primary color) had resolution of 70,400 pixels. Last year, Sharp introduced its own version with much improved performance, with resolution of about 89,500 pixels. Evolution continues with a high-resolution version jointly introduced in Japan by JVC and Seiko, which provides resolution of 210,000 pixels. The LCD projectors are still high-priced (\$3,500 to almost \$7,000), but many video engineers believe that the LCD lightvalve is the key to giant-screen TV's future.

• **Giant TV tubes.** At a time when many critics are saying that there is no American TV-receiver industry, worldwide television manufacturers are sharply increasing their investment in the United States to build giant-screen picture tubes here. Before the current wave of expansion began last year, the largest size picture tube produced in the U.S. was 27 inches, measured diagonally. Most of the expansion is in plants to manufacture tubes 30 inches and larger, in some cases with provisions for later conversion to production of widescreen tubes for *High-Definition TV* (HDTV). Major big-screen plants or additional facilities in the United States have been announced so far by Thomson Consumer Electronics (RCA and GE brands) to make 31- and 35-inch tubes; by Toshiba for 30- and 32-inch tubes; and by Philips (Philips, Magnavox, and Sylvania) for 27-inch tubes. Hitachi reportedly is seeking a plant in the United States to build giant tubes.

• **Interactive video.** Will the videodisc of the near future be based on the audio compact disc? Major developments seem to indicate that interactive audio-video discs with full realtime

motion are in the works. Two systems—both using standard five-inch CD's—are in competition. Although the *Compact Disc-Interactive* (CD-I) was the first to be announced, its video capabilities heretofore have been confined to still motion and very limited animation. A competing system called *Digital Video-Interactive* (DVI), developed at the Sarnoff Research Center and being prepared for production by Intel, claims full-motion, high-resolution video. Not to be outdone, Philips, one of the developers of CD-I, recently announced the breakthrough to 70 minutes of full-motion video. Both systems could be offered to the public late this year or early next year.

Intel is expected initially to aim DVI at computer users, while Philips, Sony, and others probably will push CD-I as a consumer-entertainment and -education medium. In addition to its interactive capabilities, the new type of video CD-ROM could become the first all-digital video product, eventually replacing the current 12-inch laserdisc (which has analog video and both analog and digital audio).

• **HDTV progress.** The tide is turning in American research on HDTV. The *Advanced Television System Committee* (ATSC), which is coordinating development and testing of proposed systems for the United States, notes that as tests get nearer many proposed systems are changing. The FCC has ruled that any American HDTV systems must be compatible with existing television, and that no system may use more than two 6-MHz channels. Most of the initial proposals envisioned the addition of a second "augmentation" channel to an existing conventional channel to add the extra lines of resolution and the "ears" for the wider picture. Now, ATSC Chairman James McKinney notes that most of the systems have switched to "simulcast" systems—those that leave the current conventional channels alone and add a separate 6-MHz channel to provide a complete HDTV picture. McKinney said recently that four of the five remaining proposals for HDTV systems envision simulcasting.

**R-E**



# Radio Shack Parts Place<sup>SM</sup>

## GREAT VALUES FOR YOUR PROJECTS AND FIX-UPS

### Parts Special-Order "Hotline"



ICs, Crystals, Tubes, Lots More!

Your Radio Shack manager can special-order a wide variety of parts and accessories from our warehouse—Long-Life tubes, linear and digital ICs, phono cartridges and stylis, crystals, transistors, diodes, even SAMS Photofacts®. No handling charge, no shipping charge—just fast delivery to the Radio Shack near you!

### Battery Special-Order Service



In addition to our large in-store stock, Radio Shack can now supply almost any battery manufactured! Batteries are sent from our warehouse to the Radio Shack near you. You never pay a postage charge!

### PC Cords & Multiconductor Cables

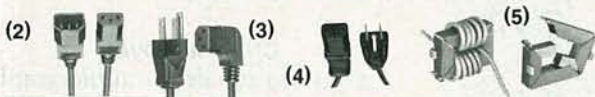

- (1) Double-Shielded Cable. 9-Cond. #278-775, 59¢ per ft. 25-Cond. #278-776, 1.19 per ft.
- (2) CEE-Type Power Cord Extension. #278-1259 . . . . . 4.99
- (3) Power Cord with 90° CEE Connector. #278-1260 . . . . . 5.99
- (4) PC Power Cord with Straight CEE Connector. #278-1257 . . . 3.99
- (5) Snap-Together RFI Choke Core. #273-104 . . . . . Pkg. of 2/7.95

### Replacement Rod Antennas

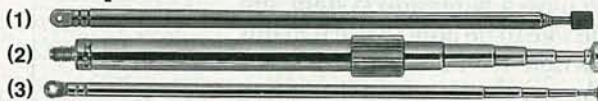
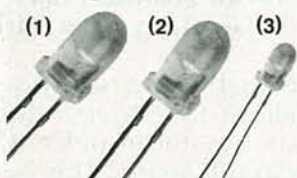

Fig.	Sections	Extended	Cat. No.	Each
1	5	30 1/2"	270-1401	2.99
—	4	34 3/4"	270-1402	3.69
—	3	39 1/2"	270-1403	3.89
2	6	11 1/4"	270-1411	2.99
—	2	16 1/2"	270-1412	2.79
—	9	24"	270-1413	3.99
—	5	13 1/2"	270-1414	2.49

Fig.	Sections	Extended	Cat. No.	Each
3	5	28"	270-1405	3.19
—	5	15 1/2"	270-1406	2.79
—	6	72"	270-1408	3.99
—	5	13"	270-1407	2.79
—	6	17 3/4"	270-1409	2.59
—	6	16"	270-1410	2.99

### Brighter LEDs



- (1) Red Jumbo. #276-086, 4.99
- (2) Red Blinking. #276-020, 3.99
- (3) Brilliant Red 2000 mcd. 20 mA/1.85VDC. #276-087 . . . . . 1.69

### Hot Hobby Items



- (1) 1.5-3V DC Motor. 8300 RPM. 1 1/2 x 1 5/16" dia. #273-223 . . . . . 99¢
- (2) Piezo Buzzer. #273-074, 2.99
- (3) 1:1 Audio Transformer. 600 to 900Ω. #273-1374 . . . . . 3.59

### Thermo Module



LCD F/C display. Use as thermometer or add simple circuitry to control fan, buzzer, heater. Programmable. #277-123 . . . . . 19.95

### Pocket Guides



- (1) Color Codes. It's all resistor, capacitor, and inductor values. #271-1210 . . . . . 69¢
- (2) Ohms Law/Parallel Resistance Slide Chart Calculator. #271-1211 . . . . . 59¢

### Grade Au + Plugs

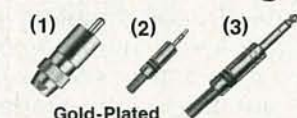

- (1) Deluxe Phono Plug. For 6mm OFC cable. #274-860 . . . . . 4.99
- 8mm Plug. #274-861 . . . . . 5.99
- (2) Three-Conductor 1/8" Phone Plug. Stereo. #274-858 . . . . . 3.49
- (3) Two-Conductor 1/4" Phone Plug. Monaural. #274-855 . . . 3.49

### Tantalum Caps



Low As **59¢**  
High Capacity

µF	WVDC	Cat. No.	Each
0.1	35	272-1432	.59
0.47	35	272-1433	.59
1.0	35	272-1434	.59
2.2	35	272-1435	.69
10	16	272-1436	.79
22	16	272-1437	1.19

### Solder Products

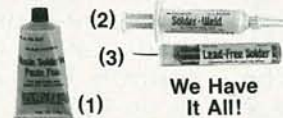

- (1) Rosin Soldering Paste Flux. #64-021 . . . . . 1.79
- (2) Solder-Weld Silver-Bearing Paste. #64-029 . . . . . 2.59
- (3) Lead-Free Solder Handy-Pak. .032", 0.25 oz. #64-025 . . . . . 1.99
- .062", 0.50 oz. #64-026 . . . . . 1.49

### Switch Values



- (1) SPST Momentary Pushbutton. 3A/125VAC. #275-1556, 1.99
- (2) Lighted SPDT Push-On/Off. 3A/125VAC. 12V lamp. #275-676 . . . . . 6.49

### 30-Range Multimeter

0.5" LCD Display **79<sup>95</sup>**



Built-in capacitor and transistor test functions make this an incredible value! Continuity sounder, low-battery indicator, diode checker. Measures to 1000 VDC and 750 VAC, 10 amps AC/DC, resistance, capacitance, transistor gain. Battery extra. #22-194 . . . . . 79.95

### High-Style Project Box



Give projects that professional look with this classy two-piece enclosure. Interlocking design lets you shorten box if desired. Polycarbonate material is impact resistant, yet easily drilled. Accepts PC board and 9V battery. 5 5/8 x 2 1/4 x 1 1/8". #270-257 . . . . . 4.99

### B-Board and Jumpers



- (1) Archer® Universal Breadboard. Molded 2 1/4 x 6 1/2" board on a 7 x 4" steel base, rubber feet. 640 plug-in points, three binding posts for fast circuit design. #276-169 . . . . . 19.95
- (2) Breadboard Jumper Wire Kit. Has 140 insulated wires in a handy snapshot plastic box. #276-173 . . . . . Set 4.95

Over 1000 items in stock! Binding Posts, Books, Breadboards, Buzzers, Capacitors, Chokes, Clips, Coax, Connectors, Fuses, Hardware, ICs, Jacks, Knobs, Lamps, Multitesters, PC Boards, Plugs, Rectifiers, Resistors, Switches, Tools, Transformers, Transistors, Wire, Zeners, More!

Prices apply at participating Radio Shack stores and dealers  
Battery-powered items exclude batteries

**Radio Shack**  
The Technology Store<sup>SM</sup>  
A DIVISION OF TANDY CORPORATION



# ASK R-E

WRITE TO:

ASK R-E  
Radio-Electronics  
500-B Bi-County Blvd.  
Farmingdale, NY 11735

## AUTO NINTENDO

We have a Nintendo system and would like to be able to use it in our van when we're traveling. Our small portable TV works fine when operating off the car's 12 volts, but the Nintendo requires 9 volts at about 850 milliamps. Is there anything that can be done to enable the Nintendo to be powered by the car's electrical system?—M. McCalla, Lanett, AL

There are lots of ways to do that, and which one you choose depends on how much work you want to make for yourself. The answers range from a simple store-bought solution to a few hours on the bench building a box of your own. The choice is yours.

If you're only interested in results, there's no doubt that the easiest thing to do is stop at your local electronics store and see what's hanging around on the shelves. The adapters should be fairly easy to find because they're also needed by people who want to run a compact disc player off the car's electrical system and that, as we all know, is a very popular thing to do.

There are two things to watch out for when you're shopping for an adapter. The first is that it can supply the correct voltage at the required current levels, and the second has to do with the mechanical connection at the power plug.

You shouldn't have any trouble finding an adapter that can supply the proper voltage and current since compact-disc players usually want about the same amount of power. Assuming that you do find one, be very careful to check the voltage polarity at

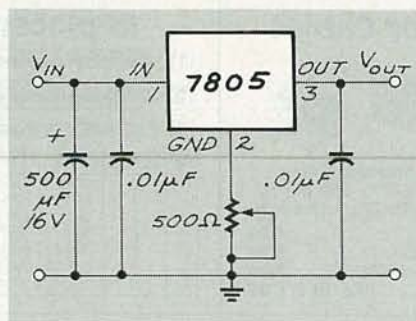

FIG. 1

the power plug. There's unfortunately no standard whatsoever about assigning plus and minus. Some adapters put ground on the center terminal and others put it on the collar. The polarity should be marked on the adapter, and your Nintendo probably has it embossed on the plastic case. Double-check everything with a meter before you make any connections. If it is backwards, cut the wire and splice it correctly. It would be a lot better to resolder it at the plug, but most of the adapters use molded plugs.

If you can't find an adapter in the store, you can build one using the circuit in Fig. 1. That is just a simple 7805 regulated supply with the ground leg lifted to raise the output voltage. You can get 850 mA out of a 7805, but you'll have to heat-sink it properly to avoid thermal shutdown. Build the circuit in a plastic box and rotate the pot until you find the point where it's putting out nine volts.

You can substitute an LM317 for the 7805 if you're really worried about drawing that much current, but a well-heat-sunk 7805 should be fine. And even though the Nintendo is rated for

850 mA, I doubt that it really requires that much.

## CHIP REMOVAL

I have to repair my audio amplifier and, after spending some time on the circuit, I'm pretty sure that the problem is a bad operational amplifier. My problem is that the chip, like all the others in the amplifier, is soldered directly to the board. What's the best way to get the chips off the board so I can test them?—F. Geoffrey, New York, N.Y.

As sad as I am to say this, I don't believe there's any absolutely safe way to unsolder IC's from a circuit board. The best way I know to get a chip off a board with the least risk of damage is to use a solder pot, a spring-loaded extractor, and a steady hand.

You'll need enough solder in the pot to form a meniscus on the top. Once the solder is melted, put the spring-loaded chip extractor under the IC and carefully lower the foil side of the board into the solder. As soon as the solder on the board melts, the chip should pop out of its holes. You'll probably wind up with some solder bridges on the board afterwards, but you can easily clean them up.

If the board is double-sided or, worse yet, a multilayer board, the chances of success with that method are going to go from so-so to just about nonexistent. Solder has a nasty habit of leaching its way into places where it shouldn't go, and the more layers there are, the more places the solder can creep.

I've removed IC's using that method but, no matter how care-



# How to build a high-paying career, even a business of your own, in computer programming.

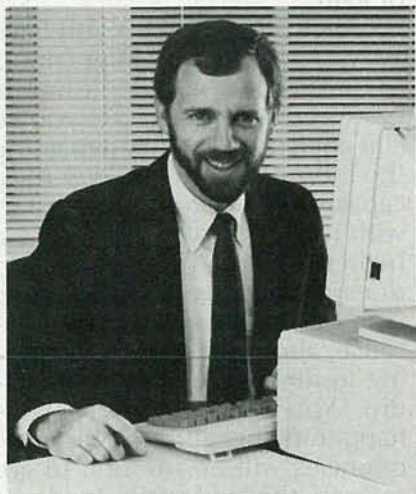

**RICK BRUSH,  
NRI PROGRAMMER/ANALYST**

**Start with training that gives you hands-on programming experience—at home and at your own pace. Training that begins with BASIC, then continues with Pascal, C, and COBOL—today's hottest computer languages. Training that even includes a powerful IBM-compatible computer, modem, and programming software you keep.**

**Start with real-world training. The kind of training only NRI provides.**

Now with NRI's new at-home training in Computer Programming, you can be one of today's highly paid, creative team of computer wizards who give computers the power to carry out an astonishing range of business, professional, and personal applications. Now, with NRI, you can be a computer programmer, ready to build a high-paying career—even a business of your own—making computers do anything you want them to do.

**The only programming course that includes a powerful computer system and software you keep.**

Unlike any other school, NRI gives you hands-on programming experience with a powerful IBM compatible West Coast computer system, including 2400



**Only NRI gives you an IBM-compatible computer with modem, 640K RAM, disk drive, monitor, and software—BASIC, Pascal, C, and COBOL—all yours to keep!**

baud internal modem, 640K RAM, disk drive, monitor, and invaluable programming software—BASIC, Pascal, C, and COBOL—all yours to keep.

You get the experience and the know-how, the computer and the software to get to the heart of every programming problem, design imaginative solutions, then use your choice of four key computer languages to build original, working programs.

**No matter what your background, NRI gives you everything you need to succeed in programming, today's top-growth computer career field.**

You need no previous experience to build a successful programming career with NRI training. Indeed, your NRI lessons start by walking you step by step through the fundamentals, giving you an expert understanding of the programming design techniques used every day by successful micro and mainframe programmers. And then the fun really begins.

C, and COBOL. Then, rounding out your training, you use your modem to "talk" to your instructor, meet other NRI students, even download programs through NRI's exclusive programmers network, PRONET.

**Your career in computer programming begins with your FREE catalog from NRI.**

For all the details about NRI's at-home training in Computer Programming, send the coupon today. Soon you'll receive NRI's fascinating, information-packed, full-color catalog.

Open it up and you'll find vivid descriptions of every aspect of your NRI training. You'll see the computer system included in your course up close in a special, poster-sized foldout section. And, best of all, you'll find out how your NRI training will make it easy for you to build that high-paying career—even a business of your own—in computer programming.

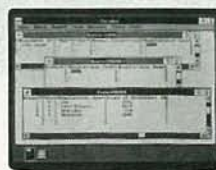

**You master today's hottest computer languages, gaining the skills you need to build programs for a wide variety of real-world applications.**

With your personal NRI instructor on call and ready to help, you use your computer and software to actually design, code, run, debug, and document programs in BASIC, Pascal,

**Send for your NRI catalog today. It's yours, free.**

If the coupon is missing, write to us at the NRI School of Computer Programming, McGraw-Hill Continuing Education Center, 4401 Connecticut Avenue, NW, Washington, DC 20008.

IBM is a Registered Trademark of the IBM Corporation

## **NRI School of Computer Programming**

McGraw-Hill Continuing Education Center  
4401 Connecticut Avenue, NW  
Washington, DC 20008



**YES! Please rush me my FREE catalog describing NRI's at-home training in Computer Programming.**

NAME \_\_\_\_\_ (please print) AGE \_\_\_\_\_

ADDRESS \_\_\_\_\_

CITY/STATE/ZIP \_\_\_\_\_ Accredited by the National Home Study Council 5415-030



ful I am, my success rate has never been any more than fifty percent. As a result, there's no way to be sure that a removed IC that tests bad wasn't destroyed in the act of removing it from the board.

If you suspect an IC of being bad, you're better off upgrading your suspicion to a certainty, and give up the idea of safely unsoldering the chip. Take a pair of cutters, snip the legs as close to the IC body as possible, and un-

solder each leg from the board. Once you do that, you can clean the board, solder in an IC socket, and replace the chip with one you know is good.

#### OVERPOWERING AM

**Every time I turn on my stereo I can hear a local AM station in the background. Is there anything I can do to get rid of it?—J. Saffir, Miami, FL**

You can buy the station and close it down, but that's probably

not what you had in mind. The reason that you're hearing the station is because the RF is being picked up by one of the early stages of your amplifier—usually one of the preamp sections, such as the phono input, that has lots of gain.

Check all the cables you have attached to the amplifier inputs to be sure that you don't have a broken ground wire. If you've still got a problem, try bypassing the inputs with small silver-mica capacitors. A good value to start with is 10 pF, but you can use a higher value if the radio station doesn't disappear completely. Don't go much over 470 pF because, above that, you'll be starting to filter out some of the audio. You'll know when that's happening because the high frequencies will be the first to go.

Keep the capacitor leads as short as possible or you'll be making the problem even worse. As a matter of fact, solder the leads right on the lugs of the connector inside the amplifier—and don't forget to turn off the power before you open the case. To be on the safe side, unplug the amplifier from the wall as well as turning it off.

#### VCR CONVERSION

**I recently returned from a posting in England, and I brought back a VCR that I bought there. The machine is set to work off 240 volts at 50 cycles, so I can't use it here. Since it's a really good VCR without many hours of use, can you give me an easy way of converting it to work here in the USA?—C. Meyer, Washington, DC**

Aside from ripping out the entire guts of the machine, and replacing them with American-standard parts, there is no simple solution. Not only are the power requirements different, but the electronics in the machine are designed to work with the English PAL video standard, and not the American NTSC standard. To put it mildly, the two are somewhat different. It would actually be a lot simpler and cheaper to go out and buy the VCR that you need, rather than try to modify one type of VCR to work with the other format. **R-E**

## OPTOELECTRONICS

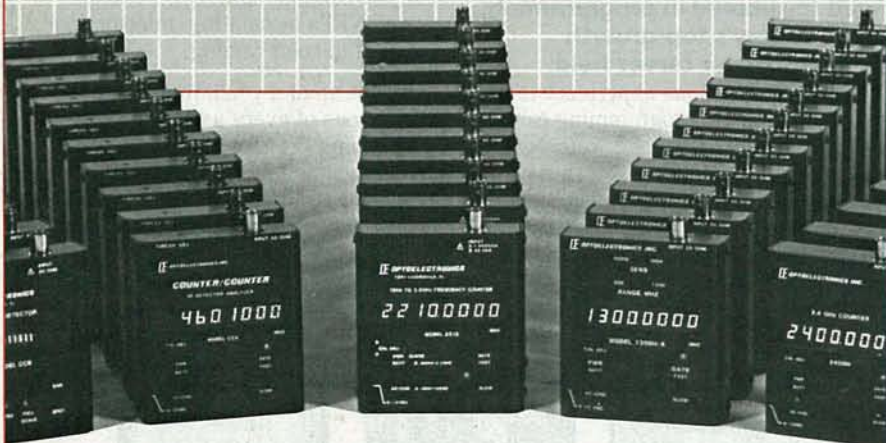

### You Have Counted on Us for 15 Years

You have counted on OPTOELECTRONICS Hand Held Frequency Counters to be the best quality, to be affordable and reliable. We have been there for you with Frequency Counters that are compact and ultra sensitive.

And more and more of you are counting on us, technicians, engineers, law enforcement officers, private investigators, two-way radio operators, scanner hobbyists, and amateur radio operators, just to name a few.

#### Hand Held Series Frequency Counters and Instruments

MODEL	2210	1300H/A	2400H	CCA	CCB
RANGE: FROM TO	10 Hz 2.2 GHz	1 MHz 1.3 GHz	10 MHz 2.4 GHz	10 MHz 550 MHz	10 MHz 1.8 GHz
APPLICATIONS	General Purpose Audio-Microwave	RF	Microwave	Security	Security
PRICE	\$219	\$169	\$189	\$299	\$99
SENSITIVITY					
1 KHz	< 5 mv	NA	NA	NA	NA
100 MHz	< 3 mv	< 1 mv	< 3 mv	< .5 mv	< 5 mv
450 MHz	< 3 mv	< 5 mv	< 3 mv	< 1 mv	< 5 mv
850 MHz	< 3 mv	< 20 mv	< 5 mv	NA	< 5 mv
1.3 GHz	< 7 mv	< 100 mv	< 7 mv	NA	< 10 mv
2.2 GHz	< 30 mv	NA	< 30 mv	NA	< 30 mv

ACCURACY ALL HAVE +/- 1 PPM TCXO TIME BASE.

All counters have 8 digit red .28" LED displays. Aluminum cabinet is 3.9" H x 3.5" x 1". Internal Ni-Cad batteries provide 2-5 hour portable operation with continuous operation from AC line charger/power supply supplied. Model CCB uses a 9 volt alkaline battery. One year parts and labor guarantee. A full line of probes, antennas, and accessories is available. Orders to U.S. and Canada add 5% to total (\$2 min, \$10 max). Florida residents, add 6% sales tax. COD fee \$3. Foreign orders add 15%. MasterCard and VISA accepted.

Orders to U.S. and Canada add 5% to total (\$2 min, \$10 max). Florida residents, add 6% sales tax. COD fee \$3. Foreign orders add 15%. MasterCard and VISA accepted.

#### OPTOELECTRONICS INC.

5821 N.E. 14th Avenue • Fort Lauderdale, Florida 33334  
1-800-327-5912 FL (305) 771-2050 FAX (305) 771-2052



# What's better than speed reading? *Speed Learning.*

Speed Learning has replaced speed reading. It's a whole new way to read and learn. It's easy to learn...lasts a lifetime... applies to everything you read. It may be the most productive course you've ever taken.

Do you have too much to read and too little time to read it? Do you mentally pronounce each word as you read? Do you frequently have to go back and reread words, or whole paragraphs, you just finished reading? Do you have trouble concentrating? Do you quickly forget most of what you read?

If you answer "Yes" to any of these questions — then here at last is the practical help you've been waiting for. Whether you read for business or pleasure, school or college, you will build exceptional skills from this major breakthrough in effective reading, created by Dr. Russell Stauffer at the University of Delaware.

**Not just "speed reading" — but speed reading — thinking — understanding — remembering — and — learning**

The new *Speed Learning Program* shows you, step-by-proven step, how to increase your reading skill and speed, so you understand more, remember more and use more of everything you read. The typical remark from over one million people taking the Speed Learning program is, "Why didn't someone teach me this a long time ago." They were no longer held back by their lack of skills and poor reading habits. They could read almost as fast as they could think.

### What makes Speed Learning so successful?

The new *Speed Learning Program* does not offer you a rehash of the usual eye-exercises, timing devices, and costly gadgets you've probably heard about in connection with speed reading courses, or even tried and found ineffective.

In just a few spare minutes a day of easy reading and exciting listening, you discover an entirely new way to read and think — a radical departure from anything you have ever seen or heard about. Speed Learning is the largest selling self-study reading program in the world. Successful with Fortune 500 corporations, colleges, government agencies and accredited by 18 professional societies. Research shows that reading is 95% *thinking* and only 5% eye movement. Yet most of today's speed reading programs spend their time teaching you rapid eye movement (5% of the problem), and ignore the most important part, (95%) *thinking*. In brief, *Speed Learning gives you what speed reading can't.*

Imagine the new freedom you'll have when you learn how to dash through all types of reading material at least twice as fast as you do now, and with greater comprehension. Think of being able to get on top of the avalanche of newspapers, magazines and correspondence you have to read...finishing a stimulating book and retaining facts and details

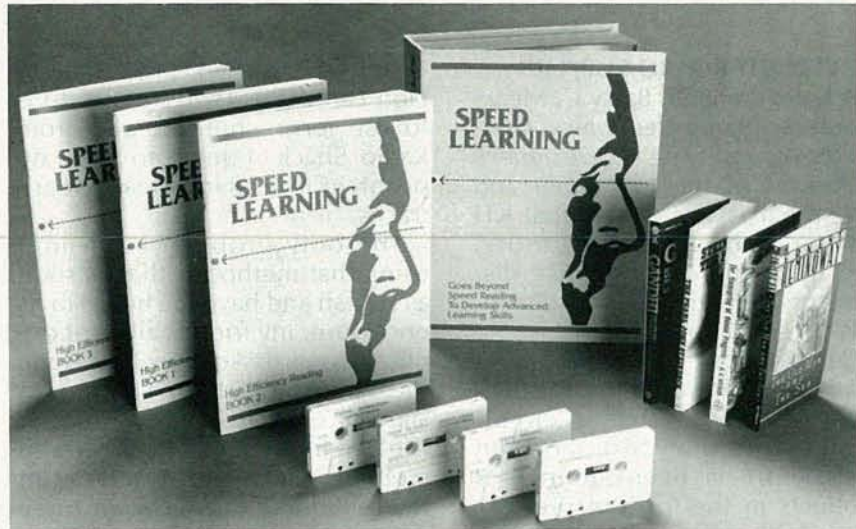

**FOR FASTER SHIPMENT CALL 1-800-729-7323 OR FAX 1-609-273-7766**

more clearly, and with greater accuracy, than ever before.

### Listen — and learn — at your own pace

This is a practical, easy-to-learn program that will work for you — no matter how slow a reader you think you are now. The *Speed Learning Program* is scientifically planned to get you started quickly...to help you in spare minutes a day. It brings you a "teacher-on-cassettes" who guides you, instructs, and encourages, explaining material as you read. Interesting items taken from *Time Magazine*, *Business Week*, *Wall Street Journal*, *Money*, *Reader's Digest*, *N.Y. Times* and many others, make the program stimulating, easy and fun...and so much more effective.

### \*Special Engineering Edition

This special edition includes the basic *Speed Learning* program plus a supplement that focuses on the type of reading you do every day. After you've mastered the basics, you'll advance to the Science/Engineering supplement, where you'll apply your new skills to reading materials and exercises taken from professional publications in your field.

### Examine Speed Learning RISK FREE for 15 days

You will be thrilled at how quickly this program will begin to develop new thinking and reading skills. After listening to just one cassette and reading the preface, you will quickly see how you can achieve increases in both the speed at which you read, and in the amount you understand and remember.

You must be delighted with what you

see, or you pay nothing. Examine this remarkable program for 15 days. If, at the end of that time you are not convinced that you would like to master Speed Learning, simply return the program for a prompt refund. (See the coupon for low price and convenient credit terms.)

### RISK FREE ORDER FORM

**YES!** I want to try Speed Learning Engineering Edition for 15 days without risk. Enclosed is the first of 4 monthly payments of \$36.25.\* If I am not completely satisfied, I may return it for a prompt refund.

**SAVE \$7.00!** I prefer to pay the \$145.00 now, and save the \$7.00 shipping & handling charge. I may still return the program for a full refund.

**Method of payment:** (Federal Tax Deductible)

Check or money order payable to Learn Incorporated

Charge to:  Visa  MC  AmEx  Discover

Card # \_\_\_\_\_ Exp. \_\_\_\_\_

Signature \_\_\_\_\_

Phone (\_\_\_\_) \_\_\_\_\_

Name \_\_\_\_\_

Address \_\_\_\_\_

City \_\_\_\_\_ State \_\_\_\_\_ Zip \_\_\_\_\_

\*Plus \$7.00 shipping and handling. For New Jersey residents, sales tax will be added.

Radio Electronics Dept. CA-02, 113 Gaither Drive, Mt. Laurel, NJ 08054-9987



# LETTERS



## CIRCUIT-BOARD SUPPLIES

A letter from Dr. Barry C. Mears ("Letters," *Radio-Electronics*, January 1990), referring to *Designer's Notebook* in the November and December issues, stated that KTI sells only through distributors, and that only one of those distributors sells the "Kodak chemicals" in small quantities.

Kepro Circuit Systems supplies anything and everything for people to produce printed-circuit boards on a prototype or short-run basis. Kepro has been offering KPR products in the form of pre-sensitized CopperClad since 1954, and has been distributing quarts of the KPR-3 Photo Resist, along with all the associated KPR products, since the late 1960's. All of their supplies and products are described in a 32-page catalog. Kepron's phone numbers are 314-343-1630 in Missouri, or 800-325-3878 out of state. KEPRO CIRCUIT SYSTEMS, INC. 630 Axminster Drive Fenton, MO 63026-2992

## SIMPLE CIRCUIT BOARDS

I would like to comment on "Hardware Hacker" (*Radio-Electronics*, December 1989). I take exception to some of Don Lancaster's views on creating etched circuit boards.

I have been designing and etching circuit boards—as, I expect, have many of your readers—for over 12 years. I have tried all the available methods, and have read most of the articles on the subject in electronics magazines.

I have found that the quickest method is the direct method using Radio Shack Dry Transfers (276-1577). It works great for single-sided boards as long as you burnish the design when finished.

One of the "stupid" (according to Don Lancaster) things that I do is to use ferric chloride, also from Radio Shack. I seem to have no problem producing clean, sharp traces.

The only problem I run into using that method is that as soon as I finish and have the board in its enclosure, my friends all want duplicate boards so they can build the same project, so I'd have to start all over again. Not on your life! Instead I use the second method, which is to screen print the board and make two or three extras.

With the proper registration I can produce single- or double-sided boards with excellent results. The second "stupid" thing that I do is to etch the boards with the resist side up in a glass or plastic container. I have never yet had a board come out bad. The only time they've been bad is when I've flipped the board resist-side down and the resist has become scratched and left a gap in the traces.

If any of your readers are interested, I have available an instructional video tape that shows the hows and whats of screen-printing circuit boards. For information, send an SASE to:

FRED AYRES  
4423 West 69  
Brooklyn, OH 44144

## PROBLEM-FREE PC BOARDS

One of the features that I always look forward to reading in *Radio-Electronics* is "Hardware Hacker," but after reading that column in the December issue I must protest. Don Lancaster's diatribes will certainly scare away more printed-circuit-board makers than create them.

Mr. Lancaster must have had some bad experience making PC boards by the direct method, but the method is not (as he says) "... more hassle than it is worth, and ends up just about totally worthless." I have made many circuit boards, all by the direct method, and have not had a single failure. All are one-of-a-kind, and were made in a lot less time than if I had used any of his recommended alternative methods. Contrary to what Mr. Lancaster says, one problem is to get the pattern on the copper with something that will truly resist the etching solution. Fingerprints, etc., won't hack it. I've had bad results on test pieces from the commercial inking pens and ended up using shellac tinted with an organic dye. It is cheap, easy to use, and easy to clean off the boards.

Mr. Lancaster says that at one time ferric chloride was used as the etchant. Ferric chloride is still being used by the majority of modern commercial circuit-board manufacturers—and by me. It is efficient and has an indefinite storage life, even though it does stain. From what I have read, ammonium persulfate has a short life and must be purchased from new stocks.

Scrubbing circuit-board material at 2 minutes per square inch is a ridiculous waste of time. A few seconds with a kitchen sponge and Comet cleanser does the job very well. I almost always etch boards face-up, unless I am reusing some old solution and the volume is not enough to cover the board very well. (And, when I make a double-sided board, one side necessarily will be face up.) I etch the boards in rectangular Pyrex baking dishes. I find that if the solution is kept moving, there



# HITACHI SCOPES AT DISCOUNT PRICES

## Digital Storage Scopes



VC-6025 20MS/S  
50MHz Bandwidth  
2K Word Memory  
Capacity  
**\$2349.00**

Advanced storage functions create new dimensions in scopes such as one shot observation, flicker free display, bright display for even high speed event, trace observation for low speed event, hard copy by plotter and data output to computer.

VC-6045 100MHz 40MS/S 4K word Memory cap (call)

All Hitachi scopes include probes, schematics, and Hitachi's 3 year worldwide warranty on parts and labor. Many accessories available for all scopes.



V-212

**\$435**  
List \$595  
Save \$160  
DC to 20MHz  
Dual Channel



V-1060  
List \$1595 **\$1,359**

- DC to 100MHz
- Dual Channel
- Delayed Sweep
- CRT Readout
- Sweep Time
- Autoranging
- Trigger Lock
- 2mV Sensitivity

V-422	40MHz	D.T., 1mV sens, DC Offset Vert Mode Trigger, Alt Mag	\$940	\$740	\$200
V-423	40MHz	D.T., 1mV sens, Delayed Sweep, DC Offset, Alt Mag	\$1,025	\$825	\$200
V-425	40MHz	D.T., 1mV sens, DC Offset, CRT Readout, Cursor Meas	\$1,070	\$849	\$221
V-660	60MHz	D.T., 2mV sens, Delayed Sweep, CRT Readout	\$1,295	\$1,145	\$150
V-1065	100MHz	D.T., 2mV sens, Delayed Sweep, CRT Readout, Cursor Meas	\$1,895	\$1,670	\$225
V-1100A	100MHz	Q.T., 1mV sens, Delayed Sweep, CRT Readout, DVM, Counter	\$2,450	\$2,095	\$355
V-1150	150MHz	Q.T., 1mV sens, Delayed Sweep, Cursor Meas, DVM, Counter	\$3,100	\$2,675	\$425

LIST	PRICE	SAVE
\$940	\$740	\$200
\$1,025	\$825	\$200
\$1,070	\$849	\$221
\$1,295	\$1,145	\$150
\$1,895	\$1,670	\$225
\$2,450	\$2,095	\$355
\$3,100	\$2,675	\$425

# ELENCO PRODUCTS AT DISCOUNT PRICES

## 20MHz Dual Trace Oscilloscope



**\$375**  
MO-1251

- 6" CRT
- Built in component tester
- TV Sync

## FREE DMM

with purchase of  
ANY SCOPE

### SCOPE PROBES

P-1 65MHz, 1x, 10x	\$19.95
P-2 100MHz, 1x, 10x	\$23.95

## 35MHz Dual Trace Oscilloscope



**\$495**  
MO-1252

- High luminance 6" CRT
- 1mV Sensitivity
- 6KV Acceleration Voltage
- 10ns Rise Time
- X-Y Operation • Z Axis
- Delayed Triggering Sweep

Top quality scopes at a very reasonable price. Contains all desired features. Two 1x, 10x probes, diagrams and manual. Two year guarantee.

## PRICE BREAKTHRU on Auto Ranging DMMs



3 to choose from:  
MDM-1180 **\$24.95**  
MDM-1181 **\$27.95**  
MDM-1182 **\$29.95**

- 3 1/2 LCD Display
- 27 Functions
- Auto/Manual Ranges
- Audible Continuity
- Data Hold (MDM-1182)
- .1% Accuracy (MDM-1181)



True RMS 4 1/2 Digit Multimeter  
**\$135** M-7000

.05% DC Accuracy  
.1% Resistance with Freq. Counter and deluxe case



Multimeter with Capacitance and Transistor Tester  
**\$55** CM-1500

Reads Volts, Ohms, Current, Capacitors, Transistors and Diodes with case

## Digital Capacitance Meter



CM-1550  
**\$58.95**

9 Ranges  
.1pf-20,000ufd  
.5% basic accy  
Zero control with case



LC-1801  
**\$125**

Measures Coils 1uH-200H  
Caps .1pf-200uf  
Res .01-20M

## Bench DMMS



M-3500 **\$125** M-4500 **\$175**  
3 1/2 digit .1% accy 4 1/2 digit .05% accy



AC Current Meter  
ST-1010  
**\$69.95**

1000 Amps Data&Peak Hold  
8 Functions  
Deluxe Case

## Solderless Breadboards



9430 1,100 pins **\$15**  
9434 2,170 pins **\$25**  
9436 2,860 pins **\$35**  
All have color coded posts

9436 SHOWN

## AC Clamp-On



Current Adapter  
ST-265  
**\$25.00**

0-1000A AC Works with most DMM

## Wide Band Signal Generators



SG-9000 **\$129**  
RF Freq 100K-450MHz  
AM Modulation of 1KHz  
Variable RF output

SG-9500 with Digital Display and 150MHz built-in Freq Ctr **\$249**



AUDIO GENERATOR  
SG-9200  
**\$129**

Low distortion (<.05%)

10-1MHz Sine/Square Wave  
600 ohm Output Impedance, High Output Voltage

## Function Generator Blox



#9600 **\$28.95**

Provides sine, tri, squ wave from 1Hz to 1MHz  
AM or FM capability

## Decade Blox



#9610 or #9620 **\$18.95**

#9610 Resistor Blox 47 ohm to 1M & 100K pot  
#9620 Capacitor Blox 47pf to 10MFD

## Digital Triple Power Supply



XP-765  
**\$249**

0-20V at 1A  
0-20V at 1A  
5V at 5A

Fully Regulated, Short circuit protected with 2 Limit Cont., 3 Separate supplies

XP-660 with Analog Meters **\$175**

## Quad Power Supply



XP-580  
**\$59.95**

2-20V at 2A  
12V at 1A  
5V at 3A  
-5V at 5A

Fully regulated and short circuit protected

XP-575 without meters **\$39.95**

## AM/FM TRANSISTOR RADIO KIT with TRAINING COURSE

Makes a great school project Model AM/FM-108

14 Transistors ♦ 5 Diodes **\$26.95**

Circuits are laid out in systematic order on an oversized PC board for easy understanding of the flow of radio signals, from antenna to speaker. Complete course includes all parts, PC board and training manual. When completed you will be proud to display your masterpiece.

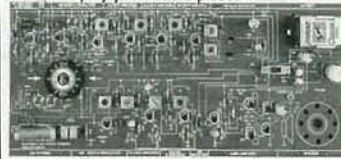

7 Transistor AM RADIO KIT **\$16.95**

## Four-Function Frequency Counters



F-100 120MH **\$179**  
F-1000 1.2GH **\$259**

Frequency, Period, Totalize, Self Check with High Stabilized Crystal Oven Oscillator, 8 digit LED display

## GF-8016 Function Generator with Freq. Counter



**\$249**

Sine, Square, Triangle Pulse, Ramp, .2 to 2MHz  
Freq Counter .1 - 10MHz

GF-8015 without Freq. Meter **\$179**

**WE WILL NOT BE UNDERSOLD!**  
UPS Shipping: 48 States 5%  
(\$10 Max) IL Res., 7% Tax



**C & S SALES INC.**  
1245 Rosewood, Deerfield, IL 60015  
(800) 292-7711 (708) 541-0710

**15 Day Money Back Guarantee**  
**2 Year Warranty** Prices subject to change  
**WRITE FOR FREE CATALOG**



is no problem at all doing it face up.

I haven't had any direct experience with sensitized boards, but friends have sensitized their own boards and had satisfactory results. They say it was simple, and there were no problems. I have two board designs that I want to make about 60 boards from, and I hope to do it with silk screen—otherwise it will be with commercially sensitized boards.

KENNETH E. STONE  
Cherryvale, KS

### COMPARING CD PLAYERS

The "Audio Update" column in the December 1989 issue of **Radio-Electronics** left the reader with the impression that all CD players sound the same and the only important thing to consider when selecting a player is the features. While Larry Klein did state that in the ABX test conducted in *Stereo Review*, all of the players were in the \$750–\$2500 price range, an important point that was not empha-

### CORRECTION

In Fig. 2, in the "RGB-to-NTSC Converter" story (**Radio-Electronics**, December 1989), the junction of XTAL1 and C3 should not be connected to any other components. In Fig. 5, the video output connector pins were mislabeled. Pin 1 should be 4, 5 should be 8, and 9 should be 12. Incidentally, the circuit will not run with EGA.

sized. I agree that when comparing CD players in a particular price range they will all sound essentially alike. However, a "top-of-the-line," \$1500 unit will always sound different (i.e., better) than a \$300 model. That is due to several factors—probably the most important is that the \$1500 model most likely will use dual digital-to-analog convertors (18 bits or more) with at least 8× oversampling, while the \$300 model probably will use a single D/A convertor (14 or 16 bits) with only 2× oversampling.

Even the casual listener would be able to differentiate between the two players.

I thought that point needed to be brought up. I enjoy Mr. Klein's column.

DWAYNE ROSENBURGH  
Elkridge, MD

### ETCHING-TANK TIPS

First I'd like to say that I enjoy **Radio-Electronics** very much. I'd like to suggest a better way of working the Plexiglas material used in the article "Make Your Own Etching Tank" (**Radio-Electronics**, December 1989). If you cut the plastic as described in the article, you probably found out that a considerable amount of filing or sanding was needed to produce the square edge needed for a good solvent-weld joint. The "score-and-break" cutting method is perfectly fine if you are making plastic window panes, but it makes a messy edge for solvent-welding purposes.

The remarks in the article about

## MOVIE TIME

### CABLE CONVERTERS

NEW!

<p>78 Channel Wireless Remote • Remote Fine Tuning • Parental Control 10 dB Amplifier Favorite Channel Memory • Fine Tune Centering 24 MONTH WARRANTY</p>			
<p>(#1) V7800-3 V7800-2</p> <p>15 Lot <b>\$62.95</b> 10 Lot <b>\$64.95</b> (3-9) \$69.95 (1-2) \$89.95</p>		<p>(#2) with Volume &amp; Mute Control Last Channel Recall Audio...Output * Decoder Loop</p> <p>10 Lot <b>\$79.95</b> (3-9) \$89.95 (1-2) \$109.95</p>	
<b>JERROLD</b>			
<p>(#3) <b>JERROLD - 450</b> 68 Channels Automatic Fine Tune Rebuilt Ch. 3 Only 90 Day Warranty</p> <p>(3-9) \$63.95 (1-2) \$73.95</p>	 <p>10 Lot <b>\$53.95</b></p>	<p>(#4) <b>JERROLD - JSX</b> 36 Channels Fine Tuning Rebuilt Ch. 3 Only 90 Day Warranty</p> <p>(3-9) \$34.95 (1-2) \$39.95</p>	 <p>10 Lot <b>\$29.95</b></p>
<p><b>MOVIE TIME REPLACEMENT HAND UNITS</b></p> <p><b>\$14.95</b> 24 Lot</p> <p>Single Lot \$24.95</p> <p>#6 JERROLD-550 #7 JERROLD-450 #9 JERROLD-400 #10 TEXSCAN AND MORE (13-23) \$16.95 (2-12) \$19.95</p>	<p>(#5) <b>HAMLIN - 4000</b> 42 Channels Fine Tuning Wired Remote or Set top Rebuilt Ch. 2 Only 90 Day Warranty</p> <p>(3-9) \$34.95 (1-2) \$39.95</p>	 <p>10 Lot <b>\$29.95</b></p>	
<p>ALL OF THE ABOVE CABLE CONVERTERS ARE COMPATIBLE WITH ALL CABLE DECODERS * NONE OF THE ABOVE UNITS ARE CABLE DECODERS</p>			
<p><b>MOVIE TIME</b> 20203 N.E. 15th Court • Miami, FL 33179 FAX: (305) 653-8102</p> <p>For More Information Call For Orders Only Call <b>1-305-652-1981 1-800-843-9845</b></p>		<p>Minimum Shipping Charge \$6.50 + \$1.00 for ea. additional converter or .25 for ea. Hand Unit. BLUE Label 2nd day air; \$12.50 Min. + \$3.50 for additional converter, or .80 for ea. Hand Unit. RED Label 1st day air; \$18.50 Min. + \$3.50 for additional converter, or \$1.00 for ea. Hand Unit. Puerto Rico, Hawaii &amp; Alaska add \$5.00. No COD Orders will be shipped by Air. Shipping Charges are not Refundable.</p> <p>C.O.D.   </p>	



sawing the material are true—but the problem is easy to overcome. To make a good solvent-welding joint, the smoother the cut the better. The smoothest cutting line can be accomplished by sawing with a very fine-tooth blade in a power saw with a rip fence. The melting problem can be overcome by keeping it cool with water. Don't worry about being electrocuted; you only need a little water, not a garden-hose full. A pump-spray bottle will do fine. The surface of the Plexiglas need only be kept wet enough so that a small puddle stays around the saw blade or drill bit. Be sure not to push the saw too hard—let the saw do the work.

That cutting method will create an edge that requires a lot less filing for a good welding surface and a water-tight joint.

STUART D. HARDEE  
Loris, SC

#### WHEN LESS IS MORE

I would like to comment on Michael Catudal's letter ("Letters," *Radio-Electronics*, December 1989). While I agree with Mr. Catudal that your magazine should feature more articles on new technology, especially some of the newer chips, I disagree that all of the featured projects should be based on the latest state-of-the-art technology.

Many years ago, when I was an engineering student, I remember a professor saying that an engineer's task will be to find the minimum of means that will solve the problem. As an example, he said, anyone could send out a 16-ounce hammer for a crew to use to drive carpet tacks—but an engineer would be expected to send out the lightest hammer that could do the job. My boss would really think I was nuts if I used an 80960 with four 27C1024's to solve a problem that an 8039 with a 2716 could handle sufficiently.

Even though I don't build them, I find many unique and time-saving hints and circuits in most of the projects in *Radio-Electronics*. I've used many of those circuits, time and time again, in designs. Keep up the good work.

CHARLES J. MANCUSO  
Sandpoint, ID

R-E

## NEXT MONTH IN Popular Electronics

### Exciting Features, Projects, Reports, & Columns

- **BUILD A REACTION TIMER**  
Use it as a game of skill, or to help you improve your reaction time.
- **BUILD A CUSTOM SECURITY SYSTEM**  
An expandable, adaptable alarm that can be used to protect your home, car, or boat.
- **THE TRANSFORMERLESS POWER SUPPLY**  
High-voltage output, high-current capacity, and no bulky transformer.
- **REVIVING A RELIC**  
Can't afford a new top-of-the-line SW receiver? Then get almost-as-good performance with one of yesterday's workhorses.



### And there is more!

**PRODUCT REVIEWS**—Yamaha TX-1000U AM/FM Stereo Tuner, Audio-Technica ATH-909 Stereo Headphones, and much more.

**DX LISTENING**—Shortwave fare from our northern neighbors.

**COMPUTER BITS**—Pushbutton computing comes to the PC.

**CIRCUIT CIRCUS**—Infrared remote-control circuits for any application.

**HAM RADIO**—Can't find a tuning coil for a special project? Then why not make your own!

**SCANNER SCENE**—Scanning above 800 MHz.

PICK UP Popular Electronics AT YOUR FAVORITE NEWSSTAND, CONVENIENCE STORE, OR SUPERMARKET.

MARCH 1990



# EQUIPMENT REPORTS

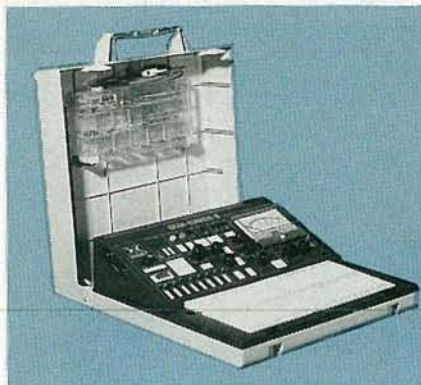

## *Jameco Electronics Wishmaker II Prototype Design Station*

*A portable, self-contained  
prototyping station to make  
your design wishes come  
true!*

CIRCLE 38 ON FREE INFORMATION CARD

THERE IS NO QUESTION THAT PROTOTYPING requires organization. While engineers are seldom noted for neatness, they'll be the first to acknowledge the importance of making a neat prototype. There's a simple reason for that: When the circuit doesn't work the first time, a clean prototype is much easier to troubleshoot.

If, despite your best intentions, your circuit prototypes seem to always end up in a tangled mess, you might need some help from the *Wishmaker II* Digital Prototype Design Station from Jameco Electronics (1355 Shoreway Road, Belmont, CA 94002).

The *Wishmaker II* combines a breadboard with power supplies, test equipment, and more in a convenient and portable package. The entire package is housed in a square, briefcase-like plastic case that measures  $13\frac{1}{2} \times 14 \times 4\frac{3}{4}$  inches. The case opens to reveal a large, removable solderless breadboard with more than 3500 tie points. Above the breadboard is a sloped panel containing various test and measurement equipment. The case top, which is removable, holds a box of assorted stripped and pre-formed jumpers, and a set of test leads.

The *Wishmaker II* offers four separate power supplies. Fixed supplies deliver +5 volts at 3 amps and -5 volts at 500 milliamperes. Variable supplies deliver +1.2 volts to

+15 volts and -1.2 volts to -15 volts at 500 milliamperes.

### **Built-in testing**

The output of the supplies, or the output of any circuit you build, can be monitored using several built-in test instruments. For example, an analog multimeter can measure DC and AC volts (250 volts maximum), DC current (250 milliamperes maximum) and resistance.

Your circuits can also be monitored with the built-in logic probe; red, green, and yellow LED's indicate logic highs, lows, and pulses. Input to the probe can be provided to either a tie-point socket or to a test probe.

A three-digit frequency counter can measure signals to 999 MHz in three ranges. Input to the probe is provided to a tie-point socket.

Two BCD-to-7-segment decoder/drivers are provided to display the outputs of digital circuits. Binary inputs are automatically converted for display on 7-segment LED's. While such a circuit would be easy enough to build on the breadboard, its inclusion on the top panel helps to keep the breadboard clutter to a minimum.

Along with the monitoring equipment, *Wishmaker II* provides several devices to provide inputs for your circuits. The simplest is a bank of eight 3-way toggle switches, that can be manually switched to provide high, low, and

floating inputs. The switches are arranged so that in the "up" position, the output is high, and so on. However, to monitor the outputs, you might want to use the eight LED display drivers. The bi-color LED's turn red with a high level is presented to their inputs, and green when a low is presented.

The *Wishmaker II* can also provide pulses to your circuits. Two pulse switches provide de-bounced pulses. Each switch has two outputs, one normally low, and the other normally high; pressing the switch causes the low output to go momentarily high, and vice versa. A pulse generator provides 50% duty-cycle pulses. Seven discrete frequencies are available, ranging from 1 Hz to 1 MHz.

A signal generator provides sine, square, and triangle outputs from 1 Hz to 100 kHz in 5 ranges. Unlike the pulse generator, the output is continuously adjustable. The exact output frequency can, of course, be measured with the built-in frequency counter.

If any of the circuits you design on the *Wishmaker II* need to be connected to a computer, a set of DB-25 connectors makes it easy. One connector, on the side panel of the unit, is internally connected to another DB-25 on the front panel. Jumper wires can easily bring the appropriate signals to the breadboard.

The *Wishmaker II* is an wish come true for engineers, technicians, hobbyists, and students. Besides being an excellent prototyping tool, it would be an excellent teaching tool in an electronics lab course. The *Wishmaker II* is priced at \$249.95. A similar device, the \$199.95 *Wishmaker I* analog prototype design station. The *Wishmaker I* does not offer the frequency counter, pulse generator or debounced pulse switches, but does add a speaker and 4 potentiometers.

R-E



# WITH CIE, THE WORLD OF ELECTRONICS CAN BE YOUR WORLD, TOO.

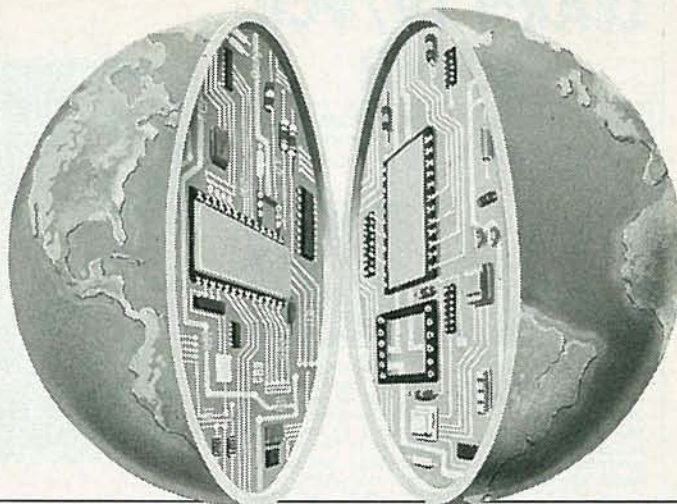

**L**ook at the world as it was 20 years ago and as it is today. Now, try to name another field that's grown faster in those 20 years than electronics. Everywhere you look, you'll find electronics in action. In industry, aerospace, business, medicine, science, government, communications—you name it. And as high technology grows, electronics will grow. Which means few other fields, if any, offer more career opportunities, more job security, more room for advancement—if you have the right skills.

## **SPECIALISTS NEED SPECIALIZED TRAINING.**

It stands to reason that you learn anything best from a specialist, and CIE is the largest independent home study school specializing exclusively in electronics, with a record that speaks for itself. According to a recent survey, 92% of CIE graduates are employed in electronics or a closely related field. When you're investing your time and money, you deserve results like that.

## **INDEPENDENT STUDY BACKED BY PERSONAL ATTENTION.**

We believe in independent study because it puts you in a classroom of one. So you can study where and when you want. At your pace, not somebody else's. And with over 50 years of experience, we've developed proven programs to give you the support

such study demands. Programs that give you the theory you need backed with practical experience using some of the most sophisticated electronics tools available anywhere, including our Microprocessor Training Laboratory with 4K of random access memory. Of course, if you ever have a question or problem, our instructors are only a phone call away.

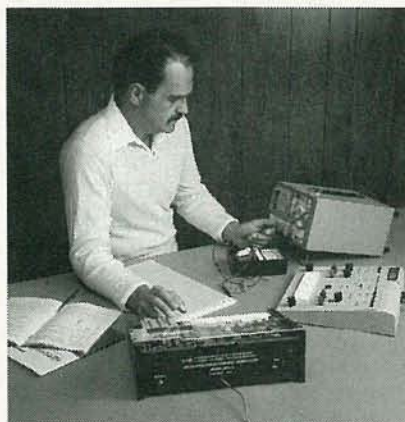

## **START WHERE YOU WANT, GO AS FAR AS YOU WANT.**

CIE's broad range of entry, intermediate, and advanced level courses in a variety of career areas gives you many options. Start with the Career Course that best suits your talents and interests and go as far as you want—all the way, if you wish, to your Associate in Applied Science Degree in Electronics Engineering Technology. But wherever you start, the time to start is **now**. Simply use the coupon below to send for your FREE CIE catalog and complete package of career information. Or phone us, toll-free, at **1-800-321-2155** (in Ohio, 1-800-523-9109). Don't wait, ask for your free catalog now. After all, there's a whole world of electronics out there waiting for you.

# CIE

**Cleveland Institute of Electronics, Inc.**  
1776 East 17th Street, Cleveland, Ohio 44114

Member NHSC  
Accredited Member National Home Study Council

ARE-162

**CIE Cleveland Institute of Electronics, Inc.**  
1776 East 17th Street, Cleveland, Ohio 44114

**YES...** I want to learn from the specialists in electronics—CIE. Please send me my FREE CIE school catalog, including details about CIE's Associate Degree program, plus my FREE package of home study information.

Name (print): \_\_\_\_\_

Address: \_\_\_\_\_

City: \_\_\_\_\_ State: \_\_\_\_\_ Zip: \_\_\_\_\_

Age: \_\_\_\_\_ Area Code/Phone No.: \_\_\_\_\_ / \_\_\_\_\_

Check box for G.I. Bill bulletin on educational benefits:

Veteran  Active Duty

**MAIL  
TODAY!**



# LEARN TV/VCR REPAIR



Now you can train at home in your spare time for a money-making career as a TV/VCR Repair Specialist. No need to quit your job or school. We show you how to troubleshoot and repair videocassette recorders and TV sets, how to handle house calls and shop repairs for almost any make of television or VCR. You learn about TV receivers, tuners and antennas, X-ray emission, the characteristics of sound, how electrical impulses are converted into a TV picture, and much, much more. Tools are included with your course so you can get "hands-on" practice as you follow the lessons step by step. Send for free facts about opportunities in TV/VCR Repair and find out how you can start making money in this great career.

**Experts show you what to do, how to do it...guide you every step of the way!**

Everything is explained in easy-to-understand language with plenty of drawings, photos and diagrams. But if there is ever anything in your lessons you don't understand, you can write or phone your instructor and you can count on getting an authoritative answer. Send for free facts and color brochure. No cost. No obligation. No salesman will visit.

MAIL COUPON TODAY

**ICS SCHOOL OF TV/VCR REPAIR, Dept. DE020**  
 SINCE 1959 925 Oak Street, Scranton, PA 18515

Please send me free facts on how I can learn TV/VCR Repair at home in my spare time. No salesman will visit.

Name \_\_\_\_\_ Age \_\_\_\_\_  
 Address \_\_\_\_\_ Apt. # \_\_\_\_\_  
 City/State \_\_\_\_\_ Zip \_\_\_\_\_  
 Phone ( ) \_\_\_\_\_

A Subsidiary of National Education Corporation

CIRCLE 188 ON FREE INFORMATION CARD

## NEW SUPER LONG PLAY TAPE RECORDERS

12 Hour Model — \$119.00\*  
 USES D-120 TAPE

Modified Panasonic Slimline, high quality, AC-DC Recorders provide 6 continuous hours of quality recording & playback on each side of cassette for a total of 12 hours. Built-in features include:  
 • Voice level control • Digital counter, etc. TDK DC 120 Cassette Furnished.



### PHONE RECORDING ADAPTER

Records calls automatically. All Solid state connects to your telephone jack and tape recorder. Starts recording when phone is lifted. Stops when you hang up. **\$28.50\***  
 FCC APPROVED



**VOX VOICE ACTIVATED CONTROL SWITCH**  
 Solid state. Self contained. Adjustable sensitivity. Voices or other sounds automatically activate and control recorder. Uses either recorder or remote mike. **\$28.50\***



\*Add for ship & hdg. Phone Adapter & Vox \$1.50 ea. Recorders \$4.00 ea. Cal. Res. add tax. Mail order, VISA, M/C, COD's OK. Money Back Guarantee. Qty. disc. avail., Dealer Inquiries invited, Free data. © **AMC SALES INC. Dept. A9335 Lubec St., Box 928, Downey, CA 90241 Phone (213) 869-8519**

CIRCLE 108 ON FREE INFORMATION CARD

## Beckman Industrial FG3A Sweep/Function Generator

A stable 2-MHz generator with linear and logarithmic sweep.



CIRCLE 39 ON FREE INFORMATION CARD

FOR MEASURING THE RESPONSE OF AN audio amplifier, finding the resonant points of a filter network, or examining any system that operates over a broad frequency range, nothing beats the combination of an oscilloscope and sweep generator. That point was driven home recently when we had the opportunity to examine the FG3A, a new sweep function generator from Beckman Industrial Corporation, 3883 Ruffin Rd., San Diego, CA 92123-1898).

The FG3A can provide sine, square, triangle, and ramp signals in seven ranges from 0.2 Hz to 2 MHz. A pulse output, at either TTL or CMOS levels (or anywhere in between) is also available. Any of the outputs can be swept either linearly or logarithmically throughout the entire range, or any portion of it. An external VCF or VOLTAGE-CONTROLLED FREQUENCY jack allows an external signal to vary the frequency of the output; A 0-10 volt signal causes a 1000:1 change in frequency. The selected output can also be amplitude- or frequency-modulated by an internal or external signal.

The output amplitude of the FG3A is 20 volts p-p into an open circuit, or 10 volts p-p into a 50-ohm load. The duty cycle of the outputs are continuously adjustable from 1:1 to 10:1.

The frequency of the output is displayed on the built-in 5-digit frequency counter. That counter sports an external input, and can be used to measure external signals of up to 10 MHz.

The FG3A is ruggedly built in a 9 x 3 x 13-inch shielded plastic case and weighs about 4½ pounds. The front panel features an intelligent layout that is dominated by

the 5-digit LED display. Switches are grouped according to function, which makes the unit very easy to operate.

### Using the sweep generator

Although the sweep function generator is not one of the most popular test instruments, it is an extremely versatile one. The most common application is measuring the frequency response of amplifiers, filters, and other networks. That task is performed by feeding the output of the generator to both the network under test to one oscilloscope channel. The output of the network is fed to the other scope channel.

If, for example, you were testing an audio amplifier, the sweep generator would be set up to provide sine waves in the audio-frequency range, and the scope would be set to display both the input and the output. At a glance, you would see the response of the amp over the entire operating range.

Using the same technique, it is a simple matter to determine the resonant point of filter networks. Carrying that a bit further, it's possible to identify the value of an unmarked inductor or capacitor, even without an LC meter. Assuming you know the value of one of the components, you can set up a simple LC network and manually sweep the generator for a null. Knowing the resonant frequency and the value of one of the components, simple arithmetic will yield the value of the unmarked part.

The FG3A is a unit that has the look, feel, and performance that you might not expect from a \$475 sweep function generator. We congratulate Beckman on a job well done.

R-E



# TEST METHODS

MIKE ROGALSKI

## Easy impedance measurements

IMPEDANCE MEASUREMENTS OFTEN CONJURE up an image of complex test equipment and tricky calculations involving at least a square root or two. However, none of that is necessary if you understand a relationship that exists between impedance and decibels.

That relationship is this: If you cut your load impedance in half, the output of the circuit drops by 3 dB. Using that knowledge, it's easy to design a simple piece of test equipment that will give you the AC impedance of a circuit, and all you need is a potentiometer, a switch, and a VOM having resistance and decibel scales. Switching between the dB- and DC-resistance readings will yield the effective AC impedance of a circuit at a given frequency.

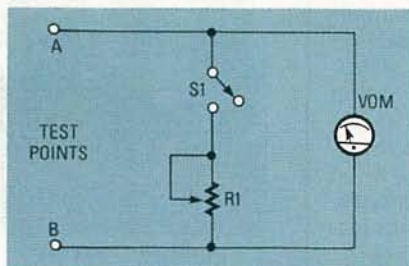

FIG. 1—THE EFFECTIVE AC IMPEDANCE of a circuit can be determined using this circuit.

Figure 1 shows the simple test circuit, which is a simplification of the Wheatstone bridge used in complex impedance-measuring equipment. To use it, connect the two test probes, A and B, across the circuit under question. Then take a relative reading on the dB setting of the meter with the potentiometer out of the circuit (S1 open). If possible, make the circuit's output as high as you can in order to make the reading as accurate as possible. Next, place the potentiometer in the circuit (close S1) and adjust it to a point where the meter reads 3 dB lower than the first reading. Without changing the setting of R1, disconnect the circuit under test and measure the DC resistance of the potentiometer; it will be the equivalent DC resistance of the AC circuit at the frequency used during the test. You may want to take several readings at different frequencies.

## Troubleshooting potentiometers

There is a unique way to check a potentiometer's wiper for continuous contact on the resistive element. The circuit shown in Fig. 2 enables you to place a potentiometer in an audio-operating environment so you can hear how it affects an audio signal without the distraction of the music itself. The circuit is particularly useful in recording studios, where audio faders tend to get a lot of wear and tear, but it is equally useful in other situations.

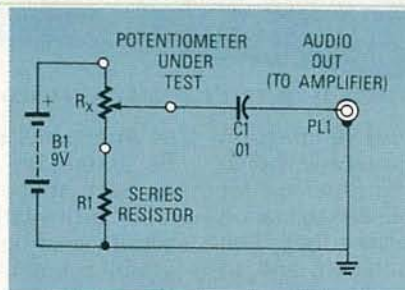

FIG. 2—A POTENTIOMETER can be checked out using this simple test circuit.

The principle behind the circuit is very simple: A DC voltage is applied to the potentiometer in question, and the wiper is moved back and forth at a steady rate. Whenever there is a "dirty" spot on the potentiometer, the DC circuit is interrupted, and a spike appears at the output of the circuit and is fed into a mini-amplifier. The audible signal from the amplifier indicates where the dirt or defect is on the potentiometer, which can then be cleaned or repaired if possible. The trick to the circuit is the output capacitor. While there is only an uninterrupted DC source, there is no signal coupled to the audio amplifier. When the DC voltage is interrupted, the capacitor sees the interruption as an AC signal and passes it to the amp as a pop.

The DC voltage from the battery generally will not burn out wire-wound potentiometers, but some carbon-composition potentiometers could be affected. To be safe, calculate how much current you anticipate through the circuit and choose a series resistor that will limit the current to  $\frac{1}{4}$  of the device's power rating. That will keep the battery from destroying the component you are testing.

R-E

## TALK IS CHEAP.

Have you heard? For less than \$90 your AT or XT-compatible computer can talk! All it needs is the HV-2000 Computer Voice Kit from Heathkit.

Reading letters, transcriptions and computerized instruction can be easier and quicker than you ever thought possible. Computer games gain a new dimension. Your computer can even entertain children with stories and songs.

**\$89.95**

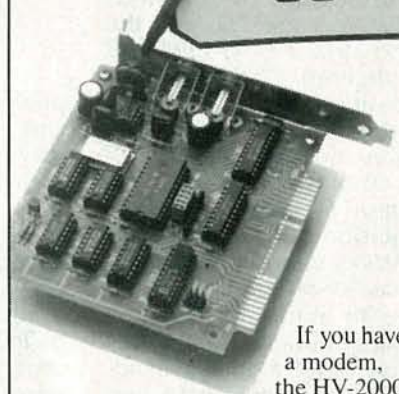

If you have a modem, the HV-2000

Computer Voice will allow your computer to recite reference and research information from time-sharing services. Or, speak radio transmitted ASCII information.

The HV-2000 Computer Voice Card, containing speech synthesizer and audio amplifier, plugs into any AT or XT-compatible computer's expansion slot. An external speaker is also included. Versatile, Heath-developed software gives you a wide variety of voices and easy interface to high and low level languages.

The HV-2000 Computer Voice. At less than \$90, talk IS cheap. To order, call toll-free 1-800-253-0570. Use your Visa, MasterCard, American Express or Heath Revolving Charge card. Use order code 620-002.

For your **FREE** Heathkit Catalog call 1-800-44-HEATH

**Heath Company**

A subsidiary of Zenith Electronics Corporation

Prices, product availability and specifications are subject to change without notice.

CIRCLE 86 ON FREE INFORMATION CARD

MARCH 1990

21



# NEW PRODUCTS

**ANALOG/DIGITAL STORAGE SCOPES.** Besides real-time sampling speeds of up to 250 MS/s, and analog and digital bandwidths of up to 100 MHz, two analog/digital storage oscilloscopes from John Fluke provide micro-processor-calculated measurements. The 60-MHz, 250-MS/s PM 3355 and the 100-MHz, 250-MS/s PM 3375 (pictured) DSO's are also designed for ease of use, with such features as cursors and full AUTOSET.

The PM 3375 uses repetitive sampling for acquisition of recurrent signals of up to 100 MHz, and has 100-MHz analog bandwidth and 150-MHz triggering bandwidth. The PM 3355 has 60-MHz analog bandwidth and 100-MHz triggering bandwidth. Both units provide 250-MS/s real-time sampling for signals to 25 MHz at 10 samples per second, four 4K memories for high-resolution acquisition and storage of digital signals, and post-trigger capability of up to 5,000 divisions. Other features include averaging for im-



CIRCLE 25 ON FREE INFORMATION CARD

proved noise suppression and greater accuracy, digitally delayed timebase for in-depth signal examination while troubleshooting, 8-bit vertical resolution, and an envelope mode to track signal variations over time.

Signal analysis is simplified with cursor facilities that allow instant, on-screen measurement with numeric readouts of measured and calculated values, automatically compensating for the probes in use. The AUTOSET feature gives automatic channel selection and setting of amplitude, timebase, and triggering for any input signal. To ensure repeatability and efficiency in routine measurements,

64 front-panel settings can be stored. The front panel on each scope also gives clear information on the sensitivity of both channels as well as timebase and trigger setting, memory status, and a display magnification indicator. Optional RS-232 and GPIB/IEEE-488 interfaces allow the DSO's to be operated under computer control or in automatic measuring systems.

The PM 3355 has a list price under \$4500.00; the list price of the PM 3375 is \$5390.00. The factory-installed interface options cost \$500.00 each.—**John Fluke Mfg. Co., Inc.**, P.O. Box 9090, Everett, WA 98206; Tel. 800-443-5853.

MAG, 1V MAG, and 2V MAG simplify signal evaluation and measurements. A  $\times 5$  vertical-gain magnifier contributes to high-resolution differential phase and gain measurements in the R-Y mode. Chroma and IRE filters can be inserted on a full-time or line-shared basis, and the selected video source is sent to a picture-monitor output for observation on a color monitor. A switching-mode power supply automatically adapts the unit to a wide range of AC and DC volt-



CIRCLE 27 ON FREE INFORMATION CARD

ages. The instrument is housed in a metal cabinet with a handle and feet for bench use; the cabinet can be removed for rack mounting purposes.

The model 5872 combination waveform monitor/vector scope costs \$3,795.00.—**Leader Instruments Corporation**, 380 Oser Avenue, Hauppauge, NY 11788.

**MAGNETIC SENSING PROBE.** By sensing the presence of magnetic fields, the *Lil Devil Mag-Probe* from HMC lets you test any electrical/electronic device for current-on/-off or glitches—and doesn't require in-depth training, schematics, or complicated hookups. The device makes it easy to accurately and safely identify and separate electrical from mechanical problems.

The *Lil Devil* detects re-

## INFRARED-DETECTOR PEN.

Technicians in the consumer-electronics repair industry will appreciate the *B.I.R.D.*, a battery-operated infrared-detector pen from *Parts Express*. The device instantly confirms operation of infrared-emitting products, such as remote controls, VCR tape-stop circuits, and alarm-system infrared detectors. The *B.I.R.D.*'s slim design makes easy work of reaching IR emitters on crowded VCR boards. An LED conveniently placed in the top of



CIRCLE 26 ON FREE INFORMATION CARD

the pen is there to indicate the presence of infrared light in normal light conditions.

The *B.I.R.D.* infrared detector pen costs \$55.00.—**Parts Express International, Inc.**, 340 East First Street, Dayton, OH 45402; Tel. 800-338-0531.

## WAVEFORM MONITOR/VECTORSCOPE.

Designed with the user's needs in mind, *Leader Instruments'* model 5872 combination waveform monitor and vectorscope is loaded with features that accommodate video-signal monitoring easily and effectively. It offers simultaneous vector and waveform display and dual-channel display for observation of two video sources on the same screen.

Sweep rates of 1H, 2H, 1V, and 2V; and 1H MAG, 2H





CIRCLE 28 ON FREE INFORMATION CARD

sidual magnetism and transient current pulses ("glitches") as fast as 10 milliseconds, and identifies north and south poles in AC- and DC-powered solenoids, relays, and any other devices that use a coil. When the instrument's probe tip is placed close to the coil in the device under test, the LED in the probe's handle lights if the device is energized. If the LED doesn't

light, the device is de-energized. The probe works without having to make a direct electrical connection, unlike an oscilloscope or voltmeter.

Two models are available. The standard-sensitivity model tests large and standard-sized solenoids and relays. The high-sensitivity model tests the full range of devices, from subminiature to the largest, including most reed relays.

The standard- and high-sensitivity *Lil Devil Mag-Probes* have suggested retail prices of \$28.50 and \$33.75, respectively.—**HUB Material Company**, P.O. Box 526, Canton, MA 02021.

**DISKETTE I.D. SYSTEM.** A computer-disk identification system, the *ReMarkAble Label Ssystem* from *Weber & Sons*, eliminates the build-up of layers of labels on 5¼- and 3½-inch floppy disks. Special marker pens are used to write on a thin, self-adhesive, plastic

surface affixed to the disk. As the data on the disk changes, old I.D. information is simply wiped off and updated notes can be added to reflect the changes. Ink removal doesn't require the use of any chemicals, alcohol, or erasers; ink is removed simply by wiping the surface with a dry tissue.

The *ReMarkAble Label System Kit* is available as the *RLS-200*, with 200 self-adhesive writing surfaces, or as the *RLS-100*, with 100 writing surfaces. Each kit also contains one marker pen and instructions.

The *RLS-200* and *RLS-100* kits cost \$39.95 and \$24.95,



CIRCLE 29 ON FREE INFORMATION CARD

respectively, including shipping.—**Weber & Sons, Inc.**, *ReMarkAble Label Systems Division*, 3468 Highway 9, Freehold, NJ 07728; Tel 800-225-0044.

**SPECTRUM ANALYZER/LAPTOP.** For true convenience and portability, *Rapid System's R355* combination FFT spectrum analyzer and digital scope includes the versatile *Toshiba 3200 SX*, a 386 laptop personal computer. The complete system allows the user to view both the input signal and its frequency spectrum in real time on the computer. A two-channel, 12-bit, 267-K data buffer; 500-MHz bandwidth; and 1-MHz sampling rate are standard features in this turnkey, stand-alone testing system.

The 16-MHz, 40-B laptop features an IBM-VGA-compatible high-resolution gas-plasma display. The combined system offers two channels of simultaneous 1-MHz acquisition with 32-KB

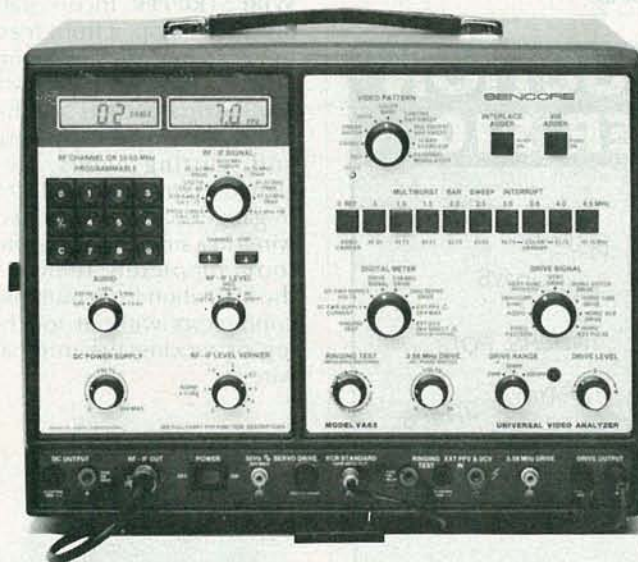

## Cut Your Video Servicing Time By 54%

With the Market Proven VA62 Universal Video Analyzing System.

Today's VCRs, TVs, and MTS Stereo TVs require a proven method to quickly isolate the defective component. New technology has made simple problem solving a time-consuming and expensive procedure.

A survey of over 1500 Video Analyzer owners has shown that the 'A62's unique signal substitution method has reduced their video servicing time by an average of 54%, and increased their servicing profits.

You can join the successful service centers that have cut their video servicing time and increased their profits with the VA62 Universal Video Analyzing System. Call for a brochure on the VA62. Call **1-800-SENCORE** and increase your profits. In Canada also call **1-800-SENCORE**.

**SENCORE**

3200 Sencore Drive, Sioux Falls, SD 57107

100% American Made

CIRCLE 177 ON FREE INFORMATION CARD

MARCH 1990

23



Get A Complete Course In

# ELECTRONIC ENGINEERING

8 volumes, over 2000 pages, including all necessary math and physics. 29 examinations to help you gauge your personal progress. A truly great learning experience.

Prepare now to take advantage of the growing demand for people able to work at the engineering level.

Ask for our brochure giving complete details of content. Use your free information card number, or write us directly. **\$99.95**, Postage Included. Satisfaction guaranteed or money refunded.



**Banner Technical Books, Inc.**

1203 Grant Ave.  
Rockford, IL 61103

CIRCLE 67 ON FREE INFORMATION CARD

Try the

**Radio Electronics**

**bulletin board system**

**(RE-BBS)  
516-293-2283**

The more you use it the more useful it becomes.

We support 300 and 1200 baud operation.

Parameters: 8N1 (8 data bits, no parity, 1 stop bit) or 7E1 (7 data bits, even parity, 1 stop bit).

Add yourself to our user files to increase your access.

Communicate with other R-E readers.

Leave your comments on R-E with the SYSOP.

**RE-BBS  
516-293-2283**



CIRCLE 30 ON FREE INFORMATION CARD

data buffers per channel, 1024-point FFT displayed at a rate of 10 per second, and 10 mV to 50 V per division with user-selectable gain scaling. The menu-driven software and features such as save (autosave) and retrieve data to/from disk make the system easy to use. Spectra can be stored either as magnitude or complex data.

The R355/3200 SX combination spectrum analyzer and laptop PC costs \$8495.—**Rapid Systems, Inc.**, 433 North 34th Street, Seattle, WA 98103.

**WIRE STRIPPER.** Incorporating a wire stop, a front feed for close-in work, and a wire cutter, *Paladin's PA 1115 Mini-Stripax* meets all the hobbyist's wire-stripping and -cutting needs. Designed to strip and cut 30- to 16-gauge solid and stranded wires in a single motion, the tool completely removes the insulation from multiple conductors without touching or nicking the internal wires.



CIRCLE 31 ON FREE INFORMATION CARD

The lightweight and ergonomically designed miniature wire stripper fits into spaces too small for other stripping tools and cuts precisely with minimal

force. Its stainless-steel laminated blades are rated for up to 20,000 strips, and fiberglass-reinforced nylon construction makes it exceptionally rugged. The *Mini-Stripax* is insulated to 600 volts to protect users from accidental contact with live wires.

The PA 1115 *Mini-Stripax* wire stripper has a suggested retail price of \$52.95.—**Paladin Corporation**, 3543 Old Conejo Road, Suite 102, Newbury Park, CA 91320.

**AM STEREO-FM STEREO ANALYZER.** Using a patented method of generating modulated RF signals, *Sencore's SG80* is the industry's first totally integrated, microprocessor-controlled, IEEE-488- and RS-232-compatible AM-stereo (C-



CIRCLE 32 ON FREE INFORMATION CARD

QUAM) and FM-stereo (MPX) analyzer. The digitally accurate instrument produces virtually noise- and harmonic-distortion-free RF, IF, and audio signals.

The SC80 analyzer allows manufacturers and servicemen to thoroughly performance-test and troubleshoot AM-stereo/FM-stereo receivers for parameters such as sensitivity, selectivity, separation, and pilot threshold. The unit's innovative design includes RF, IF, C-QUAM, MPX, SCA, audio, tunable sweep, and marker generators. Special drive capability allows in-circuit troubleshooting, which highly accurate attenuator and impedance matching for 50-, 75-, and 300-ohm receiver inputs.

The SG80 AM-stereo/FM-stereo analyzer—including test leads, manual, simplified operating guide, and "100% Made Right" lifetime guarantee—costs \$3995.—**Sencore, Inc.**, 3200 Sencore Drive, Sioux Falls, SD, 57107; Tel. 1-800-SENCORE.

## NOISE REDUCTION FOR UNDER \$10.

MIXING CONSOLES

SWITCHES

MICROPHONE CONNECTORS

SNAKE CABLES

BATTERY CONTACTS



PLUGS & JACKS

PATCHBAYS

FADERS, POTS

TERMINAL STRIPS

SPEAKER TERMINALS

### CRAMOLIN®

Even the finest equipment in the world cannot guarantee noise-free operation. One "dirty" connection anywhere in the electrical path can cause unwanted noise or signal loss.

**"MORE THAN A CONTACT CLEANER"**

**CRAMOLIN®** is a fast-acting, anti-oxidizing lubricant that cleans and preserves all metal surfaces, including gold.

When applied to metal contacts and connectors, **CRAMOLIN®** removes resistive oxides as it forms a protective molecular layer that adheres to the metal surfaces and maintains maximum electrical conductivity.

**CRAMOLIN®** - USED BY THOSE WHO DEMAND THE BEST:

Bell & Howell	Hewlett Packard	MCI(Sony)	Nakamichi
Boeing	John Fluke Mfg.	Motorola	RCA
Capitol Records	McIntosh Labs	NASA	Switchcraft

SINCE 1956

**CAIG LABORATORIES INC.**

1175-O Industrial Ave., (P.O. Box J) - Escondido, CA 92025-0051 U.S.A. • (619) 743-7143

CIRCLE 50 ON FREE INFORMATION CARD



**RADIO FACSIMILE TERMINAL.** ACE Communications' WX-1000 is a stand-alone radio facsimile terminal designed to produce hard-copy images from various radio facsimile services—including NOAA weather charts, NFA, and press



**CIRCLE 33 ON FREE INFORMATION CARD**

photos. The unit can even receive satellite weather pictures from NOAA, GOES, and METEOR. The WX-1000 requires only audio output from a short-wave receiver or an S-band receiver capable of receiving facsimile signals. The built-in high-resolution, 24-pin thermal printer pro-

duces clear, crisp images. It also has the capability to produce gray scale, which is ideal for Automatic Picture Transmission (ATP) by weather satellite.

The WX-1000 radio-facsimile terminal has a suggested retail price of \$845.00.—ACE Communications, Inc., 22511 Aspan Street, El Toro, CA 92630-6321; Tel. 800-523-6366.

**SOIC CLIP ADAPTERS.** Six SOIC clip adapters, designed to provide test points for high-density, surface-mounted Small-Outline Integrated Circuits (SOIC), are being offered as kit 5514 from Pomona Electronics. The kit includes one each of the 8-, 14-, 16-, 20-, 24-, and 28-pin SOIC clips, all housed in a sturdy plastic case that is fitted with a contoured-foam interior to separate the enclosed adapters. The SOIC-clip test adapters securely hold both wide- and nar-



**CIRCLE 34 ON FREE INFORMATION CARD**

row-body SOIC's. Access pins are 0.025-inch-square gold-plated pins on 0.100 centers, and SOIC contacts are also gold plated.

The model 5514 SOIC clip adapter kit costs \$54.50.—ITT Pomona Electronics, 1500 East Ninth Street, Pomona, CA 91766.

**SOLDERING IRONS.** Designed for soldering large components, two soldering irons from M. M. Newman feature oversize heating elements and tips to provide greater thermal inertia.

Antex CS and XS soldering irons have 0.178-inch diameter heating elements and big, iron-plated copper tips. They both feature removable finger supports.

With its heating element located directly under its tip for optimum thermal efficiency, the 17-watt CS is as powerful as a conventional 35-watt iron. The 25-watt model XS is comparable to a standard 40-watt iron.

The Antex CS and Antex XS soldering irons have suggested list prices of \$18.95 and \$21.95, respectively.—



**CIRCLE 35 ON FREE INFORMATION CARD**

M. M. Newman Corporation, 24 Tioga Way, P.O. Box 615, Marblehead, MA 01945. R-E

## Train at Home to be an Electronics Technician!

Professional training and equipment can help you qualify for a dynamic, high-paying career in your spare time.

As the demand for computers and microprocessors in business and manufacturing continues to grow, so does the need for qualified technicians. It's not unusual for experienced technicians to earn from \$35,000 to more than \$40,000 a year.\* Now there's a way you can train for this exciting field without interrupting your job or home life.

### Choose From These Programs of Study

- Electronics & Microprocessor Technology
- Industrial Electronics & Microprocessor Technology
- Computer Servicing & Electronics Technology
- Specialized Associate Degree In Electronics Technology

### You Get Professional Equipment For Professional Training

Depending on the program you select, you'll perfect your skills using this advanced equipment, included in the price of tuition:

- Zenith Data Systems eaZy Personal Computer
- Digital Multimeter
- Digital Logic Probe
- Elenco Oscilloscope

### Exclusive Extras That Enhance Your Training

Peoples College introduces some training firsts to make your learning experience more complete:

- Accelerated Learning System — a scientifically proven study system that lets you learn faster and easier than ever before.
- Optional One-Week Seminar — available with our advanced programs. Conducted on our campus near Orlando, Fla. Not required for graduation, but a valuable opportunity to fine tune your skills with personal guidance.
- Video Tutor Training Tapes — give you a permanent, visual record of informative lectures and close-up demonstrations.
- Experience Labs — professionally designed experiments that give you hands-on "bench" experience.
- Industry Certification Training Guide — provided with three of our programs. Gives you first-hand insight into the examination you may take for your professional license.



For COLOR CATALOG Mail Coupon or Call TOLL FREE 1-800-366-3113

No Obligation. No sales person will call.

Our programs are accredited by the Accrediting Commission of the National Home Study Council

YES! I would like to know more about your training programs. Send a catalog to:

Name \_\_\_\_\_  
Address \_\_\_\_\_  
City \_\_\_\_\_  
State \_\_\_\_\_ Zip \_\_\_\_\_



**PEOPLES COLLEGE**  
OF INDEPENDENT STUDIES  
233 Academy Drive • P.O. Box 421768  
Kissimmee, FL 34742-1768  
Member, D.L. Peoples Group

(\* Source: U.S. Bureau of Labor Statistics)



## Managing to Get Ahead



Test yourself with this sample question:

Which one of the following questions may you ask a prospective employee in a job interview?

- (1) Do you own or rent your home?
- (2) Are you married?
- (3) Are you able to work overtime?
- (4) Have you ever been arrested?
- (5) All of the above?

Now wouldn't you like to test yourself against the real thing?

If you've got the experience and knowledge it takes to get the job done, you can get certified in professional service management. The Certified Service Manager exam is offered through NESDA for owners or service managers with a minimum of 4 years of experience.

For a practice test and more information about CSM Certification, write to NESDA, 2708 W. Berry St., Fort Worth, TX 76109-2356, or phone (817) 921-9061.

(ANSWERS: 3)

## CABLE - TV

### SIGNAL REMOVERS

- FOR ELIMINATION OF SEVERE INTERFERENCE
- FOR "CENSORING" OF ADULT BROADCASTS



FOR FULL DESCRIPTION OF USES ask for our free brochure

- ATTENUATION - 45 dB TYPICAL
- BANDWIDTH - 4 MHz AT 5 dB POINTS
- INSERTION LOSS - 2 dB

MODEL	TUNING RANGE	FOR CHANNELS	PASSBAND	PRICE	SHIPPING
23H	50-66 MHz	2,3 (or 6 meter ham)	50-300 MHz	\$30	NO SHIPPING or C.O.D. CHARGES
46FM	66-108 MHz	4,5,6 (or any FM)	50-300 MHz	\$30	
1417	120-144 MHz	14(A) 15(B) 16 (C) 17(D)	50-400 MHz	\$30	
1822	144-174 MHz	18(E) 19(F) 20(G) 21(H) 22 (I)	50-400 MHz	\$30	
713	174-216 MHz	7,8,9,10,11,12,13	50-400 MHz	\$30	

3 for \$75 - 10 for \$200 - mix or match

CALL TOLL FREE FOR C.O.D. OR SEND CHECK TO ORDER  
FAST DELIVERY  
30 DAY MONEY BACK GUARANTEE (3 FILTER LIMIT)

**Star Circuits**

P. O. Box 94917  
Las Vegas, NV 89193-4917

1-800-433-6319

## NEW LIT

**SK CROSS-REFERENCE GUIDE.** Thomson Consumer Electronics' *SK Replacement Semiconductor number Guide (SKG202F)* contains more than 3370 parts, including 228 recently introduced semiconductors. Its 329-page cross-reference section contains references to more than 217,000 original devices.



CIRCLE 37 ON FREE INFORMATION CARD



CIRCLE 36 ON FREE INFORMATION CARD

The SK devices cover a wide variety of both discrete components and integrated circuits with consumer as well as industrial applications. The guide contains expanded specifications in the discrete devices charts. Included in the SK line are thyristors, rectifiers, optoelectronics, microprocessors, and many other types of devices, all under warranty for one year.

The *SK Replacement Semiconductor Guide (SKG202F)* is available from Thomson distributors nationwide.—**Thomson Consumer Electronics**, Distributor and Special Products, 2000 Clements Bridge Road, Deptford, NJ 08096-2088.

**DATA ACQUISITION AND CONTROL.** *Volume 21* of *MetraByte's* product handbook includes comprehensive data on the company's complete line of data-acquisition, industrial-control and -monitoring, video-imaging, signal-conditioning, personal-instru-

mentation, and communications products for IBM PC/XT/AT, PS/2, and Apple Macintosh II microcomputers. The 304-page color handbook features complete technical data on MetraByte's brand new *WORKHORSE* line of high-speed industrial-control and -monitoring products. Also included are the *PCIP-SCOPE*, a single-board digital-sampling oscilloscope; the *DAS-HRES*, a 16-bit data-acquisition board; the *VOS/DVOS* software, an Icon-based user interface for MetraByte's image-processing hardware; and the *MBIC* family of 19-inch rack-mounted IBM-compatible industrial computers. Product characteristics are presented in easy-to-use quick-selection guides, followed by complete technical and pricing information.

The *Volume 21* catalog is available at no charge.—**MetraByte Corp.**, 440 Myles Standish Blvd., Taunton, MA 02780. **R-E**





# Discover Your Career Potential In The Fast Growing Field Of High-Tech Electronics!

CIE Gives You The Training You Need to Succeed...  
At Your Own Pace...& In Your Own Home!

If you're anxious to get ahead...and build a *real* career...you owe it to yourself to find out about the Cleveland Institute of Electronics!

CIE can help you discover your career potential in the fast growing field of high-tech electronics. A career that will challenge and excite you every day...reward you with a powerful feeling of personal accomplishment...and deliver a level of financial security you may have only dreamed of before!

As the leading school in home-study electronics, CIE has helped over 150,000 students in the U.S.A. and over 70 foreign countries get started in this exciting field. To find out how CIE could be helping you...read on...then send for a CIE catalog TODAY!

## A Growing Need For Trained Professionals!

The career opportunities shown here are only a few of the challenging, high-paying careers you could enjoy as an electronics technician.

You could be the "brains" behind the scenes of an exciting TV broadcast...trouble-shoot life-saving medical equipment...design exotic new aeronautics systems...CIE's job-oriented programs offer you the quickest possible path to the career of your dreams! And CIE also features military and union re-training, to build on what you already know.

## Dozens Of Fascinating Careers To Choose From!

Even if you aren't sure which career is best for you, CIE can get you started with core lessons applicable to *all* areas of electronics. As you advance, CIE makes job opportunities available to you through the bimonthly school paper, *The Electron*.



Data Communications



Automotive Electronics



Avionics



Computer-Assisted Manufacturing



Consumer Electronics



Military Electronics

## Personal Training From A Renowned Faculty.

Unlike the impersonal approach of large classroom study, CIE offers you one-on-one instructional help 6 days a week, toll-free. Each CIE lesson is authored by an independent specialist, backed by CIE instructors who work directly with you to answer your questions and provide technical assistance when you need it.

## Practical Training... At Your Own Pace.

Through CIE, you can train for your new career while you keep your present job. Each course allows a generous completion time, and there are no limitations on how fast you can study. Should you already have some electronics experience, CIE offers several courses which start at the intermediate level.

## "State-Of-The-Art" Facilities & Equipment.

In 1969, CIE pioneered the first electronics laboratory course, and in 1984, the first Microprocessor Laboratory. Today, no other home study school can match CIE's state-of-the-art equipment. And all your laboratory equipment is included in your tuition cost. There is no extra charge—it's yours to use while you study at home and on the job after you complete your course!

## Earn Your Degree To Become A Professional In Electronics!

Every CIE course you take earns you credit towards the completion of your Associate in Applied Science Degree, so you can work towards your degree in stages. And CIE is the only school that awards you for fast study, which can save you thousands of dollars in obtaining the same electronics education found in four-year Bachelor's Degree programs! Write for details today!

## Send For Your Catalog Today!



### CIE World Headquarters

Cleveland Institute of Electronics, Inc.  
1776 East 17th St., Cleveland, Ohio 44114

ARE-163

**YES!** Please send me your independent study catalog (For your convenience, CIE will have a representative contact you—there is no obligation.)

Print Name \_\_\_\_\_

Address \_\_\_\_\_ Apt # \_\_\_\_\_

City/State/Zip \_\_\_\_\_

Age \_\_\_\_\_ Area Code/Phone No. \_\_\_\_\_

Check box for G.I. Bill bulletin on educational benefits:  Veteran  Active Duty

## Mail This Coupon Today!

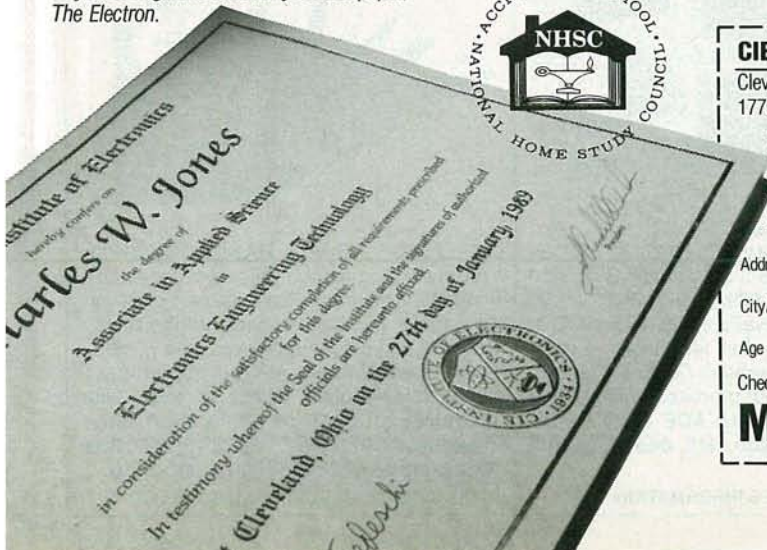

MARCH 1990



# Radio-Electronics mini-ADS



**FREE CATALOG OF HARD-TO-FIND TOOLS** is packed with more than 2000 quality items. Your single source for precision tools used by electronic technicians, engineers, instrument mechanics, schools, laboratories and government agencies. Also contains Jensen's line of more than 40 tool kits. Send for your free copy today! **JENSEN TOOLS INC., 7815 46th St., Phoenix, AZ 85044. (602) 968-6231.**

CIRCLE 115 ON FREE INFORMATION CARD



**GET YOUR RECHARGE CATALOG FREE...EARN BIG \$\$ IN YOUR SPARE TIME**—All supplies and Do-It-Yourself kits with complete instructions available. Supplies cost from **\$9.95** in qty and you can sell recharged toner cartridges for **\$40.00** to **\$55.00** each. Printers include HP LaserJet and Series II, Apple LaserWriter, QMS, etc. Canon PC-25 Copier also. **CHENESKO PRODUCTS, 62 N Coleman Rd., Centereach, NY 11720, 516-736-7977, 800-221-3516, Fax: 516-732-4650**

CIRCLE 192 ON FREE INFORMATION CARD



**THE MODEL WTT-20 IS ONLY THE SIZE OF A DIME**, yet transmits both sides of a telephone conversation to any FM radio with crystal clarity. Telephone line powered - never needs a battery! Up to ¼ mile range. Adjustable from 70-130 MHz. Complete kit **\$29.95 + \$1.50 S + H**. Free Shipping on 2 or more! COD add \$4. Call or send VISA, MC, MO. **DECO INDUSTRIES, Box 607, Bedford Hills, NY 10507. (914) 232-3878.**

CIRCLE 127 ON FREE INFORMATION CARD

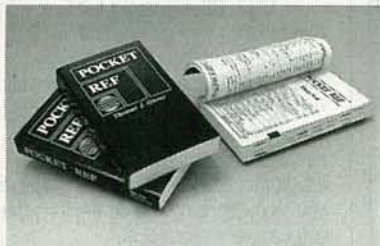

**AMAZING POCKET REFERENCE**: 480 pages of tables, formulas, constants, conversions and maps and it fits in your shirt pocket! (3.2" x 5.4" x 0.6") Chapters include Electronics, Computers, Math, Tools, Glues & Solvents, Chemistry & Physics, Construction, Carpentry, Geology, Hardware, Automotive, Air, Water, Welding, Plumbing, Pipe, 1-800 Airlines, Area Codes, Money, and much, much more. **\$9.95 + \$2.00 shipping** (Colorado inc. 56¢ tax). Check/Visa/MC. **Sequoia Publishing, Inc., Dept. 953, P.O. Box 620820, Littleton, CO 80162.**

CIRCLE 183 ON FREE INFORMATION CARD

## contact east



**NEW 1990 GENERAL CATALOG OF TOOLS & TEST INSTRUMENTS** is now available at no charge. 148 color-coded pages make this source book of products for testing, repairing and assembling electronic equipment easier than ever to use. Each product line has been expanded to include over 100 new products. With color photos, descriptions and discounted pricing, it features test equipment, precision hand tools, tool kits, soldering supplies, static control products and more. **CONTACT EAST, 335 Willow St., North Andover, MA 01845 (508) 682-2000.**

CIRCLE 55 ON FREE INFORMATION CARD

## CALL NOW AND RESERVE YOUR SPACE

- 6 x rate \$940.00 per each insertion.
- Fast reader service cycle.
- Short lead time for the placement of ads.
- We typeset and layout the ad at no additional charge.

Call **516-293-3000** to reserve space. Ask for Arline Fishman. Limited number of pages available. Mail materials to: mini-ADS, RADIO-ELECTRONICS, 500-B Bi-County Blvd., Farmingdale, NY 11735.

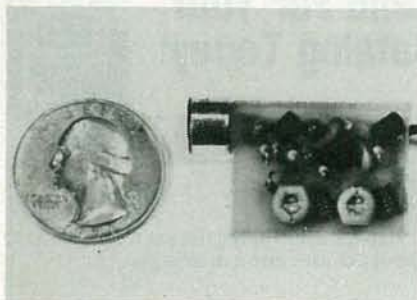

**SIMPLY SNAP THE WAT-50 MINIATURE FM TRANSMITTER** on top of a 9v battery and hear every sound in an entire house up to 1 mile away! Adjustable from 70-130 MHz. Use with any FM radio. Complete kit **\$29.95 + \$1.50 S + H**. Free shipping on 2 or more! COD add \$4. Call or send VISA, MC, MO. **DECO INDUSTRIES, Box 607, Bedford Hills, NY 10507. (914) 232-3878.**

CIRCLE 127 ON FREE INFORMATION CARD



**CABLE TV CONVERTERS AND DE-SCRAMBLERS SB-3 \$79.00 TRI-BI \$95.00 MLD-\$85.00 M35B \$89.00 JRX-DIC \$129.00** Special combos available. We ship COD. Quantity discounts. Call for pricing on other products. Dealers wanted. **FREE CATALOG.** We stand behind our products where others fail. One year warranty. **ACE PRODUCTS, P.O. Box 582, Saco, ME 04072 1 (800) 234-0726.**

CIRCLE 75 ON FREE INFORMATION CARD



**APPLIANCE REPAIR HANDBOOKS—13** volumes by service experts; easy-to-understand diagrams, illustrations. For major appliances (air conditioners, refrigerators, washers, dryers, microwaves, etc.), elec. housewares, personal-care appliances. Basics of solid state, setting up shop, test instruments. **\$2.65 to \$7.90 each.** Free brochure. **APPLIANCE SERVICE, P.O. Box 789, Lombard, IL 60148. (312) 932-9550.**

CIRCLE 84 ON FREE INFORMATION CARD



# BUILD THIS

## UNIVERSAL LABORATORY POWER SUPPLY

*This universal power supply offers high performance and flexibility at low cost.*

REINHARD METZ

remainder supplies voltage-setting and current-limiting functions. The input to IC1 comes from the output of BR1, which is filtered by C1 and C2 to about +60-volts DC, and the input for current-sense comparator IC2 comes from BR2, which also acts as a negative bias supply for regulation down to ground.

The purpose of IC1 is to maintain the OUT terminal at 1.25-volts DC above the ADJ terminal. The current drain at the ADJ terminal is very low (nominally 25  $\mu$ A) and, as a result, R15 and R16 (the coarse and fine voltage adjustments) and R8 form a voltage divider, with 1.25 volts appearing across R8. The bottom end of R16 connects to a -1.3-volt reference level generated by D7 and D8, letting the R8-R15 divider set the output voltage all the way down to ground when  $R15 + R16 = 0$  ohms. In general, the output voltage is determined by:

$$\frac{(V_{OUT} - 1.25 + 1.3)}{(R15 + R16)} = 1.25/R8.$$

Thus, the maximum value from each variable supply board is:

$$V_{OUT} = (1.25 / R8) \times (R15 + R16) = 50.18 \text{ volts DC.}$$

Using potentiometers R15 and R16

TABLE 1—PERFORMANCE SUMMARY

Characteristic	Capability
Number of supplies	2 (fully floating)
Voltage range	0—50 VDC
Current range	0—5 A
Coarse vs. fine control ratio (both current and voltage)	1:10
Voltage regulation	0.01% line, 0.1% load
Current limiter	0.5%

NOTE: (a) There's a current-limiting LED;  
(b) Has internal +5 VDC, 0—3 A supply.

to control the voltage,  $V_{OUT}$  ranges from 0—50 volts DC. As current demand increases, the drop across R2 increases, and at about 0.65 volts (which corresponds to about 20 mA), Q1 and Q2 turn on, becoming the main current path. Also, R3 and R4 ensure that Q1 and Q2 share the load equally. Current limiting is provided by IC2. Its noninverting input uses the output voltage as a reference, and its inverting input is connected to the

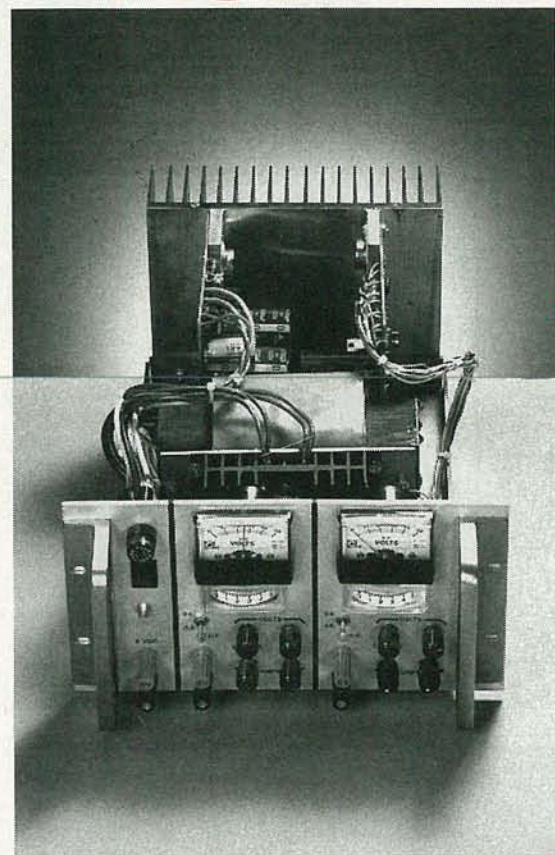

WHILE NUMEROUS BENCH POWER SUPPLIES have emerged over the years, few combine the performance, flexibility, and low cost of the version described here. This article describes a well-regulated, modular, lab-grade power supply with dual 0—50-volt, 0—5-amp DC supplies, and a single 5-volt, 3-amp DC supply. It uses two identical custom PC boards, one for each 50-volt supply. There's also a customized heat sink with space for both PC boards that minimizes point-to-point wiring in the 50-volt supplies. However, because of the modular design, you can customize the configuration as needed. See Table 1 for a performance summary.

### Circuit description

Figure 1 is the schematic of the power supply. The value of the design lies in the use of IC1, an LM317HVK adjustable series-pass voltage regulator, for broad-range performance. The "HVK" suffix specifies the high-voltage version of the regulator. The



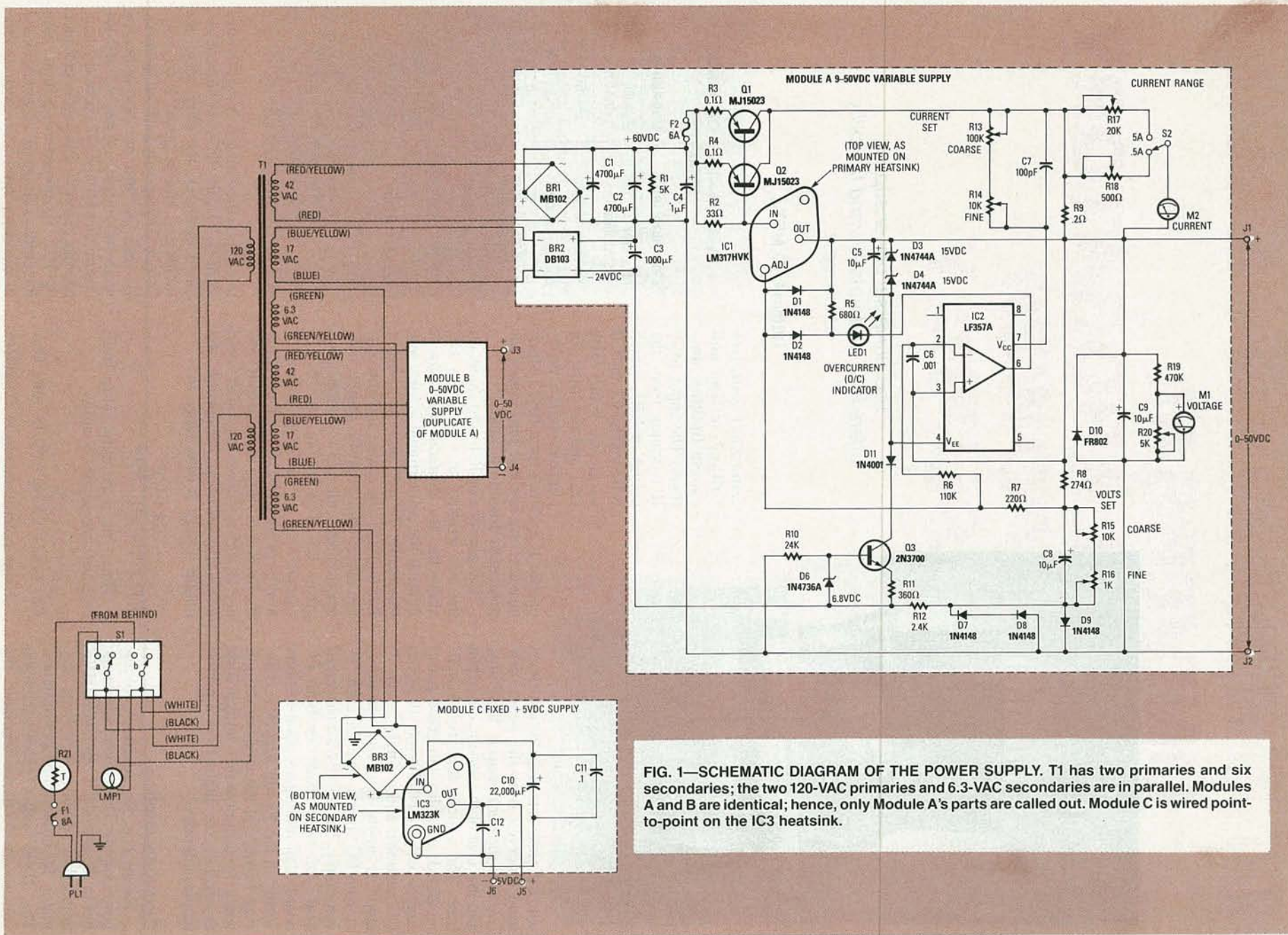

FIG. 1—SCHEMATIC DIAGRAM OF THE POWER SUPPLY. T1 has two primaries and six secondaries; the two 120-VAC primaries and 6.3-VAC secondaries are in parallel. Modules A and B are identical; hence, only Module A's parts are called out. Module C is wired point-to-point on the IC3 heatsink.



voltage divider created by R6 and current-limit potentiometers R13 and R14.

The drop across R6 is about 1.25 volts, the reference voltage mentioned above as being the difference between the OUT and ADJ terminals of IC1. Current from Q1 and Q2 flows through R9, creating a drop across R13 + R14. Thus, IC2 trips when the drop across R9 creates current through R13 and R14, causing the voltage at the non-inverting input to exceed  $V_{OUT}$ .

That sets the current limit point at:  $(I_{OUT} \times 0.2)/(R13 + R14) = 1.25/100K$ ;  $I_{OUT} = 0-5$  amps. That corresponds to a range of about 0-5 amps. At the current limit point, IC2's output goes low, pulling the ADJ lead down via D2 and lighting LED1. Additional current for D5 is provided by R5. As the ADJ lead is pulled low, the output follows, until the output current drops to a level corresponding to the setting of R13 and R14.

Since the output voltage can be anywhere from 0-50 volts, the power supply for IC2 must track that range using D3, D4, and Q3. Next, D9 ensures that the output voltage doesn't rise when the supply is shut off, while D10 protects against supply back-feeding. Finally, M1 monitors voltage and M2 monitors current. The power supply is modular: each PC board is used for one 50-volt supply, and includes all parts other than those for the front panel and the 5-volt supply. Since a dual 50-volt version may be popular, T1 accommodates two supplies and the 5-volt supply, and a custom heat sink for the two PC boards is available.

### Construction

The transformer is mounted on a 6- $\times$ -5- $\times$ -1-inch L-bracket in the center of the supply, and the heatsinks for IC1 and BR1 go on the back of the transformer bracket. A 6- $\times$ -8- $\times$ -6- $\times$ -11-inch U-shaped cover of  $\frac{1}{16}$ -inch aluminum completes the assembly. Complete all drilling and preparation before assembly, but install only the transformer and its bracket for now, to make wiring easier for you.

Next, assemble the PC board(s) for the 50-volt supplies; Fig. 3 shows the parts placement diagram. Install all components except Q1, Q2, and IC1. Check resistor values as you go, and mount the heat sink for BR1 before installation. Don't forget to observe

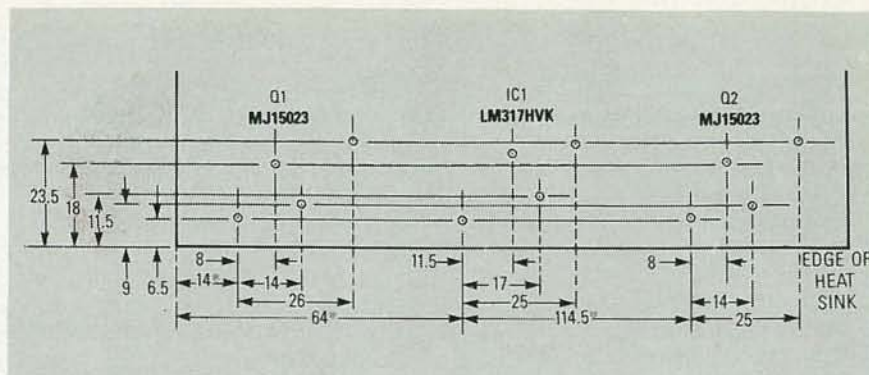

FIG. 2—POWER SUPPLY HEAT SINK LAYOUT. All marked dimensions are in millimeters, all mounting holes are  $\frac{1}{4}$ -inch in diameter, all lead holes are  $\frac{3}{16}$ -inch in diameter, and add 3 mm to all dimensions with an (\*) to align the PC boards.

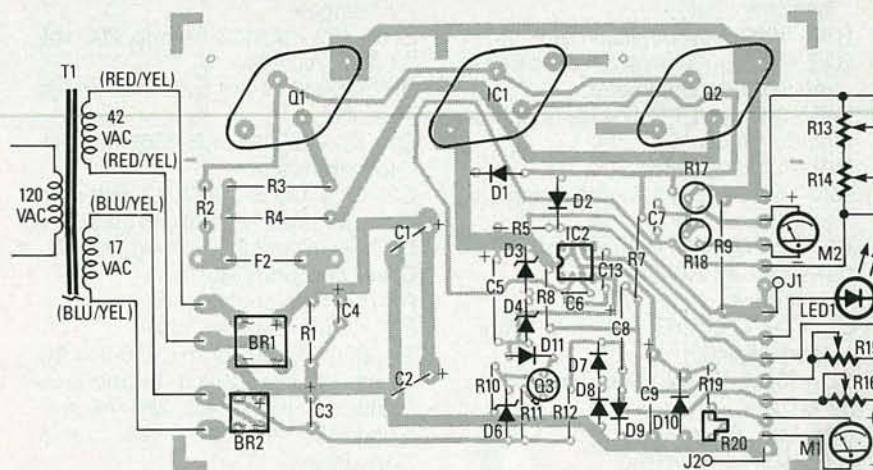

FIG. 3—PARTS PLACEMENT DIAGRAM FOR 50-volt supply. Only one primary and the two relevant secondaries of T1 have been depicted, for brevity.

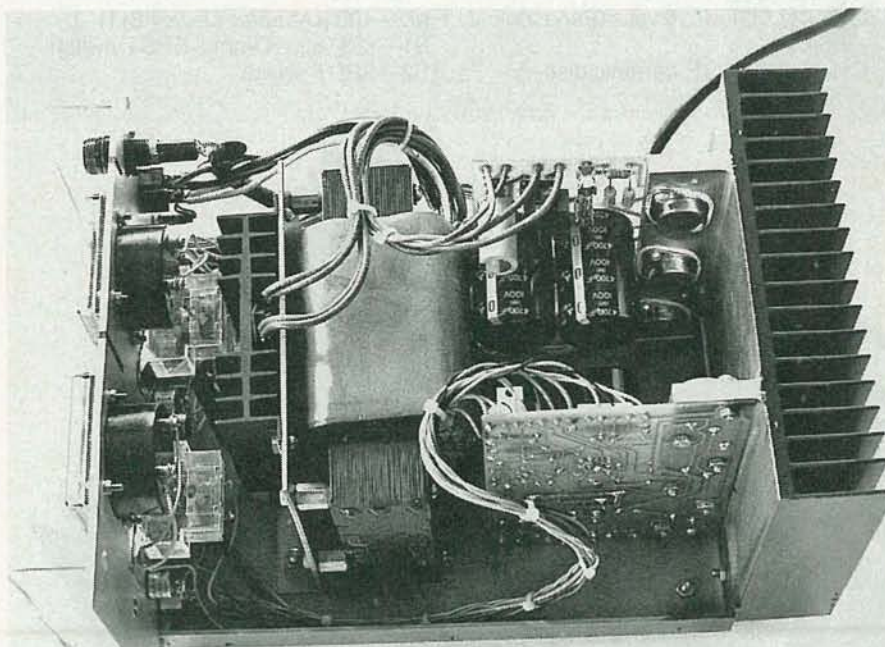

FIG. 4—PROTOTYPE OF THE POWER SUPPLY. Note the custom PC board heatsink at right, and how S1, F1, LMP1, and R21 are wired.

polarities on all the electrolytic capacitors. Use the alignment holes with 6-32 screws for the PC board(s). In-

stall Q1, Q2, and IC1, using mica insulators, heat sink compound, and 6-32 screws. Check for shorts from



## PARTS LIST

All resistors are 1/4-watt, 5%, unless otherwise indicated.

R1—5000 ohms, 1-watt  
 R2—33 ohms  
 R3, R4—0.1, 3-watt  
 R5—680 ohms  
 R6—115,000 ohms, 1%  
 R7—220 ohms  
 R8—274 ohms, 1%  
 R9—0.2 ohm, 5-watt  
 R10—24,000 ohms  
 R11—360 ohms  
 R12—2400 ohms  
 R13—100,000-ohm potentiometer  
 R14, R15—10,000-ohm potentiometer  
 R16—1000-ohm potentiometer  
 R17—20,000-ohm PC-board-mounted potentiometer  
 R18—500-ohm PC-board-mounted potentiometer  
 R19—470,000 ohms  
 R20—5000-ohm PC-board-mounted potentiometer  
 R21—thermistor in-rush protector (Keystone KC003L)

### Capacitors

C1, C2—4700  $\mu$ F, 100 volts (Panasonic P6430)  
 C3—1000  $\mu$ F, 50 volts, Panasonic P6272  
 C4—1  $\mu$ F, 63 volts  
 C5—10  $\mu$ F, 500 volts  
 C6—0.001  $\mu$ F, ceramic disc  
 C7—100 pF, mica  
 C8, C9—10  $\mu$ F, 50 volts  
 C10—22,000  $\mu$ F, 16 volts (Panasonic P6420)  
 C11, C12—0.1  $\mu$ F, ceramic disc

### Semiconductors

IC1—LM317HVK adjustable, series-pass, high-voltage regulator  
 IC2—LF357A JFET input, 8-pin DIP comparator  
 IC3—LM323K 5-volt DC regulator in TO-3 case  
 D1, D2, D7, D8, D9—1N4148 germanium diode  
 D3, D4—1N4744A, 15-volt, 1-watt Zener diode  
 D6—1N4736A, 6.8-volt, 1-watt Zener diode  
 D10—FR802 8-amp, 100-volt fast-recovery silicon rectifier (TO-220 package)  
 BR1, BR3—MB102 10-amp, 200-volt bridge rectifier  
 BR2—DB103 1-amp, 200-volt bridge rectifier  
 Q1, Q2—MJ5023 or ECG68 PNP silicon transistor  
 Q3—ECG128 or 2N3700 1 watt general purpose NPN silicon transistor  
 LED1—yellow light-emitting diode

### Other components

F1—8-amp fast-blow fuse  
 F2—6-amp fast-blow fuse  
 T1—600 VA transformer; 120-volt AC primary; two 42-volt, 5-amp secondaries; two 17-volt, 250-mA secondaries; and one 7-volt, 3-amp secondary  
 PL1—120-volt AC pilot light  
 M1—50 mA meter (GC Electronics 20-1110)  
 M2—100  $\mu$ A meter (Jewell 81T)  
 S1—120-volt, 10-amp DPST switch  
 S2—SPDT switch

J1, J3, J5—red banana jack

J2, J4, J6—black banana jack

**Miscellaneous:** 8-inch wide  $\times$  6-inch high  $\times$  11-inch deep aluminum case with 1/8-inch predrilled aluminum plate as front panel (including holes for handles) and 8- $\times$  11- $\times$  3/32-inch steel plate with a 1-inch lip on the bottom, two front-panel-mounted case handles, 6- $\times$  8- $\times$  3-1/8-inch dual-supply main heatsink, heat-sink for 5-volt DC regulator with TO-3 case, heat sink for BR1, 3-wire power cord, knobs, four rubber feet, panel-mounted fuse holder (for F1), two PC-board mounted fuse clips (for F2), PC board (Digi-Key #F040), three TO-3 transistor insulator kits, silicone grease, wire, solder, etc.

**NOTE:** The following parts are available from A&T LABS, P.O. Box 552, Warrenville, IL 60555; plated PC board with parts placement silkscreen, \$19.00; 600 VA custom dual-supply transformer (T1), \$66.00; custom dual-supply main heatsink, \$42.00; LM317HVK (IC1), \$8.00; MJ4502 (Q1 and Q2), \$6.00; M1, \$16.00. Send check or money order, except for COD orders via UPS in the U.S. If you don't order T1, add 5% shipping and handling for U.S., and 10% for Canada. If you order T1, add 12% for U.S., and 17% for Canada; Illinois residents add 6.75% sales tax.

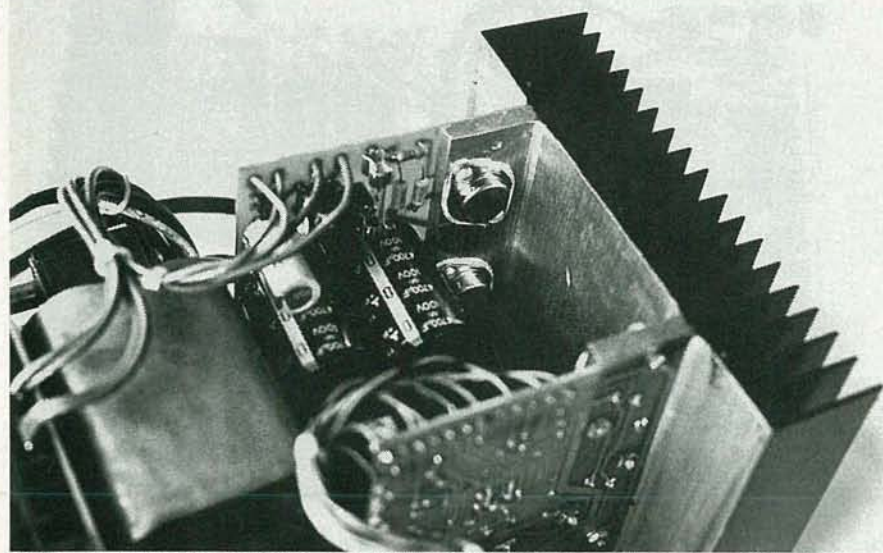

FIG. 5—PRIMARY HEAT SINK ASSEMBLY CLOSE UP. You can see how Q1 and IC1 are attached, the silicone grease used for heat transfer, and how the heatsink is attached to the PC boards. The mica insulators aren't clearly visible from this perspective.

Q1, Q2, or IC1 to the heatsink. Note that BR1 and BR3 have different pin

connections than BR2.

A variety of meters can be used

with this design. Sensitivity differences are compensated with PC-board-mounted resistors and potentiometers. The values in the parts list call for 50  $\mu$ A/2500 ohms for M1, and 100  $\mu$ A/700 ohms for M2. In most cases, panel meters require some faceplate disassembly or removal to mark them for 50 volts and 5 amps DC at full scale. Assuming sensitivities of  $I_V$  and  $R_V$  for M1 and  $I_I$  and  $R_I$  for M2, the resistor values are:

- $R_{19} = 25/I_V$ ,  $R_{20} = 2 \times R_V$ .
- $R_{17} = 2 \times (1.0/I_I - R_I)$ , for 5 amps full-scale.
- $R_{18} = 2 \times (0.1/I_I - R_I)$ , for 0.5 amp full-scale.
- $R_{18} = 2 \times (0.2/I_I - R_I)$ , for 1 amp full-scale.

Proceed with the point-to-point wiring from the PC board to the front panel. Those wires should all termi-

*continued on page 69*



# BUILD THIS

## ION METER

A COUPLE OF DECADES AGO, RESEARCH scientists were examining how the population ratio of positive to negative ions in our atmosphere affect human behavior. Many theories were generated—among them, that positive ions cause irritability and erratic behavior, and that negative ions promote well-being. That theory still persists, as can be seen from the numerous products that are marketed to flood your home or office with negative ions.

Because of the interest, the electronics magazines of the time published articles on the properties of ions, how to produce them, and even how to build chambers to measure them. The device in one of the first articles, back in 1969, used a short detector-rod antenna in a cylindrical wire-mesh detector screen. The screen was polarized to plus or minus 60 volts DC, causing ions of the opposite polarity to that of the screen be attracted to it, pass through, and be collected by the detector rod. A special tube was used to amplify the minute voltage induced in the detector rod, which had a 100,000-megohm input impedance. The device used a 1.5-volt battery for the tube filament, a 9-volt battery for the circuit, and a 67-volt battery for the screen.

### Circuit description

The schematic of an updated version is shown in Fig. 1. The tube was replaced with a dual-gate RCA 40673 or 40841 MOSFET with both gates tied together as the detector input. The input impedance isn't as high as was the case with the tube, but there's more than enough sensitivity without needing a 100,000-megohm grid resistor; and the gate impedance bleeds off ions without an external resistor. R1 prevents static-voltage buildup on the detector screen in dry weather and instability in M1.

The MOSFET drain feeds a balanced DC bridge using two 2N2222's coupled to M1, a zero-center,  $\pm 150\text{-}\mu\text{A}$  meter. Since the MOSFET

*Build this ion meter and keep track of the level of ions in your home.*

By PETER A. LOVELOCK

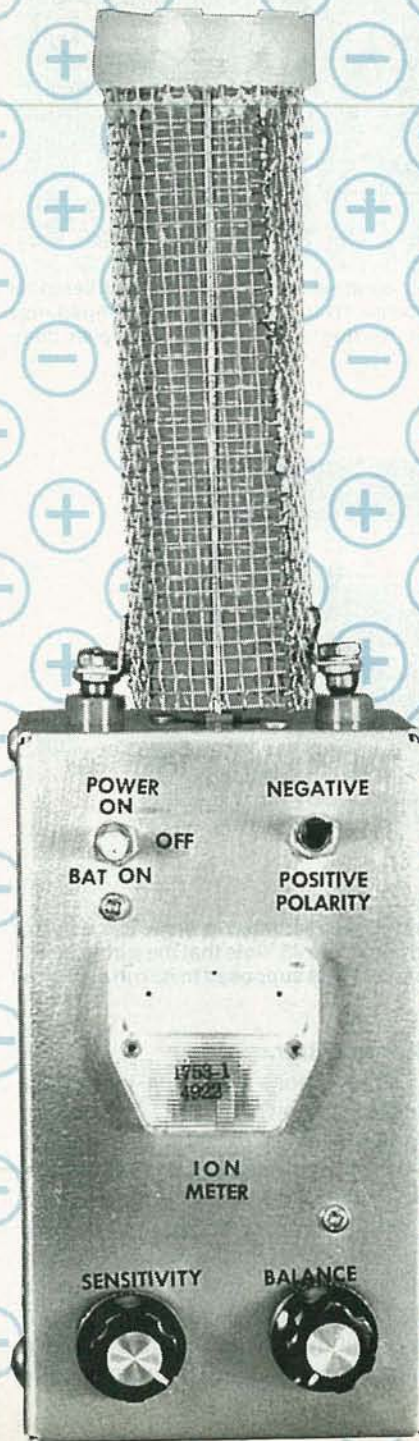

forms one leg of a bridge, any change in drain current caused by ions at the detector will unbalance it, deflecting M1. Since the device can indicate only relative negative or positive ion levels, the ion meter is balanced for zero, and reads increasing or decreasing levels for the selected polarity; don't interpret M1 as indicating a negative left-hand and positive right-hand scale. Besides filtering the ion type, the detector screen also shields the detector rod from static charge. If the shield is removed, body movements within a couple of feet of the detector rod can make M1 fluctuate, due to static charge that may be present on your clothes.

The ion meter can be powered from either a 9-volt battery, B1, or a 12-volt DC plug-in supply. Whichever supply is in use operates IC1, a 555, which generates a square wave that's fed to a 6-stage ladder multiplier composed of D1-D12 and C1-C14. Each stage acts as a voltage doubler, so the multiplier increases the applied voltage by  $2 \times 6$ , or 12. The +5-volt internal supply is boosted to plus or minus 60 volts at the detector screen, whereas using B1 the multiplier generates plus or minus 108 volts DC. The available current is a few microamps, and the output impedance is about 100 megohms, or R1. Also, R1 prevents loading the multiplier, dropping the detector-screen voltage and cutting sensitivity. The voltage polarizes the detector screen, as long as there's no load.

Measuring the multiplier's output voltage is difficult, since most multimeters, despite their high input impedances, will load the output of the ion meter. Typically, a multimeter with 10-megohm input impedance exhibits a false reading of 25–45 volts DC, when using the plug-in supply. The good thing about the very high impedance at the detector is that shorting the plus or minus 60 or 108 volts DC from screen to case won't generate much current, so a short won't damage the circuit. However,



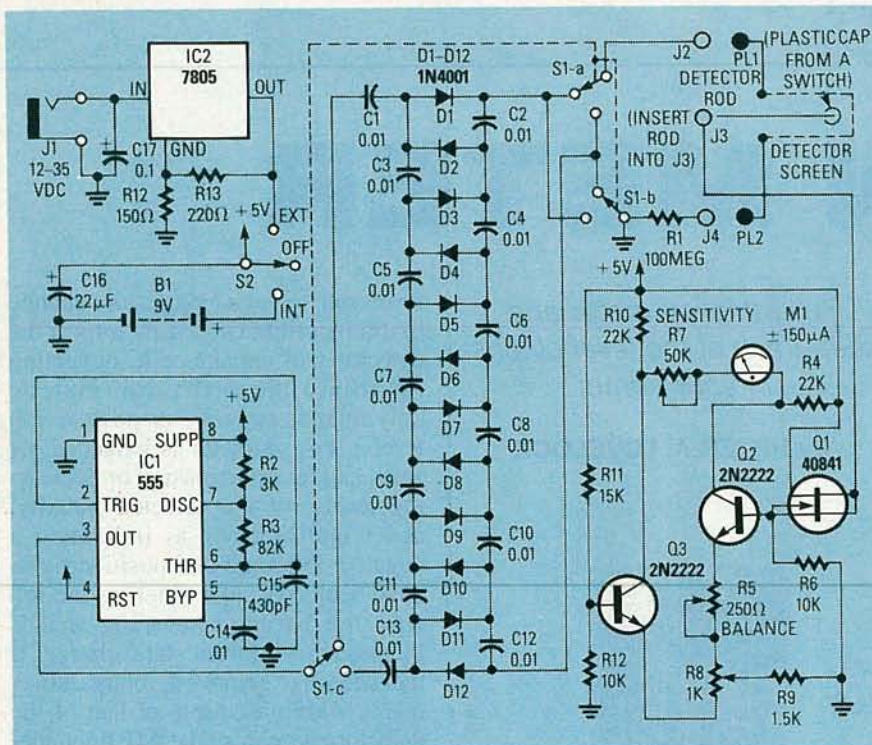

FIG. 1—SCHEMATIC OF THE ION METER; R5 controls the sensitivity of differential amplifier Q2-Q3, and R5 and R8 control the balance. Q1 is a very high input impedance dual-gate MOSFET, and IC1 is a 20-kHz astable feeding a  $\times 12$  voltage multiplier composed of D1-D12 and C1-C14.

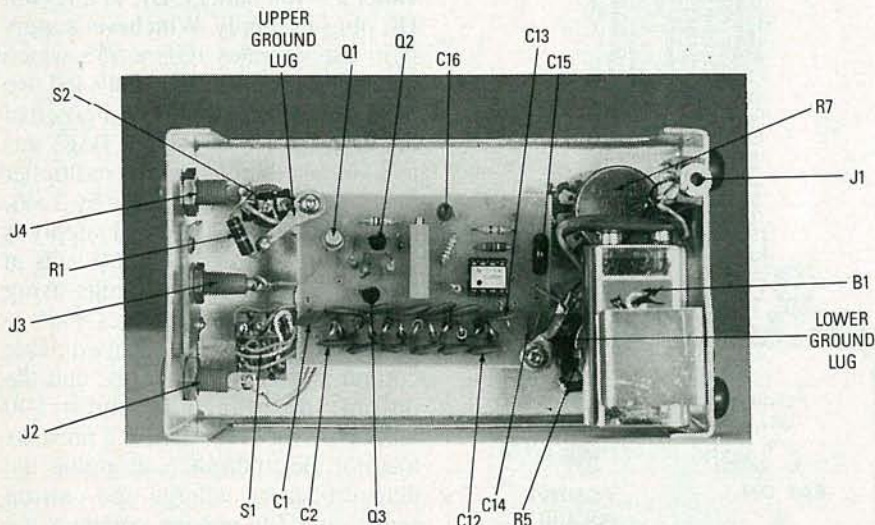

FIG. 2—PROTOTYPE OF THE ION METER, showing the rear internal view. The detector screen plugs into J2 and J4, and the detector rod plugs into J3. Note that the wiring for IC2 is fairly tight, and also that the jumper running under C12 is supposed to be run on the foil side of the PC board.

be very careful, regardless of the low current, when dealing with voltages of that magnitude. Switch S2 reverses the multiplier input-output connections, letting the detector screen voltage be either positive or negative, regardless of whether IC2 or B1 is used as the supply. The ion meter draws 4 mA at 9-volts DC, so a standard 70 mAh, 9-volt battery should be enough to give you 16 hours of continuous use.

### Construction

The interior view of ion-meter prototype is shown in Fig. 2. You can build the circuit on a  $2 \times 3$ -inch piece of perforated circuit board, or you can etch a PC board using the pattern provided in PC Service. Before you use the foil pattern provided in PC Service, you may have to modify it slightly. Figure 3 points out two jumpers that must be added, and one that must be cut. The PC-board source in

### PARTS LIST

All resistors are  $\frac{1}{4}$ -watt, 5%, unless otherwise indicated.

- R1—100 megohms (see text)
- R2—3300 ohms
- R3—82,000 ohms
- R4, R10—22,000 ohms
- R5—250-ohm, 2-watt, cabinet-mounted potentiometer
- R6, R12—10,000 ohms
- R7—50,000-ohm, 2-watt, cabinet-mounted potentiometer
- R8—1000-ohm, 15-turn, PC-board-mounted, trimmer potentiometer
- R9, R14—150 ohms
- R11—15,000 ohms
- R13—220 ohms

### Capacitors

- C1-C14—0.01  $\mu$ F, 35 volts, disc ceramic
- C15—470 pF, 50 volts, disc ceramic
- C16—22  $\mu$ F, 16 volts, tantalum
- C17—0.1  $\mu$ F, 16 volts, tantalum

### Semiconductors

- D1-D12—1N4001 silicon diode
- Q1—RCA 40673 or 40841 dual-gate, P-channel MOSFET
- Q2—2N2222 NPN transistor
- IC1—555 timer
- IC2—7805 5-volt DC regulator

### Other components

- S1—miniature 3PDT switch
- S2—miniature SP3T switch
- M1— $\pm 150$ - $\mu$ A meter with centered needle
- PL1, PL2—threaded banana plugs and nuts
- J1—miniature monophonic jack
- J2, J4—banana jacks without ground lugs
- J3—miniature pin jack

**Miscellaneous:** Chassis box,  $5\frac{1}{4} \times 3 \times 2\frac{1}{8}$ -inches, PC board stand-off kit, TO-220-type transistor case insulated mounting kit for IC2, 120 VAC-to-12 VDC plug-in power supply,  $4 \times 5$ -inch piece of  $\frac{1}{8}$ -inch grid metal screening, 8-pin DIP socket, two 3-pin transistor sockets, one 4-pin transistor socket, 9-volt battery clip, plastic cover from sub-miniature switch for detector rod, solder, wire, hardware, etc.

**NOTE:** The RCA 40673 dual-gate MOSFET is available for \$2.00 plus \$3.00 shipping and handling from Circuit Specialists, P.O. Box 3047, Scottsdale, AZ 85271-3047, (800) 528-1417 or (602) 966-0764; shipping time is normally about 10 days. The PC board is available from R.R. Assoc., 31066 Glendon, Los Angeles, CA 90034, for \$4.50. That includes shipping and handling; California residents add sales tax.



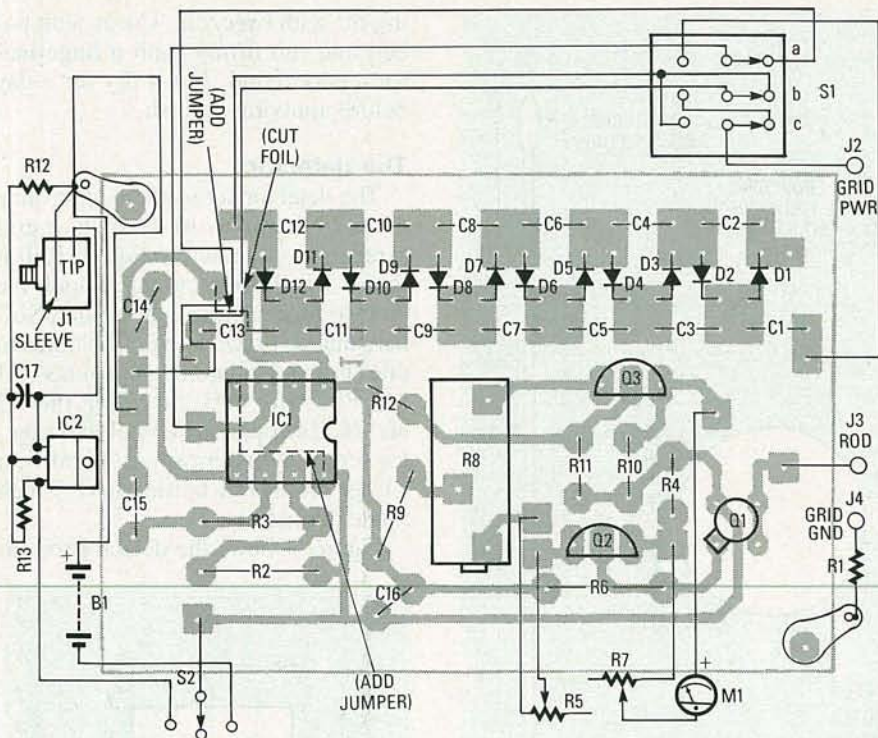

FIG. 3—PARTS-PLACEMENT DIAGRAM of the ion meter. Note the terminals used for J1, and the modifications to the PC board (all they involve is cutting a foil and adding two jumpers).

the Parts List will make every effort to make those changes for you in advance, but be aware of them anyway.

R1 may be hard to find; an alternative is ten ¼- or ⅛-watt, 10-megohm resistors in series. Potentiometer R8 is a 10–15-turn, PC-board-mounted version, while R5 and R7 are the case-mounted variety, and permit easy adjustment of M1. The parts-placement diagram is shown in Fig. 3. Mount the voltage multiplier first, being careful with C1–C13 and D1–D12. A mistake there can reduce detector-screen voltage, or result in no polarizing voltage at all. The resistance from the cathode of D1 to the anode of D12 should be about 300 ohms.

Install IC1 using an 8-pin DIP socket, then R2, R3, and C15. Next R4, R6, R8–R12, R15, and C16 are installed; R4, R10 and R15 are to be vertically mounted. Then, connect M1, R5, R8, S1, S2, and the detector. Leave plenty of extra lead length; you can trim off the surplus when the PC board is installed in the case. Install

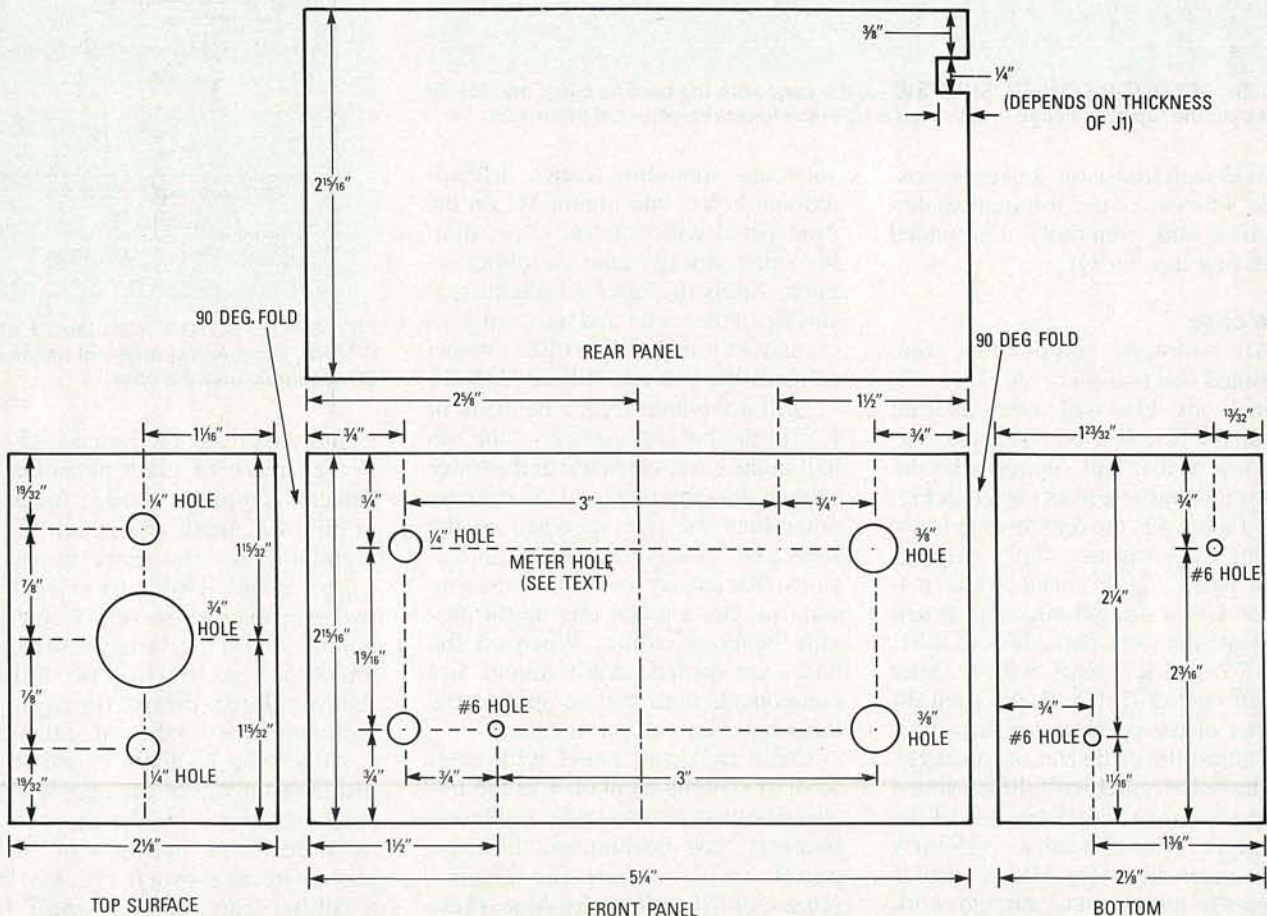

FIG. 4—ION METER CASE LAYOUT, consisting of top surface, front panel, bottom surface, and rear panel. Make sure that everything has been carefully measured before any drilling or cutting.



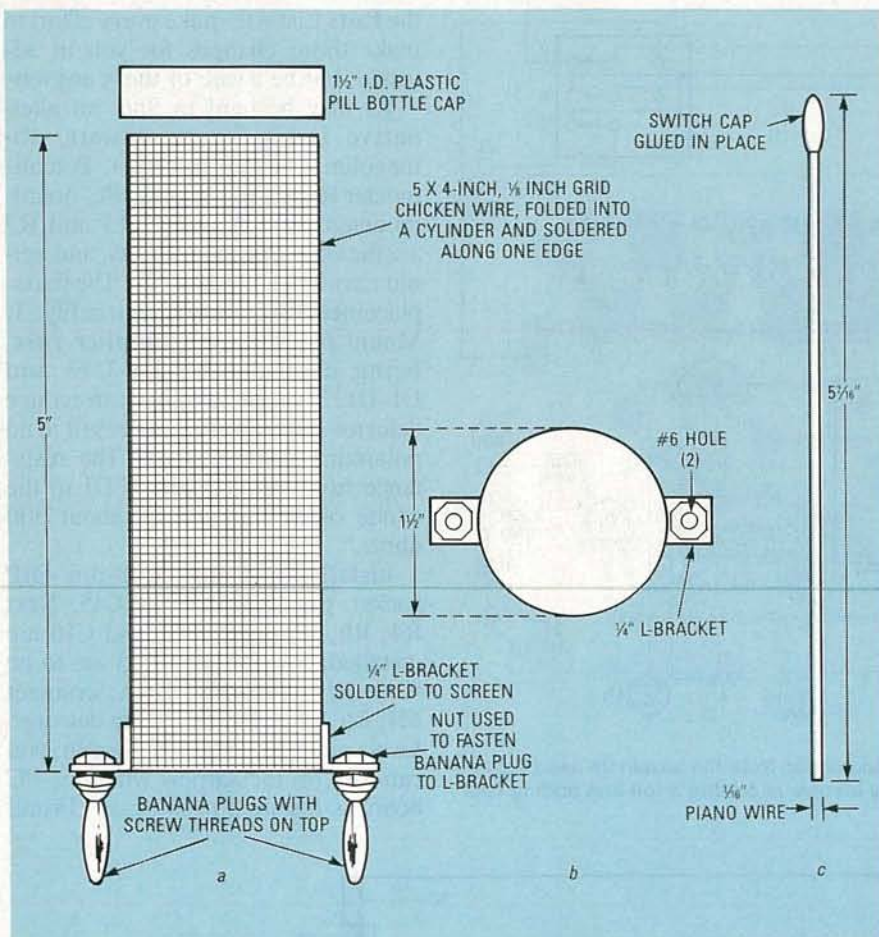

FIG. 5—DETECTOR SCREEN, SHOWING (a) the cage with the banana clips, and (b) the cap over the top of the cage, made from a 1.25-inch inner-diameter pill bottle cap.

Q1–Q3 with transistor sockets if possible; otherwise, use minimal soldering time and, preferably, a grounded soldering iron for Q1.

### The case

All prototype components were mounted in a two-piece,  $5\text{-}\frac{1}{4} \times 3 \times 2\text{-}\frac{1}{8}$ -inch box. One half serves as front panel for R5, R7, S1, S2, and M1. The top of that half supports the detector rod and screen as shown in Fig. 2-a. Figure 4 is the dimensioned case layout, showing the upper surface, front panel, lower surface, and rear panel. Use a straight-edge and pencil to locate the front-panel holes for S1, S2, R5, and R7, mark with a center punch, and drill. Check the shaft diameter of the parts you plan to use, and adjust the drill sizes accordingly.

The hole for M1 isn't dimensioned since yours may vary from that of the prototype. You'll need a  $\pm 150\text{-}\mu\text{A}$  zero-center meter for M1. A surplus FM-radio tuning meter should work nicely. Some meters are "D"-shaped, requiring modification of the hole with a small file, for an easy fit. If

yours uses mounting screws, drill additional holes, and mount M1 on the front panel with screws, clips, double-sided adhesive tape, or rubber cement. Apply the latter to both the rear surface of the meter and the front panel, and let it dry. It'll act like contact cement, but you can still pry M1 off.

Drill a #6 hole for the heatsink of IC2 in the bottom surface of the top half of the case, as shown in the lower surface drawing of Fig. 4. For a case other than the one specified in the Parts List, modify the drilling dimensions. You can try a plastic case if you want to, but a metal one might provide better shielding. When all the holes are drilled, don't mount any components until you've applied the lettering using rub-on transfers.

Clean the front panel with steel wool or rubbing alcohol. Cut the lettering with an X-acto knife, hold with tweezers, and position on the front panel; don't mount the knobs, screws, or M1 until you're done. Press the lettering with a fingernail, run a pen over the surface, and lift the backing off with tweezers. Cover with pa-

ing off with tweezers. Cover with paper, and rub firmly with a fingernail for a good bond. Let it dry for a day before applying varnish.

### The detector

The detector screen is made from a  $4 \times 5$ -inch piece of  $\frac{1}{8}$ -inch metal screening, as shown in Fig. 5. Roll it into a 5-inch long cylinder, hook the ends to form a seam, and solder. Solder small L-brackets with #6 holes to one end, and mount banana plugs PL1 and PL2 with nuts; they plug into J2 and J4. The opposite end of the detector-screen cylinder can be closed with a large plastic pill-bottle cap (1.5-inch inner diameter).

Figure 6 shows the detector-rod in-

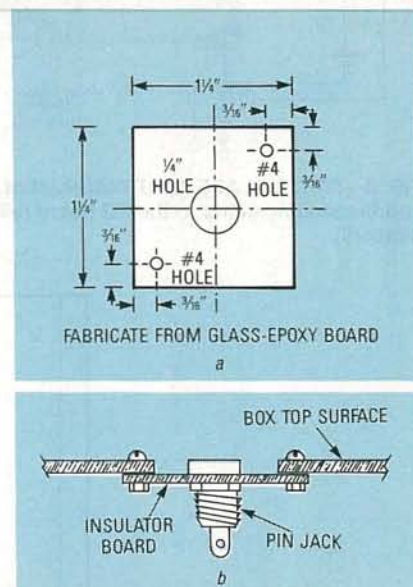

FIG. 6—DETECTOR-ROD INSULATOR BOARD, showing (a) physical layout and (b) assembly into the case.

ulator board, made from a  $1.25 \times \frac{1}{4}$ -inch piece of glass phenolic; the detector rod plugs into J3. As shown in Fig. 4-b, mark and punch the  $\frac{3}{4}$ -inch hole for the detector-rod insulator board. Drill two  $\frac{1}{4}$ -inch and two #6 holes as shown. Center the hole for J3 on the  $\frac{3}{4}$ -inch hole in the top of the case, and drill two holes in the insulator board through the mounting holes in the top of the case.

Attach the insulator board to the inside of the top of the case with #4 machine screws. Make the detector rod from a  $5\text{-}\frac{5}{16}$ -inch piece of  $\frac{1}{16}$ -inch piano wire, as shown in Fig. 4-c. Glue a rubber cap from a small sub-miniature switch handle on one end as a grip. That'll let you insert and re-

*continued on page 70*



# BUILD THIS



*Limit your audio volume to prevent clipping and distortion.*

LOWELL D. JOHNSON

HAVE YOU EVER BEEN ANNOYED BY A PAGING system that makes the speaker difficult to understand, or by a stage-show performer who rattles the speakers by singing loudly into a microphone? Most people assume that the equipment is malfunctioning, and that repairs are needed. However, in many cases that's not so; and the real culprit that's causing the distortion is audio-level mismatching.

Basically, if the gain of an audio amplifier is adjusted for a small input signal, and a large signal is applied, then the amplifier is driven beyond its capabilities and distortion results, even though the amplifier is working perfectly. And, if the amplifier is adjusted for a strong input signal, and a weak signal is applied, then it is difficult to understand what the speaker is saying. In either case, it sounds awful, and the message doesn't get across. However, if you build the circuit described in this article, it will eliminate those kinds of problems; the circuit maintains a constant output-voltage level, regardless of the input signal.

The circuit produces no clipping, which would flatten the peaks of the signal, and virtually zero distortion, because the shape of the output signal

is a true replica of the shape of the input signal. The circuit introduces little noise, so none is heard at the output. Pumping, or changes in amplifier gain that can be detected by the listener, is almost imperceptible. Transient spike handling is excellent—if it weren't, the limiter would not be fast enough to control instantaneous fast-rising spikes, such as a percussive sound.

Volume limiters aren't always desirable. For example, the circuit we'll present was installed in a church PA system to compensate for the different voice levels of the various members of the congregation who made short an-

nouncements. Everyone loved it—except the minister. After the sermon, he very strongly requested that a switch be installed that could disable the limiter. It seems that he preached fire-and-brimstone, and he *wanted* to rattle the speakers.

## Circuitry

Figure 1 shows the block diagram of the audio limiter. Amplifier IC1-a can change its gain from  $\frac{1}{100}$ th to  $\times 100$ , depending on the net effect of its feedback loop. That way, the overall gain of the circuit is such that the output level remains constant. If we put a potentiometer in the feedback loop of IC1-a that we could continuously adjust to maintain a steady output level, that would do the trick. However, that would be extremely impractical, as well as being boring; what we need is a resistor that can instantly change its value in accordance with the output voltage of IC1-a. An optically coupled Light-Dependent Resistor, or LDR would do the trick.

An optocoupler is a device that contains both a light source (an LED) and some kind of light-sensitive device (in this particular case it happens to be an LDR) inside one package,

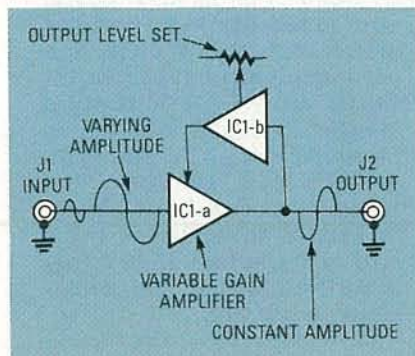

FIG. 1—BLOCK DIAGRAM of the audio limiter. The feedback loop of IC1-a controls the gain of the circuit.



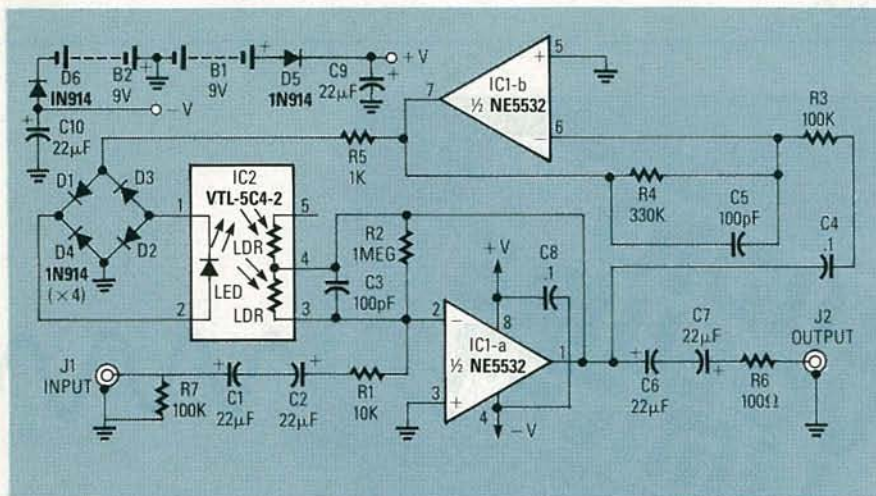

FIG. 2—SCHEMATIC OF THE VOLUME LIMITER. IC1-a is connected as an inverting amplifier whose gain is controlled by the LDR portion of an optocoupler.

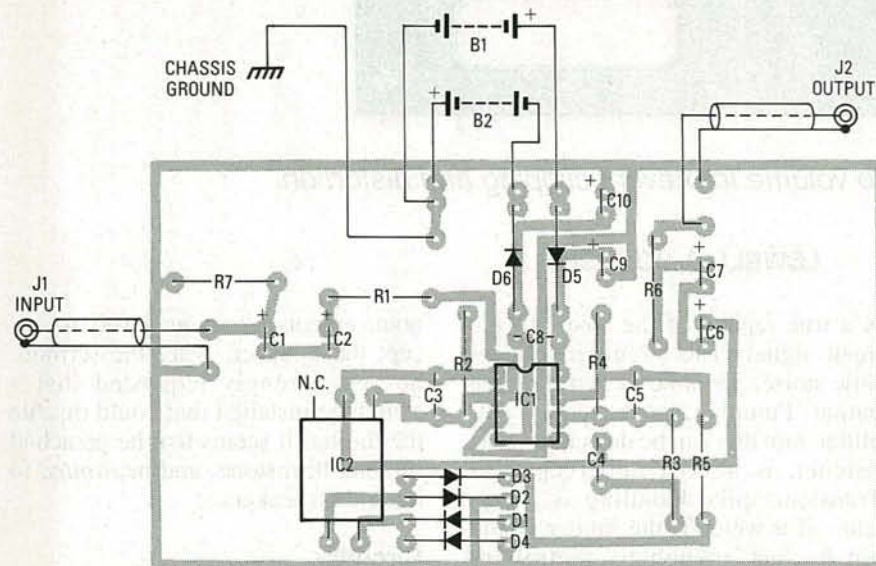

FIG. 3—FOLLOW THIS PARTS-PLACEMENT DIAGRAM if you are using the PC board.

#### PARTS LIST

All resistors are ¼-watt, 5%.

- R1—10,000 ohms
- R2—1 megohm
- R3, R7—100,000 ohms
- R4—300,000 ohms
- R5—1000 ohms
- R6—100 ohms

#### Capacitors

- C1, C2, C6, C7, C9, C10—22 µF, 35 volts, electrolytic (a larger value will also do)
- C3, C5—100 pF, 50 volts
- C4, C8—0.1 µF, 50 volts

#### Semiconductors

- IC1—NE5532 low-noise audio amplifier (Signetics)
- IC2—VTL-5C4-2 optocoupler device (Vactec)

D1–D6—1N914 diode

#### Other components

J1, J2—RCA jacks

Miscellaneous: power supply, project case, wire, solder, etc.

**Note:** A kit of parts, a PC board, and assembly instructions (power supply and enclosure not included) is available for \$48.00, and a single PC board is available for \$25.00, from Woods Electronics Inc., 4233 Spring St. #117, La Mesa, CA 92041 (619) 265-2551 (order # AVL-42889-K). An assembled and tested unit is also available for \$57.00 (order # AVL-42889-A). Check or money order, only.

very small, and when the LED is turned off, the LDR's resistance becomes very large. The resistance of the LDR can therefore be varied at a very fast rate, according to the intensity of the light from the LED. So let's use the LDR portion of an optocoupler in the feedback loop of our amplifier to produce a gain-controlling circuit.

Now, to be more specific, we need an optocoupler with an LDR that can reduce its resistance instantly when its input signal reaches the limiting threshold, thereby reducing the gain of the amplifier to just below the threshold. Then we'd like it to stay at that value until the input signal became weaker, and then gradually increase the gain until the threshold is reached. Fortunately, the VTL-5C4-2 from Vactec Inc. (10900 Page Blvd., St. Louis, MO 63132) has exactly those characteristics. When the light source is illuminated, the resistance decreases in a matter of microseconds (very fast with respect to audio frequencies), and when the light source is removed, the resistance increases over a period of seconds (very slow with respect to audio frequencies). Those combined characteristics can form a limiting circuit that produces a constant output level, but whose action is not easy—in fact, quite difficult—for the listener to detect.

Figure 2 shows the schematic of the volume limiter. IC1-a is connected as an inverting amplifier; ignoring the LDR (assume that its resistance is very high so that it doesn't affect the feedback loop), the gain is  $R2/R1$ , or 100. Standard low-impedance-microphone preamplifiers have a gain of 100. Thus, the output at IC1-a pin 1 will be about 2 volts p-p.

The second half of the amplifier, IC1-b, is connected to the output through C4, and its gain is  $R4/R3$ , or 3. The optocoupler's LED turns on when the voltage across it is about 2 volts. The higher the current through it, the brighter it illuminates. On positive peaks, it is in series with D1 and D2, and on negative peaks it is in series with D3 and D4. Since D1–D4 are silicon diodes, about 0.7 volts is dropped across each one before they begin to conduct. Therefore, the total positive voltage across the bridge required to illuminate the LED is  $0.7V + 0.7V + 2V$ , or slightly less than 3.4 volts. The same voltage with a negative polarity appearing across

with the leads of both brought out to external pins, much like an IC. When

the LED is turned on via an external input voltage, the LDR's resistance is



the bridge will also illuminate the LED.

As the AC signal at IC1-b pin 7 approaches 6.8-volts AC, the LED receives short bursts of current, and the LDR instantly reduces in value to a point where it reduces the gain of IC1-a, thereby reducing the output of IC1-b pin 7 to less than 6.8 volts AC. Because of the slow recovery time of the LDR, it appears effectively as a fixed resistor and therefore produces virtually no distortion. The output voltage, 6.8-volts AC, when divided by the gain of IC1-b, is about 2-volts p-p, which is a standard line level. Since the LDR can go below 100 ohms, the gain of IC1-a can be reduced to  $LDR/R1$ , or  $1/100$ th. That means that signals up to 200-volts p-p can be applied to the input (although you'll never have an input with that magnitude), while maintaining the output at a line level; any input signal ranging from microphone-level to 200 volts will produce a clean line-level output.

If R5 were left out of the circuit, the output level would be so constant that a monotone sound quality would result. By putting a little resistance in series with the bridge, the output voltage will be allowed to vary a little, and the sound is much more natural. A 1K resistor is a good choice for R5, but try out other values for yourself. You may also want to try other R2/R1 and R4/R3 ratios.

The NE5532 (IC1) is a relatively expensive dual op-amp with very-low-noise characteristics. If you can tolerate some noise, feel free to use a 741, 324, or any other general-purpose audio op-amp. If you do, note that the pin numbers may change. Also, C1, C2, C6, and C7 are used to block DC. If no DC exists in your design, then you may omit them. R6 is included for spike protection; if no dangerous spikes will exist, you may omit that resistor, too. Capacitors C3, C5, and C8 are included as standard practice, but if no undesirable effects occur, you may omit them. Use any regulated supply voltage, such as two 9-volt batteries or a  $\pm 12$ -volt DC supply. Just don't exceed the maximum voltage ratings of the IC that you decide to use. The current drawn by the circuit will depend on the op-amp that you decide to use for the project, but it will never be more than a few milliamps per op-amp section.

If you want to operate without a

negative supply, then connect IC1 pin 4 to ground, and create a  $V_{CC}/2$  supply with another unity-gain op-amp section and a voltage divider. Then connect all the ground connections except for the input and output grounds to that, and connect IC1 pin 8 to  $V_{CC}$  (just reference everything up to  $V_{CC}/2$ ). Always use at least 15-volts DC—preferably 24-volts DC. Also, the optocoupler used for the project is a dual-element type; they are more versatile. However, you can use the VTL-5C4 (the single-element version) if you like.

### Building the circuit

Because IC1-a may have a gain of up to 100, you must keep the leads short in that circuit. Ground loops can defeat any circuit, so keep all power-supply grounds together on one side of the board. Also, remember to use shielded wire on the input and output connections. You can use point-to-point wiring on perforated construction board, but it's best to use the foil pattern provided in PC Service to make a board and use that instead. A ready-to-use PC board is also available from the source mentioned in the parts list.

Figure 3 shows the parts-placement diagram for the audio limiter. Be sure to check for solder shorts and all of that other bad stuff before powering up and testing the circuit. RCA-type jacks are probably the best choice for J1 and J2, but use whatever best suits your application.

To test the circuit, simply connect a microphone, and observe the output on an oscilloscope, or listen to it through a headset (to cut out feedback). The output should remain at the same level, regardless of whether you whisper or scream into the microphone. A note of caution: Remember that the limiter works to correct the gain by looking at seldom-encountered maximum peaks. If you feed in a sine wave, you will notice that the output indeed remains constant, no matter what the input voltage, but a "blip" appears on each and every peak (which would imply high distortion). In a normal audio signal, not all peaks are the same amplitude, and only seldom-occurring maximum peaks are acted upon. Since they occur very infrequently (as compared to audio frequencies), the distortion of the limiter is actually very low—you won't even notice it. R-E

## Put Professional Knowledge and a COLLEGE DEGREE in your Technical Career through HOME STUDY

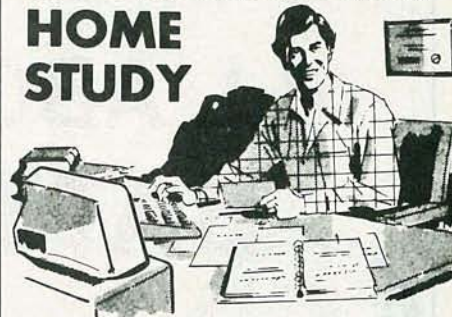

Add prestige and earning power to your technical career by earning your Associate or Bachelor degree through directed home study.

Grantham College of Engineering awards accredited degrees in  
**electronics and computers.**

An important part of being prepared to *move up* is holding the right college degree, and the absolutely necessary part is knowing your field. Grantham can help you both ways—to learn more and to earn your degree in the process.

Grantham offers two degree programs—one with major emphasis in **electronics**, the other with major emphasis in **computers**. Associate and bachelor degrees are awarded in each program, and both programs are available completely by correspondence.

No commuting to class. Study at your own pace, while continuing on your present job. Learn from easy-to-understand lessons, with help from your Grantham instructors when you need it.

Write for our free catalog (see address below), or phone us at toll-free 1-800-955-2527 (for catalog requests only) and ask for our "degree catalog."

Accredited by  
the Accrediting Commission of the  
National Home Study Council

**GRANTHAM**  
College of Engineering  
10570 Humbolt Street  
Los Alamitos, CA 90720

MARCH 1990



## ALL ABOUT BATTERIES

JOSEF BERNARD

BATTERIES, BATTERIES, AND STILL MORE batteries. There are "C" cells, "D" cells, "AA" cells, and button cells of all varieties. The assortment you'll find, even just hanging on a super-market rack, boggles the mind; there are regular, heavy-duty, "classic," alkaline, lithium, mercury, nickel-cadmium, and air-zinc cells. Simply making a decision about which type to use, even when you have no choice about the size of the cell you're replacing, can be confusing; and if you're designing a piece of equipment for battery operation, the problem is magnified enormously. In this article we'll try to make clear some of the reasons behind the multitude of battery types, and present some guidelines for choosing among them.

### A short course

To begin with, a battery is made up of *cells*. An individual cell usually outputs about 1.5 volts, although the figure may be higher or lower, depending on the materials involved. A battery of cells must be used when you need to produce more voltage or current than can be delivered by a single cell.

A battery produces electricity through an oxidation-reduction chemical reaction involving two dissimilar materials, in which electrons are transferred from one to the other. If you extract the electrons at some point along their path of travel, you can put them to work for you. The voltage and current that a given pair of materials will produce are largely determined by their places in the electromotive series, which lists the elements according to the degree to which they react with oxygen. The greater their separation along the series, the greater the potential they will produce.

*Selecting the right batteries for a particular application can be frustrating, especially when you have to choose between so many different types. This article will help you make your next selection.*

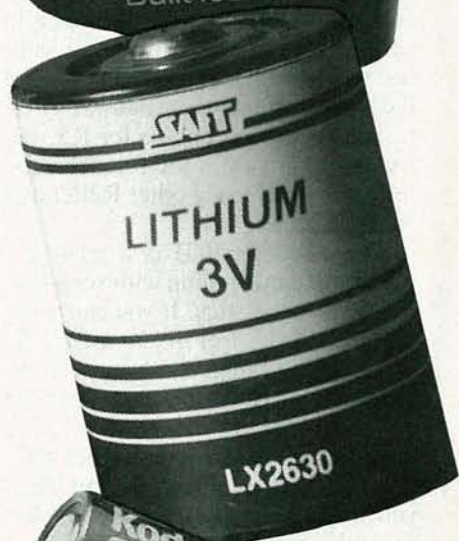



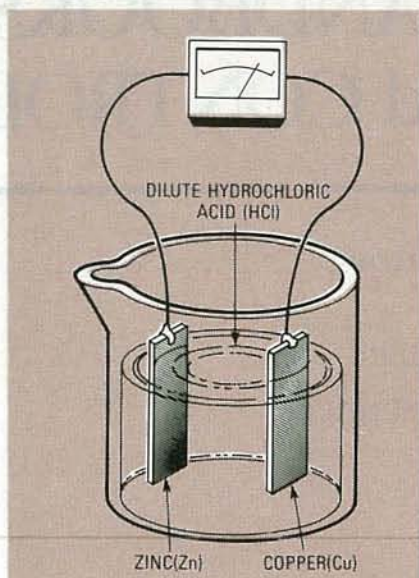

**FIG. 1—A SIMPLE ENERGY-PRODUCING cell can be constructed from two dissimilar metals such as copper and zinc immersed in an acid electrolyte.**

Any high-school chemistry book can provide you with detailed information on how the electron-producing reactions work. And, if you have fillings in your teeth and have ever bitten down on a coin or a piece of gum-wrapper foil, you have experienced (and tasted) firsthand how a simple battery works.

A simple, lab-experiment energy cell is illustrated in Fig. 1. In principle, all energy-producing cells have the same three principal components. They are:

**Anode:** the material that is oxidized and gives up electrons during the chemical reaction. The anode is usually marked with a “-.”

**Cathode:** the material that is reduced (releases oxygen) and accepts electrons during the reaction. It is usually marked with a “+.”

**Electrolyte:** the conductor through which electrons travel from the anode to the cathode as ions. The electrolyte is usually a “wet,” or at least a damp material.

Note that, contrary to customary usage in electronics, the anode is the *negative* electrode of an energy cell and is indicated with a “-.” The positive electrode, marked with a “+,” is the *cathode*. In a rechargeable device, the functions of the electrodes are reversed during charging however, and conventional terminology then applies.

Cells and batteries are divided into

two types: *primary* and *secondary*. Primary cells, which include the common throw-away “flashlight battery” types, expend their energy and, when their chemicals are exhausted, they must be discarded. Secondary cells are rechargeable (the chemical action is reversed by forcing a reverse flow of electrons), and include nickel-cadmium types and the lead-acid batteries used in automobiles.

### Leclanche cells

Figure 2 shows the construction of

an ordinary carbon-zinc D-size cell. The anode, cathode, and electrolyte are just a few of the components of a modern-day dry cell. Many of the others, though, such as the paper separator, serve just to “fine-tune” the performance of the device. That type of dry cell belongs to a class called “Leclanche cells” (sometimes pronounced Le-clan-SHAY) cells. They are named after Georges Leclanche, the Frenchman who produced the first carbon-zinc cell in 1866.

Because carbon-zinc cells are in

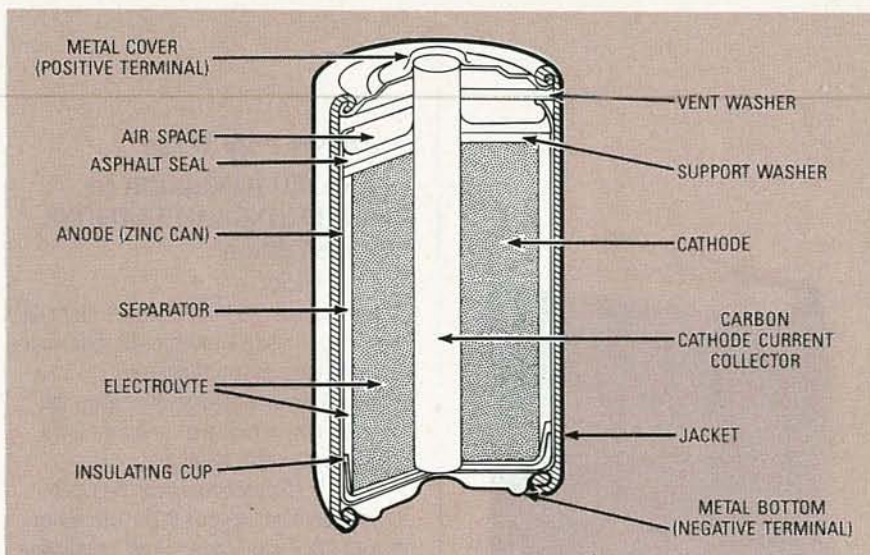

**FIG. 2—THE “CLASSIC” DRY CELL uses a zinc can as anode, an ammonium/zinc-chloride electrolyte, and a manganese-dioxide cathode mix. The carbon rod plays no active part in the electron-producing reaction.**

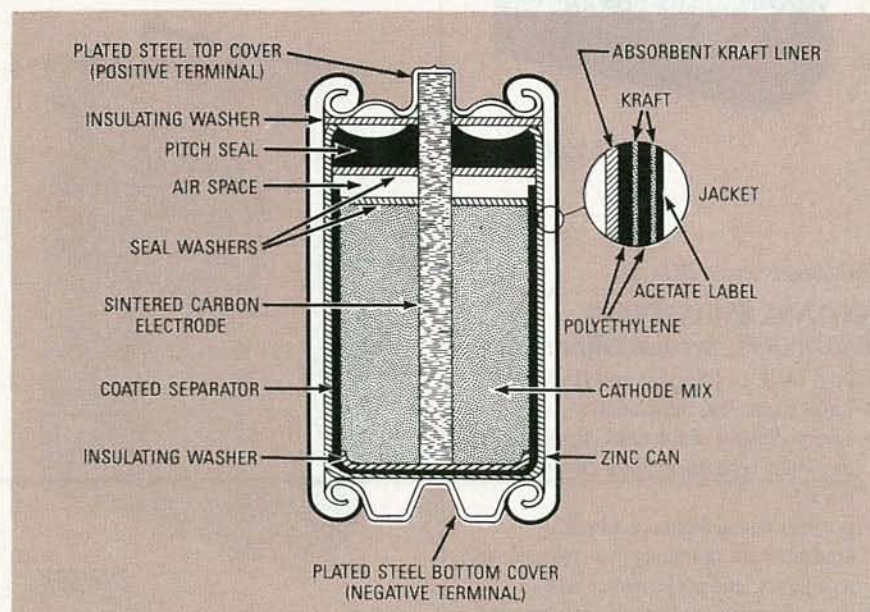
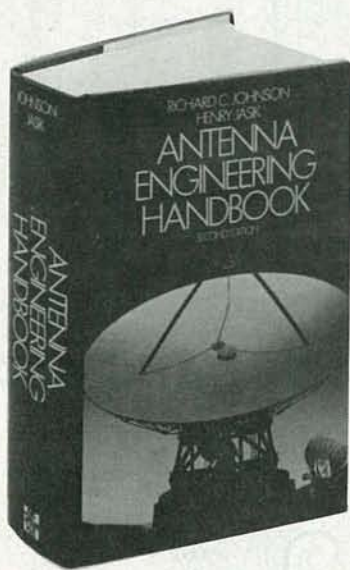

**FIG. 3—THE PAPER SEPARATOR used in more recent dry-cell designs requires less space than the older paste-type, thus allowing the inclusion of more cathode mix and making possible a greater energy density.**



# Take any one of these HANDBOOKS ELECTRONICS and CONTROL

- your one source for engineering books from over 100 different publishers
- the latest and best information in your field
- discounts of up to 40% off publishers' list prices



322/910

*Publisher's Price \$114.50*

## ANTENNA ENGINEERING HANDBOOK, Second Edition

Edited by R. C. Johnson and H. Jasik

- 1,408 pages, 946 illustrations
- covers all types of antennas currently in use with a separate chapter devoted to each
- provides detailed data on physical fundamentals, operating principles, design techniques, and performance data
- up-to-the-minute information on antenna applications
- a must for those involved in any phase of antenna engineering

*Publisher's Price \$75.00*

## STANDARD HANDBOOK OF ENGINEERING CALCULATIONS, Second Edition

By T. G. Hicks

- 1,468 pages, 793 illustrations, 499 tables
- puts more than 1,100 specific calculation procedures at your fingertips
- every calculation procedure gives the exact, numbered steps to follow for a quick, accurate solution
- virtually all procedures can be easily programmed on your PC or calculator
- uses USCS and SI units in all calculation procedures

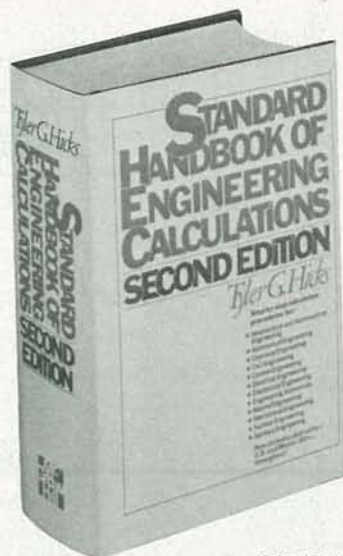

287/35X



047/790

*Publisher's Price \$98.50*

## TELEVISION ENGINEERING HANDBOOK

Edited by K. B. Benson

- 1,478 pages, 1,091 illustrations
- packed with all the technical information today's engineer needs to design, operate, and maintain every type of television equipment
- extensive coverage of receivers, broadcast equipment, video tape recording, video disc recording, and the latest technological advances
- provides television system and industry standards for the U.S. and other countries
- the most comprehensive book on the subject of television engineering



# for only \$14.95 – when you join the ENGINEERS' BOOK CLUB

values up to  
\$114.50



404/461

Publisher's Price \$89.95

## MODERN ELECTRONIC CIRCUITS REFERENCE MANUAL

By J. T. Markus

- 1,264 pages, 3,666 circuit diagrams
- a handy, desktop reference with 103 chapters organized by "family" grouping
- filled with predesigned and use-tested circuits to save you production time and money
- includes concise summaries of all the recent applications notes, journal articles, and reports on each circuit, efficiently organized and indexed for the practicing engineer

### 4 reasons to join today!



**1. Best and newest books from ALL publishers!** Books are selected from a wide range of publishers by expert editors and consultants to give you continuing access to the best and latest books in your field.

**2. Big savings!** Build your library and save money, too! Savings range up to 40% off publishers' list prices.

**3. Bonus books!** You will automatically be eligible to participate in our Bonus Book Plan that allows you savings up to 70% off the publishers' prices of many professional and general interest books!

**4. Convenience!** 14-16 times a year (about once every 3-4 weeks) you receive the Club Bulletin FREE. It fully describes the Main Selection and alternate selections. A dated Reply Card is included. If you want the Main Selection, you simply do nothing – it will be shipped automatically. If you want an alternate selection – or no book at all – you simply indicate it on the Reply Card and return it by the date specified. You will have at least 10 days to decide. If, because of late delivery of the Bulletin you receive a Main Selection you do not want, you may return it for credit at the Club's expense.

As a Club member you agree only to the purchase of two additional books during your first year of membership. Membership may be discontinued by either you or the Club at any time after you have purchased the two additional books.

Publisher's Price \$89.50

## ELECTRONICS ENGINEERS' HANDBOOK, Third Edition

Edited by D. G. Fink and D. Christiansen

- 2,496 pages, 1,600 illustrations
- the definitive reference to electronics engineering
- fully updated to cover all recent advances and developments
- ranges from essential principles and data to the latest design solutions and practical applications – with an all-new chapter on standards
- written and compiled by more than 170 contributors – all experts in their fields

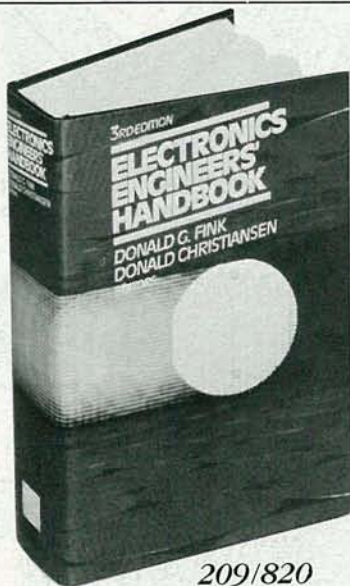

209/820

FOR FASTER SERVICE IN ENROLLING CALL TOLL FREE 1-800-2-MCGRAW

**McGraw-Hill Book Clubs**  
**Electronics and Control Engineers' Book Club®**  
P.O. Box 582  
Hightstown, NJ 08520-9959

Please enroll me as a member of the Electronics and Control Engineers' Book Club® and send me the book I have chosen for only \$14.95 plus local tax, postage and handling. I agree to purchase a minimum of two additional books during my first year as outlined under the Club plan described in this ad. Membership in the club is cancellable by me or McGraw-Hill any time after the two book purchase requirement has been fulfilled. A shipping and handling charge is added to all shipments.

I wish to order the following book:

- ANTENNA ENGINEERING HANDBOOK (322/910)
- MODERN ELECTRONIC CIRCUITS REFERENCE MANUAL (404/461)
- ELECTRONICS ENGINEERS' HANDBOOK, 3/e (209/820)
- TELEVISION ENGINEERING HANDBOOK (047/790)
- STANDARD HANDBOOK OF ENGINEERING CALCULATIONS (287/35X)

Signature \_\_\_\_\_

Name \_\_\_\_\_

Address/Apt. # \_\_\_\_\_

City/State/Zip \_\_\_\_\_

This order subject to acceptance by McGraw-Hill. Offer good only to new members. Foreign member acceptance subject to special conditions.

ECGA-028

MARCH 1990



such widespread use, it will pay to devote a paragraph or two to a discussion of the elements of which they are comprised. Figures 2 and 3 show carbon-zinc cells using paste and paper separators, respectively. (Because a paper separator occupies less space than the paste type, paper-separator cells can contain more reactive materials and produce about ten percent more power.)

The anode is a zinc can, zinc being one of the two reactive materials in the cell. The can also serves as a container for the other cell materials. Today, zinc cans are usually enclosed in a steel jacket, which increases durability and helps to contain leakage, should that occur.

Lining the inside of the can is the paste or paper separator. Its purpose is to physically and electrically isolate the positive and negative electrodes while permitting electrolytic or ionic conduction to take place through the electrolyte. The paste contains electrolyte and a gelling agent such as starch or flour. The paper-type separator is coated with a gelling agent and impregnated with electrolyte that is squeezed out of the cathode material during manufacture. Ordinary general-purpose Leclanche cells use an electrolyte made of ammonium chloride ( $\text{NH}_4\text{Cl}$ ), zinc chloride ( $\text{ZnCl}_2$ ), and water. In "heavy-duty" cells, the electrolyte is almost entirely zinc chloride and water.

The bulk of the cell consists of the cathode mix, also known as the "bobbin," "black mix," or "depolarizer." Its constituents are manganese dioxide ( $\text{MnO}_2$ ), carbon black, and electrolyte. The purpose of the carbon is twofold: it holds the electrolyte and adds electrical conductivity to the mix. Some cells use a very pure electrolytically derived form of  $\text{MnO}_2$  known as EMD (*Electrolytic Manganese Dioxide*). Although that makes them more expensive, it also makes for an extra-heavy-duty device. A carbon rod is inserted at the center of the bobbin, which is the cell's current collector (electron source). The semi-porous rod also acts as a vent for hydrogen gas.

Note that although the Leclanche cell is frequently called a carbon-zinc (or zinc-carbon) type, carbon does not take part in the chemical reaction that produces electricity. The active ingredients are zinc and the manganese compound(s).

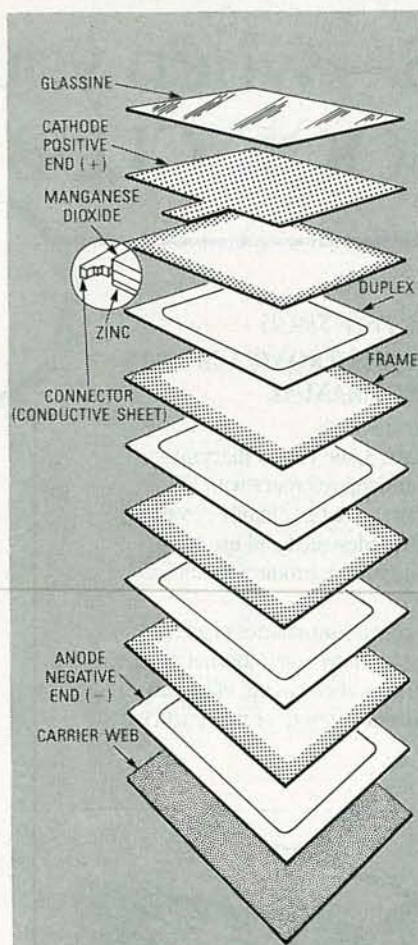

FIG. 4—THE LARGE ELECTRODE area of the Polapulse battery gives it the power to deliver enormous quantities of current.

volts, although a brand-new one may be measured as high as 1.75–1.8 volts. A general-purpose Leclanche cell has an energy density of about 30 watt-hours per pound.

A special form of the carbon-zinc design is the Polapulse battery (Fig. 4) used to power Polaroid instant cameras. Its thin, flat construction makes possible electrodes with large surface areas. That, in turn, gives it a large capacity—as much as 19 amperes of instantaneous current! A Polapulse experimenter's kit is available from Powercard Corporation, 391 Totten Pond Road, Waltham, MA 02154 (617) 890 6789. The P100 Designer's Kit contains five P100 batteries and a special holder for them; it costs \$17.50, and Massachusetts residents must add proper sales tax.

### Alkaline cells

Alkaline cells derive their name from the fact that their electrolyte is the highly caustic base, potassium hydroxide (KOH), rather than a slightly acidic one containing a salt such as ammonium- or zinc-chloride. The design of an alkaline cell, although superficially similar to that of a carbon-zinc one, is really significantly different, as can be seen in Fig. 5.

The cathode material of an alkaline cell is EMD, the electrolytically derived manganese dioxide sometimes

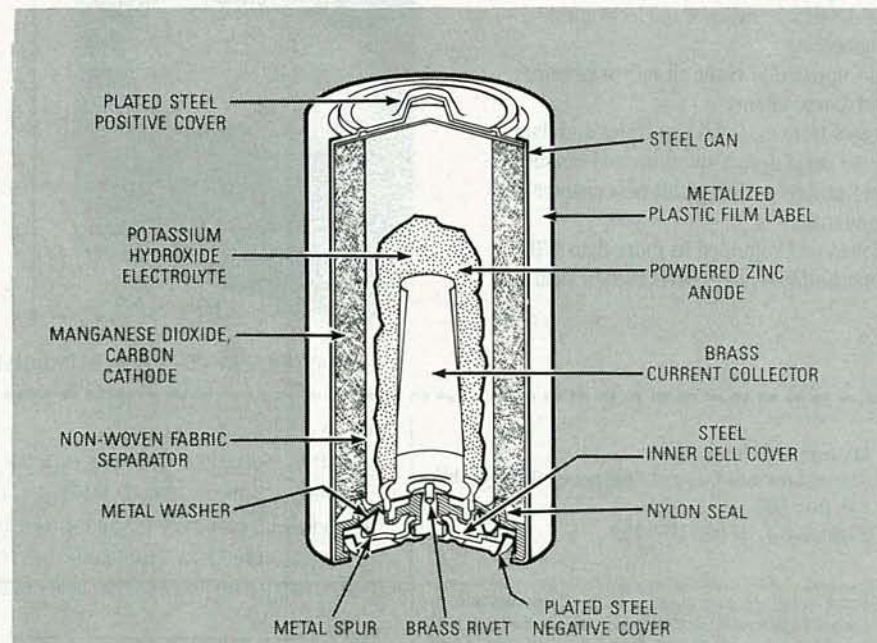

FIG. 5—TYPICAL OF MANY alkaline cells is "inside-out" construction, where the cathode material is exterior to that making up the anode.

The no-load voltage developed by a carbon-zinc cell is nominally 1.5

used in carbon-zinc cells to improve performance. It is mixed with water,



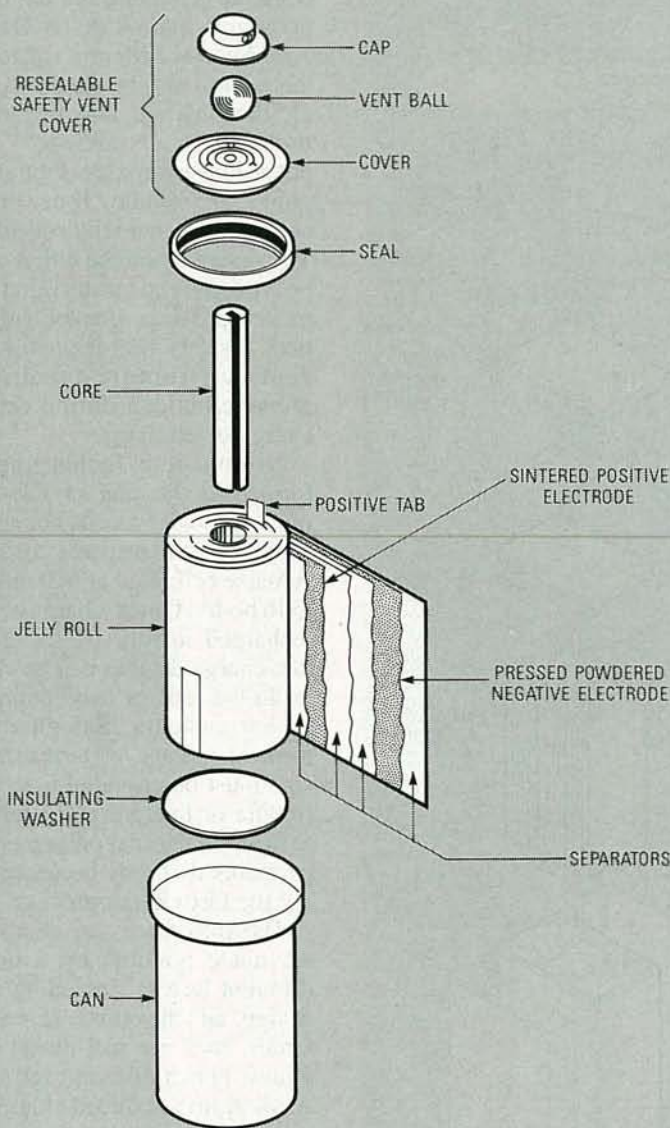

FIG. 6—THE “JELLY ROLL” construction of a typical nickel-cadmium cell gives it a large electrode area. Note the vent mechanism to protect against cell rupture resulting from the generation of gases during charging.

carbon or graphite (ten percent or a bit more), and some potassium-hydroxide electrolyte. As in a Leclanche cell, the anode is made of zinc, but the metal is in finely powdered form and the cell is contained in a steel jacket. The highly purified zinc powder is treated with mercury to form an amalgam; that greatly reduces the production of hydrogen, caused by the metal reacting with the potassium hydroxide electrolyte that pervades it. The separator that is used is made of a porous woven, felted, or bonded material.

In a cylindrical alkaline cell, the central element is the anode collector, not the cathode collector used in carbon-zinc cells. That piece, which may

be made of brass, is mechanically and electrically connected to the bottom (–) terminal of the cell. That sort of “inside-out” construction is frequently used in dry-cell designs.

Alkaline cells have an open-circuit rating of about 1.52 volts, and an energy density of about 45 watt-hours per pound. Their performance at temperature extremes exceeds that of carbon-zinc types. Their low-current-drain performance is also better, but where alkalines are best where moderate-to-high currents are drawn over an extended period.

#### Making a choice

Carbon-zinc and alkaline cells are available in a wide variety of packag-

ings and voltages. Fortunately, if it's just a replacement battery you're looking for when you walk into the store, you don't have to worry too much about your decision. The equipment into which the replacement cell or battery will be inserted can take only a particular size, and that size is usually keyed to the voltage. What you have to concern yourself with is the way the replacement performs—its behavior at various temperatures and, more important, its ability to deliver the current that your application requires. The literature provided with a dry-cell-operated device frequently recommends a specific type of cell or battery, but does not explain why that particular sort is called for. The next few paragraphs will help you to make a more informed decision about replacement cells, and in choosing a power source for something you may be designing.

Although alkaline cells have largely replaced carbon-zinc types in most applications, there are still some places where the latter will give a better price-performance ratio than the more glamorous type. Such situations are typically those where current drain is light but constant (no surges of current are called for by the device) and the operating temperature is a comfortable one. Carbon-zinc cells have a relatively short shelf or storage life, so they are best suited to applications where they will be used immediately; not where they will be expected to remain quiescent for long periods awaiting emergency use.

In a C-cell-powered wall clock it may prove more economical to install a regular carbon-zinc cell than an alkaline one; while the alkaline cell may last a bit longer, its extra cost will offset any economy that might be gained from its somewhat longer life. Heavy duty carbon-zinc cells made with somewhat higher-quality materials can even be used to power small transistor radios, provided not too much demand is made of them.

Alkaline cells, with their ability to source heftier currents than carbon-zinc ones and to depolarize, or recover, more quickly after heavy use, are better suited for the workload presented by much of today's consumer-electronics equipment; cassette players, boom-boxes, portable TV's, and the like. Devices that might suck carbon-zinc cells dry in twenty minutes can run for several hours on alkalines.



An Eveready brand called the "Conductor" promotes itself as being best for audio applications. While that was the case when it was first introduced, due to the use of premium components, the design of "ordinary" alkaline cells is today virtually identical to that of the Conductor brand, and there is little, if any, difference in performance.

Other properties of alkaline cells may also make them the better choice in certain applications. They have a longer shelf or storage life, and their output voltage falls off less rapidly than does that of carbon-zinc cells. Incidentally, you can extend the storage life of carbon-zinc cells by keeping them refrigerated to slow the chemical reactions that take place in them even when they are not being used. Because those reactions take place much less actively when alkaline cells are not in use, alkaline cells do not benefit as much from refrigerated storage.

Low temperatures cause voltage drop-offs in all types of energy-producing cells and batteries. Again, alkaline cells provide greater reliability over a greater temperature range than do carbon-zinc ones. As the temperature of a carbon-zinc cell drops below freezing, its voltage, and particularly the current it is capable of delivering, fall rapidly to unusable levels. While alkaline cells are similarly affected by low temperatures, their performance is better than that of even the best carbon-zinc cells.

Don't be swayed by those commercials that say things the likes of "Ours last 30 percent longer than..." The comparison is probably being made between the manufacturer's current production and the same product as he formulated it several years ago—not between his and somebody else's products. Virtually all alkaline cells produced today by the major manufacturers are considerably longer-lasting than those of a few years back due to the fact that changes in the construction of the shell (namely, reducing it to a single steel container with a thin plastic overcoating) has resulted in the ability to cram more reactive material inside. The voltage, of course, doesn't change, but the ability to deliver current does.

### Rechargeable cells

Are you tired of replacing worn-out dry cells all the time? Maybe you're

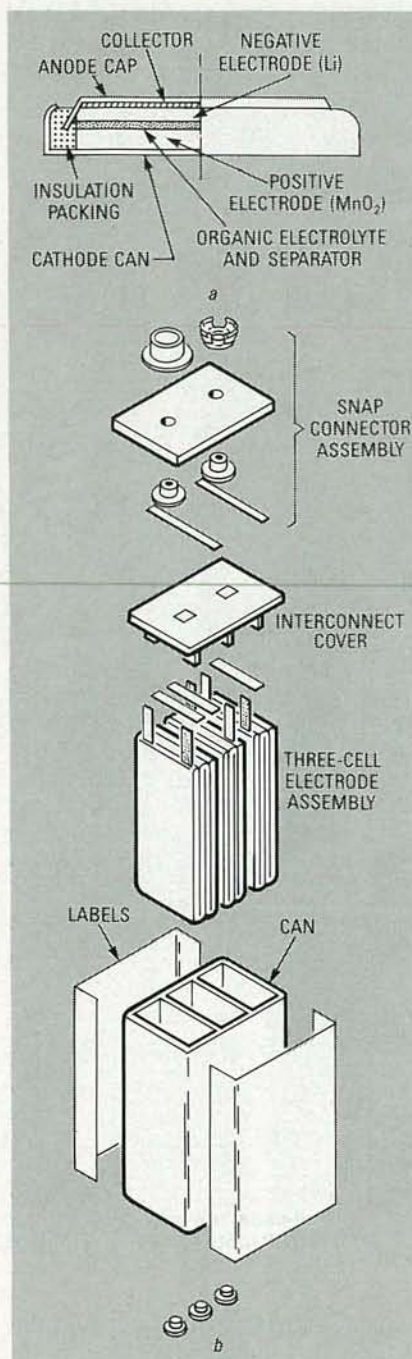

**FIG. 7—LITHIUM CELLS** have extremely high energy densities. The button-style packaging shown in *a* provides a large electrode area. Three 3-volt lithium cells are connected in series to make a 9-volt transistor-type battery (*b*).

tempted to replace them entirely with rechargeable nickel-cadmium cells. But nickel-cadmium cells (commonly called "Nicads," although that's actually a trademark owned by one manufacturer, Saft) have their pros and cons.

The internal details of a typical nickel-cadmium cell are shown in Fig. 6. The active materials are nickel oxide (NiO), which forms the cell's

positive plate; cadmium (Cd) for the negative plate; and the highly caustic potassium hydroxide (KOH) electrolyte. Several different manufacturing techniques may be used but, in general, the positive and negative electrodes form a "sandwich" with the potassium-hydroxide-saturated separator in the middle. Those three layers are wound into a jelly-roll-like spiral. The separator can be either nylon or a polypropylene material; the latter makes possible greater cell capacities. A safety vent is provided to prevent cell rupture resulting from pressure buildup during extremes of charge or discharge.

Normal-rate recharging is performed at the rate of one-tenth the rated current of a cell. For example, it takes 60 milliamperes to charge an AA-size cell rated at 600 mAh, for 14 to 16 hours. Quick-charge cells can be recharged in four to six hours, and fast-charge devices can be charged in as little as one or two hours, at much higher currents. Safeguards in the form of voltage or temperature sensors must be provided to prevent cell rupture or internal plate damage due to the high internal pressures and temperatures that may be generated during the fast-charge process.

The differences in charging rates are made possible by a number of different factors, including electrode design, and the choice of reactive materials; they are still nickel and cadmium, but in different formulations. Aside from a reduced charging time, the differences between regular-, quick-, and fast-charging cells are more or less transparent to the user. There is, however, a slight reduction in internal resistance in fast-charging cells, resulting in a nominal (on the order of millivolts) voltage increase, and the ability to better provide surge current.

Nickel-cadmium cells have a much flatter voltage-drop curve over their working life than do Leclanche and alkaline designs—a fact that may be worth considering. Immediately after charging, their open-circuit voltage is about 1.4 volts, which drops almost immediately to about 1.25 volts, a level that is maintained until their charge is nearly depleted. They can provide very large amounts of current when needed, and hold up well under conditions of continuous drain. Nickel-cadmium cells also provide good power output under extremes of tem-





**FIG. 8—RECHARGEABLE** lithium cells are intended principally for maintaining the contents of solid-state memories.

perature range.

Nickel-cadmium cells perform best when worked hard. If discharged just shallowly and then charged immediately, they will develop a “memory” for that sort of use and eventually lose some of their capacity. However, because of slight changes in cell chemistry, that’s far less of a problem than it was just a few years ago. Most manufacturers insist that memory effects no longer exist. The working life of a nickel-cadmium cell on a single charge is only about 70 percent of that of an equivalent-size alkaline cell.

Nickel-cadmium cells are most useful where they can be built into a device and the charging current supplied from the outside through a jack, or internally, directly from it. If rechargeables are used as replacements for throwaway primary cells, you generally face the inconvenience of removing them from the device for charging, and then removing them again from the charger and replacing them in their compartment for use. When replacing old or worn-out cells in a nickel-cadmium battery pack, replace them all at once—mixing old and new ones can lead to the weakest of them reversing its polarity and affecting the life and performance of the entire pack.

Rechargeable lead-acid cells and batteries (similar to the one in your car, but smaller) use lead, lead oxide, and sulphuric acid, and come with a gelled electrolyte that allows them to be used in portable equipment without fear of spillage. Lead-acid technology is also available in the form of sealed D-size cells. The nominal voltage of a lead-acid cell is 2.0 volts, and it is capable of sustaining very high rates of discharge. The performance of lead-acid cells falls off at cold and

very warm temperatures. Unlike nickel-cadmium cells, lead-acid cells must be kept well-charged if you expect them to perform efficiently over a long lifetime.

### Lithium cells

Lithium is an extremely reactive metal, and its high place in the electromotive series makes it an excellent candidate for inclusion in energy cells. Unfortunately, its high degree of activity (it reacts violently with water, for example) makes it difficult to work with. Many of the difficulties have been overcome, however, and lithium-based cells are now found widely in watches, cameras, calculators, and in situations where a small trickle of current is required to maintain the contents of solid-state memory in a standby state. Lithium cells are very efficient, with energy densities on the order of 90 watt-hours per pound. The major reason lithium cells are not more widely used (although that is changing) is the difficulty in manufacturing large-size ones that are safe to use.

Although there are a number of lithium-cell formulations, the one using lithium, manganese dioxide ( $MnO_2$ ) and a lithium perchlorate ( $LiClO_4$ ) electrolyte in an organic solvent (water cannot be used, remember) makes up about 70 percent of the lithium-cell market. Carbon monofluoride is also used. Much of the remaining portion consists of cells made using a lithium-carbon-thionyl chloride ( $SOCl_2$ ) formulation. Figure 7-a shows the construction of a typical lithium “button” cell; Fig. 7-b shows how Kodak combines three manganese-dioxide-type lithium cells in one package to produce a nine-volt, “transistor-type” battery.

The output of a lithium/ $MnO_2$  cell is nominally three volts; in some applications it may be possible to replace two 1.5-volt carbon-zinc or alkaline cells with one lithium one. By using a lithium/ferric-sulphide ( $FeS_2$ ) combination, a lightweight and powerful 1.5-volt cell can be produced. One of the great benefits of using lithium cells is their extremely long shelf life; five years or even ten. Under conditions of low drain, their useful working life may almost equal that figure.

A rechargeable lithium/ $MnO_2$  button cell has recently been introduced by Sanyo (see Fig. 8). It is intended

primarily as a replacement for the Ni-Cd cells and large-value capacitors used in keeping memory circuits alive.

### Other types

While the types of energy cells already described can fill most electronics needs, actual and anticipated, there are a few additional kinds that bear mentioning.

Mercury cells have long been used as a compact power source in devices such as hearing aids and cameras. They use a mercuric-oxide cathode, powdered-zinc anode, and a potassium hydroxide (KOH) or sodium hydroxide (NaOH) electrolyte. The output voltage is 1.3 volts, and remains stable over a long life of storage or use. Silver-oxide cells are also used for similar applications (see Fig. 9).



**FIG. 9—THIS SILVER OXIDE** battery is often used in cameras.

Another type of energy cell found in hearing aids and watches is the zinc-air, or just plain “air,” cell. It uses atmospheric oxygen to produce electrochemical energy. Zinc-air button cells use a powdered-zinc-with-potassium-hydroxide-electrolyte anode and have a very thin cathode region incorporating a catalyst. Oxygen in the air provides the cathode material. Although they are not able to output large amounts of current, zinc-air cells have very high energy densities. Because air is kept out by a pull tab until a zinc-air cell is ready to be used, its shelf life is extremely long. A zinc-air cell’s output voltage of about 1.4 volts remains stable over a working life of several hundred hours before falling rapidly to an unusable level.

There are, of course, still many more types of energy-producing cells, primary and secondary. Some are being produced today, some are still in the experimental stage, and others have been abandoned either for practical reasons or because they have been rendered obsolete by newer battery designs.

R-E



# WORKING WITH AUDIO POWER AMP IC'S

*Building your own amplifier circuits for audio applications doesn't have to be difficult. In this article we show you how easy it is to use several of the more popular audio-amplifier IC's.*

AN IDEAL AUDIO POWER AMPLIFIER CAN BE simply defined as a circuit that can deliver audio power into an external load without generating significant distortion, and which does so without overheating or consuming excessive quiescent current. In practice, circuits that come very close to that ideal can easily be built using modern integrated circuits.

Simple audio-power amplifiers with outputs up to only a few hundred milliwatts can be easily and cheaply built using little more than a standard op-amp and a couple of general-purpose transistors. For higher power levels, a wide range of special-purpose "single" or "dual" audio-power amplifier IC's are available, which can provide maximum outputs ranging from a few hundred milliwatts to roughly 20 watts. The specific IC chosen for a given application depends mainly on the constraints of the available power-supply voltage and on the required output power. This article will look at a wide selection of practical IC-based audio-power amplifier circuits.

## Low-power circuits

The ever-popular general-purpose 741 operational amplifier can supply peak output currents of at least 10 mA, and can provide peak output-voltage swings of at least 10 volts into a 1K load when powered from a dual power supply of plus- and minus-15 volts. The IC can supply peaks of about 100 mW into a 1K load. Among the reasons for the 741's popularity is that it can easily be used as a simple low-power audio amplifier, as shown in Figs. 1 and 2.

Figure 1 shows how to use the 741 with a dual power supply. There, the external load is direct-coupled be-

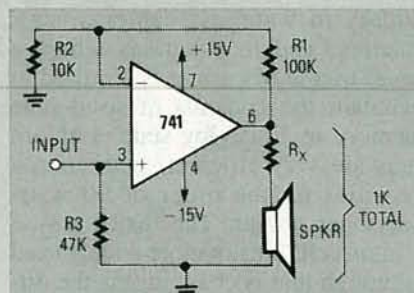

FIG. 1—LOW-POWER AMPLIFIER using dual power supplies.

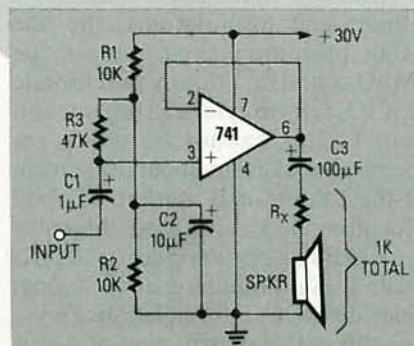

FIG. 2—LOW-POWER AMPLIFIER using a single-ended power supply.

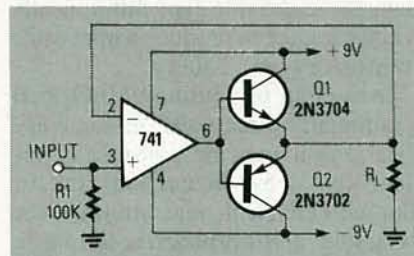

FIG. 3—BASIC BOOSTED-OUTPUT-current unity-voltage-gain op-amp circuit.

tween the op-amp output and ground, and the two input terminals are ground-referenced. The op-amp is operated in the non-inverting mode, and has a voltage gain of  $\times 10$  ( $R1/R2$ ) and an input impedance of 47K ( $R3$ ).

Figure 2 shows how to use the circuit with a single-ended power sup-

ply. In that case, the external load is AC-coupled between the output and ground, and the output is biased to a quiescent value of half of the supply voltage (to give maximum output-voltage swing) via the  $R1$ - $R2$  divider. The op-amp is operated in the unity-gain non-inverting mode, and has an input impedance of 47K ( $R3$ ).

In Figs. 1 and 2, the external load must have an impedance of at least 1K. If the external speaker has an impedance lower than that, the resistor  $R_x$  must be connected as shown to the schematic to raise the load to a total of 1K;  $R_x$  inevitably reduces the amount of power that actually reaches the speaker.

## Boosted-output circuits

The available output current (and thus the power) of a standard op-amp can easily be boosted by wiring a complementary emitter-follower between its output and its non-inverting input terminal, as shown in Fig. 3. Note that the circuit is configured to give an overall unity voltage gain, but that the base-emitter junctions of  $Q1$  and  $Q2$  are both wired into the negative-feedback loop of the circuit, so that their effective forward-voltage drops (approximately 600 mV) are reduced by a factor equal to the open-loop voltage gain of the op-amp. So, if the open-loop gain is 10,000, then the effective forward voltage drops of  $Q1$  and  $Q2$  are each reduced to a mere 6  $\mu$ V, and the circuit generates negligible signal distortion.

In practice, the open-loop voltage gain of an op-amp actually falls off at a rate of about 20 dB/octave, so that although the signal distortion of the circuit in Fig. 3 may be insignificant at 10 Hz, it may become quite objectionable at 10 kHz. That problem can



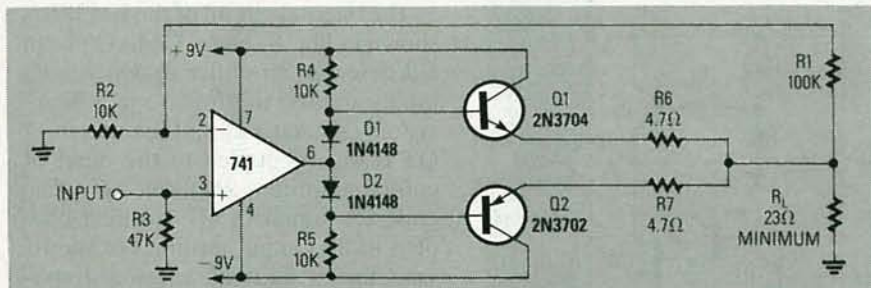

FIG. 4—OP-AMP POWER AMPLIFIER using dual supplies; output power is about 280 mW, maximum.

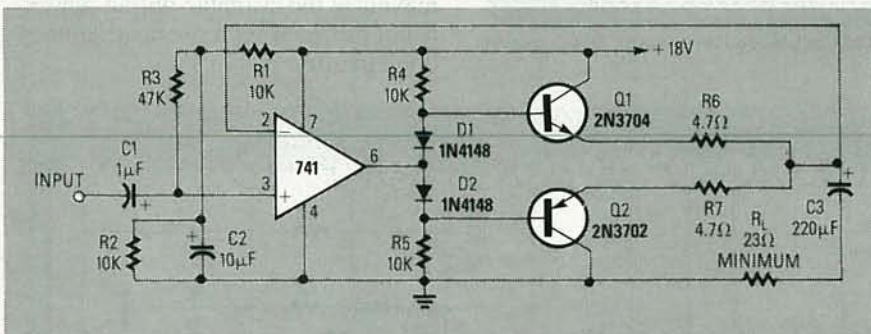

FIG. 5—OP-AMP POWER AMPLIFIER using a single-ended supply.

be overcome by applying a small amount of forward bias to Q1 and Q2, as shown in Figs. 4 and 5, so that their forward-voltage drops are reduced to near-zero and the result is that the distortion is minimized.

The circuits of Figs. 4 and 5 are designed to produce output currents up to 350 mA peak, or 50-mA RMS into a load of at least 23 ohms, thereby producing up to 280 mW RMS. The limitations are determined by the current/power ratings of Q1 and Q2, and by the power-supply voltage. The Fig. 4 circuit is designed for use with dual power supplies, and gives a voltage gain of 10. The Fig. 5 circuit uses a single-ended supply, and has unity voltage gain.

### Power-amplifier basics

If output powers in the approximate range from 200 mW to 20 watts are needed, the most cost-effective way of getting them is to use a dedicated IC to do the job. A wide range of such IC's are available, in either "single" or "dual" form. Most of them take the effective form of a simple op-amp with complementary emitter-follower output stage (like Figs. 3-5); they have differential input terminals and can provide high output current/power, but consume a low quiescent current.

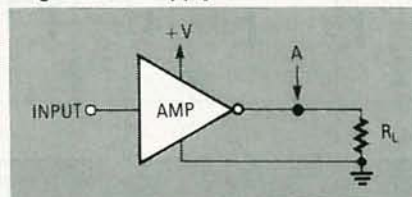

FIG. 6—AN AMPLIFIER CONNECTED in the single-ended output mode gives a peak output of  $V^2/R$  watts.

tion of Fig. 6, the peak available output power equals  $V^2/R$ , where "V" is the peak available output voltage. Note, however, that the available output power can be increased by a factor of four by connecting a pair of amplifier IC's in the "bridge" configuration shown in Fig. 7, in which the peak available load power equals  $2V^2/R$ . That power increase can be explained as follows:

In the single-ended amplifier circuit of Fig. 6, one end of  $R_L$  is grounded, so the peak voltage across  $R_L$  equals the voltage at point A. On the other hand, in the circuit in Fig. 7, both ends of  $R_L$  are "floating" and are driven out of phase; and the voltage across  $R_L$  equals the difference between points A and B. Figure 7 also shows some waveforms when the circuit is fed with a 10-volt p-p square wave. Although the waveforms at points A and B have peaks of 10 volts relative to ground, the two signals are 180° out of phase. Therefore, during period 1, point B is 10-volts positive with respect to point A. Consequently, if point A is regarded as the reference point, it can be seen that the point B varies from +10 to -10 volts between periods 1 and 2, giving a total swing of 20 volts across  $R_L$ .

The load in the 10-volt bridge-driv-

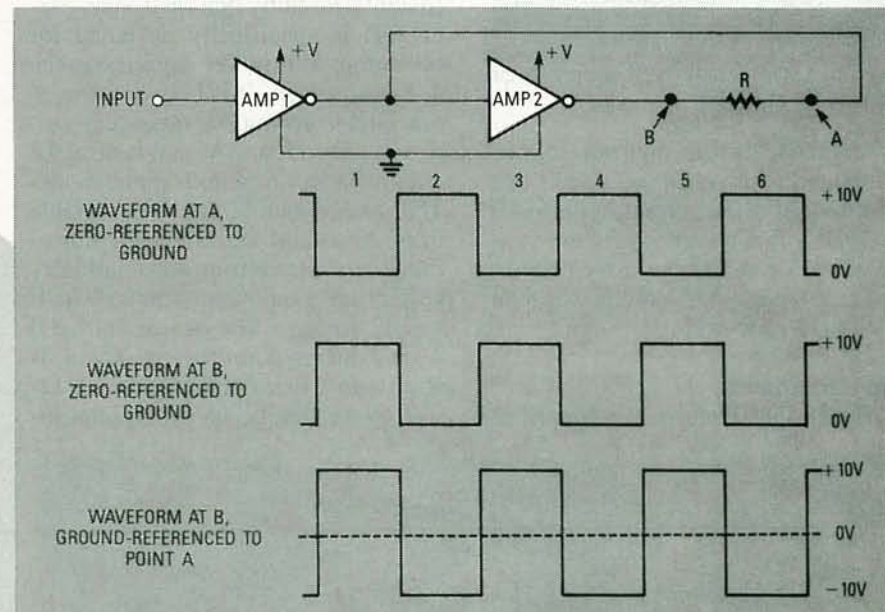

FIG. 7—A PAIR OF AMPLIFIERS connected in the bridge configuration gives a peak output of  $2V^2/R$  watts; four times the power of a single-ended circuit.

When a power amplifier is connected in the single-ended configura-

en circuit sees a total 20-volts p-p, or twice the single-ended input-voltage,



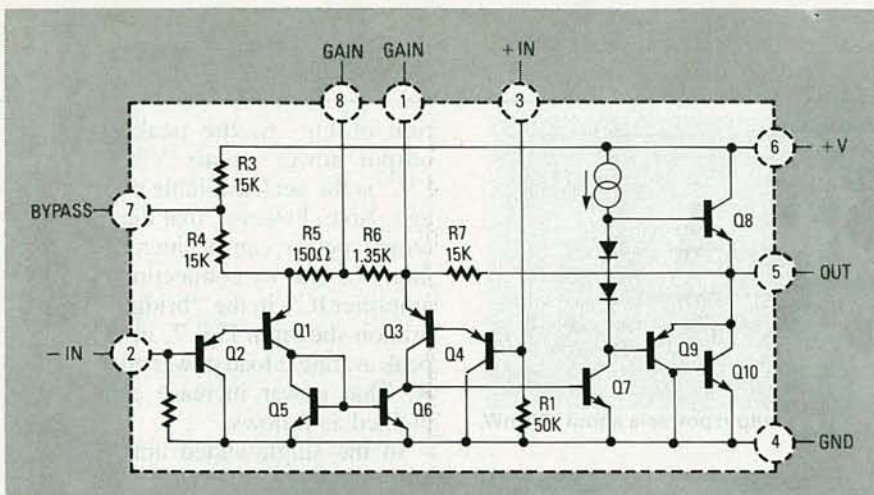

FIG. 8—INTERNAL CIRCUIT and pin connections of the LM386 low-voltage audio-power amplifier.

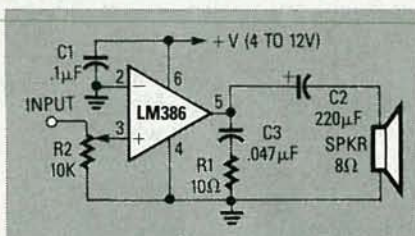

FIG. 9—A MINIMUM NUMBER OF PARTS are needed for this LM386 amplifier with  $A_v = 20$ .

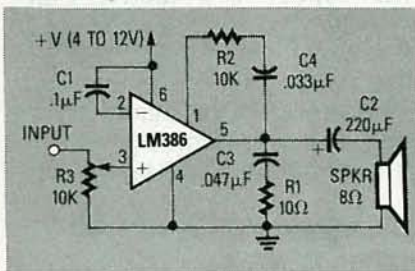

FIG. 10—LM386 AMPLIFIER with 6 dB of bass-boost at 85 Hz.

as indicated in the diagram. Since doubling the drive voltage results in a doubling of drive current, and power is equal to the current times the voltage ( $P = IV$ ), the bridge-driven circuit produces four times more power than a single-ended circuit.

### LM386 basics

The LM386 audio-power amplifier

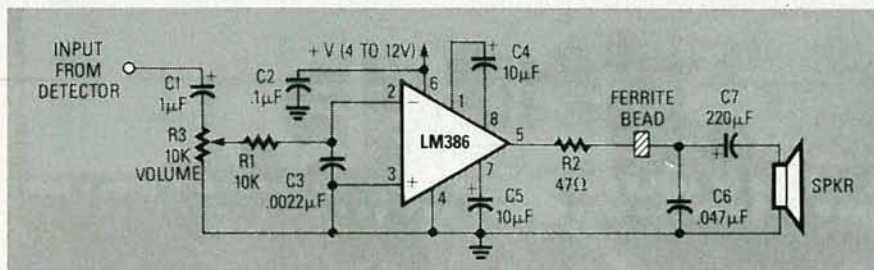

FIG. 11—AM-RADIO POWER AMPLIFIER.

put terminals are both ground-referenced, and have typical input impedances of 40K.

The internal circuit of the LM386 is shown in Fig. 8. Here, Q1 to Q6 form a differential amplifier in which both inputs are tied to ground via 50K resistors (R1 and R2) and the output of Q3 is direct-coupled to the input of common-emitter amplifier Q7. The collector signal of Q7 is direct-coupled to the output terminal of the IC via Class-B unity-gain power amplifier stage Q8-Q9-Q10 which, to minimize the internal volt-drops and maximize the available output power, is not provided with overload protection circuitry.

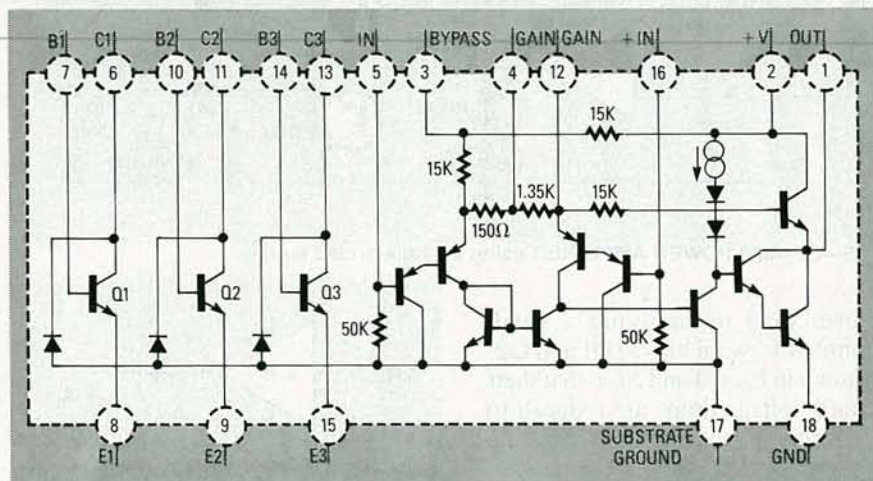

FIG. 12—INTERNAL CIRCUIT AND PIN CONNECTIONS of the LM389 low-voltage audio-power amplifier with NPN transistor array.

(manufactured by National Semiconductor) is specifically designed for operation with power supplies in the 4-12-volt range. It is housed in an 8-pin DIP, consumes a quiescent current of only a few mA, and is ideal for use in battery-powered applications. The voltage gain of the IC is variable from 20 to 200 via external connections, and its output automatically centers on a quiescent value of half-supply voltage. The device can feed several hundred milliwatts into a 8-ohm load when operated from a 12-volt power supply. Its differential in-

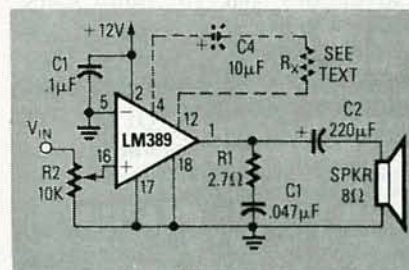

FIG. 13—BASIC CIRCUIT CONNECTIONS of the LM389 IC.

### LM386 applications

The LM386 is a very easy IC to use. The voltage gain of the IC is equal to the value of the pin-1-to-pin-5 impedance (15K in Fig. 8), divided by the impedance between the emitters of Q1 and Q3 ( $R5 + R6$  in Fig. 8). Thus, the IC can be used as a minimum-parts amplifier with an overall voltage gain of 20 by using the simple connections shown in Fig. 9. In that circuit, the load is AC-coupled to the IC output via C2, and the input signal is connected to the non-invert-



ing terminal via R2. Note that C1 is used to RF-decouple the +V supply (pin 6), and R1-C3 is an optional Zobel network that gives HF output-loading stability.

Note that in Fig. 9, pins 1 and 8 are not used. However, if you connect a 10- $\mu$ F electrolytic between pins 1 and 8 (the positive end connected to pin 1), you can change the overall gain of the circuit to 200; that's because the capacitor effectively shorts out the IC's internal 1.35K resistor. If a 1.2K

resistor is wired in series with a 10- $\mu$ F electrolytic between pins 1 and 8, the overall gain will be 50.

The voltage gain of the LM386 can also be varied by shunting the effective value of the internal pin-5-to-pin-1 15K feedback resistor. Fig. 10 shows how to shunt that resistor with C4-R2, to give 6-dB of bass boost at 85 Hz, to compensate for the poor bass response of commonly used inexpensive speakers.

Figure 11 shows how the LM386

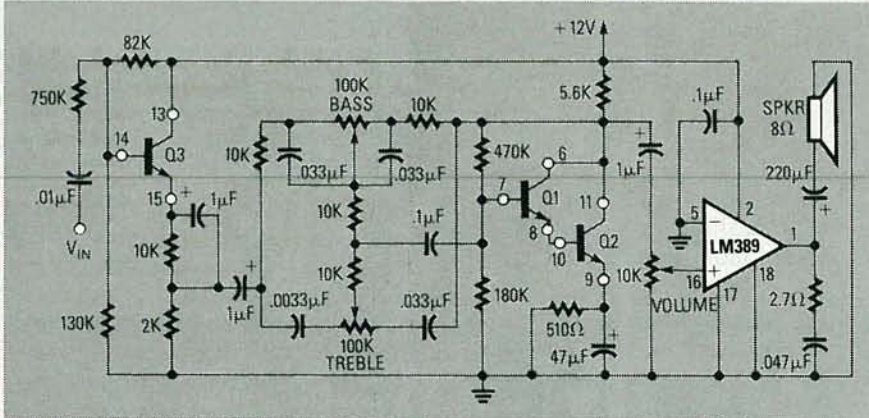

FIG. 14—CERAMIC PHONO AMPLIFIER with tone controls, using an LM389.

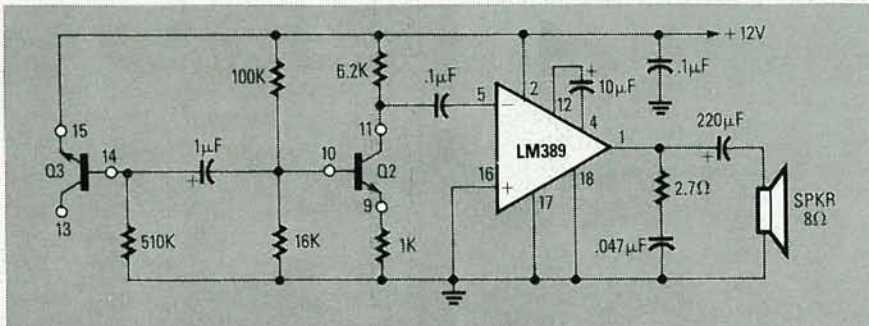

FIG. 15—LM389 WHITE-NOISE sound generator.

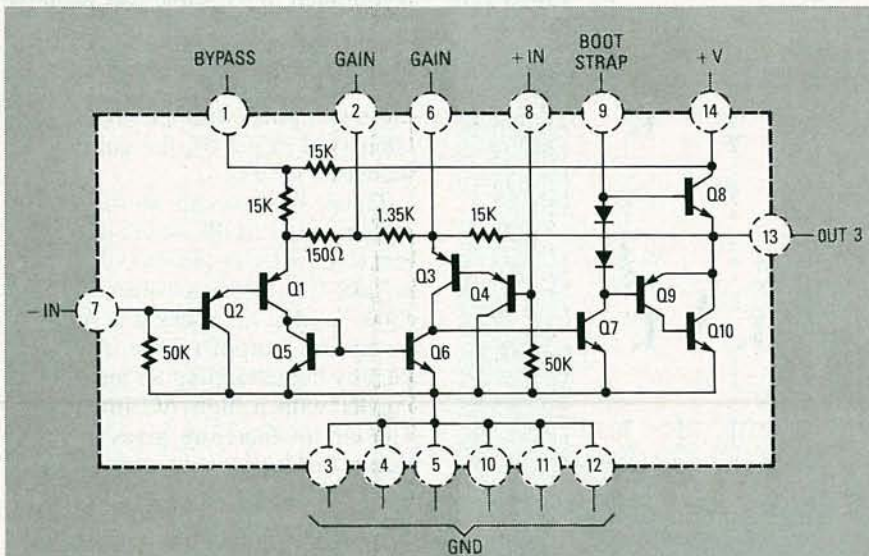

FIG. 16—INTERNAL CIRCUIT and pin connections of the LM388 1.5-watt audio-power amplifier.

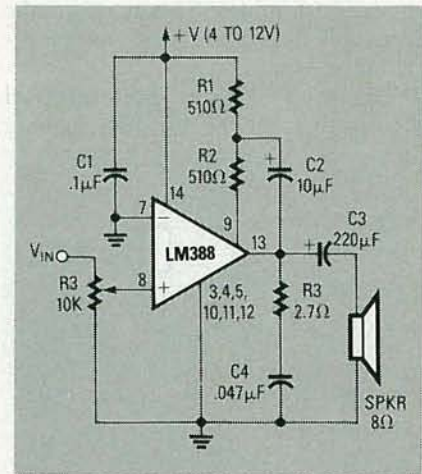

FIG. 17—LM388 WITH A GAIN OF 20 and load returned to ground.

amplifier can be modified for use as a built-in amplifier in an AM radio. Here, the detected AM signal is fed to the non-inverting input of the IC via volume-control R3, and is RF-decoupled via R1-C3; any residual RF signals are blocked from the load via a ferrite bead. The voltage gain of the amplifier is set at 200 via C4. Note that the circuit is provided with additional power-supply ripple rejection by wiring C5 between pin 7 and ground, and that the ripple-rejection capacitor can also be used with Figs. 9 and 10 if required.

### LM389 circuits

The LM389 (Fig. 12) contains an array of three wide-band and independently accessible NPN transistors on the same substrate as an audio-power amplifier that is almost identical to that of the LM386. The IC can be used with any power supply in the 4- to 12-volt range. The three NPN transistors have closely matched characteristics, can be operated with collector currents in the range from 1  $\mu$ A to 25 mA at frequencies up to 100 MHz, and each have typical current gains of 275. Also note that Q1, Q2 and Q3 are independently accessible.

Figure 13 shows the LM389 in a basic circuit. The internal power amplifier is used in the same way as the LM386; the gain of the amplifier is controlled by C4 and R<sub>X</sub>, between pins 4 and 12. If those two components are absent, the voltage gain is 20. If the two components are in place, and R<sub>X</sub> has a value of 1.2K, the gain is 50. If R<sub>X</sub> is replaced with a short-circuit, the gain rises to 200. Note that the power amplifier can be used as either an inverting or non-



inverting amplifier by connecting the external signal to the appropriate input terminal.

Figures 14 and 15 show practical applications of the LM389, making

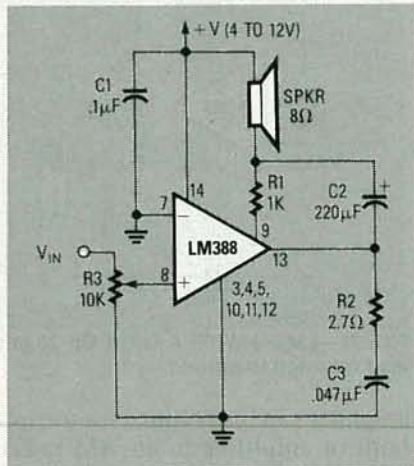

FIG. 18—LM388 WITH A GAIN OF 20 and load returned to +V supply.

use of the internal transistors. In the phono amplifier of Fig. 14, which is intended for use with a ceramic pickup, Q3 acts as a voltage-following input buffer giving an input impedance of about 80K, and Q1 and Q2 are used to make an active tone-control network with its output feeding to the non-inverting input of the power amplifier via the volume-control potentiometer. In the white-noise generator circuit of Fig. 15, Q3 is wired as a noise-generating Zener diode; the noise signal is amplified via Q2 and then fed to the inverting input terminal of the power amplifier, which is wired in the 200 voltage-gain mode.

### LM388 circuits

The LM388 (Fig. 16) can be regarded as a slightly modified version of the LM386. The device is housed

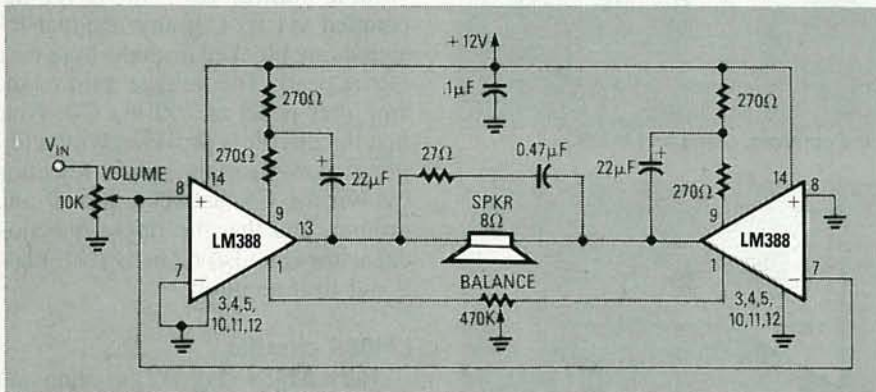

FIG. 19—LM388 BRIDGE AMPLIFIER delivering 4 watts to an 8-ohm load.

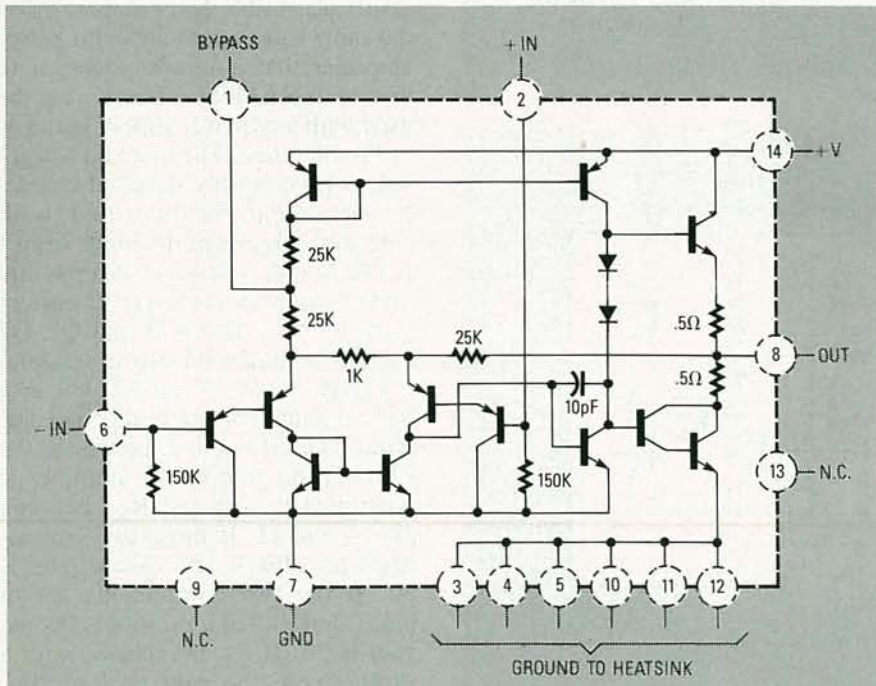

FIG. 20—INTERNAL CIRCUIT AND PIN CONNECTIONS of the LM380 2-watt and LM384 5-watt audio-power amplifier IC's.

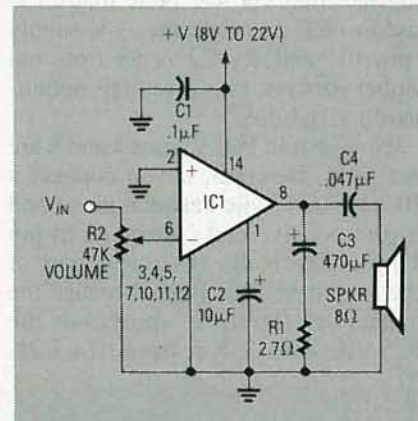

FIG. 21—IN THIS CIRCUIT, IF IC1 is an LM380, powered from 18 volts, the circuit will produce 2 watts, and if IC1 is an LM384, powered from 22 volts, it will produce 5 watts. The circuit also has simple volume control and ripple rejection.

in a 14-pin DIP with an internal heat sink, and can feed 1.5 watts into an 8-ohm speaker when powered from a 12-volt supply. The most significant internal difference between the LM388 and the LM386 concerns Q7, and an internal constant-current collector load in the LM388. That "external load" feature greatly increases the versatility of the IC.

Figure 17 shows one way of using the LM388. Here, R1 and R2 are wired in series between the positive supply line and pin 9, to provide collector current to the internal Q7. Note that the R1-R2 junction is bootstrapped from the output of the IC via C2, to raise the AC impedance of R2 (and thus the voltage gain of Q7) to a value far greater than its DC value. The overall voltage gain of the LM388 is determined in the same way as in the LM386, and equals 20 in Fig. 17. Pins 2 and 6 were not used in Fig. 17, but if you wire a 10-μF electrolytic between those two pins (with the positive end connected to pin 6), the gain can be increased to 200.

Figure 18 shows an alternative way of using the LM388 where direct current (DC) is fed to pin 9 via the speaker and R1. Note, however, that the "low" end of the speaker is AC-driven by the output of the amplifier, thereby bootstrapping R1 and providing R1 with a high AC impedance. The circuit therefore gives a performance that is somewhat similar to that of Fig. 17, but does so with a saving of two components.

Finally, Fig. 19 shows how to connect a pair of LM388 IC's in the

*Continued on page 84*



# PC SERVICE

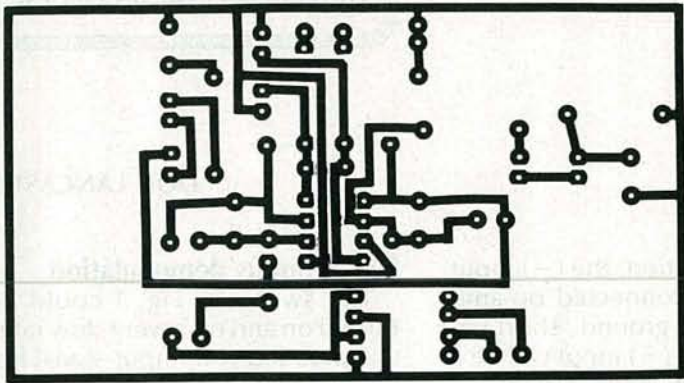

3 1/2 INCHES

AUDIO VOLUME LIMITER FOIL PATTERN.

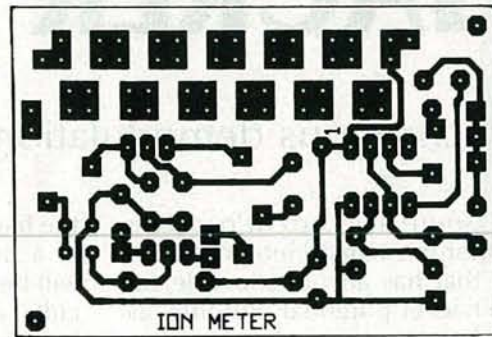

ION METER

2 5/8 INCHES

ION METER FOIL PATTERN.

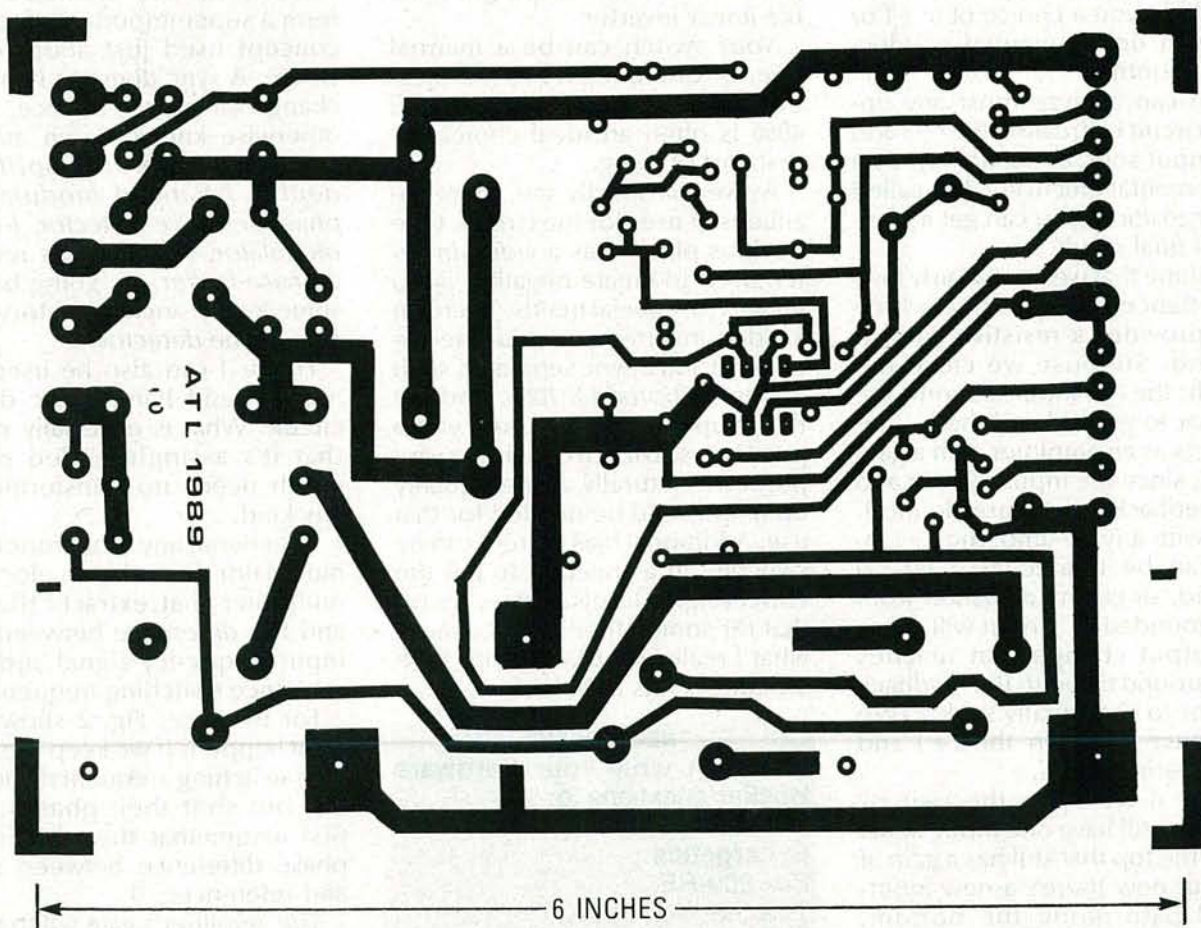

6 INCHES

UNIVERSAL POWER SUPPLY FOIL PATTERN.



# HARDWARE HACKER

LVDT position detectors  
Treasure finding circuitry  
Switchable analog inverter  
Synchronous demodulators  
Desktop accessories contest

## Synchronous demodulation

DON LANCASTER

THIS MONTH, I FIGURED WE'D LOOK AT a rather mis-named integrated circuit that has an unbelievable future hacker potential. But first, as usual, let's pick up some background...

### Programmable analog inverter

Figure 1 shows you my favorite "sleeper" circuit found in my *CMOS Cookbook*. It's a single-ended and simple op-amp circuit that gives you a choice of a +1 or -1 gain under manual or electronic control.

You can analyze most any op-amp circuit by treating the (-) and (+) input sources separately. By a fundamental electronic law called *superposition*, you can get a combined final result.

Assume that we have a fairly low-impedance input source which also provides a resistive path to ground. Suppose we close the switch; the (+) input sees only the resistor to ground and the (-) input acts as an amplifier with a gain of -1, since the input resistor and the feedback resistor are identical.

As with any op-amp, the (-) input can be treated as a *virtual ground*, since any deviation from the grounded (-) input will cause an output change that reaches back around through the feedback resistor to continually seek a zero difference between the (+) and (-) op-amp inputs.

What if we open the switch? Well, we still have one input signal along the top that still has a gain of -1. But now there's a new input-signal path along the bottom, which has a gain of +2. Because of

the feedback action, the (-) input of a properly connected op-amp will be a virtual ground "short circuit," while the (+) input will be a high impedance "open circuit."

Hmmm...the gain along the top is (-1). The gain along the bottom is +2. And, the last time I checked,  $(-1) + (+2) = +1$ . So, close that switch and you'll get a gain of -1. Open the switch and you get a gain of +1. Presto! A programmable linear inverter.

Your switch can be a manual one, or else a higher-speed electronic one. A quarter of a CMOS 4066 is often an ideal choice for that sort of thing.

As we will shortly see, there are zillions of uses for the circuit. One obvious place is as a *video inverter*, used to create negative video images for special needs. To create a video inverter, you take the circuit and add a sync separator, such as the *National LM1881*, and set things up to invert only your video portions but not the sync portions. Naturally, a video-quality op-amp would be needed for that use. Additional bias current can be switched in as needed to get the correct signal levels. But we'll save that for some other time, because what I really want to get into here are the secrets behind...

### NEED HELP?

Phone or write your **Hardware Hacker** questions to:  
Don Lancaster  
**Synergetics**  
Box 809-RE  
Thatcher, AZ, 85552  
(602) 428-4073

### Synchronous demodulation

The switch in Fig. 1 could be turned on and off at very slow rates compared to your input-signal frequency. Or at equal rates. Or even at much higher rates. Now, if you turn the switch on and off at precisely the same speed as your input signal, you create a beastie that is known as a *synchronous demodulator*.

Synchronous demodulators form a super-important electronic concept used just about everywhere. A sync demod's name can change all over the place, being otherwise known-as an *autocorrelator*, a *lock-in-amplifier*, a *doubly balanced modulator*, a *phase-sensitive detector*, *I-Q demodulator*, *phase-locker*, or, going back to some really ancient history, as a *homodyne detector*.

Figure 1 can also be used as a modern and handy sync demod circuit. What is especially nice is that it's a single-ended circuit which needs no transformers of any kind.

In general, any synchronous demodulator demod is an electronic multiplier that extracts the *sum* and the *difference* between your input-frequency signal and your reference switching frequency.

For instance, Fig. 2 shows you what happens if we keep the input and switching frequencies identical, but shift their phases. Let's first assume that there is a zero phase difference between signal and reference.

The amplifier's gain will be (+1) for the positive signal peaks, and



(-1) for the negative signal peaks, giving us a plain old full-wave rectifier. The "DC term" here will be a direct current level equal to the strength or amplitude of the input signal. The "lumps" will be a double-frequency and higher "AC term" that is usually filtered out. Thus, the zero-phased synchronous demodulation should extract only the *amplitude* of an input signal.

Suppose we next shift the phase by 180 degrees. This time, your gain is (-1) for the positive lumps and (+1) for the negative lumps of the signal. We get a *negative output*, and we could conclude that any 180 degree phased synchronous demodulation extracts only the *negative of the amplitude* of the input signal.

Now, let's get interesting. Suppose we shift the phase to 90 degrees. What happens? Well, *nothing at all*. During the time that the switch is closed, we have half of a positive cycle and half of a negative cycle, so our net (or average) DC output is zero. Very handily, any synchronous demodulation at a 90-degree phasing produces a *zero* output. And, since nothing upside down is still nothing, a similar cancellation happens at -90 or +270 degrees.

But wait a minute. If we get zero output at a 90-degree phase, can't we *double* the information placed on a carrier, simply by having an in-phase term and a 90-degree, or *quadrature* term? We sure can, and it gets done all the time.

For instance, the color information on an NTSC (Never The Same Color) television is placed onto a magic sub-carrier of 3.57545 Megahertz. The *hue* of the color is the *phase angle*, while the *saturation* of the color sets your amplitude. At the receiver, a *phase-locked loop* does an in-phase "I" and a quadrature "Q" demodulation. After further processing, all the separate amplitudes are extracted for the red, blue, and green guns in the display tube. Thus, we have used a pair of synchronous demodulators to extract both the amplitude and phase of a complex signal at the same time.

Let's look at some additional uses for synchronous demodulation. If you hard limit the input

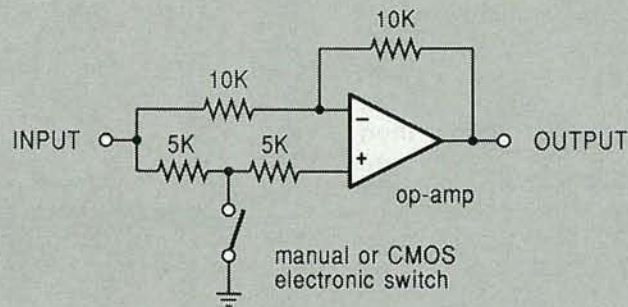

FIG. 1—A PROGRAMMABLE GAIN AMPLIFIER. When the switch is closed, the gain is -1. When the switch is opened, the gain is +1. One important circuit use is for synchronous demodulation.

## NAMES AND NUMBERS

### American Design Components

815 Fairview Ave  
Fairview, NJ 07022  
(800) 776-3700

CIRCLE 275 ON FREE INFORMATION CARD

### AST Servo Systems

115 Main Road Box 97  
Montville, NJ 07045  
(201) 335-1007

CIRCLE 276 ON FREE INFORMATION CARD

### Calogic

237 Whitney Pl  
Fremont, CA 94539  
(415) 656-2900

CIRCLE 277 ON FREE INFORMATION CARD

### Car Audio

2176 Oxnard St, Ste 1600  
Woodland Hills, CA 91367  
(818) 593-3900

CIRCLE 278 ON FREE INFORMATION CARD

### Chips & Technology

3050 Zanker Rd  
San Jose, CA 95134  
(408) 434-0600

CIRCLE 279 ON FREE INFORMATION CARD

### Chomerics

77 Dragon Court  
Woburn, MA 01888  
(800) 225-1936

CIRCLE 280 ON FREE INFORMATION CARD

### Linear Technology

1630 McCarthy Blvd  
Milpitas, CA 95035  
(408) 432-1900

CIRCLE 281 ON FREE INFORMATION CARD

### Measurement & Control

2994 W Liberty Ave  
Pittsburgh, PA 15216  
(412) 343-9666

CIRCLE 282 ON FREE INFORMATION CARD

### Midnight Engineering

PO Box 7041  
Fort Collins, CO 80525  
(303) 491-9092

CIRCLE 283 ON FREE INFORMATION CARD

### Motorola

5005 E McDowell Rd  
Phoenix, AZ 85008  
(602) 244-6900

CIRCLE 284 ON FREE INFORMATION CARD

### National Semiconductor

2900 Semiconductor Dr  
Santa Clara, CA 95051  
(408) 721-5000

CIRCLE 285 ON FREE INFORMATION CARD

### OrCAD

3175 NW Aloclek Dr  
Hillsboro, OR 97124  
(503) 690-9722

CIRCLE 286 ON FREE INFORMATION CARD

### Phillips

45 George Washington Hwy  
Midfield, RI 02917  
(401) 232-0500

CIRCLE 287 ON FREE INFORMATION CARD

### Sensors

174 Concord St  
Peterborough, NH 03458  
(603) 924-9631

CIRCLE 288 ON FREE INFORMATION CARD

### Synergetics

Box 809  
Thatcher, AZ 85552  
(602) 428-4073

CIRCLE 289 ON FREE INFORMATION CARD

### Texas Instruments

PO Box 809066  
Dallas, TX 75380  
(800) 232-3200

CIRCLE 290 ON FREE INFORMATION CARD



signal to your sync demod so that it's a clean square wave, then you will provide *phase detection*. Go through the math, and you will find that the output voltage is a triangle which linearly equals the phase angle between the input and the reference. You can then use your sync demod to measure the phase angle between two input signals.

Suppose we would synchronously demodulate one signal and, at the same time, apply an interfering signal of a different frequency. Your "wanted" signal will always be in phase and will always produce a DC output equal to its amplitude. The "unwanted" signal will create a sine wave as it "slips cycles" with respect to the wanted one. Any sine wave averages to zero over a long enough time. We apparently have a way of detecting one signal while rejecting an interfering one.

Certain types of sync demods are called *lock-in amplifiers*. They can form an extremely narrow *bandpass filter* that automatically

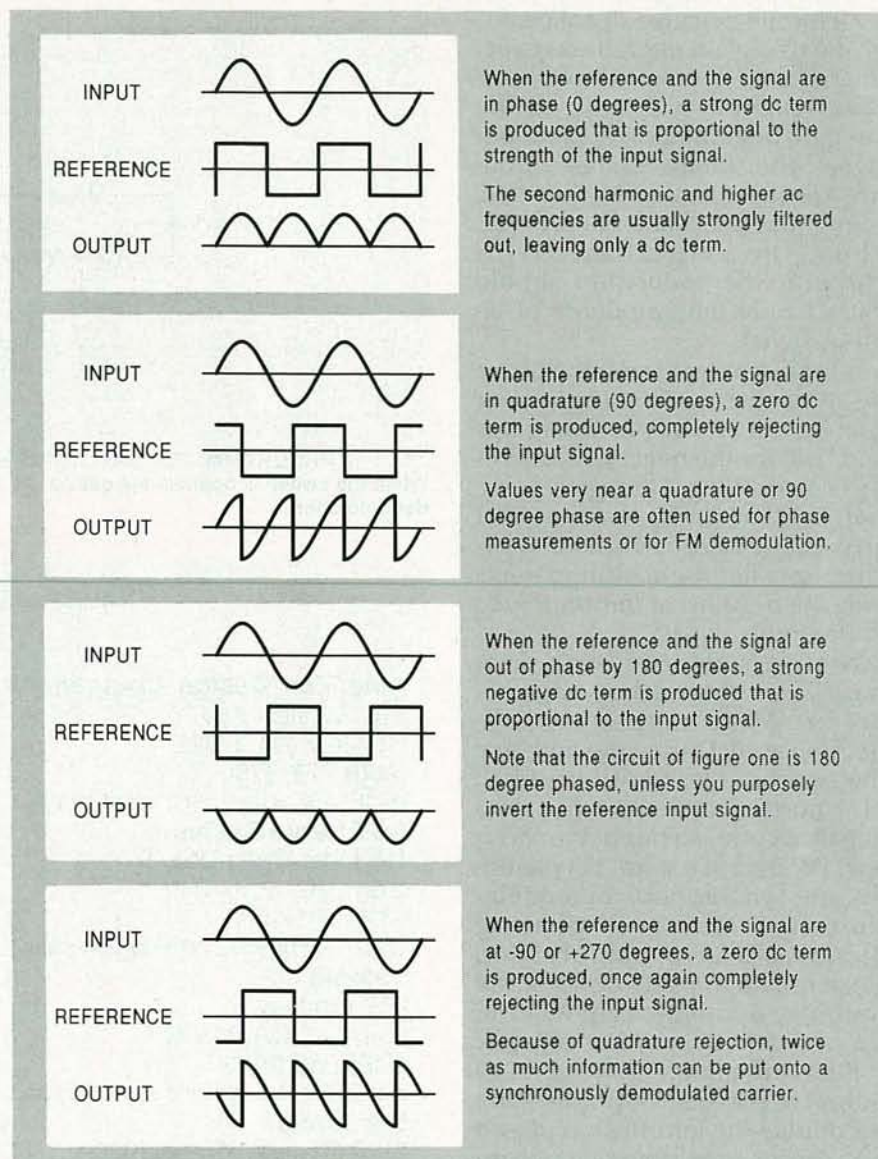

FIG. 2—SYNCHRONOUS DEMODULATOR WAVEFORMS. At 0 degrees reference phasing, the "DC" portion of the output is proportional to the input amplitude, and interfering signals are strongly rejected. At 90 degrees, the "DC" portion is zero, and the input signal itself gets strongly rejected.

centers on the frequency of interest, and can yield tremendous improvements in signal to noise ratios.

As an example, it is not unknown for your lock-in amplifier to cleanly extract a signal that is buried in noise that can be as much as 120 decibels *stronger* than the signal you want. Important uses here include extracting data from deep-space probes, and doing any laboratory and medical instrumentation that measures very weak signals in the presence of much larger interfering noise and AC hum.

A not-quite synchronous demodulation will output a sine wave

When the reference and the signal are in phase (0 degrees), a strong dc term is produced that is proportional to the strength of the input signal.

The second harmonic and higher ac frequencies are usually strongly filtered out, leaving only a dc term.

When the reference and the signal are in quadrature (90 degrees), a zero dc term is produced, completely rejecting the input signal.

Values very near a quadrature or 90 degree phase are often used for phase measurements or for FM demodulation.

When the reference and the signal are out of phase by 180 degrees, a strong negative dc term is produced that is proportional to the input signal.

Note that the circuit of figure one is 180 degree phased, unless you purposely invert the reference input signal.

When the reference and the signal are at -90 or +270 degrees, a zero dc term is produced, once again completely rejecting the input signal.

Because of quadrature rejection, twice as much information can be put onto a synchronously demodulated carrier.

equal to the *difference* between the reference and input frequencies. That is a simple example of a *downconverting*, or *mixing* of one signal against another to get a frequency difference.

By using a pair of sync demods, you can not only extract the frequency difference, but also determine *which* of the frequencies are higher.

The doppler signal extraction in a side-looking radar is one major use. Separately, synchronously demodulating a shaft encoder can give you both speed and direction information. Flangers for electronic music synthesizers use a similar principle.

## NEW FROM DON LANCASTER

### HANDS-ON BOOKS

Hardware Hacker Reprints II	24.50
Ask The Guru Reprints I or II	24.50
CMOS Cookbook	18.50
TTL Cookbook	16.50
Active Filter Cookbook	15.50
Micro Cookbook vol I or II	16.50
Enhancing your Apple I or II	17.50
AppleWriter Cookbook	19.50
Apple Assembly Cookbook	21.50
Incredible Secret Money Machine	10.50
LaserWriter Reference (Apple)	19.50
PostScript Cookbook (Adobe)	16.50
PostScript Ref. Man. (Adobe)	22.50
PostScript Prog. Design (Adobe)	22.50
Real World Postscript (Roth)	22.50

### UNLOCKED SOFTWARE

LaserWriter Secrets (Ile/Mac/PC)	29.50
PostScript Show & Tell	39.50
Intro to PostScript VHS Video	39.50
PostScript Beginner Stuff	39.50
PostScript Perspective Draw	39.50
PostScript Technical Illustrations	39.50
PostScript Work in Progress	39.50
PostScript BBS stuff	19.50
Absolute Reset Ile & Ilc	19.50
AppleWriter/Laserwriter Utilities	49.50
Enhance I or II Companion Disk	19.50
AppleWriter CB or Assy CB Disk	24.50

FREE VOICE HELPLINE

VISA/MC

## SYNERGETICS

Box 809-RE  
Thatcher, AZ 85552  
(602) 428-4073

CIRCLE 83 ON FREE INFORMATION CARD



## PRINTING RESOURCES

### American Printer

29 N Wacker Drive  
Chicago, IL 60606  
(312) 726-2802

CIRCLE 291 ON FREE INFORMATION CARD

### Font & Function

PO Box 7900  
Mountain View, CA 94039  
(800) 833-6687

CIRCLE 292 ON FREE INFORMATION CARD

### Graphic Arts Monthly

249 W 17th Street  
New York, NY 10011  
(212) 463-6834

CIRCLE 293 ON FREE INFORMATION CARD

### Graphic Arts Product News

29 North Wacker Drive  
Chicago, IL 60606  
(312) 726-2802

CIRCLE 294 ON FREE INFORMATION CARD

### High Volume Printing

Box 368  
Northbrook IL, 60065  
(312) 564-5940

CIRCLE 295 ON FREE INFORMATION CARD

### In-Plant Printer

Box 368  
Northbrook, IL 60065  
(312) 564-5940

CIRCLE 296 ON FREE INFORMATION CARD

### In Plant Reproductions

401 North Broad Street  
Philadelphia, PA 19108  
(215) 238-5300

CIRCLE 297 ON FREE INFORMATION CARD

### Instant Printer

Box 368  
Northbrook, IL 60065  
(312) 564-5940

CIRCLE 298 ON FREE INFORMATION CARD

### Print Equipment News

Box 5540  
Glendale, CA 91221  
(818) 954-9495

CIRCLE 299 ON FREE INFORMATION CARD

### The Printers Shopper

PO Drawer 1056  
Chula Vista, CA 92012  
(800) 854-2911

CIRCLE 300 ON FREE INFORMATION CARD

### Printing Impressions

401 North Broad Street  
Philadelphia, PA 19108  
(215) 238-5300

CIRCLE 301 ON FREE INFORMATION CARD

### Printing Journal

Box 91447  
Pasadena, CA 91109  
(818) 793-7901

CIRCLE 302 ON FREE INFORMATION CARD

### Printing News

245 W 17th Street  
New York, NY 10011  
(212) 463-6727

CIRCLE 303 ON FREE INFORMATION CARD

### Publishing Technology

401 North Broad Street  
Philadelphia, PA 19108  
(215) 238-5300

CIRCLE 304 ON FREE INFORMATION CARD

### Quick Printing

1680 SW Bayshore Blvd  
Port St Lucie, FL 34984  
(407) 879-6666

CIRCLE 305 ON FREE INFORMATION CARD

### Screen Printing

407 Gilbert Avenue  
Cincinnati, OH 45202  
(513) 421-2050

CIRCLE 306 ON FREE INFORMATION CARD

### Type World

15 Oakridge Circle  
Wilmington, MA 01887  
(617) 658-6876

CIRCLE 307 ON FREE INFORMATION CARD

### U&Ic

2 Dag Hammarskjold Plaza  
New York, NY 10017  
(212) 371-0699

CIRCLE 308 ON FREE INFORMATION CARD

For a really strange use of a sync demod, high-power rectifiers always have a forward drop associated with them of a volt or more that can cause all sorts of ineffi-

ciencies, especially with low-voltage solar-panel power conversions. But power transistors can have significantly lower forward drops if they are properly

# Be an FCC LICENSED ELECTRONIC TECHNICIAN!



No costly School. No commuting to class. The Original Home-Study course prepares you for the "FCC Commercial Radiotelephone License". This valuable license is your "ticket" to thousands of exciting jobs in Communications, Radio-TV, Microwave, Computers, Radar, Avionics and more! You don't need a college degree to qualify, but you do need an FCC License.

**No Need to Quit Your Job or Go To School** This proven course is easy, fast and low cost! **GUARANTEED PASS**— You get your FCC License or money refunded. **Send for FREE facts now. MAIL COUPON TODAY!**

### COMMAND PRODUCTIONS

FCC LICENSE TRAINING, Dept. 90  
P.O. Box 2824, San Francisco, CA 94126

Please rush FREE details immediately!

NAME \_\_\_\_\_  
ADDRESS \_\_\_\_\_  
CITY \_\_\_\_\_ STATE \_\_\_\_\_ ZIP \_\_\_\_\_

# FIX VCR's

**Over 75% of VCR failures are due to mechanical problems.**

If you fix or maintain VCR's, TENTEL offers fast, universal, easy to use gauges for diagnosing mechanical tape transport problems. Powerful tools for measuring torque, tape tension, spindle height, tape guide height, head protrusion, drum eccentricity and more! You can't afford to just guess when your customers and your future depends on professional service, done right the first time. **FREE CATALOG, Also Video**

Training Tape Now Available - \$24.95

**(800)538-6894**

In Calif.-(916)939-4005



**Tentel® Corp.**  
**4475 Golden Foothill Pkwy**  
**El Dorado Hills, CA 95630**

CIRCLE 194 ON FREE INFORMATION CARD



# SELECT 5 BOOKS for only \$3<sup>95</sup>

(values to \$138.70)  
and get a **FREE Gift!**

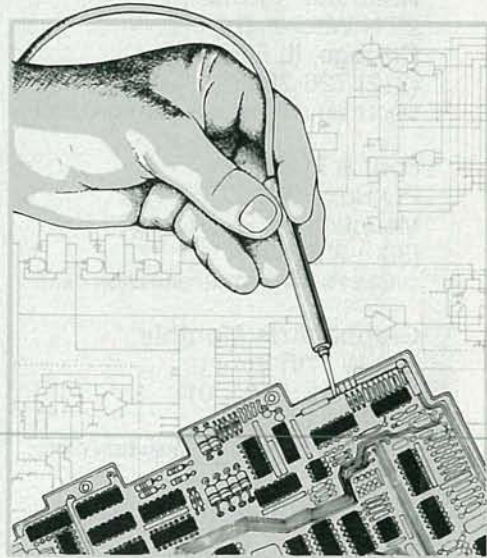

2707 \$26.95  
Counts as 2



2883P \$16.95



3195 \$28.95  
Counts as 2



2975 \$24.95



2790 \$19.95

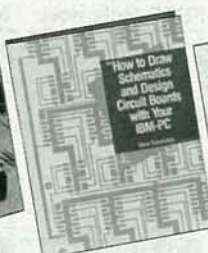

3034 \$19.95



3175 \$23.95



3183P \$11.95



3096 \$27.95  
Counts as 2

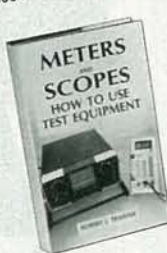

2826P \$15.95



3234 \$24.95



3155 \$19.95

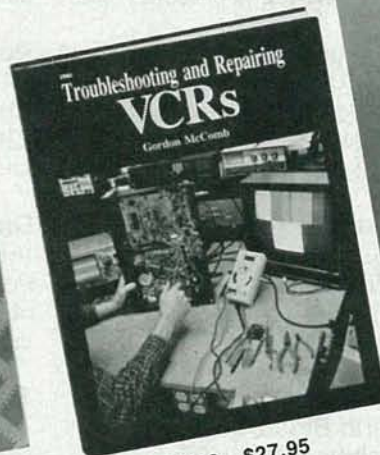

2960 \$27.95  
Counts as 2

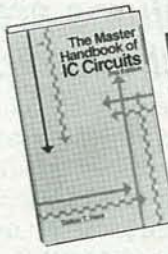

3185 \$34.95  
Counts as 2



3219 \$27.95  
Counts as 2



3205 \$24.95



2831P \$14.95



2875 \$17.95



3156 \$23.95



2800P \$14.95

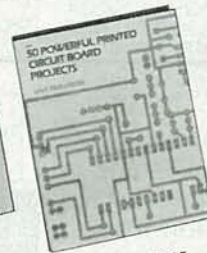

2972 \$23.95

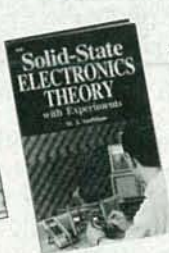

2926 \$25.95

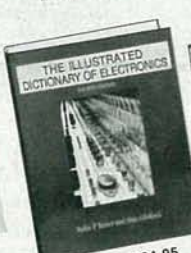

2900P \$24.95  
Counts as 2



2996P \$12.95



1897P \$14.95



For 25 years, your most complete source for electronics books.

2724P \$15.95

2613P \$15.95

1938P \$29.95  
Counts as 2

2925 \$16.95

2980P \$19.95

2809 \$27.95  
Counts as 2

3133 \$15.95

3382P \$29.95  
Counts as 2

3241 \$24.95

2772 \$17.95

1536P \$9.95

1604P \$17.95

2912P \$14.95

2867P \$17.95

3107 \$26.95  
Counts as 2

2966 \$22.95

## FREE when you join!

### Here's 15 Easy Electronic Projects From Delton T. Horn

Projects you can build—some unique, some old favorites—from the author's vast treasury of electronics know-how.

(a \$7.95 value!)

Delton T. Horn's  
All-Time Favorite  
Electronic Projects



**Membership Benefits • Big Savings.** In addition to this introductory offer, you keep saving substantially with members' prices of up to 50% off the publishers' prices. • **Bonus Books.** Starting immediately, you will be eligible for our Bonus Book Plan, with savings of up to 80% off publishers' prices. • **Club News Bulletins.** 14 times per year you will receive the Book Club News, describing all the current selections—mains, alternates, extras—plus bonus offers and special sales, with scores of titles to choose from. • **Automatic Order.** If you want the Main Selection, do nothing and it will be sent to you automatically. If you prefer another selection, or no book at all, simply indicate your choice on the reply form provided. As a member, you agree to purchase at least 3 books within the next 12 months and may resign at any time thereafter. • **Ironclad No-Risk Guarantee.** If not satisfied with your books, return them within 10 days without obligation! • **Exceptional Quality.** All books are quality publishers' editions especially selected by our Editorial Board.

All books are hardcover unless number is followed by an "P" for paperback. (Publishers' Prices Shown)  
©1990 ELECTRONICS BOOK CLUB, Blue Ridge Summit, PA 17294-0810



## ELECTRONICS BOOK CLUB<sup>SM</sup>

Blue Ridge Summit, PA 17294-0810

Please accept my membership in the Electronics Book Club and send the 5 volumes listed below, plus my FREE copy of *Delton T. Horn's All-Time Favorite Electronic Projects* (3105P), billing me \$3.95 plus shipping and handling charges. If not satisfied, I may return the books within ten days without obligation and have my membership cancelled. I agree to purchase at least 3 books at regular Club prices (plus shipping/handling) during the next 12 months and may resign any time thereafter.

Name \_\_\_\_\_  
 Address \_\_\_\_\_  
 City \_\_\_\_\_  
 State \_\_\_\_\_ Zip \_\_\_\_\_ Phone \_\_\_\_\_  
 Signature \_\_\_\_\_

Valid for new members only. Foreign applicants will receive special ordering instructions. Canada must remit in U.S. currency. This order subject to acceptance by the Electronics Book Club.

RE390

MARCH 1990



# ATTENTION! ELECTRONICS TECHNICIANS

EARN YOUR  
**B.S.E.E.  
DEGREE**

THROUGH HOME STUDY

Our New and Highly Effective Advanced-Placement Program for experienced Electronic Technicians grants credit for previous Schooling and Professional Experience, and can greatly reduce the time required to complete Program and reach graduation. No residence schooling required for qualified Electronic Technicians. Through this Special Program you can pull all of the loose ends of your electronics background together and earn your B.S.E.E. Degree. Upgrade your status and pay to the Engineering Level. Advance Rapidly! Many finish in 12 months or less. Students and graduates in all 50 States and throughout the World. Established Over 40 Years! Write for free Descriptive Literature.

**COOK'S INSTITUTE  
OF ELECTRONICS ENGINEERING**

4251 CYPRESS DRIVE  
JACKSON, MISSISSIPPI 39212

CIRCLE 58 ON FREE INFORMATION CARD

OVER **18000**

**ELECTRONIC  
COMPONENTS**

Whether you order 1 part or all 18,000+... **MOUSER** stocks to meet your needs and ships when you need it most... **today!!**

**MOUSER** also makes it easy to do business Monday through Saturday.

To get a Catalog I,  
Place your order I,  
Open your account I,  
Ask a question I,  
simply call toll-free:

**(800) 346-6873**



**MOUSER  
ELECTRONICS**

Sales & Stocking Locations Nationwide

CIRCLE 117 ON FREE INFORMATION CARD

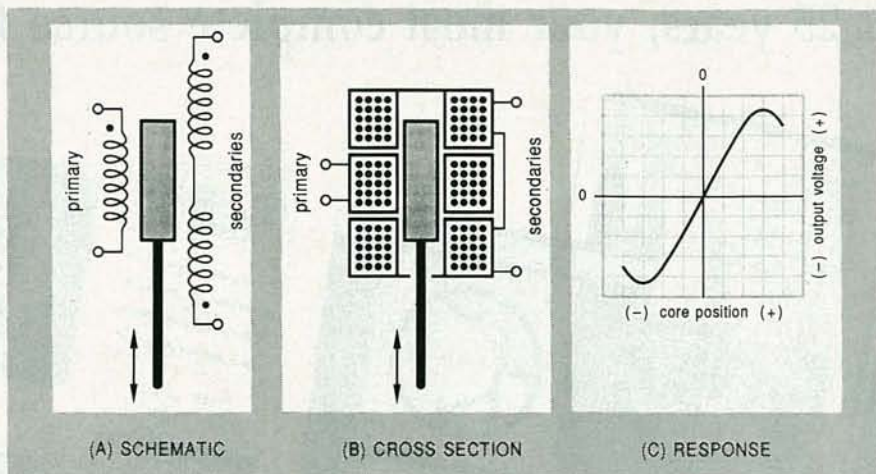

FIG. 3—LINEAR VARIABLE DIFFERENTIAL TRANSFORMERS, or LVDT's for short, can be used for extremely precise position-to-voltage transducers. The output voltage is proportional to the core position. Microweighing is one use.

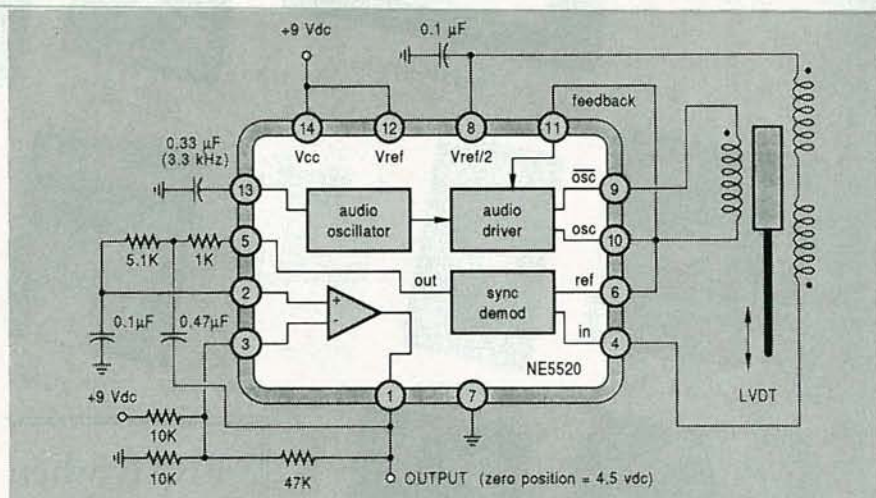

FIG. 4—THE PHILLIPS/SIGNETICS NE5520N has an internal precision sine-wave generator, a sync demod, and an extra op-amp that gets used here as an output filter. This is how to apply it as an LVDT signal conditioner. Since the chip can do so much more, it does seem a shame to waste it on LVDT uses.

overdriven as a switch. To improve the efficiency of a solar power conversion system, you create a *synchronous rectifier* that uses a sync demod and a pair of power transistors to replace your inefficient power diodes normally used.

Finally, one early way of detecting an AM radio station was known as a *homodyne detection*. Here you would synchronously demodulate your incoming signal against a reference of the same frequency as the transmitter carrier and then directly extract your audio in a single step. Unfortunately, they howled a lot as they were tuned and tended towards instability, so they were flushed in the late 1920's in favor of *superheterodyne* circuits that used intermediate frequency amplification, often at 455 kilohertz. Today, the old homo-

dyne deserves a fresh new look, especially when combined with digital synthesis, and the ability to put highly stable audio gain and good filtering into very small packages.

So, sync demods are easy to build and can be amazingly versatile. But, before we explore a great sync demod chip and more real-world uses, let's briefly look at some little-used hacker components known as...

## LVDT's

An LVDT, or a Linear Voltage Differential Transformer, is shown in Fig. 3. An LVDT is a transformer which has a movable core, a single winding on the primary, and a pair of secondary windings. The secondary windings are connected in *opposition*, so that the output



voltage will be the *difference* between the two.

When the movable core is in the center, equal and opposite voltages are induced in the secondaries, and the output voltage is zero. As your core moves up, a 0-degree phased sine wave appears in your output. As it moves down, a 180-degree phased sine wave appears instead.

With careful design, you can get a linear sine-wave output voltage whose amplitude changes with position, and whose phase is (0) degrees for positions above center and (180) degrees for positions below center.

In short, an LVDT is a very precise and ultra-sensitive *position-to-voltage transducer*. Some LVDT devices can easily sense any motions or position changes as small as a thousandth of an inch or less. They can also be made large enough to measure distances of several feet or more.

Unfortunately for hackers, LVDT's are rather pricey, since they are both low-volume and precision components. One useful surplus source is *AST Servo*, while others advertise in the *Sensors* and *Measurement and Control* trade journals.

Several LVDT uses? Weigh scales, especially for microweighing; torque sensing; accelerometers; distance measurement; inclinometers; pressure transducers; for seismometry; load cells; micropositioners; and anywhere else where you want to convert a very small motion or distance change into a useful electrical signal.

For precision results, your LVDT must get driven from a pure audio sine wave of a fixed and known amplitude. Distortion could lead to bad harmonics which will in turn create output errors and other difficulties.

To further up the LVDT precision, you can use an LVDT in its *servo mode*. Here, you'd use feedback to move, balance, shove, or otherwise continually coerce the LVDT back to its null position. That is known as *null seeking* and, because of the feedback, many nonlinearities can be greatly reduced if not canceled outright.

# Cable TV

## Descrambler Article Parts

We stock the exact parts, PC Board and AC Adaptor for two articles published in Radio-Electronics magazine on building your own CABLE TV DESCRAMBLER.

<p><b>February 1984 issue</b></p> <p>#701 Parts..... 19.00 Includes all original parts.</p> <p>#702 PC Board..... 7.95 Original 3x4 etched, drilled and silk-screened pc board.</p> <p>#704 AC Adaptor..... 7.95 Original 18 Volt DC @ 200ma.</p> <p>#701, 702 &amp; 704..... 29.00</p>	<p><b>February 1987 issue</b></p> <p>#301 Parts..... 29.00 Includes all original parts.</p> <p>#302 PC Board..... 7.95 Original 5x8 etched, drilled and silk-screened pc board.</p> <p>#304 AC Adaptor..... 7.95 Original 18 Volt DC @ 200ma.</p> <p>#301, 302 &amp; 304..... 39.00</p>
---	---

Free article reprint with purchase.

<p><b>Snooper Stopper..... 39.00</b></p> <p>Cable TV descramblers can be detected, protect your privacy with the Snooper Stopper. Free article on Cable Snooping.</p>	<p><b>Macrovision Kit..... 29.00</b></p> <p>Macrovision..now you see it, now you don't with our macroscrubber kit. Article was published in Radio Electronics 1987 issue.</p>
---	---

**CALL TOLL FREE 1-800-332-3557**

Out side USA 1-508-699-6935  
 Visa, Master Card and C.O.D. Visa MC  
 Add \$3.50 S & H. \$6.00 outside USA.  
 D & D Electronics, Inc., PO Box 3310, N. Attleboro, Ma. 02761

CIRCLE 187 ON FREE INFORMATION CARD

While LVDT's are usually super-precise, there's no reason you can't throw one together on your own to create a low-cost position sensor. Be sure to let me know what you do come up with on that.

By another of those astounding coincidences that infest this column, it looks like we need a sync demod to extract the position info from an LVDT. But, if we have a simple and cheap circuit that does that, why limit it to LVDT uses, when so much more can be done so much better with it? Which brings us around to...

### The misnamed chip

Sometimes a manufacturer might simply put the wrong name on one of their integrated circuit chips. For instance, which of these two has the greater hacker potential: a *Signetics* NE5520N LVDT Signal Conditioner, or a *Phillips* NE5520N Universal Single Chip Treasure Finder?

As you might guess, *Signetics* is *Phillips* and, of course, the NE5520N is the NE5520N. Figure 4 shows details. What we have is a

## LEARN VCR

### CLEANING/MAINTENANCE/REPAIR

EARN UP TO \$1000 A WEEK, WORKING PART TIME FROM YOUR OWN HOME!



Secrets Revealed!

NO Special Tools or Equipment Needed.

**EARN UP TO \$60 AN HOUR AND MORE!**

**THE MONEY MAKING OPPORTUNITY OF THE 1990'S**

IF you are able to work with common small hand tools, and are familiar with basic electronics (i.e. able to use voltmeter, understand DC electronics). . . . IF you possess average mechanical ability, and have a VCR on which to practice and learn. . . . then we can teach **YOU** VCR maintenance and repair!

**FACT:** up to 90% of ALL VCR malfunctions are due to simple MECHANICAL or ELECTRO-MECHANICAL breakdowns!

**FACT:** over 77 million VCRs in use today nationwide! Average VCR needs service or repair every 12 to 18 months!

Viejo's **400 PAGE TRAINING MANUAL** (over 500 photos and illustrations) and **AWARD-WINNING VIDEO TRAINING TAPE** reveals the **SECRETS** of VCR maintenance and repair—"real world" information that is **NOT** available elsewhere!

Also includes all the info you'll need regarding the **BUSINESS-SIDE** of running a successful service operation!

FREE INFORMATION  
 CALL TOLL-FREE 1-800-537-0589  
 Or write to: Viejo Publications Inc.  
 3540 Wilshire BL. STE. 310  
 Los Angeles, CA 90010 Dept. RE

CIRCLE 184 ON FREE INFORMATION CARD



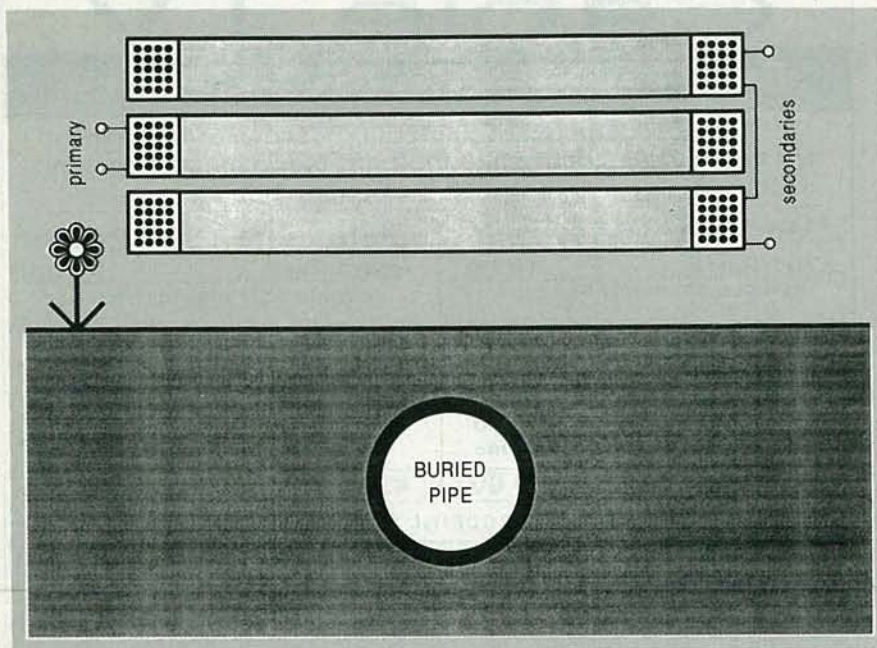

FIG. 5—THE SENSING HEAD of an induction-balance treasure finder or a metal locator can be thought of as an LVDT in disguise. The target acts as a movable core. Synchronous demodulation can separate metal from mineral detection.

precise amplitude and low-distortion audio sine-wave generator, a synchronous demodulator, and one uncommitted op-amp you can use for output filtering, meter driving, or in-phase to quadrature conversions. The circuit shows you how to power and sense the output of an LVDT.

While you actually could use one of those chips with an LVDT, the beast should work well for an extremely wide variety of hacker stuff. Where else could we use an audio source and a sync demod?

One place could include modulated infrared alarms and communicators that can ignore both sunlight and room lighting. A second might be in the fluxgate magnetometer used in solid-state digital compasses.

How about treasure finding? I can think of at least a dozen uses here. Figure 5 shows us how the search head of an induction balance metal locator is really an LVDT in disguise.

In the absence of a buried object, the voltages induced into the output sensing coils are equal and opposite. A buried ore or a metal object will distort the transmitted field, and unbalance the output voltages.

Now for the neat part; any "metal" objects return an in-phase component to the output signal,

while "mineral" deposits, such as a well-rusted can, returns us a quadrature signal. Nicely separating the goodies from all the grunge and garbage.

Thus, the NE5520N circuit can be used for in-phase discrimination of metal objects, or for quadrature discrimination of mineral objects.

To do the quadrature synchronous demodulation, just shift the phase of your reference by 90 degrees. Add a second NE5520N, and you can also add such advanced features as automatic ground tracking and the "native" soil background cancellation effects featured on the higher priced locators.

Similarly, over in those receiver-transmitter styles of metal locators often chosen for pipe finding, fiber optics can be used to optically couple from the transmitter to the receiver, minimizing any field distortions an actual cable might create. A sync demod at the receiver could then be used for improved sensitivity and for metal/mineral discrimination.

The NE5520N costs around \$7 in smaller quantities. Supply current is around seven milliamperes, easily provided by a 9-volt battery. While you can run the chip at +5 volts, its stability will not be as good.

For additional NE5520N circuit details and bunches of applications info, see the *Industrial Linear Data Manual II* offered by Phillips. Check out the NE5521N as well.

### Printing resources

As you know, each month I try to feature a *Resources Sidebar* which shows you where to go for the real insider stuff on unusual topics of hardware hacking interest. Sources that are difficult or impossible to quickly pin down on your own. Be sure to tell me what you want to see in future sidebars.

This month's sidebar gives you a rundown of the major sources of information on printing and printshops. What does that have to do with hardware hacking? Just this: there's a total desktop-publishing revolution going on out there, and traditional printing equipment and machinery is so utterly and outrageously priced that it simply won't hack it.

What we need instead is for all you hackers to come up with low-cost and low-end, do-it-yourself hardware kit solutions for desktop printing and book-on-demand publishing needs. To do that, hacking skills and a hacker mentality are essential. And the opportunities are pretty nigh unlimited.

What's needed? Well, for openers, here's a tiny part of my wish list:

- (1) A low-cost *Kroy Kolor* machine that doubles as a laminator and as a printed circuit direct-toner transfer processor.
- (2) A true perfect binder that gives fully professional cold-glue results for under \$99.
- (3) A sanely priced clamping paper cutter which can accurately trim 200 sheets at a time.
- (4) A die punch that, in one whomp, cuts out twelve business cards from a single sheet of cover stock.
- (5) A low-cost padding press.
- (6) An economical and programmable folder.
- (7) A simple-to-use pad printer for the "real" printing of pens, golf balls, mugs, keyholders, and such.
- (8) A cheap corner rounder.
- (9) A workable paper drill.
- (10) Automated conversions from

*Continued on page 78*



## NEW FROM ETT



**TELE—THE INVENTION OF TELEVISION** ..... \$9.95. How television came to be. Packed with history. 36-pages of photos and illustrations of early equipment. A collector's delight.

**PCP105—MAKE MONEY FROM HOME RECORDING** ..... \$10.00. Now that you've spent a fortune on all that recording gear, MIDI and all, wouldn't you like to get some of it back? This book shows you how.



**PCP106—SYNTHESIZERS FOR MUSICIANS** ..... \$10.00. All current popular forms of synthesis explained. LA, additive, phase distortion, FM and sampling. Get the sounds you want.

**BP182—MIDI PROJECTS** ..... \$6.95. How to interface popular home computers with MIDI systems. Also covers interfacing MIDI gear to analog and percussion synthesizers.



**BP255—INTERNATIONAL RADIO STATIONS GUIDE** ..... \$8.95. Essential reference work for the casual listener, amateur radio DXer and the professional radio monitor.

**BP85—INTERNATIONAL TRANSISTOR EQUIVALENTS GUIDE** ..... \$7.50. Find possible substitutions for a popular user-oriented selection of modern transistors made by more than 100 manufacturers.



MAIL TO: **Electronic Technology Today, Inc.**  
P.O. Box 240  
Massapequa Park, NY 11762-0240

### SHIPPING CHARGES IN USA AND CANADA

\$0.01 to \$5.00	... \$1.25	\$30.01 to \$40.00	\$5.00
\$5.01 to 10.00	... \$2.00	\$40.01 to \$50.00	\$6.00
\$10.01 to \$20.00	\$3.00	\$50.01 and above	\$7.50
\$20.01 to \$30.00	\$4.00		

**SORRY, No orders accepted outside of USA and Canada**

Total price of merchandise	..... \$
Shipping (see chart)	..... \$
Subtotal	..... \$
Sales Tax (NYS only)	..... \$
Total Enclosed	..... \$

Name \_\_\_\_\_  
Address \_\_\_\_\_  
City \_\_\_\_\_ State \_\_\_\_\_ Zip \_\_\_\_\_

## POWER SUPPLY

*continued from page 34*

nate in a row on one end of the PC board. Figure 4 shows the general chassis layout, and Fig. 5 shows the juncture between the PC boards and the custom heatsink close up. Use 16-gauge or heavier wire for the leads to J1-J4, and twisted pairs to R13-R14 and R15-R16. If you're including the 5-volt supply, install BR3, C10, C11, and IC3 with the secondary heatsink using point-to-point wiring. Connect T1, wire the primaries, and mount the primary heatsink and front panel. You should now be ready to turn on the supply.

### Checkout

Install F1 and F2, apply power, and check for +60 volts DC across C1 and C2. Check for a bias supply of -25 volts DC across C3. Vary R15 and R16, and observe the output voltage change. When the current limiter is fully counterclockwise, the output voltage may be zero, regardless of adjustments. When current limiting occurs, LED1 should glow.

R-E

## Choose from 33 Career Opportunities

Get Your Specialized Associate Degree or Career Diploma at Home in Spare Time

Now without attending college classes and with no previous experience, you can train for a money-making career...even get a degree. Send for free facts and color brochure on employment opportunities in the field that interests you most. See how easy it is to train at home for a great new career or advancement on your present job.



**CALL TOLL FREE 1-800-228-5300** Dept. DES20  
CALL ANYTIME—Operators to take your call 24 hours a day, 7 days a week. No cost. No obligation. No salesman will visit.  
**OR MAIL COUPON TODAY!**

**ICS** International Correspondence Schools  
SINCE 1990 Dept. DES20, 925 Oak Street, Scranton, PA 18515

Please send me free facts, color brochure and full information on how I can study at home for the career I have chosen. I understand I am under no obligation and no salesman will visit.

**CHECK ONE BOX ONLY!**

<input type="checkbox"/> <b>ASSOCIATE IN SPECIALIZED BUSINESS DEGREE PROGRAMS</b>	<input type="checkbox"/> <b>ASSOCIATE IN SPECIALIZED TECHNOLOGY DEGREE PROGRAMS</b>
<input type="checkbox"/> Business Management	<input type="checkbox"/> Mechanical Engineering
<input type="checkbox"/> Accounting	<input type="checkbox"/> Technology
<input type="checkbox"/> Business Management with option in Finance	<input type="checkbox"/> Civil Engineering Technology
<input type="checkbox"/> Business Management with option in Marketing	<input type="checkbox"/> Electrical Engineering Technology
	<input type="checkbox"/> Electronics Technology
<b>CAREER DIPLOMA PROGRAMS</b>	
<input type="checkbox"/> High School	<input type="checkbox"/> Bookkeeping
<input type="checkbox"/> Auto Mechanics	<input type="checkbox"/> Art
<input type="checkbox"/> Surveying & Mapping	<input type="checkbox"/> Motorcycle Repair
<input type="checkbox"/> Drafting	<input type="checkbox"/> Catering/Gourmet Cooking
<input type="checkbox"/> Air Conditioning & Refrigeration	<input type="checkbox"/> Computer Programming
<input type="checkbox"/> Wildlife/Forestry Conservation	<input type="checkbox"/> Personal Computer Specialist
<input type="checkbox"/> Police Sciences	<input type="checkbox"/> Fitness & Nutrition
<input type="checkbox"/> Diesel Mechanics	<input type="checkbox"/> TV/VCR Repair
<input type="checkbox"/> Electrician	<input type="checkbox"/> Travel Agent
<input type="checkbox"/> Small Business Management	<input type="checkbox"/> Veterinary Assistant
<input type="checkbox"/> Gun Repair	<input type="checkbox"/> Photography
<input type="checkbox"/> Electronics	<input type="checkbox"/> Journalism/Short Story Writing
<input type="checkbox"/> Microcomputer Repair	

Name \_\_\_\_\_ Age \_\_\_\_\_  
Address \_\_\_\_\_ Apt. # \_\_\_\_\_  
City/State \_\_\_\_\_ Zip \_\_\_\_\_  
Phone ( ) \_\_\_\_\_

A Subsidiary of National Education Corporation  
CIRCLE 189 ON FREE INFORMATION CARD

## DIGITAL VIDEO STABILIZER ELIMINATES ALL VIDEO COPY PROTECTIONS



While watching rental movies, you will notice annoying periodic color darkening, color shift, unwanted lines, flashing or jagged edges. This is caused by the copy protection jamming signals embedded in the video tape, such as Macrovision copy protection. Digital Video Stabilizer: RXII completely eliminates all copy protections and jamming signals and brings you crystal clear pictures.

**FEATURES:**

- Easy to use and a snap to install
- State-of-the-art integrated circuit technology
- 100% automatic - no need for any troublesome adjustments
- Compatible to all types of VCRs and TVs
- The best and most exciting Video Stabilizer in the market
- Light weight (8 ounces) and Compact (1x3.5x5")
- Beautiful deluxe gift box
- Uses a standard 9 Volt battery which will last 1-2 years.

**WARNING :**  
**SCO Electronics and RXII dealers do not encourage people to use the Digital Video Stabilizer to duplicate rental movies or copyrighted video tapes. RXII is intended to stabilize and restore crystal clear picture quality for private home use only.**

(Dealers Welcome)

To Order: \$49.95 ea + \$4 for FAST UPS SHIPPING  
**1-800-445-9285 or 516-694-1240**  
Visa, M/C, COD M-F: 9-6 (battery not included)  
SCO ELECTRONICS INC.  
Dept. CAE 581 W. Merrick Rd. Valley Stream NY 11580  
Unconditional 30 days Money Back Guarantee

CIRCLE 97 ON FREE INFORMATION CARD

## CABLE TV DESCRAMBLER



	1 Unit	10 +
Jerrold S.B.	.....\$74	.....\$55
Jerrold SB w/Trimode	.....\$90	.....\$70
Oak N-12 (w/VS)	.....\$89	.....\$65
Scientific Atlanta	.....\$109	.....\$75
Pioneer	.....\$109	.....\$75
Panasonic converter	.....\$98	.....\$79
73 channel converter	.....\$79	.....\$59

**We Beat Anyone's Price!**  
**30 Days Money Back Quarranty**  
**Free Catalog**

Visa, M/C, COD or send money order to:  
**US Cable TV Inc.** Dept. KA1  
4100 N. Powerline Rd., Suite F-4  
Pompano Beach, FL 33073

**1-800-445-9285**

Please have make and model number of the equipment used in your area ready.

**No Florida Sales!**

It's not the intent of US Cable TV Inc. to defraud any pay TV operator and we will not assist any company or individual in doing so.

CIRCLE 198 ON FREE INFORMATION CARD



# R-E Engineering Admart

Rates: Ads are 2 1/4" x 2 7/8". One insertion \$950. Six insertions \$925. each. Twelve insertions \$895. each. Closing date same as regular rate card. Send order with remittance to **Engineering Admart**, Radio Electronics Magazine, 500-B Bi-County Blvd., Farmingdale, NY 11735. Direct telephone inquiries to Arline Fishman, area code-516-293-3000. **Only 100% Engineering ads are accepted for this Admart.**

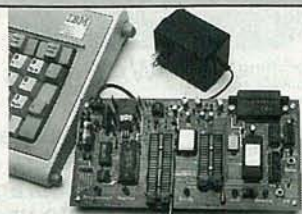

## 6805 MICROCOMPUTER DEVELOPMENT SYSTEM

The MCPM-1 system allows the IBM PC and compatibles to be used as a complete development system for the Motorola MC68705P3, P5, U3, U5, R3 and R5 single chip microcomputers. The system includes a cross assembler program, a simulator/debugger program and a programming board that connects to a serial port. Price—\$449.00 VISA and MASTERCARD accepted.

**TECI** THE ENGINEERS COLLABORATIVE, INC.

RR#3, BOX 8C Barton, Vermont 05822  
Phone (802) 525-3458 FAX (802) 525-3451

CIRCLE 195 ON FREE INFORMATION CARD

## FCC LICENSE PREPARATION

The FCC has revised and updated the commercial license exam. The **NEW EXAM** covers updated marine and aviation rules and regulations, transistor and digital circuitry. **THE GENERAL RADIOTELEPHONE OPERATOR LICENSE - STUDY GUIDE** contains vital information. **VIDEO SEMINAR KITS ARE NOW AVAILABLE.**

WPT PUBLICATION  
979 Young Street, Suite A  
Woodburn, Oregon 97071  
Phone (503) 981-5159

CIRCLE 185 ON FREE INFORMATION CARD

## MIDI PROJECTS



**BP182**—MIDI interfacing enables any so equipped instruments, regardless of the manufacturer, to be easily connected together and used as a system with easy computer control of these music systems. Combine a computer and some MIDI instruments and you can have what is virtually a programmable orchestra. To get your copy send **\$6.95 plus \$1.25 for shipping** in the U.S. to **Electronic Technology Today Inc.**, P.O. Box 240, Massapequa Park, NY 11762-0240.

## ION METER

*continued from page 38*

move the detector rod with ease; it should fit snugly into J3.

### Assembly

Mount S2, R5 and R7 on the front panel. Prewire S1 before mounting it, since access after mounting the PC board is difficult. Leave enough lead length to mount the PC board and S1 without strain. Install two metal PC-board standoffs on the back of the front panel, and connect M1 to the PC board. Mount the PC board on the standoffs, and install S1. Use solder lugs between the mounting screws and the PC board as grounds.

Wire the power leads to S2, making sure that the PC board +5-volt DC lead goes to the center terminal. Switch S2 is an SP3T version, so the up position connects to B1, and the down position to IC2. Solder two wires from the PC board to R5, the balance control; the orientation doesn't matter, since that's just a fine adjustment for R8. Solder the positive battery lead to the bottom terminal of S2, and the negative lead to the upper ground lug. Solder two leads to sensitivity-control R7 so that it's shorted when fully clockwise.

Install shoulder washers in the two 1/4-inch detector-screen mounting holes and use #6 screws to attach the detector-screen L-brackets. Also, solder one end of R1 to J4, and the other end to the upper PC-board ground

lug. If you can't find any shoulder washers to insulate the detector screen from the case, use 1/4-inch plastic grommets in the case mounting holes. Attach the 9-volt-battery clip to the left rear of the bottom surface with a 1/8-inch #4 screw.

Mount IC2 in the case hole shown in Fig. 4-c, using a TO-220 insulator kit. Solder R13 between the OUT and GND pins. Solder R12 from the IC2 GND pin to the lower PC-board ground lug. Solder the positive side of C17 to the IN pin of IC2, and the other end to the lower ground lug. Solder a wire to the OUT pin of IC2, and the opposite end to the upper terminal of S2. To avoid attaching J1 to the rear of the box and preventing its removal, cement it to the right rear edge. Connect a wire from the "tip" terminal to the IN pin of IC2, and from the "sleeve" terminal to the lower ground lug (see Fig. 3).

### Checkout

Set R7 fully clockwise, R5 to center, S1 to positive, and turn on S2 using either B1 or IC2. With a high-input-impedance multimeter, the voltage from the detector screen to the case should be +35–45 volts DC. Switch S1 to negative, which should give –35–45 volts DC. If no voltage is present, check with an ohmmeter for a short from the detector screen to the case. Check pin 8 of IC1 for 9-volts DC, and pin 3 for 20 kHz. A small AM radio tuned to either end of the broadcast band should pick up har-

monics when physically close to IC1.

When you turn the ion meter on, M1 should be nearly centered, and rotating R7 should swing the needle left or right; adjust for full scale either way. Next, adjust R8 until M1 is centered. Repeat until R7 is fully clockwise, and M1 is centered; that represents maximum sensitivity for positive ions. Then, set S1 to negative; M1 should deflect sharply to one side, so reduce sensitivity, rotating R7 counterclockwise until M1 fully deflects. Adjust R8 for center balance with full sensitivity as before; that represents maximum sensitivity for negative ions.

The ratio of negative to positive ions constantly changes. Thus, to balance both positive and negative readings at the center of M1 with full sensitivity is almost impossible. The ion meter reacts only to the immediate ion population.

To balance the ion meter, adjust R7 and R8 until equal readings on each side of zero are obtained for both settings of S1. They may or may not be full scale, but should be adjusted to be within scale using R7. When the ion polarity under observation is changed by switching S1, the detector takes about 20 seconds to stabilize, by bleeding off ions of opposite polarity. A little readjustment of balance vs. sensitivity should let you zero the ion ratio for both polarities, a basic reference level. When adjusted, carry the ion meter rapidly from room to room, and watch M1 swing.

R-E



# COMPUTER DIGEST

## DIGITAL KEYLESS ENTRY SYSTEM

Build a keyless entry system using Motorola's popular 68705 microcontroller.

STEVEN AVRITCH



**K**eyless entry systems have long been commercially available, but the costs associated with the systems usually preclude their use in homes and small businesses. However, by using a readily available and inexpensive microcontroller, a full-featured digital keyless entry system can be built from just a handful of components at a fraction of the cost of commercial units.

The digital keyless entry system presented in this article is a simple yet highly flexible design requiring approximately a dozen components. It costs less than \$75, most of which (about \$45, depending on where you get it) goes for the electromechanical door latch.

### How it works

The digital keyless entry system consists of three major components: the microcontroller, a keypad, and the electromechanical door latch (see the block diagram in Fig. 1).

To unlock the door, the user simply punches a three-digit entry code on the keypad. The microcontroller compares that code with the valid codes stored in its battery-backed RAM. If it matches, the latch is energized, and the door may be opened. In a power failure, the user can bypass the code-entry scheme and open the door with a key.

The keyless entry system may be programmed to recognize three distinct entry codes, each

*continued on page 74*

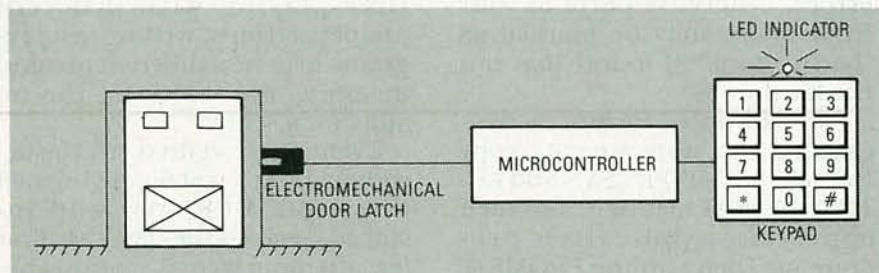

**Fig. 1.** A 68705 MICROCONTROLLER accepts keypad input and then energizes an electromechanical door latch after the proper entry code has been entered.

## EDITOR'S WORKBENCH

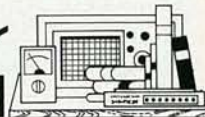

### Boot from ROM

**I**ndustrial controllers typically suffer from lack of a standard development environment—or, if one is available, it's expensive. The PC is ubiquitous; why not use it to develop real-time control systems?

One reason is cost: a full-blown PC may be too expensive for field use in many applications. Even if cost is not a major consideration, another problem is reliability; disk drives (hard or floppy) typically don't fare well in industrial environments.

Of course, disk drives aren't absolutely required; there are diskless LAN workstations, and some laptops boot from DOS in ROM. But putting DOS in ROM requires special expertise with device drivers and BIOSes—*or does it?*

It doesn't have to; Annabooks (the company famous for selling a C-language BIOS in source-code form) has done all of the dirty work for you. With their PROMKIT you insert the diskette to be emulated in a disk drive, run a one-line batch file, burn the resulting code into EPROM, and you're done.

### How it works

When a PC with a standard BIOS boots, it scans the memory area above the video adapters (C000:0000—E000:FFFF) look-



NOTES:  
THIS BOARD USES TWO 27512 PROMS AT SEGMENTS DXXXX AND EXXXX FOR 128K DRIVE ON XT TYPE MACHINES. SOME AT MACHINES MAY ALLOW ONLY 64K TO BE USED.

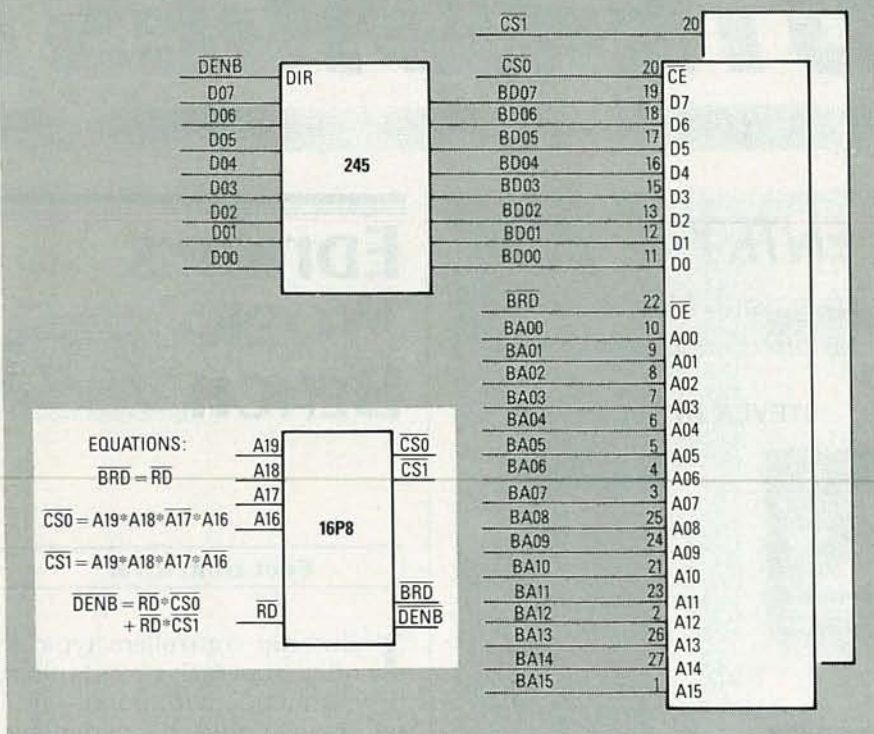

FIG. 1

ing for the "signature" word 55AAh every 2K. If the scan routine finds the signature, it picks up the third byte, which specifies the number of 512-byte blocks contained in the routine. The maximum value of the size byte is FBh (251), allowing a total of just under 128K (251 × 512) bytes. The scan routine next computes a checksum over the specified number of blocks. If the checksum equals zero, the BIOS then executes a far call to the fourth byte, which is where user code should start. The user code should perform its initialization and then terminate with a far return, which will allow the scan routine to continue at the next available block.

There's nothing magic or even particularly obscure about that procedure; IBM has used it at least since the introduction of the XT, whose hard-disk controller contains a BIOS extension allowing orderly access to one or two hard disks. The same technique is used by EGA and VGA video cards, network adapters, even some "intelligent" floppy-disk controllers, and more.

What Annabooks did was to tap into that potential by creating a set of programs that link user code into the floppy-disk drive control system of the PC—so that whenever a program tries to access an emulated drive, contents come from an EPROM rather than a physical drive. In addition, with the proper supporting hardware, static RAM's can be used to provide a fully solid-state read/write capability, and it all happens transparently at the DOS level. PROMKIT also supports multiple-drive emulation.

You use the software by creating a floppy disk with an exact image of the disk you wish to emulate. Make sure that you use a fresh floppy with no formatting errors, otherwise parts of your ROM image may be marked as "bad sectors." (I found that out the hard way.)

For example, format a disk (putting the system on it), copy the desired CONFIG.SYS and AUTOEXEC.BAT files to it, and then copy your application program(s). Then run the PROMKIT program (PK.EXE), specifying the drive letters of the source and

emulated drives, the name(s) of the file(s) that will receive the object code, number and type of EPROM's, etc. PK then builds a set of files containing both the ROM-scan loader that copies your files from ROM to RAM, and your application program. The number of files that PK creates, as well as their size, depends on the number and size of EPROM you use. The file format is a straight binary image; some EPROM programmers require a hex/ASCII format. So, Annabooks includes a utility that converts the binary file to Intel format.

How you address the burned EPROM's depends on your application. Older XT clones, for example, often have several unused sockets allowing 56K of add-on ROM. Some AT system boards have a pair of sockets addressed at E000:0000. Otherwise, in a regular PC environment you'll have to use an add-on memory card. In addition, there are PC-on-a-card solutions, including Intel's Wildcard and others, that would allow more compact solutions.

For purposes of testing, Annabooks was kind enough to loan me the Universal Memory Card (UMC) card made by Sealevel Systems. The half-length card contains eight 28-pin sockets that allow various combinations of EPROM's and static RAM's, and even includes provision for a lithium backup battery. The board can be addressed at any 256K boundary in the PC's address space; I used it at the C000:0000 bound. You have to set several jumpers to select device type and capacity, and the documentation is minimal. To figure out the necessary decoding for my tests, I spent some time playing with different jumper settings, writing test programs to access different areas of memory, and watching the results on a scope.

Eventually I figured out the decoding, built a test floppy, burned three 32K EPROM's, and installed them on the UMC. My first few attempts were disastrous because I didn't have the decoding jumpers set right, and then I



didn't understand which sockets on the board to use. I also found that a *clean* floppy is necessary.

### Hardware options

The PROMKIT documentation comes with several hardware designs for addressing various types of memory. One simple design (shown in Fig. 1) uses a single bus buffer and a PAL, and allows you to address two 27512 (64K) EPROM's in the D000 and E000 segments. Another two-chip (plus memory) design allows you to emulate a full 360K drive using only a 64K data window occupied by a standard 27128 (16K) EPROM for the driver module, and three 27011 paged EPROM's for data. The latter are organized as 16K × 8 bits × 8 pages, for a total of 128K each. The 27011's are somewhat expensive and hard to find, however. Another two-chip design allows read/write access to an emulated drive; another gives you 1MB of emulated disk using only a 32K window. The company also has information on commercial units like the Sealevel board I used.

The PROMKIT works with the company's BIOSKIT, so that you can combine the BIOS and the driver code in a single EPROM. The PROMKIT also comes with full source code (in C), heavily commented and well structured, so you can customize operation to your heart's content.

The PROMKIT is built on a foundation called the OBJEX Core Library, which provides a set of low-level data structures and routines (mostly in C, some in assembler, source included). You use OBJEX to access memory and I/O ports, manipulate 80xxx family segment registers, etc. PROMKIT is built on OBJEX; and Annabooks plans to release other system tools, including a "mini-DOS" that could be useful in situations where a full licensed copy of MS-DOS would be undesirable or cost-prohibitive. (Digital Research's DR-DOS is also available for ROM-based applications, and Microsoft recently responded to DR's growing popularity with an announcement of some support for a ROM-based DOS.) ▶CD▶



### C and Pascal programming

Object-oriented programming (OOP) may be just another fad, but it may not be. The first wide-scale implementation was on the Macintosh; now the PC world has caught up, so Microsoft and Borland are engaged in a war to define and control the market. The latest version (5.5) of Turbo Pascal adds object-oriented extensions. If you don't know what OOP is, Turbo Pascal 5.5 contains an excellent little book introducing the subject. If you feel the need for more hands-on experience, check out the *Turbo Pascal DiskTutor* by Werner Feibel. That book/disk combination consists of two parts. The first nine chapters teach you the basics of programming in Pascal and in using the tutorial environment. Chapter ten deals with

units (libraries of object code), and serves as a bridge to the next two chapters, which deal with OOP. The final chapter deals with bit manipulation and using DOS services.

If C is more to your taste, check out *Microsoft C, Secrets, Shortcuts, and Solutions* by Kris Jamsa. It's a tutorial starting at square one. No compiler is included, and the examples are all geared toward Microsoft C. The book consists of four parts; the first discusses basics of the language and the Microsoft environment. Part II goes into pointers, arrays, and file processing. Part III continues with command-line processing, accessing the DOS environment, I/O redirection, low-level file I/O, and dynamic memory allocation. Part IV discusses optimizing compiler usage, LIB and MAKE, memory models, critical error handling, and other advanced topics. I do wish that I could take a couple of months off and study the book in depth. ▶CD▶

#### ITEMS DISCUSSED

- PromKit (\$179), Annabooks, Suite 250-262, 12145 Alta Carmel Court, San Diego, CA 92128. (619) 271-9526.

CIRCLE 40 ON FREE INFORMATION CARD

- Universal Memory Card (\$199), Sealevel Systems, Inc., P.O. Box 1808, Easley, SC 29641. (803) 855-1581.

CIRCLE 41 ON FREE INFORMATION CARD

- *Turbo Pascal DiskTutor* (\$39.95), Werner Feibel, Borland-Osborne/McGraw-Hill, 2600 Tenth Street, Berkeley, CA 94710.

CIRCLE 42 ON FREE INFORMATION CARD

- *Microsoft C, Secrets, Shortcuts, and Solutions* (\$24.95), Kris Jamsa, Microsoft Press, Microsoft Corp., 16011 NE 36th Way, Box 97017, Redmond, WA 98073-9717. (206) 882-8080.

CIRCLE 43 ON FREE INFORMATION CARD

### Try the Radio Electronics

bulletin board  
system

(RE-BBS)  
516-293-2283

The more you use it the more  
useful it becomes.

We support 300 and 1200 baud  
operation.

Parameters: 8N1 (8 data bits, no  
parity, 1 stop bit) or 7E1 (7 data  
bits, even parity, 1 stop bit).

Add yourself to our user files to  
increase your access.

Communicate with other R-E  
readers.

Leave your comments on R-E with  
the SYSOP.

RE-BBS  
516-293-2283



## KEYLESS ENTRY

*continued from page 71*

of which consists of three digits. You change the entry codes from the keypad by entering a special three-digit "function" code, discussed in detail later. An LED indicates system status.

It should be noted that the digital keyless entry system is not a complete security system in and of itself; however, it can function as an integral component of a complete security system.

### Circuit description

The heart of the system is the Motorola MC68705P3 microcontroller discussed in detail in the September 1989 **Radio-Electronics** (page 82). To summarize its features, the microcontroller has 64 bytes of RAM, 2K of EPROM, a built-in clock oscillator, and 20 I/O ports.

You can program the 68705 with some off-the-shelf EPROM programmers; you may also want to consider building the programmer described in the earlier article.

The keypad used in this design is a standard four-row by three-column keypad with a common ground, as shown in Fig. 2. Each of the seven keypad outputs is pulled up by a resistor (R1-R7) of the microcontroller, as shown in Fig. 3. The microcontroller uses a software scanning routine to determine when a key is pressed.

When the microcontroller has recognized a valid entry code, it sends port PB0 high, which turns on power MOSFET Q1, which in turn enables relay RY1. Current for the door latch then flows through the relay contacts. Diode D1 is wired across the coil of the relay to prevent voltage spikes caused by the instantaneous change in current through the relay coil.

Port B7 of the microcontroller drives LED1 (STATUS) directly. A logic low on port B7 completes the circuit to ground and lights the LED.

When the EXTAL and XTAL inputs (pins 4 and 5) are connected to-

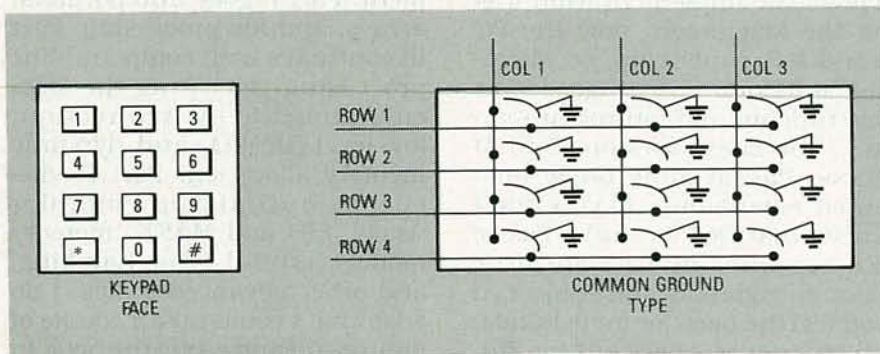

**Fig. 2.** THE KEYPAD consists of four rows by three columns. Pressing a key grounds the intersection of the corresponding row and column.

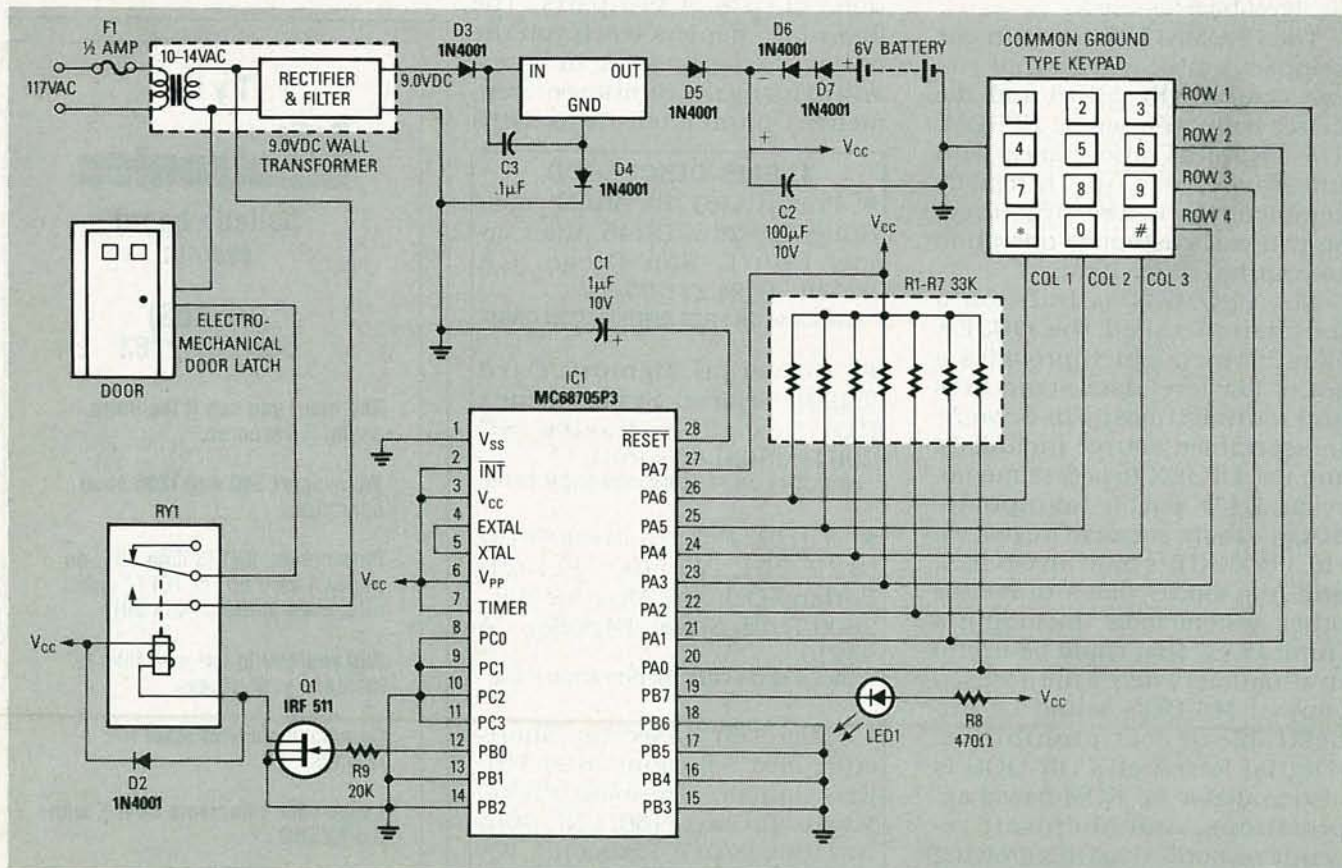

**Fig. 3.** COMPLETE SCHEMATIC of the digital keyless entry system. You can eliminate diode D4-D7 if you don't want battery backup. However, you'll be limited to the access codes burned into the microcontroller's EPROM.



## Parts List

### Resistors

All resistors are 1/4-watt, 5%, unless otherwise noted.

R1-R7	33,000 ohms
R8	470 ohms
R9	20,000 ohms

### Capacitors

C1	1 $\mu$ F, 10 volts, electrolytic
C2	100 $\mu$ f, 10 volts, electrolytic
C3	0.1 $\mu$ F, ceramic disc

### Semiconductors

IC1	MC68705P3 microcontroller
IC2	7805, 5-volt DC regulator
Q1	IRF511, power MOSFET
LED1	standard red
D2-D7	1N4001, 100 volts, 1 amp

### Miscellaneous

Keypad	common ground
Door latch	(see text)
Relay	SPST, 5-volt coil, 50 ohms, 100 mA
Fuse	1/2 amp (and holder)
Transformer	9-volt DC, wall-mount
Batteries	4 AA cells (and holder)

## Ordering Information

The following are available from Simple Design Implementations (SDI)

P.O. Box 9303  
Forestville, CT. 06010

### Preprogrammed & tested

MC68705 ..... \$25 + \$2.50 S/H

### Electromechanical door Latch

..... \$45 + \$4 S/H)

### Complete kit of parts as shown in

Parts List ..... (\$75 + \$6 S/H)

Software on 5.25" disk ... \$25 + \$3 S/H)

gether as shown in Fig. 3, the microcontroller's internal oscillator circuit runs at about 800 kHz, providing a cycle time of

about 1.25  $\mu$ s. The accuracy of a crystal oscillator is not important for this project.

The microcontroller pulls up the RESET input (pin 28), thereby eliminating the need for an external resistor. The 1- $\mu$ F capacitor (C1) connected from that pin to ground gives the power supply time to stabilize before allowing the microcontroller to start up.

The external-interrupt input (INT, pin 2) is tied high because interrupts are not required for this project. V<sub>PP</sub> (pin 6) is also tied high per the manufacturer's specifications.

## Power considerations

The power supply bears some explanation; it provides an optional battery-backup system. If you want, you can hard-code the desired entry codes into EPROM. That way, you won't need to provide battery backup. But you won't be able to change codes without changing the contents of the EPROM.

The 7805 voltage regulator (IC2) maintains the supply at five volts, and filter-capacitor C2 removes any noise from the DC supply voltage. A reversed-polarity protection diode (D3) is included to protect against misapplication of power. Diode D4 serves to "lift" the 7805's output voltage by about 0.7 volts to provide an output of 5.7 volts, which is then dropped by D5 back to 5.0 volts. Diodes D5, D6, and D7 isolate the battery and the power supply from one another, preventing current from flowing from whichever source happens to be active into the other. The batteries supply about 6.0 - 0.7 - 0.7 = 4.6 volts. Four AA batteries supply plenty of power to keep the micro-

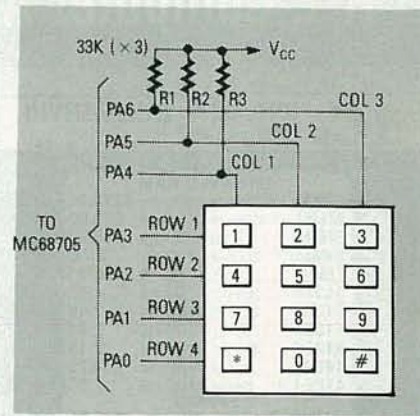

Fig. 4. AN UNGROUNDED KEYPAD may be used, but you'll have to change the keypad scan routine. An excellent opportunity to get started in 68705 programming!

controller's memory active (and your entry codes intact), but they can't operate the door latch, so in case of a power failure, you will have to use a key to open the door.

If the system encountered a battery failure and a main power failure simultaneously, the microcontroller's memory would be lost. When power was restored, the entry codes would be initialized to the default values stored in EPROM. Diodes D4-D7 may be removed if the battery-backup option is not used.

## Software design

The following describes the software running on the microcontroller; with the information provided, it should be easy to customize operation to your liking. Complete source and object code have been posted on the REBBS (516-293-2283, 300/1200 baud, 8N1) in the file DIGKEY.EXE, a self-extracting compressed file. The compressed file consists of about 20K; run it on a disk with at least 50K of free disk space.

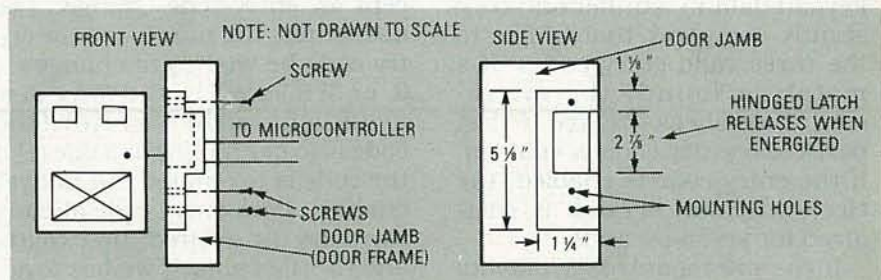

Fig. 5. MOUNTING DIMENSIONS for the prototype door latch. This is only a guide; measure your own unit carefully.



# R-E Computer Admart

Rates: Ads are 2 1/4" x 2 7/8". One insertion \$950. Six insertions \$925 each. Twelve insertions \$895 each. Closing date same as regular rate card. Send order with remittance to **Computer Admart**, Radio Electronics Magazine, 500-B Bi-County Blvd., Farmingdale, NY 11735. Direct telephone inquiries to Arline Fishman, area code-516-293-3000. *Only 100% Computer ads are accepted for this Admart.*

## ICs PROMPT DELIVERY!!!

SAME DAY SHIPPING (USUALLY)  
QUANTITY ONE PRICES SHOWN FOR DEC. 24, 1989  
OUTSIDE OKLAHOMA: NO SALES TAX

DYNAMIC RAM		
SIMM	AST Prem386/33Mhz	\$275.00
SIMM	(1) 256Kx36 80 ns	275.00
SIMM	1Mx9 80 ns	110.00
SIMM	(2) 256Kx9 100 ns	35.00
1Mbit	1Mx1 80 ns	10.25
41256	256Kx1 60 ns	4.65
41256	256Kx1 80 ns	3.40
41256	256Kx1 100 ns	2.40
41256	256Kx1 120 ns	2.15
4464	64Kx4 120 ns	3.75
41264 (3)	64Kx4 100 ns	7.50
EPROM		
27C1000	128Kx8 200 ns	\$18.00
27512	64Kx8 200 ns	7.80
27256	32Kx8 150 ns	6.50
27128	16Kx8 250 ns	3.75
STATIC RAM		
62256P-10	32Kx8 100 ns	\$10.95
6264P-12	8Kx8 120 ns	4.50
6116AP-12	2Kx8 120 ns	4.25

OPEN 6 DAYS, 7:30 AM-10 PM. SHIP VIA FED-EX ON SAT.  
SAT DELIVERY INCLUDED ON FED-EX ORDERS RECEIVED BY: 11:00 AM  
MasterCard, VISA or UPS CASH COD  
MICROPROCESSORS UNLIMITED, INC.  
24,000 S. Pasteria Ave., (918) 267-4961  
BEGGS, OK 74421  
No minimum order. Please note: prices subject to change!  
Shipping, insurance extra, up to \$1 for packing materials

## SECRETS OF THE COMMODORE 64

**BP135**—A beginners guide to the Commodore 64 presents masses of useful data and programming tips, as well as describing how to get the best from the powerful sound and graphics facilities. We look at how the memory is organized, random numbers and ways of generating them, graphics-color-and simple animation, and even a chapter on machine code. Get your copy today. **Send \$5.00 plus \$1.25 for shipping** in the U.S. to **Electronic Technology Today Inc., P.O. Box 240, Massapequa Park, NY 11762-0240.**



## GETTING THE MOST FROM YOUR PRINTER

Getting The Most From Your Printer



**BP181**—It is probable that 80% of dot-matrix printer users only ever use 20% of the features offered by their printers. This book will help you unlock the special features and capabilities that you probably don't even know exist. To order your copy **send \$6.95 plus \$1.50 for shipping** in the U.S. to **Electronic Technology Today Inc., P.O. Box 240, Massapequa Park, NY 11762-0240.**

CIRCLE 61 ON FREE INFORMATION CARD

The system can recognize as many as three distinct entry codes. Each entry code is three digits long. The three entry codes can be independently changed and independently enabled or disabled. The system also recognizes a fourth three-digit code that puts the system into the "function" mode mentioned earlier; the function mode allows the user to change the entry codes or enable/disable the entry codes.

The three entry codes and their functional status are initialized on power up to default values stored in the EPROM. The function code, on the other hand, always starts up enabled, because if it started up disabled, the user would never be able to get into the function mode to enable it!

During normal operation, the LED flashes to indicate that the microcontroller is active and ready for input. The microcontroller stores the incoming keypad data in a buffer and constantly compares that buffer to the three valid entry codes. If a match is found, the microcontroller checks to see if that particular entry code is enabled. If the entry code is enabled, the electromechanical latch is energized for seven seconds.

If the microcontroller detects too many digits before a valid match is detected, the system en-

ters a security mode prohibiting further input until the "\*" key is pressed. While in security mode, the LED stops flashing, and remains off, indicating an improper access attempt.

The microcontroller purges the input buffer three seconds after the last key was pressed. Therefore, if the user enters one, two, or three incorrect digits, he must wait at least three seconds from the last entry before reentering the correct code. If the user does not wait three seconds, the incorrect digits remain in the buffer, a correct match cannot be made, and the system will enter security mode on the fourth digit.

The microcontroller enters the function mode when the correct three-digit function code is entered. Upon entering the function mode, the LED will turn on for 1.5 seconds, turn off for 1.5 seconds, and then remain on. The microcontroller will now accept an entry-code change. The user enters the number of the entry code he wishes to change (1, 2, or 3) followed by the three new digits, followed by a zero (0) if the code is to be enabled or a one (1) if the code is to be entered but not yet enabled. If an entry code already contains the desired three digits and the user simply wishes to activate or deactivate the code, then he must hit "\*" (deactivate) or "#"

(activate), following the function code and the entry code number. The user is not required to enter the three digits of the entry code when enabling or disabling it.

### Construction/installation

The prototype was built on a small piece of perfboard using point-to-point techniques. Be sure to observe the polarity of all polarized ports.

You could use a standard row/column connect type of keyboard; doing so would allow you to eliminate four of the seven keypad pullup resistors. Figure 4 shows the basic idea. However, you'd have to implement a different keyboard scan routine.

The only change to the existing lock assembly involves removing the latch receptacle in the door jamb and replacing it with the electromechanical latch.

The latch in the prototype was obtained at a local safe and lock store. Although the physical dimensions of the latches were fairly uniform (as shown in Fig. 5), drive potential varied from three to twenty-eight volts, either AC or DC. The author recommends driving the latch with an AC voltage because the latch will buzz when energized. DC drive voltages work just as well, but the latch will make only one faint click when energized. ▶CD▶



---

---

# AUDIO UPDATE

## National sound preference?

LONG-TERM READERS OF THIS COLUMN may have noticed that I've been less than kind to those audiophiles who harbor strange, semi-magical beliefs about sound quality and the "mysterious" factors that supposedly influence it. It's not generally appreciated that many of the strange audio attitudes and peculiar belief systems originated in the same place that most of the equipment comes from—Japan.

I can remember my first encounter with Japanese audiophilia, about 15 years ago. A number of Japanese audio-magazine editors were visiting the U.S. and wanted to meet with me and other American audio editors to "exchange views." I was certainly pleased at the opportunity to meet my Japanese counterparts and looked forward to discussing technology, the audio-magazine business, the comparative natures of Japanese and American hi-fi audiences, and so forth. After a tour of the *Stereo Review* offices and sound room, we proceeded to a large local restaurant. As I recall, the first question put to me (during an excellent minestrone soup) was whether I preferred speakers with "East-Coast" or "West-Coast" sound.

It seems that the Japanese had observed that the leading U.S. west-coast speaker manufacturers of the time—Altec Lansing and JBL—produced high-efficiency systems with overly strong middle and upper midrange response, sometimes accompanied by a heavy upper bass. (Altec and JBL systems no longer sound that way.) On the other hand (or coast),

there were the New England manufacturers—Acoustic Research (AR), KLH, and several others—whose acoustic-suspension systems had a smooth and extended frequency response that was relatively free of peaks and dips. (Incidentally, at that time AR systems accounted for fully one-third of U.S. speaker sales, a feat that has never been equaled.)

### Bi-coastal disclaimer

I tried to explain that I did not find it helpful to characterize speakers by their area of origin, since I had heard systems from opposite sides of the country with similar sound qualities and systems manufactured on the same coast that sounded different. But my Japanese friends were not content with what they obviously thought was a cop-out. "What kind of sound do the Harman Kardon speakers have?" they persisted. "Long Island sound," I quipped, hoping to end the discussion. (For those readers unfamiliar with New York geography, the Long Island Sound separates Long Island, where Harmon Kardon is located, from Connecticut.) My reply had no effect on the Japanese, but caused one of the U.S. editors to choke on his soup.

In any case, our discussion ultimately turned to other matters, and I learned that their concern about East-Coast/West-Coast sound had world-wide implications. It seems that my Japanese colleagues believed that there were national tastes in sound: The Germans liked one kind of tonal balance, the English another, the



LARRY KLEIN,  
AUDIO EDITOR

Japanese a third, and so forth. Subsequently, I even saw a manufacturer's newsletter that attempted to correlate national speaker tastes with local environmental factors, such as high or low humidity levels.

On my subsequent trips to Japan, most of the engineers that I spoke to simply accepted the variations in national tastes as a given, and were prepared to export to each country the kind of sound that they believed its natives preferred. Incidentally, the speakers that came to the U.S. were of the "West-Coast" variety, because that was also the kind of sound that the Japanese liked. As a result, for many years *no* Japanese speaker ever received a good review in the American or British press, even from those publications that loved Japanese electronics.

### Insrutable ears

Here's where the story really gets confusing and mysterious. One of the American representatives (let's call him Bill) of a major Japanese manufacturer asked me to have *Stereo Review* test a new two-way bookshelf speaker system. He assured me that it was a cut above the typical Japanese speaker. I agreed to submit it to our test lab, which, to my surprise, gave it a very favorable review. A month or so after the test report appeared in print, I got a call from Bill, who asked if I would be willing to visit his company's Long Island City plant and do a little critical listening for him. He suggested that I bring my own test

*continued on page 87*



## HARDWARE HACKER

continued from page 68

a laser-printed image onto T-shirts, for rubber stamps, and for CAD/CAM machining of a plastic mockup or even actual hardware.

(11) A super scungy vacuum packer and/or shrink wrapper.

(12) A method to convert an orbital jitter sander into a paper jogger.

(13) A new combination scoring, perforating, and die-cutting machine, possibly with a hot foil die-stamping capability, as well.

(14) A very low-cost power stapler strong enough to handle *Jiffy Bags*.

(15) Solutions to economical custom glass etching.

(16) Vinyl hot-knife sign cutters and PostScript driven wood and/or aluminum routers.

Once again, your projected final cost to the end user on any and all of those should end up in the \$25 to \$99 range, or under *one-tenth* of the sales commissions of the "real" print machinery that all this stuff is inevitably going to shoot out of the saddle.

Your hacker abilities are obviously needed to hold the costs down. And lots of electronics and power control does seem to be involved. This is one hot topic right now, with a potential market in the millions of units.

### Two contests

Let us have two contests for this month. As usual, there will be an *Incredible Secret Money Machine* for the dozen or so best entries, with an all-expense-paid (FOB Thatcher, AZ) *tinaja quest* for two awarded to the very best of all.

Either (A) show to me a new and unique hacker circuit involving the NE5520N with some unusual synchronous demodulation use, or else (B) show me a low-cost solution to some desktop publishing peripheral hardware of one sort or another.

As usual, send your entries directly to me at *Synergetics*, and not to **Radio-Electronics**. Let's hear from you.

### New tech literature

Those *Phillips* folks have re-

cently bought out *Amperex* and several other companies. They've now released a wheelbarrow full of fat, new, and free data books. Check out their *Light Emitting Diode*; *RF Power Transistor*; *High-Voltage Transistor*; *RF Power Module*; *Thyristor*; *Small Signal Transistor*; *Surface Mounted Semiconductor*; and the *PowerMOS* data books for openers. There's bunches more where those came from. *Linear Technology* has issued a great new *1990 Linear Data Book* that is crammed full of great hacker integrated circuits.

Free software this month includes the latest *Specs in Secs Discrete Data* from *Motorola*, and the *PCBII* printed circuit layout demo from *OrCAD*. And unusual free samples for this month include the *MC33034 Brushless Motor Controller*, again from *Motorola*, the *Advanced Bus Interface Product Samples* from *Texas Instruments*, and the various low-cost jellybean integrated circuits from *Calogic*.

Our reminder here that *Midnight Engineering* is a great new hacker magazine aimed at all small-scale hardware and software productions. Free samples are available.

Rounding out the selections, the *Chomerics* folks have new *Cho-Flex 440-X* line of force-sensitive inks. *Car Audio* is an interesting slick magazine for high-power mobile music buffs. *American Design Components* has a new surplus catalog that includes \$14 ultrasonic radars and \$15 gyroscopes, among scads of other goodies. And *Chips and Technologies* has a new 82C235 single-chip AT motherboard out, along with a free data book.

Turning to my own stuff, for the fundamentals of digital integrated circuits, check out my million-selling *TTL* and *CMOS Cookbooks*. I also have a new and free mailer for you which includes dozens of insider and top hardware-hacking secret sources. Do write or call for your copy.

As always, this is your column and you can get technical help and off-the-wall networking per that *Need Help?* box. The best calling times are weekdays 8-5, *Mountain Standard Time*. Let's hear from you.

R-E

# SHORT CIRCUITS

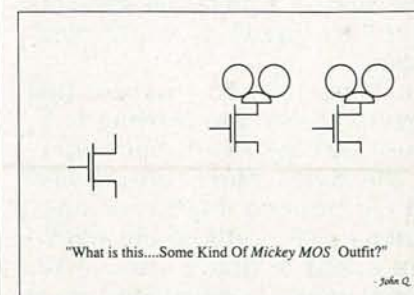
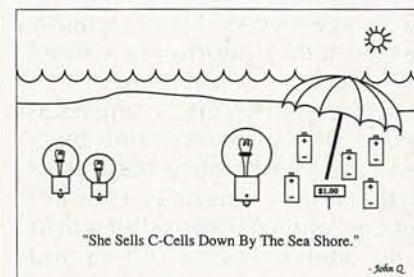
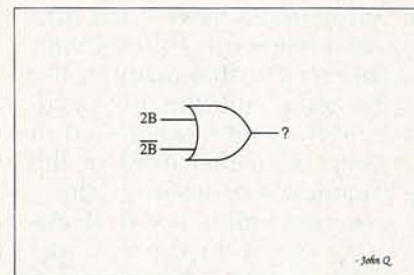
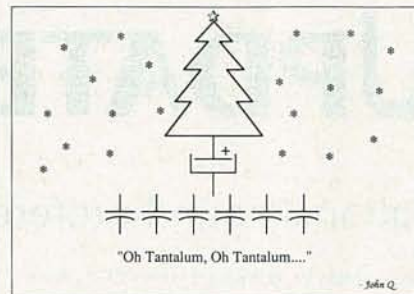



# MARKET CENTER

## FOR SALE

**PHOTOFACT** folders, under #1400 \$4.00. Others \$6.00. Postpaid. **LOEB**, 414 Chestnut Lane, East Meadow, NY 11554.

**GREAT buys!** Surplus prices, ICs, linears, transformers, PS, stepping motors, vacuum pump, phototransistor, meters, LSASE, **FERTIK'S**, 5400 Ella, Phila., PA 19120.

**DESCRAMBLERS.** All brands. Special: Combo Jerrold 400 and SB3 \$165. Complete cable descrambler kit \$39. Complete satellite descrambler kit \$45. Free catalog. **MJM INDUSTRY**, Box 531, Bronx, NY 10461-0531.

**T.V.** notch filters, surveillance equipment, brochure \$1.00. **D.K. VIDEO**, Box 63/6025, Margate, FL 33063. (305) 752-9202.

## CB RADIO OWNERS!

We specialize in a wide variety of technical information, parts and services for CB radios. 10-Meter and FM conversion kits, repair books, plans, high-performance accessories. Thousands of satisfied customer since 1976! Catalog \$2.

**CBC INTERNATIONAL**  
P.O. BOX 31500RE, PHOENIX, AZ 85046

**LASER Listener II**, other projects. Surveillance, descrambling, false identification, information. Plans, kits, other strange stuff. Informational package \$3.00 refundable. **DIRIJO/BOND ELECTRONICS**, Box 212, Lowell, NC 28098.

**ENGINEERING** software, PC/MSDOS. Hobbyists — students — engineers. Circuit design \$59.00, FFT analysis \$69.00, Mathematics \$49.00, Logic Simulation \$49.00, Circuit Analysis \$29.00. Free catalog, (614) 491-0832, **BSOFT SOFTWARE**, 444 Colton Rd., Columbus, OH 43207.

**RESTRICTED** technical information: Electronic surveillance, schematics, locksmithing, covert sciences, hacking, etc. **Huge selection. Free brochures.** **MENTOR-Z**, Drawer 1549, Asbury Park, NJ 07712.

## CABLE TV DESCRAMBLERS!



## BARGAIN HEADQUARTERS!

• JERROLD • TOCOM • HAMLIN  
• SCIENTIFIC ATLANTA • ZENITH

Oak M35B ONLY \$60

6 month warranty! We ship C.O.D.!

Lowest retail/wholesale prices!

FREE CATALOG:

Global Cable Network  
1032 Irving St. Suite 109  
S.F., CA 94122

**ORDER TODAY! 800-327-8544**

**CABLE TV converters:** Jerrold, Oak, Scientific Atlantic, Zenith & many others. "New MTS" stereo add-on: mute & volume. Ideal for 400 and 450 owners! 1 (800) 826-7623, Amex, Visa, M/C accepted. **B & B INC.**, 4030 Beau-D-Rue Drive, Eagan, MN 55122.

**DESCRAMBLER.** 1990 specials, examples, Tocom-w/r \$199.00, Jerrold 400-w/r \$125.00, Z-Tac-w/r \$225.00, SA-3 and Tri-modes \$89.00, all types in stock, COD ok. **MOUNT HOOD ELECTRONICS**, (206) 896-6837.

**TUBES:** "oldest," "latest." Parts and schematics. **SASE** for lists. **STEINMETZ**, 7519 Maplewood Ave., RE, Hammond, IN 46324.

**SURPLUS ELECTRONICS.** New giant wholesale catalog. Hundreds of amazing bargains. \$2. Box 840, Champlain, NY 12919.

## CLASSIFIED AD ORDER FORM

To run your own classified ad, put one word on each of the lines below and send this form along with your check to:

**Radio-Electronics Classified Ads**, 500-B Bi-County Boulevard, Farmingdale, NY 11735

**PLEASE INDICATE** in which category of classified advertising you wish your ad to appear. For special headings, there is a surcharge of **\$25.00**.

( ) Plans/Kits ( ) Business Opportunities ( ) For Sale  
( ) Education/Instruction ( ) Wanted ( ) Satellite Television  
( ) \_\_\_\_\_

Special Category: \$25.00

### PLEASE PRINT EACH WORD SEPARATELY, IN BLOCK LETTERS.

(No refunds or credits for typesetting errors can be made unless you clearly print or type your copy.) Rates indicated are for standard style classified ads only. See below for additional charges for special ads. **Minimum: 15 words.**

1	2	3	4	5
6	7	8	9	10
11	12	13	14	15 (\$46.50)
16 (\$49.60)	17 (\$52.70)	18 (\$55.80)	19 (\$58.90)	20 (\$62.00)
21 (\$65.10)	22 (\$68.20)	23 (\$71.30)	24 (\$74.40)	25 (\$77.50)
26 (\$80.60)	27 (\$83.70)	28 (\$86.80)	29 (\$89.90)	30 (\$93.00)
31 (\$96.10)	32 (\$99.20)	33 (\$102.30)	34 (\$105.40)	35 (\$108.50)

We accept MasterCard and Visa for payment of orders. If you wish to use your credit card to pay for your ad fill in the following additional information (Sorry, no telephone orders can be accepted):

Card Number \_\_\_\_\_ Expiration Date \_\_\_\_\_

Please Print Name \_\_\_\_\_

Signature \_\_\_\_\_

**IF YOU USE A BOX NUMBER YOU MUST INCLUDE YOUR PERMANENT ADDRESS AND PHONE NUMBER FOR OUR FILES. ADS SUBMITTED WITHOUT THIS INFORMATION WILL NOT BE ACCEPTED.**

**CLASSIFIED COMMERCIAL RATE:** (for firms or individuals offering commercial products or services) \$3.10 per word prepaid (no charge for zip code)...**MINIMUM 15 WORDS.** 5% discount for same ad in 6 issues; 10% discount for same ad in 12 issues within one year; if prepaid. **NON-COMMERCIAL RATE:** (for individuals who want to buy or sell a personal item) \$2.50 per word, prepaid...no minimum. **ONLY FIRST WORD AND NAME** set in bold caps at no extra charge. Additional bold face (not available as all caps) **55¢ per word additional.** Entire ad in boldface, \$3.70 per word. **TINT SCREEN BEHIND ENTIRE AD: \$3.85 per word. TINT SCREEN BEHIND ENTIRE AD PLUS ALL BOLD FACE AD: \$4.50 per word. EXPANDED TYPE AD: \$4.70 per word prepaid.** Entire ad in boldface, \$5.60 per word. **TINT SCREEN BEHIND ENTIRE EXPANDED TYPE AD: \$5.90 per word. TINT SCREEN BEHIND ENTIRE EXPANDED TYPE AD PLUS ALL BOLD FACE AD: \$6.80 per word. DISPLAY ADS:** 1" x 2 1/4"—\$385.00; 2" x 2 1/4"—\$770.00; 3" x 2 1/4"—\$1155.00. **General Information:** Frequency rates and prepayment discounts are available. **ALL COPY SUBJECT TO PUBLISHERS APPROVAL. ADVERTISEMENTS USING P.O. BOX ADDRESS WILL NOT BE ACCEPTED UNTIL ADVERTISER SUPPLIES PUBLISHER WITH PERMANENT ADDRESS AND PHONE NUMBER.** Copy to be in our hands on the 10th of the third month preceding the date of the issue. (i.e., Aug. issue copy must be received by May 10th). When normal closing date falls on Saturday, Sunday or Holiday, issue closes on preceding working day. Send for the classified brochure. Circle Number 49 on the Free Information Card.



# CONSOLIDATED ELECTRONICS



**COMPLETE WITH  
NEW PRICE LIST!**

## THE ULTIMATE ELECTRONICS CATALOG

Order your 260 page catalog and price list with over 14,000 money saving electronic parts and equipment! Send \$3.00 in a check or money order, or call 1-800-543-3568 today and use your Mastercard or Visa. Consolidated Electronics, Incorporated  
705 Watervliet Ave., Dayton, Ohio 45420-2599

Name \_\_\_\_\_  
Address \_\_\_\_\_  
City \_\_\_\_\_ State \_\_\_\_\_ Zip \_\_\_\_\_

CIRCLE 70 ON FREE INFORMATION CARD

## FREE CATALOG

FAMOUS "FIRESTIK" BRAND CB ANTENNAS AND ACCESSORIES. QUALITY PRODUCTS FOR THE SERIOUS CB'er. SINCE 1962  
**FIRESTIK ANTENNA COMPANY**  
2614 EAST ADAMS  
PHOENIX, ARIZONA 85034

FEB 87 Triparts \$59.00. Feb 84 SB parts \$49.00. \$3.50 shipping. **OCTE**, Box 276, Alburg, VT 05440. (514) 739-9328.

**MINIATURE** electronics like James Bond. Catalog \$3.00, refundable. **F & P ENTERPRISES**, Box 51272, Palo Alto, CA 94303-L.

**TUBES**, new, up to 90% off. **SASE, KIRBY**, 298 West Carmel Drive, Carmel, IN 46032.

**TOCOM** 5503 V.I.P. descrambler "Turnon" module. "All channels," formats. Simple hookup. "Free schematic." \$39.00. **MIKE**, Box 743, Oldsmar, FL 34677.

**CABLE TV** converters and descramblers. We sell only the best. Low prices. **SB-3** \$79.00. We ship C.O.D. Free catalog. **ACE PRODUCTS**, PO Box 582, Dept. E, Saco, ME 04072. 1 (800) 234-0726.

**SAMS** closeout sale. #2 to #2600 \$6.00 each postpaid. MC/Visa. Call 1 (800) 274-2081. 9-5 CST.

**MEMORY** chips, Simms and Sips: 4164-100 \$2.00, 41256-100 \$2.55, 41464-100 \$3.25. Call **ED/DATAFIX**, (201) 322-7666.

**TUBES** Sylvania 6LQ6, 6L6GC, 20LF6 etc. Huge discounts. **ARLEN SUPPLY**, 7409 West Chester Pike, Upper Darby, PA 19082. 1 (800) 458-1301.

**FINALLY** a digital technology course for everyone! Technicians, supervisors and managers! Free details. **TEKNOLEDGY SOURCES**, RE003, Box 1284, League City, TX 77573.

**DESCRAMBLERS**, Jerrold, Hamlin, Tocom, SA, Zenith, Oak, all remote control. Examples — **RTC-56** \$150.00, **400-DIC** — \$125.00, S.A.C., (702) 647-3799 info. 1 (800) 622-3799 orders.

**TJ SERVICES** is here to serve you! Our quality products, quick courteous service, knowledgeable sales people and rock bottom prices prove it! Not sure what you need? Call (313) 979-8356 we'll help! We specialize in **Jerrold, Hamlin, interference filters** and most **SA** equipment.

## MULTI CHANNEL MICROWAVE ANTENNAS

- CRYSTAL CONTROLLED MICROWAVE ANTENNAS FOR OVER THE AIR CABLE SYSTEMS (WIRELESS CABLE)
- CAPABLE OF RECEIVING 30 CHANNELS
- CONVERTERS AVAILABLE FOR ZENITH SYSTEMS

CATALOG & INFO: (203) 975-7543

## VIDEO-LINK ENTERPRISES

520 GLENBROOK RD., SUITE 202, STAMFORD CT 06906

**CABLE TV** descramblers **M35B**. Top quality. Tested, guaranteed, vari-sync available. Dealers wanted. \$39.00. 1 (800) 648-4600.

**MAKE** the most of your schematics. VCR/Camcorder cross-reference manual for RCA, Wards, Magnavox, Penneys, Sears, Panasonic, and many more. \$19.95 plus \$2.50 postage and handling. **CROSSPULSE IMAGING**, Box 73, Stanton, CA 90680.

**8051** Cross-disassembler, PC/MSDOS, debug/reconstruct source code. Generates labels, Xref lists and ASCII equiv. \$79. Others avail. Write for details. **DATA SYNC ENGINEERING**, Box 288 - Dept. Q, Franklin, NJ 07416.

**DESCRAMBLERS**. — For free catalog contact **CABLE CONNECTION**, 1304 E. Chicago Street, Suite 301, Algonquin, IL 60102. (708)658-2365.

**MICROWAVE** receiver TV commercial crystal controlled 230B antenna and P.S. included. After 1PM EST (718) 257-4472. \$175.00.

# CABLE TV

**TB-3 (Tri-Bi) or SA-3**

Quantity Prices

10	20
<b>\$48.</b> Each	<b>\$43.</b> Each
50	100
<b>\$39.</b> Each	<b>\$35.</b> Each

Hours open 10:00 am to 4:00 pm Eastern time  
Minimum order 5 units 55.00 ea.  
Dealers wanted. We ship COD.

King Wholesale

**1-800-729-0036**  
Fax number 6173400053

"No one beats the King's prices!"

## DESCRAMBLERS

## Employers

Willing workers available now at as little as 1/2 your usual cost.

This is your chance to get help you've needed, but thought you couldn't afford.

No business too large or too small. Call your private industry council or write **National Alliance of Business**, P.O. Box 7207, Washington, D.C. 20044

A Public Service of  
This Publication



## SINGERS! Sing With The World's Best Bands!

The Thompson Vocal Eliminator removes lead vocal from standard stereo records & CD's! Unlimited Supply of Background Music! Easily Record or Perform with the Backgrounds. Used Professionally, yet connects easily to home component stereo. Manufactured and Sold Exclusively by LT Sound. For Free Brochure & Demo Record, Call: **LT Sound**, Dept. RL-1, 7981 LT Parkway, Lithonia, GA 30058 (404)482-4724 24 Hr. Phone Demo/Info Request Line: (404)482-2485

**FREE** trial IBM-PC memory resident speller, like dictionary, \$29.00. For trials, send \$2.00: **SPELLRITE**, PO box 30753, Tucson, AZ 85751.

**CABLE TV**, best SSAVI's, Tocom's and filters in the business. We build all our own equipment, no middleman. Upgrade your SSAVI to a super SSAVI with our PAL kit. Quantity and dealer pricing. We ship COD — call to get on our mailing list. 1 (800) 526-9063. **COPA ELECTRONICS**.

## MICROWAVE TV RECEIVERS 1.9 to 2.7 GHz

	2 CH Compact Dish System - \$77.95
	5 CH Dish System - \$93.95
	12 CH Yagi (Rod) System - \$123.95
	30 CH Dish System - \$163.90 Yagi - \$183.90
	<b>SUN MICROWAVE INT'L. INC.</b> Send \$1 <sup>99</sup> for catalog on these and other fine video products.
	P.O. BOX 34522
	PHOENIX, AZ 85067
	(602) 230-0640
VISA/MC/COD	QUANTITY DISCOUNTS LIFETIME WARRANTY

**RENTAL** movie stabilizer. Connect between VCRs or to monitor. Satisfaction guaranteed. \$69.95, \$4.00 handling. 1 (800) 367-7909.

**TEST** equipment pre-owned now at affordable prices. Signal generators from \$50.00. Oscilloscopes from \$50.00. Other equipment, including manuals available. Send for Catalog. **J.B. ELECTRONICS**, 3446 Dempster, Skokie, IL 60076. (312) 982-1973.







## UNICORN YOUR I.C. SOURCE

### COLLIMATOR PEN



A low power collimator pen containing a MOVPE grown gain guided GaAlAs laser. This collimator pen delivers a maximum CW output power of 2.5 mW at 25 °C.

These collimated laser sources are designed for industrial applications such as data retrieval,

telemetry, alignment etc.

The non-hermetic stainless steel encapsulation of the pen is specifically designed for easy alignment in an optical read or write system, and consists of a lens and a laser device. The lens system collimates the diverging laser light. The wavefront quality is diffraction limited.

The housing is circular and precision manufactured with a diameter of 11.0 mm and an accuracy between + and - 11 μm.

LIST PRICE ~~\$160.00~~ PRICE **\$39.99**

Quality Components — Low Prices Since 1983

### LASER DIODE

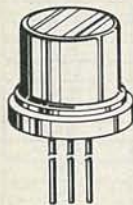

Designed for general industrial low power applications such as reading optical discs, optical memories, bar code scanners, security systems, alignment etc.

The gain guided laser is constructed on a n-type gallium arsenide substrate with a Metal

Organic Vapor Phase Epitaxial process (MOVPE). The device is mounted in an hermetic SOT148D (diameter 9.0 mm) encapsulation.

The SB1053 is standard equipped with a monitor diode, isolated from the case and optically coupled to the rear emitting facet of the laser. This fast responding monitor diode can be used as a sensor to control the laser optical output level.

LIST PRICE ~~\$38.00~~ PRICE **\$9.99**

We Carry A Full Line of Components

CALL FOR FREE CATALOG

### EPROMS

STOCK #	PINS	DESCRIPTION	1-24	25-99	100+
1702	24	256 x 4 1ns	3.99	3.79	3.41
2708	24	1024 x 8 450ns	5.79	5.50	4.95
2758	24	1024 x 8 450ns	3.99	3.79	3.41
2716	24	2048 x 8 450ns (25v)	3.19	3.03	2.73
2716-1	24	2048 x 8 350ns (25v)	3.39	3.22	2.90
TMS2716	24	2048 x 8 450ns	6.29	5.98	5.38
27C15	24	2048 x 8 450ns (25v-CMOS)	3.59	3.41	3.07
2732	24	4096 x 8 450ns (25v)	3.79	3.60	3.24
2732A-2	24	4096 x 8 200ns (21v)	3.79	3.60	3.24
2732A	24	4096 x 8 250ns (21v)	3.69	3.51	3.16
2732A-4	24	4096 x 8 450ns (21v)	3.09	2.94	2.65
TMS2532	24	4096 x 8 450ns (25v)	5.79	5.50	4.95
27C32	24	4096 x 8 450ns (25v-CMOS)	4.19	3.98	3.58
2764-20	28	8192 x 8 200ns (21v)	3.99	3.79	3.41
2764	28	8192 x 8 250ns (21v)	3.59	3.41	3.07
2764A-20	28	8192 x 8 200ns (12.5v)	3.99	3.79	3.41
2764A	28	8192 x 8 250ns (12.5v)	3.59	3.41	3.07
TMS2564	28	8192 x 8 250ns (25v)	6.79	6.45	5.81
27128-20	28	16,384 x 8 200ns (21v)	5.79	5.50	4.95
27128	28	16,384 x 8 250ns (21v)	4.79	4.55	4.10
27C128	28	16,384 x 8 250ns (21v)	5.39	5.12	4.61
27256-20	28	32,768 x 8 200ns (12.5v)	5.99	5.69	5.12
27256	28	32,768 x 8 250ns (12.5v)	4.99	4.74	4.27
27C256	28	32,768 x 8 250ns (12.5v-CMOS)	5.99	5.69	5.12
27512-20	28	65,536 x 8 200ns (12.5v)	10.49	9.97	8.97
27512	28	65,536 x 8 250ns (12.5v)	9.49	9.02	8.12
27C512	28	65,536 x 8 250ns (12.5v-CMOS)	9.99	9.49	8.54
27C1024	32	131,072 x 8 200ns (12.5v-CMOS)	27.99	26.59	23.93
68764	24	8192 x 8 450ns	18.99	18.04	16.24
68766	24	8192 x 8 450ns	15.99	15.19	13.67

### UNICORN ELECTRONICS

10010 Canoga Ave., Unit B-8  
Chatsworth, CA 91311

ORDER BY PHONE (TOLL FREE)

(800) 824-3432 (OUTSIDE CALIFORNIA)

IN CALIFORNIA (818) 341-8833

ORDER BY FAX (818) 998-7975

### ANTIQUE RADIO CLASSIFIED

Free Sample!

Antique Radio's

Largest Circulation Monthly.

Articles, Ads & Classifieds.

6-Month Trial: \$11. 1-Yr: \$20 (\$30-1st Class).

A.R.C., P.O. Box 802-L4, Carlisle, MA 01741



**DETECTION** — Surveillance, debugging, plans, kits, assembled devices. Latest high-tech catalog \$5. **DETECTION SYSTEMS**, 2515 E. Thomas, #16-864F, Phoenix, AZ 85016.

**DESCRAMBLING**, new secret manual. Build your own descramblers for **cable** and **subscription TV**. Instructions, schematics for SSAVI, gated sync, sinewave, (HBO, Cinemax, Showtime, UHF, adult) \$8.95, \$2.00 postage. **CABLETRONICS**, Box 30502R, Bethesda, MD 20824.

**BUILD your own remote controlled robot**, common construction materials, electronic kits, plans \$11.95, free details, **ROBOT WORKS**, Box 1979, Colorado Springs, CO 80901.

**SINGERS**. At last, build your own vocal filter. Remove lead vocals from standard stereo records, CDs, tapes, FM broadcasts, so you can be the lead singer of your favorite band. Schematic/theory \$6.95. PC board \$12.95. Parts also available. **WEEDER TECHNOLOGIES**, 14773 Lindsey, Mt. Orab, OH 45154.



### TUBES - 2000 TYPES DISCOUNT PRICES!

Early, hard-to-find, and modern tubes. Also transformers, capacitors and parts for tube equipment. Send \$2.00 for 24 page wholesale catalog.

### ANTIQUE ELECTRONIC SUPPLY

688 W. First St. • Tempe, AZ 85281 • 602/894-9503

**KITS** Preamplifiers, amplifiers, antenna amplifier, alarm, dice, power meter, VU meter, motion detector, siren, chime, door bell, timers and trainers. Catalog: **ARLI ELECTRONICS**, 2155 Verdugo Blvd. #22, Montrose, CA 91020.

**STRESSED out?** Relaxation technique easily learned with the aid of a simple electronic device. Not hypnosis! Plans \$9.95. **BLUE CHIP ENGINEERING**, Dept. 33, PO Box 1100, Walnut, CA 91789.

**SURVEILLANCE schematics**. Easy to build. Bug detector \$5.00, FM transmitter \$5.00, phone snoop \$5.00, all three \$12.95, \$1.00 postage. **CABLETRONICS**, Box 30502R, Bethesda, MD 20824.

**PC/XT** — Selectively boot from A: or B: drives — 5 1/4" or 3 1/2." Easy to build inexpensive switching device. Plans \$5.00. **REUTER ENGINEERING, INC.** PO Box 24514, Mpls, MN 55424.

**REMOTE controlled car starter**. Start your car from 75' away. Only \$139.95. Remote controlled car alarm with starter interrupt \$129.95. Both kits include hardware and fully illustrated instructions. Prices include shipping. Check or money order. For free information call or write. **DARK GLASS SHIELD**, 1550 West 84 Street, Suite 69-A, Hialeah, FL 33014. (305) 362-1596.

### SATELLITE TV

**FREE catalog** — Do-it-yourself save 40-60%. Lowest prices worldwide, systems, upgrades, parts, all major brands factory fresh and warranted. **SKYVISION**, 2009 Collegeway, Fergus Falls, MN 56537. 1 (800) 334-6455.

**DESCRAMBLER**: Build our low cost **video** only, satellite TV descrambler for most satellite channels. Uses easy to get, everyday parts. Board & plans \$35.00 US funds. Board, plans & parts \$99.00 US funds. Wired & tested unit \$189.00 US funds. Send check, money order or Visa to: **VALLEY MICROWAVE ELECTRONICS**, Bear River, Nova Scotia, Canada B0S 1B0 or phone (902) 467-3577. 8am to 4pm eastern time. Note: educational project only. Not to be used illegally.

**VIDEOCIPHER II** manuals. **Volume 1** — hardware, **Volume 2** — software. Either \$32.45. **Volume 3** — projects/software — \$42.45. **Volume 4** — repair — \$97.45. **Volume 5** documentation — \$42.45. **Cable Hacker's Bible** — \$32.45. **Clone Hacker's Bible** — \$32.95 CODs: (602) 782-2316. 220+ Megabytes IBM-PC/XT software — catalog \$3.00. **TELECODE**, Box 6426-RE, Yuma, AZ 85366-6426.

**ATLANTIC GROUP ENTERPRISES INC.** Buy satellite equipment. Dealing directly with the seller. We can show you how. Toll free 1 (800) 446-4039.

**VIDEOCIPHER II descrambling manual**. Schematics, video and audio. Explains DES, EPROM, CloneMaster, 3Musketeer, pay-per-view (HBO, Cinemax, Showtime, adult, etc.) \$13.95, \$2.00 postage. Collection of software to copy and alter EPROM codes, \$25. **CABLETRONICS**, Box 30502R, Bethesda, MD 20824.

## CABLE RENTERS STOP!

If you currently renting your cable equipment it's time to look into owning your own. You can save up to \$100 plus every year. Satisfaction Guaranteed.

We carry all the major brands of Converters, Remote controls and Descramblers. **JERROLD, OAK ZENITH, EAGLE, HAMLIN, SCIENTIFIC ATLANTA**. Many more. Fast courteous service.

Call today 512-250-8816 or write for your Free catalog.

VISA Order  
M/C Toll Free **1-800-228-7404**  
C.O.D.

Nu-Tek Electronic 5114 Balcones Woods dr  
Suite#307 Dept.298R Austin, Tx 78759

### TELEPHONE CALL SCREENING

**REAL telephone call screening!** Protect telephones, Fax, computer, hearing impaired, day sleepers. Eliminate wrong numbers, prank and sales calls. Plugin unit provides variable ring cadence signaling. True unlisted number on any touchtone private line. Automatic call routing. Send \$13.95 for complete theory and construction manual. **ELECTRONIC CONTROL SYSTEMS, R.D. 2 Box 3308, Wernersville, PA 19565.**

### PROJECT CABINETS/ ENCLOSURES

**RIGID 1/16** aluminum shell, hardwood trim, contemporary styling. Several sizes and styles available. \$10.99 — \$26.99, free brochures. **PYRAMID ELECTRONIC PRODUCTS**, 15020 LaGrange Road, Suite 2100, Orland Park, IL 60462.

### BUSINESS OPPORTUNITIES

**EASY work!** Excellent pay! Assemble products at home. Call for information. (504) 641-8003 Ext. 5192.

**MAKE \$50/hr** working evenings or weekends in your own electronics business. Send for free facts. **INDUSTRY**, Box 531, Bronx, NY 10461.

## CABLE TV DESCRAMBLER LIQUIDATION!

- Major Makes & Models!
- Will match or beat anyone's prices!
- Dealer discounts at 5 units!
- Examples:  
HAMLIN COMBOS . . . \$44 ea. (Min. 5)  
OAK ADD/ON . . . . \$40 ea. (Min. 5)  
OAK M35B . . . . . \$60 ea. (Min. 5)

### WEST COAST ELECTRONICS

For Information: 818-709-1758

Catalogs & Orders: 800-628-9656



**YOUR own radio station!** AM, FM, TV, cable. Licensed/unlicensed. **BROADCASTING**, Box 130-F3, Paradise, CA 95967.

**INVENTIONS**, ideas, technology wanted for presentation to industry/exhibition at national innovation exposition. Call **1 (800) 288-IDEA**.

**LET** the government finance your small business. Grants/loans to \$500,000. Free recorded message: **(707) 449-8600. (KS1)**.

**LEARN** gold, silver, platinum scrap recycling business. Free information. Write: **RECYCLING**, Box 11216RT, Reno, NV 89510-1216.

**3D color camera.** Life-like pictures. No special glasses needed. \$3.00 sample photo. **Distributors wanted.** **CHECKMATE COMMUNICATIONS**, PO Box 11-0808, Brooklyn, NY 11211.

**FREE CATALOG!**  
**1-800-648-7938**  
 For all information 1-702-362-9026  
**JERROLD HAMLIN OAK ETC.**  
**CABLE TV**  
**DESCRAMBLERS**  
 • Compare our low Low Retail Prices!  
 • Guaranteed Prices & Warranties!  
 • Orders Shipped Immediately!  
**REPUBLIC CABLE PRODUCTS INC.**  
 4080 Paradise Rd. #15 Dept. RE-90  
 Las Vegas, NV 89109

**MASTERCARD AND VISA** are now accepted for payment of your advertising. Simply complete the form on the first page of the Market Center and we will bill.

**General Technics**  
 Quality Computer Systems  
**(516) 981-9473**  
 Save hundreds of dollars assembling your own IBM XT, AT, or 386 compatible computer  
**Complete AT Computer System \$675**  
 Amber Monitor, 512k Memory, 101 Enhanced Keyboard, 1.2m Floppy Drive  
 12 mhz 80286 Mother Board, Hard/Floppy Controller Card, Instruction Manual  
**FREE CATALOG**  
 P.O. Box 2676, Lake Ronkonkoma, NY 11779

**SOFTWARE**  
**FREE software** for IBM and compatibles! Info \$1.00. **BLUE CHIP ENGINEERING**, Dept. 33, PO Box 1100, Walnut, CA 91789.

**COMPUTER BOOKS**  
**DISCOUNT computer books.** All titles available, including recent releases. Please call or write for our latest catalog. **BOOKWARE**, 147 Campville Road, Northfield, CT 06778. 1 (800) 288-5662.

**INVENTORS**  
**INVENTORS!** Can you patent and profit from your idea? Call **AMERICAN INVENTORS CORPORATION** for free information. Over a decade of service 1 (800) 338-5656. In Massachusetts or Canada call (413) 568-3753.

**DIGITAL CAR DASHBOARDS**  
**BUILD** yourself complete electronic dashboards. Informational package: \$2.00 (refundable). **MODERN LABS**, 2900-F Ruisseau, Saint-Elizabeth, QC, J0K 2J0, Canada.

**ASSEMBLE YOUR OWN COMPUTER FOR LESS**

- 10 Mhz 8088 Compatible Kit .....\$379**  
 ● 4.77/10 Mhz 8088 Motherboard  
 ● 256KB RAM (640KB max)  
 ● 150W Power Supply  
 ● Floppy Disk Controller  
 ● One 5 1/4" 360KB Drive  
 ● MonoGraphics Card w/ P  
 ● 101 Key Keyboard  
 ● Case (3LED,2Button,Key)  
 ● 12" Amber Mono Monitor  
 ● Installation Guide & Manual
- 12 Mhz 80286 Compatible Kit .....\$669**  
 ● 12 Mhz 80286 Motherboard  
 ● 512 KB RAM (4 MB max)  
 ● 200W Power Supply  
 ● Floppy Disk Controller  
 ● One 5 1/4" 1.2 MB Drive  
 ● MonoGraphics Card w/ P  
 ● 101 Key Keyboard  
 ● Case (3LED,2Button,Key)  
 ● 12" Amber Mono Monitor  
 ● Installation Guide & Manual



**20 Mhz 80386 Compatible Kit .....\$1399**  
 All Components Fully Tested Before Ship  
 One Year Warranty on All Parts  
 Installation Available at No Extra Charge !!!  
 VISA & M/C add 3% Amex add 4%  
 Price & Quantity subject to change without prior notice  
 15% Restocking Fee on All Non-Defective Items

**JINCO COMPUTERS INC.**  
 5122 WALNUT GROVE AVE.  
 SAN GABRIEL, CA 91776  
**Tel: (818) 309-1108**  
**Fax: (818) 309-1107**  
 CIRCLE 182 ON FREE INFORMATION CARD



**I See A Bright Future For You!**

If you had a crystal ball, you could gaze into it and immediately see why MCM should be your electronic parts and components supplier. Here are a few great reasons to think about...

- QUALITY** — Only the best performing products make it into our catalog.
- VALUE** — We offer some of the most competitive prices in the industry.
- SELECTION** — Choose from over 15,000 in-stock items in 30 major categories.
- CONVENIENCE** — Our TOLL-FREE phone lines and liberal terms make doing business with MCM a genuine pleasure.
- SERVICE** — We could fill a book with examples of our exceptional service. But instead, send for your FREE Catalog today and let us earn your business!

**For a FREE, ONE-YEAR SUBSCRIPTION to the MCM Electronics Catalog, Call TOLL-FREE 1-800-543-4330**

**mcm** **MCM ELECTRONICS**  
 650 CONGRESS PARK DR.  
 CENTERVILLE, OH 45459-4072  
 A PREMIER Company

CIRCLE 87 ON FREE INFORMATION CARD







# ANNOUNCING . . .

## WORLD'S FIRST High Performance Universal Counter Timer Module/Panel Meter

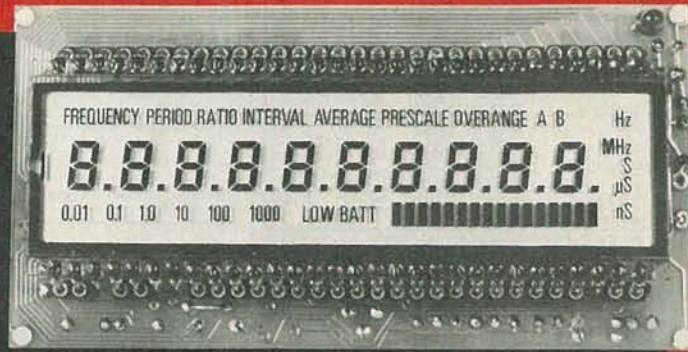

ACTUAL SIZE

### INTRODUCTORY PRICING

Quantity	Price
1-10	189.00
11-99	159.00
100 +	129.00

Engineering Evaluation Kit \$250.00

## OPTOELECTRONICS INC.

5821 N.E. 14th Avenue • Fort Lauderdale, Florida 33334  
(800) 327-5912 • FL (305) 771-2050 • FAX (305) 771-2052

- 10 Digit (120 Segment) LCD Display with Gate, Function, and Input Annunciators.
- 1 Hz to Over 150 MHz Direct Count (1 Hz resolution in 1 Sec)
- Single Shot Time Interval 100 ns, 1 ns averaged.
- Functions Include: Frequency, Period, Ratio, and Time Interval and Average.
- 16 Segment Analog Input Bargraph is driven by an 8 Bit A to D and Can Be Used for Signal Level Display.
- Low Power (250 mw) with Single 5v Supply.
- High Accuracy, 1 ppm 10 MHz Crystal Time Base with Cal Adjust on Board.
- Economical to Use in Custom OEM Applications.

CIRCLE 190 ON FREE INFORMATION CARD

### EDUCATION & INSTRUCTION

**MAGIC!** Four illustrated lessons plus inside information shows you how. We provide almost 50 tricks including equipment for four professional effects. You get a binder to keep the materials in, and a one-year membership in the International Performing Magicians with a plastic membership card that has your name gold-embossed. You get a one-year subscription to our quarterly newsletter "IT'S MAGIC!" Order now! \$29.95 for each course + \$3.50 postage and handling. (New York residents add applicable state and local sales tax). **THE MAGIC COURSE**, 500-B BiCounty Boulevard, Farmingdale, NY 11735.

### GET IN NOW ON THE \$12 BILLION A YEAR COMPUTER SERVICE INDUSTRY

EARN UP TO 45/HR!

### LEARN HOW TO CLEAN/ MAINTAIN/REPAIR PRINTERS...

VIEJO'S AWARD-WINNING TRAINING VIDEO AND COMPANION TRAINING MANUAL (OVER 300 ACTION-PACKED PAGES) REVEALS SECRETS OF PRINTER REPAIR... WITH YOUR AVERAGE MECHANICAL ABILITY WE CAN SHOW YOU HOW TO REPAIR UP TO 95% OF ALL PRINTERS - START EARNING EXTRA CASH IN DAYS!

• SERIOUS LACK OF TRAINED TECHNICIANS  
• HUGE UNTAPPED MARKET!  
OVER 37 MILLION PCs IN USE... APPROXIMATELY 95% HAVE A PRINTER ATTACHED... VAST MAJORITY OF PRINTER BREAKDOWNS ARE DUE TO SIMPLE MECHANICAL OR ELECTRO-MECHANICAL FAILURE.



FREE INFO OR WRITE TO: VIEJO PUBLICATIONS  
3540 WILSHIRE BL. # 310  
DEPT. RE2, L.A. CA 90010

CALL 1-800-537-0589

LEARN IBM PC assembly language. 80 sample programs. Disk \$5. Book \$18. ZIPFAST, Box 12238, Lexington, KY 40581-2238.

INSTALL your own car stereo! Professional secrets to buying, installing, troubleshooting. Complete guide only \$8.00. WAYNE GIPSON, 1415 Broadway, Parsons, KS 67357.

**NUTS & VOLTS** MAGAZINE P.O. Box 1111-E  
Piscenia, CA 92670  
714-632-7721

GIVE YOURSELF A BREAK - A PRICE BREAK!  
NUTS & VOLTS WILL SAVE YOU MONEY  
ON ELECTRONIC PARTS & EQUIPMENT  
PLUS SHOW YOU WHERE TO FIND UNIQUE,  
UNUSUAL AND HARD-TO-FIND ITEMS.  
SUBSCRIBE TODAY!

Subscription Rates  
U.S. FUNDS REQUIRED.  
2nd Class Mail-USA  
One Year \$12.00  
Two Years \$21.00  
Lifetime \$50.00  
Tax Class Mail  
One Year USA \$20.00  
CANADA/MEXICO \$22.00  
Airmail  
Foreign 1 Yr. \$55.00

Orders Only 800-783-4624

A National Publication For The Buying And Selling Of Electronic Equipment

### WANTED

**INVENTIONS/new products/ideas wanted:** Call TLCI for free information 1 (800) 468-7200 24 hours/day - USA/Canada.

**INVENTORS! Confused? Need help? Call IMPAC** for Free information package. In US and Canada: 1 (800) 225-5800.

**SEISMOMETER** wanted to measure earthquakes. Pay cash. D. HUTCHISON, 4000 Little Timber, Edmond, OK 73034. (405) 341-9615.

\*\*\*\*\*PRESENTING\*\*\*\*\*  
**CABLE TV  
DESCRAMBLERS**  
\*\*\*\*\*STARRING\*\*\*\*\*  
**JERROLD, HAMLIN, OAK**  
AND OTHER FAMOUS MANUFACTURERS

- FINEST WARRANTY PROGRAM AVAILABLE
- LOWEST RETAIL/WHOLESALE PRICES IN U.S.
- ORDERS SHIPPED FROM STOCK WITHIN 24 HOURS

FOR FREE CATALOG ONLY **1-800-345-8927**  
FOR ALL INFORMATION 1-818-716-5914

**PACIFIC CABLE CO. INC.**  
7325 W. RESEDA BLVD., DEPT. RE1 89  
RESEDA, CA 91335

## 3 FOR 1 SPECIAL

ON SUB-MINIATURE VOICE FM TRANSMITTERS.  
KITS CONTAIN PC BOARDS



\***FMX-1 LONG RANGE (3 MI) ULTRA SENSITIVE FM VOICE XMTR** with fine tune, range control plus.....\$29.50



\***TELX-1 TELEPHONE FM XMTR (3 MI)** automatically operates when phone is used. Crystal clear clarity with fine tune and range control. Non detectable.....\$29.50



\***ATR-1 AUTOMATIC TELEPHONE RECORDING DEVICE** tapes telephone conversation all automatically.....\$19.50

ALL THREE OF ABOVE FOR.....\$59.50

CALL OR SEND VISA, MASTER CHARGE, MONEY ORDER, ETC. TO **AMAZING CONCEPTS**, BOX 716, AMHERST, NH 03031. (603) 673-4730.

MARCH 1990



# CABLE TV DESCRAMBLERS

JERROLD™ Tri-Bi Mode	\$105.00	10 Lot \$85.00
JERROLD™ SB-3 OR 2	\$89.00	\$65.00
Hamlin ML-D1200	\$99.95	\$62.00
Oak N-12 W/V.S.	\$99.95	\$62.00
Oak M-35-B W/V.S.	\$99.00	\$78.00
OAK E-13	\$99.95	\$58.00
Zenith SSAVI	\$185.00	\$145.00
Eagle PD-3	\$120.00	\$85.00
Scientific Atlanta	\$129.95	\$105.00
SA-Combo's	CALL	\$Call
Tocom	\$350.00	\$295.00
Oak N-12 W/ Auto	\$140.00	\$105.00
Jerrold Starcom CSV	\$139.95	Call

**M.D. ELECTRONICS**  
**WILL MATCH ANY**  
**ADVERTISED PRICE**  
**IN THIS MAGAZINE**

## \*NEW STARGATE 2000 CABLE CONVERTER



1-\$89.00 10-\$69.00 100-Call

Last channel recall-Favorite channel select-75 channel-Channel scan-Manual fine tune-One year warranty-surge protection-HRC & Standard switchable-and much more. **Call Today!**

## INFORMATION(402)554-0417

Orders Call Toll Free  
**1-800-624-1150**

**M.D. ELECTRONICS**  
**115 NEW YORK MALL**  
**SUITE 133E**  
**OMAHA, NE. 68114**



CIRCLE 53 ON FREE INFORMATION CARD

# BEST BY MAIL

Rates: Write National, Box 5, Sarasota, FL 34230  
**HAWAIIAN DESIGNS! CATALOG \$3.00.** "Tiki", Box 3249, Milliani, HI 96789.

## FINANCIAL

**HAVING CREDIT PROBLEMS?** For our National Credit Guide rush \$27.95 to: DM Manuals, 3377 Wilshire Blvd., Dept. 1022, Los Angeles, CA 90010. 30 Days Money Back Guarantee!

**NEED CREDIT? \$1,500 + Gold Card.** No deposit. No turn-downs. Visa available. 1(602)420-1486.

**EARN \$2,000 PER 1,000 envelopes** you process at home. Easy plan. Free information send self-addressed stamped envelope: Lincoln Enterprises, POB 752209, Houston, TX 77275-2209.

# CABLE TV "BOXES"

Converters — Descramblers  
Remote Controls — Accessories

- ★ Guaranteed Best Prices ★
- ★ 1 Year Warranty — C.O.D. ★
- ★ Immediate Shipping ★
- ★ FREE CATALOG ★

## TRANS-WORLD CABLE CO.

12062 Southwest 117th Court, Suite 126  
Miami, Florida 33186  
1-800-442-9333



**MASTERCARD AND VISA** are now accepted for payment of your advertising. Simply complete the form on the first page of the Market Center and we will bill.

# CABLE TV CONVERTERS

WHY PAY A HIGH MONTHLY FEE?



All Jerrold, Oak, Hamlin, Zenith, Scientific Atlanta, Magnavox and all specialized cable equipment available for shipment within 24 hours. For fast service MC / VISA or C.O.D. telephone orders accepted (800) 648-3030 60 Day Guarantee (Quantity Discounts) 8 A.M. to 5 P.M. C.S.T. **CLOSED WEEK-ENDS.** Send self-addressed Stamped envelope (60¢ postage) for Catalog.

**MIDWEST ELECTRONICS INC.**  
 P.O. Box 5000  
 Suite 311 (R)  
 Carpentersville, IL 60110

No Illinois Orders Accepted.

# GET OUT OF THE DARK.

The Consumer Information Catalog will enlighten you with helpful consumer information. It's free by writing—

**Consumer Information Center**  
 Dept. TD, Pueblo, Colorado 81009

<b>V20-8</b> 14.95 8080A 2.75 280A CPU 1.75 280B CPU 3.75 280A CTC 1.95 280A DART 5.25 280A DMT 5.50 280A PFD 1.95 280A S10 5.50 280B S10 9.95 82C43 2.75 AM12901 4.00 6502 3.25 8222 3.50 6800 1.75 6802 4.50 6803L 8.00 6809 5.50 6810 1.75 6821 1.75 6845 4.50 6850 1.75 8031AH 3.00 8035 1.75 8048 5.00 8049 2.50 8085A 2.75 MS16450 12.95 6800X12 19.95 68881 95.00	<b>14.95 CPU's &amp; CHIPS</b> 8088 8.00 21102-3 30.00 2016 1.95 2101A-4 1.50 2111A 1.75 2121-1 1.95 2121-2 1.00 2121-3 1.00 2121-4 1.00 2121-5 1.00 2121-6 1.00 2121-7 1.00 2121-8 1.00 2121-9 1.00 2121-10 1.00 2121-11 1.00 2121-12 1.00 2121-13 1.00 2121-14 1.00 2121-15 1.00 2121-16 1.00 2121-17 1.00 2121-18 1.00 2121-19 1.00 2121-20 1.00 2121-21 1.00 2121-22 1.00 2121-23 1.00 2121-24 1.00 2121-25 1.00 2121-26 1.00 2121-27 1.00 2121-28 1.00 2121-29 1.00 2121-30 1.00	<b>RAM's</b> 5M4000A-12 30.00 5M4000B-12 30.00 5M4000C-12 30.00 5M4000D-12 30.00 5M4000E-12 30.00 5M4000F-12 30.00 5M4000G-12 30.00 5M4000H-12 30.00 5M4000I-12 30.00 5M4000J-12 30.00 5M4000K-12 30.00 5M4000L-12 30.00 5M4000M-12 30.00 5M4000N-12 30.00 5M4000O-12 30.00 5M4000P-12 30.00 5M4000Q-12 30.00 5M4000R-12 30.00 5M4000S-12 30.00 5M4000T-12 30.00 5M4000U-12 30.00 5M4000V-12 30.00 5M4000W-12 30.00 5M4000X-12 30.00 5M4000Y-12 30.00 5M4000Z-12 30.00	<b>TRANSISTOR SPECIAL</b> TIP 318 NPN SI TO-220 \$ .40 TIP 328 PNP SI TO-220 \$ .40 TIP 34 PNP SI \$ .95 TIP 111 \$ .50 TIP 122 NPN SI U84 \$ .50 TIP 141 NPN SI U91 \$ .50 TIP 145 \$ .35 2N1307 PNP GE TO-5 \$ .40 2N2906 PNP SI TO-18 \$ .35 2N2907 PNP SI TO-18 \$ .35 2N2908 PNP SI TO-18 \$ .35 2N2909 PNP SI TO-18 \$ .35 2N2910 PNP SI TO-18 \$ .35 2N2911 PNP SI TO-18 \$ .35 2N2912 PNP SI TO-18 \$ .35 2N2913 PNP SI TO-18 \$ .35 2N2914 PNP SI TO-18 \$ .35 2N2915 PNP SI TO-18 \$ .35 2N2916 PNP SI TO-18 \$ .35 2N2917 PNP SI TO-18 \$ .35 2N2918 PNP SI TO-18 \$ .35 2N2919 PNP SI TO-18 \$ .35 2N2920 PNP SI TO-18 \$ .35 2N2921 PNP SI TO-18 \$ .35 2N2922 PNP SI TO-18 \$ .35 2N2923 PNP SI TO-18 \$ .35 2N2924 PNP SI TO-18 \$ .35 2N2925 PNP SI TO-18 \$ .35 2N2926 PNP SI TO-18 \$ .35 2N2927 PNP SI TO-18 \$ .35 2N2928 PNP SI TO-18 \$ .35 2N2929 PNP SI TO-18 \$ .35 2N2930 PNP SI TO-18 \$ .35 2N2931 PNP SI TO-18 \$ .35 2N2932 PNP SI TO-18 \$ .35 2N2933 PNP SI TO-18 \$ .35 2N2934 PNP SI TO-18 \$ .35 2N2935 PNP SI TO-18 \$ .35 2N2936 PNP SI TO-18 \$ .35 2N2937 PNP SI TO-18 \$ .35 2N2938 PNP SI TO-18 \$ .35 2N2939 PNP SI TO-18 \$ .35 2N2940 PNP SI TO-18 \$ .35 2N2941 PNP SI TO-18 \$ .35 2N2942 PNP SI TO-18 \$ .35 2N2943 PNP SI TO-18 \$ .35 2N2944 PNP SI TO-18 \$ .35 2N2945 PNP SI TO-18 \$ .35 2N2946 PNP SI TO-18 \$ .35 2N2947 PNP SI TO-18 \$ .35 2N2948 PNP SI TO-18 \$ .35 2N2949 PNP SI TO-18 \$ .35 2N2950 PNP SI TO-18 \$ .35 2N2951 PNP SI TO-18 \$ .35 2N2952 PNP SI TO-18 \$ .35 2N2953 PNP SI TO-18 \$ .35 2N2954 PNP SI TO-18 \$ .35 2N2955 PNP SI TO-18 \$ .35 2N2956 PNP SI TO-18 \$ .35 2N2957 PNP SI TO-18 \$ .35 2N2958 PNP SI TO-18 \$ .35 2N2959 PNP SI TO-18 \$ .35 2N2960 PNP SI TO-18 \$ .35 2N2961 PNP SI TO-18 \$ .35 2N2962 PNP SI TO-18 \$ .35 2N2963 PNP SI TO-18 \$ .35 2N2964 PNP SI TO-18 \$ .35 2N2965 PNP SI TO-18 \$ .35 2N2966 PNP SI TO-18 \$ .35 2N2967 PNP SI TO-18 \$ .35 2N2968 PNP SI TO-18 \$ .35 2N2969 PNP SI TO-18 \$ .35 2N2970 PNP SI TO-18 \$ .35 2N2971 PNP SI TO-18 \$ .35 2N2972 PNP SI TO-18 \$ .35 2N2973 PNP SI TO-18 \$ .35 2N2974 PNP SI TO-18 \$ .35 2N2975 PNP SI TO-18 \$ .35 2N2976 PNP SI TO-18 \$ .35 2N2977 PNP SI TO-18 \$ .35 2N2978 PNP SI TO-18 \$ .35 2N2979 PNP SI TO-18 \$ .35 2N2980 PNP SI TO-18 \$ .35 2N2981 PNP SI TO-18 \$ .35 2N2982 PNP SI TO-18 \$ .35 2N2983 PNP SI TO-18 \$ .35 2N2984 PNP SI TO-18 \$ .35 2N2985 PNP SI TO-18 \$ .35 2N2986 PNP SI TO-18 \$ .35 2N2987 PNP SI TO-18 \$ .35 2N2988 PNP SI TO-18 \$ .35 2N2989 PNP SI TO-18 \$ .35 2N2990 PNP SI TO-18 \$ .35 2N2991 PNP SI TO-18 \$ .35 2N2992 PNP SI TO-18 \$ .35 2N2993 PNP SI TO-18 \$ .35 2N2994 PNP SI TO-18 \$ .35 2N2995 PNP SI TO-18 \$ .35 2N2996 PNP SI TO-18 \$ .35 2N2997 PNP SI TO-18 \$ .35 2N2998 PNP SI TO-18 \$ .35 2N2999 PNP SI TO-18 \$ .35 2N3000 PNP SI TO-18 \$ .35 2N3001 PNP SI TO-18 \$ .35 2N3002 PNP SI TO-18 \$ .35 2N3003 PNP SI TO-18 \$ .35 2N3004 PNP SI TO-18 \$ .35 2N3005 PNP SI TO-18 \$ .35 2N3006 PNP SI TO-18 \$ .35 2N3007 PNP SI TO-18 \$ .35 2N3008 PNP SI TO-18 \$ .35 2N3009 PNP SI TO-18 \$ .35 2N3010 PNP SI TO-18 \$ .35 2N3011 PNP SI TO-18 \$ .35 2N3012 PNP SI TO-18 \$ .35 2N3013 PNP SI TO-18 \$ .35 2N3014 PNP SI TO-18 \$ .35 2N3015 PNP SI TO-18 \$ .35 2N3016 PNP SI TO-18 \$ .35 2N3017 PNP SI TO-18 \$ .35 2N3018 PNP SI TO-18 \$ .35 2N3019 PNP SI TO-18 \$ .35 2N3020 PNP SI TO-18 \$ .35 2N3021 PNP SI TO-18 \$ .35 2N3022 PNP SI TO-18 \$ .35 2N3023 PNP SI TO-18 \$ .35 2N3024 PNP SI TO-18 \$ .35 2N3025 PNP SI TO-18 \$ .35 2N3026 PNP SI TO-18 \$ .35 2N3027 PNP SI TO-18 \$ .35 2N3028 PNP SI TO-18 \$ .35 2N3029 PNP SI TO-18 \$ .35 2N3030 PNP SI TO-18 \$ .35 2N3031 PNP SI TO-18 \$ .35 2N3032 PNP SI TO-18 \$ .35 2N3033 PNP SI TO-18 \$ .35 2N3034 PNP SI TO-18 \$ .35 2N3035 PNP SI TO-18 \$ .35 2N3036 PNP SI TO-18 \$ .35 2N3037 PNP SI TO-18 \$ .35 2N3038 PNP SI TO-18 \$ .35 2N3039 PNP SI TO-18 \$ .35 2N3040 PNP SI TO-18 \$ .35 2N3041 PNP SI TO-18 \$ .35 2N3042 PNP SI TO-18 \$ .35 2N3043 PNP SI TO-18 \$ .35 2N3044 PNP SI TO-18 \$ .35 2N3045 PNP SI TO-18 \$ .35 2N3046 PNP SI TO-18 \$ .35 2N3047 PNP SI TO-18 \$ .35 2N3048 PNP SI TO-18 \$ .35 2N3049 PNP SI TO-18 \$ .35 2N3050 PNP SI TO-18 \$ .35 2N3051 PNP SI TO-18 \$ .35 2N3052 PNP SI TO-18 \$ .35 2N3053 PNP SI TO-18 \$ .35 2N3054 PNP SI TO-18 \$ .35 2N3055 PNP SI TO-18 \$ .35 2N3056 PNP SI TO-18 \$ .35 2N3057 PNP SI TO-18 \$ .35 2N3058 PNP SI TO-18 \$ .35 2N3059 PNP SI TO-18 \$ .35 2N3060 PNP SI TO-18 \$ .35 2N3061 PNP SI TO-18 \$ .35 2N3062 PNP SI TO-18 \$ .35 2N3063 PNP SI TO-18 \$ .35 2N3064 PNP SI TO-18 \$ .35 2N3065 PNP SI TO-18 \$ .35 2N3066 PNP SI TO-18 \$ .35 2N3067 PNP SI TO-18 \$ .35 2N3068 PNP SI TO-18 \$ .35 2N3069 PNP SI TO-18 \$ .35 2N3070 PNP SI TO-18 \$ .35 2N3071 PNP SI TO-18 \$ .35 2N3072 PNP SI TO-18 \$ .35 2N3073 PNP SI TO-18 \$ .35 2N3074 PNP SI TO-18 \$ .35 2N3075 PNP SI TO-18 \$ .35 2N3076 PNP SI TO-18 \$ .35 2N3077 PNP SI TO-18 \$ .35 2N3078 PNP SI TO-18 \$ .35 2N3079 PNP SI TO-18 \$ .35 2N3080 PNP SI TO-18 \$ .35 2N3081 PNP SI TO-18 \$ .35 2N3082 PNP SI TO-18 \$ .35 2N3083 PNP SI TO-18 \$ .35 2N3084 PNP SI TO-18 \$ .35 2N3085 PNP SI TO-18 \$ .35 2N3086 PNP SI TO-18 \$ .35 2N3087 PNP SI TO-18 \$ .35 2N3088 PNP SI TO-18 \$ .35 2N3089 PNP SI TO-18 \$ .35 2N3090 PNP SI TO-18 \$ .35 2N3091 PNP SI TO-18 \$ .35 2N3092 PNP SI TO-18 \$ .35 2N3093 PNP SI TO-18 \$ .35 2N3094 PNP SI TO-18 \$ .35 2N3095 PNP SI TO-18 \$ .35 2N3096 PNP SI TO-18 \$ .35 2N3097 PNP SI TO-18 \$ .35 2N3098 PNP SI TO-18 \$ .35 2N3099 PNP SI TO-18 \$ .35 2N3100 PNP SI TO-18 \$ .35 2N3101 PNP SI TO-18 \$ .35 2N3102 PNP SI TO-18 \$ .35 2N3103 PNP SI TO-18 \$ .35 2N3104 PNP SI TO-18 \$ .35 2N3105 PNP SI TO-18 \$ .35 2N3106 PNP SI TO-18 \$ .35 2N3107 PNP SI TO-18 \$ .35 2N3108 PNP SI TO-18 \$ .35 2N3109 PNP SI TO-18 \$ .35 2N3110 PNP SI TO-18 \$ .35 2N3111 PNP SI TO-18 \$ .35 2N3112 PNP SI TO-18 \$ .35 2N3113 PNP SI TO-18 \$ .35 2N3114 PNP SI TO-18 \$ .35 2N3115 PNP SI TO-18 \$ .35 2N3116 PNP SI TO-18 \$ .35 2N3117 PNP SI TO-18 \$ .35 2N3118 PNP SI TO-18 \$ .35 2N3119 PNP SI TO-18 \$ .35 2N3120 PNP SI TO-18 \$ .35 2N3121 PNP SI TO-18 \$ .35 2N3122 PNP SI TO-18 \$ .35 2N3123 PNP SI TO-18 \$ .35 2N3124 PNP SI TO-18 \$ .35 2N3125 PNP SI TO-18 \$ .35 2N3126 PNP SI TO-18 \$ .35 2N3127 PNP SI TO-18 \$ .35 2N3128 PNP SI TO-18 \$ .35 2N3129 PNP SI TO-18 \$ .35 2N3130 PNP SI TO-18 \$ .35 2N3131 PNP SI TO-18 \$ .35 2N3132 PNP SI TO-18 \$ .35 2N3133 PNP SI TO-18 \$ .35 2N3134 PNP SI TO-18 \$ .35 2N3135 PNP SI TO-18 \$ .35 2N3136 PNP SI TO-18 \$ .35 2N3137 PNP SI TO-18 \$ .35 2N3138 PNP SI TO-18 \$ .35 2N3139 PNP SI TO-18 \$ .35 2N3140 PNP SI TO-18 \$ .35 2N3141 PNP SI TO-18 \$ .35 2N3142 PNP SI TO-18 \$ .35 2N3143 PNP SI TO-18 \$ .35 2N3144 PNP SI TO-18 \$ .35 2N3145 PNP SI TO-18 \$ .35 2N3146 PNP SI TO-18 \$ .35 2N3147 PNP SI TO-18 \$ .35 2N3148 PNP SI TO-18 \$ .35 2N3149 PNP SI TO-18 \$ .35 2N3150 PNP SI TO-18 \$ .35 2N3151 PNP SI TO-18 \$ .35 2N3152 PNP SI TO-18 \$ .35 2N3153 PNP SI TO-18 \$ .35 2N3154 PNP SI TO-18 \$ .35 2N3155 PNP SI TO-18 \$ .35 2N3156 PNP SI TO-18 \$ .35 2N3157 PNP SI TO-18 \$ .35 2N3158 PNP SI TO-18 \$ .35 2N3159 PNP SI TO-18 \$ .35 2N3160 PNP SI TO-18 \$ .35 2N3161 PNP SI TO-18 \$ .35 2N3162 PNP SI TO-18 \$ .35 2N3163 PNP SI TO-18 \$ .35 2N3164 PNP SI TO-18 \$ .35 2N3165 PNP SI TO-18 \$ .35 2N3166 PNP SI TO-18 \$ .35 2N3167 PNP SI TO-18 \$ .35 2N3168 PNP SI TO-18 \$ .35 2N3169 PNP SI TO-18 \$ .35 2N3170 PNP SI TO-18 \$ .35 2N3171 PNP SI TO-18 \$ .35 2N3172 PNP SI TO-18 \$ .35 2N3173 PNP SI TO-18 \$ .35 2N3174 PNP SI TO-18 \$ .35 2N3175 PNP SI TO-18 \$ .35 2N3176 PNP SI TO-18 \$ .35 2N3177 PNP SI TO-18 \$ .35 2N3178 PNP SI TO-18 \$ .35 2N3179 PNP SI TO-18 \$ .35 2N3180 PNP SI TO-18 \$ .35 2N3181 PNP SI TO-18 \$ .35 2N3182 PNP SI TO-18 \$ .35 2N3183 PNP SI TO-18 \$ .35 2N3184 PNP SI TO-18 \$ .35 2N3185 PNP SI TO-18 \$ .35 2N3186 PNP SI TO-18 \$ .35 2N3187 PNP SI TO-18 \$ .35 2N3188 PNP SI TO-18 \$ .35 2N3189 PNP SI TO-18 \$ .35 2N3190 PNP SI TO-18 \$ .35 2N3191 PNP SI TO-18 \$ .35 2N3192 PNP SI TO-18 \$ .35 2N3193 PNP SI TO-18 \$ .35 2N3194 PNP SI TO-18 \$ .35 2N3195 PNP SI TO-18 \$ .35 2N3196 PNP SI TO-18 \$ .35 2N3197 PNP SI TO-18 \$ .35 2N3198 PNP SI TO-18 \$ .35 2N3199 PNP SI TO-18 \$ .35 2N3200 PNP SI TO-18 \$ .35 2N3201 PNP SI TO-18 \$ .35 2N3202 PNP SI TO-18 \$ .35 2N3203 PNP SI TO-18 \$ .35 2N3204 PNP SI TO-18 \$ .35 2N3205 PNP SI TO-18 \$ .35 2N3206 PNP SI TO-18 \$ .35 2N3207 PNP SI TO-18 \$ .35 2N3208 PNP SI TO-18 \$ .35 2N3209 PNP SI TO-18 \$ .35 2N3210 PNP SI TO-18 \$ .35 2N3211 PNP SI TO-18 \$ .35 2N3212 PNP SI TO-18 \$ .35 2N3213 PNP SI TO-18 \$ .35 2N3214 PNP SI TO-18 \$ .35 2N3215 PNP SI TO-18 \$ .35 2N3216 PNP SI TO-18 \$ .35 2N3217 PNP SI TO-18 \$ .35 2N3218 PNP SI TO-18 \$ .35 2N3219 PNP SI TO-18 \$ .35 2N3220 PNP SI TO-18 \$ .35 2N3221 PNP SI TO-18 \$ .35 2N3222 PNP SI TO-18 \$ .35 2N3223 PNP SI TO-18 \$ .35 2N3224 PNP SI TO-18 \$ .35 2N3225 PNP SI TO-18 \$ .35 2N3226 PNP SI TO-18 \$ .35 2N3227 PNP SI TO-18 \$ .35 2N3228 PNP SI TO-18 \$ .35 2N3229 PNP SI TO-18 \$ .35 2N3230 PNP SI TO-18 \$ .35 2N3231 PNP SI TO-18 \$ .35 2N3232 PNP SI TO-18 \$ .35 2N3233 PNP SI TO-18 \$ .35 2N3234 PNP SI TO-18 \$ .35 2N3235 PNP SI TO-18 \$ .35 2N3236 PNP SI TO-18 \$ .35 2N3237 PNP SI TO-18 \$ .35 2N3238 PNP SI TO-18 \$ .35 2N3239 PNP SI TO-18 \$ .35 2N3240 PNP SI TO-18 \$ .35 2N3241 PNP SI TO-18 \$ .35 2N3242 PNP SI TO-18 \$ .35 2N3243 PNP SI TO-18 \$ .35 2N3244 PNP SI TO-18 \$ .35 2N3245 PNP SI TO-18 \$ .35 2N3246 PNP SI TO-18 \$ .35 2N3247 PNP SI TO-18 \$ .35 2N3248 PNP SI TO-18 \$ .35 2N3249 PNP SI TO-18 \$ .35 2N3250 PNP SI TO-18 \$ .35 2N3251 PNP SI TO-18 \$ .35 2N3252 PNP SI TO-18 \$ .35 2N3253 PNP SI TO-18 \$ .35 2N3254 PNP SI TO-18 \$ .35 2N3255 PNP SI TO-18 \$ .35 2N3256 PNP SI TO-18 \$ .35 2N3257 PNP SI TO-18 \$ .35 2N3258 PNP SI TO-18 \$ .35 2N3259 PNP SI TO-18 \$ .35 2N3260 PNP SI TO-18 \$ .35 2N3261 PNP SI TO-18 \$ .35 2N3262 PNP SI TO-18 \$ .35 2N3263 PNP SI TO-18 \$ .35 2N3264 PNP SI TO-18 \$ .35 2N3265 PNP SI TO-18 \$ .35 2N3266 PNP SI TO-18 \$ .35 2N3267 PNP SI TO-18 \$ .35 2N3268 PNP SI TO-18 \$ .35 2N3269 PNP SI TO-18 \$ .35 2N3270 PNP SI TO-18 \$ .35 2N3271 PNP SI TO-18 \$ .35 2N3272 PNP SI TO-18 \$ .35 2N3273 PNP SI TO-18 \$ .35 2N3274 PNP SI TO-18 \$ .35 2N3275 PNP SI TO-18 \$ .35 2N3276 PNP SI TO-18 \$ .35 2N3277 PNP SI TO-18 \$ .35 2N3278 PNP SI TO-18 \$ .35 2N3279 PNP SI TO-18 \$ .35 2N3280 PNP SI TO-18 \$ .35 2N3281 PNP SI TO-18 \$ .35 2N3282 PNP SI TO-18 \$ .35 2N3283 PNP SI TO-18 \$ .35 2N3284 PNP SI TO-18 \$ .35 2N3285 PNP SI TO-18 \$ .35 2N3286 PNP SI TO-18 \$ .35 2N3287 PNP SI TO-18 \$ .35 2N3288 PNP SI TO-18 \$ .35 2N3289 PNP SI TO-18 \$ .35 2N3290 PNP SI TO-18 \$ .35 2N3291 PNP SI TO-18 \$ .35 2N3292 PNP SI TO-18 \$ .35 2N3293 PNP SI TO-18 \$ .35 2N3294 PNP SI TO-18 \$ .35 2N3295 PNP SI TO-18 \$ .35 2N3296 PNP SI TO-18 \$ .35 2N3297 PNP SI TO-18 \$ .35 2N3298 PNP SI TO-18 \$ .35 2N3299 PNP SI TO-18 \$ .35 2N3300 PNP SI TO-18 \$ .35 2N3301 PNP SI TO-18 \$ .35 2N3302 PNP SI TO-18 \$ .35 2N3303 PNP SI TO-18 \$ .35 2N3304 PNP SI TO-18 \$ .35 2N3305 PNP SI TO-18 \$ .35 2N3306 PNP SI TO-18 \$ .35 2N3307 PNP SI TO-18 \$ .35 2N3308 PNP SI TO-18 \$ .35 2N3309 PNP SI TO-18 \$ .35 2N3310 PNP SI TO-18 \$ .35 2N3311 PNP SI TO-18 \$ .35 2N3312 PNP SI TO-18 \$ .35 2N3313 PNP SI TO-18 \$ .35 2N3314 PNP SI TO-18 \$ .35 2N3315 PNP SI TO-18 \$ .35 2N3316 PNP SI TO-18 \$ .35 2N3317 PNP SI TO-18 \$ .35 2N3318 PNP SI TO-18 \$ .35 2N3319 PNP SI TO-18 \$ .35 2N3320 PNP SI TO-18 \$ .35 2N3321 PNP SI TO-18 \$ .35 2N3322 PNP SI TO-18 \$ .35 2N3323 PNP SI TO-18 \$ .35 2N3324 PNP SI TO-18 \$ .35 2N3325 PNP SI TO-18 \$ .35 2N3326 PNP SI TO-18 \$ .35 2N3327 PNP SI TO-18 \$ .35 2N3328 PNP SI TO-18 \$ .35 2N3329 PNP SI TO-18 \$ .35 2N3330 PNP SI TO-18 \$ .35 
---	--	--	--



## AUDIO UPDATE

continued from page 77

records. I agreed, and we made a date for the following week.

When I arrived, and after Bill introduced by to several Japanese engineers, I was ushered into the company listening room. There I was confronted with three visually identical pairs of speakers labeled "A," "B," and "C"—obviously the same model that had been reviewed so well by our test lab. Bill handed me the control of a three-way switching system and asked me to switch among the three pairs of speakers and evaluate their sound quality. Since all the systems looked identical, I didn't know quite what to expect, but no more than about 15 minutes were needed to arrive at an opinion based on my A/B/C comparisons. I said that according to my ears system A sounded bad, system B was pretty good, and system C also sounded bad—but different from A. Bill seemed pleased with my response, but the Japanese seemed

puzzled and upset.

Here's where the inscrutable part comes in. Later, in private, I asked Bill to explain exactly what was happening. He said that the Japanese had been thrilled by our favorable test report and decided to heavily promote their speaker system in the U.S. In order to save the shipping costs from Japan, they intended to build the systems here, using an American-made cabinet and either local- or Japanese-manufactured drivers. To Bill's ears, the two pairs of locally assembled systems (A and C in my tests) sounded quite inferior to the original (B), but the Japanese insisted that they all sounded alike! That's why Bill had brought my ears into the act.

I've thought about that experience over the years, and have yet to figure out exactly what went wrong. I can understand that the Japanese engineers might prefer a different sonic quality (frequency balance) than I do, but the fact that they denied that there were any audible differences in the sound of three obviously different-

## THE ELECTRONIC GOLDMINE

### INFRARED DETECTOR KIT

Uses sensitive sensor and electronic circuitry to respond to all types of infrared TV, VCR, etc. remote controllers and LEDs by producing sound and lighting a bright red LED. Great for testing and verification of infrared output. See what you can see! Size: Small size 2.5" x 1.4". Operates on 9V battery (not included). Kit comes with all parts and PC board.



C6441 \$5.95

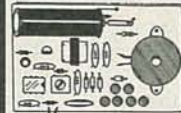

### MINI GEIGER COUNTER KIT

This useful kit lets you detect the radiation that you are being exposed to! Use it to detect radium dials on old watches, camping lantern mantles, radioactive minerals, background radiation, etc. Kit detects alpha, beta, gamma and X-ray radiation and features sensitive alpha-window GM tube with IC circuit. Emits clicks in proportion to intensity of radiation! Size only 1.9" x 3". Operates from one 9V battery (not included). With all parts and PC board.

C6430 \$59.95

### 20W + 20W STEREO AMP KIT

Two separate high power amps on one PC board. Each amp has its own level control and puts out an incredible 20 Watts RMS. Features red LED "on" indicator and low distortion circuitry. Great stereo booster amp for your car sound system. Use with any speakers capable of handling at least 20 watts. Operates on 12VDC. With all parts and pc board. C6442 \$19.95



C6443 \$16.95

### 20 WATT RMS MONO AMP KIT

High power amp for various booster applications. Kit features short circuit and open circuit protection and has very low distortion (1% or less). Amplifier has red LED "on" indicator and will boost any tuner, radio, cassette, CD player to room filling volume out of your speaker! Operates from 12VDC. With all parts and pc board.

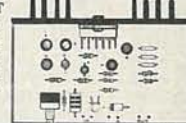

C6444 \$14.95

**FREE CATALOG!** We include our catalog containing over 130 kits and hundreds of unique components FREE with each order. We are continually adding new items to our catalog and once you order we will place your name on our preferred customer mailing list to receive it!

**MINIMUM ORDER \$10.00** plus 3.00 shipping and handling. We accept M/C, Visa and money orders. COD fee: 2.50 in addition to 3.00 shipping charge.  
**SEND ORDERS TO:** The Electronic Goldmine  
 P.O. Box 5408 Scottsdale, AZ 85261  
**PHONE ORDERS:** (602) 451-7454

CIRCLE 180 ON FREE INFORMATION CARD

## MARK V NEW FREE CATALOG IS NOW AVAILABLE!

▲ indicates the level of difficulty in the assembling of our Products. ▲ Beginner ▲▲ Intermediate ▲▲▲ Advanced ★ Fully Assembled



AMPLIFIERS		
MODEL	DESCRIPTION	KIT ASSEMBLED
TA-28MK2	Digital Voice Recorder ▲▲	30.00
TA-50A/B	Multi-Purpose Melody Generator ▲	11.84 \$ 16.58
TA-50C	Multi-Purpose Melody Generator ▲	12.65 17.71
TA-120MK2	35W Class "A" Main Power Mono Amp ▲▲	27.18 38.81
TA-300	30W Multi-Purpose Single Channel Amp ▲	20.00 29.00
TA-302	60W Stereo Power Booster	50.00 70.00
TA-322i	50W + 50W IC Stereo Amp. w/led level display ▲	35.50 46.15
TA-323A	30Wx2 Stereo Pre-main Amp. ▲	29.50 38.35
TA-377A	HI-QUALITY FET Stereo Pre-Amp. ▲▲	59.95 75.00
TA-400	40W Solid State Mono Amp ▲	28.00 34.93
TA-477	120W Mosfet Power Mono Amp. ▲▲	68.00
TA-800	80W DC Pre-Main & Power Amp. ▲▲	60.92
TA-802	80W 80W DC Stereo Main Power Amp. ▲▲	45.94
TA-820A	80W 80W OCL DC Pre-Main Stereo Amp. ▲▲	40.39
TA-1000A	100W Dynamic Class "A" Main Power Mono Amp. ▲	59.69 80.58
TA-1500	100W x 2 Class "A" DC Stereo Pre-Main Amp. ▲▲	73.70 95.81
TA-2200	FET Super class "A" DC Pre-Amp. ▲	47.70 58.24
TA-2400A	Electronic Echo & Revelation Amp. ▲▲★	93.30 116.80
TA-2500	HQ Pre-Amp. w/10 band graphic equalizer ★	90.80
TA-2800	BI-FET IC Pre-Amp. w/3 way tone control ▲▲	48.90
TA-3000	Stereo Simulator (For mono TV or any mono source) ▲	30.20 41.38
TA-3600	300W HQ HI-FI Power Mono Amp. ▲▲	79.00 103.00

POWER SUPPLIES		
TR-100A	0-15V 2A Regulated DC Power Supply	59.50 69.50
TR-355A	0-15V 5A Regulated DC Power Supply	14.55 20.76
TR-355B	0-30V 3A Regulated DC Power Supply	14.55 20.76
TR-503	0-50V 3A Regulated DC Power Supply	15.75 22.65

MISCELLANEOUS		
MODEL	DESCRIPTION	KIT ASSEMBLED
TY-23B	3 Channel Color Light Controller ▲▲▲★	\$ 56.04 \$74.50
TY-25	Stereo Loudspeaker Protector ▲	12.85 18.88
TY-35	FM Wireless Microphone ▲	9.22
TY-36	AC/DC Quartz Digital Clock ▲	18.00 25.20
TY-38	Sound/Touch Control Switch ▲	12.00
TY-41 MK111	Infrared Remote Control Unit ▲▲	15.00 25.00
TY-41 MKV	Infrared Remote Control Unit ▲▲	20.00 35.00
TY-42	Bar/Dot Level Meter ▲▲	24.15
TY-43	3 1/2" Digital Panel Meter ▲	29.00 38.00
TY-45	20 Steps Bar/Dot Audio Level Display ▲▲	28.45 46.24
TY-47	Superior Electronic Roulette ▲	19.48 27.14
SM-328	4 Channel Professional Color Light Controller	150.00
SM-333	Audio/Video Surround Sound Processor ▲▲★	62.00 83.00
SM-666	Dynamic Noise Reduction ▲	26.00 34.00

METAL CABINETS WITH ALUMINUM PANEL:		
LG-1273	3" x 12" x 7"	\$20.16
LG-1684	4" x 16" x 8"	24.64
LG-1924	4" x 19" x 11 1/2"	30.00
LG-1925	5" x 19" x 11 1/2"	33.00
LG-1983	2 1/4" x 19" x 8"	26.50

— WE ACCEPT MAJOR CREDIT CARDS, MONEY ORDERS AND CHECKS — BUSINESS & SHOWROOM HOURS (PACIFIC TIME) MON. - FRI. 9:30 A.M. - 5:00 P.M. SAT. 10:00 A.M. - 5:00 P.M. TERMS: \$10.00 MIN. ORDER. \$20.00 CHARGE CARD ORDER. WE SHIP UPS GROUND. ADD 10% OF TOTAL ORDER (MIN. \$3.00) FOR SHIPPING OUTSIDE USA. ADD 20% (MIN. \$5.00) TRANSIT INSURANCE. ADD 5% OF TOTAL (OUTSIDE USA ONLY). CA RESIDENTS ADD SALES TAX. ALL MERCHANDISE SUBJECT TO PRIOR SALE. PRICES ARE SUBJECT TO CHANGE WITHOUT NOTICE. WE ARE NOT RESPONSIBLE FOR TYPOGRAPHICAL ERRORS.

**MARK V ELECTRONICS, INC. — 8019 E. Slauson Ave., Montebello, CA 90640**

CIRCLE 93 ON FREE INFORMATION CARD

MARCH 1990

87



# AMAZING SCIENTIFIC & ELECTRONIC PRODUCTS

**PLANS IN STOCK**

GRA1 — ANTI GRAVITY GENERATOR ..... \$10.00  
 LC7 — 40 WATT BURNING CUTTING LASER ..... \$20.00  
 RUB4 — HI POWER PULSED DRILLING LASER ..... \$20.00  
 RTC5 — 1 MILLION VOLT TESLA COIL ..... \$20.00  
 MCP1 — HI VELOCITY COIL GUN ..... \$15.00  
 LLS1 — LASER LIGHT SHOW 3 METHODS ..... \$20.00  
 EH1 — ELECTRONIC HYPNOTISM TECHNIQUES ..... \$8.00  
 EML1 — LOWER POWERED COIL GUN LAUNCHER ..... \$8.00  
 JL3 — JACOB LADDER 3 MODELS ..... \$10.00  
 S05 — SEE IN THE DARK ..... \$10.00  
 LEV1 — LEVITATION DEVICE ..... \$10.00

**KITS ASSISTANCE PROGRAM AVAILABLE**

FMV1K — 3 MILE FM VOICE TRANSMITTER ..... \$34.50  
 PFS1K — HAND CONTROLLED PLASMA FIRE SABER ..... \$49.50  
 NIG7K — HI FLUX NEGATIVE ION GENERATOR ..... \$34.50  
 PG5K — PLASMA LIGHTNING GLOBE ..... \$49.50  
 LHC2K — VISIBLE SIMULATED 3 COLOR LASER ..... \$44.50  
 HOD1K — HOMING/TRACKING BEEPER TRANSMITTER ..... \$44.50  
 LGU6K — 2.5 MW HAND-HELD VISIBLE LASER GUN ..... \$249.50  
 BTC3K — 250,000 VOLT TABLE TOP TESLA COIL ..... \$249.50  
 I0G2K — ION RAY GUN, project energy without wires ..... \$129.95  
 TKE1K — TELEKINETIC ENHANCER/ELECTRIC MAN ..... \$79.50  
 VVPM7K — 3 MILE AUTO TELEPHONE TRANSMITTER ..... \$49.50

**ASSEMBLED IN OUR LABS**

LIST10 — INFINITY XMTR Listen in via phone lines ..... \$199.50  
 IPG70 — INVISIBLE PAIN FIELD BLAST WAVE GENERATOR \$74.50  
 ITM10 — 100,000 VOLT INTIMIDATOR UP TO 20" ..... \$99.50  
 TAT30 — AUTOMATIC TELEPHONE RECORDING DEVICE ..... \$24.50  
 PSP40 — PHASOR SONIC BLAST WAVE PISTOL ..... \$89.50  
 DNE10 — ALL NEW 26" VIVID COLORED NEON STICK ..... \$74.50  
 LGU20 — 5 TO 1MW VISIBLE RED HeNe LASER GUN ..... \$199.50  
 BLS10 — 100.00 WATT BLASTER DEFENSE WAND ..... \$89.50

**EASY ORDERING PROCEDURE - TOLL FREE 1-800-221-1705**  
 or 24 HRS ON 1-603-673-4730 or FAX IT TO 1-603-672-5406  
 VISA, MC, CHECK, MO IN US FUNDS. INCLUDE 10% SHIPPING. ORDERS  
 \$100.00 & UP ONLY ADD \$10.00. CATALOG \$1.00 OR FREE WITH ORDER.

**INFORMATION UNLIMITED**  
 P.O. BOX 716, DEPT. R2, AMHERST, NH 03031

sounding speakers puzzles me to this day. Perhaps something got lost in the translation.

## Postscript

About a year later I had an unexpected visitor from Japan. The gentleman had been on assignment in California for the previous month or so setting up a slow-speed recording center for a major Japanese company. Things had gone well, until the question of monitor speakers for the studio came up. It seems that my visitor felt that the "West-Coast" speakers used by so many U.S. studios suffered from excessive colorations that in his view made it impossible to accurately monitor a recording with them. He was in trouble with the home office because he refused to use the "standard" monitors in the studio he had designed.

I was surprised and gratified to encounter a Japanese engineer who seem to hear things the same way I did, and we entered into a wide-ranging discussion

about sound preference and sonic accuracy. I mentioned that in our test program we had encountered only one Japanese speaker that tested well and sounded right to our ears. "Yes," said my new friend, "I know of your test report since I designed that speaker, and, incidentally, it was a best seller in Japan!" I was flabbergasted! There should be a lesson in all this—other than that some people, whatever their nationality, can hear and others can't—but I'll be damned if I know what it is. R-E



**Parts Express**  
International Inc.

**EMINENCE** **MOTOROLA** **Polydax**

**1-800-338-0531** **PIONEER**

---

**3-WAY 100W CROSSOVER**

12 dB/octave rolloff.  
800Hz, 5000Hz  
crossover points. 8  
ohm. 100 watts RMS.

#260-210 **\$12.50** **\$9.95**  
(1-9) (10-up)

**WALNUT SPEAKER CABINET KIT**

Super quality, genuine walnut veneer cabinet. Kit includes: routed and mitred top, sides, and bottom in unfinished 3/4" walnut veneer. Cut your own custom holes in the front and rear to match your drivers. 18" x 24" x 11". Volume: 1.9 cubic feet.

#260-350 **\$22.50** **\$19.95**  
(1-3) (4-up)

**12" SUB WOOFER**

Dual voice coil sub woofer. 30 oz. magnet, 2" voice coils. 100 watts RMS, 145 watts max. fs = 25 Hz. 6 ohm (4 and 8 ohm compatible). SPL = 89 dB 1W/1M. Response: 25-700 Hz. QTS = .31, VAS = 10.3 cu. ft. Pioneer #A30GU30-5SD. Net weight: 6 lbs.

#290-145 **\$39.80** **\$36.80**  
(1-3) (4-up)

**18" EMINENCE WOOFER**

MADE IN USA  
100 oz. magnet, 3" voice coil. 250 watts RMS, 350 watts max. 8 ohm, 30 Hz resonant frequency. 22-2700 Hz response. Efficiency: 95 dB 1W/1M. Paper cone, treated accordion surround. Net weight: 29 lbs.

#290-200 **\$98.90** **\$89.50**  
(1-3) (4-up)

**SPEAKER CONTROL PANEL**

Panel with 50 watt L-pads for tweeter and midrange and built-in LED power meter. 5" x 2 1/2" 100 watt version available

#260-235 **\$14.50** **\$12.90**  
(1-5) (6-up)

**15" THRUSTER WOOFER**

Thruster by Eminence. Made in USA. Poly foam surround, 56 oz. magnet. 2-1/2", 2 layer voice coil. 150 watts RMS, 210 watts max. 4 ohm. fs = 23.5 Hz, QTS = .33, VAS = 17.9 cu. ft. SPL = 94.8 dB 1W/1M. Net weight: 15 lbs.

#290-180 **\$43.50** **\$39.80**  
(1-3) (4-up)

**TITANIUM COMPOSITE TWEETER**

Titanium is deposited on a polymer dome to combine the advantages of both hard and soft dome technologies. 8 ohm. Ferro fluid cooled voice coil. fs = 1200 Hz, SPL = 90 dB 1W/1M. 50 watts RMS, 70 watts max. 4" round. Polydax part #DTW100T125.

#270-047 **\$27.50** **\$24.80**  
(1-9) (10-up)

**12" POLY WOOFER**

Super duty, 40 oz. magnet. 100 watts RMS, 145 watts max. 4 and 8 ohm compatible (6 ohm). 2" voice coil. fs = 25 Hz. QTS = .166, VAS = 10.8 cu. ft. Response: 25-1500 Hz. Net weight: 9 lbs. Pioneer #A30GU40-51D

#290-125 **\$36.80** **\$34.50**  
(1-3) (4-up)

**PIONEER HORN TWEETER**

Mylar dome. 2.93 oz. barium ferrite magnet. 8 ohm. Response: 1800-20000 Hz. 35W RMS, 50W max. fs = 2000 Hz, SPL = 106 dB. Pioneer #AHE60-51F

#270-050 **\$6.50** **\$5.90**  
(1-9) (10-up)

**GRILL FRAME KIT**

With this kit you can make speaker grill frames up to 30" x 40". Kit includes 4 corner pieces, 2 "T" brackets, and 7 frame bars. Grill mounting kit included.

#260-333 **\$8.50** **\$7.80**  
(1-9) (10-up)

**Parts Express**  
340 E. First St., Dayton, Ohio 45402  
Local: 1-513-222-0173  
FAX: 513-222-4644

\* 15 day money back guarantee \*\$15.00 minimum order \*We accept Mastercard, Visa, Discover, and C.O.D. orders \*24 hour shipping  
 \*Shipping charge = UPS chart rate \*\$1.00 (\$3.00 minimum charge)  
 \*Hours: 8:30 am - 6:00 pm EST, Monday - Friday \*Mail order customers, please call for shipping estimate on orders exceeding 5 lbs.

**Parts Express**  
1989 CATALOG  
CALL TOLL FREE 1-800-338-0531  
**FREE CATALOG**





Support America's colleges. Because college is more than a place where young people are preparing for their future. It's where America — and American business — is preparing for its future.

**Give to the college of your choice.**

**Ad Council** A Public Service of The Publishers

COUNCIL FOR AID TO EDUCATION **CEAE**

# DESCRAMBLERS

"The Empire Strikes Back"



"We Cut Prices To The Bare Essentials"  
There Is NO Competition ANYWHERE !

JERROLD™  
TB-3

SCIENTIFIC  
ATLANTA  
SA-3

HAMLIN  
MLD 1200

OAK  
M35B  
W/ VARI-SYNC

INTELESTAR  
CONVERTERS

DF-3/2  
FILTERS

FULL  
WARRANTY

## 10% UNDER ANYONES

Quoted or Advertised Prices...Even The **WholeSale Kings!**  
For Ordering & Info. **(402)331-3228**  
Please Call.....

SALES REGULATED BY FEDERAL & STATE LAW ANYONE IMPLYING THEFT OF SERVICES WILL BE DENIED PURCHASE.

CIRCLE 200 ON FREE INFORMATION CARD

## When You Need Resistors, We Sell You Resistors (And Gravy), But Not Printed Matter!

Resistors are one of the most common of electronic component parts and having a good reliable source for them is a necessity. For years we have been the lowest price leader in this (and many other) areas, and the following price comparison table proves that although we ask for a yearly Membership Fee of \$35.00, you can recover your investment quickly after purchasing just a few thousand resistors, and what you will save on more than 10,000 additional items that we stock, is the so-called 'gravy' part of the whole deal.

Resistor Type	Quantity	Electronic Buyers Club	Digi-Key® (No Discount)	Digi-Key® (Max Discount)	Jameco Electronics®	JDR Microdevices®	Sintec®
1/4 Watt, 5% Carbon-Film (Bulk)	10 100 1,000 10,000	-- \$ 0.77 4.76 43.20	\$ 0.50 1.70 8.10 72.00	\$ 0.375 1.275 8.10 72.00	\$ 0.50 2.50 11.95 99.50	\$ 0.50 2.00 15.00 --	-- \$ 4.00 12.00 --
1/4 Watt, 1%, Metal-Film (Bulk)	10 100 1,000	0.32 1.16 8.25	1.00 3.90 20.00	0.75 2.925 20.00	-- 3.29 17.95	-- -- --	-- 8.00 30.00

### 12 Months Saving Guarantee

We will refund the first year Membership Fee of any member who has purchased \$300 or more worth of products from Electronic Buyers Club and has not saved an amount greater than the first year Membership Fee, if buying the same items elsewhere.

It is not that these other firms are trying to rip you off, the fact is that advertising in several Trade Magazines each month and printing and mailing hundreds of thousands of virtually the same catalog every few months cost a lot of money and they **have** to charge more. Call us today and start receiving components for your money instead of printed matter.

### 30 Days Money Back Guarantee

We will refund the full Membership Fee of any new member of Electronic Buyers Club who within 30 Days after receiving the Membership Binder, returns the Binder to EBC and asks for the cancellation of Membership.

**Electronic Buyers Club**

A Division of International Components Corporation

1803 N.W. Lincoln Way • Toledo, OR 97391  
PHONE (All 50 States & Canada): 1-800-325-0101  
FAX: (503) 336-4400 • Hours: 6:00 AM - 6:00 PM PST



CIRCLE 181 ON FREE INFORMATION CARD

MARCH 1990



**SIP & SIMM MODULES**

Part No.	Function	Price
512KIT	IBM PS/2 100ns 256K x 9 SIMM (2 each)	119.95
2MEGKIT	IBM PS/2 100ns 1MEG x 9 SIMM (2 each)	489.95
41256A9A-10	262 144x9 100ns 256K x 9 SIMM (Has Leads)	49.95
41256A9B-80	262 144x9 80ns 256K x 9 SIMM	64.95
42100A8B-10	1,048 576x8 100ns 1MEG x 8 SIMM	164.95
42100A9A-80	1,048 576x9 80ns 1MEG x 9 SIMM (Has Leads)	169.95
42100A9B-80	1,048 576x9 80ns 1MEG x 9 SIMM	169.95

\*Upgrade for Models 30, 502 and 60

**7400**

Part No.	1-9	10+	Part No.	1-9	10+
7400	29	19	7474	39	29
7402	29	19	7475	49	39
7404	29	19	7476	45	35
7405	35	25	7483	45	35
7406	39	29	7485	65	55
7407	39	29	7486	45	35
7408	35	25	7489	2.25	2.15
7410	29	19	7490	49	39
7411	25	15	7493	45	35
7414	49	39	7495	59	49
7416	35	25	74107	29	19
7417	35	25	74121	39	29
7420	29	19	74123	49	39
7427	29	19	74125	49	39
7430	29	19	74147	39	29
7432	39	29	74150	1.35	1.25
7438	39	29	74151	39	29
7442	49	39	74154	1.35	1.25
7445	75	65	74161	69	59
7446	89	79	74174	59	49
7447	89	79	74175	59	49
7473	39	29	74183	.79	.69

**74LS**

74LS00	26	16	74LS139	49	39
74LS02	28	18	74LS151	49	39
74LS03	28	18	74LS153	49	39
74LS04	28	18	74LS154	1.29	1.19
74LS05	28	18	74LS157	45	35
74LS06	59	49	74LS161	49	39
74LS07	59	49	74LS163	49	39
74LS08	28	18	74LS164	59	49
74LS09	28	18	74LS165	75	65
74LS10	26	16	74LS166	89	79
74LS11	29	19	74LS173	45	35
74LS14	49	39	74LS174	39	29
74LS20	28	18	74LS175	1.89	1.79
74LS21	29	19	74LS191	59	49
74LS27	35	25	74LS192	69	59
74LS30	28	18	74LS193	69	59
74LS32	28	18	74LS194	69	59
74LS38	35	25	74LS221	69	59
74LS42	49	39	74LS240	59	49
74LS47	85	75	74LS241	59	49
74LS73	39	29	74LS244	59	49
74LS74	35	25	74LS245	79	69
74LS75	39	29	74LS257	49	39
74LS76	39	29	74LS259	89	79
74LS83	55	45	74LS273	89	79
74LS85	55	45	74LS279	49	39
74LS86	29	19	74LS367	49	39
74LS90	49	39	74LS373	79	69
74LS93	49	39	74LS374	79	69
74LS123	49	39	74LS393	89	79
74LS125	49	39	74LS441	1.29	1.19
74LS132	49	39	74LS590	5.95	5.85
74LS138	49	39	74LS688	2.39	2.29

**74S/PROMS\***

74S00	25	74S188*	1.49
74S04	25	74S189	1.49
74S32	25	74S240	1.39
74S74	25	74S244	.99
74S112	25	74S277	1.49
74S124	1.25	74S288*	1.49
74S138	49	74S373	.99
74S153	29	74S374	.99
74S163	75	74S387*	1.29
74S174	29	74S472*	2.95
74S175	39	74S571*	2.49

**CD-CMOS**

CD4001	.19	CD4051	.59
CD4002	.19	CD4052	.59
CD4007	.19	CD4053	.59
CD4011	.19	CD4060	.65
CD4012	.25	CD4066	.29
CD4013	.29	CD4069	.25
CD4015	.29	CD4070	.29
CD4016	.29	CD4071	.19
CD4017	.49	CD4072	.19
CD4018	.49	CD4073	.19
CD4021	.49	CD4081	.19
CD4024	.49	CD4093	.25
CD4027	.35	CD4094	.89
CD4028	.49	CD4503	.39
CD4029	.69	CD4504	.59
CD4030	.35	CD4518	.75
CD4040	.65	CD4520	.69
CD4042	.49	CD4522	.75
CD4043	.69	CD4528	.69
CD4046	.65	CD4538	.79
CD4047	.69	CD4543	.49
CD4049	.29	CD4584	.49
CD4050	.29	CD4585	.69

**NEC V20 & V30 CHIPS**

Replace the 8086 or 8088 in Your IBM PC and Increase Its Speed by up to 30%

Part No.	Price
UPD70108-5 (5MHz) V20 Chip	5.25
UPD70108-8 (8MHz) V20 Chip	8.95
UPD70108-10 (10MHz) V20 Chip	10.95
UPD70116-8 (8MHz) V30 Chip	7.95
UPD70116-10 (10MHz) V30 Chip	13.49

**MICROPROCESSOR COMPONENTS**

Z80, Z80A, Z80B, SERIES		8000 SERIES Continued		8000 SERIES Continued	
Part No.	Price	Part No.	Price	Part No.	Price
Z80	1.25	8155-2	3.75	8286	2.29
Z80A	1.29	81C55	4.25	8741	9.49
Z80A CTC	1.65	8205	9.95	8748 (25V)	1.95
Z80A DART	4.95	82C11	1.95	8748H (HMOS)(21V)	9.95
Z80A PIC	1.89	8212	1.99	8751H (3.5-12MHz)	34.95
Z80A SIO/O	3.95	8216	1.39	8755	13.95
Z80B	2.75	8224	1.49	80C86-10 (10MHz)JLCC	29.95
Z80B CTC	3.95	8228	1.49	80C87-3 (5MHz)	109.95
Z80B PIO	3.95	8237-5	4.25	80C87-8 (8MHz)	209.95
Z8040H(B) CPU-BM#	9.95	8243	1.95	80C87-10 (10MHz)	239.95
<b>8000 SERIES</b>		8250A	4.95	80C88-16 (16MHz)	349.95
8031	3.95	8250B (For IBM)	5.95	80C87-20 (20MHz)	399.95
80C31	8.95	8251A	1.95	80C87-25 (25MHz)	499.95
8035	1.25	8253	1.89	82288 (8MHz)	5.49
8039	1.59	8254	4.95	82288 (8MHz)	6.95
8052AHBASIC	24.95	82C53-5	3.95	<b>DATA ACQUISITION</b>	
8080A	1.95	8255A-5	2.95	ADC0804LCN	3.25
8085A-2	3.59	82C55A-5	4.49	ADC0808CON	5.49
8086	3.95	8256	11.95	ADC0809CCN	3.75
8087 (5MHz) (H)	89.95	8259-5	2.25	ADC1205CCU-1	19.95
8087-2 (8MHz)	129.95	8272	3.49	DAC0808LCN	1.49
8088 (5MHz)	4.95	8274	4.75	AY-3-101SD	4.95
8088-2 (8MHz)	6.95	8279-5	2.95	AY-5-1013A	2.95
8155	2.49	8284A	1.95		

**STATIC RAMS**

Part No.	Function	Price
2016-12	2048x8 120ns	2.95
2102	1024x1 350ns	2.89
2112	256x4 450ns MOS	2.49
2114N	1024x4 450ns	2.59
2114N-2L	1024x4 200ns Low Power	1.49
21C14	1024x4 200ns CMOS	1.49
5101	256x4 450ns CMOS	1.95
6116P-1	2048x8 100ns (16K) CMOS	3.19
6116P-3	2048x8 150ns (16K) CMOS	2.79
6116LP-1	2048x8 100ns (16K) LP CMOS	3.59
6116LP-3	2048x8 150ns (16K) LP CMOS	3.09
6264P-10	8192x8 100ns (64K) CMOS	6.75
6264P-15	8192x8 150ns (64K) CMOS	6.29
6264LP-10	8192x8 100ns (64K) LP CMOS	6.95
6264LP-12	8192x8 120ns (64K) LP CMOS	6.75
6264LP-15	8192x8 150ns (64K) LP CMOS	6.49
6514	350x4 CMOS	3.25
4325E-10L	32.768x8 100ns (256K) Low Power	10.95
4325E-15L	32.768x8 150ns (256K) Low Power	9.95
62256LP-10	32.768x8 100ns (256K) LP CMOS	11.95
62256LP-12	32.768x8 120ns (256K) LP CMOS	11.25
62256LP-15	32.768x8 150ns (256K) LP CMOS	10.95

**DYNAMIC RAMS**

TMS4416-12	16.384x4 120ns	5.95
TMS4416-15	16.384x4 150ns	5.49
4116-15	16.384x4 150ns (MMS290N-2)	1.09
4128-15	131.072x1 50ns (Piggyback)	2.75
4164-100	65.536x1 100ns	4.49
4164-120	65.536x1 120ns	2.39
4164-150	65.536x1 150ns	2.15
41256-60	262.144x1 60ns	6.95
41256-80	262.144x1 80ns	5.75
41256-100	262.144x1 100ns	3.35
41256-120	262.144x1 120ns	3.59
41256-150	262.144x1 150ns	3.25
41264-12	64Kx4 120ns Video RAM	10.95
41464-80	65.536x4 80ns	5.95
41464-12	65.536x4 120ns	4.49
41464-15	65.536x4 150ns	4.25
51258-10	262.144x1 100ns Static Column	8.35
511000P-80	1,048.576x1 80ns (1 Meg)	13.95
511000P-10	1,048.576x1 100ns (1 Meg)	12.95
514256P-10	262.144x4 100ns (1 Meg)	14.49
514258-10	262.144x4 100ns Static Column	26.95

**EPROMS**

TMS2516	2048x8 450ns (25V)	4.95
TMS2532	4096x8 450ns (25V)	5.95
TMS2532	4096x8 450ns (12.5V)	5.25
TMS2564	8192x8 450ns (25V)	6.95
TMS2571	2048x8 450ns (5V, +5V, +12V)	6.49
1702A	256x8 2K (1µs)	4.25
2708	1024x8 450ns	3.95
2716	2048x8 450ns (25V)	3.49
2716-1	2048x8 350ns (25V)	3.95
27C16	2048x8 450ns (25V) CMOS	4.25
2732	4096x8 450ns (25V)	3.95
2732A-20	4096x8 200ns (21V)	3.95
27C32	4096x8 450ns (25V) CMOS	4.25
2764-25	8192x8 250ns (21V)	3.95
2764A-20	8192x8 200ns (12.5V)	4.19
2764A-25	8192x8 250ns (12.5V)	3.95
2764-15	8192x8 150ns (12.5V) CMOS	3.35
27C64-15	8192x8 150ns (12.5V) CMOS	5.95
27128-20	16.384x8 200ns (21V)	5.35
27128-25	16.384x8 250ns (21V)	5.25
27128A-15	16.384x8 150ns (12.5V)	4.95
27128A-20	16.384x8 200ns (12.5V)	4.75
27C128-25	16.384x8 250ns (21V) CMOS	5.95
27256-15	32.768x8 150ns (12.5V)	8.49
27256-20	32.768x8 200ns (12.5V)	8.49
27256-		



# Now Available...Jameco's NEW 1990 Catalog with 80 pages of Computer Peripherals, Components & More!

## Oscilloscope Probes

Attenuation: x1 / x10  
Capacitance  
F180: 180pF  
F210: 22pF (LF210):  
1pF / 17pF

F180 40MHz Oscilloscope  
Probe ..... \$19.95  
F210 100MHz Oscilloscope  
Probe ..... \$29.95

## TEST EQUIPMENT

### GoldStar 20MHz Oscilloscope and 1GHz Frequency Counter

GS7020  
Large 6" rectangular display • High  
sensitivity: 1 mV/div  
S7020 Oscilloscope.....\$399.95  
Wide measuring range • Measured  
value hold function  
C7102 Frequency Counter \$299.95

## Cometheus 9600 Baud Modem

9600E External 9600 Baud .... \$699.95  
9600B Internal 1200 Baud ..... \$49.95  
9600B Internal 2400 Baud ..... \$99.95

## Metex Digital Multimeters

**Metex General Specs:**  
Handheld, high accuracy  
AC/DC Voltage, AC/DC  
Current, Resistance, Diodes,  
Continuity, Transistor hFE  
Manual ranging w/overload  
protection  
M4650  
3650, 3650B & M4650 only:  
Also measure frequency and capacitance  
4650 only: • Data Hold Switch • 4.5 Digit

3610 3.5 Digit Multimeter ..... \$49.95  
3650 3.5 Digit Multimeter w/Frequency &  
Capacitance ..... \$69.95  
3650B Same as M3650 w/Bargraph.....\$79.95  
4650 4.5 Digit w/Frequency, Capacitance and  
Data Hold Switch.....\$99.95

## PROTOTYPING PRODUCTS

### Jameco Solderless Breadboards

JE24  
JE27  
JE21  
JE23

Part No.	Dim. L" x W"	Contact Points	Binding Posts	Price
JE21	3.25 x 2.125	400	0	\$4.95
JE23	6.5 x 2.125	830	0	\$6.95
JE24	6.5 x 3.125	1,360	2	\$12.95
JE25	6.5 x 4.25	1,660	3	\$17.95
JE26	6.875 x 5.75	2,390	4	\$22.95
JE27	7.25 x 7.5	3,220	4	\$32.95

## Prototype Design Stations WM2

**WM1 & WM2 Features:** • Removable solderless breadboard • Variable and fixed DC power supply • Multi-frequency signal generator • Analog multimeter • 8 bicolor LEDs (red & green) • 8 logic switches • Logic probe • Lighted power switch • Fuse overload protected • Sturdy ruggedized case

**WM1 Special Features:** • 4 potentiometers • Built-in speaker

**WM2 Special Features:** • Pulse Generator • Binary coded decimal (BCD) to 7-segment decoder/driver • DB25 connector • Frequency counter (1Hz to 1MHz)

WM1 Analog Prototype Station .... \$199.95  
WM2 Digital Prototype Station ..... \$249.95

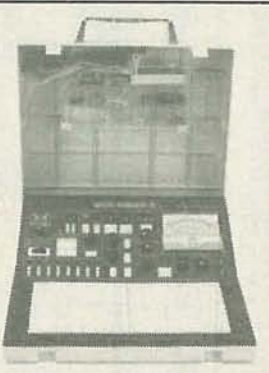

## MOTHERBOARDS

20MHz 386  
Only \$649.95!

• All w/ OK RAM

JE3520 Pictured

JE1001 Jameco 4.77MHz 8088 (PC/XT) ..... \$89.95  
JE1002 Jameco 4.77MHz 8088 (PC/XT) ..... \$99.95  
JE3005 Jameco Baby 8/12MHz 80286 (AT) .... \$199.95  
JE3010 Jameco Baby 8/16MHz 80286 (AT) .... \$299.95  
JE3011 Jameco Baby 8/20MHz 80286 (AT) .... \$399.95  
JE3020 AMI Baby 16MHz 80386.....\$999.95  
JE3025 AMI Baby 20MHz 80386.....\$1199.95  
JE3026 AMI Full-Size 25MHz 80386 ..... \$1899.95  
JE3028 AMI Full-Size 33MHz 80386 ..... \$2599.95  
JE3520 Jameco Baby 20MHz 80386 ..... \$649.95  
JE3525 Jameco Baby 25MHz 80386 ..... \$1299.95

## IBM Compatible Cases and Power Supplies

JE1010 Flip-Top Standard PC/XT Case ..... \$39.95  
JE1011 Side Standard PC/XT Case ..... \$39.95  
JE1018 Side Baby AT Case ..... \$59.95  
JE1030 150 watt PC/XT Power Supply ..... \$59.95  
JE1032 200 watt Baby AT Power Supply ..... \$89.95  
JE2011 Vertical Case w/300W Pwr. Supply ..... \$279.95  
JE2012 Mini-Vertical Case w/200W Pwr. Supply..... \$149.95  
JE2014 Flip-Top Baby XT Turbo Case ..... \$69.95  
JE2019 Flip-Top Baby AT Case ..... \$69.95

## EGA & Multiscan Monitor Packages

Casper 14" EGA monitor and EGA card package  
(720 x 350 max. resolution)

JE1059 EGA Monitor & EGA Card ..... \$459.95

Relisys 14" Multiscan monitor and EGA card  
package (800 x 600 max. resolution)

JE2057 Multiscan Monitor & EGA Card..... \$559.95



## A.R.T. EPROM Programmer

• Programs all current EPROMs in the  
2716 to 27512 range plus the X2864  
EEPROM • RS232 port • Software incl.  
EPP.....\$179.95

## UVP EPROM Eraser

• Erases all EPROM's • Erases 1  
chip in 15 Min. and 8 chips in 21  
min. • UV intensity: 6800 UW/CM<sup>2</sup>  
DE4.....\$69.95

## IBM PC/XT/AT Compatible Keyboards

JE2017  
JE2015 84-Key Standard AT Style  
Layout ..... \$59.95  
JE1016 101-Key Enhanced Layout  
with 12 Function Keys ..... \$69.95  
JE2016 111-Key Enhanced with Solar  
Powered Calculator ..... \$79.95  
JE2017 104-Key Enhanced with Trackball  
(Microsoft Compatible) .... \$99.95

## Soldering and Desoldering Stations

60 Watt Analog Display Soldering Station • Electronic temperature  
control from 200° to 878°F • Cartridge heating element for a  
longer life of the soldering tip

XY1683 ..... \$59.95

60 Watt Analog Display Soldering Station • Electronic temperature  
control from 200° to 878°F • Ceramic heating element for a  
steady temperature and long life

XY2660 ..... \$89.95

60 Watt Digital Display Soldering Station • Electronic temperature  
control from 200° to 878°F • Temperature displayed on easy  
to read .560" H 3-digit LED readout • Nichrome heating  
element

XY960 ..... \$99.95

30 Watt Electronic Temperature Controlled Desoldering Station  
• Electronic temperature control from 212° to 842°F • Self-  
contained high rotary vacuum pump

XY999 ..... \$279.95



## Hard & Hard/Floppy Disk Controller Cards

Computer Type	MFM Hard		RLI Hard		MFM Hard/Floppy		RLI Hard/Floppy	
	Part No. / Price	Part No. / Price	Part No. / Price	Part No. / Price	Part No. / Price	Part No. / Price	Part No. / Price	
8088 (PC/XT) @ 3:1 Interleave	XTGEN\$79.95	1004A27X\$99.95	JE1044\$109.95					
80286 (AT)/386 @ 2:1 Interleave	1003VMM1\$129.95	1003VSR1\$149.95	1003VMM2\$149.95	1003VSR2\$169.95				
80286 (AT)/386 @ 1:1 Interleave	1006VMM1\$149.95	1006VSR1\$169.95	1006VMM2\$169.95	1006VSR2\$189.95				

355 Shoreway Road  
Belmont, CA 94002  
24 Hour Order Hotline (415) 592-8097  
Telex (415) 592-2503 or (415) 595-2664  
Telex 176043 - Ans. Back: Jameco Blmt  
Data Sheets - 50¢ each  
Send \$2.00 Postage for a FREE 80-Page Catalog  
© 1990 Jameco Electronics 3/90  
JM is a registered trademark of  
International Business Machines



Mail Order Electronics - Worldwide  
**Jameco**  
ELECTRONICS



\$25.00 Minimum Order - U.S. Funds Only  
CA Residents Add 6%, 6.5% or 7% Sales Tax  
Shipping - Add 5% plus \$1.50 Insurance  
(May vary according to weight and shipping method)  
Terms: Prices subject to change without notice.  
We are not responsible for typographical errors.  
We reserve the right to substitute manufacturers.  
Items subject to availability and prior sale.  
Products pictured may only be representative.  
Complete list of terms/warranties is available upon request.

24-Hour Order Hotline (415) 592-8097 • The Following Services Are Also Available Through (415) 592-8097 From 7AM - 5PM P.S.T.:  
• Customer Service • Technical Assistance • Credit Department • All Other Inquiries







# ★ QUALITY PARTS ★ DISCOUNT PRICES ★ FAST SHIPPING

# ALL ELECTRONICS CORP.

## 12 VOLT DC MINI FAN

Howard Industries#

3-15-810. Operates on 12 Vdc, 0.10 amp, 1.0 watt. Compact plastic housing, 2.35" square X 1.275" thick. 9 blade fan. Two 9° pigtail leads.

CAT# CF-121 \$9.00 each

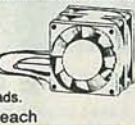

## 115 VAC COOLING FAN

STANDARD SIZE COOLING FAN.

Features die cast metal housing for strength and durability. IMPEDANCE PROTECTED 4 1/16" square X 1 1/2" deep. Factory new 120 Vac fans. CF-1-N \$9.50 each



## LED CHASER KIT

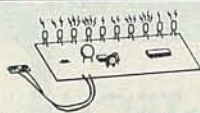

Build this variable speed led chaser. 10 leds flash sequentially at whatever speed you set them for. Easy to build kit includes pc board, parts and instructions. Ideal for special lighting effects, costumes, etc. Operates on 3 to 9 volts. PC board is 5" X 2.25". A great one hour project.

CAT# ACH \$6.50 each

## STEPPER MOTOR

Airpax# A82743-M4

Brand new 12 volt dc stepper motor. 35 ohm coil. 7.5 degrees per step. 2.25" diameter, 0.93" long excluding shaft. 0.22" dia. shaft is 0.75" long. 2 hole mounting flange, 2.675" mounting centers. 6 wire leads.



CAT# SMT-5 \$10.00 each

## RECHARGEABLE BATTERY PACK (USED)

Four AA nickel cadmium batteries connected in series to make a 4.8 volt pack. Batteries are in a 2 X 2 configuration with a 2 pin connector attached. The four batteries can be separated into single AA size solder tab nickel cadmium batteries or resoldered into other configurations.



SPECIAL SALE PRICE NOW \$3.00 per pack • 10 packs for \$25.00  
CAT# NCB-41AAU

## TIL-99 PHOTO TRANSISTOR

TO-18 case with window. For wide-angle viewing applications. Spectrally and mechanically compatible with TIL-31B. CAT# TIL-99 \$1.00 each • 10 for \$9.00

## TIL-31B PHOTO DIODE

TO-18 case with window. Infrared emitting photo diode. CAT# TIL-31B \$1.00 ea. • 10 for \$9.50

## SWITCHES

### ITT PUSH BUTTON

ITT MDPL series. 3/4" X

1/2" grey rectangular key cap. S.P.S.T. N.O. Push to dose. RATED: 0.1 amp switching, 0.25 amp carry current. P.C. mount. CAT# PB-8 65¢ each • 10 for \$6.00 100 for \$50.00



### SPDT PUSHBUTTON

Marquardt# 1843

Rated 6 amps @ 125/250 Vac. Black plastic pushbutton. Switch body: .92" X .94" X .65". CAT# PB-18 \$1.65 ea. • 10 for \$15.00 each



### PUSHBUTTON SWITCH

GC/Thomson# 35-420

S.P.S.T. normally open momentary pushbutton switch. Red plastic actuator 0.57" diameter. Chrome bezel 0.68" diameter. Threaded bushing mounts in .50" diameter hole. Rated 3 amp @ 250Vac. Solder loop terminals. CAT# PB-20 \$1.00 each



### MINIATURE TOGGLE SWITCH

S.P.D.T. (ON-ON)

Rated: 5 amp @ 120 Vac. Solder lug terminals. CAT# MTS-4 \$1.35 each 10 for \$12.50 • 100 for \$110.00



## WALL TRANSFORMERS



ALL PLUG DIRECTLY INTO 120 VAC OUTLET

12 Vdc @ 500 ma. CAT# DCTX-125 \$4.50  
6 Vdc @ 200 ma. CAT# DCTX-620 \$2.25  
9 Vdc @ 1 amp. CAT# DCTX-951 \$5.00  
24 Vdc @ 825 ma. CAT# ACTX-2462 \$3.25

## NICKEL-CAD BATTERIES (RECHARGEABLE)

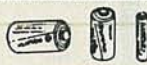

AAA SIZE \$1.50 each  
1.2 volts 180 mAh  
CAT# NCB-AAA  
AA SIZE \$2.00 each  
1.25 volts 500 mAh  
CAT# NCB-AA  
AA SIZE \$2.20 each  
WITH SOLDER TABS  
CAT# NCB-SAA  
C SIZE \$4.25 each  
1.2 volts 1200 mAh  
CAT# NCB-C  
D SIZE \$4.50 each  
1.2 volts 1200 mAh  
CAT# NCB-D

## XENON TUBE

1" long flashtube with 3 1/2" red and black leads. Ideal for electronic flash or strobe projects. CAT# FLT-3 2 for \$1.00

## RELAYS

5-6 VDC SIP REED RELAY  
Electrol  
"Blue Boy" # BBS1A05A10  
5-6 Vdc, 500 ohm coil, S.P.S.T. normally open reed relay.  
0.5 amp contacts. SIP configuration. 1" X .375" X .3".  
CAT# RRLY-SIPS \$1.10 each • 10 for \$10.00

### 5 VDC LATCHING RELAY

Aromat# RSL2D-5V  
Miniature SPDT, dual coil latching relay. 5 Vdc, 170 ohm coils. 1 amp. TTL compatible. UL and CSA recognized. 0.787" X 0.394" X 0.394".  
CAT# LRLY-5DC \$2.50 each

### 12 VOLT D.C. COIL

S.P.D.T.  
Omron# G2E-184P  
4 amp contacts. 335 ohm coil. Sugar cube size. .61" X .42" X .44" high. P.C. mount with pins on DIP spacing.  
CAT# RLY-787 \$1.50 each

## 0-30 MINUTE AUTO-SHUTOFF TIMER

Sankyo Seike Mfg.# TMCF35MYB9

120 Vac 60 Hz. 10 amp contacts. UL rated. Turn shaft to turn on lights or other electrical devices. Bell rings and circuit breaks after specified amount of time. Ideal for any device that needs to shut off automatically. 2.92" X 1.9" X 2.54" behind face plate. 1/4" half-round shaft. CAT# TMC-30 \$3.00 each



## PHOTO FLASH CAPACITOR

Rubycon# FXK

200 mfd. 330 volts. 0.79" diameter X 1.11" high. Solder loop terminals. CAT# PPC-200 \$3.25 each 10 for \$30.00 • 100 for \$275.00



## 22/44 PIN CONNECTOR

.156" pin spacing, 0.200" between double rows, gold contacts, P.C. mounting. SPECIAL. Same as AMP# 2-530655-6. CAT# EBC-1G \$1.00 each • 10 for \$8.00

## ELECTRONIC GAME BOARD

The inner workings of an electronic Scrabble game. Operates on 6 Vdc. 8 digit alpha-numeric readout, 45 button keypad, 14 transistors, 2 I.C.'s, 1 piezo element and other goodies. Top and bottom row of keypad buttons are function keys, middle 3 rows are alphabetic. No instructions available. 6" X 4.45". CAT# ST-4 \$1.75 each 10 for \$15.00



## TELEPHONE COUPLING TRANSFORMER

Multi Products International# A19N-HO-1Dv1  
Primary: 600 ohm  
Secondary: 600/600 ohm  
0.77" X 0.61" X 0.63" high. 6 p.c. pins on 0.187" centers. Primary inductance: 300 mH min., at 1kHz, 1 volt. CAT# TCTX-1 \$1.25 each • 10 for \$11.00



## LED'S

STANDARD JUMBO DIFFUSED T 1-3/4 size  
RED CAT# LED-1 10 for \$1.50 • 100 for \$13.00  
GREEN CAT# LED-2 10 for \$2.00 • 100 for \$17.00  
YELLOW CAT# LED-3 10 for \$2.00 • 100 for \$17.00

### FLASHING LED

with built in flashing circuit operates on 5 volts...  
RED CAT# LED-4 10 for \$9.50  
GREEN CAT# LED-5 10 for \$9.50  
CAT# LED-4G 10 for \$9.50

### BI-POLAR LED

Lights RED one direction, GREEN the other. Two leads. CAT# LED-6 2 for \$1.70  
LED HOLDER  
Two piece holder. CAT# HLED 10 for 65¢

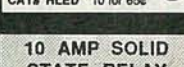

## 10 AMP SOLID STATE RELAY

ELECTROL# S217B  
CONTROL: Rated 5.5 to 10 Vdc (will operate on 3-32 Vdc). LOAD: 10 amp @ 240 Vac 2 1/4" X 1 3/4" X 7/8". CAT# SSRLY-10B \$9.50 ea. QUANTITY DISCOUNT 10 for \$85.00 • 25 for \$175.00 50 for \$300.00 • 100 for \$500.00



## OPTO SENSOR

U shaped package with mounting ears. 1/8" opening. 3/4" mounting ears. CAT# OSU-6 50¢ each 10 for \$4.50 • 100 for \$40.00



## A.C. LINE CORDS

Black 6ft., 18/2, SPT-2

NON POLARIZED PLUG CAT# LCAC 2 for \$1.00 100 for \$45.00

POLARIZED PLUG CAT# LCP-1 60¢ each 100 for \$50.00

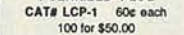

## L.E.D. FLASHER KIT

Two L.E.D.'s flash in unison when a 9 volt battery is attached. This kit includes a p.c. board, all the parts and instructions to make a simple flasher circuit. A quick and easy project for anyone with basic soldering skills. CAT# LEDKIT \$1.75 per kit



## LOOK WHAT \$1.00 WILL BUY

200 ASSORTED 1/4 WATT RESISTORS  
Bent leads, carbon comp. and carbon film. CAT# GRES \$1.00 per assortment

200 ASSORTED 1/2 WATT RESISTORS  
Bent leads, carbon comp. and film. CAT# GRABRE \$1.00 per assortment

50 ASSORTED DISC CAPACITORS  
Most are cut (p.c. leads). Some to 500 volts. CAT# GRABDC \$1.00 per assortment

15 VALUES OF ELECTROLYTICS  
Contains both axial and radial styles from 1 mfd. CAT# GRABCP \$1.00 per assortment

## LOOK WHAT \$2.00 WILL BUY

15 AMP SNAP-ACTION SWITCH  
5 pieces of a 15 amp 125,250 Vac normally open switch. Body is 1 3/4" X 5/8" X 5/8". Button extends 3/16" above switch body. CAT# GRABMS \$2.00 per package

TO-92 TRANSISTORS  
20 assorted TO-92 plastic case transistors. Various styles of NPN and PNP. Some house marked, some standard marking. CAT# GRTRN \$2.00 per assortment

SWITCHES  
10 assorted slide, toggle, rotary, pushbutton and rocker switches. Our choice. CAT# GRABSW \$2.00 per assortment

CALL OR WRITE FOR OUR FREE 60 PAGE CATALOG OVER 4000 PARTS!



OUTSIDE THE U.S.A. SEND \$2.00 POSTAGE FOR A CATALOG!!

ORDER TOLL FREE 1-800-826-5432

MAIL ORDERS TO:  
ALL ELECTRONICS  
P.O. BOX 567  
VAN NUYS, CA 91408

INFO: (818)904-0524  
FAX: (818)781-2653  
MINIMUM ORDER \$10.00  
QUANTITIES LIMITED  
CALIF. ADD SALES TAX  
USA: \$3.50 SHIPPING  
FOREIGN ORDERS  
INCLUDE SUFFICIENT SHIPPING. NO C.O.D.



MARCH 1990





# JDR Microdevices®

**MMC**  
MICROCOMPUTER  
MARKETING COUNCIL  
of the Direct Marketing Association, Inc.

30 DAY MONEY BACK GUARANTEE • 1 YEAR WARRANTY ON ALL PRODUCTS • TOLL-FREE TECHNICAL SUPPORT

## DYNAMIC RAMS

NEW LOW PRICES!

PART#	SIZE	SPEED	PINS	PRICE
4164-150	65536x1	150ns	16	2.49
4164-120	65536x1	120ns	16	2.89
4164-100	65536x1	100ns	16	3.39
TMS4464-15	65536x4	150ns	16	3.59
TMS4464-12	65536x4	120ns	16	3.95
TMS4464-10	65536x4	100ns	16	4.95
41256-150	262144x1	150ns	16	2.59
41256-120	262144x1	120ns	16	2.95
41256-100	262144x1	100ns	16	3.15
41256-80	262144x1	80ns	16	3.75
41256-60	262144x1	60ns	16	5.25
414256-100	262144x4	100ns	20	12.95
414256-80	262144x4	80ns	20	13.45
1 MB-120	1048576x1	120ns	18	11.95
1 MB-100	1048576x1	100ns	18	12.35
1 MB-80	1048576x1	80ns	18	12.95

## SIMM/SIP MODULES

NEW LOW PRICES!

PART#	SIZE	SPEED	TYPE	PRICE
41256A9B-12	256K x 9	120ns	SIMM/PC	35.95
41256A9B-80	256K x 9	80ns	SIMM/PC	49.95
421000A8B-10	1MB x 8	100ns	SIMM/MAC	109.95
421000A9B-10	1MB x 9	100ns	SIMM/PC	113.95
421000A9B-80	1MB x 9	80ns	SIMM/PC	119.95
256KX9SIP-80	256K x 9	80ns	SIP/PC	54.95
256KX9SIP-60	256K x 9	60ns	SIP/PC	64.95
1MBX9SIP-80	1MB x 9	80ns	SIP/PC	124.95

## STATIC RAMS

NEW LOW PRICES!

PART#	SIZE	SPEED	PINS	PRICE
HM6116LP-2	2048x8	120ns	24	5.49
HM6264LP-15	8192x8	150ns	28	4.95
HM6264LP-12	8192x8	120ns	28	6.49
HM43256LP-12	32768x8	120ns	28	14.95
HM43256LP-10	32768x8	100ns	28	15.95

## MATH COPROCESSORS

### 8-BIT COPROCESSORS

8087	5 MHz	89.95
8087-2	8 MHz	129.95
8087-1	10 MHz	169.95

intel 5 YEAR WARRANTY

### 16-BIT COPROCESSORS

80287	6 MHz	139.95
80287-8	8 MHz	209.95
80287-10	10 MHz	239.95
80C287	12 MHz	299.95

### 32-BIT COPROCESSORS

80387-16	16 MHz	359.95
80387-SX	16 MHz	319.95
80387-20	20 MHz	399.95
80387-25	25 MHz	499.95
80387-33	33MHz	649.95

INCLUDES MANUAL & SOFTWARE GUIDE

## 74 SERIES LOGIC

7400	.19	74LS32	.18	74LS245	.79
74LS00	.16	74LS73	.29	74LS273	.79
74LS02	.17	7474	.33	74S289	1.69
7404	.19	74LS74	.24	74LS322	3.95
74LS04	.16	74S74	.49	74LS367	.39
74S04	.29	74LS138	.39	74LS373	.79
7406	.29	74LS155	.59	74LS374	.79
7408	.24	74LS163	.39	74LS393	.79
74LS08	.18	74LS240	.69	74LS682	3.20
7432	.29	74LS244	.69	74LS688	2.40

## C.P.U.'s

8000	
8052AH	BASIC 34.95
8088	5.99
8250	6.95
8251A	1.69
8253-5	1.95
8254	9.95
8255-5	2.49
8741	9.95
8748	9.95
8749	9.95
8755	14.95

## MISC

DAC0800	3.29
1793	9.95
COM8116	8.95
MC146818	5.95
MM50167	9.95
INS9250	6.95
NS16450	10.95
LM317T	.69
NE555	.29
LM741	.29
7805T	.49
7812T	.49
75150	1.95
75154	1.95
14411	9.95

## CRYSTAL OSCILLATORS

65C02*	7.95
6522	2.95

V20	6.95
V20-8	8.95
V20-10	11.95
V30	13.95

## PALS

16L8	2.95
16R4	2.95
16R6	2.95
16R8	2.95
20L8	4.95
20R4A	4.95
20R6	4.95
20R8	4.95
20X8	4.95

## PAL KIT

AN ENTRY-LEVEL COMPLETE PAL DEVELOPMENT KIT FROM CUPL-FULL SUPPORT FOR 16L8, 16R4, 16R6, 16R8, 20L8, 20R4, 20R6, 20R8, AND 20X8. MOD-MPL-SOFT \$99.95



## Derick's HIGH-TECH SPOTLIGHT

Call our BBS: (408) 559-0253 for more info in SIG file "Hitech"

Memory speed ratings seem to cause a good deal of confusion, probably because many people are unsure of the maximum ratings of their equipment.

When you buy faster memory than your CPU requires, you will not process data any faster than if you bought the slower memory, but many people do spend the extra 5-10% and buy faster memory anyway. For some, the reason is "margin for error", and others, like myself, are looking into the future as the next generation of CPU's will no doubt require faster memory.

This list of Intel based processors contains information that should determine which memory speed you require. It is not exhaustive, and may differ from the specifications which came with your computer. Please use the manufacturers recommendations when in doubt.

CPU	Speed	Standard	0 wait	1 wait	Interleaved
8088	8MHz	150ns	-	-	-
8088	10MHz	120ns	-	-	-
80286	6MHz	-	200ns	200ns	-
80286	8MHz	-	120ns	200ns	-
80286	10MHz	-	100ns	150ns	-
80286	12MHz	-	80ns	120ns	-
80286	16MHz	-	60ns	100ns	120ns
80286	20MHz	-	< 50ns	80ns	80ns
80386	16MHz	-	60ns	100ns	120ns
80386	20MHz	-	< 50ns	80ns	100ns
80386	25MHz	-	< 40ns	80ns	80ns

Derick Moore, Director of Engineering

## PROTOTYPE CARDS

FR-4 EPOXY GLASS LAMINATE WITH GOLD PLATED EDGE CARD FINGERS AND SILK SCREENED LEGENDS



### FOR XT

JDR-PR1	WITH +5V AND GROUND PLANE	27.95
JDR-PR2	ABOVE WITH I/O DECODING LAYOUT	29.95
JDR-PR2-PK	PARTS KIT FOR JDR-PR2 ABOVE	8.95

### FOR AT

JDR-PR10	BIT WITH I/O DECODING LAYOUT	34.95
JDR-PR10-PK	PARTS KIT FOR JDR-PR10 ABOVE	12.95

### FOR PS/2

JDR-PR32	32 BIT PROTOTYPE CARD	69.95
JDR-PR16	16 BIT WITH I/O DECODING LAYOUT	49.95
JDR-PR16-PK	PARTS KIT FOR JDR-PR16 ABOVE	15.95
JDR-PR16V	16 BIT FOR VIDEO APPLICATIONS	39.95

### EXTENDER CARDS

SIMPLIFY PROTOTYPING AND TESTING

EXT-8088	8-BIT FOR 8088 MOTHERBOARDS	29.95
EXT-80286	16-BIT FOR 286/386 MOTHERBOARDS	39.95
EXT-16	MICROCHANNEL 16-BIT	69.95
EXT-32	MICROCHANNEL 32-BIT	99.95

## PC BREADBOARD-ON-A-CARD



- 62 BUS LINES
- USE UP TO 24 14-PIN IC'S
- 1940 TIE POINTS
- DB25 D-SUB CONNECT.
- PDS-604 .....\$49.95

## SOLDER STATION



- UL APPROVED
- ADJUSTABLE HEAT SETTING
- TIP TEMPERATURE READOUT
- REPLACEMENT TIPS @ \$2.95
- 168-3C .....\$59.95

## IC SOCKETS/DIP CONNECTORS

SOLDERTAIL	WIREWRAP	ZIF SOCKETS
8 PIN ST	.11 8 PIN WW	.59 ZIF-14 5.95
14 PIN ST	.11 14 PIN WW	.69 ZIF-16 5.95
16 PIN ST	.12 16 PIN WW	.69 ZIF-20 6.95
20 PIN ST	.15 20 PIN WW	.99 ZIF-24 7.95
24 PIN ST	.18 20 PIN WW	1.09 ZIF-28 7.95
24 PIN ST	.20 24 PIN WW	1.49 ZIF-40 10.95
28 PIN ST	.22 28 PIN WW	1.69
40 PIN ST	.30 40 PIN WW	1.99

VOLUME DISCOUNTS CALL!

## SOLDER-CUP D-SUBS

MALE	FEMALE	IDC'S
DB09P	.45 DB09S	.49 IDE20 .55
DB15P	.59 DB15S	.69 IDE34 .89
HDB15P	1.49 HDB15S	1.59 IDE50 .65
DB19P	.69 DB19S	.75 IDE84 .75
DB25P	.69 DB25S	.75 IDB09P 1.39
DB37P	1.35 DB37S	1.39 IDB09S 1.45
DB50P	1.85 DB50S	2.29 IDB25P 2.25
		IDB25S 2.35

## EPROM ERASERS

### DATASE II \$39.95

- SHIRT POCKET SIZE!
- ALL SIZES UP TO 4 AT A TIME
- ERASES MOST EPROMS IN 3 MINUTES



### SPECTRONICS CORPORATION

Model	Timer	# of Chips	Intensity (uW/Cm <sup>2</sup> )	Unit Cost
PE-140	NO	9	8,000	\$ 89.95
PE-140T	YES	9	8,000	\$139.95
PE-240T	YES	12	9,600	\$189.95
PL-265T	YES	30	9,600	\$255.95

## POWER SUPPLIES

### 135 WATT

- XT-COMPATIBLE • UL APPROVED • 110-220VSWITCH
- +5V @ 15A, +12V @ 4.2A, -5V @ .5A, -12V @ .5A

PS-135	.....\$59.95
PS-150 150W SUPPLY	.....\$69.95
PS-200X 200W SUPPLY	.....\$89.95

### 200 WATT

- AT-COMPATIBLE • UL APPROVED • 110-220V SWITCH
- +5V @ 20A, +12V @ 7A, -5V @ .5A, -12V @ .5A

PS-200	.....\$89.95
PS-250 250W SUPPLY	.....\$129.95

## CABLES AND GENDER CHANGERS

MOLDED; GOLD-PLATED CONTACTS; 100% SHIELDED

CBL-PRNTR	6 FT. PC PRINTER CABLE	9.95
CBL-PRNTR-25	25 FT. PC PRINTER CABLE	15.95
CBL-PRNTR-RA	RIGHT ANGLE PRINTER CABLE	15.95
CBL-DB25-MM	DB25 MALE-DB25 MALE 6 FT.	9.95
CBL-DB25-MF	DB25 MALE-DB25 FEMALE 6 FT.	9.95
CBL-9-SERIAL	DB9 FEMALE-DB25 MALE 6 FT.	6.95
CBL-KBD-EXT	5 FT. KEYBOARD EXTENSION	7.95
CBL-CNT-MM	36-PIN CENTRONICS-MM	14.95
CBL-FDC-EXT	37-PIN EXT. FLOPPY CABLE	9.95
CBL-MNT-9	9-PIN MONITOR EXTENSION	6.95
CBL-MNT-15	15-PIN MONITOR EXTENSION CABLE	9.95
CBL-MODEM	MODEM-DB25-DB25 FEMALE	6.95
GENDER-VGA	DB9-DB15 ADAPTOR	4.95
GENDER-9-25	DB9-DB25 SERIAL ADAPTOR	4.95

PARTIAL LISTINGS ONLY—CALL FOR FREE 100-PG CATALOG!

COPYRIGHT 1989 JDR MICRODEVICES

JDR MICRODEVICES AND THE JDR MICRODEVICES LOGO ARE REGISTERED TRADEMARKS OF JDR MICRODEVICES. IBM, AT, PS/2 ARE TRADEMARKS OF INTERNATIONAL BUSINESS MACHINES.

CIRCLE 113 ON FREE INFORMATION CARD  
DEALERS CIRCLE 170 ON FREE INFORMATION CARD



**4800/2400 BAUD  
FAX/DATA MODEM  
\$119.95**

- FAX TRANSMISSION ONLY
- 4800 BAUD FAX CAPABILITY TO ANY GROUP III FAX
- 2400 BAUD V.22BIX DATA MODEM
- XT/AT COMPATIBLE HALF CARD
- MENU-DRIVEN SOFTWARE
- MULTIPLE FAX TRANSMISSIONS TO GROUPED ADDRESSES

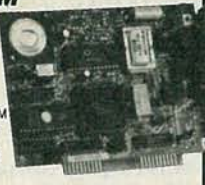

MCT-FAXM

**2400 BAUD MODEM  
\$89.95**

- 2400/1200/300 BAUD
- FULL HAYES COMPATIBILITY
- CONFIGURE AS COM1, COM2, COM3 OR COM4
- BUILT-IN SPEAKER • AUTO WAIT-FOR-DIAL TONE AND AUTO-REDIAL • PROCOMM COMMUNICATIONS SOFTWARE • MADE IN THE USA



MCT-241  
MCT-121 1200 BAUD INTERNAL MODEM ..... \$59.95

**MINI UPRIGHT CASE \$199.95**

- SMALL FOOTPRINT MINI-UPRIGHT FOR 8088 OR MINI 286/386 MOTHERBOARDS
- ROOM FOR 6 EXPANSION CARDS
- HOLDS 3 5-1/4" & 1 1/2" DRIVES (1/2 HT)
- 200 WATT POWER SUPPLY
- 2-DIGIT LED SPEED DISPLAY
- 12" H X 16" L X 8" W



**UPRIGHT CASE \$249.95**

- SPACE SAVING DESIGN HOLDS ALL SIZES OF MOTHERBOARDS AND INCLUDES: • 250W POWER SUPPLY
- MOUNTS FOR 3 FLOPPY & 4 HARD DRIVES
- TURBO & RESET SWITCH • LED SPEED DISPLAY • POWER & DISK LED'S
- ALL HARDWARE, FACEPLATE & SPEAKER



- CASE-FLIP FOR 8088 MB'S ..... \$39.95  
 CASE-SLIDE FOR 8088 MB'S ..... \$39.95  
 CASE-70 FOR 286 MB'S ..... \$89.95  
 CASE-50 FOR MINI 286 MB'S ..... \$59.95  
 CASE-JR MINI-286 W/150W PS \$149.95

**MODULAR PROGRAMMING SYSTEM**

MODULES USE A COMMON HOST ADAPTOR CARD-- 1 SLOT PROGRAMS EPROMS, PROMS, PALS, MORE!

**HOST ADAPTOR CARD \$29.95**

- UNIVERSAL INTERFACE FOR ALL PROGRAMMING MODULES!
- SELECTABLE ADDRESSES PREVENTS CONFLICTS
- MOLDED CABLE



**UNIVERSAL MODULE \$499.95**

- PROGRAMS EPROMS, EEPROMS, PALS, BI-POLAR PROMS, 8748 & 8751 SERIES DEVICES; 16V8 AND 20V8 GALS (GENERIC ARRAY LOGIC) FROM LATTICE, NS, SGS • TESTS TTL, CMOS, DYNAMIC & STATIC RAMS • LOAD DISK, SAVE DISK, EDIT, BLANK CHECK, PROGRAM, AUTO, READ MASTER, VERIFY AND COMPARE • TEXT TOOL SOCKET FOR .3" - 6" W. IC'S (8-40 PINS)

**EPROM MODULE \$119.95**

- PROGRAMS 24-32 PIN EPROMS, CMOS EPROMS & EEPROMS FROM 1K TO 1024K • HEX TO OBJ CONVERTER • AUTO, BLANK CHECK/PROGRAM/VERIFY • VPP 5, 12.5, 12.75, 13, 21 & 25 VOLTS • NORMAL, INTELLIGENT, INTERACTIVE & QUICK PULSE PROGRAMMING ALGORITHMS

- MOD-MEP-4 4-EPROM PROGRAMMER ..... \$169.95  
 MOD-MEP-8 8-EPROM PROGRAMMER ..... \$259.95  
 MOD-MEP-16 16-EPROM PROGRAMMER ..... \$499.95
- OTHER MODULES**
- MOD-MPL PAL MODULE ..... \$249.95  
 MOD-MIC DIGITAL TESTER MODULE ..... \$129.95  
 MOD-MBP BI-POLAR PROGRAMMING MODULE ..... \$259.95  
 MOD-MMP MICROPROCESSOR PROG. MODULE ..... \$179.95  
 MOD-MPL-SOFT CUPL SOFTWARE ..... \$99.95

**VGA COMPATIBLE PACKAGE**

**\$499.95**

- 720 X 540 MAX RESOLUTION, 640 X 480 IN 16 COLORS, 528 X 480 RESOLUTION IN 256 COLORS • IBM STYLE MONITOR
- VGA, EGA, CGA, AND MGA COMPATIBLE



VGA-PKG (INCLUDES VGA CARD AND MONITOR)  
**VGA MONITOR \$359.95**  
 • 14" ANALOG VGA • GLARE RESISTANT SCREEN • 720 X 480  
 • TILT/SWIVEL BASE • FRONT MOUNTED POWER SWITCH

**RELISYS MULTISYNCH \$429.95**

- FULL FEATURED MULTISCAN MONITOR WITH UNLIMITED COLORS • 1024 X 768 RESOLUTION, 14" NON-GLARE DISPLAY
- AUTO SWITCHING • TTL/ANALOG VIDEO INPUT

JDR-MULTI  
**EGA SPECIAL! CARD & MONITOR--JUST \$479**

- EGA-MONITOR 14" RGB MONITOR ..... \$339.95  
 NEC-MULTI-3D DIGITAL 1024X768 RESOLUTION ... \$649.95  
 JDR-MONO 12" TTL MONOCHROME- GREEN ..... \$84.95  
 JDR-AMBER 12" TTL MONOCHROME-AMBER ..... \$69.95

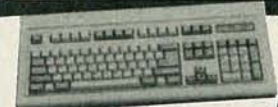

**QUALITY KEYBOARDS**

- STANDARD KEYBOARDS:**  
 BTC-5060 AUTOSENSE FOR XT/AT ..... \$59.95  
 MAX-5060 WITH TACTILE FEEDBACK ..... \$64.95

- ENHANCED KEYBOARDS:**  
 BTC-5339 AUTOSENSE FOR XT/ AT, AUTOREPEAT ... \$69.95  
 K103-A AUDIBLE "CLICK" STYLE ..... \$84.95  
 MAX-5339 MAXI-SWITCH W/TACTILE FEEDBACK ..... \$84.95

**MODULAR CIRCUIT TECHNOLOGY**

- DRIVE CONTROLLERS:**  
 MCT-FDC FLOPPY DISK CONTROLLER ..... \$29.95  
 MCT-FDC-HD 1.44MB FLOPPY CONTROLLER ..... \$49.95  
 MCT-HDC HARD DISK CONTROLLER ..... \$79.95  
 MCT-RLL RLL CONTROLLER ..... \$89.95  
 MCT-FH FLOPPY/HARD CONTROLLER ..... \$139.95  
 MCT-AFH 286/386 FLOPPY/HARD ..... \$149.95  
 MCT-AFH-RLL 286/386 RLL CONTROLLER ..... \$199.95

- DISPLAY ADAPTOR CARDS:**  
 MCT-MGP MONOCHROME GRAPHICS ..... \$49.95  
 MCT-CG COLOR GRAPHICS ADAPTOR ..... \$44.95  
 MCT-EGA ENHANCED GRAPHICS ADAPTOR ..... \$149.95  
 MCT-VGA-8 8-BIT VGA, ANALOG OUTPUT ..... \$169.95  
 MCT-VGA-16 16-BIT VGA, ANALOG OUTPUT ..... \$199.95  
 MCT-MGMO MONOGRAPHS MULTI I/O ..... \$119.75  
 MCT-MGAIO 286/386 MONOGRAPHS I/O ..... \$99.95

- MULTIFUNCTION CARDS:**  
 MCT-MIO MULTI I/O FLOPPY CONTROLLER ..... \$79.95  
 MCT-IO MULTI I/O CARD ..... \$59.95  
 MCT-AMF 286/386 MULTIFUNCTION ..... \$139.95  
 MCT-AIO 286/386 MULTI I/O CARD ..... \$59.95

- MEMORY CARDS:**  
 MCT-RAM 576K RAM CARD ..... \$49.95  
 MCT-EMS EXPANDED MEMORY CARD ..... \$99.95  
 MCT-AEMS 286/386 EMS CARD ..... \$129.95

**GeniScan 400 DPI**

**\$199.95**

- UP TO 400 DPI • 32 LEVELS OF GRAY SCALE • SPEED OVERRUN WARNING LIGHT
- INCLUDES SCANEDIT I AND DR. GENIUS SOFTWARE



**EPROM PROGRAMMER \$129.95**

- PROGRAMS 27XX AND 27XXX EPROMS UP TO 27512
- SUPPORTS VARIOUS PROGRAMMING FORMATS & VOLTAGES
- SPLIT OR COMBINE CONTENTS OF SEVERAL EPROMS OF DIFFERENT SIZES
- READ, WRITE, COPY, BLANK CHECK & VERIFY
- SOFTWARE FOR HEX AND INTEL HEX FORMATS



**HARD DISKS KITS**

- 21.4 MB \$199 21.4 MB \$249  
 32.7 MB \$219 32.1 MB \$279  
 42.8 MB \$339  
 65.5 MB \$389  
 80.2 MB \$569



SIZE	MODEL	AVG. SPEED	FORM FACTOR	DRIVE ONLY	XT KIT	AT F/H KIT
21.4MB	ST-225	65 MS	5-1/4"	\$199	\$249	\$309
32.7MB RLL	ST-238	65 MS	5-1/4"	\$219	\$279	\$379
42.8MB	ST-251-1	28 MS	5-1/4"	\$339	\$389	\$449
65.5MB RLL	ST-277-1	28 MS	5-1/4"	\$389	\$449	\$549
80.2MB	ST-4096	28 MS	5-1/4"	\$569	—	\$679
122.7MB RLL	ST-4144R	28 MS	5-1/4"	\$699	\$759	\$859
21.4MB	ST-125	40 MS	3-1/2"	\$259	\$299	\$373
32.1MB RLL	ST-138	40 MS	3-1/2"	\$289	\$339	\$429

**157.5MB ESDI DRIVE KIT \$1049**

- 5-1/4" HARD DISK, FLOPPY/HARD CONTROLLER, CABLES, MOUNTING HARDWARE & SOFTWARE, 1355-PKG

**1.44MB 3-1/2" DRIVE \$99.95**

- ULTRA HIGH DENSITY
- READ/WRITE 720K DISKS, TOO
- FDD-1.44X BLACK FACEPLATE
- FDD-1.44A BEIGE FACEPLATE
- FDD-1.44 SOFT SOFTWARE DRIVER \$19.95



- 1/2 HEIGHT FLOPPY DISK DRIVES:**  
 FD-55B 5-1/4" TEAC DS/DD 360K ..... \$99.95  
 FD-55G 5-1/4" TEAC DS/DD 1.2M ..... \$129.95  
 FDD-360 5-1/4" DS/DD 360K ..... \$69.95  
 FDD-1.2 5-1/4" DS/HD 1.2M ..... \$95.95

**MOTHERBOARDS**

**20MHZ 386 \$629 UPGRADE!**

- 16/20 MHZ
- 16 MB RAM CAPACITY - 8MB ON BOARD(OK), 8 MB RAM CARD
- USES 256K OR 1MB SIP RAMS
- 8 SLOTS: 1X32-BIT RAM 2X 8-BIT & 5X 16-BIT
- MEMORY INTERLEAVING
- AMI BIOS • XT-SIZE BOARD



- MCT-M386-20 25MHZ MINI 386 W/CACHE .. \$1199.00  
 MCT-M386-M4 8MB RAM CARD (OK) ..... \$99.95  
 MCT-386MB20 10/20MHZ 386 ..... \$799.00  
 MCT-386MB25 10/25MHZ 386 ..... \$999.00

**10MHZ MINI-286 \$189.95**

- AT COMPATIBLE • KEYBOARD SELECTABLE 6/10MHZ
- EXPANDABLE TO 4MB ON-BOARD WITH 1MB DRAMS (OK)
- SIX 16-BIT, TWO 8-BIT SLOTS • AMI BIOS • LED SUPPORT

- MCT-M286-10 8/12MHZ MINI-286 ..... \$199.95  
 MCT-M286-12 8/16MHZ 286 ..... \$289.95  
 MCT-M286-16N 10/20MHZ 286 ..... \$389.95  
 MCT-M286-20N STANDARD 4.77MHZ 8088 ..... \$87.95  
 MCT-TURBO 4.77/8MHZ 8088 ..... \$89.95  
 MCT-TURBO-10 4.77/10MHZ SINGLE CHIP 8088 ..... \$99.95

**LOGITECH MICE**

- THREE-BUTTON SERIES 9
  - 320 DPI RESOLUTION
  - SERIAL PS/2 COMPATIBLE.
- LOGC9 SERIAL MOUSE ..... \$98.95  
 LOGC9-C SERIAL (NOT PS/2 COMPATIBLE) ..... \$79.95  
 LOGC9-P SERIAL MOUSE WITH PAINTSHOW ..... \$109.95  
 LOGC9-PC SERIAL MOUSE WITH PAINT/CAD ..... \$154.95  
 LOGB9 BUS MOUSE ..... \$89.95  
 LOGB9-P BUS MOUSE WITH PAINTSHOW ..... \$104.95  
 LOGB9-PC BUS MOUSE WITH PAINT/CAD ..... \$149.95



JDR MICRODEVICES, 2233 BRANHAM LANE, SAN JOSE 95124  
 LOCAL (408) 559-1200 FAX (408) 559-0250 TELEX 171-110  
 RETAIL STORE: 1256 S. BASCOM AVE., SAN JOSE, CA  
 (408) 947-8881 HOURS: M-F 9-7 SAT. 9-5 SUN. 12-4

Terms: Minimum order \$10.00. For shipping & handling include \$3.50 for ground and \$4.50 for air. Orders over 1 lb and foreign orders may require additional shipping charges—please contact the sales department for the amount. CA residents must include applicable sales tax. Prices subject to change without notice. We are not responsible for typographical errors. We reserve the right to limit quantities and to substitute manufacturer. All merchandise subject to prior sales. A full copy of our terms is available upon request. Items pictured may only be representative.

**ORDER TOLL FREE 800-538-5000**

CUSTOMER SERVICE TOLL-FREE 800-538-5001 • TECHNICAL SUPPORT TOLL-FREE 800-538-5002

CIRCLE 113 ON FREE INFORMATION CARD  
 DEALERS CIRCLE 170 ON FREE INFORMATION CARD



**VALUE-PRICED TEST EQUIPMENT ALL WITH A 2 YEAR WARRANTY!**

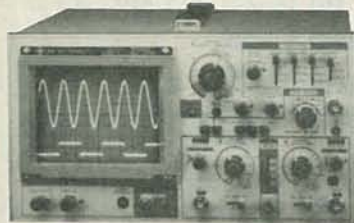

**35 MHZ DUAL TRACE OSCILLOSCOPE \$499.95**  
 • WIDE BAND WIDTH • VARIABLE HOLDOFF  
 MODEL-3500 (SHOWN)

**20 MHZ DUAL TRACE OSCILLOSCOPE \$389.95**  
 • TV SYNC FILTER • COMPONENTS TESTER  
 MODEL 2000

**THE ULTIMATE 3.5 DIGIT DMM \$79.95**  
 • BASIC DC ACCURACY  $\pm 0.25\%$   
 • 34 RANGES  
 • TEMP, TRANSISTOR & RESISTANCE FEATURES  
 DMM-300 (SHOWN)



**3.5 DIGIT FULL FUNCTION DMM \$49.95**  
 • BASIC DC ACCURACY  $\pm 0.25\%$   
 • 22 RANGES  
 DMM-200 \$49.95

**3.5 DIGIT POCKET SIZE DMM \$29.95**  
 • BASIC DC ACCURACY  $\pm 0.5\%$  • 14 RANGES  
 DMM-100

**3.5 DIGIT PROBE TYPE DMM \$54.95**  
 • AUTORANGING  
 • AC/DC 2V - 500V,  
 • RESISTANCE: 2K-2M  
 DPM-1000 (SHOWN)

**HIGH/LOW LOGIC PROBE \$17.95**  
 • DETECTS TTL/CMOS LOGIC STATES  
 • MEMORY FUNCTION FREEZES DATA FOR LATER USE  
 LP-2800

**PULSER PROBE FOR QUICK DEBUGGING \$19.95**  
 • INJECTS PULSE INTO TEST CIRCUIT-VARIABLE WIDTH  
 • TTL, DTL, TRL, HTL, HINIL, MOS, & CMOS COMPATIBLE  
 LP-540



**JIM'S BARGAIN HUNTERS CORNER**

Jim Wharton  
 JDR's VP Sales

**DFI 400 DPI HANDY SCANNER 3000+**

**\$179.95**

- QUICKLY SCANS IMAGES UP TO 4.1" WIDE
- 100, 200, 300 & 400 DPI IN BOTH DIRECTIONS
- B & W AND 3 HALF-TONE MODES
- 32 LEVELS OF GRAY SCALE
- HERCULES, CGA, EGA AND VGA COMPATIBLE
- INCLUDES INTERFACE CARD
- INCLUDES PC PAINTBRUSH SOFTWARE TO PAINT, ROTATE, FLIP, SHRINK, EXPAND, TILT, INVERT AND ADD TEXT TO YOUR IMAGES
- IMAGE EDITOR UTILITY PERMITS 90° ROTATION AND ABILITY TO SAVE IN WINDOWS, GEM, HALO AND PC PAINTBRUSH FORMATS
- IMAGE TOOLS TO ALLOW MERGING OF GRAPHICS WITH OTHER APPLICATIONS

HS-3000 WAS \$199.95

EXPIRES 3/15/90

**JDR Microdevices**  
 2233 BRANHAM LANE, SAN JOSE, CA 95124

**ORDER TOLL-FREE 800-538-5000**

LOCAL (408) 559-1200 CUSTOMER SERVICE 800-538-5001  
 TECH SUPPORT 800-538-5002 FAX (408) 559-0250

CIRCLE 113 ON FREE INFORMATION CARD  
 DEALERS CIRCLE 170 ON FREE INFORMATION CARD

**ADVERTISING INDEX**

RADIO-ELECTRONICS does not assume any responsibility for errors that may appear in the index below.

Free Information Number	Page		Page
108	AMC Sales	20	NRI Schools
75	Ace Products	30	190,191 Optoelectronics
107	All Electronics	93	— Pacific Cable
—	Amazing Concepts	85	56 Parts Express
84	Appliance Service	30	— People's College of Indep. Study
67	Banner Technical Books	24	78 Radio Shack
109	C & S Sales	15	197,198 SCO Electronics
70	CEI	80	183 Sequoia Publishing
—	CIE	29, 19	176,177 Sencore
200	Cable Network	89	74 Solid State Sales
50	Caig Laboratories	24	— Star Circuits
192	Cheneko Products	30	195 TECI
—	Command Productions	61	194 Tentel
55	Contact East	30	186 Unicorn
58	Cook's Institute	66	198 U.S. Cable TV
187	D&D Electronics	67	64 Video-Link
—	Damark International	CV3	184 Viejo Publications
127	Deco Industries	30	185 WPT Publications
82	Digi-Key	92	
180	Electronic Goldmine	87	
—	Electronics Book Club	62	
—	Electronic Tech. Today	69	
121	Fluke Manufacturing	CV2	
193	Global Specialties	5	
—	Grantham College	41	
86	Heathkit	21	
188,189	ICS	20, 69	
—	Information Unlimited	88	
181	International Components Corp	89	
113,170	JDR Microdevices	94, 95, 96	
114	Jameco	90-91	
115	Jensen Tools	30	
182	Junco Computers	83	
—	King Wholesale	80	
—	LEARN	13	
87	MCM Electronics	83	
53	MD Electronics	86	
93	Mark V. Electronics	87	
—	McGraw Hill Book Club	44	
61	Microprocessors Unltd.	78	
117	Mouser	66	
199	Movie Time	16	
—	NESDA	26	

**Gernsback Publications, Inc.**  
 500-B Bi-County Blvd.  
 Farmingdale, NY 11735  
 1-(516) 293-3000  
 President: Larry Steckler  
 Vice President: Cathy Steckler

**For Advertising ONLY**  
 516-293-3000  
 Fax 1-516-293-3115  
 Larry Steckler  
 publisher

Arline Fishman  
 advertising director  
 Denise Haven  
 advertising assistant  
 Christina Estrada  
 advertising associate  
 Lisa Strassman  
 credit manager

**SALES OFFICES**  
**EAST/SOUTHEAST**  
**Stanley Levitan**  
 Eastern Sales Manager  
 Radio-Electronics  
 259-23 57th Avenue  
 Little Neck, NY 11362  
 1-718-428-6037, 1-516-293-3000

**MIDWEST/Texas/Arkansas/ Okla.**  
**Ralph Bergen**  
 Midwest Sales Manager  
 Radio-Electronics  
 540 Frontage Road—Suite 339  
 Northfield, IL 60093  
 1-312-446-1444  
 Fax 1-312-446-8451

**PACIFIC COAST/ Mountain States**  
**Marvin Green**  
 Pacific Sales Manager  
 Radio-Electronics  
 5430 Van Nuys Blvd. Suite 316  
 Van Nuys, CA 91401  
 1-818-986-2001  
 Fax 1-818-986-2009



# DAMARK

INTERNATIONAL, INC.

**ORDER TODAY!!**  
**1-800-729-9000**  
 THE "GREAT DEAL" CATALOG

## PACKARD BELL

### PACKMATE 286 COMPUTER W/ VGA COLOR MONITOR

- 80286 micro-processor (operates at 12 MHz).
- One 3-1/2" 1.44 MB floppy drive.
- One 5-1/4" 1.22 MB floppy drive.
- 30 MB hard drive.
- 1 MB RAM on motherboard expandable to 3 MB.
- Includes VGA 14" color monitor and VGA card. • IBM compatible. • AT compatible.
- 8 expansion slots. • Dual FDD/HDD controller.
- 2 half height drive cavities exposed.
- 1 half height drive cavity enclosed. • 2 serial ports.
- 1 parallel port. • 101 key keyboard.
- System configuration in CMOS with battery back-up.
- Includes MS DOS 3.3 and GW BASIC.
- 145W Universal power supply.
- Zero wait state.
- Socket for 80287 co-processor on motherboard.
- One Year Warranty!
- Factory New & Perfect!



Mfg. Sugg. Retail:  
**\$3,449.00**

**DAMARK PRICE:**

**\$1499**

Item No. B-1793-132142  
 Insured Ship/Hand.: \$39.00

30 MB Hard Drive!  
 3-1/2" & 5-1/4" Drives!

## ZENITH TURBOSPORT 386 PORTABLE LAPTOP COMPUTER

- 80386 32-bit processor, 12/6 MHz (switchable).
- 40 MB (28ms) hard drive.
- One 3.5" 1.4 MB floppy disk drive. • 2 MB RAM.
- 100% IBM compatible.
- "Page-White" fluorescent backlit LCD display, 10.5" viewing area.
- MS-DOS 3.21 included.
- Supports: MS OS/2 version 1.0, Xenix, and Microsoft Windows/386 environments.
- Zero wait state.
- Socket for 80387 numeric coprocessor.
- Internal Hayes 2400 Baud modem.
- Serial and parallel printer ports.
- Resolution: 640 x 400 pixels.
- 79-key full function detachable keyboard.
- Real time clock and calendar.
- "Fast" charge NiCad battery pack included.
- AC adapter.
- Dim.: 13.25"W x 14.75"D x 4.75"H.
- Weight: 14.7 lbs.
- One Year Warranty!
- Factory New!
- Factory Perfect!



386 40 MB Hard Drive!

Mfg. Sugg. Retail:  
**\$8,499.00**

**DAMARK PRICE:**

**\$2999**

Item No. B-1793-128686  
 Insured Ship/Hand.: \$19.00

## maxon MICRO-SIZE CORDLESS RADAR DETECTOR

- Instant-on radar gun "pulse" signals and alerts you in 1/10 of a second!
- Detects X and K band radar.
- Micro-size...only 4-1/2"W x 3-1/4"D x 11/16"H.
- InstaLok® dual conversion superheterodyne receiver.
- SmarTrac® anti-falsing alarm circuit blocks false signals.
- Different audio warnings for X and K band.
- LED signal strength indicators.
- City/highway switch.
- Audio jack.
- Uses six "AA" batteries (not included).
- Wt: 6-1/2 oz.
- Model RD-XL.
- 90 Day Warranty!



FACTORY NEW! FACTORY PERFECT!

Mfg. Sugg. Retail:  
**\$249.95**

**DAMARK PRICE:**

**\$99**

Item No. B-1793-132761  
 Insured Ship/Hand.: \$5.00

### Accessories Include:

- Earphone, spring visor clip, suction cup windshield mount, cord clips, hook & loop fasteners, straight & coiled power cords with plugs, battery case, and soft vinyl carrying case.

## STAR STAND ALONE CORDLESS PHONE

Introducing a modern-designed telephone for today—with long range reception. Now you can pick-up this phone at an UNHEARD OF LOW PRICE!



- Stand alone design.
- Auto redial. • Frequency: 46-49 MHz.
- Call button from base to phone.
- Tone/pulse dialing.
- Includes rechargeable nickel cadmium batteries.
- Contemporary styling.
- High quality electronics.
- Model#: CP-40.
- 90 Day Warranty!
- Factory New!
- Factory Perfect!

Mfg. Sugg. Retail:  
**\$199.00**

**DAMARK PRICE:**

**\$59**

Item No. B-1793-129049  
 Insured Ship/Hand.: \$5.00

## BLACK & DECKER DELUXE WIRELESS SECURITY SYSTEM

- Intelligent home security system.
- Detects intruder during entry.
- Wireless for easy installation.
- Difficult to defeat because of new, advanced technology.
- Lamp command flashes lamp upon intrusion.
- Signal relay—relays entry sensor intrusion signal from a remote area of your home to controller.
- Tamper resistant. • 85 decibel alarm on inside siren.
- Piercing 120 decibel outside siren.
- Fail-safe battery back-up. • Low battery warning.
- 2 Year Warranty!
- Factory New & Perfect!



Mfg. Sugg. Retail:  
**\$698.00**

**DAMARK PRICE:**

**\$299**

Item No. B-1793-133389  
 Insured Ship/Hand.: \$14.00

- Includes:**
- 8 entry sensors, 1 system controller (includes inside siren), 1 signal relay, 1 lamp command, 1 outside siren, 2 window stickers, 1 yard sign, and complete hardware and batteries.

## HALOGEN TORCHIERE FLOOR LAMP

Fill your room with light from this sleek-looking Halogen Torchiera Floor Lamp. It's truly a lamp of the '90s with its stylish modern design and upward position shade.

- Halogen torchiere floor lamp.
- Shines light upward, yet fills entire room.
- Variable light control switch.
- 500 Watt halogen bulb included.
- Sleek, black finish.
- U.L. approved.
- Contemporary design.
- Glass insert below shade allows light to shine downward also—for a complete lighting effect.
- Height: Approx. 72".
- 1 Year Warranty!
- Factory New!
- Factory Perfect!



Mfg. Sugg. Retail:  
**\$170.00**

**DAMARK PRICE:**

**\$59**

Item No. B-1793-127911  
 Insured Ship/Hand.: \$9.00

**FOR FASTEST SERVICE**  
**CALL TOLL FREE**  
**1-800-729-9000**

CUSTOMER SERVICE: 1-612-566-4940

NAME \_\_\_\_\_  
 ADDRESS \_\_\_\_\_  
 CITY \_\_\_\_\_ ST \_\_\_\_\_ ZIP \_\_\_\_\_  
 PHONE \_\_\_\_\_

Check/Money Order  VISA SIGNATURE \_\_\_\_\_

MasterCard  Discover CARD NO. \_\_\_\_\_ EXP. DATE \_\_\_\_\_



QTY	DESCRIPTION	ITEM #	S/H/I	PRICE

DELIVERY TO 48 U.S. CONTINENTAL STATES ONLY

SUB TOTAL \_\_\_\_\_

in MN add 6% Sales Tax \_\_\_\_\_

Total S/H/I \_\_\_\_\_

GRAND TOTAL \_\_\_\_\_

B-1793

Send To: DAMARK INTERNATIONAL, INC., 6707 Shingle Creek Parkway, Minneapolis, MN 55430



# Introducing The SG80 AM Stereo-FM Stereo Analyzer™

Now For The First Time, A High-Performance AM Stereo (C-QUAM)® - FM Stereo Analyzer Integrated Into One Unit, Allowing You To Performance Test, Troubleshoot, And Align To Manufacturers' Requirements

**New**



**\$3,995**  
**Patented**

Licensed Under Motorola Patent No. 4,218,586

- Complete AM Stereo-FM Stereo Analyzer—exceeds manufacturers' requirements.
- Patented FM analyzing signals isolate any FM receiver defect.
- Exclusive integrated AM Stereo C-QUAM analyzer.
- Digitally accurate performance tests meet EIA/IHF requirements.
- Exclusive, tuneable FM-IF Sweep and Markers—aligns all IF stages.
- Expandable FM features for future service needs, plus SCA compatible.
- Twice the capability for less than 1/2 the cost of stand-alone instruments.

C-QUAM is a registered trademark of Motorola, Inc.

CIRCLE 176 ON FREE INFORMATION CARD

**SENCORE**

3200 Sencore Drive, Sioux Falls, South Dakota 57107

Call 1-800-SENCORE  
(736-2673)

Ask About  
A 10 Day  
Video Preview

