

Radio- Electronics

**RADON KILLS! USE R-E'S
RADON MONITOR IN YOUR BASEMENT.**

JULY 1988

TECHNOLOGY - VIDEO - STEREO - COMPUTERS - SERVICE

**BUILD THIS
LC METER**
ACCURATELY MEASURE
INDUCTANCE AND
CAPACITANCE

PUT RE'S ADVANCED
CONTROL SYSTEM
TO WORK IN YOUR HOME

A PRIMER ON THE
**GENERAL PURPOSE
INTERFACE BUS**
FOR TEST EQUIPMENT

USE OUR
CIRCUIT COOKBOOK
TO BUILD PRACTICAL
OTA CIRCUITS

COMPUTERDIGEST

BUILD A PAIR OF
LINE-CARRIER MODEMS
FOR CABLE-FREE
INTERFACING

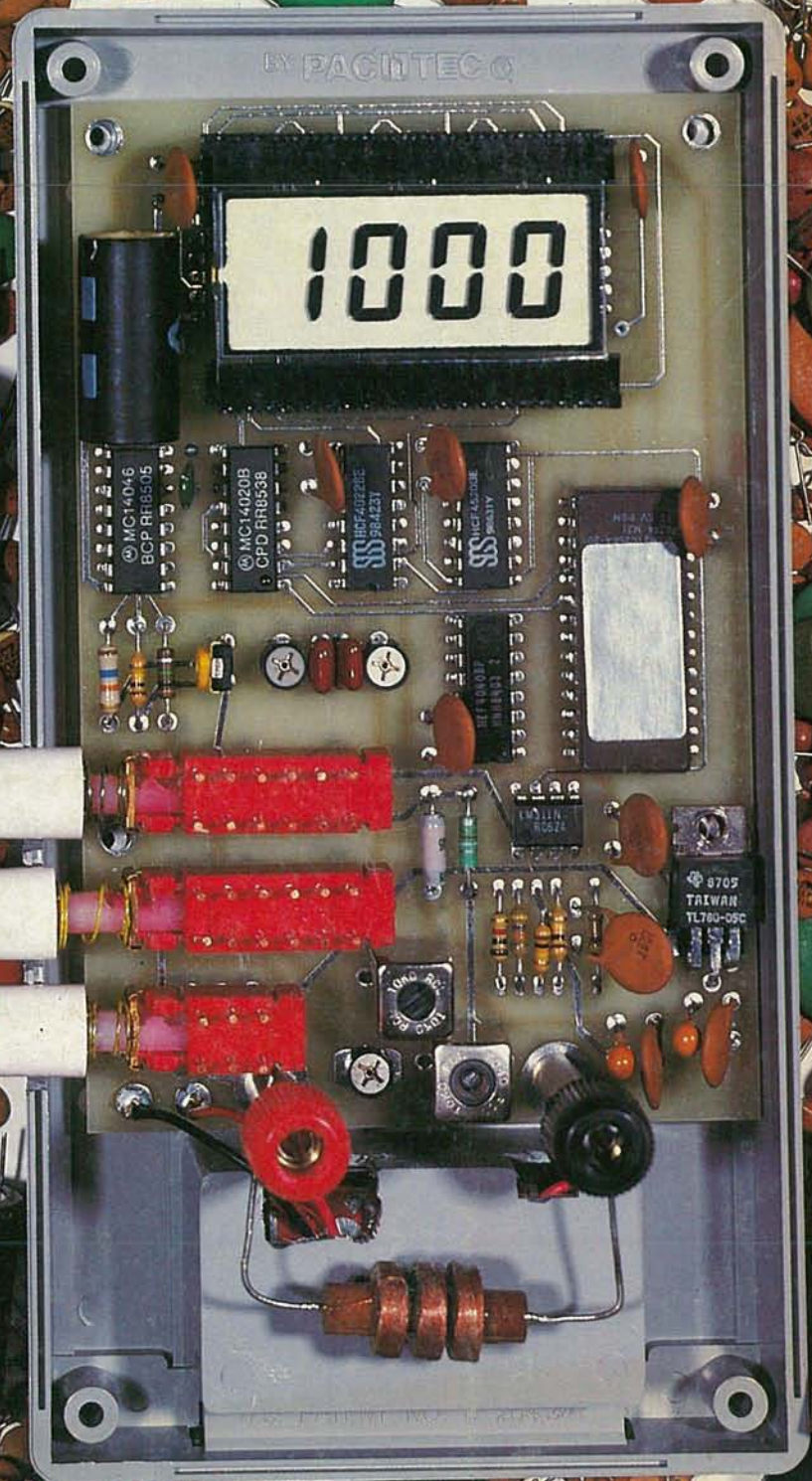

\$2.25
IN CANADA \$2.75

GENSBACK
PUB. CO.



THE ANSWER IS IN TEK DIGITAL STORAGE:

Now! The new 60 MHz Tek 2221 joins the world's best-selling family of digital storage oscilloscopes. All featuring 20 MS/s digitizing along with familiar, full-bandwidth analog operation. It's the best of both worlds in an easy-to-use portable.

Discover the potential. With digital storage you can freeze waveforms. Capture events invisible to nonstorage scopes. Find signals buried in noise. And build a library of reference waveforms.

Digital storage display accuracy enhances your confidence in measurements. And all you have to do is push a button for *real-time* display analysis.

Compare the 2230, 2221 and 2220 to each other—and all others. The new 2221 offers such advanced features as CRT readout and measurement cursors. For even more performance and flexibility, there's the 100 MHz, dual time base 2230 with optional battery-backed memory for saving up to 26 waveform sets. And if it's economy you want, choose the 60 MHz 2220 with many of the same features at an even lower cost.

\$2995
\$3995
\$4995

With each scope you can capture events as narrow as 100 ns at any sweep speed thanks to Tek's proprietary peak detect mode. View events prior to or following a trigger event with pre/post trigger. Store waveforms into 4K records. Automate measurements with optional GPIB and RS-232-C interfaces. And output direct to a printer or plotter.

Tek software is available to help you make the most of the 2230, 2221 and 2220 in system configurations.

Call Tek for a free video brochure or to place an order.

Ask about free digital storage application notes and educational materials. Orders include complete documentation, manuals and 3-year warranty on labor, parts and CRT.

**Call Tek direct:
1-800-426-2200**
for free video brochure for orders/assistance.

Features	2230	NEW! 2221	2220
Analog/Digital Storage BW	100 MHz	60 MHz	60 MHz
Maximum Sampling Speed	20 MS/s	20 MS/s	20 MS/s
Record Length	4K/1K (selectable)	4K	4K
Peak Detect	100 ns	100 ns	100 ns
Save Reference Memory	One, 4K Three, 1K	One, 4K	One, 4K
Vertical Resolution	8 bits 10 bits (AVG mode) 12 bits (AVG mode over the bus)	8 bits 10 bits (AVG mode)	8 bits
CRT Readout/Cursors	Yes	Yes	No
GPIB/RS-232-C Options	Yes (\$750)	Yes (\$500)	Yes (\$500)
Battery-Backed Memory (save 26 waveform sets)	Yes (inc with GPIB/ RS-232-C)	No	No
Price	\$4995	\$3995	\$2995



Tektronix®
COMMITTED TO EXCELLENCE

CIRCLE 92 ON FREE INFORMATION CARD

BUILD THIS

- 41 L/C METER**
Build an auto-ranging digital inductance/capacitance meter.
Neil W. Heckt

- 46 RADIO-ELECTRONICS ADVANCED CONTROL SYSTEM**
Part 6. Put REACTS to work in the real world.
H. Edward Roberts, M.D.

- 51 RADIATION MONITOR**
Part 2. How to use the Radalet radiation monitor.
Joe Jaffe, Dan Sythe, and Steve Weiss

- 57 GENERAL-PURPOSE INTERFACE BUS**
An instrument bus primer.
Vaughn D. Martin

TECHNOLOGY

- 61 WORKING WITH OTA'S**
The LM1360 operational transconductance amplifier.
Ray Marston

COMPUTERS

- 87 BUILD LINE-CARRIER MODEMS**
Get cable-free computer interfacing.
Keith Nichols

- 93 BUILD THE PT-68K**
Adding dynamic RAM circuitry.
Peter A. Stark

DEPARTMENTS

- | | |
|---|--|
| <ul style="list-style-type: none">6 VIDEO NEWS
What's new in this fast changing field.
David Lachenbruch
22 EQUIPMENT REPORTS
Philips ECG RCT7501 remote-control tester.
34 NEW IDEAS
Finger-tip Olympics.
69 HARDWARE HACKER
Making PC-board layouts.
Don Lancaster | <ul style="list-style-type: none">74 AUDIO UPDATE
Record-player problems.
Larry Klein
76 DRAWING BOARD
Clock, I/O, and BIOS.
Robert Grossblatt
80 ANTIQUE RADIOS
Classic auto radios.
Richard D. Fitch |
|---|--|

COMPUTER DIGEST

A NEW KIND OF MAGAZINE FOR ELECTRONICS PROFESSIONALS

BUILD LINE-CARRIER MODEMS
For cable-free computer interfacing Page 87



CD CLASSROOM
Adding dynamic RAM circuitry Page 93

A LOOK AT CeBIT
The greatest computer show on earth Page 84

PAGE 83

TECHNOLOGY

GENERAL PURPOSE INTERFACE BUS

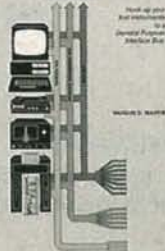

Read up on your favorite technology. The GPIB (General Purpose Interface Bus) is a standard for connecting instruments and computers. It's a bus system that allows you to connect a wide variety of instruments and computers to a central bus. The GPIB is a standard for connecting instruments and computers. It's a bus system that allows you to connect a wide variety of instruments and computers to a central bus. The GPIB is a standard for connecting instruments and computers. It's a bus system that allows you to connect a wide variety of instruments and computers to a central bus.

PAGE 57

AND MORE

- 118 Advertising and Sales Offices**
- 118 Advertising Index**
- 12 Ask R-E**
- 119 Free Information Card**
- 14 Letters**
- 101 Market Center**
- 26 New Products**
- 66 PC Service**
- 4 What's News**

ON THE COVER



Just about everyone into electronics—from the hobbyist to the engineer—has a vast collection of unknown parts; or parts whose precise tolerance isn't known. The fact of the matter is that if you need an oddball or precise value of anything it's probably in that collection. Even if the part you need is a precision capacitor or inductor our autoranging digital LC Meter will find the correct part almost as fast as you can snap an unknown value into the meter's binding posts.

For inductors the range is 0.01 μ H to 9,990 μ H. For capacitors the range is 0.1 pF to 99,990 pF. Worst-case accuracy is 3% total, or better.

COMING NEXT MONTH

THE AUGUST ISSUE IS ON SALE JULY 5

BUILD THE LISTEN-EAR

A super-amplified, super-versatile microphone. Use it for long-range listening—or use it to monitor your heartbeat.

WIRELESS SPEAKERS

An infrared transmitter and receiver lets you hook up speakers without wires, or listen to TV with wireless headphones.

BUILD THE TELEGUARD-II

Prevent unauthorized out-going calls with this easy-to-build project!

COMPUTER DIGEST

Build a Hemi-Sync Generator.

As a service to readers, RADIO-ELECTRONICS publishes available plans or information relating to newsworthy products, techniques and scientific and technological developments. Because of possible variances in the quality and condition of materials and workmanship used by readers, RADIO-ELECTRONICS disclaims any responsibility for the safe and proper functioning of reader-built projects based upon or from plans or information published in this magazine.

Since some of the equipment and circuitry described in RADIO-ELECTRONICS may relate to or be covered by U.S. patents, RADIO-ELECTRONICS disclaims any liability for the infringement of such patents by the making, using, or selling of any such equipment or circuitry, and suggests that anyone interested in such projects consult a patent attorney.

RADIO-ELECTRONICS, (ISSN 0033-7862) July 1988. Published monthly by Gernsback Publications, Inc., 500-B Bi-County Boulevard, Farmingdale, NY 11735 Second-Class Postage paid at Farmingdale, NY and additional mailing offices. Second-Class mail registration No. 9242 authorized at Toronto, Canada. One-year subscription rate U.S.A. and possessions \$17.97, Canada \$23.97, all other countries \$26.97. All subscription orders payable in U.S.A. funds only, via international postal money order or check drawn on a U.S.A. bank. Single copies \$2.25. © 1988 by Gernsback Publications, Inc. All rights reserved. Printed in U.S.A.

POSTMASTER: Please send address changes to RADIO-ELECTRONICS, Subscription Dept., Box 55115, Boulder, CO 80321-5115.

A stamped self-addressed envelope must accompany all submitted manuscripts and/or artwork or photographs if their return is desired should they be rejected. We disclaim any responsibility for the loss or damage of manuscripts and/or artwork or photographs while in our possession or otherwise.

Radio Electronics

Hugo Gernsback (1884-1967) founder

M. Harvey Gernsback,
editor-in-chief, emeritus

Larry Steckler, EHF, CET,
editor-in-chief and publisher

EDITORIAL DEPARTMENT

Art Kleiman, editorial director
Brian C. Fenton, editor
Carl Laron, WB2SLR, associate editor
Jeffrey K. Holtzman,
computer editor
Marc Spiwak, associate editor
Jonathan A. Gordon,
assistant technical editor
Teri Scaduto, assistant editor
Robert A. Young, assistant editor
Julian S. Martin, editorial associate
Byron G. Wels, editorial associate
M. Harvey Gernsback,
contributing editor
Jack Darr, CET, service editor
Robert F. Scott,
semiconductor editor
Herb Friedman,
communications editor
Robert Grossblatt, circuits editor
Larry Klein, audio editor
David Lachenbruch,
contributing editor
Don Lancaster,
contributing editor
Richard D. Fitch,
contributing editor
Kathy Campbell, editorial assistant

PRODUCTION DEPARTMENT

Ruby M. Yee, production director
Robert A. W. Lowndes,
editorial production
Andre Duzant, technical illustrator
Karen Tucker, advertising production
Marcella Amoroso, production traffic

CIRCULATION DEPARTMENT

Jacqueline P. Cheeseboro,
circulation director
Wendy Alanko,
circulation analyst
Theresa Lombardo,
circulation assistant

Typography by Mates Graphics

Cover photo by Herb Friedman

Radio-Electronics is indexed in
Applied Science & Technology Index
and *Readers Guide to Periodical Literature*.

Microfilm & Microfiche editions are
available. Contact circulation department
for details.

Advertising Sales Offices listed
on page 118.





SWEEP AND FUNCTION GENERATOR COMBINED IN ONE CONVENIENT INSTRUMENT

The high quality, cost-effective Model 3017 generates sine, triangle and square waveforms at frequencies from 0.2Hz to 2.0MHz in seven ranges. Continuously adjustable sweep width, 1000:1 ratio has settable Hi/Lo range. Sweep time is adjustable from 0.5 to 30 seconds. TTL and CMOS pulse outputs and variable amplitude output for added versatility. \$319.00. Contact: B&K-PRECISION, 6470 W. Cortland St., Chicago, IL 60635. (312) 889-1448.

CIRCLE 252 ON FREE INFORMATION CARD



4 1/2 DIGIT RMS BENCH DMM WITH 0.05% VDC BASIC ACCURACY

The Model 2833 measures volts to 1000 VDC and VAC current to 20A DC and AC, resistance to 20 MΩ, dBm from -48dB to 62.21dB. Measures frequency to 200kHz. Audible continuity check, diode test. \$330.00. Contact: B&K-PRECISION, 6470 W. Cortland St., Chicago, IL 60635. (312) 889-1448.

CIRCLE 251 ON FREE INFORMATION CARD



HIGH PERFORMANCE 3 1/2 DIGIT BENCH DMM/CAPACITANCE METER

Measures voltage, resistance, current and capacitance to 20 μF. Audible continuity check and diode test. Model 2832. \$175.00. Contact: B&K-PRECISION, 6470 W. Cortland St., Chicago, IL 60635. (312) 889-1448.

CIRCLE 250 ON FREE INFORMATION CARD



150 MHz RF SIGNAL GENERATOR

This signal generator, Model 2005, covers 100kHz to 150MHz in six fundamental bands and 450MHz in harmonics. It has a frequency monitor output that allows connection to an external frequency counter. Amplitude modulation is continuously variable, 0-100% of modulation from 50Hz to 20kHz, plus many other features. \$195.00. Contact: B&K-PRECISION, 6470 W. Cortland St., Chicago, IL 60635. (312) 889-1448.

CIRCLE 253 ON FREE INFORMATION CARD



LOW-COST CALIBRATOR KEEPS SCOPES ACCURATE

No need to send oscilloscopes out for calibration. With the B&K-PRECISION Model 1400 you can quickly and easily calibrate your scope. It provides time and amplitude signals with 0.015% time accuracy and 0.5% amplitude accuracy and can even be used as a signal source in test applications. \$499.00. Contact: B&K-PRECISION, 6470 W. Cortland St., Chicago, IL 60635. (312) 889-1448.

CIRCLE 254 ON FREE INFORMATION CARD



CONVERT ANALOG OSCILLOSCOPE TO DIGITAL STORAGE AT A FRACTION OF THE COST

Three simple cable connections can convert your analog scope to a digital storage oscilloscope. With the Model 2501 you can capture single shot events, store and magnify waveforms for analysis and review pre-trigger information at 0%, 50%, or 100%. There is even a plotter output so you can hard copy the wave-form. This compact unit weighs less than 4 pounds and is small enough to conveniently set on top of your scope. \$795.00. Contact: B&K-PRECISION, 6470 W. Cortland St., Chicago, IL 60635. (312) 889-1448.

CIRCLE 255 ON FREE INFORMATION CARD

Highest Bandwidths with Lowest Prices... B&K-PRECISION

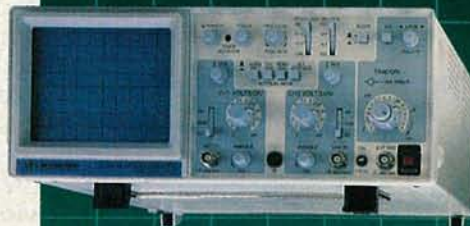

Model 2120
20 MHz
dual-input
\$479⁰⁰

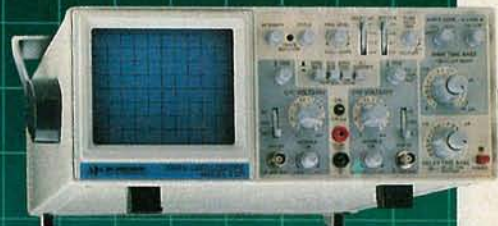

Model 2125
20 MHz
dual-time base
\$570⁰⁰

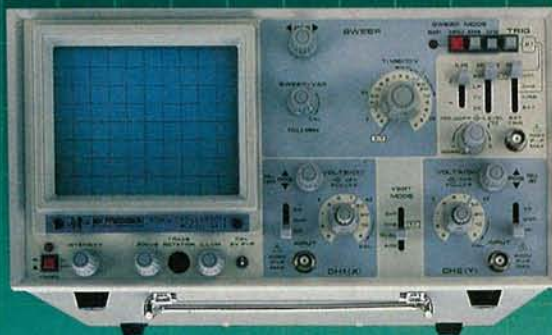

Model 1541A
40 MHz
dual-input
\$845⁰⁰

MEASURE TO THE
MAX
WITH MAXTEC

If you're looking for the most scope performance per dollar, look to B&K-PRECISION! Compare our specs, features and prices...

2120 20MHz Dual-Trace • 4mV/div sensitivity • AUTO/NORM triggered sweep with AC, TVH, TVV and Line coupling • Calibrated 48 step timebase with x10 magnifier • X-Y operation • Includes probes.

2125 20MHz Dual-Trace • 1 mV/div sensitivity • 18 delayed sweep ranges and variable X1 to X10, 3 display modes • Component tester for capacitors, inductors, semiconductors • Includes probes.

1541A 40MHz Dual-Trace • 1 mV/div sensitivity • 20 calibrated sweeps • Internal, illuminated graticule • Video sync separators • X-Y operation • X10 sweep magnification • V mode • Sum & difference capability • Channel 1 output • Includes probes.

For immediate delivery or complete information contact your local distributor or:

BK PRECISION
MAXTEC INTERNATIONAL CORP.

6470 W. Cortland St. • Chicago, IL 60635 • 312-889-1448

International Sales, 8470 W. Cortland St., Chicago, IL 60635

Canadian Sales, Atlas Electronics, Ontario

South and Central American Sales, Empire Exporters, Plainview, NY 11803

CIRCLE 77 ON FREE INFORMATION CARD

WHAT'S NEWS

Superconducting chips are now on the way

General Electric scientists, Dr. Antonio Mogro-Campero and Larry G. Turner, report successful operation of a "high-temperature" superconducting film applied to a silicon substrate at liquid-nitrogen temperatures. There is great interest in depositing superconductors on silicon, because silicon is the substrate for practically all the world's microchips. It is advantageous to be able to deposit the

new superconducting material on the same familiar substrate.

The new yttrium-barium-copper superconductors lose all resistance at temperatures as high as -310° Fahrenheit. Those high-temperature superconductors can be cooled in relatively cheap nitrogen. Low-temperature superconductors have to be cooled in liquid helium—a hundred times more expensive to produce.

Silicon presented problems. The components of the supercon-

ductor tended to mix with those of the substrate, contaminating the superconductor material and destroying the superconductivity.

GE scientists evaporated a zirconia buffer layer on the substrate and then evaporated the superconducting film on top of it, effectively isolating the superconducting material from the substrate. To deposit the active materials, a layer of copper was deposited first, then barium, and then yttrium. The sequence was repeated six times to build up an 18-layer "stack" with a total thickness of 0.6 to 0.7 micron.

No practical applications for the new chips have yet been demonstrated, but the developers see a wide range of possibilities. The use of superconductors on chips might greatly reduce the time delays in electronic circuits.

Databank access proposal abandoned by FCC

The FCC's decision to drop its proposal to impose charges for access to on-line data banks was applauded by the Consumer Electronics Group of the Electronic Industries Association's (EIA/CEG) in a recent news release.

The FCC had, in June 1987, issued a notice of proposed rule-making that would have treated modem-accessible database providers (for example, CompuServe) as if they were common carriers. This would have increased costs for both database providers and database users, and would have, in the words of the EIA/CEG, "dramatically increased the cost of using a home computer."

Bowing to strong industry and Congressional opposition, the FCC stated on March 16, 1988 that it would withdraw its proposal for the database access charge. **R-E**



ELECTRON-BEAM EVAPORATION SYSTEM is being prepared to deposit a zirconia buffer and superconducting film on silicon chips by co-developers Larry G. Turner and Dr. Antonio Mogro-Campero.

For the first time in the history of electronics, with the information that's provided on the component itself, you can determine if a capacitor or inductor is good or bad — anywhere without calculations, look-up tables or error.

- All capacitor and inductor tests display a simple good or bad readout to eliminate errors!
- Fully automatic/autoranged capacitor value test with percent tolerance calculator.
- Automatic 1000 volt applied leakage test with current or megohm readout. Test capacitor leakage to EIA standards.
- New dielectric absorption test eliminates interpretation.
- ESR tests eliminate tough capacitor problems.
- Fully automatic/autoranged inductance test with percent tolerance calculator.
- Patented Ringing Test gives effective Q for coils.
- Dynamically test resistance up to 1000 megohms.
- Automatic shutoff, battery test and lead zero.



NEW

LC77 AUTO-Z™
Automatic Capacitor And
Inductor Analyzer
\$1,895 Patented



It's like having your own Standards Engineer with you at all times.

AUTO-Z is a trademark of Sencore, Inc.

CALL WATS Free 1-800-843-3338

In Canada Call 1-800-851-8866

CIRCLE 187 ON FREE INFORMATION CARD

VIDEO NEWS



DAVID LACHENBRUCH,
CONTRIBUTING EDITOR

• **Enforcing Macrovision.** The VHS video-recorder group has recognized Macrovision—in a way.

Macrovision is the process designed to keep VCR's from making copies of copyrighted prerecorded movie cassettes. A recording made using the Macrovision process can fool the AGC circuit of most VCR's into thinking it's a non-standard signal, while not generally affecting the AGC of most TV sets. It's estimated, however, that Macrovision foils only about 75 percent of the VCR's, and often causes distortion during playback of even legitimate tapes. Also, the system is relatively easy to defeat by using reasonably inexpensive picture clarifying black boxes, which have been widely available.

Now Macrovision Corp., with the cooperation of the Motion Picture Association of America and the Japanese VCR interests, has embarked on a campaign to eliminate the capability of defeating the system.

A little-known "recommendation" was sent out last year by JVC, which holds the patents on the VHS system, urging its licensees to adopt standards on the response of the luminance-signal AGC so that their products are unable to copy Macrovision-treated tapes. It's understood that all licensees except one have agreed to the change.

At the same time, Macrovision began a legal crackdown on the so-called "defeat boxes," filing suit against manufacturers and threatening distributors and retailers who carry them. They are basing their suit on the grounds that its patents cover methods of defeating the system as well as the system itself. That aspect of Macrovision's patents has not been tested in court, but the company has achieved some success in causing the "defeat boxes" to be removed from the market.

Behind the campaign is the Motion Picture Association of America, which has endorsed Macrovision and given up its quest for anti-copy legislation, presumably in exchange for eliminating the existing technical loopholes in Macrovision's coverage.

• **Digital VTR age.** Digital recording has come into the television industry with the deliveries of digital videotape recorders to TV stations being made by three broadcast-equipment manufacturers—Ampex, Hitachi and Sony. Although Sony has been delivering component signal digital recorders (the so-called D-1 type) to teleproduction companies for some time, their price has been close to \$200,000 each, generally beyond the reach of most TV stations.

Now the three companies have adopted the Ampex-developed D-2 system which makes a composite recording and sells for less than half the price of the D-1. The D-2 system is expected to replace the current "Type-C" analog VTR's as the standard for broadcasting. The advantages of the new D-2 machines are picture quality far beyond that of any comparably priced unit to date and the ability to make at least 20 generations of copies with no noticeable deterioration.

• **A "Foreign" Industry.** The call for a "new" American TV industry comes at a time when the existing so-called "American" TV industry has passed largely into foreign hands. Although more than 20 manufacturers have television-assembly plants in the United States, almost all of them are Japanese, Korean, or European owned. With the sale of RCA/GE Consumer Electronics to Thomson of France, there is only one major TV manufacturer still American owned—Zenith.

The picture-tube industry is also rapidly becoming foreign-owned. Ten years ago, all picture-tube manufacturers were American. Today, as in TV-receiver manufacturing, Zenith is the only American-owned picture-tube manufacturer left in North America. The others are RCA (Thomas of France), Philips (Netherlands), Sony (Japan), Toshiba-Westinghouse (50% Japanese), Mitsubishi in Canada (Japan), and Japan's Matsushita ready to build new tube plant. Even the picture-tube glass industry seems to be slipping into foreign hands. One of the two major companies in that industry, Owens-Illinois' TV glass operation, has sold half of themselves to Nippon Electric Glass. **R-E**

Simpson® Professional Series

★ Quality and Reliability ★



The **Professional Series** of test instruments are characterized by the uncompromising quality and exceptional reliability that are synonymous with Simpson. The commitment to satisfy the needs of the professional began over 50 years ago with the world famous Simpson 260® and continues with the introduction of the **Professional Series**.

CLASSIC SIMPSON → THE PROFESSIONAL SERIES

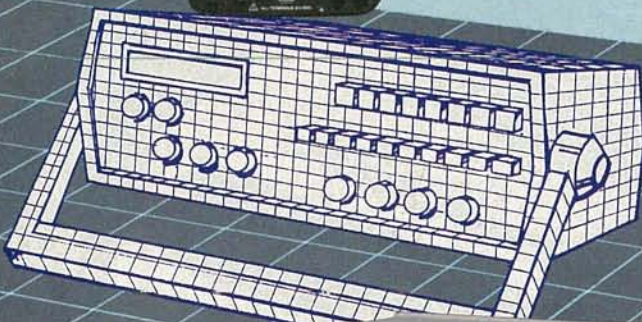

UNIVERSAL FREQUENCY COUNTERS

- 200 MHz Model 712
- 520 MHz Model 713

- Features
- Period
 - Frequency Ratio
 - Time Interval
 - 0.56" 8-Digit Orange LED Display
 - Adjustable Triggering
 - Totalize

Model 712	\$525.00
Model 713	\$675.00
Model 421	\$535.00
Model 422	\$650.00

SWEEP/FUNCTION GENERATORS

5 MHz Model 421
5 MHz with 6-Digit Display . Model 422

- Features
- .05 Hz to 5 MHz in 7 ranges
 - Linear and Log Sweeps
 - Sine, Square and Triangle Waveforms
 - Selectable Start/Stop Sweep Frequencies
 - Internal/External Reading Frequency Counter – Model 422



SIMPSON ELECTRIC COMPANY
853 Dundee Avenue, Elgin, Illinois 60120-3090
(312) 697-2260 • Telex 72-2416 • FAX (312) 697-2272

A CHIPPEWA NATION TRIBAL ENTERPRISE

For information on:
712/713 circle 197

421/422 circle 270



REASONS FOR SELECTING CIE

- Approved for educational benefits under the G.I. Bill for Veterans and other eligible persons.
- CIE provides printed job resumes, letters of recommendation, and lifetime Employment Service for all graduates at no extra charge.
- State-of-the-Art laboratory equipment is yours to keep and it comes assembled, ready for hands-on-experiments.
- Only CIE offers an Associate Degree program based on actual study time used. The faster you complete your degree, the less your overall tuition.
- Upon graduation, CIE offers you free preparation to pass the Certified Electronics Technician Exam.

CIE

CLEVELAND INSTITUTE OF ELECTRONICS 1776 East 17th Street • Cleveland Ohio 44114
PHONE TOLL FREE 1-800-321-2155 / In Ohio 1-800-523-9109

LEARNING...

THE KEY TO SUCCESS

A CAREER IN ELECTRONICS STARTS WITH CIE.

For the last few years, the electronics field and related industries have been growing at an incredible pace. And today, a career in electronics offers more opportunities and greater rewards than ever before.

Just ask any of the many graduates of the Cleveland Institute of Electronics who have landed high-paying positions with aerospace, computer, medical and communications firms. They'll tell you success didn't come easy. . . but that CIE made it all worthwhile.

SPECIALIZED TRAINING CIE isn't just another be-everything-to-everybody correspondence school. We're accredited by the National Home Study Council. And with more than 1100 graduates each year, we're the largest independent home study school specializing *exclusively* in electronics. CIE has been training career-minded students like yourself for over 50 years and we know the business inside and out.

PRACTICAL TRAINING CIE students learn by doing, using sophisticated electronic learning tools that we've designed and developed. One such tool, our 4K RAM Microprocessor Training Laboratory, teaches programming, interfacing and lets you work with a broad range of computers in a way that working with a single, stock computer simply can't.

We combine that valuable hands-on training with our unique Auto Programmed® lessons, designed to teach you step-by-step and principle-by-principle. The result is practical training . . . the kind of experience you can put to work in the marketplace.

PERSONALIZED TRAINING While some of our students have a working knowledge of electronics others are just getting started. That's why we have 10 career course levels from Basic to Advanced. They let you start where you want. Learn at your own pace. And learn as much as you like. You can even earn an Associate in Applied Science Degree in Electronics. And when you need help, our trained professionals are on hand to assist you by phone or mail.

Learning electronics isn't easy, but getting started is. For a CIE catalog and enrollment information, just mail the coupon below. Or call toll-free 1-800-321-2155. In Ohio, call 1-800-523-9109.



Accredited by the Accrediting Commission of the National Home Study Council, Washington, D.C.

CIRCLE 60 ON FREE INFORMATION CARD



YES! I want to get started. Send me my CIE school catalog including details about the Associate Degree program.

Print Name _____

Address _____ Apt. _____

City _____ State _____ Zip _____

Age _____ Area Code / Phone No. _____ / _____

Check box for G.I. Bulletin on Educational Benefits

Veteran Active Duty

MAIL TODAY!

CIE CLEVELAND INSTITUTE OF ELECTRONICS
1776 East 17th Street, Cleveland, Ohio 44114

ARE-89



Some courses feature the CIE Microprocessor Training Laboratory, an integral part of computers. You'll gain all the practical experience needed to work with state-of-the-art equipment of today and tomorrow.

ASK R-E

ASK R-E
Radio-Electronics
500-B Bi-County Blvd.
Farmingdale, NY 11735

IBM VIDEO

I'm confused about the different video cards and monitors that are available for the IBM PC and compatibles. Could you explain what the standard is for IBM video and tell me which monitors go with which cards. I've also heard that a color TV can be used as a monitor; is that so?—H.C.Y, Charleston, SC

The reason you're confused is that you're using the word "standard" when referring to IBM video. It's not that there isn't a standard, the problem is that there are several of them. When IBM entered the home-computer market, there were established standards for video, serial interfaces, disk drives and formats, and other computer peripherals. IBM, for reasons only they understood, decided to ignore all of them—including the ones for video.

The technical data that you need to understand the differences between the various types of IBM video is summarized in Table 1. Most video standards keep the vertical frequency at 60 Hz to avoid trouble from the powerline frequency. If you paint frames on the tube at a different rate, you stand a good chance of having your TV

beat against the line frequency and having interference show up on the screen. Given a fixed vertical rate, the only way to get more horizontal lines on the screen is to draw them faster—and more lines per frame means more resolution in the displayed image. It's simply a matter of arithmetic.

IBM started out with a TTL monochrome display that uses a horizontal-scan rate of 18.432 kHz. The display is denser and more attractive than that of computers that put out video at the NTSC standard of 15.75 kHz, but you need a monitor that could lock at that frequency. IBM introduced the Color Graphics Adapter (CGA) in response to the demand for color and graphics. It uses the NTSC video standard of 15.75 kHz, but requires a monitor that can accept TTL-level signals for the red, green, and blue video signals and the resolution when working with text is terrible. The 21.8-kHz scan rate of the Extended Graphics Adapter (EGA) delivers much better resolution for that type of application; it, too, delivers TTL signals. The new VGA standard uses the higher rate of 31.5 kHz (twice the NTSC color standard),

and generates 16 colors—you can get a deep red, a pale pink, and several shades in between.

Keeping all of that in mind, you have to make sure that the monitor you buy can lock to the horizontal scan frequency of the card you own—if you drive a monitor with a higher scan frequency than it can handle you'll damage the monitor. And there's no compatibility at all between digital TTL and composite (color TV) video. You can't easily feed a regular TV with computer video unless the output is really close to the NTSC standard of 15.75 kHz. Some CGA cards have composite video outputs that can be fed to an RF modulator. That's fine for graphics work, but trying to do 80-column word processing on that type of setup is only beneficial to your eye doctor.

DIRECTION-FINDER ANTENNA

I am trying to develop a transmitter-locator system that does not require an antenna array and the calculations that must be made when determining the vector of a transmitter. Perhaps you can suggest a system similar to those used in wildlife tracking.—G.P.R., Salt Lake City, UT

The type of antenna system most suitable for your transmitter-locating project will depend largely on the frequency and power output of the transmitter, and on the distance from the locator at the start of the search.

I have seen several "nature" specials on TV where a wild animal or a bird, such as the bald eagle, is tracked as it roams its natural habitat. In all the cases I've seen, the tracker or trackers, used hand-held Yagi antennas of four or five

TABLE 1
IBM VIDEO STANDARDS

VIDEO TYPE	ACRONYM	COLOR	SCAN RATE
MONOCHROME DISPLAY ADAPTER	MDA	MONOCHROME	18432 kHz
HERCULES GRAPHICS ADAPTER	HGA	MONOCHROME	18432 kHz
COLOR GRAPHICS ADAPTER	CGA	8	15750 kHz
ENHANCED GRAPHICS ADAPTER	EGA	16	21800 kHz
PROF GRAPHICS ADAPTER	PGC	256	30480 kHz
VIDEO GRAPHICS ARRAY	VGA	256	31500 kHz

elements with incoming signal (from the transmitter on the bird or animal being tracked) being fed to a detector with a meter as a signal-strength meter.

And, just recently, area Boy Scouts and Civil Air Patrol cadets participated in a training exercise simulating the location of a downed aircraft. In that case, the equipment used by the scouts and cadets to locate the "scene of the crash" was similar to that used by wildlife researchers.

Ferrite-rod and loop antennas can be used in direction-finding. Ham operators often use them for close-in work on hidden-transmitter hunts—often called "Fox" or "Bunny Hunts". Consult back issues of *QST*, *73*, and other amateur-radio magazines for articles on equipment for direction finding and hidden-transmitter hunts.

PA SPEAKER PLACEMENT

The new PA system in our church has only two speakers. Each is about 18 inches wide and about six feet tall. The enclosures are mounted

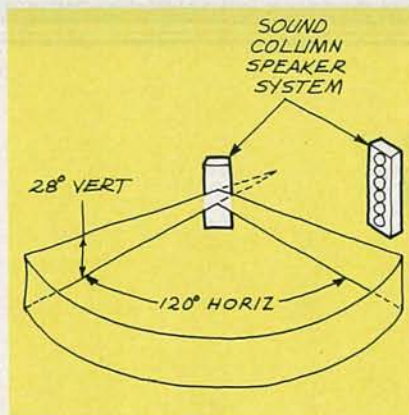

FIG. 1

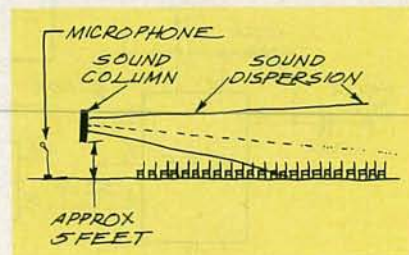

FIG. 2

vertically high on the front wall, close to the side walls. I questioned the installer and suggested that we

could get better results with the longest dimension running horizontally. The "sound expert" insisted that he was right and that the speakers—he called them "sound columns"—are always mounted with the long dimension vertical. Is he correct?—E.B., Greenville, NC

Yes, he is! Sound columns are designed for theaters, churches, arenas, and auditoriums where there is a need to cover a large area with a minimum number of speakers. A sound column usually consists of several cone speakers in a rectangular enclosure, as shown in Fig. 1.

Most of the energy from a sound column is radiated in a highly directional beam pattern. Typically, the radiation pattern from a sound column covers about 120° horizontally and 25° vertically. The enclosures are mounted so that any microphones are below the high-energy portions of the fan-shaped sound distribution pattern, while delivering equal loudness to all listeners in the room. That is illustrated in Fig. 2. R-E

PACESETTER PRODUCTIVITY

100 MHz TEK 2246A/2245A

Smart scopes, perfect setup! Tek sets the new, fast pace for frequent measurements with automatic front panel setup. Nonvolatile memory for up to 20 front-panel setups (2246A). Time and voltage cursors. Exclusive SmartCursors™ track waveform changes for voltage measurements. All backed by Tek's 3-year warranty.

NEW

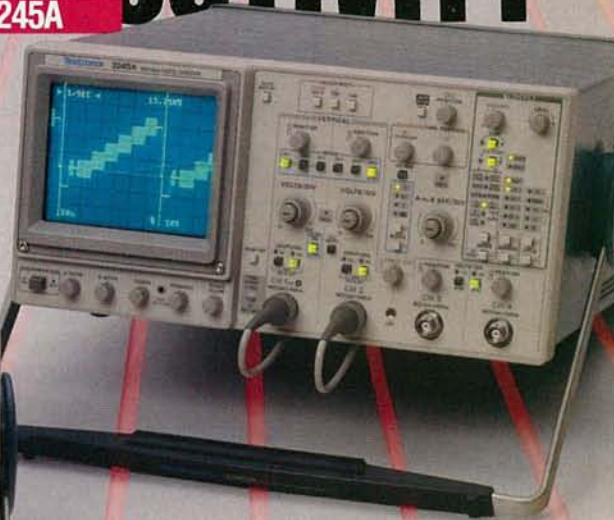

Call Tek direct
for PaceSetter specs!
1-800-426-2200

Prices subject to change without notice.

Copyright ©1988, Tektronix, Inc. All rights reserved. TTA 906-A

Tektronix
COMMITTED TO EXCELLENCE

CIRCLE 182 ON FREE INFORMATION CARD

LETTERS



ADDRESS CORRECTION

In "Hardware Hacker" in the April 1988 issue of **Radio-Electronics**, we inadvertently printed the wrong address for Melles Griot. The correct address is Melles Griot, 2251 Rutherford Road, Carlsbad, CA 92008; phone (619) 438-2131.—*Editor*

GOOD KNIGHT

Concerning the article "Electronic Knighthood" in the April 1988 issue, we have since learned that our prototype knight does not match the circuit that was shown.

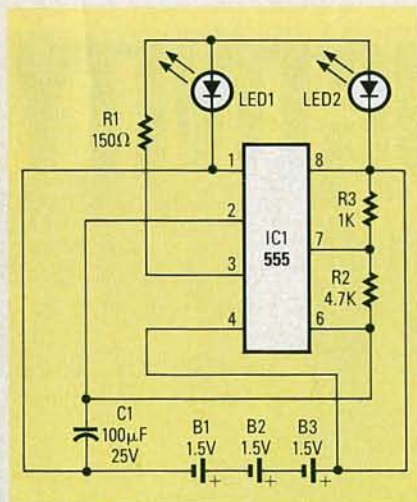

FIG. 1

The correct circuit is shown in Fig. 1, and we apologize to anyone who may have had trouble guarding their castle.—*Editor*

MORE ON THE MACRO SCRUBBER

When I built the Macro Scrubber (**Radio-Electronics**, December 1987), it would not work, due to the 14- μ s window that permitted some of the Macro Vision pulses to pass. The circuit shown in Fig. 3 is a quick, simple solution I devised to

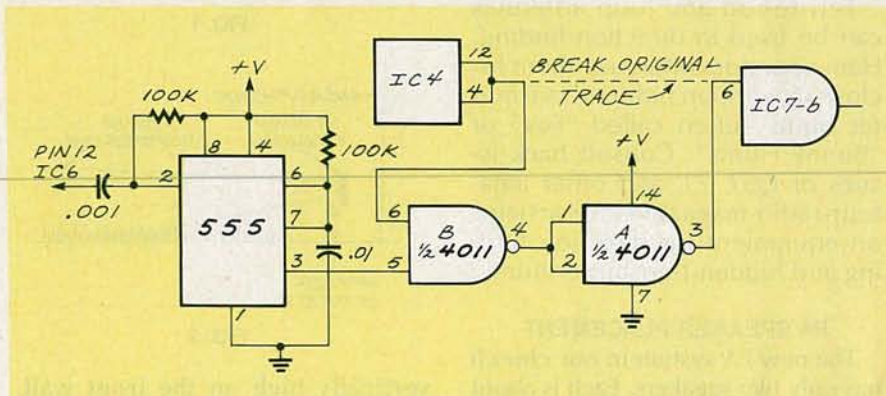

FIG. 2

prevent a total redesign and rebuild of the already-constructed project.

First I increased the oscillator frequency to 5.9 MHz. That narrowed the window to prevent any Macro Vision pulses from passing. The unfortunate result was slight, unwanted pulses on each line into the video coming from IC4. To prevent those pulses from showing up in video, I built the circuit in Fig. 2 to gate out IC4's output during the normal video lines.

I used a 555 one-shot triggered from IC6, pin 12 to "gate in" the output from IC4, pins 12 and 4, to allow IC4 to be active only from the start of serration pulses to the start of picture video. One more gate was used as an inverter in order to restore the proper logic level to IC7-b, pin 6.

The circuit uses easy-to-find parts that I already had, and was built on a small board that was simply wired in. The intent of the modification was a quick and easy answer to a problem. The result of the modification turns out to be acceptable—but not absolutely perfect—video.

ROBERT MASLAK
Johnstown, PA

MACRO SCRUBBER UPDATE

I purchased the kit and built the "Macro Scrubber" that appeared in the December 1987 issue of **Radio-Electronics**. The project is very good, and I'd like to share some changes I made to the circuit with other readers.

The input is shown as not terminated and the input and output levels shown in the article are measured with both input and output unterminated. That is not normal video practice. The input should be terminated in a 75-ohm resistor added across J1. That will then maintain the usual 1-volt level when the unit is inserted into a video system.

Resistor R24 is necessary and the adjustment is somewhat critical. With the supplied resistors and a 1-volt video level monitored on a

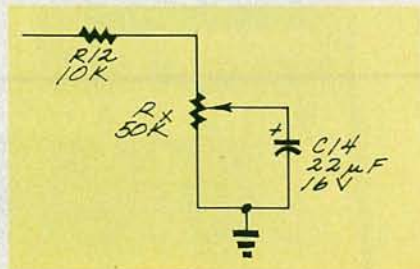

FIG. 3

television-waveform monitor, a quick dark-to-light scene transition would certainly cause lines in the picture.

The DC level of the reinserted lines 12 to 19 was about 40 IRE in my unit. The components all checked OK and the input clamp was right at 0.2 volts, as specified in the article. Adding a 50k potentiometer after R12, as shown in Fig. 3, lets me trim the level to match the video signal.

W. BLAKE HAWKINS
Atlanta, GA

MORE ON FREQUENCY STANDARDS

It's disappointing when a usually up-to-date magazine like **Radio-Electronics** presents readers with out-dated information.

In your April issue, the author of "TV-Derived Frequency Standard" asserts that there is a difference in time-base accuracy between network-originated and locally-originated programming. That is no longer true at any television station with which I am acquainted.

The difference has disappeared due to the emergence of a box called a frame synchronizer. As you know, a television signal is basically a serial-analog medium, where pictures are sent a line at a time. In order to do any kind of video special effects—such as a dissolving between two pictures or superimposing letters over a picture—all the video sources involved must be exactly synchronized to one another. Within a station, that is accomplished by feeding a reference signal developed in a master synchronizing generator to all equipment. The problem comes in dealing with out-of-house sources—such as when you need to superimpose your station's call-sign over a network sports program for a station identification. There is no way that all the synchronizing information from the network is going to be timed to within a couple of nanoseconds of your house sources by pure coincidence.

In the old days, timing was dealt with by slaving the station's master

sync generator to the incoming network video—a process known as "genlock." There are problems with that. One obvious impossibility is presented if you want to switch between network, local sources, and a remote truck. The sync generator can't be slaved to both the network and the remote truck at the same time.

Enter digital electronics: A frame synchronizer digitizes an incoming video signal—often at the rate of 14 million analog-to-digital conversions per second—and stores a full frame's worth of video information in RAM memory. The input clock is derived from incoming video. The picture in RAM is then clocked out and reconverted to analog video by an output clock that is derived from the station's master sync generator. Thus, instead of slaving the station to the remote, we have a way of converting a remote source into a local signal that can be manipulated like any other local signal.

That, incidentally, is why pictures sometimes start to lose lip

PACESETTER PERFORMANCE

100 MHz TEK 2236/2235

100 MHz scope, counter, timer,
DMM—just \$2795

The ultra-versatile Tek 2236 makes measuring everything from frequency, period and width to delay time and Δ time *push-button* easy—in addition to CRT display, you get digital readout display accurate to 0.001% and beyond. PaceSetter performance on a modest budget? Look at the 100 MHz, dual-trace Tek 2235 with the best of the basics—just \$1575!



Call Tek direct
for PaceSetter specs!
1-800-426-2200

Prices subject to change without notice.
Copyright ©1988, Tektronix, Inc. All rights reserved. TTA 906-B

Tektronix
COMMITTED TO EXCELLENCE

CIRCLE 183 ON FREE INFORMATION CARD

sync even on a live broadcast—each synchronizer in the signal path introduces at least a one-thirtieth-of-a second delay. (Some synchronizers store the full four fields required for an NTSC color frame, and introduce a total delay of one-fifteenth of a second.) To compensate for that small delay, audio-delay devices are available that can be controlled by frame synchronizers.

Frame synchronizers are quite prevalent in the broadcast indus-

try. The NBC Ku-band earth-station package, by means of which affiliates receive network programming, comes complete with synchronizers.

Since synchronizers are driven by the station's sync generator, there is no longer a timing difference between local and network programming. The networks' rubidium standard is not put directly on the air. FCC regulations require that our 3.58-MHz oscillator be within 10-Hz accuracy,

and in practice we try to maintain much closer tolerance than that.

Hope this helps put to rest what has now become an old wives' tale.

JAMES BRODSKY

KBSY-TV

San Luis Obispo, CA

COMPUTER VARIETY

I don't know whether to be mad or disappointed but I'm not going to let it slide anymore! For over a year I have owned an Atari 520ST personal computer and I still can't believe I got all that machine for the price. For \$750.00 I got a 16-bit computer with a number of standard features (512K RAM, DMA, serial, parallel, and midi in and out ports, cartridge slot, and 2 joystick/mouse ports). The price also includes a RGB monitor, 3½" disk drive, and a mouse.

It's a Macintosh, but with a bigger color screen and with quite a few more standard features—at a fraction of the cost. There is a cartridge available for the 520ST that will let you run quite a bit of Macintosh software. The disk drive uses the same format as IBM, so you can access IBM data files from current ST programs such as *Word Perfect*, *dbMan* (a *dBase* copy), and *VIP* (an exact *Lotus* clone) without any modifications. Attach a currently available 5¼" drive and a program called *PC Ditto*—you now have an IBM clone.

A large number of quality programs are now available for the ST, and that number is growing daily. When you combine that with all the Mac and IBM software you can run on it, one question comes to mind: Why are people flocking to buy IBM clones? They must pay seven or eight hundred dollars and up, and still have to spend more more more for adding things that are all standard on the ST.

My conclusion is not that people are narrow-minded or brain-washed with IBM—they just don't know about the alternatives.

What finally blew my fuse was Jeff Holtzman's article on desktop publishing (*ComputerDigest*, February 1988) which failed to mention the new Mega ST's (2 or 4 meg standard) which, combined with Atari's own laser printer (under \$3700.00 retail for both), makes an



SEEK PROFESSIONAL HELP

Servicing electronic equipment isn't always easy, especially if you're doing it in the field. At Chemtronics we can help with over 200 specially engineered products for the maintenance, repair and production of high technology equipment. Call today for our latest problem solving catalog.

Chemtronics
Keeping pace with advanced technology

Chemtronics Inc. 681 Old Willets Path Hauppauge, NY 11788 516-582-3322 Telex 968567

CIRCLE 54 ON FREE INFORMATION CARD

excellent and quite professional desktop publisher. The article didn't mention any of the current desktop publishing programs for the 520ST and a dot matrix or laser printer.

There was the same lack of information when I read of the CD-ROM player for the IBM. I believe it was around \$1200.00—compared to the \$599.00 price tag of Atari's, which has comparable features.

There is a lot more information about the ST, but nobody seems to know about it and they are losing out. Does your magazine purposely not review Atari equipment for a particular reason, or due to lack of knowledge about it? If a review is what you need, I would be glad to do it.

CARL KONA
Birmingham, MI

Mr. Kona has a legitimate concern, but there are several problems with covering Atari (and other) systems. First is that the editors grew up on CP/M systems and later moved to MS-DOS systems.

Does that mean we've been brain-washed by IBM? No, it doesn't. It means that, even though there are many systems—including the Atari—that on technical merit alone deserve coverage, in a world of limited resources (i.e., time), one simply can't learn about every system on the market.

Another problem is that our surveys indicate that the vast majority of readers (80%) use MS-DOS systems. It would not be fair to them, even if we had the expertise, to devote large amounts of space to other systems.

On the other hand, we do try to broaden our readers' horizons; Peter Stark's series on the PT-68K system is a case in point. It has proved popular with a small but vocal and dedicated group of readers, who want to build the computer; with other readers, who want to understand, by comparative means, their own non-68000 systems better; and with yet other readers, who simply want to learn about other system designs. Based on past experience, obtaining

from Atari the kind of technical detail that Mr. Stark presents would be impossible.

Mr. Kona's description of the 520ST's "compatibility" with both the Macintosh and the IBM PC family sounds fascinating, but again based on past experience, we're skeptical. Over the years we have seen many products that claim magically to transform product X into product Y, but seldom have we seen a truly seamless, bug-free hybrid that imposed no performance or convenience penalties. Adding a simulated Rolls Royce front end to a Volkswagen Beetle simply does not make the Beetle a Rolls.

As for desktop publishing, it may be true that Atari offers a better hardware platform, but that's not the point. Can the Atari run PageMaker or Ventura Publisher? If not, do truly comparable programs exist for the Atari? It's possible, but unlikely. It's a fact that Atari has never penetrated the U.S. business market (Europe is continued on page 31

PACESETTER PRICE

50 MHz TEK 2210/2225

Best-of-class performance at

\$995/\$2195 Get the PaceSetter start in digital storage with Tek's NEW 50 MHz 2210. Featuring 20 MS/s per channel digitizing, 4K record length per channel plus familiar, full-bandwidth analog operation for just \$2195. And for pure and simple analog performance with unmatched economy, look at the popular, 2-channel Tek 2225—just \$995!

NEW 2210
20 MS/s per channel

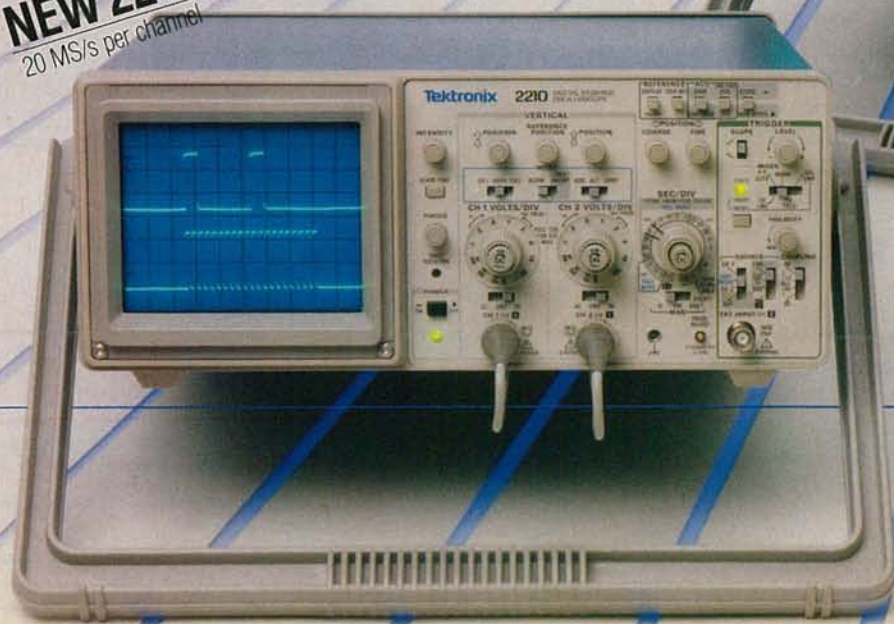

Call Tek direct
for PaceSetter specs!
1-800-426-2200

Prices subject to change without notice.
Copyright ©1988, Tektronix, Inc. All rights reserved. TTA 906-C

Tektronix
COMMITTED TO EXCELLENCE

CIRCLE 184 ON FREE INFORMATION CARD

NRI Trains You At Home—As You Build Your Own IBM PC Compatible Computer

GET THE KNOW-HOW TO SERVICE EVERY COMPUTER ON THIS PAGE... AND MORE!

Learn the Basics the NRI Way— and Earn Good Money Troubleshooting Any Brand of Computer

The demand for trained computer service technicians continues to surge forward. Computer service ranks high on the Department of Labor's list of top growth fields, with accelerated demand expected to create more than 30,000 *new* jobs in the next 10 years.

You can cash in on this opportunity—either as a full-time corporate technician or an independent service-person—once you've learned all the basics of computers the NRI way. NRI's practical combination of "reason-why" theory and "hands-on" building skills starts you with the fundamentals of electronics, then guides you through advanced electronic circuitry and on into computer electronics. You also learn to program in BASIC and machine language, the essential languages for troubleshooting and repair.

Total Computer Systems Training, Only From NRI

No computer stands alone... it's part of a total system. To really service computers, you have to understand computer *systems*. And only NRI includes a powerful computer system as part of your training, centered around the new, fully IBM PC compatible Sanyo 880 Series computer.



IBM is a Registered Trademark of IBM Corporation.
Epson is a Registered Trademark of Epson America, Inc.
Apple and the Apple logo are Registered Trademarks of Apple Computer, Inc.
Compaq is a Registered Trademark of COMPAQ Computer Corporation.
© 1985 AT&T Technologies, Inc.

NEW!
20 Meg
Hard Disk
Included!

start
the
by-step
assembly of your highly rated Sanyo com-
puter. You build and test the "intelligent"
board, install the power
supply and 360K 5 1/4" floppy disk
drive, and interface the high-
resolution monitor. But that's not all.
Go on to install a powerful 20 megabyte
hard disk drive—today's most-wanted computer
peripheral—now included as part of your hands-on
training to dramatically increase your computer's
storage capacity while at the same time giving you
fast, quick data access. With your computer now up
and running, you're ready to begin using the valuable
software also included as part of your total systems training.

It all adds up to confidence-building, real-world experience
that includes training in programming, circuit design, and
peripheral maintenance. You'll be learning about, working
on, servicing, and troubleshooting an entire computer

system—monitor,
keyboard,
computer, disk
drive, power



supply—to ensure that you have
all the essential skills you need
to succeed as a professional
computer service technician.

No Experience Needed, NRI Builds It In

This is the kind of practical,
hands-on experience that makes you uniquely prepared, with
the skills and confidence you need for success. You learn at your
own convenience in your own home. No classroom pressures,
no night school, no need to quit your present job until you're
ready to make your move. Your training is backed by your
personal NRI instructor and the NRI technical staff, ready to
answer your questions and help you when you need it. You get
it all with NRI at-home training.

Free 100-Page Catalog Tells More

Send the postage-paid reply card today for NRI's big,
100-page, color catalog on NRI's electronics training, which
gives you all the facts about NRI courses in Microcomputers,
Robotics, Data Communications, TV/Audio/Video Servicing,
and other growing, high-tech career fields. If the reply card is
missing, write to the address below.

Your NRI total systems training includes: •
NRI Discovery Lab to design and modify cir-
cuits • Four-function digital multimeter with
walk-you-through instruction on audio tape •
Digital logic probe for visual examination of
keyboard circuits • Sanyo 880 Series com-
puter with "intelligent" keyboard and 360K,
5 1/4" floppy disk drive • 20 megabyte hard
disk drive you install internally • High-
resolution monochrome monitor • 8K ROM,
256K RAM • Bundled software • Reference
manuals, schematics, and bite-sized lessons.



SEND COUPON TODAY FOR FREE NRI CATALOG!

NRI SCHOOLS

McGraw-Hill Continuing Education Center
3939 Wisconsin Avenue, NW, Washington, DC 20016



For Career courses
approved under GI Bill
 check for details.

CHECK ONE FREE CATALOG ONLY

- | | |
|--|---|
| <input type="checkbox"/> Computer Electronics | <input type="checkbox"/> Bookkeeping & Accounting |
| <input type="checkbox"/> TV/Video/Audio Servicing | <input type="checkbox"/> Electrician |
| <input type="checkbox"/> Robotics | <input type="checkbox"/> Air Conditioning, Heating & Ref. |
| <input type="checkbox"/> Electronic Music Technology | <input type="checkbox"/> Locksmithing & Electronic Security |
| <input type="checkbox"/> Satellite Electronics | <input type="checkbox"/> Travel Careers |
| <input type="checkbox"/> Digital Electronics Servicing | <input type="checkbox"/> Small Engine Repair |
| <input type="checkbox"/> Telephone Servicing | <input type="checkbox"/> Paralegal |

Name (Please print) _____

Age _____

Street _____

City/State/Zip _____

We'll give you tomorrow. Accredited by the National Home Study Council

3-078

EQUIPMENT REPORTS

Philips ECG RCT7501 Remote Control Tester

*A simple way to test your
remote-control transmitters*

CIRCLE 25 ON FREE INFORMATION CARD



EVEN IF YOU AREN'T A TV SERVICE TECHNICIAN, we're sure that there have been times when you wished for some way to test a remote-control transmitter. Since humans can't see the infrared light, and can't hear the ultrasonic signals emitted from such transmitters, troubleshooting remote controls systems has been a guessing game. The odds of winning, of course, are not in your favor.

We recently found a way to increase your odds at winning the remote-control guessing game: a new remote-control transmitter tester, the model RCT7501 from Philips ECG, Inc. (1025 Westminster Drive, P.O. Box 3277, Williamsport, PA 17701). The RCT7501 can be used to test both ultrasonic and infrared remote controls.

We tested the RCT7501 with a good assortment of transmitters, including TV, cable, compact-disc, stereo, VCR, satellite TV, and even computer-keyboard remotes. The tester had no problems detecting signals from any of those transmitters, and no false triggering was noted.

The simpler the better

The RCT7501 is one of the simplest of test instruments. Its circuitry consists of an infrared detector, an ultrasonic transducer, amplifying transistors, and a pulse stretcher. The only control is a power switch. When the detectors sense infrared or ultrasonic signals, a green TEST LED lights, and remains lighted for about 1 second after the signals cease.

No test instrument could be easier to use for go/no-go tests. Simply turn the tester on, and aim the suspected transmitter at it. When you press a key on the transmitter, you should see the green LED light. If all the other transmitter keys also give positive results, you should assume that the receiver is at fault. If you need to do further testing of the remote, a SCOPE/COUNTER test jack is provided on the side of the tester. (A cable is included.) That lets you view the received signals on an oscilloscope or measure the frequencies on a meter. If you know what signals you should expect, that feature can be an invaluable troubleshooting aid. A sample I-R

test signal is shown in Fig. 1.

The tester is a perfect example of what a shirt-pocket tester should be. It's about 4½ inches long, a little more than an inch wide, and about ¾ inch thick. The power switch is located on one side, opposite the SCOPE/COUNTER jack. The red POWER and green TEST LED's are on the front panel, and the infrared and ultrasonic detectors are on the top end.

The RCT7501 remote-control tester is available from Philips ECG for \$49.95. (Call 1-800-225-8326 for their distributor nearest you.) We were impressed by the sensible, rugged tester and recommend it highly.

Another tester

As we were finishing our review of the Philips ECG RCT7501 remote-control tester, we got a chance to evaluate a similar tester from Cableserv Electronics (18 Dufflaw Road, Toronto, Ontario, Canada M6A 1C8). Their tester, the Celtron-1, is shown in Fig. 2. It works similarly to the Philips unit: You simply turn it on, and aim a remote transmitter at it. If the transmitter is outputting infrared or ultrasonic signals, a green LED will light. The Celtron-1 includes an output jack for connection to a frequency counter or oscilloscope. No cable, however, is supplied with the tester.

The Celtron-1 offers a couple of

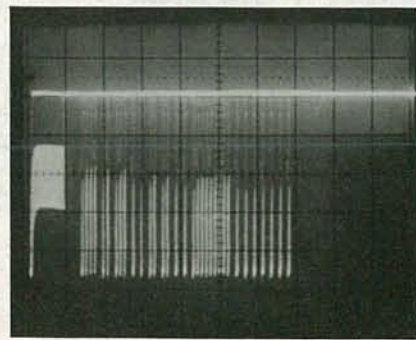
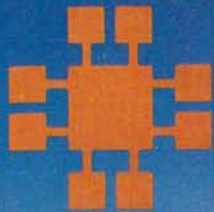
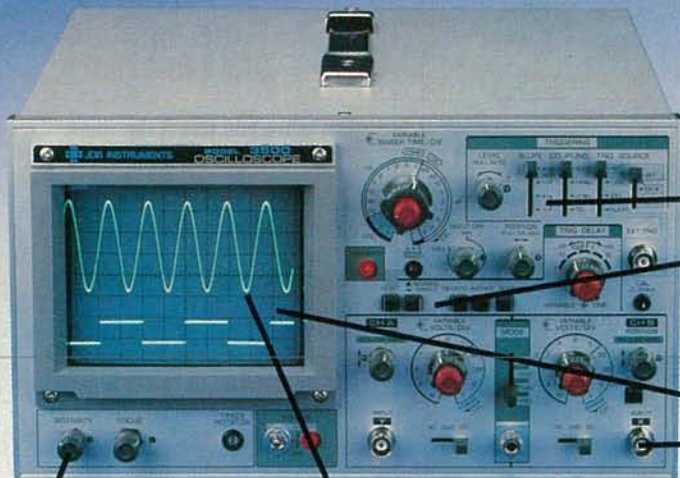

FIG. 1



JDR INSTRUMENTS™

Complete customer satisfaction... superior service... friendly, knowledgeable personnel... quality merchandise... providing the best values in leading edge technology.



35 MHZ OSCILLOSCOPE

A remarkable value

\$499⁹⁵

Wide bandwidth and exceptional 1mV/DIV sensitivity make the Model 3500 a powerful diagnostic tool for engineers or technicians at a remarkable price. Delayed triggering allows any portion of a waveform to be isolated and expanded for closer inspection. Variable Holdoff allows stable viewing of complex waveforms.

Z AXIS INTENSITY MODULATION FAST 10NS RISE TIME

TV SYNC FILTER

DELAYED AND SINGLE SWEEP MODES

EXCEPTIONALLY BRIGHT 5" CRT

X-Y OPERATION

DMM-300

3.5 DIGIT DMM/MULTITESTER

\$79.95

This full function 3.5 digit DMM offers highly accurate performance and a host of added features like audible continuity, capacitance, transistor, temperature, and conductance to help you do the job—fast. Temperature probe, test leads and battery included.

- Basic DC accuracy: plus/minus 0.25%
- DC voltage: 200mv–1000V, 5 ranges
- AC voltage: 200mv–750V, 5 ranges
- Resistance: 200 ohms–20M ohms, 6 ranges
- Capacitance: 2000pf–20 μf, 3 ranges
- Transistor Tester: 0°–2000°F
- Conductance: 200ns
- Fully overload protected
- Input impedance: 10M ohm.

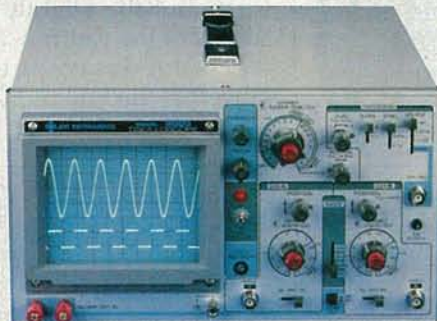

MODEL 2000

\$389.95

20 MHZ DUAL TRACE OSCILLOSCOPE

Model 2000 makes frequency calculation and phase measurement quick and easy. The component tester aids in fast troubleshooting. Service technicians appreciate the TV Sync circuits for viewing TV-V and TV-H and accurate synchronization of the video signal, Blanking, VITS, and V/H sync pulses.

- Exceptionally bright 5" CRT
- Built-in component tester
- TV Sync filter
- X-Y operation *110/220 volts

DMM-100

3.5 DIGIT POCKET SIZE DMM

\$29.95

Perfect for the field service technician. Shirt pocket size without compromising features or accuracy. Large, easy to read 1/2" LCD display. Fully overload protected for safety, 2000 hour battery life with standard 9v cell. Probes and battery included.

- Basic DC accuracy: plus/minus 0.5%
- DC voltage: 2v–1000v, 4 ranges
- AC voltage: 200v–750v, 2 ranges
- Resistance: 2k ohms–2M ohms, 4 ranges
- DC current: 2mA–2A, 4 ranges
- Input impedance: 10M ohm
- Fully overload protected
- Approx. 5" x 3" x 1". Under 7 ozs.

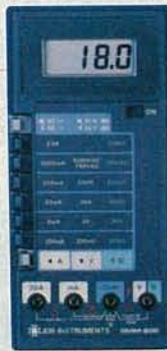

DMM-200

3.5 DIGIT FULL FUNCTION DMM

\$49.95

Get highly accurate performance at a very affordable price. Rugged construction, 20 amp current capability and 22 ranges make it a perfect choice for serious field or bench work. Low battery indicator and tilt-stand. Probes and 2000 hour battery included.

- Basic DC accuracy: plus or minus 0.25%
- DC voltage: 200mv–1000V, 5 ranges
- AC voltage: 200mv–750V, 5 ranges
- Resistance: 200 ohms–20M ohms, 6 ranges
- AC/DC current: 200μA–20A, 6 ranges
- Input impedance: 10M ohm
- Fully overload protected
- Approx. 7" x 3 1/2" x 1 1/2". Wt. 11 ozs.

DPM-1000

3.5 DIGIT PROBE TYPE DMM

\$54.95

Custom 80 pin LSI chip provides accuracy and reliability in such a compact size. Autoranging, audible continuity and data hold feature help you pinpoint the problem quickly. Case and batteries included.

- Basic DC accuracy: plus/minus 1%
- DC voltage: 2v–500v, autoranging
- AC voltage: 2v–500v, autoranging
- Resistance: 2k ohms–2M ohms, autoranging
- Fully overload protected
- Input impedance: 11M ohm
- Approx 6 1/2" x 1" x 3/4". Under 3 ozs.



- ★ 2 YEAR REPLACEMENT WARRANTY
- ★ 30 DAY MONEY BACK GUARANTEE
- ★ TOLL FREE TECHNICAL SUPPORT
- ★ NEXT DAY AIR SHIP AVAILABLE

CIRCLE 59 ON FREE INFORMATION CARD

COPYRIGHT 1987 JDR MICRODEVICES



JDR INSTRUMENTS, 110 KNOWLES DRIVE, LOS GATOS, CA 95030
RETAIL STORE: 1256 SOUTH BASCOM AVE, SAN JOSE, CA (408) 947-8881

ORDER TOLL FREE 800-538-5000

ATTENTION! ELECTRONICS TECHNICIANS

EARN YOUR
**B.S.E.E.
DEGREE**
THROUGH HOME STUDY

Our New and Highly Effective Advanced-Placement Program for experienced Electronic Technicians grants credit for previous Schooling and Professional Experience, and can greatly reduce the time required to complete Program and reach graduation. No residence schooling required for qualified Electronic Technicians. Through this Special Program you can pull all of the loose ends of your electronics background together and earn your B.S.E.E. Degree. Upgrade your status and pay to the Engineering Level. Advance Rapidly! Many finish in 12 months or less. Students and graduates in all 50 States and throughout the World. Established Over 40 Years! Write for free Descriptive Literature.

COOK'S INSTITUTE
OF ELECTRONICS ENGINEERING



4251 CYPRESS DRIVE
JACKSON, MISSISSIPPI 39212

CIRCLE 58 ON FREE INFORMATION CARD



features that the Philips unit does not. First, a piezoelectric transducer beeps to indicate the receipt of a signal, so you don't even have to look at the tester to know that your transmitter is working. Also, you cannot forget to turn the unit off. In fact, there is no off switch—



CIRCLE 26 ON FREE INFORMATION CARD

FIG. 2

the Celtron-1 turns itself off after about 30 seconds.

While we liked the added features and the slightly better sensitivity of the Celtron-1, we did not feel that it was constructed nearly as well as the Philips ECG unit. The Celtron 1 is available for \$89. R-E

Try the
**Radio-
Electronics**

bulletin board
system

(RE-BBS)
516-293-2283

The more you use it the more useful it becomes.

We support 300 and 1200 baud operation.

Parameters: 8N1 (8 data bits, no parity, 1 stop bit) or 7E1 (7 data bits, even parity, 1 stop bit).

Add yourself to our user files to increase your access.

Communicate with other R-E readers.

Leave your comments on R-E with the SYSOP.

RE-BBS
516-293-2283



Prototyping Made Easy. In The Quantities You Require.

Your Electronic Specialty Products distributor has a wide selection of 3M breadboards and prototyping labs in the quantities and styles you desire.

We invented solderless breadboarding with one thought in mind: "make it fast and easy!" And we build these products with American made reliability.

Whether your requirements demand 3M's A•C•E 100 Series solderless breadboards or Powerace prototyping labs with self-contained power supplies, or our newest Powerace labs

with removable boards, you'll find what you need at your authorized 3M Electronic Specialty Products distributor.

For educators, students, hobbyists and even professional designers, 3M prototyping products make circuit building and testing fun and easy. And whether you need one breadboard or a hundred, we've got them packaged as you need them.

Your Electronic Specialty Products distributor also has all the prototyping tools you'll need. Tools such as jumper wires, adaptor pins and patch cords.

For the name of your nearest 3M A•C•E Board and Powerace distributor, call toll free 800-321-9668 or (216) 354-2101 in Ohio.

**Electronic Specialty Products
3M Electronic Products Division**

9325 Progress Parkway
Mentor, Ohio 44060

We've Packaged Our Solutions.

3M

Worldwide Sponsor
1988 Olympic Games



CIRCLE 76 ON FREE INFORMATION CARD

SELECT 5 BOOKS for only \$3.95

(values to \$130.70)
and get a Free Gift!

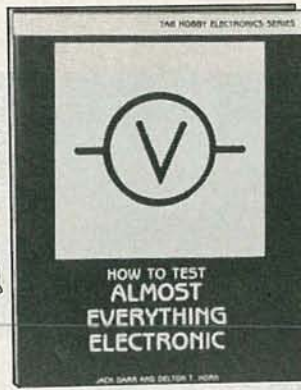
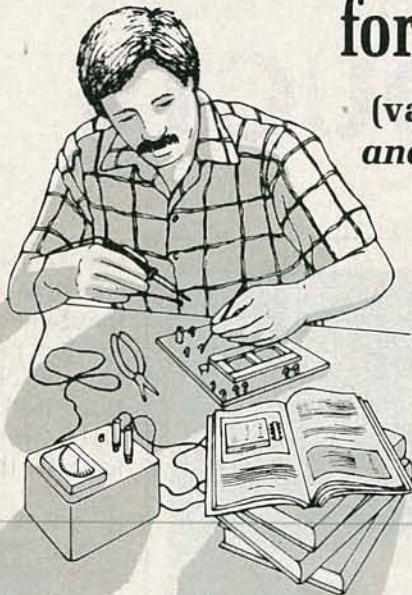

2925 \$15.95

Electronics projects . . . ideas . . . the latest technology
all at up to 50% off publishers' prices

Membership Benefits • Big Savings. In addition to this introductory offer, you keep saving substantially with members' prices of up to 50% off the publishers' prices. • **Bonus Books.** Starting immediately, you will be eligible for our Bonus Book Plan, with savings of up to 80% off publishers' prices. • **Club News Bulletins.** 14 times per year you will receive the Book Club News, describing all the current selections—mains, alternates, extras—plus bonus offers and special sales, with hundreds of titles to choose from. • **Automatic Order.** If you want the Main Selection, do nothing and it will be sent to you automatically. If you prefer another selection, or no book at all, simply indicate your choice on the reply form provided. As a member, you agree to purchase at least 3 books within the next 12 months and may resign at any time thereafter. • **Ironclad No-Risk Guarantee.** If not satisfied with your books, return them within 10 days without obligation! • **Exceptional Quality.** All books are quality publishers' editions especially selected by our Editorial Board.

All books are hardcover unless numbers are followed by a "P" for paperback. (Publishers' Prices Shown)
© 1988 ELECTRONICS BOOK CLUB®, Blue Ridge Summit, PA 17294-0810

FREE when you join!

**Reference Guide to Electronics
Manufacturers' Publications**
A time- and money-saving list
of product literature from all
the major electronics suppliers.

(a \$6.95
value!)

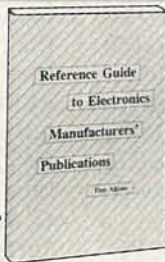

ELECTRONICS BOOK CLUB®
Blue Ridge Summit, PA 17294-0810

Please accept my membership in the Electronics Book Club® and send the 5 volumes listed below, plus my FREE copy of *Reference Guide to Electronics Manufacturers' Publications* (2683P), billing me \$3.95 plus shipping and handling charges. If not satisfied, I may return the books within ten days without obligation and have my membership canceled. I agree to purchase at least 3 books at regular Club prices (plus shipping and handling) during the next 12 months and may resign any time thereafter.

Name _____
Address _____
City _____
State/Zip _____ Phone _____
Signature _____

Valid for new members only. Foreign applicants will receive special ordering instructions. Canada must remit in U.S. currency. This order subject to acceptance by the Electronics Book Club®.
Signature of parent or guardian required for all new members under 18 years of age.

RE-788



2809 \$26.95
Count as 2



1599P \$17.95



2795 \$29.95
Counts as 2



2905 \$19.95



2645P \$10.95



1536P \$8.95



2887 \$16.95



1300P \$24.95
Counts as 2



2613 \$23.95



2750 \$25.95



2867 \$24.95



2853 \$23.95



1532P \$14.95

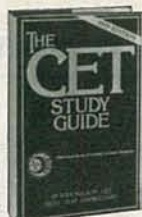

2941 \$21.95



2617 \$17.95



1897P \$13.95



1493P \$14.95



1939P \$19.95



1775P \$18.95

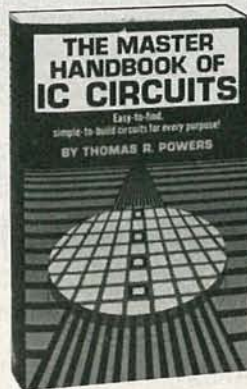

1370P \$15.50



2724 \$24.95



2707 \$26.95
Counts as 2



1964P \$12.95



1977 \$26.95
Counts as 2



2861 \$14.95



2731 \$21.95

NEW PRODUCTS



CIRCLE 10 ON FREE INFORMATION CARD

WEATHER-STATION SOFTWARE.

When we reviewed the *PC Weather Pro* ("Equipment Reports," *Radio-Electronics*, March 1988), we mentioned that Technology Marketing Inc. was planning to introduce a tool and utility kit. Their new *PC Weather Toolkit*, as it turns out, does all that we'd hoped it would.

It links data gathered by the PC-based weather station with such popular programs as *Lotus 1-2-3* and Borland's *Reflex* database. *PC Weather Tool* also generates files in standard formats—DIF (Data Interchange Format) and ASCII—that are readable by other software products, such as *dBASE III*.

PC Weather Pro monitors and stores data on barometric pressure, rainfall, inside and outside temperatures, and wind-chill temperature. Now, using *PC Weather Toolkit*, that data can span any time frame specified by the user. Once

linked to a specific software program like *Lotus 1-2-3*, files can be displayed in any graphic format that happens to be supported by that program. Also included is a utility called *File Link Software*, which enables data from *PC Weather Pro* to be read into variables in programs written in *Turbo C*, 8088/86 assembly language, *Turbo Pascal*, or BASIC/GWBASIC. Using that utility, a variable such as "windspeed" can be automatically updated every minute.

The package also includes utilities for editing, merging, and translating weather-data files, documentation software, and *File Link Software* for one language, selected by the user. *PC Weather Toolkit* is priced at \$150.00; *File Link* software for additional supported languages is available for \$50.00.—TMI, Inquiries Manager, 4000 Kruse Way Place, Bldg. 2, Suite 120, Lake Oswego, OR 97035.

LOGIC MONITOR. The model *AR-80LM*'s custom-IC design automatically detects both power and ground pins. Monitor usage is a simple, clip-on-and-view operation. Both TTL and CMOS logic levels are also detected automatically by the Logic Monitor.



CIRCLE 11 ON FREE INFORMATION CARD

The unit will indicate a logic-high, logic-low, and pulsing inputs. For pulses with repetition rates over eight Hertz, the unit flashes the LED at an 8-Hz rate. Pulses up to 40 MHz can be detected.

The *AR-80LM* logic monitor sells for a suggested price of \$79.00, which includes a storage case and an operator's manual.—ARI Media, 9241 E. Valley Boulevard, Suite 201, Rosemead, CA 91770.

GANG/SET PROGRAMMER. Logical Devices, Inc. announces the *Husky*, a fast device programmer that uses that company's "Intellegent" and "Quick Pulse" algorithms to program up to four 1-megabit EPROM's, most in less than three minutes. The *Husky*



CIRCLE 12 ON FREE INFORMATION CARD

uses an ultra-efficient switching power supply to minimize the power load on the PC.

The four 32-pin zero-insertion force (ZIF) sockets support gang programming and sequential set programming of up to four 24-, 28-, or 32-pin EE/EPROM's DIP's. With optional adaptor sockets, *Husky* supports single-chip microcomputers, CMOS EPLD's, and other devices in PLCC/PGA packages. *Husky* accepts Intel hex, Motorola hex, ASCII hex, or binary formats. As a software-driven programmer, *Husky* can be under cursor or mouse control, and supports DOS-level file manipulation and directory utilities. It is priced at \$595.00, including the IBM PC interface. An additional IBM PC interface is available for \$99.00, PAL adapter for \$75.00, and the single-chip microcomputer adapter costs \$125.00.—**Logical Devices, Inc.**, 1321 N.W. 65th Place, Fort Lauderdale, FL 33309.

PHONE CALL RESTRICTOR. The *Telelock TL-16* from Serret Systems prevents the unauthorized use of telephone and/or data communications equipment. The user has the option of restricting all outgoing calls, or only long distance, Operator, or specific prefix-number calls. Restriction override is performed by entering a user-programmable, three- or four-digit access code via the telephone dial or keypad. The save and reload



CIRCLE 13 ON FREE INFORMATION CARD

codes—also programmable by means of an internal switch—allow authorized persons the option of overriding the call restriction; a special circuit prevents any fraudulent entries.

A single *TL-16* can control any number of telephones on the same line. Other features include multicolor LED status indicators, DTMF and pulse operation, and non-volatile memory. The FCC-registered *Telelock TL-16*, has a suggested retail price of \$149.95,

including two modular connectors for easy installation.—**Serrett Systems**, P. O. Box 728, Rye, NY 10580.

MINIATURE DMM. Beckman Industrial's credit-card-sized *Circuitmate DM79* features automatic shut-off and auto-ranging. Its many functions include 5 DC-volt, 4 AC-volt, and six resistance ranges, in addition to continuity and diode checks. A special 320 millivolt range offers very high input impedance (>100 Megohms)

Tektronix® SCOPES

FREE SHIPPING • Immediate Shipment • FREE GIFT!



NEW TEKTRONIX Model #2225

The greatest value in scopes is yours from TEKTRONIX and JOSEPH ELECTRONICS. Popular portable dual channel oscilloscope, terrific new features including 50-MHz bandwidth alternate magnification, 500 microvolt sensitivity, peak-to-peak trigger filtering. Field-tested, proven performance backed by TEKTRONIX. A member of Tektronix' 2200 family. More features than scopes costing much more.

(+ FREE BONUS + FREE SHIPPING)
Only \$995

NEW/CRT READOUT 100 MHz FOUR-CHANNEL SCOPES

A real price breakthrough in lab-grade scopes from Tektronix. The 2246 and 2245 both feature: • On-screen scale factor readout • 2 mV/division vertical sensitivity • 2% vertical and horizontal accuracy • Four vertical inputs • Delayed sweep. The 2246 also features: • Pop-up menus at the touch of a button • On-screen voltage, and time and trigger-level readouts • Exclusive Smart Cursors™ track voltmeter measurements.

MODEL 2245 MODEL 2246 (+ FREE BONUS + FREE SHIPPING)
\$1,775 \$2,400

FAMOUS TEK 2200 SERIES 60/100 MHz DUAL CHANNEL SCOPES

The 100MHz 2235 and 2236 are industry leaders for value and performance • 2mV/division vertical sensitivity • Advanced triggering for stable displays • X-Y operation • Dual-timebase delayed-sweep measurements. Single timebase on 60MHz Model 2213A. • Integrated counter/timer/multimeter on 2236.

Model 2213A Model 2235 Model 2236 (+ FREE BONUS + FREE SHIPPING)
\$1,375 \$1,575 \$2,795

FULL THREE YEAR FACTORY WARRANTY ON ALL Tektronix SCOPES

FREE SHIPPING anywhere in continental U.S.A.

FREE GIFT!
BUY ANY TEKTRONIX SCOPE FROM JOSEPH'S-GET 16 PC ELECTRONIC SERVICE TOOL KIT-FREE! A \$69.95 VALUE



NEW 2220, 2230 DIGITAL STORAGE/ANALOG DUAL-CHANNEL SCOPES

The new 100MHz 2230 and 60MHz 2220 are powerful digital storage scopes with full-bandwidth analog and digital performance. Both feature: • 4K digital record length and save ref-memory for single or dual channel • Peak detect • Pre post trigger capability • Automatic process modes • 20MS/s sampling speed • X-Y plotter output. The 2230 also features: • CRT readout with cursors • Dual time base • Menu flexibility that permits user to custom tailor diagnostic functions. Both models offer optional GPIB or RS232C capability with 26k battery backed memory on 2230 only.

MODEL 2230 MODEL 2220 (+ FREE BONUS + FREE SHIPPING)
\$4,995 \$2,995

Send for FREE 480 page "Industrial Products Catalog". I understand it is FREE with any order or if requested on company letterhead. (Otherwise, \$4.95 to cover catalog and shipping costs.)

ORDER TOLL FREE
1-800-323-5925
IN ILLINOIS
312-297-4200

Our 40th Year

Joseph electronics



IL Res. 7% Tax

JOSEPH ELECTRONICS, INC.
8830 N. Milwaukee Ave. Dept. R
Niles, IL 60648

Rush merchandise per attached order. I understand rated accounts are shipped open account; otherwise send per credit card.
 Visa Master Card Discover
 Check Money Order Rush Catalog

Card No. _____ Exp. Date _____

Name _____

Company _____

Street Address _____

City _____ State _____ Zip _____

JULY 1988

REVOLUTIONARY MULTIMETER | | | |

THAT READS 4 VOLTAGES AT THE SAME TIME

CAN ALSO DISPLAY 3 VOLTAGES AND 1 CURRENT AT THE SAME TIME WITH MANY OTHER COMBINATIONS AVAILABLE INCLUDING OUR 4 1/2 DIGIT ANALOG BARGRAPH DISPLAY

MEASURE 4 VOLTAGES AT THE SAME TIME WITH 3 1/2 DIGIT DISPLAYS

1.999U 1.999U
1.999U 1.999U

EACH DISPLAY IS INDIVIDUALLY PROGRAMMABLE FOR:
RELATIVE REFERENCE (100% FULL SCALE)
HOLD, MANUAL OR AUTORANGING,
COMPARATIVE MODES USING SETPOINTS WITH AUDIBLE INDICATION (BEEPER)

OTHER FEATURES:
* COLOR CODED INPUTS TO AVOID CONFUSION
* CONTINUITY BEEPER ON RESISTANCE CHECK
* ONE YEAR PARTS + LABOUR WARRANTY
* STILL MANY MORE FEATURES

CURRENT →
RESISTANCE →



2 VOLTAGES
4 1/2 DIGIT DISPLAYS

1.9999U
1.9999U

ALL FUNCTIONS
ALL AUTORANGING

- ← VOLTAGE #1
- ← VOLTAGE #2
- ← VOLTAGE #3
- ← VOLTAGE #4
- ← COMMON

ALSO INTRODUCING A NEW CONCEPT

PANORAMIC RESOLUTION

191.990.00
U NU UJ

MODEL MM100
\$209.95

Approx. Size
7" x 4" x 1 1/2"

NOW WHEN YOU HAVE TO MONITOR SEVERAL POINTS AT THE SAME TIME ON THAT TOUGH UNIT YOU'RE TROUBLESHOOTING OR THAT DETAILED EXPERIMENT OR NEW DESIGN YOU'RE SLAVING OVER YOU'LL NEVER AGAIN HAVE TO SCRAMBLE AROUND FOR A FEW EXTRA MULTIMETERS THAT CAN'T FIND OR DON'T HAVE.

DAETRON MULTIMETER

"THE HIGH PRODUCTIVITY MULTIMETER"

10% OFF TOTAL ORDER WHEN YOU BUY BOTH UNITS

DOES YOUR DIGITAL CAPACITANCE METER DO THIS?

FULL 4 DIGIT 0.5 INCH LCD DISPLAY COMPLETELY AUTORANGING WITH 10 RANGE MANUAL CAPABILITY

AND THIS

RANGE OF 0.0 pF to 1 FARAD (999.9 mF)
0.5% BASIC ACCURACY UP TO 100 uF

AND THIS

READS DIELECTRIC ABSORPTION

AND THIS

EXTENDED PSEUDO 5 DIGIT
RESOLUTION ON SOME RANGES ONLY

AND THIS

ABILITY TO ZERO LARGE CAPACITANCE
VALUES UP TO 99.99 uF

AND THIS

CALCULATES TRUE CAPACITANCE
IF CAPACITOR IS LEAKY

AND THIS

DIODE CLAMP AND FUSED
PROTECTED INPUT.

DISCHARGE RESISTOR IN OFF
POSITION AT TERMINAL INPUTS.

POWERED BY 9V BATTERY

ONE YEAR PARTS &
LABOUR WARRANTY

MODEL
MC300 \$ 189.95

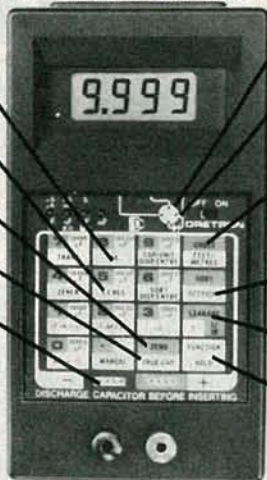

AND THIS

IDENTIFIES TRANSISTORS (NPN, PNP)
AND THEIR LEADS (E, B, C, ETC.)

AND THIS

TESTS ZENER DIODES AND RECTIFIERS.
UP TO 20V ZENER WITH AC ADAPTOR,
ZENER VOLTAGE WITH 9V BATTERY
DEPENDS ON ITS CONDITION

AND THIS

AUTOMATICALLY CALCULATES LENGTHS
OF CABLES IN FEET, METRES, MILES,
KILOMETRES (THEORETICAL RANGE
OF 9,999 MILES)

AND THIS

ABILITY TO SORT CAPACITORS IN
MANY DIFFERENT MODES

AND THIS

ABILITY TO READ LEAKY CAPACITANCE

AND THIS

HOLD FUNCTION FREEZES DISPLAY

DAETRON (416)676-1600

a division of Bergeron Technologies Inc.

935 THE QUEENSWAY, BOX 641
TORONTO, ONTARIO M8Z 5Y9

U.S. FUNDS

- [] (QTY) MM100 (INCLUDES 1 RED AND 1 BLACK TEST LEADS AND MANUAL) **\$209.95**
- TO AVOID CONFUSION IN READING MANY VOLTAGES AT ONCE WE HIGHLY RECOMMEND ONE OF THE FOLLOWING SETS WHICH ARE MATCHED TO THE COLOR CODED INPUTS OF THE MM100
- [] TL220 SET OF 6 COLOR COATED LEADS WITH EZ HOOKS @ **\$39.95**
- [] TL230 SET OF 6 COLOR COATED LEADS WITH ALLIGATOR CLIPS @ **\$39.95**
- [] CARRYING CASE, TOUGH LEATHER LIKE AND LARGE ENOUGH TO CARRY A SET OF TL220 OR TL230 LEADS AND INSTRUCTION MANUAL @ **\$34.95**
- [] (QUANTITY) MC300(S) **\$189.95**
- [] CARRYING CASE FOR MC300 **\$16.95**
- [] AC ADAPTOR (FOR EITHER UNIT) @ **\$9.95**

SHIPPING INSTRUCTIONS:

All units shipped out F.O.B. Buffalo NY via United Parcel Service (except Hawaii & Alaska) unless otherwise indicated (in which case shipments will be F.O.B. Canada)

[] 10% DISCOUNT, SUB-TOTAL x 0.9 (FOR BOTH UNITS) SUB-TOTAL \$

SHIPPING AND HANDLING @ \$5.00 PER INSTRUMENT \$

[] CHECK [] MONEY ORDER [] VISA [] MASTERCARD TOTAL \$

[] CARD NO. _____ EXPIRY DATE _____ SIGNATURE _____ BANK _____

NAME _____ TELEPHONE NUMBER _____

ADDRESS _____

CITY _____ STATE _____ ZIP CODE _____

DEALER ENQUIRIES INVITED

CIRCLE 189 ON FREE INFORMATION CARD



CIRCLE 14 ON FREE INFORMATION CARD

for minimum circuit loading. The DM79 offers DC-volt accuracy to 0.35%, instrument overvoltage protection to 700 volts, and also case insulation to 2000 volts.

Complete with an operator's manual, built-in test leads, and a carrying case, the DM79 lists for \$49.95.—Beckman Industrial Corporation, 3883 Ruffin Rd., San Diego, CA 92123-1898.

VCR IDLER TIRES KIT. Until recently, a worn-out rubber tire in a VCR's idler assembly, clutch and pulley assemblies, or take-up assemblies necessitated replacing the entire assembly. Now, Parts Express is offering a comprehensive



CIRCLE 15 ON FREE INFORMATION CARD

VCR Idler Tire Kit, containing 10 each of 15 different sizes. The kit includes a cross-reference chart listing over 80 manufacturer assembly parts-numbers, and over 200 models. The kit sells for \$55.00, with storage case.—Parts Express, 340 East First Street, Dayton, OH 45402.

S-M DEVICE REMOVAL UNIT. OK Industries presents the model SMT-W2, which is a hot tweezer for the removal of surface-mount devices; the unit features variable temperature control, and high reliability.

The model SMT-W2 incorporates an ergonomically designed

handpiece that can be held comfortably by any operator, regardless of his or her hand size. Two 8-watt ceramic heating elements provide exceptional temperature stability and sufficient power to remove any surface-mount device, from chip resistors



CIRCLE 16 ON FREE INFORMATION CARD

to large quad packs.

A full range of tips are available, including 5-mm tips for resistors or capacitors, mini-flats for SOIC's and right-angle tips for PLCC's to 84 pins. The model *SMT-W2* is priced at \$425.00.—**OK Industries, Inc.**, 4 Executive Plaza, Yonkers, NY 10701.

CHIP RESISTOR AND CAPACITOR KITS. Communications Specialists has introduced two kits: The model *CR-1* chip-resistor kit, and the model *CC-1* chip-capacitor kit. Both kits are intended as prototyping kits, but are also useful as parts kits for both repair technicians and experimenters.

The model *CR-1* contains 1540 pieces, including 10 chip resistors of every 5% value from 10 ohms to 10 megohms (145 values plus zero-ohm jumpers), plus a bonus of 10 additional resistors in eight values (0 ohms, 10 ohms, 100 ohms, 1K, 10K, 100K, 1 megohms, and 10 megohms).

The model *CC-1* contains 365 pieces composed of 5 chip capacitors of every 10% value from 1 pF to

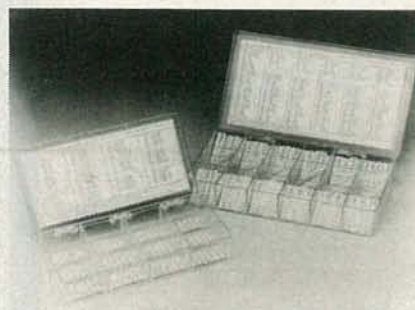

CIRCLE 17 ON FREE INFORMATION CARD

33 μ F (67 values) plus a bonus of 5 additional capacitors (1 pF, 10 pF, 100 pF, 1000 pF, 0.01 μ F, and 0.1 μ F).

The price for each of the kits is \$49.95.—**Communications Specialists, Inc.**, 426 West Taft Avenue, Orange, CA 92665.

RADIO/TELEPHONE INTERFACE. Vada Systems offers the *Alpha-Tel III*, an access system for allowing 2-way radio communications from the desk telephone. The interface provides voice-actuated transmis-

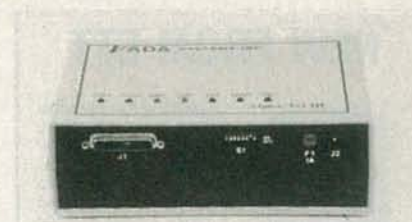

CIRCLE 18 ON FREE INFORMATION CARD

sion so that no modification needs to be made at each individual telephone station.

The *Alpha-Tel III* is compatible



KIK

Factory Direct
800-545-8784

Celebrating our 10th Year in U.S.A. . . .

Proven Quality . . .

Factory Direct Prices!

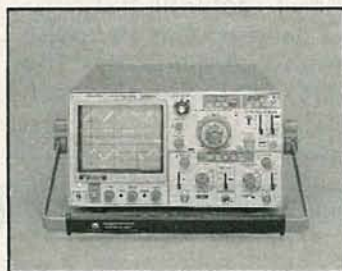

COS 5100: 100 MHz

- 3 Channel, 8 Trace
- P-P level-lock auto-trigger
- Delayed Sweep

Now Only
\$999.00

COS 5042TM, 40 MHz \$779.00

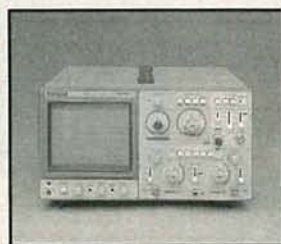

COS 5041TM

- 40 MHz, Delayed Sweep
- 2 Channel
- Ch 1 Signal Output

\$669.00

COS 5021TM

- 20 MHz, Delayed Sweep
- 2 Channel
- Ch 1 Signal Output

\$489.00

COS 5040TM

- 40 MHz
- 2 Channel
- CH 1 Signal Output

\$639.00

COS 5020TM

- 20 MHz
- 2 Channel
- CH 1 Signal Output

\$449.00

255 Frequency Counter:
150 MHz **\$299.00**

FCO1130 Frequency
Counter: 1GHz **\$739.00**

677D Wow and Flutter
Meter **\$949.00**

6701 Wow and Flutter
Meter **\$999.00**

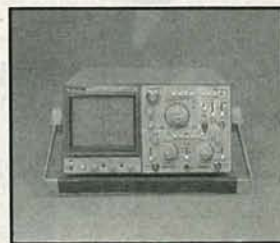

COS 5060TM

- 3 Channel, 8 Trace
- P-P level-lock auto-trigger
- Delayed Sweep

\$889.00



Add \$15 per unit shipping and handling.

(800) 545-8784

(213) 371-4662
Collect CA & AK

Local Service Centers
Nationwide



Kikusui International Corp.
19601 Mariner Avenue
Torrance, CA 90503

©Copyright Kikusui International Corp. 1988

CIRCLE 181 ON FREE INFORMATION CARD

JULY 1988

29

NEW FROM ETT



□ **RATCHET — ELEVEN-PIECE RATCHET TOOL KIT.....\$10.00.** Includes reversible ratchet handle, extension bar, six bits, two precision screwdrivers, and a cutter. Comes in fitted case. Get one for your shop, another for your car, another for your tool kit.

□ **TOOL KIT—NINE-PIECE TOOL KIT.....\$10.00.** Includes saw, bubble level, three screwdrivers, torque multiplier, calipers for inside and outside measurements, nippers, and a tape measure.



□ **BP233—ELECTRONIC HOBBYISTS HANDBOOK.....\$7.95.** Provides an inexpensive single source of easily located data that the electronics enthusiast is likely to need in his day-to-day hobby activities. 8 x 10 inches.

□ **BP232—CONCISE INTRODUCTION TO MS-DOS.....\$5.95.** If you are a PC user and want to get the most out of your computer, you must learn its MS/PC-DOS operating system. That's what this book shows you.



□ **BP194—MODERN OPTO DEVICE PROJECTS.....\$6.25.** Provides a number of practical designs that use opto-electronic devices such as fiber optics, LED's, and passive IR detectors.

□ **BP234—TRANSISTOR SELECTOR GUIDE.....\$10.00.** Prepared from a vast database of specifications. Unique guide offers a wide range of selection tables. More than 1400 devices are listed along with specs.



MAIL TO: **Electronic Technology Today Inc.**
P.O. Box 240
Massapequa Park, NY 11762-0240

SHIPPING CHARGES IN USA & CANADA

\$0.01 to \$5.00.....	\$1.00	\$30.01 to 40.00... ..	\$4.75
\$5.01 to \$10.00... ..	\$1.75	\$40.01 to 50.00... ..	\$5.75
\$10.01 to 20.00... ..	\$2.75	\$50.01 and above \$7.00	
\$20.01 to 30.00... ..	\$3.75		

OUTSIDE USA & CANADA

Multiply Shipping by 2 for sea mail
Multiply Shipping by 4 for air mail

Total price of merchandise..... \$ _____
Shipping (see chart)..... \$ _____
Subtotal..... \$ _____
Sales Tax (NYS only)..... \$ _____
Total Enclosed..... \$ _____

Name _____
Address _____
City _____ State _____ Zip _____

with all existing 1A2 and electronic-key telephone systems, and most analog and digital PABX's. When installed with a key system, the radio access is assigned a line key-position on the telephone set. When installed with a PABX, the radio access is assigned a station number. Access is easy with both applications—you merely press the line key on a key system or dial the station number on a PABX. Once access is achieved, the user transmits by speaking into the telephone. The system requires no dedicated line.

The *Alpha-Tel III* is compatible with all conventional 2-way radio equipment. It is priced at \$895.00.—**Vada Systems, Inc.**, 9329 Douglas Drive, Riverside, CA 92503.

LOGIC PROBE. Global Specialties introduces the model *LP-5*, which is capable of capturing pulses as short as 5 nanoseconds and pulse trains as fast as 100 MHz. The model *LP-5* incorporates both

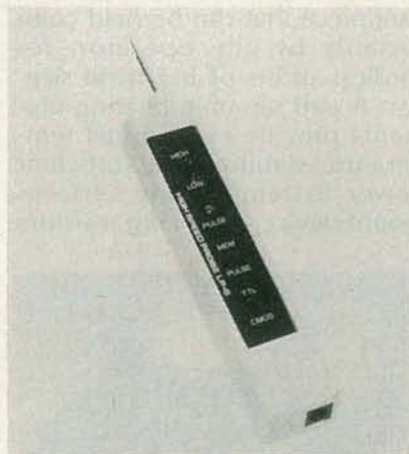

CIRCLE 19 ON FREE INFORMATION CARD

pulse and memory modes, switch-selectable TTL/CMOS thresholds, and three different color LED's for no-mixup troubleshooting.

Like all other Global logic probes, the *LP-5*'s signal inputs are protected against overvoltages, and its power leads are protected from over and reverse voltages. It is priced at \$150.00.—**Global Specialties**, 70 Fulton Terrace, PO Box 1942, New Haven, CT 06509. R-E

MOVIE TIME



1-800-843-9845
1-305-652-1981

V-7200

72 Channels
Remote Fine Tuning
Fine Tune Centering
2/3 Switchable

V-7800

Parental Control
Favorite Channel Memory
Remote Fine Tuning



V-7800

Favorite Channel Memory
Last Channel Recall
HRC/Standard Switch
90 Minute Sleep Timer

79.95

10dB Amplifier
78 Channels
HRC/Standard Switch

89.95

SPECIAL PRICED CONVERTERS

Jerrold JRX- or JSX-3
Wired Remote Push Button
36 Channel Fine Tuning
39.95

Hamlin MCC-4000-2 or
Wired Remote Slide Control
42 Channel Fine Tuning
34.95

COUPON

NAME	ADDRESS		
CITY	STATE	ZIP	
TELEPHONE 1-	Exp. Dt.		
COD <input type="checkbox"/>	CHARGE <input type="checkbox"/>	CHECK <input type="checkbox"/>	SIG <input type="checkbox"/>
ACCT. #			
QTY.	ITEM	PRICE	TOTAL
Send to:		Shipping	5.50
MOVIETIME		CHECK ONE	FL 6% Sales Tax
20203 NE 15 Ct.		AMEX <input type="checkbox"/>	MC <input type="checkbox"/>
Miami, FL 33179		VISA <input type="checkbox"/>	TOTAL

30 DAY MONEY BACK GUARANTEE

CIRCLE 204 ON FREE INFORMATION CARD

LETTERS

continued from page 17

another story), and only a business would spend \$4000 on a computer, a laser printer, or both. So how could any software developer make the enormous commitment to develop a serious desktop publishing program, when the potential market is home computerists who have little money to spend, and to whom software pirating is a game, not a breach of ethics?

Having said all that, however, we're still fascinated by the Atari. Mr. Kona, here's our challenge: Write us an article that demonstrates your claims. No hyperbole, no IBM resentment, just facts. Tell us what it can do and how it does it. Tell us about the system software that allows it to run Mac software. Tell us what kind of speed degradation occurs, what sorts of incompatibilities arise, what (if anything) works better on the Atari than on the Mac. And do the same for IBM. Then throw in a good dose of technical background on the 520's micro-processor, memory architecture, special sound and graphics IC's, bus speed, DMA capabilities, etc. Sound like a tall order? That's just what you asked us to do!

And likewise with you owners of other systems: If you want to see your system written up, do it yourself, or help us find someone qualified to do it. Contrary to what many readers think, qualified authors are hard to find, especially when it comes to the less-popular systems.—Editor

MAKING PC BOARDS

In your PC Service section, you ask **Radio-Electronics'** readers to share helpful techniques they've used in making printed circuit boards, and I have a good one!

Why use the "original" artwork to do the photo-resist light exposure at all? Simply take the foil pattern page to a photocopy house, and request a clear transparency, instead of a regular paper copy. It shouldn't cost more than a dollar, and you'll have a distinct black print with a transparent background—just what you need

Ten Things You Can Do With The VA62 Universal Video Analyzing System — That You Can't Do With The Others.



\$3,495 Patented

1. Quickly locate defective circuits by injecting signals without disconnecting components.
2. Replace video heads with confidence; a simple good/bad head test removes all doubt.
3. Align IF traps simply by just the pattern on the CRT — have the picture "looking like it did when they bought it."
4. Quickly align VCRs with special video patterns, or NTSC color bars. Meets all manufacturers' warranty requirements.
5. Performance test and troubleshoot any MTS stereo TV or VCR system, so you can cash in on new technology.
6. Confidently test deflection yokes, IHVTs, and flyback transformers, in-or out-of-circuit, before you replace them.
7. Add on phase-locked accessories into your video analyzing system to increase service potential as technology changes.
8. Performance test and troubleshoot digital/analog RGB video monitors, so you can test all of today's video systems.
9. Conquer tricky servo circuits in VCRs by injecting a reference 30 Hz servo pulse.
10. Cut your video servicing time in half . . . or your money back.

Discover what the Universal Video Analyzing System can do for you! Call Today 1-800-843-3338.

In Canada Call 1-800-851-8866.

100% American Made

SENCORE

3200 Sencore Drive, Sioux Falls, SD 57107 605-339-0100 In SD Only

CIRCLE 188 ON FREE INFORMATION CARD

Macrovision ... now you see it, now you don't.

Remove copy-protection from video cassettes.



- Digital Filter Type, removes only Macrovision pulses
- No adjustments, crystal controlled
- Compatible with all VCR's, uses automatic vertical blanking level

Macro-Scrubber — We stock the exact parts, PC board, and AC adaptor for an article on Building a Macro-Scrubber appearing in *Radio-Electronics* December 1987 issue.

JMAK-1 Parts Package \$19.00

Includes all the original resistors, capacitors, diodes, transistors, integrated circuits, and crystal.

JMAK-2 PC Board \$9.95

Original etched and drilled silk-screened PC board used in article

JMAK-3 AC Adaptor \$7.95

Original (14 to 18 volt DC @ 285 ma) AC adaptor used in article.

Free reprint of article on building a Macro-Scrubber with any purchase above. Add \$2.50 shipping & handling; \$4.50 Canadian orders.

Note: Unauthorized duplication of copyrighted material is illegal. Use Macro-Scrubber for viewing only.

72-CHANNEL CABLE CONVERTER \$79.95 WITH INFRA-RED REMOTE CONTROL

MC-702 CONVERTER



Add \$3.50 shipping & handling
\$9.50 Canadian orders.

- 72-channel capability
- Wireless, Infra-Red remote control
- Channel output 2 or 3 switchable
- Microprocessor controlled PLL operation
- Skip channel memory eliminates unused channels
- Parental control for all channels
- Last channel recall
- Fine tune memory
- UL listed/FCC approved
- Simple installation with any TV
- Includes battery and 3 foot coax cable

CABLEMASTER \$19.95 Cable/VCR Timer

- Record multiple premium play channels
- Turns cable box on and off
- Selects channel for unattended recording
- Thousands sold nationally for \$99.95

Add \$3.50 shipping & handling
\$4.50 Canadian orders

ORDER TOLL FREE ANYTIME
1-800-227-8529

Ask for **FREE**
Color Catalog

Inside MA: 617-695-8699

VISA, MASTERCARD,
or C.O.D.



J & W
ELECTRONICS, INC.

P.O. BOX 800 • MANSFIELD, MA 02048

©Copyright 1988 by J&W Electronics Inc.

to do a good exposure of the light-sensitive coating. Your exposure time will be correct, without all the guesswork. And also, there's no need to cut up the magazine you just bought.

If you have access to a photocopy machine, you can make your own copies; transparency sheets are available at commercial stationary stores, and elsewhere. However, some cautions should be observed. First, copiers sometimes shrink or distort the original image just slightly. Find one that doesn't, or where the shrinkage is so slight that you won't run into problems with lead spacing when you try to install components. That is especially critical when you are trying to produce a double-sided board.

Liquid-toner copiers operate at cooler temperatures than those that use dry or powdered toner, so there's not much of a chance of the polyester film sheets melting as they pass through the drying process.

In copiers that use dry or powdered toner, however, the fuser uses more heat to melt the toner into the page. If the transparency should get stuck in the fuser for a short time, it can easily be melted. (Some copiers can regulate the temperature.)

Finally, clear transparency sheets should be fed *one-at-a-time* from the paper tray. If you try to stack them in the tray, they sometimes stick—and if they jam inside the copier, they're really hard to get out! If you have your own copier, be sure it can accept transparency sheets, and that you use the correct ones for your specific make and model.

Scratches can be touched up with any type of black paint that doesn't have an acetone, ketone, or lacquer-solvent base. (Those could melt the transparency.) Do the touch-up on the reverse side; that is, the side *without* the toner. If some toner bleeds to an area where it shouldn't be, it can be scratched off.

That sounds much more complicated than it really is. Just use common sense, and you'll get good results with very little effort.

GERALD KOSKE
Wonder Lake, IL

R-E

HITACHI SCOPES AT DISCOUNT PRICES!

\$100 Price Reduction



V-212
NOW \$379
was \$475
List \$560

Plus 'Free' 9600 Function Generator

All Hitachi scopes include two 1x, 10x probes and have a 3 year warranty on parts and labor



40MHz **V-425** List 995
CRT readout **\$835**



60MHz **V-660** List 1,195
Delayed sweep **\$899**



100MHz **V-1060** List 1,595
Delayed sweep **\$1,285**

	List	Our Price	Save
V-223 20MHz D.T. 2mV Sens. Delayed Sweep	770	695	75
V-422 40MHz D.T. 1mV Sens. DC offset	875	695	180
V-423 40MHz D.T. 1mV Sens. Delayed Sweep DC offset	955	795	160
V-1065 100MHz D.T. 2mV Sens. Delayed Sweep	1,895	1,575	320
V-1100 100MHz Q.T. 1mV Sens. Cursor meas. DVM counter	2,295	1,995	300
V-1150 150MHz Q.T. 1mV Sens. Cursor meas. DVM counter	3,100	2,565	535

ELENCO PRODUCTS AT DISCOUNT PRICES!



\$349
MO-1251

- 6" CRT
- Built in component tester
- TV Sync
- Much More

20MHz Dual Trace Oscilloscope

MO-1253

- 40MHz Dual Trace
- Dual Time Base
- Delayed Sweep
- 12KV Acceleration Voltage
- Better than Hitachi V-423
- High Luminance 6" CRT

\$595



\$498
MO-1252

- High Luminance 6" CRT
- 1mV Sensitivity
- 6KV Acceleration Voltage
- 10ns Rise Time
- X-Y Operation • Z Axis
- Delayed Triggering Sweep
- Much More

35MHz Dual Trace Oscilloscope

Top quality scopes at a very reasonable price. Contains all desired features. Two 1x, 10x probes, diagrams and manual.



True RMS 4 1/2 Digit Multimeter
\$135 M-7000

.05% DC Accuracy
.1% Resistance
with Freq. Counter
& Deluxe Case



10MHz Oscilloscope
S-3000
\$239

10MHz DC or AC
Triggered Sweep
Calibrated Vert & Hor
Reads Volts & Freq

Scope Probes

P-1 65MHz, 1x, 10x **19.95**
P-2 100MHz, 1x, 10x **23.95**
10 meg ohms input impedance
Fits most scopes
TL-3 BNC to Minigrabber **3.49**



Low Cost Multimeter
M-1600
\$25

3 1/2 Digit LCD
1% DC Accuracy
10A Scale
Auto zero/polarity



Digital LCR Meter
LC-1800
\$138

Measures
Caps (1uH-200H)
Resistors
(.1 ohm-20M ohms)

Breadboard

9436 Shown



9430 1,100 pins \$15
9434 2,170 pins \$25
9436 2,860 pins \$35



Multimeter with Capacitance and Transistor Tester
\$55 CM-1500A

Reads Volts, Ohms
Current, Capacitors,
Transistors and
Diodes w/case

Digital Capacitance Meter CM-1550

\$58.95
9 Ranges
.1pf-20,000ufd
.5% basic accuracy
Zero control
w/case

Analog Multimeter M-1100

\$19.95
19 ranges
High Accuracy
10A reading
Mirrored scale
Kr 17.50



3 1/2 Digit Meter
Auto and Manual Ranging
28 Functions
Fully Protected

M-1180 .7% Ac \$36.95
M-1181 .1% Ac \$42.95
M-1182 .25%Ac \$39.95

Function Generator Blox #9600



\$24.95

Provides sine, tri, squ wave
From 1Hz to 1MHz
AM or FM capability

Solderless Breadblox



550 tie pts
including 2 power
bus lines
#9550
\$7.50

IC Test Clips



16 pin \$5.95
20 pin \$8.25
24 pin \$10.75
28 pin \$11.75
40 pin \$18.50

All are gold plated to
assure trouble free contact

Temperature Probe M-110CF

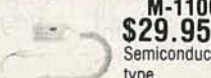

\$29.95
Semiconductor
type
Range
-58F-302F
Fits most digital multimeters

50MHz Logic Probe LP-700



\$23
Logic Pulsar LP-600 \$23

Digital 3 Amp Power Supply XP-750



\$175

0-40V @ 1.5A
0-2V @ 3A

XP-650 with Analog Meters \$129.50

Regulated P.S. Breadboard XK-400



\$99.95

- Fully regulated
- Short circuit protection
- 3550 test points
- 3 power supplies

• 5V @ 2A, 12V @ .3A, -12V @ .3A

GF-8016 Function Generator with Freq. Counter



\$239

- Sine, Square, Triangle
- Pulse, Ramp, .2 to 2MHz
- Frequency .1 thru 10MHz

GF-8015 without Freq. Meter \$179

Digital Triple Power Supply XP-765



\$239

0-20V @ 1A
0-20V @ 1A
5V @ 5A

Fully Regulated, Short Circuit Protected with
2 Limit Cont. 3 Separate Supplies

XP-660 with Analog Meters \$169.50

Quad Power Supply XP-580



\$59.95

2-20V @ 2A
12V @ 1A
5V @ 3A
-5V @ .4A

Fully regulated and
short circuit protected

XP-575 without meters \$49.95

Four-Function Frequency Counters



F-1000 \$259

1.2GH

F-100 \$179

120MH

Frequency, Period, Totalize, Self Check with High-Stabilized Crystal Oven Oscillator, 8 Digit LED Display

WE WILL NOT BE UNDERSOLD!



C & S SALES INC.
1245 Rosewood, Deerfield, IL 60015
Add 5% for Postage (\$10 Max) IL Res., 7% Tax

(800) 292-7711 15 Day Money Back Guarantee
(312) 541-0710 2 Year Warranty
ASK FOR FREE CATALOG

CIRCLE 109 ON FREE INFORMATION CARD

NEW IDEAS

Fingertip Olympics

THIS MONTH'S CIRCUIT IS A GREAT LITTLE game that's ideal for developing hand coordination, or for putting couch potatoes in the mood for the upcoming Olympic games.

The heart of the circuit, which is shown in Fig. 1, is an LM2907 (National) frequency-to-voltage converter. That low-cost IC, which is available from several of the companies that advertise in the back pages of **Radio-Electronics**, provides a voltage output that's directly proportional to the frequency at its input. That frequency is "set" by alternately closing S1 and S2, two normally-open, momentary-contact pushbuttons. The faster they're closed in sequence, the higher the frequency.

The "skill level" of the game is set by R1. The smaller the value of that resistor, the faster you'll have to hit the switches to get a measurable output. As a rule of thumb, start with a value of about 510K; if you find that's too easy, or as you get better, substitute lower-valued

units. You can also use multiple resistors and a rotary switch to set up multiple skill levels.

Setup and use

Any construction technique can be used to build the unit, But point-to-point wiring on a piece of perforated construction board is probably the simplest. For best play, the switches should be mounted about six inches or so apart, so be sure that you use a big enough piece of board.

To test, set R2 fully counterclockwise (minimum resistance) and tap the switches to make sure that there's an output, as indicated by M1. If there is, you are ready to go.

To play the game, set R2 at about mid-range, then place the unit in your lap or on a table top and begin tapping. Use two hands and go as fast as you can. The faster you tap the switches in sequence, the higher the output current. When you are tapping away at about your

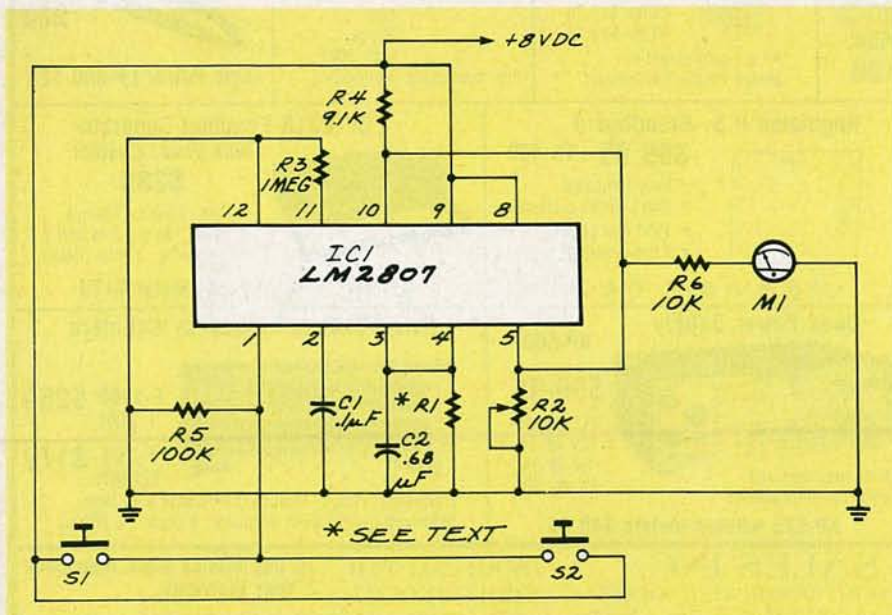
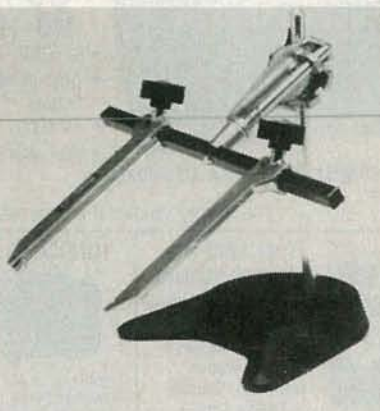

FIG. 1

NEW IDEAS

This column is devoted to new ideas, circuits, device applications, construction techniques, helpful hints, etc.

All published entries, upon publication, will earn \$25. In addition, for U.S. residents only, Panavise will donate their *model 333*—The Rapid Assembly Circuit Board Holder, having a retail price of \$39.95. It features an eight-position rotating adjustment, indexing at 45-degree increments, and six positive lock positions in the vertical plane, giving you a full ten-inch height adjustment for comfortable working.



I agree to the above terms, and grant **Radio-Electronics** Magazine the right to publish my idea and to subsequently republish my idea in collections or compilations of reprints of similar articles. I declare that the attached idea is my own original material and that its publication does not violate any other copyright. I also declare that this material has not been previously published.

Title of Idea _____

Signature _____

Print name _____ Date _____

Street _____

City _____ State _____ Zip _____

Mail your idea along with this coupon to: **New Ideas Radio-Electronics**, 500-B Bi-County Blvd., Farmingdale, NY 11735

personal limit, readjust R2 so that M1 reads about $\frac{3}{4}$ scale (a friend is very helpful for that). Then start tapping away to see if you can get the meter to go even higher. The game can get very addictive!—*Phil Blake.* **R-E**

Authorized

COMB

Liquidator

COMPUTER WITH MONITOR AND MS-DOS SOFTWARE

- 512K RAM. Two 5 1/4" 360K Disk Drives.
- 12" Hi-Res. Amber Monochrome Monitor.
- IBM Compatible 84-Key Keyboard.
- MS-DOS 3.2 Operating System.
- Centronics Parallel Interface. 4 Expansion Slots.
- Hercules Graphics Compatible. Color Card Incl.

Zenith—The Quality Goes in Before the Name Goes On. Zenith has been building fine electronics for home and business for decades. Products made to perform—and to last. Now they put this experience to work to develop the 157-2/1111 IBM Compatible Personal Computer. And, now you can order this fine computer for 50% less than you could pay for a comparable system. Why buy a no-name model, when you can own a Zenith? Get this kind of superior quality, at such a **LOW price. Order today!**

IBM is a registered trademark of International Business Machines Corp.



System for Home, School, or Office!

IBM PC/XT Compatible System for Home, School or Office!

FACTORY NEW! FIRST QUALITY!

90-Day Limited Manufacturer's Warranty.

Mfr. List Price **\$1499.00** **\$799**

Value Priced At Item H-3684-7344-054 Shipping, handling: \$49.50 ea.

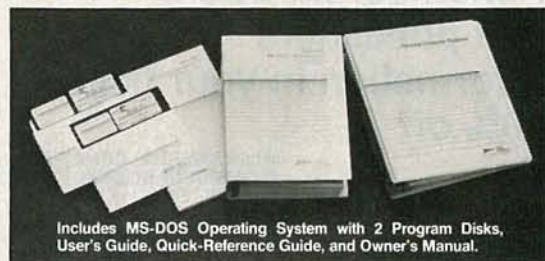

Includes MS-DOS Operating System with 2 Program Disks, User's Guide, Quick-Reference Guide, and Owner's Manual.

13 IBM COMPATIBLE SOFTWARE PROGRAMS

For Home & Business! Use with the Zenith (above), Delta or any IBM compatible. Programs use MS or PC-DOS systems 2.0 or later. Set Includes: Video File, Business/Personal File, Recall, Budget/Income Forecaster, Checkbook Reconciler, Connect, DOS Assistant, and Word Processor.

IBM is a registered trademark of International Business Machines Corp.

Mfr. List Price **\$194.35** **\$69**

Liquidation Priced At Item H-3684-7347-982 Shipping, handling: \$5.00/set

Ideal for Use with the Zenith Computer Sold Above!



FLOPPY DISKS

Stock Up at prices below dealer cost! Each is 100% certified error free. 5 1/4"

double-sided, double density. Meet ANSI standards.

Lifetime Limited Mfr's. Warranty.

40 DISKS

100 DISKS

200 DISKS

Compare: \$31.60 **\$24**

Compare: \$79.00 **\$49**

Compare: \$158.00 **\$79**

Liquidation Priced At Item H-3684-7021-314 S/H: \$4.50 per pack

Liquidation Priced At Item H-3684-3475-019 S/H: \$7.50 per pack

Liquidation Priced At Item H-3684-3475-027 S/H: \$11.50 per pack

TOLL-FREE: 1-800-328-0609

SEND ME THE ITEMS I HAVE LISTED BELOW

Credit card customers can order by phone, 24 hours a day, 7 days a week.

SEND TO:

COMB Authorized Liquidator
1405 Xenium Lane N/Minneapolis, MN 55441-4494

My check or money order is enclosed. (No delays in processing orders paid by check.)

PLEASE CHECK: VISA MasterCard Discover American Express

Acct. No. _____ Exp. / _____

PLEASE PRINT CLEARLY

Name _____

Address _____ Apt. # _____

City _____ State _____ ZIP _____

Phone () _____

Sign Here _____

Item No.	Item Description	Qty.	Price Ea.	Tot. Price	S/H Ea.	Total
H-3684-7344-054	Zenith Computer System		\$799		\$49.50	
H-3684-7347-982	13 Software Programs		\$69		\$5.00	
H-3684-7021-314	40 Floppy Disks		\$24		\$4.50	
H-3684-3475-019	100 Floppy Disks		\$49		\$7.50	
H-3684-3475-027	200 Floppy Disks		\$79		\$11.50	
TOTAL (Products plus insured shipping, handling.)						

JULY 1988

Join the Electronics and Control Engineers' Book Club®

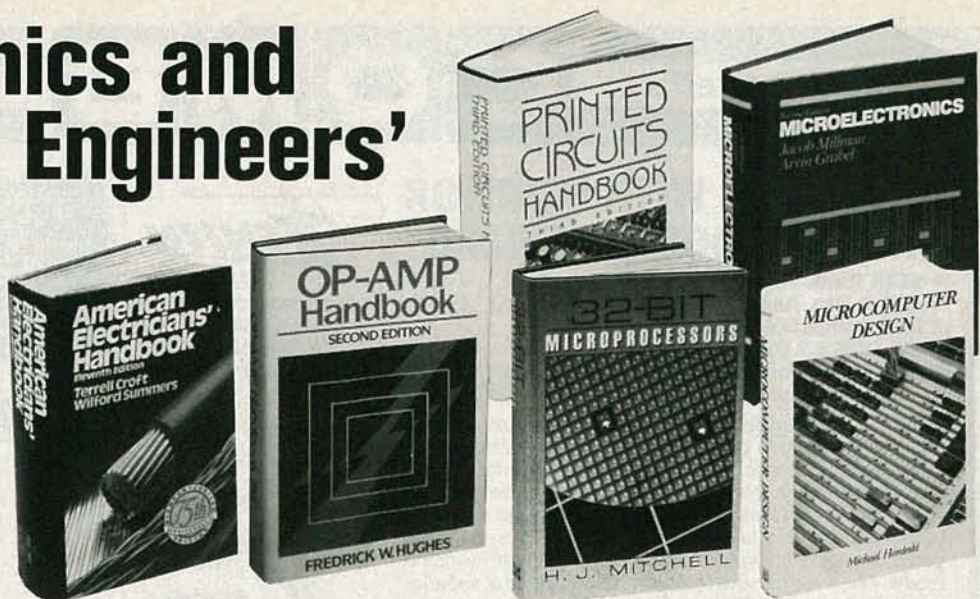

ADVANCED DIGITAL COMMUNICATIONS: Systems and Signal Processing. Edited by K. Feher. 768 pp., 436 illus. Emphasizes the newest advances and developments in telecommunications systems and networks. Chapters on subjects such as ISDN, speech coding algorithms, digital speech interpolation systems and interference are all written by international authorities to give you on-the-job expertise.

583801-X Pub. Pr., \$59.95 Club Pr., \$42.50

PRINTED CIRCUITS HANDBOOK, Third Edition. By C.F. Coombs, Jr. 960 pp., 556 illus. Here in one handy volume is all the information you need to design, manufacture, test, and repair printed wiring boards and assemblies. This new edition features ten all-new chapters, including three on SMT.

126/097 Pub. Pr., \$59.50 Club Pr., \$45.50

32-BIT MICROPROCESSORS. Edited by H. J. Mitchell. 248 pp., 104 illus. and tables. A complete survey of the architecture, operation, and applications of today's most important new devices from AT&T, Inmos, Intel, and Motorola.

425/85X Pub. Pr., \$45.00 Club Pr., \$35.00

MICROWAVE AMPLIFIERS AND OSCILLATORS. By C. Gentili. 150 pp., 79 illus. A thorough, practical introduction to the theory and design of microwave amplifiers and oscillators, with coverage of the scattering matrix, the gallium arsenide field-effect transistor, and microstrip technology.

229/953 Pub. Pr., \$34.95 Club Pr., \$27.95

COMMUNICATIONS RECEIVERS: Principles and Design. By Ulrich L. Rohde and T.T.N. Bucher. 608 pp., 402 illus. Everything you need to know if you design or work with communications receivers, from theory to practical design approaches. Coverage includes all types of receivers: shortwave, broadcast, radar, military, marine, aeronautical, and more.

535/701 Pub. Pr., \$59.50 Club Pr., \$44.50

- your one source for engineering books from over 100 different publishers
- the latest and best information in your field
- discounts of up to 40% off publishers' list prices

New Members!
Take any one of these great professional books for only **\$289** as a premium with your first selection!

McGRAW-HILL CONCISE ENCYCLOPEDIA OF SCIENCE AND TECHNOLOGY. Editor-in-Chief S. P. Parker and the Staff of the McGraw-Hill Encyclopedia of Science and Technology. 2,065 pp., 1,600 illus. This volume serves every need for understanding today's science and technology. Written by over 3,000 of the world's topmost experts, including 19 Nobel Prize winners, it covers 75 disciplines from Acoustics to Zoology.

454/825 Pub. Pr., \$99.50 Club Pr., \$63.99

CIRCUIT DESIGN FOR ELECTRONIC INSTRUMENTATION: Analog and Digital Devices from Sensor to Display, Second Ed. By D. Wobschall. 400 pp., 365 illus. Brings you the entire process of circuit design in a comprehensive, easy-to-follow format. This new edition reflects the latest in IC technology, including CMOS and ECL devices.

712/31X Pub. Pr., \$49.50 Club Pr., \$36.95

AMERICAN ELECTRICIANS' HANDBOOK, Eleventh Ed. By T. Croft and W. Summers. 1,824 pp., 1,560 illus. This newly updated handbook shows you how to select, install, maintain, and operate all the latest electrical equipment and wiring. It includes the most recent code requirements, basic formulas, and a wealth of circuit diagrams and illustrations.

139/326 Pub. Pr., \$64.50 Club Pr., \$49.50

MICROELECTRONICS, Second Ed. By J. Millman and A. Grabel. 1,001 pp., 646 illus. Takes you from the basics of semiconductor properties to an understanding of the operation of solid-state devices, and then to more advanced topics. Its up-to-date coverage, real-life examples, and practical data make this an ideal reference for the working engineer.

423/30X Pub. Pr., \$51.95 Club Pr., \$41.50

ENGINEERING MATHEMATICS HANDBOOK, Third Ed. By J. J. Tuma. 512 pp., illus. This best-selling handbook gives you the essential mathematical tools-formulas, definitions, theorems, tables, and models for computer programming — that you need for your day-to-day engineering calculations.

854/433 Pub. Pr., \$44.50 Club Pr., \$34.50

ENGINEERING FUNDAMENTALS FOR THE PROFESSIONAL ENGINEERS' EXAM, Third Ed. By L. M. Polentz. 432 pp., 170 illus. Features worked-out solutions and full explanations for all sample problems so you can learn how to solve them. It's a dependable way to prepare for the exam or a perfect on-the-job reference.

503/931 Pub. Pr., \$36.50 Club Pr., \$27.95

AUTOMATIC CONTROL SYSTEMS, Fifth Ed. By B. C. Kuo. 736 pp., illus. Provides an overview of automatic control systems, including in-depth coverage of classical control techniques, optimal control theory, and analog and digital control system design. This updated edition discusses the latest ideas on the use of computers to design control systems and as components of such systems.

583706-4 Pub. Pr., \$48.00 Club Pr., \$36.95

OP-AMP HANDBOOK, Second Ed. By F. W. Hughes. 320 pp., 231 illus. Organized for on-the-job reference, this handbook covers all facets of op-amps, from stability and protection to signal processing using op-amps. Includes a collection of over 60 practical circuits for a variety of applications, procedures, and experiments.

583651-3 Pub. Pr., \$36.33 Club Pr., \$27.50

THE LINEAR IC HANDBOOK. By M. S. Morley. 614 pp., 163 illus. The one-stop sourcebook that helps you find — quickly and easily — the lowest-cost linear IC that will meet your needs. Includes specs, applications data, and prices of linear ICs from all major manufacturers, as well as design and fabrication techniques.

583784-6 Pub. Pr., \$49.50 Club Pr., \$36.25

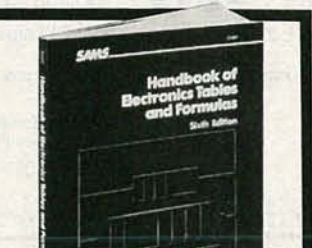

A \$19.95 Value — Yours ABSOLUTELY FREE when you join!

HANDBOOK OF ELECTRONIC TABLES AND FORMULAS

Sixth Edition

256 pages, illustrated. 583804-4

Up-to-date mathematical tables and electronic formulas in a convenient desk reference that you'll find indispensable. Included are basic formulas, constants, government/industry standards, symbols and codes, service data, and more. The handbook also has new sections describing how to do your calculations on a computer, and complete computer programs.

PRINCIPLES OF PARALLEL AND MULTI-PROCESSING. By G. R. Desrochers. 500 pp., illus. A highly practical guide to the best techniques in parallel problem-solving. Discusses parallel system design, architecture, implementation, software, and performance analysis.

165/793 Pub. Pr., \$49.50 Club Pr., \$36.95

ANALOG ELECTRONIC CIRCUITS. By G. M. Glasford. 480 pp., 350 illus. Gives you the detailed information and equations you need to create and analyze top quality circuit designs or effectively utilize the designs of others.

583768-4 Pub. Pr., \$52.33 Club Pr., \$37.95

HANDBOOK OF ELECTRONIC NOISE MEASUREMENT AND TECHNOLOGY, Second Ed. By C. A. Vergers. 440 pp., 213 illus. Provides answers to all your questions about noise origins, causes, effects. Also shows you how to predict and measure noise, and how to design low-noise circuits.

583947-4 Pub. Pr., \$39.95 Club Pr., \$29.95

SWITCHGEAR AND CONTROL HANDBOOK, Second Ed. Edited by R. W. Smeaton. 1,056 pp., 789 illus. The only handbook that treats all aspects of switchgear control, including design, applications, safety, and maintenance. Updated to reflect the changes brought about by the use of computers, solid-state devices, and programmable controls.

584/494 Pub. Pr., \$75.00 Club Pr., \$56.95

ANTENNA APPLICATIONS REFERENCE GUIDE. Edited by R. C. Johnson and H. Jaski. 496 pp., 368 illus. and tables. Covers the major applications of antenna technology in all areas of communications and their design methods. Emphasizes important new applications such as earth station, satellite, seeker, aircraft, and microwave-relay antennas.

322/848 Pub. Pr., \$53.95 Club Pr., \$42.50

MICROCOMPUTER DESIGN. By M. Hordeski. 406 pp., illus. Emphasizes the most current, cost effective methods for developing, debugging and testing all types of microprocessor products, including software and hardware.

583683-1 Pub. Pr., \$42.67 Club Pr., \$29.95

BOB MIDDLETON'S HANDBOOK OF ELECTRONIC TIME-SAVERS AND SHORTCUTS. By R.G. Middleton. 378 pp., illus., softbound. Packed with little-known tricks of the trade and brand-new techniques, this popular handbook makes it easier than ever to troubleshoot radio, TV, audio equipment, CCTV, and more.

583865-5 Pub. Pr., \$29.95 Club Pr., \$22.50

Be sure to consider these important titles as well!

INTRODUCTION TO RADAR SYSTEMS, Second Ed. By M. I. Skolnik. 579/091 Pub. Pr., \$52.95 Club Pr., \$42.50

MICROPROCESSORS IN INSTRUMENTATION AND CONTROL. By S. A. Money. 427/070 Pub. Pr., \$43.50 Club Pr., \$34.50

OPERATIONAL AMPLIFIERS AND LINEAR INTEGRATED CIRCUITS, Third Ed. By R. F. Coughlin and F. F. Driscoll. 583754-4 Pub. Pr., \$34.95 Club Pr., \$25.95

McGraw-Hill's NATIONAL ELECTRICAL CODE HANDBOOK, 19th Ed. By J. F. McPartland. 457/077 Pub. Pr., \$42.50 Club Pr., \$31.95

ELEMENTS OF ENGINEERING ELECTROMAGNETICS, Second Ed. By N. N. Rao. 583774-9 Pub. Pr., \$49.00 Club Pr., \$35.50

PROBABILITY, SIGNALS, NOISE. By J. Dupraz. 183/309 Pub. Pr., \$43.95 Club Pr., \$34.95

POWER GENERATION CALCULATIONS REFERENCE GUIDE. By T. G. Hicks. 288/003 Pub. Pr., \$36.50 Club Pr., \$27.50

HUMAN FACTORS REFERENCE GUIDE FOR ELECTRONICS AND COMPUTER PROFESSIONALS. By W. E. Woodson. 717/664 Pub. Pr., \$35.95 Club Pr., \$28.50

THE FOURIER TRANSFORM AND ITS APPLICATIONS, Second Ed., Revised. By R. N. Bracewell. 070/156 Pub. Pr., \$52.95 Club Pr., \$41.50

THE LASER GUIDEBOOK. By J. Hecht. 277/338 Pub. Pr., \$52.95 Club Pr., \$41.50

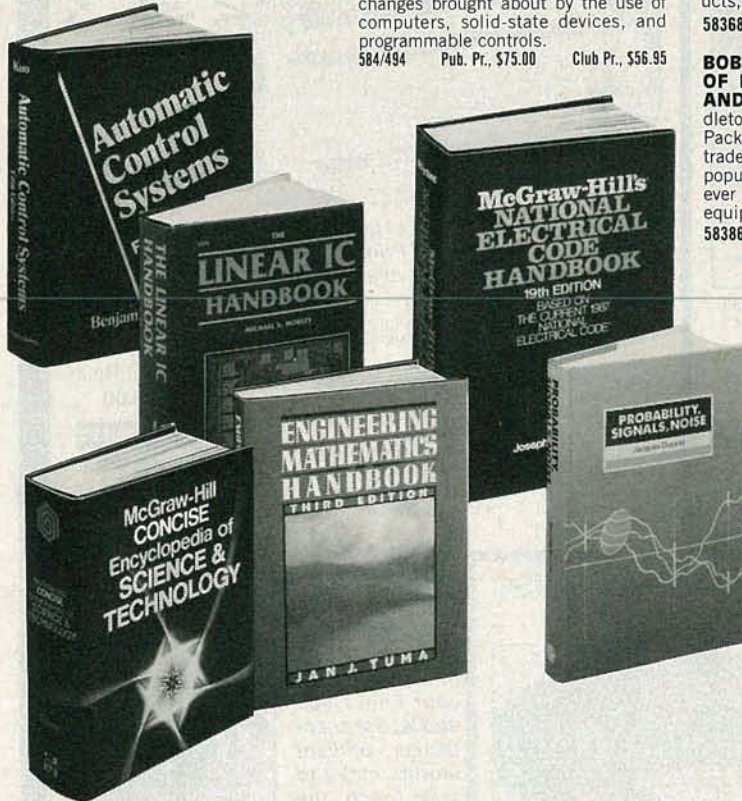

Here's how the Club works to serve YOU:

■ IMPORTANT INFORMATION... WE MAKE IT EASY TO GET!

In our rapidly changing world, those who perform best are those who are best informed. Designed exclusively for the practicing engineer, the Electronics and Control Engineers' Book Club provides you with information that is relevant, reliable, and specific enough to meet your needs. Each Club bulletin comes your way 14-16 times a year and offers you more than 30 books to choose from — the best and newest books from all publishers!

■ DEPENDABLE SERVICE... WE'RE HERE TO HELP!

Whether you want information about a book or have a question about your membership, our qualified staff is here to help. Just call us toll-free or write to our Customer Service. We also make sure you get only the books you want. All you do is simply tell us your choice on the Reply Card and return it to us by the specified date. If you want the Main Selection, do nothing — it will be sent to you automatically. (A small shipping and handling charge is added to each shipment.)

■ CLUB CONVENIENCE... WE DO THE WORK!

Beyond the benefit of timely information, Club membership offers many other benefits. For example, you get a wide choice of books that cannot be matched by any bookstore — anywhere. And all your books are conveniently delivered right to your door. You also get the luxury of 10 full days to decide whether you want the Main Selection. If you should ever receive a Main Selection you don't want because the Club bulletin came late, just return it for credit at our expense.

■ SUBSTANTIAL SAVINGS... AND A BONUS PROGRAM TOO!

In keeping with our goal to provide you with the best information at the greatest possible savings, you will enjoy substantial discounts — up to 40%! — on every book you buy. Plus, you're automatically eligible for our Bonus Book Plan which allows you savings up to 70% on a wide selection of books.

■ EASY MEMBERSHIP TERMS... IT'S WORTHWHILE TO BELONG!

Your only obligation is to purchase 2 more books — at handsome discounts — during the next 12 months, after which you enjoy the benefits of membership with no further obligation. Either you or the Club may cancel membership anytime thereafter.



**FOR FASTER SERVICE IN ENROLLING
CALL TOLL-FREE 1-800-2-MCGRAW**

MAIL THIS COUPON TODAY

McGraw-Hill Book Clubs Electronics and Control Engineers' Book Club®

P.O. Box 582, Hightstown, NJ 08520-9959

Please enroll me as a member and send me the two books indicated, plus the HANDBOOK OF ELECTRONIC TABLES AND FORMULAS. I am to receive one book for just \$2.89, the other at the discounted member's price, plus local tax, shipping and handling charges. I agree to purchase a minimum of two additional books during my first year of membership as outlined under the Club plan described in this ad. I understand that a shipping and handling charge is added to all shipments.

Your FREE Handbook	
583804-4	
Write Code No. of the \$2.89 selection here	Write Code No. for the First selection here
<input type="text"/>	<input type="text"/>

Signature _____

Name _____

Address/Apt. # _____

City _____

State _____ Zip _____

This order subject to acceptance by McGraw-Hill. All prices subject to change without notice. Offer good only to new members. Foreign member acceptance subject to special conditions.

E33975

JULY 1988

DAMARK

INTERNATIONAL, INC.

**MUST LIQUIDATE
AT FAR BELOW
DEALER COST!**

PUBLIC NOTICE:
Due to a variety of reasons, (overproductions, discontinued lines, Etc...) manufacturers & distributors get **STUCK** with inventories that must be liquidated. **DAMARK** walks in, lays down cash, and takes the entire inventory. This is how we can offer you products at **BELOW DEALER COST!** Just **LOOK** at the values below and order today - **QUANTITIES ARE LIMITED!**

NEC LAP-TOP COMPUTER

A Powerful Lap-Top Personal Computer That Lets You Get The Job Done Wherever It's Convenient!

Built-In Word Processing, Spreadsheet, Filing and Telecommunications-- Ready Instantly Wherever You Go!



- 64K RAM memory stores data.
- 4 Built-In Programs included: Word Star-To-Go, Calc-To-Go, Personal Filer and Telcom.
- Built-In 300 Baud Modem with auto dial.
- 80 column x 16 line LCD Display.
- Interfaces: Standard Parallel, 232C, Modular phone, CMT.
- Powered by 4 'C' Size batteries. (not included)
- **FULL FACTORY WARRANTY!**

Optional peripherals available from NEC.

Manufacturer's Suggested Retail \$995.00

DAMARK PRICE:

\$298

Order No. B-677-100156
Insured Ship/Hand.: \$11.50

XEROX/DIABLO DAISY WHEEL PRINTER

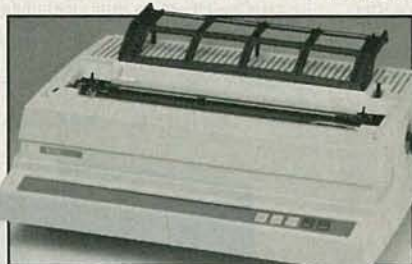

**FACTORY NEW!
FACTORY PERFECT!**

FREE CABLE!

Enjoy the ease and speed of printing with this Xerox/Diablo 630 ECS/API Daisy Wheel Printer. Prints both graphics and letter quality text without changing Daisy Wheel!

- API (All Purpose Interface) works with most personal or business computers on the market including:
 - Serial: RS232-C, 110-300-1200-2400 baud.
 - Parallel: Centronics, 8-bit.
- Includes: IBM Interface cable, Ribbon, Manual, & Plastic print wheel.
- ECS (Extended Character Set) supports 96 & up to 192 extended character set print wheels.
- 40 characters per second with plastic print wheels.
- Paper width: 16.53" max. if using friction feed; 15.25" max. if using forms tractor (not included).
- Graphics, HyPlot Vector Plotting, Word Processing.
- **90-Day Warranty!**

Manufacturer's Suggested Retail \$1995.00

DAMARK PRICE:

\$398

Order No. B-677-102103
Insured Ship/Hand.: \$26.00

BUSHNELL REFRACTOR TELESCOPE



Reach out and touch the stars with this astronomical Bushnell Telescope. This is the HOTTEST PRICE on a Bushnell Telescope in the Country!

Bushnell decided to liquidate their factory demos. As a result we can offer them to you at a **ONCE-IN-A-LIFETIME PRICE.**

- 800mm focal length.
- Three eyepieces: 40x, 64x, 200x.
- Barlow 2x doubler.
- Includes wood tripod with accessory tray.

Manufacturer's Suggested Retail \$275.00

DAMARK PRICE:

\$88

Order No. B-677-102111
Insured Ship/Hand.: \$8.00

FACTORY DEMO

Pulser COMPACT DISC BY YAMAHA



Step Into The Future of Sound!

Turn Your Stereo Into a State-of-the-Art Sound System with Pulser, MADE BY YAMAHA! This unit has many of the features found only on the most expensive CD players!

- 3-Beam Laser pickup.
- 9-Programmable memories.
- Digital Filtering
- Motorized front loading.
- Soft-touch control door.
- Dual speed audible track search.
- Hi-speed program search.
- 4-digit LED multi-function readout
- Index search.
- **Full factory warranty!**

Manufacturer's Suggested Retail \$298.00

DAMARK PRICE:

\$119

Order No. B-677-102130
Insured Ship/Hand.: \$8.50

CRYSTAL LIGHTNING BRILLIANT LIGHTNING BALL

Have the power of lightning at your finger tips and let the spectacular, brilliant storms move to your touch, the beat of your music and the sound of your voice!



With the touch of your finger, the sound of your voice, or the beat of your music this shimmering lightning show will synchronize with the beat, translating sounds into hypnotic visual images. With the touch of your hand, dazzling formations dance harmlessly from finger to finger.

- Adjustable dial to change the light density.
- DC 12v adapter included.
- Switchable from audio regulated to normal.
- Removable dark shield for viewing in daylight.
- **90-DAY WARRANTY!**

Manufacturer's Suggested Retail \$199.00

DAMARK PRICE:

\$99

Order No. B-677-103218
Insured Ship/Hand.: \$5.00

FOR FASTEST SERVICE

CALL TOLL FREE

1-800-533-3379



NAME _____
ADDRESS _____
CITY _____ ST _____ ZIP _____
PHONE _____

CHECK/MONEY ORDER

VISA MASTERCARD CARD NO. _____ EXP. DATE _____

PRODUCT	ITEM NO.	QTY.	PRICE	S/H/I	TOTAL
NEC Lap-Top Computer	B-677-100156		\$298	\$11.50	
XEROX/DIABLO Printer	B-677-102103		\$398	\$26.00	
BUSHNELL Telescope	B-677-102111		\$88	\$8.00	
PULSER CD Player	B-677-102130		\$119	\$8.50	
CRYSTAL LIGHTNING	B-677-103218		\$99	\$5.00	
			SUB TOTAL		
			in MN add 6% Sales Tax		
			Total S/H/I		
			TOTAL		

CORPORATE OFFICE (612) 560-5415
DELIVERY TO 48 U.S. CONTINENTAL STATES ONLY

Send To: **DAMARK INTERNATIONAL, INC., 7714 Brooklyn Blvd., Minneapolis, MN 55443**

BUILD THIS

LC METER

A low cost L/C meter that will give you lab-grade accuracy.

NEIL W. HECKT

EXPERIMENTERS AND TECHNICIANS WHO WORK WITH RF filters, oscillators, and amplifiers have always needed an economical way to measure the value of small inductors. Generally, the measurement is made by inserting the unknown inductor into an oscillator circuit having a known, fixed-value capacitor and inductor—a tank circuit. Because the capacitance and inductance are fixed values, a variation in the oscillator's output frequency is determined by the unknown inductor. Since the oscillator's output frequency can be measured by a conventional low-cost frequency counter, the unknown inductor's value can be easily computed by using an inexpensive hand-held scientific-type calculator. Similarly, unknown-capacitor values can be determined by again measuring how it affects the oscillator's output frequency.

Although the known-capacitor/inductor measurement technique gives reasonable accuracy for general and experimenter applications, unless extreme care is taken the end result is not what one usually accepts as "lab-grade precision." However, lab-grade accuracy can be attained by using a microprocessor-based measuring device having a built-in RF oscillator.

Whether the measuring device is a home-brew lash-up or microprocessor-based, both make measurements based on the frequency shift caused by the insertion of the component to be measured into the tank circuit of an RF oscillator. For RF circuits, that has the advantage of finding the *apparent* inductance or capacitance value as it would effect an RF tank circuit. The apparent value includes the parasitic capacitance of the inductor, or the parasitic inductance of the capacitor and its leads. That is unlike the typical capacitance meter, which inserts the component to be measured in a relaxation oscillator circuit that ignores inductance.

Calculating values

Where L_x represents an unknown inductance, and C_x represents an unknown capacitance, the formula for calculating the value of a component

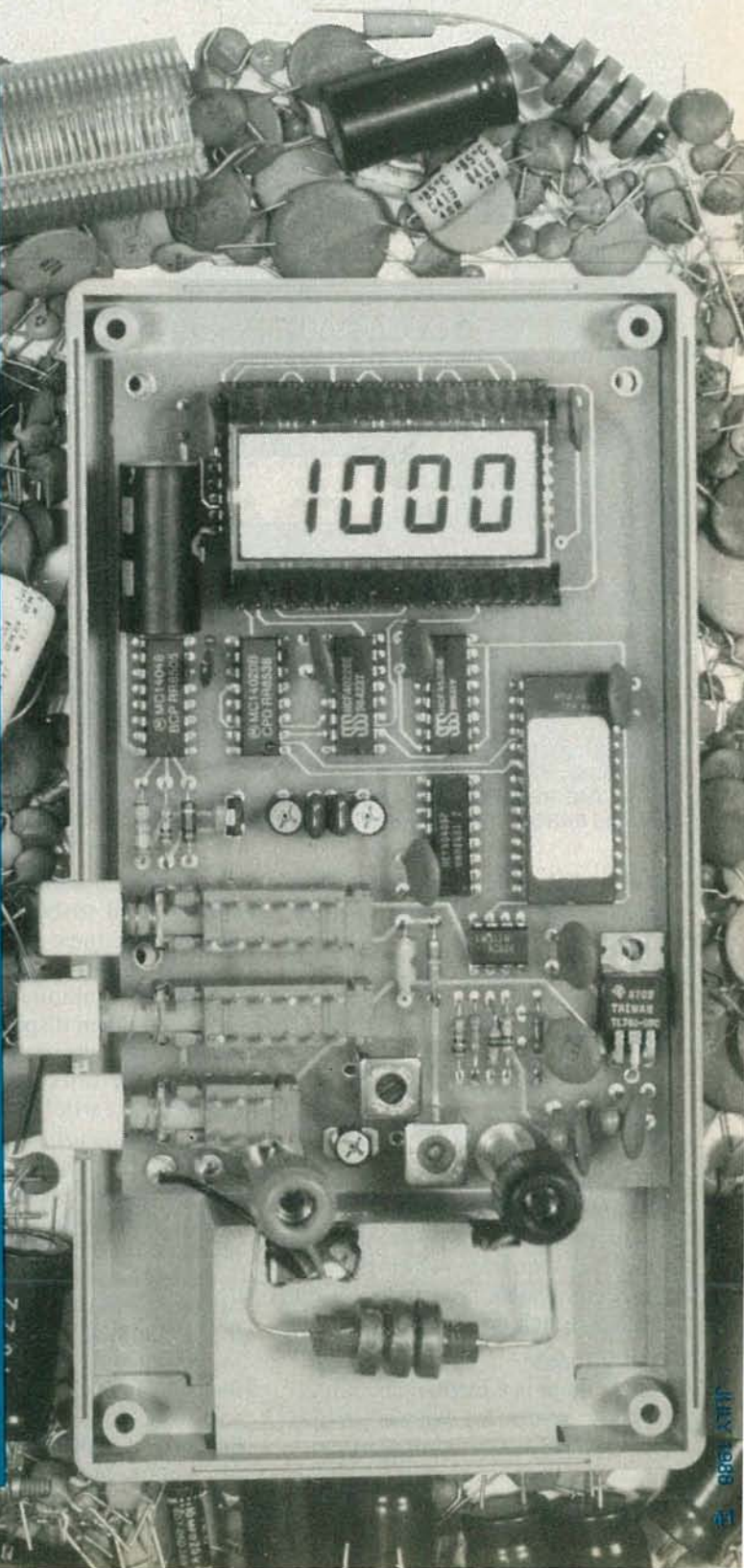

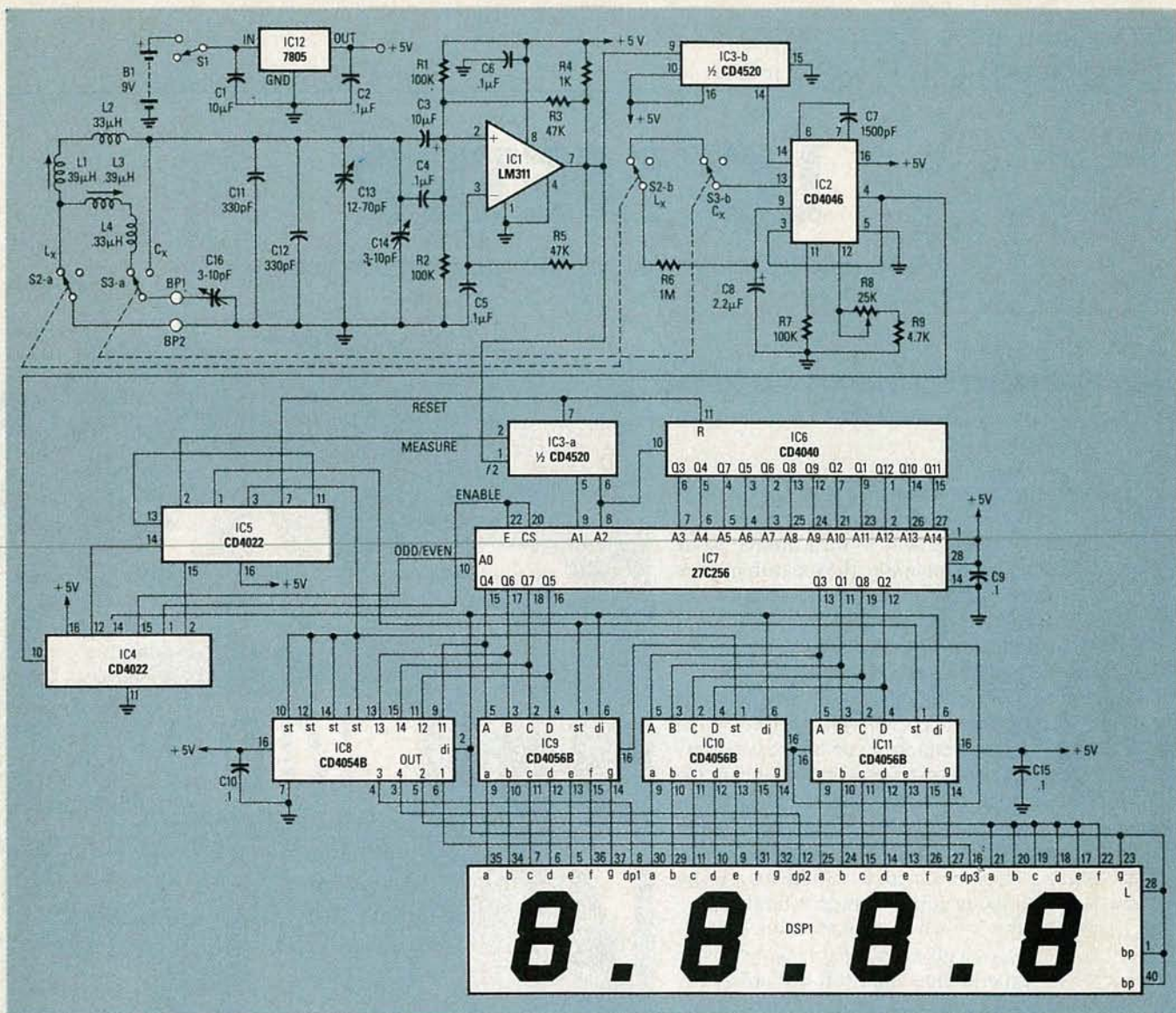

FIG. 1—THE RESULTS FOR ABOUT 15,000 EQUATIONS are stored in IC7, a pre-programmed EPROM. Input information is compared against the EPROM data.

as a function of the frequency shift it introduces into an oscillator tank circuit is:

$$L_x = ((f_1/f_2)^2 - 1) \times L_s$$

where L_s is the "standard inductor of the tank," or:

$$C_x = ((f_1/f_2)^2 - 1) \times C_s$$

where C_s is the "standard capacitor of the tank."

In both equations, f_1 is the oscillator's frequency without the unknown component; f_2 is the oscillator's frequency when the unknown component is installed in the oscillator's tank circuit.

Build a meter

Since there is a mathematical relationship between the known-component and unknown-component oscillator frequencies, to determine the

value of the unknown component we simply need to build some kind of device that measures the ratio between f_1 and f_2 , squares the ratio, subtracts 1, multiplies by the standard value, and then displays the result.

The first approach that comes to mind is the microprocessor device mentioned earlier. Unfortunately, a microprocessor-based instrument is relatively expensive because of its high IC count that includes a CPU, RAM, ROM, Timer, I/O, a display, and a power supply.

A lower-cost approach to a homebrewed L/C meter is a microcomputer that includes all of the functions of the microprocessor-based device in a single IC. Unfortunately, the initial investment would be on the order of \$40,000, which is a tad too expensive for a home-brew project. The newer

EPROM versions of the single-IC devices are reasonably priced, but require considerable expense in support equipment to develop, test, and program the software into the EPROM.

A more cost-effective approach for the hobbyist and technician is the device shown in Fig. 1; a simple frequency-counter circuit that drives an EPROM which is programmed with a large number of solutions to the L_x and C_x equations. In that way, all the mathematical functions, except for the frequency ratio, can be done outside the unit on a computer having the necessary capabilities. A 27C256 EPROM will hold 16384 solutions divided into two bytes per solution.

Circuit description

Since the frequency counter has a fixed resolution in cycles-per-second,

the EPROM contains solutions to the equations that are spaced apart by a predetermined number of cycles-per-second. Because resonant frequency is a function of the square root of inductance or capacitance, the size of the steps between adjacent solutions gradually increase, keeping approximately 0.1% (3 digit) resolution from 0.01 μ H to 10 mH, or 0.01 pF to 0.1 μ F. The advantage of that technique is that the unit will be auto-ranging.

Integrated circuits IC8 and IC9, the drivers for the liquid-crystal display (DSP1), are binary-coded decimal, requiring four bits per digit. Therefore, 12 bits are required for a three digit display. In order to provide the floating decimal point that's needed for the dynamic range of range of 10^6 , four bits are used to drive both the decimal

point and a fourth digit that is either zero or blank. Therefore, 16 bits are used to provide a direct readout in micro-henries. For capacitors, the displayed value must be mentally multiplied by 10.

The first problem was to design an oscillator that would always start, and which maintained oscillation even with very poor L/C ratios. Most oscillator circuits involve the impedance of the tank circuit in the loop gain, therefore, there are maximum values of L and C that can be used. Also, the normal output of an RF oscillator circuit is usually only a few millivolts, which requires amplification in order to drive the frequency-counting section of the instrument.

As shown in Fig. 2, the oscillator circuit uses a LM311 high-speed volt-

age comparator. Positive feedback from the output to the non-inverting input is provided by R3. The input is biased by R1 and R2 to approximately one-half of the 5-volt supply voltage. The tank circuit selected by switches S2 and S3 is capacitively coupled to IC1 by C3 and C4.

The best way to visualize the oscillator is to assume that IC1's output is a square wave. Driving the square wave into a parallel-tuned circuit through a large resistor (R3) allows the tuned circuit to filter out the sine-wave component of the square wave at the resonant frequency of the tank. (The sine wave will have a maximum amplitude when the square wave is at the resonant frequency.) Applying the sine wave to the non-inverting input of voltage-comparator IC1 produces a square-wave output of the same frequency. That, in turn, drives the tank circuit, resulting in an endless loop of oscillation. Thus, the oscillator runs at the frequency that produces the maximum sine-wave amplitude: the resonant frequency of the tuned circuit.

The inverting input of IC1 must be biased at exactly the same DC level as the non-inverting input in order for the oscillator to work. The R5/C5 RC filter from the comparator's output to the inverting input finds the average value of the square-wave output, which of course should be $\frac{1}{2}$ the peak-to-peak voltage, which is approximately $\frac{1}{2}$ the supply voltage. The same RC network is responsible for the starting and running of the oscillator. When power is first applied, the filter's output is zero, which causes IC1's output to be high (near 5 volts). The high charges C5 until its voltage reaches the bias level of the non-inverting input. That causes the output to swing low (near zero volts), putting a transient into the tank circuit, which causes it to ring at its resonant frequency. The ringing causes the output of the comparator to form a square wave of the same frequency which, after filtering by the tank circuit, is fed back to IC1's input to sustain oscillation.

The component to be measured, L_x or C_x , is always added to the standard inductor ($L1 + L2$) or standard the capacitor (C11-C14) in the oscillator's tank circuit. With the component under test installed, the oscillator's output frequency will always be lower than the frequency without the com-

PARTS LIST

All resistors $\frac{1}{4}$ -watt, 5%, unless otherwise noted.

R1, R2, R7—100,000 ohms
R3, R5—47,000 ohms
R4—1000 ohms
R6—1 Megohm
R8—25,000 ohms, trimmer potentiometer, 0.1" \times .2" spacing
R9—4700 ohms

Capacitors

C1, C3—10 μ F, 10 volts, tantalum
C2, C4, C5, C9, C10, C15—0.1 μ F, 50 volt, ceramic disc
C6—not used
C7—1500 pF, 100 volt, Mylar
C8—2.2 μ F, polystyrene (Panasonic ECQ-1225KZ)
C11, C12—330 pF, polystyrene or propolyne
*C13—12–70 pF, trimmer capacitor (Mouser ME242-1270)
*C14, C16—3–10 pF, trimmer capacitor (Mouser ME242-2710)

Semiconductors

IC1—LM311N
IC2—CD4046
IC3—CD4520
IC4—CD4020
IC5—CD4022
IC6—CD4040
IC7—27C256 special programmed EPROM (see ordering note below)
IC8—CD4054
IC9—IC11—CD4056
IC12—LM7805CT
†DSP1—four digit LCD display, AND FE0202

Inductors

*L1—39 μ H, variable inductor (Tokyo 154ANS-T1016Z)
*L2—33 μ H (J. W. Miller 8230-56)
*L3—0.39 μ H (J. W. Miller 8230-10)
*L4—0.33 μ H, variable inductor (Tokyo BTKXNS-T1047Z)

Other components

B1—9-volt battery
*BP1, BP2—5-way binding post with 8-32 thread
*S1, S2, S3—DPDT alternate action switch (ITT Shadow 51281)
*3—pushbuttons for S1–S3
†2—LCD sockets
*2—8-32 \times $\frac{3}{4}$ -inch threaded spacer with mounting hardware
*2—8-32 screws and star washers
*1—battery terminal clip !1—socket for DSP1, Samtec ESQ-120-12-T-S
1—enclosure, Pactec HPL-9VB

Note: The following parts and kits are available from Almost All Digital Electronics, 5211 117th St. SE, Bellevue, WA 98006.

A complete kit containing all components in the parts list with the exception of the EPROM, display kit, enclosure, and the PC board: \$69.95. A kit of hard-to-locate parts consisting of those indicated in the parts list with the * symbol: \$29.95. The programmed EPROM: \$19.95. The display kit consisting of those parts indicated in the parts list with a † symbol: \$14.95. The enclosure, with all holes machined and a front panel decal: \$19.95. The PC board with plated-through holes: \$19.95

A complete semi-kit (the switches are mounted and soldered) consisting of all of the above and a "standard" capacitor for calibration: \$149.95.

The completely assembled, tested, and calibrated unit: \$169.95. Add \$5 for shipping and handling per total order. Washington residents must add 8% sales tax.

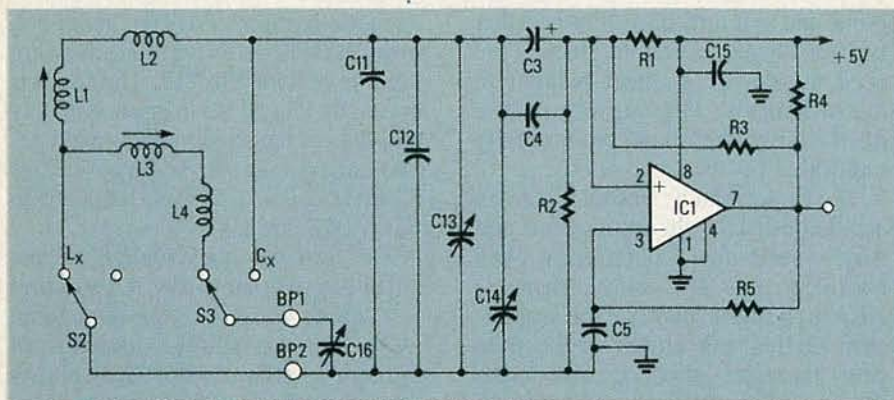

FIG. 2—A HIGH-SPEED VOLTAGE COMPARATOR, IC1, functions as an oscillator for both the capacitor and inductor tests. The unknown C and L values are determined by measuring their effect on the oscillator's reference frequency.

ponent installed. When the C_x switch (S3) is depressed, the component under test and zeroing-trimmer-capacitor C16 (which has been adjusted such that the sum of the stray capacitance + C16 = 10 pF) are connected in parallel with the CC11–C14 tuning capacitors.

Similarly, when the L_x switch is depressed, the component under test and zeroing-trimmer-inductors L3 and L4 (which has been adjusted such that the sum of the stray inductance + L3 + L4 = 1 μ H), are connected in series with the L1/L2 tuning inductors.

As shown in Fig. 1, oscillator IC1 feeds a basic frequency counter consisting of counter-register IC3-a and IC6, which have a total of 16 bits; although only the last 14 are used ($2^{14} = 16384$). If a counter register is clocked by frequency f_1 , for a period of time T, the resultant value in the register will be $f_1 \times T$ cycles. If the measurement period is derived from f_2 as $T = N/f_2$ (where N is an integer multiplier, in this case a binary counter), then the accumulated count in the counter register will be $f_1/f_2 \times N$. In that way we have resolved measuring the ratio of two frequencies as required in the equation for L_x .

Compensating for drift

Frequency drift caused by temperature, or by aging of the components, is significantly suppressed if f_1 and f_2 are derived from the same basic oscillator. For example, suppose f_1 is 1 MHz and f_2 is 500 kHz, then $((f_1/f_2)^2 - 1) \times (L_1 + L_2) = (3.00 \times (L_1 + L_2))$. If the oscillator drifts 0.1% for both f_1 and f_2 , then $((f_1 + 1000)/(f_2 + 500))^2 - 1) \times (L_1 + L_2)$ also equals $(3.00 \times (L_1 + L_2))$. If, on the other hand, only f_2 drifted .1%

(which would be the case if f_1 had been derived from an independent oscillator), then $((f_1/(f_2 + 500))^2 - 1) \times (L_1 + L_2) = (2.992 \times (L_1 + L_2))$, or 0.266% error.

There is a second, and even more significant advantage to this method of drift compensation. Regardless of the frequency, if f_2 is equal to f_1 , then $((f_1/f_2)^2 - 1) \times (L_1 + L_2) = 0$, thereby forcing an automatic zero function. Under the assumption that oscillator drift will be a percentage function rather than absolute, the effect of oscillator drift is canceled. Although that is not an entirely accurate assumption, it is reasonably valid because the majority of drift comes from drift in the values of L and C in the tank circuit. Those values drift as a percentage of their nominal value due to temperature effects, thereby leaving the accuracy of the instrument almost entirely dependent upon the values of L1 and L2 and C11–C14 (which can be easily adjusted to within 1%).

Although the foregoing explains the basic theory behind the counter section and its advantages, it is not quite the whole story. That basic concept could measure frequencies down to zero hertz (zero hertz would accumulate a count of zero in the counter register and f_1 would accumulate a count of 16383) just as a normal frequency counter would, and should do.

In order to make maximum use of the space in the EPROM, it is desirable to make the minimum value of the counter register correspond to the minimum value of f_2 (59.774 kHz) when $L_x = 10$ mH, or when $C_x = 0.1$ μ F, and the maximum value correspond to f_1 (713.3 kHz) when $L_x = 0$, or $C_x = 0$. By extending the range

of measurement period by "t" to T+t, the counter register will overflow back to zero after period "T" and continue counting for the period "t."

The final design has a period $T = 2^{16}/f_1$ and a period $t = 2^{12}/f_1$ such that the range of the counter register is 1024 to 17408 (a difference of 16384). To compensate for that, the bottom 1024 locations in the EPROM, 0–1023, contain the highest counts (16384–17408), and locations 1024–16383 contain counts 1024–16383. That is not the ideal correction for maximum EPROM usage, but it's easily achieved with simple circuitry. The 0.00 point is at location 17408 (1024) in the EPROM, while the minimum frequency of f_2 occurs at count 1455. There are, therefore, 431 wasted locations in the EPROM, or 15952 stored values in the range of 0.00–9990 μ H.

The frequency measured is $f_2/4$ (the counter register starts after the first two stages of IC3-a), so the formula to compute the accumulated value in the counter register for a given frequency of f_2 is:

$$\text{Count} = f_2/4 \times (2^{16} + 2^{12})/f_1 = f_2/4 \times 69632/f_1$$

$$\text{Count} = f_2 \times 17408/f_1$$

It is that count that addresses the EPROM to get the data for the displayed value. Maximum count corresponds to maximum frequency, which in turn corresponds to minimum L_x or C_x . The formula for the value of L_x for a given count is:

Solving the count equation for f_2 :

$$f_2 = (\text{count} \times f_1)/17408 = \text{count} \times 41.067$$

and since $L = 1/(4 \times \pi^2 \times f^2 \times C)$:

$$L_t (\mu\text{H}) = 1/(4 \times \pi^2 \times f_2^2 \times C_{11-14})$$

and

$$L_x = L_t - (L_1 + L_2)$$

where

$$L_1 + L_2 = 70.5 + \text{mH and } C_{11-14} = 705 \text{ pF}$$

$$L_x (\mu\text{H}) = 10^6/(4 \times \pi^2 \times 1686.52 \times \text{count}^2 \times C_{11-14}) - (L_1 + L_2)$$

$$L_x (\mu\text{H}) = 213334.12 \times 10^6/\text{count}^2 - 70.5$$

$$C_x = L_x(\mu\text{H}) \times 10$$

Since the count value provides the EPROM address, and the L_x value provides the EPROM data, the last

formula and the pin-to-pin IC connections provides the necessary information to program the EPROM. The connections between counter register IC3-a/IC6 and the EPROM address pins may appear to be odd because they are optimized for a printed-circuit layout rather than the traditional pin assignments.

Similarly, the data bits of the EPROM are optimized for connection to the display drivers in the PC layout.

The translation for those connections is shown in Table 1 and Table 2. The "jumbled" connections are accommodated in the programming of the EPROM. A design problem which had to be overcome was that both frequencies f_1 and f_2 had to be available simultaneously to make the measurement. It was impossible to have the same oscillator run at two frequencies at the same time and the use of two different oscillators would negate the automatic-zero capability. Some means had to be provided to store frequency f_1 while the oscillator was operating at f_2 . The solution was a phase-locked loop, IC2.

Storing a frequency

The voltage-controlled oscillator of the phase-locked loop is adjusted by the frequency discriminator within IC2 until it is the exact frequency of the signal input. The voltage that tuned the oscillator to that frequency can be stored on filter capacitor C8, thereby essentially "storing" the frequency. The frequency can be stored accurately so long as C8's voltage does not change. The only thing that will cause the voltage to change is C8's shunt resistance. The input resis-

TABLE 1
BIT WEIGHTS
Counter Rom

1	→	2
2	→	4
4	→	2048
8	→	1024
16	→	8
32	→	16
64	→	64
128	→	128
256	→	32
512	→	256
1024	→	512
2048	→	8192
4096	→	16384
8192	→	4096

TABLE 2—EPROM DATA BITS

4	400	200	800	100	1	8	2	
8	7	6	5	4	3	2	1	
C3	C1	B1	D1	A1	A3	D3	B3	stb A
128	64	32	16	8	4	2	1	
C2	dp2	dp1	0 dig	dp3	A2	D2	B2	stb B
40	/100	/100	.10	/10	10	80	20	

tance of IC2 is specified as 10^{12} ohms, which shouldn't cause any shunt-resistance problem.

On the other side of C8 are the in-use open-circuit switch contacts of S2-b (L_X) and S3-b (C_X), which should also be many megohms. The most significant cause of discharge is C8 itself, which must, therefore, be an extremely low-leakage device. Ceramic, tantalum, and electrolytic capacitors are unsatisfactory; C8 should be a high-quality plastic capacitor.

The test circuit is such that depressing either the L_X or C_X switch will open the control loop of the phase-locked loop, thereby storing f_1 while simultaneously switching in the component under test into the f_2 oscillator for measurement.

The control section of the frequency counter is IC4 and IC5. The base frequency of the oscillator, f_1 , was first divided by 16 by IC3-b, and then divided by 512 by IC4 before clocking IC5. The period of the clock to IC5 is approximately 11.46 ms (87 Hz), however, IC5 is held in the reset mode by IC4 pin 2 for a period of 91.72 ms. After IC4 pin 2 goes low, IC5 advances from a count of zero to a count of one on the next positive transition of IC4 pin 12, which is 5.73 ms later. That makes the total measurement period $91.72 \text{ ms} (2^{16}/f_1) + 5.73 \text{ ms} (2^{12}/f_1)$, or 97.45 ms.

When pin 2 of IC5 goes low it inhibits the counter register (IC3-a/IC5), ending the measurement period. At that time EPROM IC7 is addressed with the result, which is a function of the component value L_X or C_X . Next, pin 1 of IC5 goes high for 11.46 ms, strobing the data from

IC7 into display drivers IC9 and IC11. At that time, pin 14 of IC4 is low, addressing the even addresses of IC7, which must contain the data for display digits one and three.

11.46 ms later, pin 1 of IC5 goes low and pin 3 of IC5 goes high, thereby strobing IC7's data into the digit-two driver IC10 and the decimal-point register (IC8). At this time pin 15 of IC4 is high, addressing the odd addresses of IC7, which must contain the digit two and the decimal-point data. An additional 11.46 ms later, pin 3 of IC5 goes low and pin 7 of IC5 goes high, resetting the counter register preparatory to acquiring a new measurement.

Another 11.46 ms later, pin 7 of IC5 goes low and pin 11 of IC5 goes high. The high is applied to IC5's ENABLE input, causing it to freeze at count four. IC5 remains in the idle mode until pin 2 of IC4 goes high 51.57 ms later (a total measurement/display period of 183.43 ms). The result is an update rate to the display of 5.44 times/second. An AC signal is taken from pin 14 of IC4 for display DSP1's backplane drive frequency.

Resident data

There are an infinite number of L and C values that will resonate at a given frequency. Determining the exact values which would simultaneously provide: a capacitance display exactly 10 times the inductance display, provide at least 0.01 μH per count in the frequency counter register up to 10 μH , give a total count difference equal to or less than 16384 up to 10 mH with 0.1 mH per count,

continued on page 98

Build REACTS: THE RADIO-ELECTRONICS ADVANCED CONTROL SYSTEM

This month, we show you how to put REACTS to work to control the outside world.

Part 6 WE LEFT off last month promising to show you how to put REACTS to work. To get your imagination rolling on what you can do with a control computer, we'll show you how to build a digital door lock, an appliance controller, a security system, and a sprinkler controller for your garden.

The digital lock

The input/output port consists of 8 wires (bits) that are labeled from 0 to 7. Using the INP command we discussed earlier, we can read the data present at the inputs. Incidentally, similar commands exist in Assembly, C, FORTRAN, and other languages.

As mentioned earlier, we input or output eight lines or bits each time we perform an input or output. In the following example we will see how to mask each line (or bit) out independently when needed.

Figure 1 shows a simple eight-pushbutton combination lock. In order to make that lock work, we simply read the input channel that is connected to the switches. That data is then compared with the combination stored in the program shown in Listing 1. If the data matches, the system releases the lock by outputting the correct command to the output line, which controls the latch solenoid. That solenoid is activated to stay open for some predetermined period, say 2 seconds. If the door is not opened by that time the door will relock.



H. EDWARD ROBERTS

That program will work quite adequately for a lock and you can program 256 different combinations. It has one major disadvantage; it uses all eight inputs of the I/O module. Listing 2 shows an electronic entry program that only uses five switches and allows for over 6500 combinations. The door-lock program will be only one subroutine in your final home-automation program. Along with the door-lock program, the final program may contain subroutines for controlling appliances and lights, a security system, and a lawn-watering system; monitoring and controlling the home environment; and allowing remote control using a modem. It takes approximately 100 microseconds to make one check of the switches. So even if the switches are checked 20 times a second, the door-lock subroutine will only take up approximately 2 milliseconds.

It is important to understand that

when outputting to a channel, all eight bits of the channel are affected. That is true even when you want to change only one bit. The technique we use is to store all the data that is output to the channel in a common location. Then, each routine that uses the storage location is responsible for seeing that only the bits relevant to that particular routine are changed. For example, in line 160 of Listing 1, we were only interested in changing the output bit (bit 0) that activated the relay that the door-lock solenoid was wired to. To keep from changing any of the other bits, we performed a masking operation by ORing them with 0. The relay was closed by ORing a 1 at bit 0.

The two electronic door-lock programs discussed and listed in this article require simultaneous pressing of two or more switches or pushbuttons for many of the numerical entries. However, a ten or more digit keypad that uses some type of scan code easily could be implemented so that only one pushbutton is pressed for each entry number. Those types of keypads are available from several electronics hobbyist and parts houses. The supplier listed in the Sources box offers one such keypad. The keypad from that vendor comes complete with a listing of a scan-code decoding program for serial digit entry.

Figure 2 shows the connections of the external solenoid for the door control. The technique you use to actually lock and unlock the door is up to you. If you desire, an electric lock is available from commercial suppliers. Please send us any ideas that you have

that might be of interest to others; we will pass those along to other users of the system. Ideas can also be shared on the Radio-Electronics Bulletin Board (516-293-2283, 8 data bits, 1 stop bit, no parity).

Controlling appliances

Because the relay option of this month's module can be connected directly to 117 volts AC, household appliances and lighting can be controlled by REACTS with the module as long as the current drawn from each relay does not exceed 6 amps. An ideal application is to use the system to turn-on and turn-off lamps while you are on vacation to give your home a "lived in" appearance to would be burglars. Securing the leads

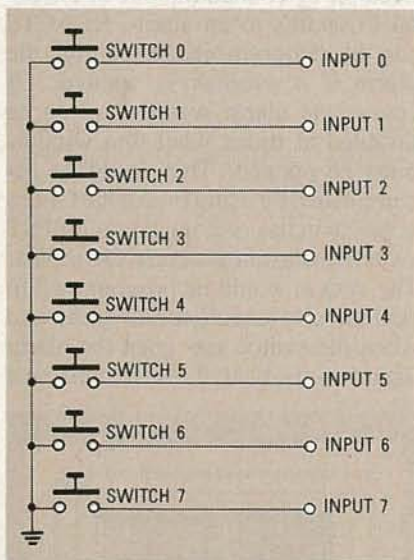

FIG. 1—A SIMPLE PUSHBUTTON LOCK. The data on the input lines is read by the computer and then compared to a combination in the lock program.

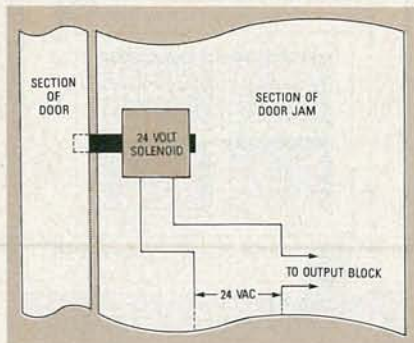

FIG. 2—ONE METHOD of implementing the door lock uses a 24-volt solenoid under computer control. Of course, many other schemes are possible.

LISTING 1

```

10 REM Sample lock program, correct combination is 131
20 REM (10000011 binary)
30 REM
40 REM TEST = Variable at which input byte is stored
50 REM ENT = Entry from switches
60 REM LCK24 = Controls output portion of module
70 REM
80 TEST = 0
90 ENT = 0
100 GOSUB "FETCH ENTRY"
110 IF TEST = 0 THEN GOTO 100
120 IF TEST > ENT THEN ENT = TEST
130 GOSUB "FETCH ENTRY"
140 IF TEST <> 0 THEN GOTO 120
150 IF ENT <> 131 THEN GOTO 80
160 LCK24 = LCK24 OR &X00000001
170 REM This sets the last bit (bit 0) to a 1 without affecting
180 REM any other bits. The output that controls the solenoid
190 REM is connected to bit 0 of output channel 24.
200 OUT 24,LCK24
210 DELAY 6000
220 REM Causes program to wait for 2 seconds.
230 LCK24 = LCK24 AND &X11111110
240 OUT 24,LCK24
250 REM This will clear the 0 bit which will relock the door.
260 REM Here also, none of the other bits are affected.
270 GOTO 80
1000 REM ***** FETCH ENTRY *****
1010 "FETCH ENTRY"
1020 REM This subroutine inputs the byte from I/O port 24 at
1030 REM which the octal I/O is addressed.
1040 TEST = INP(24)
1050 TEST = NOT TEST
1060 REM Because all the inputs are pulled high, the inputted
1070 REM byte is complemented with the NOT command in order to
1080 REM simplify programming.
1090 REM TEST = TEST AND &X11111111
1100 REM After complementing the input with the NOT command, a
1110 REM 16 bit signed integer is returned. To obtain the
1120 REM original 8 bit complemented input from the I/O port
1130 REM we must mask out the lower 8 bits.
1140 RETURN

```

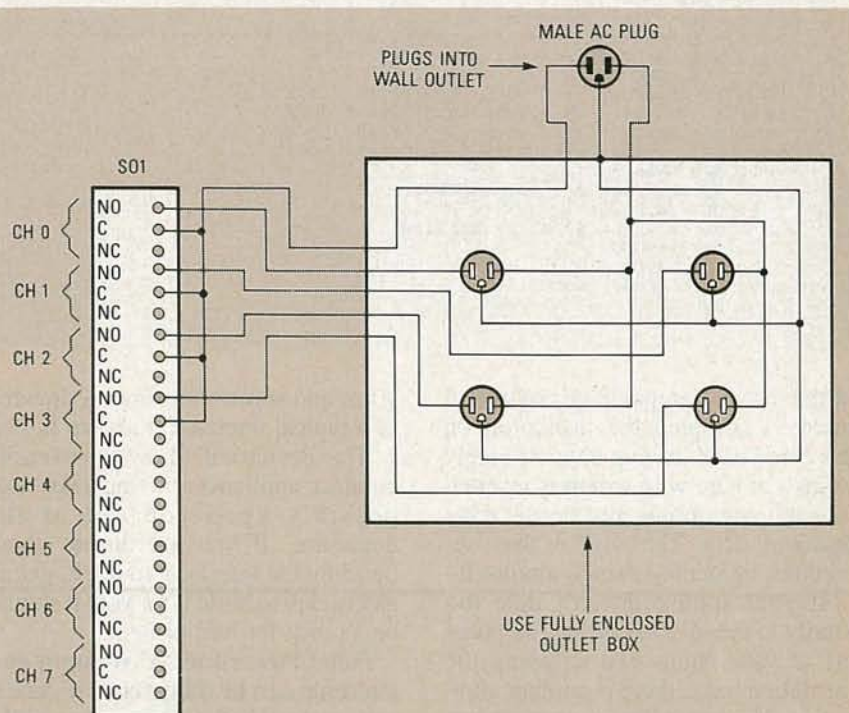

FIG. 3—FOR CONVENIENCE, use a relay interface like the one shown here when using REACTS to control household appliances.

LISTING 2

```

10 REM This program uses 5 bits of a single input channel to
20 REM produce a sophisticated combination lock which has over
30 REM 6500 possible combinations. This program is designed to
40 REM use input channel 24. The combination for this program
50 REM is 9312. Any unused I/O channel or combination could
60 REM be used.
70 REM
80 REM     COUNT() = Array where valid entries are stored.
90 REM     IP_FLAG = Signifies that entry has been made.
100 REM    TEST = Variable at which input is stored.
110 REM    HI_IP = Temporary storage location for entry.
120 REM    DIGIT = Number of valid entries.
130 REM
140 DIM COUNT(5)
150 IP_FLAG = 0
160 TEST = 0
170 HI_IP = 0
180 DIGIT = 0
190 REM ***** START LOCK *****
200 "START LOCK"
220 GOSUB "READ INPUT"
230 IF BOUNCE_OK = 0 THEN GOTO "START LOCK"
240 IF TEST = &X00010000 THEN GOTO "CLEAR LOCK"
250 IF RDY <> 1 THEN GOTO "START LOCK"
260 IF TEST = &X00000000 AND IP_FLAG = 0 THEN GOTO "START LOCK"
270 IF TEST <> &X00000000 AND TEST > HI_IP THEN HI_IP = TEST
280 IF TEST <> &X00000000 THEN IP_FLAG = 1
290 IF TEST <> &X00000000 THEN GOTO "START LOCK"
300 COUNT(DIGIT) = HI_IP
310 HI_IP = 0
320 IP_FLAG = 0
330 DIGIT = DIGIT + 1
340 IF DIGIT = 5 THEN GOTO "CK COMB"
350 GOTO "START LOCK"
1000 REM ***** READ INPUT *****
1010 REM This subroutine reads the input and maskout the 5 least
1020 REM significant digits.
1030 "READ INPUT"
1040 TEST = INP(24)
1050 TEST = NOT TEST
1060 TEST = TEST AND &X00011111
1070 DELAY 10
1080 TEST2 = INP(24)
1090 TEST2 = NOT TEST2
1100 TEST2 = TEST2 AND &X00011111
1110 IF TEST = TEST2 THEN BOUNCE_OK = 1 ELSE BOUNCE_OK = 0
1120 RETURN
2000 REM ***** CLEAR LOCK *****
2010 REM Clearing lock and setting for new entry.
2020 "CLEAR LOCK"
2030 RDY = 1
2040 DIGIT = 1
2050 GOTO "START LOCK"
3000 REM ***** CHECK COMBINATION *****
3010 REM Checking for correct combination.
3020 "CK COMB"
3030 IF COUNT(1) <> 9 THEN GOTO "START LOCK"
3040 IF COUNT(2) <> 3 THEN GOTO "START LOCK"
3050 IF COUNT(3) <> 2 THEN GOTO "START LOCK"
3060 IF COUNT(4) <> 1 THEN GOTO "START LOCK"
3070 REM Opening lock.
3080 UNLCK = UNLCK OR &X00000001
3090 OUT 24,UNLCK
3100 UNLCK = UNLCK AND &X11111110
3110 DELAY 6000
3120 OUT 24,UNLCK
3130 GOTO "START LOCK"
3140 END

```

of the device (lamps) to be controlled involves stripping the insulation on the cords back leaving approximately ¼ inch of bare wire which is inserted into the appropriate slot on the relay terminal strip. The wire is then secured by tightening a screw against it.

If your spouse doesn't take too kindly to the idea of cutting the plugs off of your lamps and stripping the insulation back, there is another alternative. You can make an interface box with a 1900-series electrical (outside-type) box, a pair of duplex outlets,

wire, and some hardware. A drawing of a typical interface is shown in Fig. 3. That device will allow you to easily connect appliances to the relay and possibly keep you out of the doghouse. If you are unsure about building the interface yourself, get an electrician to build it for you; it should be a cinch for him or her.

Note: Powerline AC voltages and currents can be dangerous if care is not exercised; you can easily damage the computer, or yourself. If you lack experience with

powerline voltages and currents, we strongly recommend you consult an electrician.

With the REACTS CPU and the real-time clock option, the lamp(s) can be made to come on and go off at different times during the day and at different times on different days. Also, since the program controlling the lamps would reside on the system's boot PROM, in the case of a power outage, when the system came back on it would automatically reload the program and continue its job. A free copy of a vacation home-control program is available from the vendor listed in this article if you send a self-addressed stamped envelope.

Open window detector

The open-window detector can be used in two different ways. First, it can be used to quickly check for open windows before leaving the house. Second, by connecting one of the octal I/O port's to an alarm, REACTS can be programmed to sound the alarm if a window is opened. Of course the alarm would have to be disabled at times when the window must be opened. That could be accomplished by using one of the CPU's sense switches or connecting a SPST switch to one of the octal I/O's inputs. The system would be programmed to periodically check the switch, and when the switch was open the alarm would be disabled; likewise, when the

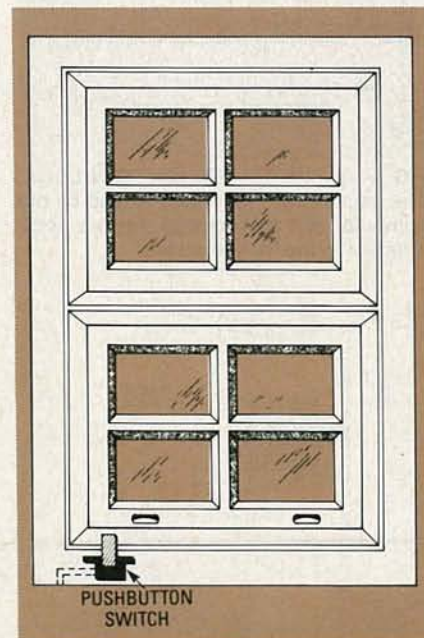

FIG. 4—A MOMENTARY SWITCH can be used to detect whether a window is open or not. When the window is fully closed, the button is depressed.

LISTING 3

```

10 CLS                                     'Clear the screen
20 FLAG = @X00000000                       'Initializing
variable flag as all windows are closed
30 OCT_IN = INP(100)                       'Inputting from
octal I/O
40 ALARM = OCT_IN AND &X00000001          'Inputting status of
alarm enable/disable
50 CHECKW = OCT_IN AND &X11111110        'Checking window
switches
60 IF FLAG = CHECKW THEN GOTO 30          'If status of
windows has not changed keep checking them
70 CLS                                     'Clear screen,
getting ready to display new window status
80 IF ALARM = 1 THEN OUT 100,1           'If alarm is
enabled, turn it on
90 REM *** Finding out which window(s) is open ***
100 WIND1 = CHECKW AND &X00000010
110 IF WIND1 <> 0 THEN PRINT "WINDOW #1 IS OPEN"
120 WIND2 = CHECKW AND &X00000100
130 IF WIND2 <> 0 THEN PRINT "WINDOW #2 IS OPEN"
140 WIND3 = CHECKW AND &X00001000
150 IF WIND3 <> 0 THEN PRINT "WINDOW #3 IS OPEN"
160 WIND4 = CHECKW AND &X00010000
170 IF WIND4 <> 0 THEN PRINT "WINDOW #4 IS OPEN"
180 WIND5 = CHECKW AND &X00100000
190 IF WIND5 <> 0 THEN PRINT "WINDOW #5 IS OPEN"
200 WIND6 = CHECKW AND &X01000000
210 IF WIND6 <> 0 THEN PRINT "WINDOW #6 IS OPEN"
220 WIND7 = CHECKW AND &X10000000
230 IF WIND7 <> 0 THEN PRINT "WINDOW #7 IS OPEN"
240 IF CHECKW = &X00000000 THEN CLS 'If no windows are
open, clear the screen
250 IF CHECKW = &X00000000 THEN OUT 100,0 'If no
windows are open turn off the alarm
260 FLAG = CHECKW
270 GOTO 30 'Go check windows again

```

switch was in the opposite position, the alarm would be enabled.

To construct the open-window detector system, all that is needed, besides the REACTS system with the octal I/O module, is some two-conductor wire and a few window-mount SPST pushbutton switches. The switches that were used on our prototype are available for as little as \$1.29 from Mouser Electronics (2401 Hwy 287 North, Mansfield, Texas), and they're available from many of our other advertisers as well. They are mounted in the window sill so that the switch closes when the window is shut (see Fig. 4).

An alternative to using the push-button switches is to use magnetic reed switches. The magnetic half of the switch is mounted in the window frame, while the reed-switch half is mounted in the window casing. When the window is shut, the magnet will pull the reed switch open or closed depending on the contacts' arrangement (see Fig. 5).

There are two ways to connect the

switches to the octal I/O module: Connect only one window switch to each of the octal I/O's inputs, or connect several window switches to each input. Each method has its advantages and disadvantages. If only one window is connected to each input, it is easy to determine exactly which windows are open. However, the number of windows that can be monitored by using that method is limited to eight per I/O module because the module has eight inputs. If several window switches are connected to one input, more windows can be monitored, but you won't know which window is open. However, all the windows in one room can be connected to the same input channel; that way, an open window could be narrowed down to one room in the house.

To connect only one window switch to each input, a two-conductor wire will have to be routed from the I/O module to each window switch. One of the two leads at the REACTS end of the wire is connected to the ground slot of the input-terminal strip

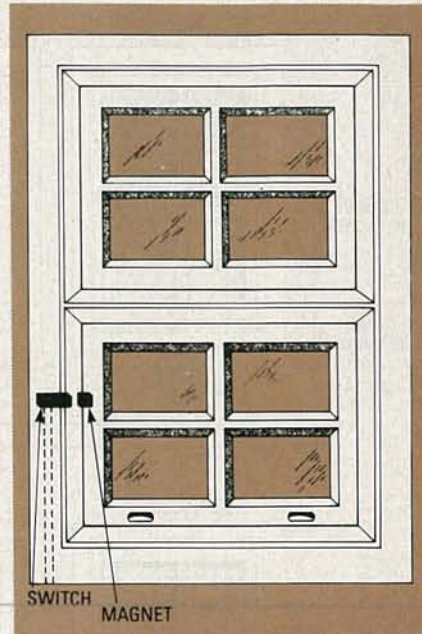

FIG. 5—A MAGNETIC REED SWITCH can also be used to make sure a window is closed. When the magnet is next to the reed switch, the switch closes. When the window is opened, the switch opens.

on the I/O module, while the other end is connected to one of the eight inputs. The leads at the window end of the wire are connected to the switch's terminals. Assuming we are

SOURCES

The following items are available from DataBlocks, Inc
579 Snowhill Road, Glenwood GA. 30428. Or call (800) 652-1336; in Georgia call (912) 568-7101.

- DP-OCT: Design package with schematic and instructions; \$10.00.
- PC-OCT: PC board for the octal I/O, including design package; \$37.00.
- REC-OCT: Complete set of parts including PC board, IC's, terminal strips, etc., but excluding relay option listed below; \$109.00.
- REC-REL: OCTAL I/O relay option includes eight, 6-amp relays and terminal strips; \$42.00.
- REC-CASE and PANEL/REC-OCTAL: Aluminum case assembly including front and rear panels; \$19.50.
- REC-KEY: 12-button keypad with scan-code decoding program; \$9.00
- VAC-PROG: vacation home-control program; free with SASE.
- Other REACTS products are available; contact DataBlocks directly for information and pricing.

Please include \$5.00 postage for any order of \$37.00 or less and \$10.00 postage for any order over \$37.00. Georgia residents must add appropriate sales tax.

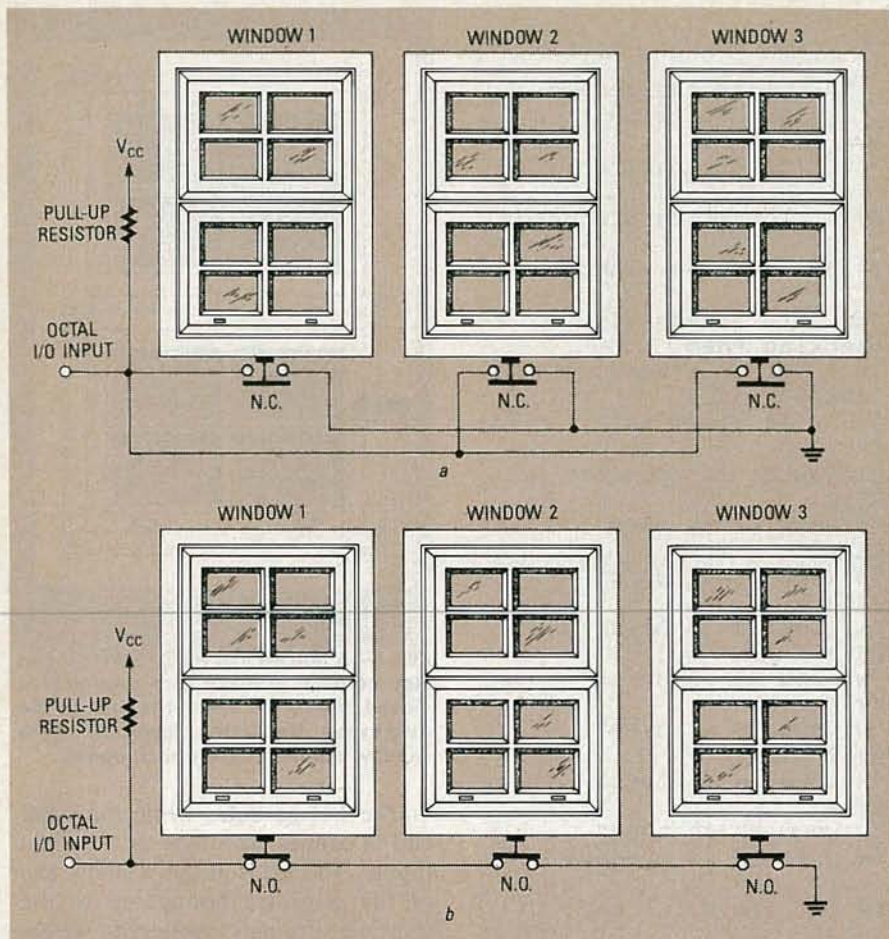

FIG. 6—SEVERAL WINDOWS CAN BE MONITORED using normally-closed switches in parallel (a) or using normally-open switches in series (b).

using normally-open switches, when the window switch is open, the input will be a logic 1 because all the inputs of the module are normally pulled high, and when the window is shut, the input will be a logic 0. If normally-closed switches are used, an open window will be a logic 0, and a closed window will be a logic 1.

The way in which the switches are connected to an input channel depends on the type of switches that are used. Normally-closed switches should be connected in parallel (see Fig. 6-a) so that when all of the windows are down, the switches are held open, resulting in a logic-1 input. If any of the windows are opened, the corresponding switch closes, causing a logic 0 to be read at the input.

The normally-open switches should be connected in series (see Fig. 6-b). When the windows are down, all of the switches are held closed, placing a logic 0 at the input. When one of the windows is opened, the corresponding switch is opened; a logic 1 is read at the input.

Listing 3 is a sample program that would control the open-window detector. For that example, we will assume the following:

- The octal I/O module is addressed at I/O port 100.
- Channel 0 (same as bit 0) of the octal I/O has a SPST switch connected to it that is used to enable and disable the alarm.
- The window switches are connected to channels 1-7.
- The alarm is connected to the channel-0 output.
- Normally open switches are being used.

The program could easily be changed to work in a system where several windows were connected to each channel. That could be accomplished by changing the print out statements to something like:

```
110 IF WIND1 0 THEN PRINT "A WINDOW IN ROOM #1 IS OPEN"
The program could also be made more personalized by printing:
"A WINDOW IN THE UPSTAIRS BEDROOM IS OPEN"
```

Lawn watering system

Besides controlling and/or monitoring devices within the home, REACTS can also be used for controlling devices outside the house. Specifically, the relay outputs of the octal I/O can be connected to electrically-actuated water valves so that the system can be used to control a lawn watering system. Indeed, by using the system's real-time clock, it can provide an extremely accurate means of cycling sprinklers on or off at pre-programmed times during the day.

The real-time clock has fourteen registers which contain the tenths of seconds, units of seconds, tens of seconds, units of minutes, tens of minutes, etc., all the way up to tens of years. By using the real-time clock, the system can be programmed to go through a watering cycle daily, every other day, every third day, or any other schedule you like.

In most cases, turning the valves on or off during the watering cycle could be done on a hourly basis. Because of that, the amount of program time needed to control the system would be minimal. A statement that checks the units of hours from the real-time clock could be placed in the main body of the program. When the units change, say an hour has passed, the processor would then go into a subroutine to determine if it was time to turn on or off any of the water valves. Of course it probably would also be desirable to have a set of switches to manually turn the water valves on or off. Switches could be wired between the transformer and each relay to control the power to the relay, or if the inputs to the octal I/O were not being used, the switches could be wired to them. Each input would control an output.

Besides the REACTS system and the octal I/O module, some other parts that you'll need to construct the watering system are the electrically-actuated water valves, wiring, and a step-down transformer. Most standard electrically-actuated water valves that you will find use a solenoid that operates on 24-volts AC to open and close the valve.

To provide the power for those valves, you'll need a 117 to 24 volt step-down transformer, available in wall-mount packages. The required power rating of the transformer will depend on the power needed to act-

continued on page 98



RADIATION MONITOR

We're always surrounded by some radiation. In this article we'll show you where it comes from, how it can help or harm you, and how to use the Radalert to warn you of dangerous conditions.

JOE JAFFE, DAN SYTHE, and STEVE WEISS

HUMAN BEINGS HAVE BEEN EXPOSED TO naturally occurring ionizing radiation for millions of years because nuclear reactions take place on our sun and on other stars continuously. Their emitted radiation travels through space, and a small fraction reaches the earth. Natural sources of ionizing radiation also exist in the ground, the most familiar and most common ground-source being uranium.

Last month we showed you how to build a nuclear radiation monitor—the Radalert. Now we'll show you how to use it, and how to interpret its readings.

Ionizing radiation

Ionizing radiation is radiation that has the ability to remove electrons (the process of ionization) when it strikes or passes through an electrically neutral atom. It was first discovered about 100 years ago and given

the name *X-rays* because its nature was unknown. X-rays can be generated in a vacuum tube by connecting the tube's anode and cathode to a source of high voltage: anything from 25,000 to 250,000 volts. When the cathode is heated it emits electrons that travel at high speed to the anode. The bombardment of the metallic anode by the electrons produces the X-rays. The ability of X-rays to penetrate a variety of materials, including body tissue, makes them a powerful tool in the physical and medical sciences. We now know that X-rays are a quantum of electromagnetic energy, also called photons.

Soon after the discovery of X-rays, it was discovered that uranium salts spontaneously give off radiation that penetrates matter in the same fashion as X-rays. Other supposedly inert materials were found to emit similar radiation, forming a class of radioactive

materials known as *radioisotopes*. Gamma rays, one type of radiation from those materials, are similar to X-rays. Other types of radiation from radioisotopes are alpha rays and beta rays.

The emission of a gamma ray, alpha ray, or beta ray causes the radioisotope to change from one type of atom to another. When the emission occurs, the atom is said to decay. The radioactive process is an electronic process in that it involves changes in the electrical charge configuration of the atom. A beta ray is actually a particle, an electron emitted by the atomic nucleus. A gamma ray is the photon emitted when an electron is added to the atomic nucleus. The alpha ray is a particle that consists of two protons and two neutrons, identical to the nucleus of the helium atom, emitted when the atom decays. In physics theory, particles sometimes

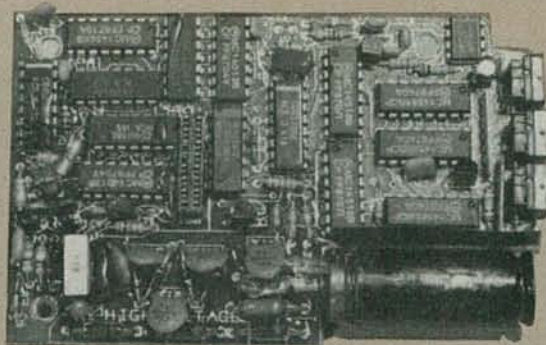

a

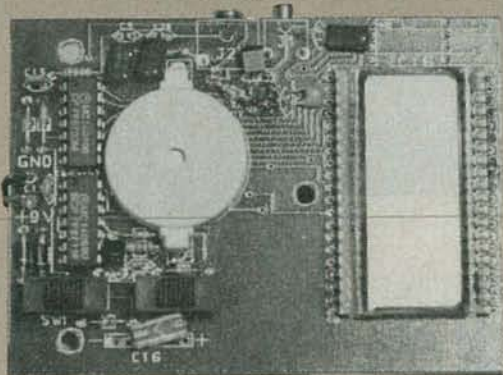

b

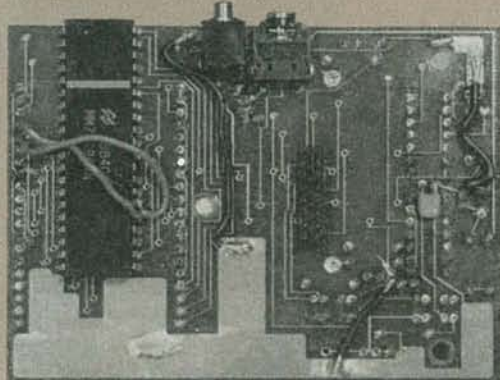

c



d

PUTTING IT ALL TOGETHER

The Radalert circuit uses two PC boards; these are the ones from the Radalert prototype. The PC-board templates shown in the PC Service section of the June issue, and the boards supplied in the kit, are slightly different from the photos so that user-assembly will be easier. Most important, jumpers are no longer required.

The main board (a) has all its components installed on one side. The display board (b and c) has components installed on both sides. The top

of the display board (b), what is usually called the "component side," has the LCD display unit, the beeper, and the two operating switches. The "solder side" (c) of the display board has the remote power and alert jacks, IC16, and the Samtec connector.

When the case is assembled the main board is automatically connected to the display board through the 16-pin Samtec connectors, forming the circuit "sandwich" shown in d (case removed for clarity).

behave like rays, which travel in waves, so the terms are quite frequently used interchangeably.

Gamma rays behave in the same manner as light waves and radio waves although the wave lengths of gamma rays are extremely short, less than 0.1 billionth of a centimeter. However the energy of gamma radiation is millions of times greater than light and radio waves, giving it the ability to penetrate matter.

The energy of ionizing radiation is measured in millions of electron volts (mev). Beta particles have energy values ranging from almost zero up to 1 mev. Alpha particles have energy values from 0.1 mev up to 5 mev, and gamma rays have energy values as high as 100 mev.

Each radioisotope has a half-life, which is the time required for half of a quantity of the material to decay. For example, thorium 234 has a half-life of 24 days. If you start out with one gram of thorium 234, at the end of 24 days, 1/2 gram of thorium 234 will have decayed to protactinium 234 by emitting beta rays. Note that theoretically it will take an infinite time for the thorium to decay completely because for each succeeding half-life only half the remaining material decays. To put that into perspective, after seven times the half-life, approximately 99% of the original material has decayed, and after 10 times the half-life, approximately 99.9% of the material has decayed. The decay products may still be radioactive. Because the decay process actually occurs randomly, the half-life represents the average rate of emission.

The decay chain

Table 1 shows the complete radioactive decay chain for uranium starting with U238 and ending with a stable isotope of lead. You can see that the half-life of the atoms in this chain range from 4.5 billion years to 164 microseconds, an astonishing span. Only the primary type of ray emitted is shown, but since radioactive decay is a complex phenomena, secondary emission of the other rays may take place to a lesser degree.

Natural radiation

Uranium and its decay products are the most common radioactive materials in the ground. They are found everywhere. All the isotopes in the uranium decay chain are solids except

TABLE 1
RADIOACTIVE DECAY CHAIN

Isotope	Emits*	Half-life	Product
U238	alpha	4.5 billion years	Th234 Thorium
Th234	beta	24.1 days	Pa234 Protactinium
Pa234	beta	1.17 minutes	U234 Uranium
U234	alpha	250,000 years	Th230 Thorium
Th230	alpha	80,000 years	Ra226 Radium
Ra226	alpha	1602 years	Rn222 Radon
Rn222	alpha	3.8 days	Po218 Polonium
Po218	alpha	3 minutes	Pb214 Lead
Pb214	beta	26.8 minutes	Bi214 Bismuth
Bi214	beta	19.7 minutes	Po214 Polonium
Po214	alpha	164 microseconds	Pb210 Lead
Pb210	beta	21 years	Bi210 Bismuth
Bi210	beta	5 days	Po210 Polonium
Po210	alpha	138 days	Pb206 Lead

*Primary emission

for radon, the only radioactive gas. High concentrations of radon are found in soils and rock containing uranium, granite, shale, and phosphate. Trace amounts of radon are widely distributed in the earth's crust. As a gas, radon migrates through the ground to enter the atmosphere. Radon is colorless, odorless, and tasteless; it does not burn or glow. In recent years, it has been discovered that radon is a serious problem in many homes.

According to the Environmental Protection Agency (which is more generally referred to as the EPA), radon was first noticed in the late 60's in homes that had been built with materials contaminated by waste from uranium mines. Only recently they have learned that houses in various parts of the U.S. may have high indoor radon levels caused by infiltration from the soil. The EPA has published booklets for the public on that topic; they are titled *A Citizen's Guide to Radon* and *Radon Reduction Methods*.

Phosphate deposits throughout the world contain relatively high concentrations of the uranium decay chain. In the U.S., about half the mined phosphate is converted to fertilizer; the rest is used to produce chemicals and gypsum building materials. Mining and processing phosphate ores distributes uranium and its decay products in the environment. The use of phosphate fertilizers with high levels of radioactivity may contaminate food crops.

Man-made radiation

The development of nuclear weap-

ons, their use at Hiroshima and Nagasaki, and subsequent atmospheric testing, significantly increased radioactive elements in the environment. The finding of high concentrations of radioactive strontium in milk and other food products led to a world-wide treaty to end atmospheric testing in 1963.

The use of nuclear reactors to generate electricity is a major contributor to man-made increases in radiation levels. The nuclear fuel cycle consists of mining and milling uranium and its conversion to fuel material, fabrication of fuel rods, use of the fuel in the reactor, reprocessing of spent fuel, transportation and storage of contaminated materials such as tools, filters, chemicals, and clothing (so-called "low-level" wastes), and transportation and storage of high-level wastes from the reprocessing of fuel rods. Each of those steps may add radioactivity to the environment.

Operation of a nuclear reactor may be accompanied by controlled small releases of radiation. There are frequent reports of uncontrolled releases, aside from major accidents such as those at Three Mile Island and Chernobyl. Unfortunately, data on radiation levels near nuclear plants are not generally available. Following the Three Mile Island accident, the people living in the area successfully sued the operator of the plant to provide funds for setting up a permanent monitoring system to give an early warning of any future releases, however, the monitoring system has yet to be implemented.

Luminous dials on watches and instrument panels incorporate radioac-

tive materials; hence, they also generate man-made radiation. Also, some early color TV sets were found to emit X-rays in excess of recommended limits, although more stringent regulations have largely eliminated that problem.

If you have ever taken a mantle-type gas lantern on a camping trip you should know that the mantle contains radioactive thorium. Although the package for replacement mantles has a warning not to keep mantles or its ash near the skin for prolonged periods, nowhere does it say that the mantles are radioactive.

Compounds containing radioactive uranium and cerium are incorporated in porcelains used in restorative and prosthetic dentistry to simulate the fluorescence of natural teeth. The amount of these radioactive materials in dental porcelain powders and artificial teeth is limited by law.

Ceramic pottery and its glazes may contain small amounts of radioactive uranium and thorium, depending on the source of the clay.

Beneficial radiation

The first, and best known, use of radiation is the X-ray. Almost every one of us has at some time been exposed to diagnostic X-rays. It is hard to imagine the practice of orthopedics or dentistry without the use of X-rays. Some uses of X-rays—such as measuring the fit of shoes in shoe stores—have been long abandoned because of health risks.

Radioisotopes behave the same way in chemical reactions as the stable isotope. That makes them useful in diagnosing and treating disease. If a sample of material containing a radioisotope of a chemical involved in a specific disease or physiological process is injected or ingested, doctors can follow the activity of that chemical within the body with appropriate instrumentation. Much of the knowledge of thyroid function and thyroid disease has come from the use of radioactive iodine, I¹³¹. Tumors can be localized with radioactive phosphorus, P³², and radioactive chromium, Cr⁵¹, is used in blood studies. Vitamin B₁₂ made with radioactive cobalt, Co⁶⁰, makes it possible to identify diseases associated with poor absorption of that vitamin.

Business Week magazine has reported an interesting side-effect of using radioactive isotopes in medi-

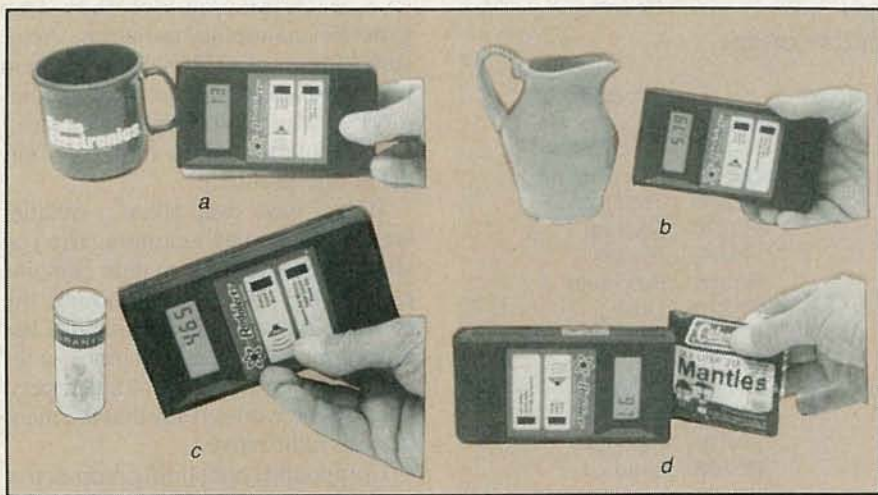

SOME COMMON RADIATION READINGS found around the office. In *a*, the RadaAlert's reading from a plastic drinking cup is the background radiation level, which means the cup is radiation-free. But *b* shows that the orange clay or glaze used in making the pitcher obviously is radioactive; more so than the tube of Uranium-235 samples shown in *c*. Also radioactive—but to a smaller degree—are the camping-lamp mantles shown in *d*.

cine. On two separate occasions, the Secret Service asked women visiting the White House to step out of the visitors line. A sensitive radiation detector had picked up radiation from the women. After questioning it was discovered that both women had recently had injections of radioisotope material for medical purposes, and enough of the isotope remained in their bodies to trigger a radiation alarm.

The uses of X-rays are not limited to medicine and dentistry. Industrial applications include the familiar baggage examination at airports, engineering studies of integrated circuits, and flaw detection in metals, including welded joints. Non-contact thickness measurements on moving extrusions of rubber and plastic is a common industrial application of beta and gamma rays.

Harmful radiation

In general, the biological effects of ionizing radiation are destructive. As alpha, beta, or gamma radiation passes through the body, it interacts with the body's cells. Atoms in the cells may be ionized, or electrons in orbit about the nucleus can be displaced from one energy state to another. In either case the cells are changed from their original form to new forms, and the information contained in them is modified.

The changes that occur may cause some cells to stop reproducing; other cells may undergo mutation, or the

control mechanism in cells that limits cellular reproduction may fail, causing cancer.

It may take years before the effects of radiation become manifest, so it is almost impossible to prove on an individual basis whether there is a relationship between radiation exposure and a subsequent disease. However, two studies on large populations indicate a statistical relationship. One study involved the survivors of the Hiroshima and Nagasaki atomic bomb blasts. Another study followed children of mothers who had diagnostic X-ray procedures during pregnancy. As a result of the latter study, the use of X-rays on pregnant women has been considerably reduced.

Many experts used to think that if radiation exposure was under a certain threshold, a person would not have any harmful effects. Although some still believe in the theory, the evidence is establishing that there is no minimum radiation level that can be considered safe. *Radiation and Human Health*, by John W. Gofman, M.D., Ph.D., is a comprehensive investigation of the evidence relating low-level radiation to disease. *The Wall Street Journal* reported in February, 1988, that the National Institutes of Health has launched "...a large-scale evaluation of cancer deaths occurring among persons living near the over 100 reactors operating in the United States."

The amount of energy received from ionizing radiation by sensitive

biological tissues is a determining factor in causing harmful effects. Energy is measured in *ergs*. If 100 ergs of ionizing radiation are received by 1 gram of body tissue, the tissue has received 1 rad of radiation, a unit of exposure. The *Roentgen* is another measurement of exposure, originally used for X-ray machines. One roentgen equals 93 ergs per gram of tissue, almost the same as a rad. For some purposes it is useful to speak of rads per unit of time such as per minute, per hour, or even per year, while sometimes just the total accumulated exposure is of interest.

To assess the potential damaging effect of radiation from radioactive materials, we need to know the number of emissions per unit of time and the amount of energy of each emission. While a Geiger counter can easily measure the emission rate in counts per minute, it can only measure the energy level in rads if the specific source of radiation is known. To get around that problem, some Geiger counters are calibrated in terms of *millirads*, or *milliroentgens*, per hour (mr/hr) for a specific source such as Cesium-137; then, comparisons can be made for other materials. The RadaAlert display is in counts per minute, or total counts, as its main purpose is to indicate changes in background radiation without the need to know what the radiation source is, a task for more expensive equipment. An Operating Manual for the RadaAlert supplied with the parts kit includes conversion charts between counts per minute and mr/hr for common isotopes.

Further information on radiation can be found in *IEEE Spectrum*, November, 1979, and in *Report of United Nations Scientific Committee on the Effects of Atomic Radiation*, 1982.

Using the RadaAlert

As mentioned earlier, we are always exposed to naturally occurring background radiation from outer space and from the earth. After you finish assembling and testing the RadaAlert you can determine the background radiation level in your area. Do that outdoors first so it can be compared with the level inside your home. Notice—by watching the count light or listening to the beeper—that background radiation occurs randomly. In a northern California labo-

ratory, an average CPM (Count Per Minute) is 12.5, but a one minute count as low as 5 or as high as 25 is not unusual. Because of the possibility for a large CPM variation, you need to collect two sets of data: one for use in setting the Alert level (which warns you if the count in any minute is higher than would be normally expected); the other to help you detect small changes that might result from radon or other sources of radiation in your home.

We suggest you set the Alert level at a value that rarely sounds a false alarm, but one that still warns you when the radiation is unusually high. To determine that value you must first find the normal variation in background level. Standard deviation is a descriptive statistical measure of the variability of a set of data.

To calculate the standard deviation, use your Radaalert in the CPM mode to measure 30 or more consecutive one-minute readings. Sum the readings and divide the sum by the number of readings to get the average value. Then take the difference between each CPM value and the average, square each of those numbers, and sum them. Divide the sum by 29 (if you have taken 30 readings, otherwise by the number of readings minus one). The square root of that number is the standard deviation. A hand calculator, or a computer, will help you do the calculations quickly.

A typical set of data has an average of 12.8 counts per minute, and a standard deviation of 4.3. $3 \times 4.3 + 12.8$ equals 25.7. Set the Alert level at 30, the next higher increment.

Use the Radaalert's Total Count mode to check for small differences in radiation (for example, between outdoors and indoors). Obtain the total count for a 12-hour period in each location. When you take the count outdoors, place the Radaalert on the ground in an unpaved area for one set of counts, then get another set of counts with the instrument about 4 to 6 feet above the ground. That procedure helps you detect alpha particle radiation from the earth, which rapidly dissipates in air.

Differences in radiation level as low as 1 CPM can be detected by comparing total counts for 12-hour periods. The differences might result from radon or concentrations of radioisotopes in the earth. Solar flares, low-level leaks from nearby nuclear

plants, or higher-level leaks from distant plants can cause small changes in the 12-hour count. If you keep your Radaalert operating continuously in the Total Count mode and take readings every 12 hours, say at 7 am and 7 pm, you will know when those events take place. For comparison purposes, it is best to convert the total count to counts per minute. After you take each 12-hour reading, switch from the Total Count mode to CPM, then back to Total Count to reset the display to zero.

There are differences of opinion on the ability of Geiger counters to detect radon. While there's no claim that the Radaalert can specifically measure radon gas, experiments in a controlled environment with different levels of radon gas indicated that average counts per minute did rise and fall with radon concentrations. (After establishing the normal background radiation for a controlled-environment test site, the background radiation was subtracted from the total counts.) Preliminary results are shown in Fig. 1. The radiation detected is a combination of the emissions from radon and its "daughters," or "progeny."

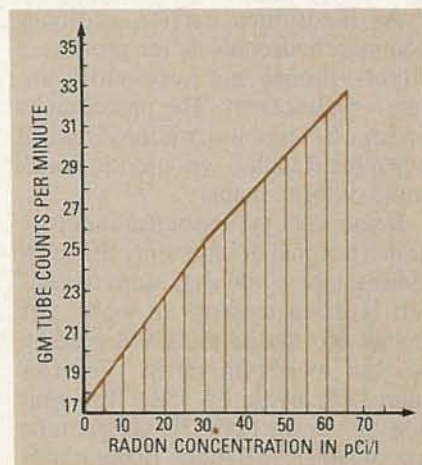

FIG. 1—GEIGER TUBE COUNTS vs. radon concentration. The CPM scale starts at 17 CPM, which was the background radiation at the testing station. The radon concentration at the test station is assumed to be between 1 and 5 picocuries per liter.

The Radon Technical Information Service of the Research Triangle Institute prepared a Cumulative Proficiency Report for the EPA in July, 1987. The report describes the approved radon testing methods, and the advantages and disadvantages of each method. The use of the Radaalert in conjunction with the EPA methods reduces the possibilities of error.

Radon entrance

The most likely entrance points for radon in homes or other buildings are cracks or openings in the floor around pipes or conduit, unsealed wall-floor joints, and underground hollow block walls. Dirt floors in basements are particularly vulnerable. Unventilated basements or closets normally have higher levels of radon than well-ventilated areas. For best results, keep air exchanges between indoors and outdoors at a minimum 12 hours before and during the test.

Place the Radaalert on the floor near any suspected entrance point. Set the display for Total Count and accumulate the counts for 12 hours in each location. If the 12-hour average CPM in your home is more than 1-CPM higher than outdoors, you should do further testing for radon using carbon canisters or other EPA-approved methods.

Common radiation

You may find that you have radioactive items in your home. Pottery and glazed dinnerware are potential sources of radiation if they are made from uranium-bearing clays or uranium oxides. If you have any ceramicware with orange glazes, check it carefully for higher radiation levels. Also, static eliminators for records and photographic film may contain polonium, an alpha emitter. Use the Radaalert in the CPM mode with the beeper *on* to identify those items.

Some commercial gemstones used in jewelry may have had their color enhanced by neutron bombardment, thereby making them radioactive. Also, gold jewelry has been made from reprocessed gold that was previously used in radiation therapy. Check those products with your Radaalert in the CPM mode.

Do you have a watch, clock, or other instrument with a luminescent dial? Place its face as close as possible to the alpha window on the Radaalert and see if there is an increase in radioactivity. Observe the change in CPM for different distances between the Radaalert and the dial, and you can see how much of the count was due to alpha rays, compared to beta or gamma rays. Repeat these experiment with a replacement mantle for a gas lantern. You may be surprised by the results. Do not handle the mantle directly; keep it in its plastic bag.

Radiation from outer space is at-

tenuated by collisions with air molecules so the radiation at sea level is normally lower than at higher elevations. Figure 2 shows the relationship between CPM and altitude based on 15-minute average readings taken in California from the top of the ski lift at Heavenly Valley (10,000 feet) to sea level.

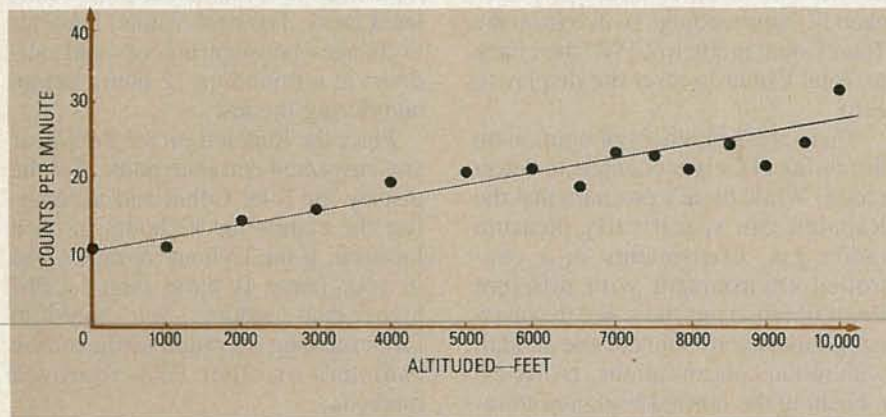

FIG. 2—THE BACKGROUND RADIATION at various altitudes, measured from a ski-lift.

The altitude effect is particularly noticeable when traveling by air at 35,000 to 40,000 feet. Radiation levels 30 to 50 times higher than on the ground have been measured at these altitudes.

At times of solar flares the radiation level may go considerably higher, so supersonic aircraft, which fly as high as 60,000 feet, have radiation-monitoring equipment to alert the pilot to move the plane to lower altitudes if the radiation reaches a predetermined level. Make some radiation measurements with your Radalert on your next flight, with the beeper *off* so that you don't disturb any of the other passengers.

You can establish a baseline of background radiation if you live, or frequently drive, near a nuclear power plant; then you can observe changes from the baseline due to controlled or uncontrolled releases of radioactivity. A baseline of 12–14 CPM for a local nuclear plant was established during drive-bys on a number of occasions. But on one occasion the CPM increased to 22, an increase of over 50%.

Use your Radalert in your car. You may be able to detect vehicles transporting radioactive materials, or discover you are passing a phosphate mining region, or other radioactive deposits. With the sound-selector switch set for the *Count* position the audible beeps will help you recognize

short-time radiation increases that might be masked by averaging.

Exploring for underground radioactive materials can be an interesting hobby. Gemstones may be found together with, or may contain, radioactive materials; also, high radon concentrations are present in some caves, so be careful if your Radalert

indicates higher than normal radiation levels while exploring. Radioactive materials can be hazardous if inhaled or handled carelessly.

In-home tests

As mentioned earlier, ordinary common household items produce a slight—though not necessarily unsafe—radioactivity. The photographs on page 54 show the readings attained when the Radalert was used to check some of those items.

If you work in the nuclear industry, or in a hospital or laboratory that uses radioisotopes, you may want to convert Radalert readings to mr/hr. For Cobalt-60, divide the CPM reading by 958 to obtain mr/hr. For Cesium-137, divide by 982. This relationship for the LND 712 Geiger tube was obtained at Battelle Laboratories using sources traceable to the National Bureau of Standards. If you have access to calibrated sources of other isotopes, you can determine the appropriate conversion factor for your isotopes.

What should you do if the Radalert shows abnormally high radiation levels in the CPM mode? First, you should seek confirmation of your readings. Public Health Departments, hospital health physics or nuclear medicine departments, civil defense offices, EPA offices, police or fire departments, are possible places with radiation-monitoring equipment. Be-

fore you start doing your own measurements, you might want to find a contact you could call for confirmation if the Radalert gives an alert signal, or other indication of unusual radiation activity. Should there be confirmation, keep in touch with your local authorities and follow their instructions. Be aware that radiation from airborne radioactive particles will be less in a closed house or inside a building.

SOURCE

A complete kit of Radalert parts which includes assembly instructions and an operating manual is available for \$153.50 postpaid. The Geiger tube, the LCD display, and a set of PC boards with plated-through holes are individually available.

A completely assembled and tested Radalert including an operating manual is priced at \$229 postpaid.

From: International Medcom, 7497 Kennedy Rd., Sebastapol, CA 95472. Or call toll-free, 1-800-257-3825. In CA 1-800-255-3825. For technical information contact International Medcom at the above address.

If you don't have (or can't get) confirmation of a general increase in radiation, you should try to identify a localized source: a parked truck with radioactive materials, an excavation that has uncovered radioactive deposits, or even a container of radioactive material that has been disposed of illegally. The radiation level from such a source will decrease by the inverse square law; that is, if you move around with the Radalert and the level decreases by a factor of four, you will be twice the distance from the source. Or conversely, if the level goes up by a factor of four, you are only half the distance to the source. If you see evidence of a localized source, notify the authorities and get as far away as you can. Up to now, there has not been a large scale use of Geiger counters outside of laboratories and nuclear plants, which has limited our knowledge of the potential existence of localized "hot spots" of naturally occurring and man-made radiation. The dispersion of man-made radiation throughout the environment is still generally unknown. We hope the use of the Radalert to collect and disseminate radiation data will contribute to better understanding of these important subjects.

R-E

GENERAL PURPOSE INTERFACE BUS

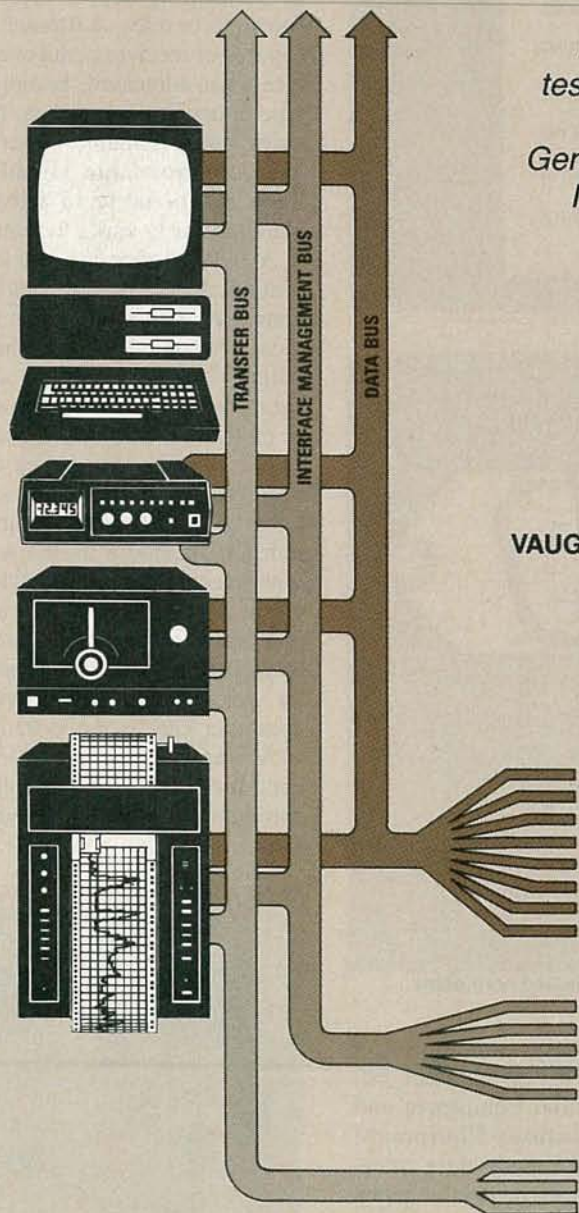

*Hook up your
test instruments
to a
General Purpose
Interface Bus.*

VAUGHN D. MARTIN

WHETHER AN INTERFACE BUS IS CALLED the I.E.E.E. 488, the General Purpose Interface Bus (GPIB), or the Hewlett-Packard Interface Bus (HP-IB), all three describe essentially the same thing; an orderly and predictable way to exchange digital data and maintain control between instrumentation devices.

First we'll concentrate on exactly what the GPIB is, and how it's configured in an instrumentation network. Then we'll give numerous practical tips on various operating data modes and cabling methods. We will look at supporting GPIB instrumentation, (such as a bus analyzer, a bus extender, a bus translator) and examine various GPIB configured systems. Finally, we'll examine the Hewlett-Packard Interface Loop (HP-IL), which is a means of accomplishing the same goals only with lower powered (sometimes battery-operated) and less expensive instrumentation and hardware.

GPIB beginnings

The IEEE-488 instrumentation interface standard evolved with Hewlett-Packard, who began in September 1965 to examine how they would standardize their future test instrumentation. Next, the International Electrotechnical Commission (IEC) took the resulting HP proposal as a starting point, and in 1974 issued a draft, for ballot vote by its members. In 1975, the Institute of Electrical and Electronics Engineers (IEEE) published their now-famous IEEE-STD 488. In January of 1976, the American National Standards Institute (ANSI) published their MC1.1, which is identical to the IEEE-488 standard. There are now two more standards, the IEC 625-1 and the British Standard B.S. 6146, which are also both identical to the IEEE-488 standard with the exception of the type of connector used to interface the hardware.

The IEEE-488 standard and its clones have been published in nine languages, used by more than 250 equipment manufacturers in 14 countries to design more than 2,500 different instruments. To say that it was well accepted as the absolute instrument-interface standard would be an understatement!

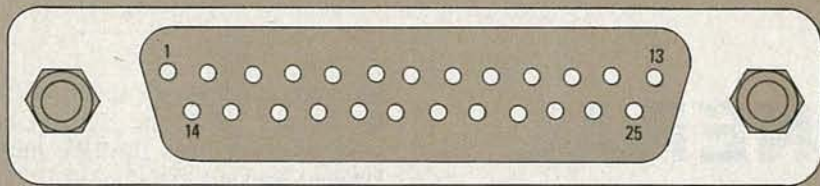

CONTACT	SIGNAL LINE	CONTACT	SIGNAL LINE
1	DIO1	14	DIO5
2	DIO2	15	DIO6
3	DIO3	16	DIO7
4	DIO4	17	DIO8
5	REN	18	GND (5)
6	EOI	19	GND (6)
7	DAV	20	GND (7)
8	NRFD	21	GND (8)
9	NDAC	22	GND (9)
10	IFC	23	GND (10)
11	SRQ	24	GND (11)
12	ATN	25	GND (12)
13	SHIELD		

FIG. 1—IEC 625-1 USES A 25-pin subminiature D-type connector.

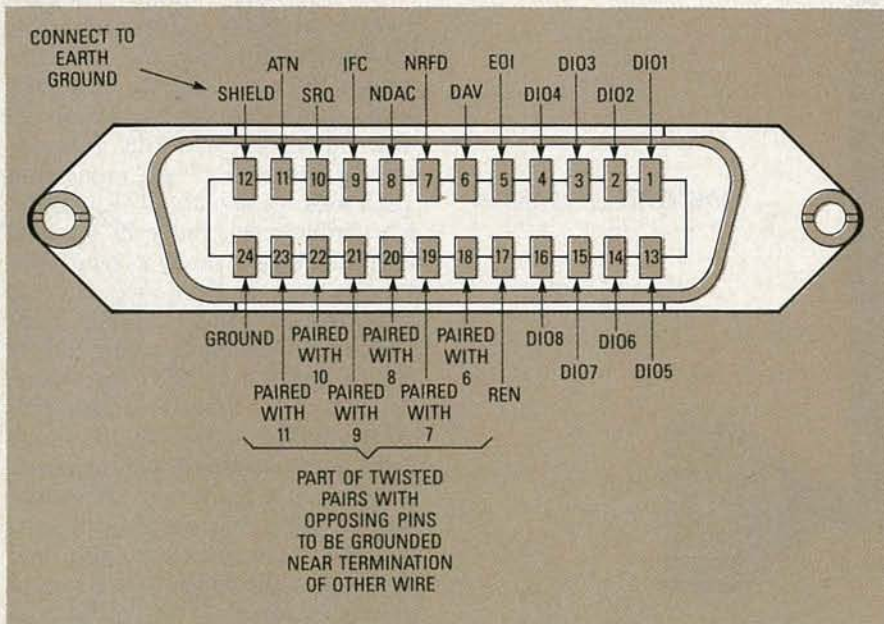

FIG. 2—GPIB USES A 24-pin miniature ribbon-type American standard connector.

standable that component damage would occur if data communication and instrument interfaces were accidentally interconnected.

In Europe, approximately 90% of bus-compatible equipment presently uses the IEEE-488/ANSI/MCI.1-type connector, and there are adaptors for interconnecting 25-pin and 24-pin connectors.

GPIB Specifications

When the controlled device such as printers, DMM's, frequency counters, etc. are commanded to do something, such as make a measurement on a particular band of frequencies, it is said that the controller "talks" and the responding devices "listen."

Every GPIB device must be capable of performing one or more interface functions or roles. A *listener* is a device capable of receiving data over the interface when addressed. Examples of that type of device are: printers, display devices, programmable power supplies, and programmable signal sources. There can be up to 15 active listeners simultaneously using the interface.

A *talker* device is capable of transmitting data over the interface when addressed. Examples of that type of device are: tape readers, voltmeters that output data, and counters that output data. There can be only one active talker on the interface bus at a time.

A *controller* is a device capable of specifying an instrument as either a talker or a listener for an information transfer (including itself). A computer with an appropriate I/O card is an example of a controller. There can be only one active controller on the interface bus at a time; although multiple controller systems are allowed, only a single controller can be the system's master.

As shown in Fig. 3, the 15:1 ratio of controlled devices to controller may be configured in either a linear or a star form.

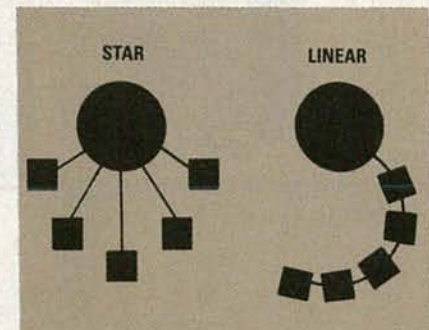

FIG. 3—THE STAR AND LINEAR form of instrument networking.

Comparing connectors

The IEC 625-1 uses the 25-pin subminiature D-type connector, shown in Fig. 1, rather than a 24-pin ribbon type specified by the American standards, shown in Fig. 2. Unfortunately, as many of you know, the 25-pin D-type connector is used as part of the

Electronic Industry Association's Standard RS-232-C; an interface between Data Terminal Equipment and Data Communications Equipment employing serial binary data interchange. That standard uses voltages up to $\pm 25V$ at 1/2 amp short circuit current. Therefore, it is quite under-

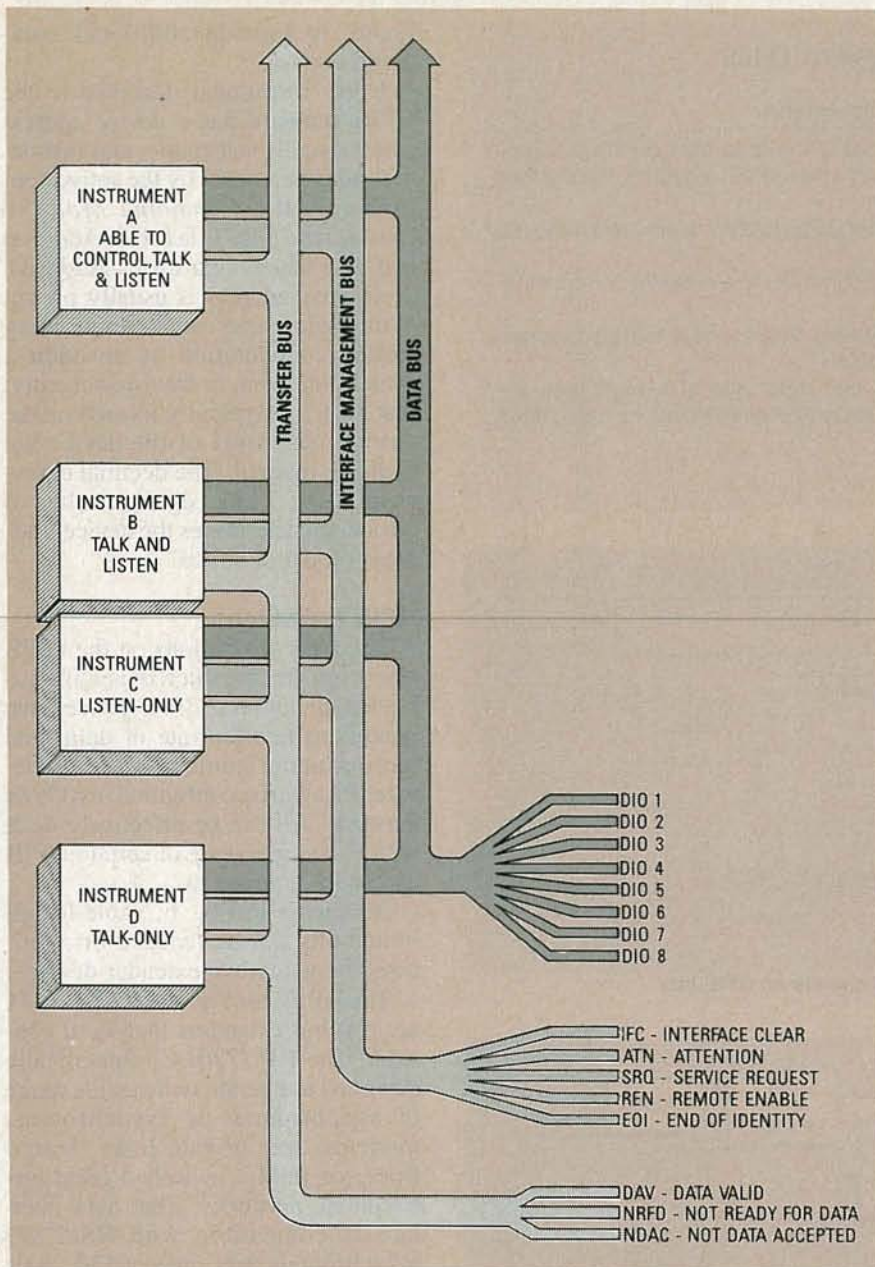

FIG. 4—THREE SEPARATE BUS LINES are used to control data flow.

TABLE 1—HANDSHAKING SIGNALS

Name	Description
DAV	Data Valid: Used to indicate the condition of the information on the Data I/O lines. Driven low by the source when data is settled and valid, and NRFD high has been sensed.
NRFD	Not Ready for Data: Used to indicate the condition of readiness of device(s) to accept data. Acceptor sets its NRFD low to indicate it is not ready to accept data. The NRFD line to the talker will not go high until all addressed listeners are ready to accept data.
NDAC	Not Data Accepted: Used to indicate the condition of acceptance of data by device(s). The acceptor will set its NDAC low to indicate it has not accepted data. When it accepts data from the Data I/O lines, it will release its NDAC line. However, the NDAC line to the talker will not go high until the last/slowest listener has accepted the data.

In total there are 16 active signal-bus lines; refer to Fig. 4. The term *bus* means a collective grouping of signals; those groups are either data, interface management, or byte transfer. Each bus is independent. In other words, the data bus would never have either byte transfer or bus management signals flowing through it.

HP-IL KIT

Hewlett Packard offers *The HP-IL interface/prototyping kit*. That kit, the HP 82166C, costs \$395 and consists of two converters, a test board, cabling, and excellent documentation which allows prototyping of loop-compatible products. Its key components consist of the HP-IL interface connection, the HP-IL transformer set, and the HP-IL panel receptacle.

The message transfer scheme used is asynchronous byte-serial/bit-parallel, with a three-wire interlocking handshake transfers. What all of that means is three handshaking lines acknowledge if the Data Are Valid (DAV); if the device addressed is *Not Ready For Data* (NRFD); or if the Data Are Not Accepted (NDAC). Figure 5 is a timing diagram of the handshaking signals for unambiguous transfer of data bytes. Table 1 summarizes those handshaking signals.

To ensure data transfer integrity, the following three conditions must be met:

1. The slowest device on the bus will determine the transfer rate during the transfer of that command.
2. More than one device can accept data at the same time.
3. Every byte transferred must undergo a handshake (except for parallel poll response).

The interface-management bus lines are responsible for the orderly flow of information; Table 2 lists those lines and their functions. Of particular importance is the ATTENTION (ATN) line, since all devices must monitor that line and respond within 200 ns after it becomes active (goes low). When the ATTENTION line is active, it places the management bus lines in the *Command Mode*, which serves four main functions:

1. Selection of the instruments that will send and accept data.
2. Selection of the specific interface operation, which includes five multiline commands and four uniline commands: INTERFACE CLEAR (IFC),

TABLE 2—MANAGEMENT LINES

Name	Description
ATTN	Attention: Causes all devices to interpret data on the bus as a controller command, and activates their acceptor handshake function (command mode).
IFC	Interface Clear: Initializes the GPIB system to an ideal state (no activity on the bus).
SRQ	Service Request: Alerts the controller to a need for communication.
REN	Remote Enable: Enables devices to respond to remote program control when addressed to listen.
EOI	End or Identify: Indicates last data byte of a multi-byte sequence; also used with ATN to parallel poll devices for their status bit.

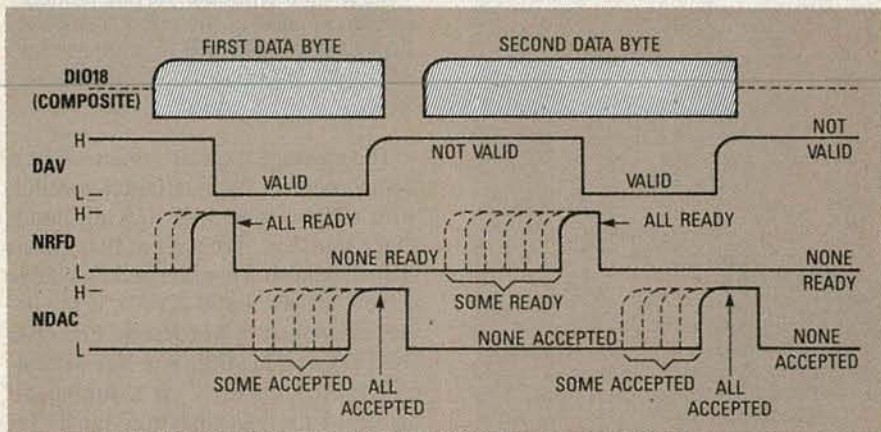

FIG. 5—TIMING DIAGRAM FOR HANDSHAKING signals on GPIB bus.

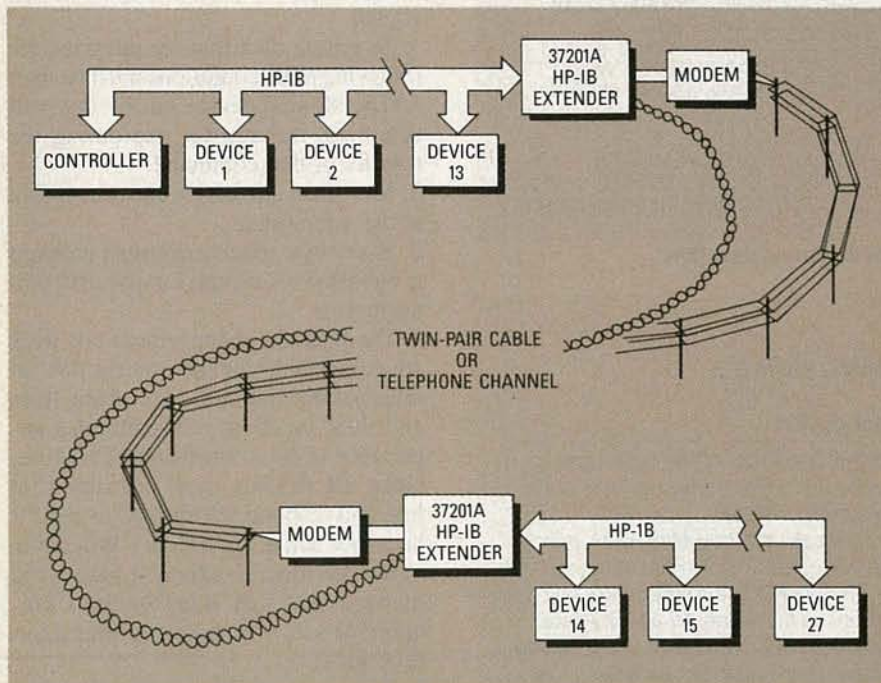

FIG. 6—USING GPIB EXTENDERS AND MODEMS, GPIB devices can be connected if separated by great distances.

REMOTE ENABLE (REN), ATTENTION (ATN), and IDENTIFY (IDY) when both ATN and EOI are active.

3. Specific device addressing for listener devices.
4. Issuing a specific secondary com-

mand, to provide additional command codes.

Every instrument designed to the GPIB standard has a device address that is usually selectable, and that device address is used by the active controller in the *Command Mode* to specify who talks (via a Talk Address) and who listens (via Listen Address). A device's address is usually pre-set at the factory and can be reset during system configuration by an address switch, jumpers, or front-panel entry; that switch is typically located on the outside rear panel of the device but could be internal. The decimal equivalent of the 5 least significant bits of the switch determines the device's address on the interface.

GPIB limitations

The basic limitations on the GPIB operation are: the interconnecting cable length between GPIB devices, the maximum transfer rate of data, and the maximum number of GPIB devices that can be configured in a GPIB network. All can be effectively dealt with if you are aware of certain GPIB accessory equipment.

As shown in Fig. 6, cable-length limitations can be reduced or eliminated by using bus-extender devices.

The HP 37201A and the HP 37203A are two bus extenders that we'll consider. The HP 37201A is specifically designed to operate with a wide range of synchronous or asynchronous modems over private lines, leased lines, or public switched (dial-up) telephone networks. That data interface is compatible with RS-232C asynchronous data rates of 150, 300, 600 and 1200 bits/seconds.

The HP 37201A provides for error checking/correcting communications protocol that protects against errors introduced by poor-quality data circuits. That instrument even provides immunity to major interruptions in the data link, such as dropouts, line breaks and modem sync. loss; and it recovers automatically without loss of data.

Data-Transfer-Rate limitations mandate that every device be turned-on; that all devices participating in the data transfer use three-state drivers; that the cable length not exceed 15 meters, or have more than one device per meter of cable; and that the capacitive loading should be limited to 50 pF per device.

continued on page 98

WORKING WITH OTA's

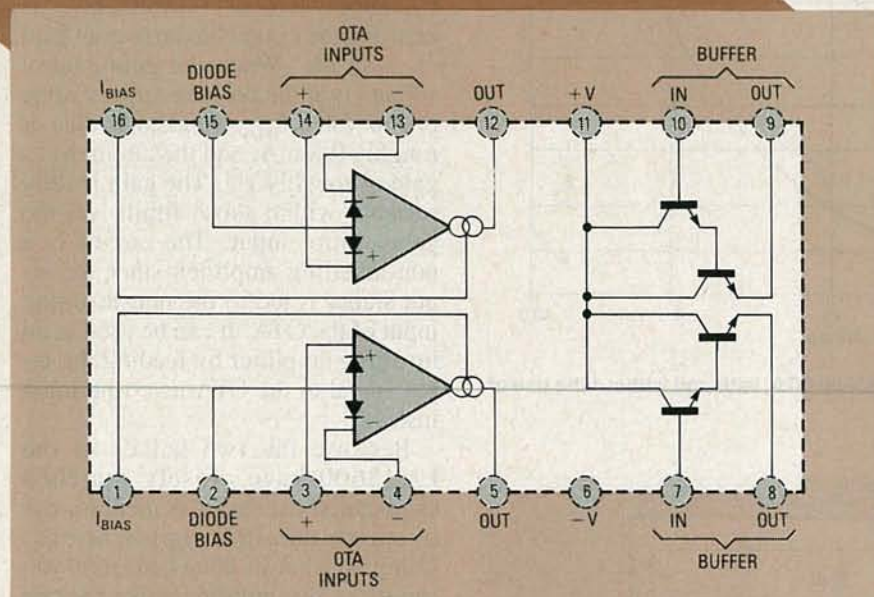

FIG. 1—PIN CONNECTIONS of the LM13600 dual OTA are as shown. You can also see how each IC contains two OTA's.

LAST TIME (MAY 1988) WE DISCUSSED THE basic operating principles of the CA3080 Operational Transconductance Amplifier (OTA), and showed how it can be used to make various types of voltage- or current-controlled amplifiers and micro-power Schmitt triggers, comparators, and oscillators. However, the CA3080 has relatively high distortion and an unbuffered high-impedance output.

In this article we will introduce you to an improved second-generation OTA; the LM13600. That device is actually a dual OTA, as shown by the pinout of Fig. 1. The package also incorporates linearizing diodes that greatly reduce signal distortion, and a coupled output-buffer stage that can provide a low-impedance output.

The two OTA's of the LM13600 share common supplies, but are otherwise fully independent. All elements are integrated on a single chip, so both OTA's have closely matched characteristics (transconductance values are typically matched within 0.3 dB), making the IC ideal for use in stereo applications. The commercial version of the LM13600 can be powered from a split supply of up to 18 volts, or a single-ended supply of up to 36 volts.

Linearizing diodes

Figure 2 shows a basic connection diagram for one of the OTA's in the LM13600. Basically, that OTA is almost identical to the one in the CA3080, except for the addition of linearizing-diodes D1 and D2. Those are integrated with Q1 and Q2, and have characteristics that are matched to the base-emitter junctions of Q1 and Q2. In use, equal low-value re-

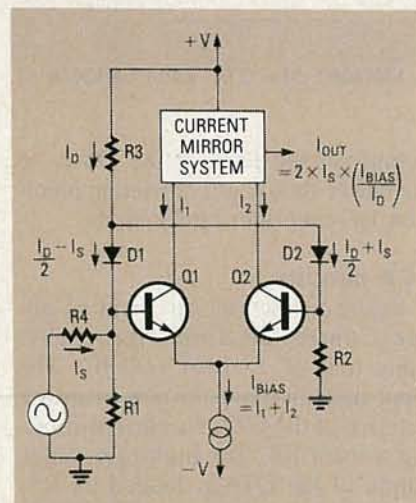

FIG. 2—SIMPLIFIED circuit of an LM13600 OTA shows one of the more basic ways of using the IC.

The LM13600 is a second-generation dual Operational Transconductance Amplifier that can be used as a voltage-controlled amplifier, resistor, filter, or oscillator. In this article we'll show you how.

RAY MARSTON

sistors R1 and R2 are wired between the inputs of the differential amplifier and ground. Bias-current I_D is fed to those resistors from the positive supply via R3, D1, and D2. Since D1 and D2 have identical characteristics, and since R1 and R2 have equal values, bias current, I_D , divides equally between R1 and R2.

The circuit's input voltage is applied via R4, which has a large value relative to R1, and generates an input signal current of I_S . That signal current feeds into R1 and generates a voltage across it, reducing D1's current to a value of $(I_D/2) - I_S$. Since I_D is constant, the D2 current rises to $(I_D/2) + I_S$. Consequently, the linearizing diodes apply a heavy negative feedback to the differential amplifier and substantially reduce the signal distortion. If I_S is small relative to I_D , the output current of the circuit is equal to $2 \times I_S \times (I_{BIAS}/I_D)$. The gain of the circuit can be controlled either by I_{BIAS} or I_D . In use, I_D and I_{BIAS} should both be limited to a maximum of 2 mA.

The graph of Fig. 3 shows typical distortion levels of the LM13600 at various peak-to-peak input voltages, with and without the use of the linearizing diodes. At a 30-mV input, the distortion is below 0.03% with the diodes, and 0.7% without them. At a 100-mV input, the distortion is roughly 0.8% with the diodes, and 8% without them.

Controlled-impedance buffers

Figure 4 shows the internal circuit of each half of the LM13600. The two

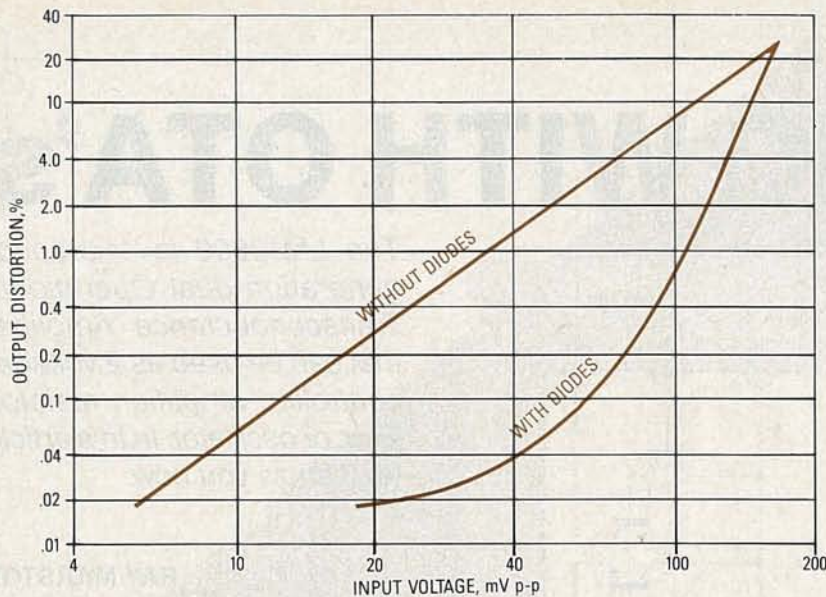

FIG. 3—TYPICAL DISTORTION LEVELS of the LM13600 OTA, with and without the use of the linearizing diodes.

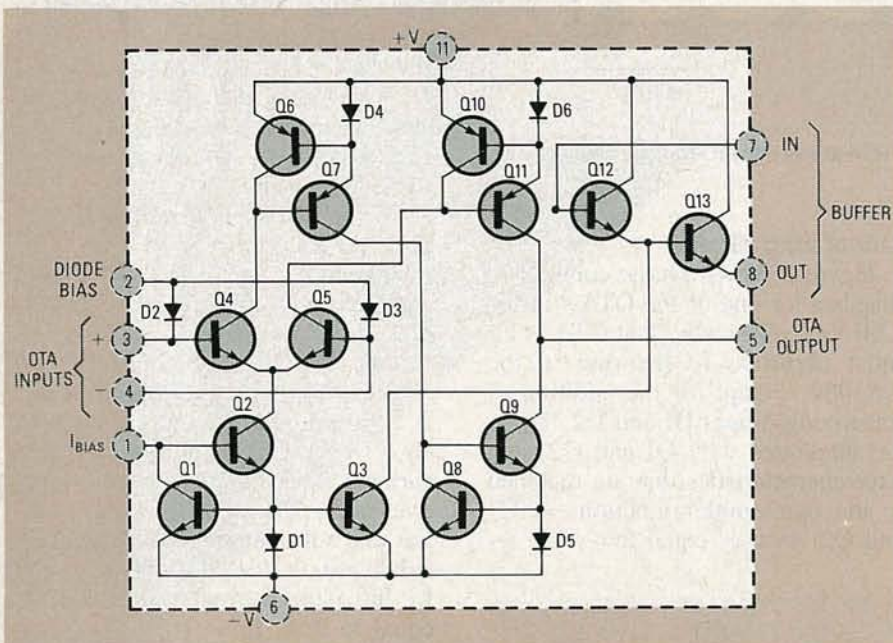

FIG. 4—INTERNAL CIRCUIT of one half of the LM13600 dual OTA. Each LM13600 IC contains two of these circuits.

output transistors (Q12 and Q13) are connected for use as a controlled-impedance Darlington emitter-follower buffer stage. When the base of Q12 is connected to the output of the OTA, and the emitter of Q13 is connected to the negative supply ($-V$) via a suitable load resistor, the buffer makes the OTA's high-impedance output signal available at a low-impedance level. The output current of each buffer stage should be limited to 20 mA maximum. Note that the output of the buffer stage is about 1.2 volts (two base-emitter voltage drops) below the

output-voltage level of the OTA, so the buffer should not be used in precision DC-amplifier applications.

VCA circuits

Figure 5 shows the circuit of a Voltage-Controlled Amplifier (VCA) using half of an LM13600 IC. The input signal is fed to the non-inverting terminal of the OTA via current-limiting resistor R4. The high-impedance output of the OTA is loaded by R5, which determines the peak amplitude of the output signal. The output signal is available at a low-impedance level

via the buffer stage, which is loaded via R6.

The circuit in Fig. 5 is powered from dual 9-volt supplies. The current I_D is fixed at about 0.8 mA via R1, but I_{BIAS} is variable via R7 and an external gain-control voltage. When the gain-control voltage is at the negative-supply level of -9 volts, I_{BIAS} is zero and the circuit has an overall gain of -80 dB. When the gain-control voltage is at the positive-supply value of $+9$ volts, I_{BIAS} reaches a value of roughly 0.8 mA, and the circuit has a gain of roughly 1.5. The gain is fully variable within those limits via the gain-control input. The circuit is a non-inverting amplifier, since the input signal is fed to the non-inverting input of the OTA. It can be used as an inverting amplifier by feeding the input signal to the OTA inverting input instead.

Because the two halves of the LM13600 have closely matched characteristics, the IC is ideal for use in stereo-amplifier applications. Using both halves of an LM13600 you can make two amplifiers like the one in Fig. 5. Then, if you connect both gain-control inputs together, and feed them from a single gain-control voltage and current-limiting resistor, you'll have a voltage-controlled stereo amplifier.

The VCA circuit of Fig. 5 can be used as an amplitude modulator or 2-quadrant multiplier by simply feeding the carrier signal to the OTA input, and the modulation signal to the gain-control input. If desired, the gain-control pin can be DC-biased so that a carrier output is available while no AC-input signal is applied. Figure 6 shows a practical example of an inverting-amplifier circuit of that type. The AC-modulation signal modulates the amplitude of the carrier-output signal.

Figure 7 shows how one half of an LM13600 can be used as a ring modulator or 4-quadrant multiplier. In that circuit, there is no carrier output when the modulation voltage is at ground level, but increases when the modulation voltage moves positive or negative with respect to ground. When the modulation voltage is positive, the carrier-output signal is inverted relative to the carrier input; and when the modulation voltage is negative, the carrier output is non-inverted.

The circuit in Fig. 7 is similar to the circuit in Fig. 6, except that the com-

ponent values shown are suited for operation from a dual 15-volt supply, and that I_{BIAS} is adjustable via R7. The OTA's output (inverted relative to the input signal) feeds into the one end of R5, and at the same time the input signal feeds directly into the other end of R5. Potentiometer R7 is adjusted so that when the modulation input is tied to ground, the overall gain of the OTA is such that its output current exactly balances (cancels) the carrier input current to R5. Under that condition the circuit has no carrier output. When the modulation input goes positive, the OTA's gain increases and its output signal exceeds that caused by the carrier input to R5, so an inverted output signal is generated. Conversely, when the modulation input goes negative, the OTA's gain decreases and the carrier input to R5 exceeds the output of the OTA; therefore, a non-inverted output signal is generated.

Offset biasing

The circuits in Figs. 5-7 are shown with the OTA's input biased by fixed-value 470-ohm resistors wired between the two input terminals and ground. In practice, that simple arrangement may cause the circuit's DC level at the output to shift slightly when the gain-control input (I_{BIAS}) is varied between its minimum and maximum value. If desired, that level-shifting effect can be eliminated by adding a presettable offset-adjust control, as shown in Fig. 8. Potentiometer R4 enables the relative values of the biasing resistors, R2 and R3, to be varied over a limited range. To adjust the offset bias, reduce I_{BIAS} to zero, note the DC level of the output signal, and then increase I_{BIAS} to maximum and adjust R4 for the same DC-output level.

AGC amplifier

Figure 9 shows how to make an Automatic Gain Control (AGC) amplifier in which a 100:1 change in the input-signal amplitude causes only a 5:1 change in the output amplitude. In that circuit, I_{BIAS} is fixed by R4, and the output signal is available directly across R5. The output buffer is fed from the output of the OTA and is used as a signal rectifier. The rectified output of the buffer is smoothed via R6 and C2, and used to apply the I_D current to the linearizing diodes of the OTA. However, no significant I_D cur-

rent is generated until the OTA's output goes high enough to turn on the Darlington buffer and the linearizing diodes. An increase in I_D reduces the OTA's gain, and negative feedback holds the output at a steady level.

The basic gain of the amplifier in Fig. 9, with no I_D current, is 40. Therefore, with an input signal of 30 mV p-p, the OTA's output of 1.2 volts p-p is not enough to generate an I_D current, so the OTA operates at full

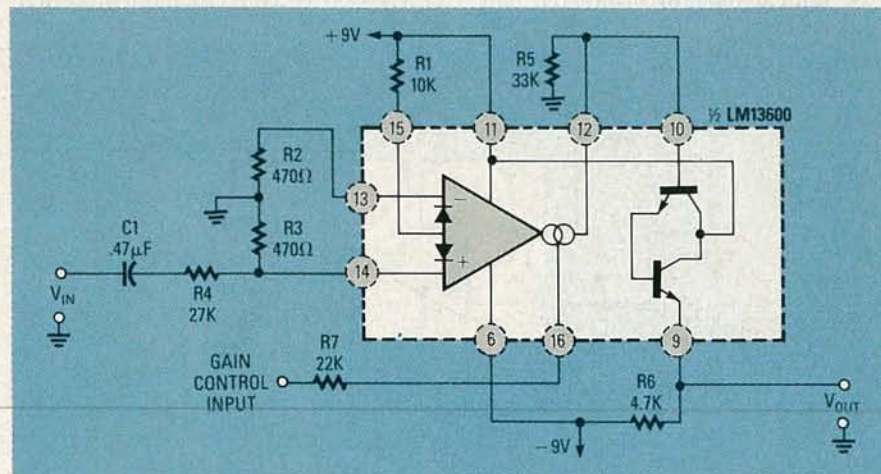

FIG. 5—A VOLTAGE-CONTROLLED amplifier (VCA) is one application for the LM13600. The LM13600 is also well suited for use as a stereo amplifier because it contains two matched amplifiers.

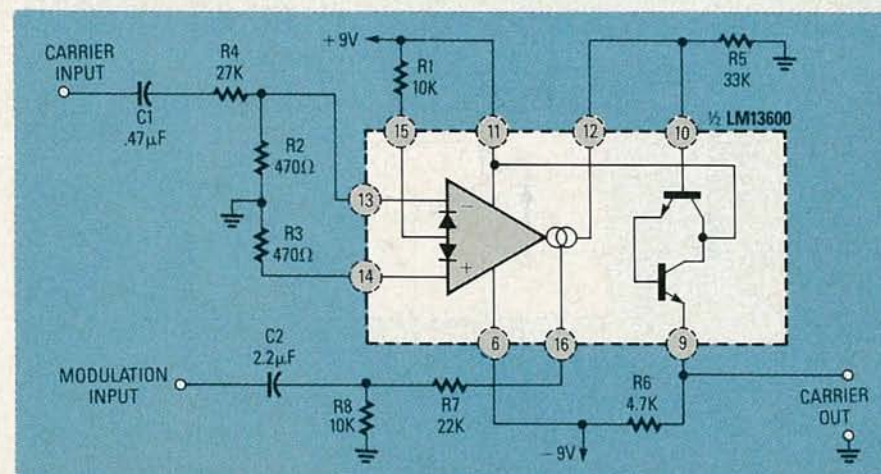

FIG. 6—AN AMPLITUDE MODULATOR or 2-quadrant multiplier can be made using one half of the LM13600.

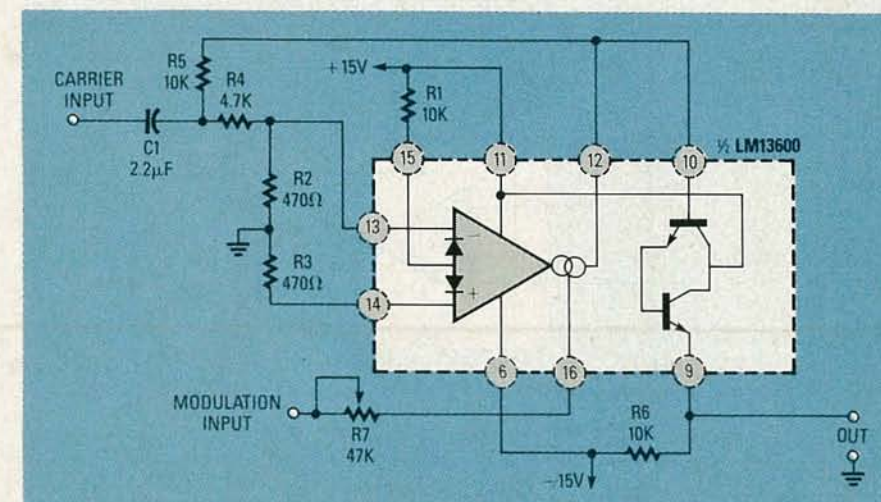

FIG. 7—THE CIRCUIT SHOWN HERE is a ring modulator or 4-quadrant multiplier.

gain. With an input of 300 mV, however, the OTA's output is enough to generate a significant I_D current, and the circuit's negative feedback automatically reduces the output level to 3.6 volts p-p, giving an overall gain of 11.7. With an input of 3 volts, the gain

falls to 2 (an output of 6 volts p-p). The circuit thus has a 20:1 signal compression over that range.

Voltage-controlled resistors

One unusual application of the LM13600 is as a Voltage-Controlled

Resistor (VCR), using the circuit shown in Fig. 10. The basic theory is as follows: An AC signal applied to the R_X terminals feeds into the inverting terminal of the OTA via C1, the output-buffer transistors, and the $R5/R_A$ attenuator. The OTA will then generate an output current that is proportional to V_{IN} and I_{BIAS} . Therefore, because $R = V/I$, the R_X terminal functions as an AC resistor whose value is determined by I_{BIAS} .

The effective resistance between the R_X terminals of the circuit in Fig. 10 equals $(R5 + R_A)/(gm \times R_A)$, where gm (transconductance) is approximately $20 \times I_{BIAS}$. That formula can be approximated as $R_X = R5/(I_{BIAS} \times 20R_A)$. Using the component values shown, R_X equals approximately 10 megohms when it has an I_{BIAS} current of 1 μA , and 10 kilohms when it has an I_{BIAS} current of 1 mA.

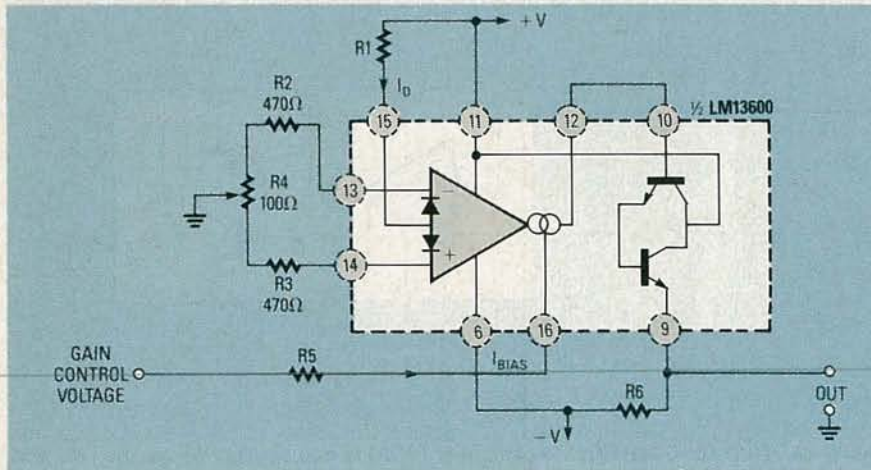

FIG. 8—A METHOD OF APPLYING offset biasing to the LM13600.

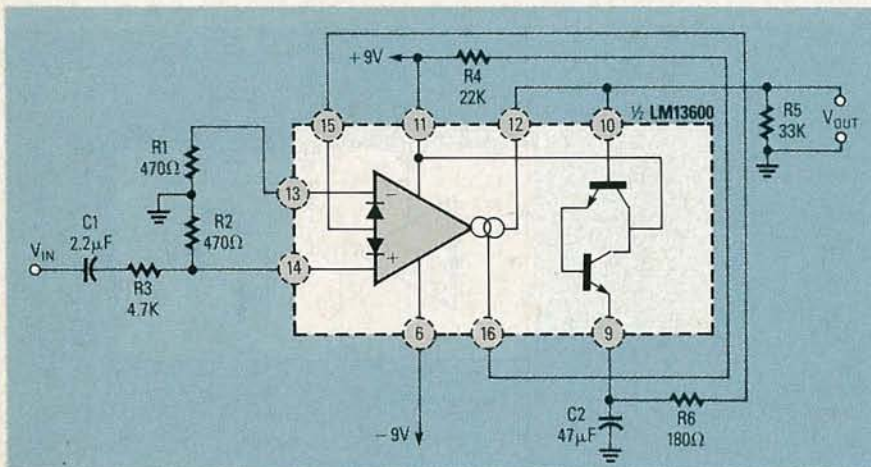

FIG. 9—AN AGC AMPLIFIER adjusts its own gain according to the magnitude of the input signal.

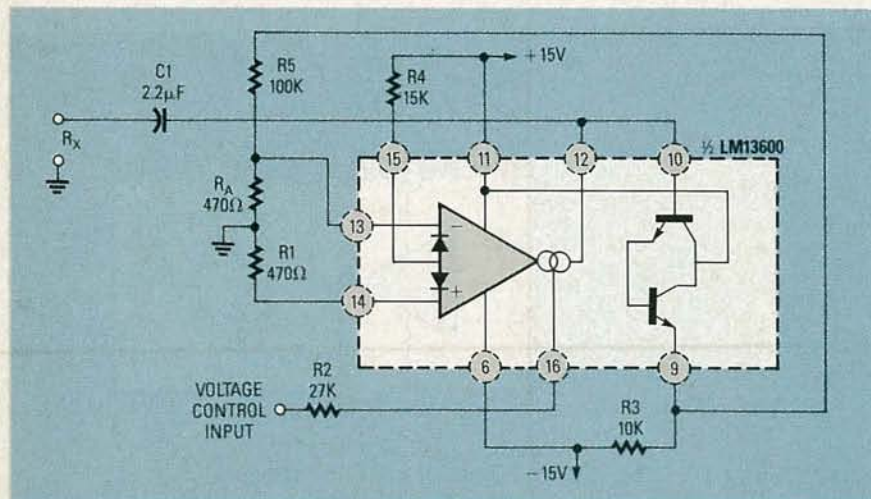

FIG. 10—A VOLTAGE-CONTROLLED RESISTOR can be used as an electronically-controlled resistor.

Voltage-controlled filters

A voltage-controlled low-pass filter can be implemented by using one half of an LM13600 in the configuration shown in Fig. 11. In that circuit, the values of $R5$, $C2$, and I_{BIAS} control the cut-off frequency (f_c) of the filter. The input signal is applied to the non-inverting terminal of the OTA via voltage-divider network $R1/R2$. The OTA's output signal is "followed" by the buffer stage and fed back to the inverting terminal via an identical voltage-divider network, $R5/R_A$. The basic OTA operates as a non-inverting amplifier with a gain of $R5/R_A$, but because the input signal to the OTA is applied via a voltage divider with a value equal to $R5/R_A$, the overall circuit operates as a unity-gain voltage follower.

At low frequencies, $C2$ has a very high impedance and is able to be fully charged by the OTA's output current, so the circuit operates as a voltage follower as was previously described. As the frequency increases, $C2$'s impedance decreases and is no longer able to be fully charged by the OTA's output current, so the output signal starts to attenuate at a rate of 6-dB-per-octave. The cut-off point of the circuit, defined as the point where the output falls by 3 dB, occurs when $X_C/20I_{BIAS}$ equals $R5/R_A$, as shown by the formula in the diagram (gm is approximately equal to $20 \times I_{BIAS}$). With the component values that are shown in Fig. 11, the filter's cut-off

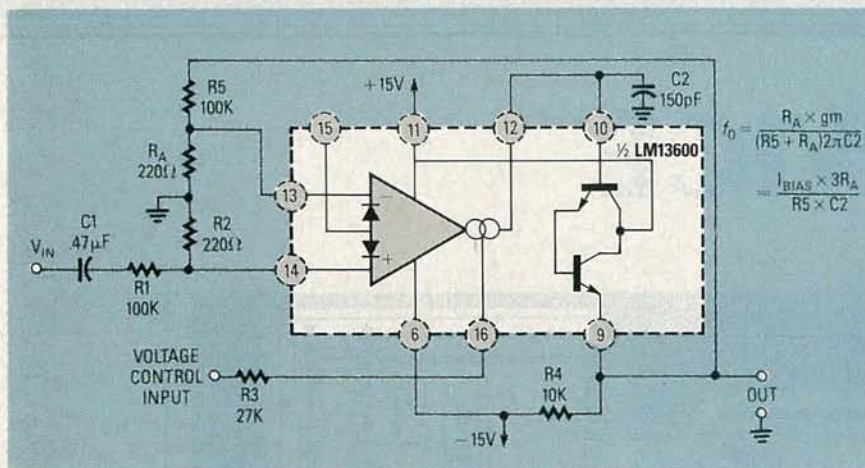

FIG. 11—A VOLTAGE-CONTROLLED LOW-PASS filter covering 45 Hz to 45 kHz.

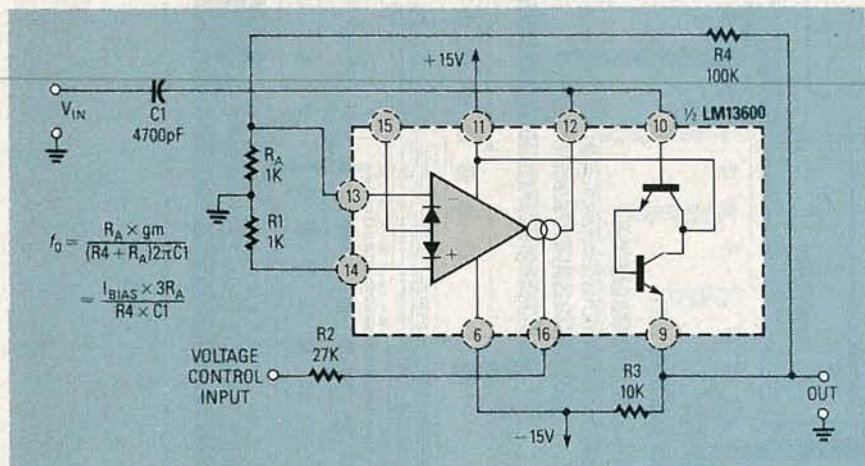

FIG. 12—A VOLTAGE-CONTROLLED HIGH-PASS filter covering 6 Hz to 6 kHz.

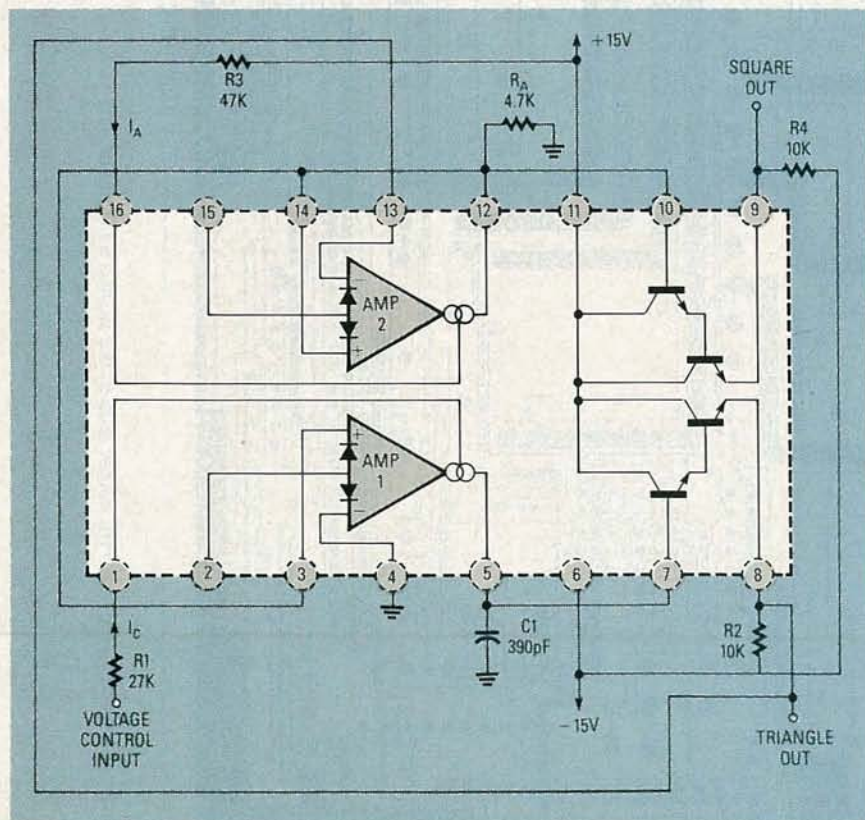

FIG. 13—A COMBINATION TRIANGLE-SQUARE-WAVE VCO covering 200 Hz to 200 kHz.

point occurs at about 45 Hz with an I_{BIAS} of $1 \mu A$, and at 45 kHz with an I_{BIAS} of $1 mA$.

A similar principle can be used to make a voltage-controlled high-pass filter. As shown in Fig. 12, that circuit has cut-off frequencies of 6 Hz when it has an I_{BIAS} current of $1 \mu A$, and 6 kHz when it has an I_{BIAS} current of $1 mA$.

Voltage-controlled oscillators

To conclude this look at the LM13600 operational transconductance amplifier, Fig. 13 shows how to use the IC as a Voltage-Controlled Oscillator (VCO). The circuit uses both halves of the LM13600, and simultaneously generates both triangle and square waves.

To understand the operating theory of the circuit, assume initially that capacitor C1 is negatively charged and that the square-wave output signal has just switched high. Under that condition a positive voltage is developed across R_A , which is fed to the non-inverting terminals of the two amplifiers. That voltage causes amp 1 to generate a positive output current, equal to bias current I_C , that flows into C1 and generates a positive-going linear ramp voltage.

The ramp voltage is then fed to the inverting terminal of amp 2 via the Darlington buffer stage, until it eventually equals the voltage on the non-inverting terminal, at which point the output of amp 2 starts to swing in a negative direction. That initiates a regenerative switching action, and at that moment, the signal at the square-wave output terminal abruptly goes negative.

In that new state, a negative voltage is generated across resistor R_A , causing amp 1 to generate a negative output current equal to I_C , causing capacitor C1 to discharge until its voltage equals that of R_A , at which point the square-wave output switches high again.

The process repeats over and over again, making available a triangle waveform at R2 and a square wave at R4. The frequency of those waveforms is variable via the voltage-control input; that input is what controls the value of I_C . With the component values shown, the circuit then generates a frequency of about 200 Hz when the I_C bias current is $1 \mu A$, and 200 kHz when the bias current is $1 mA$.

PC SERVICE

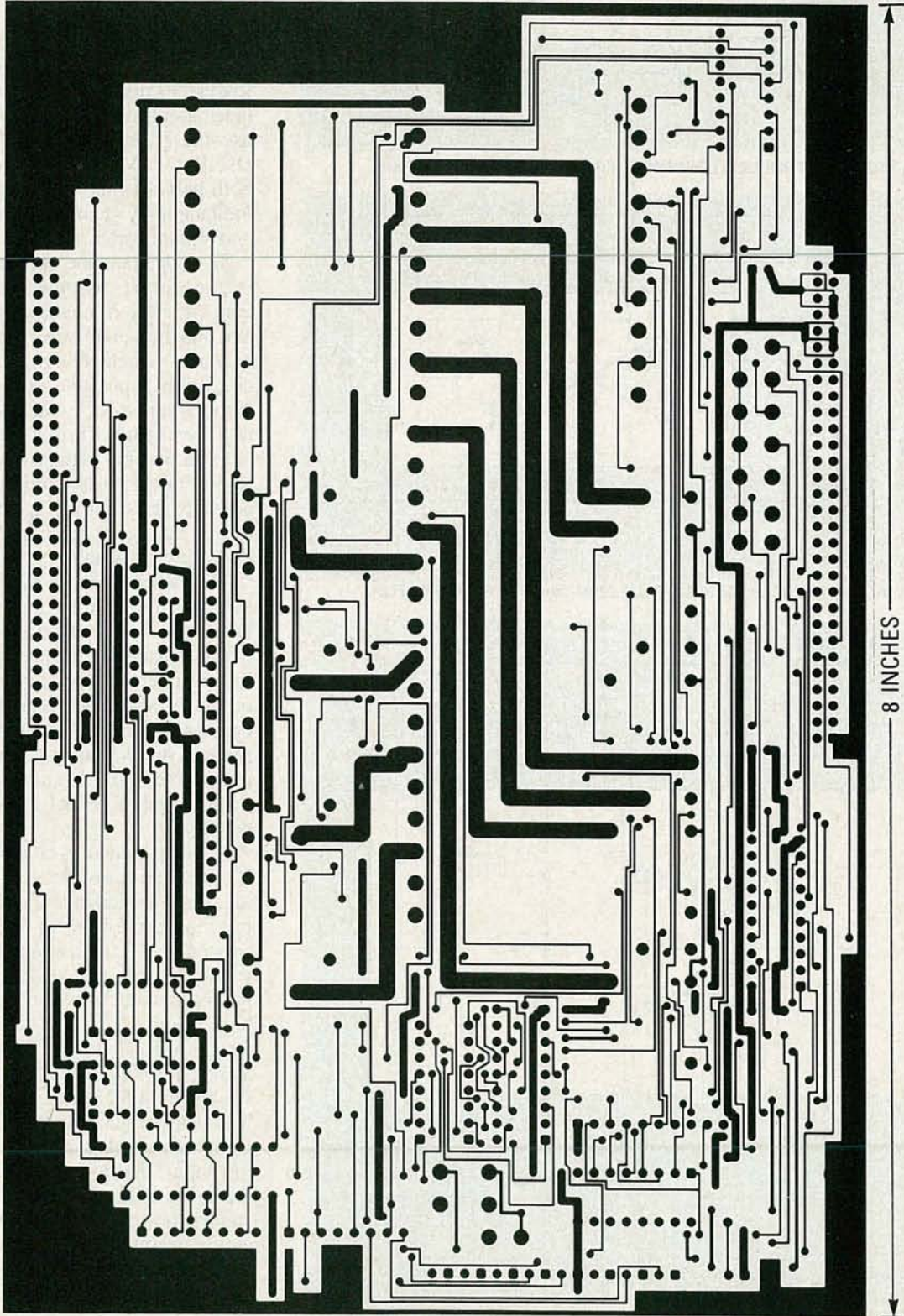

8 INCHES

THIS IS THE PATTERN FOR THE SOLDER SIDE OF THE REACTS I/O BOARD.

PC SERVICE

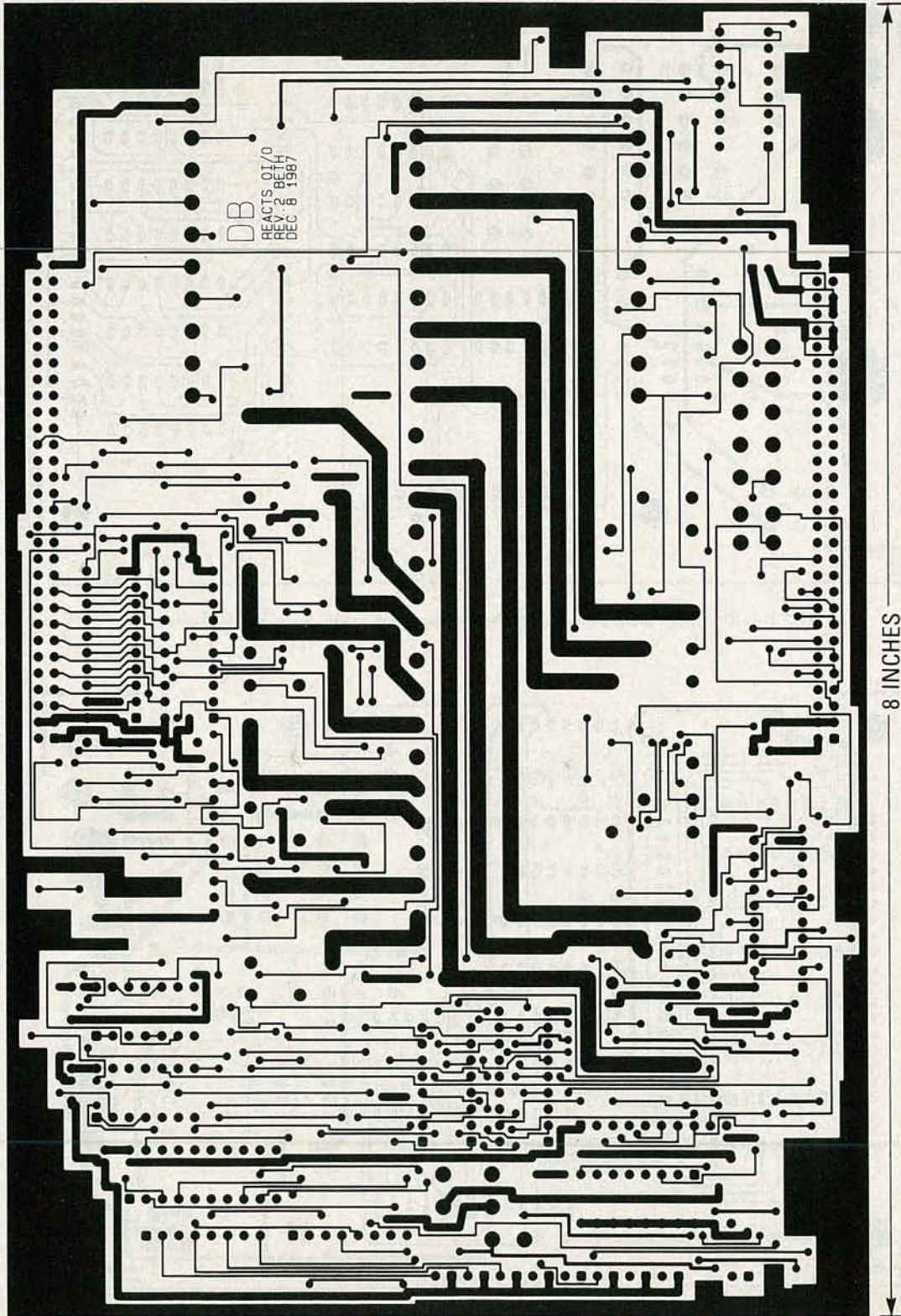

THE PATTERN for the component side of the REACTS I/O board is shown here.

PC SERVICE

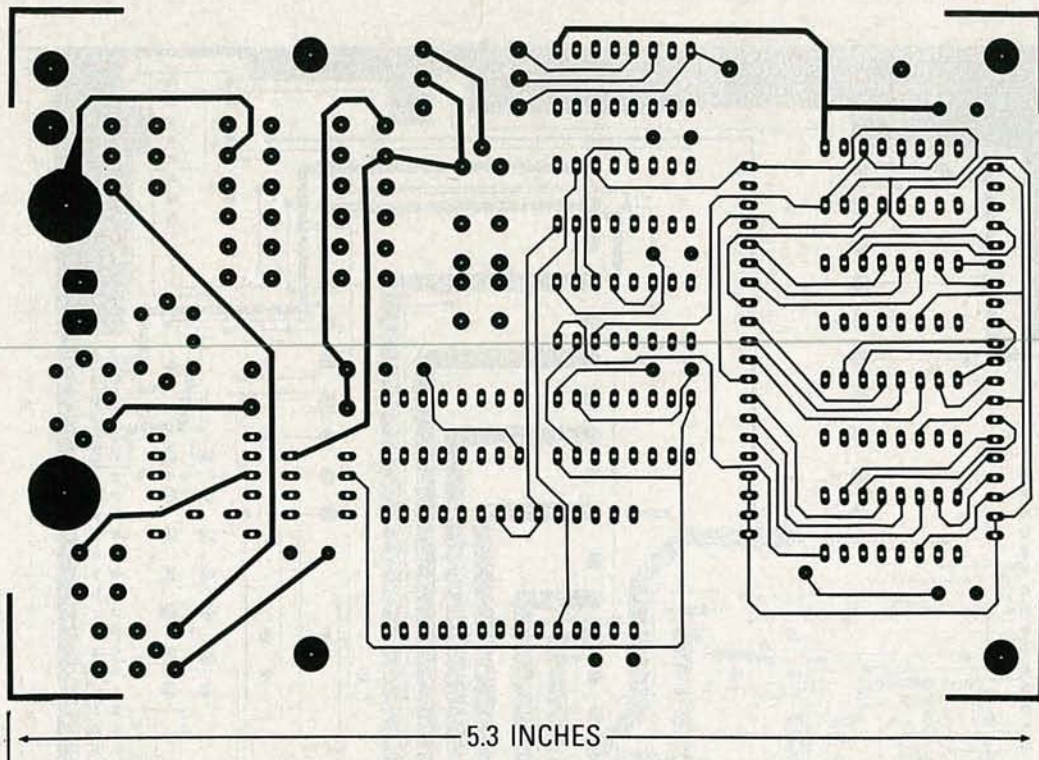

THE COMPONENT SIDE of the LC meter shown here is full sized and right-reading.

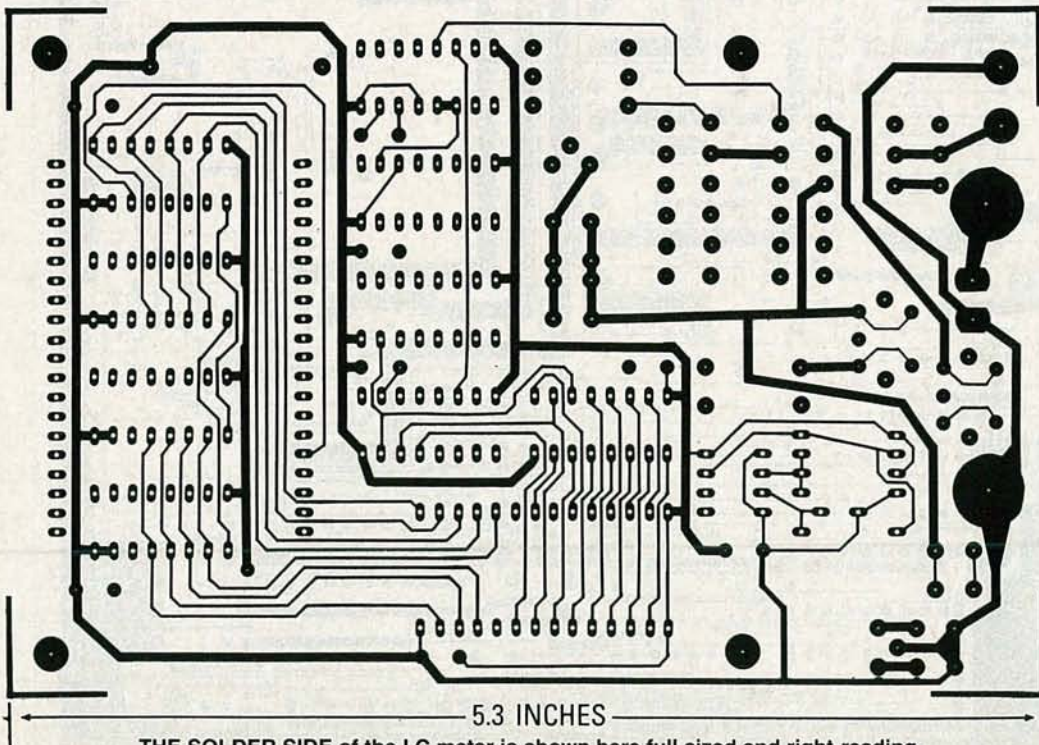

THE SOLDER SIDE of the LC meter is shown here full sized and right-reading.

HARDWARE HACKER

Absolute navigation ideas
Telephone line recording
Ring equivalency numbers
Data access arrangements
New printed circuit layouts

DON LANCASTER

Making PC-board layouts, and more!

OUR FREE HARDWARE-HACKER HELP LINE sure has been busy lately. As many as fifty of you a day have called in with well-thought-out, interesting, and very challenging problems. But, on the other hand, I've been getting far too many calls from those of you who simply did not read the story or else paid no attention whatsoever to all of our very carefully researched Names and Numbers sidebars.

So, please, to make it fair for everyone else: (1) Read the entire column twice and the Names and Numbers box three times before you call. (2) Pre-list your questions. (3) Have a pencil and paper on hand. And, finally, (4) please call only between 8 am and 5 pm week days Mountain Standard time.

If you have trouble keeping track of time zones, just remember that all California clocks are laid back. By the way, Arizona does stay on Mountain Standard Time all year round. We have so much daylight that none of it is worth saving.

Needless to say, if you find my answers of value, I wouldn't mind too terribly much if you bought something from Synergetics, or sent me some interesting reprints, some nuts and berries, or whatever. Or helped me out with my hobby of collecting federal reserve notes.

Uh, whoops. Several of you auto mechanics on our helpline have chided me for using the wrong acronym in naming that thirty-cent three-way surplus pneumatic valve we looked at back in the April issue. The correct name for those

are TCS or SCS valves, as in Transmission Controlled Spark or Speed Controlled Spark.

They were apparently used at one time as pollution controls that delayed the vacuum advance in lower gears or at lower speeds.

Some additional stock numbers on those are the JerryCo 1296, Edmund Scientific P42533 or P36716, or C & H Sales SV7904.

There's lots of interesting things going on this month in the trade journals and in some other tech publications. Check back to the January 21, 1988 issue of *EDN* for a great review of new stepper-motor drivers and circuits.

Two major new publications on superconductivity now include the *Cambridge Report on Superconductivity* and the *Journal of Low Temperature Physics*. Since those are both insanely expensive, you will want to visit a major technical library to view them.

Steve Ciarcia has started up a brand new hacker magazine called *Circuit Cellar Ink* that looks like a real winner. Steve had a classic story back in our September 1980 *Radio-Electronics* on the BSR home power controllers that I still refer many helpline callers to.

Powerconversion has renamed

NEED HELP?

Phone or write your **Hardware Hacker** questions directly to:
Don Lancaster
Synergetics
Box 809
Thatcher, AZ 85552
(602) 428-4073

itself *PCIM*. That free trade journal is a great place to go for info on "big mutha" power semiconductors as are found in welders, electric vehicles, in high-voltage deflection circuits, and larger robotics.

A competing magazine to *PCIM* is called *Motion* and emphasizes such things as steppers and servo drives. As is typical with trade journals, you qualify by making a professional request on a business letterhead. Your own letterheads, of course, are utterly trivial with today's PostScript laser printers.

Our biggie this month is a brand new way of doing hacker printed circuits that minimizes or outright eliminates any need for camera work, yet will quickly and cheaply produce first-quality results. But first, let's dream just a little....

Absolute navigation

It's fun to try and predict when and where the next big hacker breakthrough opportunity might come from. The one I am waiting for is a dramatic price reduction in a simple, accurate, and extremely low-cost system used for absolute navigation.

Figure 1 shows you one big possibility—a \$9.95 and three inch NaviCube that will always know where it is, how far it has moved in just what direction since last reset, which way true north is, and which way is up.

I am one of those spelunkers that often will spend a lot more time underground than above. Cave mapping is a weary, exasperating, tedious, and time-consuming task that is prone to all

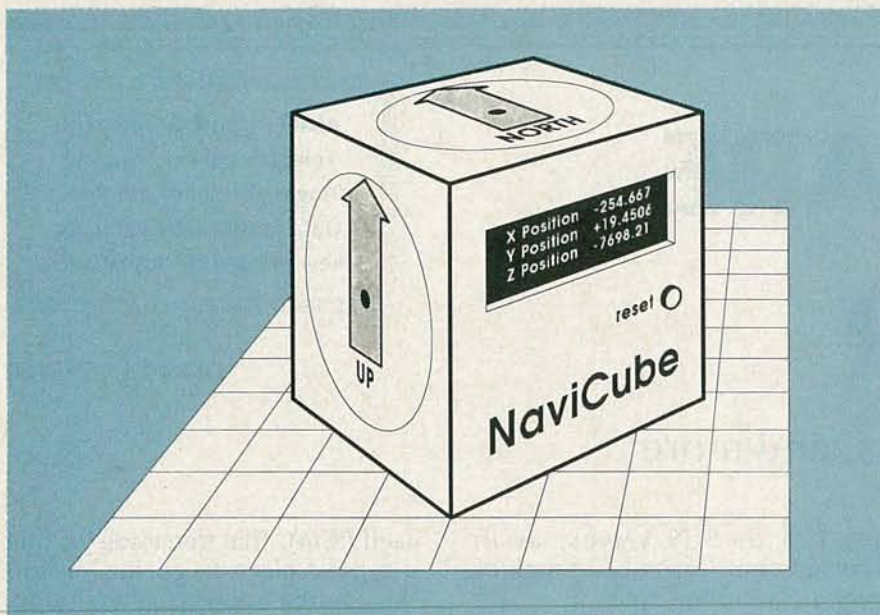

FIG. 1—THE \$9.95 NAVICUBE ALWAYS KNOWS up, north, and its own absolute position since it was last reset. Its only tiny problem is that it doesn't quite exist yet—or does it?

sorts of errors. It sure would be nice to throw one of those NaviCubes into my speleo pack, waltz on through the cave, and return with a ready-to-use map.

It would be even nicer if you put the NaviCube inside a rubber ball.

At each cave station, you simply would bounce it off the ceiling, floor, and walls to instantly map the passage size as well as its current position.

The traditional approach to the NaviCube is to use one or more gyroscopes. Basically, you take a freely supported large mass and spin it as fast as you can, while recording any deviations from its initial path. It usually takes three of those, one each for the X, Y, and Z directions.

You can still get surplus World War II gyros from such outfits as C & H Sales, Fair Radio Sales, and JerryCo. But those are bulky power hogs that are hard to use.

Today, we do have optical solid-state gyroscopes that consist of nothing but a roll of fiber optics, a pair of diodes, and a directional coupler. Coherent laser-light is squirted in both directions around the fiber coil, and then the phase difference caused by the Doppler effect is measured to tell you how much the coil has rotated.

Unfortunately, solid-state gyros are being built today by the wrong people for the wrong reasons, so they remain outrageously priced. But I feel it will only be a matter of a very few months before some Hong Kong toy company builds a \$9.95 solid-state laser gyroscope or its equivalent. And all of us hackers should be more than willing to glomp onto that jewel.

A third possibility would be to use some sort of satellite-based radio direction finding inside the NaviCube. While that is certainly possible, I feel that the resolution of that approach is unlikely to ever get much better than a few feet, and that there would be some very serious antenna and reception problems that would limit both the minimum size and the coverage.

Not to mention that it would not work very well underground.

There's a fourth approach to the NaviCube, and it is something that all you hackers can experiment with right here and right now. The price of new high-quality accelerometers has just dramatically dropped to the \$10 range, led by such outfits as SenSym and the IC Sensors people.

What you do is to take the output from a silicon solid-state accelerometer and A/D convert it into a series of pulses. You sum the pulses into an up-down counter to get the current velocity. Then, at precise time intervals you sum up the current velocity to get the current NaviCube position.

Talking some math, the rate of change of position is velocity and the rate of change of velocity is acceleration. Conversely, the first integral summation of acceleration is velocity, and the second integral summation of acceleration is the position. Details appear in almost any college-level physics book.

Newton's law and all that.

For this month's contest, let us assume that the \$9.95 three-axis NaviCube is a reality and that its stability and long-term accuracy is "good enough". Tell me what you would do with it. There will be all the usual books and tinaja quests as prizes. Also as usual, send your entries to me per the box and not to the **Radio-Electronics** offices.

Oh yes, if you are the sort of person that does thoroughly enjoy having ice water drip down your back while trying to eat a soggy and spent carbide-flavored sandwich by the light of a fading greenish *cyalume*, then give the National Speleological Society a call. They will in turn put you in touch with a local grotto or two in your immediate area.

Are we having fun yet?

NEW FROM DON LANCASTER

HANDS-ON BOOKS

Ask the Guru Reprints	24.50
CMOS Cookbook	15.50
TTL Cookbook	15.50
Active Filter Cookbook	15.50
Micro Cookbook vol I or II	16.50
Enhancing your Apple vol I	15.50
Enhancing your Apple vol II	15.50
Applewriter Cookbook	19.50
Apple Assembly Cookbook	21.50
Incredible Secret Money Machine	9.50
Postscript Ref. Man. (Adobe)	22.50
Postscript Cookbook (Adobe)	16.50

UNLOCKED SOFTWARE

Absolute Reset IIe & IIc	19.50
Applewriter/Laserwriter Utilities	49.50
Postscript Show & Tell (IIe/Mac/PC)	39.50
Postscript Technical Illustrations	39.50
Intro to Postscript VHS Video	39.50
Postscript BBS stuff	19.50
Apple Ram Card Disassembly Script	24.50
Enhance vol I Companion Disk	19.50
Enhance vol II Companion Disk	19.50
Assembly CB Companion Disk	19.50
Applewriter CB ProDOS C. Disk	24.50

FREE VOICE HELPLINE

VISA/MC

SYNERGETICS

Box 809-RE
Thatcher, AZ 85552
(602) 428-4073

CIRCLE 83 ON FREE INFORMATION CARD

NAMES AND NUMBERS

C & H Sales

2716 East Colorado Blvd.
Pasadena, CA 91107 (800)
325-9465

Cermetek Microelectronics

1308 Borregas Avenue
Sunnyvale, CA 94088
(408) 752-5000

Circuit Cellar Ink

4 Park Street
Suite 12
Vernon, CT 06066
(203) 875-2751

Circuit Specialists

P.O. Box 3047
Scottsdale, AZ 85257
(800) 528-1417

Dallas Semiconductor

4350 S. Beltwood Pkwy.
Dallas, TX 75244
(214) 450-0400

EDN

221 Columbus Avenue
Boston, MA 02216
(617) 536-4600

Fair Radio Sales

1016 E. Eureka Street
Lima, OH 45802
(419) 227-6573

Federal Communications Commission

Washington, DC 20554
(202) 632-7553

IC Sensors

1701 McCarthy Blvd.
Milpitas, CA 95035
(408) 432-1800

JerryCo

601 Linden Place
Evanston, IL 60202
(312) 475-8440

Micro Switch

11 West Spring Street
Freeport, IL 61032
(815) 235-6600

Mitsubishi

1050 E. Arques Avenue
Sunnyvale, CA 94086
(408) 730-5900

Motion

2030 Hillman Circle
Orange, CA 92667
(714) 974-0200

Nat. Speleological Society

Cave Avenue
Huntsville, AL 35810
(205) 852-1300

Newark Electronics

228 East Lake Street
Chicago, IL 60640
(312) 941-7200

PCIM

2472 Eastman Avenue
Ventura, CA 93003
(805) 658-0933

Prem Magnetics

3521 N. Chapel Hill Road
McHenry, IL 60050
(815) 385-2700

SenSym

1255 Reamwood Avenue
Sunnyvale, CA 94089
(408) 744-1500

Stancor

131 Godfrey Street
Logansport, IN 46947
(219) 722-2244

Synergetics

Box 809
Thatcher, AZ 85552
(602) 428-4073

Data-access arrangements

A data-access arrangement is any scheme to get modem tones or other audio or control signals onto or off of the phone line. The laws on how you do that will vary from country to country, but in the US you are supposed to exactly follow FCC Regulations part 68.

Simply meeting the regulations is not near enough. Besides that, your circuit or product has to be type approved before it can be sold. Getting the FCC type approval usually turns out to be a costly and very drawn-out bureaucratic nightmare.

Figure 2 shows you the essen-

tials of a typical data access arrangement. You start with an 800-volt, or so, varistor or a telephone-grade transient suppressor on the phone-line side. A pair of 10-ohm resistors is then used to drive an audio-coupling transformer. That transformer usually has 600-ohm input and output impedances, and must have a breakdown voltage of at least 1500 volts.

A de-glitching capacitor will be required over on the transformer secondary, as are a pair of series-connected Zener diodes that will prevent you from ever applying more than plus or minus four volts of peak-to-peak signal onto the telephone line.

Ready-to-use and already type-approved data-access arrangements are available from such outfits as Cermetek and Dallas Semiconductor. The prices are ridiculous.

The leading US manufacturer of the special transformer needed is Prem Magnetics. As an alternate,

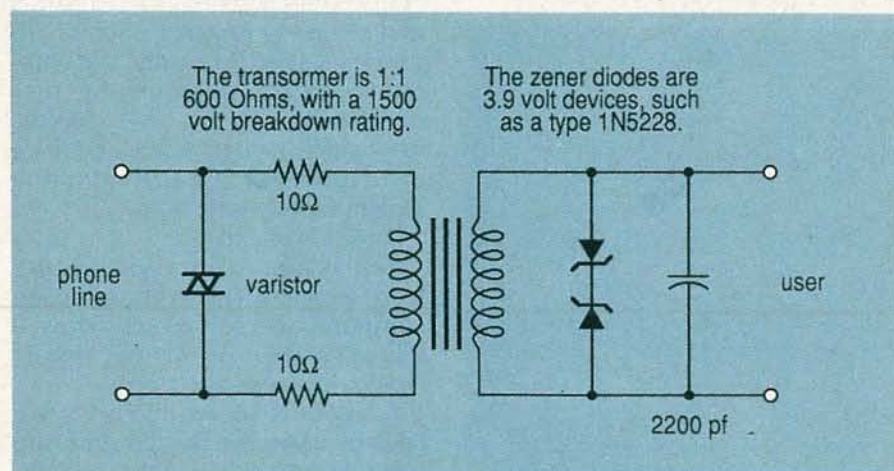

FIG. 2—A DATA-ACCESS ARRANGEMENT such as this one must provide surge suppression, signal limiting, and safety isolation, as well as being FCC part 68 type-approved.

Newark Electronics lists a Stancor TTPC-7 equivalent that sells for \$5.63 in modest quantities.

Another variation is the audio-access arrangement shown in Fig. 3. That circuit might let you automatically record any phone messages. There are two primary areas to the circuit.

The first area consists of a sensitive reed relay that pulls in only when the phone is on hook. When you pick up the telephone handset, the DC loop-current goes through the reed relay and thus activates it. Since the reed switch itself is normally open, the switch turns on the recorder whenever

the telephone's handset is picked up off the hook.

The second area of the circuit is a suitable audio transformer that couples the phone-line audio into the recorder. Note that that is a one-way circuit—you can record the phone messages, but you can't play the recorder back into the telephone line.

Because of the drop across the relay coil, the circuit only works with a single telephone. Fancier circuits are needed when extension phones are present.

The Radio Shack model 43-228 phone-recording control uses a circuit similar to that one.

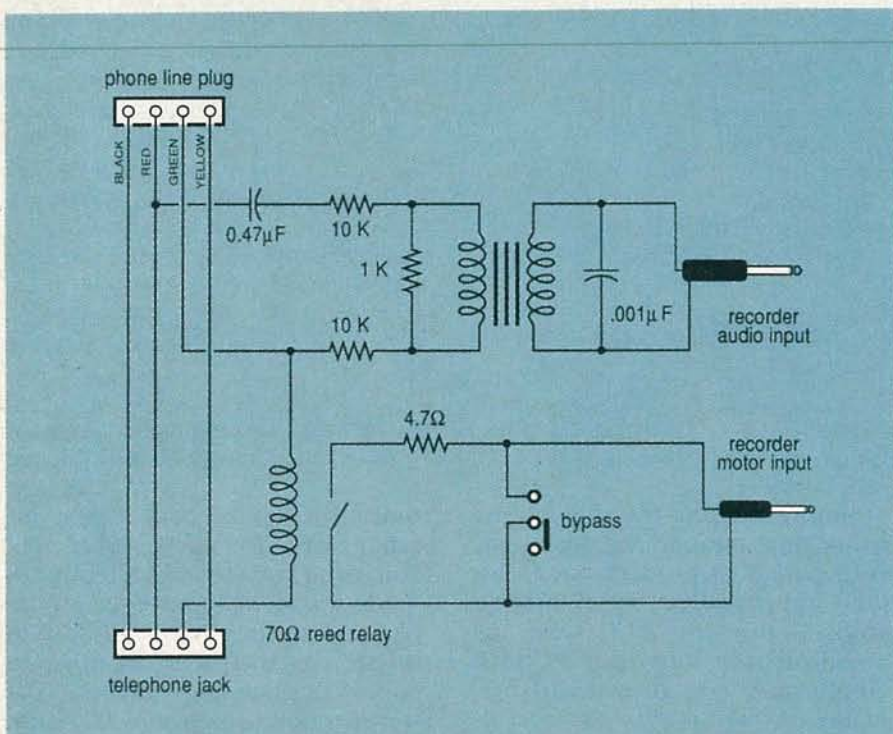

FIG. 3—AN AUDIO-ACCESS ARRANGEMENT can record both sides of a telephone conversation, but is only legal for use under certain circumstances.

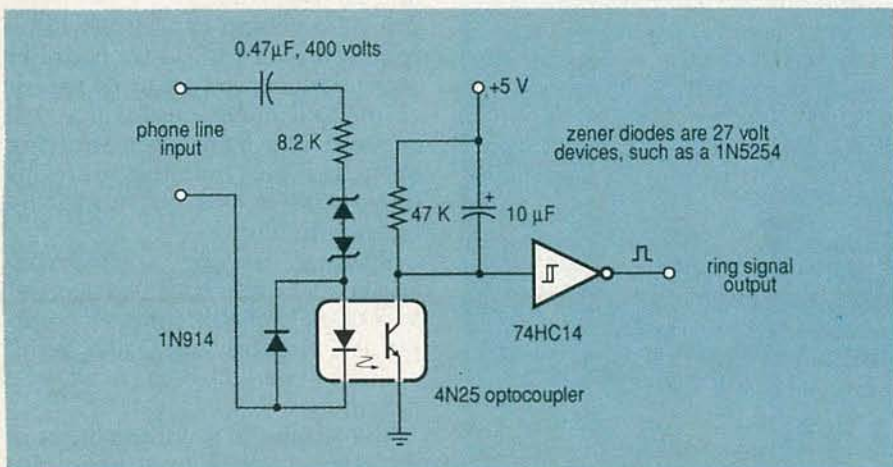

FIG. 4—A TELEPHONE RING DETECTOR. The optocoupler provides safety isolation, while the integrating capacitor converts the individual rings into a continuous signal.

Ringer-equivalency numbers

There sure seems to be a lot of confusion on what is really a very simple concept. Most of the urban telephone systems let you put five of the older telephones on them using five electromechanical bell ringers. The smaller of the rural companies may limit you to three bell ringers.

Each and every piece of new equipment that is placed on your phone line must have a label on it that tells you just what the Ringer-Equivalency Number, or REN is. A plain electromechanical bell has a REN of 1.0.

When you add up all of the REN values for everything that you have hung on your line, the total must be less than five for an urban phone and less than three for a longer rural phone line.

In theory, your phone company can adjust your line for higher ringer loads, but my local phone company refuses to do so.

Phone ringing is done by placing a high-voltage and low-frequency sinewave on the line, typically in the range of 40 to 150 volts with a frequency of 15 to 68 hertz.

In previous columns, we have seen several special integrated circuits used for ring detection and for speaker or piezo-transducer driving. Figure 4 shows you a simpler and much more flexible approach that uses an ordinary optocoupler instead.

New printed-circuit layouts

I have been putting together a brand new way of doing hacker and student printed-circuit layouts that seems to have a bunch of advantages. It will instantly, and without using any photography, produce for you 1X, 2X, or 4X layouts, frontwards or backwards, positive or negative, of any size from one square inch to one acre.

And it is cheap.

The system uses your favorite word processor with your chosen computer and can directly drive a LaserWriter or some other PostScript-language printer.

A layout is shown in Fig. 5; we have overlaid the design grid, the foil side in black and the component side in gray. Up to a dozen layers can be supported at once.

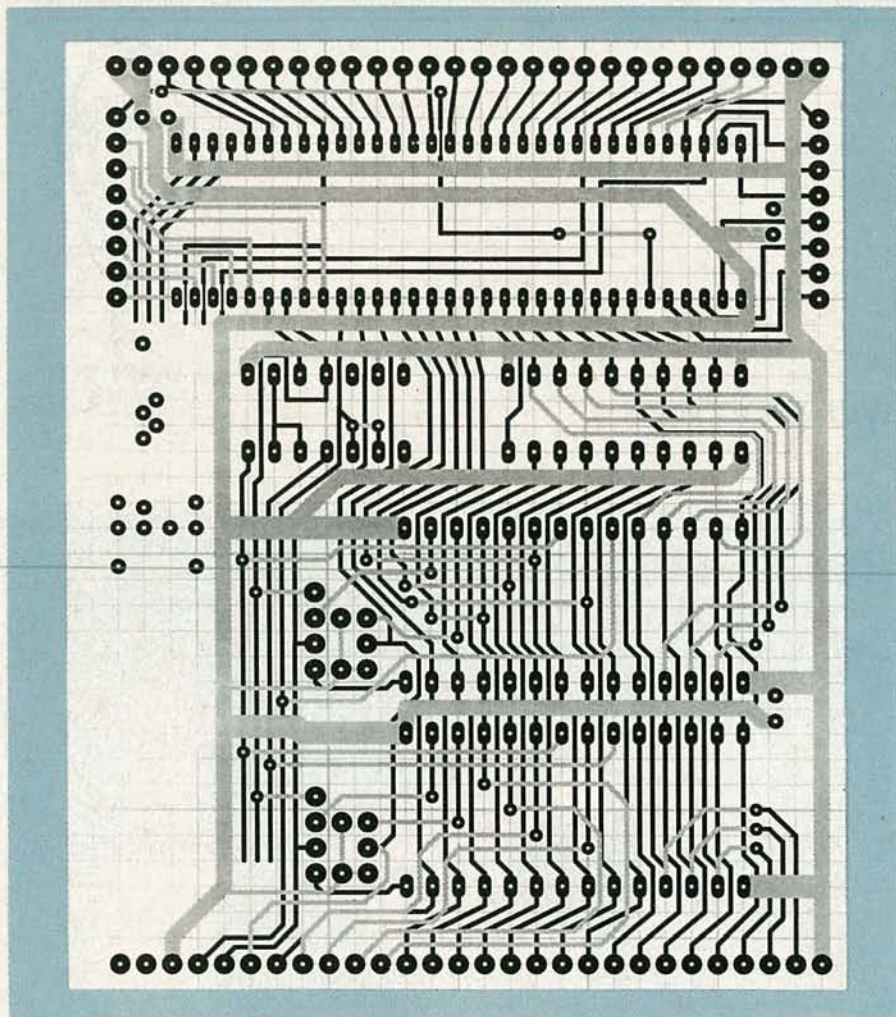

FIG. 5—THE POSTSCRIPT LANGUAGE EASILY lets you do your own custom printed-circuit layout using nothing but your favorite word processor. Here we have combined and shown you a foil side in black, a component side in gray, and a background layout grid.

Since everything is done in "raw" PostScript text, you can very easily rearrange the scenery to suit yourself in any way you like. I usually start with a fine gray grid, and then overlay the foil and component sides as needed, using some of my opaque grid-based "icons" that handle the traces and pads.

The process now has a 3-mil resolution and supports details of 10 mils or wider. You might directly print 1:1 onto mylar overhead transparency material, thus generating your negative or positive as needed for your final board.

For more serious applications, you can work two-times or four-times final size with the corresponding increase in resolution or precision. Should the final image be larger than one page, it can be automatically printed on as many

pages as is needed. Those pages can then be taped together.

You can instead run your final results on a PostScript-language-speaking phototypesetter when extreme accuracy is needed.

Let me know if you want any more details or some working code examples using that new printed-circuit layout process.

One very intriguing additional possibility is to do a 1:1 layout onto a suitable transfer material and then ironing the transferred toner directly onto your bare PC board, followed by an immediate etch. Unfortunately, that process is not quite reliable just yet.

New tech info

Newark Electronics has just released their fat new 1042-page
continued on page 100

Be an FCC LICENSED ELECTRONIC TECHNICIAN!



No costly school. No commuting to class. The Original Home-Study course prepares you for the "FCC Commercial Radiotelephone License". This valuable license is your "ticket" to thousands of exciting jobs in Communications, Radio-TV, Microwave, Computers, Radar, Avionics and more! You don't need a college degree to qualify, but you do need an FCC License.

No Need to Quit Your Job or Go To School
This proven course is easy, fast and low cost! **GUARANTEED PASS** - You get your FCC License or money refunded. **Send for FREE facts now. MAIL COUPON TODAY!**

COMMAND PRODUCTIONS

FCC LICENSE TRAINING, Dept. 90
P.O. Box 2223, San Francisco, CA 94126

Please rush FREE details immediately!

NAME _____

ADDRESS _____

CITY _____

STATE _____

ZIP _____

CONVERTERS & CABLE DECODERS

INFORMATION

402-554-0417

Orders & Free Catalog

1-800-624-1150

ALL PRODUCTS GUARANTEED

New Stargate 2000	\$99.00
SB-3/2.....	\$89.00
Tri-Bi Mode.....	\$99.00
Hamlin MLD-1200.....	\$100.00
Oak N-12 W/V.S.....	\$99.00
Panasonic.....	\$99.00
Oak-M-35-B W/V.S.....	\$100.00
Zenith SSAVI.....	\$185.00
Eagle PD-3.....	\$110.00
Scientific Atlanta.....	\$120.00
Pioneer W/ Parental.....	\$105.00
Tocom.....	Call
Oak N-12 W/ Auto.....	\$140.00
Evaluator Tap Detector..	\$495.00
ViewStar Volume+.....	\$129.95
Jerrold Starcom CSV....	\$139.95

M.D. ELECTRONICS
5078 SO. 108th
SUITE 115MD
OMAHA, NE. 68137

CIRCLE 53 ON FREE INFORMATION CARD

AUDIO UPDATE

Two common record-player problems



LARRY KLEIN,
AUDIO EDITOR

YOU MAY HAVE NOTICED THAT DESPITE the success of the compact disc, old-fashioned black LP records—and the equipment used to play them—continue to sell. And some of the people who buy them continue to experience a variety of minor and major difficulties. In this column I'm going to discuss two common and, judging from my mail, very puzzling problems.

Howling hi-fi

One common complaint usually goes this way: Ever since I upgraded my speakers, rearranged my furniture and relocated my speakers, and installed a new turntable, my amplifier makes a howling noise when I turn up the volume or bass control. And to make matters worse, even when the system is not howling, I sometimes hear a sort of "ringing" in the music. What causes my amplifier problem and how do I cure it?

The symptoms described above are caused by one of the most common (and most misdiagnosed) problems in hi-fi. Although reproduced by the amplifier, the howling and ringing are certainly *not* caused by the amplifier. Those symptoms are the result of *acoustic* feedback from the loudspeakers to the record player, as illustrated in Fig. 1. What happens is the acoustic energy (sound waves) from the speakers reach the record player with sufficient intensity to set up vibrations between the disc and the tone arm. Those vibrations are interpreted by the phono stylus as a groove signal, sent through the amplifier to the speakers, then fed back to



FIG. 1

the turntable, and the feedback goes around again, and again, and again. The effect is identical to what occurs when a microphone picks up the sound of the speakers in a sound-reinforcement system.

The cure for amplifier howling and ringing is to "open" the positive-feedback loop. Keep in mind that some models of turntables, aside from their other virtues or deficits, are more sensitive than others to air-borne or structure-borne vibrations. In such cases, accessory isolating feet or platforms available from many hi-fi dealers can make a difference; even a rubber typewriter mat might do the job. Installing the turntable on a solid structure—not bookshelves—and as far away from the speakers as possible can also be of help. Turntables should

never be operated with their hinged dust covers raised; dust covers can act as diaphragms to catch acoustic energy, which then gets passed to the phono stylus.

Groove skipping

Then there's the fellow who complains that his new—and expensive—phono cartridge causes his tone arm to skip grooves. His sad story is as follows: I have a large record collection of 1960's rock and roll. Most of the discs are in good shape except for some warpage here and there. I bought a new cartridge hoping to minimize groove wear, but now some of my records tend to jump grooves. I switched back to my old cartridge and the records play fine. Is my brand-new cartridge defective?

No, your new cartridge probably isn't defective, but its physical properties are the non-obvious cause of the groove jumping. To understand what's happening we need to know something about resonance, where it comes from, and how it works. A resonance can be thought of as a specific frequency at which a mechanical system—or the parts of it—prefer to move. Every mechanical system has resonances, the frequencies of which are determined by the masses and compliances; a "compliance" is a flexibility. Most musical instruments are tuned to resonate at specific musical frequencies by adjusting the tension (compliance), the size, or the length of their strings or diaphragms. Wind instruments use air-column resonances, but that's another story altogether.

Every phono-cartridge/tone-arm combination has several resonances whose frequencies are determined by the areas of flexibility and mass in the system. A major low-frequency resonance—somewhere between 4 and 20 Hz—results from the interaction of the stylus compliance with the effective tone-arm mass, which includes the mass of the cartridge body. The higher the compliance of a cartridge's stylus assembly, the lower the resonant frequency with a given tone arm; the higher the tone-arm mass, the lower the resonance with a given cartridge. A low-compliance cartridge in a low-mass tone arm will result in an excessively high resonant frequency; a high-compliance cartridge in a high-mass arm will result in an excessively low resonance. A high-compliance cartridge in a low-mass arm works out just fine.

A response peak in the 15-Hz to 20-Hz area may not be audible as such, but it tends to waste amplifier power and it is likely to increase a record player's sensitivity to rumble, acoustic feedback, and external vibration. It may also cause visible woofer-cone flutter in vented speaker systems. On the other hand, an excessively low resonant frequency, 6 Hz or so, can increase a player's sensitivity to external shock, such as foot falls and record warps.

When a tone arm vibrates at res-



FIG. 2

onance, the stylus tracking force fluctuates rapidly between too high and too low. In fact, the tracking force can hit zero—at which point groove jumping occurs. And even if the stylus never totally leaves the groove, the loss of stylus tracking force during resonance can cause severe distortion of other frequencies on the record.

Warp Data

More than 12 years ago, Shure Brothers undertook an in-depth research project on the effect of warps on the record-playing process, and much of the following data is derived from their report. Record warps come in various shapes and sizes. Some warps are an unsolicited gift from the pressing plant, while others result from bad storage conditions. Warps can be rated by amplitude/velocity and frequency; the frequency being determined by how rapidly the turntable moves the warp beneath the playing stylus.

To prevent the tone-arm/cartridge resonance from being triggered by warps, most of which occur in the range below 6 Hz, it's good engineering practice to design for an arm/cartridge resonance well above that frequency. And since the recorded audio frequencies start around 20 Hz, it's also a good idea to place the resonance well below that frequency. Engineers aim for 10–14 Hz or so as a good compromise frequency. Whatever the resonant frequency, mechanical damping added to the arm or cartridge, as Shure does in Fig. 2, can reduce the effects of tone-arm/cartridge resonance.

continued on page 100

CRYSTEK

The pulse of dependable communications

Reliability & Quality
From Start To Finished Product

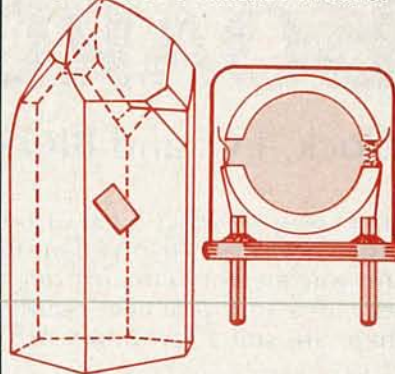

QUARTZ
CRYSTALS/OSCILLATORS
FOR
ELECTRONIC — INDUSTRIAL

- Micro-Processor Control
- Computers/Modems
- Test/Measurement
- Medical

COMMUNICATIONS-REPLACEMENT

- Mobile/2-way/Channel Elements
 - Pagers
 - Marine
 - Aircraft
 - Telemetry
 - Monitors/Scanners
- AMATEURS**

- CB
- Hobbist
- Experimenter

- COST EFFECTIVE
- MODERATE PRICING
- FAST DELIVERY



NEW
The Pulse of Dependable Communications

Crystek Crystals offers their new 16 page **FREE** catalog of crystals and oscillators. Offering state-of-the-art crystal components manufactured by the latest automated technology. Custom designed or "off the shelf," Crystek meets the need, worldwide. Write or call today!

CRYSTEK CRYSTALS

2351/2371 Crystal Dr. • Ft. Myers, FL 33907
P.O. Box 06135 • Ft. Myers, FL 33906-6135

TOLL FREE 1-800-237-3061
(813) 936-2109 • TWX 510-951-7448

CIRCLE 191 ON FREE INFORMATION CARD

DRAWING BOARD

Clock, I/O, and BIOS



ROBERT GROSSBLATT,
CIRCUITS EDITOR

WE'VE ALREADY FINISHED A LOT OF THE design work that had to be done to turn our memory circuit from a neat idea to a practical reality. There are still a few things left,

however, before we can start filling the memory with data. We're still missing a system clock, an I/O control system, and let's not forget a BIOS of some sort to make the

whole thing work. Don't forget that our memory system will only do the job as long as the Z80 keeps executing instructions. If the Z80 stops, all of our refreshing goes

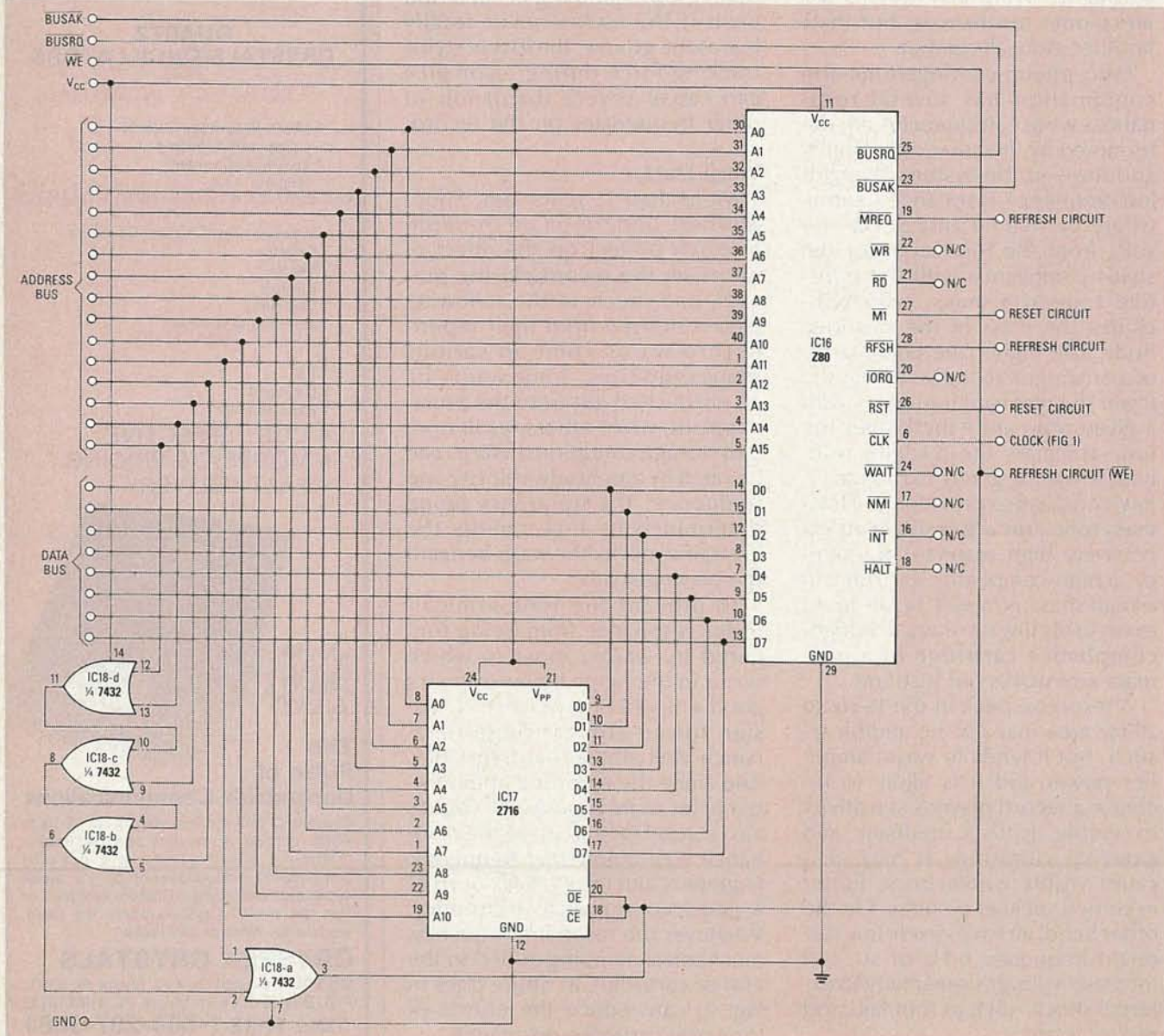

FIG. 2

out the window and, unfortunately, takes our data with it.

There are all sorts of clocks that can be used for our system but there's nothing like a crystal for stability, reliability, and total freedom from brain damage. Although there's no problem designing a crystal oscillator, there's sometimes a problem getting parts. We need a crystal frequency that meets two criteria: It has to be dividable down to 2.5 MHz, and it also has to be easy to find. After seconds of intense thought, I've settled on 10 MHz.

The circuit shown in Fig. 1 is a good, hassle-free, crystal oscillator. It's sure-starting, easy to fine tune, and, best of all, it's really tolerant to variations in component values. Even though you can get away without them, it's a good idea to use mylar capacitors. Ceramic discs have terrible tolerances and even though the circuit will put up with a lot of variation, remember Grossblatt's Third Law: HE WHO ASKS FOR TROUBLE...GETS IT and that, as we all know, is the absolute truth.

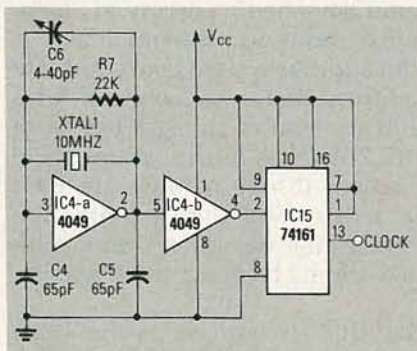

FIG. 1

You can use any kind of TTL inverters you want, but stick with the 4049-type if you're going to use 4000-series CMOS. The basic oscillator is comprised of R7, C4, C5, and XTAL1, and it oscillates at approximately the frequency that is marked on the crystal. If you find your circuit is off the mark, the trimmer (C6) will give you a few kHz of adjustment either way. If the frequency is way off, the crystal you're using is probably no good, so you should try another one.

I'm using a 74161 TTL IC to divide the 10 MHz down to 4 MHz but, as with the oscillator itself, there are

many parts you can use that will do the same job. The only proviso here is because of the frequency. It's asking just too much of standard 4000-series CMOS to handle 10 MHz with a V_{CC} of 5 volts. If you insist on using CMOS parts (and it's always a good idea to use them if you can), get your hands on some of the newer HCT parts such as a 74HCT161. They're CMOS parts that have the same drive and frequency capabilities as LSTTL parts.

The 74161 is a versatile base-16 counter but we're just using it to divide the input signal by four. Of course we'll get a nice freebie in the form of wave shaping. The output will be a nice square wave that swings pretty close to the supply rails.

The next step in putting our circuit together is to take a look at the Z80 itself. We've spent most of our time designing all the subsystems, but the CPU is what ties everything together. Figure 2 will give you an overview of the entire memory circuit. If you have the block diagram we drew a few months ago (*Radio Electronics*, July 1987), get it out because it will make things a bit easier to understand.

We'll put our BIOS in a 2716 EPROM since 2K is more than enough room for the code that we need to control the system. As you can see, the EPROM (IC17) sits on the address and data lines and both its enable pins are tied together. That is done because the EPROM's current requirements drop considerably when it's completely deselected. Now I know that we need the EPROM on line most of the time because we can only maintain data in the system if the Z80 keeps on executing instructions. But, as we've seen, the EPROM only has to be on line during the instruction-fetch cycles and we can deselect it when it's not needed.

If you draw a memory map of our system, the EPROM would live at the bottom 2K and the rest of the address space (62K) would be for our data storage. What we need now is some method of automatically letting the RAM and EPROM know which of the two is being accessed by the CPU. Once again, there are lots of ways to do that but

Put Professional Knowledge and a
COLLEGE DEGREE
in your Technical Career through
HOME STUDY

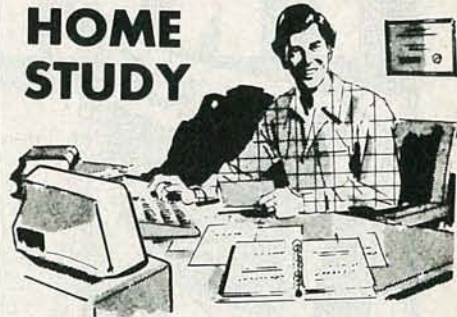

Add prestige and earning power to your technical career by earning your Associate or Bachelor degree through directed home study.

An important part of being prepared to *move up* is holding the right college degree, but the absolutely necessary part is *knowing your field*. Grantham can help you accomplish both objectives—to learn more *and* earn your degree, both of which together will prepare you for promotion in your present employment or for new better employment. Learn much more about

ELECTRONICS
and COMPUTERS,

as Grantham helps you *understand* your subjects and become a highly qualified expert, as you move thru the home study program and earn your accredited college degree.

No commuting to class. Study at your own pace, while continuing on your present job. Learn from easy-to-understand lessons, with help from your Grantham instructors when you need it.

Write for our free catalog (see address below) or telephone us at (213) 493-4421 (no collect calls) and ask for our "degree catalog."

Accredited by
the Accrediting Commission of the
National Home Study Council

GRANTHAM
College of Engineering
10570 Humbolt Street
Los Alamitos, CA 90720

JULY 1988

FREE Heathkit[®] CATALOG



Featuring superior quality electronic products in kit and assembled form. Innovative home products, test instruments, self-study electronics courses. Challenging and educational kits for first-time as well as seasoned builders. Quality ready-to-use electronic products for homeowners, sports enthusiasts and professionals. All from Heath Company, a leader in the changing electronics market.

108 full-color pages packed with the latest in high quality electronic products

Send NOW for your **FREE** Heathkit Catalog.

Send to:
Heath Company, Dept. 020-672
Benton Harbor, Michigan 49022

Name _____
Address _____
City _____
State _____ Zip _____

A subsidiary of Zenith Electronics Corporation

Heathkit[®]
Heath
Company

CL-792

the one that's the most understandable is to simply decode the address bus. Whenever there's a high on any address line from A11 to A15, we're talking to RAM. We select either the RAM or the EPROM using OR gates, as shown in Fig. 2.

The 74HCT32, (or any quad OR gate), watches the upper 5 address lines and controls the enable pins of the EPROM. The only way the output of the final OR gate can be high is if there's a high on any of the address lines it's watching. If there is, it will turn off the EPROM. That kind of automatic selection is handy because it's one less thing to worry about when you work out a BIOS for the system.

All that's left to do in the way of hardware is work out a way for external circuitry to get data in and out of the system. On the face of it, that would appear to be a tremendous design problem involving I/O requests, latches, and lots of tristate buffers. Fortunately for us, there's another way out. The designers of the Z80 have given us $\overline{\text{BUSRQ}}$ and $\overline{\text{BUSAK}}$ lines to allow DMA

(Direct Memory Access) operations to be done. That means that what would have been a messy I/O business is reducible to just about no problem at all.

DMA allows us to let another system take complete control of all the address, data, and control lines handled by the Z80. At the end of the last T-cycle of every instruction, the Z80 takes a look at the $\overline{\text{BUSRQ}}$ line. If the line is active, (brought low), the CPU finishes the T cycle activity and then tristates the three sets of lines. Once that has been done, it informs the rest of the world by bringing the $\overline{\text{BUSAK}}$ line low.

Things will stay like that for as long as the $\overline{\text{BUSRQ}}$ remains low. It's the responsibility of the external device to release control as soon as it's finished. The Z80 will look at the $\overline{\text{BUSRQ}}$ at the start of every T cycle and as soon as the line is released, it will begin executing instructions at exactly the point where it was interrupted in the first place.

The circuitry that has to be designed to let all that happen is totally dependent on the external system that's doing the DMA. In the simplest case, all we have to do is to make the control, address, and data lines available to the external system. That would be true as long as the external system had some way of OR'ing into the Z80 system. If you don't want to assume that the external system is going to provide the tristate buffers, you'll have to get some 74245's and use them to buffer all the Z80 lines.

Figure 3 is an example of how you would use the 74245's (or some other kind of buffers) to resolve bus contention. The 74245's enable control (pin 19)

NOISE REDUCTION FOR UNDER \$10.

MIXING CONSOLES
SWITCHES
MICROPHONE CONNECTORS
SNAKE CABLES
BATTERY CONTACTS



ALL PLUGS & JACKS
(XLR, PHONE, PHONO, DIN, MIDI, ETC.)
PATCHBAYS
FADERS, POTS
TERMINAL STRIPS
SPEAKER TERMINALS

CRAMOLIN[®]

Even the finest equipment in the world cannot guarantee noise-free operation. One "dirty" connection anywhere in the electrical path can cause unwanted noise or signal loss.

"MORE THAN A CONTACT CLEANER"

CRAMOLIN[®] is a fast-acting, anti-oxidizing lubricant that cleans and preserves all metal surfaces, including gold.

When applied to metal contacts and connectors, **CRAMOLIN[®]** removes resistive oxides as it forms a protective molecular layer that adheres to the metal surfaces and maintains maximum electrical conductivity.

CRAMOLIN[®] - USED BY THOSE WHO DEMAND THE BEST:

Bell & Howell	Hewlett Packard	MCI(Sony)	Nakamichi
Boeing	John Fluke Mfg.	Motorola	RCA
Capitol Records	McIntosh Labs	NASA	Switchcraft

SINCE 1956

CAIG LABORATORIES INC

1175-O Industrial Ave., (P.O. Box J) - Escondido, CA 92025-0051 U.S.A. • (619) 743-7143

should be tied to the **BUSAK** line since both are active low. That means that the Z80 would be able to control access to the external system, and allow it only when it is safe to do so.

DMA is a terrific way to put our memory system to work, but there are restrictions. Remember that the Z80 is taking care of the refresh operation for us, and while DMA is going on, the whole refresh operation is being put on the back burner. If it takes too long, you can be sure that your data is going to disappear.

The big question then is "how long is too long"?

Since our system is running at 2.5 MHz, the outside limit for a DMA operation is going to be about 1 millisecond—and that's a lot of time when you're journeying into microprocessor land. Since our DMA will be limited to storing or retrieving data from memory, there's more than enough time to have some external system execute the needed few bytes of its code.

All we need is a BIOS to make

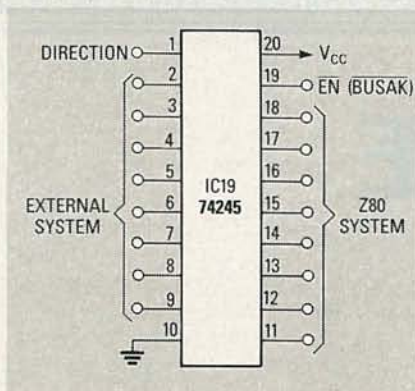

FIG. 3

the Z80 operate. That is trivial since the only job the Z80 has is to refresh the system's RAM. All we have to do is have it execute one instruction over and over again. That's right, we can load our EPROM with a "JMP \$0000" at location \$0000 and that, believe it or not, can be the extent of our BIOS! If that's all you want, you can replace the EPROM with a small PROM, (similar to an 8223), rework the enable logic, and use all 64K of address space for dynamic RAM.

I'll have a few words to say about the circuit next month. R-E

NEW SUPER LONG PLAY TAPE RECORDERS

12 Hour Model — \$105.00*
USES D-120 TAPE

Modified Panasonic Slimline, high quality, AC-DC Recorders provide 6 continuous hours of quality recording & playback on each side of cassette for a total of 12 hours. Built-in features include:
• Voice level control, • Digital counter, etc. TDK DC 120 Cassette Furnished.



PHONE RECORDING ADAPTER

Records calls automatically. All Solid state connects to your telephone jack and tape recorder. Starts recording when phone is lifted. Stops when you hang up. **\$24.50***

VOX VOICE ACTIVATED CONTROL SWITCH
Solid state. Self contained. Adjustable sensitivity. Voices or other sounds automatically activate and control recorder. Uses either recorder or remote mike. **\$24.95***

*Add for ship & hdg. Phone Adapter & Vox \$1.50 ea. Recorders \$4.00 ea. Cal. Res. add tax. Mail order, VISA, M/C, COD's OK. Money Back Guarantee. Qty. disc. avail., Dealer Inquiries Invited. Free data. ©
AMC SALES INC. Dept A 9335 Lubec St., Box 928, Downey, CA (213) 904-21 Phone 869-8519

CIRCLE 176 ON FREE INFORMATION CARD

GUARANTEED PERFORMANCE!!

METERS

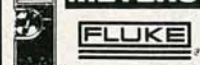

- 73 3 1/2" digit, DMM **\$67**
- 75 3 1/2" digit, DMM 99.
- 77 3 1/2" digit, DMM 128.
- 8060A 4 1/2" digit-true RMS 323.
- 8062A 4 1/2" digit-true RMS 260.
- 37 Bench portable DMM 217.
- 8010A Bench portable true RMS 255.
- 8012A Bench portable true RMS 318.
- 8050A Bench portable true RMS 349.

BECKMAN

- DM15B 3 1/2" digit, 26 ranges, beeper **\$51.98**
- DM25L 3 1/2" digit, 29 ranges, logic probe, cap measure 94.50
- DM850 4 1/2" digit, frequency counter, data hold 207.83
- Tech300 Diode Test 113.00
- Tech330 True RMS, Diode Test 206.00
- DM73 Probe-Auto-ranging, beeper, data hold 55.00
- CC6 Clamp-on meters (measure up to 600 amps) 68.18

SCOPES



HITACHI
Special

- V-212 20 MHZ dual trace scope **\$385.**
- V-222 20 MHZ dual trace scope 550.
- V-423 40 MHZ dual trace, delayed sweep scope 795.
- V-660 60 MHZ dual trace scope 999.
- V-665 60 MHZ dual trace/cursor readout scope 1245.
- V-1060 100 MHZ dual trace scope 1294.
- V-1065 100 MHZ/cursor readout scope 1544.
- V-6020 20 MHZ digital storage scope 1745.
- 9020 20 MHZ dual trace scope, component tester, delay sweep 468.
- 2120 20 MHZ dual trace scope **\$395.**

IWATSU

- DS-6411 40 MHZ digital storage scope
- DS-6612 60 MHZ digital storage scope
- SS-5706 30 MHZ 3 channel scope

- SS-5705 40 MHZ 3 channel scope
- SS-5710 60 MHZ 4 channel scope
- SS-5712 200 MHZ 4 channel scope
- SS-6122 100 MHZ 4 channel scope/CRT readout & cursor

POWER SUPPLIES

- WP-702A Dual 0-20VDC (0-200MA, dual meter) **\$190.**
- WP-703A Single 0-20VDC (0-500MA, single meter) 146.
- WP-704A Single 0-40VDC (0-250MA, single meter) 146.
- WP-705A Single 0-50VDC (0-2A, digital meter) 349.
- WP-706A Single 0-25VDC (0-4A, digital meter) 370.
- WP-707A Dual 0-25VDC (0-2A, digital meter) 465.
- WP-31A Isolation transformer 1.5KVA, 3 fixed 350VA outputs 223.78

Iwatsu
Call For Prices

B&K

- 1610 Power supply 0-30VDC, 0-1A **\$ 147.**
- 1630 Power supply 0-30VDC, 0-3A 220.
- 3011 Function generator 0.2 HZ - 2MHZ 205.

IC TESTER

- 560 Programmable IC tester **\$2970.**
- 541 Component tester 364.
- 550 T.T.L. IC comparator 364.
- 552 CMOS I.C. comparator 364.

SOLDERING SUPPLIES

- UTC 100 Temperature controlled soldering system **\$67**
- 4024 De-soldering service station 414.
- 9000 Temperature controlled soldering station 208.
- 6970 HD Heat gun (gives 1000 watts) 72.
- 1095 Heat gun (gives 1000 watts) 35.
- 1100 Soldering gun 100/140 watts 20.

WELLER

- WTCPR Control output soldering station **\$119.**
- 8200 All purpose soldering gun 21.
- D550 28.58

Kester solder and multicore solder available CALL!



"I GUARANTEE YOUR SATISFACTION!"

For 43 years professionals have counted on KELVIN, for the lowest prices and immediate delivery, from our huge inventory. Count on KELVIN!"

Lisa S. Hadar Executive V.P., C.P.A.

WE CARRY—Panavise, Xcelite Tools, Vaco Tools, X-Acto, Kester Solder, Sellastron Safety Equipment

- Electronic Parts
- Electrical Parts
- Large Selection of State of the Art Educational Kits.

Not Responsible For Typographical Errors.

KELVIN FREE CATALOG **1-800-645-9212**
ELECTRONICS 7 FAIRCHILD AVE., PLAINVIEW, N.Y. 11803 (516)349-7620 FAX: 516-349-7830

CIRCLE 193 ON FREE INFORMATION CARD

ANTIQUE RADIOS

Antique radios for antique autos



RICHARD D. FITCH

THE HORSELESS CARRIAGE AND WIRELESS sort of grew up together. Many prominent inventors from both fields knew each other and some, like Henry Ford and Thomas Edison, often socialized together. Automobile historians can probably trace the horseless carriage back as far as I've traced wireless. In the late 1920's, there was much discussion for and against the use of radios in autos, and many people thought that they should be outlawed because they were a dangerous distraction to the operator. Others thought the auto radio would be a noisy nuisance. But, as you know, the auto radio did survive. By the mid 1930's, auto manufacturers began to take the built-in receiver seriously, and started providing in-dash factory installations.

Problems

The auto-radio pioneers of the 1920's had a few extra considerations in designing the auto radio. The chassis had to be built to withstand the jarring it would be subject to due to road irregularities and the crude suspension systems of those days. All of the components had to be secured to the chassis, including the tubes in their sockets. The auto's six-volt battery fluctuated slightly, so the tubes had to be able to handle those fluctuations without affecting the receiver's operation. The receiver had to be sensitive, and also had to be encased in a metal box to shield it from interference. As a result, the auto radio ended up being built better than a comparable home receiver.

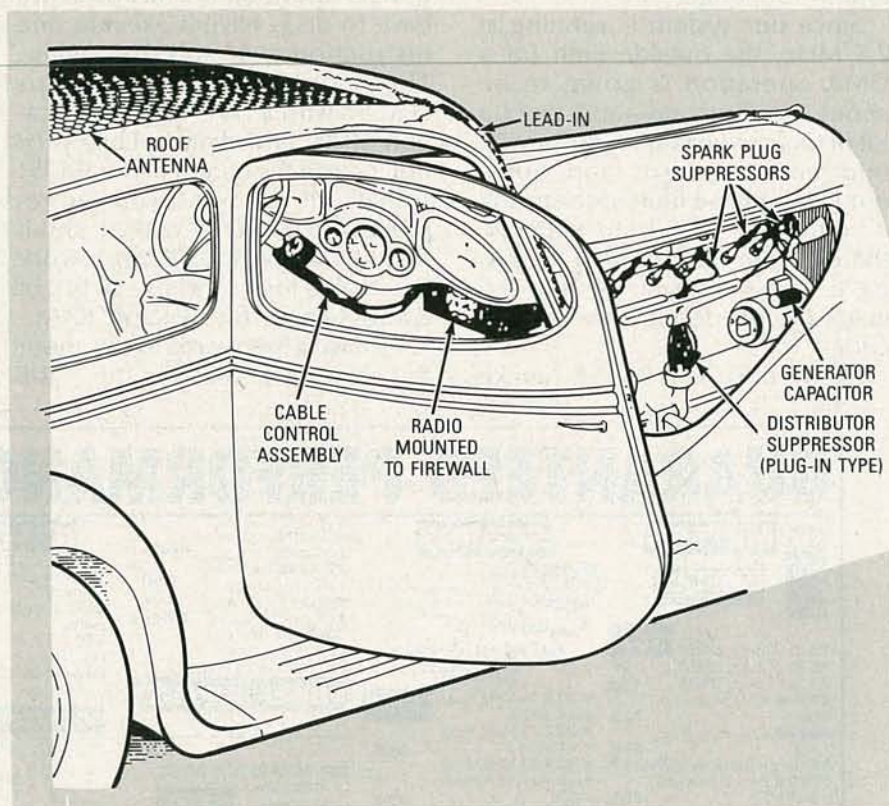

FIG. 1

In the late 1920's, the auto's 6-volt operating battery powered the radio's "A" filament, and a separate metal box lined with sponge rubber had to be installed for the "B" batteries. That box could be mounted under the rear floor boards, in the luggage compartment, or possibly in the rumble-seat compartment.

The early auto radio was mounted on the firewall under the instrument board (dash), as shown in Fig. 1. Usually the controls were right on the set, but some, even in

the 1920's, had a cable-tuning arrangement, which was placed in a convenient location for the operator, such as on the instrument board or the steering column. Consequently, that assembly added considerably to the installation of the radio.

In high sedans, the ideal place for the reproducer (speaker) was under the center of the roof. Since convertibles couldn't use that method, mounting the speaker under the dash became the most-common, yet least-desirable loca-

tion. Different types of magnetic and dynamic reproducers were used in those early autos. The field coil of an electro-dynamic reproducer to be used in an automobile had to be specially wound to operate from a six-volt battery, which, because of a large power drain, was not a particularly desirable situation. An electro-dynamic loudspeaker, however, can usually be replaced by a regular speaker, which is a big plus for the auto's storage battery.

There were many efforts to come up with a suitable aerial. Because extreme height was impractical, other methods had to be considered. In one, a flat metal plate was mounted beneath the wooden running boards, insulated from the frame, under each side. The two plates were connected to the set's aerial terminal; however, that low-slung aerial left a lot to be desired in signal pickup.

Factory aerial installations were usually between the roof and the inside upholstery (the headliner), with the shielded lead-in wire led down one of the front door posts, as seen in Fig. 1. The aerial consisted of a cloth-covered screen or some other type of insulated wire mesh. You have to remember that the roof on sedans and coupes was not a conductor. Even the frames and braces were made of wood, which made possible the roof aerial. Some sedan and coupe owners found simpler ways to install a roof aerial themselves; sewing a flexible wire through the roof liner with a large darning needle was one method used.

The engine's spark plug was the primary source of noise in an automobile's radio. To solve that problem the resistor spark plug has long been available, although I'm not sure if the resistor plug or the auto radio came first. Also, special resistors (suppressors) were available that connected directly to the spark-plug terminal and the high-tension wire, which can be seen in Fig. 1. I would consider those early resistors themselves as collectibles, and an antique auto with the original resistors on the spark plugs would be a real classic. However, even if you had those resistors, when stopped at a traffic light, the other car's ignition sys-

tems would drown out your radio. Also, the high-tension circuit wasn't the only source of interference. Electrical disturbances from the generator, and even the wheels, caused radio interference. Putting a condenser across the generator brushes and a grounding spring between the axle and the wheel helped to solve those problems.

Moving out of the 1920's, the vibrator power supply became popular. There were two basic types of vibrators that were used in auto-radio supplies: The non-synchronous, and the synchronous. The synchronous vibrator had the advantage of rectifying the voltage, and thus not requiring a rectifier tube. While it was a little noisy, the vibrator created a voltage that could be transferred up or down, eliminating the need for any storage batteries other than the automobile's.

Early manufacturers

Who were the manufacturers of the pioneer auto radios? Well, many were the same companies that made home radios. The National Company made a five-tube TRF for auto use. Atwater Kent collectors will be interested to know that that company was also in the auto-radio market, and that their AK-666 was a vibrator-operated superheterodyne. RCA Victor was in the auto market and made five- and six-tube sets with a synchronous vibrator for the mid-1930's Hudson & Terraplane.

Companies whose names appeared on early auto receivers (some dating back to the 1920's) include Stewart Warner, Majestic, Pilot, Gulbranson, Gilfillan Bros. Belmont, Wells Gardner, Silver Marshal, and United American Bosch. Franklin Radio Corp. made radios for the early 1930's air-cooled Franklin autos, and many others.

The model SA-37, by RCA Victor, was made to be installed in the 1937 Hudson and Terraplane; it is a five-tube superheterodyne set. The entire unit was housed in a metal case, except for the remote unit, which would be mounted on the steering column. The loudspeaker is mounted in the cover of the metal case.

Put a
test lab in
your tool pouch.



The Fluke 8060A 4½-digit handheld multimeter.

It's the best tool you could add to your tool pouch, because it lets you troubleshoot more ... with less.

This portable, powerful instrument has a unique combination of features not available in any other handheld DMM.

A simple push of a button on the Fluke 8060A lets you measure frequencies to 200 kHz, make relative offset measurements, convert voltages to direct reading decibels, or conduct audible continuity tests. Plus the 8060A offers wideband True RMS ac measurement capability to 100 kHz.

So say goodbye to your part-time counters, oscilloscopes, continuity testers, calculators and power supplies. And welcome a full-time professional that'll be there when you need it.

You'll find that for troubleshooting everything from motor controls to data communications equipment, the Fluke 8060A is the best multimeter value going.

Find out more by calling our toll-free hotline 1-800-44-FLUKE, ext. 33, day or night.

FROM THE WORLD LEADER
IN DIGITAL MULTIMETERS.



Get A Complete Course In

ELECTRONIC ENGINEERING

8 volumes, over 2000 pages, including all necessary math and physics. 29 examinations to help you gauge your personal progress. A truly great learning experience.

Prepare now to take advantage of the growing demand for people able to work at the engineering level.

Ask for our brochure giving complete details of content. Use your free information card number, or write us directly. **\$99.95**, Postage Included. Satisfaction guaranteed or money refunded.



**Banner
Technical
Books, Inc.**

1203 Grant Ave.
Rockford, IL 61103

CIRCLE 186 ON FREE INFORMATION CARD

TELEPHONE SCRAMBLER

Installs on most phones
including cellular



Easily installed between phones to scramble communication, including tone, wireless and cellular. Scrambler makes it impossible to intercept or decode. Solid state unit has 13000 selectable codes. Excellent sound quality allows immediate voice recognition. Fully self-contained and easy to use. Small, light weight and portable. Two units required. Only \$369.00 each plus \$4.00 shipping and handling.

OTHER AMC PRODUCTS 12 hr. modified Panasonic Recorder, Brief Case Recorder, Telephone Recording Adaptor, VOX Switch, Micro Recorder, Tie clip mike, VOX activated micros, Wired mikes, Transmitter detectors, etc. Send for FREE data. Mail order, VISA, M/C, C.O.D. ok., Cal. Res. add tax.

AMC SALES INC., Dept. A • (213) 869-8519
9335 Lubec St., Box 928, Downey, CA 90241

CIRCLE 108 ON FREE INFORMATION CARD

Built for Plymouth and Dodge, the Mopar model 604 was a popular set in later autos. The set contains five tubes and a rectifier. Unlike previous sets, it has push-button tuning. Also, the set was designed to mount directly in the dash. It has a non-synchronous vibrator that is still somewhat available. Setting the pushbuttons is done by pulling off the chrome pushbutton caps. The buttons can then be unlocked by turning the screw slightly counter-clockwise; the desired station is then tuned in with the knob, and the button is pushed in while holding the knob. The screw can then be tightened and the chrome caps replaced.

One unusual receiver is the Philco model C-4608, may have been seen in a 1936 Dodge. It has a rectifier tube and a non-synchronous vibrator. While the set was designed to mount directly in the dash, the entire side cover could be opened by removing one wing nut. That was an advantage for the radioman who might have been able to repair it without removing it from the vehicle.

Repairing auto radios

The auto radios of the 1920's, if you can find one, can be serviced in much the same manner as the home-battery receiver. The additional problems that may occur in an auto-radio are usually due to vibration, and possibly moisture. As in home receivers, corrosion is the prime cause of trouble. A dead radio is a good indication of a problem with either the fuse or the vibrator.

How do you repair a vibrator? You don't!

First, they are not designed to be dismantled. If you do manage to pry one open, most likely you'll find that the contacts are burned or welded together, or that the coil windings are shorted. In any case, it isn't something that isn't worth repairing.

Radiomen of today who can't solve a vibrator problem in their antique radio might be able to solve it with transistors. While I don't recommend the use of transistors in any antique radio, there can be exceptions—such as when there is no other solution.

Over the years there have been many transistorized vibrator substitutes. Most are too large to fit in the case of the radio and have to be mounted outside and plugged into the vibrator socket using a cable.

This and that

If you enjoy reading about wireless history and antique radios, you should join the "Antique Wireless Association". Their *Old Times Bulletin* is informative and authoritative. Those interested in Nikola Tesla, will enjoy a publication prepared by Leland I. Anderson, available to members. Applications can be obtained from Bruce Roloson, Box 212, Penn Yan, NY 14527.

A reprint of a 1938 **Radio Craft** magazine should make interesting reading. Contact Vestal Press Ltd., P.O. Box 97, 320 Jenson Road, Vestal, NY 13850 for info and catalog.

In a previous column I mentioned the difficulty in finding replacement caps for push buttons on radios. If you need those caps, send an SASE to K. Parry, 17557 Horace Street, Granada Hills, CA 91344.

R-E

Presenting an affordable Light Box System.

\$688

Model TR100 CB
Camera Light Box
with (2) transparencies

•(2) 3200° Kelvin Lamps
(meets mfr. spec.)

•1-year conditional
guarantee

•11-step gray scale
transparency

•7-Bar color
transparency

•Transparencies
mounted in acrylic with
optical scratch-resistant
surface

The method most
manufacturers
recommend

mounted in acrylic with
optical scratch-resistant
surface

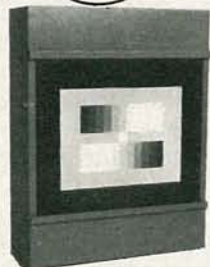

NOTRONIX

P.O. Box 77103 • Sterling Hts., MI 48077

(313) 939-2740

CIRCLE 203 ON FREE INFORMATION CARD

COMPUTER DIGEST

VOL. 5 NO. 7 JULY 1988

A NEW KIND OF MAGAZINE FOR ELECTRONICS PROFESSIONALS

BUILD LINE-CARRIER MODEMS

For cable-free computer interfacing

A
GERNSBACK
PUBLICATION

Page 87



CD CLASSROOM

Adding dynamic RAM circuitry

Page 93

A LOOK AT CeBIT

The greatest computer show on earth

Page 84

EDITOR'S WORK- BENCH

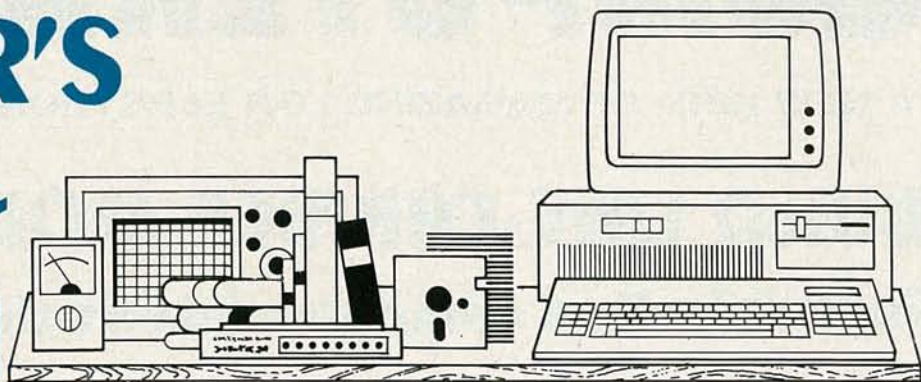

CeBIT: The Greatest Computer Show On Earth

If you've been to what you thought was a big computer trade show without having been to CeBIT in Hannover, West Germany, "you ain't seen nothin' yet."

CeBIT is the world's largest computer, office, automation, and voice/data communications exhibition in the world. The name is an acronym derived from the German show name—World Center for Bureau (office), Information, and Telecommunications Technology—rather a mouthful. Originally, CeBIT was part of the larger Hannover Fair Industry founded in 1947. The CeBIT portion became so large that in 1986, it was spun off as a trade fair on its own.

In 1988, CeBIT exhibits were spread over 2,350,000 square feet of exhibit space in 13 buildings. The show, which is held every year in March, included 2,674 exhibitors from almost 40 countries displaying state-of-the-art technology and the latest in product research and development worldwide. Over 400,000 international visitors toured CeBIT.

The exhibits included 588 office and information-systems, 151 bank equipment and security systems, 357 software management and consulting, 438 office and organizational technology, 321 on applications for small businesses and professions, 373 on peripheral equipment, 182 on Computer Integrated Manufacturing-Computer Aided Design (CIM-CAD/CAM), and 264 on telecommunications. One hundred thirty eight American exhibitors were part of the show.

If CeBIT had an any overall themes this year, they were integration and standardization of electronic equipment and systems.

CeBIT is the place to find the latest industry controversies as well as the latest technology. For example, Atari called a press conference to introduce their new work station and instead, attendees were treated to a lecture by Atari CEO Jack Tramiel who claimed the DRAM shortage is a scam. According to Tramiel, the shortage of DRAM's is artificial. He explained that there is plenty of semiconductor-manufacturing capacity in the world, but it is not being fully used due to trade agreements between the US and Japan.

Tramiel illustrated the point by explaining that Micron Technology, Inc. of Boise, Idaho convinced the US government to impose sanctions on the Japanese for selling low-cost DRAMS in the US, and then promptly proceeded to raise their own prices. Using adjectives such as "greedy" and "stupid" to describe Micron's action, Tramiel announced that Atari had filed suit against Micron for breach of contract and violation of anti-trust laws.

Printer standards

Then there was the press conference that wasn't. The Japanese were scheduled to officially announce the International Printer Standard (IPS) but they didn't show up. Instead, Peter Ohrt, the public relations manager for the Japanese printer initiative read a ten minute statement detailing how the subcommittee for office and information technology at the German Industry Association (VDMA) had started a massive campaign claiming that IPS would disturb the world market by introducing a second standard in addition to the existing European EPPT standard.

So the entire group of Japanese manufacturers decided not to inform the world about IPS even though each of their booths featured printer products based on the IPS standard. All of their brochures discussed the standard, and

thousands of press releases about IPS had been mailed to journalists worldwide.

Japanese dumping

Grundig's general manager called a press conference to complain about Japanese and Korean dumping practices. He was talking about Europe but if your eyes were closed, it sounded like any number of American executives talking about the unfairness of Japanese and Korean dumping in the United States. And when the subject reached the discussion of jobs lost due to dumping practices there could be no doubt that many of our American industry concerns are the same as industry concerns in other countries.

Beyond the various controversies swirling about the fairgrounds, there were so many new products to see, it caused sensory overload for most attendees. CeBIT lasts for eight days and the only way to fully see it is to remain on site for the duration, a feat few can manage. Products on display included many items that were being introduced for the first time anywhere, some of which will make an American debut at COMDEX in May, and a multitude of products we won't see in the United States for several years. CeBIT is where we find out what is on the horizon; if a product is coming down the pipeline from almost any country in the world, it's coming via CeBIT.

It would be impossible to describe in one magazine article, all of the working models, prototypes, or conceptual mockup formats of new products on display at CeBIT. However, let's look at some of the items we may see in the US in the not-too-distant future. It might interest you to know that many Japanese products are developed first for the European market and then adapted for US distribution at a later time.

Macintosh is being cloned in the Orient. The Taiwanese and Koreans are convinced that there will be a big market

worldwide for Mac clones, and they even hope they can find a way to export those machines to the US without encountering patent infringement. Thus far those systems are reverse engineered but Mac-BIOS cloning is probably not far in the future.

Apple is fighting back with a development that will probably be shown at COMDEX as well. Dubbed the "dream machine," the system will run both IBM DOS and MAC software on a single diskette. Apple is said to be developing a 1.7 MB floppy-disk drive to accommodate that dual capability. Don't run to your local computer dealer yet though—the system is not scheduled to be available for awhile.

New laptops abounded. Key to the laptop market were more power, faster speeds, and higher resolution screens. CeBIT is famous for being the place to introduce laptops; just three years ago Toshiba unveiled the T1100 at the show.

Handheld devices with full QWERTY keyboards, some complete with spell

checkers, were popular items at CeBIT. Those little computers could ultimately change business practices and invade the school classroom where only a few years ago teachers forbid the use of calculators. Many of the hand-held office-automation units are already on the market in Japan and are heading for European distribution this year. They should appear in American retail outlets within a year or two.

The UNIX/XENIX operating system seems to be gaining favor as a standard for multiuser applications in Europe as well as the USA because it offers the broad-based ability to integrate a variety of computers into one system. IBM, however, isn't taking that lying down. They introduced System Application Architecture (SAA), a set of software standards that allows the exclusive communication of IBM operating systems to IBM machines. Could that be a new attempt to create a monopoly?

The latest advances in Integrated Services Digital Network (ISDN) tech-

nology could be found everywhere at CeBIT. The German Bundespost (Federal Post Office) made news by presenting its new telecommunications services that establish important criteria for future ISDN developments on a worldwide level. Just a year ago, ISDN was an obscure telephone technology. At CeBIT, ISDN high-quality color-image transmission and reception became a reality thanks to a cooperative effort between Japan's Canon and Germany's Siemens companies.

What you've read is just a tiny bit of the vast quantity of new products originating from all parts of the world, that may or may not wind up in American stores. As one veteran showgoer explained, CeBIT is one of the tougher shows to cover—it takes a real world class attendee to absorb everything. But it's worth the effort because it is the world's largest show in the field and only at CeBIT is current and future technology from all over the world gathered together and displayed each year.—Janet Endrijonas



Microsoft's Mach 20

Amidst all the hoopla over the 80386, it's easy to lose track of the fact that, at the present time, most people simply can't afford 80386-based systems. Consequently, an accelerator card is a highly attractive option to the twelve million or so owners of PC's, XT's, and clones. Comparative reviews of several popular models appeared in our November 1987 cover story. When that story was written,

Microsoft had announced, but had not shipped, the Mach 20 accelerator card. After months of delays (including an unexpected audit by the FCC), the board was finally released. We received one of the first production versions, and we're impressed.

The Mach 20 is actually a three-part system: the \$495 accelerator, an optional \$395 memory card, and an optional \$99 disk controller. The disk controller and the memory card plug into the accelerator card; the assembly occupies a single full-length expansion slot.

The accelerator card, which was designed by the Personal Computer Support Group, uses a moderately speedy 8-MHz 80286. We might have wished for a faster card, but it's easy to see Microsoft's reasons for building a slower card. Typically, accelerator cards that run at 10 or 12 MHz cost 33%–50% more than 8-MHz cards. Keeping the price down should make this card highly attractive to millions of PC users who can't afford a faster card,

especially if the usual mail-order discounts on Microsoft products prevail. In any case, its on-board 16K cache memory greatly speeds up operation so that the Mach 20 is roughly equivalent in speed to an 8-MHz AT, even when accessing memory via the PC/XT's eight-bit bus.

The Mach 20 accelerator card has several advantages over the vast majority of the 80286-based competition (excluding SOTA's MotherCard and Orchid's Pcturbo 286e). First, the card can run in the 80286's protected mode. That means it can run OS/2—but you'll need the Memory Plus option to do so. In addition, the accelerator has a built-in InPort mouse port, so you plug a Microsoft mouse directly into the card without using either a slot for a bus mouse, or a port for a serial mouse.

Whether or not you want to run the Mach 20 in protected mode, the Memory Plus is an attractive option. For \$395, you get 512K of memory that can function in real (i.e. DOS) mode as EEMS memory, or in protected mode as extended memory. The EEMS memory is highly useful for running DesqView or TaskView; the fact that that memory can also be configured for protected-mode operation provides a path for upgrading to OS/2 when desired. The board will accept an additional megabyte of 256K RAM IC's, as well as two megabytes of 1-megabit IC's, for a grand total of 3.5 megabytes of memory. In addition, the modular design of the Memory Plus will allow Microsoft to develop upgrades to handle even more RAM.

The Disk Plus option is a small board that allows PC's, XT's, and clones without support for high-density disk drives (1.2-

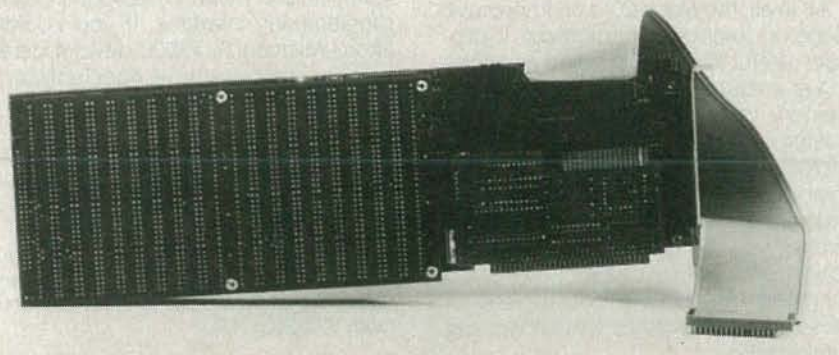

FIG. 1

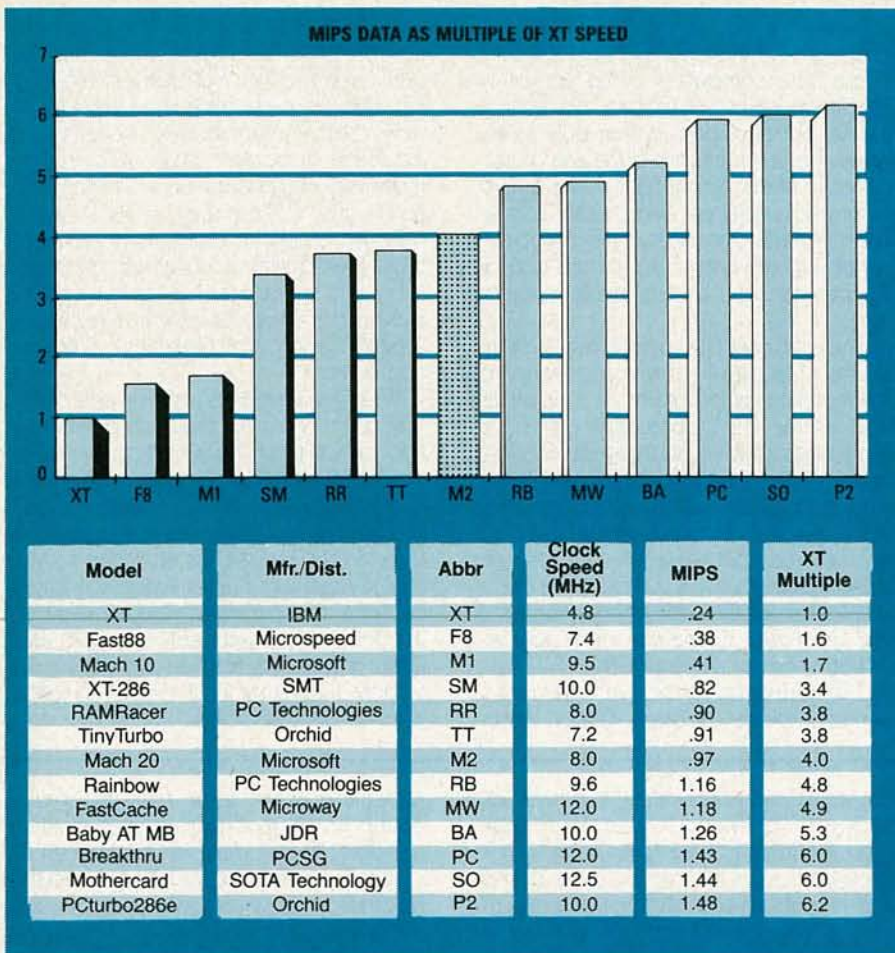

FIG. 2

megabyte 5¼-inch or 1.44-megabyte 3½-inch drives) to run those drives. You need a high-density drive to install OS/2, and merely having a high-density drive can be useful for backing up a hard disk and for swapping disks with AT owners. You'll have to purchase the high-density disk drive separately.

The sum total is a compact, modular system for upgrading PC's and XT's. You can start off with just the accelerator card and add the memory and disk options when necessary. If you're starved for slots, you can combine four functions in one slot: accelerator, mouse interface, expansion memory, and disk control.

Installing the card is simple. Set a few jumpers on the Mach 20, insert it in an empty expansion slot, remove the 8088 from your motherboard, and run a cable from the Mach 20 to the vacant socket. Microsoft's typically well-illustrated manual makes the procedure simple. To install the disk or memory options, the appropriate board(s) must be attached to the Mach 20 card and screwed together. The adapter kits contain all of the necessary components.

To use the EEMS memory, you must add a device driver to your CONFIG.SYS file. (Another driver allows you to control the Mach 20's speed from the keyboard.) Then you can let your applications use

EEMS memory directly, or set it up as a disk cache, using a program that is included. Unfortunately, Microsoft's documentation does not specify how Memory Plus may be configured as protected-mode memory. (Microsoft's version of OS/2 for the Mach 20 will configure memory automatically.)

To get some idea of the board's speed, see Fig. 2, which shows the MIPS (Millions of Instructions Per Second) performance of a dozen accelerator cards of various types. As the figure shows, the Mach 20 is about four times as fast as a standard 4.77-MHz XT, about twice as fast as Microsoft's Mach 10 (an 8086-based accelerator), and about two-thirds the speed of the fastest boards (which cost from 50% to 200% more).

All in all, the Mach 20 is an impressive piece of computing equipment. It provides useful if not astounding acceleration at a reasonable price, and, with the memory option, provides a means of moving from DOS to DesqView to OS/2. Microsoft's previous attempt at acceleration hardware was unimpressive, but the Mach 20 is a winner. A sales promotion can get you the Mach 20, the memory option, and a copy of Excel (reviewed last month) for about 70% of the cost of the three items together. That's a winning combination.



Reading up on OS/2

For those interested in getting the jump on the new operating system, Osborne McGraw-Hill is first on the stands with OS/2 reading material. The *OS/2 Programmer's Guide* was written by Ed Iacobucci, one of OS/2's principal designers at Microsoft; *Using OS/2* was written by Kris Jamsa, author of several books on DOS-related topics.

Jamsa's book begins by discussing the basics of OS/2 and how it compares with DOS. It then goes on to discuss the OS/2 commands and how they compare with their DOS counterparts. Then Jamsa goes on to discuss system configuration, device control, and batch-file processing. Quick reference cards with information on all OS/2 commands are included; a disk containing all the example programs is available directly from the author for under \$20.

From a technical standpoint, the *OS/2 Programmer's Guide* picks up where *Using OS/2* leaves off. In some 1100 pages, Iacobucci covers topics ranging from the Intel family architecture (comparing the 8086, the 80286, and the 80386), multi-tasking and dynamic linking under OS/2, the OS/2 file system, device drivers, device monitors, etc. The last third of the book contains summaries of OS/2 function calls and error codes, and approximately 150 pages of sample programs, which are available on disk for about \$25.

To those used to working in the DOS environment, the transition to OS/2 should be fairly smooth. To those used to programming in the DOS environment, the transition to OS/2 will be much more difficult. There are many new concepts to learn, and a much more complicated programming interface. If you couldn't afford Microsoft's \$3000 developers kit, Iacobucci's book is a good place to start. ▶◀

PRODUCTS REVIEWED

- *Using OS/2 and OS/2 Programmer's Guide*, Osborne McGraw-Hill, 2600 Tenth Street, Berkeley, CA 94710 (800) 227-0900, (800) 772-2531 (CA).

BUILD A PAIR OF

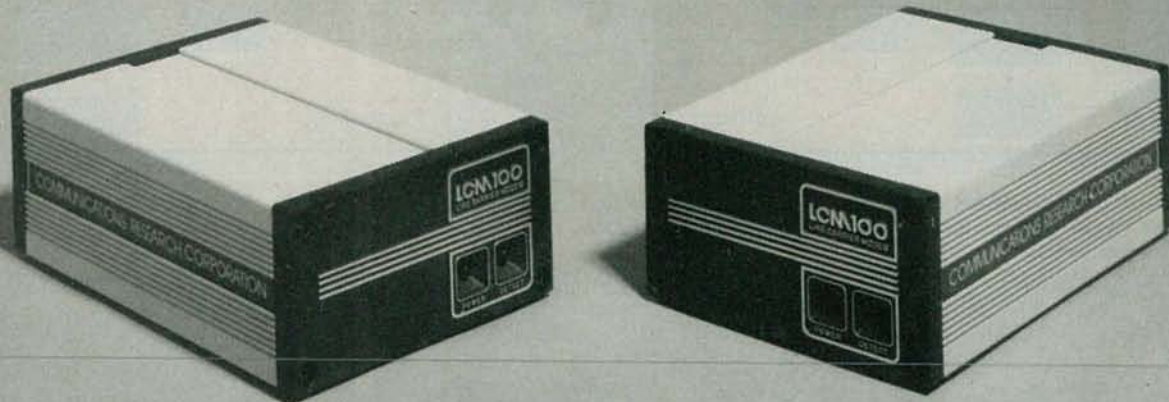

LINE-CARRIER MODEMS

*Build a pair of modems that communicate over the AC lines—
for less than \$100!*

KEITH NICHOLS, CRC ELECTRONICS

How do you connect two PC's together? Solutions range from "Sneaker Net" (wherein the user carries a diskette from one machine to the other) to complex and expensive proprietary network systems. For occasional use, Sneaker Net is easy and reliable, but as usage increases, a more efficient means of data transfer becomes necessary. The problem is that a full networking system requires dedicated wiring, expensive network servers, and lots of user training. Clearly, a midrange solution is required.

The line-carrier modem presented here is one such solution. The LCM100 is inexpensive (about \$100 for a pair of modems), easy to build and use, and uses existing AC wiring to transmit and receive signals. The LCM100 can operate at any baud rate up to 9600, and relies on your communications software to transmit and receive data.

For example, you could use a pair of modems to transmit files between two PC's in an office. You'd use your normal communications software (Crosstalk or ProComm, for example) to send files in Xmodem or Kermit format. Another possibility would be to transmit manufacturing data from a factory floor back to the central office for processing. At home, you might use the LCM100

to transmit files from the PC in your study to the kids' PC in the basement. You might also use a pair of LCM100's to transfer data between dissimilar machines—an IBM PC and a Macintosh, for example.

Background

The LCM100 operates in much the same manner as the familiar telephone modem, but sends its signals via electric-power wiring instead of telephone lines. Each module translates serial asynchronous data between RS-232C and frequency-shift-keying data formats.

A normal telephone modem translates the voltage levels of the digital input signals into two distinct audible tones, one of which represents a logic 0, and the other, a logic 1. The process of shifting the frequency of the output tone as the logic levels change is called *Frequency Shift Keying*, or FSK. The pair of frequencies representing the two logic states are conventionally called "mark" and "space".

The LCM100 converts RS-232C signals into FSK form, but the mark and space frequencies are above 100 kHz, which is well above the audible range. To permit communication in two directions simultaneously (full duplex mode),

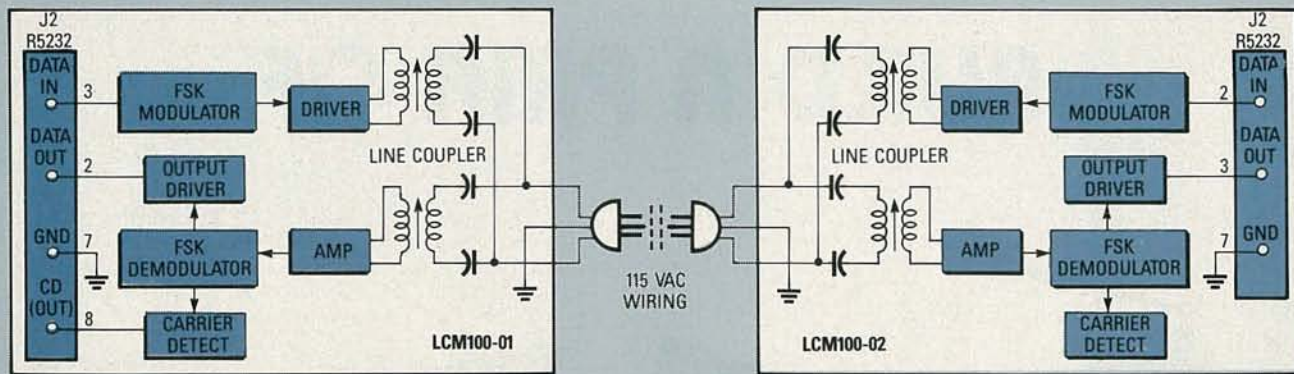

FIG. 1—BLOCK DIAGRAM of the LCM100 data-communication system. The AC-power wiring of the building is used to carry the FSK transmission.

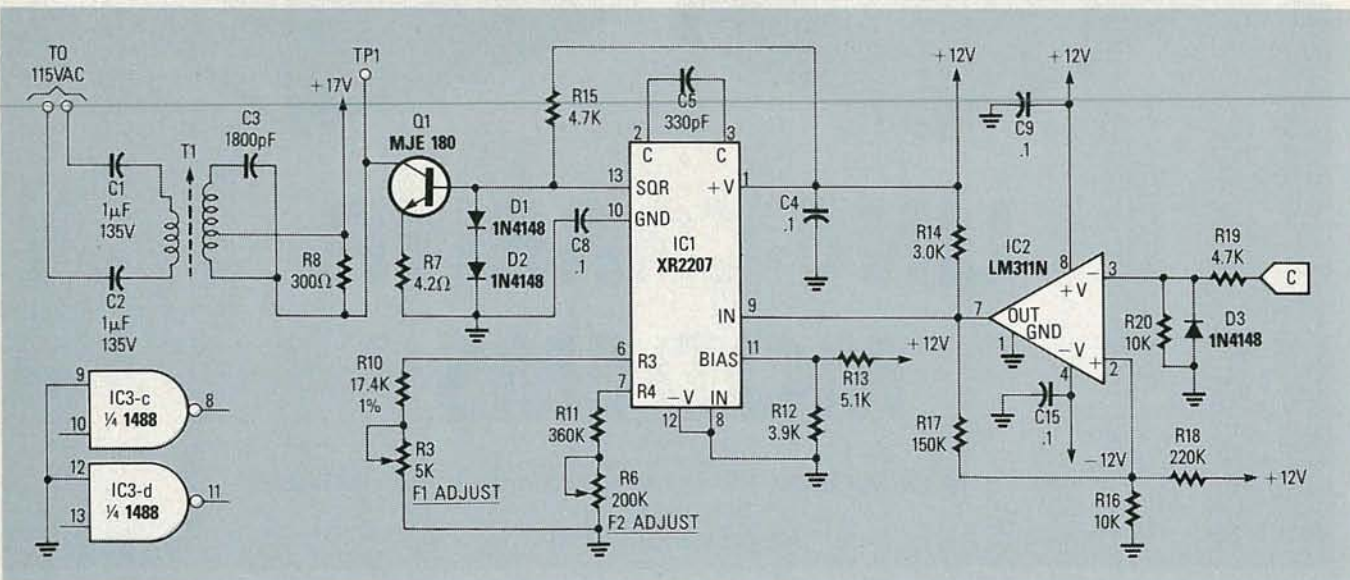

FIG. 2—TRANSMITTER SECTION of the LCM100. Op-amp IC2 shapes RS232 data and presents it to the FSK modulator, IC1. After amplification, the signal is coupled to the AC line by T1.

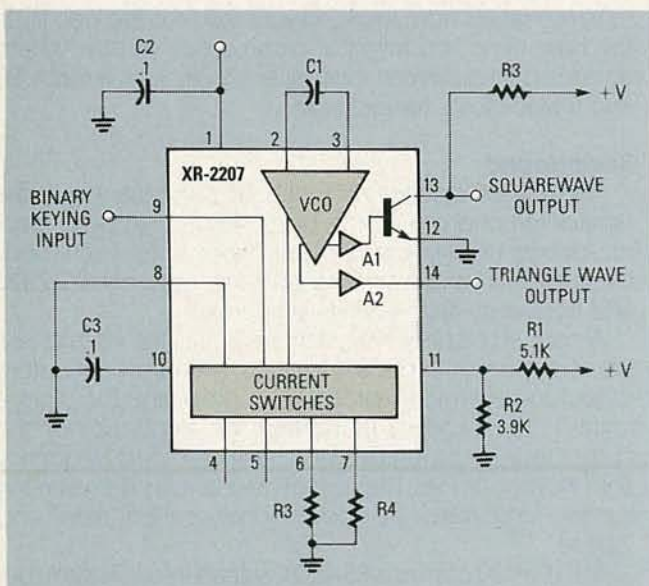

FIG. 3—BLOCK DIAGRAM AND PIN-OUT of the XR2207. The binary keying inputs (pins 8 and 9) determine output frequency.

two pairs of frequencies are used, one called highband, and the other, lowband. (The two frequency pairs are also known as the originate set and the answer set. Those terms designate only the frequencies that each unit is using and do not imply the source or content of the data itself.)

The LCM100 system consists of two modules, the LCM100-01 module, and the LCM100-02. The designation is arbitrary, but it shall be assumed herein that the LCM100-01 module transmits on the highband and receives on the lowband, and the LCM100-02 module transmits on the lowband and receives on the highband. The frequencies that are used by each of the modules are shown in Table 1.

The AC-power line is similar in some respects to the telephone line. However, although the telephone line has well-defined characteristics (a nominal impedance of 600 ohms, relatively little noise, etc.), the AC line can be a harsh environment for data signals. With an impedance as low as 2 ohms and occasional thousand-volt noise spikes, it is less than an optimum communications medium. The LCM100 system must be able to impose an FSK carrier of sufficient strength onto the low-impedance power line, as well as filter out the 60-Hz signal and any other noise components that may be present, thus demodulating only the transmitted signal.

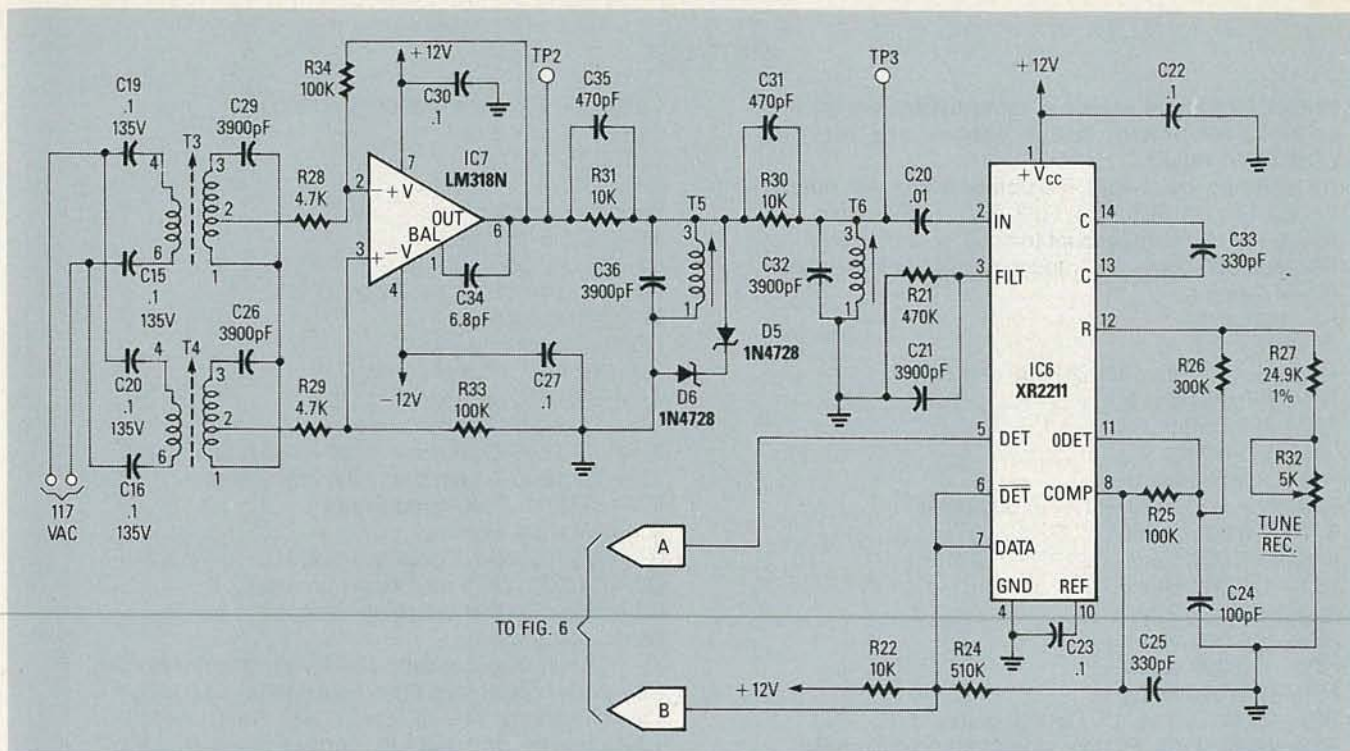

FIG. 4—RECEIVER SECTION of the LCM100. Signals coupled from the power line are conditioned by IC7 and then demodulated by IC6, an FSK demodulator.

Circuit description

Figure 1 is the block diagram of the LCM100 line-carrier modem, which consists of four basic functions: modulator/driver, line coupler, amplifier/demodulator, and output driver.

The modulator/driver and its associated line coupler comprise the transmitter stage, and the amplifier/demodulator, together with its line coupler, defines the receiver stage of the modem circuitry. Each stage is discussed in detail as we continue.

Transmitter stage

Serial input signals are fed via RS-232C port (J2) to the input-conditioning circuit surrounding IC2 (See Fig. 2). Negative-going pulses are clipped by D4, and positive-going pulses are conditioned by voltage-comparator IC2. That signal shaping ensures that the input signals to modu-

lator IC1 are above the threshold voltage required by the oscillator's binary keying input.

Exar XR2207 modulator

The XR2207 (IC1) is a monolithic voltage-controlled oscillator. It can produce simultaneous triangle- and square-wave outputs over frequencies ranging from 0.01 Hz to 1 MHz. It is ideally suited for FSK applications because it can be set for two (or four) different time bases and digitally switched among them. A block diagram of the XR2207 and a typical hookup are shown in Fig. 3.

Four main functional blocks comprise the XR2207: A Voltage-Controlled Oscillator (VCO), four current switches (which are activated by binary keying inputs), and two buffer amplifiers for the triangle- and square-wave outputs. The VCO is actually a current-controlled oscillator that gets its input from the current switches. Output frequency is proportional to input current; four discrete frequencies may be selected by two binary inputs (pins 8 and 9). Those input currents are set by timing resistors connected to pin 4—pin 7. The values for those resistors can be seen in Table 2.

The LCM100 uses only two of the four FSK levels. The unused timing inputs (pins 4 and 5) are left unconnected, and the second binary-keying input, pin 8, is tied to ground. The mark and space frequencies are set by the values of timing-resistors R3 and R4 and timing-capacitor C1 between pins 2 and 3. The FSK input signal is applied to pin 9. A low applied to pin 9 (with pin 8 tied low) produces a signal with a frequency $f1$ determined by:

$$f1 = 1/(R3 \times C1)$$

A high applied to pin 9 produces a signal $f2$ with a frequency determined by:

TABLE 1—LCM FREQUENCIES

	LCM100-01	LCM100-02
f1 (mark)	150.00	100.00
f2 (space)	156.50	106.50

TABLE 2—TIMING RESISTORS

Frequency (kHz)	R3 (K)	R4 (K)
150	20.20	
100	30.30	
156.5		466.2
106.5		466.2

PARTS LIST

Note: Component values in parentheses are for the LCM100-02 board; other values are for the LCM100-01 board.

All resistors are 1/4-watt, 5% unless otherwise noted.

R1, R2, R4, R5, R15, R19, R28, R29—4700 ohms
 R3—5000 ohms, PC-mount trimmer potentiometer
 R6—200,000 ohms, PC-mount trimmer potentiometer
 R7—4.2 ohms
 R8—300 ohms
 R9—not used
 R10—17,400 ohms, 1% (24,900 ohms, 1%)
 R11—360,000 ohms
 R12—3900 ohms
 R13—5100 ohms
 R14—3000 ohms
 R16, R20, R22, R30, R31—10,000 ohms
 R17—150,000 ohms
 R18—220,000 ohms
 R21—470,000 ohms
 R23, R35—820 ohms
 R24—510,000 ohms
 R25—100,000 ohms
 R26—300,000 ohms
 R27—24,900 ohms, 1% (16,200 ohms, 1%)
 R32—5000 ohms, PC-mount trimmer potentiometer
 R33, R34—100,000 ohms (47,000 ohms)

Capacitors

C1, C2—1 μ F, 135 volts
 C3—1800 pF (3900 pF)
 C5—330 pF
 C6—1000 μ F, 35 volts, electrolytic
 C4, C7—C10, C13, C18, C22, C23, C27, C30—0.1 μ F, 25 volts, monolithic
 C11—100 μ F, 25 volts, electrolytic
 C12, C17—10 μ F, 25 volts, tantalum
 C14, C25, C33—330 pF
 C15, C16, C19, C20—0.1 μ F, 135 volts
 C21—3900 pF
 C24—100 pF

C26, C29, C32, C36—3900 pF (1800 pF)
 C28—0.01 μ F, disk
 C31, C35—470 pF
 C34—6.8 pF

Semiconductors

BR1—50 volts, 1 amp
 D1, D2, D3, D6—1N4148
 D4, D5—1N4728 (3.3-volt Zener)
 LED1—standard red
 LED2—standard green
 IC1—XR2207, FSK modulator
 IC2—LM311N, op-amp
 IC3—1488, RS-232 line driver
 IC4—78L12ACZ, precision +12-volt regulator
 IC5—79L12ACZ, precision -12-volt regulator
 IC6—XR2211, FSK demodulator
 IC7—LM318N, op-amp
 Q1—MJE180, NPN power transistor
 Q2—PN2222, NPN switching transistor
 Q3—2N3906, PNP switching transistor

Other components

J1—115-volt AC receptacle J2—25-pin D connector P1, P2—3-pin header strip P3—2-pin header strip MOV1—150-volt varistor T1—RF coil, TOKO RAN10A6729HK T2—24-volts, 180 mA, PC mount (Dale PL-13-07) T3—T6—RF coil, TOKO RAN10A6729

Miscellaneous

Note: The following are available from CRC Electronics, 13547 S. E. 27th Place, Suite 3D, Bellevue, WA 98005, (206) 747-9636: Etched and drilled PC boards with plated-through holes, \$24.95/pair; Partial kit (includes PC boards, all transformers, coils, jacks, and high-voltage capacitors) \$49.95/pair; Complete kit excluding case and power cords, \$99.00/pair; Assembled and tested PC-board assembly without cases and power cords, \$119.95/pair; Complete assembled and tested system, \$159.95/pair. Individual components are also available.

$$f_2 = f_1 + \Delta f_1$$

where $\Delta f_1 = 1/(R_4 \times C_1)$. In both equations, f_1 is specified in Hz, R3 and R4 are in ohms, and C1 is in farads.

In an actual circuit, R3 and R4 can have values between 2K and 2 megohms, and the timing capacitor should be polycarbonate, polystyrene, or mylar, for optimum temperature stability. Table 2 shows the resistor values used to obtain the highband and lowband frequencies, in both cases using a 330-pf timing capacitor. Note that the value of R4 is the same for both the frequency bands. That is because the difference between the mark and space frequencies is the same for both frequency pairs. Because non-standard values are obtained, a series combination of a fixed resistor and a potentiometer permit fine tuning the mark and space frequencies.

The square wave output of the XR2207 (pin 13) is an open-collector stage that drives power transistor Q1. Resistor R15 is a pull-up resistor for the IC's output.

Power transistor Q1 drives the tuned line coupler (T1 and C3) that effects the impedance transformation necessary to impose the FSK carrier onto the 60-Hz power line. Protective capacitors C1 and C2 isolate the modulation circuitry from the power-line voltage.

Receiver Stage

As shown in Fig. 4, the parallel line couplers, T3/C29 and T4/C26, are capacitively isolated from the AC line by protective capacitors C15, C16, C19 and C20. One of the LC circuits is tuned to the "mark" frequency of the line-carrier signal, and the other is tuned to the "space" frequency. The line couplers effectively present a high impedance to the 60-Hz power-line signal while presenting a low-impedance path to the tuned frequencies.

Next, the received signals are amplified by IC7, an LM318N high-slew-rate op-amp. The output of IC7 is fed through a bandpass filter network composed of C35 and R31, T5 and C36, C31 and R30, and T6 and C32. Those components shape the signal and reject noise; Zener diodes D6 and D7 clip the peak-to-peak signal voltage to 6.6 volts to avoid damaging the demodulator (IC6).

Exar XR2211 Demodulator

The XR2211 is a Phase-Locked-Loop (PLL) IC designed especially for data communication and particularly suited for FSK-modem applications. It operates over a frequency range from 0.01 Hz to 300 kHz and can accommodate analog input signals between 2 millivolts and 3 volts. A block diagram of the XR2211 and a typical FSK-demodulator hookup are shown in Fig. 5.

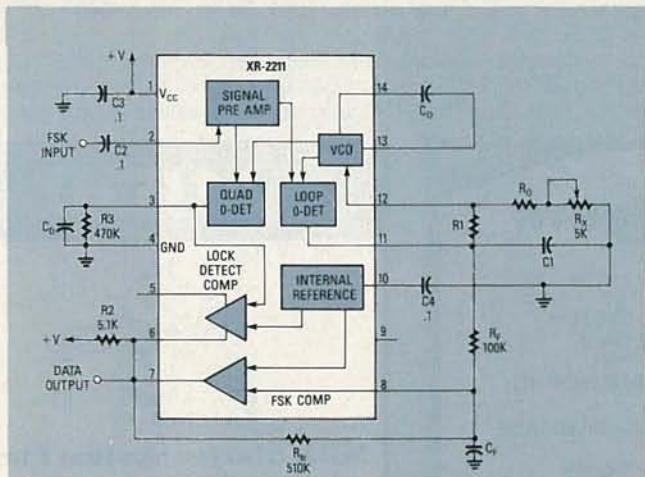

FIG. 5—BLOCK DIAGRAM and basic hookup of the XR2211 FSK demodulator. See the text for information on calculating resistor and capacitor values.

Frequency-shift-keyed input signals are fed to pin 2 of the IC through a 0.1- μ F coupling capacitor. The internal impedance is 20 kilohms and the minimum recommended input signal is 10 mV.

The center frequency of the demodulator's passband must be set at the center of the frequency band that is to be detected. In the LCM100 the passband is set halfway between the frequency pairs: $(106.5 + 100)/2 = 103.25$ kHz for the LCM100-01 demodulator, and $(156.5 + 150)/2 = 153.25$ kHz for the LCM100-02.

In Fig. 5, the oscillator's center frequency is calculated as follows:

$$f_o = 1/(R_o \cdot C_o)$$

where R_o is in ohms and C_o is in farads. Using a 330-pf capacitor for C_o the computed values for R_o are 29.35K and 19.77K for the LCM100-01 and LCM100-02 modules respectively. With a 5K trimmer wired in series, 1% resistors with values of 24.9K and 16.2K are used. Capacitor C_o should be mylar, polycarbonate, or polystyrene.

System bandwidth is set by R_1 , and C_1 sets the loop-filter time constant and damping factor. The value of R_1 is determined by the mark/space frequency difference:

$$R_1 = (R_o \cdot f_o)/(f_1 - f_2)$$

The calculated values for R_1 are 395 kilohms ($f_o = 103.25$ kHz) and 382 kilohms ($f_o = 153.25$ kHz). However, in order to increase the detectable bandwidth, both LCM100 modules use a 300K value for R_1 .

The equation for computing the loop-damping factor associated with C_1 is complex, but there is a convenient rule of thumb. The damping factor should be approximately 1/2, and a value of $C_1 = C_o/4$ will produce that. With C_o equal to 330 pf, C_1 equals 82.5 pf. Because the loop low-pass filter time constant T equals $R_1 \times C_1$, the LCM100 uses a 100-pf value for C_1 in order to compensate for the lower value of R_1 .

Resistor R_b provides positive feedback across the FSK comparator and facilitates a rapid transition between output states. A value of 510K is normally used.

Components C_f and R_f form a single-pole post-detection filter for the FSK data output (R_f generally = 100K). Capacitor C_f smoothes the data output; its value is calculated roughly as:

$$C_f = 3/\text{data rate in bits per second}$$

where C_f is in microfarads. Since the LCM100 is designed for operation up to 9600 bps (bits per second), a value of 330 pf is acceptable.

The final area requiring calculation is the lock-detect section of the XR2211, which is used in a carrier-detect function. The open-collector lock-detect output (pin 6) is connected to the data output (pin 7). That disables any output created by noise, unless a carrier signal is present within the detection passband of the PLL. Presuming a parallel resistance of 470 kilohms, the minimum value of the lock-detect filter capacitor, C_D , is:

$$C_D = 16/(f_1 - f_2)/2$$

The LCM100 uses a 3900-pf capacitor for C_D .

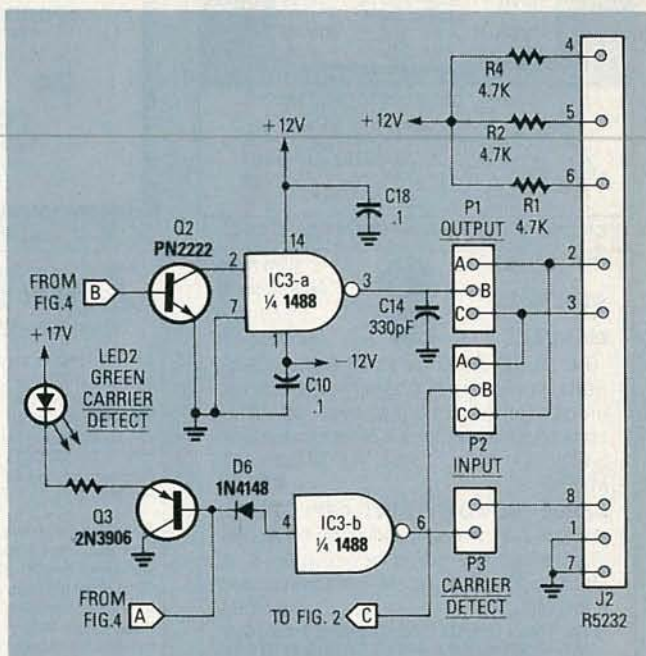



FIG. 6—OUTPUT AMPLIFIER AND CONNECTORS. Transistor Q2 amplifies the output of the XR2211. Line buffer IC3-a then converts the signal to RS-232C form.

Output driver

Referring to Fig. 6, the data output of the XR2211 (pin 7) is amplified by NPN-transistor Q2, which drives IC3-a, one section of a 1488 quad RS-232C line driver. It produces the positive- and negative-voltage levels required by the RS-232C interface.

The carrier-detect output of the XR2211 (pin 5) drives the base of transistor Q3, which controls LED2, the carrier-detect LED. The LED provides a convenient means of verifying that the two modems are "talking" to each other.

Next time

The only circuitry that we have not discussed yet is the power-supply section. Unfortunately, we have run out of room in this issue. However, the power supply's circuitry and operation will be discussed in detail in next month's **ComputerDigest**. We'll also give you the construction details, PC board patterns, and the testing and tuning instructions, so that you can get your system up and running. At this time, it might be a good idea for you to gather up all the parts you'll need, or order any of the kits that are offered at the end of the Parts List. 

R-E Computer Admart

Rates: Ads are 2 1/4" x 2 7/8". One insertion \$825. Six insertions \$800 each. Twelve insertions \$775. each. Closing date same as regular rate card. Send order with remittance to **Computer Admart**, Radio Electronics Magazine, 500-B Bi-County Blvd., Farmingdale, NY 11735. Direct telephone inquiries to Arline Fishman, area code-516-293-3000. *Only 100% Computer ads are accepted for this Admart.*

ICs PROMPT DELIVERY!!!

SAME DAY SHIPPING (USUALLY)
QUANTITY ONE PRICES SHOWN for APRIL 12, 1988

OUTSIDE OKLAHOMA - NO SALES TAX

DYNAMIC RAM		
SIMM	1048Kx8	100 ns \$450.00
1Mbit	1048Kx1	100 ns 36.50
51258 *	256Kx1	100 ns 10.50
41256	256Kx1	60 ns 10.95
41256	256Kx1	80 ns 10.85
41256	256Kx1	100 ns 10.75
41256	256Kx1	120 ns 10.50
41256	256Kx1	150 ns 9.25
41264 +	64Kx4	120 ns 13.50
EPROM		
27C1000	128Kx8	200 ns \$37.50
27C512	64Kx8	200 ns 14.95
27256	32Kx8	250 ns 7.50
27128	16Kx8	250 ns 6.95
STATIC RAM		
43256L-12	32Kx8	120 ns \$11.95
5864LP-12	8Kx8	120 ns 6.95

OPEN 6 1/2 DAYS, 7:30 AM-10 PM SHIP VIA FED-EX ON SAT.

WE EXPORT ONLY TO CANADA, GUAM, PUERTO RICO & VIRGIN ISLANDS

SAT DELIVERY INCLUDED ON FED-EX ORDERS RECEIVED BY: **THU AM 11:30** FR: **11:00** **11:30**

MasterCard/VISA or UPS CASH COD
Factory New, Prime Parts
MICROPROCESSORS UNLIMITED, INC.
24,000 S. Phoenix Ave. (918) 267-4961
BEGGS, OK. 74421

No minimum order. Please note that prices are subject to change. Shipping & insurance extra, & up to \$1 for packing materials. Orders received by 3 PM CST can usually be delivered the next morning, via Federal Express Standard Air @ \$6.00, or guaranteed next day Priority One @ \$10.25!

CIRCLE 61 ON FREE INFORMATION CARD

COMPUTER ASSEMBLY MANUALS



Eliminate Guesswork!
Build with Confidence!

BIG BLUE SEED for IBM™ BUILDERS!
Parts list, placement diagrams, instructions, mods, for assembling over 90 IBM-compatible bare cards. Latest version with guides for 640K, Turbo, AT & Baby AT MthBds. **\$17.95**

APPLE™ BUILDERS NEED APPLE SEED!
Instructions for assembling over 90 Apple-compatible bare cards including II+ & IIe MthBds. For ALL Apple enthusiasts and hobbyists **\$14.95**

SAVE 10% - ORDER TWO OR MORE MANUALS OVER 40 BARE IBM & APPLE CARDS IN STOCK
(MthBds • Disk • Video • Burner • MultiFn • I/O • Modern • Proto • etc)

Check/Money-order, VISA/MasterCard to:
NuScope Associates*, Dept RE

In U.S.A. In CANADA
P.O. Box 790 P.O. Box 742, Stn B
Lewiston, NY 14092 Willowdale, Ont. M2K 2R1
*A Division of Kosmic MicroTech Inc.

CIRCLE 72 ON FREE INFORMATION CARD

EPROM PROGRAMMER FOR PC \$129.95



- 2716 to 1 MEG • Updateable to 32 MEG
- Programs 2764 A in 10 Seconds
- Menu Driven Software
- External 40 PIN ZIF (PC only)
- Adapter 8748, 49, 51, 52, 55, TMS 7742 \$50 PC only
- 1 Year Warranty
- 10 Day Money Back Guarantee
- Available for APPLE II \$92.50
- For More Information Call



NEEDHAM'S ELECTRONICS
4535 Orange Grove, Sacramento, CA 95841
(916) 924-8037 (M-F) 8 AM to 5 PM PST

CIRCLE 196 ON FREE INFORMATION CARD

NEW! BIGMOUTH™ VERS. 2.0



REAL VOICE Digital Recording for your PC, XT, AT or Compatible

- ◆ VOICE MAIL SYSTEM
- ◆ TELEMARKETING - Inbound & Outbound
- ◆ SMARTEST ANSWERING MACHINE
- ◆ AUTODIALER—DATABASE
- ◆ VOICEPAD™ - Voice for your Programs
- ◆ PROGRAMMER'S TOOLKIT - (optional \$79.00)

1/2 card, software, cables, and speaker

\$269.00 + 5 s/h

(415) 652-9600

Talking Technology, Inc.
4383 Piedmont Ave. Suite B
Oakland, CA 94611

CIRCLE 195 ON FREE INFORMATION CARD

Z80/HD64180 Microprocessor Development Tools

SBC100 complete stand-alone HD64180 computer with prototyping area, wall transformer and debugging/data link cable to PC- \$295.00. Get your project under way fast.



Complete development tools for SBC100. Cross assembler, linker and remote debugger. Write and debug SBC100 programs from your PC- \$295.00.

CP/M HD64180 Coprocessor card. Runs all types of CP/M-80 software on your IBM-PC or AT much faster than on a "real" CP/M system- \$295.00.

HiTech C Cross compiler for Z80 and HD64180. For embedded microprocessor systems. Compatible with M80/L80. Includes SLR Systems cross assembler/linker- \$495.00. We have many other Z80/HD64180 development tools.



Z-World
1772 Picasso Ave
Davis, CA 95616
(916) 753-3722

CIRCLE 198 ON FREE INFORMATION CARD

CITIZEN™ 120D \$149

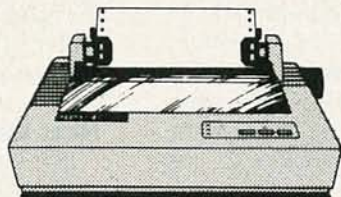

Hard Worker

120 CPS Draft/25 NLQ • 4K Buffer • Narrow

GDC COMPUTERS

VISA 714-842-9252 MasterCard 714-842-3198

7712 "C" Talbert Ave. Huntington Beach, CA 92647
Price reflects a 3% Cash Discount - Shipping & Handling. Add UPS Charges

CIRCLE 205 ON FREE INFORMATION CARD

MIDI!



MIDI Starter System Plus™

for your IBM PC or compatible

PC standard MIDI Co-Processor
MelodEase Piano Roll Composer
Easy-8 Multi-track Recorder
Synth Sound Manager Software

\$219 with MIDI cables

ask about our MIDI Programmer's Toolkit



Music Quest, Inc.
1700 Alma Dr., Suite 260
Plano, TX 75075 (214) 881-7408

CIRCLE 199 ON FREE INFORMATION CARD

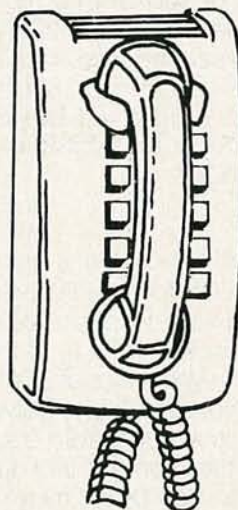

CALL NOW AND RESERVE YOUR SPACE

- 6 x rate \$800.00 per each insertion.
- Fast reader service cycle.
- Short lead time for the placement of ads.

Call 516-293-3000 to reserve space. Ask for Arline Fishman. Limited number of pages available. Mail materials to: Computer Admart, RADIO-ELECTRONICS, 500-B Bi-County Blvd., Farmingdale, NY 11735.

BUILD THE PT-68K

*This month we
install the DRAM circuitry.*



Copyright (C) 1988 by Peter A. Stark

PETER A. STARK

Last month we discussed the internal structure of dynamic RAM (DRAM), and how it works. This month we'll describe and build the DRAM circuit actually used in the PT-68K. We've already discussed the general principles behind DRAM circuits, so let's start by discussing the specific circuits used in the PT-68K.

DRAM operation during CPU accesses

Let's begin our discussion with the timing circuit shown in Fig. 1. First, assume flip-flops IC49-a and IC49-b are reset, which is the condition most of the time, because IC49-a is reset every time \overline{AS} (Address Strobe) goes low. Since IC49-b is reset, its $\overline{REFRESH}$ output is low and $\overline{REFRESH}$ is high. Furthermore, since IC49-a is also reset, the \overline{CAS} and $\overline{DRAM DTACK}$ outputs are both low.

When the 68000 wants to access DRAM (either to write to it or to read from it), it places a valid address on the address bus. The address decoder (discussed in the January issue and shown in Fig. 3 of that article) recognizes the address as referring to the DRAM, and sends out the \overline{DRAM} enable signal which goes to IC51-c (shown in Fig. 1) to initiate a DRAM cycle. The signal travels a long distance on the board, so C68, a 33-pF capacitor, is used to reduce noise pickup. When \overline{DRAM} goes low, pin 10 of IC51-c is also low (as we will see in a moment), so IC51-c sends a low pulse to pin 10 of IC37-c.

(Actually, IC51-c is an OR gate, but it is shown as an AND gate with bubbles on both its inputs and its outputs. That notation was explained in the January 1988 installment.)

So, to recap, when the 68000 wants to access DRAM, the \overline{RAM} signal is asserted, and that in turn makes pin 8 of IC51-c go low. Then pin 8 of IC37-c goes high. That signal now does two things.

First, it is inverted to a low by IC66-d to generate \overline{RAS} , the Row Address Strobe that tells the DRAM IC's to accept a row address. \overline{RAS} also goes to pin 12 of IC51-d; because

pin 13 is already low (just like pin 10), pin 11 of IC51-d also goes low. That provides a second low to IC37-c, ensuring that it continues to output a high on pin 8 even if the \overline{DRAM} signal should disappear. That's not important now, though, because the \overline{RAM} signal will not disappear until after the DRAM operation is complete. (In other words, that circuit is only needed during refresh.)

Second, the high on pin 8 of IC37-c also goes to IC52, a 150-nanosecond delay line. That IC does what the name implies—it delays signals. It has several outputs, of which we use two. Whenever a logic signal is applied to its input on pin 1, that signal is delayed and appears on the outputs a specified delay-time later. The total delay line is specified as 150 nanoseconds (ns), which means that the input comes out the last output, pin 8, 150 ns after it entered. But the delay line also has an intermediate output on pin 12, which provides only a 30-ns delay. (When you think about it, 30 ns is a very short time. For example, a beam of light—the fastest thing we know of—travels only about 30 feet in 30 ns!)

Until now, the input to the delay line was low, so both of its outputs were low. Pin 8 of IC52 therefore has been sending a low back to IC51-c and IC51-d. Meanwhile, pin 12 of IC52 has been sending a low to flip-flop IC49-a, to pin 4 of IC35-b, and to the $\overline{A/B SELECT}$ line. After the 30-ns delay, however, pin 12 of IC52 goes high. That toggles the $\overline{A/B SELECT}$ signal from low to high, and it also clocks flip-flop IC49-a. Since the data input (pin 2) of the flip-flop is already high (since flip-flop IC49-b was reset, $\overline{REFRESH}$ was high), the flip-flop now sets and sends out a high on \overline{CAS} and $\overline{DRAM DTACK}$.

Now let's jump ahead to Fig. 2 and see what is happening in the DRAM address multiplexers. As mentioned last time, the DRAM address pins receive three separate addresses. During normal memory operation, first they receive a row address, then a column address; during

Further Help

If you need further help, contact us through our BBS at 914-241-3307. If that is not possible, hardware questions can be answered by Peripheral Technology, 1480 Terrell Mill Rd. #870, Marietta GA 30067, (404) 984-0742. Software questions dealing with the HUMBUG monitor program or the SK*DOS disk operating system can be answered by Star-K Software Systems Corp., P. O. Box 209, Mt. Kisco NY 10549, (914) 241-0287.

Ordering Information

Complete details were given in part one (in the October 1987 issue). To summarize: the basic kit (PT1, \$200) contains all parts except power supply, case, and video terminal or personal computer to get a small system (ROM monitor, 2K RAM) up and running. The full basic system (PT-68K, \$530) includes 512K of dynamic RAM, floppy-disk controller, parallel port, battery-backed clock/calendar, three PC-compatible expansion slots, SK*DOS operating system, editor, assembler, and system utilities. To order, or for more information, contact Peripheral Technology, 1480 Terrell Mill Road #870, Marietta GA 30067, (404) 984-0742.

Fig. 2 generates the refresh address, which can be sent to the DRAM's through a set of three-state buffers in IC61 if their \overline{OC} (Output Control) input goes low. But since $\overline{REFRESH}$ is high, that keeps \overline{OC} high and therefore prevents the refresh address from getting to the DRAM's.

Instead, the low $\overline{REFRESH}$ signal is applied to the \overline{g} (gate) inputs of IC88, IC75, and IC62. Each is a "quad two-input multiplexer", meaning that it contains four multiplexers, each with two inputs. The A/B SELECT input on each IC selects which of the two inputs is sent to the output of each multiplexer. Scanning down the inputs of IC88, for example, A1 goes to output MA3 if the A/B SELECT input is low, or A5 goes to MA3 if the A/B SELECT input is high. Similarly, either A2 or A6 goes to MA2, depending on the A/B SELECT input. Notice that the A inputs and MA outputs seem to be mixed up in a crazy order, which seems as though the memory is going to be very confused. In actual operation, it simply means that every time the 68000 stores something into memory it will go into what looks like the wrong location; but the next time the 68000 wants to read it back, it will be read back from the same wrong location, so the correct data will come back out.

At the beginning of the operation, A/B SELECT was low, so each of the multiplexers chose one set of nine bits to send to the MA outputs. But after the delay line outputs a high A/B SELECT, the multiplexers switch and send the other nine address bits to the MA outputs. The first set of nine bits was the row address; the second set is the column address. Although it looks as though the column address comes out just 30 ns after the row address, actually the

refresh, they receive a refresh address. The multiplexers shown in Fig. 2 select which of those three addresses is applied when.

In our circuit descriptions until now, $\overline{REFRESH}$ has been low and $\overline{REFRESH}$ has been high. The circuitry at the top of

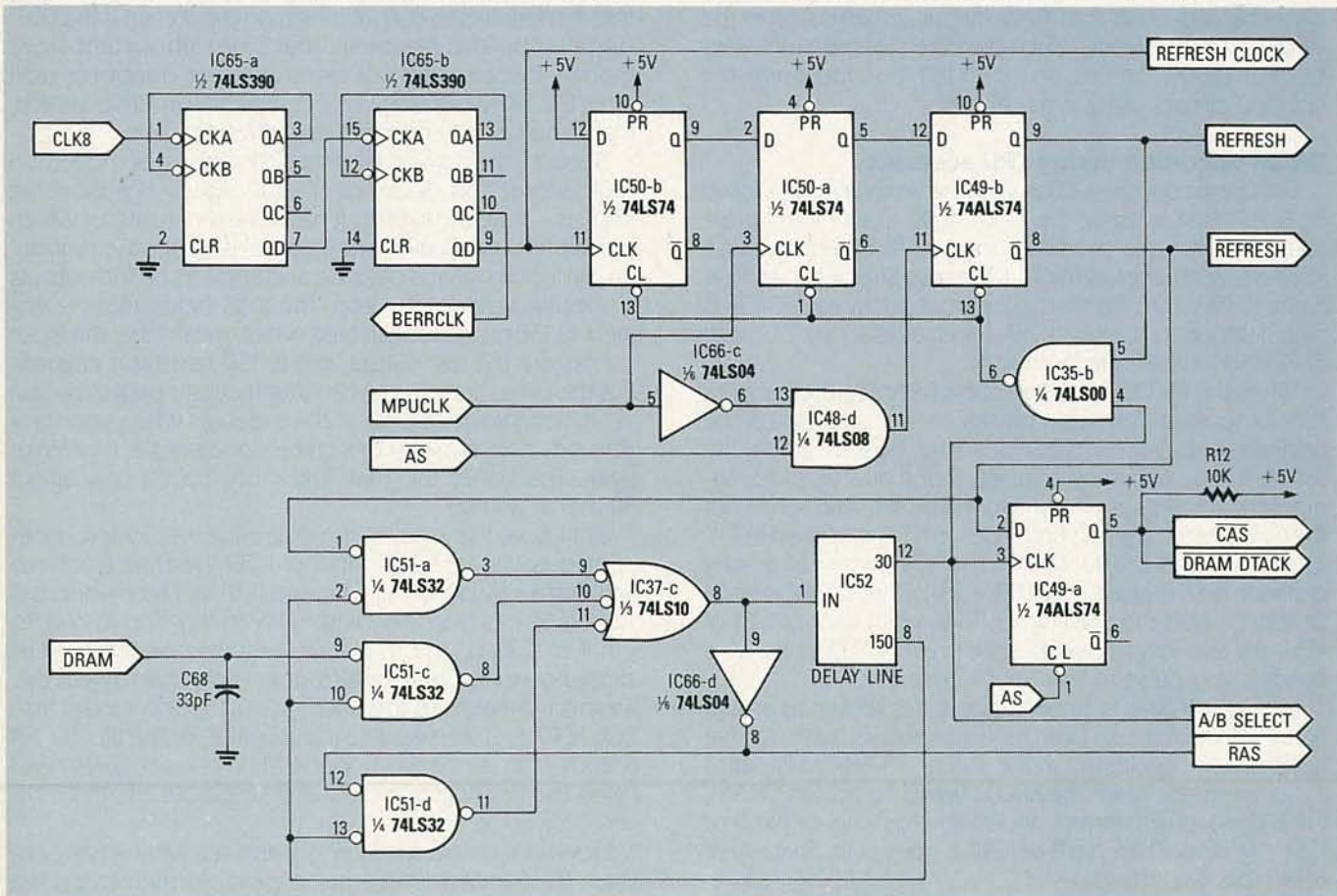

FIG. 1—THE PT-68K'S TIMING CIRCUITRY. The system clock (CLK8) is divided by 100 by IC65-a and IC65-b; it, in combination with MPUCLK, AS, and DRAM generate the refreshable signals that allow DRAM to be refreshed.

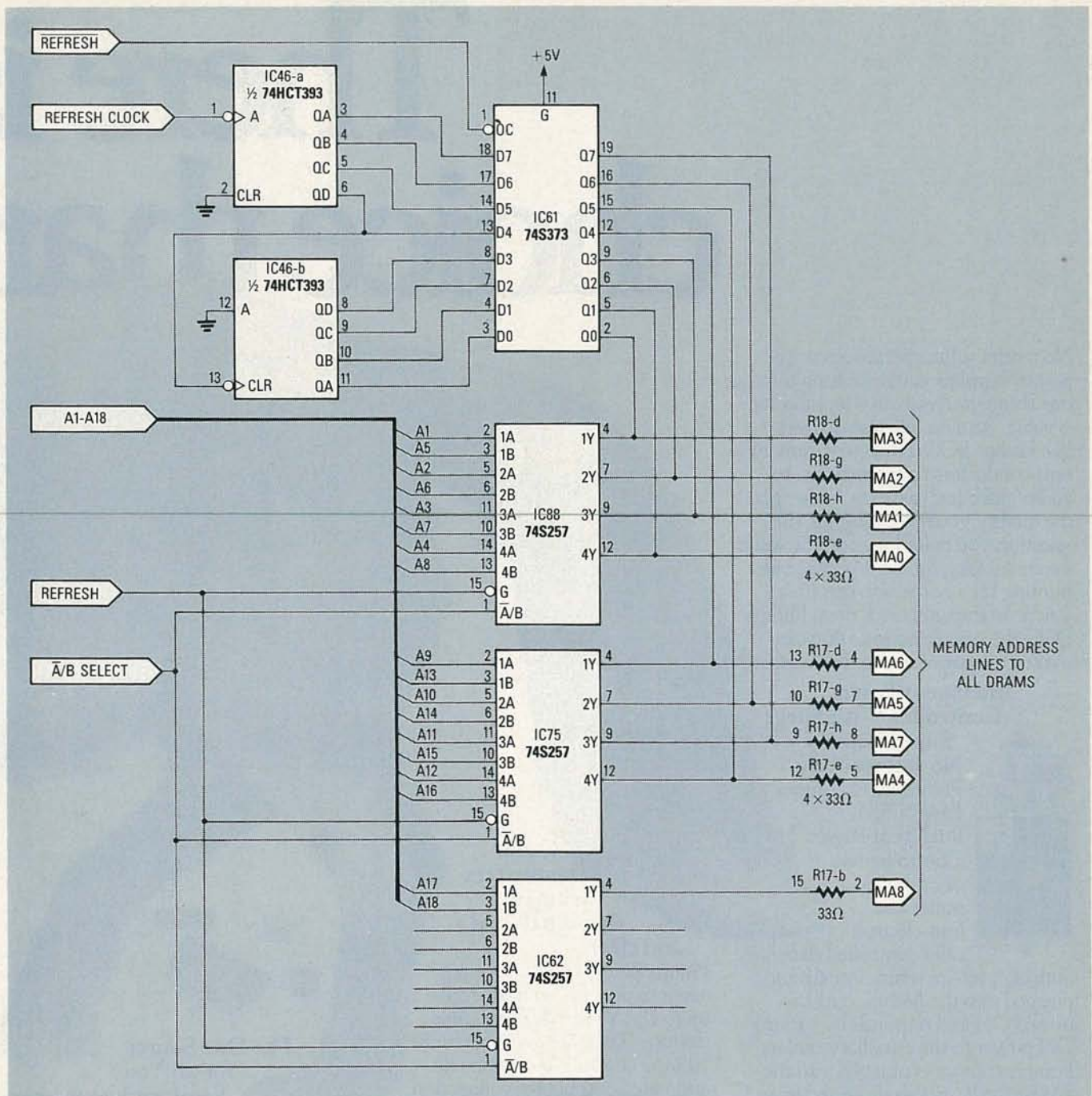

FIG. 2—THE PT-68K'S ADDRESS MULTIPLEXERS. IC61 provides the refresh addresses; IC62, IC75, and IC88 provide row and column addresses.

delay is somewhat greater. The row address is applied to the DRAM IC's as soon as the 68000 starts its memory operation; the column address is not applied until after the address decoder has recognized the DRAM address and sent out the \overline{RAM} signal, which must then go through IC51-c and IC37-c before even entering the delay line.

To summarize, operation proceeds as follows:

1) The 68000 sends out an address; since REFRESH and A/B SELECT are both low, nine bits of the address go to the DRAM's as a row address.

2) The address decoder sends out \overline{RAM} , which starts the DRAM circuitry.

3) \overline{RAS} goes low.

4) After a short delay, A/B SELECT goes high and sends the other nine address bits (column address) to the DRAM's.

5) \overline{CAS} goes low.

6) DRAM DTACK goes low.

Note that \overline{DTACK} normally signals the 68000 that a data transfer is completed, yet the DRAM access is nowhere near being finished. To operate the computer at maximum speed, \overline{DTACK} is sent to the DTACK circuitry (IC36, shown in Fig. 5 of the January issue) before the DRAM actually finishes the operation. The 68000 doesn't respond for several more clock pulses, so the DRAM will have enough time to finish what it is doing before the 68000 continues its operation.

Regretfully, our discussion must wait until next month because we've run out of space. However, when we return, we'll continue our discussion on the DRAM circuitry's operation.

There is choice than

No matter what specific electronic part or supplies you're looking for, the one thing you're always looking for is value. And no one else delivers it like Philips ECG. From replacement semiconductors to multimeters to audio/video test cassettes, we've got the quality you're looking for, the selection you're looking for, the value you're looking for. So if you've been hunting for a name you can trust, you're on the right track now. Philips ECG: the smartest choice you can make in electronic parts and supplies.

Intelligent Power Controller With Surge Suppression –

No smarter buy.

Philips ECG's unique EMF-515MC

Intelligent Power Controller has

one Master outlet and

four electronically controlled Auxiliary

outlets. It senses when something plugged into the Master outlet is turned ON and responds by turning ON power to the Auxiliary outlets. Equipment that is plugged into the EMF-515MC is also protected from transient voltage spikes on the power line three ways: hot to neutral, hot to ground and neutral to ground.

CIRCLE 201 ON FREE INFORMATION CARD



The DM-300 Multimeter puts it all in the palm of your hand.

Most multimeters' accuracy stops at 0.5%. Not the ECG DM-300!

This little dynamo delivers 0.25% accuracy! The ECG DM-300 also

has a transistor test, diode and continuity tests and is overload protected. These features and 0.25% accuracy make the DM-300 almost unbeatable!

CIRCLE 260 ON FREE INFORMATION CARD

Cable
converters
bring in
the signal loud
and clear.

Philips ECG's cable converters adapt to any TV set and receive up to 139 VHF, UHF and cable stations. They are available with volume control, separate audio and video outputs for connection to stereo and VCR systems to bring it all to you loud and clear! No matter what type of TV, Philips ECG has the converter for you.



CIRCLE 261 ON FREE INFORMATION CARD

The One Source for all Your Semiconductor Needs.

In the confusing world of electronic replacement parts, there's only one name you have to remember for all your semiconductor needs. Philips ECG. With nearly 4000 semiconductors that replace over 240,000 industry types, Philips ECG is your one source. Philips ECG's high-quality semiconductors meet most entertainment and industrial/commercial MRO replacement needs, enabling you to stock fewer parts. All of which saves you time, space and money!

CIRCLE 262 ON FREE INFORMATION CARD

no smarter Philips ECG.



Philips ECG Time Delay Relays deliver accuracy, versatility and value.

Philips ECG time delay relays are available in several time and ampere versions for optimum versatility. Series 40 and 42 are 10 ampere relays and have a range of 0.1 seconds to 5 minutes. Series 44 and 46 are 12 ampere relays with time ranges of 0.1 seconds to 3 minutes. Repeat cycle
CIRCLE 263 ON FREE INFORMATION CARD



timers, Series 48, are also available with timing ranges from 0.1 seconds to 3.0 minutes. All have input transient protection to prohibit false triggering or damage to circuitry and are UL approved. And because Philips ECG relays replace more original relay types than any other brand, there's no smarter choice.

Philips ECG's PR-60 & PR-200: The Answer to Your Scope Probe Needs.

Whether you're an engineer, technician or a hobbyist, we've got the scope probes you're looking for. Not only in terms of features—and these models are loaded—but in terms of value. Each has switchable ground reference plus X1 and X10 attenuation for a range of applications. And each is compatible with most popular oscilloscopes. For the smart choice in scope probes, look to Philips ECG!
CIRCLE 264 ON FREE INFORMATION CARD



Philips ECG Chemical Products keep your Equipment up and running!

Regular maintenance is the key to maximizing the operating efficiency of all electronic equipment. Philips ECG offers a wide assortment of High Technology Chemicals that will assure optimum equipment performance. The line includes heavy duty flux remover, all-purpose degreaser, high-purity circuit refrigerant, a general contact cleaner, and a superior spray lubricant. All are available in convenient aerosol cans or in various sizes. And all are from Philips ECG, the industry leader!



You know your business. You know what you need in electronic parts and supplies. And now you know where to get them. Philips ECG. Consistent high quality you can believe in. An incredible inventory of equipment and supplies. Reliable value all up and down the line. Contact your local Philips ECG distributor or call 1-800-225-8326. It just might be the smartest call you make all day.

The Smart Choice.
Philips ECG

A North American Philips Company

CIRCLE 68 ON FREE INFORMATION CARD

© 1988, Philips ECG

JULY 1988

97

REACTS

continued from page 50

vate the water valves, and how many valves will be activated simultaneously. When you are calculating the power that is needed, remember to consider the amount of current that is used by the water valve's solenoid when it is first activated (the inrush current), which will be somewhat higher than the holding current of the solenoid.

In most cases, each of the octal I/O relays would activate only one valve. Therefore the relays, which are rated at 6 amps, will have no trouble at all, as the average consumer water valve requires less than 1 amp. Be sure to protect the transformer against shorts and overloads with the proper size fuse.

Also, follow the water-valve manufacturer's guidelines pertaining to the minimum diameter of the wire to be used, and their recommendations on waterproofing the wire and the connections. Finally, be sure to adhere to any local building codes that may apply to the installation. It's worth it in the long run.

For information on water valves, sprinkler heads, etc., contact your local lawn and garden supply store. Two major manufacturers of consumer sprinkler-system products are Toro and Rainbird. You should be able to find them, and many other manufacturers of such equipment, in the yellow pages.

In conclusion

By now, we hope that the wheels in your head have started turning as to what the REACTS modular system can do for you. It is no secret that computers are now being used for more than just number crunching, word processing, drafting, etc. The system we have been showing you makes computerized home control affordable. It also bridges the gap between process controllers and personal computers.

In the articles to come, we will discuss and build more of the process-control modules. We will also construct modules that will enhance the system, such as the battery-backed power supply and the CRT controller/printer interface. We hope you will stay with us. **R-E**

LC METER

continued from page 45

and work with a simple binary counter scheme composed of inexpensive CMOS chips, required an Apple II program that ran for almost 4¼ hours.

The program that calculated all the required function addresses for the EPROM for each of the approximately 15,000 solutions to the equation ran for another 2½ hours. And after all the time spent calculating the EPROM data, the builder would need access to an EPROM programmer. To simplify everything, a programmed EPROM is available from the source listed in the Parts List.

Just in case you decide to test the EPROM data against your own calculations, bear in mind that the EPROM data have been compensated for the parasitic capacitive and inductance values that exists across the instrument's input terminals.

That's it for the theory. Next month we'll build and align the LC meter so that you can begin using it in your lab.

R-E

GPIB

continued from page 60

There are system and measuring-related constraints that also affect the data-transfer rate. Examples of those are high resolution (5 1/2 to 6 1/2 digit) voltmeters that use the very slow integrating A-to-D (analog-to-digital) techniques, precision low frequency counting, and narrow band spectrum analysis. Those slow real-time measuring processes were fine when a human could wait 5 or 10 seconds for a measurement to come up; however, with automated test instruments that make measurements within the millisecond range, that time frame is no longer acceptable. As a result, the test-equipment industry is converting to high-speed sampling techniques, burst measurements, smart peripherals, block-memory transfers, direct-memory accesses, and other such methods that allow the data throughput rate to be bound only by the transfer-rate of the computer-interface combination.

When we continue, we'll look at GPIB accessories and how to analyze and troubleshoot the bus. **R-E**

Radio-Electronics



APPLIANCE REPAIR HANDBOOKS—13 volumes by service experts; easy-to-understand diagrams, illustrations. For major appliances (air conditioners, refrigerators, washers, dryers, microwaves, etc.), elec. housewares, personal-care appliances. Basics of solid state, setting up shop, test instruments. **\$2.65 to \$7.90 each**. Free brochure. **APPLIANCE SERVICE, P.O. Box 789, Lombard, IL 60148. (312) 932-9550.**

CIRCLE 84 ON FREE INFORMATION CARD



THE MODEL WTT-20 IS ONLY THE SIZE OF A DIME, yet transmits both sides of a telephone conversation to any FM radio with crystal clarity. Telephone line powered - never needs a battery! Up to ¼ mile range. Adjustable from 70-130 MHZ. Complete kit **\$29.95 + \$1.50 S+H**. Free Shipping on 2 or more! COD add **\$4**. Call or send VISA, MC, MO. **DECO INDUSTRIES, Box 607, Bedford Hills, NY 10507. (914) 232-3878.**

CIRCLE 127 ON FREE INFORMATION CARD



M-BREAKOUT SOLVES RS-232 COMPATIBILITY PROBLEMS FAST!!! • Breaks/re-directs all 25 signals • 52 LED's give 4-state indication on all signals • Current loop test • No batteries required • Gold plated contacts • 8 jumper cables • Durable ABS plastic case • Manual and carrying pouch • We ship UPS 2nd day within 24 hours of order • Regularly **\$150**, R&E Special **\$135**, **M-TEST EQUIPMENT, P.O. Box 146008, San Francisco, CA 94114-6008, (415) 861-2382 FAX (415) 864-1076**

CIRCLE 200 ON FREE INFORMATION CARD

mini-ADS

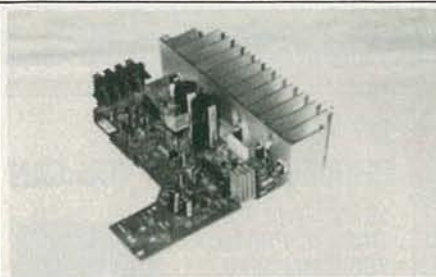

HIGH OUTPUT MOSFET AMPLIFIER DELIVERS 100 WATTS RMS INTO 8 OHMS at less than .01% THD, (20-20,000HZ). Turn on delay minimizes pops and clicks from output. Output devices protected from overload. RCA input jack and adj gain control allow easy connection to pre-amp or other signal source. ASS'M PC board complete with heatsink: **\$59.95** X'FORMER for above: **\$13.95**. **ETE ENGINEERING, 1750 S. Price #236, Tempe, AZ 85281 (602) 921-3474.**

CIRCLE 88 ON FREE INFORMATION CARD



RADAR SPEED UNIT. For clocking speeds in baseball, racing, etc. Used Decatur MV-715 professional X-band model. Moving and stationary use, dual display, **SPECIAL \$269 + \$8 shipping** (continental US), including case and tuning forks. Other used radars from **\$275**. ZENITH SSAVI UHF from **\$199**, ch. 3 input **\$229**, reconditioned. UHF SSAVI project handbook **\$6.50** ppd. N-12s & MLD-1200s. Satellite & telephone systems. Catalog **\$1**. **AIS SATELLITE, INC., P.O. Box 1226-B, Dublin, PA 18917. 215-453-1400.**

CIRCLE 81 ON FREE INFORMATION CARD



FREE CATALOG OF HARD-TO-FIND TOOLS is packed with more than 2000 quality items. Your single source for precision tools used by electronic technicians; engineers, instrument mechanics, schools, laboratories and government agencies. Also contains Jensen's line of more than 40 tool kits. Send for your free copy today! **JENSEN TOOLS INC., 7815 46th St., Phoenix, AZ 85044. (602) 968-6231.**

CIRCLE 115 ON FREE INFORMATION CARD

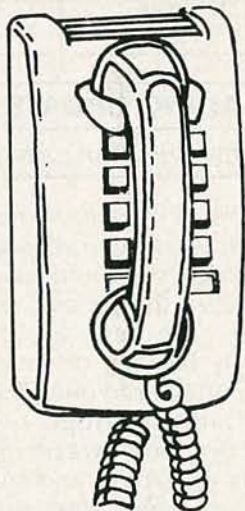

CALL NOW AND RESERVE YOUR SPACE

- 6 x rate \$815.00 per each insertion.
- Fast reader service cycle.
- Short lead time for the placement of ads.
- We typeset and layout the ad at no additional charge.

Call **516-293-3000** to reserve space. Ask for Arline Fishman. Limited number of pages available. Mail materials to: mini-ADS, RADIO-ELECTRONICS, 500-B Bi-County Blvd., Farmingdale, NY 11735.

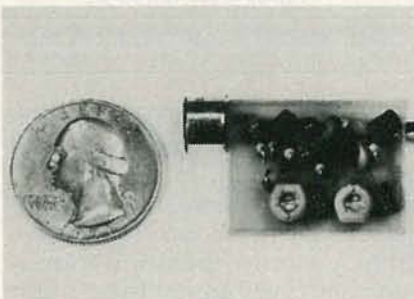

SIMPLY SNAP THE WAT-50 MINIATURE FM TRANSMITTER on top of a 9v battery and hear every sound in an entire house up to 1 mile away! Adjustable from 70-130 MHz. Use with any FM radio. Complete kit **\$29.95 + \$1.50 S + H**. Free shipping on 2 or more! COD add \$4. Call or send VISA, MC, MO. **DECO INDUSTRIES, Box 607, Bedford Hills, NY 10507. (914) 232-3878.**

CIRCLE 127 ON FREE INFORMATION CARD



TEST EQUIPMENT, PRE-OWNED, NOW AT AFFORDABLE PRICES. Signal generators, from **\$50**; Oscilloscopes from **\$50**. Other equipment, including Manuals available. Send for catalog. **J.B. ELECTRONICS, 9518 Grand Ave., Franklin Park, IL 60131. (312) 451-1750**

CIRCLE 202 ON FREE INFORMATION CARD



PANASONIC CABLE CONVERTERS, Wholesale and Retail. Scientific Atlanta and Pioneer Cable Converters in stock. Panasonic model 140N 68 channel converter **\$79.95**, Panasonic Amplified Video Control Switch Model VCS-1 **\$59.95**. Scientific Atlanta Brand new Model #8528 550MHZ 80 Channels Converter **\$89.95**. Video Corrector (MACRO, COPYGUARD, DIGITAL) ENHANCER **\$89.95**. We ship to Puerto Rico, Caribbean countries, & So. Amer. Write or call **BLUE STAR IND., 4712 AVE. N, Dept 105, Brooklyn, NY 11234. Phone (718) 258-9495.**

CIRCLE 85 ON FREE INFORMATION CARD

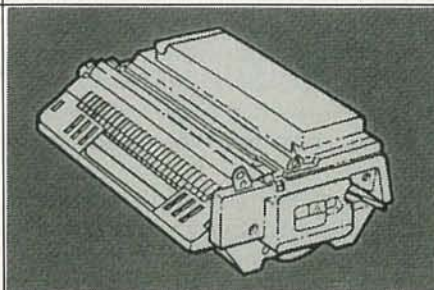

RECHARGE LASER PRINTER TONER CARTRIDGES—Earn big \$\$ in your spare time—All supplies and Do-It-Yourself kits with complete instructions available. Supplies cost from **\$10.95** in qty and you can sell recharged toner cartridges for **\$40.00 to \$55.00** each. Printers include HP LaserJet and Series II, Apple LaserWriter, QMS, etc. Canon PC-25 Copier also. **CHENESKO PRODUCTS, 21 Maple St., Centereach, NY 11720, 516-736-7977, Fax: 516-732-4650**

CIRCLE 192 ON FREE INFORMATION CARD

R-E Engineering Admart

Rates: Ads are 2 1/4" x 2 7/8". One insertion \$825. Six insertions \$800 each. Twelve insertions \$775 each. Closing date same as regular rate card. Send order with remittance to **Engineering Admart**, Radio Electronics Magazine, 500-B Bi-County Blvd., Farmingdale, NY 11735. Direct telephone inquiries to Arline Fishman, area code-516-293-3000. Only 100% Engineering ads are accepted for this Admart.

MIDI PROJECTS



BP182—MIDI interfacing enables any so equipped instruments, regardless of the manufacturer, to be easily connected together and used as a system with easy computer control of these music systems. Combine a computer and some MIDI instruments and you can have what is virtually a programmable orchestra. To get your copy send \$6.95 plus \$1.00 for shipping in the U.S. to **Electronic Technology Today Inc.**, P.O. Box 240, Massapequa Park, NY 11762-0240.

FCC LICENSE PREPARATION

The FCC has revised and updated the commercial license exam. The **NEW EXAM** covers updated marine and aviation rules and regulations, transistor and digital circuitry. **THE GENERAL RADIOTELEPHONE OPERATOR LICENSE - STUDY GUIDE** contains the necessary preparation for **ONLY \$25.00**.

WPT PUBLICATIONS
979 Young Street, Suite A
Woodburn, Oregon 97071
Phone (503) 981-6122

CIRCLE 185 ON FREE INFORMATION CARD

117 PRACTICAL IC PROJECTS BUILD YOU CAN

2645T—117 PRACTICAL IC PROJECTS YOU CAN BUILD.....

\$10.95. Dozens of fully-tested, ready-to-build circuits you can put together from readily-available, low cost IC's! There are a total of 117 IC circuits ranging from an audio mixer and a signal splitter to a tape-deck amplifier and a top-octave generator organ! From TAB Books. To order your copy send **\$10.95 plus \$2.75 shipping** to **Electronic Technology Today Inc.**, P.O. Box 240, Massapequa Park, NY 11762-0240



HARDWARE HACKER

continued from page 73

catalog number 109. Of all those traditional "old line" electronics distributors, they have always been one of my favorites. They stock just about everything, but you'll find that they tend to be both pricey and more than a tad anti-hacker.

Or, for a much smaller "new age" distributor that goes out of their way to stock single quantities of interesting and oddball hacker integrated circuits, try Circuit Specialists. Among their numerous other goodies, they now stock the Sprague ULN2429 liquid-level detector we looked at a few columns back. The cost for that device is only \$1.80.

The Micro Switch people have a new and free *Specifier's Guide for Pressure Sensors* in print. But the SenSym people have far better apnotes and much more affordable pricing when it comes to hacker pressure-transducer and interface stuff.

The Mitsubishi Series 740 CMOS Microcontrollers are outlined in a new and free brochure. Those 6502-style devices are the best selling microcomputer IC's in the world today. My personal fa-

vorite here is the M50734, A 128K beastie that includes 40 parallel I/O lines, a built-in serial UART, four A/D converters, two stepper-motor drivers, a watchdog, five timers, a pulse-position modulator, and, last but not least, a soft ice-cream dispenser.

There's even enough pins on it that you may be able to use it in a pinch as an emergency cheese grater.

We'll see much more on that hacker gem in future columns. By one of those absolutely astounding coincidences, that M50734 just happens to drop right into the printed circuit shown in Fig. 5. Any old Apple IIe, IIc, or IIgs works just beautifully with that as a development system.

Turning to my own stuff, check into my classic *TTL* and *CMOS Cookbooks* if you happen to be interested in the fundamentals of digital integrated circuits. Something like 1,400,000 copies are now in print, which must be some sort of a record for technical paperbacks.

And I do have a "zeta release" available on all my new PostScript printed-circuit layout stuff available for you if you want to get in on all the action ahead of the hoarders.

Let's hear from you.

R-E

AUDIO UPDATE

continued from page 74

By now, if my short tutorial on resonance has been absorbed, attentive readers should have some insight into the groove-skipping problem. The new cartridge was obviously heavier, or more compliant than the old one. That shifted the arm/cartridge resonant frequency downward into the warp danger-zone, and tone-arm lift-off occurred when the resonance was triggered by a warp at or near the critical frequency of the arm/cartridge combination.

The obvious solution is a cartridge whose compliance, or weight more closely resembles the old one, which apparently worked out well with the tone arm. The moral of the story—for those who want such things—is that there's a risk in choosing a cartridge or a tone arm in isolation. The two must be selected (or designed) as a compatible team to ensure that the resonances occur in the preferred range. Incidentally, because there are no mechanical interactions between a compact disc and the laser beam that "plays" it, CD players, as a rule, do not generally suffer from any resonance problems.

R-E

MARKET CENTER

FOR SALE

TUBES, new, unused. Send self-addressed, stamped envelope for list. **FALA ELECTRONICS**, Box 1376-2, Milwaukee, WI 53201.

DESCRAMBLERS. All brands. Special: Jerrold combo 400 and SB3 \$165. Complete cable descrambler kit \$39. Complete satellite descrambler kit \$45.00. Free catalog. **MJM INDUSTRY**, Box 531, Bronx, NY 10461-0531.

PHOTOFACT folders, under #1400 \$3.00. Others \$5.00. Postpaid. **LOEB**, 414 Chestnut Lane, East Meadow, NY 11554.

TRANSISTORS-tubes: MRF421 \$24.00, MRF454 \$14.50, MRF455-MRF477 \$11.75, MRF492 \$16.00, SRF2072 \$12.75, SRF3800 \$17.50, 2SC2290 \$16.75, 2SC2879 \$22.00, 6LF6, 6LQ6, 6JS6, 8950, etc-call. New **Ranger AR3500** all mode 10 Meter transceiver \$319.00. Quantity discounts! Best prices on hard-to-find parts, antennas, mics, power supplies, & equipment! Catalog \$1.00 (refundable), or free with order. **RFPC**, Box 700, San Marcos, CA 92069. For information or same day shipment—call (619) 744-0728. Visa/MC/C.O.D.

CLASSIFIED AD ORDER FORM

To run your own classified ad, put one word on each of the lines below and send this form along with your check to:

Radio-Electronics Classified Ads, 500-B Bi-County Boulevard, Farmingdale, NY 11735

PLEASE INDICATE in which category of classified advertising you wish your ad to appear. For special headings, there is a surcharge of \$23.00.

() Plans/Kits () Business Opportunities () For Sale
() Education/Instruction () Wanted () Satellite Television

Special Category: \$23.00

PLEASE PRINT EACH WORD SEPARATELY, IN BLOCK LETTERS.

(No refunds or credits for typesetting errors can be made unless you clearly print or type your copy.) Rates indicated are for standard style classified ads only. See below for additional charges for special ads. **Minimum: 15 words.**

1	2	3	4	5
6	7	8	9	10
11	12	13	14	15 (\$42.75)
16 (\$45.60)	17 (\$48.45)	18 (\$51.30)	19 (\$54.15)	20 (\$57.00)
21 (\$59.85)	22 (\$62.70)	23 (\$65.55)	24 (\$68.40)	25 (\$71.25)
26 (\$74.10)	27 (\$76.95)	28 (\$79.80)	29 (\$82.65)	30 (\$85.50)
31 (\$88.35)	32 (\$91.10)	33 (\$94.05)	34 (\$96.90)	35 (\$99.75)

We accept MasterCard and Visa for payment of orders. If you wish to use your credit card to pay for your ad fill in the following additional information (Sorry, no telephone orders can be accepted.):

Card Number

Expiration Date

Please Print Name

Signature

IF YOU USE A BOX NUMBER YOU MUST INCLUDE YOUR PERMANENT ADDRESS AND PHONE NUMBER FOR OUR FILES. ADS SUBMITTED WITHOUT THIS INFORMATION WILL NOT BE ACCEPTED.

CLASSIFIED COMMERCIAL RATE: (for firms or individuals offering commercial products or services) \$2.85 per word prepaid (no charge for zip code)...**MINIMUM 15 WORDS**. 5% discount for same ad in 6 issues; 10% discount for same ad in 12 issues within one year; if prepaid. **NON-COMMERCIAL RATE:** (for individuals who want to buy or sell a personal item) \$2.30 per word, prepaid...no minimum. **ONLY FIRST WORD AND NAME** set in bold caps at no extra charge. Additional bold face (not available as all caps) 50¢ per word additional. Entire ad in boldface, \$3.40 per word. **TINT SCREEN BEHIND ENTIRE AD: \$3.55 per word. TINT SCREEN BEHIND ENTIRE AD PLUS ALL BOLD FACE AD: \$4.15 per word. EXPANDED TYPE AD: \$4.30 per word prepaid.** Entire ad in boldface, \$5.15 per word. **TINT SCREEN BEHIND ENTIRE EXPANDED TYPE AD: \$5.40 per word. TINT SCREEN BEHIND ENTIRE EXPANDED TYPE AD PLUS ALL BOLD FACE AD: \$6.25 per word. DISPLAY ADS:** 1" x 2 1/4"—\$320.00; 2" x 2 1/4"—\$640.00; 3" x 2 1/4"—\$960.00. **General Information:** Frequency rates and prepayment discounts are available. **ALL COPY SUBJECT TO PUBLISHERS APPROVAL. ADVERTISEMENTS USING P.O. BOX ADDRESS WILL NOT BE ACCEPTED UNTIL ADVERTISER SUPPLIES PUBLISHER WITH PERMANENT ADDRESS AND PHONE NUMBER.** Copy to be in our hands on the 12th of the third month preceding the date of the issue. (i.e., Aug. issue copy must be received by May 12th). When normal closing date falls on Saturday, Sunday or Holiday, issue closes on preceding working day. Send for the classified brochure. Circle Number 49 on the Free Information Card.

SATELLITE & cable equipment. We have those hard-to-find units ready to go. Tired of junk that doesn't work properly? Try our 10 day satisfaction guarantee & 90 day warranty (wholesale only). **HI TECH ELECTRONICS**, PO Box 42423, Detroit, MI 48242, (313) 722-9381.

LASERS, components and accessories. Free catalog. **M.J. NEAL COMPANY**, 6672 Mallard Court, Orient, OH 43146.

PICTURE flyer lists quality surplus electronics at low prices. Since 1970. Send for the last 3 issues. **STAR-TRONICS**, Box 683, McMinnville, OR 97128.

CB RADIO OWNERS!

We specialize in a wide variety of technical information, parts and services for CB radios. 10-Meter and FM conversion kits, repair books, plans, high-performance accessories. Over 12 years of satisfied customers! Catalog \$2.

CBC INTERNATIONAL
P.O. BOX 31500RE, PHOENIX, AZ 85046

MICROWAVE antennas, multichannel 1.9-2.7 Ghz dual polarity. From only \$49.95. "Best in the west!" **GALAXY ELECTRONICS**. Call 1 (602) 939-1151.

TUBES, name brands, new, 80% off list. **KIRBY**, 298 West Carmel Drive, Carmel, IN 46032.

IS it true...jeeps for \$44 through the government? Call for facts! 1-(312) 742-1142, ext. 4673.

TV tunable notch filters. free brochure. **D.K. VIDEO**, Box 63/6025, Margate, FL 33063 1-(305) 752-9202.

RUN three-phase motors on single phase, free brochure. **MOTORS**, Box 63/6025, Margate, FL. 33063 1-(305) 752-9202.

TUBES. "Oldest," "latest." Parts and schematics. SASE for list. **STEINMETZ**, 7519 Maplewood Ave., R.E. Hammond, IN 46324.

SOLAR battery chargers. Homes, RVs, boats. From \$30.00. Brochure. **SUNPOWER**, Texas, Dept. 01B, P.O.B. 2788A, Freeport, TX 77544.

TESLA coils—Kirlian electrophotography—plasma bulbs...Free 1988 science plan catalog! **SCIEN-TIFIC**, Box 1054HRH, Duvall, WA 98019.

FREE CATALOG

FAMOUS "FIRESTIK" BRAND CB ANTENNAS AND ACCESSORIES. QUALITY PRODUCTS FOR THE SERIOUS CB'er. SINCE 1962
FIRESTIK ANTENNA COMPANY
2614 EAST ADAMS
PHOENIX, ARIZONA 85034

GREAT buys! Surplus prices, ICs, linears, transformers, PS, stepping motors, vacuum pump, phototransistor, meters, Isase, **FERTIK'S**, 5400 Ella, Phila., PA 19120.

SURPLUS Zenith Z100 computer motherboards. No RAM/ROM, over 100 chips in sockets including 8088, 8085, 74LSxxx, 74ALSxx, crystals and more, \$49.95. Boards without chips \$12.95 shipping included. Visa Master. **LYNBAR INDUSTRIES**, (616) 983-3389.

NEW ACCESSORIES FOR THE MOTION CONTROL SYSTEM

SCANNER CONNECTS TO THE VIDEO LOGIC BOARD AND ALLOWS THE SYSTEM TO MONITOR 92 SWITCH/RELAY CONTACTS. ASSEMBLED & TESTED ORDER NUMBER 50/04 ADD \$4 FOR SHIPPING & HANDLING **35.00**

SPIN CONNECTS TO THE SERIAL PORTS AND ALLOWS PULSE WIDTH MODULATION OF TWO DC SERVO MOTORS. TRANSPARENT TO NORMAL USE OF SERIAL PORTS. OPTICAL ENCODER FEED BACK KEEPS THE MOTORS UNDER CONTROL! INCLUDES REFLECTIVE LEDS, ENCODER DISKS, DRIVER KIT, AND SOFTWARE. 4 PATTERN DRIVERS ALLOW FORWARD & REVERSE FROM ONE 12 VOLT POWER SUPPLY. FOR USE WITH MOTORS UP TO .6 AMPS AT 12 VDC ORDER NUMBER 50/05 ADD \$4 FOR SHIPPING & HANDLING **59.00**

POWER 8 AMPS OF POWER FOR LARGER MOTORS. OUTPUT MAY BE SPLIT TO DRIVE 2 4 AMP MOTORS, OR USE 2 TO DRIVE ONE 1 6 AMP MOTOR ORDER NUMBER 50/06 ADD \$3 FOR SHIPPING & HANDLING **19.99**

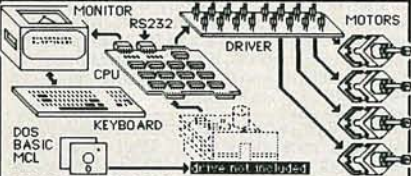

- GENERAL PURPOSE 64K SINGLE BOARD COMPUTER
- AMBER MONITOR WITH 80 BY 24 LINES DISPLAY
- QUALITY KEYBOARD WITH KEYPAD & FUNCTION KEYS
- 4 "EASY STEP" MOTORS AND DRIVER KIT
- PDS DOS: MICROSOFT BASIC AND PILOT LANGUAGE
- MOTOR CONTROL PROGRAM WITH SOURCE LISTING
- POWER SUPPLIES INCLUDED OR USE YOUR BATTERIES
- FULLY DOCUMENTED INCLUDING SCHEMATICS
- ALL BOARDS EXCEPT THE DRIVER ARE PREASSEMBLED
- DISK STORAGE (not included) EXPANDABLE TO 3.2 MEG
- ORDER NUMBER 50/03. PLEASE ADD \$14 FOR S&H

MOTION CONTROL SYSTEM \$149.00

Call for a copy of 15 day trial agreement. Tax & freight extra. COD to cont USA ok add \$3 to S&H. Price may change. Store price may differ. While supplies last. No PDs, terms, or credit cards

Silicon Valley Surplus
415-261-4506
4401 OAKPORT OAKLAND CA, 94601

OPEN 10am-6pm
CLOSED SUN & MON

CIRCLE 51 ON FREE INFORMATION CARD



FINALLY!

An interesting and worthwhile project. This **EASY-TO-BUILD** circuit lets you use any regular TV set as a simple **OSCILLOSCOPE**. Build for less than \$10. **NO MODIFICATIONS TO TV!** Single or dual trace. Send for **FREE CATALOG** of other plans and kits.

DETAILED PLANS: \$4.95

TV-SCOPE

PENN RESEARCH,
Box 3543
Williamsport, PA 17701

ELECTRONIC liquidators, computer kits, thousands of parts, chips, transistors, speakers, hardware, hobby kits, surplus, send \$3.50 for catalog. **BOX 27656, Lansing, MI 48901.**

TWO-Way-Radio, PC computers, Uniden service. General Radiotelephone licensed technician. Catalog-**RAYS**, 2025 Moline, Ft. Worth, TX 76117 (817) 831-7717.

ATTENTION laser holographic experimenters: optical computer components, instructions. \$22.95 postpaid. **STELLAR TECHNOLOGIES**, 4710 University Way N.E., #1003, Seattle, WA 98105.

AIDS? Yes we have! Cable aids to help you. Zenith, Jerrold, Scientific Atlanta, Oak, Hamlin, much more. No Michigan sales! **HOTRONICS**, (313) 675-5834.

ATTENTION, are you looking for surplus test equipment volt meters oscilloscope, etc. **J.B. ELECTRONICS**, 9518 W. Grand, Franklin Park, IL 60131, (312) 451-1750.

NUTS & VOLTS MAGAZINE

P.O. Box 1111-E
Placentia, CA 92670
714-932-7721

GIVE YOURSELF A BREAK — A PRICE BREAK!
NUTS & VOLTS WILL SAVE YOU MONEY ON ELECTRONIC PARTS & EQUIPMENT. Plus SHOW YOU WHERE TO FIND UNIQUE, UNUSUAL AND HARD-TO-FIND ITEMS.

SUBSCRIBE TODAY!

Subscription Rates	U.S. & CANADA RESIDENTS
3rd Class Mail-USA	One Year \$12.00
	Two Years \$21.00
	Lifetime \$60.00
1st Class Mail	One Year USA \$20.00
	CANADA/MEXICO \$22.00
	Air Mail
	Foreign 1 Yr \$55.00

A National Publication For The Buying And Selling Of Electronic Equipment

RESTRICTED technical information: Electronic surveillance, schematics, locksmithing, covert sciences, hacking, etc. **Huge selection. Free brochures. MENTOR-Z**, 135-53 No. Blvd., Flushing, NY 11354.

20 to 40% off retail computer parts! Free catalog. Dealers wanted. **NETCOM**, Box 12056-RE, Omaha, NE 68152.

Oak M35B combo \$90.00; **VSM35B** \$100.00; Eagle channel 3 double notch filters \$24.00; Jerrold DRZ-3DIC rebuilt combos, new cases, new remotes, \$175.00; Sylvania 4040 combos, wireless remotes, \$135.00; Eagle EVPDC wireless remote converter, descrambler, parental, favorite channel, fine tune, \$175.00; all prices COD delivered to you! **PONDEROSA**, (719) 661-1659.

FREE remote control converter with purchase of SB3, N12, VN12, SA3, etc. While quantities last. **PONDEROSA**, (719) 661-1659.

PLASTIC BAGS many sizes, types. Samples \$2 list LSASE. **BAGMAN**, E2 Box 466, Georgetown, TX 78627.

TUBES 59¢. Year guarantee. Free catalog. Tube checker \$8.95. **CORNELL**, 4215 University, San Diego, CA 92105.

SCHEMATIC drawing program for IBM compatibles. Printer output. S.A.S.E. for info. \$25 for program. **DJM**, 2329 So. County Divide, Pearl City, IL 61062.

LED lamps. Manufacturer direct to you! Specify color, R,G,Y or mixed. T1 3/4. Buy 200 PCs for \$19.00 postpaid. **EDC**, POB 4188, Burlingame, CA 94011-4188.

FAIR prices SB-3, SX3, SA3, TRI-BI, MLD-1200-3. Some Oak, any notch filters. Small dealer only. No Michigan sales (313) 979-8356.

FEDERAL legal memorandum: subscription T.V. includes descrambler use. \$16.95 \$2.00 P&H. **G.H. PUBLICATIONS**, RR1 Box 121, Hartland, MN 56042.

MAKE/save \$1000's, high technology insider secrets, catalog \$2.00 exotic parts; **LEEWARE**, Box 5636, Greensboro, NC 27435.

CONVERTER sales and repairs on all types S.A., Jerrold, Panasonic, Pioneer. **REDCOAT ELECTRONICS**, (718) 459-5088.

HACKER'S Handbook, \$12.95. **Computer Underground**, \$14.95, send \$1 postage. **CABLETRONICS**, Box 30502R, Bethesda, MD 20814.

COMMODORE-Amiga chips-diagnostics-parts-or low cost repair, (C64-\$39.95 including parts and labor). Send for complete catalog for the lowest price in town. **VISA/MC. KASARA, INC.**, 31 Murray Hill Drive, Spring Valley, NY 10977, 1-(800) 248-2983 (Nationwide) or (914) 356-3131.

FREE power supply, connectors (\$8.95 value) with Assortment #103 (February 1984 article) contains **PCB, Toko coils, transistors, IC's, diodes**. \$25.00. Five/\$12.50. **Assortment #104** contains all other parts. \$10. Shipping \$2.00. **JIM RHODES, INC.**, PO Box 3421, Bristol, TN 37625.

"**CB Trick of the Trade** book" learn CB repair tricks and transmitting theory. Send \$19.95 to **MEDICINE MAN**, CB P.O. Box 37, Clarksville, AR 72830.

FANTASTIC electric finder instantly tells if circuit is live or dead. Looks like a pen (battery operated). Specify AC or DC. \$11.00 includes postage and handling. Check/M.O. 2 extra batteries \$1.00. **F.A. BARNES**, Box 2396, Northbrook, IL 60065.

CABLE TV converter/descramblers—wholesale quantity pricing. 1-5-10-20: Jerrold 450 \$179-\$149-\$129-\$119; Tocom 5504 \$179-\$169-\$159-\$149; Oak M35B \$79-\$69-\$59-\$49; Jerrold 400 \$149-\$129-\$109-\$104; also converters, remotes, and more. 90 day warranty. **Visa, M/C, COD. ARIZONA VIDEO**, 3661 N. Campbell, #310, Tucson, AZ 85719. (602) 323-3330.

MOTOROLA Mostar radios 1 base, 1 telephone, 2 radios all hardware included \$8,500 value for \$4,000 firm (206) 754-4485.

DESCRAMBLERS! C.O.D. Quality, fast service. All types available. (in stock) SA8580-338's **S.E.E.D.** (800) 288-7333 or (404) 594-5376.

ELECTRONIC components available. Free flyer, SASE to **SANTECH ELECTRONICS**, 11 Revere Place, Tappan, NY 10983. (914) 359-1130, Telex: 155205423.

DESCRAMBLERS-converters wholesale prices example Jerrold 400 combo remote \$149.95 M35B-V/S \$79.95, SA-3 SB-3 \$69.95 all brands in stock, guaranteed. **S.A.C.** (702) 647-3799.

Quality Microwave TV Antennas

Multi-Channel 1.9 to 2.7 GHz. 40dB Gain
30-Channel System complete \$149.95
12-Channel System complete \$104.95
2-Channel System complete \$79.95

Phillips-Tech Electronics
P.O. Box 8533 • Scottsdale, AZ 85262
(602) 947-7700 (\$3.00 Credit all phone orders!)

LIFETIME WARRANTY
MasterCard • Visa • COD's

TRS-80 color computer software! Low prices! Huge selection! Free catalog. **T+D**, P.O. Box 1256, Holland, MI 49422.

NEW technology M VIP 3D color television technology utilizing a new type micro processor video concept. VCR tape-option. Details \$2.00. **WENDELL L. DANIELS**, Engineering Consultant, 8450 Anthony Wayne Ave., Cincinnati, OH 45216.

PLANS AND KITS

VOICE disguisers! FM bugs! Telephone transmitters! Phone snoops! More! Catalog \$1.00. **XANDI ELECTRONICS**, Box 25647, Dept. 60C, Tempe, AZ 85282.

BUILD this five-digit panel meter and square-wave generator including an ohms, capacitance and frequency meter. Detailed instructions \$2.50. **BAGNALL ELECTRONICS**, 179 May, Fairfield, CT 06430.

AMAZING SCIENTIFIC & ELECTRONIC PRODUCTS

PLANS—Build Yourself—All Parts Available In Stock

- LC7—BURNING CUTTING CO₂ LASER \$ 20.00
- RUB4—PORTABLE LASER RAY PISTOL 20.00
- TCC1—3 SEPARATE TESLA COIL
- PLANS TO 1.5 MEV 20.00
- IOG1—ION RAY GUN 10.00
- GRA1—GRAVITY GENERATOR 10.00
- EML1—ELECTRO MAGNET COIL GUN/LAUNCHER 6.00

- KITS**
- MFT3K—FM VOICE TRANSMITTER 3 MI RANGE 49.50
 - WVPMT—TELEPHONE TRANSMITTER 3 MI RANGE 39.50
 - BT3CK—250,000 VOLT 10-14" SPARK TESLA COIL 199.50
 - LHC2K—SIMULATED MULTICOLOR LASER 39.50
 - BLS1K—100,000 WATT BLASTER DEFENSE DEVICE 69.50
 - ITM1K—100,000 VOLT 20" AFFECTIVE RANGE INTIMIDATOR 69.50
 - PSP4K—TIME VARIANT SHOCK WAVE PISTOL 59.50
 - PTG1K—SPECTACULAR PLASMA TORNAO GENERATOR 149.50
 - MVPK SEE IN DARK KIT 199.50

- ASSEMBLED**
- PTWIK—SPECIAL EFFECT VISUAL PLASMA GENERATOR FOR GLOBES/NEON TUBING ETC \$59.50
 - BTC10—50,000 VOLT—WORLD'S SMALLEST TESLA COIL 49.50
 - LGLU40—1MW HeNe VISIBLE RED LASER GUN 249.50
 - TAT30 AUTO TELEPHONE RECORDING DEVICE 24.50
 - GPV10—SEE IN TOTAL DARKNESS IR VIEWER 349.50
 - LIST10—SNOOPER PHONE INFINITY TRANSMITTER 169.50
 - IPG70—INVISIBLE PAIN FIELD GENERATOR—MULTI MODE 74.50

• **CATALOG** CONTAINING DESCRIPTIONS OF ABOVE PLUS HUNDREDS MORE AVAILABLE FOR \$1.00 OR USE OUR PHONE FOR "ORDERS ONLY" 603-673-4730.

PLEASE INCLUDE \$3.00 PH ON ALL KITS AND PRODUCTS PLANS ARE POSTAGE PAID. SEND CHECK, MO, VISA, MC IN US FUNDS.

INFORMATION UNLIMITED
P.O. BOX 716 DEPT. RE, AMHERST, NH 03031

Multi-Channel Microwave T.V. Receivers



1.9-2.7 GHz Parabolic Dish 40+ dB Gain
LIFETIME WARRANTY
 Complete System \$99.95 (Shipping Incl.)
 Replacement Components
 & Expert Repairs Available

K & S ELECTRONICS Call now for same
 P.O. BOX 34522 day shipping!
 PHOENIX, AZ 85067 (602) 230-0640
\$2 CREDIT ON PHONE ORDERS

CABLE TV Secrets—the outlaw publication the cable companies tried to ban. HBO, Movie Channel, Showtime, descramblers, converters, etc. Supplier's list included \$8.95. **CABLE FACTS**, Box 711-R, Pataskala, OH 43062.

SATELLITE TV receiver kits! Instruction manual, boards, semiconductor parts! 59° LNA's! LNB's! Ku-Band LNB's! Catalog \$1.00 (refundable): **XANDI ELECTRONICS**, Box 25647, Dept. 21GG, Tempe, AZ 85282.

DESCRAMBLERS for movies, networks, \$149. up. Visa, MC accepted. Catalog \$4 **SKYWATCH**, 238 Davenport Road, Toronto, Ontario, Canada, M5R-1J6.

*** SCRAMBLING NEWS *** PAY TV AND SATELLITE DESCRAMBLING

Schematics, theory, bypasses, 13 cable, 7 satellite. New SA turn-on. MLD-1200-3. \$14.95. Experiments With Videocipher Cloning, musketeering. \$14.95. Cable TV Security, design. \$12.95. MDS: MMS Handbook Microwave hacking \$9.95. Build Satellite Systems Under \$500! \$12.95. Any 3-\$27. Scrambling News. Monthly feature articles, product reviews, law history, patents. \$24.95/yr. Sample \$5. Catalog \$1. PTV vol. 2 \$12.95

Shojiki Electronics Corp. 1327A Niagara St.,
 Niagara Falls, NY 14303. COD's 716-284-2163

VIDEOCYIPHER II descrambling manual, schematics, both video and audio encoding, DES, cloning, musketeering, EPROM codes. (HBO, Cinemax, adult channels.) \$13.95, \$1 postage. **CABLETRONICS**, Box 30502R, Bethesda, MD 20814.

CABLE TV. "BOXES"

**Converters—Descramblers
 Remote Controls—Accessories**

- ★ Guaranteed Best Prices ★
- ★ 1 Year Warranty—C.O.D.'s ★
- ★ Immediate Shipping ★
- ★ FREE CATALOG ★

Call or Write
TRANS-WORLD CABLE CO.
 12062 Southwest 117th Court, Suite 126
 Miami, Florida 33186
 800-442-9333

BIG PROFITS ELECTRONIC ASSEMBLY BUSINESS

Start home. spare time. Investment knowledge or experience unnecessary. BIG DEMAND assembling electronic devices. Sales handled by professionals. Unusual business opportunity.

FREE: Complete illustrated literature
 BARTA, RE-O Box 248
 Walnut Creek, Calif. 94597

BUSINESS OPPORTUNITIES

EARN thousands with your own part time electronics business. I do. Free proof, information. **INDUSTRY**, Box 531, Bronx, NY 10461.

EASY, lucrative. One man CRT rebuilding machinery. Free info: (815) 459-0666 **CRT**, 1909 Louise, Crystalake, IL 60014.

EARN big bucks—design transformers. Design tips and procedures \$10. **V.P.B. TECHNOLOGIES**, Box 1770, Temple City, CA 91780.

MECHANICALLY inclined individuals desiring ownership of small electronics manufacturing business—without investment. Write: **BUSINESSES**, 92-R, Brighton 11th, Brooklyn, NY 11235.

PROJECTION TV...Make \$\$\$'s assembling projectors...easy...results comparable to \$2,500 projectors... Total cost less than \$30.00. Plans, 8" lens and dealers information \$20.50... Illustrated information free. **MACROCAM GXK**, Washington Crossing, PA 18977. Creditcard orders 24hrs (215) 736-2880.

YOUR own radio station! AM, FM, TV, cable. Licensed/unlicensed. **BROADCASTING**, Box 130-F7, Paradise, CA 95967.

CRT equipment rebuilds Sony/color tubes/other CRT systems, 633 North Semoran, Orlando, FL 32807. Call (407) 275-9543.

P.C. board/circuit design, prototyping, and manufacture, orcad/ futurenet/schema netlists routed. PLOTTING services; schema, hiwire, smartwork, **EE DESIGNER** supported call (609) 586-4469.

HIGH return home operated business you can start for \$50.00. For information send \$7.50 to **P. O. SON**, 35080 George Smith Road, Squaw Valley, CA 93675.

Big Profits!

LEARN VCR CLEANING-REPAIR. Prior Experience UNNECESSARY. Need only small hand tools & average mechanical abilities. **BIG DEMAND** performing VCR cleaning and repairs. **REAL EXAMPLES** of VCR malfunctions and their solutions. Photos and illustrations. ALSO: Information on starting your own business.

Free information; Write:

Viejo VCR Repair
 23010 Lake Forest Dr. #155
 Laguna Hills, CA 92653
 (714) 768-1925



EDUCATION & INSTRUCTION

F.C.C. Commercial General Radiotelephone license. Electronics home study. Fast, inexpensive! "Free" details. **COMMAND**, D-176, Box 2223, San Francisco, CA 94126.

ENGINEERING software for IBM-PC. CompDes...circuit design. CompMath... math tutor. CompView...digital signal analysis. \$49 each. (614) 491-0832. **BSOFT SOFTWARE**, 444 Colton Road, Columbus, OH 43207.

100 FCC actual sample test questions. \$10 and **SASE**. **PEI**, Box 12056-RE, Omaha, NE 68152.

MICROPROFESSOR 8 bit trainer, Z-80 C.P.U., 158-instruction set 8K monitor ROM, enter programs in assembly, machine, basic, or forth \$199.95 + \$7.50 S&H. **ETRONIX**, 5326—9th Ave. N.E., Seattle, WA 98105 1-(800) 426-1044.

MICROPROFESSOR 16 bit trainer, 8088 C.P.U., 8 bit data bus, 4.77MHz, 59-key, full-size keyboard, Centronics parallel interface. Design, write, debug, and execute assembly language programs. \$349.95 + \$7.50 S&H. **ETRONIX**, 5326—9th Ave., N.E., Seattle, WA 98105. 1-(800) 426-1044.

ROBOTICS Interests Newsletter \$36.00 for 12 issues. Satisfaction guaranteed. Sample \$5.00. Check payable to **N.R. PUBLICATIONS**, Dept. RE1, P.O. Box 416, Webster, MA 01570-0416.

SPANISH custom made translations. Write in English. We translate it using Parallel Etymology for easy learning. \$9.95/500 words for written translation. Add \$8.95/500 words audio translation on cassette tape. **TRADUCCIONES**, Valle Verde 5, D-2, Ponce, Puerto Rico 00731.

PRINTED CIRCUIT BOARDS AND ARTWORK LAYOUTS

LOW priced single, double sided boards. No minimum charge. CAD artwork at discounted prices. (704) 464-1164; **PCBAL**, RT-3, Box 662-H, Conover, NC 28613.

INVENTORS

INVENTORS! Can you patent and profit from your idea? Call **AMERICAN INVENTORS CORPORATION** for free information. Over a decade of service. 1-(800) 338-5656. In Massachusetts or Canada call (413) 568-3753.

JUST SIMPLY PUT . . .

"When you're looking for a company that provides service and up-to-date technical advances, call us. That's what we're here for."

800-85-AMCOM

CABLE EQUIPMENT

NEW Super Z-TAC ADD-ON
 ELIMINATES LINE 20 FALSE FLASHING
 AUTOMATICALLY HANDLES NORMAL &
 INVERTED VIDEO. NO SWITCHES.
\$219.00

Standard SSAVI ADD-ON
 CH #3 IN CH #3 OUT

VHF TUNER \$149.00
 NO BLOCK CONVERTER

5 UNITS \$130.00 10 UNITS \$110.00
 50 UNITS \$100.00 100 UNITS \$ CALL

INTERFERENCE FILTERS \$15.00
 CHANNEL #2, 3, 8, 9, 17 ONLY

ADVANCED TRIMODE ADD-ON
\$99.00

TV TUNER VARACTORS

VHF/MID/UHF MITSUMI \$25.00
 UHF ONLY MITSUMI \$ 5.00

T O C O M

BRAND NEW
 THIS KIT WORKS ON ALL
 TOCOM SYSTEMS,
 CHANNEL #3 IN/CHANNEL #3 OUT.
 BUILD IT YOURSELF AND SAVE.

Assembled and tested **\$150.00**
 Kit includes all parts **\$9.00**

TEN-TEC DW-12 "BLASTER" \$25.00
 Metal Enclosure
 W = 10" UHF PREAMP KIT
 L = 10.25" \$22 25 db gain with only .5 NF
 H = 4.50" loss when mass mounted.
 WITH HARDWARE USES PHANTOM POWER
 STRIPLINE CIRCUITRY

WALL PWR SUPPLIES UHF SSAVI UNIT
 w/power supply \$40.00

24 VAC 525 MA N/C .50
 12 VAC 400 MA W/C 2.00
 12 VAC 265 MA W/C 1.75

ORIGINAL Z-TAC AND SSAVI POWER SUPPLY \$15.00

CALL US!!!
 WE BUY EXCESS
 INVENTORY

LINEAR		CMOS		OTHER	RARE IC CHIP
LM318 80	MC1310 1.00	CD4002 30	CD4027 35	CD4520	CAMERA SYNC CHIP
LM319 80	MC1330 .75	CD4011 15	CD4040 35	CD4526	SUPPLIES ALL SYNC
LM324 25	MC1350 1.50	CD4012 25	CD4047 55	7490	AND COLOR INFO
LF353 40	CA1398 4.00	CD4013 25	CD4053 50	74LS04	ONLY
LM359 1.25	MC1458 .24	CD4015 35	CD4066 55	74LS74	
LM393 40	LM1456 .75	CD4016 25	CD4069 20	74LS123	
LM356 35	LM1458 1.00	CD4017 35	CD4071 20	74C906	
LM365 75	TL082 .75	CD4019 40	CD4081 25		
LM382 75	TL084 1.25	CD4024 40	CD4082 20		

DEALERS WANTED!! GREAT QUANTITY PRICES



AMCOM
 P. O. Box 68391
 Virginia Beach, VA 23455
 804-456-5505 (TECHNICAL)
 800-852-6266 (ORDERS ONLY)

UPS DAILY

COD ACCEPTED
 MINIMUM ORDER \$15.00
 CALL ANYDAY BEFORE 3 PM
 ORDER WILL BE SHIPPED THAT DAY
 NO INSTATE SALES

One tree can make
 3,000,000 matches.

One match can burn
 3,000,000 trees.



WANTED

INVENTORS! AIM wants—ideas, inventions, new products, improvements on existing products. We present ideas to manufacturers. **Confidentiality guaranteed. Call toll free in U.S. & Canada 1-(800) 225-5800.**

INVENTIONS, ideas, new products wanted! Industry presentation/national exposition. Call free **1-(800) 288-IDEA.** Canada, 1-(800) 528-6060. X831.

GOVERNMENT jobs \$15,400—\$72,500 now hiring, excellent benefits. Call (504) 649-7922 Ext J-5192.

WANTED older Atlas SSB transceiver model 210X or 215X in working order reasonable (707) 445-2525.

TUBES - 2000 TYPES DISCOUNT PRICES!

Early, hard-to-find, and modern tubes. Also transformers, capacitors and parts for tube equipment. **Send \$2.00 for 20 page wholesale catalog.**

ANTIQUE ELECTRONIC SUPPLY

688 W. First St. • Tempe, AZ 85281 • 602/894-9503

DESCRAMBLER MODULE

LATEST technology alternative to Jerrold SB-3 or Radio-Electronics Feb. 1984 project. Featuring electronic tuning, AGC, auto-on/off, AD/DC power, mini-size, A&T, and more. For literature—**SOUTH-TECH DISTRIBUTING**, (813) 527-2190.

ROBOTIC SENSORS

TACTILE and pressure sensors, \$5/element, singles and arrays available. For info, send address to: **RECEPTOR TECHNOLOGY INC.**, 2 Kenwood Street, Somerville, MA 02144.

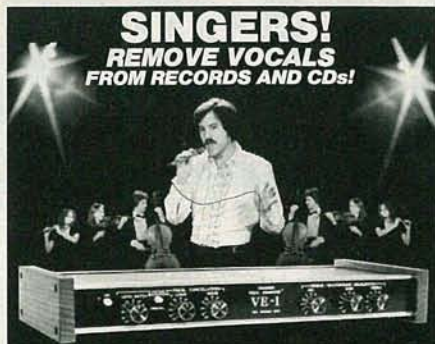

SINGERS! REMOVE VOCALS FROM RECORDS AND CDs!

An Unlimited supply of Backgrounds from standard stereo records! Record with your voice or perform live with the backgrounds. Used in Professional Performance yet connects easily to a home component stereo. This unique product is manufactured and sold Exclusively by **LT Sound** - Not sold through dealers. Call or write for a Free Brochure and Demo Record.

LT Sound, Dept. RL-3, 7980 LT Parkway
Lithonia, GA 30058 (404) 482-4724
Manufactured and Sold Exclusively by **LT Sound**
24 HOUR PHONE DEMO LINE: (404) 482-2485

CABLE TV CONVERTERS

CABLE TV converters. Scientific Atlanta, Jerrold, Oak, Zenith, Hamlin. Many others. "**New**" **VIDEO HOPPER** "The Copy Killer." Visa, M/C and Amex. **(800) 826-7623. B&B Inc.** 10517 Upton Circle, Bloomington, MN 55431.

MASTERCARD AND VISA are now accepted for payment of your advertising. Simply complete the form on the first page of the Market Center and we will bill.

Cable TV Converters

Why Pay A High Monthly Fee?

Jerrold Products include "New Jerrold Tri-Mode," SB-3. Hamlin, Oak VN-12, M-35-B, Zenith, Magnavox, Scientific Atlanta, and more. (Quantity discounts) 60 day warranty. For fast service C.O.D. orders accepted. Send SASE (60 cents postage) or call for info (312) 658-5320. **MIDWEST ELECTRONICS, INC.**, 5143-R W. Diversey, Chicago, IL 60639. MC/Visa orders accepted. No Illinois orders accepted. Mon.-Fri. 8 A.M.-5 P.M. CST

CABLE-TV AT IT'S BEST

SCIENTIFIC Atlanta models 8500—8550 remote included...\$240.00. **SB-3's**...\$74.00. **TRI-BI's**...\$95.00. **SA-3's**...\$99.00. **Zenith (Z-Tac)** descramblers...\$169.00. **N-12 (Vari-sync)**...\$89.00. **M-35 B (Vari-sync)**...\$99.00. **Hamlin MLD-1200's**...\$89.00. **80-Channel converters**...\$95.00. **Dealer discount on (5) units.** Call **N.A.S. INTERNATIONAL**, (213) 631-3552.

SCRAMBLE FACTS

718-343-0130

PHONE TODAY for 3 minutes of satellite TV industry news, technical tips, and new product information.

MARK V ELECTRONICS INC.,

8019, E. SLAUSON AVE.
MONTEBELLO CA90640
TELEX: 3716914 MARK 5

INFORMATION:(213) 888-8988

300W HQ HI-FI POWER AMPLIFIER (MONO) TA-3600

QUASI COMPLEMENTARY SYMMETRY WITH PARALLEL HIGH OUTPUT TRANSISTORS

- SPECIFICATIONS**
- *POWER OUTPUT 300W IRMS INTO 8 OHMS
 - 2450W (P.M.P.O.) INTO 8 OHMS
 - 540W (MUSIC POWER) INTO 8 OHMS
 - *LOAD IMPEDANCE 4 OHMS OR 8 OHMS
 - *FREQUENCY RESPONSE: 10Hz-200,000Hz
 - *TOTAL HARMONIC DISTORTION LESS THAN 0.05%
 - *INPUT SENSITIVITY AND IMPEDANCE AT 1KHz: 1V-1.4V 47K OHMS
 - *SUPPLY VOLTAGE DC 175V OR AC 53V x 2.8A
 - KIT/ASM WITH TESTED \$38.00
 - X'FORMER

8 Digit 1GHz Multifunctional Counter FC-1000A

A versatile laboratory bench digital counter with FIVE FUNCTION performance: FREQUENCY, PERIOD, UNIT (TOTALIZE) DATA HOLD & SELF CHECK. The period function makes the instrument outstanding for video tape recorder service applications. 0.5" Bright LED display assure easy readability of values. High stabilized crystal oscillators are used to ensure the accuracy in measurement. Durable alloy cabinet with a fancy looking panel. Comes complete with test lead and owners manual.

- FEATURES**
- Frequency range 10Hz - 10GHz GUARANTEED, 5Hz - 10GHz typical
 - Input sensitivity: 10Hz - 100MHz (10mV - 20mV)
 - 100MHz - 1.0GHz (5mV - 20mV)
 - Period range 0.5µs - 10s
 - Unit counting capacity: 99999999
 - Accuracy: ±1 count, 10mV base accuracy
 - Hold function: Hold the last input signal (Max. 8 digits)
 - Power source: 117V AC (X787) (D) X3 (H)
 - Dimensions: 9.5" (W) x 7.87" (D) x 3" (H)
 - ASM WITH TESTED & CAL. \$188.00

STEREO SIMULATOR TA-3000

You can own a stereo TV, from today! This simulator is special design of using the most advance audio monophonic LSI. It produced a superior analog stereo effect since the LSI is equalized 60 pcs of LOW NOISE SET & TRANSDUCER. The simulator can even help you to promote your television from a normal one to a special one with a H.F. STEREO function. Our simulator is also applicable to any other mono sources, in covering it to ANALOG STEREO. Undoubtedly, it is the most advanced equipment for every family while it should contribute to your listening pleasure.

Ass. with tested \$40.00

TERMS: \$10 mini order • \$20 mini charge card order • Check, money order or phone order accepted • 10% ship. UPS insured • Add 10% of total order (min. \$2.5) for shipping, outside USA add 20% (min. \$5.00) • Transit insurance add 5% of total (outside USA only) • CA residents add sales tax • All merchandise subject to prior sale • Prices are subject to change without notice • Any goods proved to be defective MUST BE RETURNED IN ORIGINAL FORM WITH A COPY OF YOUR INVOICE WITHIN 30 DAYS FOR REPLACEMENT.

1-800-423-3483

TOLL FREE

Only for orders paid by Master or Visacard
IN CAL.: 1-800-521-MARK

OFFICE HOURS: (PACIFIC TIME)
MON.-FRI. 9:30 to 5:00 SAT. 10:00 to 5:00
ELECTRONIC LOTTO

TY-8



NEW FOR '88

- * 0-49 DIGITS DISPLAY, SUITABLE FOR LOTTERY GAME.
- * AUTO-SHUT OFF POWER, SO POWER CONSUMPTION IS VERY LOW.
- * 0.5" GREEN LED DISPLAY WITH FANCY PLASTIC PANEL.
- * OPERATION VOLTAGE: 9V DC (BATTERY NOT INCLUDED)
- * DIMENSIONS: 3.1" x 2" x 0.5"
- KIT \$15.00

150MC Digital SM-100 Frequency Counter

Frequency Range 10Hz - 150MHz
Event Counter 0 to 99999999 counts (8 Digit)
Input sensitivity: KHz range 10Hz - 10MHz 50mVrms
MHz range 1MHz - 150MHz 40mVrms
Response time 0.2 second
Hold Function: Hold the last input signal
Power Supply: DC6V Battery or DC9V Adaptor
Dimensions: 9.78" x 6.11" x 1.6" x 2.3" 4"
Assembled with tested \$99.00

YAMATO 4001 3 1/2 DIGITAL MULTIMETER

The YAMATO 4001 is a 3 1/2 DIGIT COMPACT DIGITAL MULTIMETER, it employs FE type LCD, with large figures. Its ADVANTAGES: High accuracy in measuring. High impedance assures min. measuring error. One rotary switch allows fast & convenient operation. 26 measurement range enable wider application. Over-input indication & low battery life appears on display. LSI circuit use provides high reliability and durability. Measurement possible even under strong magnetic field. Measures ONLY 6 3/4" x 3 1/4" x 1"

We've rated our goods with a Δ indicating the level of difficulty for kit assembly:
Δ beginner level.
Δ intermediate level.
Δ advanced level.
* indicates the product has already been assembled

- * FREE BALL POINT-PEN WITH ANY PURCHASE
- * FREE 9 1/4 FLYER WITH EVERY PURCHASE OF \$100 OR MORE (AVAILABLE UNTIL STOCKS LAST)

WALK IN FOR YOUR FREE GIFT

ELECTRONIC ECHO AND REVERBERATION AMPLIFIER TA-2400A

Ass. with tested \$99.85

RECORDS W/ ECHO EFFECT YOURSELF!

120W VERSATILE STEREO POWER BOOSTER TA-302

With 10 band colour LED power meter, output power can be easily defined. TA-302 is a versatile amplifier for both visual and listening enjoyment. 60Wx2 P.M.P.O.

OTL full transistorize and low distortion of SEPP circuit design, high output power and sound fidelity. With high and low input impedance for selection, so it can match with all preamplifiers, low power of portable sound equipment, and all types of stereo recorder deck to use. It can boost 'walkman' type of radio and tape player, too.

KIT/ASM WITH TESTED \$50/70

DIGITAL MENO TA-28

NO TAPE REQUIRED Message Reminder!

SPECIFICATIONS

- 16 SEC. RECORD TIME • LED FUNCTION INDICATOR • AUTO RECORD CIRCUIT • INTERNAL 256K DRAM MEMORY • INTERNAL MIC AMPLIFIER • ONE PUSH ON/OFF POWER • TWO RECORD FUNCTION TALK-BACK MODE & MESSAGE MODE • LOW POWER CONSUMPTION • SUPPLY VOLTAGE: 9V 20MA D.C.
- KIT \$20/30

CIRCLE 93 ON FREE INFORMATION CARD

JULY 1988

105

NEC V20 & V30 CHIPS

Replace the 8036 or 8088 in Your IBM-PC and Increase Its Speed by up to 40%! Price

UPD70108-5 (5MHz) V20 Chip.....	\$ 7.49
UPD70108-8 (8MHz) V20 Chip.....	\$ 8.95
UPD70108-10 (10MHz) V20 Chip.....	\$21.95
UPD70116-8 (8MHz) V30 Chip.....	\$11.95
UPD70116-10 (10MHz) V30 Chip.....	\$24.95

7400

Part No.	1-9	10+	Part No.	1-9	10+
7400.....	29	19	7485.....	65	55
7402.....	29	19	7486.....	45	35
7404.....	29	19	7489.....	205	195
7405.....	35	25	7490.....	49	39
7406.....	39	29	7493.....	45	35
7407.....	39	29	74121.....	45	35
7408.....	35	25	74123.....	55	45
7410.....	29	19	74125.....	55	45
7414.....	49	39	74126.....	69	59
7416.....	35	25	74143.....	3.95	3.95
7417.....	39	29	74150.....	1.35	1.25
7420.....	35	25	74154.....	1.35	1.25
7430.....	35	25	74158.....	1.59	1.49
7432.....	39	29	74173.....	85	75
7438.....	39	29	74174.....	59	49
7442.....	55	45	74175.....	49	39
7445.....	79	69	74176.....	99	89
7446.....	89	79	74181.....	1.95	1.85
7447.....	89	79	74189.....	1.95	1.85
7448.....	2.05	1.95	74193.....	79	69
7472.....	89	79	74198.....	1.85	1.75
7473.....	39	29	74211.....	99	89
7474.....	39	29	74273.....	1.95	1.85
7475.....	49	39	74365.....	65	55
7476.....	45	35	74367.....	65	55

74LS

74LS00.....	29	19	74LS165.....	75	65
74LS02.....	29	19	74LS166.....	99	89
74LS04.....	35	25	74LS173.....	59	49
74LS05.....	35	25	74LS240.....	99	89
74LS06.....	1.09	99	74LS175.....	49	39
74LS07.....	1.09	99	74LS189.....	4.59	4.49
74LS08.....	29	19	74LS191.....	59	49
74LS10.....	29	19	74LS193.....	79	69
74LS14.....	49	39	74LS221.....	69	59
74LS27.....	35	25	74LS240.....	99	89
74LS30.....	29	19	74LS243.....	69	59
74LS32.....	35	25	74LS244.....	69	59
74LS42.....	49	39	74LS245.....	89	79
74LS47.....	99	89	74LS259.....	99	89
74LS73.....	39	29	74LS272.....	89	79
74LS74.....	35	25	74LS279.....	49	39
74LS75.....	39	29	74LS322.....	4.05	3.95
74LS76.....	55	45	74LS365.....	49	39
74LS85.....	59	49	74LS366.....	49	39
74LS86.....	35	25	74LS367.....	49	39
74LS90.....	49	39	74LS368.....	49	39
74LS93.....	49	39	74LS373.....	79	69
74LS123.....	59	49	74LS374.....	79	69
74LS125.....	49	39	74LS393.....	89	79
74LS138.....	49	39	74LS590.....	6.05	5.95
74LS139.....	49	39	74LS624.....	2.05	1.95
74LS184.....	1.09	99	74LS629.....	2.95	2.85
74LS157.....	45	35	74LS640.....	1.09	99
74LS158.....	45	35	74LS645.....	1.09	99
74LS163.....	59	49	74LS670.....	1.09	99
74LS164.....	59	49	74LS688.....	2.39	2.29

74S/PROMS*

74S00.....	29	74S188.....	1.49
74S04.....	29	74S189.....	1.69
74S08.....	35	74S196.....	2.49
74S10.....	29	74S240.....	1.49
74S32.....	35	74S244.....	1.49
74S74.....	45	74S253.....	79
74S85.....	1.79	74S287.....	1.49
74S86.....	49	74S288.....	1.49
74S124.....	2.75	74S373.....	1.49
74S174.....	79	74S374.....	1.49
74S175.....	79	74S472.....	2.95

74F

74F00.....	29	74F139.....	69
74F04.....	29	74F157.....	69
74F08.....	29	74F193.....	2.95
74F10.....	29	74F240.....	99
74F32.....	29	74F244.....	99
74F74.....	39	74F253.....	69
74F86.....	39	74F373.....	99
74F138.....	69	74F374.....	99

CD-CMOS

CD4001.....	19	CD4076.....	59
CD4008.....	69	CD4081.....	25
CD4011.....	19	CD4082.....	25
CD4013.....	29	CD4083.....	35
CD4016.....	29	CD4094.....	39
CD4017.....	49	CD40103.....	2.49
CD4018.....	59	CD40107.....	49
CD4020.....	59	CD40109.....	79
CD4024.....	49	CD4510.....	69
CD4027.....	35	CD4511.....	69
CD4030.....	29	CD4520.....	75
CD4040.....	65	CD4522.....	79
CD4049.....	29	CD4538.....	79
CD4050.....	29	CD4541.....	89
CD4051.....	59	CD4543.....	79
CD4052.....	59	CD4554.....	4.95
CD4053.....	59	CD4555.....	79
CD4063.....	1.49	CD4559.....	7.95
CD4066.....	29	CD4566.....	2.49
CD4067.....	1.29	CD4583.....	89
CD4069.....	25	CD4584.....	39
CD4070.....	25	CD4585.....	69
CD4071.....	25	MC11411P.....	8.95
CD4072.....	25	MC11490P.....	4.49

MICROPROCESSOR COMPONENTS

MISCELLANEOUS CHIPS		6500/6800/68000 Cont.		8000 SERIES Cont.	
Part No.	Price	Part No.	Price	Part No.	Price
D765AC.....	4.95 3.95	6845.....	9.95 2.95	8228.....	2.95
WD9216.....	6.95	6850.....	1.95	8237-5.....	4.95 4.49
95H90.....	9.95 5.95	6852.....	1.49	8243.....	2.25 1.75
Z80, Z80A, Z80B SERIES					
Z80.....	1.25 99	MC68000L.....	11.95	8250A (For IBM).....	6.49
Z80-CTC.....	1.79 99	MC68000L10.....	13.95	8251A.....	1.89
Z80-DART.....	4.95	MC68010L10.....	49.95	8253-5.....	1.95
Z80-PIO.....	1.79 99	MC68020RC12B.....	169.95	8254.....	4.95
Z80A.....	1.69	MC68881RC12A.....	149.95	8255A-5.....	1.89
Z80A-CTC.....	1.79	8000 SERIES			
Z80A-DART.....	1.95	8031.....	3.95	8257-5.....	1.95
Z80A-PIO.....	1.69	8033.....	3.95	8259-5.....	2.25
Z80A-SIO/O.....	5.75	8035.....	1.95	8272.....	4.95 3.95
Z80B.....	3.49	8073.....	9.95	8279-5.....	2.95
Z80B-CTC.....	3.95	8080A.....	2.95 2.49	8741.....	9.95
Z80B-PIO.....	4.29 3.95	808A.....	2.49	8742.....	29.95 22.95
6500/6800/68000 SER.					
6502.....	2.65	8086.....	5.95	8748 (25V).....	7.95
6502(CMOS).....	6.95 7.75	8086-2.....	6.95	8748H (HMOS) (21V).....	9.95
6520.....	1.95	8087 (5MHz).....	129.95	8749.....	9.95
6522.....	3.95	8087-1 (10MHz).....	229.95	8751.....	39.95
6532.....	6.49 5.49	8087-2 (8MHz).....	159.95	8752.....	14.95
6551.....	4.49 2.95	8088.....	6.49 5.75	DATA ACQUISITION	
65C02(CMOS).....	17.95	8088-2.....	6.95 7.75	ADC0804LCN.....	3.49 2.79
6800.....	1.95	8116.....	4.95	ADC08080CN.....	5.95
6802.....	3.95	8155.....	2.49	ADC08090CN.....	9.95 3.69
6810.....	1.25	8156.....	3.49	ADC08160CN.....	11.95
6821.....	1.75	8156.....	3.95	ADC1205CC1.....	19.95
6840.....	3.95	8202.....	5.95	DAC08080CN.....	1.95
		8203.....	9.95	DAC10080CN.....	4.95
		8212.....	2.29	AY-3-1015D.....	4.95
		8224.....	2.25	AY-5-1013A.....	2.95

MICROPROCESSOR SALE!

8052AHBASIC CPU w/BASIC Interpreter.....	\$ 29.95
MC68008L8 32-Bit MPU (8-Bit Data Bus).....	\$ 16.95
MC68701 8-Bit EPROM Microcomputer.....	\$ 14.95
MC68705P3S 8-Bit EPROM Microcomputer.....	\$ 14.95
MC68705U3S 8-Bit EPROM Microcomputer.....	\$ 10.95
80286-10 16-Bit Hi Performance MPU.....	\$ 99.95
80287-8 Math Co-processor (8MHz).....	\$245.95
80287-10 Math Co-processor (10MHz).....	\$309.95
80287-16 Math Co-processor (16MHz).....	\$494.95
80387-20 Math Co-processor (20MHz).....	\$795.95

DYNAMIC RAMS

Part No.	Price
*4116-15 16,384 x 1 (150ns).....	1.09
4128-20 31,072 x 1 (200ns) (Piggyback).....	9.25 2.75
*4164-100 65,536 x 1 (100ns).....	3.49
*4164-120 65,536 x 1 (120ns).....	2.75
*4164-150 65,536 x 1 (150ns).....	2.49
*4164-200 65,536 x 1 (200ns).....	5.95
*TMS4416-12 16,384 x 4 (120ns).....	7.49
*41256-80 262,144 x 1 (80ns).....	11.95
*41256-100 262,144 x 1 (100ns).....	11.49
*41256-120 262,144 x 1 (120ns).....	9.95
*41256-150 262,144 x 1 (150ns).....	9.49
*5064-15 1,024 x 4 (150ns) (4464).....	6.49
*51100P-10 1,048,576 x 1 (100ns) 1 Meg.....	49.95
*514256P-10 262,144 x 4 (100ns) 1 Meg.....	89.95

STATIC RAMS

*2016-12 2048 x 8 (120ns).....	3.95
2018-45 2048 x 8 (45ns).....	6.95 5.49
2102 1024 x 1 (350ns).....	89
2114N 1024 x 4 (450ns).....	99
2114N-2L 1024 x 4 (200ns) Low Power.....	1.49
21C14 1024 x 4 (150ns) CMOS.....	1.95
5101 256 x 4 (450ns) CMOS.....	1.95
*6116P-3 2048 x 8 (150ns) CMOS.....	3.95
*6116LP-3 2048 x 8 (150ns) LP CMOS.....	4.49
*6264LP-12 8192 x 8 (120ns) LP CMOS.....	6.89
*6264LP-15 8192 x 8 (150ns) LP CMOS.....	5.89
*6264LP-15 8192 x 8 (150ns) LP CMOS.....	5.39
6514 1024 x 4 (350ns) CMOS.....	3.49
*43256-15L 32,768 x 8 (150ns) Low Power.....	12.95

EPROMS

TMS2516 2048 x 8 (450ns) 25V.....	6.95
TMS2532 4096 x 8 (450ns) 25V.....	6.95
TMS2532A 4096 x 8 (450ns) 21V.....	5.95
TMS2564 8192 x 8 (150ns) 25V.....	9.95
TMS2716 2048 x 8 (450ns) Voltage.....	9.95 4.95
1702A 256 x 8 (1µs).....	6.95 4.95
2708 1024 x 8 (450ns).....	4.95
2716 2048 x 8 (450ns) 25V.....	3.75
2716-1 2048 x 8 (350ns) 25V.....	4.25
2716-2 2048 x 8 (450ns) 25V (CMOS).....	5.49
2732 4096 x 8 (450ns) 25V.....	3.95
2732A-20 4096 x 8 (200ns) 21V.....	4.25
2732A-25 4096 x 8 (250ns) 21V.....	3.95
27C32 4096 x 8 (450ns) 25V (CMOS).....	5.95
2764-20 8192 x 8 (200ns) 21V.....	4.25
2764-25 8192 x 8 (250ns) 21V.....	3.75
2764A-25 8192 x 8 (250ns) 12.5V.....	3.95
2764-45 8192 x 8 (450ns) 21V.....	2.95
27C64-15 8192 x 8 (150ns) 21V (CMOS).....	6.49
27C64-25 16,384 x 8 (200ns) 21V.....	6.95
27128-25 16,384 x 8 (250ns) 21V.....	5.95
27128A-25 16,384 x 8 (250ns) 12.5V.....	5.25
27C128-25 16,384 x 8 (250ns) 21V (CMOS).....	6.95
27256-20 32,768 x 8 (200ns) 12.5V.....	6.95
27256-25 32,768 x 8 (250ns) 12.5V.....	5.95
27C256-25 32,768 x 8 (250ns) 12.5V (CMOS).....	7.95
27512-20 65,536 x 8 (200ns) 12.5V.....	13.49
27512-25 65,536 x 8 (250ns) 12.5V.....	11.95
68764 8192 x 8 (450ns) 25V.....	13.95

EPROMS	
2816A 2048 x 8 (350ns) 5V Read/Write.....	5.95
2817A 2048 x 8 (350ns) 5V Read/Write.....	7.95
2865A 8192 x 8 (250ns) 5V Read/Write.....	9.95
52B13 (21V) 2048 x 8 (350ns) 5V Read Only.....	1.49

SPECIALS!

SMP81FY Prec. Sample & Hold Amp.....	7.95
Dual RS232 Rec./Trans.....	5.19
LM306P Dual Comparator.....	.79
6116P-1 16K CMOS SRAM (100ns).....	5.49
27128-45 128K EPROM (450ns) 21V.....	4.95
74LS612 Memory Mapper, Tri-State.....	11.95

74HC HI-SPEED CMOS

Part No.	Price	Part No.	Price

Worldwide • Since 1974

• QUALITY COMPONENTS • COMPETITIVE PRICING
• PROMPT DELIVERY



PROTOTYPING PRODUCTS

Jameco Solderless Breadboard Sockets

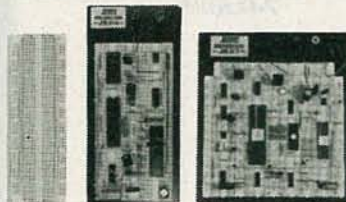

Part No.	Dim. L' x W'	Contact Points	Binding Posts	Price
JE20	6 1/2 x 3/4	200	0	\$ 2.29
JE21	3 1/4 x 2 1/8	400	0	\$ 4.49
JE22	6 1/2 x 1 3/8	630	0	\$ 5.95
JE23	6 1/2 x 2 1/8	830	0	\$ 7.49
JE24	6 1/2 x 3 1/8	1,360	2	\$14.95
JE25	6 1/2 x 4 1/8	1,660	3	\$22.95
JE26	6 1/2 x 5 1/8	2,390	4	\$27.95
JE27	7 1/4 x 7 1/2	3,220	4	\$37.95

Jameco's IBM PC/XT/AT Compatible Motherboards



- Award BIOS ROMs included
- JE1001 4.77/8MHz (PC/XT) . . . \$ 99.95
- JE1002 4.77/10MHz (PC/XT) . . . \$119.95
- JE1007 6/8/10/12MHz (AT) . . . \$349.95

2 & 3MB Memory Expansion Cards for IBM AT and Compatibles



- JE1081 2MB of expanded or extended memory (zero-K on-board) (AT) . . . \$129.95
- JE1082 3MB of expanded or extended memory, parallel printer port, serial port and game port (zero-K on-board) (AT) . . . \$169.95

Jameco Computer Power



- Protection JE1190 Power Base . . . \$29.95
- JE1191 6-Outlet Power Strip . . . \$11.95

IBM PC/XT/AT Compatible Keyboards



- Tactile touch keyswitches • Switch selectable between PC/XT or AT • Illuminated Caps Lock, Num Lock and Scroll Lock
- JE1015 . . . \$59.95
- Enhanced keyboard layout • Illuminated Num Lock, Caps Lock and Scroll Lock • Automatically switches between PC/XT or AT
- JE1016 . . . \$79.95

DATA BOOKS

- 400041 NSC Linear Data Book-Vol. I (87) . . . \$14.95
- 400042 NSC Linear Data Book-Vol. II (87) . . . \$ 9.95
- 400043 NSC Linear Data Book-Vol. III (87) . . . \$ 9.95
- 210830 Intel Memory Handbook (87) . . . \$17.95
- 230843 Intel Microsystem Hdbk. Set (87) . . . \$24.95

Jameco's New and Improved AT Compatible Kit!

FREE! Word Processing Software! / Now with I/O Board!

IBM AT Compatible Kit Mini-286 6/8/10/12MHz Kit

- JE1007 Baby AT Motherboard (Zero-K RAM - includes Award BIOS ROMs) . . . \$349.95
- JE1015 XT/AT Style Keyboard . . . \$ 59.95
- JE1017 Baby AT Flip-Top Case . . . \$ 69.95
- JE1022 5 1/4" Hi-Density Disk Drive . . . \$109.95
- JE1032 200 Watt Power Supply . . . \$ 89.95
- JE1043 360K/720K/1.2M Floppy Controller Card . . . \$ 49.95
- JE1065 Input/Output Card . . . \$59.95

Regular List \$789.65

SAVE \$99.70!

JE1059 \$519.95 (EGA Monitor and Card not included)



- JE2009* IBM AT Compatible Kit \$689.95
- JE286M JE2009 Technical Manual \$29.95

*RAM not included - Minimum RAM configuration 512K (41256-120 RAM Chips - see left)

IBM COMPATIBLE DISPLAY MONITORS

- 12" Amber Monochrome - TTL Input, High Resolution (PC/XT/AT) AMBER . . . \$109.95 \$99.95



- 14" RGB Color - CGA Compatible Amber/Green/Color Switchable, 640 x 200 Resolution (PC/XT/AT) TTX1410 . . . \$279.95

- 14" EGA Color - EGA/CGA Compat., 720 x 350 (max.) resolution (PC/XT/AT) TE5154 . . . \$399.95

IBM PC/XT/AT COMPATIBLE CARDS

Graphic Display Cards

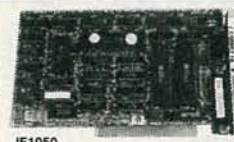

- JE1050 Mono Graphics Card w/Printer Port (PC/XT/AT) . . . \$59.95
- JE1052 Color Graphics Card w/Printer Port (PC/XT/AT) . . . \$49.95
- JE1055 EGA Card with 256K Video RAM (PC/XT/AT) . . . \$169.95
- JE1071 Multi I/O with Drive Controller and Mono Graphics (PC/XT) . . . \$119.95

Multifunction, I/O and Expansion Cards

- JE1060 I/O Card with Serial, Game, Parallel Printer Port and Real Time Clock (PC/XT) . . . \$59.95
- JE1061 RS232 Serial Half Card (PC/XT/AT) . . . \$29.95
- JE1065 I/O Card with Serial, Game and Parallel Printer Port (AT) . . . \$59.95
- JE1078 Expand to 384K (zero-K on-board) Multifunc. w/Serial, Game, Parallel Printer Port & Real Time Clock (PC/XT) . . . \$79.95

Floppy and Hard Disk Controller Cards

- JE1040 360KB Floppy Disk Drive Controller Card (PC/XT) . . . \$29.95
- JE1041 20/40MB Hard Disk Controller Card (PC/XT) . . . \$79.95
- JE1042 30/60MB RLL Hard Disk Controller (PC/XT) . . . \$99.95
- JE1043 360K/720K/1.2MB Floppy Disk Cont. Card (PC/XT/AT) \$49.95
- JE1045 360K/720K/1.2MB Floppy/Hard Disk Controller Card (AT) . . . \$159.95

Additional Add-Ons Available!

COMPUTER PERIPHERALS

- ### Seagate 20,30 40 and 60MB Half Height Hard Disk Drives
- ST225 20MB Drive only (PC/XT/AT) . . . \$224.95
 - ST225K 20MB w/Controller (PC/XT) . . . \$269.95
 - ST238 30MB Drive only (PC/XT/AT) . . . \$249.95
 - ST238K 30MB w/Controller (PC/XT) . . . \$299.95
 - ST238AT 30MB w/Controller (AT) . . . \$389.95
 - ST251 40MB Drive only (PC/XT/AT) . . . \$429.95
 - ST251AT 40MB w/Cont. Card (PC/XT) . . . \$469.95
 - ST251XT 40MB w/Controller Card (AT) . . . \$539.95
 - ST277 60MB Drive only (PC/XT/AT) . . . \$499.95
 - ST277K 60MB w/Controller Card (AT) . . . \$639.95

- ### Jameco 5.25" PC/XT & AT Compatible Disk Drives
- JE1020 360K Black Bzl. (PC/XT/AT) . . . \$ 89.95
 - JE1021 360K Beige Bzl. (PC/XT/AT) . . . \$ 89.95
 - JE1022 1.2MB Beige Bzl. (PC/XT/AT) . . . \$109.95

- ### Toshiba 3.5" PC/XT/AT Compatible Disk Drive
- 352KU 3.5" 720KB (Bezels and Installation Kit incl.) (PC/XT/AT) . . . \$129.95

2400/1200/300 Modems

- ### Datronics
- Hayes command compatible • Bell 103/212A compatible • Auto-dial/auto-answer • FCC approved 1-year warranty • Includes MaxiMite Communication Software
 - 1200H 1200/300 Baud Internal Modem . . . \$ 79.95
 - 2400S 2400/1200/300 Internal Modem . . . \$174.95
 - 1200C 1200/300 Baud External Modem . . . \$119.95
 - 2400E 2400/1200/300 External Modem . . . \$219.95

Jameco Extended 80-Column Card for Apple IIe

- 80 Col./64K RAM • Doubles amount of data your Apple IIe can display as well as its memory capacity • Ideal for word processing • Complete with instructions
- JE864 \$39.95

- ADD12 (Disk Drive II, II+, IIe) \$99.95

TEST EQUIPMENT

Digital Multimeters

- #### Kingdom KD302:
- Pocket Size in handy carry case
 - 3 1/2 Digit LCD
 - Auto or manual ranging
 - Audible continuity tester
 - Tests: AC/DC Voltage, Resistance and Continuity
 - One Year Warranty
 - Size: 4 1/2" L x 2 1/4" W x 1 1/4" H
 - KD302 . . . \$27.95

- #### Metex M4650:
- Handheld, high accuracy
 - 4 1/2 Digit LCD
 - Manual ranging with Overload Protection
 - Audible continuity tester
 - Tests: AC/DC Voltage, Resistance, Continuity Capacitance, Frequency
 - One Year Warranty
 - Size: 7 1/4" L x 3 1/2" W x 1 1/4" H
 - M4650 . . . \$89.95

U.S. Funds Only
Shipping: Add 5% plus \$1.50 Insurance
(May vary according to weight)

California Residents:
Add 6%, 6 1/2% or 7%
Sales Tax
FAX 415-592-2503
7/88



Data Sheets - 50¢ each
Prices Subject to Change

Send \$1.00 Postage for a
FREE 1988 CATALOG

Telex: 176043

©1988 Jameco Electronics

1355 SHOREWAY RD., BELMONT, CA 94002 • FOR ORDERS ONLY 415-592-8097 • ALL OTHER INQUIRIES 415-592-8121

CAPACITORS

TANTALUM

1.0µf	15V	.12	1.0µf	35V	.45
6.8	15V	.42	2.2	35V	.19
10	15V	.45	4.7	35V	.39
22	15V	.99	10	35V	.69

DISC

10µf	50V	.05	001µf	50V	.05
22	50V	.05	005	50V	.05
33	50V	.05	.01	50V	.07
47	50V	.05	.05	50V	.07
100	50V	.05	.1	12V	.10
220	50V	.05	.1	50V	.12

MONOLITHIC

01µf	50V	.14	1µf	50V	.18
047µf	50V	.15	47µf	50V	.25

ELECTROLYTIC

RADIAL		AXIAL			
1µf	25V	.14	1µf	50V	.14
4.7	50V	.11	10	50V	.16
10	50V	.11	22	16V	.14
47	35V	.13	47	50V	.19
100	16V	.15	100	35V	.19
220	35V	.20	470	50V	.29
470	25V	.30	1000	16V	.29
2200	16V	.70	2200	16V	.70
4700	25V	1.45	4700	16V	1.25

RESISTOR NETWORKS

SIP	10 PIN	9 RESISTOR	.69
SIP	8 PIN	7 RESISTOR	.59
DIP	16 PIN	8 RESISTOR	1.09
DIP	16 PIN	15 RESISTOR	1.09
DIP	14 PIN	7 RESISTOR	.99
DIP	14 PIN	13 RESISTOR	.99

38 PIN CENTRONICS

ICEN36	RIBBON CABLE	3.95
CEN36	SOLDER CUP	1.85
ICEN36/F	RIBBON CABLE	4.95
CEN36PC Rt	Angle PC Mount	1.85

EDGE CARD CONNECTORS

100 Pin	ST	S-100	.125	3.95
100 Pin	WW	S-100	.125	4.95
62 Pin	ST	IBM PC	.100	1.95
50 Pin	ST	APPLE	.100	2.95
44 Pin	ST	STD	.156	1.95
44 Pin	WW	STD	.156	4.95

BYPASS CAPACITORS

01 µf	CERAMIC DISC	100/50.00
01 µf	MONOLITHIC	100/50.00
1 µf	CERAMIC DISC	100/56.50
1 µf	MONOLITHIC	100/52.50

25 PIN D-5UB GENDER CHANGERS \$7.95



EMI FILTER \$4.95

LINE CORDS

2 conductor 39c
3 conductor 99c
3 conductor w/ female socket \$1.49

SOLDER STATION

UL APPROVED

- ADJUSTABLE HEAT SETTING W/ TIP TEMP READOUT
- QUICK HEATING & RECOVERY
- RANGE: 200°-900°F

\$49.95

EXTENDER CARDS FOR IBM

EXT-8088 \$29.95
EXT-80286 \$39.95



VOLTAGE REGULATORS

7805T	.49	7812K	1.39
7808T	.49	7905K	1.69
7812T	.49	7912K	1.49
7815T	.49	78L05	.49
7905T	.59	78L12	.49
7908T	.59	79L05	.69
7912T	.59	79L12	1.49
7915T	.59	LM323K	4.79
7805K	1.59	LM338K	6.95

SHORTING BLOCKS \$1.00



DISCRETE

1N751	.15	4N28	.69
1N4148Z5	1.90	4N33	.89
1N4004	1.10	4N37	1.19
1N5402	.25	MCT-2	.59
KBPO2	.55	MCT-6	1.29
2N2222	.25	TIL-111	.99
PN2222	.10	2N3906	.10
2N2907	.25	2N4401	.25
2N3055	.79	2N4402	.25
2N3904	.10	2N4403	.25
4N26	.69	2N6045	1.75
4N27	.69	TIP31	.49

WHY THOUSANDS CHOOSE JDR

- QUALITY MERCHANDISE
- COMPETITIVE PRICES
- MOST ORDERS SHIPPED IN 24 HOURS
- FRIENDLY, KNOWLEDGEABLE STAFF
- 30-DAY MONEY BACK GUARANTEE
- TOLL FREE TECHNICAL SUPPORT
- EXCELLENT CUSTOMER SERVICE

CALL FOR VOLUME QUOTES

WIREWRAP PROTOTYPE CARDS



FOR PS/2		FOR XT	
JDR-PR32	32 BIT PROTOTYPE CARD	IBM-PR1	WITH +5V AND GROUND PLANE
JDR-PR16	16 BIT WITH I/O DECODING CIRCUITRY	IBM-PR2	AS ABOVE WITH DECODING LAYOUT
JDR-PR16-PK	PARTS KIT FOR ABOVE		
JDR-PR16V	EXTENDED CONNECTORS FOR VIDEO APPLICATIONS		
		FOR AT	
		JDR-PR10	16 BIT WITH DECODING LAYOUT
		JDR-PR10-PK	PARTS KIT FOR ABOVE

SOLDERLESS BREADBOARDS

WBU-D	100 TIE POINTS	2.95
WBU-T	630 TIE POINTS	6.95
WBU-204-3	1360 TIE POINTS	17.95
WBU-204	1660 TIE POINTS	24.95
WBU-206	4390 TIE POINTS	29.95
WBU-208	3220 TIE POINTS	39.95

PAGE WIRE WRAP WIRE

PRECUT ASSORTMENT IN ASSORTED COLORS \$27.50

100ea: 5.5", 6.0", 6.5", 7.0"
250ea: 2.5", 4.5", 5.0"
500ea: 3.0", 3.5", 4.0"

SPOOLS

100 feet \$4.30 250 feet \$7.25
500 feet \$13.25 1000 feet \$21.95

Please specify color: Blue, Black, Yellow or Red

IDC CONNECTORS/RIBBON CABLE

DESCRIPTION	ORDER BY	CONTACTS					
		10	20	26	34	40	50
SOLDER HEADER	IDHxxS	.82	1.29	1.68	2.20	2.58	3.24
RIGHT ANGLE SOLDER HEADER	IDHxxSR	.85	1.35	1.76	2.31	2.72	3.39
WIREWRAP HEADER	IDHxxW	1.86	2.98	3.84	4.50	5.28	6.63
RIGHT ANGLE WIREWRAP HEADER	IDHxxWR	2.05	3.28	4.22	4.45	4.80	7.30
RIBBON HEADER SOCKET	IDSxx	.63	.89	.95	1.29	1.49	1.69
RIBBON HEADER	IDMxx	---	5.50	6.25	7.00	7.50	8.50
RIBBON EDGE CARD	IDExx	.85	1.25	1.35	1.75	2.05	2.45
10' GREY RIBBON CABLE	RCxx	1.60	3.20	4.10	5.40	6.40	7.50

FOR ORDERING INSTRUCTIONS, SEE D-SUBMINIATURE CONNECTORS, BELOW

SPECTRONICS CORPORATION EPROM ERASERS

Model	Timer	Chip Capacity	Intensity (µW/Cm ²)	Unit Cost
PE-140	NO	9	8,000	\$89
PE-140T	YES	9	8,000	\$139
PE-240T	YES	12	9,600	\$189

DATARASE

- ERASES 2 EPROMS IN 10 MINUTES
- VERY COMPACT, NO DRAWER
- THIN METAL SHUTTER PREVENTS UV LIGHT FROM ESCAPING

\$34.95



SOCKET-WRAP 1.0™

- SLIPS OVER WIRE WRAP PINS
- IDENTIFIES PIN NUMBERS ON WRAP SIDE OF BOARD
- CAN WRITE ON THE PLASTIC, SUCH AS AN IC #

PINS	PART #	PCK. OF	PRICE
8	IDWRAP 08	10	1.95
14	IDWRAP 14	10	1.95
16	IDWRAP 16	10	1.95
18	IDWRAP 18	5	1.95
20	IDWRAP 20	5	1.95
22	IDWRAP 22	5	1.95
24	IDWRAP 24	5	1.95
28	IDWRAP 28	5	1.95
40	IDWRAP 40	5	1.95

PLEASE ORDER BY NUMBER OF PACKAGES (PCK. OF)

D-SUBMINIATURE CONNECTORS

DESCRIPTION	ORDER BY	CONTACTS						
		9	15	19	25	37	50	
SOLDER CUP	MALE	DBxxP	.45	.59	.69	.69	1.35	1.85
	FEMALE	DBxxS	.49	.69	.75	.75	1.39	2.29
RIGHT ANGLE PC SOLDER	MALE	DBxxPR	.49	.69	---	.79	2.27	---
	FEMALE	DBxxSR	.55	.75	---	.85	2.49	---
WIREWRAP	MALE	DBxxPWW	1.69	2.56	---	3.89	5.60	---
	FEMALE	DBxxSww	2.76	4.27	---	6.84	9.95	---
IDC RIBBON CABLE	MALE	IDBxxP	1.39	1.99	---	2.25	4.25	---
	FEMALE	IDBxxS	1.45	2.05	---	2.35	4.49	---
HOODS	METAL	MHOODxx	1.05	1.15	1.25	1.25	---	---
	GREY	HOOOxx	.39	.39	---	.39	.69	.75

ORDERING INSTRUCTIONS: INSERT THE NUMBER OF CONTACTS IN THE POSITION MARKED "xx" OF THE "ORDER BY" PART NUMBER LISTED. EXAMPLE: A 15 PIN RIGHT ANGLE MALE PC SOLDER WOULD BE DB15PR.

MOUNTING HARDWARE 59¢

LIGHT EMITTING DIODES LED DISPLAYS

FND-357(359)	COM CATHODE	.362"	1.25
FND-500(503)	COM CATHODE	.5"	1.49
FND-507(510)	COM ANODE	.5"	1.49
MAN-72	COM ANODE	.3"	.99
MAN-74	COM CATHODE	.3"	.99
TIL-313	COM CATHODE	.3"	.45
TIL-311	4x7 HEX W/LOGIC	.270"	10.95

DIFFUSED LEDs

	1-99	100-UP
JUMBO RED	T1 1/4	.10 .09
JUMBO GREEN	T1 1/4	.14 .12
JUMBO YELLOW	T1 1/4	.14 .12
MOUNTING HDW	T1 1/4	.10 .09
MINI RED	T1	.10 .09

3 VOLT LITHIUM BATTERY \$1.95

HOLDER \$1.49



SWITCHES

SPDT	MINI-TOGGLE ON-OFF	1.25
DPDT	MINI-TOGGLE ON-OFF	1.50
DPDT	MINI-TOGGLE ON-OFF-ON	1.75
SPST	MINI-PUSHBUTTON N.O.	.39

DIP SWITCHES

4 position	.85	7 position	.95
5 position	.90	8 position	.95
6 position	.90	10 position	1.29

"SNAPABLE" HEADERS

CAN BE SNAPPED APART TO MAKE ANY SIZE HEADER, ALL WITH 1" CENTERS

1x40	STRAIGHT LEAD	.99
1x40	RIGHT ANGLE LEAD	.49
2x40	2 STRAIGHT LEADS	2.49
2x40	2 RIGHT ANGLE LEADS	2.99

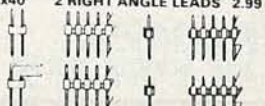

JDR MICRODEVICES, 110 KNOWLES DRIVE, LOS GATOS, CA 95030
LOCAL (408) 866-6200 FAX (408) 378-8927 TELEX 171-110

RETAIL STORE: 1256 SOUTH BASCOM AVE., SAN JOSE, CA (408) 947-8881
HOURS: M-F 10-7 SAT. 9-5 SUN. 12-4

ORDER TOLL FREE 800-538-5000

COPYRIGHT 1988 JDR MICRODEVICES CONTINENTAL U.S. AND CANADA

CIRCLE 177 ON FREE INFORMATION CARD

JULY 1988

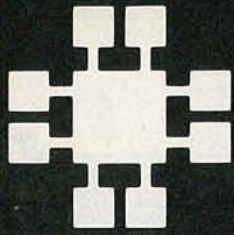

JDR Microdevices®

Complete customer satisfaction...superior service...friendly, knowledgeable personnel
quality merchandise...providing the best values in leading edge technology.

PROMETHEUS 2400 BAUD MODEM

\$129⁹⁵

NEW LOW PRICE!

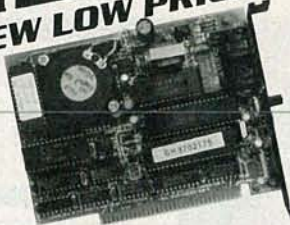

IT'S TIME TO TRADE UP NOW THAT JDR BREAKS THE PRICE BARRIER ON 2400 BAUD MODEMS

- AUTO DIAL ANSWER
- SELF TEST ON POWER-UP
- TOUCHTONE OR PULSE DIALING
- HAYES & BELL SYSTEMS COMPATIBLE
- FULL OR HALF DUPLEX
- MIRROR II COMMUNICATIONS SOFTWARE INCLUDED

MCT-241

MCT-121 1200 BAUD 1/2 CARD \$ 69.95

EXTERNAL MODEMS

MCT-12E 1200 BAUD \$ 99.95
MCT-24E 2400 BAUD \$169.95

COMPUTER CASES

ATTRACTIVE, STURDY STEEL CASES FIT THE POPULAR SIZED MOTHERBOARDS AND INCLUDE SPEAKERS, FACEPLATES, EXPANSION SLOTS, FRONT PANEL KEYLOCKS, LED INDICATORS AND ALL NECESSARY HARDWARE.



XT STYLE FLIP-TOP \$34.95
 XT STYLE SLIDE-TOP \$39.95
 AT STYLE SLIDE-TOP \$89.95
 JR. AT STYLE FLIP-TOP \$149.95
 ■ INCLUDES 150 WATT POWER SUPPLY

POWER SUPPLIES

FOR IBM XT COMPATIBLE \$59.95

- UL APP. 135 WATTS
- +5V 15A, +12V 4.2A
- -5V .5A, -12V .5A

PS-135

PS-150 150W MODEL \$69.95



FOR IBM AT COMPATIBLE \$89.95

- 200 WATTS
- +5V 22A, +12V 8A
- -5V .5A, -12V .5A

PS-200

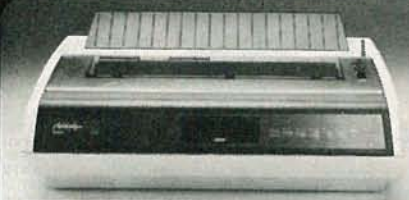

DIABLO PRINTER

\$279⁹⁵

- LETTER QUALITY AT 20 CPS, 132 COLS
- 10, 12, 15 PITCH & PROPORTIONAL SPACING
- SERIAL & PARALLEL INTERFACE
- AUTO PAPER LOAD, FRICTION FEED
- FULL XEROX WARRANTY



CENTRONICS LASER \$1195 PRINTER

NEAR TYPESET QUALITY
AFFORDABLE AT LAST

- 8 PAGES PER MINUTE ■ 300 DPI RESOLUTION
- 1 YEAR WARRANTY ■ CHOICE OF EMULATION BOARDS

MULTI-PRINTER EMULATION BOARD:

EPSON FX-80 EMULATION—NOTHING ELSE REQUIRED
IBM PC GRAPHICS, PROPRINTER & DIABLO 630
EMULATION REQUIRES ADDITIONAL FONT CARD

HP LJ+ EMULATION BOARD:

HP LASERJET EMULATION—3 RESIDENT FONTS &
2 PITCHES ADDITIONAL FONT CARD AVAILABLE

1.5MB RAM CARD \$139.95
 EXTRA FONT CARDS \$199.95
 TONER CARTRIDGES \$59.95
 PFS FIRST PUBLISHER \$99.95

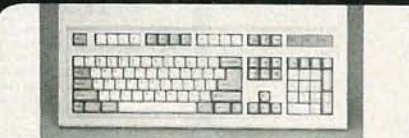

IBM COMPATIBLE KEYBOARDS

FULL ONE YEAR WARRANTY

IBM ENHANCED STYLE LAYOUT \$79.95

- AUTONSENSE FOR XT OR AT COMPATIBLES
- LED INDICATORS ■ AUTO REPEAT FEATURE
- SEPARATE CURSOR PAD

MCT-5339

IBM AT STYLE LAYOUT \$59.95

- SOFTWARE AUTONSENSE FOR XT OR AT COMPATIBLES
- LED INDICATORS ■ AUTO REPEAT FEATURE

MCT-5060

MAXI-SWITCH KEYBOARDS

ENHANCED STYLE LAYOUT \$84.95

- STANDARD ENHANCED KEYBOARD LAYOUT
- TACTILE FEEDBACK
- LIGHTED NUM. CAPS, AND SCROLL LOCK
- NUMERIC & CURSOR KEYPADS, 12 "F" KEYS

MAX-5339

MAX-5060 MAXI-SWITCH, AT STYLE \$64.95

SAMSUNG MONOCHROME MONITOR

\$129⁹⁵

- IBM COMPATIBLE TTL INPUT
- 12" NON-GLARE, LOW DISTORTION AMBER SCREEN
- 720 X 350 RESOLUTION
- SWIVEL BASE



NEC MULTISYNC \$599.95

- ORIGINAL CGA/EGA/PGA COMPATIBLE MONITOR
- AUTO FREQUENCY ADJUSTMENT
- RESOLUTION AS HIGH AS 800 X 560

CASPER EGA \$399.95

- 15.75/21.85 KHz SCANNING FREQUENCIES
- 640 X 200/350 RESOLUTION ■ .31 MM DOT PITCH
- 14" BLACK MATRIX SCREEN ■ 16 COLORS

CASPER RGB \$279.95

- COLOR/GREEN/AMBER SWITCH ■ .39MM DOT PITCH
- 640 X 240 RESOLUTION ■ 14" NON-GLARE SCREEN
- RGB/IBM COMPATIBLE ■ CABLE INCLUDED

SAKATA
MONOCHROME \$69.95

- IBM COMPATIBLE TTL INPUT
- 12" NON-GLARE SCREEN
- CABLE FOR IBM PC INCLUDED

MONITOR STANDS

MODEL MS-100 \$12.95

- TILTS AND SWIVELS
- STURDY PLASTIC CONSTRUCTION

MODEL MS-200 \$39.95

- TILTS AND SWIVELS ■ BUILT-IN SURGE SUPPRESSOR
- INDEPENDENTLY CONTROLS UP TO 5 AC OUTLETS

LOGITECH MOUSE

\$79⁹⁵



PC MAGAZINE'S EDITORS CHOICE
ALL MODELS HAVE SERIAL SUPPORT (COM1/COM2), 200
D.P.I. RESOLUTION, LOTUS 1-2-3 SHELL, SELF-INSTALLING
SOFTWARE AND "POINT EDITOR"

SERIAL MOUSE W/PC PAINTBRUSH \$99.95

BUS MOUSE W/PC PAINTBRUSH \$99.95

BUS MOUSE W/PC PAINTBRUSH/CAD \$149.95

3.5" FLOPPY DISK DRIVE

\$129⁹⁵



- IBM COMPATIBLE DRIVE ■ AT AND XT VERSIONS AVAILABLE
- FORMATS TO 720K, DS QD UNDER DOS 3.2
- MEDIA COMPATIBLE WITH PS/2 & LAPTOP MACHINES
- INCLUDES HARDWARE FOR MOUNTING IN 5 1/4" SLOT
- QUIET OPERATION

FDD-3.5X (FOR XT)

FDD-3.5A (FOR AT)

 **Seagate**

**60 MB
NOW
\$499⁰⁰**

WAS \$649 AN INCREDIBLE PRICE REDUCTION! SAVE \$150 AND GET MORE MEGABYTES PER DOLLAR THAN EVER BEFORE. THE ST-277 IS AN RLL DRIVE WITH A FAST 40 MS ACCESS TIME!
ST-277

WITH MCT-RLL CONTROLLER \$549.00
WITH MCT-AT/FH CONTROLLER \$639.00

1/2 HEIGHT DRIVES

20 MB, 65 MS, ST-225 \$225.00
WITH MCT-HDC CONTROLLER \$269.00
WITH MCT-ATFH CONTROLLER \$339.00

30 MB RLL, 65 MS, ST-238 \$249.00
WITH MCT-RLL CONTROLLER \$299.00
WITH MCT-ATFH-RLL CONTROLLER \$389.00

40 MB, 40 MS, ST-251 \$429.00
WITH MCT-HDC CONTROLLER \$469.00
WITH MCT-ATFH CONTROLLER \$539.00

FULL HEIGHT DRIVES

30 MB, 40 MS, ST-4038 \$559.00
80 MB, 28 MS, ST-4096 \$895.00

**INTERFACE CARDS FROM
MODULAR CIRCUIT TECHNOLOGY
DISPLAY ADAPTORS**

MONOCHROME GRAPHICS CARD \$59.95
TRUE HERCULES COMPATIBILITY. SUPPORTS LOTUS 123
■ PARALLEL PRINTER PORT CONFIGURES AS GPT1 OR LPT2 ■ USES VLSI CHIPS TO ENSURE RELIABILITY
MCT-MGP

ENHANCED GRAPHICS ADAPTOR \$149.95
100% IBM COMPATIBLE. PASSES IBM EGA DIAGNOSTICS
■ 256K OF VIDEO RAM ALLOWS 640 X 350 IN 16 OF 64 COLORS ■ COMPATIBLE WITH COLOR AND MONOCHROME ADAPTORS
MCT-EGA

COLOR GRAPHICS ADAPTOR \$49.95
COMPATIBLE WITH IBM GRAPHICS STANDARDS
■ SUPPORTS RGB, COLOR & COMPOSITE MONOCHROME
■ 640/320 X 200 RESOLUTION. LIGHT PEN INTERFACE
MCT-CG

MULTIFUNCTION CARDS

MONOGRAPHS MULTI I/O \$119.75
TOTAL SYSTEM CONTROL FROM A SINGLE SLOT!
■ CTRL 2 FLOPPY'S, SERIAL, PARALLEL, GAME PORT, CLOCK CAL ■ RUN COLOR GRAPHICS SOFTWARE ON A MONOCHROME MONITOR
MCT-MGMIO

MULTI I/O FLOPPY CONTROLLER \$79.95
A PERFECT COMPANION FOR OUR MOTHERBOARDS
■ SUPPORTS UP TO 2 360K FLOPPIES, 720K WITH DOS 3.2
■ SERIAL, PARALLEL, GAME PORT, CLOCK CALENDAR
MCT-MIO
MIO-SERIAL—2ND SERIAL PORT \$15.95

MULTI I/O CARD \$59.95
USE WITH MCT-FH FOR A MINIMUM OF SLOTS USED
■ SERIAL PORT, CLOCK CALENDAR WITH BATTERY BACK-UP ■ PARALLEL PRINTER PORT ADDRESSABLE AS LPT1 OR LPT2
MCT-IO

AT MULTIFUNCTION CARD \$139.95
ADDS UP TO 3 MB OF RAM TO YOUR AT
■ USER EXPANDABLE TO 1.5 MB, OR 3 MB WITH OPTIONAL PIGGYBACK BOARD (0 K INSTALLED) ■ INCLUDES SERIAL AND PARALLEL PORT
MCT-ATMF-MC PIGGYBACK BOARD \$29.95
ATMF SERIAL-2ND SERIAL PORT \$24.95

AT MULTI I/O CARD \$59.95
USE WITH MCT-ATFH FOR MINIMUM OF SLOTS USED
■ SERIAL, PARALLEL AND GAME PORTS ■ USES 16450 SERIAL SUPPORT CHIPS FOR HIGH SPEED OPS
MCT-ATIO
ATIO-SERIAL—2ND SERIAL PORT \$24.95

MEMORY CARDS

576K RAM CARD \$59.95
A CONTIGUOUS MEMORY SOLUTION IN A SHORT SLOT
■ USER SELECTABLE CONFIGURATION UP TO 576K
■ USES 64K & 256K RAM CHIPS (ZERO K INSTALLED)
MCT-RAM

EXPANDED MEMORY CARD \$129.95
2 MB OF LOTUS INTEL MICROSOFT COMPATIBLE MEMORY FOR AN XT ■ CONFORMS TO LOTUS INTEL EMS ■ USER EXPANDABLE TO 2 MB ■ CAN BE USED AS EXPANDED OR CONVENTIONAL MEMORY, RAMDISK AND SPOOLER
MCT-EMS
MCT-ATEMS AT COMPATIBLE VERSION \$139.95

DRIVE CONTROLLERS

FLOPPY DISK CONTROLLER \$29.95
QUALITY DESIGN FOR SINGLE SLOT CONTROL OF 4 FLOPPY'S ■ INTERFACES UP TO 4 FDD'S TO AN IBM PC OR COMPATIBLE ■ SUPPORTS BOTH DS/DD AND DS/QD WITH DOS 3.2
MCT-FDC

1.2 MB FLOPPY CONTROLLER \$69.95
ADD VERSATILITY AND CAPACITY TO YOUR XT
■ SUPPORTS 2 DRIVES, BOTH MAY BE 360K OR 1.2 MB
■ ALLOWS DATA TO FLOW FREELY FROM XT'S TO AT'S
MCT-FDC-1.2

FLOPPY/HARD CONTROLLER \$139.95
XT SYSTEM STARVED FOR SLOTS? THIS CARD FREES ONE UP ■ INTERFACES UP TO 2 FDD'S & 2 HDD'S, CABLING FOR 2 FDD/1 HDD ■ SUPPORTS BOTH DS/DD & DS/QD WITH DOS 3.2
MCT-FH

AT/FH CONTROLLER \$149.95
FLOPPY/HARD DISK CONTROL IN A TRUE AT DESIGN
■ SUPPORTS UP TO 2 360K/720K/1.2MB FDD'S AS WELL AS 2 HDD'S USING STANDARD CONTROL TABLES
MCT-ATFH

RLL DISK CONTROLLER \$199.95
IMPROVE SPEED AND STORAGE OF YOUR AT COMPATIBLE ■ SUPPORTS UP TO 2 RLL HARD DISCS AND 2 FLOPPY DRIVES ■ SUPPORTS 360/720/1.2 MB FLOPPIES IN 5.25" & 3.5"
MCT-ATFH-RLL

INBOARD 386/PC \$895.00

UPGRADE YOUR XT TO A 386 FOR LESS THAN \$1000
■ 16 MHZ PROCESSOR REPLACES 8088 ■ 1 MB INSTALLED ■ EXPAND TO 3MB WITH PIGGYBACK BOARD
■ 5 YR WARRANTY

INBOARD 386/AT \$1199.95
ABOVE BOARD PS 286 \$399.95
ABOVE BOARD 286 \$369.95

intel

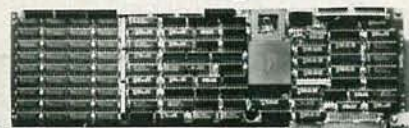

JDR MICRODEVICES, 110 KNOWLES DRIVE, LOS GATOS, CA 95030
LOCAL (408) 866-6200 FAX (408) 378-8927 TELEX 171-110

ORDER TOLL FREE 800-538-5000

COPYRIGHT 1988 JDR MICRODEVICES

CONTINENTAL U.S. AND CANADA

CIRCLE 179 ON FREE INFORMATION CARD

DISK DRIVES

1.44 MB 3 1/2" DRIVE \$149.95
■ ULTRA HIGH DENSITY
■ ALSO WORKS WITH 720K DISKS
FDD-1.44X—BLACK FDD-1.44A—BEIGE

1/2 HEIGHT FLOPPY DISK DRIVES

5 1/4" TEAC FD-55B DS/DD 360K \$99.95
5 1/4" TEAC FD-55G DS/HD 1.2M \$129.95
5 1/4" FUJITSU M2551A DS/DD 360K \$89.95
5 1/4" FUJITSU M2553K DS/HD 1.2M \$119.95
5 1/4" DS/DD 360K \$69.95
5 1/4" DS/HD 1.2M \$109.95
3 1/2" MITSUBISHI DS/DD (AT OR XT) \$129.95

**ARCHIVE XL
TAPE BACK-UP
\$369⁹⁵**

- BACK UP 40 MB IN 40 MINUTES!
- EASY-TO-USE MENU DRIVEN SOFTWARE
- USES STANDARD QIC DATA FORMAT
- FULL & INCREMENTAL BACK-UP
- PARTIAL & FULL RESTORE

AR 5240 XT —FOR XT'S & AT'S
AR 5540 AT —AT'S ONLY, 2X FASTER
TAPE NOT INCLUDED
TAPE CARTRIDGE—40 MB \$24.95



**20MB HARD DISK
ON A CARD
\$349**

- SAVES SPACE AND REDUCES POWER CONSUMPTION.
- IDEAL FOR PC'S WITH FULL HEIGHT FLOPPIES
- LEAVES ROOM FOR A HALF LENGTH CARD IN ADJACENT SLOT



“ I'M WRITING TO EXPRESS MY PLEASURE WITH THE PC-XT TYPE COMPUTERS BUILT FROM MCT COMPONENTS THAT WE HAVE OBTAINED FROM YOUR COMPANY. AFTER 3 YEARS OF DAILY USAGE I AM EXTREMELY PLEASED WITH THE LEVEL OF COMPATIBILITY AND PERFORMANCE. WITH A RECENT PURCHASE, I WAS ELATED WITH THE PROMPT MANNER IN WHICH OUR ORDER WAS HANDLED. AFTER DEALING WITH OTHER MAIL ORDER FIRMS, I HAVE FOUND ONLY JDR AND 2 OTHER SOFTWARE VENDORS HELPFUL AND RELIABLE. KEEP UP THE EXCELLENT WORK. ”

J.R.D.
OMAHA, NE.

**BARGAIN HUNTER'S CORNER
2 BUTTON
LOGITECH MOUSE**

- DEVICE DRIVER SOFTWARE INCLUDED
- CONNECTS TO STANDARD SERIAL PORT
- RELIABLE, ACCURATE OPTO-MECHANICAL DESIGN
- 90 DAY WARRANTY

ONLY
\$49.95

SPECIAL ENDS 6/30/88



JULY 1988

BUILD YOUR OWN SYSTEM

OVER 20,000 JDR SYSTEMS HAVE ALREADY BEEN BUILT. EASY TO ASSEMBLE IN JUST 2 HOURS WITH A SCREWDRIVER. SAVE MONEY AND LEARN ABOUT YOUR COMPUTER AT THE SAME TIME.

12 MHZ AT COMPATIBLE
\$1034²⁰

- 12 MHZ BABY AT MOTHERBOARD
- 256K RAM MEMORY
- MINI-AT CASE W/POWER SUPPLY
- AT STYLE KEYBOARD
- 1.2 MB FLOPPY DRIVE
- FLOPPY/HARD DRIVE CONTROLLER
- MONOCHROME MONITOR
- GRAPHICS ADAPTOR

10 MHZ XT COMPATIBLE
\$589⁰⁰

- INCLUDES SERIAL PORT, 2 PARALLEL PORTS, CLOCK/CALENDAR AND GAME ADAPTOR. RUNS COLOR GRAPHICS ON A MONOCHROME MONITOR
- MOTHERBOARD
 - 256K RAM MEMORY
 - 135 WATT POWER SUPPLY
 - FLIP-TOP CASE
 - AT STYLE KEYBOARD
 - 360K FLOPPY DRIVE
 - MONOGRAPHICS I/O CARD
 - MONOCHROME MONITOR

16 MHZ 1 MB 386
\$2298⁶⁵

- MYLEX 386 MOTHERBOARD
- 1 MB RAM ON BOARD
- 200 WATT POWER SUPPLY
- AT STYLE CASE
- ENHANCED AT STYLE KEYBOARD
- 1.2 MB FLOPPY DRIVE
- AT FLOPPY HARD CONTROLLER
- MONOCHROME MONITOR
- MONOGRAPHICS CARD

VIDEO INSTRUCTIONS
\$4⁹⁵

WITH KIT PURCHASE

IT'S A JDR EXCLUSIVE! EASY TO FOLLOW 20 MINUTE VHS TAPE SHOWS YOU STEP-BY-STEP HOW TO BUILD AN XT COMPATIBLE SYSTEM. WITHOUT KIT \$19.95



MOTHERBOARDS

TURBO 4.77/8 MHZ

\$99.95

- 4.77 OR 8 MHZ OPERATION WITH 8088-2 & OPTIONAL 8087-2 CO-PROCESSOR
- FRONT PANEL LED SPEED INDICATOR AND RESET SWITCH SET SUPPORTED
- CHOICE OF NORMAL TURBO MODE OR SOFTWARE SELECT PROCESSOR SPEED

MCT-TURBO

MCT-XTMB STANDARD MOTHERBOARD

\$87.95

12 MHZ MINI 80286

\$399.95

- 6 MHZ, 10 MHZ (0/1 WAIT STATE), 12 MHZ (1 WAIT STATE)
- USES ZYMOS ASIC'S FOR LESS CHIPS, GREATER RELIABILITY
- SUPPORTS 256K-1024K MEMORY
- RE-CHARGEABLE HIGH CAPACITY NI-CAD BATTERY
- 6 16-BIT SLOTS, 2 8-BIT SLOTS
- MOUNTS IN STANDARD XT CASE

MCT-BATMB-12

MCT-BATMB 6/10 MHZ MINI 80286 BOARD

\$389.95

80286 6/8 MHZ

\$379.95

- 8 SLOT (2 EIGHT BIT, 6 SIXTEEN BIT) AT MOTHERBOARD
- HARDWARE SELECTION OF 6 OR 8 MHZ
- 1 WAIT STATE
- KEYLOCK SUPPORTED, RESET SWITCH, FRONT PANEL LED INDICATOR
- SOCKETS FOR 1 MB OF RAM AND 80287
- BATTERY BACKED CLOCK

MCT-ATMB

16 MHZ MYLEX 386

\$1649.00

- 1 MB RAM ON BOARD
- 8 SLOTS, 2 8-BIT, 6 16-BIT
- SUPPORTS 80287 MATH CO-PROCESSOR
- SUPPORTS 80387 W/ADAPTOR
- 64 KB CACHE FOR NEAR 0 WAIT STATE
- USES AMI BIOS

MCT-386 MB

MCT-386 MB-4 4 MB MEMORY INSTALLED

\$2649.00

MCT-386 MB-MCB MATH CO-PROCESSOR ADAPTOR BOARD

\$149.00

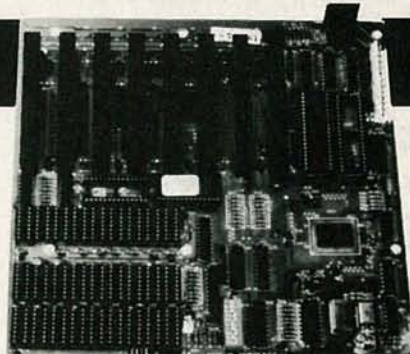

10 MHZ SINGLE CHIP XT
\$129⁹⁵

- SINGLE CHIP USES LESS POWER, IMPROVES RELIABILITY
- KEY SELECTABLE SPEED, 4.77 MHZ OR 10 MHZ
- 2.3 TIMES FASTER THAN A STANDARD
- RESET SWITCH, KEYLOCK AND SPEED/POWER INDICATORS SUPPORTED

MCT-TURBO-10

DEVELOPMENT TOOLS

EPROM PROGRAMMER

\$129⁹⁵

- PROGRAMS 27XX & 27XXX EPROMS UP TO 27512
- SUPPORTS VARIOUS PROGRAMMING FORMATS AND VOLTAGES
 - SPLIT OR COMBINE CONTENTS OF SEVERAL EPROMS OF DIFFERENT SIZES
 - READ, WRITE, COPY, ERASE CHECK AND VERIFY
 - SOFTWARE FOR HEX AND INTEL HEX FORMATS

MCT-EPROM

MCT-EPROM-4 4 GANG PROGRAMMER

\$189.00

MCT-EPROM-10 10 GANG PROGRAMMER

\$299.95

MCT-PAL PAL PROGRAMMER

\$269.95

MCT-MP PROCESSOR PROG.

\$199.95

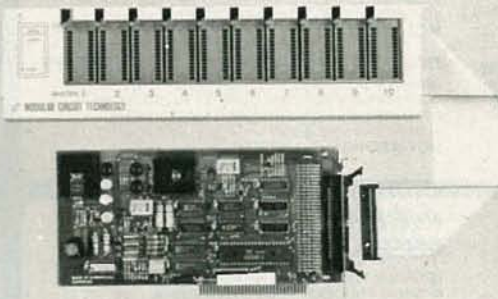

- 1 YEAR WARRANTY ON MCT PRODUCTS
- 30 DAY MONEY BACK GUARANTEE
- TOLL-FREE TECHNICAL SUPPORT
- NEXT DAY AIR SHIP AVAILABLE

JDR Microdevices®

JDR MICRODEVICES, 110 KNOWLES DRIVE, LOS GATOS, CA 95030

LOCAL (408) 866-6200 FAX (408) 378-8927 TELEX 171-110

ORDER TOLL FREE 800-538-5000

COPYRIGHT 1988 JDR MICRODEVICES

CONTINENTAL U.S. AND CANADA



INTEGRATED CIRCUITS

7400 TTL		74000 TTL	
Part	Price	Part	Price
7400	1.00	74000	1.00
7401	1.00	74001	1.00
7402	1.00	74002	1.00
7403	1.00	74003	1.00
7404	1.00	74004	1.00
7405	1.00	74005	1.00
7406	1.00	74006	1.00
7407	1.00	74007	1.00
7408	1.00	74008	1.00
7409	1.00	74009	1.00
7410	1.00	74010	1.00
7411	1.00	74011	1.00
7412	1.00	74012	1.00
7413	1.00	74013	1.00
7414	1.00	74014	1.00
7415	1.00	74015	1.00
7416	1.00	74016	1.00
7417	1.00	74017	1.00
7418	1.00	74018	1.00
7419	1.00	74019	1.00
7420	1.00	74020	1.00
7421	1.00	74021	1.00
7422	1.00	74022	1.00
7423	1.00	74023	1.00
7424	1.00	74024	1.00
7425	1.00	74025	1.00
7426	1.00	74026	1.00
7427	1.00	74027	1.00
7428	1.00	74028	1.00
7429	1.00	74029	1.00
7430	1.00	74030	1.00
7431	1.00	74031	1.00
7432	1.00	74032	1.00
7433	1.00	74033	1.00
7434	1.00	74034	1.00
7435	1.00	74035	1.00
7436	1.00	74036	1.00
7437	1.00	74037	1.00
7438	1.00	74038	1.00
7439	1.00	74039	1.00
7440	1.00	74040	1.00
7441	1.00	74041	1.00
7442	1.00	74042	1.00
7443	1.00	74043	1.00
7444	1.00	74044	1.00
7445	1.00	74045	1.00
7446	1.00	74046	1.00
7447	1.00	74047	1.00
7448	1.00	74048	1.00
7449	1.00	74049	1.00
7450	1.00	74050	1.00

1% METAL OXIDE FILM RESISTORS

Part	Price	Part	Price
100	1.00	1000	1.00
101	1.00	1001	1.00
102	1.00	1002	1.00
103	1.00	1003	1.00
104	1.00	1004	1.00
105	1.00	1005	1.00
106	1.00	1006	1.00
107	1.00	1007	1.00
108	1.00	1008	1.00
109	1.00	1009	1.00
110	1.00	1010	1.00
111	1.00	1011	1.00
112	1.00	1012	1.00
113	1.00	1013	1.00
114	1.00	1014	1.00
115	1.00	1015	1.00
116	1.00	1016	1.00
117	1.00	1017	1.00
118	1.00	1018	1.00
119	1.00	1019	1.00
120	1.00	1020	1.00
121	1.00	1021	1.00
122	1.00	1022	1.00
123	1.00	1023	1.00
124	1.00	1024	1.00
125	1.00	1025	1.00
126	1.00	1026	1.00
127	1.00	1027	1.00
128	1.00	1028	1.00
129	1.00	1029	1.00
130	1.00	1030	1.00

5% WIREWOUND RESISTORS

Part	Price	Part	Price
100	1.00	1000	1.00
101	1.00	1001	1.00
102	1.00	1002	1.00
103	1.00	1003	1.00
104	1.00	1004	1.00
105	1.00	1005	1.00
106	1.00	1006	1.00
107	1.00	1007	1.00
108	1.00	1008	1.00
109	1.00	1009	1.00
110	1.00	1010	1.00
111	1.00	1011	1.00
112	1.00	1012	1.00
113	1.00	1013	1.00
114	1.00	1014	1.00
115	1.00	1015	1.00
116	1.00	1016	1.00
117	1.00	1017	1.00
118	1.00	1018	1.00
119	1.00	1019	1.00
120	1.00	1020	1.00
121	1.00	1021	1.00
122	1.00	1022	1.00
123	1.00	1023	1.00
124	1.00	1024	1.00
125	1.00	1025	1.00
126	1.00	1026	1.00
127	1.00	1027	1.00
128	1.00	1028	1.00
129	1.00	1029	1.00
130	1.00	1030	1.00

Micro.

Part	Price	Part	Price
100	1.00	1000	1.00
101	1.00	1001	1.00
102	1.00	1002	1.00
103	1.00	1003	1.00
104	1.00	1004	1.00
105	1.00	1005	1.00
106	1.00	1006	1.00
107	1.00	1007	1.00
108	1.00	1008	1.00
109	1.00	1009	1.00
110	1.00	1010	1.00
111	1.00	1011	1.00
112	1.00	1012	1.00
113	1.00	1013	1.00
114	1.00	1014	1.00
115	1.00	1015	1.00
116	1.00	1016	1.00
117	1.00	1017	1.00
118	1.00	1018	1.00
119	1.00	1019	1.00
120	1.00	1020	1.00
121	1.00	1021	1.00
122	1.00	1022	1.00
123	1.00	1023	1.00
124	1.00	1024	1.00
125	1.00	1025	1.00
126	1.00	1026	1.00
127	1.00	1027	1.00
128	1.00	1028	1.00
129	1.00	1029	1.00
130	1.00	1030	1.00

Interface

Part	Price	Part	Price
100	1.00	1000	1.00
101	1.00	1001	1.00
102	1.00	1002	1.00
103	1.00	1003	1.00
104	1.00	1004	1.00
105	1.00	1005	1.00
106	1.00	1006	1.00
107	1.00	1007	1.00
108	1.00	1008	1.00
109	1.00	1009	1.00
110	1.00	1010	1.00
111	1.00	1011	1.00
112	1.00	1012	1.00
113	1.00	1013	1.00
114	1.00	1014	1.00
115	1.00	1015	1.00
116	1.00	1016	1.00
117	1.00	1017	1.00
118	1.00	1018	1.00
119	1.00	1019	1.00
120	1.00	1020	1.00
121	1.00	1021	1.00
122	1.00	1022	1.00
123	1.00	1023	1.00
124	1.00	1024	1.00
125	1.00	1025	1.00
126	1.00	1026	1.00
127	1.00	1027	1.00
128	1.00	1028	1.00
129	1.00	1029	1.00
130	1.00	1030	1.00

DISC CAPACITORS

Part	Price	Part	Price
100	1.00	1000	1.00
101	1.00	1001	1.00
102	1.00	1002	1.00
103	1.00	1003	1.00
104	1.00	1004	1.00
105	1.00	1005	1.00
106	1.00	1006	1.00
107	1.00	1007	1.00
108	1.00	1008	1.00
109	1.00	1009	1.00
110	1.00	1010	1.00
111	1.00	1011	1.00
112	1.00	1012	1.00
113	1.00	1013	1.00
114	1.00	1014	1.00
115	1.00	1015	1.00
116	1.00	1016	1.00
117	1.00	1017	1.00
118	1.00	1018	1.00
119	1.00	1019	1.00
120	1.00	1020	1.00
121	1.00	1021	1.00
122	1.00	1022	1.00
123	1.00	1023	1.00
124	1.00	1024	1.00
125	1.00	1025	1.00
126	1.00	1026	1.00
127	1.00	1027	1.00
128	1.00	1028	1.00
129	1.00	1029	1.00
130	1.00	1030	1.00

A/D & D/A

Part	Price	Part	Price
100	1.00	1000	1.00
101	1.00	1001	1.00
102	1.00	1002	1.00
103	1.00	1003	1.00
104	1.00	1004	1.00
105	1.00	1005	1.00
106	1.00	1006	1.00
107	1.00	1007	1.00
108	1.00	1008	1.00
109	1.00	1009	1.00
110	1.00	1010	1.00
111	1.00	1011	1.00
112	1.00	1012	1.00
113	1.00	1013	1.00
114	1.00	1014	1.00
115	1.00	1015	1.00
116	1.00	1016	1.00
117	1.00	1017	1.00
118	1.00	1018	1.00
119	1.00	1019	1.00
120	1.00	1020	1.00
121	1.00	1021	1.00
122	1.00	1022	1.00
123	1.00	1023	1.00
124	1.00	1024	1.00
125	1.00	1025	1.00
126	1.00	1026	1.00
127	1.00	1027	1.00
128	1.00	1028	1.00
129	1.00	1029	1.00
130	1.00	1030	1.00

Memory

Part	Price	Part	Price
100	1.00	1000	1.00
101	1.00	1001	1.00

SEND FOR
FREE
1988 CATALOG...
52 PAGES

★ QUALITY PARTS ★ DISCOUNT PRICES ★ FAST SHIPPING

ALL ELECTRONICS CORP.

OPTO SENSORS

TRW# OPB815

U shaped
opto emitter
and sensor unit.

CAT# OSU-3
2 for \$1.00



Clairex#
CL1800W
U shaped unit
with flange
mount.

CAT# OSU-2
75¢ each

Opto emitter
and sensor on
opposite sides

of slotted
opening. P.C. mount.

CAT# ILED-U
2 for \$1.00

PHOTO TRANSISTOR

TIL-99

TO-18 CASE
CAT# TIL-99
2 FOR \$1.50



PHOTO DIODE

Similar to
Clairex#CLD42
Sealed TO-18 case.

CAT# PD-1'
75¢ each

PHOTO RESISTOR ASSEMBLY

Center-tapped
photo resistor
mounted in
plastic case
(can be easily
removed). 700
ohms light, 36K dark,
1/4" diameter.

CAT# PR-4 \$1.00 each
10 for \$8.50

FLASHING L.E.D. KIT

Two L.E.D.'S
flash in
unison when
a 9 volt
battery is
attached.



Requires easy assembly,
you solder the parts to
the circuit board.

CAT# LEDKIT
\$1.50 each

WE STOCK OVER 4000 ITEMS
CALL OR WRITE FOR OUR FREE
CATALOG OF PARTS!

RESISTORS • CAPACITORS • DIODES • CABLES •
BRIDGE RECTIFIERS • CHOKE COILS • CRIMP
CONNECTORS • SUB MINIATURE D CONNECTORS •
CRYSTALS • LAMPS • HEAT SINKS • I.C.'S
• TRANSISTORS • MOTORS • PROTO BOARDS •
POTENTIOMETERS • POWER SUPPLIES • JACKS
• PLUGS • SWITCHES • PERF BOARD • FANS •
FUSES • SHRINK TUBING • TIE WRAPS •
KEYPADS • VIDEO ACCESSORIES • TOOLS
• TRANSFORMERS • TELEPHONE ACCESSORIES
• S.C.R.'S • RELAYS • WIRE • I.C. SOCKETS
• RIBBON CABLE • CRYSTALS • CIRCUIT
BREAKERS • TRANSDUCERS • VOLTAGE
REGULATORS • AND MANY OTHER ITEMS.....

SWITCHING POWER SUPPLY

Compact, well regulated
switching power supply
designed to power Texas In-
strument computer equipment.
INPUT: 14-25 Vac @ 1 Amp
OUTPUT: +5 Vdc @ 1.2 Amp, -5 Vdc @ 200 ma., 12
Vdc @ 350 ma. SIZE: 4 3/4" square. Includes 18 Vac
@ 1 Amp wall transformer designed to operate this
power supply. CAT# PS-TX \$5.00 each
10 for \$45.00

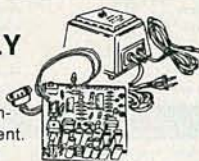

WALL TRANSFORMERS

ALL PLUG
DIRECTLY
INTO
120 VAC
OUTLET



6 Vdc @ 200 ma. \$2.25
CAT# DCTX-620
6 Vdc @ 750 ma. \$3.50
CAT# DCTX-675
9 Vdc @ 250 ma. \$2.50
CAT# DCTX-925
12 Vac @ 930 ma. \$3.50
CAT# ACTX-1293
18 Vac @ 1 Amp. \$3.50
CAT# ACTX-1885

PROTO BOARD

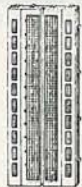

Large enough to
design most
experimental circuits.
This proto board
measures
6 3/4" X 2 1/2".
Contains main board
and two power buss
strips.
CAT# PB-101
\$11.00 each

WATER TIGHT ENCLOSURE

ROSE# 02081905
Molded fiberglass enclosure
with neoprene gasket.
2" X 3" X 7 1/2". Light blue.



CAT# WP-905 \$7.50 each

LIGHT EMITTING DIODES (L.E.D.)

STANDARD JUMBO LED
DIFFUSED
T 1-3/4 size
RED
CAT# LED-1 100 for \$13.00
1000 for \$110.00

GREEN
CAT# LED-2 100 for \$2.00
100 for \$17.00
1000 for \$150.00

YELLOW
CAT# LED-3 100 for \$2.00
100 for \$17.00
1000 for \$150.00

FLASHING LED
with built in
flashing circuit.
operates on 5 volts...

RED
CAT# LED-4 10 for \$1.00 each
100 for \$9.50

GREEN
CAT# LED-4G 10 for \$1.00 each
100 for \$9.50

BI-POLAR LED
Lights RED one
direction, GREEN the
other. Two leads.
CAT# LED-6 2 for \$17.00

LED HOLDER
Two piece holder.
CAT# HLED
10 for 65¢

CLIPLITE LED
HOLDER
Makes a L.E.D. look
like a fancy indicator.
Fits T 1-3/4 size LED.

CLEAR CAT# HLDCL-C
RED CAT# HLDCL-R
GREEN CAT# HLDCL-G
YELLOW CAT# HLDCL-Y

TRANSISTORS

CAT#	TYPE	CASE	PRICE
PN2222	NPN	TO-92	5 for .75
2N2904	PNP	TO-5	3 for \$1.00
2N2906	PNP	TO-18	3 for \$1.00
PN2907	PNP	TO-92	5 for .75
2N3055	NPN	TO-3	\$1.00 each
PN3569	NPN	TO-92	5 for .50
2N3904	NPN	TO-92	5 for .75
2N3906	PNP	TO-92	5 for .75
2N4400	NPN	TO-92	5 for .75
2N4402	PNP	TO-92	5 for .75
2N5400	PNP	TO-92	4 for \$1.00
2N5880	PNP	TO-3	\$2.00 each
2N5882	NPN	TO-3	\$2.00 each
MJE2955	PNP	TO-3	1.50 each
MJE2955T	PNP	TO-220	.75 each
MJE3055T	NPN	TO-220	.75 each
TIP30	NPN	TO-220	.75 each
TIP31	NPN	TO-220	.75 each
TIP32	PNP	TO-220	.75 each
TIP41	NPN	TO-220	.75 each
TIP42	PNP	TO-220	.75 each
TIP121	NPN	TO-220	.75 each
TIP126	PNP	TO-220	.75 each

10 AMP SOLID STATE RELAYS



ELECTROL# S2181
CONTROL:
Rated 5.5 to 10 Vdc
(will operate on 3-32 Vdc)
LOAD:
10 Amp @ 240 Vac
2 1/4" X 1 3/4" X 7/8"
CAT# SSRLY-10B
\$9.50 each
10 for \$8.50 each
QUANTITY DISCOUNT!
25 for \$7.00 each
50 for \$6.00 each
100 for \$5.00 each

SOUND ACTIVATED SWITCH

This circuit is designed to react to
high pitched sounds. Each board
contains many useful parts including
a condenser mike. Operates on
6 Vdc. CAT# SAB \$2.50 each



SOUND & VIDEO MODULATOR

TI# UM1381-1.
Designed for use
with T.I. comput-
ers. Can be used
with video cam-
eras, games, or
other audio/
video sources.
Built in A/B
switch enables
user to switch
from T.V. antenna without dis-
connection. Operates on chan-
nel 3 or 4. Requires 12 Vdc.
Hook up diagram included.
CAT# AVMOD \$5.00 each



GRAB BAGS \$1.00 each

50 ASSORTED
DISC CAPS.
Cat leads. Many common
values, some 500 volts.
CAT# GRABDC

ASSORTED
1/4 WATT
RESISTORS
Approximately 200
pieces of assorted values
some cut leads.
CAT# GRABRE

ASSORTED
PARTS
Strips of 100 assorted
parts. Each strip contains
an assortment of resis-
tors, capacitors, diodes,
coils etc. 100 parts.
CAT# GRABTR

15 VALUES OF
ELECTROLYTICS
Assortment contains 15
values from 1 Mfd up.
Some with cut leads.
CAT# GRABCP

600 / 600 OHM COUPLING TRANSFORMER

600 ohm
c.t.
P.C. mount
1" centers
on mounting tabs.
1" X 3/4" X 7/8"
CAT# CPTX
\$1.25 each
10 for \$11.00

SWITCHES

MINIATURE TOGGLE
SWITCHES
all rated 5 Amps

S.P.D.T.(on-on)
Solder lug terminals.
CAT# MTS-4
\$1.00 each
10 for \$9.00



S.P.D.T.(on-on)
Non threaded bushing.
P.C. mount.
CAT# MTS-40PC
75¢ each
10 for \$7.00



D.P.D.T.(on-on)
Solder lug terminals.
CAT# MTS-8
\$2.00 each
10 for \$19.00



MINI PUSH BUTTON

S. P. S. T. momentary.
Push to make. 1/4"
threaded bushing.
Red button.
CAT# MPB-1
35¢ each • 10 for \$3.25



ITT PUSH BUTTON

ITT MDPL series. 3/4" X 1/2"
gray rectangular key cap.
S.P.S.T. N.O. Push to close.
RATED:

0.1amp
switching,
0.25 amp
carry current. P.C. mount
CAT# PB-8 65¢ each
10 for \$6.00 • 100 for \$50.00



HALL EFFECT SWITCH

MICROSWITCH #4BE3
Slanted keyboard
switch with hall
effect sensor.
Snaps into 5/8"
square chassis
hole. Hall effect
sensor slides easily from
switch and can be used in
other applications.
CAT# HESW 4 for \$1.00
10 for \$2.00
100 for \$15.00



NICKEL-CAD (RECHARGEABLE) BATTERIES



AA SIZE \$2.00 each
1.25 Volts 500 mAh
CAT# NCB-AA
AA SIZE \$2.20 each
WITH SOLDER TABS
CAT# NCB-SAA
C SIZE \$4.25 each
1.2 Volts 1200 mAh
CAT# NCB-C
D SIZE \$4.25 each
1.2 Volts 1200 mAh
CAT# NCB-D

STORES:

LOS ANGELES
905 S. VERMONT AVE.
LOS ANGELES, CA 90006
(213) 380-8000

VAN NUYS
6228 SEPULVEDA BLVD.
VAN NUYS, CA 91411
(818) 997-1806

MAIL ORDERS TO:

ALL ELECTRONICS
P.O. BOX 567
VAN NUYS, CA
91408

TELEX: TWX-5101010163
ALL ELECTRONICS
FOREIGN CUSTOMERS SEND \$1.50
POSTAGE FOR FREE CATALOG!!

TOLL FREE

800-826-5432
INFO: (818)904-0524
FAX: (818)781-2653

QUANTITIES LIMITED
MINIMUM ORDERS \$10.00
CALIF. ADD SALES TAX
USA: \$2.00 SHIPPING
FOREIGN ORDERS INCLUDE
SUFFICIENT SHIPPING.
NO C.O.D.

JUST A FEW OF OUR QUALITY PARTS

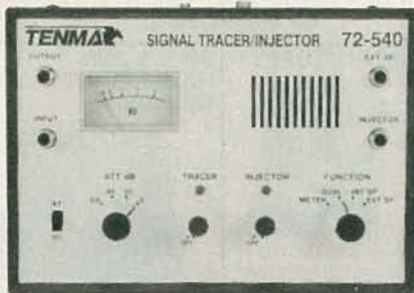

TENMA Signal Tracer/Injector

- Variable level 1KHz injection signal
- VU level meter ■ Switchable detector for troubleshooting AM circuits
- Speaker test output ■ Output provided for oscilloscope or other measurements
- Comes complete with test probe and owners manual

#72-540

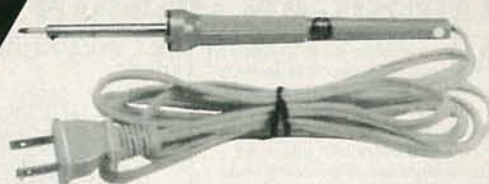

TENMA Micro Iron

- 16 watt ■ 117VAC ■ Small size ideal for soldering ICs
- Low wattage for heat sensitive devices

#21-775

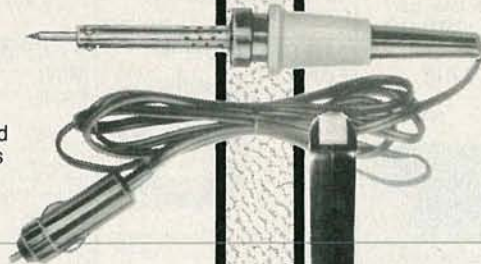

TENMA 12 Volt Soldering Iron

- This iron is specially designed for the autosound installer ■ Fast heat-up and recovery heating element ■ 7', 18 gauge cord with 12V cigarette lighter plug

#21-780



TENMA Autorange DMM

- 3½ digit LCD display ■ Autorange/manual range selector ■ Data hold: Holds display reading after meter is removed from circuit ■ Memory: Removes stored measurement from future readings ■ Audible continuity tester ■ Low battery indicator
- Switchable Lo/Hi power ohms
- Comes complete with test leads, carrying case and owners manual

#72-560

Pistol Grip Joystick

- To be used with Atari, Commodore and other VCS compatible systems ■ Three firing buttons ■ 4½' cord with 9 pin plug

#83-765

Replacement Joystick

- Quality replacement joystick for Atari video games ■ 4½' cord with 9 pin plug
- Atari #CA012994-3

#83-080



NEW

SURGE STOPPER

Swivel Power Center

- For 9" to 12" monitors ■ Swivels 360° ■ Tilts 25° up and down ■ Built-in EMI filter and surge suppression
- Power receptacles for computer, monitor, printer, and two auxiliary ■ All peripherals are switched on power center ■ Illuminated master power switch ■ Built-in circuit breaker

#83-0120

Anti-Static Field Service Kit

- 24" x 24" electrically conductive work mat with two built-in storage pockets
- Provides electrostatic protection for sensitive boards during transport or installation ■ Wrist strap and ground cord are included ■ Kit folds to 8½" x 12" x ½"

#21-740

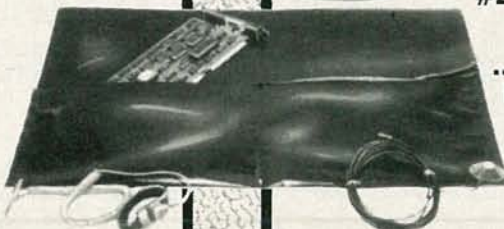

TF Solvent

- Non-toxic solvent dissolves accumulated dust and oxide particles adhering to heads, restoring clear contact for better recording and playback
- Non-conductive, leaves no residue
- Contains 100% virgin freon TF ■ New adjustable nozzle adjusts spray force
- 16 oz. aerosol can ■ 12 cans per case

#20-490

Circuit Cooler

- Will not leave residue ■ Cools circuits instantly for rapid location of heat related problems ■ Adjustable spray nozzle ■ 16 oz. ■ 12 cans per case

#20-220

... AND FOR MORE QUALITY PARTS,
LOOK INSIDE OUR FREE CATALOG!



MCM ELECTRONICS

858 E. CONGRESS PARK DR.
CENTERVILLE, OH 45459-4072

A PREMIER Company

© 1988, MCM Electronics

SOURCE CODE: RE-46

CIRCLE 87 ON FREE INFORMATION CARD

Radio Shack Parts Place™

ELECTRONICS VALUES AT OUR STORE NEAR YOU

"Hotline" Service



Over 200,000 Substitutions

Your Radio Shack store manager can special-order a huge variety of parts not in our catalog: tubes, ICs, transistors, crystals and much more. No minimum order, no postage. Delivery time, about one week!

Switch Selection



- (1) SPDT Lighted. 3 amps at 120 VAC. 12-volt lamp. #275-676 6.49
- SPST Push-On/Off. 3 amps at 125 VAC. #275-1565 1.99
- (2) Momentary SPST Push-On/Off. 3 amps at 125 VAC. #275-1566 1.89
- (3) Mini SPDT Relay. 1 amp at 125 VAC. Coil: 6-9 VDC, 500 ohm. #275-004 2.99

Ham Package and "How-To" Book



(1) Includes Two Cassettes



(2) Great Beginner Book

- (1) Novice License Exam Package. Become a Ham! Everything you need to prepare for the new voice/digital class FCC exam. Two instructional audio tapes, plus practice exam questions and answers. #62-2402 19.95
- (2) Getting Started in Electronics. "Hands on" introduction featuring basic electronics projects. 128 pages. #276-5003 2.49

Sight 'n Sound

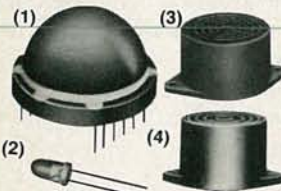

- (1) Big Red LED. #276-064 3.49
- (2) Brilliant Red LED. #276-066 1.19
- (3) Tri-Sound Siren. Three 80-dB outputs. #273-072 5.95
- (4) 12VDC IC Chime. #273-071 8.69

Builder Bargains



- (1) High-Torque Motor. 1.5-3 VDC, approx. 8300 RPM. #273-223 89¢
- (2) 1:1 Audio Transformer. 600-900 ohms impedance. #273-1374 3.49
- (3) Magnet Wire. Three spool set—22, 26, 30 gauge. #278-1345 4.79

Computer and Peripheral Hookups

Solder-Type "D" Submini Connectors



Fig.	Type	Pos.	Cat. No.	Each
1	Male	9	276-1537	1.49
2	Female	9	276-1538	2.49
3	Hood	9	276-1539	1.19

Type	Pos.	Cat. No.	Each
Male	25	276-1547	1.99
Female	25	276-1548	2.99
Hood	25	276-1549	1.29

First Quality Data Connectors

- (4) RS-232 Modular Jack Adapter Kit. For interoffice local area networking. For 2,4,6 wire hookups. #276-1405 2.99

Coax Cable Tools



- (1) Stripper. For all popular sizes. #278-240 11.95
- (2) Cutter. Blades do not flatten cable, preserve impedance. #278-244 5.95
- (3) Professional Crimper. #278-243 14.95

Rare Values

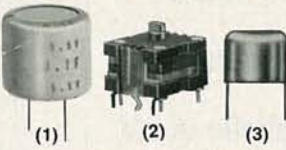

- (1) CPU/RAM Backup Cap. For CMOS microprocessors. 0.1 farad, 5.5 WV. #272-1440 2.95
- (2) Dual-Ganged 335 pF Cap. PC mount. Knob, pinout. #272-1337 4.95
- (3) 6-50 pF Trimmers. PC/perboard mount. #272-1340 Pkg. of 2/1.59

Project Bonanza



- (1) Vented Metal Cabinets. 3 1/4 x 2 1/8 x 4". #270-251 2.99
- 4 x 2 3/8 x 6". #270-252 3.99
- 4 1/4 x 3 x 5 7/8". #270-253 5.79
- (2) Panel-Mount Fuse Holder. Square bezel. UL recognized. #270-365 1.49
- (3) Panel-Mount DC Voltmeter. 0 to 15 volts DC. #270-1754 7.95

IC "Talk" Sale!



- (1) Speech Synthesizer. Cut 23%. Interfaces with most PCs. Requires 3.12 MHz crystal (special-order). Reg. \$12.95. #276-1784 Sale 9.95
- (2) RS-232 Adapter. 30% Off. Pre-programmed 8-bit processor translates serial port data into control data for #276-1784 above. Requires 10 MHz crystal (special-order). Reg. 16.95. #276-1786 Sale 11.88

Autoranging VOM



34⁹⁵

With Probes

Just select the function, and it does the rest! Digital display multimeter measures to 1000 volts DC, 500 volts AC, DC current to 200 mA. Resistance to 2 megohms. With test leads. Batteries extra. #22-188

Logic Probe & Pulsar



17⁹⁵

- Operate from 4.7 to 15 VDC. Obtain power from circuit under test.
- (1) Probe. "Peek inside" TTL, LS and CMOS digital circuits. Color-coded LEDs. #22-303
 - (2) Pulsar. Single 5 µs pulse or a continuous 5 Hz pulse train at the push of a button. #22-304

RS-232 Mini Tester

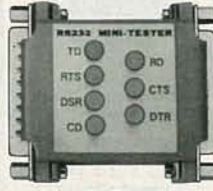

14⁹⁵

Diagnose interface problems in micros and peripherals yourself, without costly outside repairs. Dual-color LEDs indicate status of TD, RTS, DSR, CD, RD, CTS and DTR lines. Connects inline. #276-1401

AC Outlet Voltage Spike Protectors



- (1) Heavy-Duty Single Outlet. Rated 15 amps at 120 VAC. #61-2792 9.95
- (2) Triple Outlet. Ideal for protecting audio/video systems. Status indicator light. 15 amps, 120 VAC. #61-2793 14.95

Over 1000 items in stock: Binding Posts, Books, Breadboards, Buzzers, Capacitors, Chokes, Clips, Coax, Connectors, Fuses, Hardware, ICs, Jacks, Knobs, Lamps, Multitesters, PC Boards, Plugs, Rectifiers, Resistors, Switches, Tools, Transformers, Wire, Zeners and More!

Prices apply at participating Radio Shack stores and dealers

Radio Shack®
The Technology Store™

A DIVISION OF TANDY CORPORATION

ADVERTISING INDEX

RADIO-ELECTRONICS does not assume any responsibility for errors that may appear in the index below.

Free Information Number	Page		Page		Page
81	A.I.S. Satellite	99	82	Digi-Key	113
108, 176	AMC Sales	82	88	ETE Engineering	99
—	AMCOM	104	—	Electronic Technology Today	30
107	All Electronics	114	—	Electronics Book Club	25
—	Amazing Devices	102	121	Fluke Manufacturing	81
106	American Design Components	115	194	Fordham Radio	CV4
84	Appliance Service	98	205	G.D.C. Computers	92
76	Associated Electronics/3M	24	—	Grantham Col. of Engineering	77
77	B&K Precision	3	—	Heath	78
250-255	B&K	3	65	J & W	32
186	Banner Technical Books	82	202	J.B. Electronics	99
85	Blue Star Industries	99	59	JDR Instruments	23
109	C & S Sales	33	113, 177	JDR Microdevices	108, 109
—	C.O.M.B.	35	178, 179	JDR Microdevices	110, 111
60	CIE	8	180	JDR Microdevices	112
50	Caig Laboratories	78	114	Jameco	106, 107
54	Chemtronics	16	115	Jensen Tools	99
192	Chenesko Products	99	—	Joseph Electronics	27
—	Command Productions	73	193	Kelvin	79
58	Cook's Institute	24	181	Kikusui	29
191	Crystek	75	200	M Test Equipment	98
189	Daetron	28	87	MCM Electronics	116
—	Damark International	40	53	MD Electronics	73
127	Deco Industries	98, 99	93	Mark V. Electronics	105
—	—	—	—	McGraw Hill Book Club	36
—	—	—	61	Microprocessors Unltd.	92
—	—	—	204	Movie Time	30
—	—	—	199	Music Quest	92
—	—	—	—	NRI	18
—	—	—	196	Needham	92
—	—	—	72	NuScope Associates	92
—	—	—	203	Nutronix	82
—	—	—	—	Pacific Cable	103
—	—	—	56	Parts Express	118
—	—	—	68, 201	Philips ECG	96
—	—	—	260-264	Philips ECG	96
—	—	—	78	Radio Shack	117
—	—	—	187, 188	Sencore	5, 31
—	—	—	51	Silicon Valley Surplus	102
—	—	—	197	Simpson	7
—	—	—	83	Synergetics	70
—	—	—	195	Talking Technology	92
—	—	—	92, 182	Tektronix	CV2, 13
—	—	—	183, 184	Tektronix	15, 17
—	—	—	185	WPT Publications	100
—	—	—	190	Weka Publishing	CV3
—	—	—	198	Z World	92

Parts Express International Inc.

PIONEER



10" WOOFER

Heavy duty paper cone with 20 oz. magnet. 60 watts RMS, 90 watts max. Response: 35-3,500 Hz.

#290-083 \$18⁹⁰ \$16⁹⁰
(1-3) (4-UP)

FREE CATALOG



Call or write today for your free catalog containing speakers, semi-conductors, CATV products, tools, hardware, TV-VCR parts, and more.

PIONEER



HORN TWEETER

3" wide dispersion horn tweeter. 1800-15,000 Hz response. 35 watts RMS, 50 watts max. 8 ohm impedance.

#270-050 \$6⁵⁰ \$5⁹⁰
(1-9) (10-UP)

CROSSOVERS



2-Way, 30 watt #260-190 \$3⁹⁵
3-Way, 60 watt #260-200 \$7⁵⁰
3-Way, 100 watt #260-210 \$12⁵⁰

MOTOROLA



PIEZO TWEETER

Mfg. #KSN1005A, 3/4" x 3/8". No crossover required. 50 watts maximum input power.

#270-010 \$4⁹⁵ \$3⁹⁵
(1-79) (80-UP)

PIONEER



8" POLY WOOFER

Clear ribbed polypropylene cone. 60 watts RMS, 90 watts max. power. 20 oz. magnet. 35-2500 Hz. 4-8 ohm compatible.

#290-055 \$20⁵⁰ \$18⁹⁵
(1-3) (4-UP)

PIONEER



15" WOOFER

20 oz. magnet. 60 watts RMS, 90 watts max. 8 ohm impedance. 1 1/2" voice coil. 25-2000 Hz.

#290-160 \$30⁹⁵ \$28⁴⁰
(1-3) (4-UP)

PIONEER



5 1/2" CUP MIDRANGE

Tuned cup. Paper cone, 1" voice coil. 9.3 oz. magnet. 50 watts RMS, 70 watts max. Response: 320-6000 Hz. 8 ohm impedance.

#280-020 \$11⁵⁰ \$9⁹⁵
(1-9) (10-UP)

Try the

Radio Electronics

bulletin board system

(RE-BBS)
516-293-2283

The more you use it the more useful it becomes.

We support 300 and 1200 baud operation.

Parameters: 8N1 (8 data bits, no parity, 1 stop bit) or 7E1 (7 data bits, even parity, 1 stop bit).

Add yourself to our user files to increase your access.

Communicate with other R-E readers.

Leave your comments on R-E with the SYSOP.

RE-BBS
516-293-2283

Gernsback Publications, Inc.
500-B Bi-County Blvd.
Farmingdale, NY 11735
(516) 293-3000

President: Larry Steckler
Vice President: Cathy Steckler

For Advertising ONLY

516-293-3000

Larry Steckler

publisher

Arline Fishman

advertising director

Shelli Weinman

advertising associate

Lisa Strassman

credit manager

Christina Estrada

advertising assistant

SALES OFFICES

EAST/SOUTHEAST

Stanley Levitan

Eastern Sales Manager

Radio-Electronics

259-23 57th Avenue

Little Neck, NY 11362

718-428-6037, 516-293-3000

MIDWEST/Texas/Arkansas/Okla.

Ralph Bergen

Midwest Sales Manager

Radio-Electronics

540 Frontage Road—Suite 339

Northfield, IL 60093

312-446-1444

PACIFIC COAST/ Mountain States

Marvin Green

Pacific Sales Manager

Radio-Electronics

5430 Van Nuys Blvd. Suite 316

Van Nuys, CA 91401

1-818-986-2001

CALL TOLL FREE

1-800-338-0531

Local: (513) 222-0173

* 15 day money back guarantee. * \$10.00 minimum order. * COD orders accepted. * 24 hour shipping. * Shipping charge = UPS chart rate (\$2.50 minimum charge). Hours 8:30 a.m. - 6 p.m. EST M-F.

PARTS EXPRESS INTL. INC.
340 East First St.
Dayton, Ohio 45402



A major NEW publication for anyone with a real interest in electronics

This brand new MODERN AMATEUR ELECTRONICS MANUAL provides you with a single comprehensive and practical reference work—to keep you completely up-to-date with all aspects of amateur electronics.

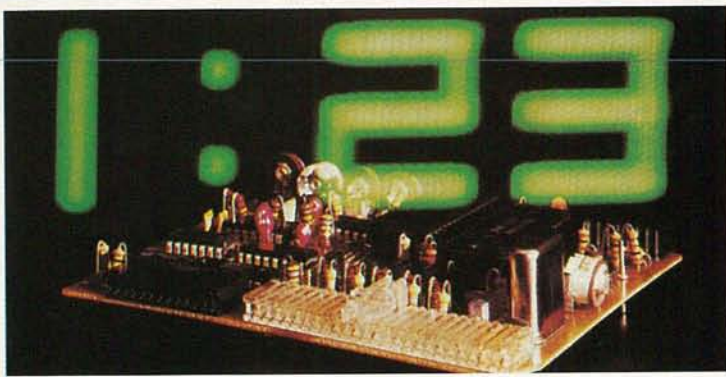

If you're excited about electronics...if you want to understand, assemble, repair, and have fun with electronics, you need...

THE MODERN AMATEUR ELECTRONICS MANUAL ...the major guide and reference volume in the electronics field.

No field is more fascinating than electronics. But no field changes more rapidly. Think of the advances in computer technology, audio and video equipment, short wave radio, to name just a few. To keep up-to-date you would probably have to read ten magazines.

Now with THE MODERN AMATEUR ELECTRONICS MANUAL, plus updates, you keep abreast of new developments, new equipment, new theories, new products.

Don't waste time searching for reference sheets, data sheets, or instructions. You have them now in one looseleaf volume plus its supplements.

Everything for the electronics hobbyist.

THE BASICS. Learn about measurement instruments—neon bulb voltage indicators, VOMs, VTVMs. Build your own circuit boards. Check out the MANUAL's printed-on-film PCB layouts, ready to transfer to copper clad boards for immediate use.

EQUIPMENT. Latest information on stereo, VCR, compact disc, and other audio equipment is provided.

ASSEMBLY. Hobbyists interested in radios, synthesizers, computers, loud speakers and amplifiers can use the assembly instructions given for many kinds of electronic equipment.

SHORT WAVE AND HAM RADIOS. The MANUAL gives you information on equipment and regulations. Learn what's legal before you go on the air.

ALWAYS UP-TO-DATE. WEKA Publishing, one of the largest technical publishers in the world, sends you supplements four to five CIRCLE 190 ON FREE INFORMATION CARD

COMPONENTS. Need capacitors, inductors, semi-conductors, switches, relays and many other kinds of electronic hardware? Check the MANUAL. You will find descriptions and sources and very often alternative possibilities.

COMPUTERS AND PERIPHERALS. Learn how to program your computer. Use BASIC or other languages; it's all in the MANUAL. Modems, bulletin boards, graphic cards, and much more are all explained.

SUPPLY SOURCES. Every hobbyist is constantly on the prowl for parts. The MANUAL's reference sheets save you time. They tell you where you can obtain hundreds of components. Updating sheets assure that your volume is always current.



Basic Edition: 400 Pages
Size: 9" x 12"

times a year. You put these in the appropriate sections of the book—a sturdy, well-built looseleaf binder.



IMPORTANT: WEKA Publishing is independent of any electronic manufacturer. We provide fair and unbiased information on equipment, as well as on sources of parts and service.

Elliot S. Kanter, Editor-In-Chief, has assembled a team of top technical writers who not only work in the electronics field, but write with authority and clarity

Assemble your own CIRCUIT BOARDS—we give you ready-to-use PCB layouts on film—a very popular feature.

ORDER TOLL FREE 24 HOURS **1-800-453-1214**
FOR CREDIT CARD ORDERS ONLY

MONEY BACK GUARANTEE

You must be completely satisfied with any book you order from WEKA Publishing, or you can return it any time within 10 days—no questions asked. We'll even pay the return postage.

PRE-PUBLICATION SAVINGS CERTIFICATE

All orders received before August 31, 1988 will get a discount of 10%!

Yes, please reserve my copy of The Modern Amateur Electronics Manual for only \$49.95 (plus \$4.50 for shipping and handling). NY State residents please add appropriate sales tax.

Payment enclosed (check payable to WEKA Publishing) Charge my MasterCard VISA
Acct. No. _____ Exp. Date _____
Signature _____

NAME _____
ADDRESS _____
CITY _____ STATE _____ ZIP _____

I understand I'll also receive the supplements 4 to 5 times each year at 25¢ per page to ensure my manual remains completely up-to-date. I'll be billed with each separate supplement and can return them unpaid if I'm not satisfied. I can also cancel further supplements at any time.

WEKA Publishing, Inc.
150 Purchase Street, Rye, New York 10580
A Member of the International WEKA Publishing Group:
Austria, France, Germany, Italy, Netherlands, Switzerland,
United Kingdom and United States. 5008



Fordham measures up

Quality • Price • Delivery

Mini-Meters with Maxi-Specs



SCOPE 3 1/2 Digit LCD Meter

- 0.5% Accuracy • DC Voltage • AC Voltage • DC Current • Resistance • Diode Test • Battery Life 300 Hrs.
- Overload Protection: DC 500V, AC 350V, ohms 250V DC/AC.

Model DVM-630
Our Price **\$2995**

Zippered carrying case CC-30 \$4.50

NEW! SCOPE 3 1/2 Digit, LCD 8 Function with Transistor Tester

- 0.5% Accuracy • Audible continuity and diode test • 10 Amp measurement • Resistance • DC/AC Voltage.

Model DVM-632
Reg. \$60.00
Our Price **\$4495**

Zippered carrying case CC-30 \$4.50

SCOPE 3 1/2 Digit LCD with Autoranging

- 0.5% Accuracy • Auto/Manual range selection • DC Voltage • AC Voltage • AC Current • DC Current • Resistance.

Model DVM-631
Our Price **\$4995**

Special

Deluxe carrying case CA-92 \$9.95

SCOPE Hand-Held Digital Multimeters

- Overload protection • Auto-decimal LCD readout • Polarity indication • 300 hr. 9V battery life • Low battery indicator.

- 8 Function, 37 ranges including Transistor and Capacitance measurements

Model DVM-636
Our Price **\$6750**



- 11 Function, 38 ranges including Logic Level Detector, Audible and Visual Continuity, Capacitance and Conductance measurements

Model DVM-638
Our Price **\$8750**



CA-92 Deluxe Padded Case for DVM meters: \$9.95
TL-216 Transistor and Capacitance Test Leads \$9.90



NEW!
SCOPE Frequency Counters
• 8-digit LED • Compact • lightweight
• High performance • Automatic range and Hold function • High stability in reference oscillator.

Model FC-7011
100 MHz Our Price **\$16995**

Model FC-7051
550 MHz Our Price **\$24995**



FORDHAM Frequency Counter

- 10 Hz - 150 MHz Range • 7-digit LED display • VHF/HF selection • Gate time 1 sec., 5 sec. • ±1 count accuracy.

Model FC-150
Our Price **\$13990**



NEW FORDHAM Function Generator

- 0.5 Hz - 500 KHz in 6 ranges • Sine, square & triangle wave forms • VCA and VCF inputs • Accuracy ±5% of full scale.

Model FG-202
Our Price **\$14990**



FORDHAM Signal Tracer/Injector

- Easy to operate • VU meter • Two LED mode indicators • 1 KHz test tone • 8 ohm speaker • Test leads.

Model SE-610
Our Price **\$11990**



FORDHAM LCR Bridge Meter

- Fully transistorized • 1 KHz signal generator • Measures resistance • Inductance • High mechanical and electrical stability • Battery operated.

Model LC-340
Our Price **\$14995**

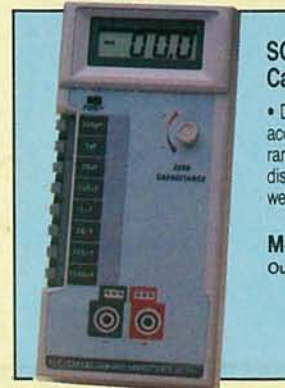

SCOPE Digital Capacitance Meter

- Digital LCD display • LSI-circuit • High accuracy: 100 ppm 0.5% • Broad test range • Fast sampling time • Capacitor discharge protection • Compact, lightweight design • One-hand operation.

Model DCM-602
Our Price **\$5995**

Telephone Orders Now! EVERYDAY INCLUDING SATURDAY
Mon. - Fri. 8 a.m. - 8 p.m. EST. Sat. 9 a.m. - 3 p.m. EST

ASK FOR FREE CATALOG. Money orders, checks accepted. C.O.D.'s require 25% deposit

Fordham

260 Motor Parkway, Hauppauge, NY 11788

Toll Free **800-645-9518**

In NY State 800-832-1446

Service & Shipping Charge Schedule Continental U.S.A.

FOR ORDERS	ADD
\$25-100	\$4.50
\$101-250	\$6.00
\$251-500	\$8.00
\$501-750	\$10.50
\$751-1,000	\$12.50
\$1,001-1,500	\$16.50
\$1,501-2,000	\$20.00
\$2,001 and Up	\$25.00