

48783

PROTECT YOUR HOME WITH AN
ELECTRONIC SECURITY SYSTEM

\$2.25 APR. 1988
IN CANADA \$2.75

Radio Electronics

TECHNOLOGY - VIDEO - STEREO - COMPUTERS - SERVICE

WIRELESS STEREO TRANSMITTER

HOW TO TUNE UP AND ALIGN
R-E's WIRELESS AUDIO LINK

BUILD A FREQUENCY STANDARD

TV-BASED STANDARD FEATURES
ACCURACY BETTER THAN 1 PPM

THE BEST ELECTRONICS COLUMNS

- ★ HARDWARE HACKER
- ★ VIDEO NEWS
- ★ NEW COLUMN: SHORTWAVE RADIO

MONOSTABLE MULTIVIBRATORS

A COOKBOOK OF PRACTICAL
PULSE-GENERATOR CIRCUITS

COMPUTERDIGEST

PROTECT YOUR SENSITIVE DATA
WITH ENCRYPTION TECHNIQUES

BUILD THIS SURROUND SOUND PROCESSOR



BRING MOVIE-THEATRE SOUND
TO YOUR LIVING ROOM



A
GERNSBACK
PUBLICATION

**NOW!
DIGITAL
STORAGE
ANSWERS
STARTING AT
\$2995.**

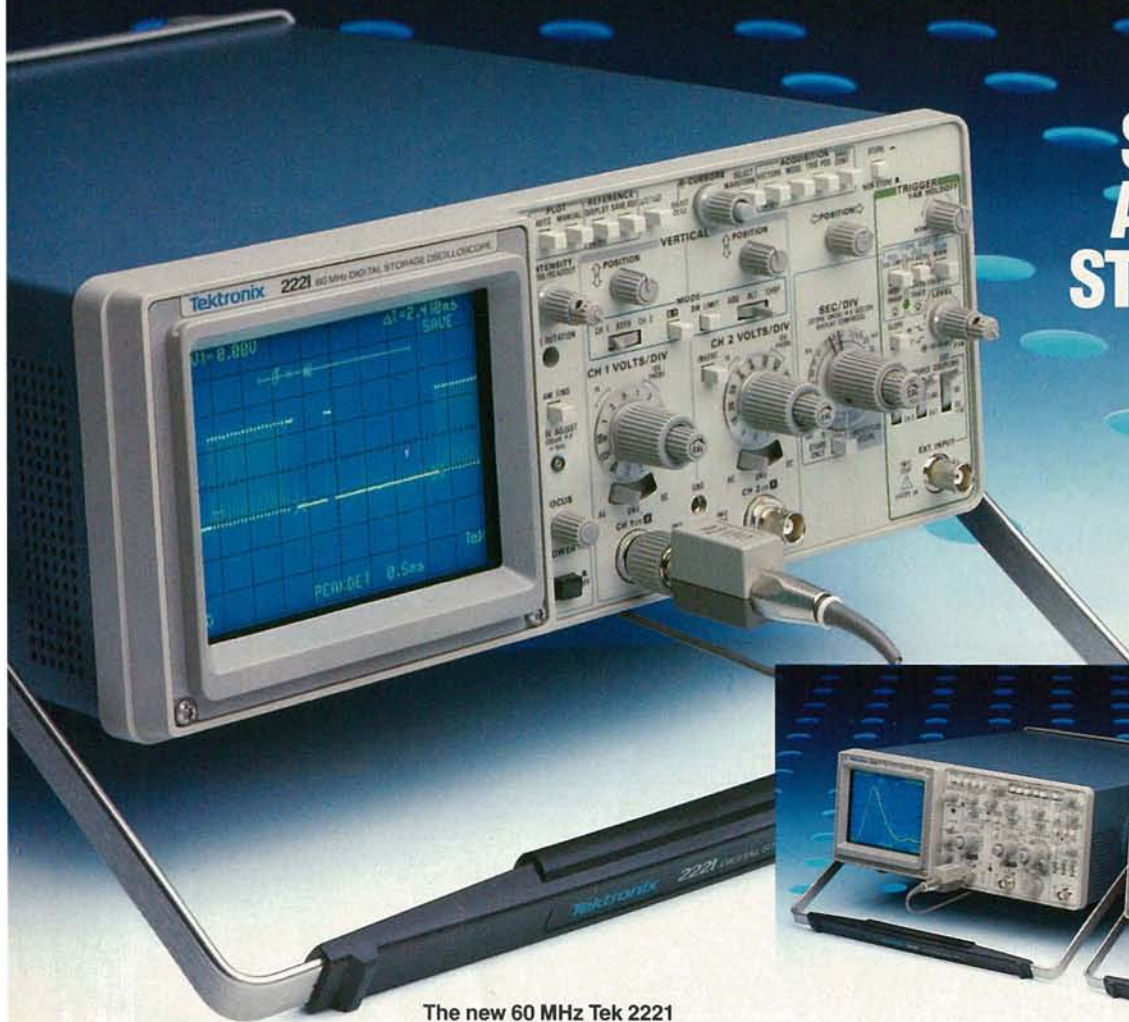

The new 60 MHz Tek 2221 (above) offers such features as CRT readout and measurement cursors for just \$3995.

Now you have three low-cost choices in Tek digital storage oscilloscopes. All featuring powerful 20 MS/s digitizing along with familiar, full-bandwidth analog operation. It's the best of both worlds in one easy-to-use, portable package.

Discover the potential!

With digital storage you can freeze waveforms. Capture events invisible to non-storage scopes. Find signals buried in noise. And build a library of reference waveforms.

CRT readout and cursors distinguish the new 2221. For even higher performance, there's the 100 MHz, dual time base 2230 with optional battery-backed

Features	2230	NEW! 2221	2220
Analog/Digital Storage BW	100 MHz	60 MHz	60 MHz
Maximum Sampling Speed	20 MS/s	20 MS/s	20 MS/s
Record Length	4K/1K (selectable)	4K	4K
Peak Detect	100 ns	100 ns	100 ns
Save Reference Memory	One, 4K Three, 1K	One, 4K	One, 4K
Vertical Resolution	8 bits 10 bits 12 bits (AVG mode over the bus)	8 bits 10 bits (AVG mode)	8 bits
CRT Readout/Cursors	Yes	Yes	No
GPIB/RS-232-C Options	Yes (\$750)	Yes (\$500)	Yes (\$500)
Battery-Backed Memory (save 26 waveform sets)	Yes (inc with GPIB/RS-232-C)	No	No
Warranty	3 year on labor and parts, including the CRT		
Price	\$4995	\$3995	\$2995

memory for saving up to 26 waveform sets. And if it's economy you want, choose the 60 MHz 2220 with many of the same features at an even lower cost.

With each scope you can automate measurements with interface options. And output direct to a printer or plotter. Tek software is available for systems.

**Call Tek direct:
1-800-426-2200**
for free video brochure for orders/assistance.



Tektronix
COMMITTED TO EXCELLENCE

BUILD THIS

- 45 SURROUND SOUND DECODER**
Bring movie-theatre sound to your living room.
Norman M. Hill
- 50 WIRELESS VIDEO LINK**
Part 2. Fine-tuning the wireless FM transmitter.
William Sheets and Rudolf F. Graf
- 52 ADVANCED CONTROL SYSTEM**
Part 3. Build the CPU module.
H. Edward Roberts, M.D.
- 55 TV-DERIVED FREQUENCY STANDARD**
Use your TV as a frequency reference.
Luther M. Stroud, CET

TECHNOLOGY

- 59 ELECTRONIC SECURITY SYSTEMS**
Today's home security systems, and how they can protect you.
Alan Glasser
- 64 NEW MAGNETIC MEMORIES**
An April 1st breakthrough!
Glynn G. Gillette

CIRCUITS AND COMPONENTS

- 65 WORKING WITH MONOSTABLE MULTIVIBRATORS**
How to design, build and use these pulse generators.
Ray Marston

DEPARTMENTS

- | | |
|---|--|
| <ul style="list-style-type: none">12 VIDEO NEWS
What's new in this fast changing field.
David Lachenbruch27 EQUIPMENT REPORTS
Videonics' <i>DirectED</i> video editing system.72 HARDWARE HACKER
Video imaging devices—and more!
Don Lancaster | <ul style="list-style-type: none">77 NEW IDEAS
A sine-wave generator.
Dale Nassar78 SHORTWAVE RADIO
Welcome to a new column!
Stanley Leinwoll80 AUDIO UPDATE
Hi-fi history.
Larry Klein82 ANTIQUE RADIOS
We hear from our readers.
Richard D. Fitch |
|---|--|

COMPUTER DIGEST

A NEW KIND OF MAGAZINE FOR ELECTRONICS PROFESSIONALS

PROTECT YOUR SENSITIVE DATA

Use encryption techniques to keep your information out of the wrong hands.



CD CLASSROOM

The PC-compatible expansion connectors

HANDS-ON REVIEWS

AutoCAD, AutoSketch, Irwin's tape backup system, and more!

PAGE 85

BUILD THIS

TV Derived Frequency Standard

LUTHER M. STROUD, CET



Accurate frequency standards are essential for the proper operation of many electronic systems. The most common type of frequency standard is the quartz crystal oscillator. However, quartz crystals are expensive and difficult to obtain in large quantities. A TV-derived frequency standard is a much simpler and more economical solution. This article describes the design and construction of a TV-derived frequency standard. The circuit is based on a TV tuner circuit which provides a stable reference frequency. The frequency is derived from a TV channel which is selected from a TV set. The frequency is then divided by a counter to produce the desired output frequency. The circuit is simple to build and requires only a few components. It is a useful addition to any electronics workshop.

How it works
The TV tuner circuit in a TV set provides a stable reference frequency. This frequency is derived from a TV channel which is selected from a TV set. The frequency is then divided by a counter to produce the desired output frequency. The circuit is simple to build and requires only a few components. It is a useful addition to any electronics workshop.

PAGE 55

AND MORE

- 120 Advertising and Sales Offices**
- 120 Advertising Index**
- 4 Editorial**
- 121 Free Information Card**
- 14 Letters**
- 101 Market Center**
- 36 New Products**
- 69 PC Service**
- 6 What's News**

ON THE COVER



You have the latest video release playing on a wide-screen set, with stereo sound, and even fresh-popped popcorn—but it's still not quite like being in the movie theatre? Our Surround Sound Decoder can change that by bringing three-dimensional sound to your living room! The rear channel needed to create the surround-sound effect is concealed within the stereo tracks on modern home videos, and on TV movies broadcast in MTS stereo. Turn to page 45 to learn how to build a decoder to extract these hidden rear tracks, and how to position your speakers for optimal effect. Then dim the lights—you'll swear you're in a theatre!

COMING NEXT MONTH

THE MAY ISSUE
IS ON SALE
APRIL 5

BUILD A FUNCTION GENERATOR

An easy-to-build addition to your workbench

Radio Electronics ADVANCED CONTROL SYSTEM: PART 4

Add a battery backup for uninterruptible operation.

BUILD A SUBWOOFER SIMULATOR

Turn any speaker into a subwoofer.

THERMOELECTRIC COOLERS

How they work and how they're used.

COMPUTER DIGEST

Build an IC tester for your Commodore 64

As a service to readers, RADIO-ELECTRONICS publishes available plans or information relating to newsworthy products, techniques and scientific and technological developments. Because of possible variances in the quality and condition of materials and workmanship used by readers, RADIO-ELECTRONICS disclaims any responsibility for the safe and proper functioning of reader-built projects based upon or from plans or information published in this magazine.

Since some of the equipment and circuitry described in RADIO-ELECTRONICS may relate to or be covered by U.S. patents, RADIO-ELECTRONICS disclaims any liability for the infringement of such patents by the making, using, or selling of any such equipment or circuitry, and suggests that anyone interested in such projects consult a patent attorney.

RADIO-ELECTRONICS, (ISSN 0033-7862) April 1988. Published monthly by Gernsback Publications, Inc., 500-B Bi-County Boulevard, Farmingdale, NY 11735 Second-Class Postage paid at Farmingdale, NY and additional mailing offices. Second-Class mail registration No. 9242 authorized at Toronto, Canada. One-year subscription rate U.S.A. and possessions \$17.97, Canada \$23.97, all other countries \$26.97. All subscription orders payable in U.S.A. funds only, via international postal money order or check drawn on a U.S.A. bank. Single copies \$2.25. © 1988 by Gernsback Publications, Inc. All rights reserved. Printed in U.S.A.

POSTMASTER: Please send address changes to RADIO-ELECTRONICS, Subscription Dept., Box 55115, Boulder, CO 80321-5115.

A stamped self-addressed envelope must accompany all submitted manuscripts and/or artwork or photographs if their return is desired should they be rejected. We disclaim any responsibility for the loss or damage of manuscripts and/or artwork or photographs while in our possession or otherwise.

Radio Electronics®

Hugo Gernsback (1884-1967) founder
M. Harvey Gernsback,
editor-in-chief, emeritus

Larry Steckler, EHF, CET,
editor-in-chief and publisher

EDITORIAL DEPARTMENT

Art Kleiman, editorial director
Brian C. Fenton, managing editor
Carl Laron, WB2SLR, associate editor
Jeffrey K. Holtzman,
computer editor
Marc Spiwak, associate editor
Jonathan A. Gordon,
assistant technical editor
Robert A. Young, assistant editor
Julian S. Martin, editorial associate
Byron G. Wels, editorial associate
M. Harvey Gernsback,
contributing editor
Jack Darr, CET, service editor
Robert F. Scott,
semiconductor editor
Herb Friedman,
communications editor
Robert Grossblatt, circuits editor
Larry Klein, audio editor
David Lachenbruch,
contributing editor
Don Lancaster,
contributing editor
Richard D. Fitch,
contributing editor
Teri Scaduto, editorial assistant

PRODUCTION DEPARTMENT

Ruby M. Yee, production director
Robert A. W. Lowndes,
editorial production
Andre Duzant, technical illustrator
Karen Tucker, advertising production
Marcella Amoroso, production traffic

CIRCULATION DEPARTMENT

Jacqueline P. Cheeseboro,
circulation director
Wendy Alanko,
circulation analyst
Theresa Lombardo,
circulation assistant

Typography by Mates Graphics
Cover photo by Herb Friedman

Radio-Electronics is indexed in
Applied Science & Technology Index
and *Readers Guide to Periodical Literature*.

Microfilm & microfiche editions are
available. Contact circulation department
for details.

Advertising Sales Offices listed
on page 120.



Electronics Paperback Books

GREAT ELECTRONICS PAPERBACKS FROM ETT



- BP125—25 SIMPLE AMATEUR BAND ANTENNAS.....\$5.00.** All are inexpensive to build, yet perform well. Diodes, beams, triangle and even a mini rhombic.
- BP128—20 PROGRAMS FOR THE ZX SPECTRUM AND 16K ZX82.....\$5.75.** Included with each program is a flow chart and a description of what happens. Notes for converting programs for use on other computers are also included.
- BP235—POWER SELECTOR GUIDE.....\$10.00.** Complete guide to semiconductor power devices. More than 1000 power handling devices are included. They are tabulated in alpha-numeric sequence, by technical specs. Includes power diodes, Thyristors, Triacs, Power Transistors and FET's.
- BP234—TRANSISTOR SELECTOR GUIDE.....\$10.00.** Companion volume to BP235. Book covers more than 1400 JEDEC, JIS, and brand-specific devices. Also contains listing by case type, and electronic parameters. Includes Darlingtons transistors, high-voltage devices, high-current devices, high power devices.
- BP99—MINI-MATRIX BOARD PROJECTS.....\$5.00.** Here are 20 useful circuits that can be built on a mini-matrix board that is just 24 holes by ten copper-foil strips.
- BP157—HOW TO WRITE ZX SPECTRUM AND SPECTRUM+ GAMES PROGRAMS.....\$5.95.** A crystal-clear step-by-step guide to writing your own graphics games programs.
- BP117—PRACTICAL ELECTRONIC BUILDING BLOCKS—Book 1.....\$5.75.** Oscillators, Timers, Noise Generators, Rectifiers, Comparators, Triggers and more.
- BP184—INTRO TO 68000 ASSEMBLY LANGUAGE.....\$6.50.** The 68000 is a great new breed of microprocessor. Programming in assembly language increases the running speed of your programs. Here's what you need to know.
- BP179—ELECTRONIC CIRCUITS FOR THE COMPUTER CONTROL OF ROBOTS \$5.00.** Data and circuits for interfacing the computer to the robot's motors and sensors.
- BP126—BASIC & PASCAL IN PARALLEL.....\$4.95.** Takes these two programming languages and develops programs in both languages simultaneously.
- BP198—AN INTRODUCTION TO ANTENNA THEORY...\$6.95** Basic concepts relevant to receiving and transmitting antennas.
- 225—A PRACTICAL INTRODUCTION TO DIGITAL IC'S.....\$4.95.** Mainly concerned with TTL devices. Includes several simple projects plus a logic circuit test set and a digital counter timer.
- BP170—INTRODUCTION TO COMPUTER PERIPHERALS.....\$5.95.** Shows how to use a variety of co computer add-ons in as non-technical a way as possible.
- 227—BEGINNERS GUIDE TO BUILDING ELECTRONIC PROJECTS.....\$5.00.** How to tackle the practical side of electronics so you can successfully build electronic projects.
- BP169—HOW TO GET YOUR COMPUTER PROGRAMS RUNNING.....\$5.95.** Shows how to identify error in program and what to do about them.
- BP194—MODERN OPTO DEVICE PROJECTS.....\$6.25.** Crammed with great projects for the experimenter. Includes sections on Fiber optics, passive Infra-Red detectors, plus an assortment of miscellaneous projects.
- BP180—ELECTRONIC CIRCUITS FOR THE COMPUTER CONTROL OF MODEL RAILROADS.....\$6.25.** It's easy to interface home computers to model railroad control. The main problem is in interfacing the computer to the system.
- BP110—HOW TO GET YOUR ELECTRONIC PROJECTS WORKING.....\$5.00.** How to find and solve the common problems that can occur when building projects.

- BP33—ELECTRONIC CALCULATOR USERS HANDBOOK.....\$5.75.** Invaluable book for all calculator owners. Tells how to get the most out of your calculator.
- BP36—50 CIRCUITS USING GERMANIUM, SILICON & ZENER DIODES.....\$5.00.** A collection of useful circuits you'll want in your library.
- BP37—50 PROJECTS USING RELAYS, SCR'S & TRIACS.....\$5.00.** Build priority indicators, light modulators, warning devices, light dimmers and more.
- BP39—50 FET TRANSISTOR PROJECTS.....\$5.50.** RF amplifiers, test equipment, tuners, receivers, tone controls, etc.
- BP42—SIMPLE LED CIRCUITS.....\$5.00.** A large selection of simple applications for this simple electronic component.
- BP127—HOW TO DESIGN ELECTRONIC PROJECTS.....\$5.75.** Helps the reader to put projects together from standard circuit blocks with a minimum of trial and error.
- BP122—AUDIO AMPLIFIER CONSTRUCTION.....\$5.75.** Construction details for preamps and power amplifiers up through a 100-watt DC-coupled FED amplifier.
- BP92—CRYSTAL SET CONSTRUCTION.....\$5.00.** Everything you need to know about building crystal radio receivers.
- BP45—PROJECTS IN OPTOELECTRONICS.....\$5.00.** Includes infra-red detectors, transmitters, modulated light transmission and photographic applications.
- BP48—ELECTRONIC PROJECTS FOR BEGINNERS.....\$5.00.** A wide range of easily completed projects for the beginner. Includes some no-soldering projects.
- BP49—POPULAR ELECTRONIC PROJECTS.....\$5.50.** Radio, audio, household and test equipment projects are all included.
- BP51—ELECTRONIC MUSIC AND CREATIVE TAPE RECORDING.....\$5.50.** Shows how you can make electronic music at home with the simplest and most inexpensive equipment.
- BP56—ELECTRONIC SECURITY DEVICES.....\$5.00.** Includes both simple and more sophisticated burglar alarm circuits using light, infra-red, and ultrasonics.
- BP59—SECOND BOOK OF CMOS IC PROJECTS.....\$5.00.** More circuits showing CMOS applications. Most are of a fairly simple design.
- BP72—A MICROPROCESSOR PRIMER.....\$5.00.** We start by designing a small computer and show how we can overcome its shortcomings.
- BP74—ELECTRONIC MUSIC PROJECTS.....\$5.95.** Provides the experimenter with a variety of practical circuits including a Fuzz Box, Sustain Unit, Reverberation Unit, Tremelo Generator and more.
- BP91—AN INTRODUCTION TO RADIO DXING.....\$5.00.** How you can tune in on those amateur and commercial broadcasts from around the world in the comfort of your home.
- BP94—ELECTRONIC PROJECTS FOR CARS AND BOATS.....\$5.00.** Fifteen simple projects that you can use with your car or boat. All are designed to operate from 12-volt DC supplies.

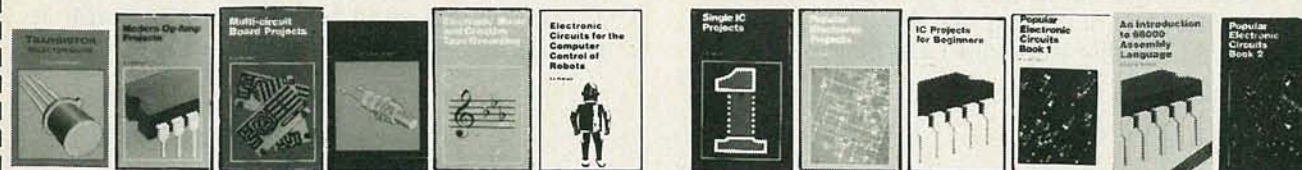

ELECTRONIC TECHNOLOGY TODAY INC.
P.O. Box 240, Massapequa Park, NY 11762-0240

Name _____
Address _____
City _____ State _____ Zip _____

R-488

SHIPPING CHARGES IN USA & CANADA

\$0.01 to \$5.00 . . .	\$1.00
\$5.01 to \$10.00 . . .	\$1.75
\$10.01 to 20.00 . . .	\$2.75
\$20.01 to 30.00 . . .	\$3.75
\$30.01 to 40.00 . . .	\$4.75
\$40.01 to 50.00 . . .	\$5.75
\$50.01 and above . . .	\$7.00

SORRY No orders accepted outside of USA & Canada

Number of books ordered

Total price of merchandise \$ _____
Sales Tax (New York State Residents only) \$ _____
Shipping (see chart) \$ _____

All payments must be in U.S. funds

Total Enclosed . . . \$ _____

APRIL 1988

EDITORIAL



The potential of CD-I

Are you ready for the next hi-tech wonder? Well, get ready for CD-I or Compact Disc-Interactive technology. It promises to be to the 1990's what the VCR was to the 1980's. That is, the hottest consumer electronics product of the decade.

CD-I combines the digital audio quality that we've come to expect from compact discs with high quality graphic images, a limited amount of full-motion video, and text. It can merge written and spoken words, music, pictures, and more to create entertaining, informational, or educational experiences. CD-I players will be stand-alone devices with audio and video outputs for your stereo and TV, and an RS-232 output, if you so desire, for your printer.

CD-I is not CD-V, which combines 5 minutes of video with 20 minutes of digital audio. CD-I is not CD-ROM, which is a computer peripheral that is powerful, but limited essentially to textual information. CD-I is not DVI, which is similar in many ways to CD-I, but is a CD-ROM peripheral. So what is CD-I?

CD-I is a truly interactive multi-media system that promises to open up a new world of applications in entertainment, education, and information. But will it live up to its promise?

That's all up to the applications developers. The right application could create a demand for CD-I. For example, imagine that you are planning a trip to San Francisco. Instead of watching a travel video to get an overall view of the popular attractions, you could pop a CD-I disc into your CD-I player, and

get the same overall view. However, if you saw something that interested you specifically—such as Coit Tower—you could “click” yourself inside, and take a look around, and climb the steps to see what the view from the top is like. When you had seen enough, you could continue the tour until you came up to the next attraction that excited you—a ferry ride to the island of Alcatraz, for example.

The educational impact could be enormous because of the interactive nature of CD-I. Imagine, for example, an electronics-teaching disc. The display could show a schematic of a video detector circuit. By pointing to a given spot on the schematic, you could see what a signal at that point was. You could change the input signal and immediately see the effect at different parts of the circuit.

Imagine watching a music concert video. Instead of being limited to watching the band play, you could have control over what you watched. You could change the camera angles to see what you were interested in, whether it's the crowd, or the fingering method that the guitarist is using. You could, perhaps, call up the sheet music on part of the screen.

Those examples only scratch the surface. The technology behind CD-I is exciting, and we'll be covering all the details in a future issue. But the applications of CD-I could prove to be even more exciting. What would *you* do if you could be a CD-I author and could create an application that combined audio, video, graphics, and text?

BRIAN C. FENTON
Managing Editor

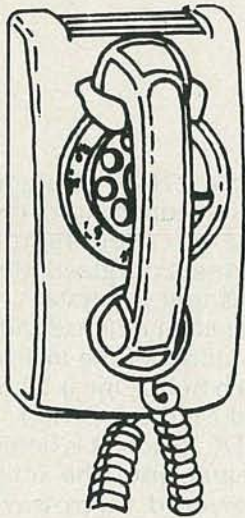

**CALL NOW
AND
RESERVE
YOUR SPACE**

- 6 x rate \$815.00 per each insertion.
- Fast reader service cycle.
- Short lead time for the placement of ads.
- We typeset and layout the ad at no additional charge.

Call 516-293-3000 to reserve space. Ask for Arline Fishman. Limited number of pages available. Mail materials to: mini-ADS, RADIO-ELECTRONICS, 500-B Bi-County Blvd., Farmingdale, NY 11735.



SYLVANIA 4040 CONVERTER/DECODER \$169. Non-addressable gated sync, reconditioned with new wireless remote; 10-day money-back guarantee/30-day warranty. Extra remotes \$29 each (new). ZENITH SSAVI UHF Level II \$199, channel 3 in/out \$229, reconditioned. UHF SSAVI project handbook \$6.50 ppd. Converters, amplifiers, accessories. Catalog \$1. Quantity discounts. AIS SATELLITE, INC., P.O. Box 1226-A, Dublin, PA 18917. 215-453-1400 or 215-249-9411.

CIRCLE 197 ON FREE INFORMATION CARD



THE MODEL WTT-20 IS ONLY THE SIZE OF A DIME, yet transmits both sides of a telephone conversation to any FM radio with crystal clarity. Telephone line powered - never needs a battery! Up to 1/4 mile range. Adjustable from 70-130 MHZ. Complete kit \$29.95 + \$1.50 S+H. Free Shipping on 2 or more! COD add \$4. Call or send VISA, MC, MO. DECO INDUSTRIES, Box 607, Bedford Hills, NY 10507. (914) 232-3878.

CIRCLE 127 ON FREE INFORMATION CARD

Electronic Computer and Science

SURPLUS

We are wholesale distributors and liquidators of:

• Closeouts

• Factory Surplus

• Bankruptcy Inventories

Attention
Specialists
Wholesale Distributors
Liquidators
All Product
Categories
Wholesale Distributors
Not Subject to
Minimums

SURPLUS WANTED
CONTACT OUR BUYERS BY TELEPHONE

CANADIANS:
For sale by special order only. No cash. Minimum order \$1000. U.S. funds only. Payment by check or money order. \$1000. Minimum order. \$1000. Minimum order. \$1000.

SURPLUS TRADERS
P.O. Box 276
Waters Lane
Albany, Vermont 05440
514-739-9328

SURPLUS ELECTRONICS, ELECTRICAL, SCIENCE and computer parts and equipment at wholesale prices. FREE CATALOG featuring some of the biggest deals and lowest prices in America (and Canada). Wholesale and bulk pricing for dealers, distributors, exporters, manufacturers and volume users. Catalog request taken only by mail and must be on company letterhead. **SURPLUS TRADERS, PO BOX 276, ALBANY, VT 05440. (514) 739-9328**



DEC. R-E ARTICLE ON MACRO SCRUBBER, the original parts as mentioned MAK-1. All components shown on parts list and much more. Silk screened and etched P.C. board, power supply, IC sockets, precut jumpers, power jack, plug and pre-drilled enclosure. \$52.95 & 3.00 S/H. Order today from: **THE HOBBY HELPER, P.O. Box 308, Bridgewater, MA 02324, or call (617) 339-1026. Visa/MC accepted.**

CIRCLE 70 ON FREE INFORMATION CARD



DECODE NEARLY ANY SINGLE LEVEL GATED PULSE SIGNAL. New circuit works with Hamlin, Jerrold, Sylvania, and Eagle systems. Decodes In-band, Out-band, AM or FM reference. Complete educational kit including P.C. board, parts, case, and 40 page gated pulse theory booklet is only \$47.00 plus \$3.00 shipping. Order no. 1PFD-1K. **ELEPHANT ELECTRONICS INC. P.O. Box 41865-R, Phoenix, AZ 85080. (602) 581-1973**

CIRCLE 120 ON FREE INFORMATION CARD

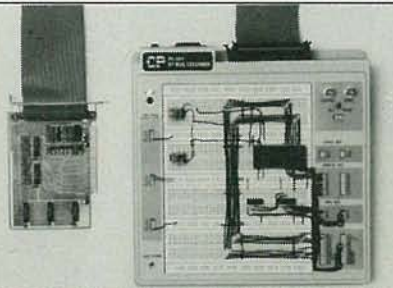

PC-601 XT BUS EXTENDER BREADBOARD LAB connects to any IBM PC compatible computer and extends all PC electrical bus connections out to the PC-601 for easy circuit prototype connection, testing and trouble-shooting. Includes large 3060 tie-point breadboard, ±5V and ±12Vdc AC line powered power supplies. Includes buffer card, 2' ribbon cable & 1-Year warranty. Price: \$369.95 **CHENESKO PRODUCTS, 21 Maple St., Centereach, NY 11720. 516-736-7977, Fax: 516-732-4650**

CIRCLE 196 ON FREE INFORMATION CARD



PANASONIC CABLE CONVERTERS, Wholesale and Retail. Scientific Atlanta and Pioneer Cable Converters in stock. Panasonic model 140N 68 channel converter \$79.95, Panasonic Amplified Video Control Switch Model VCS-1 \$59.95. Scientific Atlanta Brand new Model #8528 550MHZ 80 Channels Converter \$89.95. Video Corrector (MACRO, COPYGUARD, DIGITAL) ENHANCER \$89.95. We ship to Puerto Rico, Caribbean countries, & So. Amer. Write or call **BLUE STAR IND., 4712 AVE. N, Dept 105, Brooklyn, NY 11234. Phone (718) 258-9495.**

CIRCLE 85 ON FREE INFORMATION CARD

WHAT'S NEWS

New solid electrolyte is absolutely dry

The world's first solid electrolyte, in the form of a kind of paper, has been announced jointly by Matsushita Electric Industrial Co. and Japan Synthetic Rubber Co. The new electrolyte can be used in a large number of solid-state devices, including primary or secondary batteries, electrolytic capacitors, and chemical sensors.

The current carrier can be chosen from a variety of ions, including silver, copper, lithium, etc. The present electrolyte is composed of $\text{RbCu}_4\text{I}_{1.75}\text{Cl}_{3.25}$, with the current being carried by copper ions. Temperature range is from -60 to $+100^\circ\text{C}$.

The paper-form electrolyte is made by dissolving powdered solid electrolyte in an organic solvent with an insulating polymer that gives it the correct elec-

trochemical and mechanical characteristics. The resulting slurry is coated on a sheet and dried. It can be made paper-thin or up to several millimeters thick. Increased thickness, of course, decreases flexibility. The "paper" is then sandwiched between electrodes to make a cell of any desired area.

Its freedom from leakage and the reliable stability of the electrolyte are expected to make construction and handling of certain devices much easier. Conceivable applications include semiconductor devices with built-in batteries and semi-permanently embedded heart pacemakers. Its dry nature makes it especially suited for applications in the high vacuums and wide temperature fluctuations of outer space.



THE WORLD'S FIRST SOLID ELECTROLYTE.

Microwaves at megavolts from new pulse generator

A new machine for generating megavolt microwave pulses of 100-

nanosecond duration at repetition rates of 1 to 10 times a second has been designed by scientists of Sandia National Laboratories (Al-

buquerque, NM). Designed for burst-mode operation, the new machine is called Tempo, for Transformer Energized Megavolt Pulsed Output generator.

Designed for defense and medical uses, three of the instruments have been built. One is at the Walter Reed Medical Center, Washington, DC, where it is being used for research into the effects of high-powered microwaves on organs and organisms. The other two, located at the Harry Diamond Laboratory in Maryland and at the Air Force Weapons Lab in Albuquerque, New Mexico, are used for testing the vulnerability of electronic and weapons systems to microwaves, and for microwave systems development.

The heart of the instrument is a voltage-doubling, pulse-forming transmission line called a *Blumlein*. A transformer and a 30-kilovolt capacitor bank at the rear charges the two parallel strip-line Blumleins, at the front is a microwave converter that transforms the high-voltage electrical pulses into high-power microwaves that are transmitted through a waveguide to an antenna.

Interactive TV, land mobile, pushing for spectrum space

Land-mobile radio operators have been pushing for frequencies in the 220-MHz range, to the extent that the FCC now has before it a docket proposing to reallocate the amateur 220-222 MHz band for mobile frequencies. Now a company known as TV Answer has petitioned the FCC for a 500-kHz slice of the same band for interactive TV systems (systems in which the receiving party can "talk back" to the transmitter, for merchandise ordering, polls, etc.).

The amateurs are contesting such moves vigorously, and thousands of letters in opposition have been received by the FCC. R-E

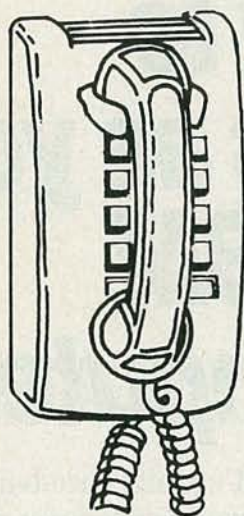

CALL NOW AND RESERVE YOUR SPACE

- 6 x rate \$815.00 per each insertion.
- Fast reader service cycle.
- Short lead time for the placement of ads.
- We typeset and layout the ad at no additional charge.

Call 516-293-3000 to reserve space. Ask for Arline Fishman. Limited number of pages available. Mail materials to: mini-ADS, RADIO-ELECTRONICS, 500-B Bi-County Blvd., Farmingdale, NY 11735.

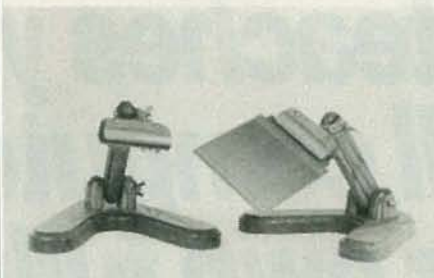

DESIGNED specifically to hold board for fast, simple, construction. Easy front to backside of board movement. Multi position head, rubber lined jaws, solid oak construction. Finish tolerates cleanup with alcohol. Full refund if not completely satisfied. Send **\$21.50** each to: **ALLEN'S ELECTRONICS, P.O. Box 235, Ephrata, WA 98823**

CIRCLE 182 ON FREE INFORMATION CARD

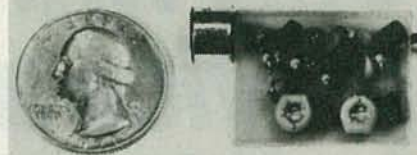

SIMPLY SNAP THE WAT-50 MINIATURE FM TRANSMITTER on top of a 9v battery and hear every sound in an entire house up to 1 mile away! Adjustable from 70-130 MHz. Use with any FM radio. Complete kit **\$29.95 + \$1.50 S + H**. Free shipping on 2 or more! COD add \$4. Call or send VISA, MC, MO. **DECO INDUSTRIES, Box 607, Bedford Hills, NY 10507. (914) 232-3878.**

CIRCLE 127 ON FREE INFORMATION CARD



SAVE \$200.00 ON SOLA SPS 300 STAND-BY POWER SUPPLY. The first designed specifically to power the smallest desktop computer, or fully configured IBM PC. Provides 200 watts or 300 VA. List **\$620.00**. Special **\$420.00**—Hurry! Quantities are limited. Credit cards welcomed. Call, write, or FAX for our 480 page catalog featuring more than 100 national brands too! **JOSEPH ELECTRONICS, INC., 8830 North Milwaukee Avenue, Niles, IL 60648, (312) 297-4200/1-800-323-5925. FAX: 312/297-6923**



RADAR SPEED UNIT. For clocking speeds in skiing, racing, bowling, baseball, etc. Used Decatur MV-715 professional X-band model. Moving and stationary use, dual display, Special **\$239 + \$8 shipping** (continental US), including case and tuning forks. Other used radars from **\$275**. Catalog **\$1**. Full line of TV accessories, including surplus N-12s and MLD-1200s. **AIS SATELLITE, INC., P.O. Box 1226-M, Dublin, PA 18917. 215-453-1400 or 215-249-9411.**

CIRCLE 81 ON FREE INFORMATION CARD



AN INTRODUCTION TO BASIC PROGRAMMING TECHNIQUES. This book is based on the author's own experience in learning BASIC and also in helping others, mostly beginners to programming, to understand the language. Included is a program library of programs that the author has actually written and run. Order your copy today. Send **\$5.00 plus \$2.65 for shipping** in the U.S. to **Electronic Technology Today Inc., P.O. Box 240, Massapequa Park, NY 11762-0240.**



2645T—117 PRACTICAL IC PROJECTS YOU CAN BUILD.....\$10.95. Dozens of fully-tested, ready-to-build circuits you can put together from readily-available, low cost IC's! There are a total of 117 IC circuits ranging from an audio mixer and a signal splitter to a tape-deck amplifier and a top-octave generator organ! From TAB Books. **To order your copy send \$10.95 plus \$2.75 shipping to Electronic Technology Today Inc., P.O. Box 240, Massapequa Park, NY 11762-0240**



MICROPROFESSOR 1-P—LEARN ASSEMBLY LANGUAGE PROGRAMMING Z-80 C.P.U. 8 bit trainer. 158 instruction set. Teaches essential programming and hardware skills for technicians, trouble-shooters, circuit designers, system architects and engineers. Industrial controller. Additional languages-BASIC and FORTH. Fully expandable with I/O, EPROM Programmer, Printer and Accessories. Three manuals included. **\$199.95 plus \$7.50 shipping.** **ETRONIX Dept. RE 488, 5326 Ninth N.E., Seattle, WA 98105, 1-800-426-1044.**

CIRCLE 111 ON FREE INFORMATION CARD

Train for the Fastest Growing Job Skill in America

Only NRI teaches you to service all computers as you build your own fully IBM compatible microcomputer

With more and more new applications being developed for every facet of business, education, and personal computer use, the demand for trained computer service technicians surges forward. The Department of Labor ranks computer service high on its list of top growth fields, with accelerated demand creating more than 30,000 *new* jobs in the next 10 years.

Total systems training

No computer stands alone. . . it's part of a total system. And if you want to learn to service and repair computers, you have to understand computer

systems. Only NRI includes a powerful computer system as part of your training, centered around the new, fully IBM PC compatible Sanyo 880 Series computer.

You start with the step-by-step assembly of the highly rated Sanyo 880 computer. You build and test the "intelligent" keyboard, install the power supply and 5¼" floppy disk drive, and interface the high-resolution monitor. But that's not all. You go on to install a powerful 20 megabyte hard disk drive—to-day's most-wanted computer peripheral, now included as part of your hands-on training.

It's confidence-building, real-world experience that includes training in programming, circuit design, and peripheral maintenance.

No experience necessary—NRI builds it in

Even if you've never had any previous training in electronics, you can succeed with NRI training. You'll start with the basics, then rapidly build on them to master such concepts as digital logic, microprocessor design, and computer memory. You'll build and test advanced electronic circuits using the exclusive NRI Discovery Lab[®],

Learn Computer Servicing Skills with NRI's "Hands-On" Training . .



Using NRI's unique Action Audio Cassette, you are talked through the operation and practical application of your hand-held digital multimeter—the basic, indispensable tool for the computer specialist.



You'll set up and perform electronics experiments and demonstrations using your NRI Discovery Lab. You'll even interface the lab with your computer to "see" keyboard-generated data.



After you build this digital logic probe, you'll explore the operation of the Sanyo detached "intelligent" keyboard and its dedicated microprocessor.

NEW!
20 Meg
Hard Disk
Included!

Your NRI total systems training includes all this: NRI Discovery Lab to design and modify circuits • Four-function digital multimeter with walk-you-through instruction on audio tape • Digital logic probe for visual examination of keyboard circuits • Sanyo 880 Series computer with "intelligent" keyboard and 360K, 5 1/4" floppy disk drive • 20 meg hard disk drive you install internally • High-resolution monochrome monitor • 8K ROM, 256K RAM • Bundled software • Reference manuals, schematics, and bite-sized lessons.

professional digital multimeter, and logic probe. Like your computer, they're all yours to keep as part of your training. You even get some of the most popular software, including WordStar, CalcStar, GW Basic and MS DOS.

Send for 100-page free catalog

Send the post-paid reply card today for NRI's 100-page, full-

color catalog, with all the facts about at-home computer training. Read detailed descriptions of each lesson, each experiment you perform. See each piece of hands-on equipment you'll work with and keep. And check out NRI training in other high-tech fields such as Robotics, Data Communications, TV/Audio/Video Servicing, and more.

If the card has been used, write to NRI Schools, 3939 Wisconsin Ave., N.W., Washington, D.C. 20016.

NRI SCHOOLS

McGraw-Hill Continuing Education Center
3939 Wisconsin Avenue, NW
Washington, DC 20016



We'll Give You Tomorrow.

IBM is a Registered Trademark of International Business Machine Corporation.

as You Build Your Own Sanyo 880 Computer System.



The power supply is assembled in the main unit of the computer. You check out keyboard connections and circuits with the digital multimeter included for training and field use.



Next, you install the 5 1/4" floppy disk drive, learning disk drive operation and adjustment. Later, you increase your data storage capacity dramatically by installing a 20 meg hard disk drive.



Using the monitor, you focus on machine language programming, an indispensable troubleshooting tool for the technician. You continue by learning BASIC language programming.

VIDEO NEWS



DAVID LACHENBRUCH,
CONTRIBUTING EDITOR

• **Sony goes VHS.** Sony, the inventor of the *Betamax*, the first successful consumer videocassette recorder, has announced that it will add VHS products to its line after 13 years of fighting its chief competitor. Although videophiles have always preferred the Beta format, the JVC-developed VHS format jumped to the lead among consumers in the United States in 1979, largely due to its longer recording time. Beta steadily declined in popularity, to the point where it is believed to have represented less than one percent of VCR sales in 1987. Other Japanese companies in the Beta camp—NEC, Sanyo, and Toshiba—switched over to VHS in 1985, after such American brands as Sears and Zenith changed sides.

Sony won't abandon Beta, and will continue to manufacture decks in the standard Beta format and the new high-resolution ED (*Extended Definition*) Beta. According to the company's announcement, Sony initially will buy VHS decks from Hitachi, but will start up its own production line around midyear. The Hitachi-made decks will go to Europe, while Japan and the United States will get the Sony-made version, with American sales probably starting late next fall.

• **3D camcorder on the way.** Long before stereophonic sound, "stereo" stood for stereo *scopic*, or three-dimensional vision. Now, Toshiba promises to bring a 3D video camera-recorder combination to the United States this summer for \$2,850. *3D CAM* has two half-inch CCD pickups, two lens systems, and records on a VHS-C cassette. Left and right images are carried on alternate frames. The version to be sold here uses a standard TV set, although a flickerless model is coming. That model requires a special TV set with a frame-doubling system.

• **Laservision revival.** For years, Pioneer was the only US supplier of laser optical videodisc players—but now the medium is suddenly making a comeback. It's all presumably keyed to the new *Compact Disc-Video* (CD-V)

system, which puts five minutes of video and 20 minutes of audio on a five-inch CD. The new laserdisc players are capable of playing the standard 8- and 12-inch videodiscs, the 5-inch CD-V discs, standard 5-inch audio CD's, and the new 3-inch CD singles.

While the CD-V discs haven't yet fulfilled their promise of becoming a new medium aimed at younger listeners and viewers, their very existence seems to have encouraged the spread of all-purpose laserdisc players—to the point where the number of brands available on the American market has increased from one to eight in a single year. Already on the market or announced for availability this year, in addition to two models from Pioneer, are players under the brand names of Yamaha, Sony, Devon, Hitachi, Image Entertainment, Magnavox, and Toshiba.

• **CD + graphics.** When Philips and Sony agreed on what were to be industry-wide standards for audio Compact Discs, they included eight inaudible subcodes in addition to the digital audio tracks. Two of those codes are used to control the player—programming the order of selections, and so forth. The rest are available for text and graphics. In Japan, special CD's are designed for "karaoke," or sing-along jukeboxes, which display lyrics on a video screen.

In the United States, Warner New Media, an affiliate of Warner Communications and Warner Records, has proposed to add graphics to compact discs, and has demonstrated such uses as reproduction of album covers, liner notes, guitar chords, and even elaborate color photographs, paintings, and pseudo-automation in time to the music. The graphics are viewed in the form of changing still pictures on a TV screen, with changes possible every two seconds for simple graphics, and about seven seconds for more complex art. JVC plans to make CD-players with the graphics feature, and says it can market them at about \$399 after it completes design of an LSI IC. Warner says it will release about 50 CD's this year with encoded graphics. **R-E**

More Functions. Smaller Budget.

Beckman Industrial Circuitmate™ DMMs put hFE, Logic, Capacitance, Frequency and True RMS In Your Hand. For Less.

Get more, for less. It's a simple definition of value. For DMMs, value means finding the combination of capabilities that meets your needs at the right price. Without losing sight of accuracy and reliability. If you want more functions at a low price, Beckman Industrial's Circuitmate™ Digital Multimeters are the best value around.

From the pocket-sized DM20L to the DM850, with true RMS capability and accuracy to 0.05% ± 1 digit, Circuitmate DMMs give you the functions you need.

For instance, the DM20L puts both a Logic Probe, a transistor gain function (hFE), and a full range of DMM functions in the palm of your hand. For only \$79.95.

Then there's the DM25L. Where else does \$99.95 buy you a Logic Probe, capacitance measurement, transistor gain function (hFE), and 24 DMM ranges including resistance to 2000 megohms? Nowhere else.

When high accuracy counts, there's the DM800 with a 4 1/2 digit display. The DM800

DM20L Pocket-Size w/Logic \$79.95*

TTL Logic Probe: 20MHz
Hi/lo/off indications
Detects 25nS pulse widths

hFE (NPN or PNP):
1 range (1000)

DMM: Input Impedance—
10 Megohms
DCA/ACA-5 ranges
(200µA to 2A)

Ohms-8 ranges (200 ohms
to 2000 Megohms)
Continuity beeper



also gives you frequency counting. A full-function DMM, and more, doesn't have to cost over \$195.00. If it's a Circuitmate DM800.

Or, for a few dollars more, get true RMS (AC coupled) to let you accurately measure non-sinusoidal AC waveforms, and all the capability of the DM800, in the DM850.

Of course, there's a whole range of Circuitmate DMMs and service test instruments, including the DM78 autoranger that

DM850 True RMS

4 1/2 digits. DCV accuracy is .05% +3 digits

True RMS
Frequency counter to 200KHz

Data Hold display capability

Continuity beeper

Built-in bail

Anti-skid pads

Price: DM850 (True RMS) . . . \$219.95*
DM800 (Average) . . . \$195.00*



fits in a shirt pocket, yet gives you a full size 3 1/2 digit, 3/8" readout. Not to mention a complete line of accessories like test leads, current clamps, even probes that can extend your DMMs range and sensitivity. All designed to work flawlessly with your Beckman Industrial Circuitmate DMM.



DM25L Capacitance, Logic, hFE \$99.95*

TTL Logic Probe: 20MHz
Hi/lo/off indications
Detects 25nS pulse widths

Capacitance: 5 ranges
(2nF to 20µF)

hFE (NPN or PNP):
1 range (1000)

Continuity beeper

Built-in bail

Anti-skid pads

See your Beckman Industrial distributor and discover more DMM performance. For less.

*Suggested list price (\$US) with battery, test leads and manual.

In Service Instruments,
We're The One.

Beckman Industrial™

Beckman Industrial Corporation, Instrumentation Products Division
A Subsidiary of Emerson Electric Company
3883 Ruffin Road, San Diego, CA 92123-1898
(619) 495-3200 • FAX: (619) 268-0172 • TLX: 249031
© 1987 Beckman Industrial Corporation

CIRCLE 98 ON FREE INFORMATION CARD



LETTERS



NEW ADDRESS

Just after the February 1988 issue of *Radio-Electronics* hit the stands, we were notified of a change of address for one of the suppliers that was listed in "Making Your Own PC Boards."

The correct address for The Datak Corporation is: 3117 Paterson Plank Road, North Bergen, NJ 07047. Their new phone number is (201) 863-7667.—Editor

CORRECTION

Don Lancaster's "Hardware Hacker" in the February issue of *Radio-Electronics* contained an error. In the Names and Numbers box on page 77, the correct phone number of Sprague is (617) 853-5000.—Editor

SORRY!

In our article "Build This Audio/Video Switcher" in the February 1988 issue, there are a couple of corrections to be made concerning the parts-placement diagram of Fig. 5. The first one, although it won't affect the operation of the switcher whatsoever, is that diodes D1-D8 are numbered incorrectly. From left to right they should read: D1, D3, D4, D2, D5, D8, D6, and D7. The second correction is that voltage-regulator IC7 is shown backwards. When correctly oriented, the flat side should be on the right with pin 3 at the top and pin 1 at the bottom.—Editor

ADDRESS CHANGE

I was glad to read MSgt. Flick's letter in the February 1988 issue, and to learn that my article on electronic technician certification (*Radio-Electronics*, August 1987) was helpful to members of the armed forces who are preparing

for second careers. As he noted, The National Association of Business and Educational Radio has relocated. The current address is NABER, 1501 Duke St., Suite 200, Alexandria, VA 22314.
W. CLEM SMALL, CET

HDTV UPDATE

There are two flaws in the description of Advanced Compatible TeleVision (ACTV) in "HDTV Update" (*Radio-Electronics*, January 1988). First, the NTSC-compatible "center panel" is not enough to make a watchable picture. Currently, wide-screen films are adjusted for the narrower screen—usually by squeezing the picture during the credits, then panning the film to keep the relevant action on-screen. ACTV will eliminate such compensation.

Second, once NTSC receivers have been phased out, we'll be stuck with an unnecessarily convoluted system. Better to decide on a global television standard *once and for all*, and design converters for NTSC receivers—even if it means some loss in the picture's resolution to make a 16:9 picture fit in a 4:3 screen.

JOE MESZAROS
Danvers, MA

U-MATIC FORMAT

As a technical support specialist for a television systems and equipment dealer, I must take exception with several comments made by David Lachenbruch (*Video News*, *Radio-Electronics* January 1988) on the fate of the 3/4" U-matic videotape system. While I agree that this format is on its way out, its demise is not as imminent as he or Panasonic may believe.

On the broadcast end, Sony's Betacam (now *Betacam SP*) and, to

a much lesser extent, Panasonic's *MII*, have already started to replace U-matic for Electronic News Gathering (ENG). However, the real pressure from those 1/2" machines is on the 1" market, where the few remaining manufacturers are scrambling to adopt one format or the other.

With industrial and small-market broadcast users, U-matic is still a viable alternative to the high-priced formats and lower quality VHS. The new U-matic SP is a significant improvement over conventional U-matic, and should extend the life of the format. Contrary to Mr. Lachenbruch's statement, U-matic SP is fully compatible with standard U-matic, and it does not use a true metal tape.

There are several factors being downplayed in the current marketing of Super VHS. First, SVHS is "upward compatible" only. Tapes recorded in SVHS format cannot be played back on standard machines. Second, SVHS quality requires a monitor with a special Y/C input and circuitry; connectors for those inputs have not been standardized. Third, there is very little compatible support equipment available at this time, resulting in limited production capabilities.

A few years ago, true component systems were being touted as the next generation in video production. To date, there have been problems bringing those systems on line, and they have not been as well-received as was hoped. What about SVHS, where the quality depends on a component signal?

I'm not trying to bash Super VHS—it is an improvement. I just think Mr. Lachenbruch should have told the whole story.

PETER MECABE
Climax, NY

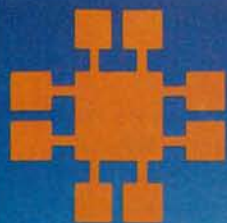

JDR INSTRUMENTS™

Complete customer satisfaction... superior service... friendly, knowledgeable personnel... quality merchandise... providing the best values in leading edge technology.

BEAT THE PRICE INCREASE!

349.95

20 MHz OSCILLOSCOPE

Save \$40 if you buy before April 1st when our price goes up to 389.95. This model makes frequency calculation and phase measurement quick and easy. Service technicians appreciate the TV Sync circuits for viewing TV-V and TV-H and accurate synchronization of the video signal, Blanking, VITS, and V/H sync pulses. A component tester for fast troubleshooting.

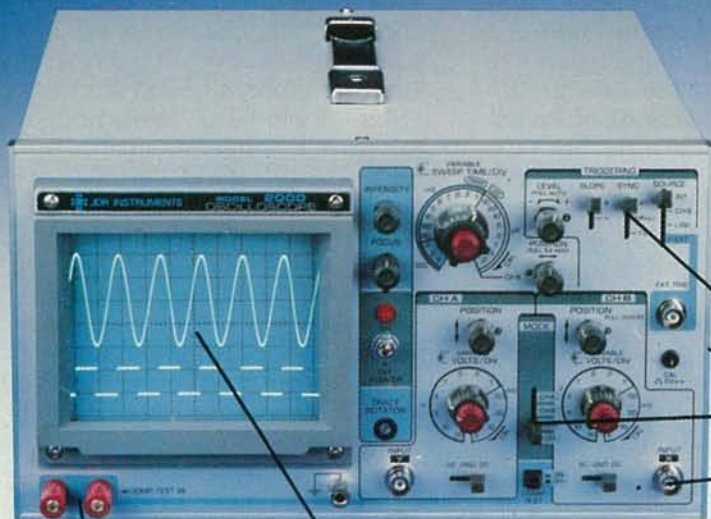

BUILT-IN COMPONENT TESTER

EXCEPTIONALLY BRIGHT 5" CRT

TV SYNC FILTER

110/220 VOLTS

TV-V & TV-H SIGNALS

X-Y OPERATION

DMM-300

\$79.95

3.5 DIGIT DMM/MULTITESTER

This full function 3.5 digit DMM offers highly accurate performance and a host of added features like audible continuity, capacitance, transistor, temperature, and conductance to help you do the job—fast. Temperature probe, test leads and battery included.

- ★ Basic DC accuracy: plus/minus 0.25%
- ★ DC voltage: 200mv–1000V, 5 ranges
- ★ AC voltage: 200mv–750V, 5 ranges
- ★ Resistance: 200 ohms–20M ohms, 6 ranges
- ★ Capacitance: 2000pf–20 μf, 3 ranges
- ★ Transistor Tester: 0°–2000°F
- ★ Conductance: 200ns
- ★ Fully overload protected
- ★ Input impedance: 10M ohm.

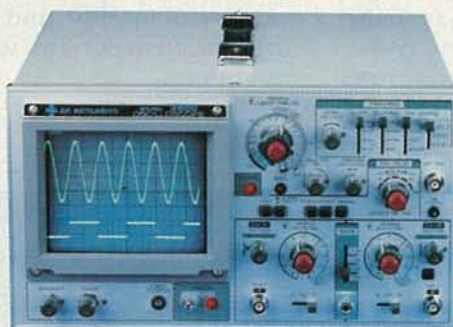

MODEL 3500

\$499.95

35 MHz DUAL TRACE OSCILLOSCOPE

Wide bandwidth and exceptional 1mV/DIV sensitivity make this a powerful tool for engineers or technicians at a remarkable price. Delayed triggering allows any portion of a waveform to be isolated and expanded for closer inspection. Variable Holdoff allows stable viewing of complex waveforms.

- ★ Exceptionally bright 5" CRT
- ★ Delayed and single sweep modes
- ★ Z axis intensity modulation
- ★ X-Y operation ★ TV sync filter
- ★ Fast 10ns rise time

DMM-100

\$29.95

3.5 DIGIT POCKET SIZE DMM

Perfect for the field service technician. Shirt pocket size without compromising features or accuracy. Large, easy to read 1/2" LCD display. Fully overload protected for safety. 2000 hour battery life with standard 9v cell. Probes and battery included.

- ★ Basic DC accuracy: plus/minus 0.5%
- ★ DC voltage: 2v–1000v, 4 ranges
- ★ AC voltage: 200v–750v, 2 ranges
- ★ Resistance: 2k ohms–2M ohms, 4 ranges
- ★ DC current: 2mA–2A, 4 ranges
- ★ Input impedance: 10M ohm
- ★ Fully overload protected
- ★ Approx. 5" x 3" x 1". Under 7 ozs.



DMM-200

\$49.95

3.5 DIGIT FULL FUNCTION DMM

Get highly accurate performance at a very affordable price. Rugged construction, 20 amp current capability and 22 ranges make it a perfect choice for serious field or bench work. Low battery indicator and till-stand. Probes and 2000 hour battery included.

- ★ Basic DC accuracy: plus or minus 0.25%
- ★ DC voltage: 200mv–1000V, 5 ranges
- ★ AC voltage: 200mv–750V, 5 ranges
- ★ Resistance: 200 ohms–20M ohms, 6 ranges
- ★ AC/DC current: 200μA–20A, 6 ranges
- ★ Input impedance: 10M ohm
- ★ Fully overload protected
- ★ Approx. 7" x 3 1/2" x 1 1/2". Wt. 11 ozs.

DPM-1000

\$54.95

3.5 DIGIT PROBE TYPE DMM

Custom 80 pin LSI chip provides accuracy and reliability in such a compact size. Autoranging, audible continuity and data hold feature help you pinpoint the problem quickly. Case and batteries included.

- ★ Basic DC accuracy: plus/minus 1%
- ★ DC voltage: 2v–500v, autoranging
- ★ AC voltage: 2v–500v, autoranging
- ★ Resistance: 2k ohms–2M ohms, autoranging
- ★ Fully overload protected
- ★ Input impedance: 11M ohm
- ★ Approx 6 1/2" x 1" x 3/4". Under 3 ozs.



- ★ 2 YEAR REPLACEMENT WARRANTY
- ★ 30 DAY MONEY BACK GUARANTEE
- ★ TOLL FREE TECHNICAL SUPPORT
- ★ NEXT DAY AIR SHIP AVAILABLE

CIRCLE 59 ON FREE INFORMATION CARD

COPYRIGHT 1987 JDR MICRODEVICES



JDR INSTRUMENTS, 110 KNOWLES DRIVE, LOS GATOS, CA 95030
RETAIL STORE: 1256 SOUTH BASCOM AVE, SAN JOSE, CA (408) 947-8881

ORDER TOLL FREE 800-538-5000

FAN MAIL

I just received the November issue of **Radio-Electronics** and I was thrilled to see Forrest Mims' name on the cover. I wasn't let down—his series on SMT was as easy to read and appropriate to the hobbyist as ever.

Getting Started in Electronics was the first book by Mr. Mims that I read. Wonderfully easy to read, it forms a basis of intuitive notions on which one can learn more about electronics. I love the book, and constantly recommend it to anyone just getting started.

I searched out his two-volume *Engineer's Notebook* in used-book shops, and by the time I finished *Circuit Scrapbook* I felt happy and confident putting together my own projects. Last year I read Mims' *Siliconconnections* because I was curious about the man who was responsible for so much of my practical knowledge of electronics, the stuff which was so difficult to pick up from other sources. I was also pleased to read about my own company, Rising Star Industries, in that book.

I discovered **Radio-Electronics** about two years ago, and found articles for the beginning and experienced hobbyist alike. Most important to me was that each project was accompanied with explanations of circuit operation, which allowed for education and growth. I studied all the issues like text books, and felt I'd "graduated" from the school of **Radio-Electronics** by earning my FCC General Radiotelephone Operator License last month.

Now I'm enrolled in a masters program in computer engineering. I earned a B.A. in physics in 1982, but I gained a distinct distaste for formal education in the process. Reading *Siliconconnections* gave me great hope for the success of sticking with just tinkering, but I have decided to give school another chance.

In any case, Forrest M. Mims III has been an inspiration as well as a wonderful teacher, and I have the utmost respect for wonderful teachers.

RICK SANGER
Monterey, CA

CROWBAR CIRCUIT

I was disappointed when I read "Ask R-E" in the January 1988 issue of **Radio-Electronics**. The design of the "Crowbar" circuit was drawn incorrectly.

The Zener diode (D1), as shown in Fig. 2 of the column, is used in its forward-bias mode of operation. Therefore, the voltage drop across D1 will be 0.7 volts and its resistance is negligibly small. Consequently, the D1/R1 series combination across the output of the voltage regulator will be seen as a virtual "short" to ground through resistor R1.

That will cause R1 to load down the power supply, assuming that D1 and R1 can handle the current that the power supply will deliver under that condition.

Surely that was not intentional. For the crowbar circuit to function properly, the Zener diode should be used in its reverse bias mode of operation, as shown in Fig. 1.

Now D1 will try to maintain a certain zener breakdown voltage V_Z by shunting current to ground through R1. This time, the current will be much smaller than before, since the resistance of D1 is nominally high now. If the output voltage of the power supply falls

Test VCR Mechanics Fast and Easy!

Take the guesswork and hassles out of VCR mechanical problem diagnosis!
Four Universal, Powerful Tools for VCR Service

Tape Tension Gauge: The Tentelometer® is the world's most universal method of measuring hold back tension. Calibration can easily be checked in the "field". Merely slide the probes over tape to measure tape tension directly in grams. Illustrated instruction manual included. This is the back tension gauge referenced by many of the VCR service manuals, and it will work on all VCRs.

T2-H7-UM \$325



Video Head Protrusion Gauge: Universal, fast, safe method of measuring the amount of video head tip wear. Measures in thousandths of an inch. Allows accurate predictions of remaining head life. Head wear provides useful information regarding VCR condition and wear on other components. Stop guessing about head wear. Accessory "S1" stand allows use on any VCR.

HPG-1 \$495 S1 \$95



Spindle/Elevator Gauge: The TSH gauge inserts into the VCR just like a cassette. The new TSH-V5 performs 6 critical measurements to eliminate tape binding and edge damage. This gauge quickly locates problems that can't even be detected by other methods. Fully illustrated instruction manual is included.

TSH-V5 for VHS: \$395

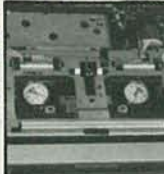

Torque Gauge: A universal, inexpensive, accurate torque gauge for VHS and Beta VCRs. Calibrated in Gram-Centimeters both clockwise and counterclockwise. Complete with easy-to-follow, detailed instruction manual for VHS recorders. Includes a modified VHS cassette for ease-of-use.

Complete System
TQ-600 \$139



Tentel® provides the most powerful, easy-to-use, field calibrateable, universal VCR test equipment available for various mechanical tests. Call our application engineers today for answers to your questions. Ask about the combination discount when ordering all 4 gauges.

Tentel® Corp.

1506 Dell Avenue
Campbell, CA 95008

(800) 538-6894
(408) 379-1881
in California

CIRCLE 181 ON FREE INFORMATION CARD

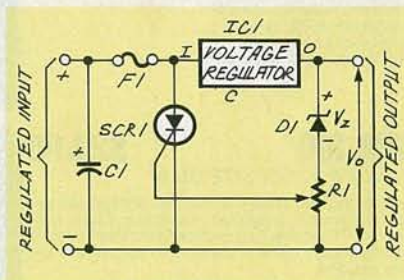

FIG. 1

below its rated output V_O , the diode will act as an open circuit. If the output voltage is at or above V_O , D1 will begin shunting current to ground through R1.

TREEFON J. SIAMPOS
Scott AFB, IL

MACRO-SCRUBBER

It seems that Mr. Dupre had not done his homework when he presented his article, "Macro-Scrubber", in the December issue of **Radio-Electronics**.

The 14 μ sec delay after the beginning of each horizontal-sync pulse that precedes a Macrovision

Eliminate Costly Guesswork And Interpretation Errors In LCR Testing!

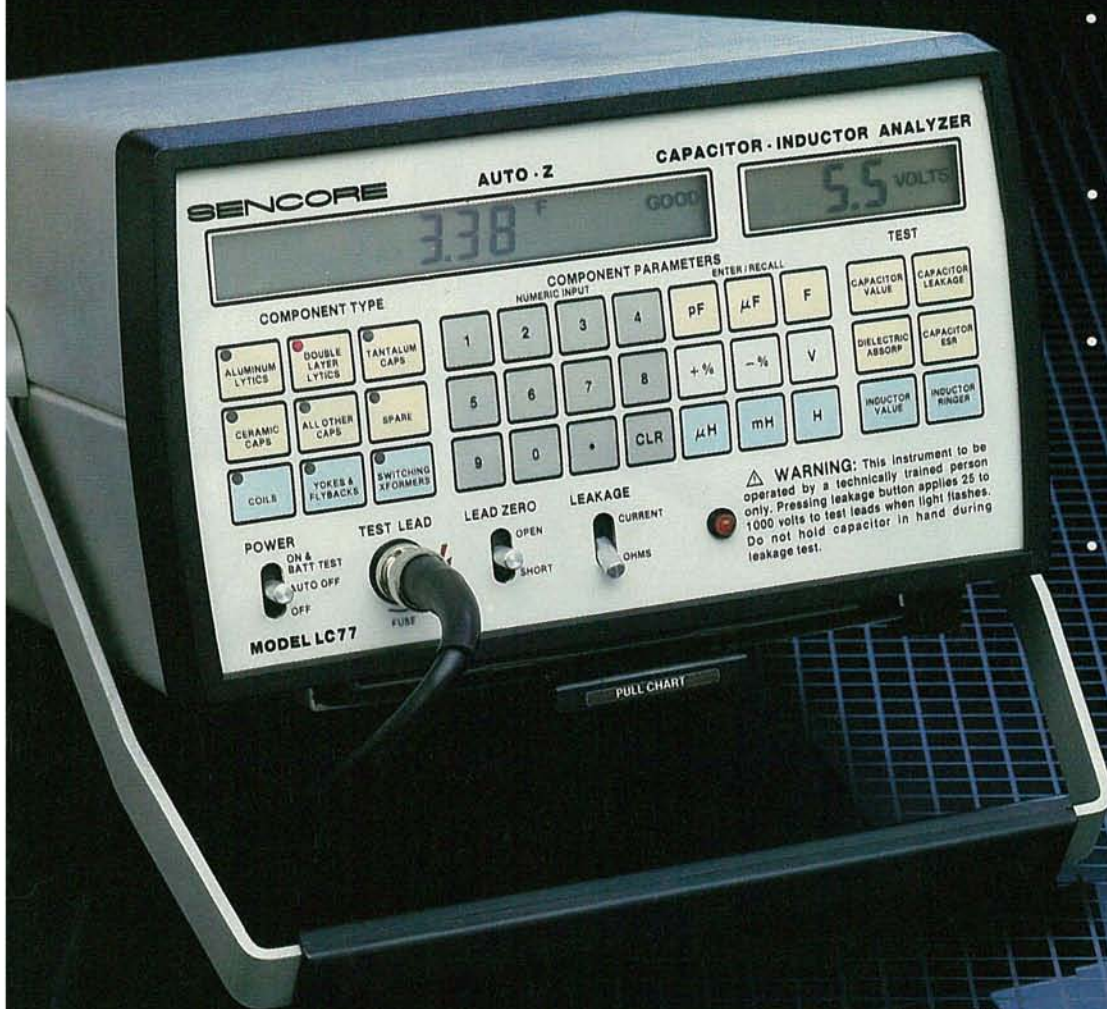

- **Completely Analyze Capacitors**
From 1pf to 20F for value, leakage, Dielectric absorption and ESR.
- **Thoroughly Test Inductors**
From .1uH to 20H for value, opens and shorts even to one shorted turn!
- **Dynamically Test For Resistance**
Measure resistances up to 1,000 Megohms, and leakage down to 1 microamp with 1,000 volts applied potential.
- **Good/Bad Tests Eliminate Guesswork**
Exclusive good/bad readout gives you easy to read, reliable tests to internal EIA and industry standards.
- **100% Portable**
Works all day on one charge for testing in the field or on the bench.

LC77 AUTO-Z™
Capacitor-Inductor Analyzer
\$1895 Patented

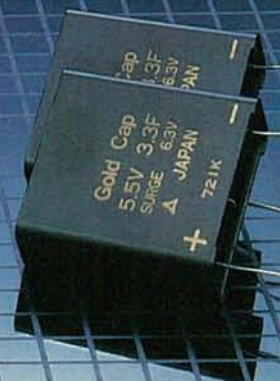
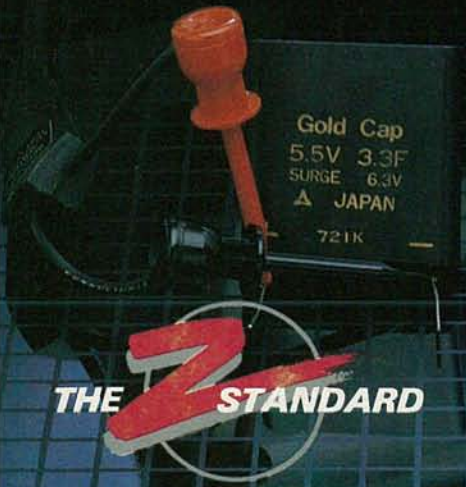

SENCORE

Call **1-800-843-3338** today.

In Canada call **1-800-851-8866** today.

100% American Made CIRCLE 198 ON FREE INFORMATION CARD



REASONS FOR SELECTING CIE

- Approved for educational benefits under the G.I. Bill for Veterans and other eligible persons.
- CIE provides printed job resumes, letters of recommendation, and lifetime Employment Service for all graduates at no extra charge.
- State-of-the-Art laboratory equipment is yours to keep and it comes assembled, ready for hands-on-experiments.
- Only CIE offers an Associate Degree program based on actual study time used. The faster you complete your degree, the less your overall tuition.
- Upon graduation, CIE offers you free preparation to pass the Certified Electronics Technician Exam.

CIE

CLEVELAND INSTITUTE OF ELECTRONICS 1776 East 17th Street • Cleveland Ohio 44114
PHONE TOLL FREE 1-800-321-2155 / In Ohio 1-800-523-9109

LEARNING...

THE KEY TO SUCCESS

A CAREER IN ELECTRONICS STARTS WITH CIE.

For the last few years, the electronics field and related industries have been growing at an incredible pace. And today, a career in electronics offers more opportunities and greater rewards than ever before.

Just ask any of the many graduates of the Cleveland Institute of Electronics who have landed high-paying positions with aerospace, computer, medical and communications firms. They'll tell you success didn't come easy... but that CIE made it all worthwhile.

SPECIALIZED TRAINING CIE isn't just another be-everything-to-everybody correspondence school. We're accredited by the National Home Study Council. And with more than 1100 graduates each year, we're the largest independent home study school specializing *exclusively* in electronics. CIE has been training career-minded students like yourself for over 50 years and we know the business inside and out.

PRACTICAL TRAINING CIE students learn by doing, using sophisticated electronic learning tools that we've designed and developed. One such tool, our 4K RAM Microprocessor Training Laboratory, teaches programming, interfacing and lets you work with a broad range of computers in a way that working with a single, stock computer simply can't.

We combine that valuable hands-on training with our unique Auto Programmed® lessons, designed to teach you step-by-step and principle-by-principle. The result is practical training... the kind of experience you can put to work in the marketplace.

PERSONALIZED TRAINING While some of our students have a working knowledge of electronics others are just getting started. That's why we have 10 career course levels from Basic to Advanced. They let you start where you want. Learn at your own pace. And learn as much as you like. You can even earn an Associate in Applied Science Degree in Electronics. And when you need help, our trained professionals are on hand to assist you by phone or mail.

Learning electronics isn't easy, but getting started is. For a CIE catalog and enrollment information, just mail the coupon below. Or call toll-free 1-800-321-2155. In Ohio, call 1-800-523-9109.



Accredited by the Accrediting Commission of the National Home Study Council, Washington, D.C.

CIRCLE 60 ON FREE INFORMATION CARD



YES! I want to get started. Send me my CIE school catalog including details about the Associate Degree program.

Print Name _____

Address _____ Apt. _____

City _____ State _____ Zip _____

Age _____ Area Code/Phone No. _____ / _____

Check box for G.I. Bulletin on Educational Benefits

Veteran Active Duty

MAIL TODAY!

CIE CLEVELAND INSTITUTE OF ELECTRONICS
1776 East 17th Street, Cleveland, Ohio 44114

ARE 82



...ourses feature the CIE Microprocessor Laboratory, an integral part of com-
ou'll gain all the practical experience
to work with state-of-the-art equip-
oday and tomorrow.

Put Professional Knowledge and a
COLLEGE DEGREE
in your Technical Career through
**HOME
STUDY**

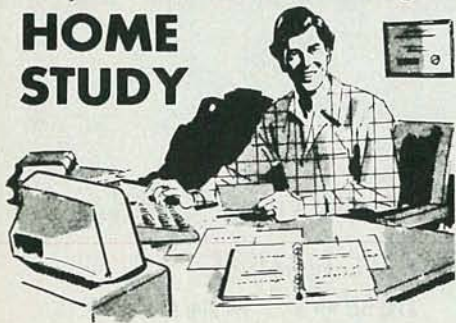

Add prestige and earning power to your technical career by earning your Associate or Bachelor degree through directed home study.

No commuting to class. Study at your own pace, while continuing on your present job. Learn from easy-to-understand lessons, with help from your Grantham instructors when you need it.

Grantham College of Engineering is a specialized institution catering to adults who are employed in electronics and allied fields such as computers. These fields are so enormous that opportunity to *move up* is always present. Promotions and natural turn-over make desirable positions available.

An important part of being prepared to *move up* is holding the proper college degree, but the essential part is *really knowing your field*. Grantham offers two B.S. degree programs — one with major emphasis in *electronics* and the other with major emphasis in *computers*. Both programs are offered by correspondence.

Write for our free catalog (see address below) or telephone us at (213) 493-4421 (no collect calls) and ask for our "degree catalog."

Accredited by
the Accrediting Commission of the
National Home Study Council

GRANTHAM
College of Engineering
10570 Humbolt Street
Los Alamitos, CA 90720

"noise-burst" is entirely too long to effectively eliminate all portions of the Macrovision signal. After checking several copy-protected tapes, it appears that at approximately 9 μ sec after the beginning of the sync pulse, the Macrovision is added. (Perhaps the author designed his system around an older version of Macrovision?)

The result is that several pulses during each Macrovision-encoded line are allowed to pass to the output. While that may not appear to cause a problem, I noticed some brightness changes on my VCR system. I purchased the kit and confirmed the above.

Being curious, I decided to reprogram IC4, the binary counter, to decimal 9 (9 μ sec). The result of that was to entirely eliminate the video signal.

It appears that the counter is being preset by sync pulses on Pin 13 of IC4 that have a duration of greater than 9 μ sec. That occurs because IC2 is generating 11 μ sec pulses corresponding to *all* horizontal sync pulses. The end result

is the placing of "burst-locating pulses" throughout the entire video field.

R. FALCONE
Cincinnati, OH

CALIBRATING VCR COUNTERS

I read the article "Calibrating VCR Counters" (*Radio-Electronics*, January 1988) with interest. I had considered the same problem—for audio recorders—many years ago with the idea of solving the problem mathematically rather than empirically.

At first glance, the problem appeared difficult because the pack radius is a non-linear function of tape length and the effective tape thickness in the tape pack is hard to determine. The solution became much easier when I realized that the length of tape on the take-up pack is proportional to the pack *area*, while the tape counter (usually on the take-up reel) is linearly related to the pack radius.

In particular, where n = counter count; l = tape length on take-up
continued on page 76

**Crystek
Crystals**

FOR OPTIMUM STABILITY
AND RELIABILITY IN
FREQUENCY MANAGEMENT

**QUARTZ CRYSTALS
FOR**

Industrial Equipment/Instrumentation

- Micro-processor control
- Computers/Modems
- Test/Measurement
- Medical



General Communications

- Channel element Service (VHF/UHF)
- Land Mobile 2-way
- Marine
- Aircraft
- Telemetry
- Monitors/Scanners/Pagers



**Amateurs/2-Meter/General Coverage
CB/Hobbyist/Experimenter**

NEW



**The
Pulse of
Dependable Communications**

Crystek Crystals offers their new 16 page **FREE** catalog of crystals and oscillators. Offering state of the art crystal components manufactured by the latest automated technology. Custom designed or "off the shelf," Crystek meets the need, worldwide. Write or call today!

CRYTEK CORPORATION

DIVISION OF WHITEHALL CORPORATION

2351/2371 Crystal Drive • Ft. Myers, FL 33907
P.O. Box 06135 • Ft. Myers, FL 33906-6135

TOLL FREE 1-800-237-3061

PH 813-936-2109/TWX 510-951-7448/FAX 813-939-4226

TOLL FREE IN THE U.S.A. EXCEPT FLORIDA, ALASKA, HAWAII

CIRCLE 209 ON FREE INFORMATION CARD

LETTERS

Here are some of the more "interesting" letters we've received since April 1st.

THE ULTIMATE CONSTRUCTION PROJECT

As a subscriber, I have enjoyed reading the articles and building some of the projects presented in **Radio-Electronics**.

However, I would like to see more sophisticated projects, such as a handheld, experimental band, precision-synchronized, clocked, microprocessor-controlled, random code scrambled, voice-activated, frequency-modulated, spread-spectrum, two-way transceiver with on-board ten-digit key-

board for random seed number entry.

I'm sure every hobbyist would love to have at least two.

H.D.

Guthrie, OK

FLOATING DISH

We are on a ship operating in Southeast Asia, and we are interested in purchasing a satellite dish for our vessel so that we can receive a larger number of TV channels. Could you refer us to a company that sells them? Any in-

formation you can provide will be greatly appreciated.

THE RECREATIONAL COMMITTEE
FPO San Francisco

Do you also need a high-speed dish actuator with ocean-wave compensation?—Editor

IBM-INCOMPATIBLE

I was happy to see "Build This IBM Incompatible" in the April 1987 issue of **Radio-Electronics**. I always wanted to build a computer. Thanks to you, now I can.

PACESETTER PRODUCTIVITY

100 MHz TEK 2246A/2245A

Smart scopes, perfect setup! Tek sets the new, fast pace for frequent measurements with automatic front panel setup. Nonvolatile memory for up to 20 front-panel setups (2246A). Time and voltage cursors. Exclusive SmartCursors™ track waveform changes for voltage measurements. All backed by Tek's 3-year warranty.

NEW



Call Tek direct
for PaceSetter specs!
1-800-426-2200

Prices subject to change without notice.

Copyright ©1988, Tektronix, Inc. All rights reserved. TTA 906-A

Tektronix
COMMITTED TO EXCELLENCE

CIRCLE 188 ON FREE INFORMATION CARD

R-E Service Admart

Rates: Ads are 2 1/4" x 2 7/8". One insertion \$825. Six insertions \$800 each. Twelve insertions \$775. each. Closing date same as regular rate card. Send order with remittance to **Service Admart**, Radio-Electronics Magazine, 500-B Bi-County Blvd., Farmingdale, NY 11735. Direct telephone inquiries to Arline Fishman, area code-516-293-3000. *Only 100% Service ads are accepted for this Admart.*

VCR MAINTENANCE AND REPAIR ON VIDEO TAPE

There is no other tape like ours on the market.

Learn how to clean the entire tape path as well as replace the belts in any VCR. You need no special schooling or tools to perform the simple task shown on our video. **To save time and money on your VCR repairs, order your tape NOW!**

Price \$32.95
Simply call:
(513) 548-6113
MASTER CARD
and VISA are
accepted.

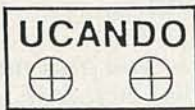

VCR EDUCATIONAL
PRODUCTS CO.
BOX 386
GREENVILLE, OHIO 45331

CIRCLE 187 ON FREE INFORMATION CARD

ELEVEN-PIECE RATCHET TOOL KIT



Includes reversible ratchet handle, extension bar, six bits, two precision screwdrivers, and a cutter. Comes in fitted case. Get one for your shop, another for your car, another for your tool kit. To order send \$10.00 plus \$1.75 for shipping in the U.S. to **Electronic Technology Today Inc.**, P.O. Box 240, Massapequa Park, NY 11762-0240.

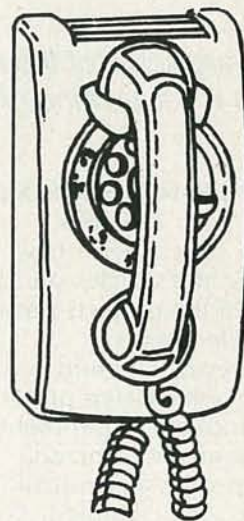

CALL NOW AND RESERVE YOUR SPACE

- 6 x rate \$800.00 per each insertion.
- Fast reader service cycle.
- Short lead time for the placement of ads.

Call 516-293-3000 to reserve space. Ask for Arline Fishman. Limited number of pages available. Mail materials to: Service Admart, RADIO-ELECTRONICS, 500-B Bi-County Blvd., Farmingdale, NY 11735.

POCKET BATTERY TESTER



Tests all 1.5-volt cells including A, AA, AAA, C, and D. Also checks miniature watch and calculator batteries. Special side connector provides rapid check of square 9-volt batteries. Positive meter reading shows "GOOD, LOW, REPLACE". \$6.00 each. Two for \$10.00. Add \$1.75 for UPS. Send check to **Electronic Technology Today Inc.**, P.O. Box 240, Massapequa Park, NY 11762.

NINE-PIECE TOOL KIT



Includes saw, bubble level, three screwdrivers, torque multiplier, calipers for inside and outside measurements, nippers, and a tape measure. To order send \$10.00 plus \$1.75 for shipping in the U.S. to **Electronic Technology Today Inc.**, P.O. Box 240, Massapequa Park, NY 11762-0240.

I'm a carpenter, and I got a bunch of my friends together and built a whole bunch of those "NAND gates." We built the positron catcher to fill up the NAND gates. It didn't work but, being a carpenter, I figured it out.

Figure 1-a of the article shows that the positrons are mostly square-shaped. So, we heated the funnel and sort of squared it up. Then we filed the hole in the thimble square (you know about round pegs in square holes?). We put a

straight straw on it after we found positrons jamming in the round bend of the straw. Figure 1 here shows the positron catcher for the Northern hemisphere. We got all of the NAND gates filled up, but, after a while, everything leaked out and we couldn't measure any positive electricity.

Now we've got two questions: 1. Is there some way of closing the gates a little tighter, or did we do something wrong? 2. How do you work those W's? I need a whole lot

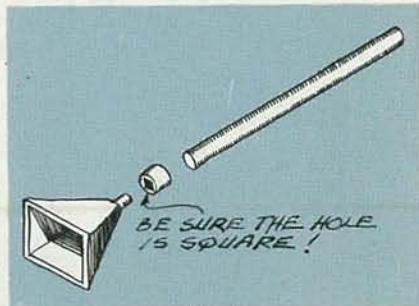

FIG. 1

more information on how to manipulate those W's!

You're my favorite magazine—
keep 'em rolling!
WALT HENRY
Madera, CA

WHEN WILL IT END?

In his story, "Build This IBM Incompatible," Jeff Holtzman states that the series will extend to 463 parts. By my calculations, if you run one part in each issue of **Radio-Electronics**, it will take 38½ years to reach the end. Am I right?

How can this be? Will you include two or three parts in each issue to reduce the time-span?

A BEGINNER IN ELECTRONICS

Aguada, PR

You didn't read the article carefully enough. The series is supposed to appear in each April issue only; thus, it will take 463 years to reach its conclusion. (Unfortunately, we ran out of room in this issue....464 years?)—Editor

HELP!

I hope there is, among my high-tech fellow readers, somebody who can help me design an elec-

tronic trap for small insects. I've been bothered by an insect that entered my home on a contaminated house plant, and none of the chemically-toxic buy sprays have succeeded in eliminating it.

It is a flying insect that crawls into the hairy areas of my body. It doesn't bite—it just seeks out the warmest and most humid areas and walks around. The insect is too small to see with the naked eye, and local doctors don't believe me simply because they can't see it. They tell me to capture and identify it, but I can't trap or kill it.

I've tried the ultrasonic pest repeller described in the July 1985 issue of **Radio-Electronics**, but that only succeeded in annoying my neighbors. I had no success using an ultraviolet light bulb to lure it into a high-voltage zapper. All the toxic room fumigators do is poison me temporarily. Yet this little bug is still bugging me. Does anyone on your staff have any electronic suggestions?

GETTING DESPERATE
New York, NY

COMPACT DISC PROGRAMMER

We have a Sony CDP-C10 compact disc player which can be programmed to play 20 songs from any of 10 compact discs. We entertain frequently, using the compact disc as the source of music. Since most of the songs popular for parties are about 3 minutes long, we have only one hour of music before it is interrupted for reprogramming. This is an inconvenience—particularly if we are in the pool or jacuzzi, or on the tennis courts.

Is there a schematic available which will allow the programming of additional songs to be stored in a memory, and then send the signal to the compact disc player?

L.C.F.

Canoga Park, CA

Have you considered buying several more CD-players or, perhaps, teaching the butler to reprogram it for you?—Editor

PORTABLE LASER

I'm thinking of building my own helium-neon laser from scratch.

PACESETTER PERFORMANCE

100 MHz TEK 2236/2235

100 MHz scope, counter, timer,
DMM—just \$2795

The ultra-versatile Tek 2236 makes measuring everything from frequency, period and width to delay time and Δ time push-button easy—in addition to CRT display, you get digital readout display accurate to 0.001% and beyond. PaceSetter performance on a modest budget? Look at the 100 MHz, dual-trace Tek 2235 with the best of the basics—just \$1575!



Call Tek direct
for PaceSetter specs!

1-800-426-2200

Prices subject to change without notice.

Copyright ©1988, Tektronix, Inc. All rights reserved. TTA 906-B

Tektronix
COMMITTED TO EXCELLENCE

CIRCLE 189 ON FREE INFORMATION CARD

Macrovision ... now you see it, now you don't.

Remove copy-protection from video cassettes.



- Digital Filter Type, removes only Macrovision pulses
- No adjustments, crystal controlled
- Compatible with all VCR's, uses automatic vertical blanking level

Macro-Scrubber — We stock the exact parts, PC board, and AC adaptor for an article on Building a Macro-Scrubber appearing in *Radio-Electronics* December 1987 issue.

JMAK-1 Parts Package \$19.00

Includes all the original resistors, capacitors, diodes, transistors, integrated circuits, and crystal.

JMAK-2 PC Board \$9.95

Original etched and drilled silk-screened PC board used in article

JMAK-3 AC Adaptor \$7.95

Original (14 to 18 volt DC @ 285 ma) AC adaptor used in article.

Free reprint of article on building a Macro-Scrubber with any purchase above. Add \$2.50 shipping & handling; \$4.50 Canadian orders. Note: Unauthorized duplication of copyrighted material is illegal. Use Macro-Scrubber for viewing only.

72-CHANNEL CABLE CONVERTER WITH INFRA-RED REMOTE CONTROL

MC-702 CONVERTER \$79.95



Add \$3.50 shipping & handling
\$9.50 Canadian orders.

- 72-channel capability
- Wireless, Infra-Red remote control
- Channel output 2 or 3 switchable
- Microprocessor controlled PLL operation
- Skip channel memory eliminates unused channels
- Parental control for all channels
- Last channel recall
- Fine tune memory
- UL listed/FCC approved
- Simple installation with any TV
- Includes battery and 3 foot coax cable

CABLEMASTER \$19.95 Cable/VCR Timer

- Record multiple premium play channels
 - Turns cable box on and off
 - Selects channel for unattended recording
 - Thousands sold nationally for \$99.95
- Add \$3.50 shipping & handling
\$4.50 Canadian orders

ORDER TOLL FREE ANYTIME
1-800-227-8529
Ask for **FREE**
Color Catalog

Inside MA: 617-695-8699

VISA, MASTERCARD,
or C.O.D.



**J & W
ELECTRONICS, INC.**

P.O. BOX 800 • MANSFIELD, MA 02048

©Copyright 1988 by J&W Electronics Inc.

CIRCLE 65 ON FREE INFORMATION CARD

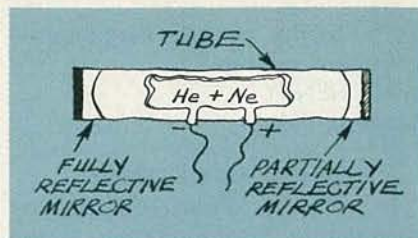

FIG. 2

Figure 2 shows what the "tube" will look like. I have some questions I hope you can answer.

What amounts of helium and neon can safely be put in the tube? Do you need a lot of gas for the tube to be effective? When you throw the switch, the atoms become excited and give off photons that bounce back and forth until a beam breaks through. How do you know where the beam would come through the mirror?

Finally, what volume of gas and what amount of current is needed to produce an effect like punching a hole through a *Radio-Electronics* at 50 yards.

I plan on making this laser portable. I was thinking about making a fuel cell (Fig. 3) which could be carried on my back.

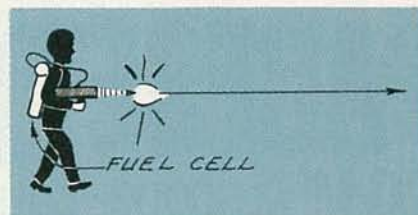

FIG. 3

If this is not a practical method of making a HeNe laser, please send a diagram of one.

R.B.
Stillwater, OK

AMERICA'S ILLITERACY PROBLEM

It might be an individual's own business on whether or not he/she can read or write, and I am certainly the latter would agree, but the circumstances that brings about the causes is what I would like to comment on. The 1986 U.S. Census Bureau report of 17 million to 21 million adults that are illiterate is partly due to the fact that the Humanities are neglected in secondary educational schools.

B. M.
Atlanta, GA

Yes, we do seem to have an illiteracy problem.—Editor

EQUIPMENT REPORTS

Videonics DirectED Video Editing System

Turn your home videos into professional-looking productions.

CIRCLE 49 ON FREE INFORMATION CARD



THE VIDEO CAMCORDER IS ONE OF THE hottest consumer electronics products of the last five years. But despite the continuing improve-

ment in the capabilities of camcorders, shooting an interesting video continues to be extremely difficult. Making a good, interest-

ing video requires that you do more than simply point and shoot. If you've ever been forced to watch a 45-minute video of a baby learning how to walk, you're sure to agree that the point could have been gotten across better—and faster—in 5 minutes of well-edited scenes. But editing videocassettes at home has never been an easy proposition.

All that will change with *DirectED*, from Videonics (1129 Dell Avenue, Campbell, CA 95008, 408-866-8300). *DirectED*, which Videonics calls a personal movie maker, is an advanced, micro-processor-controlled system that gives you the ability to turn your choppy, boring, home videos into

PACESETTER PRICE

50 MHz TEK 2210/2225

Best-of-class performance at

\$995/\$2195

Get the *PaceSetter* start in digital storage with Tek's NEW 50 MHz 2210. Featuring 20 MS/s per channel digitizing, 4K record length per channel plus familiar, full-bandwidth analog operation for just \$2195. And for pure and simple analog performance with unmatched economy, look at the popular, 2-channel Tek 2225—just \$995!

NEW 2210
20 MS/s per channel

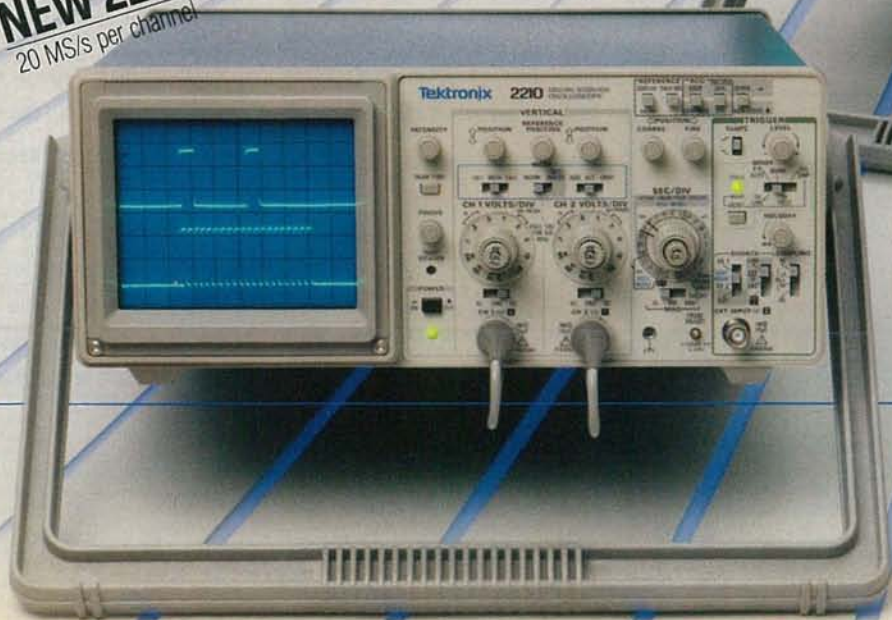

Call Tek direct
for PaceSetter specs!
1-800-426-2200

Prices subject to change without notice.
Copyright ©1988, Tektronix, Inc. All rights reserved. TTA 906-C

Tektronix
COMMITTED TO EXCELLENCE

CIRCLE 190 ON FREE INFORMATION CARD

Join the Electronics and Control Engineers' Book Club®

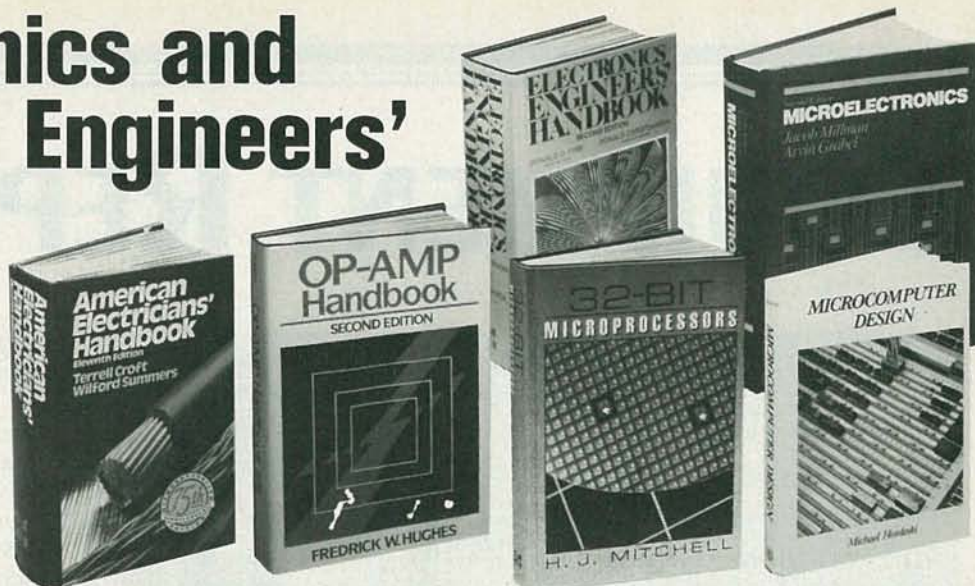

ADVANCED DIGITAL COMMUNICATIONS: Systems and Signal Processing. Edited by K. Feher. 768 pp., 436 illus. Emphasizes the newest advances and developments in telecommunications systems and networks. Chapters on subjects such as ISDN, speech coding algorithms, digital speech interpolation systems and interference are all written by international authorities to give you on-the-job expertise.
583801-X Pub. Pr., \$59.95 Club Pr., \$42.50

ELECTRONICS ENGINEERS' HANDBOOK, Second Ed. Edited by D. G. Fink & D. Christiansen. 2,272 pp., 2,189 illus. This updated and enlarged edition covers all the latest knowledge in the field, including new advances in integrated circuits, pulsed and logic circuits, laser technology, telecommunications, and much more.
209/812 Pub. Pr., \$89.00 Club Pr., \$61.50

32-BIT MICROPROCESSORS. Edited by H. J. Mitchell. 248 pp., 104 illus. and tables. A complete survey of the architecture, operation, and applications of today's most important new devices from AT&T, Inmos, Intel, and Motorola.
425/85X Pub. Pr., \$39.95 Club Pr., \$29.50

MICROWAVE AMPLIFIERS AND OSCILLATORS. By C. Gentili. 150 pp., 79 illus. A thorough, practical introduction to the theory and design of microwave amplifiers and oscillators, with coverage of the scattering matrix, the gallium arsenide field-effect transistor, and microstrip technology.
229/953 Pub. Pr., \$31.95 Club Pr., \$24.95

TROUBLESHOOTING ELECTRONIC EQUIPMENT WITHOUT SERVICE DATA By R. G. Middleton. 303 pp., 162 illus. and tables. Packed with charts, diagrams, and case histories, this practical handbook shows you how to pinpoint defective electronic circuitry when no service data is available.
583134-1 Pub. Pr., \$27.95 Club Pr., \$22.50

- your one source for engineering books from over 100 different publishers
- the latest and best information in your field
- discounts of up to 40% off publishers' list prices

New Members!
Take any one of these great professional books for only **\$289** as a premium with your first selection!

Spectacular values up to **\$98.50**

McGraw-Hill Concise Encyclopedia of Science and Technology. Editor-in-Chief S. P. Parker and the Staff of the McGraw-Hill Encyclopedia of Science and Technology. 2,065 pp., 1,600 illus. This volume serves every need for understanding today's science and technology. Written by over 3,000 of the world's topmost experts, including 19 Nobel Prize winners, it covers 75 disciplines from Acoustics to Zoology.
454/825 Pub. Pr., \$98.50 Club Pr., \$63.99

CIRCUIT DESIGN FOR ELECTRONIC INSTRUMENTATION: Analog and Digital Devices from Sensor to Display, Second Ed. By D. Wobschall. 400 pp., 365 illus. Brings you the entire process of circuit design in a comprehensive, easy-to-follow format. This new edition reflects the latest in IC technology, including CMOS and ECL devices.
712/31X Pub. Pr., \$49.50 Club Pr., \$36.95

AMERICAN ELECTRICIANS' HANDBOOK, Eleventh Ed. By T. Croft and W. Summers. 1,824 pp., 1,560 illus. This newly updated handbook shows you how to select, install, maintain, and operate all the latest electrical equipment and wiring. It includes the most recent code requirements, basic formulas, and a wealth of circuit diagrams and illustrations.
139/326 Pub. Pr., \$64.50 Club Pr., \$49.50

MICROELECTRONICS, Second Ed. By J. Millman and A. Grabel. 1,001 pp., 646 illus. Takes you from the basics of semiconductor properties to an understanding of the operation of solid-state devices, and then to more advanced topics. Its up-to-date coverage, real-life examples, and practical data make this an ideal reference for the working engineer.
423/30X Pub. Pr., \$49.95 Club Pr., \$36.50

ENGINEERING MATHEMATICS HANDBOOK, Third Ed. By J. J. Tuma. 512 pp., illus. This best-selling handbook gives you the essential mathematical tools—formulas, definitions, theorems, tables, and models for computer programming—that you need for your day-to-day engineering calculations.
654/433 Pub. Pr., \$44.50 Club Pr., \$34.50

ENGINEERING FUNDAMENTALS FOR THE PROFESSIONAL ENGINEERS' EXAM, Third Ed. By L. M. Polentz. 432 pp., 170 illus. Features worked-out solutions and full explanations for all sample problems so you can learn how to solve them. It's a dependable way to prepare for the exam or a perfect on-the-job reference.
503/931 Pub. Pr., \$36.50 Club Pr., \$27.95

AUTOMATIC CONTROL SYSTEMS, Fifth Ed. By B. C. Kuo. 736 pp., illus. Provides an overview of automatic control systems, including in-depth coverage of classical control techniques, optimal control theory, and analog and digital control system design. This updated edition discusses the latest ideas on the use of computers to design control systems and as components of such systems.
583706-4 Pub. Pr., \$48.00 Club Pr., \$36.95

OP-AMP HANDBOOK, Second Ed. By F. W. Hughes. 320 pp., 231 illus. Organized for on-the-job reference, this handbook covers all facets of op-amps, from stability and protection to signal processing using op-amps. Includes a collection of over 60 practical circuits for a variety of applications, procedures, and experiments.
583651-3 Pub. Pr., \$36.33 Club Pr., \$27.50

THE LINEAR IC HANDBOOK. By M. S. Morley. 614 pp., 163 illus. The one-stop sourcebook that helps you find—quickly and easily—the lowest-cost linear IC that will meet your needs. Includes specs, applications data, and prices of linear ICs from all major manufacturers, as well as design and fabrication techniques.
583784-6 Pub. Pr., \$49.50 Club Pr., \$36.25

HANDBOOK OF ELECTRONIC TABLES AND FORMULAS Sixth Edition

256 pages, illustrated. 583804-4
Up-to-date mathematical tables and electronic formulas in a convenient desk reference that you'll find indispensable. Included are basic formulas, constants, government/industry standards, symbols and codes, service data, and more. The handbook also has new sections describing how to do your calculations on a computer, and complete computer programs.

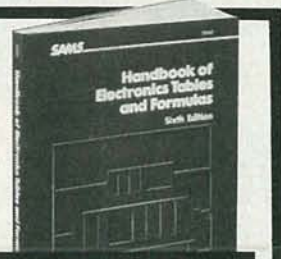

A \$19.95 Value — Yours ABSOLUTELY FREE when you join!

PRINCIPLES OF PARALLEL AND MULTI-PROCESSING. By G. R. Desrochers. 500 pp., illus. A highly practical guide to the best techniques in parallel problem-solving. Discusses parallel system design, architecture, implementation, software, and performance analysis. 165/793 Pub. Pr., \$49.50 Club Pr., \$36.95

ANALOG ELECTRONIC CIRCUITS. By G. M. Glasford. 480 pp., 350 illus. Gives you the detailed information and equations you need to create and analyze top quality circuit designs or effectively utilize the designs of others. 583768-4 Pub. Pr., \$52.33 Club Pr., \$37.95

HANDBOOK OF ELECTRONIC NOISE MEASUREMENT AND TECHNOLOGY, Second Ed. By C. A. Vergers. 440 pp., 213 illus. Provides answers to all your questions about noise origins, causes, effects. Also shows you how to predict and measure noise, and how to design low-noise circuits. 583947-4 Pub. Pr., \$39.95 Club Pr., \$29.95

SWITCHGEAR AND CONTROL HANDBOOK, Second Ed. Edited by R. W. Smeaton. 1,056 pp., 789 illus. The only handbook that treats all aspects of switchgear control, including design, applications, safety, and maintenance. Updated to reflect the changes brought about by the use of computers, solid-state devices, and programmable controls. 584/494 Pub. Pr., \$75.00 Club Pr., \$56.95

ANTENNA APPLICATIONS REFERENCE GUIDE. Edited by R. C. Johnson and H. Jasik. 496 pp., 368 illus. and tables. Covers the major applications of antenna technology in all areas of communications and their design methods. Emphasizes important new applications such as earth station, satellite, seeker, aircraft, and microwave-relay antennas. 322/848 Pub. Pr., \$49.50 Club Pr., \$36.50

MICROCOMPUTER DESIGN. By M. Hordeski. 406 pp., illus. Emphasizes the most current, cost effective methods for developing, debugging and testing all types of microprocessor products, including software and hardware. 583683-1 Pub. Pr., \$42.67 Club Pr., \$29.95

DESIGNING ELECTRONIC CIRCUITS. By R. G. Middleton. 351 pp., 192 illus. Covers virtually every category of circuits commonly used. This practical manual provides the basic design procedures, tables and formulas vital to effective electronic circuit design. Plus over 60 start-to-finish procedures are featured along with scores of computer programs to help you design and analyze electronic circuits. 583673-4 Pub. Pr., \$36.95 Club Pr., \$27.50

Be sure to consider these important titles as well!

INTRODUCTION TO RADAR SYSTEMS, Second Ed. By M. I. Skolnik. 579/091 Pub. Pr., \$51.95 Club Pr., \$38.95

MICROPROCESSORS IN INSTRUMENTATION AND CONTROL. By S. A. Money. 427/070 Pub. Pr., \$39.50 Club Pr., \$29.50

OPERATIONAL AMPLIFIERS AND LINEAR INTEGRATED CIRCUITS, Third Ed. By R. F. Coughlin and F. F. Driscoll. 583754-4 Pub. Pr., \$34.95 Club Pr., \$25.95

McGraw-Hill's NATIONAL ELECTRICAL CODE HANDBOOK, 19th Ed. By J. F. McPartland. 457/077 Pub. Pr., \$42.50 Club Pr., \$31.95

ELEMENTS OF ENGINEERING ELECTROMAGNETICS, Second Ed. By N. N. Rao. 583774-9 Pub. Pr., \$49.00 Club Pr., \$35.50

PROBABILITY, SIGNALS, NOISE. By J. Dupraz. 183/309 Pub. Pr., \$39.95 Club Pr., \$29.95

POWER GENERATION CALCULATIONS REFERENCE GUIDE. By T. G. Hicks. 288/003 Pub. Pr., \$36.50 Club Pr., \$27.50

HUMAN FACTORS REFERENCE GUIDE FOR ELECTRONICS AND COMPUTER PROFESSIONALS. By W. E. Woodson. 717/664 Pub. Pr., \$32.50 Club Pr., \$23.75

THE FOURIER TRANSFORM AND ITS APPLICATIONS, Second Ed., Revised. By R. N. Bracewell. 070/156 Pub. Pr., \$49.95 Club Pr., \$38.95

THE LASER GUIDEBOOK. By J. Hecht. 277/338 Pub. Pr., \$49.50 Club Pr., \$37.50

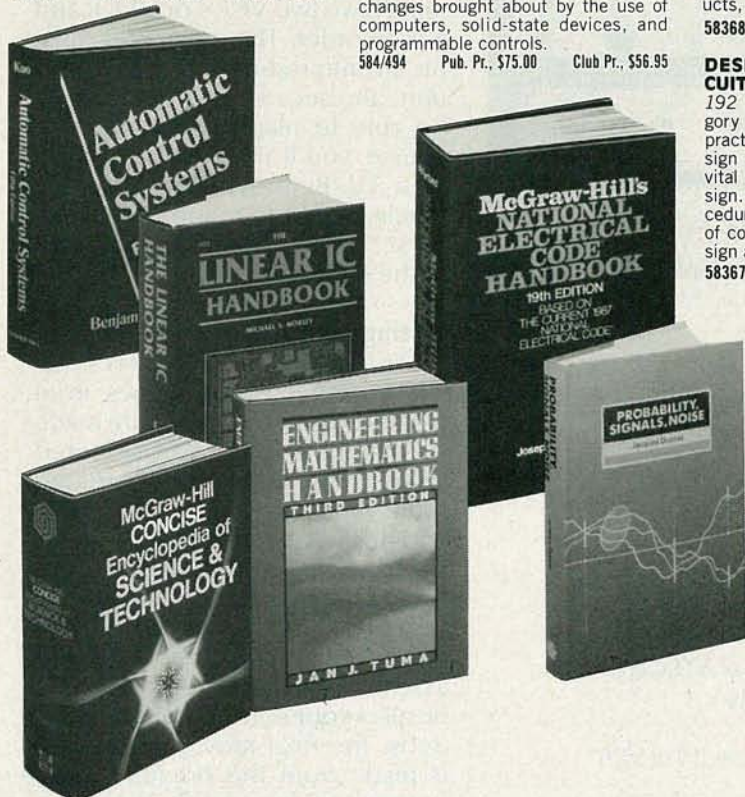

Here's how the Club works to serve YOU:

■ IMPORTANT INFORMATION... WE MAKE IT EASY TO GET!

In our rapidly changing world, those who perform best are those who are best informed. Designed exclusively for the practicing engineer, the Electronics and Control Engineers' Book Club provides you with information that is relevant, reliable, and specific enough to meet your needs. Each Club bulletin comes your way 14-16 times a year and offers you more than 30 books to choose from — the best and newest books from all publishers!

■ DEPENDABLE SERVICE... WE'RE HERE TO HELP!

Whether you want information about a book or have a question about your membership, our qualified staff is here to help. Just call us toll-free or write to our Customer Service. We also make sure you get only the books you want. All you do is simply tell us your choice on the Reply Card and return it to us by the specified date. If you want the Main Selection, do nothing — it will be sent to you automatically. (A small shipping and handling charge is added to each shipment.)

■ CLUB CONVENIENCE... WE DO THE WORK!

Beyond the benefit of timely information, Club membership offers many other benefits. For example, you get a wide choice of books that cannot be matched by any bookstore — anywhere. And all your books are conveniently delivered right to your door. You also get the luxury of 10 full days to decide whether you want the Main Selection. If you should ever receive a Main Selection you don't want because the Club bulletin came late, just return it for credit at our expense.

■ SUBSTANTIAL SAVINGS... AND A BONUS PROGRAM TOO!

In keeping with our goal to provide you with the best information at the greatest possible savings, you will enjoy substantial discounts — up to 40%! — on every book you buy. Plus, you're automatically eligible for our Bonus Book Plan which allows you savings up to 70% on a wide selection of books.

■ EASY MEMBERSHIP TERMS... IT'S WORTHWHILE TO BELONG!

Your only obligation is to purchase 2 more books — at handsome discounts — during the next 12 months, after which you enjoy the benefits of membership with no further obligation. Either you or the Club may cancel membership anytime thereafter.



68000 MICROPROCESSOR: ARCHITECTURE, SOFTWARE & INTERFACE TECHNIQUES. By W. A. Triebel & A. Singh. 583613-0 Pub. Pr., \$42.67 Club Pr., \$29.95

FOR FASTER SERVICE IN ENROLLING CALL TOLL-FREE 1-800-2-MCGRAW

MAIL THIS COUPON TODAY

McGraw-Hill Book Clubs Electronics and Control Engineers' Book Club®

P.O. Box 582, Hightstown, NJ 08520-9959

Please enroll me as a member and send me the two books indicated, plus the HANDBOOK OF ELECTRONIC TABLES AND FORMULAS. I am to receive one book for just \$2.89, the other at the discounted member's price, plus local tax, shipping and handling charges. I agree to purchase a minimum of two additional books during my first year of membership as outlined under the Club plan described in this ad. I understand that a shipping and handling charge is added to all shipments.

Your FREE Handbook	
583804-4	
Write Code No. of the \$2.89 selection here	Write Code No. for the First selection here
<input type="text"/>	<input type="text"/>

Signature _____

Name _____

Address/Apt. # _____

City _____

State _____ Zip _____

This order subject to acceptance by McGraw-Hill. All prices subject to change without notice. Offer good only to new members. Foreign member acceptance subject to special conditions.

E33927

APRIL 1988

Ten Things You Can Do With The VA62 Universal Video Analyzing System — That You Can't Do With The Others.

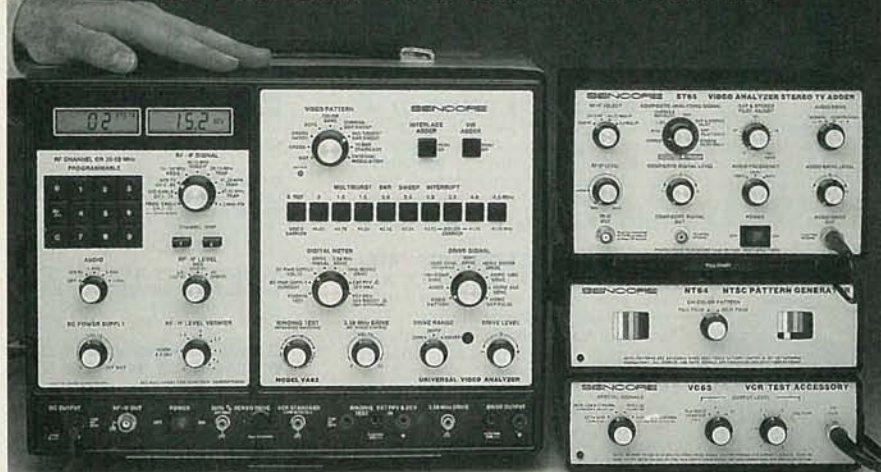

\$3,495 Patented

1. Quickly locate defective circuits by injecting signals without disconnecting components.
2. Replace video heads with confidence; a simple good/bad head test removes all doubt.
3. Align IF traps simply by just the pattern on the CRT — have the picture "looking like it did when they bought it."
4. Quickly align VCRs with special video patterns, or NTSC color bars Meets all manufacturers' warranty requirements.
5. Performance test and troubleshoot any MTS stereo TV or VCR system, so you can cash in on new technology.
6. Confidently test deflection yokes, IHVTs, and flyback transformers, in-or out-of-circuit, before you replace them.
7. Add on phase-locked accessories into your video analyzing system to increase service potential as technology changes.
8. Performance test and troubleshoot digital/analog RGB video monitors, so you can test all of today's video systems.
9. Conquer tricky servo circuits in VCRs by injecting a reference 30 Hz servo pulse.
10. Cut your video servicing time in half . . . or your money back.

Discover what the Universal Video Analyzing System can do for you! Call Today 1-800-843-3338.

In Canada Call 1-800-851-8866.

100% American Made

SENCORE

3200 Sencore Drive, Sioux Falls, SD 57107 605-339-0100 In SD Only

CIRCLE 199 ON FREE INFORMATION CARD

professional-looking video productions. It's compatible with most remote-controlled VCR's on the market, regardless of format, and despite its power, *DirectED* is surprisingly easy to use.

The *DirectED* system consists of three parts: the handheld remote unit, the control unit, and the control wand. To use *DirectED*, you must have two VCR's or a VCR and a camcorder. The main VCR must be an infrared-remote controlled unit; the second VCR only has to be able to play back a tape. Of course, you'll also need a monitor or a TV. Before we get into the details of the equipment and how it's set up, let's step back and look at the editing process.

Editing your own movie

DirectED's editing process starts with an original tape or tapes, from which duplicates or dubs are made (so that the originals can be stored away safely). Then good scenes are found and marked on the dubs, and they are named and numbered. A *rough-cut master* is assembled from those scenes so that you can check your work before you go back to the original tapes to assemble your movie. While you do all of your editing work with the dubs, the final movie production is made from the original tapes, not second-generation copies.

DirectED remembers the name of each scene, where each scene is, and how long it is. It even remembers what tape a given scene is on—you can assemble your movie production from many different tapes. The scene list can be displayed on screen and, if you wish, you can preview all of the scenes in order before making your final movie.

DirectED can do more than assemble scenes in sequence, however. It allows you to rearrange the order of scenes, add graphics, add titles, add fades or wipes between scenes, and more. When you're satisfied with your choices, you simply tell *DirectED* to make the production. It prompts you to insert the appropriate tapes into your VCR's, and does all the rest of the work by itself.

Using the movie maker

The power of *DirectED* shows it-

self in how easy the system is to use. Every step of the way is guided by menu screens that are arranged logically. And a help key is available to call up more information about a particular function. *DirectED* also keeps track of all your tapes! All your dubs and finished productions reside on library tapes. If you label your tapes when prompted by *DirectED*, you'll always be able to find not only a particular movie, but a particular scene as well. *DirectED* will tell you which tape to insert into the VCR, and it will forward the tape to the beginning of the scene you want.

Now that we know how *DirectED* is used, let's go back and take a closer look at the equipment and how it is hooked up.

You must start with two VCR's. One, which we'll call the main VCR, must be infrared-remote controlled. The other can be any deck, from a playback-only VCR to a camcorder. The two decks can be different formats.

The two decks are connected to the *DirectED* video control unit, which is an unobtrusive grayish box that measures about 8½ x 9½ x 2½ inches. It accepts video and stereo-audio inputs from both VCR's, and it outputs stereo audio and video to a monitor and the main VCR. A modulated RF output is not available, so if your TV does not have video inputs, you will have to purchase an RF modulator separately.

One final connection must be made to the video control unit: The control wand, which outputs the infrared signals to control your main VCR, is plugged into the rear panel of the control unit and is placed so that it can be seen by the main VCR's infrared sensor.

Making all those connections takes about 5 minutes. When you're done, you really never have to touch the video control unit again. It can simply be placed on a shelf, out of the way, where it can see the handheld controller, which is the user interface to *DirectED*. The controller has a 50-key keypad that contains the alphabet (in an "ABC" sequence), numerals, cursor controls, and a few special-function keys, including the all-important HELP key.



New solid-state and digital TV sets, stereos, and videorecorders are tougher to repair than old-fashioned tube type sets and require special training for the service technician who works on them.

Only a few states have laws requiring competency tests for licensing technicians who repair consumer electronics, but fifteen years ago the International Society of Certified Electronic Technicians (CET) began its own certification program to qualify these technicians and those in industry. To carry the CET designation, technicians must have four years experience and pass a rigid examination on general electronics and a specific area of expertise such as audio or radio-TV.

Many consumers look for a Certified Electronic Technician in the shop when they need any electronic item repaired.

Free Consumer Checklist. A consumer checklist for selecting a service shop is available free by sending a stamped, self-addressed envelope to: Checklist, ISCET, 2708 West Berry, Fort Worth, TX 76109. The list reminds consumers to check such items as "Does the business have the parts for your particular brand?", "Did you get an estimated price?", and "Did you check this company with the Better Business Bureau?"



Modern electronic equipment such as digital TVs or stereos should be repaired by specially trained people.

available free by sending a stamped, self-addressed envelope to: Checklist, ISCET, 2708 West Berry, Fort Worth, TX 76109. The list reminds consumers to check such items as "Does the business have the parts for your particular brand?", "Did you get an estimated price?", and "Did you check this company with the Better Business Bureau?"

Nine Test Probes with only one difference between them and your scope's original equipment

Manufacturers Scope	Original Probe	Price	Coline/TPI Equivalent	Price				
TEKTRONIX								
2300 Series	P6101A	\$53	M12X1	\$38				
	P6108A	\$75	M12X10	\$62				
2200 Series	P6121	\$100	M12X10AP	\$68				
	P6122	\$58	P100	\$38				
2400 Series	P6131	\$140	M15X10HFAP	\$87				
	P6133	\$115	M12X10AP	\$68				
400 Series	P6105A	\$93	M12X10AP	\$68				
	P6106A	\$140	M15X10HFAP	\$87				
	P6130	\$130	M12X10AP	\$68				
IWATSU								
SS-5321	SS-0014	\$92	M12X10	\$62				
SS-5711	SS-0012	\$77	M12X10	\$62				
LEADER								
LBO-315	LP-060X	\$60	SP100	\$43				
LBO-518	LP-100X	\$76	SP100	\$43				
PHILIPS								
PM3267 & PM3256	PM8924	\$60	M12X1	\$38				
PM3264	PM8926	\$70	P100	\$38				
	PM8928	\$95	M12X10	\$62				
HITACHI								
V-1100A } V-670 } V-509 }	AT-10AL1.5	\$64	SP100	\$43				
HEWLETT PACKARD								
1715A					10018A	\$135	M20X10	\$68
1722B	10017A	\$130	M15X10HF	\$79				
1725A	10017A	\$130	M15X10HF	\$79				
1740 Series	10041A	\$135	P100	\$38				
	10021A	\$85	IP20	\$29				

Take up the TPI challenge and compare our prices with the probes you currently use. In many cases you can replace both probes on your dual trace scope at the cost of one probe from the scope manufacturer. Plus, bandwidth and overall performance of the TPI probe typically exceed that of the original equipment. Satisfaction is guaranteed with a ten day return privilege. TPI Specialists in probes for over 15 years.

Available from your local distributor.

TOLL FREE INFORMATION LINE

1-800-368-5719,

1-800-643-8382 in California

TEST PROBES, INC. TPI

9178 Brown Deer Road,
San Diego CA, 92121
Phone: (619) 535 9292

CIRCLE 123 ON FREE INFORMATION CARD

Sent to: 9178 Brown Deer Road, San Diego CA, 92121
 Please send full line catalog
 Name _____
 Company _____
 Address _____
 Phone: _____

APRIL 1988

33

Teaching *DirectED*

Although everything is properly hooked up, you're not ready to use *DirectED* until you teach it about your setup, or more accurately, until *DirectED* learns about your system for itself. First you must choose names for each of your VCR's, such as "Play Only" and "Main", and tell *DirectED* their formats. Then you simply tell *DirectED* to "learn VCR remote control" by making the appropriate choice from the menu.

The screen display instructs you what to do next. Basically, you insert Videonics' "Getting Started" tape into the main VCR. That tape, which is included with the system, instructs *DirectED* to send various manufacturers' STOP commands to the main VCR while watching the video output. When the video stops, *DirectED* knows which stop command works, and it can deduce the rest of the codes from that. In our tests, we used the VR-HF800 from Canon, who we would like to thank for their cooperation. The process took only a few sec-

onds, and we could then proceed to the menu choice "Checking the VCR control." *DirectED* then puts your VCR through its paces. All you have to do is to sit back and make sure that your VCR is doing what *DirectED* tells you it should be doing.

In the last setup step, *DirectED* must learn your VCR's motion characteristics, such as fast-forward and rewind speed, etc. That helps *DirectED* to be able to find scenes as quickly as possible, and to edit as accurately as possible. Once the menu choice is made, *DirectED* does all the work. When it's finished, you're ready to make your first movie.

Inside *DirectED*

The heart of *DirectED* is an NEC V40 microprocessor running at 8 MHz. (The V40 is a superset of Intel's 80188 microprocessor, which, as we saw in the R-E Robot series, is well suited for control applications.) The system program is contained in 8K of non-volatile RAM. *DirectED* contains 256K of RAM

for storage of such information as scene location, name, time, graphics, etc. To keep track of all that, timing codes are written in the vertical blanking interval of each video frame. When a scene is marked, the time code is written to RAM along with the scene's name. When your editing session is over, the contents of RAM can be written to videotape for permanent storage.

The graphics capabilities of *DirectED* are provided, in part, by Motorola's 1378 processor. Digital graphics are available with a resolution of 768 x 480, and 64 video levels are available. The circuitry provides the capability of switching between external and internal video sources pixel-by-pixel.

DirectED is not only a sophisticated consumer electronics product, it is one of the most innovative products we've seen in recent years. We congratulate Videonics for finding answers to a real problem while creating none of its own. *DirectED* is priced at \$499, and it's worth it. **R-E**



HITACHI COMPACT SERIES

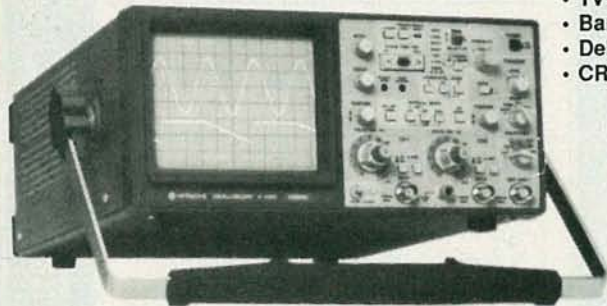

V-1065 DC to 100MHz With Cursor Readout

\$1545⁹⁵ Save \$250!

- 6" CRT with Internal Graticule
- Dual Channel X-Y Display
- Sweep Time Autoranging
- 400V High Input Voltage Protection
- TV Sync Trigger Circuit
- Bandwidth Limiter • Trigger Lock
- Delayed Sweep • Single Sweep
- CRT Readout • ±3% Accuracy

V-1060 DC to 100MHz

\$1295⁹⁵ Save \$200!

V-665 DC to 60MHz

With Cursor Readout.

\$1145. Save \$150!

V-660 DC to 60MHz

\$945⁹⁵ Save \$150!

Best Deals in Test Equipment
in USA... Ask for Bob Ladnier

Dual Channel 6" CRT Scopes

V-425 DC to 40MHz, CRT Readout
\$845. Save \$150!

V-423 DC to 40MHz, Single Time
Base Delayed Sweep

\$745. Save \$250!

V-422 DC to 40MHz, DC Offset

\$795. Save \$130!

V-225 DC to 20MHz, CRT Readout

\$720. Save \$75!

V-223 DC to 20MHz, Delayed Sweep

\$695. Save \$100!

V-222 DC to 20MHz, DC Offset

\$515. Save \$200!

V-212 DC to 20MHz

\$440. Save \$175!

Dual Channel Mini-Portable Scopes

V-509 DC to 50MHz,

Delayed Sweep

\$1195. Save \$250!

V-209 DC to 20MHz

\$822. Save \$175!

Quad Channel Multi-Function Scopes

V-1150 DC to 150MHz,

Delayed Sweep

\$2600. Save \$350!

V-1100AU DC to 100MHz,

Delayed Sweep

\$2175. Save \$315!

Digital Storage Scope

V-6020 1MHz Sampling,
Dual Channels

\$1750. Save \$200!

NTSC Waveform Monitors

V-079 6" CRT

\$1625. Save \$125!

V-099 3.5" CRT

\$950. Save \$300!

NTSC Vector Scopes

V-069 6" CRT

\$1825. Save \$125!

V-089 3.5" CRT

\$1284. Save \$400!

Instant Hard Copy!!

From Oscilloscopes

POLAROID® DS-34 CAMERA



Save \$135! **\$290.**

- 5", 6" and 7" Hoods (Available separately @ \$51 ea. Please Specify size)
- Pistol Grip For Ease of Operation
- Works on Any Make of Oscilloscope
- Three Full Year Warranty

Replacement Probes For:

Tektronix • Hewlett-Packard • Hitachi • Leader • B&K

• Philips • Kikusui • As Low as \$32.00!

Call for pricing and quantity discounts.

PROBES INCLUDED WITH ALL HITACHI
SCOPES AT NO EXTRA CHARGE!



WM. B. ALLEN SUPPLY COMPANY

ALLEN SQUARE
300 Block North Rampart Street
New Orleans Louisiana 70112

USA 800 535-9593 • LA 800 462-9520
LOCAL 504 525-8222 • FAX 504 525-6391

American Express • Visa • MasterCard • 928 pg Catalog FREE with your order

ELECTRONIC KNIGHTHOOD

A guardian for your junkbox, from your junkbox!

VICKY di ZEREGO

IF KING ARTHUR HAD HAD THIS ELECTRONIC knight to guard the kingdom, we'd still be living in Camelot, for the knight's alternately blinking red eyes would strike fear into the hearts of any invader.

Body parts

The electronic knight's body consists of the components that make up a simple 555 free-running multivibrator that drives the LED's used for the eyes (Fig. 1), with a few "extras" added for show. The torso is a 14- or 16-pin wire-wrap DIP socket that also holds the 555. The 8-pin 555 uses only half the socket; the remaining socket pins are used to support the other components.

The arm holding the staff is an old plate choke; the staff is a length of coathanger that also serves as the battery's ground connection through the choke to IC1 pin 1. The other arm is two series-connected 1-watt resistors. (The resistors' wattage ratings are selected so the components are in proportion to the rest of the body.) The resistor closest to the torso is R3, with

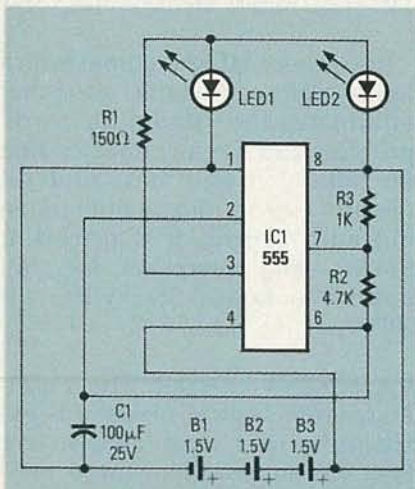
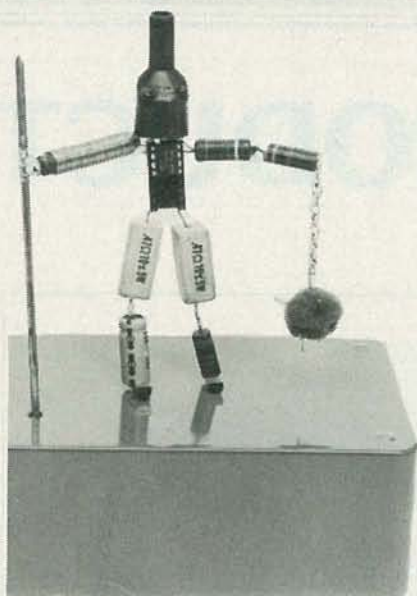

FIG. 1—THE SCHEMATIC for the electronic knight.



PARTS LIST

- R1—150 ohms, ¼ watt, 10%
- R2—4700 ohms, ¼ watt, 10%
- R3—1000 ohms, 1 watt, 10%
- C1—100- μ F, 25 volts, electrolytic
- IC1—555 timer
- LED1, LED2—Miniature red LED
- B1-B3—1.5 volt D-battery
- Miscellaneous: IC socket, parts used for body, battery holder, stand, wire, solder, etc.

its connection looped behind the resistor so that it can't be seen. The resistor connected to the chain is a dummy.

The knight's thigh's are 0.47-ohm, 5-watt wirewound resistors (effectively a short-circuit). One leg is electrolytic capacitor C1, the other leg is a 0.2-ohm, 1-watt resistor (also effectively a short-circuit) that provides B1's positive connection to the circuit. The feet are flat-sided transistors that are simply soldered in the proper location.

The knight's helmet is a black alligator-clip insulator that has been punched out for the miniature red LED's (LED1 and LED2) used for the eyes. The mace is a small ball of conductive foam with small pieces of wire stuck into it. The chain is made from small loops of No. 22 solid wire.

The electronic knight is mounted on a small plastic box containing a three D-cell battery holder. No power switch is provided because the current drain is so low that a set of batteries can blink continuously for several months before they run down. R-E

Free Famous hi-tech catalog



A very special guide to what the exciting world of computer and electronics kit-building can do for you.

The informative Heathkit Catalog shows you more than 450 exciting electronic products that will challenge, instruct, and entertain you. You'll find countless kits that you can build and enjoy, from computers and robots to color tv's and a variety of home products. And each is backed by our years of experience and our promise, "We won't let you fail!"



IBM-PC Compatible Expandable Computers



HERO® 2000 Educational Robot and Courseware



Precision Test Instruments



Electronic Keyless Doorlock



PackKit Multi-Mode TNC



Send NOW for your FREE Heathkit Catalog.

Send to: Heath Company, Dept. 020-642
Benton Harbor, Michigan 49022

Name _____

Address _____

City _____ State _____ Zip _____

A subsidiary of Zenith Electronics Corporation CL-784R3

Heathkit
Heath
Company

NEW PRODUCTS



CIRCLE 10 ON FREE INFORMATION CARD

DMM. The Simpson model 464-4 DMM is a bench digital multimeter designed to meet UL 1244 requirements. It provides true rms voltage and current readings with frequency response to 100 kHz for accurate measurements of power, control, and audio circuits. The

0.56-inch orange 3½-digit LED display makes for easy reading by the user under a wide range of ambient light conditions.

The model 464-4 is priced at \$325.00.—**Simpson Electric Company**, 853 Dundee Ave., Elgin, IL 60120.

COMMERCIAL CONNECTOR KIT.

Jensen Tools' 273-piece RS-232 commercial connector kit is designed for easy fabrication and maintenance of RS-232 cable con-

nectors. The kit includes 16 25-pin plug (male), and 6 25-pin receptacle (female) connectors; 100 each stamped and formed pins and sockets; 50 cable ties; and one insertion/extraction tool. All are contained in a sturdy, compact plastic case. Connector hoods are available separately. The kit is priced at \$69.50.—**Jensen Tools, Inc.**, 7815 S. 46th Street, Phoenix, AZ 85044.

SPEAKER/MIC. The MFJ Enterprises model MFJ-284 is designed for handheld radios. With it, you can comfortably carry your radio on

your belt without ever having to remove it to monitor calls or talk. You will never have to turn up the audio annoyingly loud to monitor calls because the model MFJ-184's lapel/pocket clip lets it be placed close to your ear for easy listening. Nor will it be necessary to remove your radio from the belt because you can conveniently take the speaker/mic in one hand, press its push-to-talk button, and simply talk.



CIRCLE 12 ON FREE INFORMATION CARD

The model MFJ-284 comes with a lightweight retractable cord that eliminates the "dangling cord" problem and has a connector that fits both Icom and Yaesu units; it features clean audio on both transmit and receive. It is priced at \$24.95.—**MFJ Enterprises, Inc.**, 921 Louisville Road, Starkville, MI 39759.

UV EPROM ERASER. The *Palm-Erase* from Logical Devices is extremely fast and can erase EPROM's in less than three minutes. Measuring 4 inches long, 2 inches wide, and 2 inches high, the *Palm Erase* is particularly suit-



CIRCLE 11 ON FREE INFORMATION CARD



CIRCLE 13 ON FREE INFORMATION CARD

ed for field service and engineering applications where space is at a premium. The product incorporates a small tray that can accommodate one 24- or 28-pin EPROM at a time.

Palm-Erase is packaged in a gray and white plastic enclosure and operates from the 117-volt AC power line. The UV bulb's intensity is 1.7 $\mu\text{w}/\text{cm}^2$, and average bulb life is rated at 3000 hours. It is priced at \$49.95.—**Logical Devices, Inc.**, 1321 N.W. 65th Place, Fort Lauderdale, FL 33309.

ANTISTATIC CLEANER. Chemtronics offers *Plast-N-Glas*, an aerosol agent that dissipates electrostatic charges on all glass and plastic surfaces while removing dirt, ink, grease, fingerprints, and nicotine stains.

The cleaner itself will not stain, smear, streak, scratch, or abrade, and offers long-lasting protection from electrostatic build-up. It is nonflammable, clear, odorless, and fast-drying.

Plast-N-Glas is available in 8 oz. and 16 oz. cans. The price of an 8 oz. can is \$3.25; a 16 oz. can costs



CIRCLE 14 ON FREE INFORMATION CARD

\$4.70.—**Chemtronics**, 681 Old Willets Path, Hauppauge, NY 11788.

MOUNTED ANTENNA. Electron Processing, Inc., announces the *VAK-TENNA*, which mounts to glass or any other smooth surface with suction cups; it is designed to provide a means of mounting an antenna where drilling holes is not possible. The antenna can be installed or removed in minutes without leaving any marks, and no



CIRCLE 15 ON FREE INFORMATION CARD

tools are required for either operation. Vertical or horizontal configurations can be used as desired.

The *VAK-TENNA* covers 30–500

Immediate Delivery

DMM's at SALE PRICES!

3 1/2 DIGIT 3200 COUNT ANALOG/DIGITAL MULTIMETERS

Model 73
Value Leader-World's Most Popular DMM-Autoranging
\$69 reg. \$79

Model 75
Autoranging + Range Hold Audible Continuity Function
\$105 reg. \$119

Model 77
Touch-Hold Feature + Features of Model 75
\$129 reg. \$149

Model 37
Bench/Portable, 0.1 VDC Accuracy 10 A. Range 2 yr. Warranty
\$219 reg. \$249

40th Year Anniversary Sale

Model 77
Model 8021B

3 YEAR WARRANTY

3 1/2 DIGIT HIGH-ACCURACY HAND HELD

Model 8021B
0.25% DC Accuracy, Audible Continuity Function
\$159 reg. \$179

Model 8020B
0.1% DC Accuracy, Audible Continuity & Conductance Function
\$189 reg. \$219

Model 8024B
0.1% DC Accuracy, 11 Functions Peak Hold, Temperature
\$225 reg. \$259

Model 8026B
0.1% DC Accuracy True RMS AC Volts & Current
\$199 reg. \$229

FREE SHIPPING!
FREE SHIPPING ON FLUKE TO UPS SHIPPABLE DESTINATION.

4 1/2 DIGIT TRUE RMS HAND HELD

Model 8060A
Measures True RMS AC Volts & Amps, dB + Frequency From 12 Hz to 200 kHz, Resistance to 300 M
\$325 reg. \$369

Model 8062A
Same as 8060A, but Less Frequency & dB
\$265 reg. \$299

Model 8060A
1 YEAR WARRANTY

TRUE RMS BENCH DMMs

Model 8010A
3 1/2 Digit 10 AMP Range
\$259 reg. \$299

Model 8010A-01
With Rechargeable Battery
\$299 reg. \$339

Model 8012A
3 1/2 Digit Two Low Ranges
\$319 reg. \$359

Model 8012A-01
With Rechargeable Battery
\$355 reg. \$399

Model 8050A
4 1/2 Digit Relative Ref. Function 0.03% DC Accuracy
\$355 reg. \$399

Model 8050A-01
With Rechargeable Battery
\$389 reg. \$439

*True RMS AC TO 50/ KHz *Conductance Function Checks High Resistance

Send for FREE 480 page "Industrial Products Catalog". I understand it is FREE with any order or if requested on company letterhead. (Otherwise, \$4.95 to cover catalog and shipping costs.)

ORDER TOLL FREE
1-800-323-5925
IN ILLINOIS
312-297-4200
SINCE 1947

Joseph Electronics

JOSEPH ELECTRONICS, INC.
8830 N. Milwaukee Ave. Dept. R
Niles, IL 60648

Rush merchandise per attached order. I understand rated accounts are shipped open account; otherwise send per credit card.

Visa Master Card Discover
 Check Money Order Rush Catalog

Card No. _____ Exp. Date _____

Name _____
Company _____
Street Address _____
City _____ State _____ Zip _____

IL Res. 7% Tax

MHz for receive and from 50–250 MHz for transmission and is rated to 50 watts. Two telescoping elements extend to a full 79 inches, yet collapse to 20 inches, and can be folded to 12 inches for storage or transport. A 15-foot 50-ohm RG-58 cable is provided for connection to the radio equipment. Standard connectors are either PL-259, BNC, Motorola, or F; other connectors are available on special order. Pricing of the VAK-TEN-NA starts at \$29.95.—**Electron**

Processing, Inc., P.O. Box 708, Medford, NY 11763.

TOOL KIT. HMC offers the Gemini Series model 71A376, tool kit, which contains a complete complement of tools required for the repair and maintenance of computers, office machines, telecom and datacom electronics, aerospace navigation, and radar equipment. Quality, name-brand tools are placed inside a 6½-inch aluminum case in a way that allows



CIRCLE 16 ON FREE INFORMATION CARD

quick and easy identification and access.

The case comes complete with two removable pallets that hold tools securely in place. A literature pocket is attached to the back of the lid pallet.

The model 71A376 is priced at \$540.00.—**Hub Material Company**, 33 Springdale Avenue, Canton MA 02021.

ARTWORK SYSTEM. Bishop Graphics has introduced a new surface-mount technology (SMT) artwork system to help circuit designers lay out and create artwork for that new, rapidly growing technology.

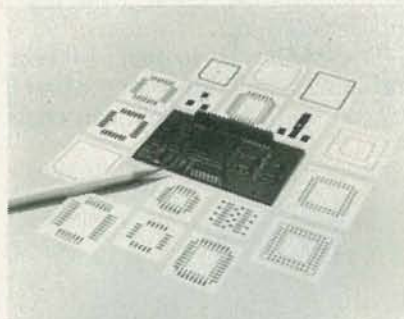

CIRCLE 17 ON FREE INFORMATION CARD

The new artwork system includes 30 lines/inch resolution layout grids, component land patterns that conform to IPC-SM-72 design guidelines, corresponding silkscreen symbols that also serve as component-placement aids, special-size artwork tapes, and SMT design layout templates in both 2× and 4× scale.

continued on page 42



CABLE TV SPECIALS

CONVERTERS



	JRX-3 DIC—36 Channel Corded Remote ...	\$129.95
	JSX-3 DIC—36 Channel Set Top	\$129.95
	SB-3 — 'The Real Thing'	\$109.95
	SB-M-Refurbished	\$89.95
	DRZ-3D1C—68 Channel Wireless with Decoder	\$199.95
ZENITH:	Z-TAC Cable Add-On	\$189.95
VIEW STAR:	EVSC-2010—60 Channel Wireless— with Parental Lockout	\$ 99.95
	EVSC-2010 A-B—Same as above with A-B Switch	\$109.95
	View Star 2501—60 Channel Wireless	
	with Volume	\$119.95
	Unika MR-702—72 Channel Wireless with Parental Lockout	\$89.95

MISCELLANEOUS

OAK:	N-12 Mini-Code	\$ 89.95
	N-12 Mini-Code Vari-Sync	\$99.95
	N-12 Mini-Code Vari-Sync Plus Auto On-Off ..	\$149.95
OAK:	Sine-wave Anti-Jammer Kit	49.95
JERROLD:	400 & 450 Handheld Transmitters	\$ 29.95
HAMLIN:	MLD-1200	\$ 99.95
NEW ITEMS:	Ripco Tape Copy Stabilizer	\$109.95
	Scientific Atlanta SA-3	\$129.95
GENERAL INSTRUMENTS:	VCU Amplified Video Switch Signal Amplifier	\$59.95

ALL UNITS GUARANTEED. QUANTITY PRICES AVAILABLE.

UNITED ELECTRONIC SUPPLY

P.O. BOX 1206 • ELGIN, ILLINOIS 60121 • 312-697-0600

CIRCLE 185 ON FREE INFORMATION CARD

Discover—Explore—Experience
Today's Electronics With ...

McGraw-Hill's Contemporary Electronics Series

Now you can meet the challenges of today's electronics quickly and easily. This professional level learning series is as innovative as the circuitry it explains and as fascinating as the experiments you build and explore! And it's for anyone who has an interest in electronics... from the hobbyist to the professional.

Thousands Have Already Experienced the Excitement!

Today's high-tech world demands an entirely new and innovative approach to understanding electronics. That's why McGraw-Hill has developed this unique "hands-on" learning method that brings to life the dynamics of the new electronics. It's a unique combination of interactive materials that gets you involved as you build and experiment with today's latest electronic circuitry.

Just how well this innovative learning approach meets the challenge of the new electronics is confirmed by those who have already completed the Series... "You have put me right into the middle of an extraordinary learning experience. With each lab exercise I have gained a new understanding of the intricacies of today's electronics." Or... "For me, the Series was just the answer. I felt confident within my specialty, but my grasp of other areas of electronics was slipping away. Your Series helped me upgrade my knowledge of the latest electronics concepts." Or this from a company director of training... "We manufacture sophisticated electronic products, with a lot of people in sales, assembly and purchasing. McGraw-Hill has answered a real need in helping our employees see the total picture. They now communicate with customers and each other more effectively."

Your Involvement in the New Electronics Begins Immediately.

You master one subject at a time with 15 McGraw-Hill *Concept Modules*, sent to you one

every 4 to 6 weeks. You waste no time on extraneous materials or outdated history. It's an entertaining, lively, nontraditional approach to the most modern of subject matter.

Your very first module takes you right to the heart of basic circuit concepts and gets you ready to use integrated circuits to build a digital oscillator. Then, you'll verify the operation of different electronic circuits using a light emitting diode (LED).

And each successive module brings you up to speed quickly, clarifying the latest advances in today's electronics... from digital logic and microprocessors to data communications, robotics, lasers, fiber optics, and more.

Unique Combination of Interactive Instruction Materials Makes Learning Easy.

Laboratory experiments, vividly illustrated text and interactive cassette tapes all blend together to give you a clear, simplified understanding of contemporary electronics.

With each module, you receive a McGraw-Hill *Action-Audio Cassette* that brings to life the facts and makes you feel as if you're participating in a lively dialogue with experts.

Your ability to quickly make this knowledge your own is further aided by strikingly *illustrated* texts that use diagrams, explanations, illustrations, and schematics to drive home and rein-

force the meaning of each important point. Carefully indexed binders conveniently house all this material, as well as the instructions that will guide you through your "hands-on" lab experiments.

Throughout your Series, *laboratory experiments* reinforce every significant concept. With this essential "hands-on" experience using actual electronic components, you master principles that apply all the way up to tomorrow's VLSI (Very Large Scale Integrated) circuitry.

Discover, Explore, Experience for Yourself—15-Day Trial.

In all ways, the Contemporary Electronics Series is an exciting learning experience that offers you the quickest and least expensive method available to master today's electronics... and the only one with "hands-on" experience.

To order your first module for a 15-day

trial examination, simply complete the card and send today! If the card is missing, write to us for ordering information.



McGraw-Hill
Continuing
Education Center

3939 Wisconsin Avenue, NW
Washington, DC 20016



With your first module, you'll build this solderless breadboarding system. As you add additional boards, you create increasingly complex circuits easily and quickly, bringing today's electronics concepts to life.

Our guaranteed savings plan.



Fluke 70 Series Analog/Digital multimeters are like money in the bank. Buy one, and you're guaranteed to save both time and money.

Money, because you get longer battery life and longer warranty coverage — 3 years vs. 1 year or less on others.

And time, because 70 Series meters are easier to operate and have more automatic measurement features.

So before buying any meter, look beyond the sticker price. And take a closer look at the new low-priced \$79 Fluke 73, the \$119 Fluke 75, and the deluxe \$149 Fluke 77. In the long run, they'll cost less, and give higher performance, too.

And that, you can bank on.

For a free brochure, and your nearest distributor, call toll-free **1-800-44-FLUKE, ext. 33.**

FROM THE WORLD LEADER
IN DIGITAL MULTIMETERS.



© 1985 Fluke, Ad No. 1271-F70

CIRCLE 121 ON FREE INFORMATION CARD

The new surface-mount component land patterns have via pads connected to each land area to simplify integrating designs into a through-hole environment. The patterns are designed to fit on a .050-inch grid to facilitate PCB bare-board testing, and allow maximum component density and trace routing.

Pricing for Bishop's SMT artwork products range from \$2.05 for SMT tapes to \$76.00 for a 36" by 48-inch grid pattern.—**Bishop Graphics, Inc.**, 5388 Sterling Center Drive, Westlake Village, CA 91359.

DESOLDERING HAND PUMPS.

A.P.E. Corporation offers two manual desoldering hand pumps, the model *DP-4* and the model *DP-5*. Both models come with conductive tips to protect even the most delicate components from static damage. The pump system has been designed to minimize recoil, thus protecting circuitry from mechanical damage.



CIRCLE 18 ON FREE INFORMATION CARD

Those pumps are self-cleaning in each operation, have a bayonet twist for quick disassembly, and a fully enclosed plunger shaft for operator safety.

The model *DP-4* is priced at \$13.95. The model *DP-5* is the same as the *DP-4*, but is completely conductive and antistatic; it is priced at \$14.25.—**A. P. E. Corporation**, 142 Peconic Ave., Medford, NY 11763.

20-MHZ OSCILLOSCOPE. Leader Instruments' model *1020* has an ergonomic front panel that makes

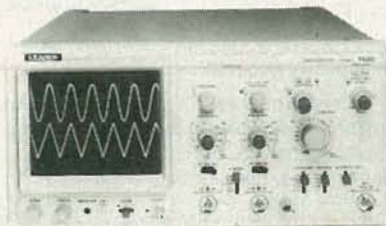

CIRCLE 19 ON FREE INFORMATION CARD

operation simple and straightforward, while offering comprehensive triggering controls, which include channel triggering, variable trigger hold-off, TV-sync separators, and line triggering.

With 0.5-mV sensitivity, very low-level signals can be observed on the unit's 8 × 10-cm rectangular CRT. An internal graticule, auto focus, and scale illumination are also standard features. The model *1020* is priced at \$595.00.—**Leader Instruments Corporation**, 380 Oser Avenue, Hauppauge, NY 11788.

SOLDERING IRON.

Weller offers the *Pyropen*, a cordless LP-gas catalytic soldering iron, torch, and hot-air gun. It is designed for field and service jobs, and in the electrical and communications industries, when electricity is not available. The multi-purpose tool can be used as a heat gun to shrink tubing, connect vinyl-chloride pipes and dry glues; as a soldering iron; and as a torch to braze copper and other metals.

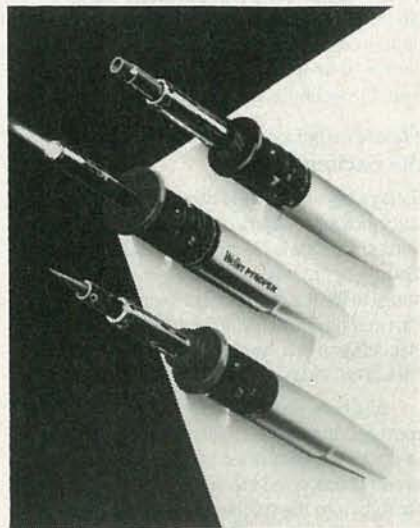

CIRCLE 20 ON FREE INFORMATION CARD

The handle of the 9 $\frac{5}{8}$ -inch long tool serves as the gas container, and holds enough LP gas for about a three-hour operation. It only takes a few seconds to refill the container.

A control lever that regulates the gas volume changes the tip temperature when soldering, and flame length when being used as a torch. When it's used as a heat gun, the gas-catalyst reaction system converts the flame to hot air. Fingertip action operates the gas

open/close lever and controls the volume of gas. By regulating the setting of the main valve, temperature control of the iron has a range of 392°F to 932°F.

The Weller *Pyropen* is priced at \$59.95.—**The Cooper Group**, P. O. Box 728, Apex, NC 27502.

RF POWER METER. The model 4421 RF power meter, from Bird Electronic Corporation, is a programmable, microprocessor-based instrument that measures forward and reflected RF power, VSWR, and return loss in watts or dBm to 1 GHz and 1 kW. Its accuracy is plus or minus 3%-of-reading. There is also a 4020-series remote sensor head based on Bird's "ThruLine" principles for in-line unterminated measurement to 1 kW without the need for directional couplers or attenuators.

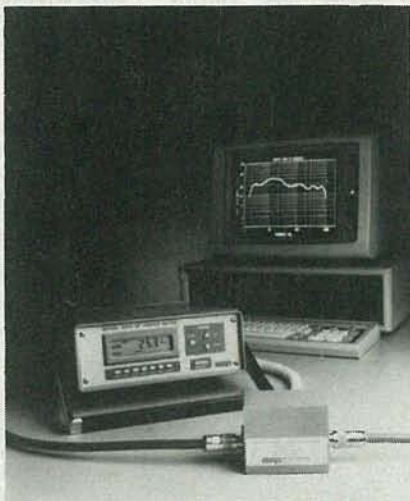

CIRCLE 21 ON FREE INFORMATION CARD

The model 4421 display unit features a backlit 3½-digit LCD display with annunciators for function and input trends; arrow indicators facilitate peak or null adjustments by showing at a glance whether a reading is increasing or decreasing. It also includes an audible alarm to warn of overloads in excess of 120% of the selected range.

The model 4421 is priced in the \$2,000–\$3,000 range, depending on accessories.—**Bird Electronic Corporation**, 30303 Aurora Road, Cleveland (Solon), OH 44139.

COAXIAL WIRE STRIPPER. Paladin Corporation's *Toggle* uses a new blade system whereby the field technician, service person, or in-



CIRCLE 22 ON FREE INFORMATION CARD

staller can quickly, accurately, and repeatedly strip braid and di-

electric off coax cable in any number of strip configurations for any type of coax connectors.

Toggle is available in sizes suited for cables up to and including RG8/11. That includes the most popular cable groups of RG59, RA62AU, RG6, and 8281 video cable. Custom sizes can be accommodated upon request. *Toggle* is priced at \$24.95 each.—**Paladin Corporation**, 3543 Old Conejo Road, Suite 102, Newbury Park, CA 91320. **R-E**

POMONA still leads the way in test technology.

For over 35 years POMONA has proven its leadership position on the cutting edge of test technology. For example, we have created innovative solutions to the challenge of advanced ultra-miniaturized electronic components such as surface-mount devices. This sort of inspired dedication is another reason why the industry depends on POMONA.

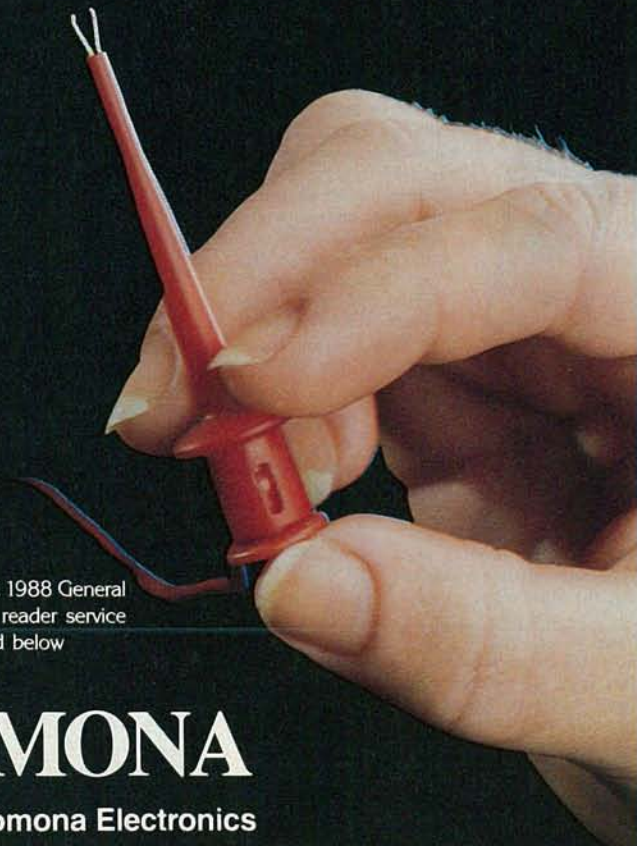

For your FREE 1988 General Catalog, circle reader service number printed below

POMONA
ITT Pomona Electronics

CIRCLE 101 ON FREE INFORMATION CARD



\$75 DMM MEASURES CAPACITANCE, TRANSISTOR HFE, MORE...

B&K-PRECISION'S new 2905 is a more-than-full-feature 3½ digit DMM, at a surprisingly low price. Features include 0.5% VDC accuracy; 100 µV, 0.1µA, 0.1Ω resolution. Measures capacitance to 20mF with up to 1pF resolution. Audible continuity and diode junction tests are built in. For field survivability, it features a drop resistant case, reverse polarity and overload protection and high-energy fusing. Contact: B&K-PRECISION, 6470 W. Cortland Street, Chicago, IL 60635 (312) 889-9087.

B&K-PRECISION'S new 2905 is a more-than-full-feature 3½ digit DMM, at a surprisingly low price. Features include 0.5% VDC accuracy; 100 µV, 0.1µA, 0.1Ω resolution. Measures capacitance to 20mF with up to 1pF resolution. Audible continuity and diode junction tests are built in. For field survivability, it features a drop resistant case, reverse polarity and overload protection and high-energy fusing. Contact: B&K-PRECISION, 6470 W. Cortland Street, Chicago, IL 60635 (312) 889-9087.

*RT
Check out
these features
& prices. wow!
FL*

4½ DIGIT TRMS DMM READS FREQUENCY AND TEMPERATURE

The new 2945 is well suited for both the analog and digital worlds. DCV accuracy is 0.05%, with 10µV, 10nA, 0.01Ω resolution. Data hold freezes voltage and current readings. °C and °F temperature readings are from -20° to +1000°C; frequency from 20 Hz to 200kHz. AC voltage and current are read in true RMS. Also checks continuity and diodes. \$250.00 Contact: B&K-PRECISION, 6470 W. Cortland Street, Chicago, IL 60635 (312) 889-9087.



FREQUENCY COUNTER AND DATA HOLD HIGHLIGHT NEW 4½ DIGIT DMM

For engineers in need of a high-accuracy 4½ digit DMM and a low range frequency counter the 2940 is made to order. DC voltage accuracy is 0.05%. Resolution is 10µV, 10nA, and 0.01Ω. Frequency measurements span from 20Hz to 200kHz with up to 1Hz resolution. The 2940 features a drop resistant case with full internal circuitry protection. \$155.00 Contact: B&K-PRECISION, 6470 W. Cortland Street, Chicago, IL 60635 (312) 889-9087.



HAND-HELD TEST BENCH READS VOLTAGE, RESISTANCE, CURRENT, HFE TEMPERATURE AND LOGIC.

The new 2906 3½ digit DMM from B&K-PRECISION is virtually a hand-held test bench, with a remarkable range of functions. °C and °F temperature measurements cover from -20C to 1000°C. The logic capability is ready for TTL and CMOS circuits. Other features include drop resistant case, reverse polarity and overload protection; plus high-energy fusing. DC accuracy, 0.25% VDC. \$95.00 Contact: B&K-PRECISION, 6470 W. Cortland Street, Chicago, IL 60635 (312) 889-9087.



TRUE RMS DMM OFFERS PEAK HOLD, CAPACITANCE, AND LOGIC

3½ digit true RMS handheld DMM featuring 0.1% DC accuracy. Housed in an ergonomic, drop-resistant case, the 2907 offers many functions and a low price. Resolution is 100µV, 0.1µA and 0.1Ω. Capacitance to 20µF with 1pF resolution. Peak hold feature freezes transient readings. Fully protected. Also checks logic, continuity and diodes. \$190. Contact: B&K-PRECISION, 6470 W. Cortland Street, Chicago, IL 60635 (312) 889-9087.



THE BEST DMM BUY? NOW IT'S B&K-PRECISION

- ✓ Better specs
- ✓ Lower prices
- ✓ More features
- ✓ More capabilities
- ✓ More circuit and safety protection
- ✓ Ruggedized case with safety test leads

Five all-new models step ahead of the competition with better specs and higher performance per dollar. We've also packed more features than ever into every model.

All five instruments measure voltage, current and resistance, check continuity and diodes, and feature a new ergonomic case with angled LCD readout. Depending on model, additional capabilities include logic level, capacitance measurement, transistor gain, true RMS, frequency measurement, high-current measurement, data hold, peak hold and even temperature.

Like all B&K-PRECISION instruments, these new meters are made for the real world. They offer a drop-resistant case and the triple protection of reverse polarity protection, overload protection, and high-energy fusing.

Best of all, the B&K-PRECISION DMM you want is already in stock at your local distributor. Call today for full details.



BK PRECISION

MAXTEC INTERNATIONAL CORP.
6470 West Cortland St. • Chicago, IL 60635 • 312-889-9087

International Sales, 6470 W. Cortland St., Chicago, IL 60635

Canadian Sales, Atlas Electronics, Ontario
South and Central American Sales, Empire Exporters, Plainview, NY 11803

CIRCLE 77 ON FREE INFORMATION CARD

BUILD THIS

Radio- Electronics Surround Sound Decoder

AS STARFLEET COMMANDER, YOUR STARFIGHTER HAS the latest in weaponry. From above and behind you hear the dull *thwup-thwup* of the laser pom-poms as the ball-turret tracks the incoming enemy spacefighters, whose energy bolts *zing* past your ship into the void behind. From your ship's right and left energy pods the phasor cannons fire a staccato stream whose roar fades off into a darkness that can be seen only by your ship's time-transporter.

But turn off the sound effects and once more the indefatigable starfleet commander is just another viewer in a movie theater. Without the imagery created by multi-directional sound—what we call *surround-sound*—even the most thrilling sci-fi adventure flick is not much better than an “olde-tyme” silent movie.

Just try to imagine *Star Wars* or *Top Gun* without surround-sound: They would be deadly dull. In fact, the lack of video-movie surround-sound is what turns many of the great action movies into a dull night at home on TV.

Surround-sound brings scenes to life by wrapping you in a sound environment that's as good as being there. If the picture is a forest, you become surrounded by wind and wildlife. In auto chases, cars roar out of the back of the room and onto the screen. In crowd scenes, you actually sense yourself in the center of the crowd. Surround-sound creates such a sensation of being there, that once you hear it, you'll lose interest in video and movies without it.

This month, we'll show you how to build a low-cost surround decoder. Next time, we'll show you how to add even more excitement to your TV sound with a subwoofer simulator.

Concealed sounds

Every modern home video-movie now contains high-fidelity stereo tracks, which are output on the back panel of a modern VCR as left and right channels. When connected to a stereo system, they provide a *wide-screen* (semi-stereo) sound rather than the mono heard from a conventional TV or video monitor.

But *wide screen*, even genuine stereo, isn't surround-sound because it's still two-dimensional. The three-dimensional effect of surround-sound requires, at the very least, a rear channel, which might be provided by one or

*Add some excitement
to your TV viewing!
Our easy-to-build
surround-sound decoder
brings movie-theatre sound
to your living room.*

NORMAN M. HILL

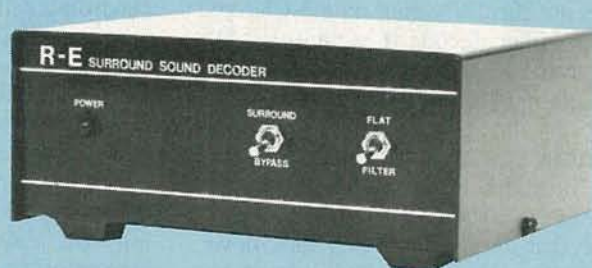

more additional sound tracks in the original theatrical release print; or, the rear sounds can be encoded within the stereo tracks. As far as home videos are concerned, there is only the stereo tracks, so the rear channel that creates the illusion of surround-sound is concealed by a special encoding within the left and right sound tracks. The encoded signals either blend into the front stereo channels or cancel each other; either way, they are not heard as distinct sounds when the sound you hear is played through a conventional stereo system.

It takes a special kind of decoder, such as our surround-sound decoder, to extract the rear sounds from the stereo signal, and it is the decoded rear sounds that cause the home viewer to be enveloped by a surround-sound that is very similar to what is heard in a movie theater.

Broadcast movies

What happens if the movie is broadcast by a TV station? The same thing, but only if the station is broadcasting MTS stereo. If you decode the MTS stereo signal you will again derive the rear audio channel. If you record the TV signal on a VCR, you can either decode the station's MTS stereo, or have the VCR do the stereo decoding (if it is so equipped).

Dolby

Surround-sound is brought to you by Dolby Laboratories, the same people that developed Dolby tape-noise reduction. A form of Dolby noise reduction is part of their surround-sound record/play system, and Dolby owns the rights to the surround-sound technique. Our decoder however does not include Dolby noise reduction yet it still produces good results.

How it began

The early 1970's saw the development of a patented technique of encoding four channels into two stereo tracks. When decoded, the stereo signal produced four distinct outputs. By adjusting the phasing and relative levels of the signals blended into the stereo tracks, it was possible, by using the speaker placement shown in Fig. 1, to create the illusion of sound coming from the front, the sides, or the rear. Effectively, the sound could be located anywhere within a 360° field.

The technique was later modified so that a conventional stereo-front/

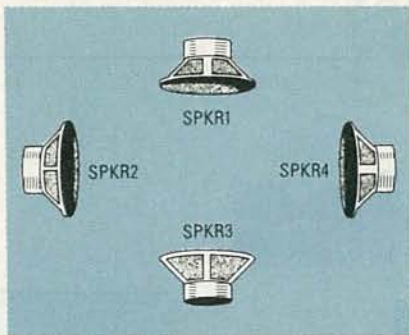

FIG. 1—THE EARLIEST OF MULTI-DIRECTIONAL sound systems used this unusual speaker arrangement, which foreclosed true stereo listening.

stereo-rear speaker placement could be used; that is, left and right speakers in front of the listener and left and right speakers behind the listener. Unfortunately, the stereo-type technique eliminated wide stereo separation. In fact, left-to-right and front-to-rear separation was often reduced to as little as 3 dB. Since 3 dB is the *minimum* change in *program material* that can be sensed by the human ear, electronic enhancement of 4-channel sound was necessary in order to create the spectacular effects expected by the listener. Basically, it was done by electronic gain-riding. A monitor circuit determined which sound position (location) was dominant and adjusted the gain of the various channels so that the listener would perceive a stronger signal at that position. As a general rule, the electronic enhancement added 3 dB to the already existing 3-dB separation. The total of 6-dB separation was sufficient to trick the brain into believing it was sensing a precise sound location.

For various reasons, among them being the extra cost of the rear amplifiers and speakers, and the eventual deployment of several kinds of encode/decode circuits, 4-channel sound, usually referred to as *quadraphonic* or *quadriphonic* sound, met with little success in the marketplace. But it did establish that a multi-directional sound could be encoded within conventional stereo tracks.

About that time, the movie industry was searching for a blockbuster technology that would bring in more patrons; something more attractive than just another form of wide-screen projection. The blockbuster was to be Dolby Stereo.

Dolby Stereo

The Dolby Stereo system was intro-

duced for movie theaters in 1975. Under that system, 35-mm film carries two stereo tracks, and uses quadraphonic weighting to encode/decode the stereo signal into four outputs.

However, the need in a theater is not for 360° quadraphonic coverage. A theater needs only a single rear track to generate spectacular effects. There is no need for side sound because the primary sound placement is almost always on the screen, which is in front of the viewer. The needed speaker arrangement is shown in Fig. 2.

Unfortunately, that's far from a complete solution because the limited 3-dB channel separation of movie surround-sound is a real problem for all but the good seats at the center. Seats close to the rear will be swamped by the 3-dB leakage from front left and front right. Up front, better separation

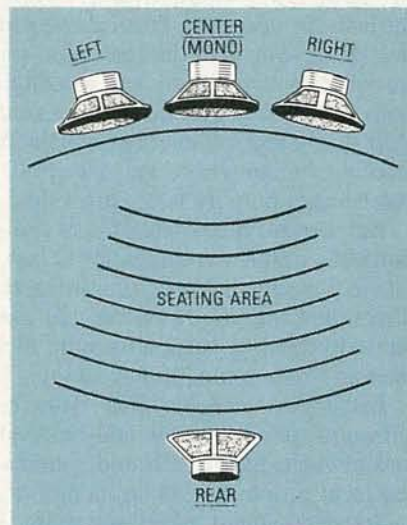

FIG. 2—THIS IS THE SPEAKER ARRANGEMENT for movie-theater surround-sound. Notice that a center speaker provides direct mono, rather than a mono image that's derived from left and right speakers.

is also desired so that audio sources track with the image on screen.

For those reasons, the quadraphonic concept of gain-control positioning of the dominant audio direction was incorporated into Dolby Stereo, and the smashing 1977 success of the Dolby-Stereo encoded *Star Wars* entrenched the system as the industry standard.

The gain-control circuitry is a serious complication, necessary to make all the seats in the house good ones. Home decoders loaded with such circuitry, such as the Shure HTS5000 are available for around \$750. Units that incorporate gain

control are identified by the *Dolby Surround Pro Logic* logo.

The Dolby home decoder

In 1981, Dolby Labs acknowledged a need for a low-cost, no-gain-control decoder for home video and recommended an appropriate circuit. Decoders without gain-control carry the *Dolby Surround* logo.

Those lower-cost units are available from various licensed manufacturers for \$200-\$400, and to carry the *Dolby Surround* logo they must process audio according to the block diagram shown in Fig. 3.

Dolby's decoder.

All processing is performed on the (L-R) difference signal, which is concealed within the left and right stereo tracks. While only a single rear-channel is decoded, it is intended that two speakers will be positioned at the rear of the room, hence, the rear output is shown as REAR LEFT and REAR RIGHT, even though they both carry the same signal. Two traditional stereo speakers provide the front sound.

As shown in Fig. 3, Dolby restricts the rear channel's high-end frequency response to 7 kHz. When the standard was being developed, the high-frequency coherence between the two channels of home-video equipment wasn't consistent. Directional placement could become random if high-frequency phase-coherence were to be lost on a wide-band signal; for example, an actor's voice might be reproduced with the lower frequencies from the front and the sibilants from the rear. However, the likelihood of that happening depends on the equipment used for recording and playback. While some tapes sound better

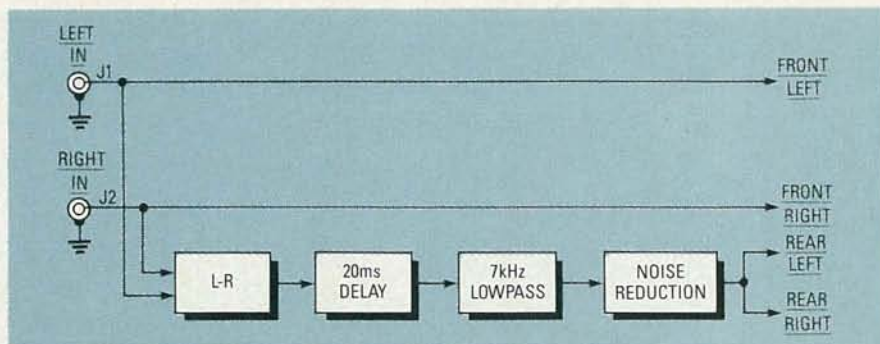

FIG. 3—DOLBY'S RECOMMENDED HOME DECODER includes a 20-ms delay and a noise-reduction system.

with a rear filter, many tapes and the equipment they are played on have cohered high-frequency phase performance, and they sound better—at least more natural—without the filter. If you're finicky about sound quality, the 7-kHz cut-off should be switch selectable so that you can enjoy the best in sound when the tape and equipment make it possible.

Notice that Fig. 3 indicates a 20-ms time delay. The delay serves two purposes. First, since 20 ms represents the time it takes the sound to travel about 20 feet, it allows the rear speakers to be positioned close to the seating, yet the sound appears to originate from farther back, more closely simulating theater sound, where the rear speakers are located considerably behind the viewer. The time delay also proves useful when there is accidental leakage of the front-left or front-right sound to the rear. Since the 20-ms delay causes the sound to arrive after the front sound, it reinforces the perception that the sound is up front.

Fortunately, the positioning of home rear speakers can usually be juggled so that the delay isn't really necessary, which simplifies con-

struction of a home decoder, reduces its cost, and also eliminates the noise and distortion that might be caused by a delay unit.

Noise reduction

In the Dolby system shown in Fig. 3, the rear-channel information is supposed to be encoded with a noise-reduction that is similar to the *Dolby B* processor used for cassette recorders. Listening tests and inspection of a frequency/gain table indicate that we could probably do without it as far as surround-sound is concerned, so we left it out of the prototype.

Note, in particular, that Fig. 3 does not show signal processing to the front speakers: Differential signals driving the rear speakers pass to the front unchecked. If we add some of each front channel to the other, we attenuate to the leakage of the rear signals while reducing the front stereo separation. The reduction in separation is desirable because it helps viewers in off-center seats hear a stereo spread without resorting to a center channel. (Note the center mono speaker used in the movie system shown in Fig. 2.)

WHICH IS WHICH?

The type of circuits used in a home *Dolby Surround* decoder is identified by the kind of *Dolby* logo used. If the decoder contains both 20-ms time delay and noise reduction circuits it is called a *PRO LOGIC* model and has this logo shown.

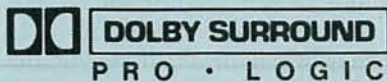

If the decoder is the less expensive design that does not contain time delay and noise reduction circuits, it is identified by this *Dolby* logo.

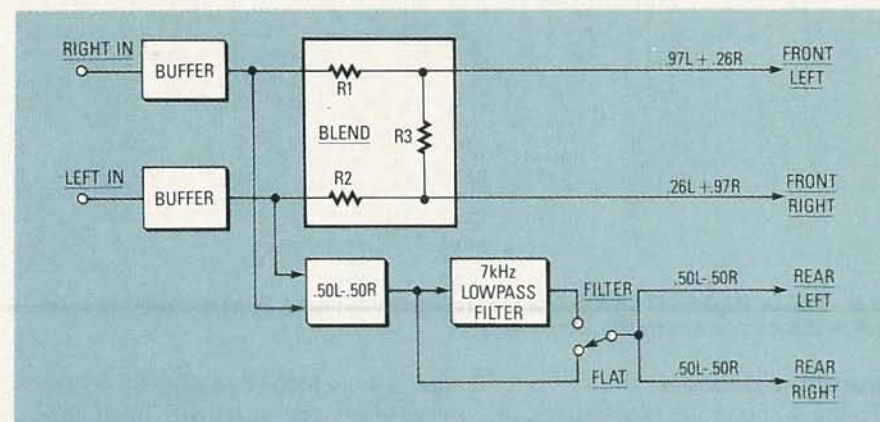
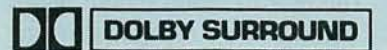

FIG. 4—OUR SURROUND-SOUND DECODER ELIMINATES both the time delay and the noise reduction, which doesn't seem to degrade how the three-dimensional effect sounds in the home.

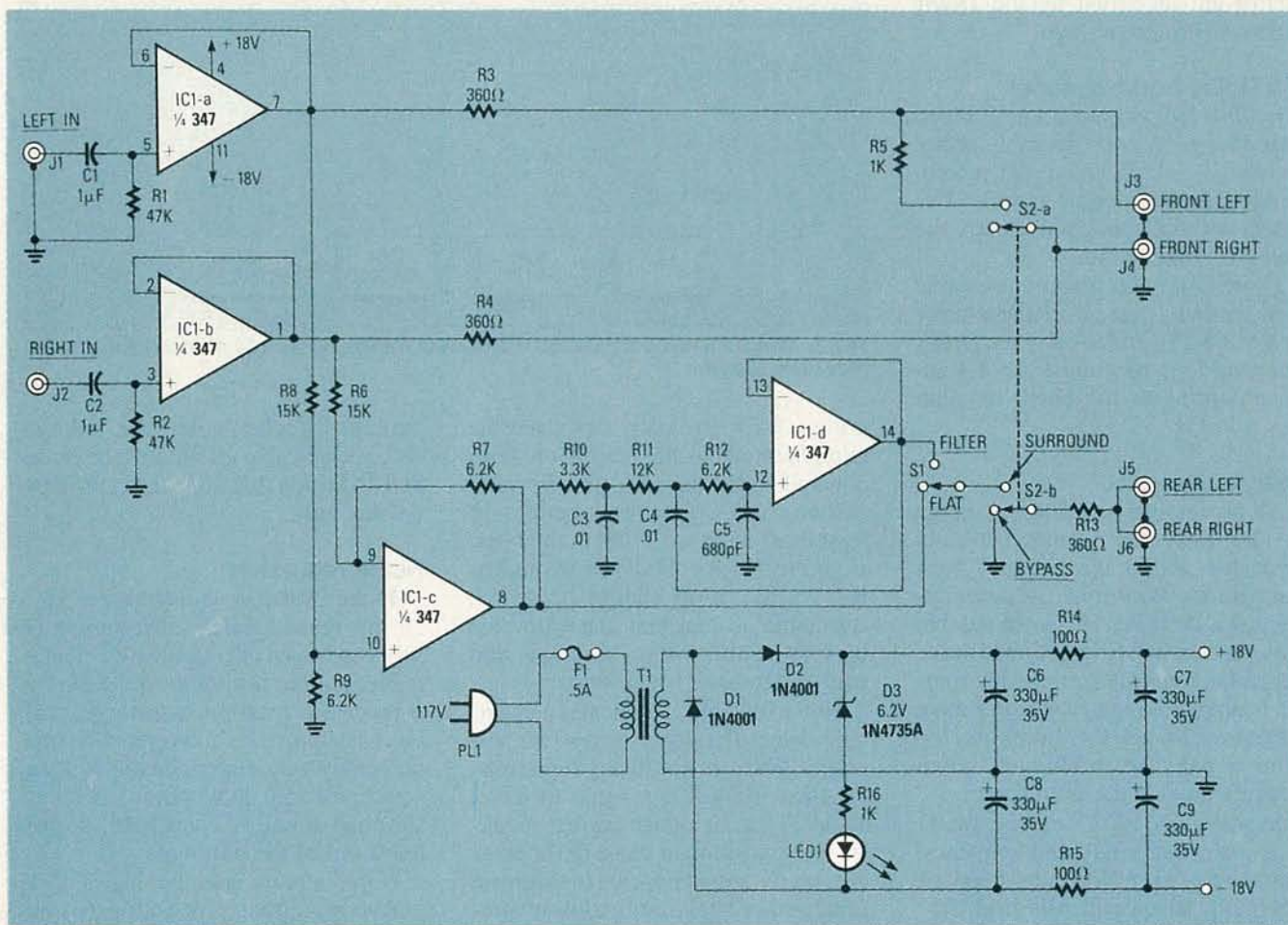

FIG. 5—THE DECODER'S CIRCUIT. Virtually nothing is critical because R3 and R4 isolate the buffer amplifiers from the capacitance of the shielded cables connected to J3 and J4.

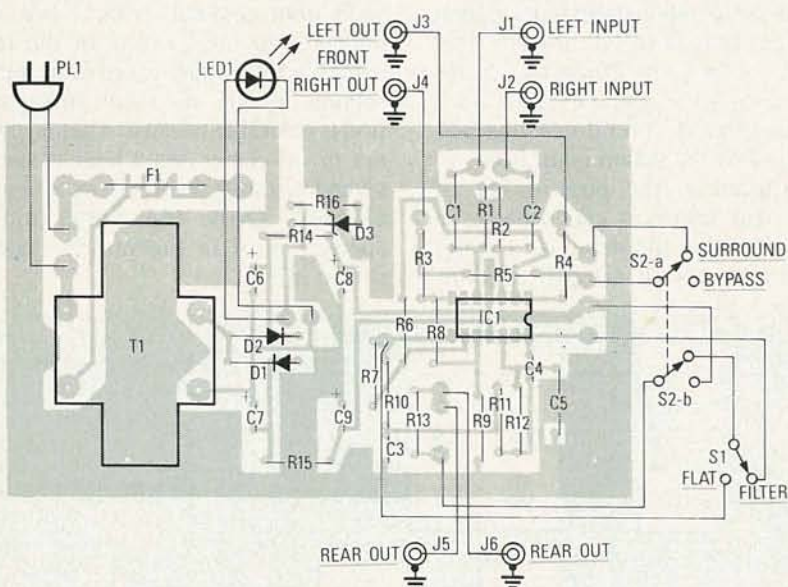

FIG. 6—THE COMPONENT LAYOUT for the printed circuit board. Double-check the polarity of all diodes and electrolytic capacitors.

A surround decoder

Figure 4 shows the block diagram for our surround-sound decoder. It consists of input buffers, a front blender, a rear difference decoder,

and a switchable low-pass filter. The rear levels are such that, if all four speakers are identical, and the driving amps have identical gain, the system would be balanced for proper level

with no need for level adjustments. In practice, however, the rear speakers are different and the level is adjusted on the rear amplifier.

If any one speaker sounds at full volume, the other two sound half as loud (-6 dB), 1/4-power. A separation of 6 dB is a lot better than the 3-dB separation of a four-channel system, and such a decoder is easier to build than a "true" Dolby type, yet it sounds as good or better when it is fed from a Dolby surround-sound signal source.

Notice that the system actually puts out only three sound channels (the rear-right and rear-left are the same); it does not use a 20-ms delay, nor noise reduction, and although it lacks any form of gain control, the separation between channels is maximized.

In a typical home environment, the front speakers should just about flank the screen, because we want the sound to appear to originate up front, at the screen, just as it does in a theater. The rear speakers should be located behind and flanking the seating location of the viewer.

PARTS LIST

All resistors are 1/4-watt, 5%.

R1, R2—47,000 ohms
 R3, R4, R13—360 ohms
 R5, R16—1000 ohms
 R6, R8—15,000 ohms
 R7, R9, R12—6200 ohms
 R10—3300 ohms
 R11—12,000 ohms
 R14, R15—100 ohms

Capacitors

C1, C2—1 μ F, 100 volts, polyester
 C3, C4—.01 μ F, 50 volts, polyester
 C5—680 pF, polyester
 C6—C9—330 μ F, 35 volts, electrolytic

Semiconductors

IC1—LF347N, quad op-amp
 D1, D2—1N4001 silicon rectifier
 D3—1N4735A, Zener, 6.2 volts
 LED1—Light-emitting diode

Other components

F1—Fuse, slo-blo, 0.5 ampere
 J1—J6—Phono jack
 PL1—Power plug
 S1—SPDT switch
 S2—DPDT switch
 T1—Power transformer: 120-volt primary; 12.6-volt, 300-mA secondary

Miscellaneous: Printed-circuit ma-

terials, fuse clips, enclosure, etc.

Note. The *Kwik-Kal* tape is available for \$16 VHS, \$19 BETA, plus \$2 shipping and handling from Zero Ohm Enterprises, 15214 NE 8th, Suite G-10, Bellevue, WA 98007. WA residents must add appropriate sales tax.

An etched and drilled circuit board is available for \$10.25 postpaid from Fen-Tek, P.O. Box 5012, Babylon, NY 11707-0012. NY residents must add appropriate sales tax.

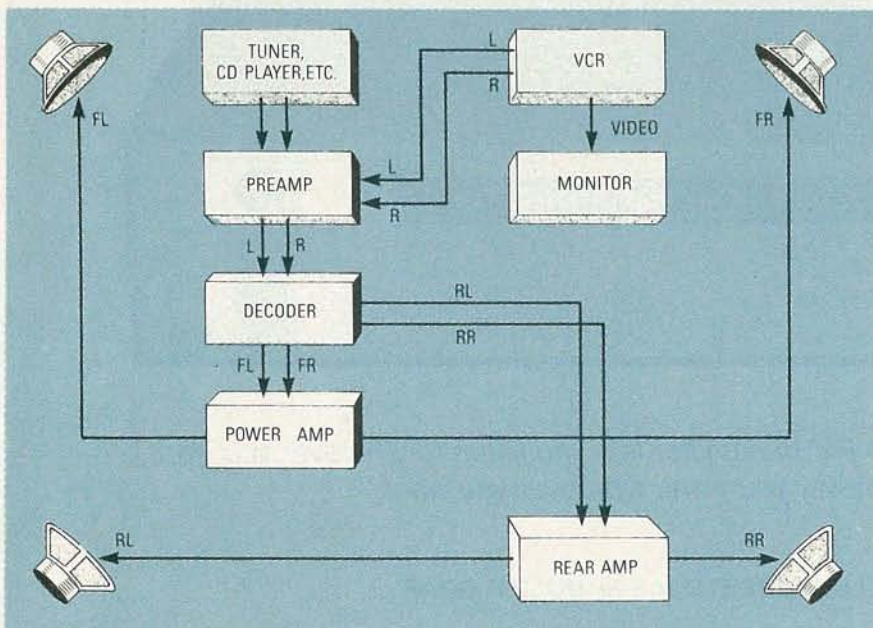

FIG. 7—THE MOST FLEXIBILITY IS ATTAINED if the decoder is used in a component system. This kind of arrangement also allows tuner and CD-player signals to be decoded.

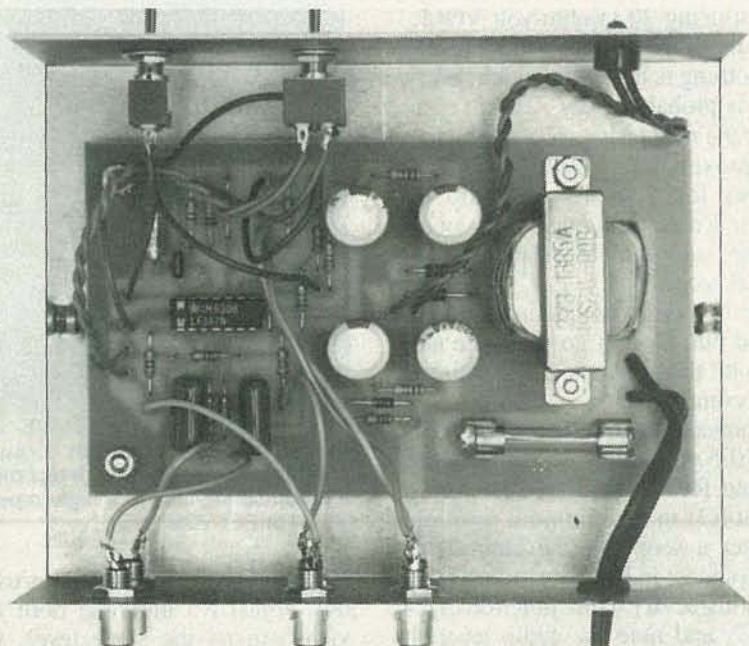

FIG. 8—THE PROTOTYPE USES PHONO JACKS for all input and output connections. Grouping them on the rear apron allows the decoder to be easily connected into any kind of component arrangement.

The circuit

The complete circuit is shown in Fig. 5. Components R1, R2, C1, C2, IC1-a, and IC1-b buffer the left and right channels at unity gain over the audio band. The front channel blending described earlier is attained when switch S2-a connects R5 across R3 and R4. When S2 is set to the BYPASS mode, R3 and R4 isolate IC1-a and IC1-b from the capacitance of the shielded cables that are connected to J3 and J4.

Resistors R6–R9, and integrated circuit IC1-c, make the L–R difference signal the correct level if all speaker/amplifiers are equal. Resistors R10–R12, along with capacitors C3–C5, and amplifier IC1-d, form a 3-pole Chebychev 7-kHz active filter. When the filter is selected, R13 isolates the capacitive cable loading from IC1-d.

The power supply is not regulated because precise voltage values are not critical. Diode D3 is used to slow the power-off loss of the positive-voltage output, reducing “turn-off” pops.

Our prototype decoder is assembled on a printed-circuit board; the template for the board is provided in PC service. There are no unusual assembly considerations other than insuring that there is isolation between T1’s ground lead and C6–C8 (there should be only one power-supply ground, as shown). Also, ceramic capacitors should not be used because their tolerance varies with temperature and the applied voltage, thereby possibly creating distortion. Polyester capacitors are recommended.

The PC-board’s component layout is shown in Fig. 6. Nothing is unusual or critical as long as the polarity of all diodes and electrolytic capacitors is

continued on page 54

BUILD THIS

WIRELESS STEREO LINK



This great little stereo FM transmitter lets you listen to whatever you want, whenever you want, wherever you want.

WILLIAM SHEETS and RUDOLF F. GRAF

Part 2 LAST TIME WE showed you how to build the wireless link. Now it's time to get it up and running.

After you are sure that everything is okay, connect your chosen power supply to the B+ connection on the PC board. Now, you must quickly make the following voltage checks using a VTVM or FET VOM having a 10-megohm input.

- IC4 pin 8: 12 volts
- IC1 pins 1 & 7: 5-7 volts
- IC4 pins 1 & 7: 5-7 volts
- IC2 pin 16: 11 volts
- IC3 pin 12: 8-10 volts
- IC3 pin 8: 4-6 volts
- IC3 pin 4: 3-4 volts
- IC3 pin 5: 0.5-1.5 volts
- Q1 collector: 8-9 volts
- Q1 emitter: 1.5-3 volts
- Q2 collector: 6-10 volts
- Q3 collector: 8-9 volts
- Q3 emitter: 1.5-3 volts
- Q4 emitter: 1.5-2.5 volts
- Junction of R54 & D2: 6-9 volts if

using a VTVM or a FET VOM; or 3-9 volts if using 20 kilohm/volt VOM.

If all those voltages are present, and nothing is hot to the touch, everything is probably okay.

For the next tests, use a steady tone of approximately 1,000 Hz. Suitable sources for that are an audio oscillator, a recording made from an on-air tone, such as a TV-test pattern, or a test-LP record.

The following procedures must be carried out. Do not go on to the next step until the previous one is satisfactorily completed.

1—Connect a 1-kHz audio signal of about 0.5 volt p-p, to J1. Set R7, R9, R3, and R10 to their mid-positions, and set R31 to its minimum position. Connect a scope or the audio-level meter (shown in Fig. 8) or some other indicating device to the junction of C4 and R7, and note the audio level. It should be nearly equal to the input. Then connect the audio signal to J2. The level should be equal to that ob-

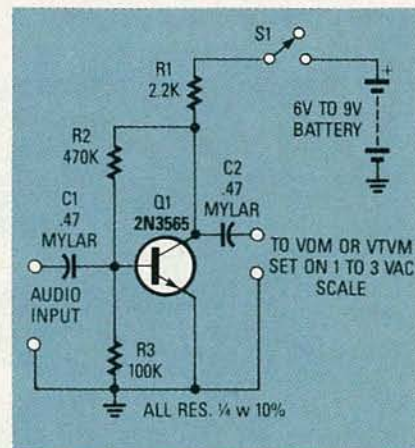

FIG. 8—IF YOU DON'T HAVE an oscilloscope, this amplifier circuit will provide sufficient gain to detect millivolt-level audio signals on a high-impedance VTVM or FET-VOM.

tained when the left input was used. If not, adjust R3 until the both inputs yield *exactly* the same level, which should occur near the middle of the adjustment range of R3.

2—Connect the scope or audio-level

meter to the junction of C5 and R9, and connect the audio signal to the J1 (left) input. The output level should be approximately the same as the input level. Now connect the audio signal to the right channel, and the output-level should still be about equal to the input. Connect a jumper between the left and right inputs so that the audio-signal is on both inputs. The output should now drop to zero or nearly zero. Adjust R10 for lowest output: ideally zero. If you have any problems, check the IC1 audio-matrixing circuit.

3—Connect a frequency counter to the collector of Q2 and adjust L1 for a reading of 76.000 kHz. If you don't have access to a frequency counter you can use an AM radio tuned to a station at 760 kHz. If you have trouble doing that, try it at night when more stations can be heard. Otherwise, you need an accurate signal generator. Run a wire from the collector of Q2 to the antenna of the receiver, or simply lay the wire near the radio. Now adjust L1 so that a whistle is heard on the radio, and then adjust L1 for lowest audio tone (pitch). Now tune the radio to a station at 1140 kHz, and that station should also be experiencing the audio interference. Rock the slug of L1 back and forth slightly to verify that. If not, go back to 760 kHz and readjust L1.

4—Adjust R31 at halfway and connect the scope or audio-level meter to

the junction of R31 and C19. Adjust the slug of L3 for a maximum output (19 kHz). That should occur with the slug well into the coil. If you must back out the slug almost all the way, you are probably not tuned to 19 kHz but to 57 kHz (the 3rd harmonic). Check your wiring, and C17 and C18. Return R31 to its minimum setting after this step.

5—Connect the scope or audio-level meter to the junction of C26 and R50. Set R35 temporarily all the way to either side. The audio input should be zero. Set R9 to minimum and adjust L2 for maximum output; then *very slowly* adjust R35 for a null. That should occur somewhere near midpoint and should be deep and definite. If there's no null, check IC3 and its associated components.

6—Reset R9 to midpoint and apply the audio signal to the left and right inputs. You should get an indication on the scope of a signal at the junction of R50 and C26. If the left and right inputs are connected together, and audio is simultaneously applied, no output should be obtained. Adjust R35 again if necessary and then return R9 to zero.

7—Set R7 to about $\frac{1}{3}$ of maximum, set R9 to about $\frac{1}{4}$ maximum, set R31 about halfway, and set R64 to about $\frac{1}{2}$ maximum. Then, tune a stereo FM receiver to an unused channel near 88 MHz, and set it for mono. Connect a stereo-audio source to the left and

ORDERING INFORMATION

The following items are available from North Country Radio, P.O. Box 53, Wykagyl Station, New Rochelle, NY 10804: PC board and all components that mount on it including all resistors, capacitors, semiconductors, L1–L3, cores and wire for L4 and L5 (LED and 1K resistor, power-supply components, cabinet, on/off switch, and phono jacks NOT included) \$57.50 + \$2.50 S/H. PC board only \$14.00 + \$2.50 S/H. NY residents must include sales tax.

right inputs of the transmitter. Turn C32 until the FM receiver picks up the program fed into the transmitter's inputs. A 12" wire can be connected to the junction of C40 and C41 to serve as an antenna. If the program is not heard, check the setting of R64, the Q3 and Q4 circuitry, and that L4 and L5 are correctly made.

8—Adjust R64 until the volume on the FM receiver is about the same as when a commercial FM station is tuned in. Switch the FM receiver to stereo. Adjust R31, the pilot-level pot, until the receiver's stereo indicator lights, and then advance it about 50% further. If there's no stereo light, check to see if the Q1 stage is producing 76 kHz, and then try readjusting R31. You should now hear stereo-audio on the receiver.

9—Adjust R9 for the best stereo separation, and then adjust L3 for the best separation. If you used a scope, little adjustment will be required. If you did not use a scope, adjust R9, L3, R7, and R3 a little bit at a time. It takes some patience, but it's not too difficult. A pair of stereo headphones and a tone on one channel at a time is a great help.

10—Adjust L5 so that the signal-strength meter on your FM receiver is at a maximum. This step is not critical, and if your receiver does not have a signal-strength indicator, forget this step unless the range of your transmitter is inadequate.

The alignment is now complete. You can mount the transmitter board and its power supply in any suitable cabinet, such as shown in Fig. 9. All you have to add is a power switch, and an LED and a 1K resistor for a pilot light.

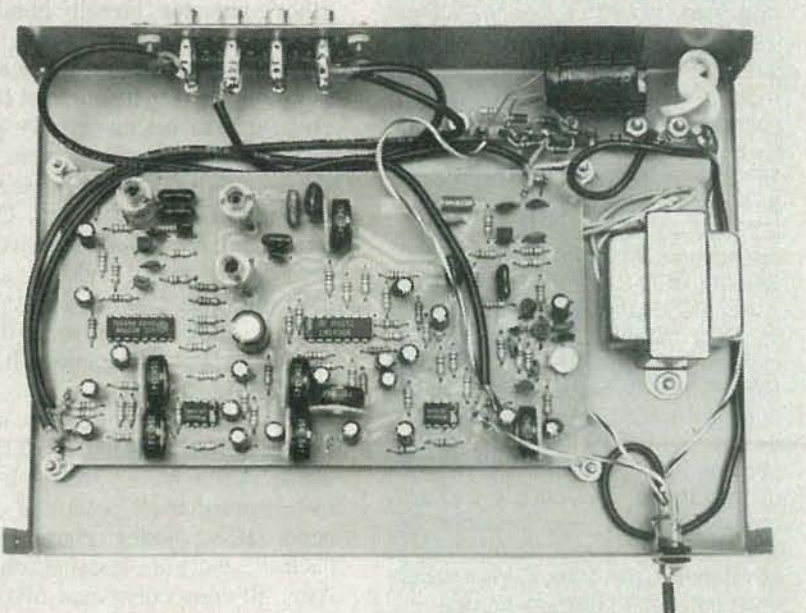

FIG. 9—YOU CAN MOUNT your transmitter in a cabinet similar to this one.

Build REACTS: THE RADIO-ELECTRONICS ADVANCED CONTROL SYSTEM

This month we get to work and build the CPU module.

Part 3 LAST TIME we looked at the theory behind the REACTS CPU module. Now, it's time to put our theory to practice and build the CPU module.

Construction

Construction is straightforward. The PC board, which is shown in PC Service, is double-sided; a plated-through board with silk screen and solder mask applied is available from the supplier listed in the Sources box.

Components are mounted on the board following the parts-placement diagram shown in Fig. 1. Figure 2 is a photograph of the author's prototype. Although there are some minor differences, your finished board will closely resemble that one.

Note that, as shown in Fig. 2, we used sockets for all IC's; despite the fact that only IC16, the EPROM disk, strictly requires the use of a socket, we strongly recommend that you too use them for all IC's.

Care should be taken in handling the CMOS parts since they are very sensitive to static-discharge damage. Grounding the workbench and soldering iron is highly desirable, especially if you don't use sockets. Placing the IC's, PC board, and tools on a single sheet of grounded aluminum foil will prevent static damage to any components.

You should be careful when installing the Molex connectors (SO3 and SO4). The connector comes in two



H. EDWARD ROBERTS, M.D.

Sources

The following items are available from DataBlocks, Inc., 579 Snowhill Road, Glenwood, GA 30428. Or call (800) 652-1336; in Georgia call (912) 568-7101: DP-CPU—design package of schematics and instructions, \$10.00; PC-CPU—PC board for CPU module (includes DP-CPU design package, \$37.00; PC-CLK—PC Board for clock, \$18.00; SYS-PROM—the REACTS operating system (enhanced SB-80) installed on a 32K UV-erasable PROM (includes operating system documentation), \$44.00; REC-CPU—complete kit of parts, PC boards, IC's, connectors, for CPU module (does not include clock or system PROM), \$147.00; REC-CLK—complete clock subsystem including all parts, PC boards, NiCd battery, and connectors, \$43.00; and REC-SYS—All of the above, \$218.00. An Elpac power supply is also available for \$49.00. Please add \$10.00 postage and handling per order. GA residents must add appropriate sales tax.

pieces, one with pins and one without pins. To install the connector, the piece with the pins is mounted flush with the top (component) side of the board and the pins are soldered on the bottom of the board. When soldering the connector to the board, use a minimum amount of solder and make sure no solder bridges occur. Furthermore, don't "drag" solder up the pins. That's because those pins must slide down over the other half of the connector, and any excess solder could damage the friction fit. The connectors are designed to be assembled once only; it is a bad idea to push the two

halves together and then to pull them apart. But if assembled following the preceding recommendations, they are extremely reliable and durable, and may be plugged and unplugged into other connectors literally hundreds of times.

Note, however, that when separating modules **it is important that the connectors be carefully pulled apart by pure vertical force. Prying the boards apart may cause serious damage to the connectors.** The connectors are the most expensive single item on the board, and they are time consuming to remove and replace if damaged. That doesn't mean that they are fragile, but with careless handling they can be broken.

Other than the connectors, installation of all other parts is straightforward, although care should be taken to be sure that all polarized components (IC's, diodes, electrolytic capacitors, etc.) are installed correctly. After all components are installed, a careful inspection for proper compo-

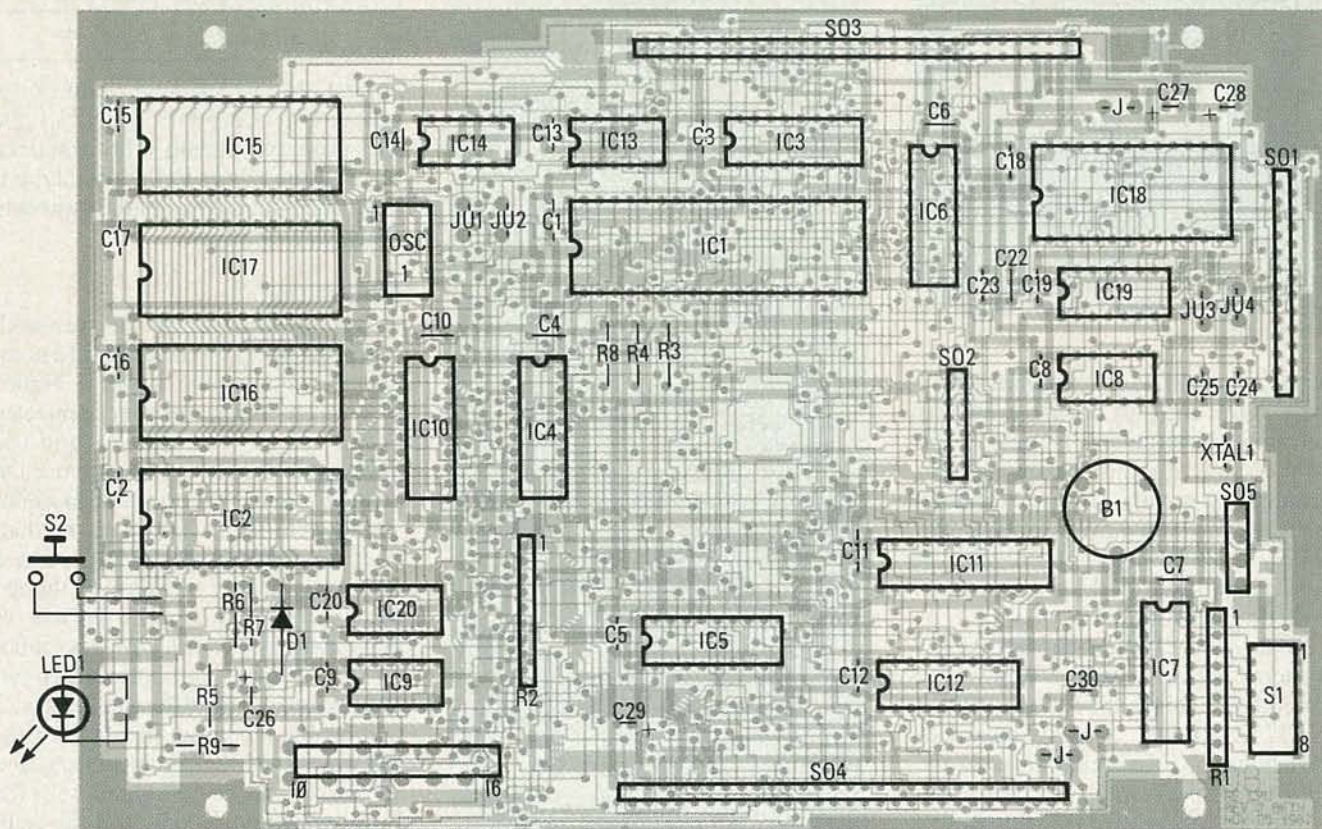

FIG. 1—ALL OF THE COMPONENTS mount on one double-sided board. The patterns for the board can be found in PC Service.

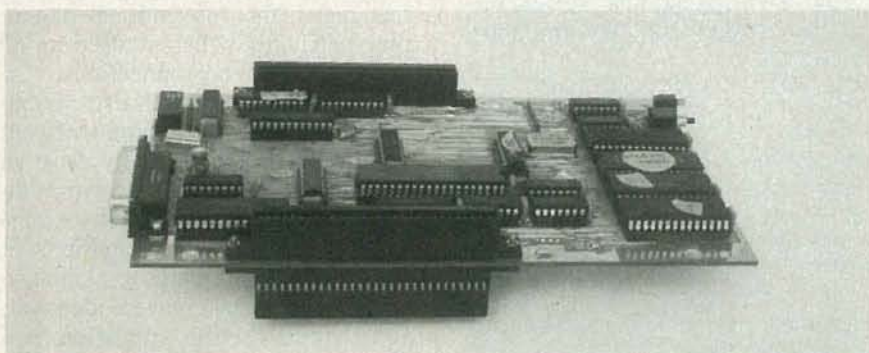

FIG. 2—THE COMPLETED AUTHOR'S PROTOTYPE. While the prototype differs slightly from the project described in the article, your board and this one will appear similar

ment location should be made. Also, the board should be carefully searched for solder bridges or other construction defects; a magnifying glass will be useful for that.

The operating system

REACTS uses an enhanced version of Lifeboat Associates SP-80. SP-80 was designed to be an improved version of CP/M. We have added enhancements to the package in order to produce the REACTS DOS. If you are familiar with CP/M, MS-DOS, or SB-80, you will feel right at home with the operating system. REACTS DOS is available on a PROM from the

vendor listed in the Sources box elsewhere in this article. Once the CPU module is assembled, that PROM is installed, a terminal is connected via the serial port, and power is applied, the CPU is ready for checkout and use.

Checkout

Power can be applied to the CPU via the power jack (S05) using an Elpac power supply (available from the source listed in the Sources box found elsewhere in this article). Other supplies can also be used, as long as they provide the appropriate voltages and currents and are well regulated

TABLE 1

Parameter	Setting
EMULATION	QVT101C
PARITY	OFF
DATA BITS	8
STOP BIT	1
BIT8	0
FDX/HDX (Full or Half Duplex)	FDX
CHAR/LINE/BLCK	CHAR
ON LINE/LOCAL	ON LINE
BAUD RATE	9600

and current limited. The Elco power supply produces +5 volts DC at 860 mA, +12 volts DC at 300 mA, and -12 volts DC at 300 mA.

The checkout itself is actually quite simple. Just connect a standard terminal to the serial port and apply power to the system after setting switch S1 as shown in Fig. 3. If everything is working correctly, in less than a second (about 250 milliseconds to be more exact) you will see the opening screen. If that happens, you are ready to use your system to control the world!

Adding a terminal

Before we wrap up, let's spend a couple of moments discussing exactly

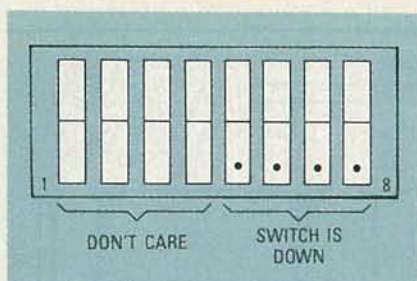

FIG. 3—SET THE EIGHT DIP SWITCHES of S1 as shown here. The settings of the don't-care switches will not affect the checkout.

what we mean by a "standard terminal." Over the past decade computer terminals have gotten "smarter" and at the same time less expensive. For example, a quality "dumb" terminal sells in single quantities for less than \$400. Ten years ago, a terminal with less capability would have sold for 4 to 5 times that price.

While developing the REACTS system, we have made extensive use of both the Qume 101 and the ADDS VPT/A2 terminal. Also, we have tested a number of different terminals and all operate in a satisfactory manner.

Another alternative is to purchase a used terminal. At the present time there are a number of used terminals on the market (e.g. ADM-7, etc.) that can be purchased for next to nothing. Be sure that any terminal you consider is compatible with a standard RS-232 interface before buying. In addition, it is probably a good idea not to purchase any used terminal if its technical manual is not available.

The settings we use on the Qume 101 terminal are shown in Table 1. They will give you a starting place even if you use a different machine.

In addition, the REACTS system allows you to use two other devices for the terminal. One is to use an IBM PC or compatible as a terminal. If you have a computer and a modem, the software needed to convert your PC into a terminal is available on the REBBS (516-293-2283, 8 data bits, no parity, 1 stop bit). It is also available on disk from the supplier mentioned in the Sources box for \$18.00 plus postage. That disk also includes a routine that allows you to use your hard or floppy disk as a storage device for the REACTS system.

Finally, you can choose to build your own terminal. The last alternative has several advantages; we will go into those in detail and provide construction plans for the REACTS

PARTS LIST

All resistors 1/4-watt, 5%, unless otherwise noted

R1, R2—10,000 ohms, 9-into-1 resistor network, SIP package
R3-R6, R8—10,000 ohms
R7—10 ohms
R9—470 ohms

Capacitors

C1-C20, C22, C23—0.47 μ F, 25 volts, ceramic disc
C21—not used
C24, C25—22 pF, 25 volts, ceramic disc
C26—10 μ F, 16 volts, electrolytic
C27, C28—47 μ F, 16 volts, electrolytic
C29—47 μ F, 10 volts, electrolytic
C30—6-36 μ F, trimmer

Semiconductors

IC1—Z80 microprocessor
IC2—82C59 programmable interrupt controller
IC3-IC7—74HC245 octal three-state transceiver
IC8—74HC02 quad 2-input NOR gate
IC9, IC20—74HC14 hex inverting Schmitt trigger
IC10, IC12—16L8 custom PAL, see text
IC11—EP600 custom PAL, see text
IC13, IC14—74HC73 dual JK flip-flop with clear
IC15, IC17—55257 32K static RAM
IC16—27C256 32K UV-erasable EPROM
IC18—82C52 programmable UART
IC19—MC145406 RS-232 driver/receiver
D1—1N914 switching diode
LED1—Red LED, right-angle PC mount

Other components

OSC1—8-MHz crystal oscillator
XTAL1—2.4576-MHz crystal
B1—3.6-volt rechargeable NiCd battery (Panasonic MMB 3.6C)
S1—8-position DIP switch
S2—SPDT, momentary pushbutton switch
SO1—25-pin female connector, DB-25 type
SO2—16-pin double-row header, PC mount
SO3, SO4—60-pin male/female feedthrough bus connector assembly (Molex 70090/70088), see text
SO5—4-pin jack

Miscellaneous: PC board, extruded aluminum case (see Part 1), IC sockets, hardware, wire, solder, etc.

terminal in a future installment. Note that the REACTS terminal also features a parallel printer port.

Next, we will show you how to build a battery back-up system. **R-E**

SURROUND SOUND

continued from page 49

correct. Note that there is no power switch between power plug PL1 and T1's primary winding. That was done because the power to the prototype is switched with the rest of the system to avoid turn-on pops.

Setting up

Figure 7 shows how the surround-sound decoder can be set-up in a component video-sound system. Notice that by having the decoder connected between the preamplifier and the power amplifier it can also be used to decode signals that originate in a conventional tuner, a CD player, or whatever. Also note the use of left-rear and right-rear speaker signals even though the left and right decoder outputs, as previously discussed, are the same. Obviously, your particular video-audio system will be different, but Fig. 7 will give you a good idea of the various ways in which signal sources and amplifiers can be combined with the surround-sound decoder. As shown in Fig. 8, all of the decoder's inputs and outputs are made through phono jacks that match the conventional phono-plug patch cords that are used for all home video-sound connections.

If your system doesn't use components, and the stereo outputs of your VCR or TV normally drive an integrated amplifier or a receiver, simply connect the decoder between the VCR or TV and the amplifier's or receiver's AUX or VIDEO-SOUND inputs.

If all four speakers were identical, and if their driving amplifiers had identical gain, and if the front and rear speakers were equidistant from the viewer, no level balancing or adjustment would be necessary. But that's a lot of ifs. More than likely, you'll spend some time fiddling with the amplifier controls. A better way to calibrate Hi-Fi surround-sound system is to use a 7-minute video calibration tape called *Kwik-Kal: A Seven Minute Surround Test*, which features on-screen indication of speaker placement, the channel being encoded, and its weighting. The tape is available in the Beta and VHS formats and contains a Hi-Fi track. (See Parts List.) Once the system is optimized by using the tape, there's no need to fiddle with any adjustments. Simply sit back, relax, and enjoy the show. **R-E**

TV Derived Frequency Standard

LUTHER M. STROUD, CET

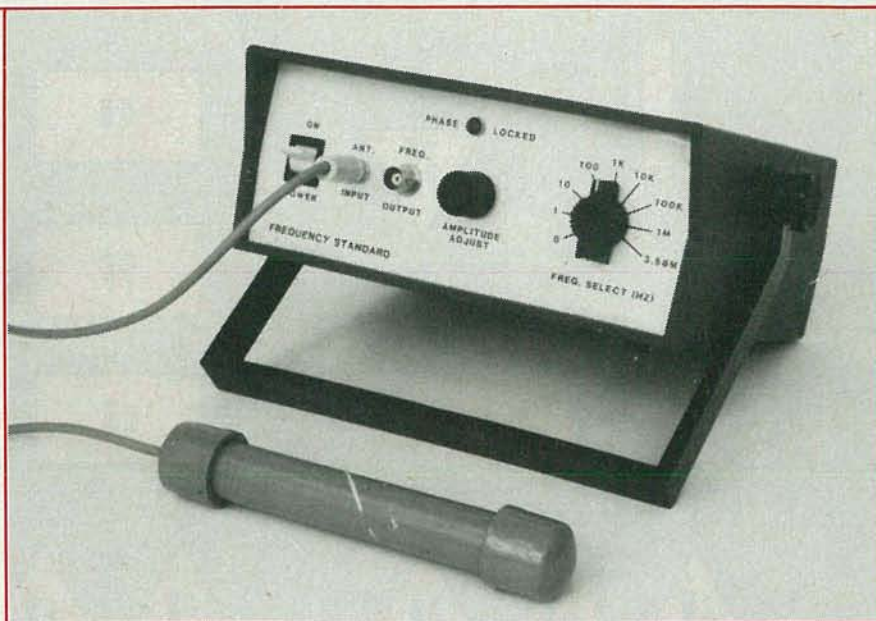

You can use almost any TV as an accurate frequency reference.

REGARDLESS OF THE KIND OF MEASUREMENT being made, you must always consider the accuracy or tolerance of the tool you're using. Sometimes, overall accuracy isn't important because all that's needed is an approximation of a circuit's voltage, current, frequency, or whatever. But in most cases, simply using an approximation isn't good enough when the technology becomes more complex; in those instances, a more precise degree of accuracy is necessary. The general rule regarding measurement-accuracy is for the test equipment to be at least ten times more accurate than the parameter being measured.

Measurement standards, to which all other standards of measurement are compared, are set for the United States by the National Bureau of Standards (NBS), a branch of the U.S. Department of Commerce. Calibrated measurement devices having documented proof of being compared to the primary standards at NBS are referred to as *secondary standards*. (A system of secondary standards have been worked out world-wide for use by anyone who has a need for such accuracy.)

NBS distributes time and frequency reference standards through a radio system known as WWV, which operates on numerous shortwave frequencies. The system allows your time and

frequency standards to be calibrated by comparison to the WWV signals, a somewhat painstaking process. A simpler and more convenient way for the hobbyist and professional to calibrate time and frequency measurement devices, with greater accuracy than most applications require, is by using a television-derived frequency standard.

Color-TV precision

When television broadcasting converted to color, in order to ensure uniformity of color reproduction throughout the broadcast system, the three major networks agreed to carefully control the accuracy of the color-subcarrier frequency. The subcarrier frequency of 3579545.454 Hz (3.58 MHz) is derived from a precision 5-MHz oscillator controlled by a rubidium atomic-standard that is directly traceable to NBS. Since the synchronization pulses for locking the TV receiver's sweep circuits are derived from the 3.58-MHz color subcarrier, the TV's horizontal-sync (H-sync) pulses are directly traceable to NBS when viewing a network-originated broadcast. It is the NBS-referenced H-sync pulse that is used by the television-derived frequency standard to provide more useful reference frequencies for the electronic hobbyists and professional.

How it works

The television-derived frequency standard has three primary functions. First, the 3.58-MHz subcarrier is recreated by frequency-multiplying the H-sync pulse picked up by the standard's antenna (which is a resonant circuit tuned to 3.58 MHz that is placed near a TV set). Second, a sub-multiple of the 3.58-MHz signal is used to tune and hold a phase-locked oscillator precisely on 1-MHz. Third, the 1-MHz signal is step-divided in 10:1 steps to provide the user with output signals down to 1 Hz.

The schematic is shown in Fig. 1. Ferrite-rod antenna L1 is tuned by C2 to parallel resonance near the TV horizontal-sweep frequency of 15734.265 kHz. The voltage induced in the antenna is amplified by IC11-d—a logic-inverter that is biased for linear operation. Its output triggers IC1, a 555 timer operating as a monostable oscillator having a time delay (set by R1 and C1) of about 90 microseconds. The timer triggers on every other H-sync pulse, creating a 50% duty-cycle square-wave output of one-half the H-sync rate, or 7867.1325 Hz. That signal is applied to one input (pin 14) of phase detector IC5.

Meanwhile, IC2-a functions as a crystal-controlled oscillator whose output frequency can be "rubbered" (changed slightly) by capacitor C10

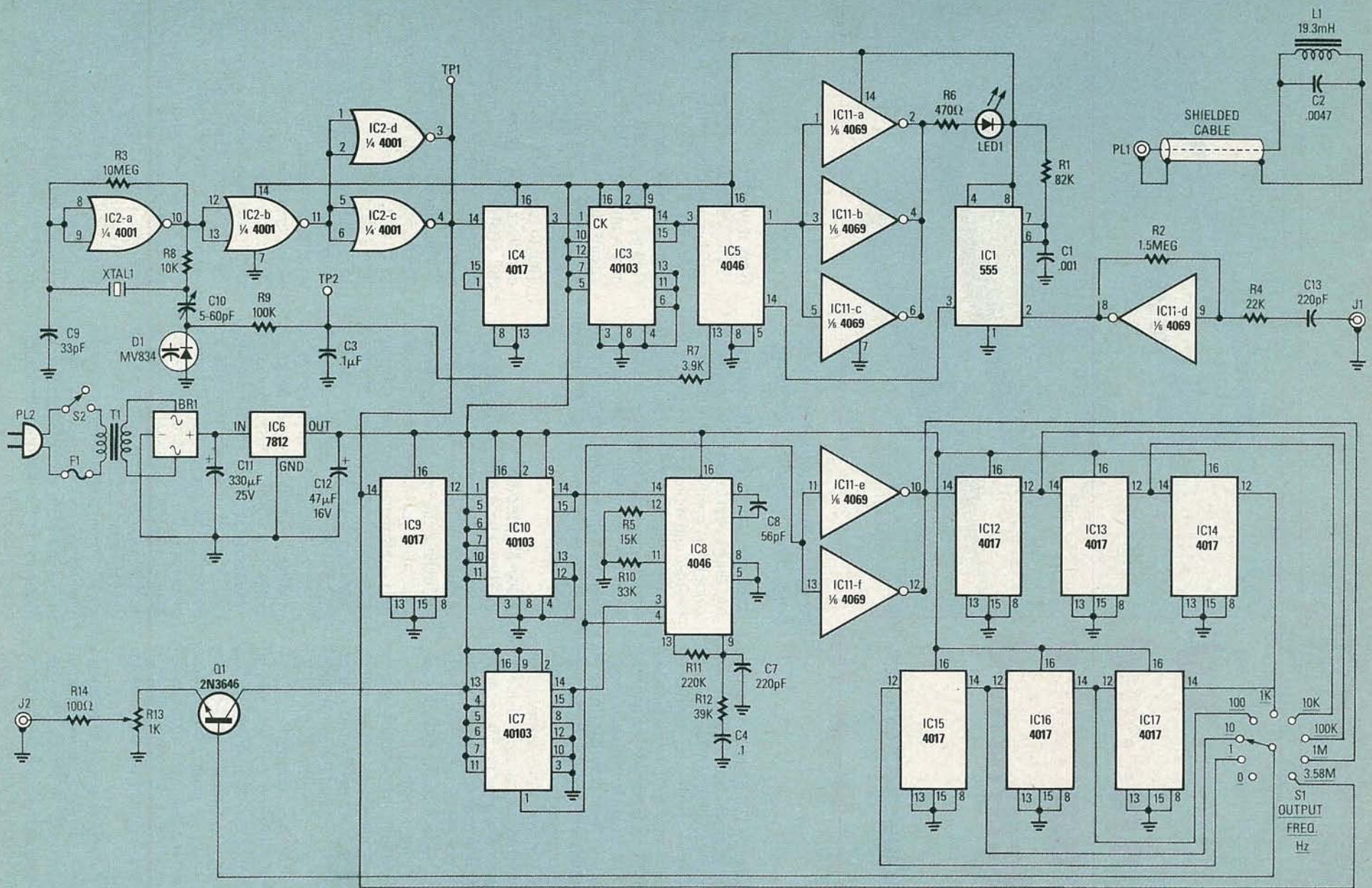

FIG. 1—ALL FOUR SECTIONS OF IC2 ARE USED FOR THE CRYSTAL OSCILLATOR, WHILE THREE PARALLEL-CONNECTED SECTIONS OF IC11 ARE USED AS THE LED DRIVER

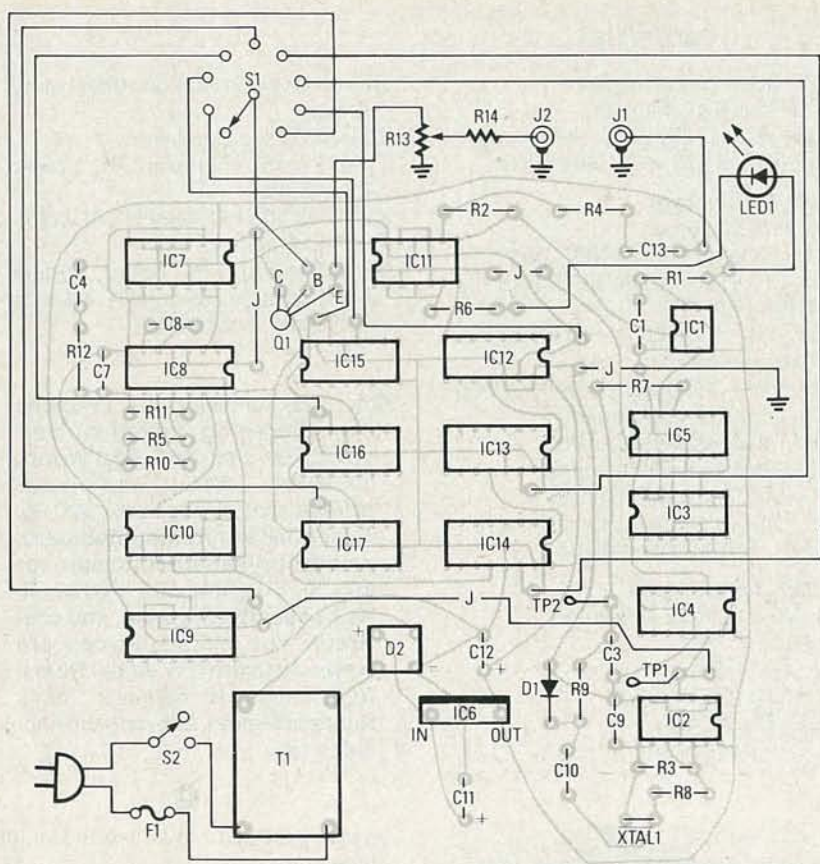

FIG. 2—TAKE EXTRA CARE THAT VARACTOR DIODE D1 is installed with the correct polarity, and double-check the connections to output selector switch S1 before applying power to the circuit.

and varactor diode D1; thus, the crystal-controlled oscillator becomes voltage-tunable. Capacitor C10 adjusts the crystal close to the correct operating frequency, while the capacitance determined by the voltage applied to D1 through R9 determines the oscillator's precise output frequency.

The remaining sections of IC2 are used as buffers to prevent loading the crystal. The output of the buffers, at test point TP1, is divided by IC4 ($\div 5$) and IC3 ($\div 91$) to 7867.1325 Hz, which is applied to the other input (pin 3) of phase detector IC5. The output voltage at IC5 pin 13 varies between zero and 12 volts, depending on the phase difference between the input signals on pins 3 and 14. The voltage at pin 13 is filtered by R7 and C3 and is used to correct the 3.58-MHz oscillator for a zero phase difference at pins 3 and 14. IC5's output voltage (pin 1) is inverted and buffered by three paralleled sections of IC11, which drive lock-indicator LED1.

Something useful

So far, we have multiplied one-half of the horizontal-sweep frequency by

455 to the color sub-carrier frequency of 3579545.454 Hz. Now let's see how we take such an odd frequency and convert it to something that is more useful.

A common sub-multiple of both 3.5 MHz and 1 MHz is used for phase comparison to lock IC8 to exactly 1,000 MHz. The 3.58-MHz reference signal is divided by IC9 ($\div 10$) and IC10 ($\div 63$) to 5681.818 Hz. The frequency of 1 MHz divided by 176 is also 5681.818 Hz, so IC7 is connected as a divide-by-176 counter in the feedback path of IC8, a phase-locked loop oscillator. IC8's free-running VCO frequency is set near 1 MHz by C8 and R5. Resistor R10 creates an offset so that the VCO is restricted to 1 MHz \pm 100 kHz. Restricting the operating range in that manner minimizes the jitter in the output signal caused by system noise when the device is in phaselock.

The output at IC8 pin 13 is a voltage proportional to the difference in the frequency applied to pins 3 and 14. That voltage is filtered by R11, R12, C4, and C7 and is used as the VCO's control voltage input at pin 9. The

voltage at pin 9 tunes the VCO frequency until the signals applied to pins 3 and 14 are equal or phase-locked. At phase-lock the VCO's output is a stable, high-accuracy square wave of 1.0000 MHz. To review, we have divided 3.58 MHz by 630 and then multiplied the result (5681.818 Hz) by 176 to yield 1.0000 MHz. The original accuracy of the color sub-carrier (3.58 MHz) is transferred to the 1-MHz signal.

A series of decade counters, IC12-IC17, divide the 1-MHz signal in decade steps to 1 Hz. Switch S1 selects the desired output frequency signal and feeds it to emitter-follower Q1, whose output level is determined by potentiometer R13. Resistor R14 ensures that the minimum output impedance will be 100 ohms.

Getting it together

While the device can be assembled on perforated wiring board if you're careful to keep lead lengths short, the best method is to use a printed-circuit board. A suitable pattern is shown in PC Service; alternately, the PC board can be ordered from the source given in the Parts List.

The PC board's parts-placement diagram is shown in Fig. 2. Begin stuffing the board by first installing the four jumpers, then the resistors and capacitors—taking particular care that the polarity of the electrolytic capacitors is correct. Next, install XTAL1, using a drop of silicone-rubber adhesive to cement the crystal to the PC board to prevent damage.

Finally, install the IC's, but take note that not all are oriented in the same direction; double-check the location of pin 1 when installing all IC's on the board. And just to be on the safe side, we suggest testing the power-supply section (including IC6) before installing the IC's.

Clean the board with a solvent wash to remove the soldering flux, and then check the board closely for solder bridges, especially where the traces pass between the IC pins.

The main circuit can be housed in a metal or plastic cabinet, and just about any kind of layout can be used for the components that are not mounted on the PC board. Figure 3 shows the author's prototype.

The antenna

Antenna-coil L1 should be 19.3 millihenries $\pm 20\%$. The coil used for

PARTS LIST

All resistors are ¼-watt, 5%, unless otherwise noted.

R1—82,000 ohms
R2—1.5 megohm
R3—10 megohms
R4—22,000 ohms
R5—15,000 ohms
R6—470 ohms
R7—3900 ohms
R8—10,000 ohms
R9—100,000 ohms
R10—33,000 ohms
R11—220,000 ohms
R12—39,000 ohms
R13—1000-ohm potentiometer
R14—100 ohms

Capacitors

C1—0.001 µF, 50 volts, ceramic disk or Mylar
C2—0.0047 µF, 50 volts, Mylar
C3, C4—0.1 µF, 50 volts, ceramic disk or monolithic axial
C5, C6—not used
C7, C13—220 pF, 50 volts, ceramic disk or monolithic axial
C8—56 pF, 50 volts, ceramic disk

C9—33 pF, ceramic disk
C10—5–60 pF, trimmer
C11—330 µF, 35 volts, electrolytic
C12—47 µF, 16 volts, electrolytic

Semiconductors

IC1—NE555 timer
IC2—CD4001B quad NOR gate
IC3, IC7, IC10—CD40103B divide by N counter
IC4, IC9, IC12-IC17—CD4017B decade counter
IC5, IC8—CD4046B phase-lock loop
IC6—7812 12-volt regulator
IC11—CD4069B hex inverter
Q1—2N3646 NPN transistor
D1—MV834 varactor diode
D2—Bridge rectifier, 50 volt, 1 amp
LED1—light-emitting diode

Other components

F1—¼-amp fuse and holder
J1—phono jack
J2—BNC jack
L1—19.3 mH, see text
PL1—Phono plug
PL2—Power plug

S1—10-position non-shorting rotary switch
S2—SPST toggle switch
T1—12-volt PC-mounting power transformer
XTA1—3.58-MHz, type HC-18 color-burst crystal

Miscellaneous: PC board, 70-foot No. 30 enameled wire, 3/8" × 4-inch ferrite rod, enclosure.

Note. The following are available from Pershing Technical Services, P.O. Box 1951, Fort Worth, TX 76101: A drilled and plated-printed circuit board for \$20.00. A kit of all board-mounted parts and the printed-circuit board for \$65.00. The board is also available assembled, tested, and calibrated for \$95.00. Prices are postpaid in the U.S. Allow from 4 to 6 weeks for delivery. Texas residents must add appropriate sales tax.

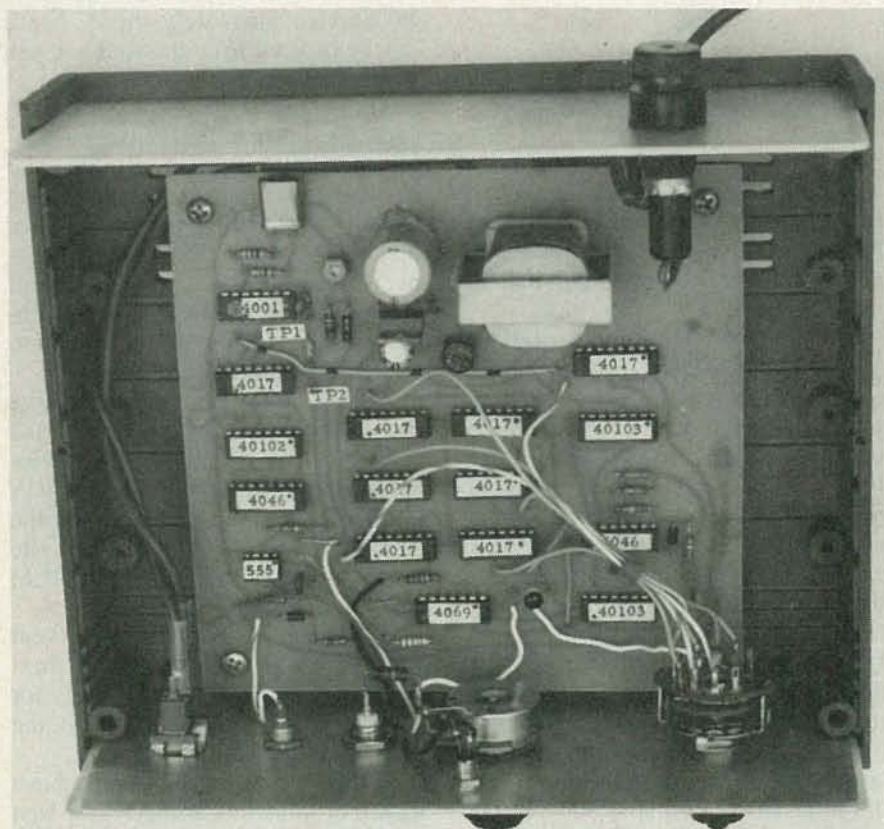

FIG. 3—ANY KIND OF CABINET can be used for the main circuit. Even the layout of the cabinet-mounted components isn't critical. If you wish to use a PC board, the pattern is shown in PC Service.

the prototype is made from 70-feet of No. 30 magnet wire wound on a 3/8" × 4-inch ferrite rod salvaged from a discarded AM radio. (Because recep-

tion of the 15,734 Hz pulse from a TV set requires a rather large inductance having many turns of wire, rather than counting turns we are specifying the

length of the wire to be wound on the ferrite core.)

The winding is spread evenly along the length of the rod to within 1/2-inch of either end. (The rod can be inserted in a variable-speed drill because it yields a coil much neater and faster than hand winding.) Secure the wire with tape when finished, but leave three inches free for connection to a length of shielded cable. Tin both free ends and solder C2 and the shielded cable in parallel with the leads. Secure the shielded cable to the coil with tape and set the assembly aside.

The antenna assembly is shown in Fig. 4. The enclosure for the antenna is made from a 5-inch length of 1/2-in. I.D. plastic water pipe and two end caps. Drill a hole slightly larger than the shielded cable in one of the plastic caps and pass the shielded cable through the hole. Install an RCA-type phono plug on the free end of the cable. Then install a rubber grommet on each end of the ferrite rod and slide the antenna assembly into the plastic pipe. Do not cement the caps in place, just slide them on the pipe.

Connect the antenna to the main circuit via J1.

Adjustment

Place the antenna near an operating TV set and adjust C10 with a plastic

continued on page 71

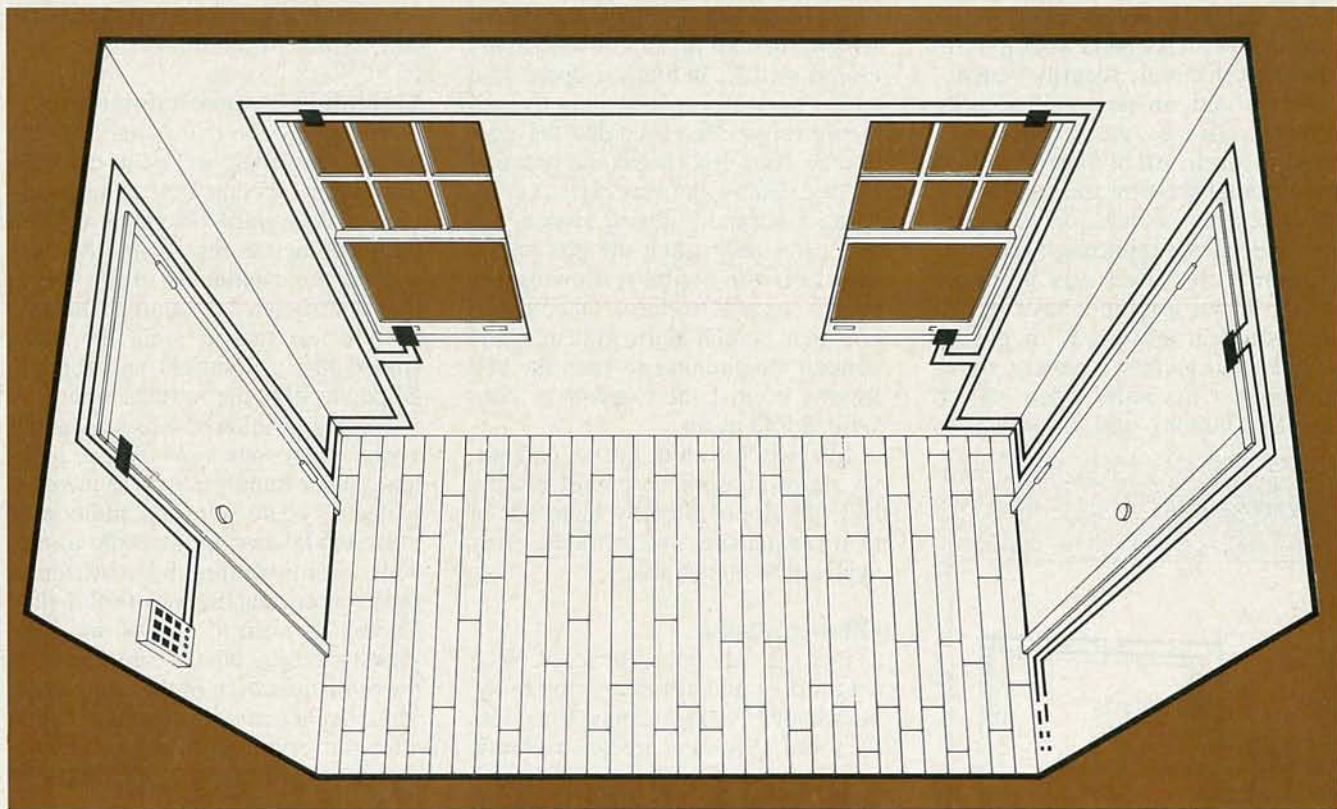

ELECTRONIC SECURITY SYSTEMS

Seize the advantage from would-be burglars with an electronic security system.

ALAN GLASSER

ACCORDING TO THE MOST RECENT REPORT released by the Federal Bureau of Investigation, one out of every four households will be burglarized over a ten year period with your odds of being burglarized increasing to one out of two in a thirty year period. It is no longer a question of *whether* you will become a victim of crime, but only a matter of *when*!

Worse, according to the Director of the National Crime Prevention Institute, residential break-ins have reached a point where traditional law-enforcement methods cannot contain the problem. Since there are not enough police officers to control crime, a self-help approach to protecting your home is required.

Electronic security systems

Probably the first burglar alarm ever developed was by Ugh the cave-man, who used a large rock propped

up by a trip-stick. When an intruder entered Ugh's cave, he would inadvertently activate the trip-stick and be struck on the head with the rock. Upon hearing the racket, Ugh would awaken and finish off the intruder with his club.

Not too many improvements in Ugh's system took place until the late 1800's (although many civilizations used animals, or geese, to sound an "alarm" if strangers approached). In 1853, Augustus R. Pope patented the first electromechanical alarm. It consisted of electromagnetic contacts, which were mounted on doors and windows and wired to a battery and a bell. It met with minor success in the Boston area. In 1858, Pope sold the patent to Edwin Holmes.

Holmes, a true pioneer in the alarm industry, opened a business for selling alarm systems in New York City. By 1872, Holmes opened *central-station*

offices in New York City and Boston to monitor alarms from a remote location. (By the way, the Boston location was to become the first telephone exchange in the country.) In 1882, Chauncy McCulloh was awarded a patent for a method of alarm transmission still in use today, known as the *McCulloh loop*. It is interesting to note that the electromechanical burglar alarm was invented in 1853, prior to the invention of the telephone (1876) and the electric light (1879).

Alarm-system basics

All electronic security systems consist of three basic parts: the *control panel* (the brains), the *detection devices* (the eyes, ears, nose and sense of touch), and the means to notify a third party (the voice). Pope's patent consisted of detection devices (electromagnetic contacts), third-party notification (the bell), and the con-

trol (a battery housed in a box, along with a switch to turn it on and off), as shown in Fig. 1. Follow along as we explain how all the parts work to form a modern electronic security system.

As we said, an electronic security system needs eyes, ears, a nose and a sense of touch. All of those functions are accomplished by the use of different sensors or detectors designed for a specialized application. The first "sensor" ever used was a simple switch. It was used in a basic circuit that you learned about in grade-school science class: a battery, in series with a normally open switch (doorbell button), and a doorbell as

shown in Fig. 2. In your science class you pressed on the switch and the bell rang. In an alarm circuit, the closed window or door presses on a normally closed switch, holding it open. If it were a normally open switch, the bell would ring all the time that the window or door was closed and pressing on the switch—not very effective. By using a normally closed switch, the bell rings only when the pressure is taken off the switch (allowing the switch contacts to close). Of course, a complete burglar-alarm system would contain the circuitry to keep the bell ringing even if the window or door were closed again.

But switches alone are not enough, so alarm-equipment manufacturers have developed literally hundreds of alarm switches to meet virtually every application imaginable.

Other sensors

Did you ever put a bucket of water over a door and attach a string to the door knob? When someone came into the room, they were greeted by a rude surprise! Sounds almost like Ugh's alarm. What would happen if you attached a very fine string to an alarm-system switch and stretched the string across the room at just about knee height? No bucket of water, but your alarm system would ring when someone tripped on the string and triggered the pull trap!

Now, what would happen if we were able to put the string under the carpet so that no one could see it? Just a little impractical. So how about developing a long flat switch? Such a switch is called a *mat switch*. Step on it and the alarm will sound.

A *vibration detector* is a variation of the basic switch. It works on the principle that the vibrations set up when an intruder is breaking through a wall, roof, or plate glass window will activate the switch. The switch contains a heavy weight (relative to its size) that cause the switch to bounce open and closed each time a vibration is sensed.

Another type of sensor is a *glass breakage detector*. Did you ever notice the silver stripe on the edge of the plate glass on most store-front windows and doors? That's part of the alarm system. Although that stuff is commonly called foil, it's actually extremely thin lead tape that carries a small amount of electrical current supplied by the burglar-alarm system.

The foil is applied in a special manner that causes it to break with the slightest crack in the glass. When the foil breaks, the alarm sounds.

Electronic intrusion detectors

The *photoelectric beam* was the earliest electronic intrusion detector. The earliest version used an incandescent visible-light beam aimed at a photocell across the room. Interruption of the continuous beam by an intruder triggered the alarm. The only trouble was that at night the beam shined like a flashlight and actually helped to light the intruder's path.

Adding an infrared lens to filter out visible light took care of that problem. Other improvements to the photoelectric beam were the addition of pulse modulation to the beam to prevent circumvention by a different light source, and the use of solid-state electronics such as LED's and integrated circuits, which contributed to the miniaturization of the equipment. Modern photoelectric beams can span a length varying from across a three-foot doorway to across a warehouse of up to a thousand feet.

Ultrasonic motion detectors

Next in the development of electronic detectors was the *ultrasonic motion detector*. That was the first truly electronic motion detector, incorporating tubes, power supplies, piezoelectric elements used as transducers, and a host of other electronic components. The ultrasonic motion detector was also the first detector to use the *Doppler effect*. The Doppler effect is the change in received frequency of a vibration (ultrasonic energy between 19 to 30 kHz in this case) caused by any motion of an object within the energy field. In sound, the effect is most readily recognized as the change in pitch of a train whistle or in an automobile's roar as it approaches, passes in front of, and then travels away from you. In an ultrasonic motion detector, the Doppler effect occurs when the ultrasonic energy is reflected off a moving object, such as a moving person.

Most ultrasonic motion detectors are transceivers: the transmitter and the receiver are located in the same housing. The received frequency is compared to the transmitted frequency. If both are the same, then there is no motion and no alarm. If the received frequency is different (due to

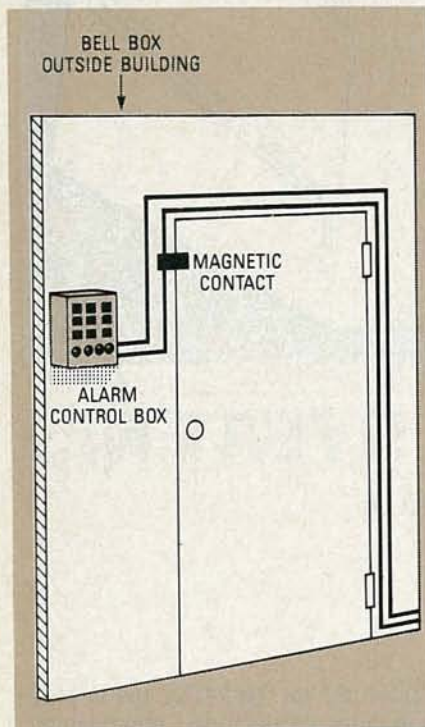

FIG. 1—A SECURITY SYSTEM consists of a detection device (electromagnetic switch), a control box, and an alarm to alert others.

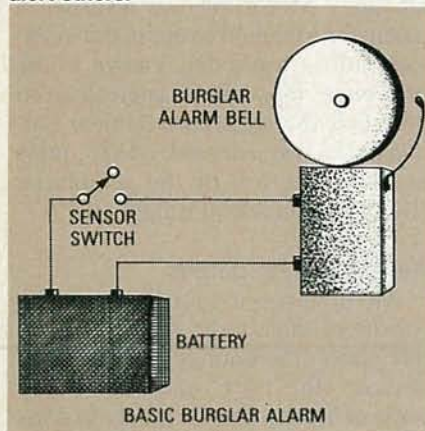

FIG. 2—THE FIRST SENSOR was a normally open switch. Putting that switch in a science-class doorbell circuit yields a basic burglar alarm.

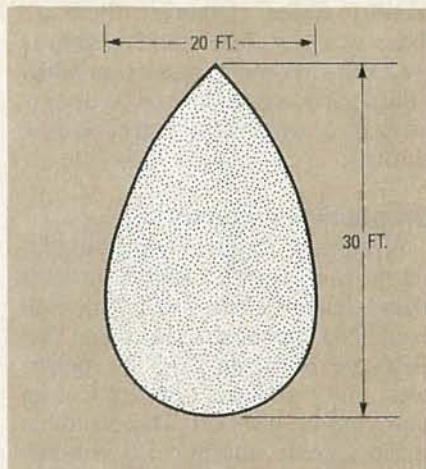

FIG. 3—COMMON ULTRASONIC DETECTORS have a teardrop shaped coverage pattern. That pattern can be altered for special applications.

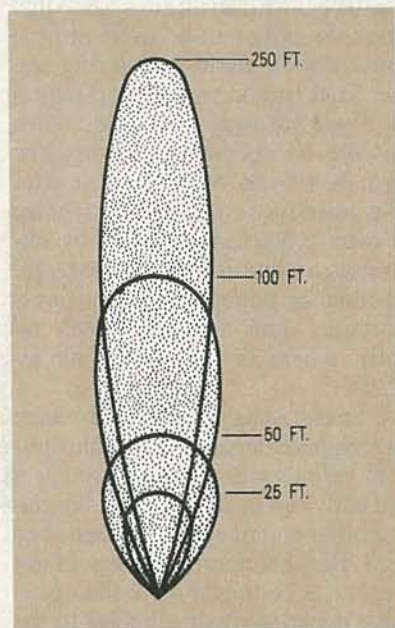

FIG. 4—MICROWAVE MOTION DETECTORS are available with many different coverage ranges.

the Doppler effect), then the unit will go into the alarm condition. Special filters and logic circuits are built into the ultrasonic motion detectors to allow them to respond only to human-sized objects moving within a certain speed range peculiar to, and indicative of, human motion.

The most common detection pattern of an ultrasonic motion detector is teardrop in shape and covers an area approximately 30 feet by 20 feet, as shown in Fig. 3. Patterns and distances can vary due to the protection needs. Since ultrasonic energy cannot penetrate solid objects such as walls, doors, or glass, their detection pattern is confined to the enclosed area in which they operate.

Microwave motion detectors

Microwave motion detectors are much like ultrasonic motion detectors in that they use the Doppler-effect principle. However, microwave motion detectors use microwave energy around 10.5 GHz while ultrasonic motion detectors use ultrasonic energy in the 19- to 30-kHz range.

Unlike an ultrasonic motion detector, a microwave motion detector's microwave energy can penetrate walls, doors, glass and almost any non-metallic substance. Therefore, a microwave motion detector can detect outside its enclosed area. The advantage is that the detection pattern (which is much the same as that of an ultrasonic motion detector) can extend beyond the enclosed area, such as to a second room or even outside the building into a parking lot. The disadvantage is that the detection pattern may extend out even when you don't want it to. Preplanning and careful placement of microwave motion detectors is a must. Microwave motion detectors are available with short- to long-range detection patterns, as shown in Fig. 4.

Passive IR motion detectors

The passive infrared motion detector is one of the newest of all of the detection devices. It is based on the fact that all objects having a temperature above absolute zero emit infrared radiation. Infrared radiation is also a form of electromagnetic radiation and it falls just below the visible light spectrum.

Just as your eye can see visible light and your brain can then detect a moving object, a passive infrared motion detector can "see" radiated infrared energy by use of a highly specialized pyroelectric sensor and a segmented lens arrangement. In addition, its electronic "brain" can detect movement by comparing the background radiated infrared energy to the moving person's radiated infrared energy. It can then activate a relay.

The passive infrared motion detector is different from the photo beam, ultrasonic motion detector, and the microwave motion detector in that it does not emit any energy in order to do its job. A typical passive IR motion detector is shown in Fig. 5.

Dual-technology detectors

The dual-technology motion detector uses a hybrid motion-detection

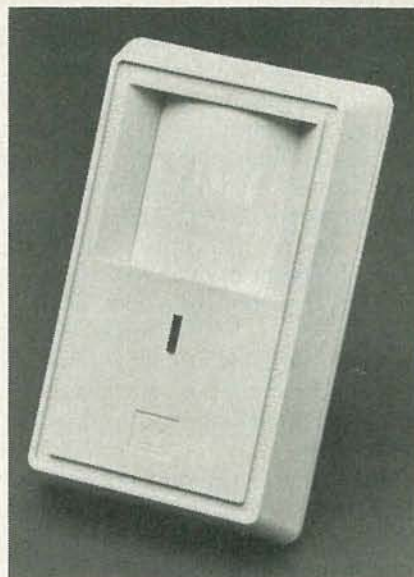

FIG. 5—A PASSIVE INFRARED DETECTOR does its job without emitting energy.

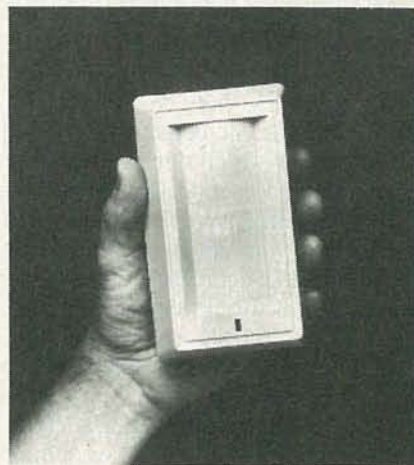

FIG. 6—THIS DUAL-TECHNOLOGY DETECTOR combines passive-infrared and microwave sensors. Other technology combinations can also be used.

system that incorporates two different motion-detection technologies in one unit. For example, the dual-technology motion detector shown in Fig. 6 has passive infrared detection capabilities (radiated infrared energy) and microwave detection capabilities (Doppler effect). Another acceptable combination is passive infrared and ultrasonic. The reasoning behind the dual technology is that both technologies must sense the presence of the intruder before the unit will go into the alarm condition, thereby eliminating many of the false alarms due to background and/or environmental disturbances.

Detecting intrusion sounds

The *audio switch* or *sound discriminator* is an electronic device that re-

sponds to the sounds that are associated with an intrusion. Those sounds can range from infrasonic (which is below the range of human hearing) to ultrasonic (which is above the range of human hearing).

Infrasonic-sound detection takes place between 0.5 hertz and 2.0 hertz and is based on the principle that when an abrupt intrusion is made—such as the opening of a door, a window, or by any kind of forced entry through a wall, floor, window, or ceiling—infrasound waves are generated. Those waves are generated primarily in two ways.

First, when an abrupt opening is made, the difference between the outside environment and the inside environment of a tightly enclosed area creates a pressure wave. As that low-frequency pressure wave propagates, it reflects off various surfaces and is detected by the infrasonic detector. Second, the acceleration of a hinged door or window surface in or out starts a low-frequency wave in motion toward the infrasonic detector.

Mid-range-sound detection takes place when the actual sounds of an intrusion taking place (the same sounds that you and I can hear, i.e. pounding on surfaces, splintering wood, breaking glass, etc.) are “heard” by the detector’s microphone, which then activates a relay. Ultrasonic-sound detection is mainly used to detect breaking glass. The vibrations of glass breaking or splintering fall high within the ultrasonic range. Those detectors are designed to detect only those frequencies associated with breaking glass.

But detection devices can’t function on their own. They need something to which to report, something that can serve as the brains of the system and make the decision to sound an alarm.

The control panel

Now that we know how to detect the intruder, we need some way to turn the system on and off and to notify a third party that an intrusion is taking place. The control panel fulfills that function.

All control panels consist of an on/off switch, a power source (battery), and a latching relay that keeps the bell ringing even after the detection device has reset. Within the last ten years, security equipment manufacturers have developed modern micro-

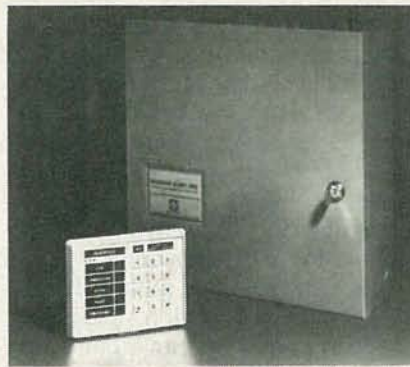

FIG. 7—A MODERN, SOPHISTICATED control panel allows the user to zone the protection. It also allows the user to arm and disarm the system using a digital control.

processor-based control panels that provide a variety of enhancements. They allow the user to arm and disarm the security system by entering a “secret” digital code through a numeric key pad similar to the kind found on a telephone. See Fig. 7. Some control panels allow for multiple users to have different levels of security through different user codes. Most control panels will allow the “zoning” of the security system, whereby the user can turn on or off different areas of protection or different detection devices as the need arises. Zoning also allows the pinpointing of where an intrusion is taking place so the police department can be sent directly to the point of entry.

While most control panels require wires to be run between the detection devices and the panel, there are some control panels that establish the link through low-power radio-frequency transmitters. Those wireless control panels allow a system to be installed with a minimum of wires being run throughout the premises and make it easier for systems to be installed in areas where wire can’t be run.

All control panels have one thing in common, however. They all will notify a third party that an intrusion has taken place. However, how that notification takes place differs from system to system. Most people are familiar with the sound of the burglar-alarm bell that is used in many commercial as well as residential security systems. Now, the electronic siren is gaining in the popularity race. Many of them can be programmed for different sounds and one manufacturer even has one that has a prerecorded, voice-synthesized message!

An intruder is sure to run when either a bell or siren is activated by the

security system. However, there are times when a silent alarm system is preferable or even necessary, or when a third party such as the police department or a responsible party *must* be notified.

Off-premises monitoring

A properly designed home burglar-alarm system will feature a distinct alarm signal (be it bell or siren), both inside and outside the premises. That alerts the occupants and the neighbors, and warns the intruder that an alarm has been set off. Those audible alarm signals, along with window stickers that make it clear that your home or business is protected, will deter a high percentage of break-ins.

A higher degree of protection can be achieved with an alarm system that causes the police to be notified by a central-station alarm-monitoring service. That can be particularly important if you are away from home, such as while on vacation, or when the alarm has been tripped by a fire. Many insurance companies recognize the extra protection provided by off-premises monitoring, and offer larger discounts on homeowner or business insurance, some as high as 20% annually, where such systems are installed.

A central station is a place where alarm-signal transmissions (transmitted in various ways) are received so a third party can be notified of a burglary or other emergency condition. See Fig. 8. Besides central stations, alarm signals can be transmitted directly to police departments or directly to the owners or other concerned parties.

There are a number of methods used to transmit an alarm signal from the protected premises to the receiving party. We’ll start with the oldest and work our way to the most recent.

In the late 1800’s, cotton-covered wire was run over roof tops from the protected premises to the central station. As the central station gained more customers, burglar-alarm poles (remember, the burglar alarm was invented before the telephone) were used to get the wires from one place to another. The use of wires running directly from the protected premises to the central station was known as a *direct-wire* circuit. Those direct-wire circuits are still in use today but now use the telephone company’s existing telephone poles or underground conduits and existing wiring. Unlike the



FIG. 8—A MODERN COMPUTERIZED central station. Information from a tripped alarm system is displayed on a CRT and help is sent within moments.

direct-wire circuits of the 1800's, today's direct-wire circuits are protected against tampering and circumvention by very elaborate electronic encoding processes, some unbeatable by even the most sophisticated computer.

A variation of the direct-wire circuit is the *McCulloh* loop, which we mentioned earlier; that circuit can best be described as a party line. Another arrangement is the *multiplex* circuit, where highly sophisticated digitally-encoded signals allow many customers to be serviced using one telephone line.

The important thing to remember is that all of those circuits make use of a dedicated pair of telephone-company wires leased for the sole purpose of alarm transmission. In the mid 1960's, an electro-mechanical device was developed that used the telephone company's existing switched telephone network. That device was known as the *tape dialer*. It consisted of a tape-playback mechanism and associated electronic circuitry that, when activated, would electronically dial a telephone number and play a voice-recorded message indicating that a burglary or some other emergency was taking place. Some modern versions of the tape dialer are completely solid-state, voice-synthesized, units. Some of those units allow for remote confirmation of the received message.

By the early 1970's, a new device was developed to take advantage of the switched-telephone network and thereby alleviate the high cost of leased, dedicated, telephone lines. The *digital-alarm communicator* revolutionized the central-station alarm business. Digital-alarm communicators are sophisticated dedicated microcomputers that, when activated, use a built-in modem to conduct complex two-way communications with a remote central station. Within sec-

onds, the information can be displayed on a CRT and help sent.

The newest development in alarm transmission uses the switched-telephone network. Spread-spectrum transmission is used, permitting the overlay of alarm and data signals onto already existing telephone-subscriber services. A supervisory signal is constantly transmitted (which is outside the range of human hearing) from a terminal unit located at the customer's premises to the telephone company's exchange office. Those transmissions are constantly monitored by a telephone-company computer that monitors each terminal unit's status. Any indication of tampering or of an alarm condition results in the telephone company's computer notifying the appropriate central station, which sends help.

The cable-television industry has in some instances provided the necessary link between the alarm company's central station and the customer's protected premises. Modern two-way interactive cable-TV plants have the ability to transmit and receive alarm signals over existing coaxial cable. Alarm signals received by the cable operator are retransmitted to the appropriate central station, which in turn sends help.

Long-range radio-alarm monitoring should not be confused with the wireless alarm systems that were discussed earlier in this article. Long-range radio-alarm monitoring provides a very reliable method of monitoring an alarm system without the use of wires.

Developed in the early 1970's, long-range radio systems can be found working on frequencies ranging from 27 to 900 MHz. Different manufacturers use different transmission methods, from double-sided narrow-band AM to high-speed FM packet switching. Typical line-of-sight coverage for long-range radio is about 25 miles, with repeaters extending the range as needed.

Installing security systems

By this point, you should have a good working knowledge of the many reasons why you should consider the installation of an electronic security system, the component parts of the system, and how they work. Now you have to make the decision as to whether you want to install one yourself or hire a professional security

contractor. The decision is a hard one. However, it is important to note that some of the more sophisticated detection devices and control panels mentioned in this article are only available to professional security contractors on a wholesale basis. If your particular situation requires the features of those more sophisticated systems, then the decision has pretty much been made for you.

However, do-it-yourself installation may be appropriate for many simpler situations. Many electronics hobby stores, electrical supply houses, and mail-order houses do sell some limited security system equipment. Most of those devices consist of an all-in-one tabletop control console with a built-in detection device such as an IR or ultrasonic motion detector. They will also have a built-in sounding device and/or the capacity to add an external sounding device. Separate components, such as a simple control panel, different types of switches, motion detectors, sirens, bells, wire, batteries, foil, as well as how-to books, can be obtained through those sources as well.

Professional installations

For those that choose to go the professional-installation route, here are a few guidelines that may save you some headaches:

A security system is often a once-in-a-lifetime purchase and is simply too important to trust to the lowest bidder or a friend's expertise. Shop around, but not for price. Look for a well-established company that will be there if and when your alarm requires service. Look for a professional company, one that will explain to you clearly the services they provide. Recommendations from friends and neighbors are also valuable in selecting an alarm company.

Almost every state, and many local regions, have burglar- and fire-alarm associations. A call to a local association for a list of dealers would surely help in the selection process. Also, while police departments generally are not supposed to give out individual recommendations, a phone call to them might net two or three names on a non-official basis. Another source of information or recommendations is the National Burglar and Fire Alarm Association (1120 Nineteenth Street, N.W., Suite LL-20, Washington D.C. 20036).

R-E

NEW MAGNETIC MEMORIES

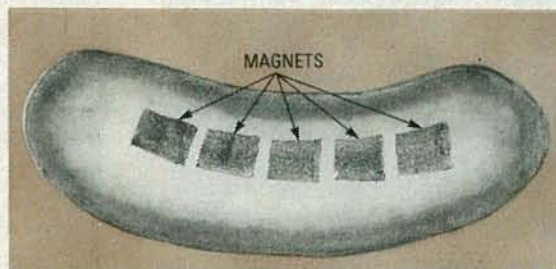

GLYNN G. GILLETTE

A new breakthrough, announced April 1st, makes tiny magnetic memories possible.

SCIENTISTS AND ENGINEERS ARE CONSTANTLY seeking ways to make computer memories smaller and more reliable. Now, a new breakthrough has allowed scientists to fabricate magnetic memories that are far smaller than was ever possible using any other technology.

The key is the discovery of a type of creature that regularly creates magnetic structures that are as small as 300 angstroms (an angstrom is 1/10,000 of a micron)! Called *magnetoactive* bacteria, they use the magnets for navigation. A mature specimen measures about 2000 angstroms long and contains about five of the tiny magnets.

Those microscopic creatures are far from rare; a small sample of muddy pond water may contain millions. When the creatures die and decompose, they leave behind large aggregates of the tiny magnets, which are known as *loadstones*. (Those natural magnets are not to be confused with the more well known lodestones, which, of course, have a completely different origin.)

Now, computer scientists and engineers at Foolem Laboratory, working hand-in-hand with a team of top microbiologists, have found a way to incorporate the magnets generated by the bacteria into a promising new magnetic read-only memory.

First of all, it was discovered that certain types of magnetoactive bacteria are north seeking, while others are south seeking. If a uniform north-seeking bacteria culture is placed in a magnetic field, all of the bacteria will face and swim in the same direction. If the polarity of the field is reversed, all of the bacteria will turn around and swim in the opposite direction.

To create a uniform north-seeking culture, a sample of pond water is passed through a north magnetic field to draw out any north-seeking bacteria. After the bacteria are removed from the sample, the balance is then discarded.

To make a memory, or any one-or-zero switch, the north seeking bacteria are washed over a specially prepared semiconductor wafer. On that wafer, holes that measure 1000 angstroms deep by 2500 angstroms in diameter that have been etched wherever a one-or-zero switch is to be placed. Each hole traps one and only one bacterium. See Fig. 1.

Using an external magnetic field, the bacteria are manipulated into the appropriate position for a one. A low powered laser then zaps the cells where ones are desired. After all of the ones have been programmed (zapped), the field is reversed. The remaining live bacteria turn around and face the opposite way. Then the remainder are zapped as zeros. The wafer is then finished along with the rest of the circuitry.

To detect a one or zero from the extremely small magnets, a slow rise-time pulse is applied to the column line. When the level of voltage is at maximum, a magnetic field will appear 90° from the bacterium magnets;

continued on page 108

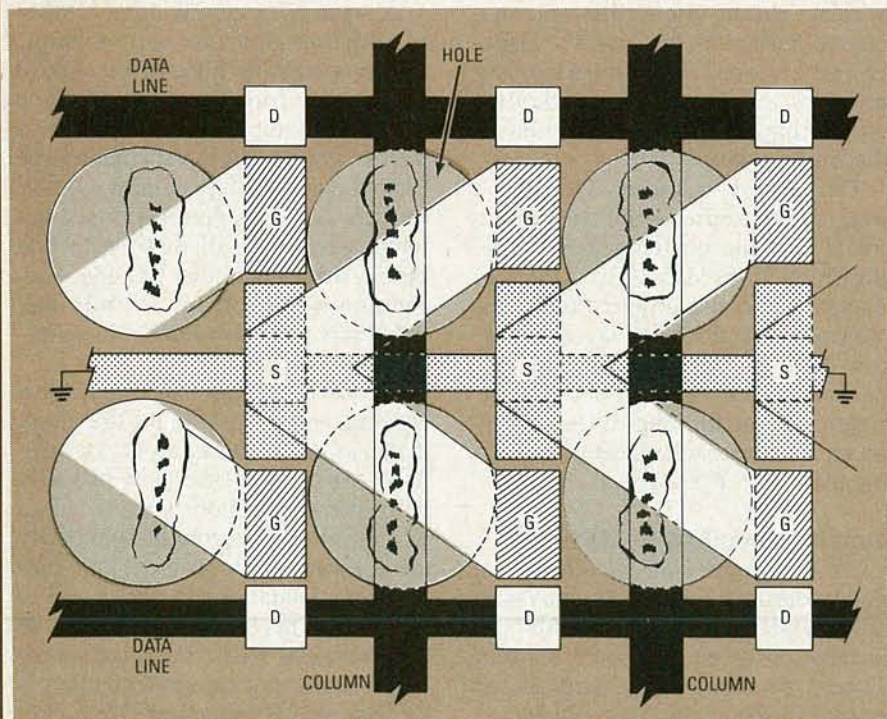

FIG. 1—NORTH-SEEKING BACTERIA are washed onto a semiconductor wafer and are trapped in the holes. The bacteria are then manipulated by an external magnetic field and then zapped by a low-power precision laser.

WORKING WITH MONOSTABLE MULTIVIBRATORS

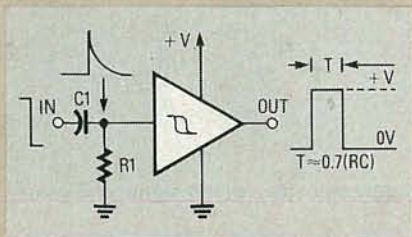

FIG. 1—THIS LEADING-EDGE DETECTOR circuit has a positive output pulse.

RAY MARSTON

CIRCUIT DESIGNERS often need to come up with a circuit to generate a pulse when triggered by the leading or trailing edge of a waveform. When the pulse width is not critical, they usually turn to a circuit element that's known as a *half-monostable* or *edge-detector*. When the pulse width is critical, they usually use a circuit element known as a *full-monostable multivibrator*.

There are two types of monostables, standard and retriggerable. In a standard monostable circuit, the arrival of the trigger signal initiates an internal timing cycle that causes the output of the monostable to change state at the start of the timing cycle, and then revert back to the original state on completion of the cycle. Note that once a timing cycle has been initiated, the standard monostable is immune to the effects of subsequent trigger signals until the timing period ends. That type of circuit can be modified by adding a RESET control, so that the output pulse can be terminated or aborted at any time.

In a retriggerable monostable circuit, the trigger signal actually resets the monostable and initiates a new timing cycle even if the trigger signal arrives in the midst of an existing cycle. Thus, the retriggerable monostable's output will stay in its active state as long as new trigger pulses are introduced before the timing cycle ends.

The choice of an IC to implement a pulse generator is usually dictated by economics and convenience, rather than by the actual design requirements. So, if the designer needs a

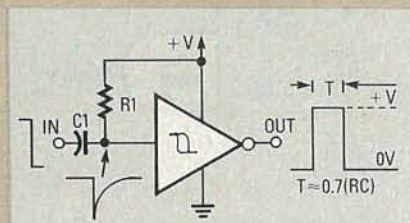

FIG. 2—THIS TRAILING-EDGE DETECTOR circuit also has a positive output pulse.

standard CMOS monostable of only modest precision, he can build it very inexpensively using IC's such as a 4011B or 4011B. Otherwise, it can be done at a greater expense using a 555 timer or a dedicated monostable IC such as 4047B.

Edge-detector circuits

Edge-detector circuits are used to generate an output pulse on the arrival of either the leading or trailing edge of a rectangular input waveform. In most applications, the precise width of the output pulse is not critical. The basic method of making an edge-detector is to feed the input waveform to a short-time-constant RC network, which produces an output waveform with a sharp leading edge and an exponential trailing edge upon the arrival of each input edge. The unwanted edge waveform is then eliminated with a discriminator diode, and the remaining spike or sawtooth waveform is then converted into a clean pulse by feeding it through a Schmitt-trigger.

CMOS Schmitt IC's incorporate built-in protection diodes on all input terminals, which can be used as discriminator diodes as was previous-

Learn how to design and build pulse generators and monostable multivibrators, and how to use them in your projects.

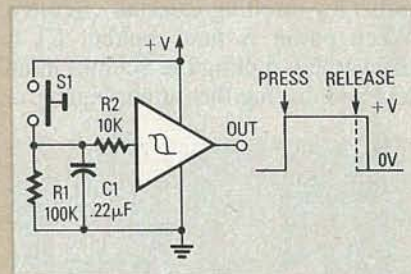

FIG. 3—IF YOU NEED A NOISELESS push-button switch, this circuit can be used to de-bounce a switch.

ly described. The 4093B quad 2-input NOR Schmitt can be used as a normal Schmitt inverter by wiring one input terminal to the positive supply and using the other terminal as the input. Also, a non-inverting Schmitt trigger can be made by wiring two inverting Schmitts in series.

Figure 1 shows a leading-edge detector circuit. The input of the Schmitt is tied to ground via R1, and the RC time constant is relatively short compared to the period of the input waveform. As shown, the leading edge of the input signal is converted to the spike waveform, and the spike is then converted into a pulse waveform by the Schmitt. The circuit will generate a positive-going output pulse if a non-inverting Schmitt is

used, or a negative-going output pulse with an inverting Schmitt. In either case, the output has a period (T) of roughly $0.7(RC)$. Figure 2 is a similar circuit that is set up as a trailing-edge detector.

An edge-detector circuit can be used to make a "noiseless" push-button switch as shown in Fig. 3. The input of the non-inverting Schmitt is tied to ground via timing-resistor $R1$ and by input-protection-resistor $R2$, so the output of the circuit is normally low. When $S1$ is closed, $C1$ charges almost immediately to the positive supply voltage, and the Schmitt output goes high. When $S1$ is released, $C1$ discharges relatively slowly via $R1$, and the Schmitt output does not return low until roughly 20 ms later. Therefore, the circuit provides a clean output waveform.

The reset-pulse generator circuit in Fig. 4 generates a reset pulse when power is first applied to the circuit. The circuit produces a 700-ms output pulse for resetting external circuitry. When power is first applied, $C1$ is discharged, pulling the Schmitt input low and driving the output high. Ca-

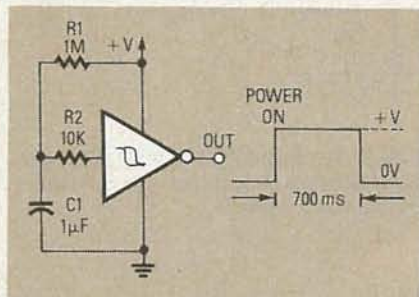

FIG. 4—A RESET-PULSE generator circuit will generate a reset pulse upon power up.

pacitor $C1$ then charges via $R1$ until, after about 700 ms, the $C1$ voltage rises to such a level that the Schmitt output switches low.

Monostable IC's

The cheapest possible way of building a standard or resettable monostable circuit is to use a 4001B quad 2-input NOR gate or a 4011B quad 2-input NAND gate; circuits using those IC's are shown in Figs. 5-8. Note, however, that the output pulse widths of those circuits are subject to variations between individual IC's and variations in the supply voltage, so they are not suitable for use in high-precision applications.

Figures 5 and 6 show two versions of the standard monostable circuit,

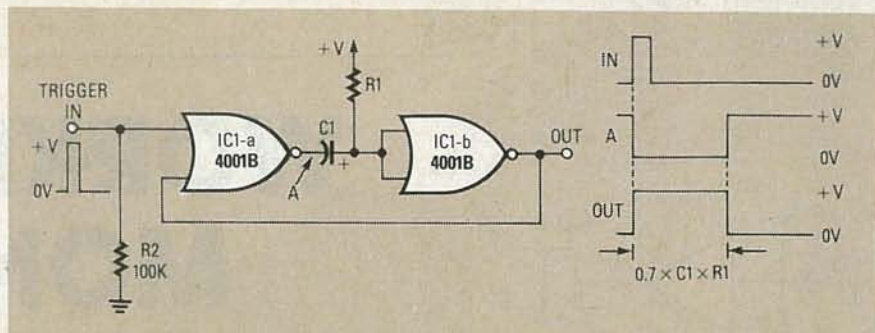

FIG. 5—THIS 2-GATE NOR monostable is triggered by a positive-going signal and generates a positive-going output pulse.

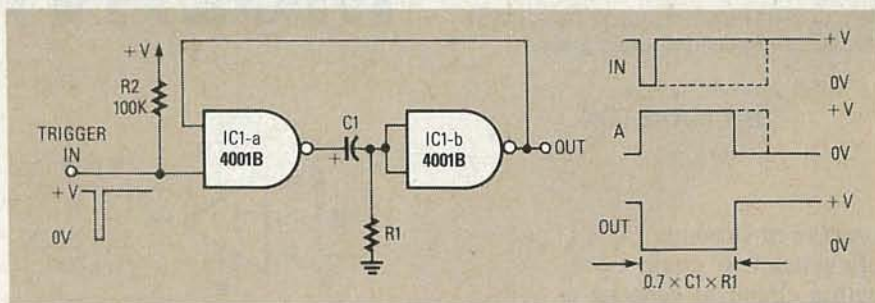

FIG. 6—THIS 2-GATE NAND monostable is triggered by a negative-going signal and generates a negative-going output pulse.

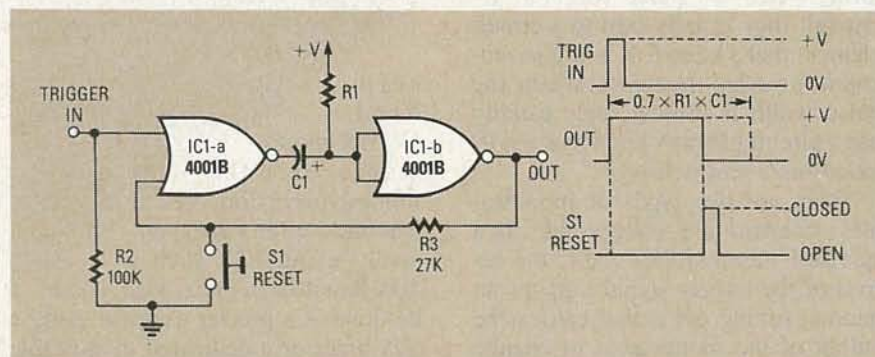

FIG. 7—A RESETTABLE NOR monostable can be reset by pressing $S1$. It is triggered by a positive-going signal and produces a positive-going pulse.

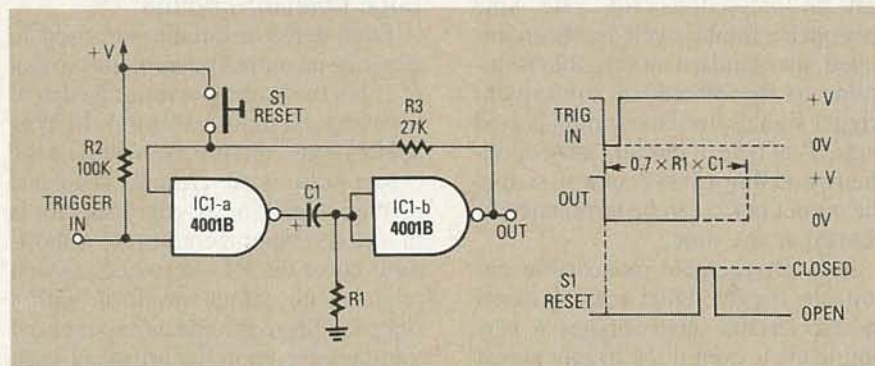

FIG. 8—THE CIRCUIT SHOWN HERE is a NAND monostable. Unlike the NOR-type, it is triggered by a negative-going signal and produces a negative-going pulse.

each using only two of the four gates that are available in the CMOS package. The duration of the output pulse is determined by the values of $R1$ and $C1$, and is approximately $0.7 \times C1 \times R1$. When $R1$ has a value of 1.5 megohms, the period of the pulse is

approximately one-second-per- μF of $C1$'s value. In practice, $C1$ can have any value from about 100 pF up to a few thousand μF , and $R1$ can have any value from 4.7K to 10 megohms. The NOR version of the circuit (Fig. 5) has a normally-low output, and is trig-

gered by the edge of a positive-going input signal, while the NAND version (Fig. 6) has a normally-high output and is triggered by the edge of a negative-going input signal.

One good feature of those circuits is that the input trigger pulse can be direct coupled, and the duration of the trigger pulse has little effect on the length of the generated output pulse. Another useful feature is that the signal appearing at point A has a period equal to that of either the output pulse or the input trigger pulse, whichever is greater. That feature is valuable when making pulse-length comparators and over-speed alarms.

The operating principles of those two circuits are fairly simple. Let's look first at the circuit in Fig. 5, where IC1-a is wired as a NOR gate and IC1-b is wired as an inverter. When the circuit is in the quiescent stage, the trigger-input terminal is held low by R2, and the output of IC1-b is also low. Both inputs of IC1-a are low, so the output of IC1-a is forced high and C1 is discharged. When a positive trigger signal is applied to the circuit, the output of IC1-a is immediately forced low and, since C1 is now discharged, it pulls the input of IC1-b low and drives its output high. The output of IC1-b is coupled back to the input of IC1-a, and forces the output of IC1-a to remain low, irrespective of the prevailing state of the input trigger signal. As soon as the output of IC1-a switches low, C1 starts to charge up via R1, and after a delay determined by the values of those components, C1's voltage rises to such a level that the output of IC1-b starts to swing low, terminating the output pulse. The circuit will not return to its quiescent state if the trigger signal is high when the output pulse is terminated.

The circuit in Fig. 6 operates like the one in Fig. 5, except that IC1-a is

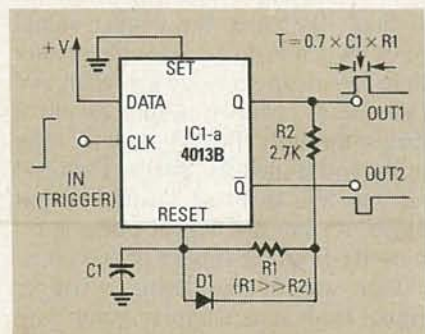

FIG. 9—A D-TYPE FLIP-FLOP can be used as a monostable. It produces both negative- and positive-going pulses.

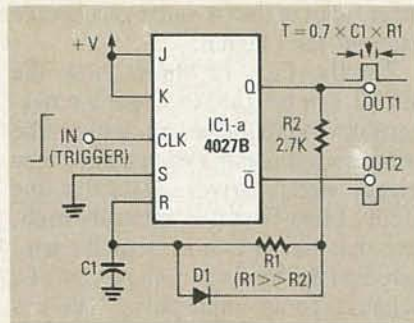

FIG. 10—A JK-TYPE FLIP-FLOP can also be used as a monostable. Its operation is similar to the D-type in Fig. 9.

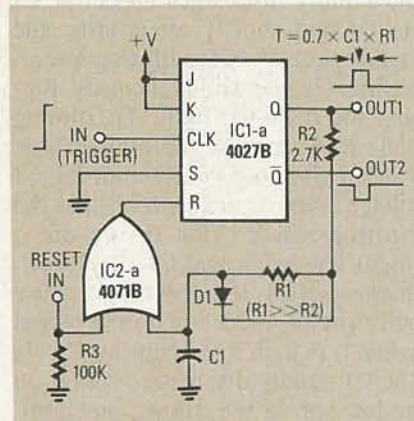

FIG. 11—THIS JK-TYPE monostable is electronically resettable.

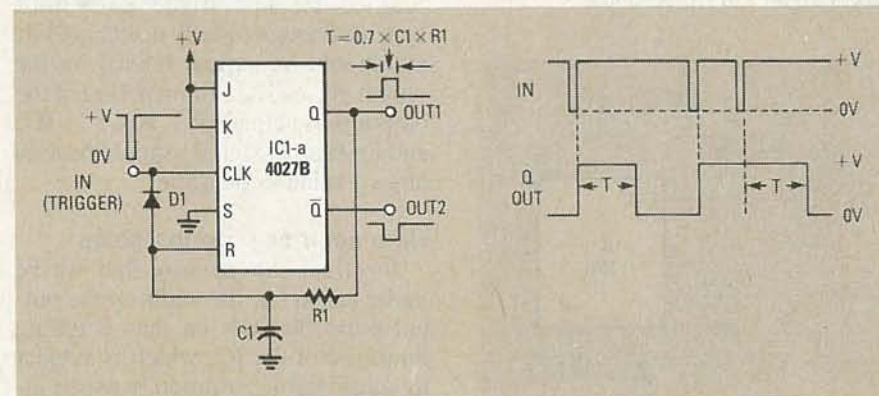

FIG. 12—A RETRIGGERABLE JK-type monostable has an output pulse that can be prolonged by an additional trigger pulse before the timing cycle ends.

wired as a NAND gate, with its trigger input tied to the positive supply via R2, and the timing-resistor R1 is connected to ground.

The circuits in Figs. 5 and 6 have their outputs coupled directly to one input of IC1-a to effectively maintain a trigger input once the original trigger signal is removed, thereby providing semi-latching operation.

The circuits in Figs. 5 and 6 can be made resettable by providing them with a means of breaking the feedback path, as shown in Figs. 7 and 8. The feedback connection from the output of IC1-b to the input of IC1-a is made

via R3. Consequently, once the circuit has been triggered, and the original trigger signal has been removed, the circuit can be reset by forcing the feedback input of IC1-a to its normal quiescent state by pressing S1. In practice, S1 can be replaced with a transistor, enabling the circuit to be reset electronically.

Flip-flop monostables

Medium-accuracy monostable circuits can be built using standard edge-triggered CMOS flip-flop IC's, such as the 4013B dual D-type or the 4027B dual JK-type, in the configurations shown in Figs. 9 and 10. Both circuits operate in the same basic manner, with the IC wired in the divider mode by proper connection of their control terminals (DATA and SET in the 4013B, and J, K and SET in the 4027B), but with the Q terminal connected to RESET by an RC time-delay network. The operating sequence of both circuits is as follows:

When the circuit is in its quiescent state, the Q output terminal is low and discharges timing capacitor C1 via R2 and the parallel combination of R1 and D1. Upon the arrival of a sharply

rising leading edge on the CLK terminal, the Q output flips high, and C1 starts to charge up via the series combination of R1 and R2. Eventually, after a delay determined mainly by values of C1 and R1, the C1 voltage rises to such a value that the flip-flop is forced to reset, driving the Q terminal low again. Capacitor C1 then discharges rapidly via R2 and the D1/R1 network, and the circuit is ready to generate another output pulse when the next trigger signal arrives.

The timing period of the circuits in Figs. 9 and 10 is roughly equal to $0.7 \times C1 \times R1$, and the reset period (the

time for C1 to discharge after each pulse) is roughly equal to $C1 \times R2$. In practice, R2 is used mainly to prevent degradation of the trailing edge of the pulse waveform as C1 discharges; R2 can be replaced by a jumper if degradation is acceptable. Note that the circuit generates a positive-going output pulse at Q, and a negative-going pulse at \bar{Q} .

The circuit in Fig. 10 can be made resettable as shown in Fig. 11. That is done by connecting capacitor C1 to the RESET terminal of the circuit via one input of an OR gate, and using the

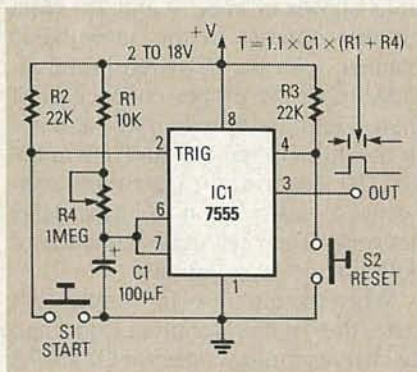

FIG. 13—THIS MONOSTABLE can be manually-triggered and has a variable pulse width from 1.1 to 100 seconds.

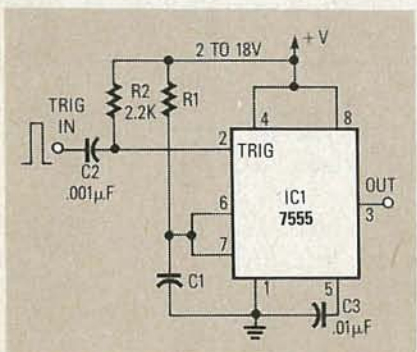

FIG. 14—THIS 7555 MONOSTABLE is similar to the one in Fig. 13, with the exception that it can be electronically triggered.

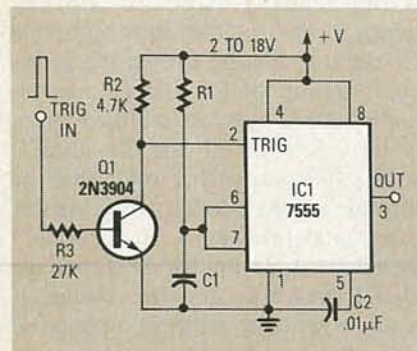

FIG. 15—A PULSE-TRIGGERED 7555 monostable can produce an accurate output pulse from a medium-accuracy input signal.

other input of the OR gate to accept the external reset signal.

Finally, Fig. 12 shows how the 4027B can be used to make a retriggerable monostable, in which the pulse period restarts each time a new trigger signal arrives. Note that the input of that circuit is normally high, and that the circuit is actually triggered on the trailing (rising) edge of a negative-going input pulse. The circuit operates as follows:

At the start of each timing cycle, the input trigger pulse switches low and rapidly discharges capacitor C1 via D1 and shortly afterwards, the trigger pulse switches high again, releasing C1 and simultaneously flipping the Q output high. The timing cycle then starts in the normal way, with C1 charging via R1 until the C1 voltage rises to such a level that the flip-flop resets. That drives the Q output low again and C1 slowly discharges via R1. If a new trigger pulse arrives in the midst of a timing period (when Q is high and charging C1 via R1), C1 rapidly discharges via D1 on the low part of the trigger, and commences a new timing cycle as the input waveform switches high again. In practice, the input trigger pulse must be wide enough to fully discharge C1, but should be narrow relative to the output pulse. The timing period of the output pulse equals $0.7 \times C1 \times R1$, and for best results, R1 should have as large a value as possible.

High accuracy monostables

In all of the circuits that we've looked at so far, the width of the output pulse depends on the switching threshold of the IC, which is subject to considerable variation between individual IC's, and variations in supply voltage and temperature. Therefore, the circuits have only moderate accuracy. If precise pulse widths are needed, the best way of generating them is to use a 7555 IC, which is the CMOS version of the ubiquitous 555 timer. It has a built-in precision voltage comparator that activates internal flip-flops and precisely controls the output pulse width, irrespective of wide variations in supply voltage and temperature. The 7555 can operate from supplies that range from 2 volts to 18 volts.

Figure 13 shows the basic way of using the 7555 as a manually triggered variable-pulse generator. The IC is triggered by briefly pulling pin 2

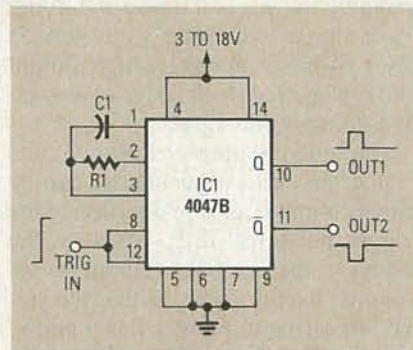

FIG. 16—THE 4047B can be used as a retriggerable monostable, with positive-edge triggering.

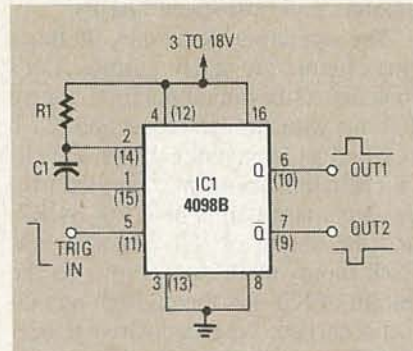

FIG. 17—THE 4098B is used here as a retriggerable monostable with negative-edge-triggering.

low (less than $\frac{1}{3}V$) via S1. At that time, the output (pin 3) switches high and the IC enters its timing cycle, with C1 charging up via the R1/R4 circuit. Eventually, after a delay of $1.1 \times C1 \times (R1 + R4)$, C1's voltage rises to the upper switching threshold ($\frac{2}{3}V$), and the output abruptly switches low, ending the timing cycle. The timing cycle can be terminated prematurely by briefly pulling RESET (pin 4) low via S2. The circuit can produce a pulse from 1.1 to 100 seconds; the duration is controlled by R4.

In most practical applications using the 7555 the designer will want to trigger the IC electronically, rather than manually (by pressing a button). If that's the case, the trigger signal must switch from an off value greater than $\frac{2}{3}V$ to an on value less than $\frac{1}{3}V$ (triggering actually occurs as pin 2 drops through the $\frac{1}{3}V$ value). The pulse width must be greater than 100 ns, but less than the desired output pulse, so that the trigger pulse is removed before the timing period ends.

One way of generating a trigger signal from a rectangular input is to connect the signal to pin 2 of the 7555 via a short-time-constant RC dif-

continued on page 71

PC SERVICE

Here are the PC patterns for the construction projects in this month's issue.
All patterns are right reading and full sized, unless otherwise noted.

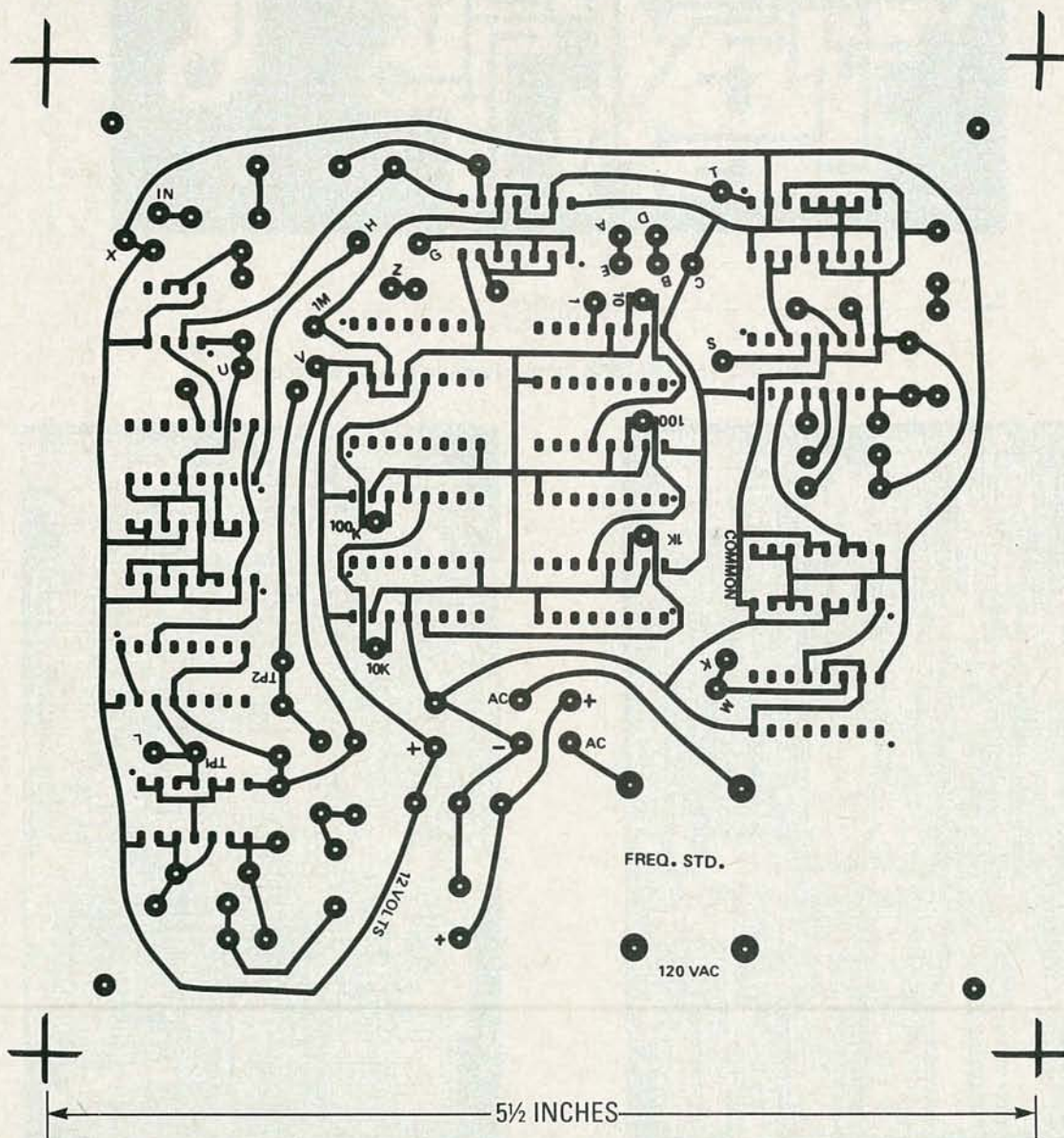

BUILD THE FREQUENCY STANDARD using this PC pattern.

PC SERVICE

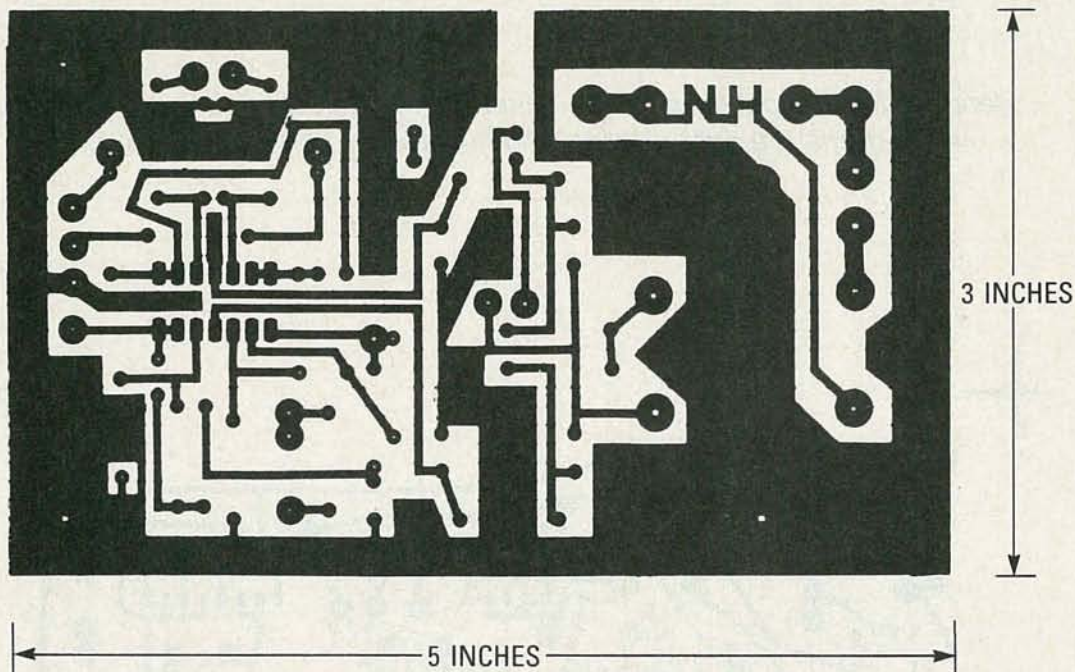

HERE'S THE PATTERN for the Surround-Sound decoder.

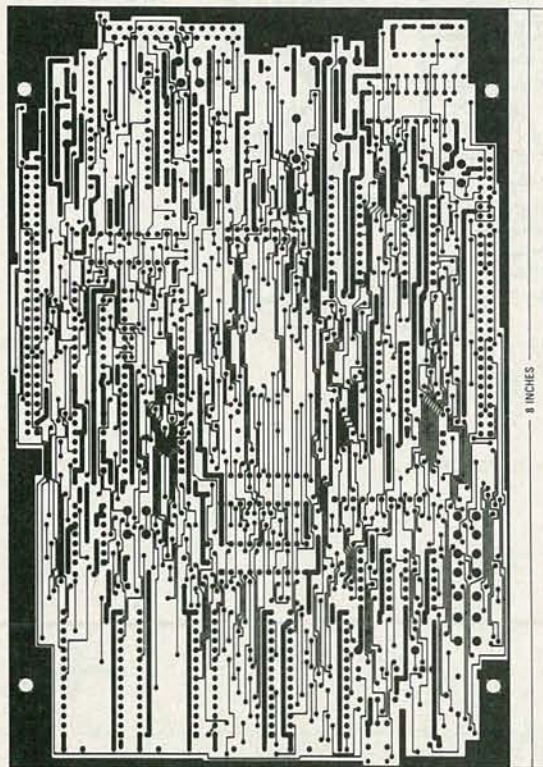

SOLDER SIDE for the REACT's board. It is shown half size.

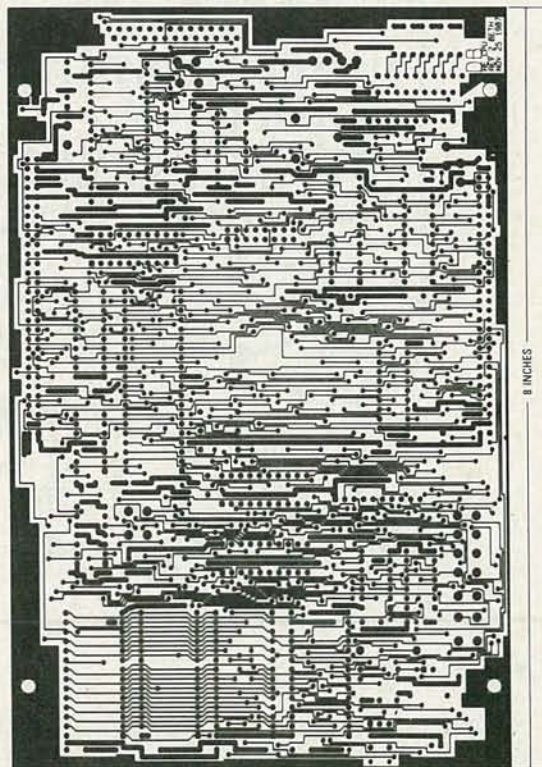

COMPONENT SIDE of the REACT's board. It is shown half size.

FREQUENCY STANDARD

continued from page 58

alignment-tool or a non-conducting screwdriver until the LED glows brightly without flicker, and the voltage at test point TP2 is between 6 and 10 volts. If you have problems with the above procedure, perform the following tests:

- Using an oscilloscope, observe the square-wave output at IC1 pin 3; it should be *clean* with no jitter, as shown in Fig. 5. Overcoupling of the antenna to the TV will cause too much signal on IC1 pin 2, which will result in an unstable output.

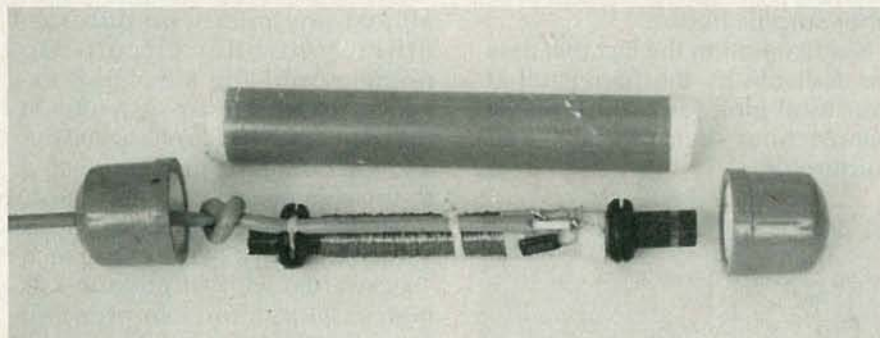

FIG. 4—THE ANTENNA IS HOUSED in a section of PVC pipe. Note that one end cap must be pre-installed on the antenna's connecting cable.

- Check the operation of IC8 by temporarily jumping pin 9 to pin 16. The VCO output at IC8 pin 4 should be greater than 1 MHz but not greater than 1.1 MHz. Reducing the value of resistor R5 will increase the operating frequency.

- Remove the jumper and check IC8 pin 1 for a narrow negative pulse that indicates the PLL is locked. Connect a frequency counter through a $\times 10$ probe at test point TP1 and adjust C10 for a reading of 3579545 Hz when 6 volts is applied to TP2 from an external power supply. In some cases, the value of C9 will need to be changed

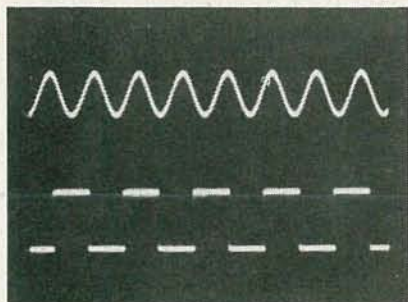

FIG. 5—THE FREQUENCY-STANDARD OUTPUT (bottom trace) should be jitter free. The top trace is the input from the antenna.

slightly to allow a proper adjustment range for C10.

- Connect a frequency counter or a scope to output jack J2 and verify proper operation of the decade counters and wiring of the frequency output select switch. The output level of the standard is adjustable between 0 and 12 volts.

Accuracy

You may have noticed that the readings on your frequency counter may not be exactly 1.000 MHz when the output selector is set for 1 MHz. The worst-case error measured when the TV was tuned to a locally-originated TV program was 1-ppm (part per million), or 1 Hz at 1 MHz. When the TV

is tuned to a network-originated program the error is less than 1 part in 10^{-7} , or 0.1 Hz at 1 MHz. (The local broadcasts are not always on the network atomic standard. Local news and local live productions use their own master oscillator.)

Set S1 for a 3.58-MHz output and select a network-originated broadcast. Then change the channel to a different network broadcast and note that the reading on the frequency counter is the same—you are thereby assured that the atomic standard is in use. Adjust the counter's timebase to exactly 3579545.45 Hz. If your frequency counter has an external timebase input you can use the 1-second (1-Hz) or the $\frac{1}{10}$ -second (10-Hz) output from the standard to gate the counter for good accuracy without having to calibrate the counter or warm up its crystal oven (if it has an oven).

The internal decade counters can be reprogrammed to divide by any number between 2 and 10, which makes a myriad of other output frequencies available to those wanting to customize the standard. R-E

MULTIVIBRATORS

continued from page 68

ferentiating network. It converts the leading or trailing edge of the input waveform into suitable trigger pulses, as shown in Fig 14.

The best way of triggering the 7555 is to use one of the previously described medium-accuracy monostables to generate a narrow (about 100 ns) positive-going trigger pulse, and transistor-couple it to pin 2 of the 7555, as shown in Fig. 15. Note in that circuit, and also the previous one, C2 is used to decouple the trigger circuitry from supply transients.

CMOS monostables

A number of dedicated CMOS monostable IC's are available. The best of those devices are the 4047B monostable/astable IC and the 4098B dual monostable. It should be noted that both devices have rather poor pulse-width accuracy and stability. They are, however, quite versatile, and can be triggered by either the positive or the negative edge of an input signal, and can be used in the standard or the retriggerable mode.

When the 4047B is used in the monostable mode, the trigger signal actually starts the astable and resets the counter, driving its Q output high. After a number of astable cycles, the counter flips over and simultaneously switches the Q output low. Consequently, the circuit will produce relatively long output pulses; the period is approximately $2.5 \times R1 \times C1$.

In practice, R1 can have any value from 10K to 10 megohms, and C1 must be non-polarized with a value greater than 1000 pF. Figure 16 shows how to connect the 4047B in the retriggerable mode. It can be reset at any time by pulling pin 9 high.

The 4098B dual monostable has two sections that share common supply connections, but can otherwise be used independently. The timing period of both monostables is controlled by a single resistor (R1) and capacitor (C1), and is approximately $0.5 \times R1 \times C1$. Resistor R1 can have any value from 5K to 10 megohms, and C1 can have any value from 20 pF to 100 μ F. Figure 17 shows the 4098B used as a retriggerable monostable that is triggered by a negative input edge. R-E

HARDWARE HACKER

Surplus EGR valves for the hacker, and more!

OUR BIG NEWS THIS MONTH IS THE brand new *Optoelectronics and Image Sensor Data Book* you can get from Texas Instruments. Inside it you will find the details on two remarkable chips called the TC240 and the TC241.

They're both solid-state image sensors intended for use in video cameras and such, with a total of 367,952 photo elements, arranged in a 754 × 488 format.

Incredibly, the TC240 also includes a set of three built-in color filters so that one single device and one simple lens is all you need to obtain full resolution red, blue, and green "RGB" color outputs. That is done by actually placing all of the individual filters precisely above each light sensing element of the IC.

If you aren't into using color, the TC241 is the same device intended for monochrome use, sans filters.

And, yes, they are available. So much for the good news. The bad news is that they are not yet hacker priced. The sensors list at \$375 in monochrome and \$405 for full color. And five other custom chips are needed to convert the sensor into a "real" camera.

But the devices are available today, and the prices are certain to drop in the future. So now is a good time to at least start studying high-resolution CCD sensors.

Let's move on to one of my all time favorites.

What is your favorite surplus component?

It's been on the surplus market for at least ten years now, and virtually no one has picked up on this incredible hacker opportunity. It's called an automotive EGR valve,

and they are available for as little as thirty cents(!) from Jerryco, besides being available in singles for \$1 to \$3 each from just about any other surplus house.

Not to mention the fact that they are available by the barrel full at your local junk yard. The original manufacturer seems to be Carter Carburetor.

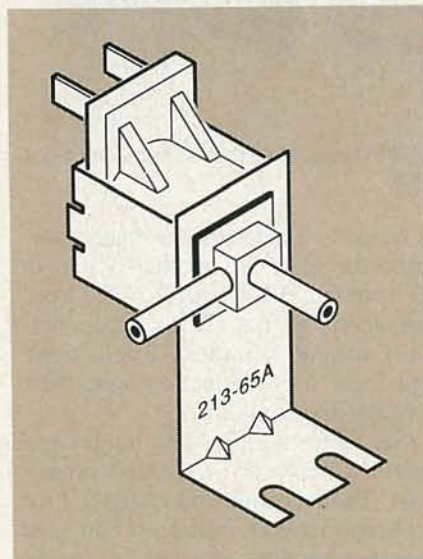

FIG. 1—3-WAY AUTOMOTIVE EGR VALVES are available for as little as thirty cents each! They are ideal for robotics and for low-pressure pneumatic hacking.

NEED HELP?

Phone or write your **Hardware Hacker** questions directly to:
Don Lancaster
Synergetics
Box 809
Thatcher, AZ 85552
(602) 428-4073.

Bar code information
Pressure transducer data
Low pressure pneumatics
Battery powered regulators
New video imaging devices

DON LANCASTER

Figure 1 shows you a typical EGR valve. What you have here is a three-way pneumatic control valve that can interface beautifully with almost any microcomputer or other controller circuit. Do nothing, and the side pipe exhausts to ambient air via a filter at the rear. Apply +12 volts at 200 mA and the front pipe gets connected to the side pipe.

While it was intended for use as a vacuum valve, you can use it "backwards" with air pressures as high as 10 psi. You can even run water through it, if you plug up the exhaust vent with epoxy.

Low-pressure air in the 4- to 6-psi range has all sorts of robotic and hacker opportunities. You can use a large aquarium pump with a simple accumulator made up from a toilet-bowl float, and a surplus regulator as a power source. Then you use the valves to activate various actuators under computer or manual control.

Unlike a solenoid, most any air actuator is cheap, tough, powerful, and offers a very linear force. It also "amplifies", since most of the muscle comes from the air pump, rather than from the electrical input. And unlike mechanisms, air lines can easily go around corners, particularly robotic elbows.

What about the actuators? Figure 2 should give you some ideas. One thing I have found out about using low-pressure air is that you absolutely, positively must never have a seal that moves! If the seal is a good one, then all your force is spent overcoming friction. If the seal is not a good one, then all your air goes bye bye around the seal and is gone forever.

So, your best bet in actuators is

NAMES AND NUMBERS

A.I.M.

1326 Freeport Rd.
Pittsburgh, PA 15238
(412) 782-1624.

Automatic ID News

7500 Old Oak Blvd.
Cleveland, OH 44130
(216) 243-8100

C & H Sales

2716 E. Colorado Blvd.
Pasadena, CA 91107
(213) 681-4925

Carter Carburetor

9666 Olive Rd.
St. Louis, MO 63132
(314) 997-7400

Clippard Minimatic

7390 Colerain Rd.
Cincinnati, OH 45239
(513) 521-4261

Computer Shopper

Box F
Titusville, FL 32781
(305) 269-3211

Ferranti

87 Modular Ave.
Commack, NY 11725
(516) 543-0200

Hygenic Manufacturing

1245 Home Ave.
Akron, OH 44310
(216) 633-8460

Identification Journal

2640 N. Halsted St.
Chicago, IL 60614
(312) 528-6600

Jerryco

601 Linden Pl.
Evanston, IL 60202
(312) 475-8440

Maxim

510 Pastoria Ave.
Sunnyvale, CA 94086
(408) 737-7600.

Melles Groit

435 S. Pacific St.
San Marcos, CA 92069
(619) 744-7060

Meredith Instruments

6403 N. 59th Ave.
Glendale, AZ 85301
(602) 934-9387

Nova Sensor

1055 Mission Court
Fremont, CA 94539
(415) 490-9100

Player Piano Company

704 E. Douglas
Wichita, KS 67202
(316) 263-3241

SenSym

1255 Reamwood Ave.
Sunnyvale, CA 94089
(408) 744-1500

Siemens

2191 Laurelwood Rd.
Santa Clara, CA 95054
(408) 980-4500

Texas Instruments

Box 5012
Dallas, TX 75265
(214) 995-3821

UPC Council

7075 Corporate Way S-106
Dayton, OH 45459
(513) 435-3870

Value Plastics

626 W. 66th St.
Loveland, CO 80357
(303) 669-4351

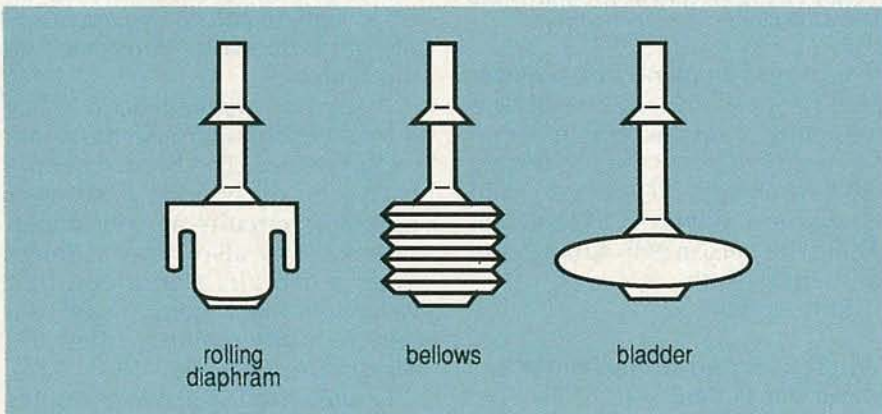

FIG. 2—THE FORMOST RULE of low-pressure hacker pneumatics is this: **NEVER** have any seal that moves! Here are some actuator ideas to get you started.

to use balloon, rolling-diaphragm, or elbow actuators of one type or another, since none of them have seals that move. Old toys at a yard sale are often an excellent source of actuator ideas.

By the way, if you ever need a static seal, a plain old "O" ring is the only way to go. Those "O" rings nearly always work like a champ. Unless you freeze one up

on a poorly designed rocket seal, of course.

Some other sources I have found handy when hacking low-pressure pneumatics: Check out Hygenic for low-cost tubing and rubber sheeting, Value Plastics for connectors, and C & H Sales for regulators. You might also check out the Clippard people for some real miniature air components,

but they often are rather overpriced.

Another "must have" reference for low-pressure pneumatics work is the superb catalog from the Player Piano Company.

You'll get the best results in the 4- to 6-psi range. Less than that and you don't get enough power. More than that and you get into seal and leakage problems.

Figure 3 shows you a typical low-pressure pneumatic system.

The accumulator is just a fairly large air tank that will hold the pressure constant during the pump cycles. Adjustable regulators, such as the one shown, typically go for around \$5 at surplus prices.

The manifold is simply any way to distribute air to several valves and actuators. A quantity of "T" connectors could also be used. I once made a manifold by taking a foot length of heavy-wall rubber tubing, 3/4-inch o.d. by 1/2-inch i.d. and then putting a pinhole every

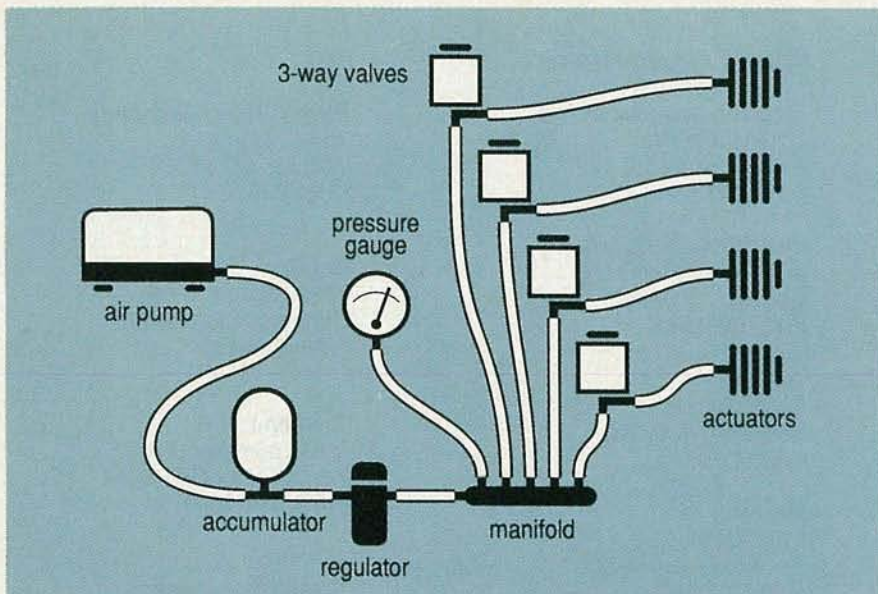

FIG. 3—A TYPICAL LOW-PRESSURE air system. Note that three-way valves MUST be used; otherwise, the air will stay stuck in the tubing and all of the actuators will remain extended.

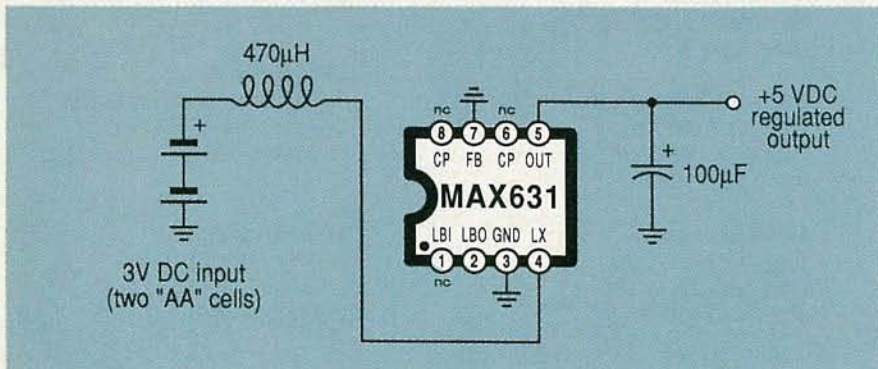

FIG. 4—THIS SIMPLE SWITCHING REGULATOR steps up two AA cells to give you a fixed +5-volt output at 10 mA. A pass transistor can be added for more output current.

place I wanted an EGR valve to go. Each valve snout was simply pushed through the tubing wall, giving an adequate seal.

One thing that beginners in pneumatics often miss—three-way valves are usually essential. If you connect an air source directly to an actuator through a two-way (or “SPST”) valve, when you turn the valve off, the air stays stuck in the actuator and the actuator will stay extended. Instead, the three-way valve action either lets you “fill” the actuator from the accumulator or else “empty” it to ambient.

Tellyawhatweregonnado. For this month's contest, just come up with a paper design that uses the valves for economical low-pressure control of gases or liquids. To start you thinking, how about an automatic bartending/drink-mixing machine? Or some sort of aide for the handicapped? Or a device

to convert any piano into a player piano? At any rate, there will be a free copy of my Incredible Secret Money Machine to the top twenty entries, and an all expense paid *tinaja* quest for two (FOB Thatcher, AZ) to the person who submits the best entry of all.

Fair enough?

Where can I go to find out all about bar codes?

Bar codes, of course, are now popping up just about everywhere, and there are all sorts of nickels to be made reading and entering codes, printing labels, or offering label software for sale to others.

While there are many different “standard” bar codes, far and away the most popular one is called the Uniform Product Code (UPC). An outfit named the UPC Council will be glad to sell you a complete set of UPC standards for \$30.

If enough of you are interested, we might go further into what those standards are and how to use them in a future column. I always like to work directly from a copy of an actual standard, rather than using any third-party information. There are fewer rude surprises that way.

Meanwhile, there are several other bar-code resources you might like to pick up on. One group is called the AIM, which is shorthand for the Association of Identification Manufacturers. Their membership list is particularly useful for pinning down bar-code sources.

Two free trade journals are also now available for all you bar-code enthusiasts. One of them is called *Automatic I.D. News*, while the other one is the new *Identification Journal*. The latter people also publish *Marking Industry*.

How do I build a battery-powered regulator?

There's often a real dilemma in any portable electronic equipment, particularly the ultra-low-power hacker stuff. Many of the integrated circuits require a finely regulated supply that is very close to +5 volts DC. On the other hand, you often would like to run off a penlight cell or two, or possibly off a nine-volt “transistor” radio battery.

A very innovative Silicon Valley integrated circuit house has come to the rescue. The Maxim people have some outstanding low-power regulator circuits at very cheap prices. They also have a *Power Supply Circuits Handbook* that you might like to get, as well as a new monthly mailing called the *Maxim Design News*.

Figures 4 and 5 are two examples of what you can do with their components. Figure 4 is a switching mode regulator that steps two AA cells up to a solid and regulated five volts. The intended output power is 10 mA or less, for which you can get 80 hours or so of operation. The integrated circuit itself needs 100 microamperes off the battery.

Figure 5 shows you a classic linear regulator that drops 9 volts down to the needed 5. Linear regulators are normally much less

efficient than switching ones. At a 10-mA load, you'll get around 55 hours of operation.

But the linear regulator has one exceptional feature—it only needs a mere 5 microamperes to operate. Thus, for very low load currents, the MAX 666 might actually give you a longer battery life.

Let's think about where we could go with ultra-efficient, ultra-low-voltage regulators. One quite obvious use is solar power, where a few series connected 0.6-volt cells could be up-converted to useful voltage levels.

And, how about this: A super-efficient, three volt output switching and up-converting regulator that can be powered from a ridiculously low input voltage, say 0.4 volt or so. Just snap one of them onto the top cell of your flashlight, and you can utterly and completely flatten your flashlight cells clear down to zilch, all the while maintaining a constant lamp output brightness.

What's new in pressure transducers?

The price of silicon pressure transducers does continue to drop ridiculously, and I'm now working up some sample circuits for you. But, to get you started, the Nova Sensor people recently had a sale on their new NPS-100 pressure sensors, for \$11 each. That beauty is packaged completely in a six pin mini-DIP. It is rated 0-15 psi, but it will need an external op-amp for most serious hacker uses.

You might also like to get a copy of the new *SenSym Pressure Sensor Handbook*. There is a wealth of design information on what pressure sensing is all about and how to go about doing it. A series of application notes is also included.

What's new this month?

There's a new and informative free *HeNe Laser Guide 2* available from the folks at Melles Griot. Besides the usual red color, they also offer helium-neon lasers in green and infrared. They are a tad pricey though; for the best in surplus and other low-cost lasers, look into Meredith Instruments instead.

Also, be sure to check out the *Standard IC Product Guide* from Ferranti Semiconductors. In-

HITACHI SCOPES AT DISCOUNT PRICES!

20MHZ



Model V212 \$475

100MHZ

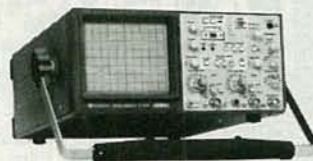

Model V1060 \$1,375

Model V-212 20MHZ Dual Channel (1mV Sens.) \$475
 Model V-422 40MHZ Dual Channel (1mV Sens.) \$699
 Model V-425 40MHZ Dual Channel (with cursor) \$825
 Model V-660 60MHZ Dual Channel (Delayed Sweep) \$990
 Model V-1060 100MHZ Dual Channel (Delayed Sweep) \$1,375
 All above scopes have a 3 year warranty on parts and labor

15-25%
**OFF LIST
 PRICE**

ELENCO PRODUCTS AT DISCOUNT PRICES!



20MHz DUAL TRACE OSCILLOSCOPE

\$349 MO-1251

**MO-1253
 40MHz
 Dual Trace
 12KV HV
 Delayed Sweep
 \$550**



35MHz DUAL TRACE OSCILLOSCOPE

\$498 MO-1252

Top quality scopes at a very reasonable price. Contains all the desired features. Elenco's 2 year guarantee assures you of continuous service. Two 1x, 10x probes, diagrams and manual included. Write for specs.
 100MHz test probes, switchable 1x, 10x, Ref. (Complete w/ 5 accessories) Fits most scopes \$22



MULTIMETER with CAPACITANCE AND TRANSISTOR TESTER
 Model CM-1500A **\$58**
 Reads Volts, Ohms, Current, Capacitors, Transistors & Diodes W/Case



TRUE RMS 4 1/2 DIGIT MULTIMETER
 Model M-7000 **\$135**
 .05% DC Accuracy
 .1% Resistance with Freq. Counter & Deluxe Case



Auto Ranging plus Manual Ranging
 3 1/2 Digit Meter
 28 Functions
 Fully protected

M-1180 .7% Acy \$36.95
 M-1182 .25% Acy \$39.95
 M-1181 .1% Acy \$42.95



GF-8016 FUNCTION GENERATOR with Freq. Counter
\$239

- Sine, Square, Triangle
- Pulse, Ramp, .2 to 2MHz
- Frequency .1 thru 10MHz

GF-8015 without Freq. Meter \$179



10MHz OSCILLOSCOPE
\$239
 Model S-3000

- 10MHz DC or AC
- Triggered Sweep
- Calibrated Vert & Hor
- Reads Volts & Freq

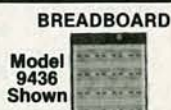

BREADBOARD
 Model 9436 Shown

9430 1,100 pins \$15
 9434 2,170 pins \$25
 9436 2,860 pins \$35



DIGITAL TRIPLE POWER SUPPLY
 Model XP-765 **\$239**

0-20V @ 1A
 0-20V @ 1A
 5V @ 5A

Fully Regulated, Short Circuit Protected with 2 Limit Cont. 3 Separate Supplies

XP-660 with Analog Meters \$169.50



DIGITAL LCR METER
\$138

Model LC-1800 Measures: Inductors, Capacitors, Resistors

50MHz LOGIC PROBE
 20 nsec with memory LP-700



Logic Pulsar LP-600 **\$23**



QUAD POWER SUPPLY
 Model XP-580 **\$59.95**

2-20V @ 2A
 12V @ 1A
 +5V @ 3A
 -5V @ .4A

Fully regulated and short circuit protected
 Model XP-575 without meters \$49.95

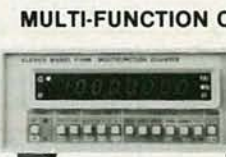

MULTI-FUNCTION COUNTERS

F-1000 **\$259**
 1.2GH

F-100 **\$179**
 120MH

Frequency, Period, Totalize, Self Check with High-Stabilized Crystal Oven Oscillator, 8 Digit LED Display

C&S SALES INC., 1245 Rosewood Dr. Deerfield, IL 60015
 800-292-7711 312-541-0710 ASK FOR CATALOG



15 DAY MONEY BACK GUARANTEE

2 Year Limited Guarantee! Add 5% for Postage (\$10 max), IL Res., 7% Tax

CIRCLE 109 ON FREE INFORMATION CARD

Be an FCC LICENSED ELECTRONIC TECHNICIAN!



Earn up to \$30 an hour and more!

Learn at home in spare time. No previous experience needed.

No costly school. No commuting to class. The Original Home-Study course prepares you for the "FCC Commercial Radiotelephone License". This valuable license is your "ticket" to thousands of exciting jobs in Communications, Radio-TV, Microwave, Computers, Radar, Avionics and more! You don't need a college degree to qualify, but you do need an FCC license.

No Need to Quit Your Job or Go To School
This proven course is easy, fast and low cost! **GUARANTEED PASS** - You get your FCC license or money refunded. **Send for FREE facts now. MAIL COUPON TODAY!**

COMMAND PRODUCTIONS
FCC LICENSE TRAINING, Dept. 90
P.O. Box 2223, San Francisco, CA 94126
Please rush FREE details immediately!

NAME _____
ADDRESS _____
CITY _____ STATE _____ ZIP _____

DOES YOUR DIGITAL CAPACITANCE METER DO THIS?

FULL 4 DIGIT 0.5 INCH LCD DISPLAY COMPLETELY AUTORANGING WITH 10 RANGE MANUAL CAPABILITY

- AND THIS**
RANGE OF 0.0 pF to 1 FARAD (999.9 mF)
0.5% BASIC ACCURACY UP TO 100 uF
- AND THIS**
READS DIELECTRIC ABSORPTION
- AND THIS**
EXTENDED PSEUDO 5 DIGIT
RESOLUTION ON SOME RANGES ONLY
- AND THIS**
ABILITY TO ZERO LARGE CAPACITANCE
VALUES UP TO 99.99 uF
- AND THIS**
CALCULATES TRUE CAPACITANCE
IF CAPACITOR IS LEAKY
- AND THIS**
DIODE CLAMP AND FUSED
PROTECTED INPUT.
DISCHARGE RESISTOR IN OFF
POSITION AT TERMINAL INPUTS.
POWERED BY 9V BATTERY
- ONE YEAR PARTS & LABOUR WARRANTY**
- FOR ONLY THIS**



- AND THIS**
IDENTIFIES TRANSISTORS (NPN, PNP)
AND THEIR LEADS (E, B, C, ETC.)
- AND THIS**
TESTS ZENER DIODES AND RECTIFIERS.
UP TO 20V ZENER WITH AC ADAPTOR,
ZENER VOLTAGE WITH 9V BATTERY
DEPENDS ON ITS CONDITION
- AND THIS**
AUTOMATICALLY CALCULATES LENGTHS
OF CABLES IN FEET, METRES, MILES,
KILOMETRES (THEORETICAL RANGE
OF 9,999 MILES)
- AND THIS**
ABILITY TO SORT CAPACITORS IN
MANY DIFFERENT MODES
- AND THIS**
ABILITY TO READ LEAKY CAPACITANCE
(INSULATION RESISTANCE OR CURRENT)
- AND THIS**
CALCULATES TIME CONSTANTS WITH
USER DEFINED RESISTANCE VALUES
- AND THIS**
HOLD FUNCTION FREEZES DISPLAY

SHIPPING INSTRUCTIONS:

All units shipped out F.O.B. Buffalo NY via United Parcel Service (except Hawaii & Alaska) unless otherwise indicated (in which case shipments will be F.O.B. Canada)

PLEASE SEND ME	U.S. FUNDS
(QUANTITY) MC300(S) @	\$169.95 \$ _____
CARRYING CASE	\$ 16.95 \$ _____
AC ADAPTOR	\$ 9.95 \$ _____
SHIPPING AND HANDLING @ \$5.00 PER INSTRUMENT	
[] CHECK [] MONEY ORDER	\$ _____
[] VISA [] MASTERCARD	\$ _____
[] CARD NO. _____	TOTAL \$ _____
EXPIRY DATE _____	SIGNATURE _____
NAME _____	TELEPHONE _____
ADDRESS _____	
CITY _____ STATE _____	ZIP CODE _____

MODEL MC300 Approx. Size 7" x 4" x 1 1/2"
DAETRON
a division of Bergeron Technologies Inc.
935 THE QUEENSWAY, BOX 641
TORONTO, ONTARIO M8Z 5Y9
CANADA (416) 676-1600

DEALER ENQUIRIES INVITED

CIRCLE 194 ON FREE INFORMATION CARD

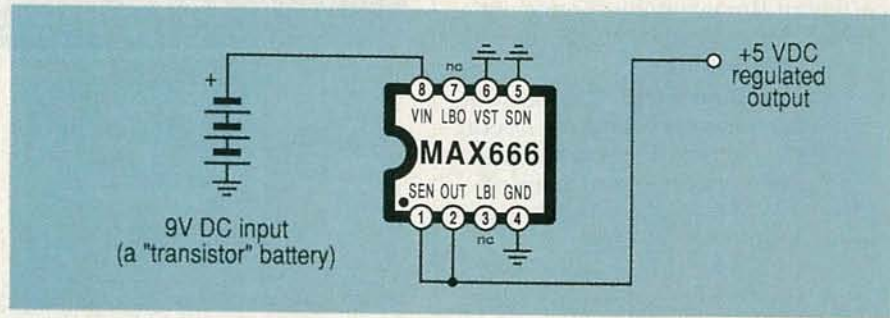

FIG. 5—THIS LINEAR REGULATOR drops down a 9-volt battery to give you a fixed +5-volt output at up to 40 mA. The standby current is a mere 5 μ A.

cluded here are details on such hacker IC oddments as special television-pattern chips, low-noise preamps, telephone circuits, A/D and D/A stuff including video, some digital thermometers, and lots more.

A new *Integrated Circuits and Microcomputers* short form catalog is available from Seimens. Included there are remote-control chips and infrared receivers.

Turning to my own product, for any of you interested in Apple computing, there's my *AppleWriter Cookbook*, *Apple Assembly Cookbook*, *Enhancing your Apple IIe*, volumes I and II,

and my *Ask the Guru* reprints from one of my other columns over in the *Computer Shopper*. I do stock autographed copies on hand here for you.

Once again, this is your column, so be sure to write or call. I'll be most happy to send you more info on all my hacker goodies. **R-E**

LETTERS

continued from page 22

reel; r_o = radius of empty take-up reel; r = radius of tape pack:

$$n = K_1(r - r_o) \quad (1)$$

$$l = K(\pi r^2 - \pi r_o^2) \quad (2)$$

$$\text{or } l = K_2(r^2 - r_o^2) \quad (2)$$

These equations may be solved for l as a function of n , or for n as a function of l . By solving (1) for r and substituting into (2) we get:

$$l = \frac{K_2}{K_1^2} n^2 + \frac{2K_2 r_o}{K_1} n \quad (3)$$

Using the quadratic formula to solve (3) we get:

$$n = K_1(\sqrt{r_o^2 + l/K_2} - r_o) \quad (4)$$

To find values for K_1 and K_2 , all that is needed is a ruler and the number of counts at the end of a tape. To get this, simply record for 2 hours at SP and look at the counter. My "typical" T-120 tape had about 126 minutes of tape on it. For my typical T-120:

$$r_{\text{end}} = 39.1 \text{ mm}$$

$$r_o = 12.8 \text{ mm}$$

I must confess that I do not use that method with my home VCR. Instead, I use a tabular listing of 30 minute (EP) readings. This is easier, and accurate enough for my purposes.

P.S. Congratulations on signing up Don Lancaster; he's a great addition to **Radio-Electronics!**

CHARLES KEITH
Poway, CA

R-E

NEW IDEAS

Simple sine-wave generator

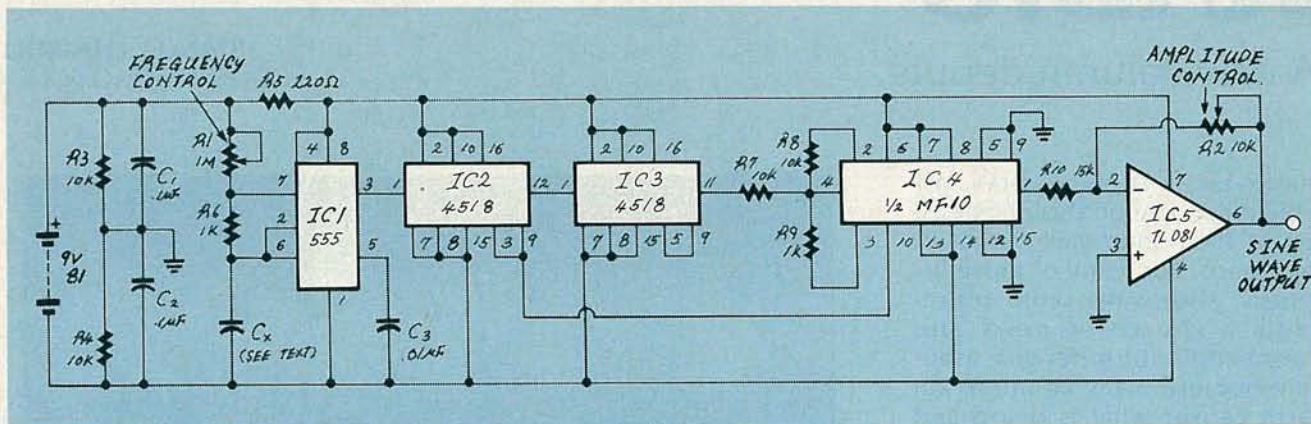

FIG. 1

FOR PEOPLE WHOSE NEEDS DON'T WARRANT buying an expensive feature-filled sine-wave generator, a simple, low-cost one might often be useful. The circuit shown here is just that. It features amplitude and frequency controls, is made from low-cost components that are easy to obtain, and is powered from a 9-volt battery.

At the heart of the sine-wave generator circuit shown in Fig. 1 is an MF-10 IC made by National Semiconductor. It is part of a new generation of switched-capacitor filters that use an ingenious technique of switching internal capacitors to determine the cutoff frequency. The output frequency of the MF-10 follows the frequency of an external clock. A square-wave input signal is fed into the device, and only the frequency of the clock signal is allowed to pass through. All other components of the input signal are filtered out. Because both the clock signal and the input signal must be square waves, a dual-output square-wave oscillator is used to simultaneously drive the clock and signal inputs. Therefore, the clock signal and the input signal are correspondingly shifted so that the MF-10 always filters out all but the

fundamental frequency of the input signal. The result is a nice clean sine wave at the output.

A 555 timer operating in the astable mode generates the driving pulses and two 4518 dual BCD (Binary Coded Decimal) counters provide the square waves. A TL081 op-amp serves as an output buffer-amplifier, and potentiometers R1 and R2 are used in order to control the pulse's frequency and amplitude respectively.

The output-frequency range can be varied by changing C_x . For example, a value of 0.1 μF gives a range from about 0.1–30 Hz, and a value of 470 pF gives a range from about 10 Hz to 1.5 kHz. The maximum output frequency is 30 kHz.

The circuit can be built on a piece of perforated construction board using point-to-point wiring techniques. Further, it is inexpensive to build, and therefore practical for use in dedicated applications where the sine-wave generator is permanently incorporated into another circuit or device.

For more information on the MF-10 switched capacitor filter IC, write to National Semiconductor Corporation, 2900 Semiconductor Drive, Santa Clara, California 95051.—Dale Nassar.

R-E

NEW IDEAS

This column is devoted to new ideas, circuits, device applications, construction techniques, helpful hints, etc.

All published entries, upon publication, will earn \$25. In addition, for U.S. residents only, Panavise will donate their model 333—The Rapid Assembly Circuit Board Holder, having a retail price of \$39.95. It features an eight-position rotating adjustment, indexing at 45-degree increments, and six positive lock positions in the vertical plane, giving you a full ten-inch height adjustment for comfortable working.

I agree to the above terms, and grant **Radio-Electronics** Magazine the right to publish my idea and to subsequently republish my idea in collections or compilations of reprints of similar articles. I declare that the attached idea is my own original material and that its publication does not violate any other copyright. I also declare that this material has not been previously published.

Title of Idea

Signature

Print Name

Date

Street

City

State

Zip

Mail your idea along with this coupon to: **New Ideas Radio-Electronics**, 500-B Bi-County Boulevard Farmingdale, NY 11735

SHORTWAVE RADIO

A new column debuts

STANLEY LEINWOLL,
CONTRIBUTING EDITOR

DURING EACH WEEK, MORE THAN HALF a billion people on this planet listen to their shortwave radios at least once. For many of those listeners, shortwave radio represents a source of news and information not otherwise available because many countries on Earth censor what is heard and seen on their media.

For many millions of other listeners, the excitement of shortwave radio comes from seeking broadcasts that originate as far as half a world away, in remote, and sometimes unlikely, corners of the world. The miracle of shortwave radio makes it possible, at virtually any time of day or night, to seek out those distant stations and, sometimes as an end in itself, obtain verification that they were heard on a given frequency at a particular time of day. The hobby of verifying broadcasts—DX'ing—has grown rapidly in the United States in recent years.

Whether you listen to shortwave radio to obtain another viewpoint, because you are a DX'er, or for the sheer joy of listening to the world, this column is for you.

I do not plan to inundate you with numbers unless they are of particular significance. There are more than enough shortwave publications available that provide numbers by the ton, and the *World Radio and TV Handbook* has more numbers in it than you can shake a whip antenna at.

What I hope to accomplish is to inform you about the general conditions you can expect during the next two months to facilitate your listening. You will be told which

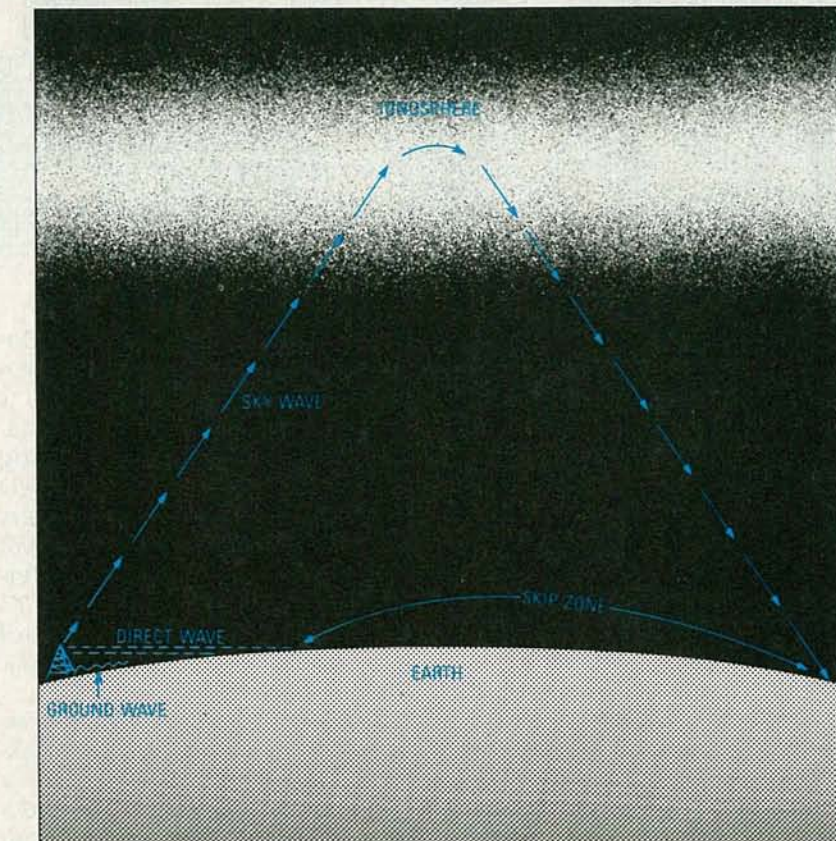

FIG. 1

frequency bands will be best during the listening period, as well as any unusual conditions.

There will also be a bi-monthly feature on a subject of special interest to listeners and DX'ers. Among the topics to be covered in future columns are sunspots, jamming, out-of-band broadcasting, radio storms, etc. In addition, other topics of more than passing interest will be covered, even though they don't relate directly to shortwave. For example, within a few years we will be seeing regular

CB, TV, and possibly FM and amateur 6-meter DX. We hope to tell you about it just before it starts happening. I also hope to devote a future column to medium wave (broadcast band) DX.

I will have a chit-chat section that will periodically provide you with insider information: What new transmitter sites are under construction? What broadcasters are exchanging facilities, and where? What new clandestine stations are being heard, and where are they located?

Finally, and this will depend on you, there will be a mail-bag section. I will try to answer all your questions, and those of special interest will be reprinted here.

So, without further delay, let's begin. And what could be more appropriate for a shortwave column than to describe the medium itself, and how it works?

Shortwave propagation

When a radio wave leaves a transmitting antenna, it travels outward in all directions, as shown in Fig. 1. Part of the signal travels along the ground, and is called the *ground or surface wave*. Part of the signal travels through the lower atmosphere in a direction nearly parallel to the surface of Earth, in a line of sight trajectory. That component of the signal is called the *direct or space wave*. Still another part of the signal travels upward at an angle to Earth. That component is generally referred to as the *sky or the ionospheric wave*.

In the shortwave (high-frequency) portion of the spectrum (3-30 MHz), the ground- and space-wave components travel relatively short distances that rarely exceed 25 or 30 miles. The sky-wave component, however, often propagates to great distances, making long-distance shortwave communication possible. The medium that makes that possible is the ionosphere, a region of electrified gases in Earth's upper atmosphere that has the unique property of being able to bend, or refract, certain radio frequencies and return them to Earth at considerable distances.

Rocket, satellite, and other measurements have shown that the ionosphere extends from about 60 miles to several hundred miles above the surface of Earth. It is formed primarily by ultraviolet and X-rays from the sun. That solar radiation interacts with the gases in Earth's upper atmosphere and ionizes them—separates them into positively charged gas molecules and free electrons. The process is called ionization and the region is collectively called the ionosphere.

The ionosphere is not a single region. It actually consists of several distinct layers. Those layers,

whose characteristics vary, are formed by different wavelengths of solar radiation. The most important layer of the ionosphere, insofar as shortwave radio is concerned, is the F-layer, which starts at an altitude of about 150 miles and extends to about 300 miles above the surface of the earth.

Radio signals that are refracted by the F-layer may be returned to Earth at distances as great as 2,000 miles from the transmitter. At the point where a signal returns to Earth, it may be reflected by the ground and returned once again to the ionosphere, where the process of refraction is repeated. That process may take place several times, and, although the signal weakens with each "hop," signals are often transmitted to remotely distant points by means of that multiple-hop method of propagating radio waves.

The skip zone

Close to the transmitting antenna, the ground and direct wave components are strongly received. The signal strength drops off very rapidly as the distance from the antenna increases, and within 25 or 30 miles or so is too weak to be received. Beyond the limit of ground and direct-wave reception there generally lies a zone of silence in which the signal cannot be heard. Then, at a still greater distance, a strong signal is received again. That is where the sky wave component first returns to Earth after being refracted by the ionosphere. The region between the end of the direct wave and the beginning of the sky wave is called the *skip zone*, and the distance between the two is called the *skip distance*. Both are functions of the frequency, time of day, and many other factors, which we will discuss in future columns.

There is rarely any skip zone after the first hop—that is the region where the sky wave first returns to Earth. That is so because the radio energy is widely dispersed by the planet, Earth, and by the ionosphere, as well.

Frequency dependence

When a shortwave radio signal enters the ionosphere it will either

continued on page 83

CABLE-TV

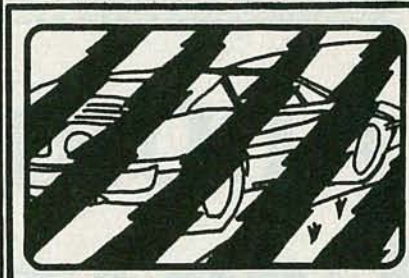

signal remover

50dB NOTCH FILTER

Any* signal coming in on your cable can be completely "removed" with this powerful filter. Particularly useful on "pay" channels. Also can be used to eliminate any* over-the-air signal which prevents normal reception. The filter's external adjustments allow precise tuning to any frequency required.

*AVAILABLE FOR THE FOLLOWING CHANNELS:

- MODEL 26 - For any channel between 2 and 6 (Tuning range 54 - 108 Mhz)
- MODEL 713 - For any channel between 7 and 13 (Tuning range 174 - 216 Mhz)
- MODEL 1422 - For any channel between 14(A) and 22(I) (Tuning range 120 - 174 Mhz)

★★ ONLY \$30 EACH ★★ 30 DAY FREE TRIAL ★★
To order, send \$30 check or money order. Specify Model. If not completely satisfied, simply return within 30 days for a full and speedy refund.

- ★ All models in stock
- ★ One year warranty
- ★ Fast, free delivery
- ★ Quantity discounts to 50%

STAR CIRCUITS/DEPT. R
P.O. BOX 8332, PEMBROKE PINES, FL 33084

ATTENTION! ELECTRONICS TECHNICIANS

EARN YOUR
**B.S.E.E.
DEGREE**

THROUGH HOME STUDY

Our New and Highly Effective Advanced-Placement Program for experienced Electronic Technicians grants credit for previous Schooling and Professional Experience, and can greatly reduce the time required to complete Program and reach graduation. No residence schooling required for qualified Electronic Technicians. Through this Special Program you can pull all of the loose ends of your electronics background together and earn your B.S.E.E. Degree. Upgrade your status and pay to the Engineering Level. Advance Rapidly! Many finish in 12 months or less. Students and graduates in all 50 States and throughout the World. Established Over 40 Years! Write for free Descriptive Literature.

COOK'S INSTITUTE OF ELECTRONICS ENGINEERING



4251 CYPRESS DRIVE
JACKSON, MISSISSIPPI 39212

CIRCLE 58 ON FREE INFORMATION CARD

AUDIO UPDATE

History of hi-fi

HI-FI AUDIO COMPONENTS AND THE baby boom were both post-World War-II phenomena. It has been suggested that the interest in high-quality audio equipment may have resulted from the technical training acquired during military service; the baby boom was self-explanatory. In any case, during the late 1940's and early 1950's, returned veterans began to acquire—through different means—both babies and audio equipment.

In June 1948, when Columbia Records announced the 33-1/3 rpm microgroove LP record, the "premature" audiophiles of the day were essentially limited to public-address, recording-studio, and broadcast equipment. If you were truly dedicated to operating at the leading edge of audio reproduction, you might own a 250-pound broadcast-console two-speed turntable with a 16-inch transcription arm bearing a very expensive European magnetic cartridge. All of that was to change in only a few short years.

Early components (circa 1950)

A Sun Radio pamphlet entitled *Audio Equipment Handbook for Music Lovers* that was published in the early 1950's listed 15 phono-equipment manufacturers, 17 tuner and amplifier manufacturers, and 14 speaker manufacturers. And I suspect that there were at least a dozen more companies whose products weren't represented. A page spread from that pamphlet is shown in Fig. 1 where some of the accessories that were available can be seen. Some of the listed brand names still exist as au-



LARRY KLEIN
AUDIO EDITOR



FIG. 1

dio companies—Pickering, Altec Lansing, Scott, Jensen, Jim Lansing (JBL), Electro-Voice—but most have long since faded away. Perhaps it's worth mentioning that everything was tube-operated in those good old days, and stereo was something that you looked through funny glasses to see.

Tuners

In 1950, Browning, Radio Craftman, and Meissner were important brand names, and FM/AM-tuner prices ran from a low of about \$45 to almost \$200 for a state-of-the-art-model that included a full complement of switched inputs and tone controls; however, stereo FM broad-

casting was still about 10 years away. The higher-priced quasi-pre-amp tuners were meant to directly feed a power amplifier.

Amplifiers

The amplifiers in those days were mostly single-chassis integrated models with powers ranging from 8 watts to a high of about 30 watts. Prices ranged from about \$40 to over \$200 for an H.H. Scott "remote control" amplifier with a "Dynaurl" noise-suppressor circuit. The remote-control feature referred to a separate full-featured preamp that derived its power-supply voltages through a thick multiconductor cable plugged into the power-amp's chassis.

The high-end models were usually massively built two-chassis units with powers ranging from 10 to 30 watts, just like their smaller single-chassis brethren. However, the other specs were slightly better, although 1.5 to 2% distortion at full output was about as good as most equipment could manage at the time.

The British had a burgeoning audio industry on their home island and were represented here by prestigious brands such as Tannoy, Wharfedale, Goodmans, Garrard, and Leak. In the next several years, British-made products acquired such an excellent reputation among knowledgeable New York audiophiles (many of whom were Jewish) that it was suggested that in order to be a successful audio sales manager in the U.S. it was necessary to "Look British—and speak Yiddish."

The Williamson power-amplifier circuit appeared in England in 1947 and its simplicity and superior performance made it a popular build-it-yourself project for advanced audiophiles on both sides of the Atlantic. It required a carefully wound output transformer, and the original article in *Wireless World* provided precise instructions on how to wind your own. Several companies came up with versions of the transformer, and commercial versions of the Williamson amplifier subsequently appeared under a variety of U.S. and British brand names.

Record players

Changers of reasonable quality were available from Webster-Chicago, Garrard, and V-M, but anyone who was really serious owned a manual turntable from Red-O-Kut, Presto, or later, Thorens. Tone arms and cartridges were available from Audax, Clarkstan, Fairchild, Pickering, General Electric, and Weathers. The last two deserve special discussion: The GE was a high-quality, reliable "variable-reluctance" magnetic cartridge that was only slightly more expensive than the crystal cartridges of the day. However, it did require a "pre-amplifier" to boost its 6-8 millivolt output up to the 0.5-volt level of the usual "xstl" phono-cartridge input. It was a tribute to the suc-

cess of the GE cartridge that in the next year or so all new integrated amplifiers—even those at the lower-price levels—came with "mag" inputs. A 6SC7 tube usually provided the extra gain.

The Weathers FM cartridge and tone arm were exceptional products very much ahead of their time. For example, the Weathers cartridge would track reliably at 1 gram, while most other brands were grinding away at 6 to 8 grams. The Weathers low-mass basswood tone arm not only ignored warps, but was so designed that it was untroubled by the critical leveling requirements that troubled most other arms. In fact, I found that the Weathers tone arm could play reliably with the turntable tilted at a 45-degree angle.

All cartridges offered a choice of sapphire or diamond stylus and tip radii intended for microgroove (LP) or standard (78 rpm) recordings. Of course, everything was monophonic since stereo discs were not due to appear until mid-1958.

Tape

In the early 1950's there were a few open-reel home tape recorders, most of which offered single- or two-track heads, and 3-3/4, 7-1/2, and 15 ips (inches per second) speed options. The best of the units, which cost between \$350 and \$500 in 1954 dollars, had a performance at their 15-ips speed roughly equivalent to that of a cassette deck selling for \$350 to \$500 in inflated 1986 dollars. Some of the two-track machines that were available could be hooked up to play stereo, but there wasn't any real interest in stereo tape until Shure's 1958 introduction of the first four-track tape head.

Stereo growing pains

1958 was a very good year for stereo. The conflict among the various stereo-disc formats was finally resolved in favor of the Westrex system still in use today. The audio industry geared up for the change, and the 1959 hi-fi directories listed about thirty models of stereo preamps, power amps, and integrated amplifiers. (The directories from the previous year had *continued on page 84*

You Can Be
One Of The
20,000 Technicians
Certified By IS CET



The International Society Of Certified Electronics Technicians offers permanent certification by administering the CET exam with the FCC recognized communications option for \$20. A second exam on FCC regulations for a \$10 fee is required for a Radiotelephone License. Upon passing, technicians receive both a permanent Radiotelephone Operator Certificate and a CET Certificate issued by IS CET.

IS CET Offers License Renewal

IS CET has developed a program for registration of those who currently hold a valid Radiotelephone Operator License. By sending a completed application, a photocopy of your FCC License, and \$10 your license will be renewed with the assurance of a recognized national technicians association behind it.

For More Information Contact:

IS CET 2708 W. Berry, Ft. Worth, TX
76109. (817) 921 - 9101

BRIEF CASE RECORDERS



NEW
12 HOUR
MODEL

USES
D-120
TAPE

\$359.00**

Modified Panasonic recorder installed in top quality 3 inch Samsonite™ Attache Case. Has built in electret condenser mike. Recorder is activated by combination lock on brief case. Unit provides complete portable recording capability. Fold down work table conceals recorder. TDK DC 120 Cassette furnished.

OTHER AMC ITEMS

12 hour modified Panasonic recorders, \$105.00**. Also Telephone Recording Adaptors \$24.50*, VOX SWITCHES \$24.95*, Micro recorders with tie clip microphone, VOX activated micros, Wired mikes, Transmitter detectors, etc. Send for FREE data. **Add \$4.00 each shipping and handling. *Add \$1.50 shipping and handling. Calif. residents add sales tax. Mail Order.

AMC Sales Inc., Dept. A (213) 869-8519
9335 Lubec St., Box 928, Downey, Calif. 90241

CIRCLE 108 ON FREE INFORMATION CARD

ANTIQUE RADIOS

Our readers write

THIS MONTH, WE'LL TURN OUR ATTENTION to some of the many questions I've received from budding antique-radio hobbyists. Not surprisingly, many of those questions have involved the prices of some old radios.

Assigning a monetary value to an old radio is a very subjective task. Technically, no radio can truly be an antique; in the antique field, that term is generally reserved for items that are at least 100 years old. Instead, a radio is a "collectible." As with all collectibles, or antiques for that matter, the value is set by the marketplace and hinges on several factors. Of course, the condition of both the electronics and the cabinet are critical, but regional demand and the "fad" factor can also play significant roles. There are several price guides available, but their accuracy can vary widely.

Further, there's no guarantee that market conditions will stay the same or improve. An antique or collectible that's "hot" today could easily be "cold" tomorrow, leaving those who invested in that type of item with large losses.

Therefore, the best guide to value is common sense. Collect for the pleasure of it, not for future rewards. When sizing up a new acquisition ask yourself: What am I willing to pay to add this particular radio to my collection? The answer will tell you whether or not a radio is a "good buy."

What is it?

Many readers are sending in photos or descriptions of radio sets for me to identify. I always



FIG. 1

enjoy receiving such photos because early sets are fascinating. But, would you believe that during the first decade of broadcast radio (the 1920's), there were over 1000 manufacturers! Some made many different models during that time, others made but a few.

What's more, during the same period there were many hobbyists that built their own sets from plans published in the electronics magazines of the day. Those sets often used top-quality parts and featured construction that was superior to anything available in a store. The radios they built make up a large pool of unidentified and unidentifiable units.

Despite all of those handicaps, if you send in your photos, I'll do my best to identify a set for you, or at least match it up with a similar one. However, if you want any of those photos returned, *please enclose a self-addressed, stamped envelope*. Otherwise those photos will remain in my files.

Radio restoration

Don't get the idea that none of the questions I get are technical; many are. But the most popular



RICHARD D. FITCH

question is how faithful to the original must a restoration project be?

The answer is that it should be as faithful to the original as is practical. If you are going to restore only one or two radios, then it's possible and enjoyable to take the time to search out the part or parts that you need. But if you are someone like myself that may have some 30 or 40 sets on hand at a time, some allowances must be made to keep from being overwhelmed. It's a lot more rewarding to get your sets operating and on display (see Fig. 1) then to have them all on your workbench waiting for original parts.

There is a difference, however, between making a substitution or modification and stripping an antique radio of any semblance of its original design. Some readers have asked that I cover using solid-state components as substitutes for vacuum tubes. I won't do that because it goes against the spirit of what most antique-radio hobbyists are trying to achieve. Even if the changes were made under the chassis and the original components were left in place for show, it would be little better than installing a transistor radio in an old cabinet. Old tubes, etc., may be hard to find, but there seems to be sufficient supply still around to make doing that type of modification unnecessary.

On the other hand, however, if you need to replace a capacitor or resistor, there's no reason not to use a modern component. Further, capacitors often deteriorate over time. That's particularly true

of the old paper types. In fact, some hobbyists practice a little bit of preventive medicine by replacing all of the capacitors in their sets with new units.

On-off switches can be a headache. That's because they sometimes are combined with other components, such as a potentiometer. For safety, **never try to repair a broken power switch.** Instead, find a suitable replacement. Sometimes, an electronic wholesaler can fabricate a suitable switch, however there are few who will take the time to search their stocks for the suitable parts. A long-established TV or radio repair shop may be more helpful, or try sending an SASE to some of the names on the Haves list that we publish on occasion.

To operate the set in the meantime, you can use a simple toggle switch. Mount the switch on a bracket at the rear of the chassis rather than on the front of the cabinet. Then you won't have a hole to patch later.

Working with cabinets

That brings us to our last popular question for this month: How do I restore my cabinet? Unfortunately, the time to ask that question is when you are buying the set. The condition of the cabinet should play an important role in determining whether the radio is worth having, especially if you are not experienced in woodworking. Further, the condition of the cabinet will often reflect the condition of the chassis.

Even if you are comfortable working with wood, you should remember that refinishing radio cabinets is more difficult than refinishing many other pieces of furniture because you are working with thin veneers cemented to a lower-quality wood.

The reading list

On occasion I mention something in my column that results in a stack of mail. Recently, that happened with my request for reading material on antique radios. As soon as I can confirm the availability of the various publications, I will pass the information along. My thanks to everyone who took the time to respond. **R-E**

SHORTWAVE RADIO

continued from page 79

be reflected back to Earth, penetrate the ionosphere and be lost in outer space, or be absorbed by the ionosphere and so weakened that it dies out entirely. The effect of the ionosphere on the radio wave depends primarily on its frequency, the angle at which it leaves the transmitting antenna, and the variable condition of the ionosphere.

With few exceptions, the ionosphere will reflect a fairly wide range of frequencies. Frequencies above that range will penetrate the ionosphere, and frequencies below it will be absorbed. The highest frequency that the ionosphere will reflect over a particular circuit is called the *Maximum Usable Frequency*, or MUF. The *Lowest Usable Frequency* is called the LUF.

That's all for now. Next time we'll continue with a discussion of the layers of the ionosphere.

Condition report

Many of the world's shortwave broadcasters will make major schedule changes on March 6, in accordance with international radio regulations, which stipulate schedule changes be made on the first Sunday in March, May, September, and November.

During recent years, however, there has been a tendency on the part of some major broadcasters, such as the Voice of America and the BBC, to make major schedule changes only twice yearly—in March and September, to coincide with the changes in European clock time.

On March 27, therefore, when Europe shifts to summer time, the VOA and the BBC will, among others, inaugurate their summer schedules, which will continue until September 25.

During the spring, with increasing hours of daylight in the northern hemisphere, the higher bands—15, 17, and 21 MHz—will be open longer. At night, frequencies from 6 to 11 MHz will be open for DX, with 11 MHz especially strong from Latin America, Africa, and Australia. **R-E**

Get A Complete Course In

ELECTRONIC ENGINEERING

8 volumes, over 2000 pages, including all necessary math and physics. 29 examinations to help you gauge your personal progress. A truly great learning experience.

Prepare now to take advantage of the growing demand for people able to work at the engineering level.

Ask for our brochure giving complete details of content. Use your free information card number, or write us directly. **\$99.95**, Postage Included. Satisfaction guaranteed or money refunded.



**Banner
Technical
Books, Inc.**

1203 Grant Ave.
Rockford, IL 61103

CIRCLE 183 ON FREE INFORMATION CARD

Need Quick Turnaround on CRYSTALS?

**Try Our E.O.D.
(Emergency Order Dept.)**

and get

**JAN QUALITY
and STABILITY
PLUS Low Prices!**

You benefit from 21 years of manufacturing quality crystals for industry, military services, radio amateurs, citizen band and experimenters.

To Get Free Catalog
Call or Write

JAN CRYSTALS

P.O. Box 06017
Ft. Myers, FL 33906
(813) 936-2397



**CALL 1-800-237-3063
FREE (Except Florida)**

CIRCLE 104 ON FREE INFORMATION CARD

APRIL 1988

R-E Engineering Admart

Rates: Ads are 2 1/4" x 2 1/8". One insertion \$825. Six insertions \$800 each. Twelve insertions \$775 each. Closing date same as regular rate card. Send order with remittance to Engineering Admart, Radio Electronics Magazine, 500-B Bi-County Blvd., Farmingdale, NY 11735. Direct telephone inquiries to Arline Fishman, area code-516-293-3000. Only 100% Engineering ads are accepted for this Admart.

FCC LICENSE PREPARATION

The FCC has revised and updated the commercial license exam. The NEW EXAM covers updated marine and aviation rules and regulations, transistor and digital circuitry. THE GENERAL RADIOTELEPHONE OPERATOR LICENSE - STUDY GUIDE contains the necessary preparation for ONLY \$25.00.

WPT PUBLICATIONS
979 Young Street, Suite A
Woodburn, Oregon 97071
Phone (503) 981-6122

CIRCLE 180 ON FREE INFORMATION CARD

Circuit Board Layout Made Easy!

Create and Revise
P-C-B Artwork on your
IBM or Compatible

- User Friendly
- Supports Microsoft Mouse
- Economical
- On-line Help Screen
- 2X artwork on printer

Requirements: IBM or compatible PC - 256K memory - CGA card - IBM graphics compatible printer.

ONLY \$99.00

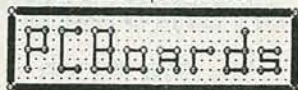

2145 Highland Ave./Ste. 201
Birmingham, Al. 35205
(205) 933-1122

DEMO DISK \$10.00

CIRCLE 205 ON FREE INFORMATION CARD

MIDI PROJECTS



BP182—MIDI interfacing enables any so equipped instruments, regardless of the manufacturer, to be easily connected together and used as a system with easy computer control of these music systems. Combine a computer and some MIDI instruments and you can have what is virtually a programmable orchestra. To get your copy send \$6.95 plus \$1.00 for shipping in the U.S. to Electronic Technology Today Inc., P.O. Box 240, Massapequa Park, NY 11762-0240.

117 PRACTICAL IC PROJECTS BUILD YOU CAN

2645T—117 PRACTICAL IC PROJECTS YOU CAN BUILD.....

\$10.95. Dozens of fully-tested, ready-to-build circuits you can put together from readily-available, low cost IC's! There are a total of 117 IC circuits ranging from an audio mixer and a signal splitter to a tape-deck amplifier and a top-octave generator organ! From TAB Books. To order your copy send \$10.95 plus \$2.75 shipping to Electronic Technology Today Inc., P.O. Box 240, Massapequa Park, NY 11762-0240



CALL NOW AND RESERVE YOUR SPACE

- 6 x rate \$800.00 per each insertion.
- Fast reader service cycle.
- Short lead time for the placement of ads.

Call 516-293-3000 to reserve space. Ask for Arline Fishman. Limited number of pages available. Mail materials to: Engineering Admart, RADIO-ELECTRONICS, 500-B Bi-County Blvd., Farmingdale, NY 11735.

AUDIO UPDATE

continued from page 81

none.) Of the twenty or so phono cartridges listed, about half were stereo, and those were equally divided between ceramic and magnetic types. A number of stereo adapters were also available; they provided the master volume control and the switching facilities needed to combine two separate mono systems into one clumsy stereo system.

Several tuners labeled AM-FM

stereo were also on the dealer's shelves—despite the fact that there were no stereo FM broadcasts. The tuners were stereo in the sense that they had independently-tuned AM and FM sections whose outputs were available separately and simultaneously. A station with AM and FM affiliates would occasionally broadcast stereo material with one channel mostly on AM and the other mostly on FM. (It had to be a "mostly" arrangement to prevent AM- or FM-only listeners from losing half the audio material.) But despite the limited separation

provided by AM-FM stereo, I remember how thrilling it sounded—particularly with headphones. (Incidentally, there were no commercial stereo headphones at the time; I had to rewire a pair of military-surplus mono phones.) Also in 1958, the first Japanese audio product arrived; it was an unboxed \$25 8-inch full range driver made by Panasonic. I'm sure that at the time no one in the U.S. could guess what it ultimately presaged.

Next time, we'll continue our look back and then peer into the crystal ball for a look into the future.

A NEW KIND OF MAGAZINE FOR ELECTRONICS PROFESSIONALS

PROTECT YOUR SENSITIVE DATA

Use encryption techniques to keep your information out of the wrong hands

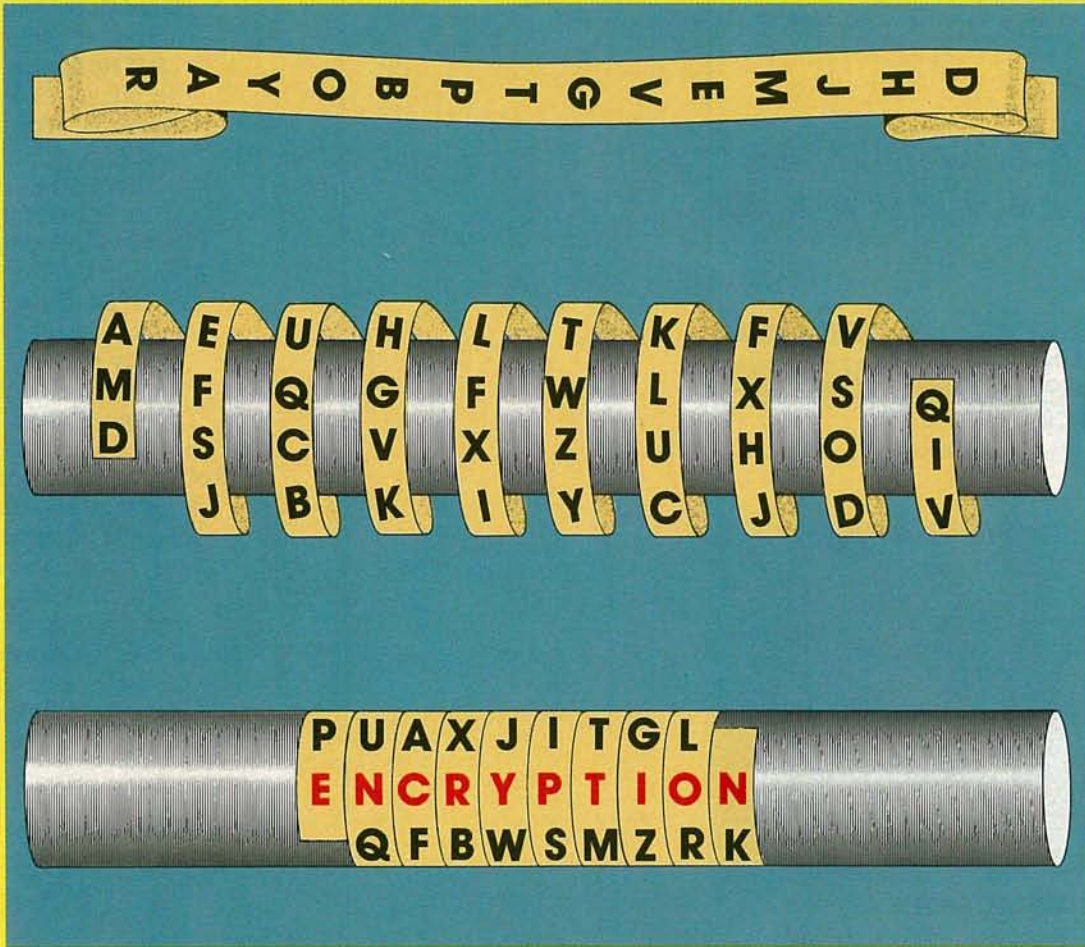

CD CLASSROOM

The PC-compatible expansion connectors

HANDS-ON REVIEWS

AutoCAD, AutoSketch,
Irwin's tape backup system, and more!

A
GERNSBACK
PUBLICATION

CONTENTS

APRIL

1988

Vol. 5 No. 4

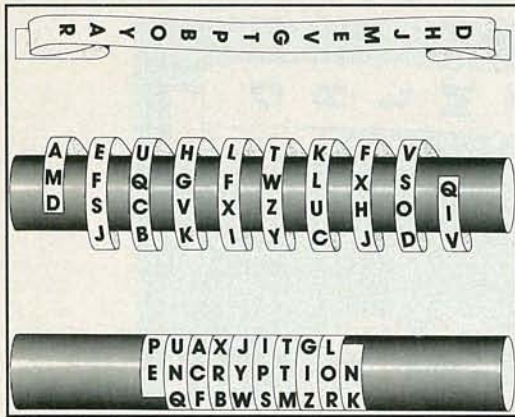

93 DATA ENCRYPTION

The ultimate data-encryption algorithm

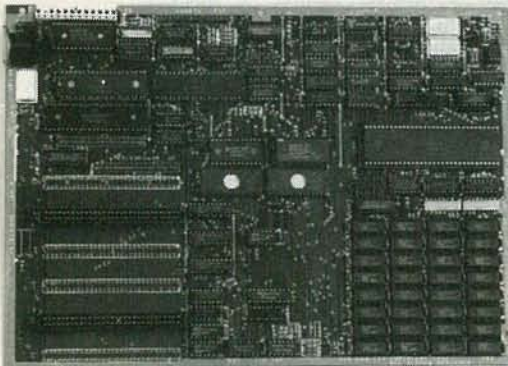

91 CD CLASSROOM, PART 6

Address decoders, RAM, and ROM

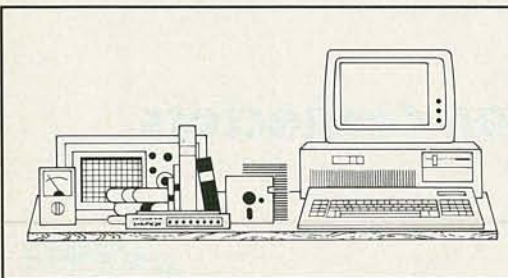

87 EDITOR'S WORKBENCH

A tape backup subsystem, AutoCAD and AutoSketch, Disk Technician, and GrafPlus print-screen utility

COMPUTER DIGEST

Larry Steckler,
EHF, CET: publisher & editor in chief

Art Kleiman,
editorial director
Brian C. Fenton,
managing editor
Jeff Holtzman
technical editor
Byron G. Wels,
associate editor
Carl Laron,
associate editor
Robert A. Young,
assistant editor
Teri Scaduto
editorial assistant
Ruby M. Yee,
production director
Karen Tucker,
production advertising
Robert A. W. Lowndes,
production associate
Marcella Amoroso
production assistant
Andre Duzant,
technical illustrator
Jacqueline P. Cheeseboro
circulation director
Arline R. Fishman,
advertising director

ComputerDigest
Gernsback Publications, Inc.
500-B Bi-County Blvd.
Farmingdale, NY 11735

ADVERTISING SALES 516-293-3000

Larry Steckler
Publisher

NATIONAL SALES

Joe Shere
1507 Bonnie Doone Terrace
Corona Del Mar, CA 92625
714-760-8697

Cover Illustration by André Duzant

EDITOR'S WORK- BENCH

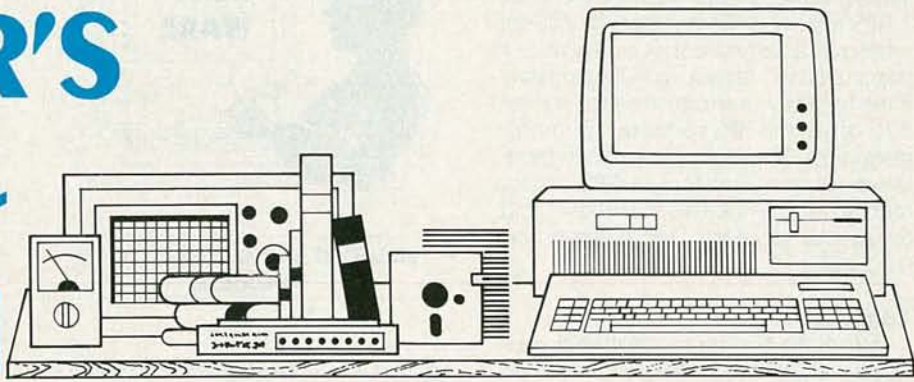

Irwin Model 310 Backup Tape Subsystem

Because a hard disk holds a relatively huge amount of data, making floppy disk backups is often so time-consuming and expensive that many users prefer to play Russian-roulette with their data, hoping that the hard disk won't fail, and that someone doesn't accidentally key in the command DEL *.* and erase an entire directory. But we all know what must eventually happen, because even with the best of luck and care, hard disk drives quite often have a rated lifetime of only five years.

The best way to guard against both a *.* delete and a hard-disk failure is to back up the hard disk with magnetic tape, because next to punched paper



tape—which is no longer in general use—magnetic tape is the most reliable storage media for personal computers, and it can do its job while unattended.

Low-cost system

One of the lowest cost and easiest-to-use tape backup systems that we've come across is the Irwin Backup Tape Subsystem, which is available as the model 310 for PC and XT compatibles and clones. See Fig. 1. (A somewhat different model, the 325 is available for use with the AT.)

The Irwin tape subsystem copies files from a hard disk to a magnetic-tape cartridge, and restores the files in the event the originals are damaged. Most important, the subsystem can restore files either to the hard disk or to a floppy; so if the hard-disk unit actually dies you can continue using your files from floppies until you get the hard-disk unit repaired or otherwise replaced.

The system consists of an integral tape drive and power supply unit measuring approximately 11.5"D × 4.5"H × 6.75"W, and controlling software that is compatible with DOS 2.0 or higher. The tape mechanism uses the Irwin-type TC200 and 3M-type DC1000 mini data cartridges, which can store up to 10 megabytes. If the hard disk contains more than 10 meg, or if the tape's 10-meg capacity will be exceeded, operations automatically cease and the user is prompted to install another cartridge.

Just one connection

The backup subsystem has only one signal cable, whose connector matches the 37-pin D-connector on the back of a PC/XT's disk controller. The D-connector is there because IBM originally made provision for four floppy drives: two internal, two external. The Irwin tape subsystem uses one of the two external floppy con-

nections. If your PC/XT-compatible is one of the models having a multi-function disk controller, and therefore doesn't have the 37-pin connector, you must purchase an optional interface adapter for the tape backup, or substitute an IBM-type disk controller.

The Irwin system requires that the tape be specially formatted. One formatted tape is supplied with the system. Others are formatted using the supplied TFORMAT software. The two-part formatting records a servo pattern that identifies eight specific tracks on the tape, and the block structure used for storing the data. The formatting verifies the tape as it writes the block structure, and if the tape contains a spot that cannot be recorded or read reliably its block is listed at the beginning of the tape in a "bad-block" table, and that block is skipped over each time during subsequent save and restore operations.

Backup and restore

To backup or restore files, the user simply calls up the appropriate menu-driven IMAGE or FIPS (file oriented) software. In an image backup, all the parts of the hard disk known to DOS are transferred to tape, except for empty sectors. During an image restore, the data is put back on the hard disk exactly from where it originated. The user has no control over what gets restored—it all gets restored. If, in the interim, a bad spot has developed on the hard disk, the restore won't know about it and will simply write the data back over the bad spot, and the data will be unusable.

In a file backup, directories that represent the groups of files the user has selected for backup are written on the tape. The groups, called *savesets*, can be keyed to a specific date and time, to selected files, to specific directories, or to files that were modified since they were

last backed up. The files can be restored to the hard disk as a unit directory, by saveset name, or even individually. Since a FIPS restore is file oriented, it will not write over a defective spot on a hard disk (because it will fail the verify). Alternately, if the hard disk is reformatted to lock out bad spots, the FIPS software will simply restore the files using the good sectors. Unlike an image restore, a FIPS restore represents only the files themselves, not the precise location of those files on the hard disk.

Command driven

Although the three supplied programs—TFORMAT, IMAGE, and FIPS—are menu driven, a command structure is also available through the FIPS program. The advantage to the command mode is that it has more flexibility and allows more sophisticated save and restore operations. For example, the user can take a directory listing of a saveset and create a customized saveset having a selected group of files. Files from other disk directories can also be included in the custom saveset. The command mode also allows individual files to be unselected from a saveset.

In the restore mode, the command structure allows the usual directory listings, can restore or copy selected files or groups of files to the hard disk or floppy disks, can unselect files from groups to be restored, and can even restore new versions of files in place of older versions having the same file name. If it's necessary to preserve both old and new versions of a file, DOS can be used to rename either the old or new files.

Reusing tapes

The tapes can be reused any number of times, but the data must be erased first. The FIPS program provides a RESET function that erases the tape—actually, only the data is erased. If the tape is erased by using a bulk tape eraser it must be reformatted, because unlike the RESET software, bulk erasure destroys the tape's formatting. On the other hand, if you want to reformat a tape because you believe the tape is defective or that new "bad spots" have developed, the tape must be bulk erased because servo writing on a formatted tape can create conflicting servo signals.

The Irwin 310 tape subsystem is available from computer dealers for about \$450, or less, depending on the particular source. The exact same tape mechanism and software (no housing or power supply) is also available for internal mounting within the computer for a price that's about \$100 less. For further information on the system it's best to write directly to the manufacturer, Irwin Magnetics, 2311 Green Road, Ann Arbor, MI 48105. 



AutoCAD and AutoSketch, by Autodesk

AutoCAD is the standard by which all other personal-computer based CAD systems are judged. The program has become an institution in itself; is it used not only for its intended purpose of computer-aided drafting and design, but also as a speed benchmark and as a compatibility-testing program for new hardware designs. Subsidiary industries have arisen that supply AutoCAD add-ons, add-ins, and educational materials.

Until a few years ago, AutoCAD was the only product of its type, but as the market has expanded, competition has increased. To meet that competition, Autodesk has not rested on its laurels. New versions have been introduced at the rate of several per year, and each version has greatly improved on the capabilities of its predecessor.

Those improved capabilities have brought concomitant increases in the hardware required to run the program. It was possible, if impractical, to run previous versions on an XT (or compatible), but an 80286 microprocessor running at 8 MHz really is the minimum hardware for acceptable performance. In addition, the current version (called Release 9) simply will not run without a math coprocessor (8087, 80287, or 80387), which can cost anything from \$100 to \$500, depending on the type of IC and its speed.

AutoCAD is not cheap; the list price of Release 9 is \$2850. If that sounds like a lot of money, it is. Counting the cost of the hardware (computer, mouse or digitizing tablet, printer, plotter), you can easily double or triple that figure. Counting the cost of user training, you can easily add several hundred or thousand more.

If that makes you weak in the knees, either you don't need the facilities AutoCAD provides, or you're being unrealistic about the investment that's required to attain them.

At the other end of the spectrum is a program Autodesk released this past summer. AutoSketch is an easy-to-use drawing program that sells for under \$100. (Weak-kneed types take note.) You cannot do with AutoSketch what you can with AutoCAD, but you can do a great deal. In fact, you can do a rough draft of a

drawing in AutoSketch, and then transfer it to AutoCAD for final polishing.

Actually, there are two versions of AutoSketch: The standard version (\$79.95) will use a math coprocessor, if one is present; the enhanced version (\$99.95) requires one. The enhanced version runs three to nine times faster than the standard version.

What is it like to use AutoCAD? What is it like to use AutoSketch? How are the two similar? How are they different? In what follows, we'll try to answer those questions. Keep in mind, however, that thick books have been written that describe use of AutoCAD, so we'll only be able to hint at some of its advanced features. Both programs will work with just the keyboard, but using a mouse or digitizing tablet is much more convenient and productive.

Installation and documentation

The AutoCAD package weighs about ten pounds; the box contains a hard-bound Reference manual, a supplement to it, an Installation Guide, a Programmer's Reference, a quick-start guide, and other materials. The Reference manuals are highly technical, and not suitable for use in learning the program; if you're new to CAD you'll almost certainly want third-party training, or at least one of the many books on learning how to use AutoCAD.

The software itself is contained on ten DSDD floppy disks. Installation takes about ten minutes, and is not automatic, so you must have basic understanding of DOS commands, subdirectories, etc. You'll need more than a megabyte of disk space for the required files.

AutoCAD requires a graphics adapter of some sort; the program supports all common display adapters, including CGA, EGA, PGC, and Hercules, as well as many specialized adapters, for a total of about 40 in all.

Similarly, some 30 digitizing instruments are supported, including most popular mice (Microsoft, Logitech, Mouse Systems) and digitizing pads (Houston Instruments, Pencent, Summagraphics). Seventeen types of plotters and fourteen types of printers are also supported. Device drivers are updated fairly often, as new hardware is released.

As for RAM, the program will run in 512K, but some functions will be unavailable. AutoCAD really needs 640K, with few RAM-resident programs occupying any of it. In addition, AutoCAD can be configured to use extended (AT) or expanded (EMS) memory.

The first time you run AutoCAD, you must configure the program for your hardware. Thereafter you can do so at will. You needn't clutter your hard disk with unnecessary software drivers; they can be called in from the installation disks if you change hardware.

AutoSketch, by contrast, comes in a slender package weighing less than a pound; software is contained on a single disk. (A second disk containing sample drawings is included.) The program supports only the most popular display adapters, digitizers, printers, and plotters. All installation information is maintained in the program itself, so you needn't worry with extra files containing hardware drivers. You can only set the program up to drive a single printer or a single plotter (AutoCAD supports one of each); to create draft prints on a dot-matrix printer and final copy on a plotter, you must re-configure the program, or maintain two separate copies of it. AutoSketch will run on an XT with 512K of RAM and two floppies. However, more RAM, an accelerator card, a math coprocessor, and a hard disk make it much more pleasant. The program does not utilize extended or expanded memory.

A 58-page paperback book contains the program's documentation. The book is a model of clarity and conciseness. It contains a quick-start tutorial and a reference section. The book is well indexed. You won't need third-party documentation in order to become proficient with the program.

Off and running

At this point, we'll describe how you work with AutoSketch. AutoCAD has most of the facilities we'll discuss; we'll point out those it doesn't, as well as differences in how those it does have are accessed. Then we'll go on to discuss some of the many facilities that are exclusive to AutoCAD.

AutoSketch first presents you with a drawing screen like that shown in Fig. 1. The central portion is for drawing; the top line contains menu titles, the current time, and a memory-usage indicator; the bottom line contains the current file name, and is also used for prompts.

A menu is accessed by moving the pointer to its title and pressing a mouse button (to Macintosh and Windows users, a process known as *clicking*). A menu "drops down," revealing several options. The Draw menu (shown in Fig. 1), for example, allows you to pick the type of figure you'd like to draw: line, circle, arc, box, text, etc. The Change menu allows you to modify drawing entries; you can erase, copy, and move items, as well as rotate them, create mirror images of them, stretch them, etc. The View menu allows you to magnify a portion of your drawing, in one of several ways. The Assist menu sets up operational characteristics that help you align drawing elements. The Settings menu lets you pick line type, drawing color, drawing layer, size and orientation of text, etc. Measure allows you to determine lengths and angles of drawing elements; the menu also allows you to add automatic dimension lines and values to horizontal and vertical objects. If you use the Stretch item in the Change menu, those dimensions will automatically change accordingly. Last, the File menu allows you to save the current file, clear the screen for a new drawing, load a previously saved drawing, play a game, etc.

Working with AutoSketch is easy, intuitive, and fun. And, because of two special features (Undo and Redo), you feel free to experiment. If you make a mistake—even erase the whole drawing—just choose Undo, and the drawing will be restored to its previous state. In fact, AutoSketch maintains a file listing each change to the current drawing; successive Undo's can be counteracted by successive Redo's. Undo/Redo is one of the few features that actually works better in AutoSketch than in AutoCAD.

Getting your drawing on paper may take some experimentation the first time around, but once you understand the system, it works well. From the File menu

you create a plot box, which appears on-screen as a box labeled "Plot box", along with the plot size (in inches) of the box. If you find that part of your drawing is cut off, or the plot box is wider than your printer, just change the draw/plot ratio and view the new plot box.

AutoCAD

AutoSketch is so intuitive that you can become proficient with it in just a few hours. AutoCAD, on the other hand, requires much time and study before you can even begin to talk about proficiency. And because the program has a built-in programming language, as well as the ability to be thoroughly customized, proficiency means more than just deep familiarity with the program; it means customizing it for your hardware and for the type of work you do. In fact, numerous companies are in the business of customizing AutoCAD for specific applications—electronics, for one.

For example, the Great Softwestern Company markets a product called AutoBoard that turns AutoCAD into a system that helps you create schematic diagrams. With the information provided, AutoBoard can then automatically generate a PC board. (See page 71 of the August 1987 issue for a discussion of AutoBoard.)

The classic AutoCAD screen is shown in Fig. 2. The top line shows status information; the bottom line shows the most recently entered commands; and along the right is the program's main menu. The main menu leads to subsidiary menus, which in some cases lead to yet other menus. For example, choosing *Display* from the main menu leads you to a menu that gives you several ways to vary your view of the current drawing. The most common are *Pan* and *Zoom*. Choosing the latter brings up yet another menu that allows you to look at the previous view, the entire drawing, an area you define by drawing a box, etc.

That's classic AutoCAD. The new version beefs up the graphics appeal of the program. For one, colors are used more effectively than in previous versions. But the biggest change is in the drop-down menus. In Release 9, when you move the pointer into the status line, it changes into a series of menu titles. Click on one and a menu drops down. Then click on the desired function, and get to work. Figure 2 shows AutoCAD's drop-down menu of drawing tools.

The drop-down menus in and of themselves don't add any new drawing or design capabilities. In fact, they present a limited subset of AutoCAD's plethora of functions. But they do provide a more intuitive way to get at those functions. And you can customize the menus, removing functions you don't like to use, and adding others that you do.

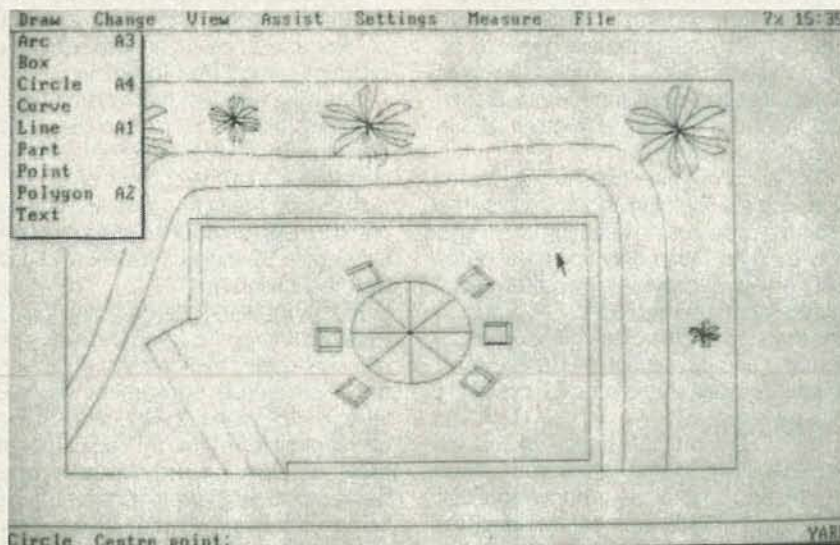

FIG. 1

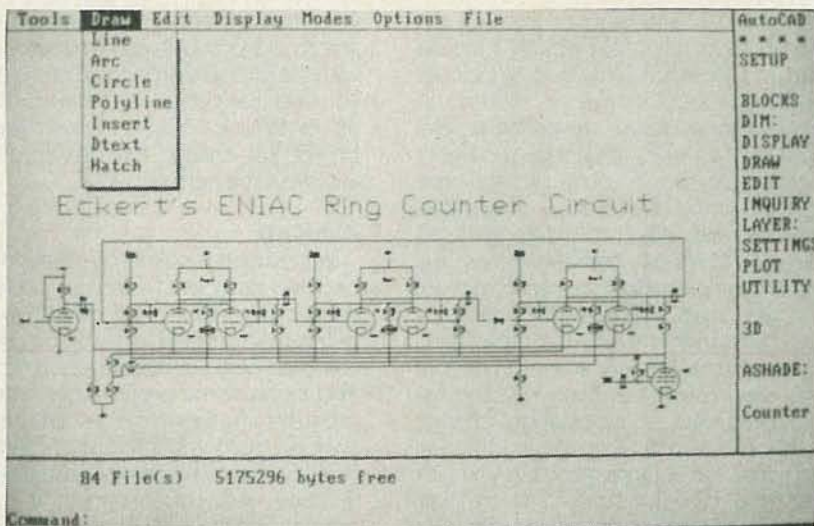

FIG. 2

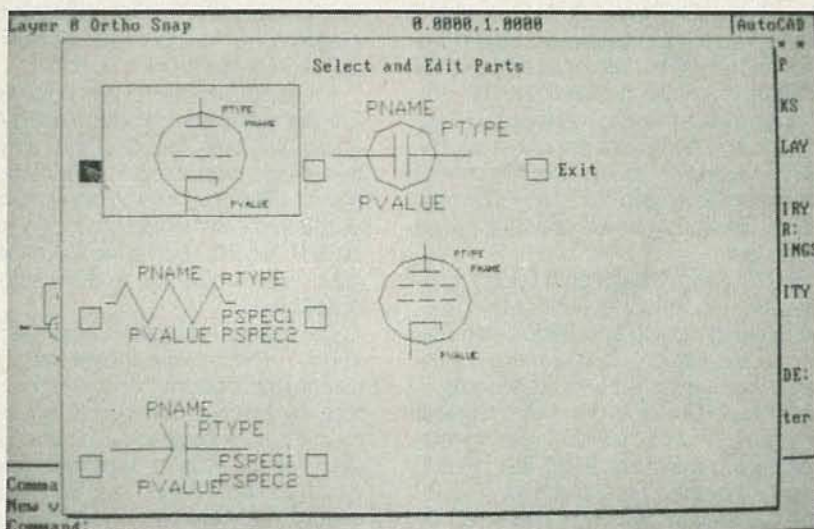

FIG. 3

Graphics are put to good use in other places, too. For example, older versions of AutoCAD required you to select hatch patterns by name; now a Dialog Box presents samples on-screen; you choose the desired one by clicking on it. For inserting "parts" into drawings, you can create your own menus, as shown in Fig. 3.

To help you differentiate between AutoCAD and AutoSketch, let's discuss several commands that AutoCAD shares with AutoSketch, pointing out how they differ in the two programs. In addition, we'll show the enhanced versions of many commands that AutoCAD provides; those commands can greatly simplify some kinds of work. Our discussion will be representative, not exhaustive.

Both programs allow you to copy drawing entities by selecting them one-by-one or in groups. In addition, AutoCAD provides an Array command that allows you to create a circular or rectangular array of objects. Laying out an array of memory IC's on a PC board would be child's play with that command.

Both programs provide a Break command that allows you to delete part of an entity—the end of a line that is too long, for example. AutoCAD improves on Break with the Trim and Extend commands. Essentially, Trim performs a Break on multiple objects simultaneously. Extend, on the other hand, allows you to patch up an object that has been Trimmed or Broken too much (or that for any other reason needs to be extended).

Two areas in which AutoSketch is sorely lacking are hatching and text fonts. The program provides no hatching at all, and only a single, rather ugly text font. AutoCAD, however, provides almost four dozen hatch patterns and almost two dozen text fonts. You can create your own hatch patterns and text fonts if you like, and several companies market such products independently.

AutoCAD has no true three-dimensional capabilities, but it has a number of commands that allow construction of three-dimensional objects. More commands are added to each release of the

program; we expect a full 3-D version in the not-too-distant future. AutoSketch has nothing comparable.

Third-party support is one area in which AutoCAD really shines. Autodesk itself occasionally publishes a book listing products for enhancing or customizing AutoCAD. The *AutoCAD Applications Catalog* runs more than 300 pages, and contains products that support disciplines ranging from electronics to theatrical lighting.

Because it is so new, we have seen few support products for AutoSketch, but just as we were going to press, libraries of electronics and other symbols was announced by CAD Easy.

Disk Technician

Reliability is the most important characteristic of a hard disk. In fact, an unreliable hard disk is worse than no disk at all. Hard disks are inexpensive these days, but not so inexpensive that you can afford simply to throw an unreliable one away. But what can you do with it? You can perform a low-level format, hoping that marginal sectors will be recognized and marked, so that DOS will not try to use them. The problem is that most low-level format routines are not sensitive enough to pick up intermittent errors.

A company called Prime Solutions learned about unreliable hard disks the hard way (no pun intended). Prime Solutions came into existence building CP/M machines that were very powerful for their day (1980). The machines never came to market because of—you guessed it, intermittent hard-disk troubles.

Attempting to locate and remedy the problem, the company switched direction. Rather than build computer systems, Prime Solutions focused on writing software that would both find and fix intermittent disk errors. Early last year the fruit of their effort finally came to market in a product named Disk Technician.

Actually, there are two versions of the program; Disk Technician and Disk Technician Plus. The former (\$99.95) can handle standard (MFM) hard disks of up to 32 megabytes; the latter (\$129.95) can handle RLL disks, partitioned disks, and disks larger than 32 megabytes. We evaluated Disk Technician Plus.

Before installing the program, we had been having some trouble running several disk-speed benchmarks in conjunction with some equipment we were testing. Occasionally we'd receive a value ranging from two to four times the usual value. We figured our disk was suffering from "soft" errors (bits on the hard disk that sometimes showed up as a 1, and at other times as a 0), and those errors

caused DOS to retry—in some cases many times—reading some sectors. The problem was that we had no idea which sectors were causing the problem. So we backed up the disk, did a low-level format (using our Xebec controller's built-in format routine), restored our files—and still suffered the same problems.

We were considering junking the drive when we learned of Disk Technician. We obtained a copy in short order, and let it run its paces on our disk—a process that took about seven hours. When finished, it had noted and repaired 101 soft errors of various types, and it had simply marked several sectors as bad, so that DOS would not try to use them. The program also took note of about 140K of "suspect" areas, which it would specially monitor in future runs.

After running Disk Technician that first time, our benchmarks ran consistently. But we'll be watching that drive very carefully from now on.

Preventative maintenance

For maximum reliability Prime Solutions recommends running Disk Technician on a daily basis. The program comes with daily, weekly, and monthly tests, which take progressively longer periods of time, but which do progressively more comprehensive testing and repair. On our machine, the daily test runs in six minutes, the weekly test in about two hours, and the monthly test in about seven hours. Those times will vary, depending on the type of disk and on its quality. You can run each test automatically, in which case the entire disk is tested, or manually, in which case you can then test individual tracks and sectors.

Disk Technician maintains a database of several classes of errors; it processes the database using what the company calls AI (Artificial Intelligence) techniques. It thereby monitors all of the occasional soft errors, upgrading their status as they become more frequent, and finally marking a sector as bad if the errors become too frequent.

The program allows you to perform a non-destructive low-level format (on an AT), a destructive low-level format (on an XT), and it comes with a small RAM-resident utility that automatically parks your disk's read/write head after a user-specified period of inactivity.

The manual shows you how to run Disk Technician without getting involved in the details, but if you're so inclined, it also has a lot of information.

The only problem with Disk Technician is that it's copy protected; you must run the program from the distribution disk. You can make a backup copy of the disk, but you'll still only be able to run it on the same hard disk. Considering the benefits, however this, may be one case where it is worthwhile tolerating the inconvenience of copy protection. 

Correction

An apparent installation error caused erroneous timings of PC Technologies' Rainbow Plus to be reported in the article "Turbocharge Your PC," which appeared in the November 1987 issue. The board is actually much faster than reported; in fact its speed in most tasks is roughly equivalent to that of the Break-Thru 286. Our apologies to PC Technologies for the error. 

GrafPlus

Print-screen utilities—at least good ones—are hard to come by. Here's one that sells for only \$49.95, and can print just about any IBM screen on just about any printer. In fact, GrafPlus can print screens from all common IBM video adapters (Hercules, CGA, EGA, PGC, VGA), and several you probably never heard of. Likewise with printers—the present incarnation of the program can drive literally hundreds of printers (including laser printers).

Printing color screens on a black-and-white printer? No problem; GrafPlus does a reasonable job of translating colors into different shades of gray. You can set the program up to print in landscape (horizontal) or portrait (vertical) orientation. You can also set it up for reverse printing. All those capabilities cost you only about 13K of RAM.

Installing the program is simple; you can specify the desired video adapter, printer, and the print parameters (reverse, etc.) on the command line. If you don't specify the desired set-up on the command line, the program presents you with a series of menus that allow you to choose your set-up by number.

In the unlikely event your printer isn't on the GrafPlus list, you can add it yourself (assuming you can dig a few control codes out of your manual).

Linkable binary forms of the program are included, so a Fortran, BASIC, or Pascal programmer can link the appropriate file in his program, and cause a screen to be printed at will. Another special feature is the ability to "clip" portions of the screen image. That allows AutoCAD users to avoid printing the menu and command-line areas of the screen.

As much as we like GrafPlus, we have a few suggestions that would make it even easier to use. First, you cannot change any of the program's operating parameters without rebooting and reloading the program. For example, in order to obtain the best printout you might want to print a screen in both normal and reversed modes. The only way to do so is to re-

PRODUCTS REVIEWED

• Model 310 Backup Tape Subsystem (prices vary), Irwin Magnetics, 2311 Green Road, Ann Arbor, MI 48105.

CIRCLE 50 ON FREE INFORMATION CARD

• Disk Technician (\$99.95, \$129.95), Prime Solutions, Inc., 1940 Garnet Avenue, San Diego, CA 92109. (619) 274-5000.

CIRCLE 51 ON FREE INFORMATION CARD

• GrafPlus (\$49.95), Jewell Technologies, Inc., 4740 44th Ave. SW, Seattle, WA 98116. (800) 628-2828 ext. 527, (206) 937-1081.

CIRCLE 52 ON FREE INFORMATION CARD

• Rainbow Plus (\$945), PC Technologies, 704 Airport Road, Ann Arbor, MI 48106. (313) 996-9690.

CIRCLE 53 ON FREE INFORMATION CARD

• AutoCAD (\$2850), Autodesk, Inc., 2320 Marinship Way, Sausalito, CA 94965, (415) 332-2344.

CIRCLE 54 ON FREE INFORMATION CARD

• The AutoBoard System (\$2500), The Great Softwestern Company, Inc., 207 W. Hickory St., Suite 309, Denton, TX 76201.

CIRCLE 55 ON FREE INFORMATION CARD

• AutoSketch Symbol Libraries (prices vary), CAD Easy, 15125-D S. W. Koll Parkway, Beaverton, OR 97006, (503) 649-0966.

CIRCLE 56 ON FREE INFORMATION CARD

• For information on learning AutoCAD, we recommend *Inside AutoCAD*, New Riders Publishing, P.O. Box 4846, Thousand Oaks, CA 91360, (818) 991-5392.

CIRCLE 57 ON FREE INFORMATION CARD

• *CADalyst, The Journal for AutoCAD Users* is published bimonthly by CADalyst Publications, Ltd., 282-810 W. Broadway, Vancouver, BC, Canada, V5Z 4C9, (604) 873-0811. The magazine contains update information, hints on using AutoCAD more effectively, new product announcements, and advertisements from third-party vendors of AutoCAD add-ons.

CIRCLE 58 ON FREE INFORMATION CARD

boot, re-install GrafPlus, run your application again, and then press the print-screen key.

Second, you can only clip the right and bottom edges of the screen. The ability to clip all four edges could be useful, depending on the application.

Third, printing Hercules monochrome graphics screens can be a little tricky, because some programs use the first page, and others use the second. Because you can't change operating parameters on the fly, you may have to experiment (i.e., re-install the program) to find which page your application uses. A way of toggling between the two pages after pressing the print-screen key, perhaps by pressing the space bar, would be very useful.

However, those wish-list items don't detract from the real usefulness of GrafPlus. If you need to print the screen of anything but a standard CGA, you need GrafPlus. 

R-E Computer Admart

Rates: Ads are 2 1/4" x 2 7/8". One insertion \$825. Six insertions \$800 each. Twelve insertions \$775. each. Closing date same as regular rate card. Send order with remittance to Computer Admart, Radio Electronics Magazine, 500-B Bi-County Blvd., Farmingdale, NY 11735. Direct telephone inquiries to Arline Fishman, area code-516-293-3000. Only 100% Computer ads are accepted for this Admart.

EPROM PROGRAMMER FOR PC \$129.95

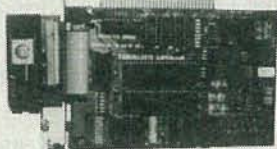

- 2716 to 1 MEG
- Updateable to 32 MEG
- Programs 2764 A in 10 Seconds
- Menu Driven Software
- External 40 PIN ZIF (PC only)
- Adapter 8748, 49, 51, 52, 55, TMS 7742 \$50 PC only
- 1 Year Warranty
- 10 Day Money Back Guarantee
- Available for APPLE II \$92.50
- For More Information Call



NEEDHAM'S ELECTRONICS
4535 Orange Grove, Sacramento, CA 95841
(916) 924-8037 (M-F) 8 AM to 5 PM PST

CIRCLE 191 ON FREE INFORMATION CARD

SPECIAL EPROM PROGRAMMER



APROTEK 1000
ONLY
\$225.00

COMPLETE WITH PERSONALITY MODULE

117 AC POWER-RS-232 CONNECT
6 BAUD RATES - HANDSHAKE TO HOST
ALLOWS READ, WRITE, VERIFY & COPY
Comes complete with IBM-PC, Apple IIe, or CPM (Specify Computer) Driver Program on Disc.

Programs the following 5 Volt 24 or 28 pin devices: 2716 series through 27512, 25xx series, 68764 plus others. Please Specify Personality Module desired with order. Additional Personality Modules only \$15.00 ea. Full 1 year warranty.

TO ORDER: CALL 1-800-962-5800 OR WRITE

APROTEK
1071-A AVENIDA ACASO Add
CAMARILLO, CA 93010 \$4.00 Shipping USA
Info: (805) 987-2454 VISA or MC Add 3%
We Accept Govt., School & Large Corp. P.O.s

CIRCLE 193 ON FREE INFORMATION CARD

GRAPHICS TOOLKIT

COMPATIBLE WITH
PC/XT/AT AND NEW PS/2
\$59.95 LIMITED INTRODUCTORY OFFER (ADD \$3 S/H)

- SUPPORTS NEW VGA GRAPHICS MODES
- 50+ FUNCTIONS
- MEMORY/DISK SAVE AND RESTORE
- FREE LISTING UTILITY
- DATA COMPRESSION ALGORITHM
- ALL SOURCE CODE INCLUDED
- ROUTINES WRITTEN IN MICROSOFT C AND ASSEMBLER
- NO ROYALTIES
- PROGRAMMER SUPPORT PROVIDED



DEVTRONICS, INC.
1571 MAIN STREET
ATLANTIC BEACH, FLA. 32253

ORDERS ONLY: 1-800-332-4250 AMEX/COD
TECHNICAL INQUIRIES: (904) 241-3281

CIRCLE 207 ON FREE INFORMATION CARD

COMPUTER ASSEMBLY MANUALS



Eliminate Guesswork!
Build with Confidence!

BIG BLUE SEED FOR IBM™ BUILDERS!
Parts list, placement diagrams, instructions, mods, for assembling over 90 IBM-compatible bare cards. Latest version with guides for 640K, Turbo, AT & Baby AT MthBds. **\$17.95**

APPLE™ BUILDERS NEED APPLE SEED!
Instructions for assembling over 90 Apple-compatible bare cards including II+ & IIe MthBds. For ALL Apple enthusiasts and hobbyists **\$14.95**

SAVE 10% - ORDER TWO OR MORE MANUALS OVER 40 BARE IBM & APPLE CARDS IN STOCK
(MthBds - Disk - Video - Burner - MultiFn - I/O - Modem - Proto - etc)

Check/Money-order, VISA/MasterCard to:
NuScope Associates*, Dept RE
In U.S.A. In CANADA
P.O. Box 790 P.O. Box 742, Stn B
Lewiston, NY 14092 Willowdale, Ont. M2K 2R1
*A Division of Cosmic MicroTech Inc.

CIRCLE 72 ON FREE INFORMATION CARD



5 1/4" 5 Box 10 Box
D-Side 950 850 795
D-Den. 1750 1650 1600
HIGH Den.

3.5 S-Side 1195	DATA CARTRIDGES	8" S-Side 1540
3.5 D-Side 1650	DC 1000 - 12.95	8" S-Den. 1895
3.5 H-Den. 4795	DC 2000 - 17.50	8" D-Side 2095
	DC 300XLP 19.75	
	DC 600A - 21.95	

Authorized Distributor
Magnetic Media Division **3M**

Old Reader Delaware: 1-800-451-1849
P.O. BOX 10247, WILMINGTON, DE 19850
Diskette Connection Oklahoma: 1-800-654-4058
P.O. BOX 1074, OKLAHOMA CITY, OK 73102
Nevada: 1-800-621-6221
P.O. BOX 12396, LAS VEGAS, NV 89112
Minimum Order: \$25.00. Visa, MasterCard accepted. C.D. orders add \$3.00. Surface Shipping is 2.95 per 25 and \$3.00 per 100 disks. *Add \$4.00 per 100 disks. UPS delivery only. (U.S. mail for APD, FPD, AM, MI or PM add an additional 5% for P&H. Prices subject to change without notice!

CIRCLE 206 ON FREE INFORMATION CARD



UNIVERSAL E(E)PROM PROGRAMMER KITS FROM \$95

- No personality modules; Menu-driven device selection.
- On board power supply (110/220V AC).
- Direct technical support; Full 1 year warranty.
- User friendly software; Complete help menu.
- Quick pulse algorithm (27256 under 60 sec).
- Programs 27xx to 1 Mbit; 25xx, 68xx, CMOS; EEPROMS.
- Micros: 8741, 8742, 8748, 8748H, 8749, 8749H & more.
- IBM-PC, Apple, CPM or Unix driver; Autobaud RS232.
- Offset/split Hex, Binary, Intel & Motorola 8,16,32 bit.
- Manual with complete schematics.

VISA & MC Call today for datasheets!!

B&C MICROSYSTEMS

355 WEST OLIVE AVE. SUNNYVALE, CA 94096
PH: (408) 730-5511 FAX: (408) 730-5521 TELEX: 984185

CIRCLE 208 ON FREE INFORMATION CARD

ICs PROMPT DELIVERY!!!

SAME DAY SHIPPING (USUALLY)
QUANTITY ONE PRICES SHOWN FOR JAN. 24, 1988

OUTSIDE OKLAHOMA: NO SALES TAX				
640K MOTHERBOARD UPGRADE - Zenith 150, IBM PC XT, Compat Portable & Plus-Tip Vectra	DYNAMIC RAM		ASTECIC COLLEGE FORMS MAIL ROOM * 1-800-80387-15 80387-20 80387-2 80387-8 80387-16 \$160.00 \$245.00	
	1Mbit	1048Kx1 100 ns		\$32.00
	1Mbit	256Kx4 100 ns		28.50
	51258	* 256Kx1 100 ns		6.75
	4464	64Kx4 150 ns		4.15
	41256	256Kx1 80 ns		5.75
	41256	256Kx1 100 ns		5.15
	41256	256Kx1 120 ns		4.75
	41256	256Kx1 150 ns		4.35
	41264	+ 64Kx4 120 ns		5.75
EPROM				
27C1000	128Kx8 150 ns	\$37.95		
27C512	64Kx8 200 ns	15.50		
27256	32Kx8 250 ns	6.50		
27128	16Kx8 250 ns	6.25		
STATIC RAM				
43256L-12	32Kx8 120 ns	\$11.50		
5864LP-12	8Kx8 120 ns	3.85		

OPEN 6 1/2 DAYS, 7:30 AM-10 PM. SHIP VIA FED-EX ON SAT.

SUNDAYS & HOLIDAYS: SHIPMENT OR DELIVERY VIA U.S. EXPRESS MAIL

SAT DELIVERY INCLUDED ON FED-EX ORDERS
RECEIVED BY: 24,000 S. Peoria Ave., BEGGSS, OK. 74421
Microprocessors Unlimited, Inc. (918) 267-4961
No minimum order. Please note that prices are subject to change. Shipping & insurance extra, & up to \$1 for packing material. Orders received by 3 PM CST can usually be delivered the next morning, via Federal Express Standard Air in \$4.00, or guaranteed next day Priority One in \$10.00!

CIRCLE 61 ON FREE INFORMATION CARD

CALL NOW AND RESERVE YOUR SPACE

- 6 x rate \$800.00 per each insertion.
- Fast reader service cycle.
- Short lead time for the placement of ads.

Call 516-293-3000 to reserve space. Ask for Arline Fishman. Limited number of pages available. Mail materials to: Computer Admart, RADIO-ELECTRONICS, 500-B Bi-County Blvd., Farmingdale, NY 11735.



CSS-5152 Graphics Printer (Epson)

- 100% IBM Compatible
- IBM Parallel Interface, 80 cps
- IBM PC Graphics Compatible
- Order Cable No. 5152, \$10
- Discount on 2 or more

\$149

For more information on our products, send a self-addressed stamped envelope to:



Computer Surplus Store
715 Sycamore Drive
Milpitas, CA 95035
Tel. Orders: 408-434-1060
FAX: 408-434-0931

CIRCLE 192 ON FREE INFORMATION CARD

DATA ENCRYPTION

The ultimate data-encryption algorithm. Encrypt your data and gain peace of mind.

MARIO J. MANISCALCO

Lock it or lose it! For sensitive data, it's that simple. If it's more than just an annoyance if someone obtains a sensitive file, encrypting that file can provide security as well as peace of mind. Encryption does not prevent file theft, but it does render a stolen file useless to anyone who does not possess the encryption key.

In this article, we will present a highly secure data-encryption algorithm (called Crypt) that combines the best features of several other algorithms. We'll discuss its implementation in the C programming language, and we'll also present a challenge offering a reward to any reader who can decrypt an encoded message that is published herein. The full source code in C, an executable version of Crypt, and the encoded message are available from the R-E BBS and on IBM PC format diskette from the author; see the "Ordering Information" box for more information.

Background

A number of simple yet powerful encryption algorithms exist, including what is probably the most widely known: the National Bureau of Standards Data Encryption Standard (DES) algorithm. The problem with most standard algorithms is that the keyspace provided is seldom large enough for the desired security (more about keyspace later).

In addition, it's best not to use a standard simply because it is a standard. However, although there is an abundance of non-standard algorithms, seldom can one find conclusive proof of the security provided by any of those algorithms.

The final design consideration is that the author wanted an encryption system that was portable between several computer systems (especially PC and VAX systems).

The algorithm presented here is simple to implement on any micro or minicomputer, and it is unbreakable in any practical sense of the word.

How to use it

To use Crypt (on a PC system), make sure the executable file is located in your path. CRYPT.EXE performs both the encryption and decryption functions. Invoke it as follows,

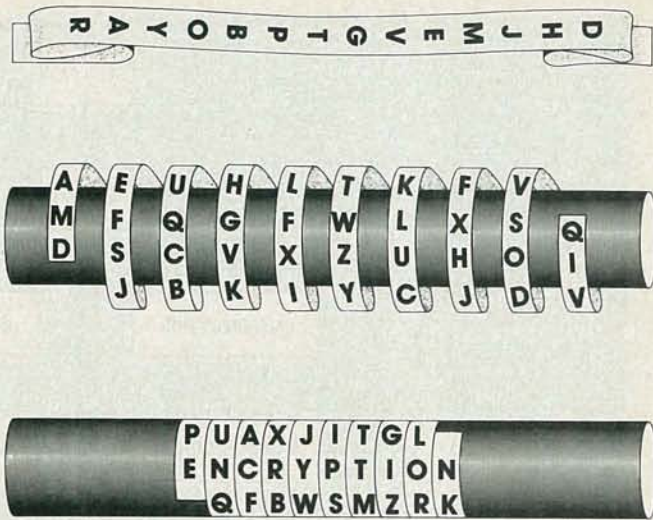

```
CRYPT INFILE.TYP OUTFILE.TYP E
```

where the first parameter is the file to be encrypted, the second is the file that will contain the encrypted data, and the third specifies encryption. To decrypt a file, specify the two file names followed by "D." The file must consist only of the printable ASCII characters (with values ranging from 32 to 125) carriage return (13), line feed (10), form feed (12), and tab (9). A tilde (-) will be substituted for any other character.

Whether encrypting or decrypting a file, the program will then ask you for the key, which may be as long as 64 characters. Like the data file itself, the key may contain any of the printable ASCII characters, in the form of a sentence or phrase that can be remembered easily. To avoid wasting time processing a file with an incorrect key, the program requires that you type the key in twice.

How it works

For this discussion, refer to Fig. 1, which shows pictorially the operations performed by the algorithm. Also refer to the sidebars entitled "Basic Terms," "Cipher Types," and "Key Types" for definitions of unfamiliar terms.

The power of Crypt comes from three main features that are as follows: 1) it has an extremely (and arbitrarily) large functional keyspace, 2) it is a product cipher, and 3) the key is only used once.

Crypt has an effective key space of 95^{64} ; compare that to a key space on the order of 10^{17} for DES. The key is used only once, for encrypting the first 32 characters of the plaintext. Thereafter, Crypt groups the plaintext into a series of 32-character blocks and encrypts each block one at a time. Blocking provides a useful benefit: the codebreaker cannot tell anything about the format of the plaintext file from the ciphertext file. He cannot determine the number of paragraphs, etc., since all that appears are blocks of 32 seemingly unintelligible characters.

The first 32 characters of the key are used as the transposition key (TK). Those characters determine a permutation of the plaintext block. The next 32 characters are used as a substitution key (SK). That key is added byte by byte to the permuted plaintext, and determines the substitution characters.

Things are a little more complicated than that, however.

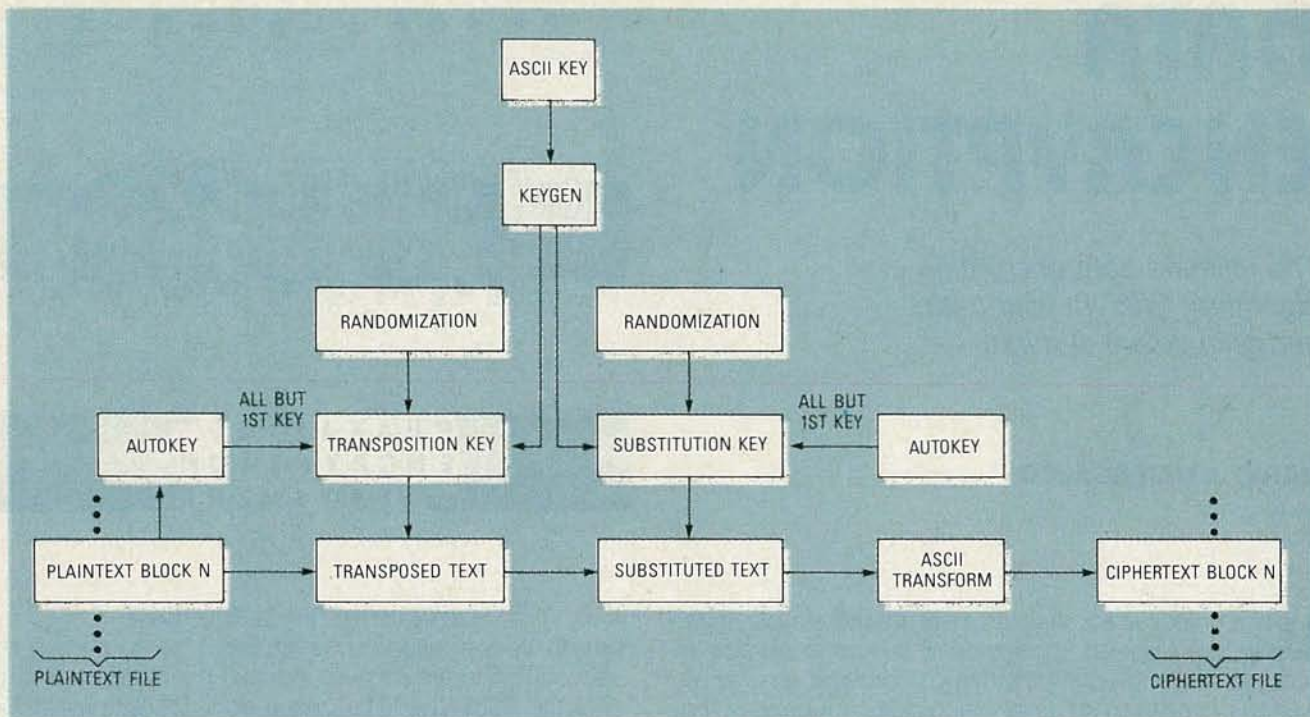

FIG. 1—THE ENCRYPTION/DECRIPTION ALGORITHM works on 32-byte blocks, performing both substitution and transposition ciphers.

The first key used is not the raw key entered by the user, but one that has been randomized prior to use by adding two pseudo-random number sequences to it. That may seem unnecessary, but it is essential to protect against a plaintext attack. Each successive key is also randomized, as well as having the running sum of plaintext added to it (modulo addition), forming what I call a randomized autokey.

The new permuted and substituted block will in general have integer values that are not printable ASCII characters. Before writing to the ciphertext file, each character is transformed into a printable character by a special routine (xform). The inverse transformation is performed when decrypting the ciphertext file.

In summary, the plaintext is chopped into blocks of 32 characters. A unique randomized autokey is used to permute and then substitute the characters in each block. The block is then transformed into printable ASCII, and written to the ciphertext file. The inverse is performed on decryption.

Security

The security of the algorithm is determined by the keyspace, or the length of the effective (or usable) key. Crypt's keyspace is 95^{64} , because each of the 64 key characters may be one of the 95 printable ASCII characters. Also, it is a true functional keyspace. Changing even one character in the key will yield a totally new mapping function by changing both pseudo-random number sequences. The result is that decrypting a file with a key that is off by only one ASCII value will result in a file of total garbage.

The key length is determined by a constant in the program (KEYLEN). In fact, KEYLEN is the separate length of the transposition and substitution keys, which makes it

BASIC TERMS

The following are basic terms and definitions that are necessary to understand how the encryption algorithm works. Interested readers will also find additional information in the sidebar entitled "References," which can be found elsewhere in this article.

The *plaintext* is the message to be put into a secret form. The *ciphertext* is the encrypted message. The *encryption algorithm* is the function that maps plaintext into ciphertext, or vice versa. Mapping is determined by a *key*; mapping is often called a *cipher*.

The *keyspace* describes the size of the domain (set of all possible keys). For example, a 16-bit key has a keyspace of 65,536. The *functional* keyspace is the number of keys that result in a unique mapping function, and may not be as large as the *apparent* keyspace. For example, suppose a 64-character key (composed of the 95 printable ASCII characters) is used. If the program were to use a shift-and-add process to generate a 16-bit number which is used to determine the mapping function, then the apparent keyspace is 95^{64} , but the functional keyspace is still only 16 bits, or 65,536.

In order for the functional keyspace to be equal to the apparent keyspace, each unique key must have a one-to-one correspondence to a unique mapping function, i.e., each unique key must yield a unique ciphertext for the given plaintext.

The reason the distinction between apparent and functional keyspace is important is that it is easy to be fooled into believing that a long key in and of itself yields more security. In fact, that is only true if the long key results in a large functional keyspace. That is the case in the Crypt algorithm, where changing one character of the key (by only one ASCII value) results in an entirely new ciphertext.

CIPHER TYPES

Ciphers can be grouped into three major types: substitution, transformation, and product ciphers. As the name suggests, a *substitution* cipher simply substitutes each character in the plaintext by another character, as determined by the key. The substitution cipher is a weak cipher, and it falls apart under a *plaintext attack*, wherein the codebreaker has a portion of the plaintext, either by guessing or stealing it. Any serious encryption algorithm must account for the possibility of a plaintext attack, because in many cases message content can be guessed from the name of a file, or, if the plaintext is in the form of a letter, return address and salutation could probably be guessed.

A *transposition* cipher, by contrast, performs a permutation of the characters in the plaintext message (i.e., it rearranges their order), as determined by the key. The transposition cipher is also weak, because even though their order has been changed, all of the original characters are present.

Something amazing happens, however, when the two types of weak ciphers are combined. When both substitution and permutation are performed on a message, it is called a *product* cipher, and is considered the most difficult type of cipher to break. Even if a portion of the plaintext is known, the permutation is not known, and that creates many problems for the codebreaker. Although it contains other features (such as a randomized autokey, described below) Crypt can be classified as a product cipher.

half the length of the user-entered key. So, for a 64-character key, KEYLEN must be 32. As will be discussed later in this article, a 64-character key provides sufficient security for any need. However, if desired, the key space can be increased (or decreased) by changing the value of KEYLEN. The limiting factor is that the computation time (due to the permutation) is a square law function, and program efficiency drops off rapidly with increasing key length.

The program

Crypt uses only standard C constructs and library functions, so the program should be easily portable to any C system. The program (in both source and executable forms) is available as mentioned in the sidebar "Ordering Information." The source code includes the complete design language (consisting of narrative and pseudo-code), so that programmers can implement the algorithm in another language.

Items that may require change on different machines or compilers are found in the `#define` statements. Also, in order for the algorithm to be portable between systems (and for the pseudo-random sequences to be the longest), it is necessary that long integers are used in several places in the Crypt program. Those *longint*'s should be 32 bits long, so that the maximum integer is 07FFFFFFh. All C compilers provide 32-bit long integers, but on some machines *longint* may be even longer. If that is the case, change the *longint* definitions to obtain 32-bit integers, or change MAXINT to match the size of integer used. Remember, however, that for portability between different machines, the integer sizes (for those integers defined as *longint*) must be the same.

KEY TYPES

It is commonly accepted that the only unbreakable cipher is a one-time key or one-time pad system. In that type of system, the key is only used once, so it must therefore be as long as the plaintext. For example, if the message is 1000 characters long, the key must also be 1000 characters long. If the key is random in nature, then the message can never be broken, since any and every 1000-character message can be formed from an appropriate key. Although the one-time key cipher is unbreakable, it is not very useful.

There are other, more practical ways of generating a key that are almost as effective and much more practical than the one-time key method. For example, if a key that is shorter than the plaintext message is used, one method of using the key only once is the *autokey* approach. An autokey is simply a key that is used only once, and then is transformed (using the plaintext) into a new key. The problem is that autokey becomes useless under a plaintext attack, because if the codebreaker has the first block of the plaintext, he can then generate successive autokeys.

However, the autokey can be made effective if it is also randomized, with the randomization determined by the initial key. That is what is done in Crypt. In fact, the algorithm uses a *randomized* autokey, which means that pseudo-random number sequences are also added to the autokey. So even if the codebreaker has the plaintext, he must still deal with the randomization, in addition to the autokey!

Most C compilers generate relatively efficient codes, but the execution time of course will vary from machine to machine. To give the reader an idea of execution speed, encrypting the 53K C source file required about 90 seconds on an IBM PC AT.

Portability

An encrypted file is portable between systems because the ciphertext is composed only of printable ASCII characters (plus CR, LF, TAB, and FF). Note that if the ciphertext file was a binary file, the results might be unpredictable for different systems. However, it is possible that those few control characters might not be transmitted correctly between systems. It is important to note that although Crypt will function correctly on any system, transmitting the ciphertext file through communications lines may cause the control characters to be handled incorrectly.

For that reason, I have created a tool called Chat (Ciphertext Hex-ASCII Translator), which can be used to convert ciphertext to hex ASCII and vice versa. This hex ASCII code can then be transmitted between any two systems as an ordinary ASCII file. The program, which is also written in C, is available as discussed in the sidebar "Ordering Information," which can be found elsewhere in this article. Chat creates a printable version of the ciphertext file, so the program can also be used to print an encrypted file for sending through the mail or other purposes. Hex ASCII is a hexadecimal representation of a byte, wherein two ASCII digits are used by the program to represent each byte. For example, a space has the ASCII value of 20 hex. Therefore, the ASCII characters "20" are used to represent a space.

CHALLENGE

The author will offer a reward of \$100 to the first person to break Crypt by decrypting the ciphertext shown in Listing 1, and who meets the requirements specified below. (First person is defined as the first letter or communication which I receive.) In the event of a tie, the reward will be split among the tying parties. A time limit of one year from the publication of the second part of this article will be allowed. (One year is defined as being from the last day of the month of this publication to the last day of the same month of the following year.)

To aid you in breaking Crypt, Listing 2 contains a portion of the ciphertext in plaintext form, hence allowing you to launch the most feared type of attack there is: a plaintext attack.

In order to collect the reward, the codebreaker must provide the author with the method used to break the cipher (including source code for any program or programs used). The codebreaker must also provide the author with the fully decrypted message as proof that Crypt was broken. The key need not be provided, because it is given in the plaintext message. That's right, the key is encrypted along with the message!

ORDERING INFORMATION

For \$10, the author will provide an IBM PC format disk containing: source and executable code for both Crypt and Chat, the encrypted message, and ciphertext and plaintext shown in Listings 1 and 2. Write to Mario J. Maniscalco, 11413 St. Mark Ve., Cleveland, OH 44111.

A photocopy of the encrypted message is also available from **Radio-Electronics** by sending an SASE to our editorial offices. Or you can obtain all the files from our BBS (516-293-2283, 300/1200 baud, 1 start, 1 stop, and 8 data bits); download the file CRYPT.ARC. Also, after the one year period has elapsed, the author will send the plaintext message and key to any reader who sends in an SASE.

Testing

In order to verify that Crypt has been implemented properly on a particular system, I have provided a test procedure, shown in the sidebar "Test Procedure." The reader should execute the test procedure to determine whether the implementation produces ciphertext that is compatible with the author's version. That compatibility is especially important if the reader wishes to accept the decryption challenge (described elsewhere).

Limitations

The plaintext file must contain only printable ASCII characters, with the exception of the "newline" character or characters (i.e., CR, LF, or both), formfeeds and tabs. If the plaintext file contains illegal characters, they will be substituted with the SUBCHAR character, a tilde (~) in this implementation. However the rest of the file will be encrypted and decrypted correctly.

Warning: Double or multiple encryption will not work. The reason is that Crypt requires 4 control codes for its own use, and if those codes are found in a "plaintext" file, they are replaced by SUBCHAR. Besides, Crypt is strong enough that multiple encryption is not necessary.

Modifications

If necessary for a particular application, the program can be modified for special purposes easily. For example, if the user can refrain from using the last four ASCII characters in his plaintext, Crypt can be modified to produce printable ciphertext. That is done by changing the values of MIN—ASCII, MAX—ASCII, MIN—LEGAL and MAX—LEGAL. Of course, there is really no need to produce printable ciphertext, because Chat can convert ciphertext to printable form.

Crypt can also be modified by increasing or decreasing

LISTING 1

```
24297A24692F3D58574D632071693C393A4B4E263271F234A4C2E32413A6039
376679351D1E2741496B283341296229B495F7275254D69262A307C3473464C
4151435A56751F49393B32634A583823692A155504F356C54782A251D554859
486E39286C385C292A4F2550242F2A2E3C5D6E54785C614275464A1F4735326A
3152483340274B3E61475542561C53522B6C3D52626D35587922327D6C39531D
1C433D4C1D514B66523A63504B6C2E4C7A3730436A624B5263B2944774313976
4W3E3A65274E64B3F5836666A725A21615B362854721E675C7E8565E5D5A5C2E
3E2475484C5D23215529447B23523E5148657B257C602D1D3E40682F4A663564
51342C44681F7C674E50442C5528383743A2B3C5366493B695533444F7C2E42
76471C42292345682C4667263F58624E5B2A714B2860224F65686E8B2793B752D
52785424543E325B4D275A4E649407E33541D413392B584857D33962374547
57637B224836695344332F48534339336C3961675339546D661E6055756384D
712D353977795E293235472D427246205125653C563B3246742E653579663D65
701C735B54E1F6A6B34684830267A3164608480577A4A95729645210566217447
466677591E56623C57347D456C4F764647283544533D46A5155383362493B1D
66273E2623511C3D2434715C441C2A3B1E584E3475E676474394239654A47335
434E6E2B784F4247307A3B425F4374105A2E4F4C20A333B6325412856571D28
5B3A5D786466D695257766338241F7C7B352060554A497E4E2E537C1F6257635
221E602E5A3D6245331E5645416C46547C7A4E4121444A50413P43A5B32134C
5A3936144206084364253148593E5C423A5C316F2D20772D6B56436P2822633D
35692F495B7E6B772E6225425A4C312B31546C207E752948582C4127566F7A2D
1ED264A5A752C5E8485A3849764A5664474948517C49527B242A717463593D57
773D3C5935566647277493F252F337D67396A3D34351E636059665F2D30487B
3F7365784666663753423222F2A207B2C4458705436484E252F5C366A7E4A6B
4C301C5873434D513270333C4560664B485834537543445D5D2D3E6045513630
2C62493B2A3301F24393C366C16F772948485877A4A95729645210566217447
523937565A36211E1D2834423F461E3D4E4E4F3B78533C50583C543733773C67
42483F56486334403805125743A6A54574D263B7861605E4E462556385A2B45555C
2E3569645E2B7D1F557E7748734F7853664877486E34653C5E7B3C481F435837
4D514C417A4D546E2C4552746E7867263B7861605E4E462556385A2B45555C
3C5141473372D2C486C6773724E5A7644224934573727372649753D405E6B39
29345D395877287976266841234676284C2F4675294F3C7A317A483852825345
4E6A496755D5F43673F5E34425D784F746647451C6E2B6052552B4B4E67721D
461E3A4E765B2E5C521C795B256151381E65293A675B513237317D6149424952
286040336E543156366D596757536236277A632623617A5E346D783942724751
3595B365C6345764R6C6975704D347552F447454522D6B5864427E4B485251F
466653423D67479537D6E2A7E766C66592252D766554703C374B495B37584B
7425213B3336285C322E5655B4D675432307B48485B4C27495331608736454D
252B385E6168493F383D49245F40573453735C4564A4C3A456741586541729442
575C1C67483543C4085B57264B4D222R4A724036471C483D423552473525422
1F366E5D511C4E464C4C62304E314C564248443345417E2668211D4F7B7355A
687844466E282622547521F2D4D577B344D4424217138414A6F55287474F753B
7A63233C2E6F422A385E241E445C444E704862462072734D42E5B63411D227468
33643135674D376E607A75377E1D286D5A3C4D2C54376B2C4E271E2062673730
1C564A407D33285B7A3851302F3B485C31786B6F31425D44786E791F536F4B3F
773B1F5B4154751D51545C475B617E38715D4552414C455A51456204464E5758
3B266C6A56707D2C7E4P65335B382E3E7B471F707E4E5B686B5D4566C73432C
5A5D5B2863E265652304251404C4827297E2A555F2C257E5P616F32697A4E2C
52707E586B6F727D3C467C437C24692C233C7B7D2A316C32233F73376F16873
457C6E285B70315F2657627A4C5A1E53F2F752F487E3D675E225827A77343A75
7C343B732532295931445C662D7358314F754C3339322B50403C434877393759
6D44446522704D5A7957254B2D3E3445A3B6C564335593237682522462387C
20216630744F5B305D6B5325F1D41626D2825471D5F573C60837B3D27524254
763E603E24391B485C305E5F4A723420273744313C515420531C421D641P7142
663B7285D44591E1C667943486C473E237A3C6P745E2D3139475E486A676043
34307B485E614161213E307D4F55393E65334E603A4E5D64302F351E636A72
396E2F7B3C4C5632775B444A5234451E487D392E47265558275664413F66603B
3B3E724853403659343D283C1F225D624C5E43472D4D3C21397529614322613B
612659444C715D26371D414F66567443342B5E264E4C562B7C2D426345492C2E
4448267A49315E66767463A622649721F782E723D793A432E18664D7C348451
7E1E7075207857146322F5C47482E7B68675A23126235516260773D302F
58414D725E386D483C1F45477E443952402A416869552B646B2530D283F5C6C
5056664B3A3D5D205D227B75246415355342F236B465D226D573B3B28464D65
49452C302554232C5452554170422B305D4466351E48466020527A58523D5544
70786E40637548454A4E505629692E5B68666E35783D666038751C4766485C4D
203B4E447D4C55215C2C3378374A586475267C6D63797869654D5E7A2E66452D
```

LISTING 2

In this challenge, I have given the codebreaker everything he needs to break this ciphertext: the algorithm, the program itself, that was used to encrypt the plaintext, and even this portion of the plaintext! The only information which I have kept from the codebreaker is the key itself. I will not give any clues about the key, except I will state that it is a full 64 character key (obviously I would not want to use an abbreviated short key).

I should also mention that there are no hidden spaces in this plaintext. (An example of a hidden space is one or more spaces which trails at the end of a line.) The only spaces which exist are those between words, or the five spaces in the indentation of a new paragraph. Also, note that there are two spaces between sentences. The blank lines between paragraphs are composed only of a newline character, and do not contain any spaces. Also, the very first character of this message is the first of 5 spaces in the indentation of the first paragraph.

TEST PROCEDURE

To determine whether Crypt has been implemented correctly on a particular system, the following test message should be encrypted with both a null key and the given key. The following is the test message:

This is just a test message to see if Crypt has been implemented properly.

In that message, the "newline" character after the word *been* is part of the message. (On your system, press Return after the word *been*.) There is no newline at the end of the second line.

First try to encrypt the message using a null key. A null key simply means answering the key prompt with a carriage return. You should get the ciphertext shown below. However, note that several unprintable characters are not shown. Therefore the Chat hex ASCII form of the ciphertext is also given. From the hex ASCII, you can verify that each character of the ciphertext is correct.

CIPHERTEXT FOR THE NULL KEY

```
.oSCh8LE1EiMA5 CCD%5(j6-qX7oY2da
?hYHLZd-UYQIEKP%b<Le x CMPJXKM
i-:JV9,7R6jG = = #V-0'NM33aImOg&
```

HEX-ASCII CIPHERTEXT FOR THE NULL KEY:

```
2E6F536348384C453145694D41352043
43442535286A362D7158376F59326461
3F681F59484C5A641D2D55595174454B
507C25623C4C652B58434D504A584B4D
692D3A2F4A56392C3752365D473D3D23
562D30274E4D333361211E6D4F7E6726
```

Now try encrypting the given test message with the following key (which is a statement of Gauss's law):

The flux crossing a closed surface is equal to the charge enclosed.

Note that the key is longer than 64 characters, so Crypt will only use the first 64 characters. Again, here are the ciphertext and hex-ASCII forms of the test message. CIPHERTEXT FOR THE GAUSS'S LAW KEY:

```
d#Q8ow;U%S%6 tP<ZPB#e
```

HEX-ASCII CIPHERTEXT FOR GAUSS'S LAW KEY:

```
642351386F773B55251D532536207450
3C333F774B4D527C7C7D394D1D236330
604E252F7E5A1E42455C3655404D763B
57643474543B51374B58512466585365
5A7A4A492A465E5D2E232F4B226A6B50
346D6D461C275A6B2A3C5A504223651D
```

Now you should decrypt the encoded versions of the test message, and use the DOS COMP command to compare the decrypted files to the original one. They should all be identical.

REFERENCES

1. Akritas, A. G., S. S. Iyengar and A. A. Rampuria, "Computationally Efficient Algorithms for a One-Time Pad Scheme," *International Journal of computer and Information Sciences*, vol. 12, No. 4, 1983, page 285.
2. Block, David, "Cnhy Vf Qrnq!," *Microcomputing*, May 1984, page 86.
3. Bryce, Heather, "The NBS Data Encryption Standard: Products and Principles," *Mini-Micro Systems*, March 1981, page 111.
4. Burton, C. E., "An Enhanced ADFGVX Cipher System," *Dr. Dobb's Journal*, February 1985, page 48.
5. Costas, John P., "Cryptography in the Field," *Byte*, Part 1, March 1979, page 56; part 2, April 1979, page 114.
6. Feistel, Horst, "Cryptography and Computer Privacy," *Scientific American*, Vol. 228 Number 5, May 1973, page 15.
7. Hines, Theodore, Lois Winkel, Rosann W. Collins, and Francis A. Harvey, "Cipher via Computer: The One-Time Pad," *Byte*, September 1983, page 404.
8. Kernighan, Brian W. and Dennis M. Ritchie, *The C Programming Language*, Bell Telephone Laboratories, Inc., 1978.
9. Knuth, Donald E., *The Art of Computer Programming*, Addison-Wesley Publishing Company, Vol. 2, page 9, 1969.
10. Kolata, Gina, "NSA to Provide Secret Codes," *Science*, Vol. 230, October 4, 1985, page 45.
11. Legg, Gary, "Encryption Software Guards Valuable Data," *EDN*, July 7, 1983, page 258.
12. Mansfield, Victor, "Encryption Methods," *PC Tech Journal*, April 1985, page 96.
13. Meushaw, Robert V., "The Standard Data Encryption Algorithm," *Byte*, Part 1, March 1979, page 66; Part 2, April 1979, page 110.
14. Pollock, Harvey, "Data Encryption: Unscrambling the Mystery," *Canadian Datasystems*, February 1983, page 41.
15. Scacchitti, Fred A., "The Cryptographer's Toolbox," *Dr. Dobb's Journal*, May 1986, page 58.
16. Sclawy, Alan, "CP/M Encryption Prescription," *Microcomputing*, November 1980, page 42.
17. Smith, John, "Public Key Cryptography," *Byte*, January 1983, page 198.
18. Thomas, John A. and Joan Thersites, "An Infinite Key Encryption System," *Dr. Dobb's Journal*, August 1984, page 44.
19. Willett, Michael, "Cryptography Old and New," *Computers and Security*, Vol.1 No. 2, June 1982, page 177.

ing the key length (KEYLEN). A shorter KEYLEN will of course provide less security, but faster execution. A longer KEYLEN has the opposite effect. A KEYLEN of 32 (resulting in an ASCII key length of 64) was found to be a good compromise.

It is possible to make other modifications to the program. For instances, you might want to change the default seeds and starting points for the pseudo-random number sequences. Doing so would produce a unique version of Crypt, one that would be incompatible with all of the other versions of the program.

Last, if Crypt is used on a system where it can be invoked by a batch file or a command procedure, it is possible to create procedures to make Crypt easier to use, and to accomplish many of the necessary operations

(such as deleting plaintext files from the disk after encryption) automatically.

Conclusions

When I leave work at night, I have no worries. If I forget to remove my floppy disk (which contains sensitive information), or if the system manager leaves his terminal logged on with SYSTEM privileges—so what! My private files are encrypted. Even if someone cracks the computer system's security, he can't crack Crypt.

Likewise, if a burglar breaks into my home and steals my computer equipment, at least he hasn't stolen my *information!*

In short, I can sleep at night, and, with Crypt, so can you! 

BUILD THE PT-68K

68000 addressing, and more.



PETER A. STARK,
STARK SOFTWARE SYSTEMS CORPORATION

Part 6 Before we get to this month's topic, let's finish up the connector discussion from February.

Most of the pins on the right side of the connector are simply buffered address and data lines. Figure 5 shows how we buffer the address lines, Fig. 6 shows how we generate the PC control signals, and Fig. 7 shows how we buffer the data bus and generate additional control signals.

To begin with the latter, the lower eight bits of the 68000's data bus drive the expansion connector's eight-bit data bus (BD0-BD7). Therefore, each expansion bus address is an odd 68000 address. Moreover, the 68000's A1 line becomes BA0 on the expansion bus, A2 becomes BA1, and so on, up to A20 which becomes BA19. That is necessary because the expansion connectors need a BA0 line, but the 68000 does not have an A0 output; hence, everything is shifted by one bit.

Intel memory decoding

To understand how expansion slot addresses equate to 68000 addresses, we have to understand the decoding circuit in Fig. 6. In a 68000 (and, in fact, most Motorola microprocessors) there is only one set of addresses, which are used for both memory and I/O. The 8088 (and most Intel processors) have two sets of addresses: one for memory, and another for I/O. Typically, memory addresses are accessed by MOV instructions, and I/O addresses are accessed by IN and OUT instructions. A typical Intel processor manipulates memory and I/O locations with four control lines: \overline{MEMW} , to write to memory; \overline{MEMR} , to read from memory; \overline{IOW} , to write to an I/O device; and \overline{IOR} , to read from an I/O device.

In a typical PC, those four signals are brought to the bus connectors, and all four are used by many I/O cards. For example, on a monochrome or color video board, \overline{IOW} and \overline{IOR} are used to control the card, but \overline{MEMW} and \overline{MEMR}

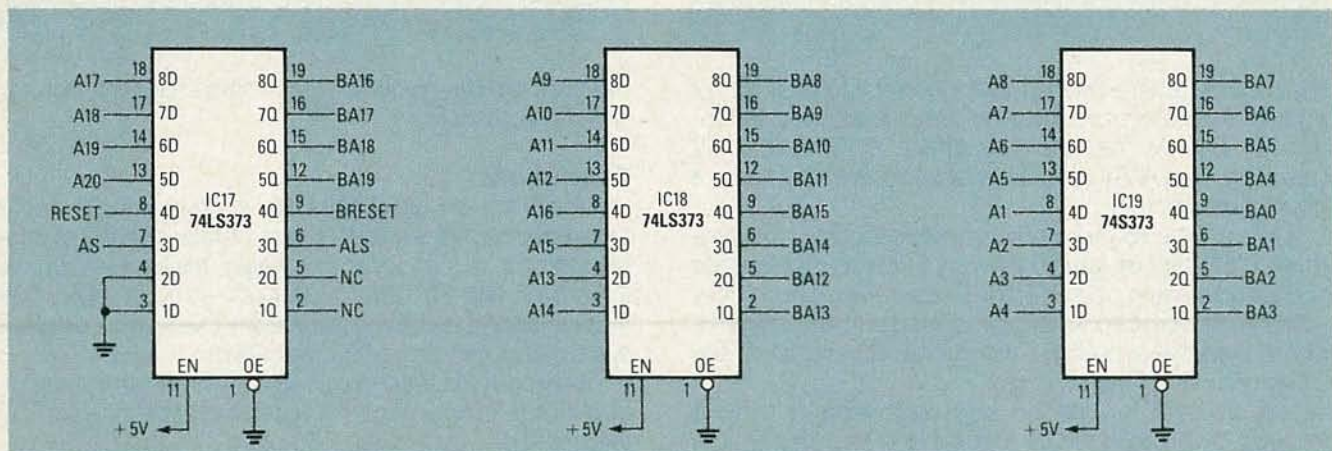

FIG. 5—ADDRESS BUFFERS for the PC-compatible expansion slots are shown here. Note that only IC19 is a 74S373; IC17 and IC18 are LS parts.

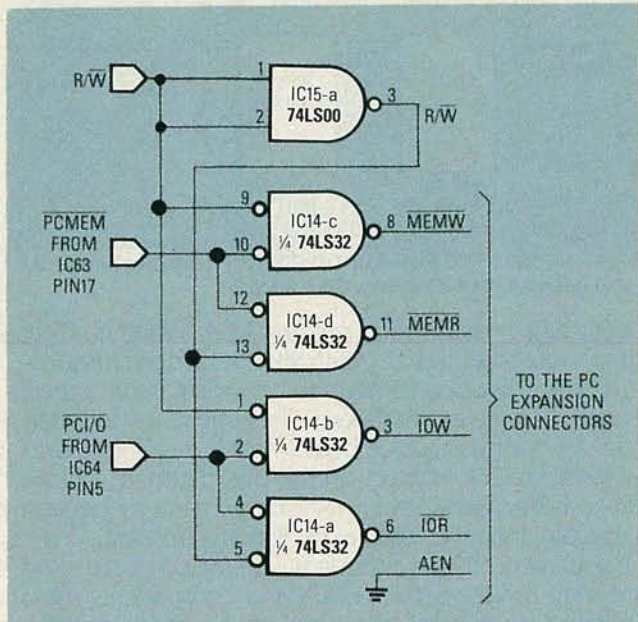

FIG. 6—I/O AND MEMORY CONTROL SIGNALS for the PC-compatible expansion slots are decoded as shown here.

Although most PC's have a maximum of 640K of RAM, the microprocessor can actually address one megabyte of memory, and 64K of I/O addresses, using 20 address bits for memory and 16 bits for I/O. Memory above the first 640K (i.e., above \$9FFFF) is reserved for video (128K), hard disk (32K), BIOS and BASIC ROM's (64K), and the remaining 128K may be used for different purposes (expanded memory boards, for example).

As we saw in Fig. 3 in the January 1988 issue, the address decoder generates a $\overline{\text{PCMEM}}$ signal for 68000 addresses \$C00000 through \$DFFFFF, and a $\overline{\text{PCI/O}}$ signal for addresses \$FA0000 through \$BFFFFF. Those two enable signals are used by the circuit shown in Fig. 6 here as follows:

1. If $\overline{\text{PCMEM}}$ is low and $\overline{\text{R/W}}$ is low, then IC14-c generates a low $\overline{\text{MEMW}}$ signal.
2. If $\overline{\text{PCMEM}}$ is low and $\overline{\text{R/W}}$ is high, then IC14-d generates a low $\overline{\text{MEMR}}$ signal.
3. If $\overline{\text{PCI/O}}$ is low and $\overline{\text{R/W}}$ is low, then IC14-a generates a low $\overline{\text{IOW}}$ signal.
4. If $\overline{\text{PCI/O}}$ is low and $\overline{\text{R/W}}$ is high, then IC14-b generates a low $\overline{\text{IOR}}$ signal.

So when the 68000 reads or writes memory addresses

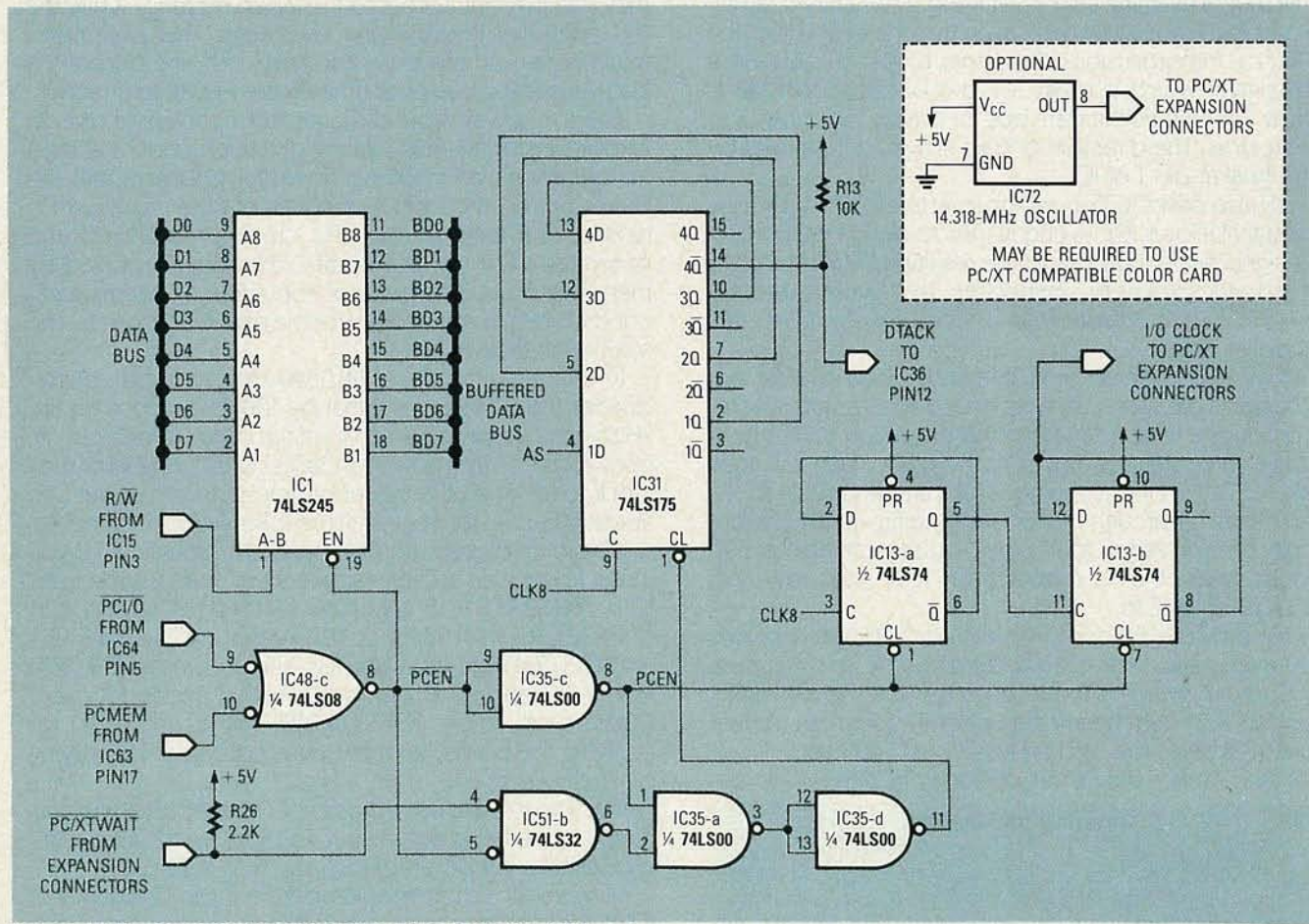

FIG. 7—THE EXPANSION-SLOT DATA-BUS BUFFER (IC1) and miscellaneous control signals are shown here.

are used to access the video RAM where display data is stored. On a hard-disk controller, $\overline{\text{IOR}}$ and $\overline{\text{IOW}}$ again control the hardware, but $\overline{\text{MEMR}}$ is needed to read the ROM on the board. All of those addresses must be squeezed into the 68000's single memory-address space.

\$C00000 through \$DFFFFF, cards plugged into the expansion slots get a memory-read or a memory-write signal; when the 68000 accesses memory addresses \$FA0000 through \$BFFFFF, the cards get an I/O-read or an I/O-write signal.

The result is that cards in the expansion connectors can be written to and read from, but the addresses accessed are not simply translated from the 68000's address space. For PC memory addresses, the relationship is given by the following formula:

$$68000 \text{ address} = \$C00001 + 2 \times \text{PC address}$$

For example, the character in the upper left corner of the screen in a monochrome PC is stored at address \$B0000, which translates to address \$D60001 in the PT-68K. That character's attribute byte is located at \$B0001 on the PC, and at \$D6003 on the PT-68K.

For PC I/O addresses, the relationship is indicated by the following formula:

$$68000 \text{ address} = \$FA0001 + 2 \times \text{PC address}$$

For example, the control port of a monochrome video board is at PC I/O address \$03B8, which translates to address \$FA0771 in the PT-68K.

The result is that the PC's one-megabyte address space occupies two megabytes in the PT-68K, ranging from \$C00000 through \$DFFFFF, and the 64K of PC I/O addresses translates to 128K of 68000 addresses, from \$FA0000 through \$FBFFFF. One consequence of our design is that it is not practical to connect a PC memory board to the PT-68K.

Now let's examine the circuit in Fig. 7. Whenever either \overline{PCIO} or \overline{PCMEM} goes low, indicating that the 68000 is trying to access the expansion connectors, IC48-c outputs a low \overline{PCEN} signal, which enables IC1, the bi-directional transceiver that buffers the data bus for use by the expansion connectors. The direction of data flow is determined by the signal at pin 1 of IC1.

\overline{PCEN} also drives IC35-c, which inverts it to produce \overline{PCEN} ; that signal allows IC13-a and IC13-b to divide the 8-MHz $CLK8$ signal by four and send the resulting 2-MHz I/O CLOCK signal to the expansion connectors. That signal is used by some PC video adapters as a clock for the 6845 CRT controller chip.

\overline{PCEN} is also buffered by IC35-a and IC35-d to drive the \overline{CLEAR} input (pin 1) of IC31, which is wired as a shift register to produce a time delay. In normal operation, IC31 is held in the cleared state, so it does nothing. But when \overline{PCEN} goes high, IC31's \overline{CLEAR} input also goes high and it starts to shift a high (from AS) through the register, one flip-flop for every pulse of $CLK8$. After four clock pulses, or about 500 nanoseconds, the \overline{Q} output from IC31 goes low and sends \overline{DTACK} to IC36.

That provides PC-compatible cards 500 nsec to work. However, some cards need additional time, so they return a \overline{WAIT} signal, which is fed through IC51-b. The \overline{WAIT} signal prevents IC31 from timing out until \overline{WAIT} goes high. At that point IC31 gives the card an additional 500 nsec.

Figure 7 also shows an optional 14.31818-MHz os-

Ordering Information

Complete details were given in part one (in the October issue). To summarize: The basic kit (PT1, \$200) contains all parts except power supply, case, and video terminal or personal computer to get a small system (ROM monitor, 2K RAM) up and running. The full basic system (PT68K, \$460) includes 512K of dynamic RAM, floppy-disk controller, parallel port, battery-backed clock/calendar, and three PC-compatible expansion slots. To order, or for more information, contact Peripheral Technology, 1480 Terrell Mill Road #870, Marietta, GA 30067, (404) 984-0742.

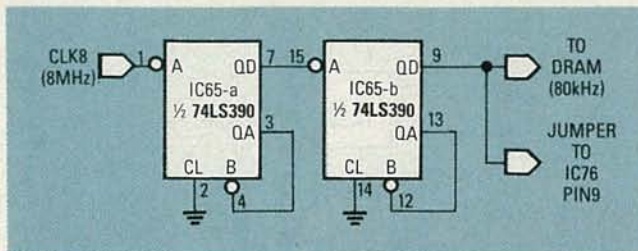

FIG. 8—MODIFY THE BUS-ERROR CIRCUIT as shown here ONLY if you intend to use a modern CGA adapter.

cillator, which is needed by some CGA adapters. (That signal is four times the 3.579545 MHz color-burst frequency). Some color boards have their own oscillator; others need one on the motherboard. The easiest way to determine whether your color board needs that signal is to examine the OSC contact on the board connector (the next-to-last on the left side). If the board has a connection to that pin, then the external oscillator is needed.

If you intend to use a modern CGA video board—the type with surface-mounted ICs and components—you may need to do a bit of surgery on the PT-68K motherboard at this time. Since designing the PT-68K, we found that some boards generate a very long \overline{WAIT} signal so that they can prevent access to the video memory while the CRT controller is displaying characters. That is done to minimize on-screen snow and hash, but, unfortunately, it also causes the bus-error timer in the PT-68K to time out.

There is a way around the problem, however; the fix involves installing an IC, cutting one trace, and installing a jumper, all on the PT-68K. As shown in Fig. 2 last month, the bus error circuit counts four pulses of the ϵ clock (which runs at one tenth of the CPU clock, or 800 kHz) and generates a \overline{BERR} signal if no \overline{DTACK} has been received by then. That provides a delay of about four or five microseconds, which is not enough for the new CGA boards. The solution is shown in Fig. 8.

In that circuit, IC65, a 74LS390 dual decade counter divides the 8-MHz $CLK8$ signal by 100 to produce an 80-kHz signal. That IC is really part of the DRAM refresh circuit, but we can install it now and use its output instead of the ϵ clock to lengthen the bus error time-out from about 5 to about 50 μ s. To do so, install the following components:

62-pin card edge connectors at J1 through J6 (if you install fewer than six, then space them apart); sockets for IC18 (74LS373), IC15 and IC35 (74LS00), IC14 and IC51 (74LS32), IC1 (74LS245), IC48 (74LS08), IC31 (74LS135), and IC13 (74LS74). Install the IC's, and then install R13 (10K) R26 (2.2K), and C1 (0.1 μ F disk). Also, if needed for your CGA board, solder IC92 (14.31818-MHz oscillator) directly to the board, with the pointed corner identifying pin 1 closest to J4.

If you're going to use a modern CGA adapter, also install IC65, cut the trace between IC76 pin 9, and IC47 pin 20, and install a jumper from IC65 pin 9 to IC76 pin 9.

Now install a short wire jumper from pin 12 to pin 7 of IC15. The reason is that part of IC15 is generating a false \overline{DTACK} , which is upsetting everything else. For now, the jumper disables the circuit; we'll remove it later.

If you have a PC-compatible video board and matching monitor, plug it in now and turn on the power. If all is well, you should now see the message "Please press enter" on the screen. If not—well, we're running a bit short of space this month, so we'll discuss debugging next time. **▶◀**

MARKET CENTER

FOR SALE

TUBES, name brands, new, 80% off list. **KIRBY**, 298 West Carmel Drive, Carmel, IN 46032.

DESCRAMBLERS catalog. All brands. Special combo Jerrold 400 and SB3 \$165. Cable descrambler kit \$39.00 Satellite descrambler kit \$45.00. **MJ INDUSTRY**, Box 531, Bronx, NY 10461-0531.

CLASSIFIED AD ORDER FORM

To run your own classified ad, put one word on each of the lines below and send this form along with your check to:

Radio-Electronics Classified Ads, 500-B Bi-County Boulevard, Farmingdale, NY 11735

PLEASE INDICATE in which category of classified advertising you wish your ad to appear. For special headings, there is a surcharge of **\$23.00**.

() Plans/Kits () Business Opportunities () For Sale
() Education/Instruction () Wanted () Satellite Television

Special Category: \$23.00

PLEASE PRINT EACH WORD SEPARATELY, IN BLOCK LETTERS.

(No refunds or credits for typesetting errors can be made unless you clearly print or type your copy.) Rates indicated are for standard style classified ads only. See below for additional charges for special ads. **Minimum: 15 words.**

1	2	3	4	5
6	7	8	9	10
11	12	13	14	15 (\$42.75)
16 (\$45.60)	17 (\$48.45)	18 (\$51.30)	19 (\$54.15)	20 (\$57.00)
21 (\$59.85)	22 (\$62.70)	23 (\$65.55)	24 (\$68.40)	25 (\$71.25)
26 (\$74.10)	27 (\$76.95)	28 (\$79.80)	29 (\$82.65)	30 (\$85.50)
31 (\$88.35)	32 (\$91.10)	33 (\$94.05)	34 (\$96.90)	35 (\$99.75)

We accept MasterCard and Visa for payment of orders. If you wish to use your credit card to pay for your ad fill in the following additional information (Sorry, no telephone orders can be accepted.):

Card Number

Expiration Date

Please Print Name

Signature

IF YOU USE A BOX NUMBER YOU MUST INCLUDE YOUR PERMANENT ADDRESS AND PHONE NUMBER FOR OUR FILES. ADS SUBMITTED WITHOUT THIS INFORMATION WILL NOT BE ACCEPTED.

CLASSIFIED COMMERCIAL RATE: (for firms or individuals offering commercial products or services) \$2.85 per word prepaid (no charge for zip code)...**MINIMUM 15 WORDS.** 5% discount for same ad in 6 issues; 10% discount for same ad in 12 issues within one year; if prepaid. **NON-COMMERCIAL RATE:** (for individuals who want to buy or sell a personal item) \$2.30 per word, prepaid...no minimum. **ONLY FIRST WORD AND NAME** set in bold caps at no extra charge. Additional bold face (not available as all caps) **50¢ per word additional.** Entire ad in boldface, \$3.40 per word. **TINT SCREEN BEHIND ENTIRE AD: \$3.55 per word.** **TINT SCREEN BEHIND ENTIRE AD PLUS ALL BOLD FACE AD: \$4.15 per word.** **EXPANDED TYPE AD: \$4.30 per word prepaid.** Entire ad in boldface, \$5.15 per word. **TINT SCREEN BEHIND ENTIRE AD PLUS ALL BOLD FACE AD: \$5.40 per word.** **TINT SCREEN BEHIND ENTIRE EXPANDED TYPE AD PLUS ALL BOLD FACE AD: \$6.25 per word.** **DISPLAY ADS:** 1" x 2 1/4"—\$320.00; 2" x 2 1/4"—\$640.00; 3" x 2 1/4"—\$960.00. **General Information:** Frequency rates and prepayment discounts are available. **ALL COPY SUBJECT TO PUBLISHERS APPROVAL. ADVERTISEMENTS USING P.O. BOX ADDRESS WILL NOT BE ACCEPTED UNTIL ADVERTISER SUPPLIES PUBLISHER WITH PERMANENT ADDRESS AND PHONE NUMBER.** Copy to be in our hands on the 12th of the third month preceding the date of the issue. (i.e., Aug. issue copy must be received by May 12th). When normal closing date falls on Saturday, Sunday or Holiday, issue closes on preceding working day. Send for the classified brochure. Circle Number 48 on the Free Information Card

TUBES, new, unused. Send self-addressed, stamped envelope for list. **FALA ELECTRONICS**, Box 1376-2, Milwaukee, WI 53201.

PHOTOFACT folders, under #1400 \$3.00. Others \$5.00. Postpaid. **LOEB**, 414 Chestnut Lane, East Meadow, NY 11554.

TI-99/4A software/hardware bargains. Hard-to-find items. Huge selection. Fast service. Free catalog. **DYNA**, Box 690, Hicksville, NY 11801.

CABLE-TV equipment S.A., Jerrold, Zenith, Hamlin, Oak, Eagle filters remotes and more. **Best prices. C.O.D.'s accepted. Dealers needed. Ours work where others failed and we guarantee it!** **TRANS-WORLD CABLE, Co. (218) 543-6671.**

TRANSISTORS-tubes: MRF421 \$24.00, MRF454 \$14.50, MRF455-MRF477 \$11.75, MRF492 \$16.00, SRF2072 \$12.75, SRF3800 \$17.50, 2SC2290 \$16.75, 2SC2879 \$22.00, 6LF6, 6LQ6, 6JS6, 8950, etc.-call. New **Ranger AR3500** all mode 10 Meter transceiver \$319.00 Quantity discounts! Best prices on hard-to-find parts, antennas, mics, power supplies, & equipment! Catalog \$1.00 (refundable), or free with order. **RFPCC**, Box 700, San Marcos, CA 92069. For information or same day shipment—call (619) 744-0728. Visa/MC/C.O.D.

FREE CATALOG

FAMOUS "FIRESTIK" BRAND CB ANTENNAS AND ACCESSORIES. QUALITY PRODUCTS FOR THE SERIOUS CB'er. SINCE 1962

FIRESTIK ANTENNA COMPANY
2614 EAST ADAMS
PHOENIX, ARIZONA 85034

LASERS, components and accessories. Free catalog. **M.J. NEAL COMPANY**, 6672 Mallard Court, Orient, OH 43146.

REPAIR your own TV...it's easy. Write **RESEARCH**, Rt. 3, Box 601BR, Colville, WA 99114.

AIDS? Yes we have! Cable aids to help you. Zenith, Jerrold, Scientific Atlanta, Oak, Hamlin's, much more. No Michigan sales! **HOTRONICS**, (313) 675-5834.

PICTURE flyer lists quality surplus electronics at low prices. Since 1970. Send for the last 3 issues. **STAR-TRONICS**, Box 683, McMinnville, OR 97128.

CAD-CAM controller sends computer screen drawings to XY table for cutting or etching. **KERN ELECTRONICS**, 812 King, Wadena, MN 56482.

ELECTRONIC Liquidators, thousands of parts, kits, hardware. Send \$3.50 for catalog. Box 27656, Lansing, MI 48901.

CB RADIO OWNERS!

We specialize in a wide variety of technical information, parts and services for CB radios. 10-Meter and FM conversion kits, repair books, plans, high-performance accessories. Over 12 years of satisfied customers! Catalog \$2.

CBC INTERNATIONAL
P.O. BOX 31500RE, PHOENIX, AZ 85046

CABLE-TV converters and descramblers. Low prices, quality merchandise, we ship C.O.D. Send \$2.00 for catalog. **CABLETRONICS UNLIMITED**, P.O. Box 266, South Weymouth, MA 02190, (617) 843-5191.

MICROWAVE antennas, multichannel 1.9-2.7 Ghz dual polarity. From only \$49.95. "Best in the west!" **GALAXY ELECTRONICS**. Call 1 (602) 939-1151.

CABLE TV. We carry a full line including units for Tocom and Pioneer. Tocom turn-ons, technically correct, recordable, auto sensing. **DELUXE ELECTRONICS**, 1432 Heim, Orange, CA 92665 (714) 998-6866.

SUPERCONDUCTORS National Bureau of Standards research publication shows how to process Barium, Yttrium, Copper Oxides into high temperature superconducting ceramics. \$14.95. **CABLETRONICS**, Box 30502R, Bethesda, MD 20814.

IS it true...jeeps for \$44 through the government? Call for facts! 1-(312) 742-1142, ext. 4673.

FAIR prices, SB-3-\$65, Tri Bi-\$90, SA3-\$95, N-12VS-\$85, MLD-1200-3 \$85, Zenith #165 filters for beeping any channel 2 to 22, converters all types, hand remotes. **No Michigan sale**. **BEN-NY-(313) 979-8356**. Note any order over \$200 dollars will get a six outlet surge protector goes into wall socket.

NUTS & VOLTS MAGAZINE

GIVE YOURSELF A BREAK - A PRICE BREAK! NUTS & VOLTS WILL SAVE YOU MONEY ON ELECTRONIC PARTS & EQUIPMENT. Plus SHOW YOU WHERE TO FIND UNIQUE, UNUSUAL AND HARD-TO-FIND ITEMS.

SUBSCRIBE TODAY!

A National Publication For The Buying And Selling Of Electronic Equipment

P.O. Box 111-E
Placentia, CA 92670
714-632-7721

Subscription Rates
S.U. FUNDS REQUESTER
3rd Class Mail - USA
One Year \$30.00
Two Years \$50.00
Lifetime \$50.00
*1st Class Mail
One Year USA \$38.00
CANADA/MEXICO \$20.00
Air Mail
Foreign 1 Yr \$50.00

CB tricks booklet. Modifications, tune-ups, channel expansion, clarifier tricks. Send \$19.95 to **MEDICINE MAN CB**, P.O. Box 37, Clarksville, AR 72830.

COMMODORE chips or repairs. C-64 repair \$39.95 includes parts/labor. We sell low cost Commodore chips—6526/6510-\$8.95, 82S100/PLA-\$11.95 and many others. HD/C-64 P.S. \$27.95. "Commodore Diagnostician," a complete chart for diagnosing faulty IC's \$6.95. Send for complete catalog. **VISA/MC. KASARA INC.**, 31 Murray Hill Drive, Spring Valley, NY 10977, 1-(800) 248-2983 (Nationwide) or (914) 356-3131.

JOYSTICKS. Quality assemblies \$5.00 plus \$1.00 shipping and handling. **CNC TECHNICAL**, 1270 W. Ave. F, Garland, TX 75040.

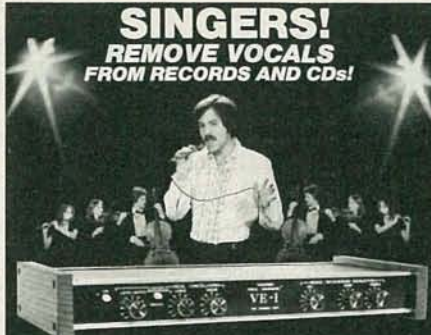

SING WITH THE WORLD'S BEST BANDS!

An Unlimited supply of Backgrounds from standard stereo records! Record with your voice or perform live with the backgrounds. Used in Professional Performance yet connects easily to a home component stereo. This unique product is manufactured and sold Exclusively by LT Sound - Not sold through dealers. Call or write for a Free Brochure and Demo Record.

LT Sound, Dept. R.L-3, 7980 LT Parkway Lithonia, GA 30058 (404) 482-4724
Manufactured and Sold Exclusively by **LT Sound**
24 HOUR PHONE DEMO LINE: (404) 482-2485

PC-SPRINT slotless speedup board for the Tandy 1000/A, includes V20, Norton SI = 2.8. "At \$99 it may be the best productivity bargain you'll ever find". 80 Micro. Jan. 1988. **DAS TECHNOLOGIES**, (602) 844-1777.

CABLE TV equipment, specializing in Scientific Atlanta, Jerrold, Oak, Hamlin, and Zenith. Our units have worked where others have failed. Call toll free 1 (800) 327-3407, or send \$3.00 for catalog to K.D. VIDEO, P.O. Box 29538, Mpls, MN 55429.

MAX232 \$6.38, new 10/\$1.00 2N4124, 2N4126, 2N4401, 2N4403, MP5A20, MP5A70. **VISA MC**, \$1.00 shipping. **LYNBAR INDUSTRIES**, 205 Main, 822, St. Joseph, MI. 49085-0822.

TV tunable notch filters, free brochure. **D.K. VIDEO**, Box 63/6025, Margate, FL 33063 1-(305) 752-9202.

SATELLITE & cable equipment. We have those hard-to-find units ready to go. Tired of junk that doesn't work properly? Try our 10 day satisfaction guarantee & 90 day warranty (wholesale only). **HI TECH ELECTRONICS**, PO Box 42423, Detroit, MI 48242, (313) 722-9381.

RESTRICTED technical information: electronic surveillance, schematics, locksmoothing, covert sciences, hacking, etc. **Huge selection. Free brochures.** **MENTOR-Z**, 135-53 No. Blvd., Flushing, NY 11354.

LASER device schematics, light show, weapon sight, construction leveler, medical laser, surplus lasers. For brochure send \$2 to **MWK INDUSTRIES**, 9852 Katella Ave., Suite 340R, Anaheim, CA 92804.

INTERCOM security systems-Nutone-sales service parts repair/update old systems. **PHIL CHECK CORPORATION**, 1-(800) 648-2080.

TUBES - 2000 TYPES DISCOUNT PRICES!

Early, hard-to-find, and modern tubes. Also transformers, capacitors and parts for tube equipment. Send \$2.00 for 20 page wholesale catalog.

ANTIQUE ELECTRONIC SUPPLY
688 W. First St. • Tempe, AZ 85281 • 602/894-9503

PROFUSER circuit breakers protect your expensive equip. Profuser's trip where you set them. Models from 10 mA. to 3Amps write **PROFUSER INC.**, 2090 Bluehaven Ct., San Diego, CA 92154.

SONY Trinitron rebuilt picture tubes are now available. All tubes shipped U.P.S. No charge. We buy all Sony duds **ROCHESTER KINESCOPE**, (716) 235-0750.

MARK V ELECTRONICS INC.,
8019, E. SLAUSON AVE.
MONTEBELLO CA90640
TELEX: 3716914 MARK 5

1-800-423-3483
TOLL FREE
Only for orders paid by Master or Viscard
IN CAL.: 1-800-521-MARK

INFORMATION: (213) 888-8988

300W HQ HI-FI POWER AMPLIFIER (MONO) TA-3600

QUASI-COMPLEMENTARY-SYMMETRY WITH PARALLEL HIGH OUTPUT TRANSISTORS

SPECIFICATIONS:
*POWER OUTPUT: 300W (RMS) INTO 8 OHMS
2450W (P.M.P.O.) INTO 8 OHMS
540W (MUSIC POWER) INTO 8 OHMS
*LOAD IMPEDANCE: 4 OHMS OR 8 OHMS
*FREQUENCY RESPONSE: 10Hz-200,000Hz
*TOTAL HARMONIC DISTORTION LESS THAN 0.05%
*INPUT SENSITIVITY AND IMPEDANCE AT 1KHz:
1V/4V 47K OHMS
*SUPPLY VOLTAGE: DC ±75V OR AC 53V x 2 8A
KIT/ASSM WITH TESTED \$80/92
X'FORMER \$30.00

DIGITAL MENO TA-28

NO TAPE REQUIRED

NEW FOR 1988

8 Digit 1GHz Multifunctional Counter SM/FC-1000A

A versatile laboratory bench signal counter with FIVE FUNCTION performance: FREQUENCY, PERIOD, UNIT TOTALIZED DATA HOLD & RELY-CHECK. The period function makes the instrument outstanding for video tape recorder service applications. 0.5" Bright LED display assure easy readability of values. High stabilized dual crystal oscillators are used to ensure the accuracy in measurement. Durable alloy cabinet with a fancy locking panel. Comes complete with test lead and owners manual.

FEATURES:
Frequency range: 10Hz-1GHz GUARANTEED, 5Hz-1.2GHz typically.
Input sensitivity: 10Hz-100MHz (10mV-20mV),
100MHz-1.2GHz (5mV-20mV)
Period range of 5µs-10s
Unit counting capacity: 99999999
Accuracy: ±1 count, 3 time base accuracy
Hold function: holds the last reading (Max. 8 digit)
Power source: 117V AC ±10% 50-60Hz
Dimensions: 9.89"(W) x 7.87"(D) x 3.71"(H)
ASSM. WITH TESTED & CAL.

LAB. QUALITY AT A BREAKTHROUGH PRICE!

150MC Digital SM-100 Frequency Counter

Frequency Range: 10Hz - 150MHz
Event Counter: 0 to 999999999 counts. (8 Digit)
Input sensitivity: KHz range 10Hz - 10MHz 50mVrms.
MHz range 1MHz - 150MHz 40mVrms.
Response time: 0.2 second.
Hold Function: Hold the last input signal.
Power Supply: DC6V Battery or DC9V Adaptor.
Dimensions: 9 7/8" x 6 11/16" x 2 3/4"
ASSM. WITH TESTED & CAL. \$99.00

FREE AC ADAPTOR AVAILABLE UNTIL STOCKS LAST

FREE BALL POINT-PEN WITH ANY PURCHASE

FREE T-SHIRT (ONE SIZE FITS ALL) WITH EVERY PURCHASE OF \$100 OR MORE (AVAILABLE UNTIL STOCKS LAST)

WALK IN FOR YOUR FREE GIFT

STATE OF ARTS HQ FET ST. PRE-AMP TA-377A

0.007% T.H.D.

• This Pre-amplifier employs 18 pairs of HIGH QUALITY N channel and P channel FET and 1% metal film resistor to form a state of art full complementarily symmetric mirror circuit.
• It uses "CIR" RIAA EQ preamplifier to minimize TIM distortion and to obtain high-fidelity.
• The power supply is based on by pass coupling DC stabilizer which uses class A design to obtain low internal impedance at high frequency and to greatly reduce transient distortion.
• Professional ratay delay circuit prevents noise which may occur during power on and off.
• All FETs were tested and paired in the factory so no problem is likely to occur during building.
• It can be directly connected to any power amplifier. The best partner is TA-477 120W MOS FET power amplifier.

KIT/ASS. WITH TESTED \$55/...
METAL CABINET \$18

STEREO SIMULATOR TA-3000

You can own a stereo TV from today! This simulator is special design of using the most advanced analog monophonic L.S.I. it produced a superior analog stereo effect since the L.S.I. is equalized 60 pcs. of LOW NOISE FET & TRANSISTOR. The simulator can even help you to promote your television from a normal one to a special one with a Hi-Fi STEREO function. Our simulator is also applicable to any other "mono sources" in covering it to ANALOG STEREO. Undoubtedly, it is the most advanced equipment for every family, while it should contribute to your listening pleasure \$30.00 Ass. with tested

16 SEC. RECORD TIME * LED FUNCTION INDICATOR * AUTO RECORD CIRCUIT * INTERNAL 256K DRAM MEMORY * INTERNAL MIC AMPLIFIER * ONE PUSH ON/OFF POWER * TWO RECORD FUNCTION TALK-BACK MODE & MESSAGE MODE * LOW POWER CONSUMPTION * SUPPLY VOLTAGE: 9V 20MA D.C. KIT \$20.00

TA-477 120W MOSFET POWER AMPLIFIER

BUILD A PROFESSIONAL AMP BY YOURSELF

NEW

4 1/2 HI-PRECISION D.P.M. SM-48A

SPECIFICATIONS:
*4 1/2 digit 14mm red large display with overload flash.
*Multi-functions: including BCD, BUSY, STROBE output, very suitable for micro computer.
*MEMORY SYSTEM CAN HOLD the input reading for comparison and monitor.
*Range: DC voltage DC±1mV-±2000A
DC current DC1µA-±20A
*Accuracy: DC±0.025% ±2 digit
*Power: DC5-6V at 200mA
DIMENSIONS: 3 3/4" (W) x 1 7/8" (H) x 4 1/16" (D). (MEET WITH DIN. STANDARD OF W. GERMANY.)
KIT/ASSM. WITH TESTED & CAL. \$41/51

PROFESSIONAL COLOR LIGHT CONTROLLER SM-328

FEATURES:
1. FOUR GROUPS OF INDEPENDENT OUTPUT SYSTEM 1000W/CH. MAX. 4600W (100-117V) 2. PROFESSIONAL COLOR CONTROL SYSTEM (KEY, BOARD TYPE) 3. INDEPENDENT INPUT SIGNAL ADJUSTMENT 4. FOUR GROUPS OF INDEPENDENT DIMMER CONTROL 5. SPEED CONTROL CHASER 6. AUTOMATIC CHASING CONTROL SYSTEM 7. FOUR KINDS OF SPECIAL CHASING PROGRAM 8. COMBINATION OF PROGRAM AND MUSIC CHASING EFFECT 9. FORWARD/ BACKWARD/ CHASING CONTROL SM-328 color light controller is specialized for ballroom, night club disco and advertisement lighting. It consorts with several color control characteristics, which employ professional color control system and keyboard program selection. Therefore, it is capable of producing lighting effects by using chasing program and fluctuating music signal. There are two kinds of lighting effects. The first type is controlled by "music" signal. In order to adjust the brightness of four groups of lightings, each music signal will be separated into high, medium, low A, and low B frequency range. Furthermore, each group of lightings is incorporated with an independent signal adjustment. The second kind is composed of electrical circuits and this is the main part for creating a special lighting effect. It has four chasing programme.
Dimensions: 14 5/16" x 8 15/16" x 3 3/16"
Ass. with tested \$150.00

OFFICE HOURS: (PACIFIC TIME)
MON.-FRI. 9:30 to 5:00 SAT. 10:00 to 5:00

RADIO-ELECTRONICS

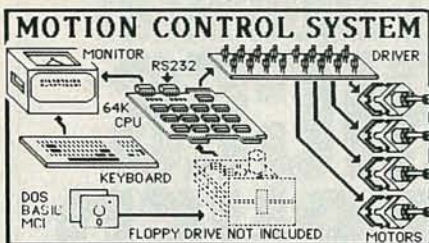

MOTION CONTROL SYSTEM
COMPUTER • MONITOR • KEYBOARD
MOTOR CONTROLLER
FLOPPY CONTROLLER **\$149⁰⁰**
4 MOTORS • SOFTWARE
A. C. POWER SUPPLY ADD \$12 FOR FREIGHT

■ GENERAL PURPOSE 64K SINGLE BOARD COMPUTER HAS 2 SERIAL PORTS & 1 CENTRONICS PORT ■ AMBER MONITOR WITH 80 BY 24 LINES OF TEXT DISPLAY ■ HIGH-QUALITY KEYBOARD THAT HAS A SEPARATE NUMERICAL KEYPAD ■ LIGHTED CAPS LOCK AND ENTER KEYS ■ 10 FUNCTION KEYS ■ STEPPER MOTOR DRIVER KIT WITH 4 OF OUR "EASY STEPPER" MOTORS ■ PDS DOS ■ MICROSOFT BASIC ■ PILOT LANGUAGE ■ MOTOR CONTROL PROGRAM WITH SOURCE LISTING ON DISK ■ SCHEMATICS INCLUDED ■ JUST ABOUT EVERY THING YOUR ROBOT WILL NEED FOR "BUILT IN" SMARTS! ■ WE PROVIDE AN A. C. SUPPLY FOR BENCH TESTING. OUTPUT VOLTAGES ARE +12VDC @ 2.5 AMPS, -12VDC @ 5 AMPS, +5 VDC @ 5 AMPS, +24 VDC @ 1.5 AMPS ■ EXCEPT FOR THE STEPPER DRIVER KIT ALL BOARDS ARE ASSEMBLED AND TESTED JUST WIRE THEM TOGETHER. ■ SOLDERING IS REQUIRED ■ DISK STORAGE (NOT INCLUDED) IS EXPANDABLE TO 3.2 MEG

NEED A FLOPPY DRIVE ? **\$60⁰⁰**
 WE HAVE BRAND NEW ULTRA THIN (1/3 HIGH) OKI DATA GM3305B'S DOUBLE SIDE DOUBLE DENSITY LOW POWER DISK DRIVES WITH PURCHASE MOTION CONTROL SYSTEM REG \$89

Call for a copy of 15 day trial agreement. Tax & freight extra. C.O.D. accepted just add \$1.90 Price may change. Store Price may differ. While supplies last. No P.O.s, terms, or credit cards

Silicon Valley Surplus
 415-261-4506
 4401 OAKPORT OAKLAND CA, 94601
 OPEN 10am-6pm
 CLOSED SUN & MON
CALL OUR BBS 415-261-4513

CIRCLE 51 ON FREE INFORMATION CARD

CONSOLIDATED ELECTRONICS

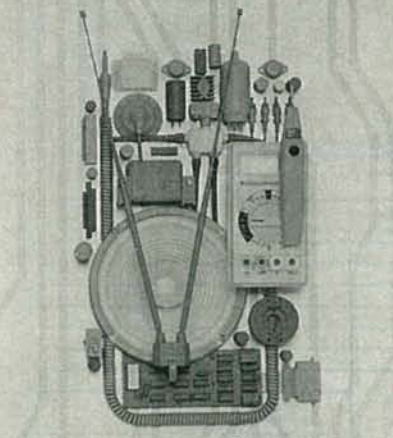

CONSUMER & INDUSTRIAL ELECTRONICS CATALOG • 17TH EDITION

THE ULTIMATE ELECTRONICS CATALOG.

Order your 260 page catalogue packed with over 10,000 money saving electronic parts and equipment. Send \$3.00 check or money order, or call 1-800-543-3568 today and use your Mastercard or Visa
 Consolidated Electronics, Incorporated
 705 Watervliet Ave., Dayton, Ohio 45420-2599

NAME _____
 ADDRESS _____
 CITY _____
 STATE _____ ZIP _____

CIRCLE 184 ON FREE INFORMATION CARD

TUBES

• RECEIVING • SERVICE • ANTIQUE

The Most Complete Range of Domestic and Foreign Tubes In The World

— Over 2000 Types —
 ...at 75-90% OFF

Send \$2 for Consumer Product Catalog and receive FREE 1/4 or 1/2 Watt Resistor Kit

Steven

Mail Order Electronics Corp.

P.O. Box 698, Melville, NY 11747

1-800-833-6693

In NYS (516) 752-0060

CABLE descrambler liquidation. Major makes and models available. Industry pricing! (Example: Hamlin Combo's, \$44 each...minimum 10 orders). **Dealers only!** Call **WEST COAST ELECTRONICS**, (818) 989-0890.

ELECTRONICS components available. Free flyer, SASE for list. **STEINMETZ**, 7519 Maplewood Ave., R.E. Hammond, IN 46324.

TUBES. "Oldest," "latest." Parts and schematics. SASE for list. **STEINMETZ**, 7519 Maplewood Ave., R.E. Hammond, IN 46324.

SOLAR battery chargers. Homes, RVs, boats. From \$30.00. Brochure. **SUN POWER**, Texas, Dept. 01B, P.O.B. 2788A, Freeport, TX 77541.

HACKER'S Handbook \$12.95, \$1.00 postage. **Computer Underground** \$14.95, \$1.00 postage. **CABLETRONICS**, Box 30502R, Bethesda, MD 20814.

PLANS AND KITS

HI-FI speaker systems, kits and speaker components from the world's finest manufacturers. For beginners and audiophiles. Free literature. **A&S SPEAKERS**, 3170 23rd Street, San Francisco, CA 94110. (415) 641-4573.

VOICE disguisers! FM bugs! Telephone transmitters! Phone snoops! More! Catalog \$1.00 (Refundable): **XANDI ELECTRONICS**, Box 25647, Dept. 60Z, Tempe, AZ 85282.

BUILD this five-digit panel meter and square-wave generator including an ohms, capacitance and frequency meter. Detailed instructions \$2.50. **BAGNALL ELECTRONICS**, 179 May, Fairfield, CT 06430.

REMOTE CONTROL KEYCHAIN



Complete w/mini-transmitter and +5 vdc RF receiver Fully assembled including plans to build your own auto alarm

\$19.95 Check, Visa or M/C 30 days return

VISITECT INC. (415) 872-0128
 PO BOX 5442, SO. SAN FRAN., CA 94080

TRANSISTOR devices that grab attention. Spinning tops, swinging figures. Plans \$6.00. **MOTION PRODUCTS**, Box 32631, San Jose, CA 95132.

SCRAMBLING News. Monthly \$24.95/yr. Fantastic. Sample \$5. **Z-TRAP** \$14.95. **Z-BAG** (Zenith bogus address generator) \$19.95. Both \$29.95. Catalog \$1. **SHOJIKI**, Box 1732, Niagara Falls, NY 14303. CODs (716) 284-2163.

STEREO-Vision. Convert your old TV into a laser light show. Watch your favorite albums, FM, or guitar on the screen. Easy and inexpensive. Send \$5.00 for plans to **ACG**, PO Box 1972, Alexandria, VA 22313.

CHEMICAL magic. Those hard-to-find formulas. Catalog \$1. **CFC**, Box 30007 Des Moines, IA 50310.

CRYSTAL radio sets, plans, kits, catalog \$1.00. **MIDCO**, 660 North Dixie Highway, Hollywood, FL 33020.

TOP quality imported, domestic kits, surplus, discount electronics, computer components. Free catalog. **TEKTRASONIX**, 1120 Avenue of the Americas, 1/fi suite 4038, New York, NY 10036.

STRANGE stuff. Plans, kits, new items. Build satellite dish \$69.00. Descramblers. Bugging information adult toys. Informational photo package \$3.00 refundable. **DIRIJO CORPORATION**, Box 212, Lowell, NC 28098.

THE Decoder. National monthly technical newsletter covering Satellite/Cable descrambling systems. Includes: news, schematics, modifications, reviews, tips and more!!! \$18.00 per year. Sample \$2.00. **TELECODE**, Box 6426, Yuma, AZ 85364-0874.

VIDEOCIPHER II technical manuals. 120+ pages. **Volume 1**—hardware, **Volume 2**—software. Either \$29.95 both \$49.95. Catalog—\$3.00. **MICROTRONICS**, Box 6426, Yuma, AZ 85364-0840.

TIRED of bleedover? Fits all 7.8 MHZ. IF CB radios, tremendous -125 db rejection, adjustable biasing, peak limiter circuit. \$2.00 for tech info or \$21.95 for kit. **J&J ELECTRONICS**, 12008 Riverhills Drive, Tampa, FL 33617.



DETAILED PLANS: \$4.95
TV-SCOPE
 PENN RESEARCH,
 Box 3543
 Williamsport, PA 17701

FINALLY!

An interesting and worthwhile project. This **EASY-TO-BUILD** circuit lets you use any regular TV set as a simple **OSCILLOSCOPE**. Build for less than \$10. **NO MODIFICATIONS TO TV!** Single or dual trace. Send for **FREE CATALOG** of other plans and kits.

R-DAP digital audio recorder/player. Record and playback :10 seconds of audio on a self contained 256K Ram. Complete kit including microphone and speaker. Detailed documentation \$59.95 plus \$1.00 postage. **DJ INC., Suite 108, 217 East 85th Street, New York, NY 10028.**

DESCRAMBLING, new secret manual. Build your own descramblers for cable and subscription TV. Instructions, schematics for SSAVI, gated sync, sinewave. (HBO, Cinemax, Showtime, etc.) \$8.95, \$1 postage. **CABLETRONICS**, Box 30502R, Bethesda, MD 20814.

FREE power supply, connectors (\$8.95 value) with Assortment #103 (February 1984 article) has printed circuit, TOKO coils, transistors, IC's, diodes \$25.00. Five-\$112.50 shipping \$2.00. **JIM RHODES, INC.**, P.O. Box 3421, Bristol, TN 37625.

FREE catalog 99-cents kits—audio, video, computer parts. **ALLKIT**, 434 W. 4th St., West Islip, NY 11795.

Multi-Channel Microwave T.V. Receivers



19-27 GHz Parabolic Dish 40+ dB Gain
LIFETIME WARRANTY
 Complete System \$89.95 (Shipping Incl.)
 Dealer Rates, Replacement Components
 & Expert Repairs Available

K & S ELECTRONICS Call now for same
 P.O. BOX 34522 day shipping!
 PHOENIX, AZ 85067 (602) 230-0640

VISA/MC/COD

\$2 credit on phone orders!

SAVE money! Light bulb saver extends the life of bulbs up to 75,000 hours or about 10 years. 6 savers \$9.95 plus \$2.40 postage. Satisfaction guaranteed. **INTERNATIONAL**, 5425 West Almeria, Phoenix, AZ 85035.

TENMA

TEST EQUIPMENT

#72-540

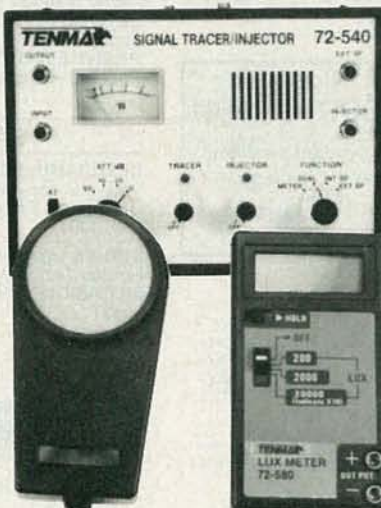

#72-580

#72-560



#72-505



#72-555



#72-455

TENMA Audio Generator

A precision audio generator suitable for use in all audio applications.

Features: ■ Generates sine and square waveforms ■ Six step and continuously variable attenuators ■ External sync input ■ Comes complete with test leads and owners manual #72-455

TENMA Signal Tracer/Injector

NEW

Troubleshoots audio circuits from input to speaker.

Features: ■ Variable level 1KHz injection signal ■ VU level meter ■ Switchable detector for troubleshooting AM circuits ■ Speaker test output ■ Output provided for oscilloscope or other measurements ■ Comes complete with test probe and owners manual #72-540

TENMA Digital Light Meter

NEW

Provides a highly accurate and convenient way to measure light levels.

Features: ■ 3½ digit LCD display ■ Data hold function ■ Low battery indicator ■ Output provided for recorder ■ Comes complete with carrying case, protective lens cap and instruction manual #72-580

TENMA Autorange DMM

NEW

New rotary dial design permits rapid selection of functions. Meter automatically selects proper range for most accurate reading.

Features: ■ 3½ digit LCD display ■ Autorange/manual selector ■ Data hold: Holds display reading after meter is removed from circuit ■ Memory: Removes stored measurement from future readings ■ Audible continuity tester ■ Low battery indicator ■ Switchable Lo/Hi power ohms ■ Comes complete with test leads, carrying case and owners manual #72-560

TENMA Hand Held Audio Generator

NEW

The audio generator is ideal for field/bench service of audio equipment, car stereo, etc.

Features: ■ Wide frequency range ■ Sine wave or square wave output ■ Sync output ■ Continuously variable and 20dB fixed output attenuators ■ Low battery indicator ■ Comes complete with test leads and owners manual #72-505

TENMA AC Clamp Adaptor

NEW

Works with almost any DMM to provide an easy way to measure AC current.

Features: ■ Measures AC current without cutting wires ■ Measures up to 1000 amps AC ■ Safety wrist-strap provided ■ Comes complete with test leads (banana plug) and owners manual #72-555

For A Wide Variety of Electronic Parts Call Toll Free 1-800-543-4330

In Ohio, 1-800-762-4315 — In Alaska and Hawaii, 1-800-858-1849

© MCM ELECTRONICS, 1988.

SOURCE NO. RE-43



MCM ELECTRONICS

858 E. CONGRESS PARK DR.
CENTERVILLE, OH 45459

A PREMIER Company

CIRCLE 87 ON FREE INFORMATION CARD

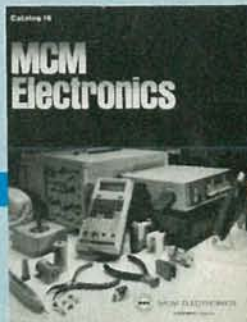

AMAZING SCIENTIFIC & ELECTRONIC PRODUCTS

PLANS—Build Yourself—All Parts Available In Stock

- LC7—BURNING CUTTING CO₂ LASER \$ 20.00
- RUB4—PORTABLE LASER RAY PISTOL 20.00
- TCC1—3 SEPARATE TESLA COIL
- PLANS TO 1.5 MEV 20.00
- IOG1—ION RAY GUN 10.00
- GRA1—GRAVITY GENERATOR 10.00
- EML1—ELECTRO MAGNET COIL GUN/LAUNCHER 60.00

KITS

- MFT1K—FM VOICE TRANSMITTER 3 MI RANGE 49.50
- WPM5K—TELEPHONE TRANSMITTER 3 MI RANGE 39.50
- BTC3K—250.00 VOLT 10" 14" SPARK TESLA COIL 199.50
- LH2K—SIMULATED MULTICOLOR LASER 39.50
- BLS1K—100.000 WATT BLASTER DEFENSE DEVICE 69.50
- ITM1K—100.000 VOLT 20" AFFECTIVE RANGE INTIMIDATOR 69.50
- PSP4K—TIME VARIANT SHOCK WAVE PISTOL 59.50
- PTG1K—SPECTACULAR PLASMA TORNAO GENERATOR 149.50
- MVIK—SEE IN DARK KIT 199.50

ASSEMBLED

- PG70H—MULTICOLORED VARIABLE MODE PLASMA GLOBE 7" 199.50
- BTC10—50.000 VOLT—WORLD'S SMALLEST TESLA COIL 44.50
- LGU40—1MW HeNe VISIBLE RED LASER GUN 199.50
- TAT20 AUTO TELEPHONE RECORDING DEVICE 24.50
- GPV10—SEE IN TOTAL DARKNESS IR VIEWER 349.50
- LIS10—SNOOPER PHONE INFINITY TRANSMITTER 169.50
- IPG70—INVISIBLE PAIN FIELD GENERATOR—MULTI MODE 74.50

• CATALOG CONTAINING DESCRIPTIONS OF ABOVE PLUS HUNDREDS MORE AVAILABLE FOR \$1.00 OR INCLUDED FREE WITH ALL ABOVE ORDERS.

PLEASE INCLUDE \$3.00 PH ON ALL KITS AND PRODUCTS PLANS ARE POSTAGE PAID. SEND CHECK, MO. VISA, MC IN US FUNDS.

INFORMATION UNLIMITED
P.O. BOX 716 DEPT. RE, AMHERST, NH 03031

(EP)ROM Emulator/programmers. Develop ROMs for your own microprocessor-based designs. Free information sheet. **SOLICON**, 8825 El Matador Dr., Gilroy, CA 95020.

CATALOG: Hobby/broadcasting/HAM/CB: Cable TV, transmitters, amplifiers, bugging devices, computers. More! PANAXIS, Box 130-F(4), Paradise, CA 95967

VIDEO catalog, electronic kits, remote control items much more. Write **VIDEO VIBES**, 670 Central Park Ave., Yonkers, NY 10704. (914) 476-4864.

ROBOT plans: grippers, welders, AGV's, vision; **W. OLIVADOTI**, 191 Harder Road, #1, Hayward, CA 94544.

THE Decoder. National monthly technical satellite/cable descrambling newsletter. News-schematics-modifications-reviews. \$18.00/year. Sample \$3.00. **TELECODE**, Box 6426, Yuma, AZ 85364-08740.

**VIDEO TAPE
COPYGUARD**

Eliminate the latest copyguard problems
units from \$59⁹⁵ to \$169⁹⁵

Deluxe Electronics (714) 998-6866
1432 Heim Wy., Orange, Ca. 92665

PROJECTION TV...Convert your TV to project 7 foot picture. Results comparable to \$2,500 projectors...total cost less than \$30.00. Plans and 8" lens \$21.95...Illustrated information free...**MAC-ROCOMA-GH**, Washington Crossing, PA 18977. Creditcard orders 24hrs (215) 736-3979.

BUILD this MIDI for your Macintosh computer. \$12.00 for schematic. **DON RIVALDO**, 253 Lynn Drive, Rochester, NY 14622.

**** SCRAMBLING NEWS **** PAY TV AND SATELLITE DESCRAMBLING

Schematics, theory, bypasses, 13 cable, 7 satellite. New SA turn-on. MD-1200-3, \$14.95. Experiments With Videocipher, Cloning, musketeering, \$14.95. Cable TV Security, design, \$12.95. MDS/ MMS Handbook Microwave hacking \$9.95. Build Satellite Systems Under \$600 \$12.95. Any 3 \$27. Scrambling News, Monthly. Feature articles, product reviews, law history, patents, \$24.95/yr. Sample \$5. Catalog \$1. PTV vol. 2 \$12.95

Shojiki Electronics Corp. 1327A Niagara St., Niagara Falls, NY 14303. COD's 716-284-2163

DECODING plans and theory booklets. Video tape copy protection, removes flashing and jitter, 30 pages, \$15.45. Jerrold DI and DIC decoder theory, 12 pages, \$6.95. Gated pulse decoding plus new universal single level suppression decoder, works on Hamlin, Jerrold, Sylvania, Eagle, 39 pages, \$15.00. Video scrambling techniques, the original secret manual. Sinewave and Zenith SSAVI, 57 pages, \$14.95. Hidden signals on satellite TV, 178 pages, \$16.95, P.C. board and kits available. **ELEPHANT ELECTRONICS INC.**, P.O. Box 41865-J, Phoenix, AZ 85080, (602) 581-1973.

SATELLITE TV

DESCRAMBLERS for movies, networks, \$149 up. Visa, MC accepted. Catalog \$4 **SKYWATCH**, 238 Davenport Road, Toronto, Ontario, Canada, M5R-1J6.

DISHES systems upgrades, Chaparral, Drake, Houston, etc. **SAVE \$\$\$\$ Toll free** (800)334-6455 **SKYVISION**, 2066R Collegeway, Fergus Falls, MN 56537

Cable TV Converters

Why Pay A High Monthly Fee?

Jerrold Products include "New Jerrold Tri-Mode," SB-3. Hamlin, Oak VN-12, M-35-B, Zenith, Magnavox, Scientific Atlanta, and more. (Quantity discounts) 60 day warranty. For fast service C.O.D. orders accepted. Send SASE (60 cents postage) or call for info (312) 658-5320. **MIDWEST ELECTRONICS, INC.**, 5143-R W. Diversey, Chicago, IL 60639. MC/Visa orders accepted. No Illinois orders accepted. Mon.-Fri. 8 A.M.-5 P.M. CST

CABLE TV Secrets—the outlaw publication the cable companies tried to ban. HBO, Movie Channel, Showtime, descramblers, converters, etc. Supplier's list included \$8.95. **CABLE FACTS**, Box 711-R, Pataskala, OH 43062.

SATELLITE TV receiver kits! Instruction manual, boards, semiconductor parts! 59" LNA's! LNB's! Ku-Band LNB's! Catalog \$1.00 (refundable): **XANDI ELECTRONICS**, Box 25647, Dept. 21DD, Tempe, AZ 85282.

VIDEOCYpher II descrambling manual schematics, video and audio, DES, cloning, Eprom codes. (HBO, Cinemax, Showtime, Addt. channels) \$12.95, \$1.00 postage. **CABLETRONICS**, Box 30502R, Bethesda, MD 20814.

SPANISH custom made translations. Write it in English. We translate it using Parallel Etymology for easy learning. \$9.95/500 words for written translation. Add \$8.95/500 words audio translation on cassette tape. **TRADUCCIONES**, Valle Verde 5, D-2, Ponce, Puerto Rico 00731.

INVENTORS

INVENTORS! Can you patent and profit from your idea? Call **AMERICAN INVENTORS CORPORATION** for free information. Over a decade of service. 1-(800) 338-5656. In Massachusetts or Canada call (413) 568-3753.

**At KELVIN...
Price, Service
& Quality for
over 42 years.**

**B & K · FLUKE · UNGAR
HITACHI · WELLER
BECKMAN · DREMEL
STANLEY · MAKITA
X-ACTO · KEPRO · XCELITE**



LISA HADAR
EXECUTIVE VP, CPA

METERS/OSCILLOSCOPES

B & K	2120	20Mhz Dual Trace	\$ 375*
Beckman	9020	20Mhz Dual Trace	425
Hitachi	V212	20Mhz	\$365
Fluke	73	3 1/2" Digit DMM	SPECIAL
Fluke	75	3 1/2" Digit DMM	
Fluke	77	3 1/2" Digit DMM	

*PLUS Shipping & Insurance. Prices subject to change without notice.

WE HAVE IT ALL...

• COMPONENTS • TOOLS • KITS • SECURITY • SEMI-CONDUCTORS • ELECTRICAL SUPPLIES • SOLDER EQUIPMENT • KELVIN KITS • TSM KITS • DRAFTING SUPPLIES

Volume Quotes, Industrial & School Bids Welcome.

ORDER TOLL FREE FOR INQUIRES & N.Y.S.
1-800-645-9212 516-349-7620

**KELVIN
ELECTRONICS**

NEW ADDRESS:

7 Fairchild Avenue • Plainview, NY 11803 • FAX: 516-349-7830

VISA/MASTER CARD ACCEPTED

**When someone
in your family
gets cancer,
everyone
in your family
needs help.**

Nobody knows better than we do how much help and understanding is needed. That's why our service and rehabilitation programs emphasize the whole family, not just the cancer patient.

Among our regular services we provide information and guidance to patients and families, transport patients to and from treatment, supply home care items and assist patients in their return to everyday life.

Life is what concerns us. So you can see we are even more than the research organization we are so well known to be.

No one faces cancer alone.

AMERICAN CANCER SOCIETY

WANTED

INVENTORS! AIM wants—ideas, inventions, new products, improvements on existing products. We present ideas to manufacturers. Confidentiality guaranteed. Call toll free **1-(800) 225-5800** for information kit.

INVENTIONS, ideas, new products wanted! Industry presentation/national exposition. Call free **1-(800) 288-IDEA.** Canada, 1-(800) 528-6060. X831.

COMPUTER repairs. Flat rate. Commodore C64 \$44.95, 1541 \$49.95, 1571 \$54.95, SX64 \$64.95, Atari 800XL \$49.50, 130XE \$65.00, 1050 \$85.00, 810 \$70.00. Includes most parts. STs \$89.95 plus parts. \$5.00 shipping. **MIDTOWN,** 27 Midway Plaza, Tallmadge, OH 44278, (216) 633-0997.

SCRAMBLE FACTS 718-343-0130

PHONE TODAY for 32 minutes of satellite TV industry news, technical tips, and new product information.

EDUCATION & INSTRUCTION

F.C.C. Commercial General Radiotelephone license. Electronics home study. Fast, inexpensive! "Free" details. **COMMAND, D-176,** Box 2223, San Francisco, CA 94126.

SUPERFAST Morse Code supereasy. Subliminal cassette. \$10. Learn Morse Code in 1 hour. Amazing new supereasy technique. \$10. Both \$17. Moneyback guarantee. Free catalog: **SASE. BAH,** 2549-E2 Temple, Palmbay, FL 32905.

CABLE T.V. DESCRAMBLERS

**We Will Not Be Undersold
BY ANYONE!!!**

WARNING—Be leary of prices that seem too low. Such companies offering this, have no responsibility to you, the customer and will often leave you holding the bag. This is why people go out of their way to do business with us.

FULL WARRANTY

FOR CATALOG CALL OR WRITE:
402-330-7673

ORDERS ONLY: 1-800-435-7057
DISTRIBUTORS
5078 So. 108th Suite #333 Dept RE
Omaha, NE 68137

FCC commercial general radiotelephone license correspondence course. 60 individual lessons for \$89.50. Payment plan. Results guaranteed! Details free. **AMERICAN TECHNICAL INSTITUTE,** Box 201, Cedar Mountain, NC 28718

ROBOTIC SENSORS

TACTILE and pressure sensors, \$5/element, singles and arrays available. For info, send address to: **RECEPTOR TECHNOLOGY INC.,** 2 Kenwood Street, Somerville, MA 02144.

CABLE TV CONVERTERS

CABLE TV converters. Scientific Atlanta, Jerrold, Oak, Zenith, Hamlin. Many others. **"New" Video Hopper** "The Copy Killer". Visa, M/C & Amex. 1-(800) 826-7623. **B&B INC.,** 10517 Upton Circle, Bloomington, MN 55431.

BUSINESS OPPORTUNITIES

EARN thousands with our own part time electronics business. I do Free proof, information. **INDUSTRY,** Box 531, Bronx, NY 10461.

EASY, lucrative. One man CRT rebuilding machinery. Free info: (815) 459-0666 **CRT,** 1909 Louise, Crystalake, IL 60014.

MECHANICALLY inclined individuals desiring ownership of small electronics manufacturing business—without investment. Write: **BUSINESSES,** 92-R, Brighton 11th, Brooklyn, NY 11235.

PROJECTION TV...Make \$\$\$'s assembling projectors...easy...results comparable to \$2 500 projectors...Total cost less than \$30 00. Plans 8 lens and dealers information \$20 50. Illustrated information free **MACROCOMA GHX,** Washington Crossing, PA 18977. Creditcard orders 24hrs (215) 736-2880.

YOUR own radio station! AM, FM, TV cable. Licensed/unlicensed **BROADCASTING,** Box 130-F(4), Paradise, CA 95967.

DESCRAMBLER MODULE

COMPLETE cable-TV decoder in a mini-module. Latest technology upgrade for Jerrold SB-3 or Radio-Electronics Feb. 1984 project. Versatile, sophisticated, and low cost. For literature, **SOUTHTECH DISTRIBUTING.** (813) 527-2190.

Big Profits!

LEARN VCR CLEANING-REPAIR Prior Experience UNNECESSARY. Need only small hand tools & average mechanical abilities. **BIG DEMAND** performing VCR cleaning and repairs. **REAL EXAMPLES** of VCR malfunctions and their solutions. Photos and illustrations ALSO. Information on starting your own business.

Free information. Write:

Vicjo VCR Repair
22672 Lambert #610
El Toro, California 92630
(714) 458 2646

MICRO MART

508 Central Ave.
Westfield, N.J. 07090
(201) 654-6008

TTL SERIES					LINEAR					TRANSISTORS & DIODES										
7400	25	74390	85	74LS164	45	4012	25	LM309K	50	LM7980	50	MFR901	1/29	50	LM7971	40	MC1335	50	2N2222A	10/1
7401	25	74393	100	74LS173	45	4013	25	LM308H	60	MC1350	40	PN2222A	10/1	100	LM3074	40	MC1388	50	2N2222A	4/1
7402	25	75324	20	74LS191	45	4019	30	LM311H	50	MC1398	50	PN2907A	10/1	50	7403	25	74LS192	60	4022	80
7403	25	74532	35	74LS194	40	4018	25	LM311E	40	LM1458	25	2N2904A	5/1	50	7404	25	74LS195	60	4024	45
7404	25	74544	55	74LS192	60	4022	80	LM318H	50	LM2903	50	PN3363A	10/1	50	7405	25	74LS201	45	4025	20
7406	30	74544	55	74LS192	60	4022	80	CAS24	35	LM2904	50	PN3363A	5/5	50	7407	25	74LS204	45	4026	30
7407	25	74544	55	74LS192	60	4022	80	LM325A	95	MC7805	45	PN3394	10/1	50	7408	25	74LS207	45	4028	60
7408	25	74544	55	74LS192	60	4022	80	LM339N	35	MC7806	45	25C089	2/50	50	7409	30	74LS211	45	4029	30
7409	30	74544	55	74LS192	60	4022	80	LM3809	75	MC7812	45	25C1125	2/25	50	7410	25	74LS212	45	4030	30
7410	25	74544	55	74LS192	60	4022	80	LM3858A	80	MC7824	45	25C1125	2/25	50	7411	25	74LS213	45	4031	30
7411	25	74544	55	74LS192	60	4022	80	LM393N	35	MC7905	45	25C1125	2/25	50	7412	25	74LS214	45	4032	30
7412	25	74544	55	74LS192	60	4022	80	NE555	25	MC7912	45	25C1125	2/25	50	7413	25	74LS215	45	4033	30
7413	25	74544	55	74LS192	60	4022	80							50	7414	25	74LS216	45	4034	30
7414	25	74544	55	74LS192	60	4022	80							50	7415	25	74LS217	45	4035	30
7415	25	74544	55	74LS192	60	4022	80							50	7416	25	74LS218	45	4036	30
7416	25	74544	55	74LS192	60	4022	80							50	7417	25	74LS219	45	4037	30
7417	25	74544	55	74LS192	60	4022	80							50	7418	25	74LS220	45	4038	30
7418	25	74544	55	74LS192	60	4022	80							50	7419	25	74LS221	45	4039	30
7419	25	74544	55	74LS192	60	4022	80							50	7420	25	74LS222	45	4040	30
7420	25	74544	55	74LS192	60	4022	80							50	7421	25	74LS223	45	4041	30
7421	25	74544	55	74LS192	60	4022	80							50	7422	25	74LS224	45	4042	30
7422	25	74544	55	74LS192	60	4022	80							50	7423	25	74LS225	45	4043	30
7423	25	74544	55	74LS192	60	4022	80							50	7424	25	74LS226	45	4044	30
7424	25	74544	55	74LS192	60	4022	80							50	7425	25	74LS227	45	4045	30
7425	25	74544	55	74LS192	60	4022	80							50	7426	25	74LS228	45	4046	30
7426	25	74544	55	74LS192	60	4022	80							50	7427	25	74LS229	45	4047	30
7427	25	74544	55	74LS192	60	4022	80							50	7428	25	74LS230	45	4048	30
7428	25	74544	55	74LS192	60	4022	80							50	7429	25	74LS231	45	4049	30
7429	25	74544	55	74LS192	60	4022	80							50	7430	25	74LS232	45	4050	25
7430	25	74544	55	74LS192	60	4022	80							50	7431	25	74LS233	45	4051	35
7431	25	74544	55	74LS192	60	4022	80							50	7432	25	74LS234	45	4052	60
7432	25	74544	55	74LS192	60	4022	80							50	7433	25	74LS235	45	4053	30
7433	25	74544	55	74LS192	60	4022	80							50	7434	25	74LS236	45	4054	60
7434	25	74544	55	74LS192	60	4022	80							50	7435	25	74LS237	45	4055	30
7435	25	74544	55	74LS192	60	4022	80							50	7436	25	74LS238	45	4056	30
7436	25	74544	55	74LS192	60	4022	80							50	7437	25	74LS239	45	4057	30
7437	25	74544	55	74LS192	60	4022	80							50	7438	25	74LS240	45	4058	60
7438	25	74544	55	74LS192	60	4022	80							50	7439	25	74LS241	45	4059	30
7439	25	74544	55	74LS192	60	4022	80							50	7440	25	74LS242	45	4060	30
7440	25	74544	55	74LS192	60	4022	80							50	7441	25	74LS243	45	4061	30
7441	25	74544	55	74LS192	60	4022	80							50	7442	25	74LS244	45	4062	30
7442	25	74544	55	74LS192	60	4022	80							50	7443	25	74LS245	45	4063	30
7443	25	74544	55	74LS192	60	4022	80							50	7444	25	74LS246	45	4064	30
7444	25	74544	55	74LS192	60	4022	80							50	7445	25	74LS247	45	4065	30
7445	25	74544	55	74LS192	60	4022	80							50	7446	25	74LS248	45	4066	30
7446	25	74544	55	74LS192	60	4022	80							50	7447	25	74LS249	45	4067	30
7447	25	74544	55	74LS192	60	4022	80							50	7448	25	74LS250	45	4068	60
7448	25	74544	55	74LS192	60	4022	80							50	7449	25	74LS251	45	4069	30
7449	25	74544	55	74LS192	60	4022	80							50	7450	25	74LS252	45	4070	30
7450	25	74544	55	74LS192	60	4022	80							50	7451	25	74LS253	45	4071	25
7451	25	74544	55	74LS192	60	4022	80							50	7452	25	74LS254	45	4072	25
7452	25	74544	55	74LS192	60	4022	80							50	7453	25	74LS255	45	4073	25
7453	25	74544	55	74LS192	60	4022	80							50	7454	25	74LS256	45	4074	30
7454	25	74544	55	74LS192	60	4022	80							50	7455	25	74LS257	45	4075	30
7455	25	74544	55	74LS192	60	4022	80							50	7456	25	74LS258	45	4076	30
7456	25	74544	55	74LS192	60	4022	80							50	7457	25	74LS259	45	4077	30
7457	25	74544	55	74LS192	60	4022	80							50	7458	25	74LS260	45	4078	30
7458	25	74544	55	74LS192	60	4022	80							50	7459	25	74LS261	45	4079	30
7459	25	74544	55	74LS192	60	4022	80													

BIG PROFITS

ELECTRONIC ASSEMBLY BUSINESS

Start home, spare time. Investment knowledge or experience unnecessary. BIG DEMAND assembling electronic devices. Sales handled by professionals. Unusual business opportunity.

FREE: Complete illustrated literature BARTA, RE-O Box 248 Walnut Creek, Calif. 94597

SCIENTIFIC ATLANTA & SB-3

SCIENTIFIC Atlanta Models 8500-8550, remote included... \$240.00 SB-3's...\$74.00. TRI-B's...\$95.00. BSA-3's...\$99.00. Zenith (Z-Tac) Descramblers...\$169.00. N-12 (Vari-sync)...\$89.00. M-35 B (Vari-sync)...\$99.00. Hamlin MLD-1200's...\$89.00. 80-channel converters...\$95.00. Dealer discount on (5) units. Call...N.A.S. INTERNATIONAL. (213) 631-3552.

CABLE T.V. "BOXES"

Converters—Descramblers Remote Controls—Accessories

- Guaranteed Best Prices
1 Year Warranty—C.O.D.'s
Immediate Shipping
FREE CATALOG

Call or Write: TRANS-WORLD CABLE CO. HC 83, Box 531 Pequot Lakes, MN 56472 (218) 543-6671

ELECTRONICS TECHNICIANS HONORED

Electronics technicians, and the members of the International Society of Certified Electronics Technicians (ISCET), will be honored nationally on March 8, 1988, with the celebration of National Electronics Technicians Day. This special day recognizes their high standards of performance, and the vital part that they play in helping to assure our country's continued technological and economic leadership in international competition.

ISCET maintains the certification program for professional electronics technicians. March 8, 1988 will be set aside as a national testing day for certification of electronics technicians, and ISCET test administrators encourage technicians all over the nation to demonstrate their own professionalism by taking the CET exam.

ISCET 2708 West Berry Fort Worth, TX 76109 (817) 921-9101

NEW MAGNETIC MEMORIES

continued from page 64

when the voltage is pulled low fast the magnetic field will collapse, inducing a voltage on the gate which gives a one on the data line. For a zero, the gate will be low, disrupting the channel and giving a zero on the data line.

While the memory is designed to be read-only, reprogramming is possible. The procedure involves placing opposite but equal voltages on the data and ground line.

One problem in reprogramming is that the memory must be completely shielded from any external magnetic fields. Otherwise, the effects of the reprogramming procedure can be unpredictable. In fact, because of the tiny size of the magnets, even the Earth's magnetic field can effect the procedure. Further, studies have detected a tiny but noticeable seasonal variation in the Earth's field. As a result, it has been concluded that the best time for reprogramming is in the early spring, with the optimum date being April 1.

R-E

Table with columns for V20-B, CPU's & CHIPS, RAM's, REGISTERS, INTERFACE, DIP SOCKETS, and various component prices.

TRANSISTOR SPECIAL table listing various transistor models and their prices.

SCR's, TRIAC's, LINEAR CIRCUITS, C/MOS, and TTL IC SERIES tables listing component prices.

74LS SERIES table listing various 74LS series integrated circuits and their prices.

RCA, HC 2500, PAL's, TANTALUM CAPACITORS, DISC CAPACITORS, REGULATORS, and various other electronic components and their prices.

POSTAGE RATES ADD 10% FOR ORDERS UNDER \$25.00 ADD 5% FOR ORDERS BETWEEN \$25.00 AND \$50.00 ADD 3% FOR ORDERS ABOVE \$50.00

TERMS: FOB CAMBRIDGE, MASS. SEND CHECK OR MONEY ORDER. MINIMUM TELEPHONE, C.O.D. PURCHASE ORDER OR CHARGE \$20.00. MINIMUM MAIL ORDER \$5.00.

SEND \$25 FOR OUR CATALOG FEATURING TRANSISTORS & RECTIFIERS. 145 HAMPSHIRE ST., CAMBRIDGE, MASS. 02139

SOLID STATE SALES P.O. BOX 74 D - SOMERVILLE, MASS. 02143

TEL: (617) 547-7053 FAX: 617-354-1417 TOLL FREE 1-800-343-5230 FOR ORDERS ONLY

WE SHIP OVER 95% OF OUR ORDERS WITHIN 24 HOURS OF RECEIPT

CIRCLE 74 ON FREE INFORMATION CARD

RADIO-ELECTRONICS

Send for a **FREE**
copy of our **NEW**
52 page **CATALOG**

***QUALITY PARTS *DISCOUNT PRICES *FAST SHIPPING!**

ALL ELECTRONICS CORP.

TRANSFORMERS



5.6 VOLT - 750ma
CAT# TX-56 \$3.00

12 V.C.T. - 1 amp
CAT# TX-121 \$4.00

12 V.C.T. - 2 amp
CAT# TX - 122 \$4.85

12 V.C.T. - 4 amp
CAT# TX-124 \$7.00

18 VOLT - 650 ma
CAT# TX-186 \$2.00
10 for \$17.50

24 V.C.T. - 1 amp
CAT# TX-241 \$4.85

24 V.C.T. - 2 amp
CAT# TX-242 \$6.75

24 V.C.T. - 3 amp
CAT# TX-243 \$9.50

24 V.C.T. - 4 amp
CAT# TX-244 \$11.00

A/B SWITCH

JVC# PU53593-2

High quality
A/B switch.

75 OHMS IN/OUT

Measures: 3 3/4" X 1 7/16" X 1".

CAT# ABS-2 \$3.50 each

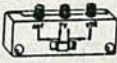

48 KEY ASSEMBLY

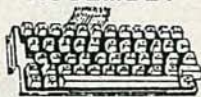

NEW T.I. KEYBOARDS.

Originally used on computers,
these keyboards contain 48
S.P.S.T. mechanical switches.
Terminates to 15 pin connector.
Frame size 4" X 9".

CAT# KP-48 \$3.50 each

WALL TRANSFORMER

11.5 Vdc 1.95 AMP.
Input: 120 Vac
Size: 3 3/4" X
2 7/8" X 2 5/8"

CAT# DCTX-11519

\$6.50 each



SOUND & VIDEO MODULATOR

Ti# UM1381-1.

Designed for use with
T.I. computers. Can be
used with video camera,
games, or other audio/video
sources. Built in A/B
switch enables user to switch from
T.V. antenna without disconnection.
Operates on channel 3 or 4.
Requires 12 Vdc. Hook up diagram
included.

CAT# AVMOD \$5.00 each



LED'S STANDARD JUMBO

DIFFUSED

T 1-3/4 size

RED 10 for \$1.50 • 100 for \$13.00
CAT# LED-1 1000 for \$110.00

GREEN 10 for \$2.00
CAT# LED-2 100 for \$17.00
1000 for \$150.00

YELLOW 10 for \$2.00
CAT# LED-3 100 for \$17.00
1000 for \$150.00

FLASHING LED

with built in flashing circuit operates on 5 volts...

RED \$1.00 each
CAT# LED-4 10 for \$9.50
GREEN \$1.00 each
CAT# LED-4G 10 for \$9.50

BI-POLAR LED

Lights RED one direction,
GREEN the other. Two leads.

CAT# LED-6 2 for \$1.70

LED HOLDER

Two piece holder.

CAT# HLED

10 for 65¢

CLIPLITE LED HOLDER

Makes a L.E.D. look like a fancy
indicator. Fits T 1-3/4 size LED.

CLEAR CAT# HLDCL-C
RED CAT# HLDCL-R
GREEN CAT# HLDCL-G
YELLOW CAT# HLDCL-Y
4 for \$1.00

SWITCHES

MINIATURE TOGGLE

SWITCHES

all rated 5 Amps

S.P.D.T.(on-on)

Solder lug terminals.

CAT# MTS-4

\$1.00 each

10 for \$9.00



S.P.D.T.(on-on)

Non threaded bushing.

P.C. mount.

CAT# MTS-40PC

75¢ each

10 for \$7.00



D.P.D.T.(on-on)

Solder lug terminals.

CAT# MTS-8

\$2.00 each

10 for \$19.00



MINI PUSH BUTTON

S. P. S. T. momentary.

Push to make. 1/4"

threaded bushing.

Red button.

CAT# MPB-1

35¢ each • 10 for \$3.25



13.8 VDC REGULATED POWER SUPPLY



Solid state, fully regulated 13.8 Vdc
power supplies. Both feature 100%
solid state construction, fuse protection
and LED power indicator. UL listed.

2 AMP CONSTANT, 4 AMP SURGE
CAT# DVP-412 \$22.50 each

3 AMP CONSTANT, 5 AMP SURGE
CAT# DVP-512 \$30.00 each

COMPUTER GRADE CAPACITORS

1400 MFD 200 VDC
2" dia. X 3" high
CAT# CG-1420 \$2.00

7500 MFD 200 VDC
3" dia. X 5 3/4" high
CAT# CG-75 \$4.00

22000 MFD 25 VDC
2" dia. X 4 3/4" high
CAT# CG-22 \$2.50

SWITCHING POWER SUPPLY

Compact, well regulated switching
power supply designed to power Texas
Instruments computer

equipment. INPUT:

14-25 Vac @ 1 amp

OUTPUT: +12 Vdc @

350 ma. +5 Vdc @1.2

amp -5 Vdc @ 200 ma.

SIZE: 4 3/4" square.

Includes 18 Vac @ 1 amp wall trans-

former designed for this power supply.

CAT# PS-TX \$5.00 per set

10 for \$45.00



BLACKLIGHT ASSEMBLY

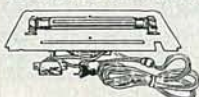

Complete, functioning assembly including
ballast, on-off switch, power cord,
sockets and F4T5-BL blacklight.
Mounted on a 7 1/8" X 3 1/8" metal
plate. Use for special effects lighting or
erasing EPROMS.

CAT# BLTA \$10.00 each

RELAYS

12 VDC 4PDT

P.C. mount

5 amp

contacts.

150 ohm

coil. Size:

1 1/4" X 1 3/4 X 7/8"

CAT# 4PRLY-12PC

\$3.50 each



10 AMP SOLID STATE RELAY

Control:

3-32 Vdc

2 1/2" X

3/4" X 7/8".

CAT# SSR1Y-10A

\$9.50 ea. 10 for \$85.00

MINI 12 VDC S.P.D.T.

4 Amp

contacts

335 ohm coil

61" X .42" X .44". Fits

DIP socket, P.C. mount.

CAT # RLY-787

\$1.50 ea. • 10 / \$12.50



VIC 20 MOTHERBOARD

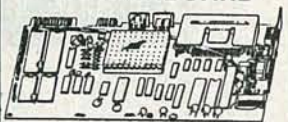

26 IC's including 6520A and 6560. Not
guaranteed but great for replacement
parts or experimentation.

CAT# VIC-20 \$15.00 each

SOUND EFFECTS BOARD

P.C. board with 2 1/4"

speaker, 2 LED's, IC,

battery snap, other com-

ponents 2 3/8" X 3". When switch is

pulled board beeps and LED's light.

Operates on a 9 volt battery (not

included). CAT# ST-3 \$1.25 each



NICKEL-CAD CHARGER/TESTER

Will charge most
nickel-cad batteries
even button & N size.

CAT# UNCC-N \$15.00



RECHARGEABLE NICKEL-CAD BATTERIES

AAA SIZE 1.25V	180mAh	\$2.25
AA SIZE 1.25V	500mAh	\$2.00
AA with solder tabs		\$2.20
C SIZE 1.2 V	1200mAh	\$4.25
SUB-C with solder tabs		\$4.25
D SIZE 1.2V	1200mAh	\$4.25

XENON FLASH TUBE

3/4" X 1/8" dia.

CAT# FLT-1 2 for \$1.00

POLARITY SWITCH



Designed to control
an external coaxial relay on a satellite
t.v. system. Ideal for parts. Contains a 5
Vdc relay and many other parts on a
P.C. board.

CAT# RDPS

\$1.75 each • 10 for \$15.00

LIGHT ACTIVATED MOTION SENSOR

This device con-
tains a photocell
which senses
sudden change in
ambient light.
Could be used as
a door annunciator or modified to trigger
other devices. 5 1/2" X 4" X 1". Oper-
ates on 6 Vdc. Requires 4 AA batter-
ies (not included).

CAT# LSMD \$5.75 per unit

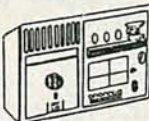

6-12 VDC MOTOR

Mabuchi# RS-550S
Permanent magnet motor.

1 7/16" dia. X 2 1/4" long.

2600 RPM @ 6 V 5300 RPM @ 12 Vdc

CAT# DCM-7 \$3.00 each



TRANSISTORS

2N2222A 3 for \$1.00

PN2222A 10 for \$1.50

2N2904 3 for \$1.00

2N2905 3 for \$1.00

2N3055 \$1.00 each

PN3569 10 for \$1.00

2N4400 10 for \$1.50

BRIDGE RECTIFIER

10 AMP 200 P.I.V.

5/8" square.

CAT#FWB-1020

\$1.00 each • 10 for \$9.00



STORES:

LOS ANGELES
905 S. VERMONT AVE.
LOS ANGELES, CA 90006
(213) 380-8000

VAN NUYS
6228 SEPULVEDA BLVD.
VAN NUYS, CA 91411
(818) 997-1806

MAIL ORDERS TO:
ALL ELECTRONICS
P.O. BOX 567
VAN NUYS, CA
91408

TELEX 51010163
(ALL ELECTRONIC)
CUSTOMERS
OUTSIDE OF THE U.S.
SEND \$1.50 POSTAGE
FOR CATALOG

TOLL FREE
800-826-5432
INFO: (818) 904-0524
FAX: (818) 781-2653

QUANTITIES LIMITED
MINIMUM
ORDER \$10.00
CALIF. ADD SALES TAX
USA: \$3.00
SHIPPING
NO C.O.D.



NEC V20 & V30 CHIPS

Replace the 8086 or 8088 in Your IBM-PC and Increase Its Speed by up to 40%!

Part No.		Price
UPD70108-5 (5MHz) V20 Chip	...	\$ 7.49
UPD70108-8 (8MHz) V20 Chip	...	\$ 8.95
UPD70108-10 (10MHz) V20 Chip	...	\$21.95
UPD70116-8 (8MHz) V30 Chip	...	\$11.95
UPD70116-10 (10MHz) V30 Chip	...	\$24.95

7400

Part No.	1-9	10+	Part No.	1-9	10+
7400	.29	19	7485	.65	55
7402	.29	19	7486	.45	35
7404	.29	19	7489	2.05	195
7405	.35	25	7490	.49	39
7406	.39	29	7493	.45	35
7407	.39	29	74121	.45	35
7408	.35	25	74123	.55	45
7410	.29	19	74125	.55	45
7414	.49	39	74126	.69	59
7415	.35	25	74143	3.95	385
7417	.39	29	74150	1.35	125
7420	.35	25	74154	1.35	125
7430	.35	25	74158	1.59	149
7432	.39	29	74173	.85	75
7438	.39	29	74174	.59	49
7442	.55	45	74175	.99	89
7445	.79	69	74176	.99	89
7446	.89	79	74181	1.95	185
7447	.89	79	74189	1.95	185
7448	2.05	195	74193	.79	69
7472	.89	79	74198	1.85	175
7473	.39	29	74271	.99	89
7474	.39	29	74273	1.95	185
7475	.49	39	74365	.65	55
7476	.45	35	74367	.65	55

74LS

74LS00	.29	19	74LS165	.75	65
74LS02	.29	19	74LS166	.99	89
74LS04	.35	25	74LS173	.59	49
74LS05	.35	25	74LS240	.89	79
74LS06	1.09	99	74LS155	.49	39
74LS07	1.09	99	74LS189	4.59	449
74LS08	.29	19	74LS191	.59	49
74LS10	.29	19	74LS193	.79	69
74LS14	.49	39	74LS221	.69	59
74LS27	.35	25	74LS240	.89	79
74LS30	.29	19	74LS243	.69	59
74LS32	.35	25	74LS244	.69	59
74LS42	.49	39	74LS245	.89	79
74LS47	.99	89	74LS259	.99	89
74LS73	.39	29	74LS273	.89	79
74LS74	.35	25	74LS279	.49	39
74LS75	.39	29	74LS322	4.05	395
74LS76	.55	45	74LS365	.49	39
74LS85	.59	49	74LS366	.49	39
74LS86	.35	25	74LS367	.49	39
74LS90	.49	39	74LS368	.49	39
74LS93	.49	39	74LS373	.79	69
74LS123	.59	49	74LS374	.79	69
74LS125	.49	39	74LS393	.89	79
74LS138	.49	39	74LS590	6.05	595
74LS139	.49	39	74LS624	2.05	195
74LS154	1.09	99	74LS629	2.95	285
74LS157	.45	35	74LS640	1.05	95
74LS158	.45	35	74LS645	1.09	99
74LS163	.59	49	74LS670	1.09	99
74LS164	.59	49	74LS688	2.39	229

74S/PROMS*

74S00	.29	74S188	1.49
74S04	.29	74S189	1.69
74S08	.35	74S196	2.49
74S10	.29	74S204	1.49
74S32	.35	74S244	1.49
74S74	.45	74S253	1.79
74S85	1.79	74S287	1.49
74S86	.45	74S288	1.49
74S124	2.75	74S373	1.49
74S174	.79	74S374	1.49
74S175	.79	74S472	2.95

74F

74F00	.29	74F139	.69
74F04	.29	74F157	.69
74F08	.29	74F193	2.95
74F10	.29	74F240	.99
74F32	.29	74F244	.99
74F74	.39	74F253	.69
74F86	.39	74F373	.99
74F138	.69	74F374	.99

CD-CMOS

CD4001	.19	CD4076	.59
CD4008	.69	CD4081	.25
CD4011	.19	CD4082	.25
CD4013	.29	CD4093	.25
CD4016	.29	CD4094	.89
CD4017	.49	CD40103	2.49
CD4018	.59	CD40107	.49
CD4020	.59	CD40109	.79
CD4024	.49	CD4510	.69
CD4027	.35	CD4511	.69
CD4030	.69	CD4520	.69
CD4040	.29	CD4522	.79
CD4049	.29	CD4538	.79
CD4050	.29	CD4541	.89
CD4051	.59	CD4543	.79
CD4052	.59	CD4553	4.95
CD4053	.59	CD4555	.79
CD4063	1.49	CD4559	7.95
CD4066	.29	CD4566	2.49
CD4067	1.29	CD4583	.89
CD4069	.25	CD4584	.39
CD4070	.25	CD4585	.39
CD4071	.25	MC14511P	8.95
CD4072	.25	MC14490P	4.49

MICROPROCESSOR COMPONENTS

MISCELLANEOUS CHIPS		6500/6800/68000 Cont.		8000 SERIES Cont.	
Part No.	Price	Part No.	Price	Part No.	Price
D765AC	4.95 3.95	6845	9.95 2.95	8228	2.95
WD9216	6.95	6850	1.95	8237-5	4.95 4.49
95H90	9.95 5.95	6852	1.49	8243	2.95 1.75
Z80, Z80A, Z80B SERIES					
Z80	1.25 99	MC68000L8	1.195	8250A	6.49
Z80-CTC	1.79 99	MC68000L10	13.95	8250B (For IBM)	6.95
Z80-DART	1.79 99	MC68010L10	49.95	8251-A	1.89
Z80-PI0	1.79 99	MC68020RC12B	169.95	8253-5	1.95
Z80A	1.69	MC6881RC12A	149.95	8254-A	4.95
Z80A-CTC	1.79	8000 SERIES			
Z80A-DART	4.95	80C31	9.95	8257-5	1.95
Z80A-PI0	1.79	80C35	9.95	8259-5	2.25
Z80A-SIO/0	3.75	8073	9.95	8279-5	2.95
Z80B	3.49	8080A	2.95 2.49	8741	9.95
Z80B-CTC	3.95	8085A	2.49	8742	29.95 22.95
Z80B-PI0	4.29 3.95	8086	5.95	8748 (25V)	7.95
6500/6800/68000 SER.					
6502	2.65	8086-2	6.95	8749	9.95
6502(CMOS)	6.95 5.95	8087-1 (10MHz)	129.95	8751	39.95
6520	1.95	8087-2 (8MHz)	159.95	8755	14.95
6522	3.95	8088-2	6.95	DATA ACQUISITION	
6532	6.49 5.49	8116	4.95	ADC0804LCN	8.49 2.79
6551	4.49 2.95	8155	2.49	ADC0808CCN	5.95
65C02 (CMOS)	17.95	8155-2	3.49	ADC0809CCN	9.95 3.69
6800	1.95	8156	3.95	ADC1205CCU-1	19.95
6802	3.95	8202	5.95	DA08080LCN	1.95
6810	1.25	8203	9.95	DAC10080LCN	4.95
6821	1.75	8212	2.29	AY-3-1015D	4.95
6840	3.95	8224	2.25	AY-5-1013A	2.95

MICROPROCESSOR SALE!

8052AHBASIC CPU w/BASIC Interpreter	...	\$ 29.95
MC68008L8 32-Bit MPU (8-Bit Data Bus)	...	49.95 \$ 16.95
MC68701 8-Bit EPROM Microcomputer	...	\$ 14.95
MC68705P3S 8-Bit EPROM Microcomputer	...	\$ 14.95
MC68705U3L 8-Bit EPROM Microcomputer	...	\$ 10.95
80286-10 16-Bit Hi Performance MPU	...	\$ 99.95
80287-8 Math Co-processor (8MHz)	...	\$259.95
80287-10 Math Co-processor (10MHz)	...	\$309.95
80387-16 Math Co-processor (16MHz)	...	\$494.95
80387-20 Math Co-processor (20MHz)	...	\$895.95

DYNAMIC RAMS

Part No.		Price
4116-15	16,384 x 1 (150ns)	1.09
4128-20	131,072 x 1 (200ns) (Piggyback)	9.25 2.75
4164-120	65,536 x 1 (120ns)	2.75
4164-150	65,536 x 1 (150ns)	2.49
4164-200	65,536 x 1 (200ns)	1.19
TMS4416-12	16,384 x 4 (120ns)	3.49
8118	16,384 x 1 (120ns)	49 39
41256-100	262,144 x 1 (100ns)	5.95
41256-120	262,144 x 1 (120ns)	4.95
41256-150	262,144 x 1 (150ns)	4.75
50464-15	65,536 x 4 (150ns) (4464)	4.95
51100P-10	1,048,576 x 1 (100ns) 1 Meg	94.95 29.95
514256P-10	262,144 x 4 (100ns) 1 Meg	29.95

STATIC RAMS

2016-12	2048 x 8 (120ns)	1.69
2018-45	2048 x 8 (45ns)	6.95 5.49
2102-2L	1024 x 1 (250ns) Low Power	1.95
2114N	1024 x 4 (45ns)	.99
2114N-2L	1024 x 4 (200ns) Low Power	1.49
21C14	1024 x 4 (200ns) (CMOS)	.49
2149	1024 x 4 (45ns)	2.49
5101	256 x 4 (45ns) CMOS	1.95
6116P-3	2048 x 8 (150ns) CMOS	1.89
6116LP-3	2048 x 8 (150ns) LP CMOS	1.95
6264L-P-12	8192 x 8 (120ns) LP CMOS	4.25 3.95
6264P-15	8192 x 8 (150ns) CMOS	6.95 3.49
6264LP-15	8192 x 8 (150ns) LP CMOS	6.95 3.49
6514	1024 x 4 (350ns) CMOS	.349
43256-15L	32,768 x 8 (150ns) Low Power	11.95

EPROMS

TMS2516	2048 x 8 (450ns) 25V	6.95
TMS2532	4096 x 8 (450ns) 25V	6.95
TMS2532A	4096 x 8 (450ns) 21V	5.95
TMS2564	8192 x 8 (450ns) 25V	9.95
TMS2716	2048 x 8 (450ns) 3 Voltage	9.95 6.95
1702A	256 x 8 (1µs)	6.95 4.95
2716	2048 x 8 (450ns) 25V	3.75
2716-1	2048 x 8 (350ns) 25V	4.25
27C16	2048 x 8 (450ns) 25V (CMOS)	5.49
2732	4096 x 8 (450ns) 25V	3.95
2732A-20	4096 x 8 (200ns) 21V	4.25
2732A-25	4096 x 8 (250ns) 21V	3.95
27C32	4096 x 8 (450ns) 25V (CMOS)	5.95
2764-20	8192 x 8 (200ns) 21V	4.25
2764-25	8192 x 8 (250ns) 21V	3.75
2764A-25	8192 x 8 (250ns) 12.5V	3.95
2764-45	8192 x 8 (450ns) 21V	3.95
27C64-15	8192 x 8 (150ns) 21V (CMOS)	2.95
27128-20	16,384 x 8 (200ns) 21V	6.95
27128-25	16,384 x 8 (250ns) 21V	5.95
27128A-25	16,384 x 8 (250ns) 12.5V	5.25
27C128-25	16,384 x 8 (250ns) 21V (CMOS)	

Worldwide • Since 1974

• QUALITY COMPONENTS • COMPETITIVE PRICING
• PROMPT DELIVERY

Mail Order Electronics • Worldwide
Jameco
ELECTRONICS

PROTOTYPING PRODUCTS

Jameco Solderless Breadboard Sockets

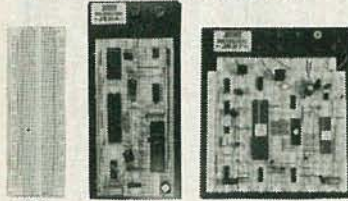

Part No.	Dim. L' x W'	Contact Points	Binding Posts	Price
JE20	6 1/2 x 3 1/4	200	0	\$ 2.29
JE21	3 1/4 x 2 1/8	400	0	\$ 4.49
JE22	6 1/2 x 1 3/8	630	0	\$ 5.95
JE23	6 1/2 x 2 1/8	830	0	\$ 7.49
JE24	6 1/2 x 3 1/8	1,360	2	\$14.95
JE25	6 1/2 x 4 1/8	1,660	3	\$22.95
JE26	6 7/8 x 5 3/8	2,390	4	\$27.95
JE27	7 1/4 x 7 1/8	3,220	4	\$37.95

Jameco General Purpose Prototype PC Boards

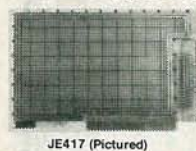

- Wire Wrap
- Component Testing
- Point-to-Point Wiring
- 31/62 Connection

JE415	(6 1/2" No Pads, PC/XT)	\$14.95
JE417	(6 1/2" Plated w/Pads, PC/XT)	\$19.95
Extended Board		
JE421	(4 3/4" Extender, 31/62 Connector)	\$19.95

DATA BOOKS

30003	National Linear Data Book (82)	\$19.95
30005	Logic Data Book - Vol. II (84)	\$19.95
30009	Intersil Data Book (87)	\$14.95
21398	CMOS Cookbook (88)	\$14.95
210830	Intel Memory Handbook (87)	\$17.95
230843	Intel Microsystem Hndbk. Set (87)	\$24.95

MUFFIN/SPRITE-STYLE FANS

TA450S	\$11.95
Torin Industries (4.68" sq., 50 cfm)		
SU2A1	\$11.95
EG&G Rotron (3.125" square, 34 cfm)		



NEW! Switching Power Supply

+5V @ 5A, +12V @ 1A x 2

Regulated, 110VAC/220VAC
Switchable • 40 watt • Size: 8 1/2" L x 3" W x 2 1/4" H • Weight: 1.1 lbs. • Data included

PSCC07	\$14.95
--------	-----------	---------

Jameco Computer Power Protection

JE1190	Power Base.	\$29.95
JE1191	6-Outlet Power Strip	\$11.95
JE1192	300 Watt Back-Up.	\$269.95
JE1193	500 Watt Back-Up.	\$349.95

IBM AND APPLE COMPATIBLE DISPLAY MONITORS

Franklin 12" Green Monochrome

Apple II, II+, IIe, IIc Compatible
• Composite video output • 18MHz
• Resolution: 800 lines at center

SMON. \$59.95



12" Amber Monochrome —

TTL Input, High Resolution (PC/XT/AT)

AMBER. \$109.95 \$99.95

14" RGB Color — CGA Compatible Amber/Green/Color Switchable, 640 x 200 Resolution (PC/XT/AT)

TTX1410. \$279.95

14" EGA Color - EGA/CGA Compat., 720 x 350 (max.) resolution (PC/XT/AT)

TE5154. \$399.95

14" Ultrascan Color — CGA/EGA/PGC/VGA Compatible, 800 x 560 (max.) Resolution (PC/XT/AT)

4375M. \$579.95 \$549.95

IBM PC/XT/AT Compatible Cards

JE1050	Mono Graphics Card.	\$ 59.95
JE1052	Color Graphics Card.	\$ 49.95
JE1055	EGA Card.	\$149.95

JAMECO COMPUTER KITS

FREE! PC Write Word Processing Software Included!

Jameco's IBM™ AT Compatible Mini-286 6/8/10/12 MHz Kit!

Part No.	Description	Price
JE1043	1.2M/360K Floppy Control	\$ 49.95
JE1015	XT/AT Style Keyboard.	\$ 59.95
41256-120	512K RAM (18 Chips)	\$ 89.10
JE1017	Baby AT Flip-Top Case.	\$ 69.95
JE1032	200W Power Supply.	\$ 89.95
JE1022	5 1/4" High Density Disk Drive	\$109.95
JE1007	Baby AT Motherboard (Zero-K RAM-incl. Award BIOS ROM)	\$349.95
JE1059	\$499.95	
		Reg. List \$818.80
		SAVE \$68.85!
		(EGA Monitor and Card not included)
JE1009	IBM™ AT Compatible Kit.	\$749.95

Jameco's 4.77/8MHz Turbo IBM PC/XT Compatible Kit

4164-150	128K RAM (18 Chips).	\$ 44.82
41256-150	512K RAM (18 Chips).	\$ 85.50
JE1010	Flip-Top Case.	\$ 34.95
JE1015	XT/AT Style Keyboard.	\$ 59.95
JE1030	150 Watt Power Supply \$	\$ 69.95
JE1020	5 1/4" DSDD Disk Drive	\$ 89.95
AMBER	12" Amber Monitor	\$ 99.95
JE1001	4.77/8MHz Turbo Motherboard (Zero-K RAM — Includes Award BIOS ROM)	\$ 99.95
JE1071	Multi I/O with Controller and Graphics.	\$119.95
		Regular List \$704.97
		SAVE \$105.02!
JE1005	(IBM™ PC/XT Turbo Compatible Kit)	\$599.95

Jameco's IBM PC/XT/AT Compatible Motherboards

• Award BIOS ROM included		
JE1000	4.77MHz (PC/XT)	\$ 84.95
JE1001	4.77/8MHz (PC/XT)	\$ 99.95
JE1007	6/8/10/12MHz (AT)	\$349.95

Additional Add-Ons Available!

COMPUTER PERIPHERALS



ST225	20MB Drive only (PC/XT/AT)	\$259.95
ST225K	20MB w/Controller (PC/XT)	\$289.95
ST238	30MB Drive only (PC/XT/AT)	\$299.95
ST238K	30MB w/Cont. (PC/XT/AT)	\$329.95
ST251	40MB Drive only (PC/XT/AT)	\$469.95
ST251XT	40MB w/Cont. Card (PC/XT)	\$549.95
ST251AT	40MB w/Cont. Card (AT)	\$589.95

Jameco PC/XT & AT Compatible Disk Drives

JE1020	360K Black Bzl. (PC/XT/AT)	\$ 89.95
JE1021	360K Beige Bzl. (PC/XT/AT)	\$ 89.95
JE1022	1.2MB Beige Bzl. (AT)	\$109.95

DATATRONICS

2400/1200/300 Modems

1200H	1200/300 Baud Internal Modem.	\$ 79.95
2400S	2400/1200/300 Internal Modem.	\$174.95
1200C	1200/300 Baud External Modem.	\$119.95
2400E	2400/1200/300 External Modem.	\$219.95

Prometheus 1200B Internal Modem

PM1200B-2S (Software incl.) \$149.95 \$189.95

Jameco Extended 80-Column Card for Apple IIe

JE864	\$39.95
• 80 Col./64K RAM • Doubles amount of data your Apple IIe can display as well as its memory capacity • Ideal for word processing • Complete with instructions		

ADD12 (Disk Drive II, II+, IIe) \$99.95

ZUCKERBOARD

TANDY 1000 Expansion Memory Half Card

TE512	Includes 512K RAM.	\$119.95
TANC	Plug-in Clock option chip only.	\$39.95

30Meg Hard Disk for Tandy 1000, 1000A, 1000SX, 1200, 3000 and 3000HL

T30MB	30MB Hard Disk Drive Board.	\$599.95
-------	-------------------------------------	----------

Accessories for Commodore VIC-20, C-64 & C-128

JE232CM	(RS232 Inter. VIC-20, C-64 and C-128 in 64 mode)	\$39.95
JE232CM	(C-64 Power Supply)	\$39.95
CPS10	(C-64 Power Supply)	\$39.95
CPS128	(C-128 Power Supply)	\$59.95

U.S. Funds Only
Shipping: Add 5% plus \$1.50 Insurance
(May vary according to weight)

\$20 Minimum Order
IBM is a registered trademark of International Business Machines

Data Sheets — 50¢ each
Prices Subject to Change

California Residents:
Add 6%, 6 1/2% or 7%
Sales Tax
FAX 415-592-2503
4/88



Send \$1.00 Postage for a
FREE 1988 CATALOG

Telex: 176043

©1988 Jameco Electronics

1355 SHOREWAY RD., BELMONT, CA 94002 • FOR ORDERS ONLY 415-592-8097 • ALL OTHER INQUIRIES 415-592-8121

DIGI KEY CORPORATION

1-800-344-4539

AK, Puerto Rico - 218-661-6674 Telex - 62287814 FAX - 218-661-3380 TWX - 910350882 DIGI KEY CORP

NATIONAL SEMICONDUCTOR • PANASONIC
 MC MACHINE • EMC, INC. • INTRINSIC
 EAC, INC. • J. W. MILLER • AAVID ENGINEER
 E. F. JOHNSON • ATLANTIC SEMICONDUCTOR

256K (262,144 x 1) DRAM 150NS \$5.70/1; \$39.95/9

Factory Firsts

MODES • DIAMOND TOOL • UNGAR •
 ES • G.W. INDUSTRIES • AMDEK • G.E.
 LARAR • YAGEDI • J.W. MILLER • LUK
 3C CHEMICALS • ARIES • PLESSEY

VISA
MasterCard

INTEGRATED CIRCUITS

Part No.	Description	Price
7400 TTL	74100N 1.00	1.00
7401	74101N 1.00	1.00
7402	74102N 1.00	1.00
7403	74103N 1.00	1.00
7404	74104N 1.00	1.00
7405	74105N 1.00	1.00
7406	74106N 1.00	1.00
7407	74107N 1.00	1.00
7408	74108N 1.00	1.00
7409	74109N 1.00	1.00
7410	74110N 1.00	1.00
7411	74111N 1.00	1.00
7412	74112N 1.00	1.00
7413	74113N 1.00	1.00
7414	74114N 1.00	1.00
7415	74115N 1.00	1.00
7416	74116N 1.00	1.00
7417	74117N 1.00	1.00
7418	74118N 1.00	1.00
7419	74119N 1.00	1.00
7420	74120N 1.00	1.00
7421	74121N 1.00	1.00
7422	74122N 1.00	1.00
7423	74123N 1.00	1.00
7424	74124N 1.00	1.00
7425	74125N 1.00	1.00
7426	74126N 1.00	1.00
7427	74127N 1.00	1.00
7428	74128N 1.00	1.00
7429	74129N 1.00	1.00
7430	74130N 1.00	1.00
7431	74131N 1.00	1.00
7432	74132N 1.00	1.00
7433	74133N 1.00	1.00
7434	74134N 1.00	1.00
7435	74135N 1.00	1.00
7436	74136N 1.00	1.00
7437	74137N 1.00	1.00
7438	74138N 1.00	1.00
7439	74139N 1.00	1.00
7440	74140N 1.00	1.00
7441	74141N 1.00	1.00
7442	74142N 1.00	1.00
7443	74143N 1.00	1.00
7444	74144N 1.00	1.00
7445	74145N 1.00	1.00
7446	74146N 1.00	1.00
7447	74147N 1.00	1.00
7448	74148N 1.00	1.00
7449	74149N 1.00	1.00
7450	74150N 1.00	1.00
7451	74151N 1.00	1.00
7452	74152N 1.00	1.00
7453	74153N 1.00	1.00
7454	74154N 1.00	1.00
7455	74155N 1.00	1.00
7456	74156N 1.00	1.00
7457	74157N 1.00	1.00
7458	74158N 1.00	1.00
7459	74159N 1.00	1.00
7460	74160N 1.00	1.00
7461	74161N 1.00	1.00
7462	74162N 1.00	1.00
7463	74163N 1.00	1.00
7464	74164N 1.00	1.00
7465	74165N 1.00	1.00
7466	74166N 1.00	1.00
7467	74167N 1.00	1.00
7468	74168N 1.00	1.00
7469	74169N 1.00	1.00
7470	74170N 1.00	1.00
7471	74171N 1.00	1.00
7472	74172N 1.00	1.00
7473	74173N 1.00	1.00
7474	74174N 1.00	1.00
7475	74175N 1.00	1.00
7476	74176N 1.00	1.00
7477	74177N 1.00	1.00
7478	74178N 1.00	1.00
7479	74179N 1.00	1.00
7480	74180N 1.00	1.00
7481	74181N 1.00	1.00
7482	74182N 1.00	1.00
7483	74183N 1.00	1.00
7484	74184N 1.00	1.00
7485	74185N 1.00	1.00
7486	74186N 1.00	1.00
7487	74187N 1.00	1.00
7488	74188N 1.00	1.00
7489	74189N 1.00	1.00
7490	74190N 1.00	1.00
7491	74191N 1.00	1.00
7492	74192N 1.00	1.00
7493	74193N 1.00	1.00
7494	74194N 1.00	1.00
7495	74195N 1.00	1.00
7496	74196N 1.00	1.00
7497	74197N 1.00	1.00
7498	74198N 1.00	1.00
7499	74199N 1.00	1.00
7500	74200N 1.00	1.00

INTEGRATED CIRCUITS

Part No.	Description	Price
4000 CMOS	4001 1.00	1.00
4002	4002 1.00	1.00
4003	4003 1.00	1.00
4004	4004 1.00	1.00
4005	4005 1.00	1.00
4006	4006 1.00	1.00
4007	4007 1.00	1.00
4008	4008 1.00	1.00
4009	4009 1.00	1.00
4010	4010 1.00	1.00
4011	4011 1.00	1.00
4012	4012 1.00	1.00
4013	4013 1.00	1.00
4014	4014 1.00	1.00
4015	4015 1.00	1.00
4016	4016 1.00	1.00
4017	4017 1.00	1.00
4018	4018 1.00	1.00
4019	4019 1.00	1.00
4020	4020 1.00	1.00
4021	4021 1.00	1.00
4022	4022 1.00	1.00
4023	4023 1.00	1.00
4024	4024 1.00	1.00
4025	4025 1.00	1.00
4026	4026 1.00	1.00
4027	4027 1.00	1.00
4028	4028 1.00	1.00
4029	4029 1.00	1.00
4030	4030 1.00	1.00
4031	4031 1.00	1.00
4032	4032 1.00	1.00
4033	4033 1.00	1.00
4034	4034 1.00	1.00
4035	4035 1.00	1.00
4036	4036 1.00	1.00
4037	4037 1.00	1.00
4038	4038 1.00	1.00
4039	4039 1.00	1.00
4040	4040 1.00	1.00
4041	4041 1.00	1.00
4042	4042 1.00	1.00
4043	4043 1.00	1.00
4044	4044 1.00	1.00
4045	4045 1.00	1.00
4046	4046 1.00	1.00
4047	4047 1.00	1.00
4048	4048 1.00	1.00
4049	4049 1.00	1.00
4050	4050 1.00	1.00
4051	4051 1.00	1.00
4052	4052 1.00	1.00
4053	4053 1.00	1.00
4054	4054 1.00	1.00
4055	4055 1.00	1.00
4056	4056 1.00	1.00
4057	4057 1.00	1.00
4058	4058 1.00	1.00
4059	4059 1.00	1.00
4060	4060 1.00	1.00
4061	4061 1.00	1.00
4062	4062 1.00	1.00
4063	4063 1.00	1.00
4064	4064 1.00	1.00
4065	4065 1.00	1.00
4066	4066 1.00	1.00
4067	4067 1.00	1.00
4068	4068 1.00	1.00
4069	4069 1.00	1.00
4070	4070 1.00	1.00
4071	4071 1.00	1.00
4072	4072 1.00	1.00
4073	4073 1.00	1.00
4074	4074 1.00	1.00
4075	4075 1.00	1.00
4076	4076 1.00	1.00
4077	4077 1.00	1.00
4078	4078 1.00	1.00
4079	4079 1.00	1.00
4080	4080 1.00	1.00
4081	4081 1.00	1.00
4082	4082 1.00	1.00
4083	4083 1.00	1.00
4084	4084 1.00	1.00
4085	4085 1.00	1.00
4086	4086 1.00	1.00
4087	4087 1.00	1.00
4088	4088 1.00	1.00
4089	4089 1.00	1.00
4090	4090 1.00	1.00
4091	4091 1.00	1.00
4092	4092 1.00	1.00
4093	4093 1.00	1.00
4094	4094 1.00	1.00
4095	4095 1.00	1.00
4096	4096 1.00	1.00
4097	4097 1.00	1.00
4098	4098 1.00	1.00
4099	4099 1.00	1.00
4100	4100 1.00	1.00

I. I. SOCKETS

Part No.	Description	Price
1 18 188	1 18 188	1.00
1 18 189	1 18 189	1.00
1 18 190	1 18 190	1.00
1 18 191	1 18 191	1.00
1 18 192	1 18 192	1.00
1 18 193	1 18 193	1.00
1 18 194	1 18 194	1.00
1 18 195	1 18 195	1.00
1 18 196	1 18 196	1.00
1 18 197	1 18 197	1.00
1 18 198	1 18 198	1.00
1 18 199	1 18 199	1.00
1 18 200	1 18 200	1.00
1 18 201	1 18 201	1.00
1 18 202	1 18 202	1.00
1 18 203	1 18 203	1.00
1 18 204	1 18 204	1.00
1 18 205	1 18 205	1.00
1 18 206	1 18 206	1.00
1 18 207	1 18 207	1.00
1 18 208	1 18 208	1.00
1 18 209	1 18 209	1.00
1 18 210	1 18 210	1.00
1 18 211	1 18 211	1.00
1 18 212	1 18 212	1.00
1 18 213	1 18 213	1.00
1 18 214	1 18 214	1.00
1 18 215	1 18 215	1.00
1 18 216	1 18 216	1.00
1 18 217	1 18 217	1.00
1 18 218	1 18 218	1.00
1 18 219	1 18 219	1.00
1 18 220	1 18 220	1.00
1 18 221	1 18 221	1.00
1 18 222	1 18 222	1.00
1 18 223	1 18 223	1.00
1 18 224	1 18 224	1.00
1 18 225	1 18 225	1.00
1 18 226	1 18 226	1.00
1 18 227	1 18 227	1.00
1 18 228	1 18 228	1.00
1 18 229	1 18 229	1.00
1 18 230	1 18 230	1.00
1 18 231	1 18 231	1.00
1 18 232	1 18 232	1.00
1 18 233	1 18 233	1.00
1 18 234	1 18 234	1.00
1 18 235	1 18 235	1.00
1 18 236	1 18 236	1.00
1 18 237	1 18 237	1.00
1 18 238	1 18 238	1.00
1 18 239	1 18 239	1.00
1 18 240	1 18 240	1.00

5% Carbon Film Resistors

Part No.	Description	Price
100	100 1.00	1.00
101	101 1.00	1.00
102	102 1.00	1.00
103	103 1.00	1.00
104	104 1.00	1.00
105	105 1.00	1.00
106	106 1.00	1.00
107	107 1.00	1.00
108	108 1.00	1.00
109	109 1.00	1.00
110	110 1.00	1.00
111	111 1.00	

Radio Shack Parts Place™

PARTS FOR PROJECTS ARE NEIGHBORHOOD CLOSE

Save With Hotline Order Service

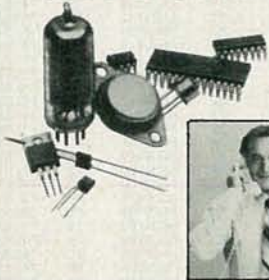

Over 200,000
Substitutions
Available



Your Radio Shack store manager can instantly phone in a special order for a wide variety of parts and accessories not shown in our catalog—tubes, ICs, phono stylus, diodes, crystals and much more. No postage or handling charges, no minimum order! Please give us a try!

Audio Amp With Speaker

11⁹⁵

- Makes an Excellent Test Amp
- Perfect for Computer-Sound Output

Dozens of uses—get one for your test bench. Ready-to-use audio amplifier features a high-gain IC design and 200-mW output. Rotary on/off volume control. 1/8" input jack and 1/8" output jack for connecting an external speaker or headphone. Battery extra. #277-1008



Sale! Voice-Synthesizer Team



9⁹⁵

Speech Synthesizer. Cut 23%. Easy to interface with most computers. Requires 3.12 MHz crystal. Reg. 12.95. #276-1784 Sale 9.95



11⁸⁸

Text-to-Speech IC. 30% Off. Use with synthesizer chip (above) for RS-232 hookup. Reg. 10 MHz crystal. Reg. 16.95. #276-1786 .. Sale 11.88

12-Tune Melody Synthesizer IC



- With On-Chip Audio Preamp
- Programmed With 12 Tunes

UMC3482. Just the thing for musical doorbells, games, clocks, telephone music-on-hold and novelty applications. Tunes include Happy Birthday, Oh My Darling Clementine, London Bridge, Home Sweet Home, Row-Row-Row Your Boat, more. Operates on 1.5 VDC. 16-pin DIP with data and circuit examples. #276-1797 2.99

Irresistables

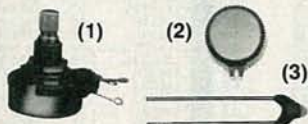

- (1) 5-Watt, 25-Ohm Rheostat. For lots of projects. #271-265 2.99
(2) Knob for Above. 1/4" shaft. With red insert. #274-433 ... Pkg. 2/99¢
(3) Thermistor. Resistance changes with temperature. #276-110 ... 1.99

Hard-to-Find Parts

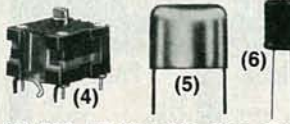

- (4) 335 pF Variable Cap. Two-section, PC-mount. #272-1337, 4.95
(5) 6-50 pF Trimmers. Low peaking, PC-mount. #272-1340 ... Pkg. 2/1.59
(6) TV Colorburst Crystal. Precision 3.579545 MHz standard. #272-1310 1.69

Antennas

Replacements for cordless phones, walkie-talkies and portable radios.

Sections	Extends to	Cat. No.	Each
5	30 1/2"	270-1401	2.99
4	34 3/4"	270-1402	3.49
3	39 1/2"	270-1403	3.59
5	28"	270-1405	2.99
5	15 1/2"	270-1406	2.59
5	13"	270-1407	2.59
6	72"	270-1408	3.99
6*	17 3/4"	270-1409	2.49

*#270-1409 has L-mounting bracket.

Builders' Helpers

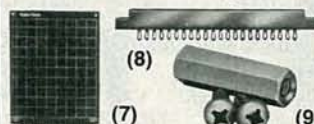

- (7) Plug-In PC Board With Ground Plane. #276-188 4.99
(8) 44-Position Card-Edge Socket. #276-1551 2.99
(9) PC Board Standoffs With Screws. #276-195 Pkg. 4/99¢

Test Lead Sets

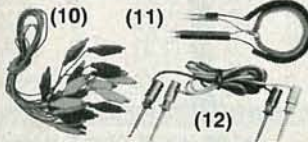

- (10) Set of Ten Color-Coded Test Cables. Gator clips. #278-1156, 3.99
(11) Coiled 6-Foot Leads. Probe at one end, banana plug at the other. #278-750 Pair/4.39
(12) Mini-Clip Jumper. 20" long. #278-016 Pair/3.49

FM Receiver IC



Combines RF, mixer, IF and demodulator in a single IC. Makes receiver projects a cinch to build; and with 70KHz IF, no coils are required. Built-in mute circuit reduces spurious reception. With application notes. #276-1304 5.95

Buzzer & Lamps



- (13) Tri-Sound Siren/Buzzer. Three different, extra-loud 80 db sounds. Requires 3 VDC. #273-072 ... 5.95
(14) Super-Bright Red LED. 300 mcd at 20 mA. #276-066 1.19
(15) 12V Flashing Lamps. Yellow, red, green. #272-1097, Pkg. of 3/99¢

Classy Touches



- (16) Aluminum Chassis Box. With screws. 2 3/4 x 2 1/2 x 1 1/2". #270-235 ... 1.79
5 1/4 x 3 x 2 1/2". #270-238 2.49
4 x 2 1/2 x 1 1/2". #270-239 1.99
(17) Heavy-Duty Toggle Switch. DPDT, 10 amps at 125 VAC. UL. #275-1533, 1.79
(18) Lighted Pushbutton Switch. SPST, 5 amps at 250 VAC. UL. #275-678, 5.95

AC Spike Protectors



- (19) Power Strip. Built-in noise filter and circuit breaker. Lighted on/off switch. Rated 15 amps at 120 VAC. UL listed. #61-2780 29.95
(20) Cordless Power Outlet. Plugs into wall. With circuit breaker, noise filter. Rated 13 amps at 120 VAC. UL listed. #61-2786 24.95

Solderless Breadboard



Especially
Designed for
Students,
Hobbyists,
Designers

Our finest! The 2 1/4 x 6 1/2" universal board is mounted on a 4 x 7" "stay-put" steel base with rubber feet. Accepts DIPs, discrete components and up to 22-gauge wire. Has 640 plug-in tie points and three binding posts for external power connections. #276-169 19.95

Bench LCD Multimeter



99⁹⁵

Low As
\$15 Per
Month*

The 31-segment analog bar graph display makes input peaks and trends easier to follow. With autoranging, autopolarity, min/max hold, transistor checker (h_{FE}), diode checker, buzzer continuity checker. Measures AC/DC voltage/current, resistance. Batteries extra. #22-195

Over 1000 items in stock: Binding Posts, Books, Breadboards, Buzzers, Capacitors, Chokes, Clips, Coax, Connectors, Fuses, Hardware, ICs, Jacks, Knobs, Lamps, Multimeters, PC Boards, Plugs, Rectifiers, Resistors, Switches, Tools, Transformers, Wire, Zeners, More!

*Revolving credit from Radio Shack. Actual payment may vary depending on your account balance.

Radio Shack®

A DIVISION OF TANDY CORPORATION

Prices apply at participating Radio Shack stores and dealers

256K STATIC 32K x 8 150ns \$1295 256K DRAM 41256 150ns \$395

STATIC RAMS

2112	256x4	(450ns)	2.99
2114	1024x4	(450ns)	.99
2114L-2	1024x4	(200ns)(LOW POWER)	1.49
TMM2016-100	2048x8	(100ns)	1.95
HM6116-4	2048x8	(200ns)(CMOS)	1.79
HM6116-3	2048x8	(150ns)(CMOS)	1.85
HM6116LP-4	2048x8	(200ns)(CMOS)(LP)	1.85
HM6116LP-3	2048x8	(150ns)(CMOS)(LP)	1.90
HM6116LP-2	2048x8	(120ns)(CMOS)(LP)	2.45
HM6264LP-15	8192x8	(150ns)(CMOS)(LP)	3.95
HM6264LP-12	8192x8	(120ns)(CMOS)(LP)	4.49
HM43256LP-15	32768x8	(150ns)(CMOS)(LP)	12.95
HM43256LP-12	32768x8	(120ns)(CMOS)(LP)	14.95
HM43256LP-10	32768x8	(100ns)(CMOS)(LP)	19.95

DYNAMIC RAMS

4116-250	16384x1	(250ns)	.49
4116-200	16384x1	(200ns)	.89
4116-150	16384x1	(150ns)	.99
4116-120	16384x1	(120ns)	1.49
MK4332	32768x1	(200ns)	6.95
4164-150	65536x1	(150ns)	1.79
4164-120	65536x1	(120ns)	1.99
MCM6665	65536x1	(200ns)	1.95
TMS4164	65536x1	(150ns)	1.95
4164-REFRESH	65536x1	(150ns)(PIN 1 REFRESH)	2.95
TMS4416	16384x4	(150ns)	3.75
41128-150	131072x1	(150ns)	5.95
TMS4464-15	65536x4	(150ns)	4.95
41256-150	262144x1	(150ns)	3.95
41256-120	262144x1	(120ns)	4.95
41256-100	262144x1	(100ns)	5.49
HM51258-100	262144x1	(100ns)(CMOS)	6.95
1 MB-120	1048576x1	(120ns)	31.95
1 MB-100	1048576x1	(100ns)	34.95

EPROMS

2708	1024x8	(450ns)(25V)	4.95
2716	2048x8	(450ns)(25V)	3.49
2716-1	2048x8	(350ns)(25V)	3.95
TMS2532	4096x8	(450ns)(25V)	5.95
2732	4096x8	(450ns)(25V)	3.95
2732A	4096x8	(250ns)(21V)	3.95
2732A-2	4096x8	(200ns)(21V)	4.25
27C64	8192x8	(250ns)(12.5V CMOS)	4.95
2764	8192x8	(450ns)(12.5V)	3.49
2764-250	8192x8	(250ns)(12.5V)	3.69
2764-200	8192x8	(200ns)(12.5V)	4.25
MCM68766	8192x8	(350ns)(21V)(24 PIN)	15.95
27128	16384x8	(250ns)(12.5V)	4.25
27C256	32768x8	(250ns)(12.5V CMOS)	7.95
27256	32768x8	(250ns)(12.5V)	5.95
27512	65536x8	(250ns)(12.5V)	11.95
27C512	65536x8	(250ns)(12.5V CMOS)	12.95

xxV-Program Voltage

6500 1.0 MHz

6502	2.25
65C02 (CMOS)	7.95
6520	1.65
6522	2.95
6526	13.95
6532	5.95
6545	2.95
6551	2.95

2.0 MHz

6502A	2.69
6520A	2.95
6522A	5.95
6532A	11.95
6545A	3.95
6551A	6.95

3.0 MHz

6502B	4.25
-------	------

6800 1.0 MHz

6800	1.95
6802	2.95
6803	3.95
6809	2.95
6809E	2.95
6810	1.95
6820	2.95
6821	1.25
6840	3.95
6843	4.95
6844	6.95
6845	4.75
6847	2.75
6850	1.95
6883	22.95

2.0 MHz

68B00	2.95
68B02	3.95
68B09E	5.49
68B09	5.95
68B21	1.99
68B45	4.95
68B50	1.75
68B00	9.95

Z-80 2.5 MHz

Z80-CPU	1.25
4.0 MHz	
Z80A-CPU	1.29
Z80A-CTC	1.69
Z80A-DART	5.95
Z80A-DMA	5.95
Z80A-PIO	1.89
Z80A-SIO-0	5.95
Z80A-SIO-1	5.95
Z80A-SIO-2	5.95

6.0 MHz

Z80B-CPU	2.75
Z80B-CTC	4.25
Z80B-PIO	4.25
Z80B-DART	6.95
Z80B-SIO-0	12.95
Z80B-SIO-2	12.95
Z8671 ZILOG	9.95

6800 1.0 MHz

6800	1.95
6802	2.95
6803	3.95
6809	2.95
6809E	2.95
6810	1.95
6820	2.95
6821	1.25
6840	3.95
6843	4.95
6844	6.95
6845	4.75
6847	2.75
6850	1.95
6883	22.95

2.0 MHz

68B00	2.95
68B02	3.95
68B09E	5.49
68B09	5.95
68B21	1.99
68B45	4.95
68B50	1.75
68B00	9.95

★★★ HIGH-TECH ★★★

8052AH WITH BASIC \$3495

- * SINGLE CHIP MICRO-CONTROLLER WITH BASIC IN ROM
- * BUILT-IN SERIAL PORT, THREE 16 BIT TIMERS, FIVE INTERRUPTS AND 256 BYTES OF RAM
- * REQUIRES VERY FEW PARTS TO BUILD AND EASY-TO-PROGRAM CONTROLLER
- * BASIC INTERPRETER IS OPTIMIZED FOR CONTROL APPLICATIONS

★★★ SPOTLIGHT ★★★

8000

8031	3.95
8035	1.49
8039	1.95
8052AH BASIC	34.95
8080	2.49
8085	1.95
8086	6.49
8088	5.99
8088-2	7.95
8155	2.49
8155-2	3.95
8741	9.95
8748	7.95
8749	9.95
8755	14.95

8200

8203	14.95
8205	3.29
8212	1.49
8216	1.49
8224	2.25
8228	2.25
8237	3.95
8237-5	4.75
8243	1.95
8250	6.95
8251	1.29
8251A	1.69
8253	1.95
8255	1.49
8255-5	1.59
8259	1.95
8259-5	2.29
8257	4.39
8274	4.95
8275	16.95
8279	2.49
8279-5	2.95
8282	3.95
8283	3.95
8284	2.25
8286	3.95
8287	3.95
8288	4.95

int MATH COPROCESSORS

8087	\$99.95	80287-8	\$249.95
8087-2	\$159.95	80287-10	\$309.95
80287	\$179.95	80387-16	\$499.95

TOLL FREE
800-538-5000
U.S. AND CANADA

DISK CONTROLLERS

1771	4.95
1791	9.95
1793	9.95
1795	12.95
1797	12.95
2791	19.95
2793	19.95
2797	29.95
UPD765	4.39
MB8876	12.95
MB8877	12.95
1691	6.95
2143	6.95
9216	6.29

UARTS

AY5-1013	3.95
AY3-1015	4.95
TR1602	3.95
2651	4.95
IM6402	3.95
IM6403	9.95
INS8250	6.95
NS16450	10.95

MISC.

ADC0804	2.99
ADC0809	3.85
DAC0800	3.29
DAC0808	1.95
DAC1022	5.95
MC1408L8	1.95
ST57	1.29
DP8304	2.29
9334	1.75
9368	2.85
9602	.69
ULN2003	.79
MAX232	7.95
MC3470	1.95
MC3487	2.95
AY5-3600 PRO	11.95

V 20 SERIES

V20-5 MHz	8.95
V20-8 MHz	10.95
V20-8 MHz	13.95

Replaces 8088 to speed up your PC by 10 to 40%

CRYSTALS

32,768 KHz	.95
1.0 MHz	2.95
1.8432	2.95
2.0	1.95
2.4576	1.95
3.579545	1.95
4.0	1.95
5.0	1.95
5.0688	1.95
6.0	1.95
6.144	1.95
8.0	1.95
10.0	1.95
10.738635	1.95
12.0	1.95
14.31818	1.95
16.0	1.95
18.0	1.95
18.432	1.95
20.0	1.95
22.1184	1.95
24.0	1.95
32.0	1.95

OSCILLATORS

1.0MHz	5.95
1.8432	5.95
2.0	5.95
2.4576	5.95
2.5	5.95
4.0	4.95
5.0688	4.95
6.0	4.95
6.144	4.95
8.0	4.95
10.0	4.95
12.0	4.95
16.0	4.95
18.432	4.95
20.0	4.95
24.0	4.95

PALS

16L8	\$2.95
16R8	\$2.95
16R6	\$2.95
16R4	\$2.95

74F/74S

74F00	.35
74F02	.35
74F04	.35
74F08	.35
74F10	.35
74F12	.35
74F15	.35
74F16	.35
74F18	.35
74F20	.35
74F22	.35
74F24	.35
74F28	.35
74F30	.35
74F32	.35
74F36	.35
74F38	.35
74F40	.35
74F42	.35
74F44	.35
74F46	.35
74F48	.35
74F50	.35
74F52	.35
74F54	.35
74F56	.35
74F58	.35
74F60	.35
74F62	.35
74F64	.35
74F66	.35
74F68	.35
74F70	.35
74F72	.35
74F74	.35
74F76	.35
74F78	.35
74F80	.35
74F82	.35
74F84	.35
74F86	.35
74F88	.35
74F90	.35
74F92	.35
74F94	.35
74F96	.35
74F98	.35
74F100	.35

74LS00

74LS00	.16	74LS112	.29	74LS241	.6
74LS01	.17	74LS122	.45	74LS242	.6
74LS02	.17	74LS123	.49	74LS243	.6
74LS03	.18	74LS124	2.79	74LS244	.6
74LS04	.16	74LS125	.39	74LS245	.7
74LS05	.18	74LS126	.39	74LS251	.4
74LS08	.18	74LS132	.39	74LS252	.4
74LS09	.18	74LS133	.49	74LS257	.3
74LS10	.16	74LS136	.39	74LS258	.4
74LS11	.22	74LS138	.39	74LS259	1.2
74LS12	.22	74LS139	.39	74LS260	.4
74LS13	.26	74LS145	.99	74LS266	.3
74LS14	.39	74LS147	.99	74LS273	.7
74LS15	.26	74LS148	.99	74LS279	.3
74LS20	.17	74LS151	.39	74LS280	1.9
74LS21	.22	74LS153	.39	74LS283	.5
74LS22	.22	74LS154	1.49	74LS290	.8
74LS27	.23	74LS155	.59	74LS293	.8
74LS28	.26	74LS156	.49	74LS299	1.4
74LS30	.17	74LS157	.35	74LS322	3.9
74LS32	.18	74LS158	.29	74LS323	2.4
74LS33	.28	74LS160	.29	74LS365	.3
74LS37	.26	74LS161	.39	74LS367	

20 MEG HARD DISK DRIVE ON A CARD \$349!

BARGAIN HUNTERS CORNER DIABLO D25 PRINTER

THIS OFFICE WORKHORSE LISTED AT \$695
A REAL STEAL AT \$279.95!

- ★ LETTER QUALITY AT 20 CPS, 132 COL.
- ★ USES STANDARD DIABLO 630 PRINT-WHEELS AND RIBBONS
- ★ 10, 12, 15 PITCH AND PROPORTIONAL
- ★ SERIAL AND PARALLEL INTERFACE
- ★ QUIET OPERATION — LESS THAN 58 dB
- ★ AUTO PAPER LOAD, FRICTION FEED
- ★ FULL XEROX WARRANTY!

ONLY \$279.95

PARALLEL OR SERIAL CABLE (PLEASE SPECIFY) \$19.95

HURRY—QUANTITIES LIMITED!
SPECIAL ENDS 3/31/88

CAPACITORS

TANTALUM			
1.0µf	15V	12	1.0µf 35V .45
6.8	15V	42	2.2 35V .19
10	15V	45	4.7 35V .39
22	15V	99	10 35V .69

DISC

10µf	50V	.05	.001µf 50V .05
22	50V	.05	.005 50V .05
33	50V	.05	.01 50V .07
47	50V	.05	.05 50V .07
100	50V	.05	1 12V .10
220	50V	.05	1 50V .12

MONOLITHIC

.01µf	50V	.14	.1µf 50V .18
.047µf	50V	.15	.47µf 50V .25

ELECTROLYTIC

RADIAL		AXIAL	
1µf	25V	1µf	50V .14
4.7	50V .11	10	50V .16
10	50V .11	22	16V .14
47	35V .13	47	50V .19
100	16V .15	100	35V .19
220	35V .20	470	50V .29
470	25V .30	1000	16V .29
2200	16V .70	2200	16V .70
4700	25V 1.45	4700	16V 1.25

SOLDER STATION

- UL APPROVED
- ADJUSTABLE HEAT SETTING W/TIP TEMP READOUT
- QUICK HEATING & RECOVERY
- RANGE: 200°—900°F

\$49.95

EXTENDER CARDS FOR IBM

EXT-8088 \$29.95
EXT-80286 \$39.95



WIREWRAP

PROTOTYPE CARDS
FR-4 EPOXY GLASS LAMINATE
GOLD-PLATED EDGE-CARD FINGERS



XT

BOTH CARDS HAVE SILK SCREENED LEGENDS & MOUNTING BRACKET

IBM-PR1 WITH +5V AND GROUND PLANE \$27.95
IBM-PR2 AS ABOVE WITH DECODING LAUNCH \$29.95

AT

IBM-PRAT LARGE +5V & GROUND PLANES \$29.95

SOLDERLESS BREADBOARDS

WBU-D	100 TIE POINTS	2.95
WBU-T	630 TIE POINTS	6.95
WBU-204-3	1360 TIE POINTS	17.95
WBU-204	1660 TIE POINTS	24.95
WBU-206	4390 TIE POINTS	29.95
WBU-208	3220 TIE POINTS	39.95

PAGE WIRE WRAP WIRE PRECUT ASSORTMENT

IN ASSORTED COLORS \$27.50
100ea: 5.5", 6.0", 6.5", 7.0"
250ea: 2.5", 4.5", 5.0"
500ea: 3.0", 3.5", 4.0"

SPOOLS

100 feet \$4.30 250 feet \$7.25
500 feet \$13.25 1000 feet \$21.95
Please specify color: Blue, Black, Yellow or Red

SOCKET-WRAP I.D.™

- SLIPS OVER WIRE WRAP PINS
- IDENTIFIES PIN NUMBERS ON WRAP SIDE OF BOARD
- CAN WRITE ON THE PLASTIC; SUCH AS AN IC #

PINS	PART #	PCK. OF	PRICE
8	IDWRAP 08	10	1.95
14	IDWRAP 14	10	1.95
16	IDWRAP 16	10	1.95
18	IDWRAP 18	5	1.95
20	IDWRAP 20	5	1.95
22	IDWRAP 22	5	1.95
24	IDWRAP 24	5	1.95
28	IDWRAP 28	5	1.95
40	IDWRAP 40	5	1.95

PLEASE ORDER BY NUMBER OF PACKAGES (PCK. OF)

SWITCHES

SPDT	MINI-TOGGLE ON-ON	1.25
DPDT	MINI-TOGGLE ON-ON	1.50
DPDT	MINI-TOGGLE ON-OFF-ON	1.75
SPST	MINI-PUSHBUTTON N.O.	.39

DIP SWITCHES

4 position	.85	7 position	.95
5 position	.90	8 position	.95
6 position	.90	10 position	1.29

"SNAPABLE" HEADERS

CAN BE SNAPPED APART TO MAKE ANY SIZE HEADER, ALL WITH .1" CENTERS

1x40	STRAIGHT LEAD	.99
1x40	RIGHT ANGLE LEAD	1.49
2x40	2 STRAIGHT LEADS	2.49
2x40	2 RIGHT ANGLE LEADS	2.99

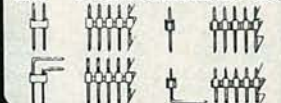

25 PIN D-SUB GENDER CHANGERS \$7.95



EMI FILTER \$4.95 LINE CORDS

2 conductor 39c 3 conductor 99c
3 conductor w/female socket \$1.49

BYPASS CAPACITORS

.01 µf CERAMIC DISC	100/\$5.00
.01 µf MONOLITHIC	100/\$10.00
.1 µf CERAMIC DISC	100/\$6.50
.1 µf MONOLITHIC	100/\$12.50

SHORTING BLOCKS 5/\$1.00



WHY THOUSANDS CHOOSE JDR

- ★ QUALITY MERCHANDISE COMPETITIVE PRICES
- ★ MOST ORDERS SHIPPED IN 24 HOURS
- ★ FRIENDLY, KNOWLEDGEABLE STAFF
- ★ MONEY BACK GUARANTEE (ASK FOR DETAILS)
- ★ TOLL FREE TECHNICAL SUPPORT
- ★ EXCELLENT CUSTOMER SERVICE



DATARASE

- ERASES 2 EPROMS IN 10 MINUTES
- VERY COMPACT, NO DRAWER
- THIN METAL SHUTTER PREVENTS UV LIGHT FROM ESCAPING

\$34.95



SPECTRONICS CORPORATION EPROM ERASERS

Model	Timer	Chip Capacity	Intensity (uW/Cm²)	Unit Cost
PE-140	NO	9	8,000	\$89
PE-140T	YES	9	8,000	\$139
PE-240T	YES	12	9,600	\$189

LIGHT EMITTING DIODES

FND-357(359)	COM CATHODE	.362"	1.25
FND-500(503)	COM CATHODE	.5"	1.49
FND-507(510)	COM ANODE	.5"	1.49
MAN-72	COM ANODE	.3"	.99
MAN-74	COM CATHODE	.3"	.99
TIL-313	COM CATHODE	.3"	.45
TIL-311	4x7 HEX W/LOGIC	.270"	10.95

DIFFUSED LEADS

JUMBO RED	T1 1/4	.10	.09	100-UP
JUMBO GREEN	T1 1/4	.14	.12	
JUMBO YELLOW	T1 1/4	.14	.12	
MOUNTING HDW	T1 1/4	.10	.09	
MINI RED	T1	.10	.09	

3 VOLT LITHIUM BATTERY \$1.95 HOLDER \$1.49

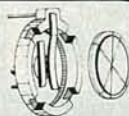

Dear Mr. Rose,
I am writing to compliment the service I received yesterday on a phone call to JDR. I spoke to a salesperson named Helen. She went out of her way to assist... it is service like this that keeps us coming back to JDR.

Thanks!
Jim Mikeworth

IDC CONNECTORS/RIBBON CABLE

DESCRIPTION	ORDER BY	CONTACTS				
		10	20	26	34	40 50
SOLDER HEADER	IDHxxS	.82	1.29	1.68	2.20	2.58 3.24
RIGHT ANGLE SOLDER HEADER	IDHxxSR	.85	1.35	1.76	2.31	2.72 3.39
WIREWRAP HEADER	IDHxxW	1.86	2.98	3.84	4.50	5.28 6.63
RIGHT ANGLE WIREWRAP HEADER	IDHxxWR	2.05	3.28	4.22	4.45	4.80 7.30
RIBBON HEADER SOCKET	IDSxx	.63	.89	.95	1.29	1.49 1.69
RIBBON HEADER	IDMxx	---	5.50	6.25	7.00	7.50 8.50
RIBBON EDGE CARD	IDExx	.85	1.25	1.35	1.75	2.05 2.45
10' GREY RIBBON CABLE	RCxx	1.60	3.20	4.10	5.40	6.40 7.50

FOR ORDERING INSTRUCTIONS, SEE D-SUBMINIATURE CONNECTORS, BELOW

D-SUBMINIATURE CONNECTORS

DESCRIPTION	ORDER BY	CONTACTS					
		9	15	19	25	37 50	
SOLDER CUP	MALE	DBxxP	.45	.59	.69	.69	1.35 1.85
	FEMALE	DBxxS	.49	.69	.75	.75	1.39 2.29
RIGHT ANGLE PC SOLDER	MALE	DBxxPR	.49	.69	---	.79	2.27 ---
	FEMALE	DBxxSR	.55	.75	---	.85	2.49 ---
WIREWRAP	MALE	DBxxPWW	1.69	2.56	---	3.89	5.60 ---
	FEMALE	DBxxSww	2.76	4.27	---	6.84	9.95 ---
IDC RIBBON CABLE	MALE	IDBxxP	1.39	1.99	---	2.25	4.25 ---
	FEMALE	IDBxxS	1.45	2.05	---	2.35	4.49 ---
HOODS	METAL	MHOODxx	1.05	1.15	1.25	1.25	---
	GREY	HOODxx	.39	.39	---	.39	.69 .75

ORDERING INSTRUCTIONS: INSERT THE NUMBER OF CONTACTS IN THE POSITION MARKED "xx" OF THE "ORDER BY" PART NUMBER LISTED. EXAMPLE: A 15 PIN RIGHT ANGLE MALE PC SOLDER WOULD BE DB15PR.

MOUNTING HARDWARE 59C

IC SOCKETS/DIP CONNECTORS

DESCRIPTION	ORDER BY	CONTACTS									
		8	14	16	18	20	22	24	28	40	
SOLDERTAIL SOCKETS	xxST	.11	.11	.12	.15	.18	.15	.20	.22	.30	
WIREWRAP SOCKETS	xxVW	.59	.69	.69	.99	1.09	1.39	1.49	1.69	1.99	
ZIF SOCKETS	ZIFxx	---	4.95	4.95	---	5.95	---	5.95	6.95	9.95	
TOOLED SOCKETS	AUGATxxST	.62	.79	.89	1.09	1.29	1.39	1.49	1.69	2.49	
TOOLED WW SOCKETS	AUGATxxVW	1.30	1.80	2.10	2.40	2.50	2.90	3.15	3.70	5.40	
COMPONENT CARRIERS	ICCx	.49	.59	.69	.99	.99	.99	.99	1.09	1.49	
DIP PLUGS (IDC)	IDPxx	.95	.49	.59	1.29	1.49	---	.85	1.49	1.59	

FOR ORDERING INSTRUCTIONS, SEE D-SUBMINIATURE CONNECTORS, ABOVE

CALL FOR VOLUME QUOTES COPYRIGHT 1987 JDR MICRODEVICES

CIRCLE 177 ON FREE INFORMATION CARD

64K DRAM 4164 150ns **\$179**

256K DRAM 41256 150ns **\$395**

MONITOR STANDS

- MODEL MS-100** **\$12.95**
 • TILTS & SWIVELS • STURDY PLASTIC CONSTRUCTION
- MODEL MS-200** **\$39.95**
 • TILTS AND SWIVELS • BUILT-IN SURGE SUPPRESSOR
 • BUILT-IN POWER STATION INDEPENDENTLY CONTROLS UP TO 5 120 VOLT AC OUTLETS • UL APPROVED



NASHUA DISKETTES

- BOXES OF 10**
- | | | | |
|-------------------|---------|--------------------------|---------------------|
| 5 1/4" DS/DD 360K | \$9.95 | 5 1/4" DS/DD SOFT SECTOR | |
| 5 1/4" DS/HD 1.2M | \$24.95 | 49¢ ea | 39¢ ea |
| 3 1/2" DS/QD 720K | \$16.95 | BULK QTY 50 | BULK QTY 250 |

- 5 1/4" DISKETTE STORAGE FILE** **\$8.95**
- HOLDS 70 5 1/4" FLOPPIES
 - STURDY, ATTRACTIVE SMOKE ACRYLIC CASE
 - COMPLETE WITH HINGED DIVIDERS
- VERSION FOR 3 1/2" FLOPPIES AVAILABLE \$9.95**



- 2 WAY SWITCH BOXES** **\$39.95**
- CONNECT 2 PRINTERS TO 1 COMPUTER OR VICE VERSA
 - SERIAL & PARALLEL MODELS AVAILABLE
 - ALL LINES SWITCHED
 - GOLD PLATED CONNECTORS & QUALITY SWITCHES

- 6' INTERFACE CABLES**
- MEETS FCC REQUIREMENTS 100% SHIELDED
- IBM COMPATIBLE PARALLEL PRINTER CENTRONICS (MALE TO FEMALE) \$9.95
 - CENTRONICS (MALE TO MALE) \$15.95
 - IBM COMPATIBLE MODEM CABLE \$14.95
 - RS232 SERIAL (MALE TO FEMALE) \$7.95
 - RS232 SERIAL (MALE TO MALE) \$9.95
 - COILED KEYBOARD EXTENDER \$7.95

- JOYSTICK** **\$19.95**
- SET X-Y AXIS FOR AUTO CENTER OR FREE MOVEMENT
 - FIRE BUTTON FOR USE WITH GAME SOFTWARE
 - INCLUDES ADAPTOR CABLE FOR IBM



- SWITCHING POWER SUPPLIES**
- PS-135** **\$59.95**
 • FOR IBM XT COMPATIBLE
 • UL APP., 135 WATTS
 • -5V/15A, -12V/4.2A
 • -5V/5A, -12V/5A
 • ONE YEAR WARRANTY
- PS-150** 150W MODEL **\$69.95**
- PS-200** **\$89.95**
 • FOR IBM AT COMPATIBLE
 • 200 WATTS
 • -5V/22A, -12V/8A
 • -5V/5A, -12V/5A
 • ONE YEAR WARRANTY
- PS-A** **\$49.95**
 • FOR APPLE TYPE SYSTEM
 • -5V/6A, -12V/3A
 • -5V/1A, -12V/1A
 • APPLE CONNECTOR
- PS-1558** **\$34.95**
 • 75 WATTS, UL APPROVED
 • BY POWER SYSTEMS
 • -5V/7A, -12V/3A
 • -12V/250mA, -5/300mA



MONITORS

- SAMSUNG MONOCHROME**
- IBM COMPATIBLE TTL INPUT
 - 12" NON-GLARE, LOW DISTORTION, AMBER SCREEN
 - RES: 720 x 350
 - SWIVEL BASE
 - 1 YEAR WARRANTY
- \$129.95**



- MULTISYNC** BY NEC **\$599.95**
- ORIGINAL CGA/EGA/PGA COMPATIBLE MONITOR
 - AUTO FREQUENCY ADJUSTMENT
 - RESOLUTION AS HIGH AS 800 x 560

- EGA** BY CASPER **\$399.95**
- 15.75/21.85 KHz SCANNING FREQUENCIES
 - RES: 640 x 200/350
 - 14" BLACK MATRIX SCREEN
 - RES: 640 x 240
 - .31mm DOT PITCH
 - 16 COLORS FROM 64

- RGB** BY CASPER **\$279.95**
- COLOR/GREEN/AMBER SWITCH
 - RES: 640 x 240
 - RGB/IBM COMPATIBLE
 - 14" NON-GLARE SCREEN
 - .39mm DOT PITCH
 - CABLE FOR IBM PC INCLUDED

- MONOCHROME** BY SAKATA **\$69.95**
- IBM COMPATIBLE TTL INPUT
 - 12" NON-GLARE GREEN SCREEN
 - CABLE FOR IBM PC INCLUDED

TOLL FREE
800-538-5000
U.S. AND CANADA

20MB HARD DISK ON A CARD



- SAVES SPACE AND REDUCES POWER CONSUMPTION
 - IDEAL FOR PCs WITH FULL HEIGHT FLOPPIES
 - LEAVES ROOM FOR A HALF LENGTH CARD IN ADJACENT SLOT
- \$349**

RITEMAN II PRINTER



- 160 CPS DRAFT, 32 CPS NLQ MODE
 - SUPPORTS EPSON/IBM GRAPHICS
 - 9 x 9 DOT MATRIX
 - FRICTION AND PIN FEEDS
 - VARIABLE LINE SPACING & PITCH
- \$219.95**
- IBM COMPATIBLE PRINTER CABLE** **\$9.95**
REPLACEMENT RIBBON CARTRIDGE **\$7.95**

DISK DRIVES

- 5 1/4" SEAGATE HARD DISK DRIVES**
- | | | | | |
|---------|-------------|------|-----------|-------|
| ST-225 | HALF HEIGHT | 20MB | 65ms | \$259 |
| ST-238 | HALF HEIGHT | 30MB | 65ms (RL) | \$299 |
| ST-251 | HALF HEIGHT | 40MB | 40ms | \$469 |
| ST-277 | HALF HEIGHT | 60MB | 40ms (RL) | \$649 |
| ST-4038 | FULL HEIGHT | 30MB | 40ms | \$559 |
| ST-4096 | FULL HEIGHT | 80MB | 28ms | \$895 |

- 1/2" HEIGHT FLOPPY DISK DRIVES**
- | | | |
|----------------------------|------------|----------|
| 5 1/4" TEAC FD-55B DS/DD | 360K | \$99.95 |
| 5 1/4" TEAC FD-55F DS/QUAD | 720K | \$119.95 |
| 5 1/4" TEAC FD-55G DS/HD | 1.2M | \$129.95 |
| 5 1/4" FUJITSU M2551A DS | DD 360K | \$89.95 |
| 5 1/4" FUJITSU M2553K DS | HD 1.2M | \$119.95 |
| 5 1/4" DS/DD | 360K | \$69.95 |
| 5 1/4" DS/HD | 1.2M | \$109.95 |
| 3 1/2" MITSUBISHI DS/DD | (AT OR XT) | \$129.95 |

- DISK DRIVE ACCESSORIES**
- 1/2" HT MOUNTING HARDWARE FOR IBM \$2.95
 - MOUNTING RAILS FOR IBM AT \$4.95
 - "Y" POWER CABLE FOR 5 1/4" FDDs \$2.95
 - 5 1/4" FDD POWER CONNECTORS \$1.19

- DRIVE ENCLOSURES WITH POWER SUPPLIES**
- | | | |
|----------|--------------------------|----------|
| CAB-2SV5 | DUAL SLIMLINE FOR 5 1/4" | \$49.95 |
| CAB-1FH5 | FULL HEIGHT FOR 5 1/4" | \$69.95 |
| CAB-2SV8 | DUAL SLIMLINE FOR 8" | \$209.95 |
| CAB-2FH8 | DUAL FULL HEIGHT FOR 8" | \$219.95 |

EASYDATA MODEMS

All models feature auto-dial/answer/redial on busy, power up self test, touchtone or pulse dialing, built-in speaker, Hayes and Bell Systems 103 & 212A compatible, full or half duplex, PC Talk III Communications software with internal models and more.

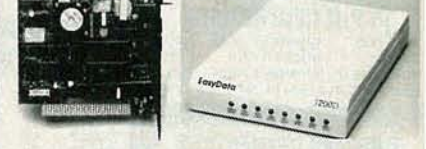

- INTERNAL**
- | | | | |
|-----|-----------|-----------|----------|
| 12H | 1200 BAUD | 1/2 CARD | \$69.95 |
| 24B | 2400 BAUD | FULL CARD | \$179.95 |
- EXTERNAL**
 (NO SOFTWARE INCLUDED)
- | | | |
|-----|-----------|----------|
| 12D | 1200 BAUD | \$119.95 |
| 24D | 2400 BAUD | \$219.95 |

COMPUTER CASES

Attractive, sturdy steel cases fit the popular sized motherboards and include speakers, faceplates, expansion slots and all necessary hardware.



- | | |
|---------------------------|----------------|
| XT STYLE FLIP-TOP | \$34.95 |
| XT STYLE SLIDE-TOP | \$39.95 |
| AT STYLE SLIDE-TOP | \$89.95 |
- FRONT PANEL KEYLOCK AND LED INDICATORS
- JR. AT STYLE FLIP-TOP** **\$149.95**
- INCLUDES 180 WATT POWER SUPPLY
 - FRONT PANEL KEYLOCK AND LED INDICATORS

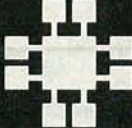

Visit our retail store located at 1256 S. Bascom Ave. in San Jose, (408) 947-8881

JDR Microdevices
 110 Knowles Drive, Los Gatos, CA 95030
 Toll Free 800-538-5000 • (408) 866-6200
 FAX (408) 378-8927 • Telex 171-110

PLEASE USE YOUR CUSTOMER NUMBER WHEN ORDERING

TERMS: Minimum order \$10.00. For shipping and handling include \$2.50 for UPS Ground and \$3.50 for UPS Air. Orders over 1 lb. and foreign orders may require additional shipping charges—please contact our sales department for the amount. CA. residents must include applicable sales tax. All merchandise is warranted for 90 days unless otherwise stated. Prices are subject to change without notice. We are not responsible for typographical errors. We reserve the right to limit quantities and to substitute manufacturer. All merchandise subject to prior sale. A full copy of our terms is available upon request. Items pictured may only be representative.

THE JDR MICRODEVICES LOGO IS A REGISTERED TRADEMARK OF JDR MICRODEVICES. JDR INSTRUMENTS AND JDR MICRODEVICES ARE TRADEMARKS OF JDR MICRODEVICES. IBM IS A TRADEMARK OF INTERNATIONAL BUSINESS MACHINES CORPORATION. APPLE IS A TRADEMARK OF APPLE COMPUTER.

RADIO-ELECTRONICS

ALL MCT PRODUCTS CARRY A 1 YEAR WARRANTY

INTERFACE CARDS

FROM MODULAR CIRCUIT TECHNOLOGY



MCT-MF

DISPLAY CARDS

MCT-MGP MONOCHROME GRAPHICS \$599⁹⁵

TRUE HERCULES COMPATIBILITY, SUPPORTS LOTUS 123
SOFTWARE DRIVER ALLOWS COLOR GRAPHICS PROGRAMS TO RUN
ON A MONOCHROME MONITOR - PARALLEL PRINTER PORT

MCT-EGA ENHANCED GRAPHICS ADAPTOR \$1499⁹⁵

100% IBM COMPATIBLE, PASSES IBM EGA DIAGNOSTICS
256K OF VIDEO RAM ALLOWS 640 x 350 IN 16 OF 64 COLORS
COMPATIBLE WITH COLOR AND MONOCHROME ADAPTOR

MCT-CG COLOR GRAPHICS ADAPTOR \$499⁹⁵

COMPATIBLE WITH IBM COLOR GRAPHICS STANDARDS
SHORT SLOT SUPPORTS RGB, COLOR & COMPOSITE MONOCHROME
640/320 x 200 RESOLUTION, LIGHT PEN INTERFACE

MULTIFUNCTION CARDS

MCT-MF MULTIFUNCTION \$799⁹⁵

ALL THE FEATURES OF 6 PACK* AT HALF THE PRICE
0-384K DYNAMIC RAM USING 4164s
SERIAL, PARALLEL, GAME PORTS, CLOCK / CALENDAR

MCT-MGMIO MONOGRAPHS I/O \$1199⁹⁵

TOTAL SYSTEM CONTROL FROM A SINGLE SLOT
2 FLOPPY CONT, SERIAL, PARALLEL, GAME PORT, CLOCK/CAL
RUN COLOR GRAPHICS SOFTWARE ON A MONOCHROME MONITOR

MCT-MIO MULTI I/O FLOPPY \$799⁹⁵

A PERFECT COMPANION FOR OUR MOTHERBOARDS
SERIAL, PARALLEL, GAME PORT, CLOCK / CALENDAR
SUPPORTS UP TO 2 360K FLOPPIES, 720K WITH DOS 3.2

MCT-IO MULTI I/O CARD \$599⁹⁵

USE WITH MCT-FH FOR A MINIMUM OF SLOTS USED
SERIAL PORT, CLOCK / CALENDAR WITH A BATTERY BACK-UP
PARALLEL PRINTER PORT ADDRESSABLE AS LPT1 OR LPT2

MCT-ATMF AT MULTIFUNCTION \$1399⁹⁵

ADDS UP TO 3 MEGABYTES OF RAM TO THE AT
USER EXPANDABLE TO 1.5 MB OF MEMORY (ZERO K INSTALLED)
INCLUDES SERIAL PORT AND PARALLEL PORT

MCT-ATIO AT MULTI I/O \$599⁹⁵

USE WITH MCT-ATFH FOR A MINIMUM OF SLOTS USED
SERIAL, PARALLEL AND GAME PORTS
USES 16450 SERIAL SUPPORT CHIPS FOR HIGH SPEED OPERATION

MCT-ATMF MC PIGGYBACK BOARD (NO MEMORY) \$249⁹⁵

MCT-ATMF MC PIGGYBACK BOARD (NO MEMORY) \$299⁹⁵

MCT-ATMF MC PIGGYBACK BOARD (NO MEMORY) \$249⁹⁵

MCT-ATMF MC PIGGYBACK BOARD (NO MEMORY) \$249⁹⁵

MCT-ATMF MC PIGGYBACK BOARD (NO MEMORY) \$249⁹⁵

MCT-ATMF MC PIGGYBACK BOARD (NO MEMORY) \$249⁹⁵

MCT-ATMF MC PIGGYBACK BOARD (NO MEMORY) \$249⁹⁵

MCT-ATMF MC PIGGYBACK BOARD (NO MEMORY) \$249⁹⁵

MCT-ATMF MC PIGGYBACK BOARD (NO MEMORY) \$249⁹⁵

MCT-ATMF MC PIGGYBACK BOARD (NO MEMORY) \$249⁹⁵

MCT-ATMF MC PIGGYBACK BOARD (NO MEMORY) \$249⁹⁵

MCT-ATMF MC PIGGYBACK BOARD (NO MEMORY) \$249⁹⁵

MCT-ATMF MC PIGGYBACK BOARD (NO MEMORY) \$249⁹⁵

MCT-ATMF MC PIGGYBACK BOARD (NO MEMORY) \$249⁹⁵

MCT-ATMF MC PIGGYBACK BOARD (NO MEMORY) \$249⁹⁵

MCT-ATMF MC PIGGYBACK BOARD (NO MEMORY) \$249⁹⁵

MCT-ATMF MC PIGGYBACK BOARD (NO MEMORY) \$249⁹⁵

MCT-ATMF MC PIGGYBACK BOARD (NO MEMORY) \$249⁹⁵

MCT-ATMF MC PIGGYBACK BOARD (NO MEMORY) \$249⁹⁵

MCT-ATMF MC PIGGYBACK BOARD (NO MEMORY) \$249⁹⁵

MCT-ATMF MC PIGGYBACK BOARD (NO MEMORY) \$249⁹⁵

MCT-ATMF MC PIGGYBACK BOARD (NO MEMORY) \$249⁹⁵

MCT-ATMF MC PIGGYBACK BOARD (NO MEMORY) \$249⁹⁵

MCT-ATMF MC PIGGYBACK BOARD (NO MEMORY) \$249⁹⁵

MCT-ATMF MC PIGGYBACK BOARD (NO MEMORY) \$249⁹⁵

MCT-ATMF MC PIGGYBACK BOARD (NO MEMORY) \$249⁹⁵

MCT-ATMF MC PIGGYBACK BOARD (NO MEMORY) \$249⁹⁵

MCT-ATMF MC PIGGYBACK BOARD (NO MEMORY) \$249⁹⁵

MCT-ATMF MC PIGGYBACK BOARD (NO MEMORY) \$249⁹⁵

MCT-ATMF MC PIGGYBACK BOARD (NO MEMORY) \$249⁹⁵

MCT-ATMF MC PIGGYBACK BOARD (NO MEMORY) \$249⁹⁵

MCT-ATMF MC PIGGYBACK BOARD (NO MEMORY) \$249⁹⁵



1/2 HEIGHT HARD DISK DRIVES

40 MB \$469
60 MB \$649

Drives are Seagate models ST-251 (40 MB) & ST-277 (60 MB RLL) 5 1/4" half heights
FAST 40ms access time!

1/2 HT HARD DISK SYSTEMS

20 MB \$289
30 MB \$329

Systems include Seagate 1/2 height hard drive, drive controller, cables & instructions. All drives are pre-tested & warranted for 1 year.

IBM COMPATIBLE MOTHERBOARDS

FROM MODULAR CIRCUIT TECHNOLOGY

MCT-TURBO TURBO 4.77/8 MHz \$999⁹⁵

4.77 OR 8 MHz OPERATION WITH 8088-2 & OPTIONAL 8087-2 CO-PROCESSOR
FRONT PANEL LED SPEED INDICATOR AND RESET SWITCH SET SUPPORTED
CHOICE OF NORMAL / TURBO MODE OR SOFTWARE SELECT PROCESSOR SPEED

MCT-XTMB STANDARD MOTHERBOARD \$879⁹⁵

MCT-ATMB 80286 6/8 MHz \$3799⁹⁵
8 SLOT (2 EIGHT BIT, 6 SIXTEEN BIT) AT MOTHERBOARD
HARDWARE SELECTION OF 6 OR 8 MHz
1 WAIT STATE
KEYLOCK SUPPORTED, RESET SWITCH, FRONT PANEL LED INDICATOR
SOCKETS FOR 1 MB OF RAM AND 80287
BATTERY BACKED CLOCK

MCT-BATMB MINI 80286 \$3899⁹⁵

REPLACEMENT BOARD FOR XT STYLE CHASSIS
OPERATE AT 6 / 10 MHz WITH UP TO 1MB ON-BOARD MEMORY (ZERO K INSTALLED)
SOCKET FOR 80287 MATH CO-PROCESSOR
BATTERY BACKED CLOCK
8 SLOTS: 2 EIGHT BIT, 6 SIXTEEN BIT
USES CHIPS & TECHNOLOGY CHIP SET FOR RELIABILITY AND SMALL SIZE

IBM COMPATIBLE KEYBOARDS

FULL ONE YEAR WARRANTY



MCT-5339 \$799⁹⁵

IBM ENHANCED STYLE LAYOUT
SOFTWARE AUTOSENSE FOR XT OR AT COMPATIBLES
LED INDICATORS
AUTO REPEAT FEATURE
SEPARATE CURSOR PAD

MCT-5060 \$599⁹⁵

IBM AT STYLE LAYOUT
SOFTWARE AUTOSENSE FOR XT OR AT COMPATIBLES
LED INDICATORS
AUTO REPEAT FEATURE

MCT-5150 XT STYLE LAYOUT \$499⁹⁵

MCT-5151 KB5151™ EQUIV. \$699⁹⁵

WHY BUY A SYSTEM FROM JDR?

- BUILD IT YOURSELF AND SAVE!
- MONEY BACK GUARANTEE (ASK FOR DETAILS)
- LEARN ABOUT THE INNER WORKINGS OF A COMPUTER
- YOU CAN ASSEMBLE A SYSTEM IN ABOUT 2 HOURS WITH A SCREWDRIVER & OUR EASY-TO-FOLLOW INSTRUCTIONS
- MOST ORDERS SHIPPED IN 24 HOURS
- QUALITY COMPONENTS AND COMPETITIVE PRICES
- TOLL FREE TECH SUPPORT IN THE U.S. AND CANADA

BUILD YOUR OWN 256K XT COMPATIBLE

- MOTHERBOARD
- 256K OF MEMORY
- 135 WATT POWER SUPPLY
- FLIP-TOP CASE
- XT STYLE KEYBOARD
- 360K FLOPPY DRIVE
- DRIVE CONTROLLER
- MONOCHROME MONITOR
- GRAPHICS ADAPTOR

FOR ONLY \$498¹⁵

ANYONE CAN BUILD A SYSTEM IN ABOUT 2 HOURS USING A SCREWDRIVER AND OUR EASY-TO-FOLLOW INSTRUCTIONS!



OVER 10,000 SOLD!

DEVELOPMENT TOOLS

FROM MODULAR CIRCUIT TECHNOLOGY

MCT-EPROM PROGRAMMER \$1299⁹⁵

PROGRAMS 27xx & 27xxx EPROMS UP TO 27512
SUPPORTS VARIOUS PROGRAMMING FORMATS AND VOLTAGES
SPLIT OR COMBINE CONTENTS OF SEVERAL EPROMS OF DIFFERENT SIZES
READ, WRITE, COPY, ERASE CHECK AND VERIFY
SOFTWARE FOR HEX AND INTEL HEX FORMATS

MCT-EPROM-4 4 GANG PROGRAMMER \$1899⁹⁵

MCT-EPROM-10 10 GANG PROGRAMMER \$2999⁹⁵

MCT-PAL PAL PROGRAMMER \$2699⁹⁵

MCT-MP PROCESSOR PROG. \$1999⁹⁵

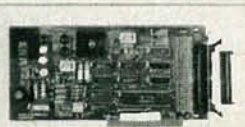

PARTIAL LISTING ONLY-CALL FOR A FREE CATALOG!

COPYRIGHT 1987 JDR MICRODEVICES

CIRCLE 179 ON FREE INFORMATION CARD

APRIL 1988

117

What's New at AMERICAN DESIGN COMPONENTS?

We warehouse 60,000 items at American Design Components - expensive, often hard-to-find components for sale at a fraction of their original cost!

You'll find every part you need - either brand new or removed from equipment (RFE) in excellent condition. But quantities are limited. Order from this ad, or visit our retail showroom and find exactly what you need from the thousands of items on display.

OPEN MON. - SAT., 9-5

THERE'S NO RISK.

With our full 90-day warranty, any purchase can be returned for any reason for full credit or refund.

Mindset® Color Graphics PERSONAL COMPUTER SYSTEM (Does not incl. monitor)

Runs all the same programs as an IBM® PC!



Fast graphics capabilities allow you to draw/animate & color objects instantly. 265K, w/360K floppy disk drive. Includes built-in RGB/monochrome card & TV adapter. Also incl. Mouse & Joystick, & is supplied w/GW Basic & MSDOS 2.1

Item #16077 \$299.00 New

Accessories Available (limited supply):

★ NV RAM 8K Cartridge

Provides 8K non-volatile RAM.

Item #16078 \$29.95 New

★ RS-232 Module w/Power Option

Provides EIA standard RS-232-C serial interface.

Item #16080 \$39.95 New

★ Modem Module

Item #16081 \$39.95 New

14" EGA COLOR MONITOR

(25 KHz.)

PC, XT, & AT Compatible



Perfect for text, CAD & other graphics applications. Requires a 25KHz EGA card ('Wonder' or compatible). Resolution: 752 x 410 max. Input: 110/220V, 50/60Hz, 80W. Hook-up diagram included. Mounted in metal housing. Mfr. #14-GZF2

Item #14864 \$179.00 New

PLUG-IN POWER SUPPLIES

COMPUTER/ GAME ADAPTOR

Output: +5 VDC, .9A

-5 VDC, .1A

+12 VDC, .3A

Input: 120 VAC/60 Hz., .25A

Mfr - Coleco #55416

Item #1882 \$4.95 New

9 VDC ADAPTOR

Input: 115 VAC, 50/60 Hz.

Output: 9.5V @ 1A.

Dimensions: 2 3/4" W x 3 3/8" H x 2" deep

Mfr - Commodore #251539-01/02

Item #9393 \$5.95 New

12 VDC ADAPTOR

DC Output: 14V @ 200ma.

Input: 110VAC/60Hz., 2.8W.

Mfr - Spirit Ind. #CS-451

Item #12872 \$2.95 New

3 1/2", 20 Mb, HALF HT. HARD DISK DRIVE



Fits standard 5 1/4" spacing. High speed, low power. Comes w/both full ht. and half ht. face plates. Mfr - Lapine #LT200/2000

Item #15853 \$199.00 New

15 Mb, 5 1/4" FULL HT. HARD DISK DRIVE



(IBM® PC/XT Compatible) Removed from working equipment. Tested & formatted. Mfr - CMI model CM5619

Item #14511 \$199.00

5 1/4" 1/2 HT. DISK DRIVES



IBM® AT Compatible 48/96 TPI, 1.2 Mb Double side, high density: 160 tracks. Mfr - Panasonic #JU-475

Item #10005 \$109.95 New

96 TPI, DOS 3.2 Compat. Double side, quad density.

Mfr - Tandem TM55-4

Item #1904 \$79.00

2 for \$150.00

5 1/4" FULL HEIGHT DISK DRIVES -

48 TPI (IBM® Compatible) DS/DD, 80 Track

Tandon #TM100-2 or equiv.

Item #7928 \$79.00 New

2 for \$150.00 New

48 TPI (TRS80/Zenith/Xerox 800 Compat.) DS/DD, 40 Track

Shugart #450. Item #1892.

\$79.00; 2 for \$150.00

48 TPI, SS/DD, 40 Track

Shugart #SA400. Item #1895.

\$39.50; 2 for \$75.00

96 TPI, DS/Quad Density

CDC #9409T

Item #1893 \$89.00

ADAM 5 1/4" DISK DRIVE



Gives your Adam fast, reliable data storage and retrieval. Can hold up to 160K bytes of information. Uses industry-standard SS/DD disks. Connects directly to your Adam memory console. Comes w/disk drive power supply, Disk Manager disk & owner's manual. Mfr - Coleco, model 7817.

Item #12830

Like New - \$199.00

Fans . . .

115 CFM MUFFIN® FANS



115 VAC, 60 Hz.; 21W; 28A.; 3100 RPM; 5-blade model; aluminum housing. Can be mtd. for blowing or exhaust. Dim.: 4 1/8" sq. x 1 1/2" deep

NEW - Mfr: IMC

Item #1864 \$9.95

USED - Mfr: Centaur/Howard

Item #5345 \$5.95

ADAM COMPUTER



(Less printer)

No wiring nec. (just plugs together). Hook-up diagram incl. Incl.: keyboard, 1 cassette digital data drive, 2 game controllers, power supply & 1 cassette. Cap. of running CPM, has built-in word processor. Item #7410

Complete - \$99.00

27 CFM MINI FANS



115VAC; 50/60Hz.; 12W. Low noise level fans, can be mounted for blowing or exhaust.

1" Thin -

Contains 9 plastic blades.

Dim.: 3 1/8" sq. x 1" deep

Mfr - Tobishi #U92018

Item #10960 \$7.95 New

1 1/2" Standard -

Contains 7 metal blades.

Mfr - Rotron #SU2A1

Item #5970 \$7.95 New

ANALOG TO DIGITAL CONVERTER



Binary output: 12 bit; Conversion time: 8 microseconds; Linearity: 8 ms. ± 1/2 lbs. Parallel and series outputs; internal reference. Mfr - Data! ADC-HZ-12BGC

Item #7052 (RFE - tested good!)

Originally \$130.00

Special - \$39.95

5 1/4" FLOPPY DISKETTES



Single side/single density; 16 hard sectors. Mfr - Xerox #11R61630

Item #14537

Pack of 10 \$9.95 New

150 CFM SUPER VENTURI FAN



Ball bearing; 115 VAC, 60 Hz.;

.195/178 amps. Has 2 sets of mtg. holes (fits standard rack or larger). Can be mtd. for blowing or exhaust. Dim.: 5" sq. x 1 1/2" deep.

Mfr - Rotron

Item #1866 \$19.95 New

Protect your Printer/ Typewriter with our DIABLO CLEANING KIT



For printers & typewriters w/print wheel, spindle, & metal ball type print elements. Good for 5 cleanings. Incl.: platen cleaner, type/print element cleaner, sound shield cleaner, plus buffers & cloths.

Mfr - Diablo Supplies #9R87106

Item #15419

3 sets \$14.95 New

Adam & ColecoVision Accessories . . .

Data Drive -

Item #6641 \$19.95

Printer Power Supply -

Item #6642 \$14.95

ASCII Keyboard -

Item #6643 \$19.95

Controllers (Set of 4) -

Item #7013 \$9.95 RFE

Adam Cassettes -

(Incl. Smart Basic, Buck Rogers & blank cassette.) Item #7786

BAKER'S DOZEN - \$19.95

Adam Link Modem -

(Software included.)

Item #12358 \$29.95

Auto-Dialer Address Book -

Item #12365 \$19.95

Adam Daisy Print Wheel -

Item #13305 \$3.95

Adam Ribbon Cartridge -

Item #13306 \$3.95

ColecoVision to Adam Expansion Kit -

This expansion module just plugs into your ColecoVision. With printer power supply & data drive (both included), you will have a working Adam computer. Adam keyboard, 1 Smart Basic cassette & hook-up diagram also included.

Item #9918 \$59.50

Expansion Module #2 -

Includes Turbo cartridge.

Item #13146 \$39.95 New

Roller Controller -

Includes Slither cartridge.

Item #13147 \$39.95 New

Super Action Controller Set -

Includes Baseball cartridge.

Item #13148 \$39.95 New

Call or Write with Your Requirements

MECHANICAL KEYBOARDS . . .



48-KEY - Timex Z81/1000

Item #6712 \$5.95 New

75-KEY - Timex or Adam

For computer upgrade. . .

Item #7429 \$5.95 New

66-KEY - Commodore C-16

Item #9394 \$5.95 New

RECORDING TAPE

7 1/2" Reel, 2400 ft.



Bulk erased. Major mfrs.: Amplex, Scotch, etc.

Item #6711 - 1/4 Mil.

15 reels for \$9.95

STEPPING MOTORS for ROBOTICS . . .

Precision steppers with increments from 1 to 7.5 degrees. Speeds up to 5,000 steps.



Stall

Item Step Volts Torque

No. Angle DC oz/in Type Mfr. & Part No. Fig Price

5431 1 5 17 PM N.A. Phillips 1 \$9.95 ea.

A82310-M2 2/ \$14.95

5275 1.8 1.8 72 PM Superior Electric 2 \$19.95 ea.

2 0 M061-FF-6201B 2/ \$37.50

6671 3.7 1.2 18 - Mitsubishi 2 \$9.95 ea.

42SH-32KOA 2/ \$14.95

7630 1.8 3.0 200 PM Superior Electric 2 \$34.50 ea.

M092-FT-402 2/ \$59.50

MINI MICRO-COMPUTER REGULATOR



140 VA

Provides voltage regulation & ultra isolation for microprocessor-based equipment. Contains less than 3% harmonic distortion, better than 60 dB traverse noise rejection. Contains dual outlet for CPU & monitor, & 6 ft. line cord.

Input: 95 - 130V, 60Hz.

Output: 120V @ 1.17A

Dimen.: 11 1/2" L x 4 3/8" H x 5 1/2" W

Mtd on metal base w/rubber ft.

Mfr - Sola #63-13-114

Item #9999 \$89.00 New

COPPER-CLAD PRINTED CIRCUIT BOARD (Double-sided)

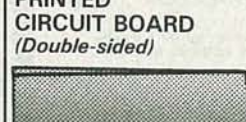

Glass coated, epoxy laminated, 1 oz. Double sided, .022" thick.

Dimensions: 24" L x 18.5" H

Item #13606

3 sheets/ \$9.95

ADVERTISING INDEX

RADIO-ELECTRONICS does not assume any responsibility for errors that may appear in the index below.

Free Information Number	Page		Page		Page
81, 197	A.I.S. Satellite	5, 7	82	Digi-Key	112
108	AMC Sales	81	206	Diskette Connection	92
107	All Electronics	109	—	Electronic Technology Today	3
182	Allen's Electronics	7	120	Elephant Electronics	5
103	Allen, Wm B	34	111	Etronix	7
—	Amazing Devices	106	121	Fluke Manufacturing	42
106	American Design Components	118	—	Fordham Radio	CV4
193	Aprotek	92	—	Grantham College of Engineering	22
208	B & C Microsystems	92	—	Heath	35
77	B&K Precision	44	—	ISCET	81
183	Banner Technical Books	83	65	J & W	26
98	Beckman Industrial	13	59	JDR Instruments	14
85	Blue Star Industries	5	113, 177	JDR Microdevices	114, 115
109	C & S Sales	75	178, 179	JDR Microdevices	116, 117
184	CEI	101	114	Jameco	110, 111
60	CIE	18	104	Jan Crystals	83
196	Chenesko Products	5	—	Joseph Electronics	5, 37
—	Command Productions	76	195	Kelvin	106
192	Computer Surplus Store	92	87	MCM Electronics	105
58	Cook's Institute	79	93	Mark V. Electronics	102
209	Crystek	22	—	McGraw Hill Book Club	28
194	Daetron	76	—	McGraw Hill Cont. Ed. Series	41
127	Deco Industries	5, 7	63	Micro-Mart	107
207	Devtronics	92	61	Microprocessors Unltd.	92
				NRI	8
				Needham	92
				NuScope Associates	92
				OCTE Electronics	5
				PC Boards	81
				Pacific Cable	103
				Parts Express	120
				Pomona Electronics	43
				Radio Shack	113
				198, 199 Sencore	17, 32
				51 Silicon Valley Surplus	104
				74 Solid State Sales	108
				— Star Circuits	79
				92, 188 Tektronix	CV2, 23
				189, 190 Tektronix	25, 27
				181 Tentel	16
				123 Test Probes	33
				70 The Hobby Helper	5
				187 Ucando VCR Ed. Prods.	21
				185 United Electronic Supply	38
				— Windjammer	CV3
				180 WPT Publications	84



 <p>10" WOOFER Heavy duty paper cone with 20 oz. magnet. 60 watts RMS, 90 watts max. Response: 35-3,500 Hz.</p> <p>#290-083 \$18⁸⁰ \$16⁹⁰ (1-3) (4-UP)</p>	<p>FREE CATALOG</p>  <p>Call or write today for your free catalog containing speakers, semi-conductors, CATV products, tools, hardware, TV-VCR parts, and more.</p>	 <p>8" POLY WOOFER Clear ribbed polypropylene cone. 60 watts RMS, 90 watts max. power. 20 oz. magnet. 35-2500 Hz. 4-8 ohm compatible.</p> <p>#290-055 \$20⁵⁰ \$18⁹⁵ (1-3) (4-UP)</p>
 <p>HORN TWEETER 3" wide dispersion horn tweeter. 1800-15,000 Hz response. 35 watts RMS, 50 watts max. 8 ohm impedance.</p> <p>#270-050 \$6⁵⁰ \$5⁹⁰ (1-9) (10-UP)</p>	<p>CROSSOVERS</p>  <p>2-Way, 30 watt #260-190 \$3⁹⁵ 3-Way, 60 watt #260-200 \$7⁵⁰ 3-Way, 100 watt #260-210 \$12⁵⁰</p>	 <p>15" WOOFER 20 oz. magnet. 60 watts RMS, 90 watts max. 8 ohm impedance. 1 1/2" voice coil. 25-2000 Hz.</p> <p>#290-160 \$30⁹⁵ \$28⁴⁰ (1-3) (4-UP)</p>
 <p>PIEZO TWEETER Mfg. #KSN1005A, 3 1/2" x 3 1/2". No crossover required. 50 watts maximum input power.</p> <p>#270-010 \$4⁹⁵ \$3⁹⁵ (1-79) (80-UP)</p>	 <p>5 1/2" CUP MIDRANGE Tuned cup. Paper cone. 1" voice coil. 9 3/4 oz. magnet. 50 watts RMS, 70 watts max. Response: 320-6000 Hz. 8 ohm impedance.</p> <p>#280-020 \$11⁵⁰ \$9⁹⁵ (1-9) (10-UP)</p>	

CALL TOLL FREE 1-800-338-0531

Local: (513) 222-0173

PARTS EXPRESS INT'L INC.
340 East First St.
Dayton, Ohio 45402



GOT A FAVORITE?

FEATURE:
PAGE
DEPARTMENT:
PAGE

NAME _____
ADDRESS _____
CITY _____ STATE _____ ZIP _____

R-E APR '88

RETURN TO
RADIO-ELECTRONICS — 500B BI-COUNTY BLVD., FARMINGDALE, NY 11735

Gernsback Publications, Inc.
500-B Bi-County Blvd.
Farmingdale, NY 11735
(516) 293-3000
President: Larry Steckler
Vice President: Cathy Steckler

For Advertising ONLY
516-293-3000
Larry Steckler
publisher
Arline Fishman
advertising director
Shelli Weinman
advertising associate
Lisa Strassman
credit manager
Christina Estrada
advertising assistant

SALES OFFICES
EAST/SOUTHEAST
Stanley Levitan
Eastern Sales Manager
Radio-Electronics
259-23 57th Avenue
Little Neck, NY 11362
718-428-6037, 516-293-3000

MIDWEST/Texas/Arkansas/Okla.
Ralph Bergen
Midwest Sales Manager
Radio-Electronics
540 Frontage Road—Suite 339
Northfield, IL 60093
312-446-1444

PACIFIC COAST/ Mountain States
Marvin Green
Pacific Sales Manager
Radio-Electronics
5430 Van Nuys Blvd. Suite 316
Van Nuys, CA 91401
1-818-986-2001

RADIO-ELECTRONICS

East of the sun. West of the moon. Windjammer.



A place to live your fantasies.
A place to free your soul.

To cozy up to the Caribbean sun.
To dance among a thousand stars
to the rhythms of steel drums.
To play on sparkling white and
pink sand beaches.
To discover the underwater
paradise of the reefs.
To find a new friend and share the
intimacies of a sensuous night.

To come alive and live.
To remember for a lifetime.
6 days and 6 nights. From \$625.

Reservations toll free
1-800-327-2600
In Florida 305/373-2090.

**Windjammer
Barefoot Cruises**

Post Office Box 120,
Miami Beach, Florida 33119.



Cap'n Mike, rush me my free, full color "Great Adventure" booklet and show
me the way to Paradise for 6 days and 6 nights from \$625."
Windjammer "Barefoot" Cruises,
P.O. Box 120, Dept. 1642, Miami Beach, Fla. 33119.

Name _____
Address _____
City _____
State/Zip _____

SCOPE 3 1/2 Digital Multimeters



Model DVM-636
\$6750

- 8 function, 37 ranges
- Capacitance measurement

Model DVM-638
\$8750

- Test leads included
- 11 function, 38 ranges
- Logic level detector
- Audible visual continuity
- Capacitance and conductance measurement

SCOPE 3 1/2 Digit Capacitance Meter



Model DCM-602
\$5995

- Test leads included
- 8 ranges with full scale values to 2000 uF
- LSI circuit
- Crystal time base
- Frequency range 800 Hz to 8Hz

SCOPE Pocket Sized Audio Signal Generator



Model RC-555
\$5995

- Test leads & 9V battery included
- Low distortion sine-wave signal
- 46 step selected frequency
- x1 range 20 Hz to 1.5 KHz
- x100 range 2 KHz to 150 KHz

SCOPE 4 1/2 Digit LCD Bench Digital Multimeter



Model DVM-6005
\$21995

- Test lead set 6, "D" size batteries included
- 0.4" high characters
- Conversion period: 500 milliseconds
- Automatic, negative polarity

Mini-Meters with Maxi-Specs

SCOPE 3 1/2 Digit LCD with 8 Full Functions

Model DVM-632

\$4495
OUR PRICE

Measures only 5 5/8" x 2 13/16" x 1 1/4"

- Deluxe test leads included
- 0.5% accuracy
- Transistor gain test
- Audible continuity checking & diode test
- 10 Amp measurement

Zipped Carrying Case CC-30 **\$450**



SCOPE 3 1/2 Digit LCD



Measures only 5" x 2 3/4" x 7/8"

Model DVM-630

\$2995

OUR PRICE

- Test leads included
- 0.5% accuracy
- 6 functions, 19 ranges
- Automatic zero adjust
- Low battery indication

Zipped Carrying Case CC-30 **\$450**

ASK FOR FREE CATALOG. Money orders, checks accepted. C.O.D.'s require 25% deposit.



Fordham
260 Motor Parkway, Hauppauge, NY 11788

Toll Free **800-645-9518**
In NY State **800-832-1446**

Service & Shipping Charge Schedule Continental U.S.A.	
FOR ORDERS	ADD
\$25-\$100	\$4.50
\$101-\$250	\$6.00
\$251-500	\$8.00
\$501-750	\$10.50
\$751-1,000	\$12.50
\$1,001-1,500	\$16.50
\$1,501-2,000	\$20.00
\$2,001 and up	\$25.00