

48783

# Radio - CONTROL YOUR HOME BY TELEPHONE

\$2.25 JUNE 1987  
IN CANADA \$3.75

# Electronics®

TECHNOLOGY - VIDEO - STEREO - COMPUTERS - SERVICE

A  
**GERNSBACK**  
PUBLICATION

## BUILD A DIGITAL DASHBOARD

Add a tachometer to your car



## NEW LIFE FOR OLD CAR RADIOS

Convert them to receive shortwave!

## BUILD THE R-E ROBOT

Adding the control board.

## FLIP FLOPS

A circuit cookbook

## COMPUTER DIGEST

Designing PC boards on your computer

### PLUS:

- ★ Audio Update
- ★ Video News
- ★ New Ideas
- ★ Antique Radios
- ★ Satellite TV
- ★ New Products
- ★ PC Service
- ★ Ask R-E



# New GPS Series: Tek sets the pace with SmartCursors™ and push-button ease.

Work faster, smarter, with two new general purpose scopes from Tektronix. The four-channel, 100 MHz 2246 and 2245 set the new, fast pace for measurements at the bench or in the field. They're easy to use and afford, by design.

**On top: the 2246 with exclusive integrated push-button measurements.** Measurements are accessed through easy, pop-up menus and implemented at the touch of a button. Measure peak volts, peak-to-peak,  $\pm$  peak, dc volts and gated volts with new hands-off convenience and on-screen readout of values.

SmartCursors™ track voltmeter measurements in the 2246 and visually indicate where ground and trigger levels are located. Or use cursors in the manual mode for immediate, effortless measurement of waveform parameters.

**Both scopes build on performance you haven't seen at the bandwidth or prices.** Lab grade features include sweep speeds to 2 ns/div. Vertical sensitivity of 2 mV/div at full bandwidth for low-level signal capture. Plus trigger

Features	2246	2245
Bandwidth	100 MHz	100 MHz
No. of Channels	4	4
Scale Factor Readout	Yes	Yes
SmartCursors™	Yes	No
Volts Cursors	Yes	No
Time Cursors	Yes	No
Voltmeter	Yes	No
Vertical Sensitivity	2 mV/div	2 mV/div
Max. Sweep Speed	2 ns/div	2 ns/div
Vert/Hor Accuracy	2%	2%
Trigger Modes	Auto Level, Auto, Norm, TV Field, TV Line, Single Sweep	
Trigger Level Readout	Yes	No
Weight	6.1 kg	6.1 kg
Warranty	3-year on parts and labor including CRT	
Price	\$2400	\$1875

sensitivity to 0.25 div at 50 MHz, to 0.5 div at 150 MHz.

Accuracy is excellent: 2% at vertical, 2% at horizontal. And four-channel capability includes two channels optimized for logic signals.

**Best of all, high performance comes with unmatched convenience.** You can see it and feel it—in the

responsive controls and simple front-panel design, in extensive on-screen scale factor readouts, and in simplified trigger operation that includes Tek's Auto Level mode for automatic triggering on any signal. Start to finish, the GPS Series saves steps and simplifies tasks.

**Get out in front! Call toll-free today to order, to get more details or a videotape demonstration.**

**1-800-433-2323**

In Oregon, call collect 1-627-9000

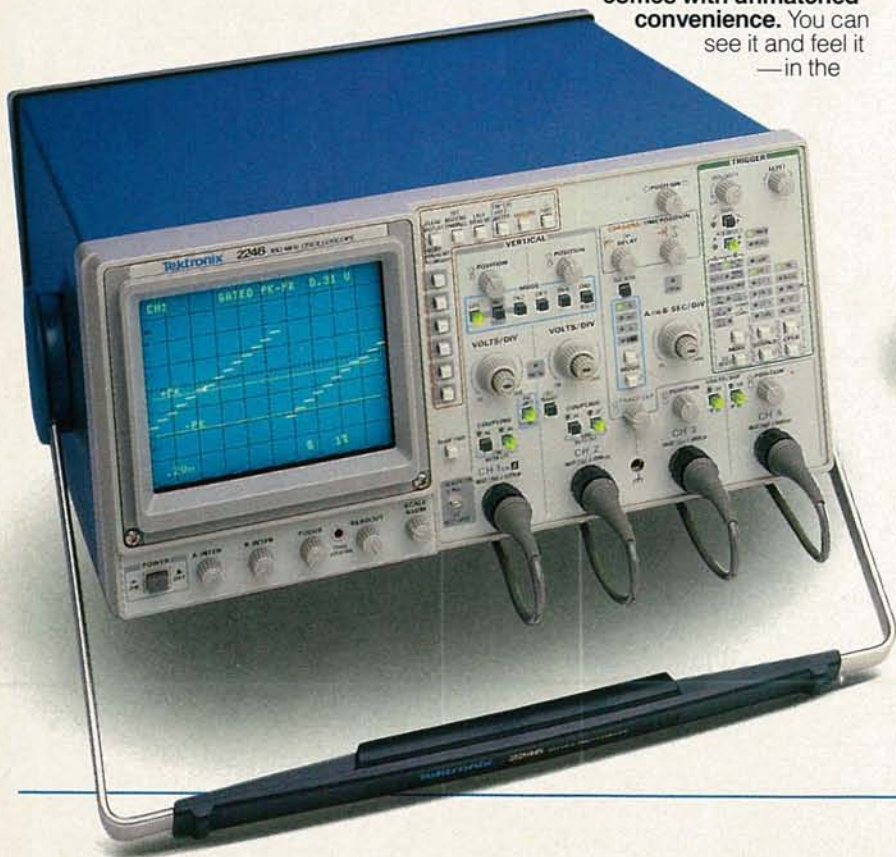

Featuring four channels, flexible triggering, extensive CRT readouts and push-button ease of use, the new Tek 2246 (left) and 2245 (above) bring high-quality, low-cost analysis to diverse applications in digital design, field service and manufacturing.

**Tektronix**  
COMMITTED TO EXCELLENCE

- BUILD THIS**
- 45 DIGITAL TACHOMETER FOR YOUR CAR**  
Give your car a high-tech dashboard display of engine rpm.  
**Ross Ortman.**
  - 53 PHONLINK INTERACTIVE REMOTE CONTROL**  
Part 2. Monitor and control your home by telephone.  
**Gene Roseth**
  - 58 R-E ROBOT**  
Part 7. More on the control board.  
**Steven E. Sarns**
  - 71 PC SERVICE**  
Use our exclusive direct-etch foil patterns to make circuit boards for a shortwave converter, the Phonlink, and digital tachometer

- TECHNOLOGY**
- 8 VIDEO NEWS**  
Inside the fast-changing video scene.  
**David Lachenbruch**
  - 76 SATELLITE TV**  
A descrambling fraud.  
**Bob Cooper, Jr.**
  - 78 AUDIO UPDATE**  
Unwanted sound transmissions.  
**Larry Klein**

- CIRCUITS AND COMPONENTS**
- 40 NEW IDEAS**  
A sound effects generator.
  - 50 NEW LIFE FOR OLD CAR RADIOS**  
Part 2. How to build a shortwave radio converter.  
**Gary McClellan**
  - 61 TESTING SEMICONDUCTORS**  
Part 5. Transistor AC parameters.  
**TJ Byers**
  - 64 WORKING WITH FLIP FLOPS**  
A circuit cookbook.  
**Ray Marston**
  - 70 TV TROUBLESHOOTER'S NOTEBOOK**  
Black vertical bars.  
**Jay Shane**
  - 87 STATE OF SOLID STATE**  
Instrumentation amplifiers.  
**Robert F. Scott**

## RADIO

- 80 ANTIQUE RADIOS**  
Restoring a classic radio.  
**Richard D. Fitch**
- 82 COMMUNICATIONS CORNER**  
Antennas and propagation  
**Herb Friedman**

## COMPUTER DIGEST

- 93 EDITOR'S WORKBENCH**
- 97 DESIGNING PC BOARDS ON YOUR COMPUTER**
- 100 THE KEPROM: SINKING THE SOFTWARE PIRATE**

## EQUIPMENT REPORTS

- 21 Leader LCD-100 Portable Oscilloscope/DMM**

## DEPARTMENTS

- 124 Advertising and Sales Offices**
- 124 Advertising Index**
- 10 Ask R-E**
- 4 Editorial**
- 125 Free Information Card**
- 14 Letters**
- 105 Market Center**
- 30 New Products**
- 6 What's News**

# COVER 1



If you like to keep your car up to date no matter how old it is, then our cover project—a digital tachometer—is for you. Although the tach is a digital project and offers a digital display, it also offers an easy-to-read analog indication. It will work with 4-, 6-, and 8-cylinder engines, and can even be used for tuning your engine! Next month, we'll show you how to build a matching speedometer to really jazz up your dash board.

# NEXT MONTH

## THE JULY ISSUE IS ON SALE JUNE 4

**SPECIAL SECTION ON CAR AUDIO**  
Overview of the newest equipment  
Some example installations

**BUILD A DIGITAL SPEEDOMETER FOR YOUR CAR**  
A high-tech dashboard for any car.

**BUILD THE R-E ROBOT**  
A look at the robot control language.

**THE STORY BEHIND CET**  
What is a Certified Electronics Technician?

**COMPUTER DIGEST**  
Keyboards, keyboards, and keyboards!

As a service to readers, RADIO-ELECTRONICS publishes available plans or information relating to newsworthy products, techniques and scientific and technological developments. Because of possible variances in the quality and condition of materials and workmanship used by readers, RADIO-ELECTRONICS disclaims any responsibility for the safe and proper functioning of reader-built projects based upon or from plans or information published in this magazine.

Since some of the equipment and circuitry described in RADIO-ELECTRONICS may relate to or be covered by U.S. patents, RADIO-ELECTRONICS disclaims any liability for the infringement of such patents by the making, using, or selling of any such equipment or circuitry, and suggests that anyone interested in such projects consult a patent attorney.

## Radio- Electronics®

Hugo Gernsback (1884-1967) founder  
M. Harvey Gernsback,  
editor-in-chief, emeritus

Larry Steckler, EHF, CET, editor-in-chief  
and publisher

### EDITORIAL DEPARTMENT

Art Kleiman, editorial director  
Brian C. Fenton, managing editor  
Carl Laron, WB2SLR, associate editor  
Jeffrey K. Holtzman,  
assistant technical editor  
Robert A. Young, assistant editor  
Julian S. Martin, editorial associate  
Byron G. Wels, editorial associate  
M. Harvey Gernsback,  
contributing editor  
Jack Darr, CET, service editor  
Robert F. Scott,  
semiconductor editor  
Herb Friedman,  
communications editor  
Bob Cooper, Jr. satellite-TV editor  
Robert Grossblatt, circuits editor  
Larry Klein, audio editor  
David Lachenbruch,  
contributing editor  
Richard D. Fitch,  
contributing editor  
Teri Scaduto, editorial assistant

### PRODUCTION DEPARTMENT

Ruby M. Yee, production director  
Robert A. W. Lowndes,  
editorial production  
Andre Duzant, technical illustrator  
Karen Tucker, advertising production  
Marcella Amoroso, production traffic

### CIRCULATION DEPARTMENT

Jacqueline P. Cheeseboro,  
circulation director  
Wendy Alanko,  
circulation analyst  
Theresa Lombardo,  
circulation assistant

Typography by Mates Graphics

Cover Foto by Dan Muro

Radio-Electronics is indexed in  
*Applied Science & Technology Index*  
and *Readers Guide to Periodical Literature*.

Microfilm & Microfiche editions are available. Contact circulation department for details.

Advertising Sales Offices listed  
on page 124.



# Your Best Source for "Black Boxes" is POMONA ELECTRONICS

COMPONENT-MOUNTING  
PHENOLIC BOX; BNC FEMALE  
TO DOUBLE BANANA PLUG:  
MODEL 2097



PHENOLIC BOX:  
MODEL 2103



PHENOLIC BOX:  
MODEL 2104



SIZE C DIE CAST ALUMINUM  
BOX: MODEL 2901



SIZE F EXTRUDED ALUMINUM  
BOX: MODEL 3301

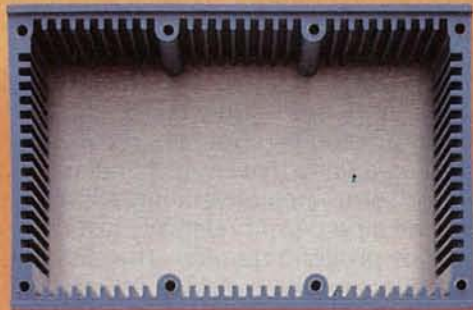

COMPONENT-MOUNTING  
ALUMINUM BOX; BNC MALE  
TO BNC FEMALE : MODEL 2391



FREE 1987 GENERAL CATALOG

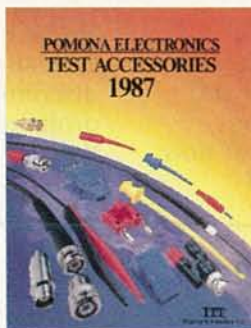

**ITT** Pomona Electronics  
1500 E. Ninth St., Pomona, CA 91766  
Tel: (714) 623-3463

SIZE B DIE CAST ALUMINUM  
BOX: MODEL 2417



Our Products are available through your favorite electronics parts distributor.  
CIRCLE 101 ON FREE INFORMATION CARD

---

---

# EDITORIAL



## Why digital audio tape isn't here.

The biggest story—or should I say *non-story*—of the Winter Consumer Electronics Show was *Digital Audio Tape* or DAT. Several manufacturers—including Sony, Kenwood, Onkyo, and Mitsubishi—displayed prototype DAT players, and several more manufacturers—including TDK and 3M—displayed DAT tape. But the official word was that the units were prototypes only, and no marketing plans were in place.

Let's hope that following the Summer Consumer Electronics Show (which will be held from May 31 to June 3) we'll be able to announce the introduction of digital audio tape decks for consumer use. Why? Because DAT promises to do for audio tape what CD's have done for audio discs. And because the time—and the technology—is here to bring high-quality digital taping into the home.

Digital audio tapes are about half the size of a compact cassette, but slightly thicker. Yet a DAT cassette can provide two hours of recording time, and recording quality that rivals that of a compact disc. DAT cassettes are convenient: Digital codes stored on the tape permit relatively fast random addressing by program number. The cassettes are easy to handle, and the cartridge protects the tape from dust.

Unfortunately, the CD-player manufacturers and the recording industry don't want DAT, and they could kill the format before it even starts.

The manufacturers are afraid that DAT players would make consumers stop and think about whether they wanted to buy a CD player or a DAT machine—and perhaps buy nothing at all. The manufacturers fear that the introduction of DAT now would severely damage the CD market—and perhaps even kill the format.

That's nonsense! Both digital formats have a place, and each has its benefits. Compact discs are durable, and players can access tracks rapidly, in a user-programmed order. Digital audio tapes are not as durable, but they are more portable, and are much easier to handle in an automobile. And, of course, they offer recording capability.

The recording industry is worried about something else: piracy. DAT's recording capability is just so good that a copy would be indistinguishable from the original. They fear the loss of CD sales—and of pre-recorded digital audio tapes.

The RIAA (Recording Industry Association of America) wants anti-taping IC's to be incorporated into the DAT machines to prevent home recording of commercially recorded material. (The IC's would detect a special signal incorporated into the original recording.)

That would be a misguided effort: Home taping has nothing to do with commercial piracy. Such anti-taping IC's would destroy the main purpose of DAT—to make home recordings. But they would not stop commercial piracy—only prosecution will. Because of the huge illicit profits involved, pirates will find ways to beat anti-taping devices. Undoubtedly, a black market would open up for home-deck conversions as well.

Home taping has become a consumer's right over the last 20 or thirty years. Recording a disc so you can conveniently listen to it in your car is transferring copyrighted material—which you bought the right to listen to—from one format to another. Making such format shifting illegal would be akin to selling recorded material for a specified number of listenings only, after which, you'd be violating a copyright.

Home cassette decks don't contain anti-taping IC's. Why should a new, superior technology be discriminated against? Doesn't it sound silly to prohibit DAT machines from recording just because they do a better job?

BRIAN C. FENTON  
Managing Editor

# The UnExpected HP-28C— HEWLETT PACKARD is this your next calculator?

## A first report:

If you're at all like me, this is what you've been holding your breath for (in the calculator direction, of course). Just a few years back, calculators were exciting. Maybe once a year there was a new model that could do startlingly more. Not recently, however.

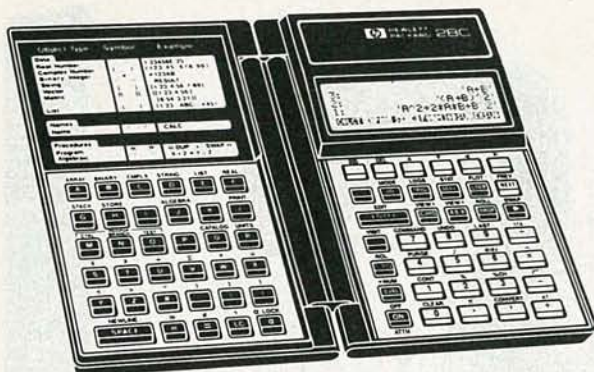

Now here's the next tantalizing toy and technical tool. I haven't got room here to do it justice, there are so many interesting features and specs for it. I'll sketch it for you, though...

You'll have **ON-SCREEN MENUS** and **SOFTKEYS**, just like a PC—sensible access to hundreds of functions (128K ROM!) and high-level problem solving. Gamma function, random numbers,...

Complex numbers, matrices, vectors, lists, and algebraic expressions can be viewed, edited, and then used in calculations just as easily as ordinary numbers. Dot and cross products, determinant,...

You can choose **RPN LOGIC** for calculations OR use the built-in **ALGEBRAIC LOGIC**—with RPN its 4-line display shows your stack OR you'll see your equation displayed just as you would write it. You choose.

You'll do no programming to get solutions, either—it will solve for any unknown variable anywhere in your equation.

It will convert between different unit systems, too. The values of 120 units are built-in, and you can add your own. Are you ready for all this right now? (I have them in stock).

You'll use **SEPARATE KEYBOARDS**, the right hand one for **NUMBERS** and the left for **LETTERS**. Later, you can fold it to pop into your shirt pocket.

You can plot graphs of your functions, even two at a time. Then place the cursor near where the graphs cross and press a key to calculate the x-value of the crossing, correct to 12 digits. I was amazed.

Scatter plots of your statistical data are easy too. Imagine showing all this to your colleagues!

**Plotting.** Plot mathematical functions and statistical data; set plot scales, axes, and center; display graphics.

**Statistics.** Single- or multi-variable statistics: summation, deletion, mean, standard deviation, total, maximum, minimum, variance, covariance, correlation. Linear regression and predicted value. Normal, Students t, F, and Chi-square distributions.

A major leap in technology—you'll do **SYMBOLIC ALGEBRA**, even **SYMBOLIC CALCULUS**. You'll manipulate unknowns and letters as well as numbers, even differentiate functions to get their derivative functions. This is the first small machine capable of doing symbolic mathematics, like **MACSYMA**® on a mainframe, and it can be yours right now. (® Symbolics, Inc.)

**Symbolic Algebra.** All real and complex number functions; expand, collect terms; expression editor; subexpression recall and substitution, symbolic solve; quadratic equations.

**Calculus.** Symbolic differentiation of arbitrary expressions; symbolic integration of polynomials; numerical integration of arbitrary expressions; Taylor series.

**Programmability**—You can use all of the built-in functions with your own menus and softkeys, plus sophisticated utilities.

**Binary Integer Operations.** Decimal, octal, hexadecimal, and binary bases; arithmetic; variable wordsize; bit shift and rotate, byte shift and rotate, arithmetic shift; logical operators; floating-point/integer conversion.

**Programming Features.** User-defined functions, local variables, indefinite nesting and recursion, IF... THEN... ELSE, FOR... NEXT, DO... UNTIL, WHILE... REPEAT; halt, continue, abort, single-step, pause, read key, beep, display, error message, error number; set/clear/test 64 user flags; conditionals, logical operators; object type.

But you can't see the best part—Your HP-28C comes with

a built-in InfraRed Printer Interface. This means no wires or cables to your portable thermal printer—just point your 28C at it and press a key for an instant record. Have your printer now, or get it later—your choice.



**The HP-28C lists for \$235.**

It will be the world's standard for years to come. You're sure to get one sooner or later. Why not now? I have them in stock, and I'll give you a discount savings of \$45 now.

You know that Hewlett-Packard builds durable calculators—your new 28C is going to last for years.

**You'll have more fun with this than you would with a new car—at 1/100 the cost!**

Order by mail: each HP-28C is **\$189.95**; save \$29 on each InfraRed Printer at **\$105.95** (Calif. residents add 6% tax). Add \$4 for UPS delivery (no extra charge for multiple items). Allow 12 days for personal checks to clear, or send your MC/Visa number and card address.

For fastest service, call during west-coast business hours at **(714) 582-2637**. Or, for all days/all hours call toll-free **(800) 633-2252**, ext. 352, with your MC or VISA card. Of course, if you live in Southern California, drop by in person and pick up your new HP-28C.

**I guarantee you'll be delighted with the HP-28C—or your money back within 15 days, no questions asked.**

*Jim Carter, Mgr.* EduCALC Mail Store-52  
27953 Cabot Road  
Laguna Niguel, CA 92677

# WHAT'S NEWS

## Kodak introduces high-capacity, high-speed optical-disc system

Eastman Kodak, long known for its leadership in the field of photography, is dramatically increasing its presence in the information-technology field with the introduction of an advanced optical-disc information storage and retrieval system. The 6800 optical-disc system is a high-capacity data storage and retrieval system that uses Kodak's new 14-inch write-once/read-many-times optical discs. Each disc offers a capacity of 6.8 gigabytes of random-access on-line storage. The basic 6800 library unit consists of a single drive, controller, and 50 optical discs with robotic retrieval equipment in an environmentally controlled cabinet (a mini "clean room"). Three optional add-on units give the user the ability to increase the disc hardware and software capacity to up to 150 discs. At its maximum configuration, the system offers a total storage capacity of one terabyte (one trillion bytes). For example, that is more than enough capacity to store 12 years of records of X-rays, CAT scans, and ultrasound examinations for a 250-bed hospital. Retrieval time for the system is 12 seconds or less.

Kodak's Mass Memory Division will market the 6800 system on a

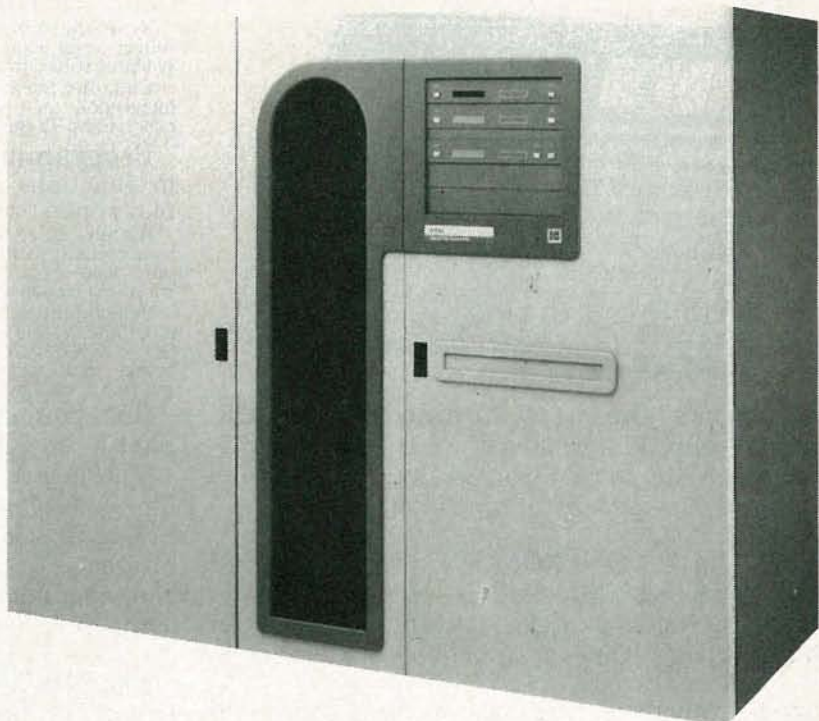

THE KODAK 6800 OPTICAL DISC SYSTEM is shown here with an optional add-on unit (left) attached.

limited basis in late 1987, and in quantity in 1988. It will not be sold directly to end users. "We will work through computer companies, original equipment manufacturers, and others, including business divisions within Kodak," says Frank Strong, group vice president and general manager of Kodak's Diversified Technologies. "These companies will integrate their equipment with ours and

market specific products to end users."

One such integrator will be Kodak's own Business Imaging System, which will integrate the 14-inch optical discs into their line of KIMS systems. Such systems are not inexpensive, however, with one, the KIMS 5000, expected to cost in the neighborhood of \$700,000. Less ambitious KIMS systems will start at about \$150,000.

## Descramblers and the law

The Cable Home Group of General Instrument, manufacturer of the *VideoCipher* scrambling system, instituted a civil suit last March against Network, Inc., of Piscataway, NJ; Robert Cooper, Jr., well known to readers of this magazine; Dr. Stephen Bepko of Baltimore, and Karen Howes and Shaun Kenney of the *Boresight* satellite program. The suit charges

them with distributing illegal descrambling IC's at a "Descrambling Summit" trade meeting held in the British West Indies, and seeks damages including \$5 million in "punitive damages" from the defendants.

Two of the defendants, Howes and Kenny, appear in a weekly television program distributed by satellite. *Boresight* is a 60-minute report on activities in the home

dish industry, and has—as a matter of viewer information—listed sources outside the United States for *VideoCipher* IC's.

Dr. Bepko is an electronics engineer who appeared as a lecturer at the summit. Cooper, the publisher of *Coop's Satellite Digest* and a **Radio-Electronics** contributing editor, was the organizer of the meeting, which was held on the island of Providenciales. **R-E**



# TEST EQUIPMENT THAT MEASURES UP TO YOUR SPECIFICATIONS



**DMM-300 \$79.95**  
3.5 DIGIT DMM / MULTITESTER

Our best model. A highly accurate, full function DMM loaded with many extra features. Audible continuity, capacitance, transistor, temperature and conductance all in one hand-held meter. Temperature probe, test leads and battery included.

- Basic DC accuracy: plus or minus 0.25%
- DC voltage: 200mv — 1000v, 5 ranges
- AC voltage: 200mv — 750v, 5 ranges
- Resistance: 200 ohms — 20M ohms, 6 ranges
- AC/DC current: 200uA — 10A, 6 ranges
- Capacitance: 2000pf — 20uf, 3 ranges
- Transistor tester: hFE test, NPN, PNP
- Temperature tester: 0° — 2000° F
- Conductance: 200ns
- Fully over-load protected
- Input impedance: 10M ohm



**DMM-200 \$49.95**  
3.5 DIGIT FULL FUNCTION DMM

High accuracy, 20 amp current capability and many range settings make this model ideal for serious bench or field work. Tilt stand for hands-free operation. 2000 hour battery life with standard 9v cell. Probes and battery included.

- Basic DC accuracy: plus or minus 0.25%
- DC voltage: 200mv — 1000v, 5 ranges
- AC voltage: 200mv — 750v, 5 ranges
- Resistance: 200 ohms — 20M ohms, 6 ranges
- AC/DC current: 200uA — 20A, 6 ranges
- Fully over-load protected
- Input impedance: 10M ohm
- 180 x 86 x 37mm, weighs 320 grams



**DMM-700 \$49.95**  
3.5 DIGIT AUTORANGING DMM

Autorange convenience or fully manual operation. Selectable LO OHM mode permits accurate in-circuit resistance measurements involving semi-conductor junctions. MEM mode for measurements relative to a specific reading. Probes and battery included.

- Basic DC accuracy: plus or minus 0.5%
- DC voltage: 200mv — 1000v, autoranging or 5 manual ranges
- AC voltage: 2v — 750v, autoranging or 4 manual ranges
- Resistance: 200 ohms — 20M ohms, autoranging
- AC/DC current: 20mA — 10A, 2 ranges
- Fully over-load protected
- Audible continuity tester
- Input impedance: 10M ohm
- 150 x 75 x 34mm, weighs 230 grams



**DMM-100 \$29.95**  
3.5 DIGIT POCKET SIZE DMM

Shirt-pocket portability with no compromise in features or accuracy. Large, easy to read 5" LCD display. 2000 hour battery life with standard 9v cell provides over two years of average use. Probes and battery included.

- Basic DC accuracy: plus or minus 0.5%
- DC voltage: 2v — 1000v, 4 ranges
- AC voltage: 200v — 750v, 2 ranges
- Resistance: 2k ohms — 2M ohms, 4 ranges
- DC current: 2mA — 2A, 4 ranges
- Fully over-load protected
- Input impedance: 10M ohm
- 130 x 75 x 28mm, weighs 195 grams

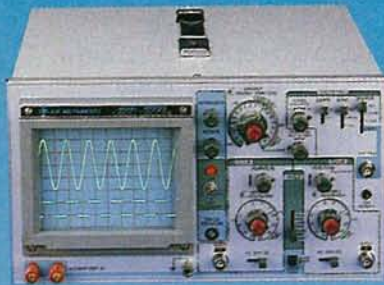

**MODEL 2000 \$349.95**  
20 MHz DUAL TRACE OSCILLOSCOPE

Model 2000 combines useful features and exacting quality. Frequency calculation and phase measurement are quick and easy in the X-Y Mode. Service technicians will appreciate the TV Sync circuitry for viewing TV-V and TV-H as well as accurate synchronization of the Video Signal, Blanking Pedestals, VITS and Verticle/Horizontal sync pulses.

- Lab quality compensated 10X probes included
- Built-in component tester
- 110/220 Volt operation
- X-Y operation • Bright 5" CRT • TV Sync filter

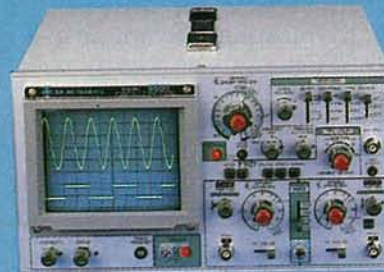

**MODEL 3500 \$499.95**  
35 MHz DUAL TRACE OSCILLOSCOPE

Wide bandwidth and exceptional 1mV/DIV sensitivity make the Model 3500 a powerful diagnostic tool for engineers or technicians. Delayed triggering allows any portion of a waveform to be isolated and expanded for closer inspection. Variable Holdoff makes possible the stable viewing of complex waveforms.

- Lab quality compensated 10X probes included
- Delayed and single sweep modes
- Z Axis intensity modulation
- X-Y operation • Bright 5" CRT • TV Sync filter



**DPM-1000 \$54.95**  
3.5 DIGIT PROBE TYPE DMM

Autoranging, pen style design for the ultimate in portability and ease of use. Custom 80 pin LSI chip increases reliability. Audible continuity tester and data hold feature for added convenience. Case, test leads and batteries included.

- Basic DC accuracy: plus or minus 1%
- DC voltage: 2v — 500v, autoranging
- AC voltage: 2v — 500v, autoranging
- Resistance: 2k ohms — 2M ohms, autoranging
- Fully over-load protected
- Input impedance: 11M ohm
- 162 x 28 x 17mm, weighs 75 grams

**2 YEAR WARRANTY ON ALL MODELS**



**JDR INSTRUMENTS**

110 Knowles Drive, Los Gatos, CA 95030  
(408) 866-6200 • FAX (408) 378-8927 • Telex 171-110

**ORDER TOLL FREE 800-538-5000**

OR VISIT OUR RETAIL STORE  
1256 SOUTH BASCOM AVE.  
SAN JOSE, CA. (408) 947-8881  
CIRCLE 58 ON FREE INFORMATION CARD

COPYRIGHT 1986 JDR MICRODEVICES  
THE JDR INSTRUMENTS LOGO IS A REGISTERED TRADEMARK OF JDR MICRODEVICES.  
JDR INSTRUMENTS IS A TRADEMARK OF JDR MICRODEVICES.

# VIDEO NEWS



● **Kiddie camcorder.** We've seen all kinds of new VCR formats lately—8mm, Super VHS, 4mm, etc.—so why not a VCR that uses a standard audio cassette? That presumably is what Fisher-Price, the toy company, thought when it decided to introduce what it hopes will be next year's hottest Christmas gift for kids—a complete camcorder for less than \$150. *Pixelvision* records 11 minutes (5½ minutes per side) of black-and-white video on a C-90 audio cassette. The one-piece unit contains a low-cost fixed-focus video camera and a record and playback deck that will run for five hours on six AA-size alkaline batteries. The entire package, including tape and batteries, weighs two pounds.

The secret behind the unit is that it uses a stationary head and lays down a longitudinal recording track; conventional decks use heads mounted on a revolving drum and lay down a helical track. The tape is recorded at a high speed, virtually equivalent to the fast-forward speed of an audio tape recorder.

Interestingly, Fisher-Price's recording method harks back to the earliest efforts to develop a videotape recorder, back in the 1940's and 1950's. Those early attempts were unsuccessful. But presumably a fixed-head recorder is practical today because of advances in head design, although Fisher-Price currently isn't giving out any technical details on *Pixelvision*.

● **RCA Labs changes hands.** The David Sarnoff Research Center, informally known as "RCA Labs," isn't RCA Labs any more. The nation's leading electronics research organization has been donated as a gift to SRI International by General Electric, which is RCA's new owner.

The Sarnoff Center, in Princeton, NJ, was founded in 1941 to bring together research efforts scattered around RCA's various operations. It was a prime mover in the development of U.S. black-and-white and color television, stereo, injection lasers, high-speed computer memories, and videodiscs.

SRI International, formerly Stanford Research Institute, was originally part of Stanford

University, but now is an independent research organization with headquarters in Menlo Park, CA. GE donated the Sarnoff Center to SRI because GE has its own research and development operations, and much of the work would be redundant. To get the newly independent lab off to a good start, GE plans to fund about \$250 million in research, much of it in consumer electronics, over the next five years.

● **Super VHS specifications.** Although relatively little still is known about Super VHS, the JVC-developed home-VCR format that can record and play back a picture of better-than-broadcast quality (**Radio-Electronics**, May 1987), JVC has released some specifications for the new system. Super VHS is capable of recording a signal with a horizontal resolution of better than 400 lines. It uses high-band circuitry with a carrier shift of 2.6 MHz in white-peak frequency; white-peak frequency is 7 MHz, as opposed to 4.4 MHz in standard VHS.

Outlining the recording method, JVC says: "Although Super VHS will use the same frequency-modulated recording method used in the conventional VHS format for luminance-signal recording, the FM frequency range has been changed from the conventional format's 3.4–4.4 MHz to 5.4–7 MHz. Frequency deviation has been changed from conventional VHS's 1 MHz to 1.6 MHz. To achieve overall high picture quality for video output signals, separated Y (luminance) and C (chrominance) signals are used in addition to NTSC signals currently used in order to eliminate interference between luminance and chrominance signals."

The tape used for Super VHS is coated with a cobalt-doped oxide and has a coercivity of 850 to 900 oersteds, as opposed to about 750 oersteds for the best standard VHS tapes. A special notch in the cassette tells the recorder that Super VHS tape is being used. The Super-VHS format will be used for camcorders as well as home decks, according to JVC, but only when sufficiently high-resolution pickup devices are available, so that the advantages of the new format may be applied to home-movie making.

Simpson Electric Co.  
Introduces

# mercer

## The Ultimate in Low-Cost Test Equipment

At last! Here is your opportunity to take your pick from a new test equipment line that has all the features you need and more... and at a price that is unbelievably low.

**MODEL 9340**  
Pocket size, 3½-digit  
DMM with 20 megohm  
range and 10 megohm  
input resistance  
**\$48<sup>00</sup>**

**MODEL 9670**  
Digital capacitance  
tester covering 0.1 pF  
to 20,000 µF  
**\$105<sup>00</sup>**

**MODEL 9101**  
Compact VOM with 27  
ranges, including a  
100 megohm range  
**\$29<sup>00</sup>**

**MODEL 9301**  
3½-digit, hand-held  
DMM with 0.25%  
basic accuracy and  
2,000-hour battery life  
**\$69<sup>00</sup>**

**MODEL 9120**  
Analog VOM with 12 A  
DC range and output  
jack  
**\$39<sup>00</sup>**

**MODEL 9401**  
4½-digit, full function,  
hand-held DMM with  
.05% accuracy and  
data hold  
**\$129<sup>00</sup>**

**MODEL 9702**  
digi-clamp™ compact  
AC clamp-on volt-ohm-  
ammeter with data hold  
**\$79<sup>00</sup>**

**MODEL 9370**  
3½-digit autoranging  
DMM with a memory  
mode and 0.5% basic  
DC accuracy  
**\$59<sup>00</sup>**

# mercer

ELECTRONICS

Division of Simpson Electric Company

859 Dundee Avenue, Elgin, IL 60120-3090  
(312) 697-2265 • Telex 72-2416

Mercer Electronics products reflect the design and quality standards established by Simpson Electric Company, an industry leader for over 50 years and known worldwide for its integrity and product excellence.

**In Stock... Available Now!** Stop in at your nearest distributor and see this new, complete line of Mercer test instruments. For the name of the MERCER distributor in your area, call (312) 697-2265, or send for our new line catalog.

# ASK R-E

## WRITE TO:

ASK R-E  
Radio-Electronics  
500-B Bi-County Blvd.  
Farmingdale, NY 11735

### AIR IONIZERS

I've heard a lot about air ionizers and am wondering how effective they really are. What can you tell me?—T.L., Hamilton, OH.

Experience tells me to stay out of this one. Probably more arguments start with the discussion of air ionizers and positive and negative ions than on "the direction of current flow." But I'll try and give you an answer without putting my foot in my mouth.

Research on ionized air and its effects on humans, animals, and plants has been going on since the

middle 1930's. Here are some of the "findings" and opinions:

- The concentration of ions in the air does have a pronounced effect on animals and plants. Also, the polarity of ionization has a distinct effect on life.
- Ion depletion is said to cause depression, mental fatigue, headaches, and respiratory problems in man, and has been shown to reduce the survival rate of animals.
- Increasing ion concentration promotes healing, relieves the pain of burns, and promotes plant growth.

- High concentrations of *negative* ions seem to promote mental agility and alertness and, over the long term, greatly reduce employee-days-lost due to respiratory illnesses.
- Positively charged ions tend to promote hostility and aggressiveness while negative ions promote tranquility.
- Atmospheric pollution in cities and industrial areas tends to promote a drastic depletion in air-ion concentration and to increase the critical positive-to-negative air-ion ratio. Perhaps that explains why

## Fluke breaks the old mold.



Dollar for dollar the Fluke 37 breaks into the market with more features for the money than any other bench DMM. It's bold new design includes built-in handle and storage compartment, and it has all the high performance features of the world's best, most reliable 3½-digit DMMs.

Autoranging, to eliminate guesswork. Audible Continuity, so you don't have to look at the display. An exclusive analog *and* digital display. Superior EMI shielding. Plus a two-year warranty.

And, how many other bench/portable meters give you these features? Min-Max recording, for monitoring signals. 38 components dedicated exclusively to input protection. Relative mode, to help you calculate changes in readings. And Fluke's patented Touch Hold, to give you an extra set of hands when you're taking critical measurements.

None. Only the Fluke 37.

For more information call 1-800-426-0361.

**FLUKE**®

# Regency "Scanner Answer" Giveaway



Here's your chance to win a complete monitoring package from Regency Electronics and Lunar Antennas. 18 scanners in all will be awarded, including a grand prize of the set-up you see above: the Regency HX1500 handheld, the Z60 base station scanner, the R806 mobile unit, and a Lunar GDX-4 Broadband monitoring/reference antenna.

## 55 Channels to go!

When you're on the go, and you need to stay tuned into the action, take along the Regency HX1500. It's got 55 channels, 4 independent scan banks, a top mounted auxilliary scan control, liquid crystal display, rugged die-cast aluminum chassis, covers ten public service bands including aircraft, and, it's keyboard programmable.

## Compact Mobile

With today's smaller cars and limited installation space in mind, Regency has developed a new compact mobile scanner, the R806. It's the world's first microprocessor controlled crystal scanner. In addition, the R806 features 8 channels, programmable priority, dual scan speed, and bright LED channel indicators.

## Base Station Plus!

Besides covering all the standard public service bands, the Regency Z60 scanner receives FM broadcast, aircraft transmissions, and has a built-in digital quartz clock with an alarm. Other Z60 features include 60

channels, keyboard programming, priority control, digital display and permanent memory.

## Lunar Antenna

Also included in the grand prize is a broadband monitoring/reference antenna from Lunar Electronics. The GDX-4 covers 25 to 1300 MHz, and includes a 6 foot tower.



**ELECTRONICS INC.**  
7707 Records Street  
Indianapolis, IN 46226

### Grand Prize (1 awarded)

- 1—Regency Z60 Base station scanner
- 1—Regency HX1500 Handheld scanner
- 1—Regency R806 Mobile scanner
- 1—Lunar GDX-4 Antenna

### First Prize (5 awarded)

- 1—Regency Z60 Base station scanner
- 1—Regency R806 Mobile scanner

### Second Prize (5 awarded)

- 1—Regency HX1500 scanner

**Contest rules:** Just answer the questions on the coupon, (all answers are in the ad copy) fill in your name and address and send the coupon to Regency Electronics, Inc., 7707 Records Street, Indianapolis, IN 46226. Winners will be selected from all correct entries. One entry per person. No purchase necessary. Void where prohibited by law. Contest ends June 30, 1987.

1. The Regency Z60 is
  - a digital alarm clock     an FM radio
  - a scanner     all of the above
2. The Regency R806 is the world's first \_\_\_\_\_ controlled crystal scanner.
3. The Regency HX1500 features
  - 55 channels     Bank scanning
  - Liquid crystal display     all of the above
4. The Lunar GDX-4 antenna covers \_\_\_\_\_ to \_\_\_\_\_ MHz.

Name: \_\_\_\_\_

Address: \_\_\_\_\_

City: \_\_\_\_\_ State: \_\_\_\_\_ Zipcode: \_\_\_\_\_

I currently own \_\_\_\_\_ scanners.

Brands owned: \_\_\_\_\_



Send in a photo (like this one of Mike Nikolich and his Regency monitoring station) and receive a free gift from Regency. Be sure to include your name, address and phone number.

suburbanites—breathing the clean country air—escape some of the health and mental problems suffered by city dwellers.

### SCA DECODER

I am modernizing my old tube-type FM receiver and would like to add a solid-state SCA decoder so I can receive the programs that some FM stations transmit on a 67-kHz subcarrier. Can you provide an appropriate circuit?—J.C.M., Baldwin, NY.

I have found that replacing a high-performance vacuum-tube circuit with a solid-state version does not always ensure equal or superior operation. It should be done only when no alternatives are available. However, putting together a tube-type SCA circuit is impractical because of its high component count. Instead, use a solid-state circuit like the one shown in Fig. 1. That circuit uses a Signetics NE565 PLL (Phase-Locked Loop) as a detector to recover

## Tektronix OSCILLOSCOPES PLUS FREE 16 PC. ELECTRONIC SERVICE TOOL KIT ONLY FROM JOSEPH ELECTRONICS



MODEL 2245  
**\$1,875**  
(+ FREE BONUS + FREE SHIPPING)

MODEL 2246  
**\$2,400**  
(+ FREE BONUS + FREE SHIPPING)

### NEW CRT READOUT 100 MHz FOUR-CHANNEL SCOPES

A real price breakthrough in lab-grade scopes from Tektronix. The 2246 and 2245 both feature: • On-screen scale factor readout • 2mV/division vertical sensitivity • 2% vertical and horizontal accuracy • Four vertical inputs • Delayed sweep. The 2246 also features: • Pop-up menus at the touch of a button • On-screen voltage, and time and trigger-level readouts • Exclusive Smart Cursors™ track voltmeter measurements.

**FREE SHIPPING**

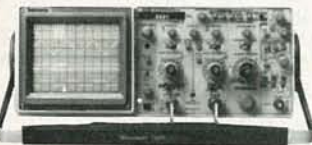

60MHz 2213A  
**\$1,275**

\*100MHz 2235  
**\$1,575**

60MHz 2215A  
**\$1,525**

\*100MHz 2236  
**\$2,650**

(+ FREE BONUS + FREE SHIPPING)

### FAMOUS TEK 2200 SERIES 60/100 MHz DUAL-CHANNEL SCOPES

The 60MHz 2213A, 2215A and 100MHz 2235 and 2236 are industry leaders for value and performance • 2mV/division vertical sensitivity • Advanced triggering for stable displays • X-Y operation • Dual-timebase delayed-sweep measurements. Single timebase on 2213A. • Integrated counter/timer/multimeter on 2236.

### NEW 2220, 2230 DIGITAL STORAGE/ANALOG DUAL-CHANNEL SCOPES

The new 100MHz 2230 and 60MHz 2220 are powerful digital storage scopes with full-bandwidth analog and digital performance. Both feature: • 4k digital record length and save ref-memory for single or dual channel • Peak detect • Pre/post trigger capability • Automatic process modes • 20MS/s sampling speed • X-Y plotter output. The 2230 also features: • CRT readout with cursors • Dual time base • Menu flexibility that permits user to custom tailor diagnostic functions.

Both models offer optional GPIB or RS232C capability with 26k battery backed memory on 2230 only.

**FULL THREE YEAR FACTORY WARRANTY ON ALL Tektronix SCOPES**



MODEL 2230  
**\$5,150**

MODEL 2220  
**\$4,120**

(+ FREE BONUS + FREE SHIPPING)

**BUY ANY TEKTRONIX SCOPE FROM JOSEPH'S—GET THIS 16 PC ELECTRONIC SERVICE TOOL KIT—FREE! A \$69.95 VALUE.**

Perfect for field service or in-shop. Contains: 4" cutter, 4 1/2" pliers, 15W soldering iron, vacuum desolder tool, anti-static wrist strap with coiled ground cord, IC extractor and 2 IC inserters with pin straighteners, 4 soldering aid tools and solder all in a zipper vinyl case.



Free tool kit offer valid on any TEK scope purchased from Joseph's... while kits lasts.

**HURRY! QUANTITIES LIMITED**  
**ORDER TOLL-FREE: 1-800-323-5925**  
**IN ILLINOIS: 312-297-4200**

**FREE SHIPPING OF ALL TEK SCOPES TO UPS DESTINATIONS**

VISA • MASTERCARD • DISCOVER • Phone Orders Welcome!  
Open Account to Rated Companies Illinois Residents Add 7% Tax.

SINCE 1947  
**Joseph Electronics**  
8830 N. Milwaukee  
Niles, IL 60648

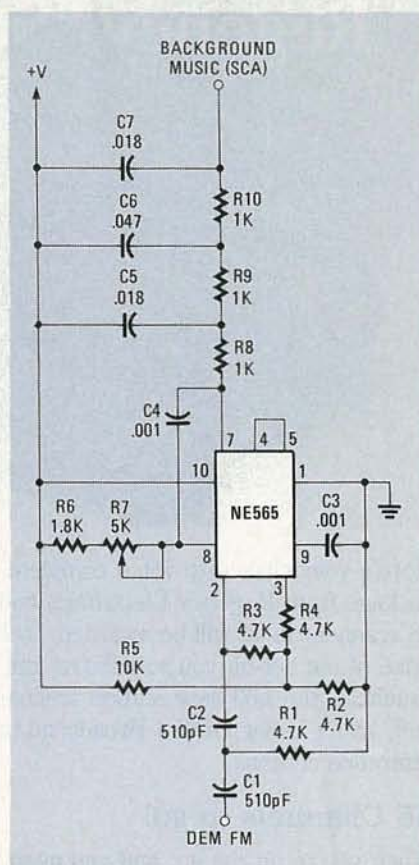

FIG. 1

the SCA signal; the circuit is taken from that company's data sheet for the device. The input to the SCA decoder circuit is connected to an FM receiver at a point between the FM discriminator and the de-emphasis filter network.

The early tube-type SCA decoders that I'm familiar with have several resonant circuits that must be tuned and aligned. Since resonant circuits are not used in the circuit shown in Fig. 1 there will be some slight spill from a stereo station's main channel. The PLL, IC1, is tuned to 67 kHz by R7, a 5K potentiometer. Tuning need not be exact since the circuit will seek and lock onto the subcarrier.

The demodulated signal from the FM receiver is fed to the input of the 565 through a high-pass filter consisting of two 510-pF capacitors (C1 and C2) and a 4.7K resistor (R1). Its purpose is to serve as a coupling network and to attenuate some of the main-channel spill. The demodulated SCA signal at pin 7 passes through a three-stage de-emphasis network as shown. The resulting signal is around 50 mV, with the response extending to around 7 kHz. R-E

You'll find 116 pages of tremendous discount prices on 25 leading instrumentation lines in JOSEPH'S TEST EQUIPMENT CATALOG. **WRITE FOR YOUR FREE COPY TODAY.**

### the fourth law of robotics

A robot shall make learning fun for man and thereby improve the quality of life for mankind.



**A robot is a robot is a robot... was a robot. Until HERO 2000.**

HERO 2000 is much more than a robot. It's a walking, talking 16-bit computer. With 64K ROM and 24K RAM expandable to more than half a megabyte. And a fully articulated arm with five axes of motion. Yours to program. Command. Modify and expand. Total system access and solderless experimenter boards provide almost limitless possibilities. Its remote RF console with ASCII keyboard gives total control. Available with three self-study courses. Backed by Heath Company, world leader in electronic kits.

Build your own HERO 2000. Or buy it assembled. Have fun learning skills that translate directly to the world of work.



# HERO<sup>®</sup> 2000

the  
knowledge  
builder

**FREE. Send today for latest Heathkit Catalog.**



Mail coupon today to receive a **FREE** Heathkit Catalog featuring HERO 2000.

Mail to: Heath Company  
Dept. 020-548  
Benton Harbor, Michigan 49022

Name \_\_\_\_\_

Address \_\_\_\_\_

City \_\_\_\_\_ State \_\_\_\_\_

Zip \_\_\_\_\_

RO-141

**Heathkit<sup>®</sup>**  
Heath  
Company

A subsidiary of Zenith Electronics Corporation.

CIRCLE 86 ON FREE INFORMATION CARD

# LETTERS



**THE POLAPULSE BATTERY**  
 The article, "Using the Polapulse Battery," by Fred Blechman in the February 1987 **Radio-Electronics** was well-written, and the many unique properties of the Polaroid battery line were described very well. There were, however, a few small errors that we would like to correct.

The first paragraph should state that the P500 battery gives 100 mA for 12 hours, not 20 hours. The P70 battery was developed for use in the original SX-70 film. The 600

film pack, which usually must power an electronic flash as well as the camera, uses the new higher-power P80, as described correctly. The special contact described in the article is available from us, but only in minimum lots of 100 pieces. Under carefully controlled conditions only, the P100 battery has been successfully recharged; but under no circumstances should the P500 battery be charged.

Ameritoy has new address: 6039 West Washington Blvd., Culver City, CA 90232. Exergen has moved

to 251 W. Central St., Natick, MA 01760; Sinclair no longer sells the P500 batteries at a loss, and a limited number of their TV sets are still available from A+ Computer Response, 69B Island St., Keene, NH 03431.

The article did not mention the Polaroid Safety Flasher, a compact amber flashing light that weighs just 4 oz., but which can be seen for over a mile, and runs over 4 hours on one P100 battery. Those are distributed by Consumer Products Source, 881 Dover Drive,

## TEST INSTRUMENTS High Quality Lowest Prices Off-The-Shelf

*New!* **MINI-METERS w/MAXI-SPECS**

**SCOPE 3 1/2 Digit LCD with 8 Full Functions**  
**Model DVM-632 \$4495**  
 Deluxe test leads included  
 • 0.5% accuracy • Transistor gain test • Audible continuity checking & diode test  
 • 10 Amp measurement

**SCOPE 3 1/2 Digit LCD Multimeter**  
**Model DVM-630 \$2995**  
 Test leads included • 0.5% accuracy • 6 functions, 19 ranges • Automatic zero adjust • Low battery indication  
 • Measures 5" x 2 3/4" x 7/8"

**B & K 20 MHz Dual Trace**  
**Model 2120 \$37995**  
 Probes included • 20 and 26 MHz band widths • TVV and TVH • X-Y operation • Trace rotation: adjustable front panel • Channel 1 output

**SCOPE 3 1/2 Digit Capacitance**  
**Model DCM-602 \$6995**  
 Test leads included • 8 ranges with full scale values to 2000 uF • LSI circuit  
 • Crystal time base • Frequency range 800 Hz to 8 Hz

**SCOPE 3 1/2 Digital Multimeters**  
**Model DVM-638 \$7995**  
 Test leads included • 11 function, 38 ranges • Logic level detector • Audible visual continuity • capacitance and conductance measurement.

**Model DVM-634 \$4875**    **Model DVM-636 \$6275**  
 • 7 function, 32 ranges    • 8 function, 37 ranges  
 • Transistor measurement    • Capacitance measurement

**SCOPE Pocket Sized Audio Signal Generator**  
**Model RC-555 \$6995**  
 Test leads & 9V battery included • Low distortion sine-wave signal • 46 step selected frequency • x1 range 20 Hz to 1.5 KHz/x100 range 2KHz to 150 KHz

**HITACHI 35 MHz Dual Trace Oscilloscope**  
**Model V-355 \$59995**  
 (Reg. \$899.95)  
 Probes included • Thin, lightweight, compact • Large 6" rectangular, internal graticule CRT • Autofocus

**FORDHAM Sweep Function Generator**  
**Model FG-801 \$21995**  
 (Reg. \$289.95)  
 Test leads included • 7 frequency ranges, 0.2 Hz to 2 MHz • Accuracy to ±5%

**FORDHAM 550 MHz Frequency Counter**  
**Model FM-8 \$16995**  
 (Reg. \$249.95)  
 Completely assembled, pre-tested, precalibrated • High intensity 8-digit LED display

*New!* **SCOPE 4 1/2 Digit LCD Bench Digital Multimeter**  
**Model DVM-6005 \$19995**  
 Test lead set & 6 "D" size batteries included • 0.4" high characters • Conversion period: 500 milliseconds  
 • Automatic, negative polarity

*Ask for our FREE Catalog*

**Fordham** TOLL FREE **800-645-9518**  
 260 Motor Parkway, Hauppauge, NY 11788    In New York State 800-832-1446

FOR ORDERS	ADD	FOR ORDERS	ADD
\$25-100	\$4.50	\$751-1,000	\$12.50
\$101-250	\$6.00	\$1,001-1,500	\$16.50
\$251-500	\$8.00	\$1,501-2,000	\$20.00
\$501-750	\$10.50	\$2,001 and up	\$25.00



# NEW! Turbo Scan™ Scanners

Communications Electronics™, the world's largest distributor of radio scanners, introduces new lower prices to celebrate our 16th anniversary.

## NEW! Regency® TS2-MA

Allow 30-120 days for delivery after receipt of order due to the high demand for this product.

List price \$499.95/CE price \$319.95  
**12-Band, 75 Channel • Crystalless • AC/DC**  
Frequency range: 29-54, 118-175, 406-512, 806-950 MHz. The Regency TS2 scanner lets you monitor Military, Space Satellites, Government, Railroad, Justice Department, State Department, Fish & Game, Immigration, Marine, Police and Fire Departments, Aeronautical AM band, Paramedics, Amateur Radio, plus thousands of other radio frequencies most scanners can't pick up. The Regency TS2 features new 40 channel per second Turbo Scan™ so you won't miss any of the action. Model TS1-MA is a 35 channel version of this radio without the 800 MHz. band and costs only \$239.95.

## Regency® Z60-MA

List price \$299.95/CE price \$184.95/SPECIAL  
**8-Band, 60 Channel • No-crystal scanner**  
Bands: 30-50, 88-108, 118-136, 144-174, 440-512 MHz. The Regency Z60 covers all the public service bands plus aircraft and FM music for a total of eight bands. The Z60 also features an alarm clock and priority control as well as AC/DC operation. Order today.

## Regency® Z45-MA

List price \$259.95/CE price \$159.95/SPECIAL  
**7-Band, 45 Channel • No-crystal scanner**  
Bands: 30-50, 118-136, 144-174, 440-512 MHz. The Regency Z45 is very similar to the Z60 model listed above however it does not have the commercial FM broadcast band. The Z45, now at a special price from Communications Electronics.

## Regency® RH250B-MA

List price \$699.95/CE price \$329.95/SPECIAL  
**10 Channel • 25 Watt Transceiver • Priority**  
The Regency RH250B is a ten-channel VHF land mobile transceiver designed to cover any frequency between 150 to 162 MHz. Since this radio is synthesized, no expensive crystals are needed to store up to ten frequencies without battery backup. All radios come with CTCSS tone and scanning capabilities. A monitor and night/day switch is also standard. This transceiver even has a priority function. The RH250 makes an ideal radio for any police or fire department volunteer because of its low cost and high performance. A 60 Watt VHF 150-162 MHz. version called the RH600B-MA is available for \$439.95. A UHF 15 watt version of this radio called the RU150B-MA is also available and covers 450-482 MHz. but the cost is \$439.95.

## Bearcat® 50XL-MA

List price \$199.95/CE price \$114.95/SPECIAL  
**10-Band, 10 Channel • Handheld scanner**  
Bands: 29.7-54, 136-174, 406-512 MHz. The Uniden Bearcat 50XL is an economical, handheld scanner with 10 channels covering ten frequency bands. It features a keyboard lock switch to prevent accidental entry and more. Also order the new double-long life rechargeable battery pack part # BP55 for \$29.95, a plug-in wall charger, part # AD100 for \$14.95, a carrying case part # VCO01 for \$14.95 and also order optional cigarette lighter cable part # PS001 for \$14.95.

## NEW! Scanner Frequency Listings

The new Fox scanner frequency directories will help you find all the action your scanner can listen to. These new listings include police, fire, ambulances & rescue squads, local government, private police agencies, hospitals, emergency medical channels, news media, forestry radio service, railroads, weather stations, radio common carriers, AT&T mobile telephone, utility companies, general mobile radio service, marine radio service, taxi cab companies, tow truck companies, trucking companies, business repeaters, business radio (simplex) federal government, funeral directors, veterinarians, buses, aircraft, space satellites, amateur radio, broadcasters and more. Fox frequency listings feature call letter cross reference as well as alphabetical listing by licensee name, police codes and signals. These Fox directories are \$14.95 each plus \$3.00 shipping. State of Alaska-RL019-1; State of Arizona-RL025-1; Buffalo, NY/ Erie, PA-RL009-2; Chicago, IL-RL014-1; Cincinnati/ Dayton, OH-RL006-2; Cleveland, OH-RL017-1; Columbus, OH-RL003-2; Dallas/Ft. Worth, TX-RL013-1; Denver/Colorado Springs, CO-RL027-1; Detroit, MI/ Windsor, ON-RL008-2; Fort Wayne, IN/Lima, OH-RL001-1; Hawaii/Guam-RL015-1; Indianapolis, IN-RL022-1; Kansas City, MO/ KS-RL011-2; Long Island, NY-RL026-1; Louisville/Lexington, KY-RL007-1; Milwaukee, WI/Waukegan, IL-RL021-1; Minneapolis/St. Paul, MN-RL010-2; Nevada/E. Central CA-RL028-1; Oklahoma City/Lawton, OK-RL005-2; Orlando/Daytona Beach, FL-RL012-1; Rochester/Syracuse, NY-RL020-1; San Diego, CA-RL018-1; Tampa/St. Petersburg, FL-RL004-2; Toledo, OH-RL002-3. Regional directories which cover police, fire ambulance & rescue squads, local government, forestry, marine radio, mobile phone, aircraft and NOAA weather are available for \$19.95 each. RD001-1 covers AL, AR, FL, GA, LA, MS, NC, PR, SC, TN & VI. RD002-1 covers IL, IN, KY, MI, OH & WI. For an area not shown above call Fox at 800-543-7892 or in Ohio 800-621-2513.

## Regency® HX1500-MA

List price \$369.95/CE price \$218.95  
**11-Band, 55 Channel • Handheld/Portable**  
**Search • Lockout • Priority • Bank Select**  
**Sidelit liquid crystal display • EAROM Memory**  
**Direct Channel Access Feature • Scan Delay**  
Bands: 29-54, 118-136, 144-174, 406-420, 440-512 MHz. The new handheld Regency HX1500 scanner is fully keyboard programmable for the ultimate in versatility. You can scan up to 55 channels at the same time including the AM aircraft band. The LCD display is even sidelit for night use. Includes belt clip, flexible antenna and earphone. Operates on 8 1.2 Volt rechargeable Ni-cad batteries (not included). Be sure to order batteries and battery charger from the accessory list in this ad.

## Bearcat® 100XL-MA

List price \$349.95/CE price \$178.95/SPECIAL  
**9-Band, 16 Channel • Priority • Scan Delay**  
**Search • Limit • Hold • Lockout • AC/DC**  
Frequency range: 30-50, 118-174, 406-512 MHz. Included in our low CE price is a sturdy carrying case, earphone, battery charger/AC adapter, six AA ni-cad batteries and flexible antenna. Order your scanner now.

### ★★★ SPECIAL SAVINGS COUPON ★★★

★★★ FREE DURACELL® Batteries Included ★★★  
★★★★ Free local frequency directories ★★★★★  
Save even more with this special coupon. As long as your order is prepaid by money order, you'll get extra special pricing on items listed in this coupon. In addition, if you order a Bearcat 50XL or Regency HX1500 scanner with this coupon, you'll get a free set of Duracell batteries which we recommend for best performance. If you buy a Regency Z60 or Z45 scanner using this coupon, you'll get a free Fox frequency directory worth \$14.95. This coupon must be included with your prepaid order. Credit cards and quantity discounts are excluded from this offer. Offer valid only on prepaid orders mailed directly to Communications Electronics Inc., P.O. Box 1045 - Dept. M3, Ann Arbor, Michigan 48106-1045 U.S.A. Coupon expires July 31, 1987. Coupon may not be used in conjunction with any other offer from Communications Electronics Inc. Be sure to add shipping & handling fees listed in this ad (add \$3.00 for shipping free books or batteries).

RH250B-M3 Regency 25 W. VHF Transceiver.....\$299.95  
RH600B-M3 Regency 60 W. VHF Transceiver.....\$388.95  
RU150B-M3 Regency 15 W. UHF Transceiver.....\$399.95  
UC102-M3 Regency 1 W. VHF2 channel trans.....\$119.95  
HX1500-M3 Regency 55 channel scanner.....\$217.95  
Z60-M3 Regency 60 channel scanner.....\$158.95  
Z45-M3 Regency 45 channel scanner.....\$148.95  
BC100XL-M3 Bearcat 16 channel scanner.....\$177.95  
BC800XL-M3 Bearcat 40 channel scanner.....\$278.95  
INF1-M3 Regency Informant scanner.....\$249.95  
BC210XW-M3 Bearcat 20 channel scanner.....\$168.95  
BC50XL-M3 Bearcat 10 channel scanner.....\$113.95  
RD55-M3 Uniden Radar Detector.....\$97.95

### ★★★ SPECIAL SAVINGS COUPON ★★★

## Bearcat® 800XLT-MA

List price \$499.95/CE price \$289.95/SPECIAL  
**12-Band, 40 Channel • No-crystal scanner**  
**Priority control • Search/Scan • AC/DC**  
Bands: 29-54, 118-174, 406-512, 806-912 MHz. The Uniden 800XLT receives 40 channels in two banks. Scans 15 channels per second. Size 9 1/4" x 4 1/2" x 1 1/2".

### OTHER RADIOS AND ACCESSORIES

Panasonic RF-2600-MA Shortwave receiver.....\$179.95  
RD55-MA Uniden Visor mount Radar Detector.....\$98.95  
NEW! BC70XLT-MA Bearcat 20 channel scanner.....\$169.95  
BC145XL-MA Bearcat 16 channel scanner.....\$98.95  
BC140-MA Bearcat 10 channel scanner.....\$89.95  
BC210XW-MA Bearcat 20 channel scanner.....\$169.95  
BC-WA-MA Bearcat Weather Alert.....\$38.95  
PC22-MA Uniden remote mount CB transceiver.....\$99.95  
PC55-MA Uniden mobile mount CB transceiver.....\$59.95  
NEW! R1080-MA Regency 30 channel scanner.....\$118.95  
NEW! R1090-MA Regency 45 channel scanner.....\$148.95  
NEW! INF1-MA Regency Informant scanner.....\$289.95  
UC102-MA Regency VHF 2 ch. 1 Watt transceiver.....\$124.95  
P1405-MA Regency 5 amp regulated power supply.....\$69.95  
P1412-MA Regency 12 amp reg. power supply.....\$164.95  
MA549-MA Drop-in charger for HX1200 & HX1500.....\$84.95  
MA518-MA Wall charger for HX1500 scanner.....\$14.95  
MA553-MA Carrying case for HX1500 scanner.....\$19.95  
MA257-MA Cigarette lighter cord for HX12/1500.....\$19.95  
MA917-MA Ni-Cad battery pack for HX1000/1200.....\$34.95  
SMMX7000-MA Svc. man. for MX7000 & MX5000.....\$19.95  
B-4-MA 1.2 V AAA Ni-Cad batteries (set of four).....\$9.95  
B-8-MA 1.2 V AA Ni-Cad batteries (set of eight).....\$17.95  
FB-E-MA Frequency Directory for Eastern U.S.A.....\$14.95  
FB-W-MA Frequency Directory for Western U.S.A.....\$14.95  
ASD-MA Air Scan Directory.....\$14.95  
SRF-MA Survival Radio Frequency Directory.....\$14.95  
TSG-MA "Top Secret" Registry of U.S. Govt. Freq.....\$14.95  
TIC-MA Techniques for Intercepting Comm.....\$14.95  
RRF-MA Railroad frequency directory.....\$14.95  
EEC-MA Embassy & Espionage Communications.....\$14.95  
CIE-MA Covert Intelligent, Elect. Eavesdropping.....\$14.95  
A60-MA Magnet mount mobile scanner antenna.....\$35.95  
A70-MA Base station scanner antenna.....\$35.95  
USAMM-MA Mag mount VHF/UHF ant. w/ 12' cable.....\$39.95  
USAK-MA 3/4" hole mount VHF/UHF ant. w/ 17' cable.....\$35.95  
USATLM-MA Trunk lip mount VHF/UHF antenna.....\$35.95  
Add \$3.00 shipping for all accessories ordered at the same time.  
Add \$12.00 shipping per shortwave receiver.  
Add \$7.00 shipping per scanner and \$3.00 per antenna.

### BUY WITH CONFIDENCE

To get the fastest delivery from CE of any scanner, send or phone your order directly to our Scanner Distribution Center. Michigan residents please add 4% sales tax or supply your tax I.D. number. Written purchase orders are accepted from approved government agencies and most well rated firms at a 10% surcharge for net 10 billing. All sales are subject to availability, acceptance and verification. All sales on accessories are final. Prices, terms and specifications are subject to change without notice. All prices are in U.S. dollars. Out of stock items will be placed on backorder automatically unless CE is instructed differently. A \$5.00 additional handling fee will be charged for all orders with a merchandise total under \$50.00. Shipments are F.O.B. Ann Arbor, Michigan. No COD's. Most products that we sell have a manufacturer's warranty. Free copies of warranties on these products are available prior to purchase by writing to CE. Non-certified checks require bank clearance. Not responsible for typographical errors.

Mail orders to: Communications Electronics, Box 1045, Ann Arbor, Michigan 48106 U.S.A. Add \$7.00 per scanner for R.P.S./U.P.S. ground shipping and handling in the continental U.S.A. For Canada, Puerto Rico, Hawaii, Alaska, or APO/FPO delivery, shipping charges are three times continental U.S. rates. If you have a Discover, Visa or Master Card, you may call and place a credit card order. Order toll-free in the U.S. Dial 800-USA-SCAN. In Canada, order toll-free by calling 800-221-3475. FTCC Telex anytime, dial 825333. If you are outside the U.S. or in Michigan dial 313-973-8888. Order today.

Scanner Distribution Center™ and CE logos are trademarks of Communications Electronics Inc.  
† Bearcat is a registered trademark of Uniden Corporation.  
‡ Regency and Turbo Scan are registered trademarks of Regency Electronics Inc. AD #050487-MA/M3  
Copyright © 1987 Communications Electronics Inc.

For credit card orders call  
**1-800-USA-SCAN**

**COMMUNICATIONS ELECTRONICS INC.**

Consumer Products Division  
P.O. Box 1045 □ Ann Arbor, Michigan 48106-1045 U.S.A.  
Call 800-USA-SCAN or outside U.S.A. 313-973-8888  
CIRCLE 79 ON FREE INFORMATION CARD



Regency  
RH250



MODEL TS-2



MODEL HX 1500

# Learn robotics and you build this

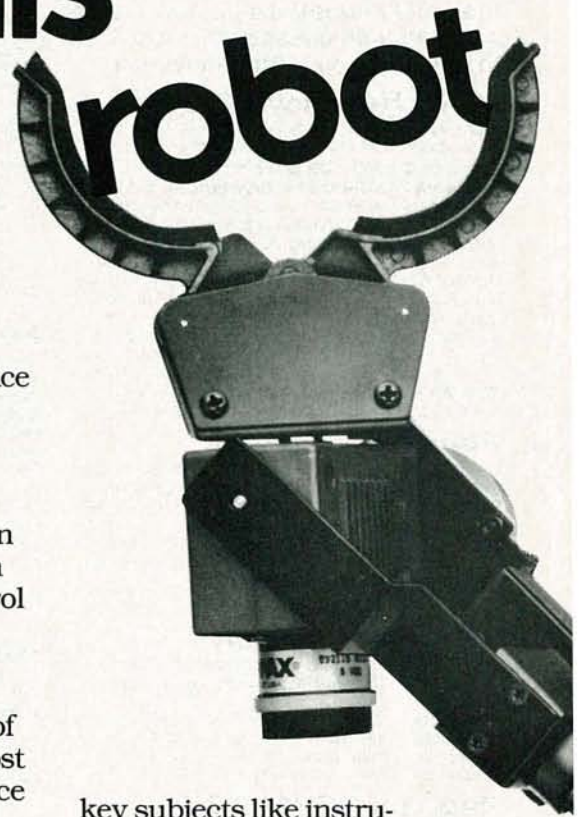

**New NRI home training prepares you for a rewarding career in America's newest high-technology field.**

The wave of the future is here. Already, advanced robotic systems are producing everything from precision electronic circuits to automobiles and giant locomotives. By 1990, over 100,000 "smart" robots will be in use.

## **Over 25,000 New Jobs**

Keeping this robot army running calls for well-trained technicians . . . people who understand advanced systems and controls. By the end of the decade, conservative estimates call for more than 25,000 new technical jobs. These are the kind of careers that pay \$25,000 to \$35,000 a year right now. And as demand continues

to grow, salaries have no place to go but up!

## **Build Your Own Robot As You Train at Home**

Now, you can train for an exciting, rewarding career in robotics and industrial control right at home in your spare time. NRI, with 70 years of experience in technology training, offers a new world of opportunity in one of the most fascinating growth fields since the computer.

You need no experience, no special education. NRI starts you at the beginning, takes you in easy-to-follow, bite-size lessons from basic electronics right on through

key subjects like instrumentation, digital and computer controls, servomotors and feedback systems, fluidics, lasers, and optoelectronics. And it's all reinforced with practical, hands-on experience to give you a priceless confidence as you build a programmable, mobile robot.

## **Program Arm and Body Movement, Even Speech**

Designed especially for training, your robot duplicates all the key elements of industrial robotics. You learn to operate, program, service, and troubleshoot using the same techniques you'll use in the field. It's on-the-job training at home!



You get and keep Hero 1 robot with gripper arm and speech synthesizer, NRI Discovery Lab for electronic experimentation, professional multimeter with 3½-digit LCD readout, 51 fast-track training lessons.

# industrial control as

Building this exciting robot will take you beyond the state of the art into the next generation of industrial robotics.

You'll learn how your completely self-powered robot interacts with its environment to sense light, sound, and motion. You program it to travel over a set course, avoid obstacles using its sonar ranging capability. Program in complex arm and body movements using its special teaching pendant. Build a wireless remote control device demonstrating independent robot control in hazardous environments. You'll even learn to synthesize speech using the top-mounted hexadecimal keyboard.

## Training to Build a Career On

NRI training uniquely incorporates hands-on building experience to

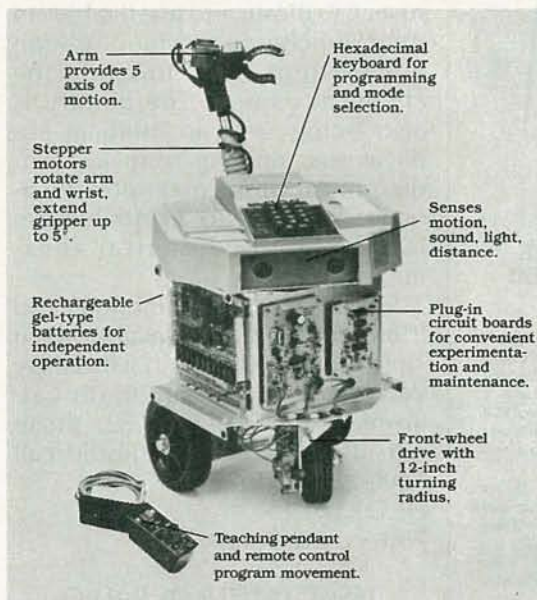

Your mobile robot duplicates functions of state-of-the-art industrial units.

reinforce your learning on a real-world basis. You get professional instruments, including a digital multimeter you'll use in experiments and demonstrations, use later in your work. And you get the exclusive NRI Discovery Lab<sup>®</sup>, where you examine and prove out theory from basic electrical concepts to the most advanced solid-state digital electronics and microprocessor technology. Devised by an experienced team of engineers and educators, your

experiments, demonstrations, and equipment are carefully integrated with 51 clear and concise lessons to give you complete confidence as you progress. Step-by-step, NRI takes you from the beginning, through today, and into an amazing tomorrow.

## Send for Free Catalog Now

Send for NRI's big free catalog describing Robotics and Industrial Control plus over a

dozen other high-technology courses. You'll see all the equipment you get in detail, get complete descriptions of every lesson, find out more about career opportunities for trained technicians. There's no cost or obligation, so send today. Your action today could mean your future tomorrow. If the card has been removed, please write us today.



## NRI SCHOOLS

McGraw-Hill Continuing Education Center  
3939 Wisconsin Ave.  
Washington, DC 20016

**WE'LL GIVE YOU TOMORROW.**



## VIDEO TAPE COPY PROTECTION GOT YOU DOWN?

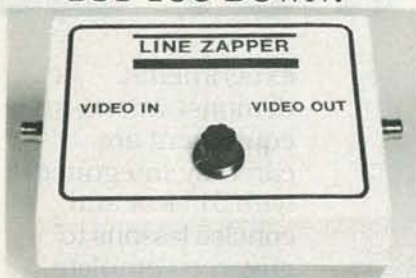

### STABILIZE YOUR PICTURE WITH THE NEW, IMPROVED LINE ZAPPER

Bothered by brightness changes, vertical jumping and jittering, and video noise? Tired of renting or buying tapes and being forced to watch an unstable washed out picture? Solve your problems with the Line Zapper.

The Line Zapper accepts direct video from any VCR and monitors the signal, line by video line. When it sees the copy protection signal it Zaps it, giving you a normal, clean signal at the output.

Available in both kit form and fully assembled. The kit is only \$69.95 (Not recommended for the beginner) plus \$3.00 shipping. Assembled, tested units with a 90 day warranty are only \$124.95 plus \$3.00 shipping.

Arizona residents must add 6.7% sales tax. Please allow 6 to 8 weeks for delivery. Dealer inquiries welcome.

**ELEPHANT ELECTRONICS INC.**



BOX 41865-F  
PHOENIX, AZ 85080  
(602) 581-1973

CIRCLE 120 ON FREE INFORMATION CARD



**THE MOST POPULAR WIRE-WOUND CB ANTENNAS IN THE WORLD**

*Because...they perform!*

#### FACT

"When CB was legalized in England, 'Firestik' antennas were barred from sale because the emitted signal was too strong. Fortunately, no other country, including the U.S., limits antenna efficiency."

**YOU CAN HAVE SECOND BEST OR, 'Firestik'!**

Call or Write for **FREE Catalog**

'Firestik' Antenna Company  
2614 East Adams  
Phoenix, Arizona 85034  
(602) 273-7151

**MILLIONS OF SATISFIED OWNERS**

CIRCLE 100 ON FREE INFORMATION CARD

Suite 14, Newport Beach, CA 19663.

The model rockets mentioned in the article are made by Estes Industries, Highway 50 West, Penrose, CO 81240, and use the P100 in their launcher to provide a sudden high-current surge to ignite the chemical engine. The battery is also being used in medical applications, ranging from the cardiac monitor in magnetic resonance imaging, to a portable defibrillator, to hospital thermometers.

Small quantities of the P100 and P500 batteries are available from Time Craft Industries, 1300 Galaxy Way, Concord, CA 94520. (In California, call 1-800-642-0232; those outside of California, should call 1-800-227-2480.)

FRED COHEN

*PowerCard Corporation*

### TESLA, FATHER OF RADIO

I have followed with interest **Radio-Electronics'** "Antique Radios" column, but I was disappointed with the treatment of Tesla in the installment that appeared in the March issue. Far from being among the inventors "who worked with electricity, but were not involved with wireless," Yugoslav-born Nikola Tesla, as early as his lecture at the Franklin Institute, in Philadelphia, in March, 1893, suggested a system consisting of "an electrical oscillator, or source of alternating current," one of the terminals of which would connect to Earth, the other to "an insulated body of large surface." That, he thought, might be used to transmit "intelligence, or perhaps even power, to any distance.... I am firmly convinced that this can be done and hope that we shall live to see it done."

Tesla continued, taking out several patents, and in 1899 gave a demonstration of radio remote control in Madison Square Garden, New York City. Model boats in a large tank were started, steered, and stopped by radio waves from a short distance.

If that is so, why then isn't Tesla hailed as the inventor of radio? Hugo Gernsback had the answer. In his article "Nikola Tesla, the Father of Wireless," written on the occasion of Tesla's death, (January

7, 1943) he says:

"By 1900 Tesla had patented a wireless system, much of which was used later to make commercial wireless possible.... These very means were used much later by Marconi and others who appropriated Tesla's ideas.

"Tesla in due time brought suit against Marconi, but could not establish his patent rights in court and blamed his failure on the paucity of technical knowledge of the times, of the lawyers and the court. When, many years later, his language had become clear, even to a mediocre technician, his patents had run out. Nevertheless, there would have been no wireless transmission without Tesla's fundamental work."

Gernsback did not know it, but at that very time, proceedings that would rectify the injustice were under way. On June 21, 1943, the Supreme Court disallowed Marconi's fundamental patent, on the basis of "earlier work by Tesla" and others. It's a true pity that Tesla did not live six more months!

Not only did Tesla outline the concepts—he was active in developing the instruments used in practical work. He devised the rotary spark gap and was the inventor of the oscillating arc, later adapted and used by de Forest for phone and in much marine telegraphy. He pioneered the high-frequency generator, used by Fessenden in the first telephone broadcast, and which became the standard high-power transmitter until it was superseded by tubes in the 1920's.

FRED SHUNAMAN (former Editor, **Radio-Electronics**)

### ENERGY STORAGE IN 2001

Here's an addendum to my article, "Energy Technology in the 21st Century," which began on page 107 of the May 1987 issue of **Radio-Electronics**:

Recently, a new superconducting oxide material has been discovered by two university research teams. That material maintains zero electrical resistance at temperatures as "high" as  $-150^{\circ}\text{F}$ ; contrast that with the maximum superconducting temperature of niobium-tin wire, which is  $-450^{\circ}\text{F}$ ,  
*continued on page 29*

# EQUIPMENT REPORTS

## Leader LCD-100 Portable DMM/Storage Oscilloscope



CIRCLE 9 ON FREE INFORMATION CARD

*Here's a 200-kHz digital storage scope  
you can (almost) fit in your pocket.*

HAVE YOU EVER WISHED FOR A COMPACT AND PORTABLE TEST instrument that combined the features of a digital multimeter with those of a storage oscilloscope yet weighed only about two pounds? Probably not—it sounds too good to be true. But Leader Instruments Corporation (380 Oser Avenue, Hauppauge, NY 11788) has developed just such an instrument: their *LCD-100*.

Not everyone needs an oscilloscope that can be held comfortably in the palm of his hand. But if portability is important to you, the *LCD-100* is worth looking at. When you first see it, you'll be tempted to say, "Gee, that's *cute!*" But when you look more closely, you'll be impressed by what it can do.

### Basic specifications

The scope has a bandwidth of 200 kHz, a vertical sensitivity of 10 millivolts/div, and a rated accuracy of  $\pm 4\%$ . Its multimeter section offers autoranging measurements of resistance, voltage, and current. The input impedance is 1 megohm.

The oscilloscope display is a  $64 \times 192$ -pixel dot matrix LCD. The settings of the scope's controls are

# HAMEG Instruments

2 year warranty

## HM 205-2

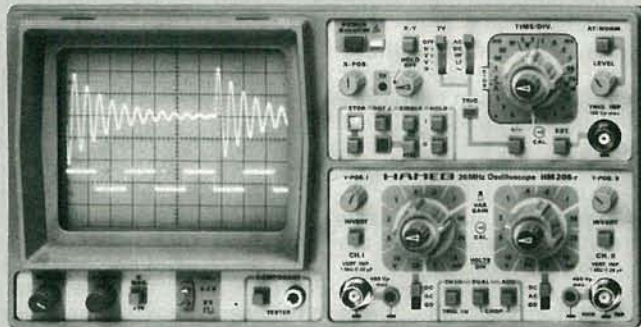

### A new Storage Oscilloscope with 5 MHz sampling rate.

This instrument offers all the outstanding features of a state-of-the-art **20MHz** realtime oscilloscope. In addition, it provides digital storage capability for signals between **50s** and **5 $\mu$ s** duration. Maximum memory is **1024x8** bits for each channel. A Dot Join feature permits linear interpolation between sample points. An X-Y recorder option and an optional  **GPIB interface** allow full integration in automatic test systems.

In many cases, the **HM 205-2** can easily replace considerably more expensive digital storage oscilloscopes.

Price incl. 2 Probes 888,- \$

Demonstration of the excellent transmission performance of the **HM 205-2** in analog mode with a fast risetime 1MHz square wave signal. All HAMEG Oscilloscopes are specified to have less than 1% aberrations and overshoot.

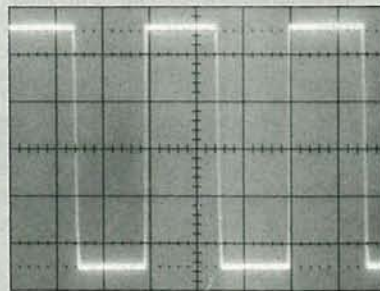

This screen photo shows a 20kHz sine wave signal in storage mode. The screen resolution of 1024 x 256 points offers an outstanding display that can easily be compared to those found on analog instruments.

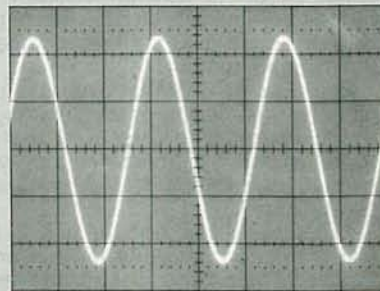

Write or call toll free 800247 1241

## HAMEG, INC.

88-90 Harbor Road · Port Washington N.Y. 11050  
Phone (516) 883.3837 · TWX (023) 497.4606

CIRCLE 62 ON FREE INFORMATION CARD

JUNE 1987

21

# Bad News For Escort

3RD IN A SERIES

Dear Customer,

From Drew Kaplan

Escort has ignored DAK's second, one-on-one Maxon versus Escort radar challenge. And frankly, I'm fighting mad. I suppose they have a right to ignore me. But after referring to my challenge as only an "advertising gambit" and calling Maxon's radar detector an off-shore, primitive, and bottom-end unit, I'd think they'd be glad to wipe us out in a head to head duel to the death. But, I'm really mad for two other reasons and I think that you may be as fascinated by them as I am.

**Mad Reason 1.** Road and Track Magazine held an independent general radar detector test in their September 86 issue.

As far as I can see, Maxon beat Passport in Uninterrupted Alert, and Passport beat Maxon in Initial alert. Now to be fair, neither of us seem to have beaten the other by even 2 seconds at 55 miles per hour. So, we didn't win or lose by much.

And, Maxon's \$99<sup>90</sup> detector was tested against the \$295 Passport, not the \$245 Escort we challenged. What's interesting is that Road and Track had nice things to say about Passport and even about Escort, which **wasn't even included** in the tests any more.

Now, if you've been following DAK's challenge, you know we've only been challenging Escort. If you've read Road and Track's tests, you'll be amazed when you read Boardroom Reports, which I've reprinted for you to the right. What's really interesting is that **it's the exact same person** in both publications.

Actually, Maxon did extremely well. Road and Track only used 'over hill' and 'around curve' tests because on straight-aways the differences weren't worth describing. (Imagine that!)

It's just as I've said in my challenge. I don't think there's much difference between Maxon's and Cincinnati's Radar detectors when it comes to sensing radar.

## THE CHALLENGE GROWS

In view of the opinions stated in the article in Boardroom Reports about the \$245 Escort, DAK hereby adds the \$295 Passport to our challenge.

**Mad Reason 2.** Did you ever hear about the cure for dandruff that was developed in the middle-ages? It was the guillotine. And frankly, I think you should be aware of Cincinnati Micro-

wave's advertising cure for the Rashid VRSS Collision Avoidance System.

The Rashid VRSS system, as described in Popular Science magazine, January 1986, sends out a radar signal on the K band ahead of your car. The good part is that it can help you avoid running into things higher than your front bumper. The bad news is that since it operates on K band, it sets off radar detectors.

Well, hats off to Cincinnati Microwave. I've tested the Passport against the Rashid unit and, as usual, they have done a splendid job. While every other detector I tested, including Maxon's, was driven crazy, theirs didn't utter a peep.

But then, my Maxon hasn't uttered any peeps lately either and let me tell you why. I was on my way to the Far East to visit Maxon, so I asked Tom, a manager at DAK, to purchase and test the Rashid.

Well, did I ever hear from him. First the unit cost \$558 plus about \$100 to install. Then buying it and finding someone to install it took almost a month.

But the real reason he was unhappy was that the recommended method of installation involved **cutting a 6 1/2" hole** in the front grill of his neat new car.

Well, much to my wife's chagrin, it's now installed in her station wagon.

After installation, it has to be set by an installer. He drives between 15 and 30 miles per hour toward a solid object. When the installer **thinks** he's reached a safe stopping distance, he adjusts the warning alarms to sound. Then in the future, when a similar distance is reached, lights will flash and an alarm will sound.

Of course, if you accelerate too quickly into a lane behind another car the same alarms can go off.

And, I haven't figured out what to do if

there's a dog in the road, dirt on the radar sensor, or how to compensate for the different stopping distances encountered on dry, wet, icy or snowy roads.

## MOST IMPORTANT PART

Speaking of advertising gambits, in **virtually every magazine I pick up**, I've been seeing Cincinnati's Bad News for Radar Detector ads spelling out the obsolescence of all other detectors.

If it's such an important feature that distinguishes them from us, there had better be some of these devices on the road, or Cincinnati Microwave's credibility may just be on the road as well.

**I will add \$10,000 to my Escort/Passport challenge** if Cincinnati Microwave can prove that there are even 1000 Rashid units on the road **anywhere** in the U.S. Oh heck, I'll add \$5000 if they can even find 500. (And, look at this.)

**NOTE:** There are several other potential collision avoidance systems on the drawing boards and each may have a **DIFFERENT FINGERPRINT**.

So, if you're a current Escort or Passport owner, I suggest that you find out how many Rashid units there are and what Cincinnati Microwave will do about the 'other' units **before** you pay \$\$\$ to have your current detector upgraded.

Besides, with over 3,000,000 square miles in the U.S., even 1,000 units would work out to less than one unit for every 3,000 square miles.

If a major car company successfully sells a collision avoidance system, then Maxon will be ready. But, the car companies currently can't even get consumers to pay \$200 for air bags. So, you decide. Is it significant, or an advertising gambit?

Below is the **NEW** version of the challenge. Escort, a reply please!

# A \$20,000 Challenge To Escort

Let's cut through the Radar Detector Glut. We challenge Escort & Passport to a one on one Distance and Falsing 'duel to the death' on the highway of their choice. If they win, the \$20,000 check pictured below is theirs.

By Drew Kaplan

We've put up our \$20,000. We challenge Escort to take on Maxon's new Dual Superheterodyne RD-1 \$99<sup>90</sup> radar detector on the road of their choice in a one on one conflict.

Even Escort says that everyone compares themselves to Escort, and they're right. They were the first in 1978 to use superheterodyne circuits and they've got a virtual stranglehold on the magazine test reports.

But, the real question today is: 1) How many feet of sensing difference, if any, is there between this top of the line Maxon Detector and Escort's or Passport's? And 2) Which unit is more accurate at interpreting real radar versus false signals?

So Escort, you pick the road (continental U.S. please). You pick the equipment to create the false signals. (Don't forget our \$10,000 Rashid challenge). And finally, you pick the radar gun.

Maxon and DAK will come to your  
...Next Page Please



... Challenge Continued highway with engineers and equipment to verify the results.

And oh yes, we'll have the \$20,000 check (pictured) to hand over if you beat us by more than 10 feet in either X or K band detection with the Escort, or by 2 seconds at 55mph with the Passport.

**BOB SAYS MAXON IS BETTER**

Here's how it started. Maxon is a mammoth electronics prime manufacturer. They actually make all types of sophisticated electronic products for some of the biggest U.S. Electronics Companies. (No, they don't make Escort's).

Bob Thetford, the president of Maxon Systems Inc., and a friend of mine, was explaining their new RD-1 anti-falsing Dual Superheterodyne Radar detector to me. I said "You know Bob, I think Escort really has the market locked up." He said, "Our new design can beat theirs".

So, since I've never been one to be in second place, I said, "Would you bet \$20,000 that you can beat Escort?" And, as they say, the rest is history.

By the way, Bob is about 6'9" tall, so if we can't beat Escort, we can sure scare the you know what out of them. But, Bob and his engineers are deadly serious about this 'duel'. And you can bet that our \$20,000 is serious.

**We ask only the following.** 1) The public be invited to watch. 2) Maxon's Engineers as well as Escort's check the radar gun and monitor the test and the results.

3) The same car be used in both tests. 4) We'd like an answer from Escort no later than July 31, 1987 and 60 days notice of the time and place of the conflict. 5) If Escort can prove that there are 1,000, or even 500 Rashid units in operation, we will present them with the appropriate \$10,000 or \$5,000 check at the beginning of the conflict. And, 6) We'd like them to come with a \$20,000 check made out to DAK if we win.

**HOW'S THIS FOR FAIR**

Cincinnati Microwave will be deemed the winner and given the check if either

Escort beats Maxon by 10 feet in both uninterrupted and initial alerts, OR if Passport beats Maxon by 2 seconds at 55mph in both uninterrupted and initial alerts. So, DAK wins only if we beat both Escort and Passport.

A tie will exist only if both the \$295 Passport and \$245 Escort fail to beat Maxon's \$99<sup>90</sup> Dual Superheterodyne RD-1 Radar Detector.

**SO,WHAT'S**

**DUAL SUPERHETERODYNE?**

Ok, so far we've set up the conflict. Now let me tell you about the new dual superheterodyne technology that lets Maxon leap ahead of the pack.

It's a technology that tests each suspected radar signal 4 separate times before it notifies you, and yet it explodes into action in just 1/4 of one second.

Just imagine the sophistication of a device that can test a signal 4 times in less than 1/4 of one second. Maxon's technology is mind boggling.

**But, using it isn't.** This long range detector has all the bells and whistles. It has separate audible sounds for X and K radar signals because you've only got about 1/3 the time to react with K band.

There's a 10 step LED Bar Graph Meter to accurately show the radar signal's strength. And, you won't have to look at a needle in a meter. You can see the Bar Graph Meter with your peripheral vision and keep your eyes on the road and put your foot on the brake.



So, just turn on the Power/Volume knob, clip it to your visor or put it on your dash. Then plug in its cigarette lighter cord and you're protected.

And you'll have a very high level of protection. Maxon's Dual Conversion Scanning Superheterodyne circuitry combined with its ridge guide wideband horn internal antenna, really ferrets out radar signals.

**By the way, Escort,** we'll be happy to have our test around a bend in the road or over a hill. Maxon's detector really picks up 'ambush type' radar signals.

And the key word is 'radar', not trash signals. The 4 test check system that operates in 1/4 second gives you extremely high protection from signals from other detectors, intrusion systems and garage door openers.

So, when the lights and X or K band sounds explode into action, take care, there's very likely police radar nearby. You'll have full volume control, and a City/Highway button reduces the less important X band reception in the city.

Maxon's long range detector comes complete with a visor clip, hook and loop dash board mounting, and the power cord cigarette adaptor.

It's much smaller than Escort at just 3 1/2" Wide, 4 3/4" deep and 1 1/2" high. But, it is larger than Passport. It's backed by Maxon's standard limited warranty.

Note from Drew: 1) Use of radar detectors is illegal in some states.

2) Speeding is dangerous. Use this detector to help keep you safe when you forget, not to get away with speeding.



**CHECK OUT RADAR YOURSELF RISK FREE**

Put this detector on your visor. When it sounds, look around for the police. There's a good chance you'll be saving money in fines and higher insurance rates. And, if you slow down, you may even save lives.

If you aren't 100% satisfied, simply return it in its original box within 30 days for a courteous refund.

To get your Maxon, Dual Superheterodyne, Anti-Falsing Radar Detector risk free with your credit card, call toll free or send your check for just \$99<sup>90</sup> (\$4 P&H). Order No. 4407. CA res add tax.

**Special Note:** Now that we're challenging Passport, we've added an optional suction cup windshield mount and extra coiled power cord. (Sorry we can't afford to throw them in for free.)



They're just \$5<sup>90</sup> (\$1 P&H) Or. No. 4800. OK Escort, it's up to you. We've got \$20,000 that says you can't beat Maxon on the road. Your answer, please?

Escort and Passport are registered trademarks of Cincinnati Microwave. Rashid VRSS, and Rashid Radar Safety Brake are registered trademarks of Vehicle Radar Safety Systems, Inc.

**DAK INDUSTRIES INC.**  
Call Toll Free For Credit Card Orders Only  
24 Hours A Day 7 Days A Week  
RE64 **1-800-325-0800**

For Toll Free Information, Call 6AM-5PM Monday-Friday PST  
**Technical Information... 1-800-272-3200**  
**Any Other Inquiries... 1-800-423-2866**  
8200 Remmet Ave., Canoga Park, CA 91304

**John Tomerlin, Road & Track**  
**Radar detectors**

Today's best radar detectors aren't much bigger than a pack of cigarettes. They weigh less than eight ounces and have exciting new circuitry.

**What to look for:**

- X-band and K-band sensitivity. Both are used by the police.
- Different alarm sounds for the different types of speed radar. K-band radar is used in the newer instant-on radar units where police locate themselves out of sight of this type of radar. Since X-band radar, a warning buzz doesn't call for an instant reaction. The driver can gradually slow down as the intensity of the alarm increases. X-band is also used in many automatic burglar alarms, which makes it much more likely to generate false alarms.
- False-alarm filtering. Most newer models have specialized circuits that filter out many false alarms. Since many older models don't have good filtering capability, they build up great if almost impossible to determine whether the near-constant buzzing means that speed radar is being used or device gets closer.
- Easy mounting method. Good detectors have become almost as popular with thieves as car stereos. It helps if a unit is simple for the owner to remove whenever he leaves the car.
- Bright visual display. The best detectors have light emitting diodes (LEDs) that glow brightly during daylight. Caution: Analogs meters that use needles on a numeric scale are less useful, and they can be dangerous, because the driver has to focus on the meter to see exactly where the needle is.

**The best at any price:** Cincinnati Microwave's Passport. The price is a steep \$295 for this 6 1/2-ounce unit that measures 1/2" high x 4 1/4" deep x 2 1/2" wide. Features: Dual-tone alarm, automatic brightness adjustment of the LED false-alarm filter, a very sophisticated buzzer that allows the driver to turn the switch off during one radar contact and have it reset automatically for the next encounter. Caution: Don't mistake Cincinnati Microwave's Escort for the Passport. It was once the best available but is less technologically sophisticated than Escort. Both units are available only directly from the factory, there's no price discounting.

**Good protection for half the price:** The Cobra Transceptor offers many of the same features as the Passport for a suggested retail price of \$234. Major drawbacks: In bright sunlight it's difficult to tell if the LED lights are on. Others worth considering: B.E. Electronics Limited's Micro Eye XAR-LE, \$299.95 and Micro Eye Spectrum 2, \$140.

Reprinted with permission of Boardroom Reports, 330 West 42nd Street, New York, NY 10036.

Boardroom Reports □ September 15, 1986





. . . Publishing Continued

It simply removes the last thing you did. So, no matter what you do wrong, you're a button away from removing it.

If you don't want a solid line, just spray an area. It's like using a spray can.

Let's say you want to connect two points with a straight line. Use the Angle Line. It produces a computer generated straight line between any two points.

What if you want a circle? Just touch the return key. Then use the diagonal arrow key to enlarge or reduce the circle. If you use the up/down or right/left arrows, you'll get an ellipse.

In the same way you can create squares, rectangles or triangles. And you'll be amazed how many things, from houses to technical drawings, are made up of squares, rectangles, circles and triangles.

But, that's not all. You can choose any of 32 background patterns to fill in enclosed areas or broad lines. And if 32 isn't enough, you can design your own.

There's so much more. You can juggle a picture. Imagine, turning it over or sideways with the touch of a button.

You can copy or move a picture or even part of a picture right on the screen. So, draw it once and copy it or move it.

But, here's my favorite. You can enlarge or reduce any picture or part of a picture right on the screen. So you can change its size equally, or you can stretch it out or make it tall and thin. Wow!

There are 12 included font/sizes. So you can have large or small type in your choice of styles within a picture or integrated with your text.

And, each of the 12 font/sizes can be shown on the screen and printed normally, in bold, in italic, in outline, or in shadow. Plus, you can write normally across the page, up the page, down the page or upside down.

Finally, you can zoom into any small section of the screen and edit your pictures, pixel by pixel. With this kind of power, you don't need to be an artist, just have the ability to push a button.

You can operate this Paint program independently. Or, you can access any picture from within word processing.

So, for banners and pictures, you can

print directly from the Paint Program. Or, for everything previously described, simply access your pictures, captions, graphs or charts through the desktop publishing section.

This program is incredibly powerful, yet you'll be comfortable using it within just a few hours.

Every picture in this ad was created with this program. And, you haven't even seen the tip of the iceberg of its capabilities. For example, if you have a picture on the screen, you can bring a second picture up and join them together.

### WHO CAN USE THE SYSTEM

All you need is an IBM PC, AT, XT or 100% compatible with standard IBM CGA or EGA graphics capability. It must have at least 256K, and either two floppy disk drives or one floppy and a hard disk.

Below is a list of some of the dot matrix, ink jet and daisy wheel printers that have been tested with this program. If your printer is compatible with any of these printers, it should work too.

**Special Note:** Most daisy wheel printers are Diablo 620/630 compatible, so they will work with this program.

**Special Note:** With a color printer you can print 3 colors plus black text.

C. Itoh 8510, Epson Fx-80, Fx-85, Fx-185, Jx-80 (color), LQ-800, LQ1500, LX80, MX80 with Graftrax Plus or Graftrax, RX-80, Hewlett Packard 2225C Think Jet or QuietJet, LaserJet, or LaserJet Plus, IBM 80CPS Graphics Printer, IBM Proprinter, IBM 3852 Jetprinter (color), Juki 6100, Mannesmann Tally Spirit 80, NEC 3500, 3510, 3520, 3530, 3550, 5500 series, 8023A, NEC Pinwriter P5XL, P6, P7, (single or color), OKIDATA Microline 92, ML92, w/IBM Plug & Play, Microline 193, 20 (color), Panasonic KX-P1091, KX-P1091i, Quadram Quadjet (color), Radio Shack DMP-200, Silver Reed EXP 400, 600, 800 and all EXP series, Star Micronics SG-10, Texas Instruments 855, 865, Xerox (Diablo) 620, 630.

### FINAL FACTS

There's a pop down calculator which lets you deposit your results right into your text. A clock/timer picks up the time from your computer, and there's a 7,300 year calendar. They are all available as pop-down windows. Savtek's program is backed by a standard limited software warranty/license. It comes with a superb, easy to use reference manual.

### DESKTOP PUBLISHING FOR YOU RISK FREE

Make your ideas explode in front of your readers. When you send out a letter or proposal, let it be really dramatic. They will be your ideas, but you'll be presenting them like never before.

If you're not 100% satisfied, simply return it in unused condition within 30 days for a courteous refund.

To order Savtek's ETG Integrated Word Processing and Graphics Desktop Publishing System for your IBM PC or Clone, call toll free or send your check for the breakthrough price of just \$89<sup>99</sup> (\$4 P&H) Order No. 4801. CA add tax.

Look at the 12 sample pages I created. You'll see graphs, pictures and charts mixed into my text. I even designed a logo for my newsletter. Just think about the impact you'll make when you present your ideas with a combination of text and graphics. And oh, it's so incredibly easy to use.

IBM is a registered trademark of International Business Machines.

**DAK INDUSTRIES INC.**  
Call Toll Free For Credit Card Orders Only  
24 Hours A Day 7 Days A Week  
RE65 **1-800-325-0800**

For Toll Free Information, Call 6AM-5PM Monday-Friday PST  
Technical Information. . . 1-800-272-3200  
Any Other Inquiries. . . . 1-800-423-2866  
8200 Remmet Ave., Canoga Park, CA 91304

JUNE 1987

**SMOKING**

1980 1981 1982 1983 1984 1985 1986 1987 1988 1989 1990 1991 1992 1993 1994 1995 1996 1997 1998 1999 2000 2001 2002 2003 2004 2005 2006 2007 2008 2009 2010 2011 2012 2013 2014 2015 2016 2017 2018 2019 2020 2021 2022 2023 2024 2025 2026 2027 2028 2029 2030

**IT'S YOUR ORGANIZATION**

**COMPUTER** **FINED** **PERSONAL ELECTRONICS**

**DESIGN LAYOUTS**

**THE NEWSLETTER**

**HELP NOW**

**TOTAL PICTURE CONTROL**

**BACKGROUNDS**

**STRETCHED**

**TOTAL CREATIVE CONTROL**

**ALL AROUND TEXT**

THIS IS NORMAL  
THIS IS BOLD  
THIS IS ITALIC  
THIS IS OUTLINE  
THIS IS SHADOW  
THIS IS STRETCHED

**HAPPY VALENTINE'S DAY**

**CHAPTER 2**

**BEAUTIFUL PAGES**

THANK YOU!!!

HAPPY BIRTHDAY

**IDEA STARTERS**

**TOTAL CREATIVE CONTROL**

**ALL AROUND TEXT**

THIS IS NORMAL  
THIS IS BOLD  
THIS IS ITALIC  
THIS IS OUTLINE  
THIS IS SHADOW  
THIS IS STRETCHED

**HAPPY VALENTINE'S DAY**

**BEAUTIFUL PAGES**

THANK YOU!!!

HAPPY BIRTHDAY

**IDEA STARTERS**

Authorized

# COMB

Liquidator

## XEROX® 6064 PERSONAL COMPUTER

**XEROX®... They Set the Standards!**

For over 20 years Xerox® has been the world leader in office products and copying equipment. They have set standards that others can only imitate. The Xerox® 6064 Personal Computer was designed to meet the demands of business, professional, and personal computing today, and into the future! We are proud to offer this complete Xerox® System at a remarkably **LOW price!** Compare for yourself... then buy your Xerox® 6064 from C.O.M.B.!

**Get the Xerox® Advantage!** The Xerox® PC offers you the advantage of running IBM™ compatible MS™-DOS, so you can run the hundreds of business and professional software programs available today! And the Xerox® PC is easy to use! It's designed to get you up and running as quickly as possible with computer-aided instruction and superior documentation covering all aspects of personal computing.

**Xerox®... Service You Can Count On!** If you're considering an IBM™-compatible, don't be misled by price alone! The system we are offering is a **complete system**... very easy to hook up and use... and very affordable. But more than that, each system we sell is backed by Xerox® service and support. When you buy this system, your name and computer's serial number is automatically registered with Xerox®. Should you need service or advice, a network of over 150 service centers stands ready to help you. Before you buy... compare! Xerox® is your best value! Check all these features:

- IBM™-PC/XT Compatibility.
- 256KB Memory Features an 8MHz Intel 8086-2 Microprocessor for Faster Speed, Less Waiting Time.
- Two 5¼" Floppy Disk Drives, 360K Each.
- Seven Expansion Slots, Plus a Serial Port for Communications or Printer, and Parallel Printer Port.
- High-Resolution 640 x 400 Pixels Monochrome Monitor, with 12" Diagonal Non-Glare Screen, Swivel and Tilt Base.
- Standard 83-Key PC Keyboard with Mouse Interface (Mouse Not Included.)
- Comes with ScreenMate™, a User Friendly Guide to the Functions of the MS™-DOS Operating System. ScreenMate™ is Menu Driven... No Need to Remember Complicated Commands!



Lets You Select from a Menu and Provides Clear On-Line Instructions If You're Confused About Your Next Step.

**Complete Tutorial Software and Manuals Included:**

- "Getting Started" Booklet.

- Four Reference Guides.
- Four Software Programs: Two X-Cel™ Training Disks, Two Diagnostic Disks, GW™-BASIC Interpreter, and MS™-DOS/ScreenMate™ Operator's Guide.
- Twenty Blank Disks.

**Over 150 Service Centers Nationally.**

**Manufacturer's Limited 90-Day Warranty on Parts/Labor.**

List Price ..... **\$2224.80** **\$999**

Priced At Only .....

Item H-2483-7129-232 Shipping, handling: \$49.00 ea.

**Memory Expansion Board for Xerox® 6064 Personal Computer:** Expands the memory to 640K.

List: **\$249.00** **\$129**  
Priced At .....

Item H-2483-7128-978 Shipping, handling: \$3.50 ea.

XEROX® ScreenMate™ and the identifying numbers herein are trademarks of Xerox® Corporation. IBM™, IBM™ PC, and PC™-DOS are trademarks of International Business Machines Corporation. MS™-DOS is a trademark of Microsoft Corporation.

**Toll-Free: 1-800-328-0609**

Credit Card customers can order by phone, 24 hrs. a day, 7 days a week.



SEND TO: Item H-2483  
 C.O.M.B. Direct Marketing Corp.  
 1405 Xenium Lane N/Minneapolis, MN 55441-4494  
 Send      Xerox® Personal Computer(s) Item H-2483-7129-232 at \$999 each, plus \$49 each for ship, handling.  
 Send      Xerox® Memory Expansion Board(s) Item H-2483-7128-978 at \$129 each, plus \$3.50 each for ship, handling.  
 (Minnesota residents add 6% sales tax. Sorry, no C.O.D. orders.)  
 My check or money order is enclosed. (No delays in processing orders paid by check.)  
 Charge:  VISA®  MasterCard®  Discover<sup>SM</sup>  American Express®  
 Acct. No. \_\_\_\_\_ Exp.     /    

PLEASE PRINT CLEARLY

Name \_\_\_\_\_  
 Address \_\_\_\_\_  
 City \_\_\_\_\_  
 State \_\_\_\_\_ ZIP \_\_\_\_\_  
 Phone (\_\_\_\_) \_\_\_\_\_  
 Sign Here \_\_\_\_\_

Sales outside the 48 contiguous states are subject to special conditions. Please call or write to inquire.

# COMB COMB COMB COMB COMB COMB COMB COMB COMB

indicated on the left side of the LCD, leaving a  $64 \times 160$  dot matrix to display the waveform on a  $4 \times 10$ -division graticule. The display measures about  $4\frac{1}{2} \times 1\frac{1}{2}$  inches and dominates the front panel of the LCD-100. (The entire front panel measures about  $8\frac{3}{4} \times 5\frac{1}{4}$  inches, and the unit is  $1\frac{1}{2}$  inches deep.) The rest of the panel is broken into five major control groupings: vertical amplifier, sweep, trigger, memory, and DMM.

The vertical amplifier controls, on the bottom right of the panel include an AC-DC/GND input-coupling switch, a position control, and the vertical attenuator control. The

Leader		LCD-100												
OVERALL PRICE														
EASE OF USE														
INSTRUCTION MANUAL														
PRICE/VALUE														
		1	2	3	4	5	6	7	8	9	10			
		Poor		Fair			Good			Excellent				

vertical sensitivity can be varied from 10 mV/div to 20 V/div division.

The sweep controls of the LCD-100 are different from those of a conventional oscilloscope. The sweep rate can be varied (from 5  $\mu$ s/div to 20 s/div in 21 steps) by using SLOW and FAST pushbuttons. The selected rate is indicated on the scope's display. An AUTO RANGE button can be used to automatically select the timebase that provides an optimal display of input signals between 50 Hz and 200 kHz.

When the horizontal sweep is set at 50 ms/div or slower, the LCD-100 automatically switches to the roll mode, which turns the screen into a strip-chart recorder—without the paper, of course. If you see something on the display that you want to examine more closely, you can press the HOLD button to freeze the display.

The trigger controls include LEVEL, SLOPE, and SOURCE, which operate as on any other scope. There are three trigger modes available: automatic, normal, and single-shot.

## Now test and restore every CRT on the market . . . without ever buying another adaptor socket or coming up embarrassingly short in front of your customer . . . or your money back



with the new improved CR70 "BEAM BUILDER"™  
Universal CRT Tester and Restorer  
Patented \$995

### Have you ever?

**Thrown away a good TV CRT, data display CRT, or scope CRT** that could have been used for another two or three years because you had no way to test or restore it?

**Lost valuable customers because you advised them that they needed a new CRT** when another technician came along and restored the CRT for them?

**Lost the profitable extra \$35 or more** that you could have gotten for restoring a CRT while on the job and locked in the profitable CRT sale later?

**Avoided handling profitable trade-ins or rentals** because you were afraid you'd have to replace the picture tube when you could have restored it?

**Had a real need to test a CRT on the job**, but didn't have the right adaptor socket or setup information in your setup book?

If any of these things have happened to you, CALL TODAY, WATS FREE, 1-800-843-3338, for a FREE 15 day Self Demo.

"BEAM BUILDER" is a trademark of Sencore, Inc.



Call Today Wats Free 1-800-843-3338

**SENCORE**

3200 Sencore Drive  
Sioux Falls, SD 57107  
605-339-0100 In SD Only

*innovatively designed  
with your time in mind.*

CIRCLE 177 ON FREE INFORMATION CARD

# SUPER LONG PLAY TAPE RECORDERS

10 Hour Model — \$95.00\*  
14 Hour Model — \$159.00\*

Modified Panasonic Slimline, high quality, AC-DC Recorders provide 5 or 7 continuous hours of quality recording & playback on each side of cassette for a total of 10 or 14 hours depending on model. Built-in features include • Voice level control, • Digital counter, etc. TDK DC 180 Cassette Furnished.

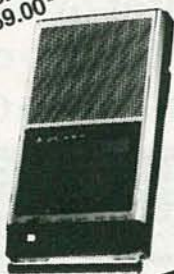

## PHONE RECORDING ADAPTER

Records calls automatically. All Solid state connects to your telephone jack and tape recorder. Starts recording when phone is lifted. Stops when you hang up.

\$24.50\*

FCC APPROVED

**VOX VOICE ACTIVATED CONTROL SWITCH**  
Solid state. Self contained. Adjustable sensitivity. Voices or other sounds automatically activate and control recorder. Uses either recorder or remote mike. \$24.95\*

\*Add for ship & hdlg. Phone Adapter & Vox \$1.50 ea. Recorders \$4.00 ea. Cal. Res. add tax. Mail order, VISA, M/C, C.O.D.'s OK. Money Back Guarantee. Qty. disc. avail.. Dealer inquiries invited, Free data. ©  
**AMC SALES, Dept. A 9335 Lubec St., Box 928, Downey, CA (213) 90241 Phone 869-8519**

CIRCLE 108 ON FREE INFORMATION CARD

The DISPLAY POSITION pushbuttons can also be used in the trigger mode to vary the amount of *pre-trigger information*—one of the benefits of digital storage scopes. It allows you to see transients that occur before the trigger.

### Memory storage

Another advantage that the LCD-100 has over a conventional oscilloscope is the ability to store waveforms in non-volatile memory. In the field, that could prove to be a very convenient feature; the unit could be used as a sort of logging device, to store waveforms for later analysis. Conversely, reference signals could be stored before the unit was taken into the field for comparison against the device under test. An internal lithium battery holds the memory even when the main batteries die.

The LCD-100 isn't only a digital storage scope: flipping a function switch transforms the scope into an autoranging DMM. Three input jacks (V, COM, and mA/Ω) are located at the top right of the front

panel. Three pushbuttons select either the voltage, resistance or current functions of the meter, and another pushbutton selects either AC or DC inputs (in the voltage and current modes) or standard or low-power resistance modes. The DMM has top ranges of 1000 volts DC, 750 volts AC (40 Hz–500 Hz), 320 milliamps, and 32 megohms. Unfortunately, the the DMM section can't be used at the same time you're using the scope section, and it uses different probes.

We examined an early version of the LCD-100, and had only a preliminary instruction manual. Our rating chart, therefore, does not include a manual rating.

The LCD-100 will never replace your bench scope—but it doesn't try to. Its \$950 price should stop you from even thinking about buying it unless portability is the most important feature you need in a scope. As a portable scope, The LCD-100 is fantastic: It's small, light, easy to use, and it's designed for portability right down to its convenient carrying case. **R-E**

Send Purchase Order  
Check, Money Order, or C.O.D.  
or Call Toll Free  
**800-223-0826**  
in N.Y. State (212) 865-5580

# #1 IN CABLE BOXES SPECIAL!

MODEL STARCOM-460

**\$99.95**

ANY QUANTITY

- Volume control
- 68 channels
- Mute control
- Automatic fine tuning
- Instant channel recall
- Programmable to go on at a particular channel and off automatically
- Compatible with descramblers

## JERROLD CORDLESS CABLE TV CONVERTERS



\*ADD \$5.00 FOR VISA OR MASTER CARD

## JERROLD CORDLESS CABLE TV CONVERTER

MODEL DRX3-105/400

**\$69.95**

- 58 channels
- Remote channel changing
- Remote on/off switch
- Remote fine tuning



## JERROLD CORDLESS CABLE TV CONVERTER

MODEL DRZ/450

- 66 channels
- Automatic fine tuning
- A/B switch option

**\$69.95/** 10 lot  
\$79.95 ea.



## JERROLD CORDED CABLE TV CONVERTER

MODEL JRX3-105

**\$49.95**

- 36 channels
- push button



## "THE RABBIT" VIDEO MULTIPLYING SYSTEM

TR-7000

**\$51.95**

\$59.95/6-11

\$69.95/1-5

12 up



IT'S LIKE HAVING A VCR IN EVERY ROOM

■ MASTER CARD ■ VISA

# OMNITRON ELECTRONICS

770 Amsterdam Ave., New York, NY 10025

SHIPPING CHARGES

For Orders	Add
\$25-100	\$6.50
\$100-500	\$8.50
\$500-750	\$10.50
\$750 and up	\$20.00



## LETTERS

continued from page 20

and that's quite a difference.

The new discovery should have a dramatic impact on the size and cost of superconducting coils. Household-sized units costing as little as \$1500 are now feasible. Future developments may bring that cost even lower.

Dr. STEPHEN B. KUZNETSOV

### ON ELECTRONS

I would like to make a comment on something in the March 1987 issue of *Radio-Electronics*. On page 61, in the article "The Evolution of VHSIC," we read: "Electrons move through the IC at the speed of light."

That is not true; only light travels at the speed of light. Electrons can be accelerated to very high speeds in a vacuum, but not to the speed of light. In a circuit, an electron's motion is slower, because of collisions with atoms. Reducing the trace width moves the components closer together, thereby decreasing the number of time-consuming collisions.

JONATHAN E. DARMSTADT  
Potsdam, NY

### FROM A HOBBYIST

I have been a reader of the various Gernsback publications since 1946. They have gone through high and low periods of usefulness to both electronics professionals and hobbyists alike.

I would like to congratulate you on your present content and format. It is first rate: the magazine proves to be informative and impressive, without forgetting the hobbyist's interests.

Particularly, I thank you for your PC Service feature. That innovative approach section makes it far easier for a hobbyist to fabricate his or her own circuit boards. I read several electronics magazines, and to my knowledge, *Radio-Electronics* is the only publication that has gone to the extent that you have done consistently, year after year, to help the builder. Keep up the good work and thank you.

J.L. BROWNING  
Buena Park, CA

## Walk "tough dog" troubles out of any TV & VCR in half the time . . . or your money back

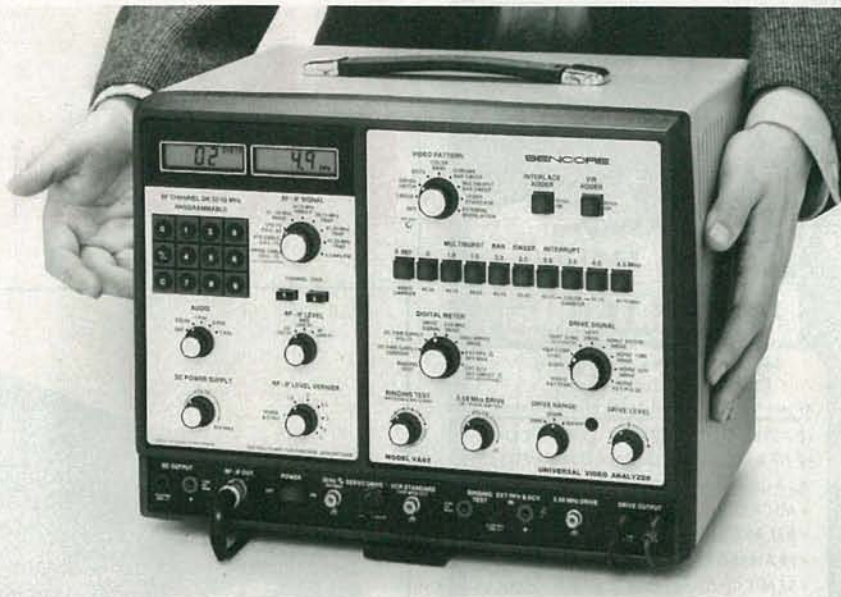

with the exclusive, patented,  
VA62 Universal Video Analyzer . . . \$3,295

### Would you like to?

**Reduce analyzing time:** Isolate any problem to one stage in any TV or VCR in minutes, without breaking a circuit connection, using the tried and proven signal substitution method of troubleshooting?

**Cut costly callbacks and increase customer referrals** by completely performance testing TVs & VCRs before they leave your shop? Own the only analyzer that equips you to check all standard and cable channels with digital accuracy? Check complete, RF, IF, video and chroma response of any chassis in minutes without taking the back off the receiver or removing chassis plus set traps dynamically right on CRT too? Simplify alignment with exclusive multiburst pattern?

**Reduce costly inventory from stocking yokes, flybacks, and other coils and transformers, for substitution only,** with the patented Ringing Test. Run dynamic proof positive test on any yoke, flyback, and integrated high voltage transformer . . . in- or out-of-circuit?

**Protect your future** by servicing VCRs for your customers before they go to your competition? Walk out "tough dog" troubles in any VCR chrominance or luminance circuit — stage-by-stage — to isolate problems in minutes? Have proof positive test of the video record/play heads before you replace the entire mechanism?

**Increase your business** by meeting all TV and VCR manufacturers' requirements for profitable warranty service work with this one universally recommended analyzer?

To prove it to yourself, CALL TODAY, WATS FREE, 1-800-843-3338, for a FREE Self Demo . . . or learn how the VA62 works first by calling for your free simplified operation and application instruction guide, worth \$10.00.



Call Today Wats Free 1-800-843-3338

**SENCORE**

3200 Sencore Drive  
Sioux Falls, SD 57107  
605-339-0100 In SD Only

*innovatively designed  
with your time in mind.*

CIRCLE 178 ON FREE INFORMATION CARD

JUNE 1987

## ELECTRONIC COMPONENTS



176 PAGE

**FREE CATALOG**

Manufacturers of Quality Electronic Components

Serving the Nation from Texas and California

- BATTERY HOLDERS & CLIPS • COILS
- CAPACITORS • CONNECTORS • FUSES
- JACKS • KNOBS • LAMPS • PLUGS
- MICROPHONES • POTENTIOMETERS
- RELAYS • RESISTORS • SWITCHES
- TRANSFORMERS • SPEAKERS • LEDS
- SEMICONDUCTORS • RF COILS

OVER 16,000 DIFFERENT ITEMS IN STOCK!  
CATALOGS MAILED OUTSIDE USA SEND \$2.00

**MOUSER ELECTRONICS**

2401 HWY 287 NORTH MANSFIELD, TX 76063  
PHONE 817-483-4422

CIRCLE 117 ON FREE INFORMATION CARD

## Need Quick Turnaround on CRYSTALS?

Try Our E.O.D.  
(Emergency Order Dept.)

and get

**JAN QUALITY  
and STABILITY  
PLUS Low Prices!**

You benefit from 21 years of manufacturing quality crystals for industry, military services, radio amateurs, citizen band and experimenters.

To Get Free Catalog  
Call or Write

**JAN CRYSTALS**

P.O. Box 06017  
Ft. Myers, FL 33906  
(813) 936-2397

VISA

MasterCard

**CALL 1-800-237-3063  
FREE (Except Florida)**

RADIO-ELECTRONICS

CIRCLE 104 ON FREE INFORMATION CARD

# NEW PRODUCTS



CIRCLE 30 ON FREE INFORMATION CARD

**RADAR DETECTOR**, the model *G-300S* uses microprocessor-based superheterodyne circuitry and a GaAs diode mixer to provide top sensitivity. That bonus extra edge provides maximum time for a driver to check speed and slow down if required.

Among its other features, the *G-300S* includes circuitry that analyzes incoming signals to eliminate false alerts. One circuit looks for and eliminates false alerts caused by other radar detectors in nearby vehicles. Another singles out the fixed frequency of police radar signals from random background signals. In urban areas, a six-second delay can be switched in to prevent triggering by weak X-band signals that may be caused by electronic door openers, security systems, etc. However, the unit re-

sponds instantly to strong signals. For full protection, full sensitivity is retained at all times for shorter range K-band signals.

Both audio and visual alerts are issued. The audio alert has a selectable volume level and features auto shut-off after four "beeps." It identifies the radar band via the alert's tone. Visual alerts are issued using a bank of six LED's. The LED's flash in sequence, with the flash rate increasing as the radar source is approached.

Measuring only 3¼" × 4½" × 1", the unit is small enough to be carried around in a briefcase or a coat pocket; it can be easily hidden to prevent theft. The model *G-300S* carries a suggested retail price of \$260.00—**GUL Industries Corporation**, 23970 Craftsman Rd., Calabasas, CA 91302.

**SATELLITE RECEIVER**, the model *ESR924i*, incorporates both an Earth-station receiver and an antenna-positioning system in one unit. It features priority view, which allows the user to pre-pro-

gram up to 9 channels for instant viewing; parental lockout, whereby channels that parents do not want the children to explore can be locked out on the remote-control module; enhanced stereo,



CIRCLE 31 ON FREE INFORMATION CARD

which allows the user to choose either narrow or wide bandwidths for best audio reception; and positioning programmability, whereby the viewer sets the alphanumeric designations for the satellite wanted, and the dish moves into place automatically. The unit can be programmed for up to 21 channels.

The model *ESR924i* is priced at \$980.00.—R. L. Drake Company, PO Box 112, Miamisburg, OH 45342.

**MICRO-MINI RECORDER**, records three hours (ninety minutes per side) on a special Angrom tape cassette (included). The unit has a detachable microphone for use with a tie clip. The recorder measures  $\frac{5}{8} \times 2 \times 4$  inches, and uses two AAA batteries. It also operates on AC power using an AC adaptor (which is included).



CIRCLE 32 ON FREE INFORMATION CARD

The *Micro-Mini* has two-speed capability with *silent* automatic stop; one-touch recording; tape counter, and many other features not found in other miniature recorders. Extras that come with the unit include tie-pin cord, microphone capsule, earphone, and carrying case.

The *Micro-Mini* is priced at

## Exclusive, triple patented dynamic cap and coil analyzing . . . guaranteed to pinpoint your problem every time or your money back



with the all new LC75 "Z METER 2"  
Capacitor Inductor Analyzer  
Patented \$995

The "Z METER" is the only LC tester that enables you to test all capacitors and coils dynamically — plus, it's now faster, more accurate, and checks Equivalent Series Resistance (ESR) plus small wire high resistance coils.

**Eliminate expensive part substitution and time-consuming shotgunning** with patented tests that give you results you can trust every time. Test capacitor value, leakage, dielectric absorption, and ESR dynamically; with up to 600 volts applied for guaranteed 100% reliable results — it's exclusive — it's triple patented.

**Save time and money** with the only 100% reliable, in- or out-of-circuit inductor tester available. Dynamically test inductors for value, shorts, and opens, automatically under "dynamic" circuit conditions.

**Reduce costly parts inventory** with patented tests you can trust. No more need to stock a large inventory of caps, coils, flybacks, and IHVTs. The "Z METER" eliminates time-consuming and expensive parts substituting with 100% reliable LC analyzing.

**Turn chaos into cash** by quickly locating transmission line distance to opens and shorts to within feet, in any transmission line.

**Test troublesome SCRs & TRIACs easily and automatically** without investing in an expensive second tester. The patented "Z METER 2" even tests SCRs, TRIACs, and High-Voltage Diodes dynamically with up to 600 volts applied by adding the new SCR250 SCR and TRIAC Test Accessory for only \$148 or FREE OF CHARGE on Kick Off promotion.

To try the world's only Dynamic LC Tester for yourself, CALL TODAY, WATS FREE, 1-800-843-3338, for a FREE 15 day Self Demo.



Call Today Wats Free 1-800-843-3338

**SENCORE**

3200 Sencore Drive  
Sioux Falls, SD 57107  
605-339-0100 In SD Only

*innovatively designed  
with your time in mind.*

CIRCLE 179 ON FREE INFORMATION CARD

# 2 SIMPLE SOLUTIONS TO 235,000 PROBLEMS.

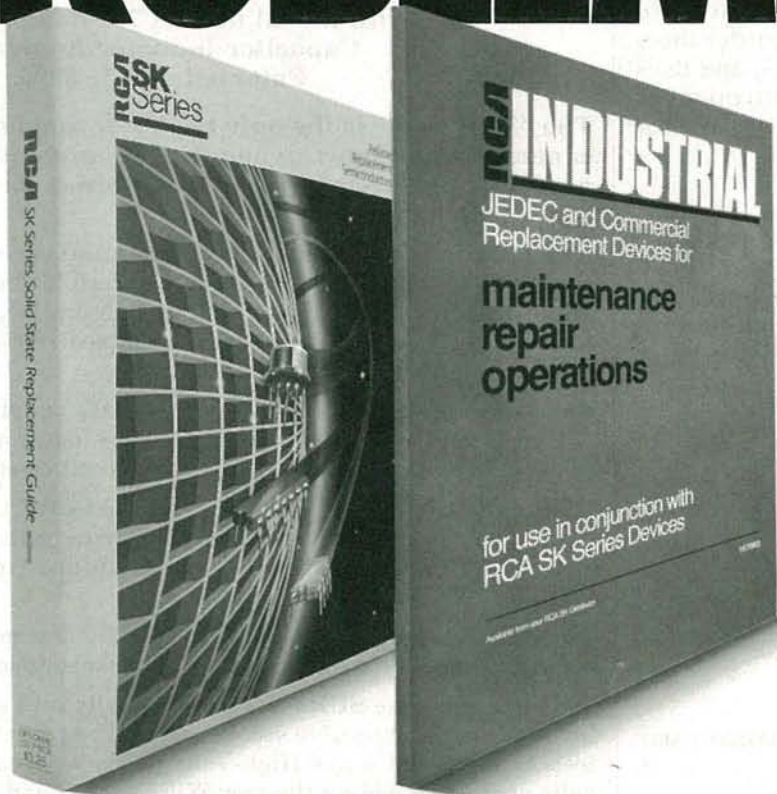

RCA's SK Series Replacement Guide (SKG202E) is your one source for over 214,000 solid state replacements using 2,900 SK and KH types. Integrated circuits, thyristors, rectifiers, transistors, microprocessors — RCA has them all.

Likewise, RCA's Industrial MRO Guide (1K7862) lists over 4,000 devices that replace more than 21,000 JEDEC\* and Commercial types. The Guide also includes Power MOS/FETs, QMOS Integrated Circuits, a combined index/cross reference, and a section on high-reliability devices.

Together, these RCA Guides provide fast, easy answers for 235,000 solid state replacement problems.

For copies, see your local RCA distributor. Or write: Sales Promotion Services, RCA Distributor and Special Products Division, 2000 Clements Bridge Rd., Deptford, NJ 08096-2088.

\*Joint Electron Device Engineering Council

**RCA** SK Replacement  
Solid State



\$179.00 plus \$4.00 shipping and handling.—AMC Sales, Inc., Box 928, Downey, CA 90241.

**OPTICAL-CABLE FAULT LOCATOR**, the model 2135, handles single-mode fibers at 1300 nm wavelength up to 24-mile distances.

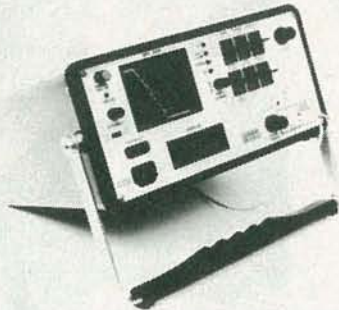

CIRCLE 40 ON FREE INFORMATION CARD

The locator has a dynamic range of 20 dB; attenuation can be measured to better than  $\pm 0.1$  dB accuracy by positioning the dial cursors on the integral CRT display. The unit has ergonomic easy-to-use front-panel controls combined with a bright CRT screen and LCD. Splice- or connector-loss measurement is fully automatic.

Intended for use in the field, the portable device weighs only 17.6 pounds and measures 11.6"  $\times$  11.6"  $\times$  6". It can be powered from rechargeable batteries to provide a minimum of 3 hours' continuous use.

For further information and price, you can write to **Cossor Electronics Limited**, The Pinnacles, Elizabeth Way, Harlow, Essex CM19 5BB, England.

**BAR-CODE READER**, the 300C, offers the user either single-code decoding or auto-recognition at the flip of a switch. In the single-



CIRCLE 33 ON FREE INFORMATION CARD

code state, the unit decodes any one of the following: Code 39, the most common alphanumeric bar

## Analyze defective waveforms faster, more accurately, and more confidently — every time or your money back



with the SC61 Waveform Analyzer  
Patented \$2,995

If you value your precious time, you will really want to check out what the exclusively patented SC61 Waveform Analyzer can do for you. 10 times faster, 10 times more accurate, with zero chance of error.

**End frustrating fiddling with confusing controls.** Exclusive ultra solid ECL balanced noise cancelling sync amplifiers, simplified controls, and bright blue dual trace CRT help you measure signals to 100 MHz easier than ever.

**Accurately and confidently measure waveforms from a tiny 5 mV all the way to a whopping 3,000 V without hesitation** with patented 3,000 VPP input protection — eliminates expensive "front end" repairs and costly equipment downtime.

**Make only one circuit connection and push one button for each circuit parameter test:** You can instantly read out DC volts, peak-to-peak volts and frequency 100% automatically with digital speed and accuracy. It's a real troubleshooting confidence builder.

**Confidently analyze complex waveforms fast and easily.** Exclusive Delta measurements let you intensify any waveform portion. Analyze glitches, interference signals, rise or fall times or voltage equivalents between levels; direct in frequency or microseconds.

**Speed your digital logic circuit testing.** Analyzing troublesome divide and multiply stages is quicker and error free — no time-consuming graticule counting or calculations. Simply connect one test lead to any test point, push a button, for test of your choice, for ERROR FREE results.

To see what the SC61 can do for your troubleshooting personal productivity and analyzing confidence, CALL TODAY, WATS FREE, 1-800-843-3338, for a FREE 15 day Self Demo.



Call Today Wats Free 1-800-843-3338

**SENCORE**

3200 Sencore Drive  
Sioux Falls, SD 57107  
605-339-0100 In SD Only

*innovatively designed  
with your time in mind.*

CIRCLE 180 ON FREE INFORMATION CARD

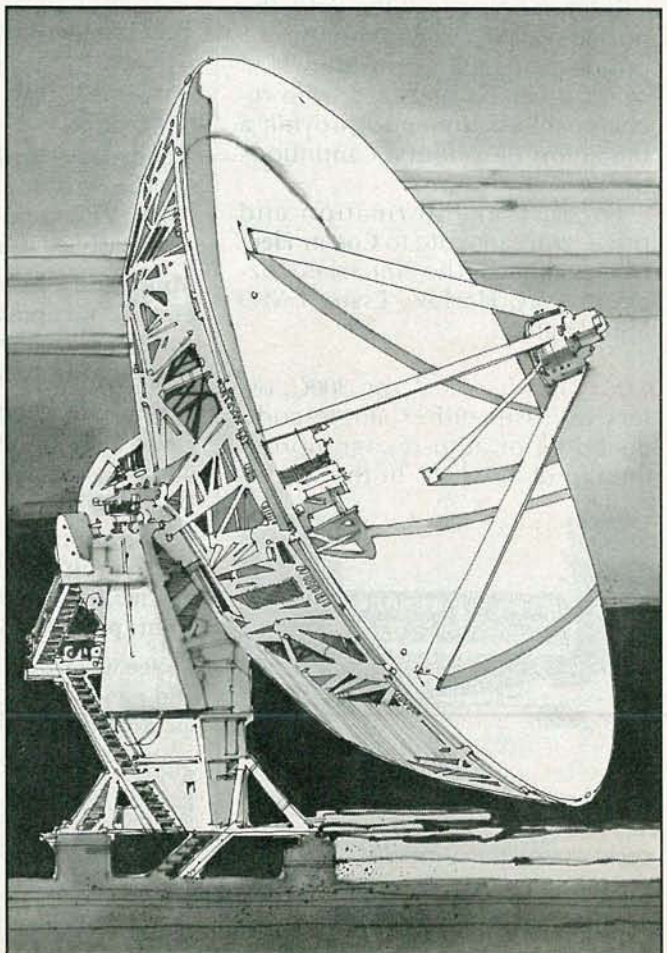
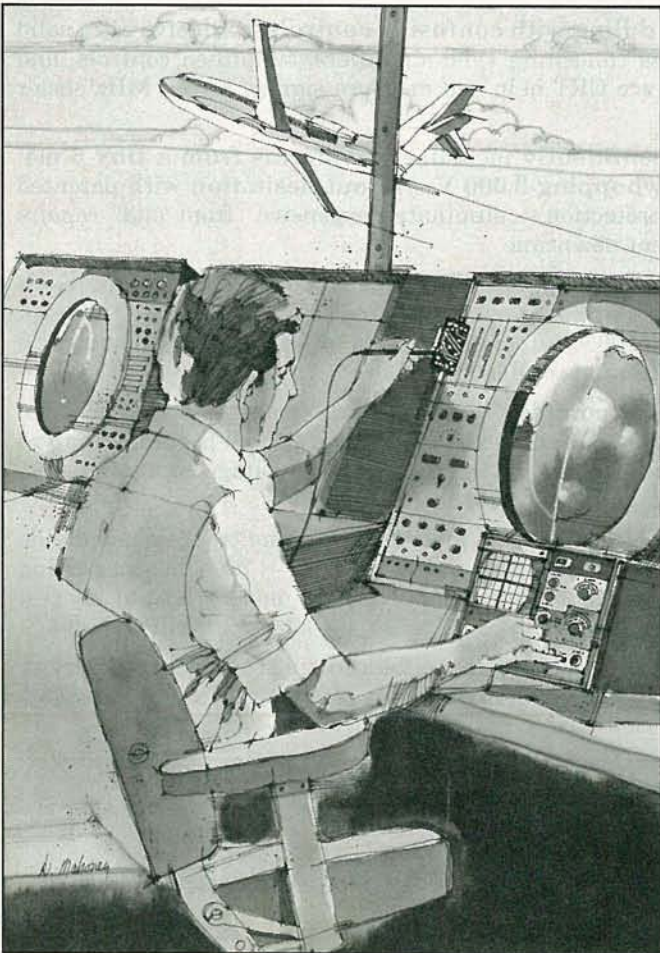
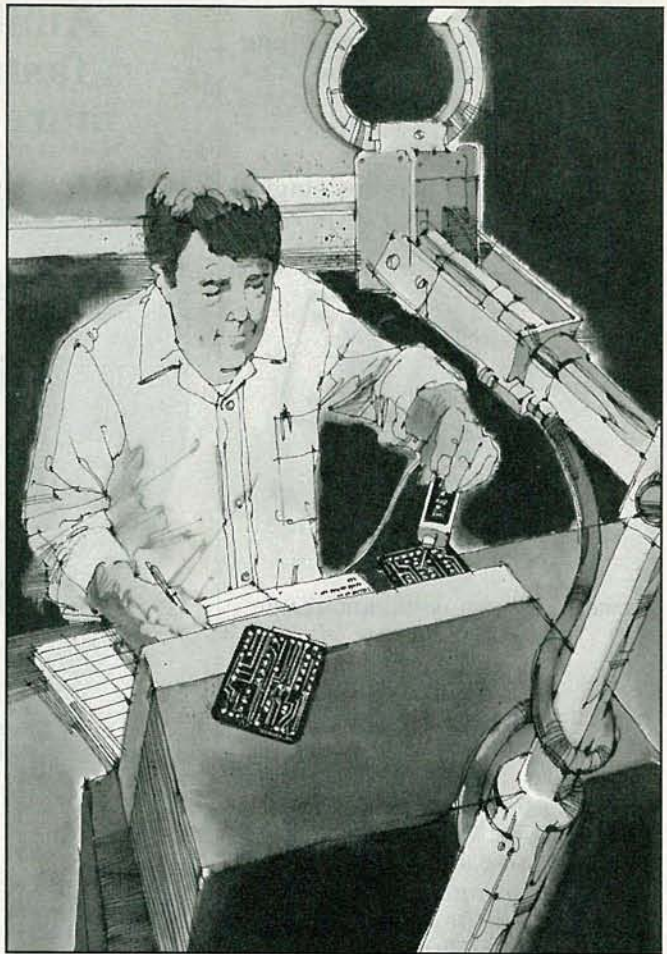

# CIE MAKES THE WORLD OF ELECTRONICS YOURS.

**T**oday's world is the world of electronics. To be part of it, you need the right kind of training, the kind you get from Cleveland Institute of Electronics, the kind that can take you to a fast growing career in business, aerospace, medicine, science, government, communications, and more.

## **Specialized training.**

You learn best from a specialist, and that's CIE. We're the leader in teaching electronics through independent study, we teach only electronics and we've been doing it for over 50 years. You can put that experience to work for you just like more than 25,000 CIE students are currently doing all around the world.

## **Practical training.**

You learn best with practical training, so CIE's Auto-Programmed® lessons are designed to take you step-by-step, principle-by-principle. You also get valuable hands-on experience at every stage with sophisticated electronics tools CIE-designed for teaching. Our 4K RAM Microprocessor Training Laboratory, for example, trains you to work with a broad range of computers in a way that working with a single, stock computer simply can't.

## **Personalized training.**

You learn best with flexible training, so we let you choose from a broad range of courses. You start

with what you know, a little or a lot, and you go wherever you want, as far as you want. With CIE, you can even earn your Associate in Applied Science Degree in Electronics Engineering Technology. Of course, you set your own pace, and, if you ever have questions or problems, our instructors are only a toll-free phone call away.

## **The first step is yours.**

To find out more, mail in the coupon below. Or, if you prefer, call toll-free **1-800-321-2155 (in Ohio, 1-800-523-9109)**. We'll send a copy of CIE's school catalog and a complete package of enrollment information. For your convenience, we'll try to have a representative contact you to answer your questions.

### **CIE** Cleveland Institute of Electronics 1776 East 17th St., Cleveland, Ohio 44114

YES! I want to get started. Send me my CIE school catalog including details about the Associate Degree Program. I am most interested in:

- |  |   |
|--|---|
| <input type="checkbox"/> computer repair     | <input type="checkbox"/> television/high fidelity service |
| <input type="checkbox"/> telecommunications  | <input type="checkbox"/> medical electronics              |
| <input type="checkbox"/> robotics/automation | <input type="checkbox"/> broadcast engineering            |
| <input type="checkbox"/> other _____         |   |

Print Name \_\_\_\_\_

Address \_\_\_\_\_ Apt. \_\_\_\_\_

City \_\_\_\_\_ State \_\_\_\_\_ Zip \_\_\_\_\_

Age \_\_\_\_\_ Area Code/Phone No. \_\_\_\_\_

Check box for G.I. Bulletin on Educational Benefits **ARE-62**  
 Veteran  Active Duty **MAIL TODAY!**

# Discover Dick Smith Electronics - for Fun & Profit!

## New from SAMS Books! Hundreds of Great Projects!

Would you like to build a miniature laser system or experiment with state-of-the-art optical fibers? You can master these and many other electrical circuitry challenges with this exciting new collection of columns (originally published in *Popular Electronics*, *Computers & Electronics*, or *Modern Electronics* magazines) by noted electronics author Forrest Mims III. All circuits in this book were either designed by the author or adapted from manufacturers' application notes & other sources. Included are MOSFET, analog & digital circuits; LED's, laser diodes & optoelectronics; lightwave communications, control & telemetry; radio control & remotely triggered camera; sensors; thermoelectronics, experimental circuits & more!



**Forrest Mims' Circuit Scrapbook II** B-3001 **\$19.95**

## New from DAETRON! Have you ever seen a Cap Meter this powerful?

This compact, handheld 4-digit LCD capacitance meter measures the full range from 0.1 pF to 1 FARAD (999.9 mF) in completely autoranging or manual modes. Check out these features:

- Extended resolution ● Calculates true capacitance ● Shows leakage
- Calculates time constants ● Reads dielectric absorption ● Auto or manual zeroing ● Sorts capacitors ● Calculates cable lengths
- Hold function ● Transistor, zener diode & rectifier tests ● Identifies transistor type & leads ● Diode clamp ● Includes 3 test leads & manual

Requires 9V alkaline or AC adaptor



**\$169.95**  
Q-1560

## 4-Digit Auto-Range Cap Meter

## Give your projects that professional finish at minimal cost!

### SPEEDY BOXES

Quality plastic project cases with PCB slots on all 4 sides; 4 screws & aluminum lid. Interior dimensions shown.



3 1/4" x 2" x 3/4" (H-2755) **\$1.25**  
4 3/4" x 2 1/2" x 1 1/2" (H-2753) **\$1.75**  
6" x 3 1/2" x 1 3/4" (H-2751) **\$2.00**  
7 1/2" x 4 1/4" x 2 1/4" (H-2752) **\$2.50**

Same as above with ABS plastic lids (which add 3/16" to height)

3 1/4" x 2" x 3/4" (H-2855) **\$1.50**  
4 3/4" x 2 1/2" x 1 1/2" (H-2853) **\$2.00**  
6" x 3 1/2" x 2 1/4" (H-2851) **\$2.50**  
7 1/2" x 4 1/4" x 2 1/4" (H-2852) **\$2.75**

## Get low-cost project boards!

No soldering required - components leads simply push in! Holes are spaced to accept standard DIP packages & alpha-numerically coded. Each board includes a pad of layout paper.

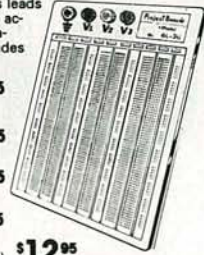

**Super** (P-4617) **\$29.95**  
8" x 9 3/4" x 3/4"  
**Maxi** (P-4616) **\$19.95**  
8" x 6" x 3/4"  
**Basic** (P-4615) **\$9.95**  
7" x 2 3/4" x 3/4"  
**Mini** (P-4614) **\$4.95**  
3" x 2 3/4" x 3/4"

### WIRE JUMPER KIT (W-4650) \$12.95

Pre-cut, pre-stripped, pre-formed jumpers in 22AWG color-coded lengths, including 50 ea. of 5/16" and 25 ea. of 12 lengths from 5/16" to 1/2". Includes plastic storage case.

**Wire Jumper Replacement (W-4652) \$5.95**  
350 assorted wire jumpers (as above) without case.

## Build your own high quality test equipment!

### FUNCTION GENERATOR KIT (K-3520) \$69.95

Features 4-digit frequency display; produces sine, triangle & square waves from below 20Hz to above 170kHz in 3 ranges; continuously variable output from 3mV -2.5V peak-peak; 600 ohms (nominal) output impedance; readout accuracy  $\pm 2\%$   $\pm 1$  digit.

### FREQUENCY COUNTER KIT (K-3439) \$89.95

Features 7-digit LED display; reliably measures 0-10MHz, 0-50MHz and (with optional prescaler below) 10-500MHz; 4 gating times - .01, .1, 1 & 10sec.; 4 period measuring ranges - 1, 10, 100, & 1000 input cycles; input sensitivity 10mV-30mV, 100mV-50mV @ 10MHz input impedance; accuracy typically better than  $\pm 0.005\%$

### Prescaler Kit (K-3432) Expands range of K-3439 \$22.50

### AUDIO OSCILLATOR KIT (K-3469) \$29.95

Generates sine & square waves in frequencies from 15Hz -150kHz in 4 range settings; adjustable output from 0-1V; midband distortion typically < 0.05%; requires 9V battery; easy to build.

## Build your own audio amp for only pennies per watt!

### 100W AMP MODULE KIT (K-3442) \$19.95

100W RMS; 100dB S/N ratio @ 5KHz; 1V input sensitivity. Reliable design, easy to build. Use with K-3438 power supply & M-0144 transformer.

### 50W AMP MODULE KIT (K-3440) \$14.95

Similar to K-3442, but with lower power; 2 units can run off one K-3438 power supply. Input sensitivity 500mV.

### 480 PS POWER SUPPLY KIT (K-3438) \$14.95

Includes speaker de-thump relay & zener regulated  $\pm 15V$  pre-amp rails. Requires M-0144 transformer.

### 28-0-28 (56V CT)-2A Transformer (M-0144) \$19.95

## 19" RACK-MOUNTING CABINETS & RACK

Professional quality black aluminum & steel instrument cases fit standard 19" racks. Heavy gauge (1/4") front panels, ventilated top & bottom panels. Supplied flat, assemble in minutes.

**Slim** 16 1/4" x 9 3/4" x 1 1/2" (H-2483) **\$24.95**  
5lbs., 10.5oz.

**Medium** 16 1/4" x 9 3/4" x 3 1/4" (H-2482) **\$27.50**  
7lbs., 8oz.

**Large** 16 1/4" x 9 3/4" x 5 1/2" (H-2481) **\$29.95**  
9lbs., 5oz.



**DSE 19" RACK** **\$49.95**  
H-2470  
Brushed aluminum  
21 1/4" x 14 1/4" x 37"

Cabinet not included

## DSE carries a complete range of COMPONENTS & HARDWARE

RESISTORS including 1/4W 1%, 1/4W 5%, 1/2W 5%, 1W 5%. CAPACITORS including electrolytic, tantalum, ceramic & polyester. SEMICONDUCTORS covering a multitude of applications specifically suited to the enthusiast, including transistor, diodes & IC's.

**Check our catalog! Please circle reader service number indicated below to receive your FREE copy!**

## Practical Anti-static Precautions

**ANTI-STATIC FOAM MAT** 12" x 12" (H-5072) **\$6.95**

**ANTI-STATIC WRIST STRAP** (N-2000) **\$9.95**

**ANTI-STATIC SOLDER SUCKER** (T-2570) **\$7.95**

Polypropylene barrel, carbon filter tip, self-cleaning plunger.

**Replacement Tip for T-2570** (T-2571) **\$2.50**

## World Band Receiver D-2831 \$149

Full AM/FM frequency range (150KHz - 29.999MHz) plus FM 87.5 - 108MHz; direct push-button access to all 12 SW bands; 5 tuning functions; 14 memories; built-in clock, alarm & sleep timer; adjustable RF gain & BFO; runs off batteries (2 x AA & 6XD, not included) or AC adaptor. You must see this beauty to believe it!

## R-E Reader's Special 4.5 DIGIT MULTIMETER

5 DCV ranges from 200mV-1000V, 10M ohm impedance; 4 DC current ranges from 2mA 10A; 5ACV ranges from 20mV-750V; 4AC current ranges from 2mA-10A; 6 resistance ranges; diode & continuity tests.



Regularly \$119.95 **\$60** Q-1510

**Hurry! Offer limited to stock on hand!**

Only 200 units available - offer valid 4/1 thru 5/31/87

## Get the IBM clone of your choice at a fantastic savings!

### AT Turbo Computer System

Superb engineering for reliability, performance, and full IBM AT compatibility at less than half the Big Blue price! Comes in easy to assemble kit form with complete instructions.

80286 AT Baby Motherboard - 6/10MHz (X-1050) \$499.00  
2 x 256K Upgrade Kit (X-1190) 89.90  
Hard/Floppy Disk Controller Card (X-1052) 199.00  
1.2MB Floppy Disk Drive (X-7502) 135.00  
200W Power Supply (X-1111) 99.00  
84-key Keyboard (X-1122) 59.95  
Heavy-duty Steel Case (X-1121) 79.00

**\$975**  
X-1152  
**SAVE \$165**  
off individual component prices

Individual Components Total 1140.85

### XT Compatible Computer

IBM compatible. Easy to assemble (complete instructions included).

XT Motherboard (X-1001) \$129.00  
BIOS for Motherboard (X-1000) 29.95  
64K RAM (X-1187) 11.95  
Monochrome Graphics Card (X-012) 89.95  
Floppy Disk Controller (X-1009) 34.95  
130 Watt Power Supply (X-1110) 69.95  
IBM-style Case (X-1120) 39.95  
Half-height Disk Drive (X-7506) 89.95  
IBM-compatible Monochrome Monitor (X-1132) 99.95  
84-key Keyboard (X-1122) 59.95

**\$599**  
X-1150  
**SAVE \$56**  
off individual component prices

Individual Components Total \$655.55

## All DSE computer products carry a 1 year warranty!

Protect your CMOS components - see our Anti-static products above!

Stores in BERKELEY, CA (415) 486-0755; REDWOOD CITY, CA (415) 368-8844; SAN JOSE, CA (408) 241-2266

## 14-Day Satisfaction Guarantee

## MAIL ORDERS

DSE, P.O. BOX 8021, Redwood City, CA 94063

We ship UPS Ground unless otherwise requested. Add 5% of order total (min \$1.50) for shipping. Outside USA add 20% (min \$4). There is an additional \$1.50 handling fee. California residents please add sales tax. VISA and MASTERCARD welcome. Minimum order value \$20.00.

## Order Toll Free 1-800-332-5373

Pre-paid & Credit Card Orders Only!

Mon - Fri 7am - 6pm Pacific Time

California Orders call 415-368-1066

For information call 415-368-8849



EVERYTHING FOR THE ELECTRONICS ENTHUSIAST

To receive your copy of our colorful 148 page catalog, circle Reader Service 95

code), UPC A/E, Codabar, Codabar/ABC, or Interleaved 2 of 5. In the auto-recognition mode, Code 39, UPC A/E, Codabar, and Interleaved 2 of 5 are all *automatically* decoded and sent to the user's computer.

The 300C decoding algorithm includes the extensive error-checking routines that are necessary to decode both dot matrix and preprinted labels accurately.

The 300C offers either an RS-232C serial or IBM keyboard interface, and the list price is \$635.00, including a high-grade sealed-tip metal wand.—**Peripheral Connections**, 2190 W. 11th St., Eugene, OR 97402.

**CAR VIDEO SYSTEM**, the American Audio *In-Dash Car Video System*, features a stereo cassette player with auto reverse, AM-FM stereo radio, 50-watt sound system, digital readout, and digital clock, plus a 2" black-and-white TV set with zoom (enlarging the picture 30%) and a VCR input. The unit can be installed easily; for automotive in-dash applications, the system must be wired, so that the TV picture only works in the key's accessory position.



CIRCLE 34 ON FREE INFORMATION CARD

The *In-Dash Car Video System* can be installed on any 12-volt system. It is priced at \$299.00.—**Bould Electronics**, 1325 Broadway - 222, Boulder, CO 80302.

**PORTABLE PATTERN GENERATOR**, the model LCG-409, is battery-operated and is designed to be a precision NTSC signal source for field adjustments to VTR's, VCR's, large-screen TV receivers and monitors, and other video systems, as well as for bench operations.

Housed in a metal cabinet measuring 8 x 3 x 10 inches, weighing approximately 6.6 lbs, including the four C cells for power, the unit features full-field 75% color bars, dot, crosshatch, and full raster sig-

*continued on page 42*

# With the HEATHKIT ONLINE CATALOG

**you can order over 400 kit and assembled computer and electronic products — with the press of a button.**



As a CompuServe® user, you want the full advantages this system can offer. And what better way to make CompuServe work for you than to let it bring you the Heathkit Online Catalog. Menu-Driven, our catalog lets you browse over 400 kit and assembled products from 17 major product categories. You can even order a free hardcopy version of our catalog.



**Among the many high-quality products you'll find are:**

- IBM AT-compatible advanced personal computers
- IBM PC-compatible compact personal computers • IBM PC-compatible expandable personal computers
- Portable and desktop PCs • Laptop computers with built-in software • Microcomputer-Aided Drafting and Design programs • the HERO® 2000 Robot • Test Instruments
- Home Security Systems • TV's and video recorders
- Amateur Radio gear and more

All of our products are meticulously engineered and backed by excellent service and support. And as an added plus, our kits offer you the satisfaction of building a high-tech quality product yourself.

You'll also find complete hands-on training courses in areas ranging from basic electricity and programming languages to microprocessors and robotics. All courses are designed by educators knowledgeable in their respective fields.

And for added convenience, you can place your order through your computer using your Visa, MasterCard or Heath Revolving Charge — it's that easy.

**To benefit from this unique opportunity, type**

## GO HTH

**at any "!" or "OK" prompt on the system**

The Heathkit Online Catalog — your direct line to quality high tech products



CompuServe is a registered trademark of CompuServe Inc. An H&R Block Company.

CL-785R1

JUNE 1987

# NEW IDEAS

## Sound-effects generator

HERE'S A CIRCUIT THAT PROVIDES GREAT fun for kids. It can generate a European police-car siren, bird noises, spaceship sounds, etc. In addition, it can be put to serious use as a doorbell, an alarm, etc. It's easy to build, uses readily-available parts, and is inexpensive.

### How it works

A block diagram of the circuit is shown in Fig. 1. As you can see, the

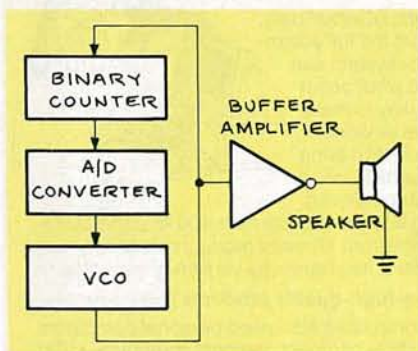

FIG. 1

circuit consists of four parts: a binary counter, a D/A converter, a VCO, and an audio output amplifier. The speed at which the counter counts depends on the frequency of the output of the VCO, which in turn is determined by the output of the counter. That feedback loop is what gives this circuit its characteristic output.

Referring to the schematic in Fig. 2, the initial frequency of oscillation is determined by potentiometer R11. The VCO first oscillates at a relatively low frequency, and gradually picks up speed as the control voltage supplied by the D/A converter increases.

The D/A converter is simply the group of resistors R1-R8. When none of IC1's outputs is active, little current will flow into the base of Q1, so the VCO's control voltage will be low. As more and more counter outputs become active, base current increases, and there-

by so does the VCO's frequency of oscillation.

The VCO itself is composed of IC2-a, IC2-b, Q1, and the timing network comprising D1-D4, C1, R10, and R11. The diode bridge functions basically as a voltage-controlled resistor.

The buffer amplifier is made up of the four remaining gates from IC2, all wired in parallel. Volume is sufficient for experimental purposes, but you may want to add an amplifier, speaker, or both.

### Construction

Use any convenient means of wiring the circuit—point-to-point, wirewrap, etc. Layout is not critical; just be sure to connect the power supply to the IC's correctly.

Press S1; you should get a sound from the speaker. The sound you get will depend on the position of R11. To vary the effect, try tapping on S1.—Edwin B. Tupue

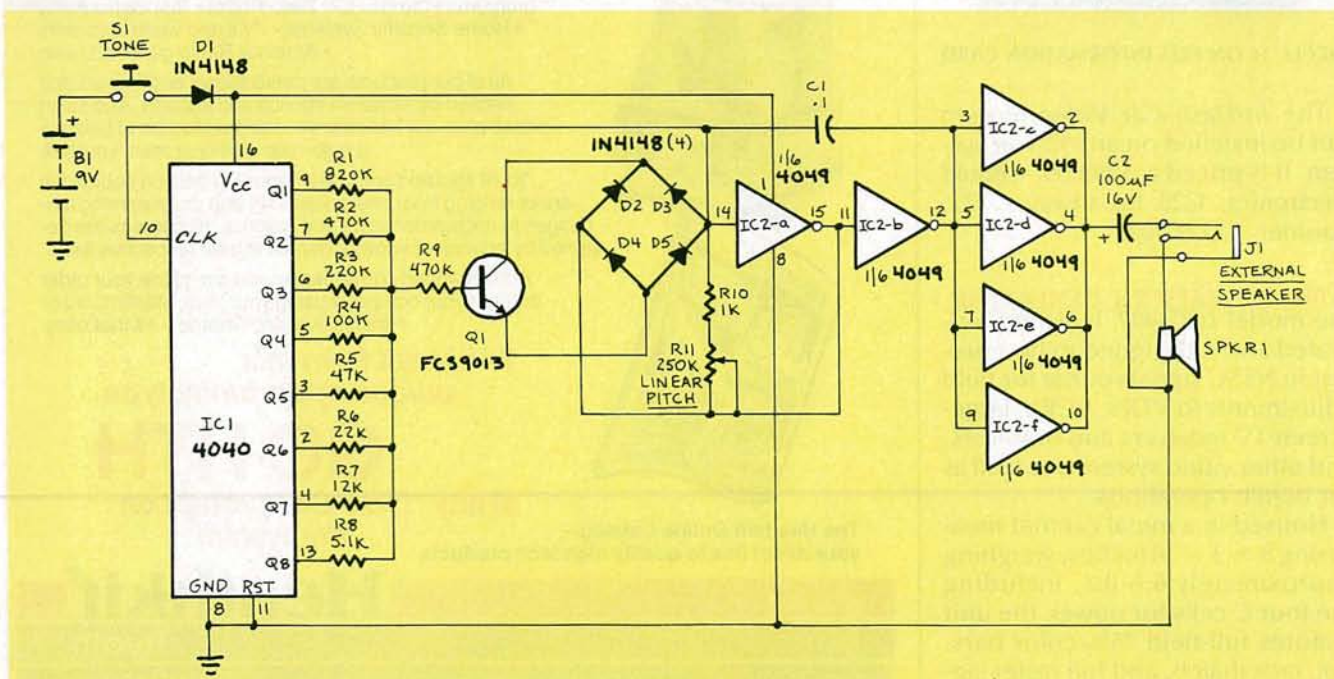

FIG. 2

# MOVIE TIME PRESENTS



### V430 REMOTE VIDEO SYSTEM

The V430 enables you to send any of four (4) input signal sources to any or all of three (3) TV's or VCR's by remote control.

Any video equipment that can be connected directly to the VHF terminals of a TV, can be controlled by the V430, such as a cable converter or decoder, a satellite antenna, a video game, a VCR or a video disk player or a video camera, etc.

By using the V430 you can monitor the baby's room or see who is at your front door, at the same time that you're recording HBO via satellite or cable, and watching a ballgame on local TV. . . .

Any or all of the above can be done without leaving your chair.

The addition of a V430 to your present video system will create a Video Control System, that is limited in flexibility, only by your imagination . . . . . \$ 99.45

### MOVIETIME V7200 REMOTE CABLE CONVERTER

Fine Tuning

Favorite Channel Memory

HRC Switch

Switchable AC outlet

Output Channel 2 or 3 (switchable)

Guaranteed to work with any cable system anywhere . . . . . \$ 64.95

### REFURBISHED JERROLD JSX-3 36 CHANNEL CONVERTERS

The JRX-3 IS A TWO PIECE WIRED REMOTE. The JSX-3 is one piece settop. Great for connecting a second set to cable, or for making your VCR cable ready . . . . . \$ 34.95

Remote Control Hand Units for the JERROLD 400 and 450 . . . . . \$ 19.95

### VIEWSTAR XCT 2501

67 Channel Wireless Remote Cable Tuner with Volume Control And Mute Control Audio and Video Outputs. Last Channel Recall Decoder Input / Output Jacks makes this unit compatible with all decoders . . . Fine tuning. Fine Tuning Centering Control . . . . . \$119.95

### C L O S E O U T V S C 2500-3

Same as above less audio / video outputs \$ 99.95

### V620 MTS STEREO TV DECODER

True TV Stereo has arrived. Wait until you hear the sound. It's like switching from a pocket portable AM radio to a FM Stereo receiver running thru a full hi-fidelity stereo system. To say the least, it's an astonishing experience that's instantly apparent.

It has a dynamic theatre like sound. But, in your home, you choose the seat putting you in the middle of the action, making it sound better than a theater. It changes dull monotone TV sound into dramatic 3-D life like action. When the bullets on Miami Vice start flying, you duck . . . It sounds that real.

It's better than Stereo TVs because their speakers, generally, do not have sufficient distance between the left and right channels for a true stereo effect. And the quality of the speakers supplied with your TV . . . well?

The V620 will extract two distinctly separate sound channels that will give the same stereo separation in your home as it was produced in the recording studio. The V620 is versatile enough to be used with any amplifier or VCR, because it has a variable output matching network that is externally controlled.

If you use your existing stereo system the V620 TV Stereo will equal the sound of your FM stereo receiver.

The V620 can extract a true stereo signal from either the MPX out of a TV or VCR, or the output of a cable converter or VCR. It can be hooked up by anyone in a few minutes. No Probes, to play with . . . Try it you'll love it. . . . . \$ 89.95

30 DAY MONEY BACK GUARANTEE / 1 YEAR WARRANTY ON ALL ITEMS  
Mail Order Form to: **MOVIETIME**, 20203 NE 15 Ct., Miami, FL, 33179 ( ) Check ( ) COD ( ) Money Order

___ V430	\$ 99.95	___ Total Purchase	_____
___ V620	89.95	___ FL Residents -	Name _____
		___ 5% Sales Tax	_____
___ V7200	64.95	___ Shipping Chg.	Address _____
___ JSX-3 ( ) JRX-3 ( )	34.95	___ PER UNIT \$3.95	City _____ State _____
___ Hand Unit 400	19.95	___ Total Amount	_____
___ Hand Unit 450	19.95	___ American Express	Zip _____ Phone _____
___ Viewstar Chan. 3( )		___ Exp. Date	(800) # can't be called in FL
___ or 2( )		___ Acct. #	<b>1-800-843-9845</b>
___ VSC2500	99.95	___ Signature	<b>1-305-652-1981</b>
___ XCT2501	119.95	_____	<b>1-305-652-3971</b>
	Total		

No extra charge for COD orders. COD & American Express orders shipped within 72 Hrs.

CIRCLE 202 ON FREE INFORMATION CARD

# Radio-Electronics mini-ADS

## NEW PRODUCTS

continued from page 39

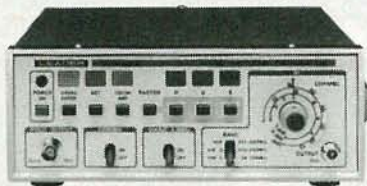

CIRCLE 35 ON FREE INFORMATION CARD

nals of 100% white, red, green, blue, yellow, cyan, magenta, and black burst.

In addition to 1-volt p-p video output into a 75-ohm load, the unit features RF output on all U.S. broadcast VHF and UHF channels, on-off switchable FM sound carriers with internal 1-kHz modulation, and on-off control of chrominance.

The model LCG-409 is priced at \$499.00.—**Leader Instruments Corporation**, 380 Oser Avenue, Hauppauge, NY 11788.

**PORTABLE ELECTRONIC LAB**, the model 4444, essentially combines five different types of measuring equipment into a portable, fully integrated test-station.



CIRCLE 36 ON FREE INFORMATION CARD

Included are a dual-channel oscilloscope with DC to 20-MHz bandwidth and 2mV/div sensitivity on both channels, a component tester/comparator for quick evaluation of component characteristics, a triple-output DC source for external use, a frequency counter that measures the frequency of a waveform displayed on either oscilloscope channel, and a function generator that offers sinewave, squarewave, and triangular wave outputs.

The model 4444 is priced at \$750.00.—**ET&T Corporation**, 3001 Redhill Avenue, 1-219, Costa Mesa, CA 91626. R-E



**PANASONIC CABLE CONVERTERS**, Wholesale and Retail. Scientific Atlanta and Pioneer Cable Converters in stock. Panasonic model 120N 68 channel converter \$79.95, Panasonic Amplified Video Control Switch Model VCS-1 \$59.95. Scientific Atlanta Brand new Model #8528 550MHZ 80 Channels Converter \$89.95. Video Corrector (MACRO, COPYGUARD, DIGITAL) ENHANCER \$89.95. Write or call **BLUE STAR IND.**, 4712 AVE. N, Dept 105, Brooklyn, NY 11234. Phone 1-718-258-9495.

CIRCLE 85 ON FREE INFORMATION CARD

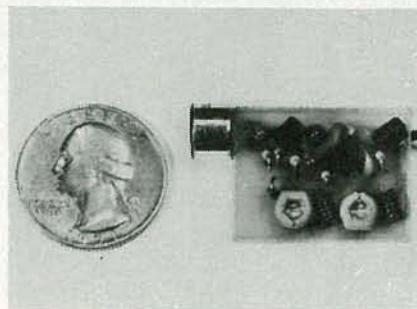

**SIMPLY SNAP THE WAT-50 MINIATURE FM TRANSMITTER** on top of a 9v battery and hear every sound in an entire house up to 1 mile away! Adjustable from 70-130 MHz. Use with any FM radio. Complete kit \$29.95 + \$1.50 S + H. Free shipping on 2 or more! COD add \$4. Call or send VISA, MC, MO. **DECO INDUSTRIES**, Box 607, Bedford Hills, NY 10507. (914) 232-3878.

CIRCLE 127 ON FREE INFORMATION CARD



**LOOKSOUND FM SUNGLASSES**. Super durable sunglasses with that great look. Each one has a state of the art micro FM radio built right in. Great for jogging, bicycling, boating, sports events, etc. \$39.95 plus \$3.00 shipping and handling. Visa, mastercard, and cod. 1-800-522-2636 for orders. (617) 843-1900 for information. **CAMEO ENTERPRISES INC.** P.O. Box 63 Accord, MA 02018

CIRCLE 89 ON FREE INFORMATION CARD

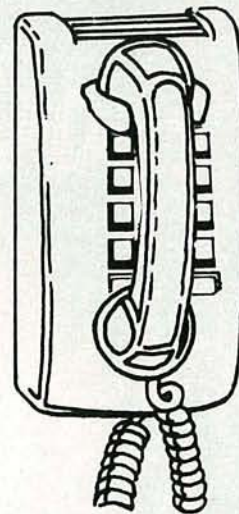

## CALL NOW AND RESERVE YOUR SPACE

- 6 x rate \$745.00 per each insertion.
- Reaches 239,312 readers.
- Fast reader service cycle.
- Short lead time for the placement of ads.
- We typeset and layout the ad at no additional charge.

Call 516-293-3000 to reserve space. Ask for Arline Fishman. Limited number of pages available. Mail materials to: mini-ADS, RADIO-ELECTRONICS, 500-B Bi-County Blvd., Farmingdale, NY 11735.

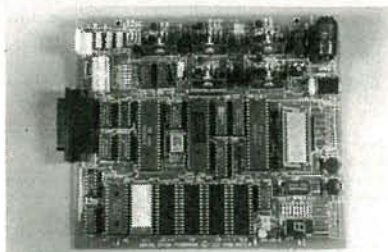

**BUILD STEVE CIARCIA'S INTELLIGENT SERIAL EPROM PROGRAMMER**. • Use Standalone or with Computer/Terminal; • Programs Standard or Fast Algorithm Mode; • Menu Selectable, No Configuration Jumpers; • Programs All 5V 27XXX EPROMs from 2716 to 27512. Includes CMOS and 12.5V Vpp; • Read, Copy, Verify after Write; • Intel Hex File Upload/Download. Full Programmer Kit \$199.00, Power Supply add \$19.00. S&H \$5 in USA. **CCI**, 4 Park St., Suite 12, Vernon, CT 06066. (203) 875-2751.

CIRCLE 194 ON FREE INFORMATION CARD



# Radio-Electronics mini-ADS

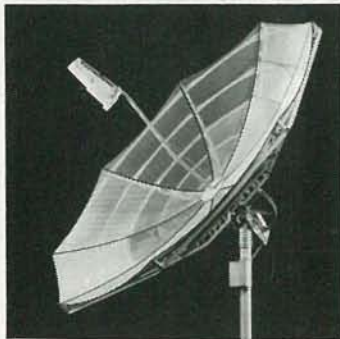

**IF YOU'RE TIRED OF MONTHLY CABLE BILLS** \$25.00-\$100.00 a month or just want more and better television then it's time for a Satellite Antenna System from Advance Video. Prices start at **\$795.** + S/H with 2 yrs. warranty. 200 channels available. Call 1 800-223-1127 toll free. The best product, the best prices. Visa/MasterCard accepted. **ADVANCE VIDEO, 10636 Main St. #111, Bellevue, WA 98004.**

CIRCLE 203 ON FREE INFORMATION CARD



**THE MODEL WTT-20 IS ONLY THE SIZE OF A DIME,** yet transmits both sides of a telephone conversation to any FM radio with crystal clarity. Telephone line powered - never needs a battery! Up to 1/4 mile range. Adjustable from 70-130 MHz. Complete kit **\$29.95** + **\$1.50** S+H. Free Shipping on 2 or more! COD add **\$4.** Call or send VISA, MC, MO. **DECO INDUSTRIES, Box 607, Bedford Hills, NY 10507. (914) 232-3878.**

CIRCLE 127 ON FREE INFORMATION CARD



**FREE CATALOG OF HARD-TO-FIND TOOLS** is packed with more than 2000 quality items. Your single source for precision tools used by electronic technicians, engineers, instrument mechanics, schools, laboratories and government agencies. Also contains Jensen's line of more than 40 tool kits. Send for your free copy today! **JENSEN TOOLS INC., 7815 46th St., Phoenix, AZ 85044. (602) 968-6231.**

CIRCLE 115 ON FREE INFORMATION CARD



**TUNABLE NOTCH FILTER**—for elimination of any TV, FM, or VHF signal. Can be tuned precisely to ANY signal within these ranges: \*MODEL 26-Ch's. 2-6 plus FM [54-108 Mhz] \*MODEL 1422-Ch's. 14(A)-22(I) [120-174 Mhz] \*MODEL 713-Ch's. 7-13 [174-216 Mhz] Highly selective 60dB notch. Send **\$30** each. Quantity prices as low as **\$14.** **STAR CIRCUITS, P.O. Box 8332, Pembroke Pines, FL. 33084**

CIRCLE 94 ON FREE INFORMATION CARD

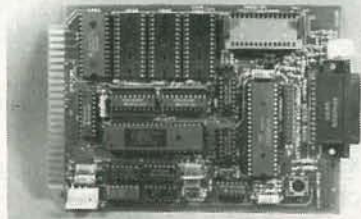

**BUILD STEVE CIARCIA'S BASIC-52 COMPUTER.** CCI BASIC-52 Computer board includes 8K byte ROM resident floating point BASIC, autobaud rate serial terminal port, serial printer port, 3 parallel ports, 2764/27128 EPROM programmer, sockets for 48K bytes of RAM or EPROM, and 44 pin edge card expansion bus. Over 10 expansion cards available. Full BASIC-52 Kit w/8K RAM **\$169.00,** Power Supply add **\$19.00.** S&H **\$5** in USA. CCI, 4 Park St., Suite 12, Vernon, CT 06066. (203) 875-2751.

CIRCLE 205 ON FREE INFORMATION CARD

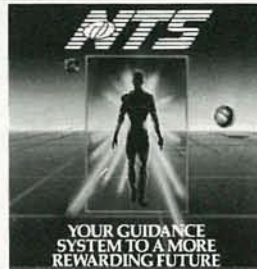

**YOUR GUIDANCE SYSTEM TO A MORE REWARDING FUTURE**

**A CAREER START FOR THE 21ST CENTURY.** Since 1905, National Technical Schools has helped people build successful careers. Enter the 21st Century through home study courses in Robotics, Computer Technology and Servicing, Microprocessors, Video Technology, Basic Electronics, Transportation Technology, Climate Control Technology or TV and Radio Servicing. For a FREE catalog, call 1-800-B-BETTER. Or write **NTS/INDEPENDENT TRAINING GROUP, 456 West M. L. King Jr. Blvd. L.A., CA 90037.**

CIRCLE 186 ON FREE INFORMATION CARD



**NEW: PANASONIC VIDEO SWITCHER.** Record a cable channel while viewing any one of your 4 video options, another cable channel, 2nd VCR, TV games, video camera, etc. No need to use your cable converter for channel selection VCS-1 gives your cable ready TV or VCR full control of your viewing. Compatible with all scrambled and one way addressable systems. **\$85.00** Guaranteed. Free Catalog. (402) 331-4957 **M.D. ELECTRONICS, 5078 So. 108th #115, Omaha, NE 68106.** We accept MC. Visa. C.O.D.

CIRCLE 198 ON FREE INFORMATION CARD



**RADAR SPEED GUNS.** Professional (used by police). From **\$275.** Used for clocking speeds in baseball, car/boat racing, bowling, skiing, etc. **ZENITH SSAVI \$169+**. Reconditioned, original UHF equipment. Satellite components. Surplus TV equipment: N-12, SB-3, Hamlin 1200, Ztac, etc. Converters, amplifiers, TV accessories. Catalog & coupon **\$1.** SSAVI modification/troubleshooting handbook **\$6.50** ppd. **AIS SATELLITE, INC., P.O. Box 1226-M, Dublin, PA 18917. 215-249-9411.**

CIRCLE 81 ON FREE INFORMATION CARD



**NEW JERROLD CS 68 CHANNEL CABLE TV CONVERTER** with volume control & descrambler loop (Port). Programmable clock turns TV on/off & changes channel. Audio mute kills commercials. Programmable channel scan. Instant channel recall. Automatic fine tuning with manual override. Video & audio outputs. Friendly to all descramblers. Specify output. 1 year warranty. **\$139, \$108** ea./case lot of 10. Free delivery. Dealers wanted. (514) 739-9328. **CROSLY ELECTRONICS, Box 840, Champlain, N.Y. 12919.**

CIRCLE 189 ON FREE INFORMATION CARD

# Where's Your **ELECTRONICS** Career Headed?

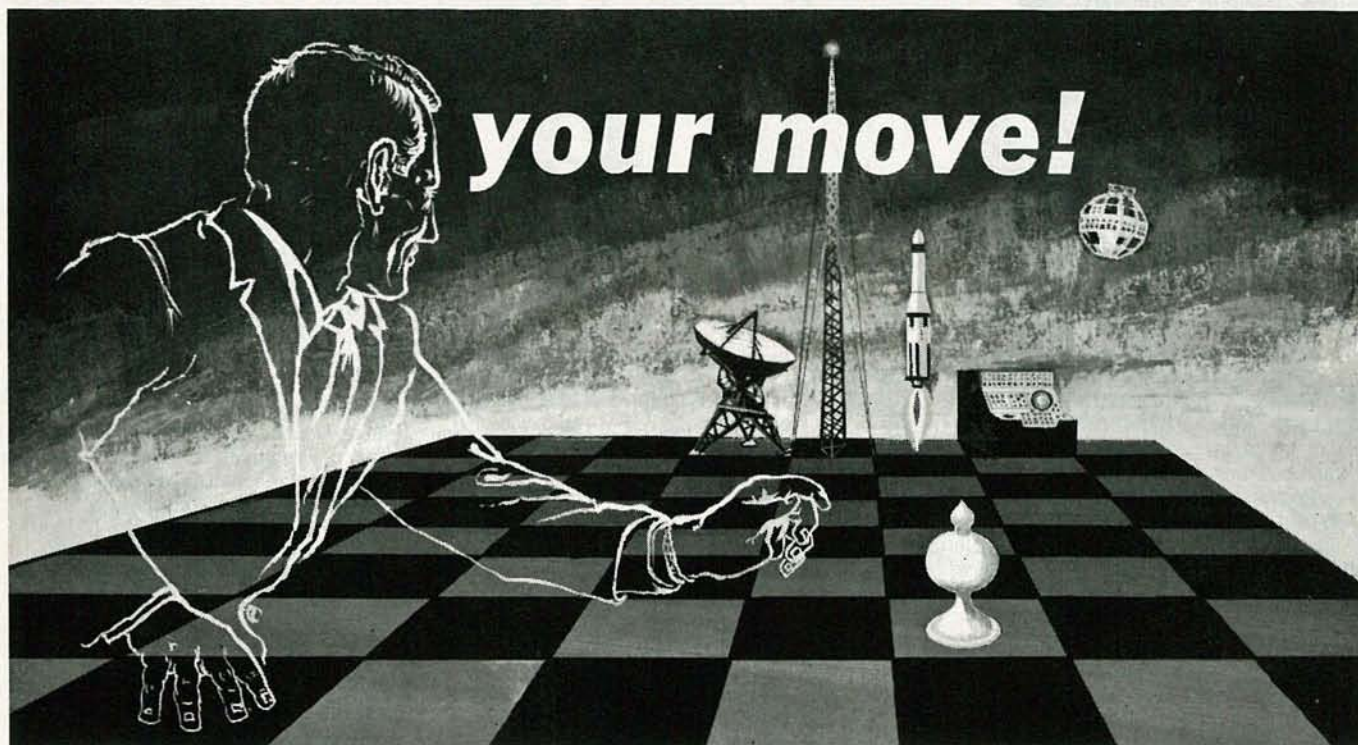

## The Move You Make Today Can Shape Your Future

Yes it's your move. Whether on a chess board or in your career, you should plan each move carefully. In **electronics**, you can *move ahead* faster and further with a

## B. S. DEGREE

Put professional knowledge and a COLLEGE DEGREE in your electronics career. Earn your degree through independent study at home, with Grantham College of Engineering. No commuting to class. Study at your own pace, while continuing your present job.

The accredited Grantham non-traditional degree program is intended for mature, fully employed workers who want to upgrade their careers . . . and who can successfully study electronics and supporting subjects through

### INDEPENDENT STUDY, AT HOME

Free Details Available from:

**Grantham College of Engineering**  
10570 Humbolt Street  
Los Alamitos, California 90720

### Independent Home Study Can Prepare You

Study materials, carefully written by the Grantham staff for independent study at home, are supplied by the College, and your technical questions related to those materials and the lesson tests are promptly answered by the Grantham teaching staff.

### Recognition and Quality Assurance

Grantham College of Engineering is accredited by the Accrediting Commission of the National Home Study Council.

All lessons and other study materials, as well as communications between the college and students, are in the English language. However, we have students in many foreign countries; about 80% of our students live in the United States of America.

**Grantham College of Engineering** R-6-87  
10570 Humbolt Street, Los Alamitos, CA 90720

Please mail me your free catalog which explains your B.S. Degree independent-study program.

Name \_\_\_\_\_ Age \_\_\_\_\_

Address \_\_\_\_\_

City \_\_\_\_\_ State \_\_\_\_\_ Zip \_\_\_\_\_

ROSS ORTMAN

UNTIL RECENTLY, THE DIGITAL dashboard has been seen only in movies and custom show cars. Automobile manufacturers now incorporate digital displays in selected models, but only as an extra-cost option. But that leaves the rest of us in the dark—literally! So here's an inexpensive, easy-to-build tachometer that displays engine speed in both analog and digital form. The circuit is versatile enough to be adapted for use as a speedometer; we'll show how to do so in a future issue.

Why did we provide both analog and digital displays? Mainly because a digital readout can be harder to read and interpret under rapidly changing engine speeds than an analog dial. After the circuit is calibrated, you can get a good idea of engine speed just by glancing at the gauge. After calibration, the digital readout will display accurately from 0 to 9990 RPM in increments of 10 RPM.

### Theory of operation

The tachometer works by counting pulses from the distributor points for a period of time, and then scaling and displaying that number. The digital display has three significant digits; the fourth (and least significant) digit always displays "0," so that RPM's can be read from the display directly.

Breaker-point frequency is determined by this formula:

$$f = \text{RPM} \times (\text{Number of cylinders} / 120)$$

For example, with a speed of 600 RPM on an eight cylinder engine, breaker-point frequency is  $600 \cdot (8/120) = 40$  Hz. At 3000 RPM, it is 200 Hz.

Now let's use the 600-RPM value to establish how to display the correct value on the tachometer. With an input frequency of 40 Hz, the display must read 600. Because the least-significant digit is zero and the counter section controls only the three active digits, we need to end up with a value of 60 in our counter. With a time-base of 0.5 second (2 Hz), 60 pulses must be read within 0.5 second. Dividing 0.5 by 60 gives us 8.33 ms; the reciprocal of that is 120 Hz—the value we must feed the counter section to obtain the correct reading. So we must multiply the 40-Hz incoming frequency by 3. The circuit that does that will be described later.

Following the same procedure, we find that, to obtain accurate readings for a 4-, 6-, or 8-cylinder engine, the input frequency must be multiplied by a value of 6, 4, or 3, respectively.

# DIGITAL TACHOMETER FOR YOUR CAR

*Monitor your car's engine speed with digital accuracy and analog readability.*



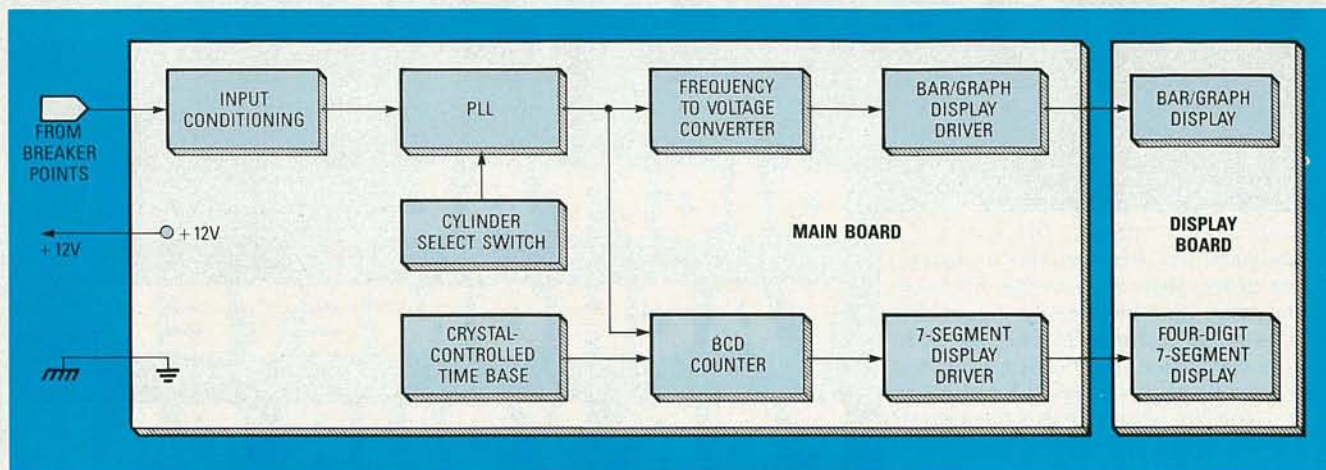

FIG. 1—BLOCK DIAGRAM OF THE TACHOMETER: The PLL scales the breaker-points signal for display directly in RPM.

### Circuit overview

A block diagram of the circuit is shown in Fig. 1. After conditioning the noisy input signal, a PLL (Phase-Locked Loop) is used to multiply the incoming frequency by the value set by the cylinder-select switch (S1). The output of the PLL drives both the analog and digital sections that follow.

The BCD counter is the heart of the digital circuit; it counts the multiplied input signal. After a predetermined sampling interval, a latch pulse latches the number present in the counter at that instant. Immediately following the latch pulse, a clear pulse resets the counter so that counting may start from zero for the next sampling period. The readout is updated every 0.5 second. Figure 2 shows the circuit's timing diagram.

The latch and clear pulses that control the counter are derived from a crystal-controlled oscillator. The oscillator uses a 3.58-MHz TV color-burst crystal to generate a 0.5-second gate time that is stable over a wide range of temperatures.

To produce the analog display, the output of the PLL section is converted to a voltage by a frequency-to-voltage converter. That relative voltage is then displayed on a row of twenty LED's that are driven by a pair of bar/graph display-driver IC's.

### Circuit description

The input-conditioning circuit, PLL, and timebase are shown in Fig. 3. Pulses from the points (or tachometer hookup on an electronic ignition system), are fed through a coaxial cable to the input circuit. Waveshaping is accomplished by rectifying the pulses, filtering out spikes, and squaring the signal up by using a comparator with hysteresis. The input circuit limits the amplitude of the 200–300-volt pulses from the points to about nine volts in order to avoid damaging the PLL. Negative pulses are clipped by D1, and positive pulses are filtered by C1 and C2.

Pulses are next squared by IC1, an LM741 op-amp that functions as a comparator. The comparator uses positive feedback via resistor R6 to produce hysteresis, which helps square up the signal.

The PLL section is made up of IC5 (a 4046), its associated circuitry, and IC6, a 4018 presettable divide-by-*n* counter. The setting of IC6 is what determines the PLL's multiplication factor. If IC6 is set to divide by 3, the output frequency of the PLL section will be locked at 3 times the input frequency. Switch S1 determines the number by which IC6 will divide the PLL's output frequency.

The clock is built around an MM5369 17-stage programmable oscillator/divider (IC2); it uses a 3.58 MHz crystal to pro-

duce an output of 60 Hz. The 60-Hz output is then divided down to 2 Hz by IC3. The 50-millisecond latch pulse is produced by IC7-a; a delayed version of that pulse is generated by C11, C12, R14, R15, IC7-b, and IC7-c. The delayed pulse functions as the clear signal that was described earlier.

Now let's examine the digital display section (shown in Fig. 4). Counting, latching, and display multiplexing is done by IC9, an MC14553 three-digit BCD counter. The common-cathode LED segments are driven by IC8 (a 74C48); the LED's common cathodes are driven by the three PNP transistors (Q1–Q3).

The analog display (shown in Fig. 5) is based on a frequency-to-voltage converter IC12, an LM2917. It produces a voltage that is proportional to the frequency of the signal fed to its pin-1 input. That voltage is fed to the two bar/graph display drivers, IC10 and IC11, through potentiometer R34, which allows the display to be calibrated. The display drivers are cascaded to drive the 20 discrete LED's. Cascading is accomplished by referencing IC11's internal comparator reference voltage to the final reference voltage of IC10. Resistor R29 limits the amount of current the drivers must dissipate.

### Construction

The tachometer is built on two PC boards, a display board, and a main board. The display board (Fig. 6) contains four seven-segment LED displays, twenty discrete LED's, and several current-limiting resistors. The main board (Fig. 7) contains the remainder of the circuitry. The PC boards can be made using the foil patterns shown in PC Service, or a set of boards with plated-through holes can be bought from the supplier mentioned in the Parts List. If you etch your own boards, be sure to solder both sides of the board wherever necessary. If possible, use machined-type IC sockets that don't have plastic bodies, as they can be soldered on both sides of the board easily.

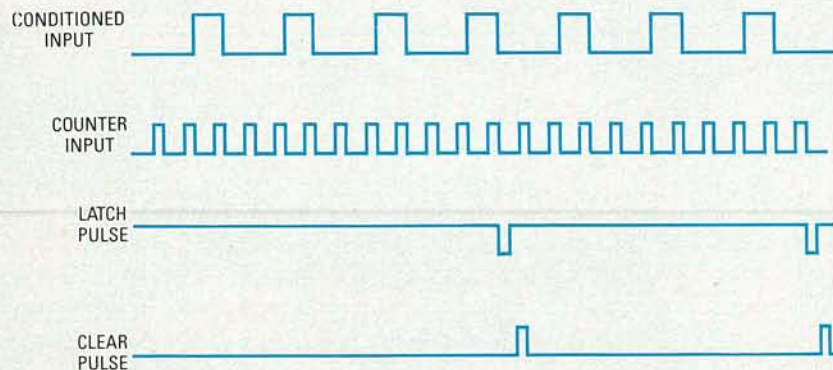

FIG. 2—THE SIGNAL FROM THE POINTS is multiplied by the PLL and counted until a latch pulse is received. The counter is then reset.

## PARTS LIST

All resistors are 1/4-watt, 5% unless otherwise noted.

R1—4700 ohms  
 R2, R3, R5, R12, R14, R15, R30, R33—10,000 ohms  
 R4, R7, R8, R10—100,000 ohms  
 R6—470,000 ohms  
 R9—22 megohms  
 R11—2.2 megohms  
 R13—1 megohm  
 R16, R17, R18, R27—1000 ohms  
 R19—R25—220 ohms  
 R26, R31—470 ohms  
 R28, R36—22,000 ohms  
 R29—50 ohms, 5 watts, wire-wound  
 R32—33,000 ohms  
 R34—10,000 ohms vertical trimmer pot  
 R35—2200 ohms

### Capacitors

C1—0.22  $\mu$ F disc  
 C2—0.022  $\mu$ F disc  
 C3—0.01  $\mu$ F disc  
 C4—10  $\mu$ F, 16 volts, electrolytic  
 C5—33 pF disc  
 C6—22 pF disc  
 C7, C8, C15—1  $\mu$ F, 16 volts electrolytic  
 C9—0.1  $\mu$ F disc  
 C10—0.05  $\mu$ F disc  
 C11, C12, C13—0.1  $\mu$ F 001 disc  
 C14—0.022  $\mu$ F mylar

### Semiconductors

IC1—LM741 op-amp  
 IC2—MM5369 17-stage oscillator/divider  
 IC3—CD4518 dual synchronous up counter  
 IC4—CD4081 quad AND gate  
 IC5—CD4046 micropower phase-locked loop  
 IC6—CD4018 presetable divide-by-*n* counter  
 IC7—CD4001 quad NOR gate  
 IC8—74C48 BCD to 7-segment decoder/driver  
 IC9—MC14553 three-digit BCD counter  
 IC10, IC11—LM3914 bar/graph display driver  
 IC12—LM2917N frequency-to-voltage converter  
 D1—D3—1N4004 rectifier  
 D4—1N4739A, 9.1 volts, 1 watt Zener  
 D5—1N4148 switching diode  
 D6—1N4001 rectifier  
 Q1—Q4—2N3906 PNP transistor  
 LED1—LED10—0.125" green diffused LED  
 LED11—LED16—0.125" yellow diffused LED  
 LED17—LED20—0.125" red diffused LED  
 DISP1—DISP4—7-segment common-cathode display (Panasonic LN516RK, Digi-Key P351, P352, P353, & P354 may also be used.)

### Other components

S1—DP3T slide switch (CW Industries GPI154-3013, Digi-Key SW115-ND)  
 XTAL1—3.58 MHz color-burst crystal  
 F1—1 amp slo-blow automotive fuse  
 P1, P2—0.1" 2-pin Molex connector

**Note:** The following are available from Dakota Digital, R. R. 1 Box 83, Canistota, SD 57012: Single-sided display board, \$6.95; double-sided (with plated-through holes) main board, \$12.95. All orders add \$1.50 for shipping and handling. South Dakota residents and 4% sales tax.

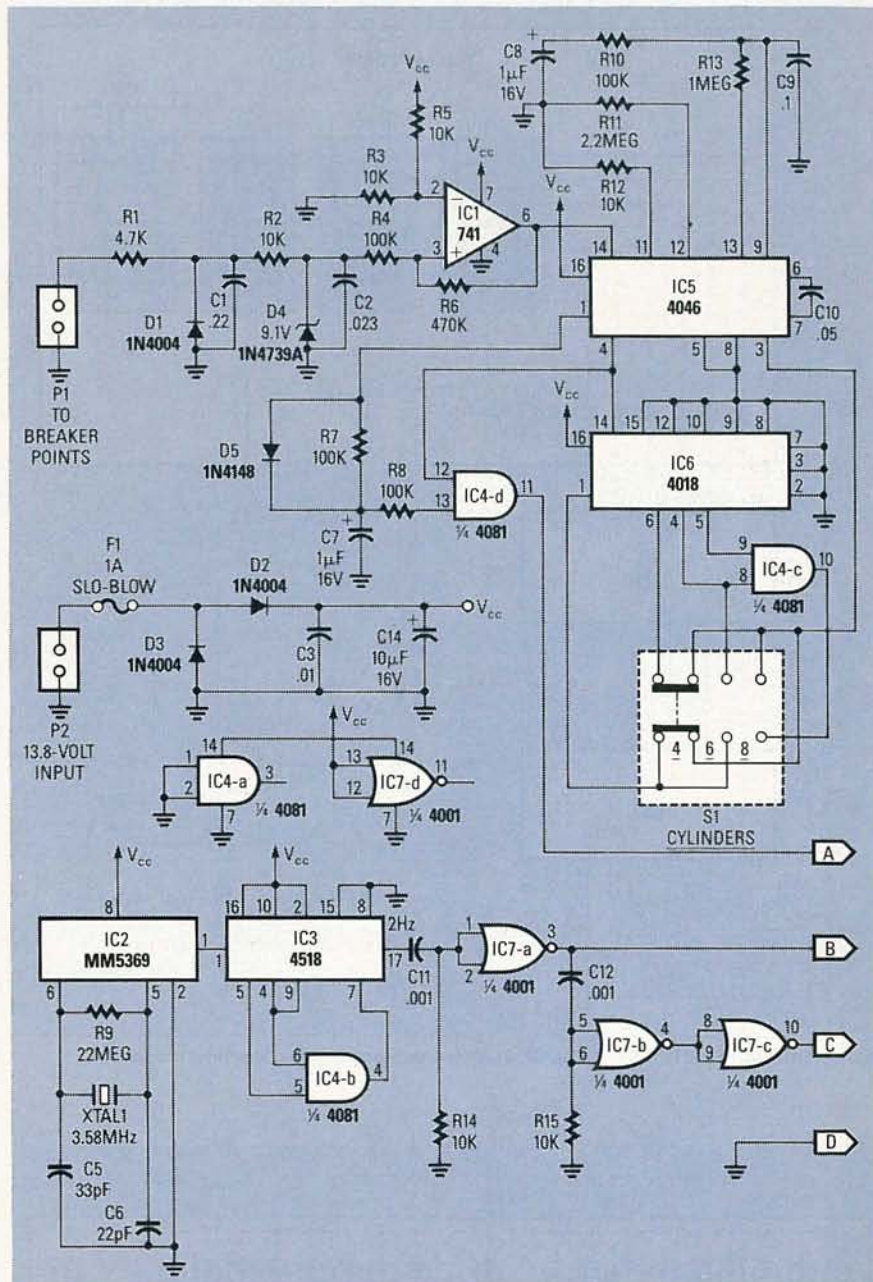

FIG. 3—THE TIMEBASE, INPUT CONDITIONING, and PLL circuits are shown here. Op-amp IC1 functions as a comparator that squares up the input signal for processing by the PLL.

When stuffing the display board, begin with the eight resistors and the three jumpers; then install the four seven-segment displays. Next, insert the twenty LEDs into their respective holes. Pay close attention to the polarity of the LED's. The cathode (or flat side) goes toward the row of holes at the lower edge of the board. After the LEDs have been set in place, carefully turn the board over and lay it down on a flat sturdy surface. Now position the LED's and the displays so they are the same height above the board. If they're not, the LED's must be inserted into their mounting holes further. After the LED's and displays are at the same approximate height, solder one lead of each LED to the board. Then turn the

board over and align the LED's so they stand up straight and follow a smooth curve. Now, finish soldering the LED's and set the display board aside.

The next step is to stuff the main board. Begin with the smaller parts: resistors and diodes. Next install the IC's. Because they're mainly CMOS IC's, the use of sockets is recommended, but not essential. If you don't use sockets, insert the IC's carefully, and solder only a few legs at a time to keep heat to a minimum. If sockets are used, install them now and insert the IC's later. Doing so will lessen any chances of static damage. Remember, if you don't use boards with plated-through holes, you'll have to solder most components on both sides of the board.

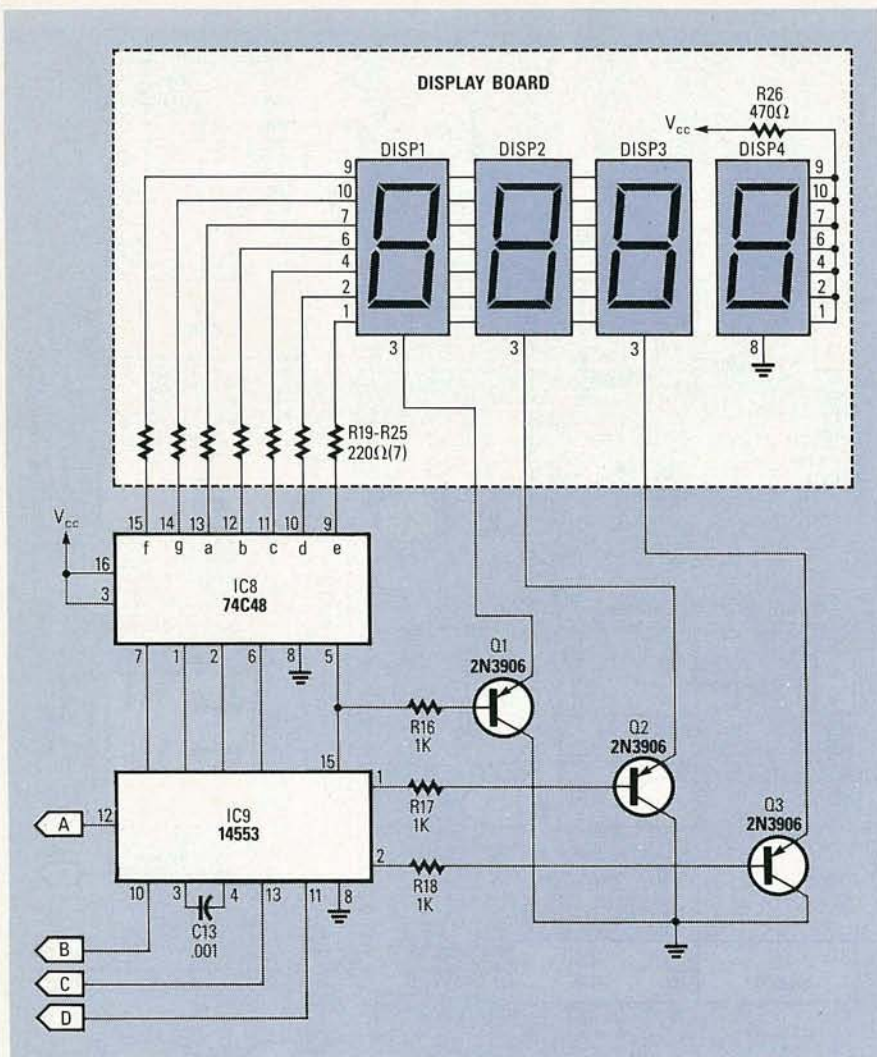

FIG. 4—THE TACHOMETER'S DIGITAL DISPLAY is a conventional decoder/driver circuit.

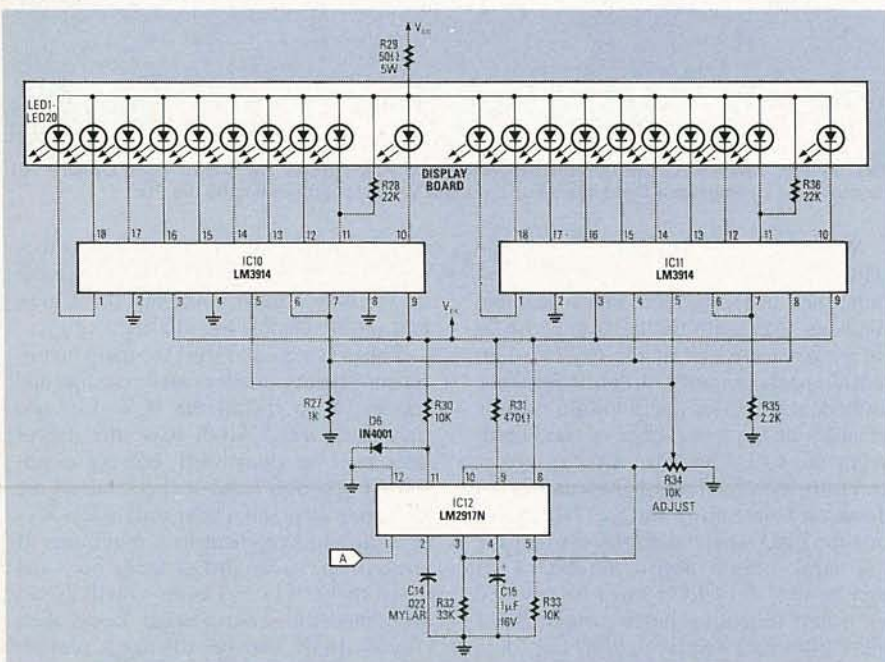

FIG. 5—THE TACHOMETER'S ANALOG DISPLAY is built around a frequency-to-voltage converter (IC12) that drives two bar/graph drivers (IC10 and IC11).

Install the remaining components (capacitors, connectors, and transistors). The base or center leg of each 2N3906 is bent toward the flat side of the package; the transistor should rest about 1/4 inch off the board. Install the remaining parts on the board and double-check both boards for errors.

Mechanically, the boards are mounted back to back, separated by 1/4-inch stand-offs. Note that each PC board has a row of 35 holes along the lower edge. The boards were designed so that corresponding holes in each should be connected electrically using short pieces of bare wire. Trimmed resistor legs work admirably. If troubleshooting should prove necessary, you can separate the boards by bending those wires carefully.

Before soldering the wires, connect the boards together using stand-offs and #6 hardware. Assemble the boards with the foil side of each facing that of the other. Then lay the assembly down and insert a bare wire through each hole in the top board and into the corresponding hole in the bottom board. Insert and solder several wires at a time; continue until all wires have been inserted and soldered.

### Testing

After the two boards are stuffed and connected together, apply 12 volts to P2 using a power supply or battery. The three right-hand digits should display zero's, and the left hand digit should show nothing. Also, no LED's should be lit. Now, using an audio-frequency function generator, apply a 9-volt peak-to-peak 40-Hz squarewave to the junction of D4 (the 9.1-volt Zener diode) and R2. If your generator cannot supply a squarewave with a DC offset, you may have to feed the test point through a 1K resistor and use a higher-amplitude signal.

Set the cylinder-select switch to 8. The readout should now display something close to 600. Change the cylinder-select switch to 6; the display should read 800. Last, set the switch to 4; the display should read 1200.

Now we'll calibrate the analog display. Set the cylinder-select switch to the setting you plan to use. Next, set the generator to the frequency that will produce the "redline" RPM reading for your engine (i. e., the speed above which the manufacturer recommends you not run the engine.) For an eight-cylinder engine, that speed is typically 5000 RPM. When the redline reading is obtained on the digital readout, adjust R34 so the first red LED lights up. The tachometer is now calibrated and ready for installation.

### Installation

First decide where the tachometer will be installed. You'll have to find a spot that provides a good view, that doesn't interfere with pre-existing components, and

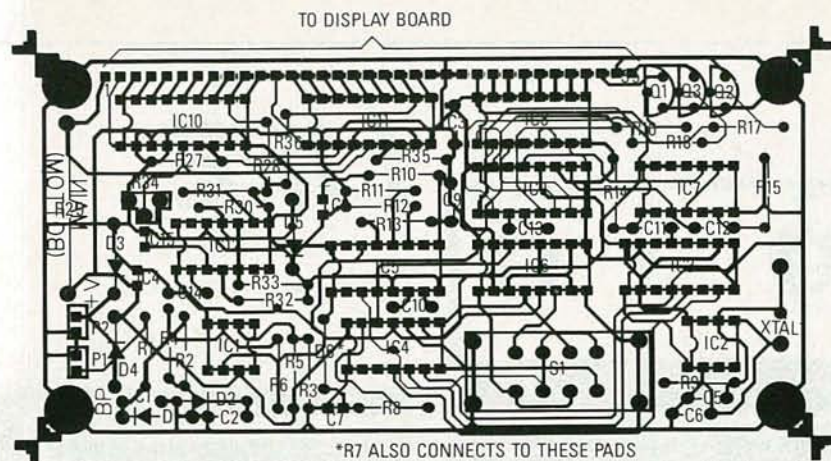

FIG. 6—STUFF THE TACHOMETER'S MAIN BOARD as shown here. Use clipped resistor leads to make the connections to the display board.

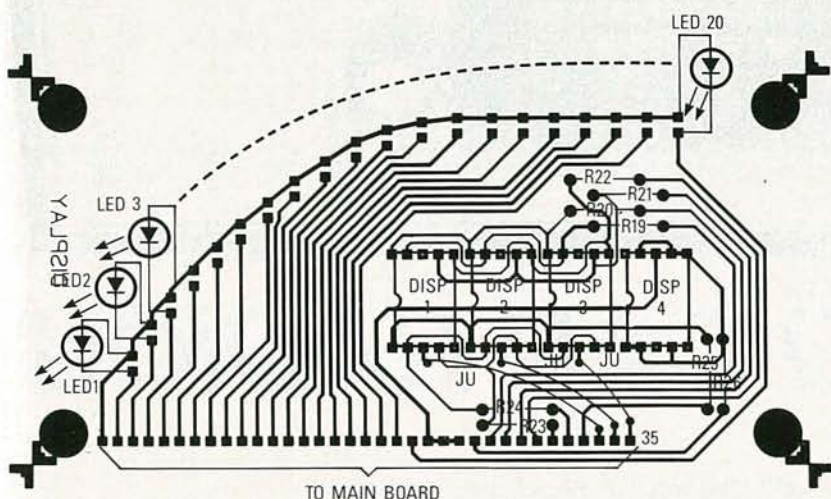

FIG. 7—STUFF THE DISPLAY BOARD as shown here. The flat side of each LED should point toward the bottom of the board. The two boards are sandwiched together, and corresponding pads on the boards are connected with short pieces of stiff wire.

one that you can get to without being a Chinese contortionist!

When a suitable mounting site has been chosen, run a wire from your ignition system to the PC-board assembly. Three possible wiring schemes for different types of ignition systems are shown in Fig. 8-a, Fig. 8-b, and Fig. 8-c. Whatever type of ignition system you have, run a piece of coaxial cable from the distributor points or tachometer hookup to the mounting location. An easy and reliable way to make the connection is to attach the center conductor of the coax to the terminal labeled *DISP* or *-* on the ignition coil. Many electronic ignition systems also use a conventional coil, and the connection is made in the same manner as to a distributor/points system. Some electronic ignition systems do not use a conventional coil, so the connection must be made by fastening the center conductor of the coax to the terminal marked *TACH*.

After putting a connector on the opposite end of the signal coax, connect the power wires. Connect the black wire to chassis ground and the red one to a source

that is on only when the ignition key is in the *ON* position.

Now you're ready to install the tachometer. A case can be built from just about any type of material, but an attractive, durable front panel is important. The use of bronze-colored Plexiglass for the front panel will not only protect the displays, but also make them more visible. Don't use red filter plastic because it will wash out the green and yellow LED's of the bar/graph display. To enhance appearance further, the front panel can be masked on the inside to allow only the LED's and displays to show, thus hiding the rest of the display board. Masking can be done by taping over the area through which the displays will show, and painting the uncovered area black. You may also want to label the front panel using white dry-transfer lettering.

After building your enclosure, mount the PC-board assembly in it, and then install the enclosure in your vehicle. Be sure to install it and the connecting wires so they will not present a safety hazard. Now plug in the power and signal con-

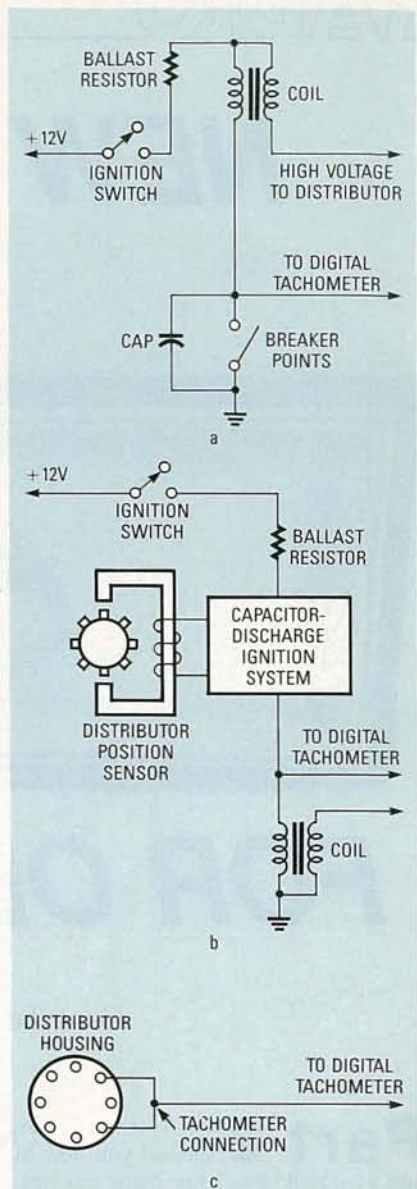

FIG. 8—TO INTERFACE THE TACHOMETER, follow one of these circuits. A conventional (Kettering) ignition system is shown in (a), a capacitor-discharge system in (b), and a General Motors hook-up in (c).

nectors. The installed digital tachometer is now ready to display your engine's speed with both digital accuracy and analog readability.

### Conclusions

The circuit can be used in a car, truck, boat, or wherever an accurate and reliable tachometer is needed. If you're interested in adding other digital display equipment to your car, see the July, August, and September 1983 issues of **Radio-Electronics**. Those issues contain circuits for displaying voltage, water temperature, and oil pressure in digital form. In addition, the circuit shown here can also be adapted for use as a speedometer—we'll show you how to do it next time. **R-E**

## NEW

## LIFE



# FOR OLD CAR RADIOS

*Hear the world with this deluxe shortwave converter!*

GARY McCLELLAN

**Part 2** LAST MONTH, WE showed you how to turn a car radio into a fine home receiver. But perhaps you're tired of hearing the same old music, news, and sports from your local stations. If so, take heart! This month we're going to show you how to build a shortwave converter that will let you hear the latest news from the places where it happens, while it happens. With it, you'll also hear the kinds of music and cultural events that are popular in many faraway places.

Our converter adapts any analog (dial type) AM car radio to receive international shortwave stations. It covers the two most popular bands, namely 49 (6 MHz) and 31 (9 MHz) meters, plus WWV (5 MHz); WWV is a frequency measurement service that also broadcasts time signals, making it great for setting your household clocks very accurately, among other things.

But why is using a converted car radio so important to this project? First, as outlined last time, those radios feature sensitivity and selectivity that is superior to what is offered by conventional home ra-

dios; a car radio modified for home use and outfitted with our shortwave converter will provide performance that is far superior to that of the low-cost multiband radios often seen at discount stores. Also, car radios are well shielded, so noise pickup is reduced resulting in quieter reception.

Considering those advantages, and the ease and low cost of converting a car radio to home use (as demonstrated last time), using a modified car radio for this project makes perfect sense.

### Exploring the bands

If you've never listened to shortwave radio, you are probably wondering about the stations that you might discover and their programs. Of course, what you hear will vary due to broadcast conditions and what time of day you tune in; but here is a typical sample of what to expect: Radio HCJB (Ecuador), the BBC (UK) and Radio Deutsche Welle (Germany) offer music and news programs with a perspective not heard on U.S.-broadcast news reports. Other stations that you may find interesting include the Voice of Free China (Taiwan), Radio Havana Cuba (Cuba) and the Voice of America (U.S.). Those stations also offer music and cultural-affairs programs that are very entertaining. Surprisingly, those stations, and many more, were heard using only the equipment described here, plus a 4-foot antenna!

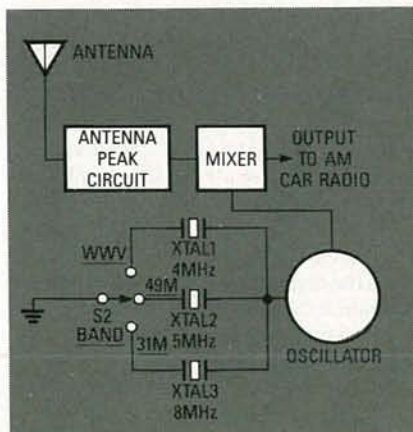

FIG. 4—THE SIGNAL FROM THE ANTENNA is mixed with a locally generated signal and the difference mixer-output frequency is output to the radio.



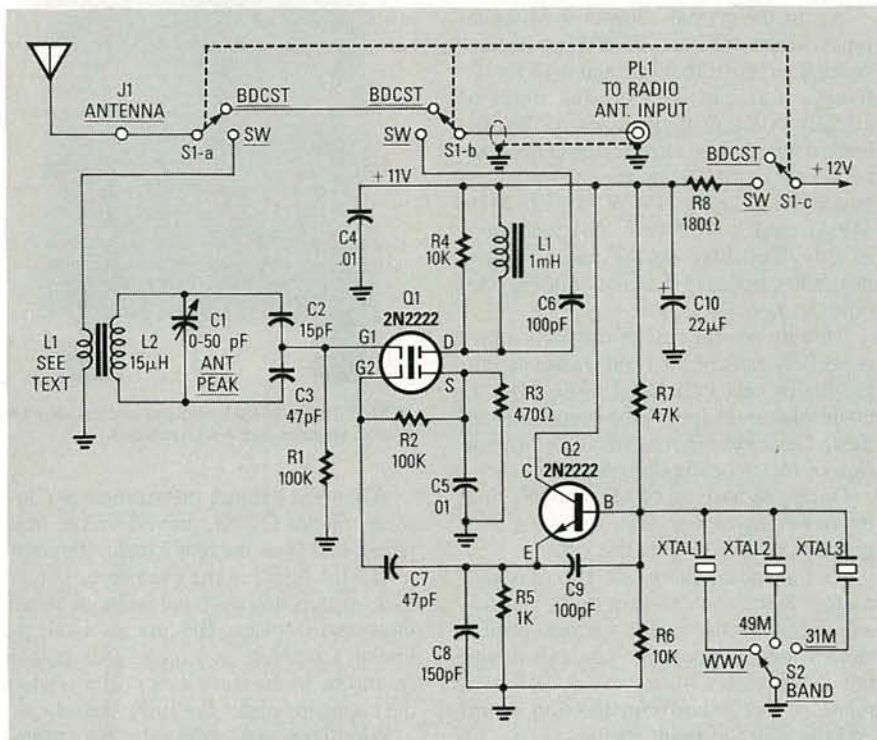

FIG. 5—COMPLETE SCHEMATIC for the shortwave converter. Few of the parts are critical, so feel free to make appropriate substitutions.

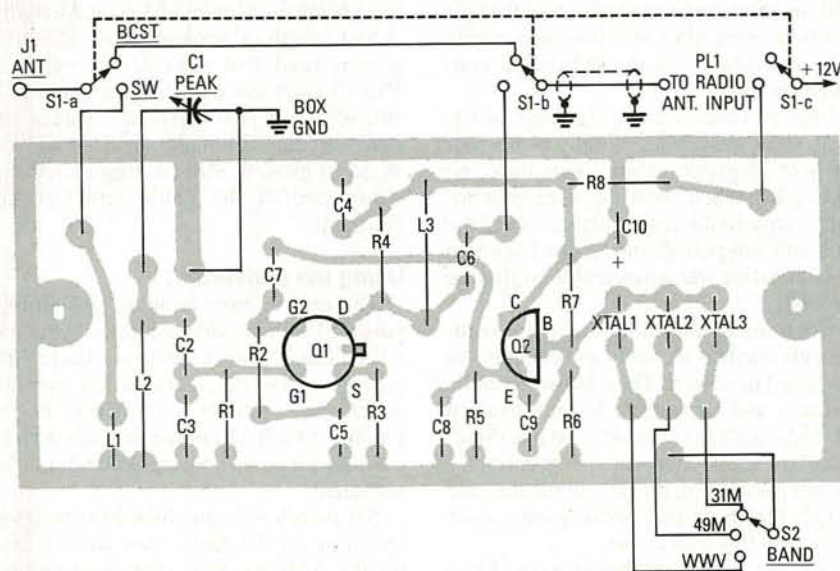

FIG. 6—USE THIS GUIDE when mounting the components; we recommend following it even if you are using perforated construction board.

### How it works

The circuit downconverts signals from WWV, 49 meters, and 31 meters to frequencies in the AM-broadcast band. With it, it is possible to tune in worldwide shortwave stations just like the conventional AM broadcasts you normally hear on your radio. A block diagram in Fig. 4 shows the basic details of the converter circuitry.

The shortwave converter consists of mixer and crystal oscillator circuits. The mixer combines signals picked up by the antenna with a locally generated signal. The result is output signals in the 540–1600 kHz range; those are the frequencies that are normally received by the car radio.

The local signal is generated by the oscillator. Three crystals, 4 MHz,

### PARTS LIST

#### All resistors ¼-watt, 5%

R1, R2—100,000 ohms  
R3—470 ohms  
R4, R6—10,000 ohms  
R5—1000 ohms  
R7—47,000 ohms  
R8—180 ohms

#### Capacitors

C1—50 pF, variable, see text  
C2—15 pF, ceramic disc  
C3, C7—47 pF, ceramic disc  
C4, C5—0.01 µF, ceramic disc  
C6, C9—100 pF, ceramic disc  
C8—150 pF, ceramic disc  
C10—22 µF, 16 volts, electrolytic

#### Semiconductors

Q1—40673 dual-gate MOSFET (RCA)  
Q2—2N2222 NPN transistor

#### Other components

L1—4 turns, 28-gauge wire over L2, see text

L2—15-µH RF choke, JW Miller 9310-40 or equivalent

L3—1-mH RF choke, JW Miller 70F103AI or equivalent

J1—5-way binding post

PL1—Motorola-type auto-radio plug

S1—3PDT toggle switch, see text

S2—three-position rotary switch

XTAL1—4-MHz crystal, 32-pF parallel mode, HC-18 case

XTAL2—5 MHz crystal, 32 pF parallel mode, HC-18 case

XTAL3—8 MHz crystal, 32 pF parallel mode, HC-18 case

**Miscellaneous**—PC board or perforated construction board, knobs, 2- × 4- × 4-inch aluminum project box (LMB CR-442 or equivalent), RG-59 coax cable, hardware, hookup wire, solder, etc.

and 8 MHz are used to provide coverage of the bands previously mentioned. Selection of the appropriate crystal, and hence the band to be received, is done using a three-position switch, S2.

Now that we know how the converter works, let's examine the circuitry in a little more detail; a complete schematic is shown in Fig. 5.

Signals from an antenna are input to the circuit via J1, a five-way binding post. A three-pole switch, S1, is used to select or bypass the converter. When that switch is in the broadcast position, your radio will operate as normal; in the shortwave position, power is fed to the converter (via S1-c) and shortwave frequencies are then easily received.

Assuming that shortwave reception has been selected, signals are first fed to a tuned circuit made up of L1, L2, and capacitors C1–C3. That circuit is set to pass only the frequency of interest and reject all others. The circuit is included to pre-

vent AM-broadcast signals from reaching the radio and causing interference. Capacitor C1 should be peaked for best reception once the circuit is fully assembled and tested.

The output across C3 is fed to the mixer circuit, which is built around Q1, a dual-gate MOSFET that functions as an RF amplifier and mixer, thereby reducing the number of parts required.

The local oscillator signal from Q2 is also fed to the mixer, via capacitor C7. The mixer output appears across L3 and R4 and is coupled to the output via C6. Resistor R4 limits the output level; it is needed because strong signals could otherwise cause distortion in the radio.

The local oscillator circuitry is simple and straightforward. It uses a standard Colpitts oscillator circuit built around Q2, with C8 and C9 providing feedback for oscillation. Crystals XTAL1-XTAL3 provide the proper operating frequencies as described earlier.

That about does it for the theory. Let's get started with construction.

### Building the converter

The circuitry is simple, and easy to build, too. As we've shown, only two transistors and a few other assorted parts are used. While we've provided a PC pattern (see PC Service) and a placement guide (see Fig. 6), they are not strictly required. If you wish, you could wire up the circuit on a small piece of perforated construction board with good results. And best of all, no alignment of any kind is needed. That is great news for those of us who lack an RF test generator.

Probably the only hard-to-find part in the project will be variable capacitor C1. Those units are becoming scarce, because many of the original manufacturers are out of business. Try surplus stores for C1, or else substitute a higher-value unit. A 100-pF capacitor should work fine.

The semiconductors aren't too critical. Other MOSFET's, such as members of the 3N200 series, can be used if the RCA 40673 isn't available; the RCA component is preferred, however, since it is overload-resistant. For Q2, most garden-variety silicon NPN transistors such as the 2N3904, 2N4124, and others, should work just as well.

The coils may be almost any type avail-

able, providing that the inductances are the same. The miniature units specified were used simply because they were handy.

As for the crystals, low-cost computer types were used here; there is no need to order them custom made and wait for delivery. You can use surplus units of slightly different frequencies, if desired; all that will do is to change dial calibration on the car radio. However, with the values specified, 5 MHz (WWV), 6.0 MHz (49M), and 9.0 MHz (31M) tune in at exactly 1000 kHz on the radio. That is desirable, because it makes finding specific frequencies easier.

Moving on, the rest of the parts aren't especially critical. But you should assemble the project in a metal project box to avoid pickup of local AM-broadcast signals. The switches may be any combination of rotary or toggle types available.

Once you have all of the parts it's time to start construction. Here are some suggestions to help you do the job:

At this point there are two possible routes: First, you can turn to PC Service and fabricate the board for this project shown there. Otherwise you can mount the components on a 1.5- x 3.5-inch piece of perforated construction board and use point-to-point wiring.

If you choose to go the PC-board route, a parts-placement diagram is shown in Fig. 6. Those using point-to-point wiring will find that diagram useful, too; for best results we recommend following roughly the same layout on the perforated construction board.

Start construction by winding coil L1. That is an easy task. Simply wind four turns of 28-gauge magnet wire over one end of L2. Then twist the wire ends together to hold the coil in place, secure the coil with nail polish, and let dry. Finish up by untwisting the wires and then tinning the ends.

Continue by installing the major components, such as the coils and crystals, on the board as shown. Then follow with the resistors and capacitors; be sure to keep all leads as short as possible. When done, install the semiconductors. Note carefully the tab positioning on Q1 and the flat side of Q2. Finish up by checking your work and correcting any errors.

Set the assembled board aside for a moment and prepare the aluminum box. Refer to Fig. 7 for a suggested panel layout, then drill your box accordingly. No dimensions are given for the layout because it will vary with the sizes of the parts you are using. Although not shown, you'll also have to drill a mounting hole for J1, as well as a hole for the output cable and the power lead; those holes should be located on the rear panel. When all holes are drilled, mark the functions with press-on labels and coat the box's exterior with clear plastic spray.

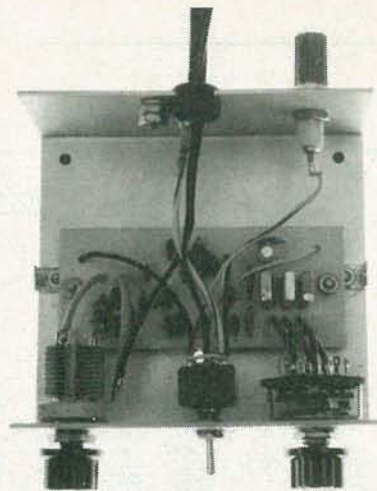

**MOUNT THE BOARD** inside the enclosure using 1/4-inch spacers and 4-40 hardware.

When the cabinet preparation is complete, mount C1, S1, and S2 on the front panel, and J1 on the rear panel. After that, install the board in the enclosure. Use 1/4-inch spacers and 4-40 hardware to secure the board in place. Be sure to install the knobs, too. Note that on C1, the pointer should be in the 9-o'clock position when the capacitor plates are fully closed.

Wire the board to the cabinet-mounted components using using stranded hookup wire; be sure to cut each wire as short as possible. Don't forget to install the bypass wire between S1-a and S1-b, and install a 3-foot length of hookup wire at S1-c for power. Feed that wire and a length of RG-59 coax through the rear-panel hole intended for that purpose. Solder the coax's center conductor to S1-b and the braid to ground. Attach plug PL1 to the other end of the cable and you are finished!

### Using the converter

The unit is easy to hook up. Simply plug PL1 into the antenna jack of your car radio. Then connect the power lead to the power supply (as described last month). After that, connect a short antenna to binding post J1. A simple antenna such as a 4 foot piece of hookup wire should be sufficient.

Set switch S1 to the broadcast position and turn on the radio; you should hear regular AM-broadcast stations as before. Then set the band switch, S2, to the WWV position and turn S1 to the short-wave position. Tune your radio carefully around 1000 kHz and you should hear the WWV time clicks at least weakly. Adjust C1 for maximum volume and then you are all set!

Reception on 49 and 31 meters works the same way. Set the band switch to the band of interest, then tune in stations from 1000 to 1600 KHz on your radio. Adjust C1 for maximum volume on each station. That's all there is to it, so enjoy! **R-E**



**FIG. 7—THE COMPLETED CONVERTER.** If you wish, follow the design shown here when laying out your front panel.



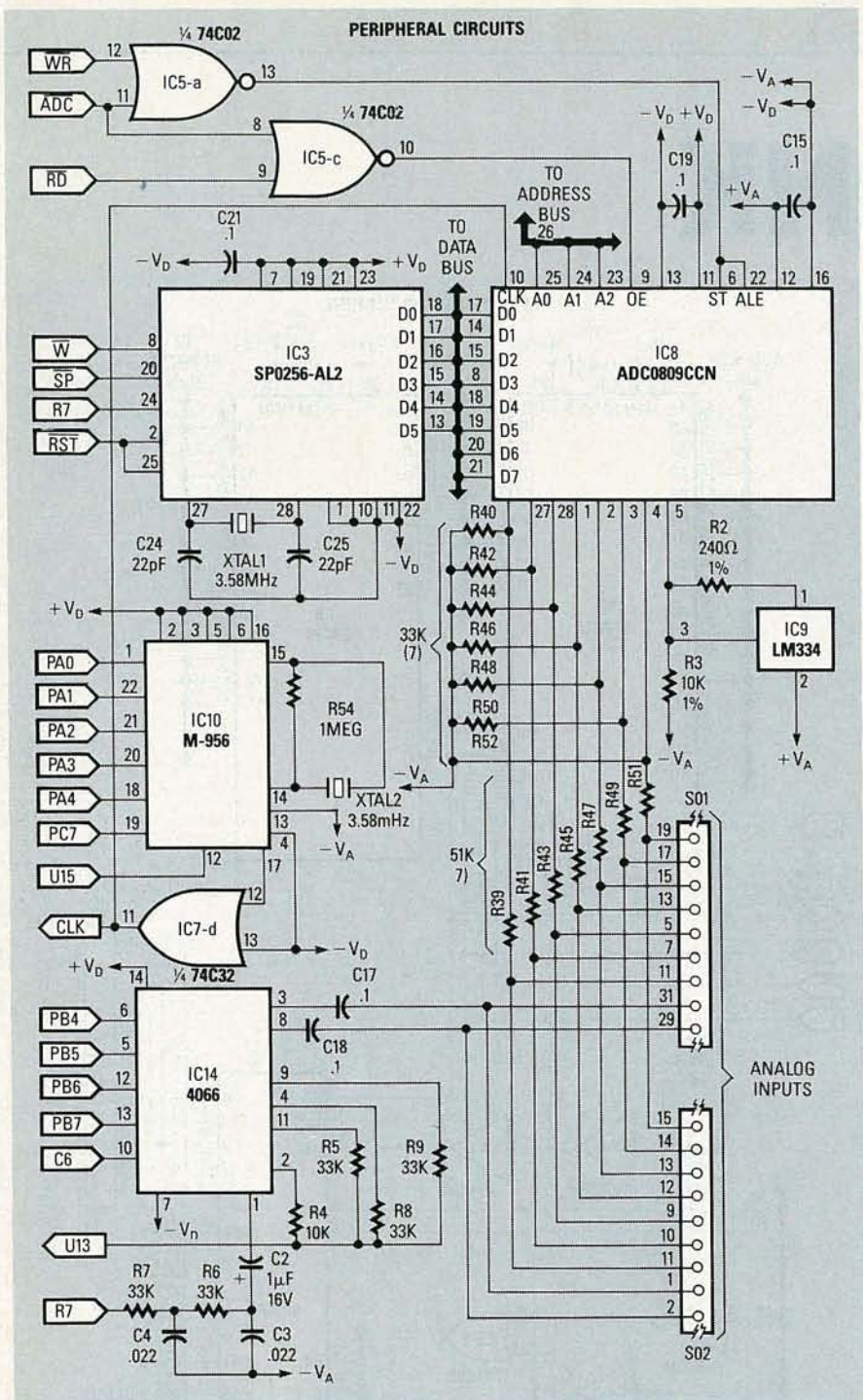

FIG. 6—THE ANALOG-INTERFACE CIRCUITS, including a speech synthesizer (IC3), an A/D converter (IC8), and a DTMF decoder (IC10) are shown here.

The ADC is a successive-approximation type; the resistive voltage divider connected to each of the first seven inputs (pins 1–5 and 26–28) is in the proper ratio to allow the microprocessor to translate a 0–5-volt input to a 0–100 percent output. For other input-voltage ranges, those resistors must be changed accordingly. The eighth input is connected to IC9, a precision current reference that produces a voltage proportional to ambient temperature.

Turning to Fig. 7, note first of all that

there are two separate five-volt power supplies, one for the analog and one for the digital circuits. Now you know why the power connections to some IC's in the previous figures are labeled  $\pm V_D$  and to others,  $\pm V_A$ . The analog and digital grounds are connected together, but only at one point; analog and digital ground runs around the board are separate.

The remainder of the circuitry provides the telephone-line interface. Line isolation is achieved through the use of opto-isolators. Opto-isolator IC16 and its asso-

### WARNING

PLEASE NOTE THAT, ALTHOUGH THE CONTROLLER presented here has been designed to meet the interface requirements of the telephone system, it is not FCC type-approved. Connection of such a device to your operating company's line is subject to the regulations of that company. It is *your* responsibility to ascertain the pertinent regulations for your area.

ciated passive components comprise the ring detector. Each time a ring occurs, a negative-going pulse is generated at pin 5 of IC16; that pulse is applied to pin 2 of IC13-a. The output of that op-amp is then applied to the PIO where it can be detected by the CPU.

Driving the remainder of the interface is BR1, a fullwave bridge rectifier that ensures proper operation of the controller even if the controller is connected to the phone lines backwards. Relay RY1 serves as the hook switch, which is equivalent to the cradle switch on any telephone. The relay is controlled by Q1, which in turn is controlled via the Z80.

A closed-loop feedback circuit is composed of IC12, IC17, IC19, IC13-c, and the C9/R16 lowpass filter; that circuit compensates for temperature drift. The data or voice signal is modulated onto the phone line by IC13-c and IC19, but the rest of the feedback loop is needed for stability and to optimize the operating point of IC19. The purpose of IC18 is to detect the disconnect pulse from the tele-

TABLE 1—I/O CONNECTIONS

Function	Pin Number	
	S01	S02
Self-cancel function 2	31	1
Self-cancel function 1	29	2
Output 4	27	3
Output 5	25	4
Output 1	23	5
Output 2	21	6
Output 3	3	7
Ground	*	8
Input 3	5	9
Input 2	7	10
Input 1	11	11
Input 4	13	12
Input 5	15	13
Input 6	17	14
Input 7	19	15
+ 5 volts, 200 mA	33	16

\*All even numbered pins are grounded.

Note: Pin 1 and pin 9 are not connected.

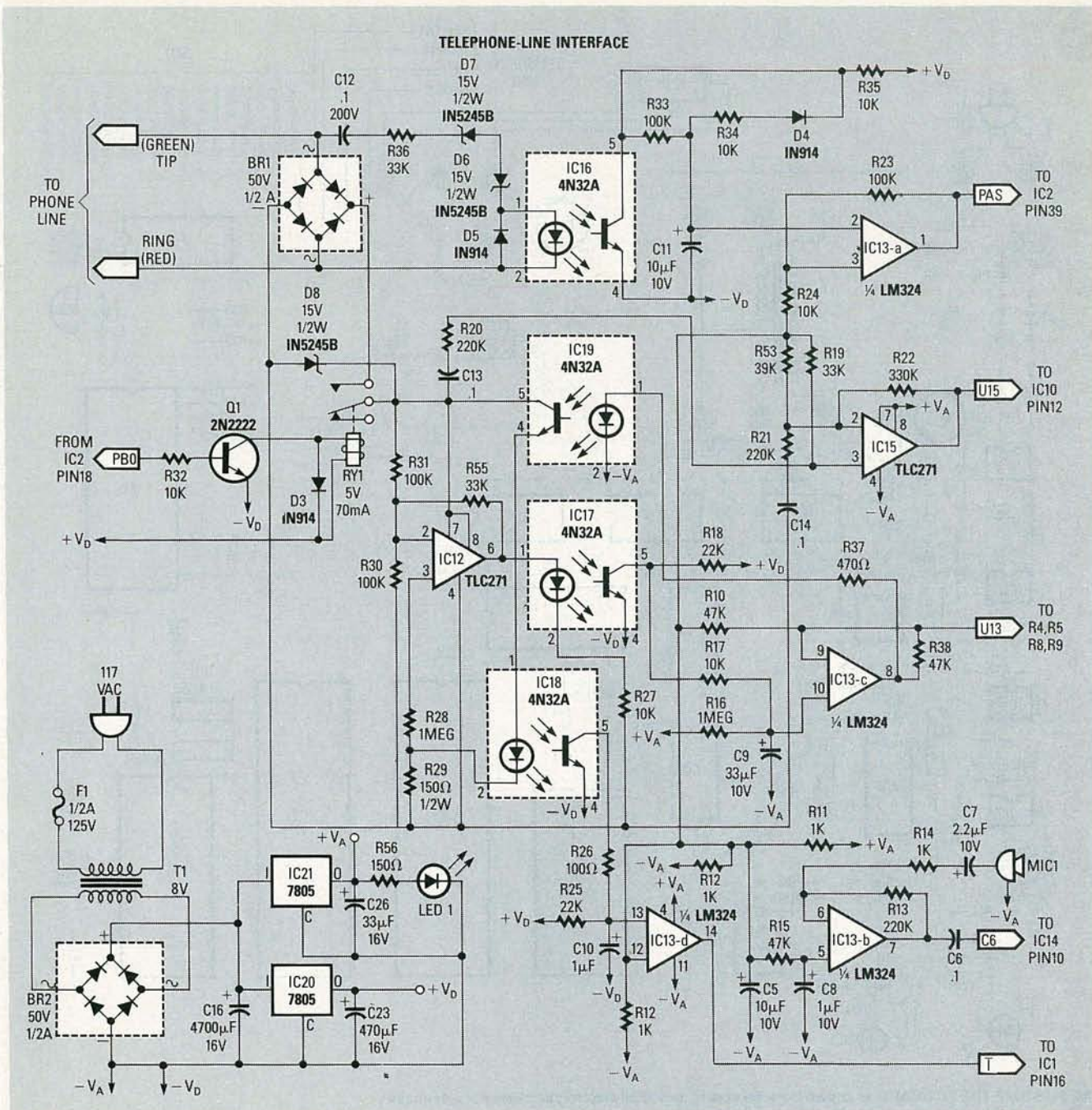

FIG. 7—THE POWER SUPPLY AND TELEPHONE-LINE INTERFACE are shown here. There are separate supplies for the analog and digital circuits.

phone exchange if the caller hangs up. That pulse causes an interrupt to the microprocessor, which then terminates the current session, re-entering the program near the top of the flowchart that was shown in Fig. 1 last time (*Radio-Electronics*, May 1987).

### Software

The controller's software is written in Z80 assembly language; it comprises about 1800 lines of code. Due to space limitations, we can't print the listing here, but we have posted it on our BBS. The file is called PHONLINK.AQM, and it has been squeezed, so you'll have to unsqueeze it to use it.

### LISTING 1

```

;
;
; *ENTER8* MODULE
ENTER8 LD      A,04H           ;PA5
      OUT     (SPCHPT),A       ;PRE-DELAYS
      OUT     (SPCHPT),A       ; " "
      OUT     (SPCHPT),A
      OUT     (SPCHPT),A
      OUT     (SPCHPT),A
      LD      HL,RTRN85
      JP      ENTER           ;"ENTER"
RTRN85 LD      HL,RTRN86
      JP      EIGHT          ;"EIGHT"
RTRN86 LD      HL,RTRN87
      JP      TWO           ;"TO"
RTRN87 LD      HL,RTRN88

```

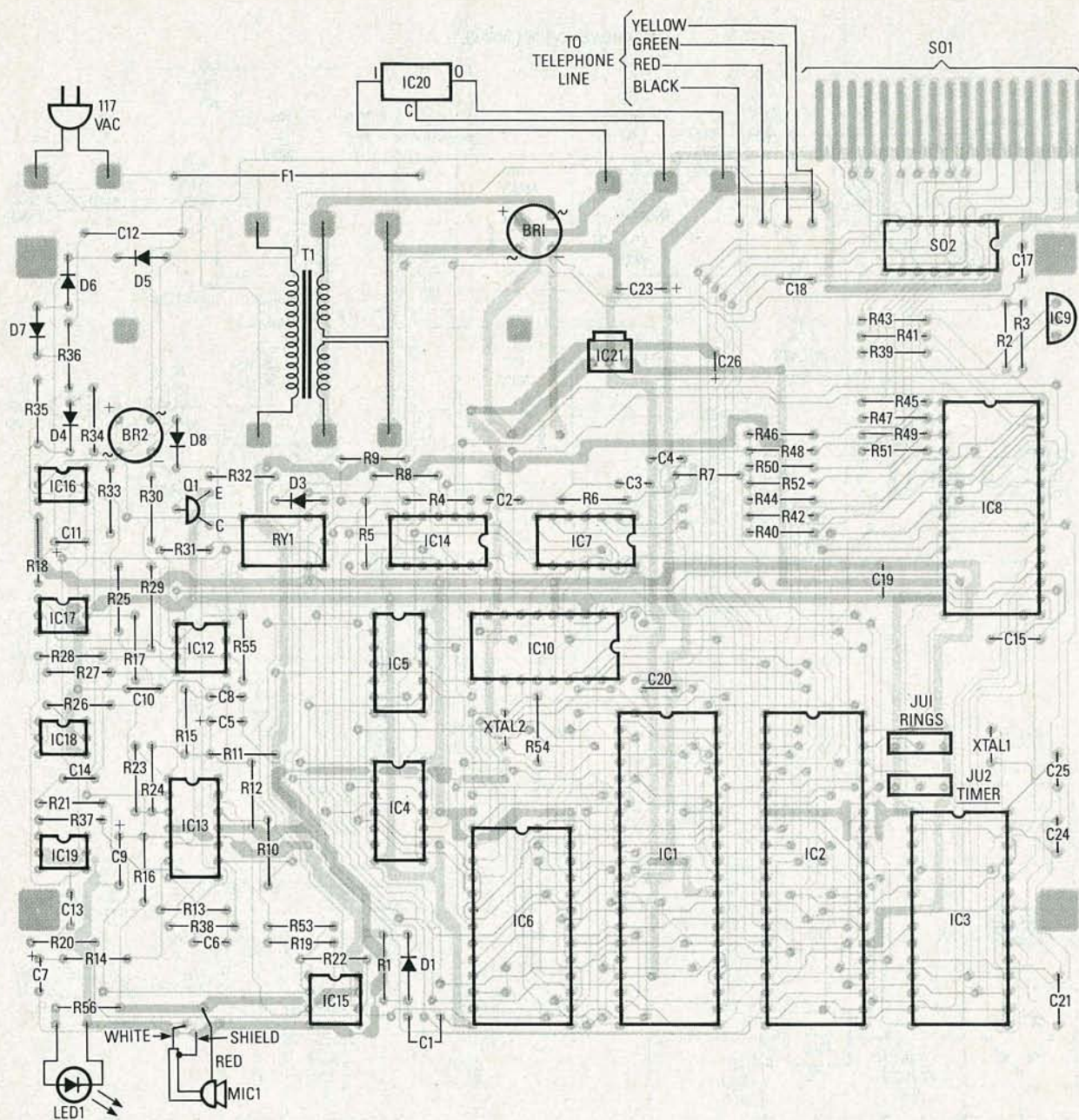

FIG. 8—STUFF THE PC BOARD as shown here. Be sure to mount all electrolytic capacitors, semiconductors, and the power transformer in the correct orientation.

To get an idea of how we use the Z80's registers rather than RAM to store subroutine return addresses, examine the routine in Listing 1.

The routine shown there causes the speech synthesizer to say "Enter eight to end or seven to repeat." After executing several delays (by outputting a 4 to the speech port), the address of the routine that speaks the word *Enter* (RTRN85) is loaded in the HL register. Then the program jumps to the routine that pronounces the word.

That routine returns to the location pointed to by HL—the next line in the routine shown in Listing 1. It in turn calls the routine that speaks the word *eight* and continues in the same manner.

### Construction

Use of a PC board is not absolutely necessary, but is strongly recommended, in order to minimize crosstalk and other problems. The commercially available PC board is double-sided, has plated-through holes, and is silk-screened, which greatly simplifies construction. Alternatively, you can etch your own board using the patterns shown in PC Service.

To stuff the board, follow the parts-placement diagram (shown in Fig. 8). Observe all polarity markings and make sure that the transformer is mounted correctly! Mount IC20 (the 7805 regulator that supplies power to the digital circuitry) on the rear panel of your case, or some other heatsink. The power-on indicator (LED1)

and the microphone (MIC1) should be inserted through holes in the front panel. Don't forget to solder the two jumpers in the desired positions.

### Interfacing

There are two basic approaches to interfacing the controller with external circuitry. The simpler method, which is suitable for small, low-power circuits, is to mount a small piece of perfboard inside the cabinet. The board can be secured to the top half of the cabinet with #4 screws. DIP connector SO2 on the main board allows an easy interface to the user board. The pinouts of SO1 and SO2 are shown in Table 1. The wires connecting the user board to the real-world inputs and outputs

## PARTS LIST

All resistors are 1/4-watt, 5% unless otherwise noted.

R1—100,000 ohms  
 R2—250 ohms, 1%  
 R3—10,000 ohms, 1%  
 R4, R17, R24, R27, R32, R34, R35—10,000 ohms  
 R5—R9, R19, R36, R40, R42, R44, R46, R48, R50, R52, R55—33,000 ohms  
 R10, R15, R38—47,000 ohms  
 R11, R12, R14—1000 ohms  
 R13, R20, R21—220,000 ohms  
 R16, R28, R54—1 megohm  
 R18, R25—22,000 ohms  
 R22—330,000 ohms  
 R23, R30, R31, R33—100,000 ohms  
 R26—100 ohms  
 R29—150 ohms, 1/2-watt, 5%  
 R37—470 ohms  
 R39, R41, R43, R45, R47, R49, R51—51,000 ohms  
 R53—39,000 ohms  
 R56—150 ohms

### Capacitors

C1, C6, C13—C15, C17—C22—0.1  $\mu$ F, ceramic disc  
 C2, C8, C10—1  $\mu$ F, 16 volts, electrolytic  
 C3, C4—0.022  $\mu$ F, ceramic disc

C5, C11—10  $\mu$ F, 16 volts, electrolytic  
 C7—2.2  $\mu$ F, 16 volts, electrolytic  
 C9, C26—33  $\mu$ F, 16 volts, electrolytic  
 C12—0.1  $\mu$ F, 200 volts, disc  
 C16—4700  $\mu$ F, 16 volts, electrolytic  
 C23—470  $\mu$ F, 16 volts, electrolytic  
 C24, C25—22 pF, disc

### Semiconductors

IC1—TMPZ84COOP, CMOS Z80 (Toshiba)  
 IC2—8255A, PIO  
 IC3—SP0256-AL2, speech synthesizer  
 IC4—74C04, hex CMOS inverter  
 IC5—74C02, quad CMOS NOR  
 IC6—27C64, 8K CMOS EPROM  
 IC7—74C32, quad CMOS OR gate  
 IC8—ADC0809CCN, A/D converter  
 IC9—LM234Z, precision current reference  
 IC10—M-956, DTMF decoder (Telton)  
 IC11, IC22—unused  
 IC12, IC15—TLC271, op-amp  
 IC13—LM324, quad op-amp  
 IC14—4066, quad analog switch  
 IC16—IC19—4N32A, opto-isolator  
 IC20—LM7805CK, five-volt regulator, TO3 case  
 IC21—LM7805CT, five-volt regulator, TO220 case

BR1—200 volts, 1/2 amp  
 BR2—50 volts, 1/2 amp  
 D1, D3—D5—1N914, switching diode  
 D6—D8—1N5245B, 15-volt, 1/2-watt Zener diode

Q1—2N2222, NPN small-signal transistor

### Other components

F1—125 volts, 1/2 amp, pigtail leads  
 MIC1—Electret microphone (Radio Shack 270-092B or equivalent)  
 RY1—Relay, five volts, 70 mA, (Radio Shack 275-243 or equivalent)  
 S01—16-pin DIP socket  
 S02—34-pin edge-card connector  
 T1—12.6 volts, 0.6 amp (Tria F-158XP)  
 XTAL1, XTAL2—3.58 MHz

Note: The following items are available from STG Associates, 2705-B Juan Tabo Blvd. N. E., #117, Albuquerque, NM 87112: Complete kit of parts, including cabinet, PC board, and programmed EPROM (KPL-1), \$195; etched, drilled, and silk-screened PC board (KPL-2), \$36; programmed EPROM (KPL-3), \$19; printout of source code (KPL-4), \$8. Add 5% for postage and handling. New Mexico residents add appropriate sales tax.

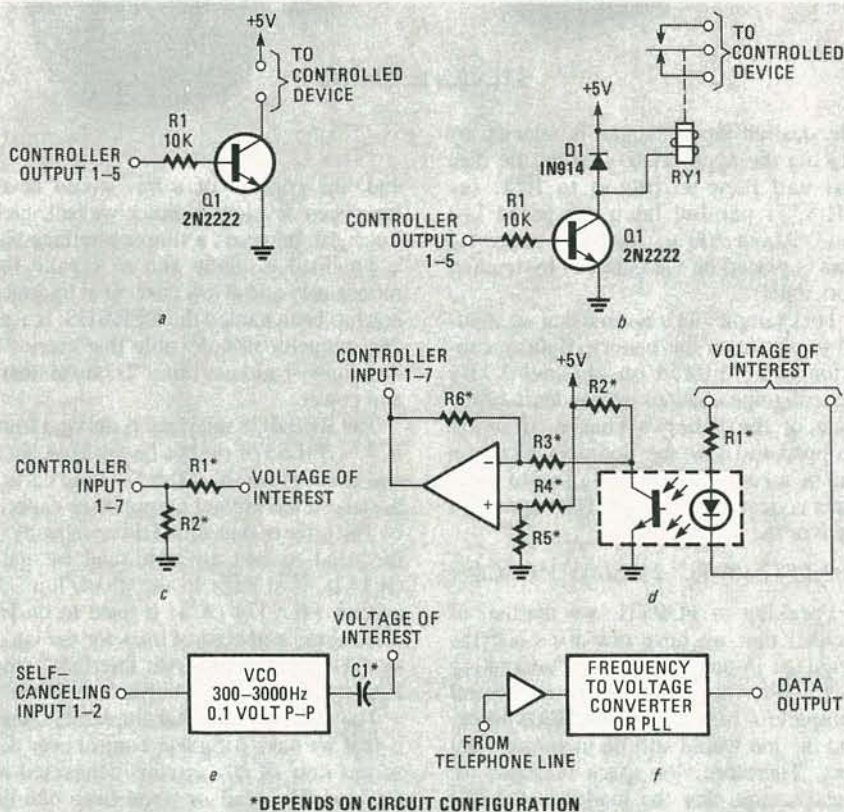

FIG. 9—A VARIETY OF INPUT/OUTPUT CIRCUITS: at a, an unisolated digital output; at b, an isolated digital output; at c, an unisolated analog input; at d, an isolated analog input. Shown in e and f are one means of transmitting digital data over the phone lines.

can be routed out an opening in the rear panel. The internal power supply can provide a maximum of about 200 mA to user circuitry. If that's not enough for your applications, use another method.

The other method of interfacing is required when the application demands devices that are too big or too power-hungry to be mounted internally. Here a separate box should be built that contains its own

internal power supply. The edge-card connector identified as S01 in the schematics can be used to connect the controller to the interface box.

Construction aside, the type of circuit you'll need will depend on your inputs and outputs. Figure 9 shows ideas for several types of interfaces. Component values are not given for most of the circuits because those values can only be determined based on the voltage levels you'll be dealing with. But the circuits shown provide a good starting place.

Figure 9-a and Figure 9-b show two simple digital-output circuits. Neither can supply much current; the relay in Fig. 9-b should be a low-current type. The Fig. 9-a circuit is suitable for applications where isolation is unimportant; otherwise, use the Fig. 9-b circuit.

Figure 9-c and Figure 9-d show two simple analog-input circuits. As with Fig. 9-a and Fig. 9-b, the Fig. 9-c circuit is suitable for applications where isolation is unimportant; otherwise, use the Fig. 9-d circuit.

Last are circuits for transmitting digital data over the telephone lines. As shown in Fig. 9-e, the remote voltage of interest should be processed by a VCO (Voltage-Controlled Oscillator) so that a tone suitable for phone-line bandwidth (3000 Hz) will be generated. The signal applied to either of the converter's self-canceling inputs should be in the range of 50–100 mV p-p. As shown in Fig. 9-f, the tone can be recovered at the receiving end after suitable isolation and buffering by a voltage-to-frequency converter or a PLL (Phase-Locked Loop). **R-E**

# BUILD THIS

# R-E ROBOT

More on the electronics  
that makes our robot go.

**Part 7** THIS MONTH WE'LL continue our look at the robot's control electronics. You'll need to refer to the schematic that appeared last time ("R-E Robot, Part 6," *Radio-Electronics*, May 1987), so have it handy as we proceed.

## Analog-to-digital converter

An Analog-to-Digital Converter (ADC) is required to convert information about the torque output of the drive motors and the state of the batteries to a digital signal that can be processed by the RPC (*Robotic Personal Computer*). Additionally, an ADC is needed to convert the outputs of environmental sensors to digital form; almost all such sensors have analog outputs.

Because it is easily interfaced with our microprocessor bus, the ADC we selected is the ADC0804 (National). That IC is self-clocking, uses an internal ratiometric reference, and needs only +5-volts DC to operate. The input-voltage range of that IC is adjustable; we've set it for 0 to +5-volts DC.

The ADC's input channel is selected using two 4051 8-channel multiplexer IC's. The input channels are allocated as follows: Two channels are connected to amplifiers monitoring each drive motor's current. Two channels are connected to the RERBUS (*Radio-Electronics Robot BUS*) connector; we'll discuss the structure of the RERBUS in a moment. Two channels are dedicated to internal heat-sensing. Eight channels are available at the user connector for external sensors or other peripherals you may add later.

The analog-to-digital conversion process is started by writing to port 150H.

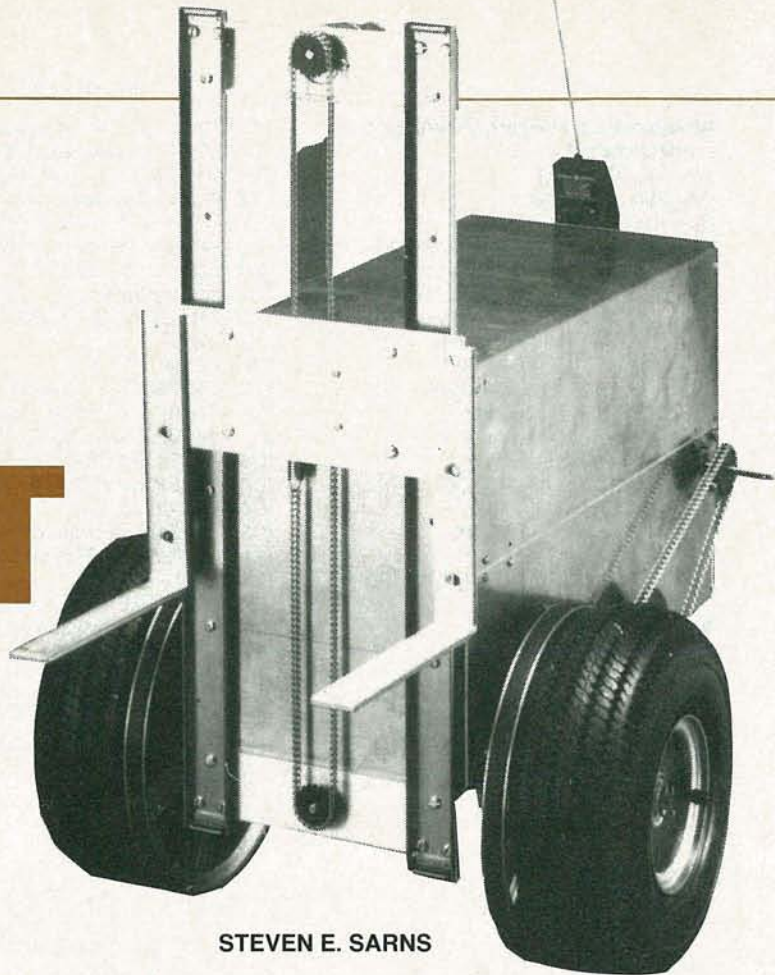

STEVEN E. SARNS

The desired input channel is selected by placing the appropriate data on the data bus and then writing it to IC4, the 74LS377 parallel latch discussed last time. About 200  $\mu$ s later, the requested data is placed on the data bus by reading port 150H.

For example, let's assume that we wanted to check on the battery. Battery condition is monitored on channel 3. By selecting that channel we can learn of the state of the battery's charge; if it has dropped too low the appropriate action can be taken. The following line of computer code, written in FORTH, returns the state of the battery:

```
: BATT? 2 150 PC! 2 DELAY 150 PC@ ;
```

Speaking of FORTH, we realize, of course, that we have not discussed the language in any detail yet. Undertaking such a task would require devoting several complete *issues* of *Radio-Electronics*, and the job would still be incomplete, at best. Therefore, for space reasons, we must assume that the reader is familiar with the language. On that premise, when we present FORTH routines in future installments of this series, we will explain what the routine does in general terms, but not the function of each term or line.

## RERBUS user interface

If circuit designers always knew in the beginning what would be needed in the

end, the concept of a bus would never have been developed. Since we lack such foresight, however, a simple interface bus is provided to allow you to expand the robot easily and at low cost. That interface bus has been named the RERBUS; it uses 26-conductor ribbon cable that carries 8 data lines, 4 address lines, 2 control lines, and power.

The RERBUS interface is derived from IC7, a 74LS374 output latch. That latch was chosen over the 74LS377 used earlier because it has greater output drive capacity. The price of that added drive capacity is the need to add an additional OR gate (IC15-b,  $\frac{1}{4}$ 74LS32) to the clock line. A second 74LS374 (IC8) is used to buffer the address and control lines for the interface. Data is read from the interface using IC6, a 74LS541 octal buffer/line driver.

The advantage of that implementation is that we have complete control over the access time of any circuits connected to the bus. The read or write lines can be enabled as long as the external circuits require. That is particularly important when a flexible cable is used instead of a backplane because a flexible-cable bus requires slow access times because of its high inter-conductor capacitance.

## Motor controllers

Before describing our motor-control



circuit, remember that we are dealing with DC brush-type torque motors. Those motors are characterized by poor speed regulation, lack of an integral tachometer, and, consequently, low-cost; the last characteristic explains why they were selected. Stepper motors with the torque capability we need would have been difficult to locate and would have cost much more. Brushless motors, though less expensive, require so much support circuitry that they wind up costing as much to use as steppers. Servo motors with an integral analog tachometer could have been used, but they too are much more expensive than lowly torque motors. Remember, any automobile starter motor will deliver around 1/2 horsepower, just about what we need.

Motor controllers fall into two general classifications; linear and switching. In a linear controller, the terminal voltage of the motor is varied to keep the motor speed constant. A switching controller keeps motor speed constant by regulating the duty cycle of the power applied to the motor. Bear in mind that our motor controllers may have to handle up to 500 watts. Examining the power-dissipation requirements of typical series-pass transistors we see that there will be a power-dissipation problem if linear controllers are used. The worst case is at high-torque loads and low motor speeds. Then the series-pass transistors must conduct maximum current while withstanding nearly full battery voltage. The result is over 1 kW of power dissipation in the series-pass transistors.

A switching controller, on the other hand, is either fully conducting or fully off. In either case, power dissipated by the series-pass transistors is zero. Actually, it's a very near zero. During transitions between off-to-on and on-to-off, power is lost, but the total dissipation is many orders of magnitude lower than that of a linear controller.

Some form of feedback is required in all motor-control circuits. That can be derived from an analog generator attached to the motor shaft, as is done with servo motors. Sometimes the motor itself is used as an analog tachometer by measuring the back EMF generated. In our case, optical encoders will be attached to the motor shafts to obtain motor-speed information. The information from the encoders is brought to the controller via connectors PL2 (right motor) and PL6 (left motor); it is decoded by a pair of 74LS74 dual flip-flops (IC28 and IC29).

The final stage of each motor controller is the output driver. That stage must deliver the power to the motor. It must also be

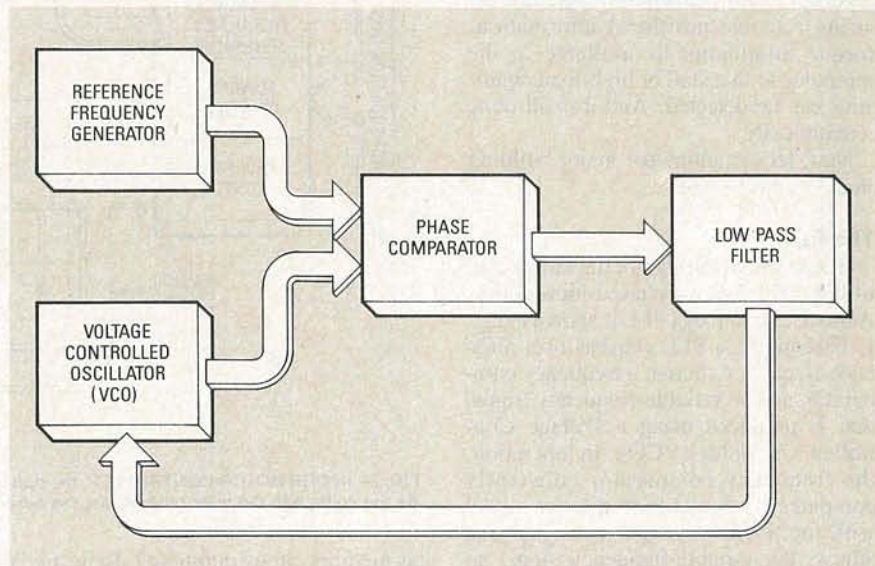

FIG. 1—THE PLL IS THE KEY CIRCUIT comprising the motor controllers. Here, the operation of a PLL is shown in block diagram form.

capable of reversing and stopping the motor. One method of doing that requires two power supplies of equal voltage and opposite polarity. The motor is connected to the positive supply to run in one direction and to the negative supply to operate in the opposite direction. That solution does not use batteries efficiently, so it is not used.

Another alternative would be to use an H bridge. In that scheme each motor is surrounded by four switches (transistors) that direct the current through the motor in the desired direction. Although efficient in terms of power usage, the circuit requires four high-power transistors and associated circuitry, all of which increases the cost.

Finally, the classic approach is to connect the motor to the center arm of two SPDT relays and to use the relays to establish the direction of the current in the motor. That approach is simple and inexpensive; it is the approach used in our robot.

#### Design considerations

It is important that the motor controller be able to operate as independently as possible. We could design a motor-control system in which a microprocessor controls the power delivered to the drive transistors and counts the incremental revolutions of the drive wheels. That is an ideal application for a slave processor, and, in fact, that is how the *HERO 2000* works. Unfortunately, however, developing a dedicated slave-microprocessor system for our robot was a luxury that we could not afford.

On the other hand, it is important that we do not load the RPC down with too many tasks. Therefore, our motor controller will have to be smart enough to operate without constant attention from the microprocessor.

We also need an accurate system that can keep track of how far the robot has moved. The drive wheels will be used to steer the robot, so, not only must the motors be capable of accurate differential actions, they must be well-behaved at low (maneuvering) speeds. The robot's arm has just one degree of freedom. The other two degrees of freedom are obtained from the base unit. Therefore, the motor controls must be able to move the unit in small forward, backward, or rotational steps to enable the arm to grasp its target.

The wheel-derived distance will be used as our first-approximation navigational system. However, no matter how accurate our wheel-based navigation is, there is no solution to the "bump in the road" problem. For example, if our robot were traveling in a straight line, maintained by equal distance traveled by each wheel, and one wheel went over a bump, the robot would turn towards the bump. That is because the wheel that went over the bump went farther to achieve the same linear distance that the wheel that missed the bump. In spite of that problem, it would simplify later problems if the robot were able to go where it is told reliably.

The motor controller designed for the robot meets those specifications. We have designed a totally digital, Phase-Locked Loop (PLL) motor-control system that uses a single pulse-width modulated tran-

sistor. The controller board has two such circuits, one for each drive motor. Directional control is achieved with two relays, a big cost saving compared to the H-bridge approach at high current levels. Feedback is fully quadrature-decoded assuring accurate positional information. Torque information is available to the computer so that stall or high-load conditions can be detected. And it is all done economically.

Now, let's examine the major building blocks of the system.

### The PLL

The key to the design of the motor controller is the use of a phased-locked loop. A block diagram of a PLL is shown in Fig. 1. Essentially, a PLL consists of a reference-frequency source, a frequency comparator and a variable-frequency signal that is produced using a Voltage Controlled Oscillator (VCO). In operation, the frequency comparator constantly compares the variable-frequency signal with the reference-frequency signal and adjusts the variable-frequency signal so that the two match.

By now you may be getting an idea about how our controller works. A reference frequency that is proportional to the desired speed is generated. That frequency is compared with the output of an optical encoder that is linked to the motor; the encoder plays the part of the VCO in this PLL. If the controlled voltage is lower than the reference voltage, the PLL circuit will turn the drive transistor on more; if it is higher, the PLL will turn the drive transistor on less.

A block diagram of the system is shown in Fig. 2. As mentioned, two such systems are required by the robot, one for each drive motor. To keep things simpler in the following discussion, we will examine the circuit for the left motor only; the right-motor controller works identically.

### Reference frequency

The reference frequency is derived from the 80188 microprocessor clock (on the RPC) and one of the three independent timers of IC13, an 8253 programmable 16-bit counter. The clock signal is divided by 16 to produce a 500-kHz clock for the 8253. The 8253 then divides the input clock by a 16-bit number to produce an output frequency between 2 Hz and 250 kHz, depending on the number selected. That output is used as the reference frequency by the PLL. The reference frequency can be turned on and off via pin 11, G0, by writing to port 124H. When the reference frequency is off, the motor must stop completely.

### Frequency comparator

The frequency comparator used by our PLL is the internal type-II comparator in the 4046 PLL, IC23. A sophisticated digi-

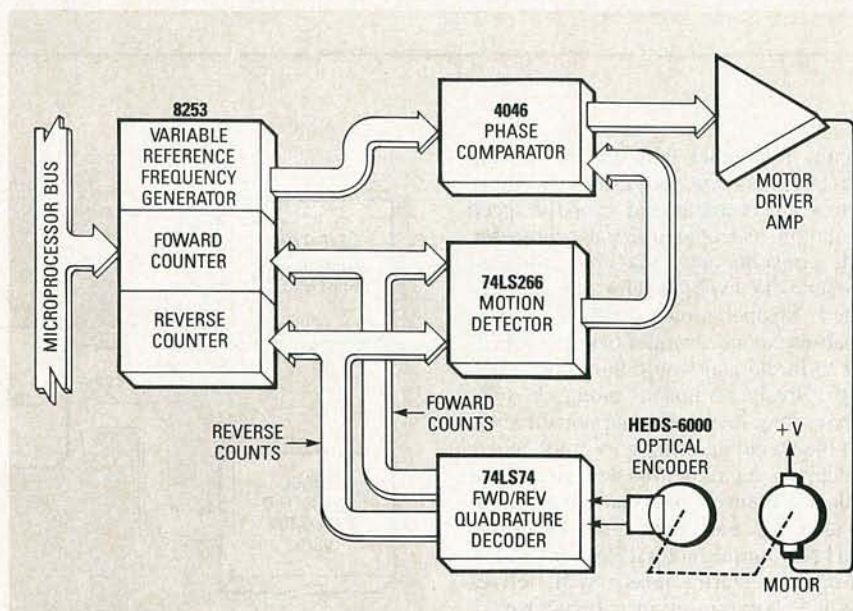

FIG. 2—IN OUR MOTOR CONTROLLER, the optical encoder takes the place of a VCO in the PLL circuit. As the voltage to the motor increases, the output frequency of the encoder increases.

tal-memory circuit outputs a 1 (logic high) if the phase of the reference signal leads that of the controlled signal. A 0 (logic low) is output if the phase of the reference signal lags that of the controlled signal. As you can see, the circuit is actually a phase comparator. However, in our description we will continue to refer to the circuit as a frequency comparator because in our system it is used to control the frequency of the optical-encoder feedback signal rather than the phase.

The output of the frequency comparator is a pulse train whose duty cycle will vary from 0 to 100%, depending upon the difference in phase between the reference frequency and the optical-encoder outputs. The frequency of that pulse train will be equal to the reference frequency. If you examine the output of the 4046 with an oscilloscope while applying a load to the motor you will see the duty cycle of the comparator's output increase, but its frequency will remain the same.

### Motor driver

Like the reference frequency, the motor driver is gated on and off via port 124H. When the driver is gated on, the output of NAND gate IC24-a drives transistor Q1 into saturation. That 2N3906 small-signal PNP transistor drives a Darlington pair. Note that rather than a single unit, in our circuit we use a Darlington pair fashioned from discrete transistors (Q2 and Q3). That approach is used because it offers you much flexibility in matching drive transistors and motors. The 2N3772 transistor used for Q3 in our circuit is rated at 30 amperes; that means it can deliver up to 1 kilowatt to the motor at the maximum recommended battery voltage (36 volts  $\times$  30 amps).

The motor is connected to the center

position of two SPDT power relays. A single flyback diode, D2, protects the driver transistor from damage due to motor inductance. The use of two relays instead of an H-bridge output-driver circuit allows us to reverse motor directions, yet saves three expensive power transistors, several level-matching components, and three flyback diodes. Maximum dynamic braking of the motors is achieved when both relays are in the de-energized position, an important consideration when the robot is parked.

It is possible to perform regenerative braking with the circuit, wherein the kinetic energy of the robot in motion is used to generate electricity in the motor and charge the batteries. However, due to the complexity of the control algorithms and the small amount of energy recovered, we did not implement that feature.

Motor current is sensed at the 0.01-ohm resistor, R21, amplified and filtered by the LM358 operational amplifier, IC20, and presented to the ADC. In a given motor, the relationship between load and current is linear irrespective of motor speed. Once that relationship has been determined, the information can be used by the RPC to sense the grade or surface that the robot is operating on.

### Shaft encoders.

We used a Hewlett Packard HEDS 6000 optical encoder for our robot. That unit has a quadrature output of 500 counts-per-revolution.

Note that the HEDS 6000 is one of the most expensive components in the system. You have two choices if you do not want to follow our lead in using that encoder. You can make your own encoder, either with or without quadrature outputs,

*continued on page 90*

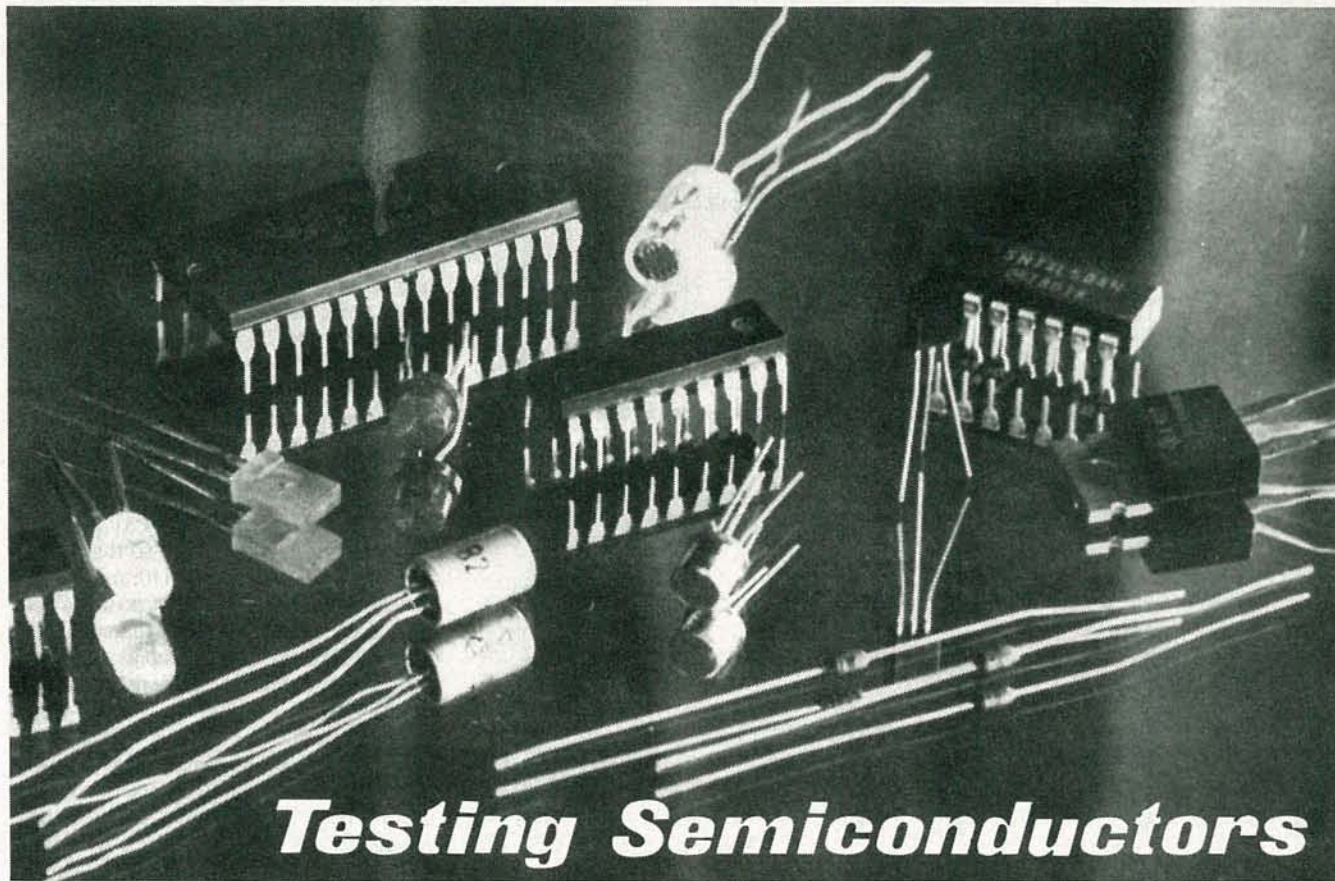

Our back-to-school series continues this month with a discussion of a transistor's AC parameters.

TJ BYERS

**Part 5** ALTHOUGH STATIC (DC) measurements address a wider range of conditions and are easier to make than dynamic (AC) measurements, dynamic measurements are actually more realistic because they apply directly to normal usage.

As you recall from the first installment of this series, dynamic tests are performed by measuring a semiconductor's influence on an AC input signal when the device is operating under DC conditions. Let's take a look at why that is so, and begin with an analysis of bipolar-transistor dynamic measurements.

### Transistor gain

The dynamic parameter of primary interest to the design engineer and the hobbyist alike is undoubtedly  $h_{fe}$ , which is called beta, and which is often represented by the symbol  $\beta$ . Commonly referred to as *beta*,  $h_{fe}$  is the AC short-circuit forward-current gain of a bipolar transistor in the common-emitter configuration. In plain terms,  $h_{fe}$  is the ratio of the change in collector current to a corre-

sponding change in base current brought about by an AC signal.  $h_{fe}$  can be expressed by the equation:

$$h_{fe} = \frac{\Delta I_C}{\Delta I_B}$$

where  $I_B$  is the change in base current and  $I_C$  is the change in collector current.

Keep in mind that the key word in the above equation is *change*. (The  $\Delta$  symbol is used to indicate a change) Let's say, for example, that a transistor is DC-biased with a base-emitter current of 1 mA, which results in a corresponding collector current of 50 mA. Those values are called the *static* conditions of the circuit.

The static conditions that determine the operating parameters of a transistor are established by a constant-voltage power supply across the collector and emitter, and a constant-current source for the base-emitter junction. A test circuit having those conditions is shown in Fig. 1. Meter M1 indicates base current ( $I_B$ ); meter M2 indicates collector current ( $I_C$ ). Resistor  $R_L$  is the collector's load.

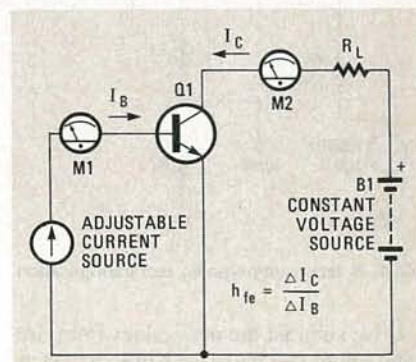

FIG. 1—A basic configuration for testing transistors to determine  $h_{fe}$ .

After noting the static base and collector currents, make a change in the base current and note the resulting shift in the collector current. For illustration, assume we apply an input signal of 1 mA to the base (in addition to the static 1 mA current, for a total of 2 mA) and see what happens. Assume that the increase in base current causes the collector current to increase from 50 mA to 100 mA.

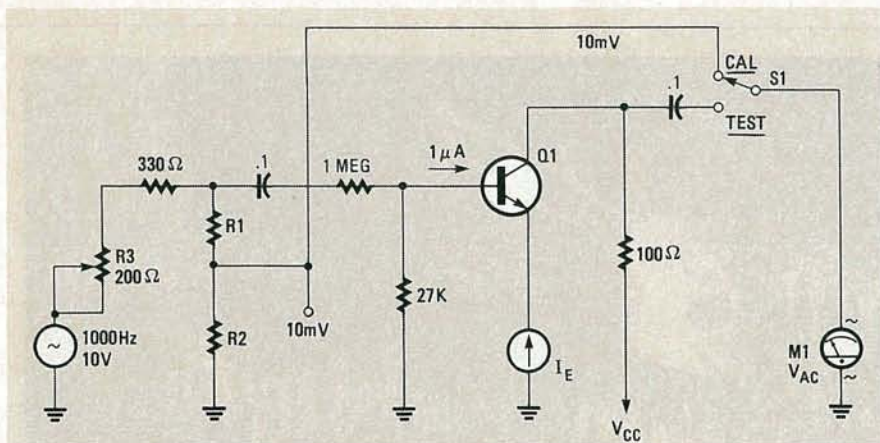

FIG. 2—A laboratory-type  $h_{fe}$  test configuration. Resistors R1 and R2 are selected so that AC voltmeter M1 indicates 10 mV when switch S1 is in the CAL position.

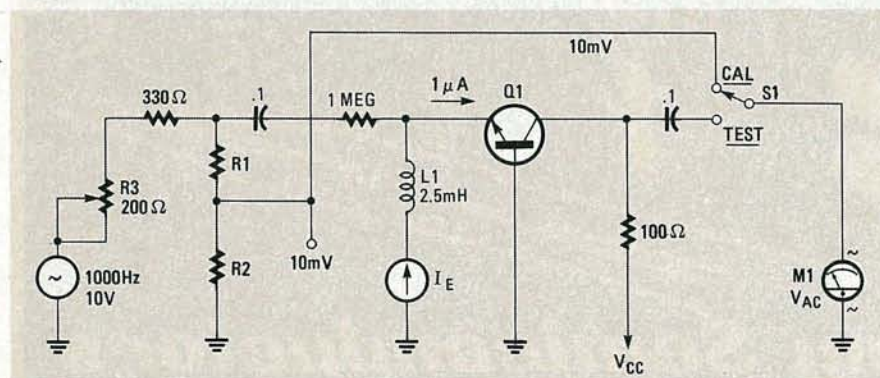

FIG. 3—A laboratory-type  $h_{fb}$  tester.  $h_{fb}$  always measures less than unity.

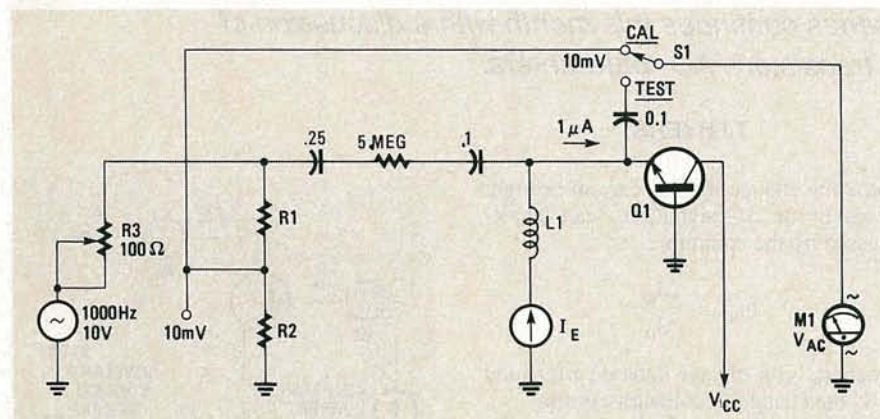

FIG. 4—A laboratory-type  $h_{fb}$  test configuration.

If we subtract the new values from the static values, we see that a 1-mA change in base current produces a 50-mA change in collector current. By entering those values into the equation above we can determine that the transistor has an  $h_{fe}$  of 50.

#### Testing $h_{fe}$

Although the preceding test procedure is acceptably accurate, it is also rudimentary. Normally, a transistor is tested with an AC input signal having a specific frequency, a procedure that more accurately describes the conditions under which the transistor will operate.

Two test frequencies are commonly used: 60 Hz (because it is readily available), and 1 kHz. The higher frequency gives slightly more accurate measurements and has become the standard test frequency throughout the industry. The nomenclature for  $\beta$  tested at 1 kHz is  $h_{fe0}$ . More often than not, however, the "o" is left out (not used), and the data-sheet listing is shown as  $h_{fe}$ . Beta values derived by testing at frequencies other than 1 kHz are noted as such.

A commonly used circuit for testing  $h_{fe}$  at 1 kHz is shown in Fig. 2. Q1 is the transistor under test. (Only the functional

AC-measurement circuit is shown. The constant-current generator connected from emitter-to-ground represents Q1's base-emitter biasing; it eliminates having to clutter the illustration with the DC biasing circuit.) The test circuit measures  $h_{fe}$  by comparing the AC input voltage to the AC output voltage. The meter's scale is specifically calibrated so that it directly indicates Q1's  $\beta$ . (The conversion between current and voltage is made in the voltage divider consisting of resistors R1 and R2. The values for those components were selected so that 10 mV appears across resistor R2 when 1  $\mu$ A flows into transistor Q1's base.)

A calibration level of 10 mV was chosen so that an  $h_{fe}$  in the range of 0 to 100 can be read directly from a meter (M1) that normally indicates 0–10 mV full-scale. The meter's calibration works this way: Switch S1 is set to its CAL position and resistor R3 is adjusted so that meter M1 indicates full scale (10 mV). The switch is then set to its TEST position and the meter reading, which indicates the transistor's  $\beta$ , is noted. Keep in mind that a full-scale reading represents a beta of exactly 100.

The  $h_{fe}$  value obtained by that method will probably agree very well with  $h_{FE}$ , the static (DC) gain parameter, but not every time or for every transistor. The parameter  $h_{fe}$  is frequency dependent and can fluctuate widely from the measured static (DC) values, a fact that is especially true of high-frequency transistors.

#### Alpha gain

Another commonly-used parameter is  $\alpha$  (alpha), which represents the AC short-circuit forward-current gain for a transistor operating in the grounded-base mode. Its nomenclature is  $h_{fb}$ . While the  $\alpha$  value is not as familiar to some as  $\beta$ , it is often used to establish gain parameters for high-frequency circuits that require a grounded-base configuration.

Alpha can be determined in two different ways: either by direct tests, or by mathematical derivation from other parameters, such as  $h_{fe}$ . The formula for converting  $h_{fe}$  into  $h_{fb}$  is:

$$h_{fb} = \frac{-h_{fe}}{1+h_{fe}}$$

Be aware that the conversion only yields an approximation for  $\alpha$ . Circuit factors such as distributed capacitance and inductance are not taken into consideration by the formula.

To arrive at a more accurate value for alpha, the transistor must be tested in a circuit such as the one shown in Fig. 3. Once again, the constant-current source in Q1's emitter lead represents the biasing circuit. As before, the ratio between the input signal and the output signal is used to determine alpha. The formula is:



## WORKING WITH FLIP-FLOPS

Flip-flops are the basis of all digital circuits. Learn about the different types and practical applications for them.

RAY MARSTON

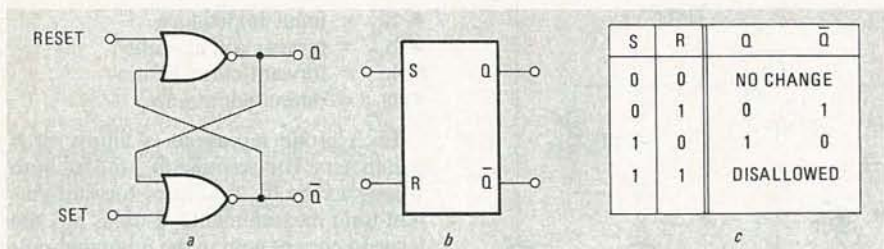

FIG. 1—THE SET-RESET FLIP-FLOP is built from two NOR gates *a*. Its symbol is shown in *b*, and its truth table in *c*.

DIGITAL IC'S CAN BE CLASSIFIED INTO TWO basic types: gates and flip-flops. The latter are also known as bistable latches and memory elements. Many devices are based on flip-flops, including counters, dividers, shift registers, data latches, etc., as well as presettable up/down counters and dividers, and other devices.

In this article we will explain how several types of flip-flops work. Then we'll go on to discuss several versatile CMOS flip-flops. Last, we'll show many practical circuits that use flip-flops.

### Basic principles

The simplest type of CMOS flip-flop is the cross-coupled bistable latch shown in Fig. 1-*a*. The circuit is built from two NOR gates; it has two inputs (usually tied low via pull-down resistors), and a pair of out-of-phase outputs. The circuit works like this: If the SET terminal is briefly taken high, the Q output immediately goes high, and the  $\bar{Q}$  output goes low. The cross-coupling between the two gates causes the outputs to latch in that state, even when both inputs are pulled low again. The only way the output states can be changed is by applying a high to the RESET terminal, in which case the Q output immediately goes low, and the  $\bar{Q}$  output goes high. Again, cross-coupling causes the outputs to latch into the new state even when both inputs are pulled low.

Because of the latching action, the basic Set-Reset (S-R) flip-flop acts as a

simple memory element that "remembers" which of the two inputs last went high. Note, however, that the output state cannot be predicted if both inputs go high simultaneously, so that must not be allowed to occur. Fig. 1-*b* shows the symbol of the S-R flip-flop, and Fig. 1-*c* shows its truth table.

The versatility of the basic circuit can be enhanced greatly by wiring an AND gate in series with each input terminal as

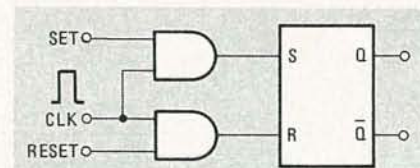

FIG. 2—THE CLOCKED S-R FLIP-FLOP is built from two AND gates, in addition to the S-R flip-flop.

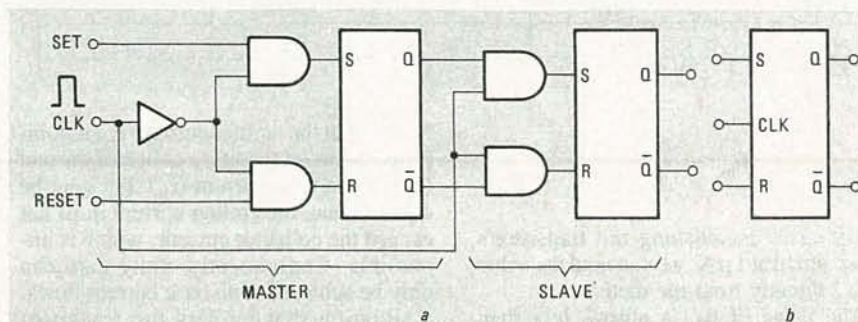

FIG. 3—THE CLOCKED MASTER-SLAVE FLIP-FLOP (*a*) is built from two S-R flip-flops driven by an out-of-phase clock. Its symbol is shown in *b*.

shown in Fig. 2. That way high input signals can reach the S-R flip-flop only when the clock (CLK) signal is also high. Therefore, when CLK is low, both inputs of the flip-flop are held low, irrespective of the states of the SET and RESET inputs, so the flip-flop functions as a "permanent" memory. However, when CLK is high, the circuit functions as a standard S-R flip-flop. Consequently, information is not automatically latched into the flip-flop, but must be "clocked" in; that's why the circuit is known as a clocked S-R flip-flop.

Figure 3-*a* shows how to make the most important of all flip-flops, the clocked master-slave flip-flop. It's built from two clocked S-R flip-flops that are cascaded and clocked out of phase via an inverter in the clock line.

It works as follows. When the CLK input is low, the inputs to the master flip-flop are enabled via the inverter, so the SET-RESET data is accepted. However, the inputs to the slave flip-flop are disabled, so the data is not passed to the output terminals. Then, when the CLK input goes high, the inputs to the master flip-flop are disabled, so the input data is latched in the outputs; simultaneously, the input to the slave flip-flop is enabled, and the latched data is passed to the output terminals. The symbol of the clocked master-slave flip-flop is shown in Fig. 3-*b*.

The clocked master-slave flip-flop can be made to toggle (or divide by two) by cross-coupling the input and output terminals as shown in Fig. 4-*a*. By doing so, SET and Q (and RESET and  $\bar{Q}$ ) are always at opposite logic levels. So when CLK goes

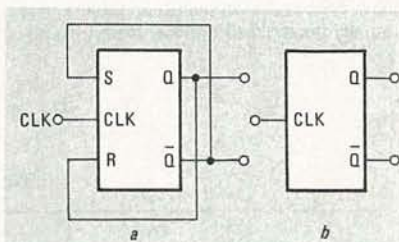

FIG. 4—THE TOGGLE OR TYPE-T FLIP-FLOP (*a*) is built from a clocked master-slave flip-flop. Its symbol is shown in *b*.

low, the master flip-flop changes state. When CLK goes high, the slave flip-flop changes state. Note that the output states change on the arrival of the leading edge of each new clock pulse.

It takes two clock pulses to change the output from one state to another and back again, so the frequency of the output is half the frequency of the clock. The circuit is known as a Toggle (or type-T) flip-flop; its symbol is shown in Fig. 4-b.

### The D flip-flop

The type-T flip-flop is a special device that functions only as a counter/divider. A far more versatile device is the Data or type-D flip-flop, which is made by connecting the clocked master-slave flip-flop as shown in Fig. 5-a. In that circuit, an inverter is wired between the s and r terminals of the flip-flop, so those terminals are always out of phase, and the input is applied via a single pin. Fig. 5-b and Fig. 5-c show the symbol and the truth table of the type-D flip-flop, respectively.

A type-D flip-flop can be used as a data

latch by connecting it as shown in Fig. 6-a, or as a binary counter/divider by connecting it as shown in Fig. 6-b.

### The JK flip-flop

Figure 7-a shows the basic circuit of an even more versatile clocked flip-flop, which is universally known as the JK-type. It can function either as a data latch, a counter/divider, or as a do-nothing element by suitably connecting the J and K terminals. The symbol of the JK flip-flop is shown in Fig. 7-b, and its truth table is shown in Fig. 7-c.

In essence, the JK flip-flop functions as a T-type when inputs are both high, and as a D-type when they're different. When they're both low, the outputs remain unchanged when a pulse arrives.

### Real-world devices

The two best-known clocked CMOS flip-flops are the 4013 D-type and the 4027 JK-type. Each IC contains two independent flip-flops that share power and ground connections. Figure 8-a shows the

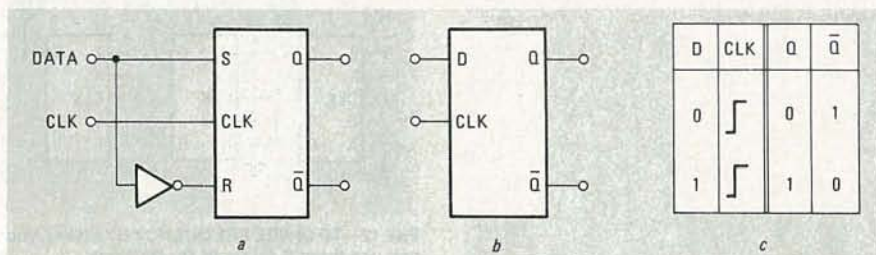

FIG. 5—THE DATA OR TYPE-D FLIP-FLOP *a* is built from a clocked master-slave flip-flop. Its symbol is shown in *b*, and its truth table in *c*.

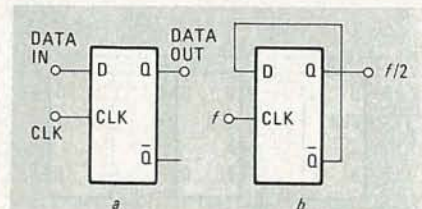
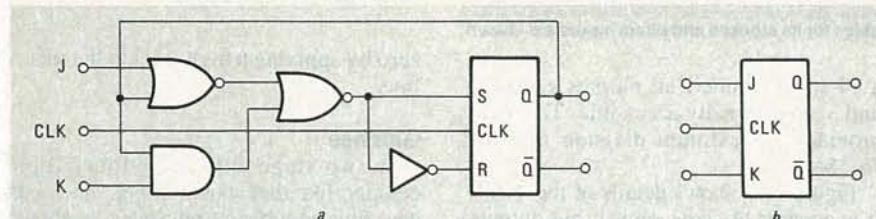

FIG. 6—THE D FLIP-FLOP can be used as a data latch (*a*) or as a divide-by-two counter (*c*).

functional diagram of the 4013; the truth table of its clocked inputs is shown in Fig. 8-b, and that of its direct inputs is shown in Fig. 8-c. Corresponding diagrams for the 4027 are shown in Fig. 9-a, Fig. 9-b, and Fig. 9-c.

Note that both the 4013 and the 4027 have SET and RESET inputs in addition to the normal clocked inputs. For both IC's



J	K	CLOCKING ACTION
0	0	DOES NOTHING (INHIBITS)
0	1	SETS Q OUTPUT LOW
1	0	SETS Q OUTPUT HIGH
1	1	CHANGES OUTPUT STATE

FIG. 7—THE JK FLIP-FLOP'S CIRCUIT is shown in *a*, along with its symbol (*b*) and action table (*c*).

those terminals are direct inputs that enable the clocked action of the flip-flop to be overridden, in which case the device functions as a simple unclocked S-R flip-flop. For normal clocked operation, the direct inputs must be grounded.

The 4013 and 4027 are fast-acting, so it is important that their clock signals be absolutely noise-free and bounceless, and that they have risetimes and falltimes of less than five  $\mu$ s. Both IC's clock on the positive transition of the clock signal.

### Ripple counters

The most popular application of the clocked flip-flop is as a binary counter. Fig. 10-a shows how to connect the 4013 as a divide-by-two counter; Fig. 10-b shows the corresponding connections for the 4027. When clocked by a fixed-frequency waveform, both circuits give a symmetrical square-wave output at half the clock frequency.

As shown in Fig. 11, you can cascade several ripple counters (so called because of the way that clock pulses appear to ripple from stage to stage) to provide division by successive powers of two. Figure 11-a shows how to cascade two D-type flip-flops, and Fig. 11-b shows how to cascade two JK-type flip-flops to provide a division ratio of 4 ( $2 \times 2$  or  $2^2$ ). In a like manner, Fig. 12-a and Fig. 12-b show how three stages can be cascaded to give a division ratio of eight ( $2^3$ ). In fact, an arbitrary number of stages can be cascaded, as shown in Fig. 13, to provide a division ratio of  $2^n$ , where  $n$  is the number of stages.

The circuits shown in Fig. 11–Fig. 13 are known as ripple counters, because each stage is clocked by the output of the preceding stage, rather than by a master clock signal. The effect, therefore, is that the clock signal seems to “ripple” through the counter chain. The problem is that the propagation delays of all the dividers add together and provide a delay that prevents the counter stages from clocking synchronously. Counters of that sort are in fact called asynchronous counters. If the outputs of the stages are decoded via gate networks, output glitches and inaccurate decoding can result.

### Long ripple counters

Although 4013 and 4027 counters can be cascaded to give any desired number of stages, when more than four stages are needed, it's usually economical to use a special-purpose MSI ripple-carry binary counter/divider IC. Our next few figures show several examples.

The 4024, shown in Fig. 14, is a seven-stage ripple counter; all seven outputs are externally accessible. The IC provides a maximum division ratio of 128 ( $2^7$ ). The

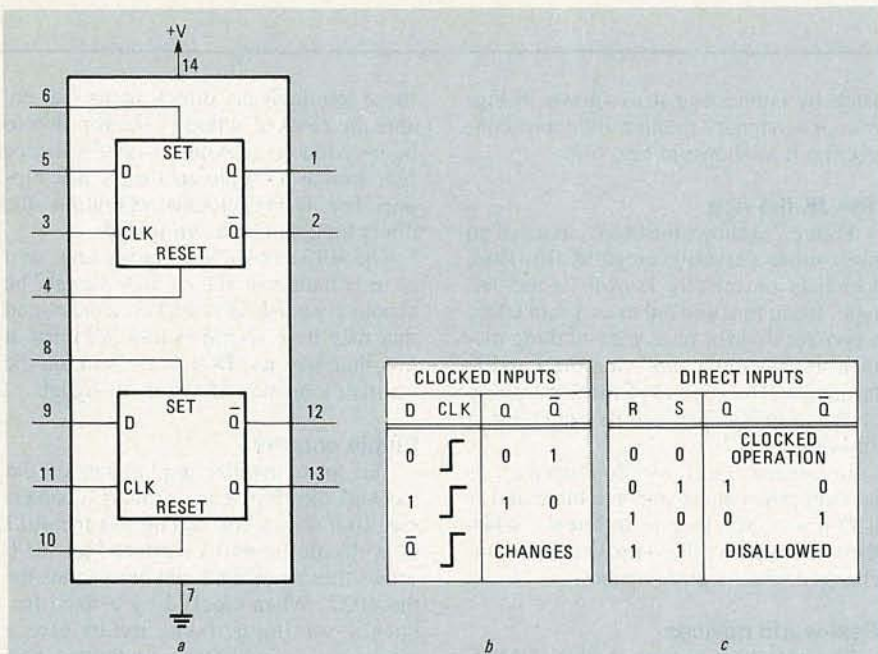

FIG. 8—THE 4013 contains two type-d flip-flops (a). Truth tables for its clocked and direct inputs are shown in b and c, respectively.

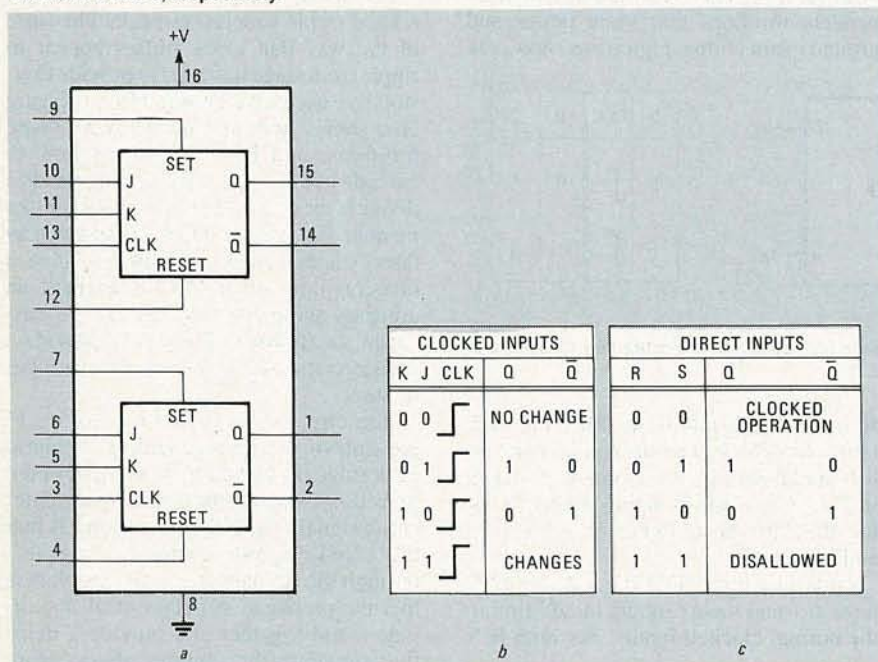

Fig. 9—THE 4027 contains two JK flip-flops (a). Truth tables for its clocked and direct inputs are shown in b and c, respectively.

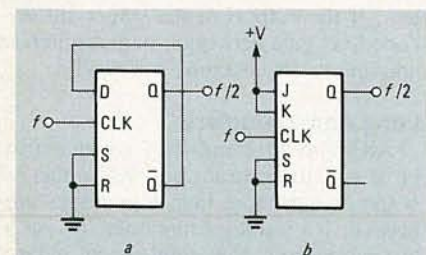

FIG. 10—TO DIVIDE FREQUENCY BY TWO, you can use a D (a) or a JK (b) flip-flop.

4040, shown in Fig. 15, is a 12-stage device, of which all outputs are accessible. It provides a maximum division ratio of 4096 ( $2^{12}$ ). The 4020, shown in Fig. 16, is

a 14-stage counter; all outputs except 2 and 3 are externally accessible. The 4020 provides a maximum division ratio of 16,384 ( $2^{14}$ ).

Figure 17-a shows details of the 4060. It is another 14-stage device, but outputs 1, 2, 3, and 11 are not accessible. A special feature of the IC is that it incorporates a built-in oscillator circuit. As shown in Fig. 17-b and Fig. 17-c, the device can use either a crystal or an RC network to set the frequency of oscillation.

The 4020, 4024, 4040, and 4060 IC's all have Schmitt-trigger inputs that trigger on the negative transition of each input pulse. All of those counters can be set to

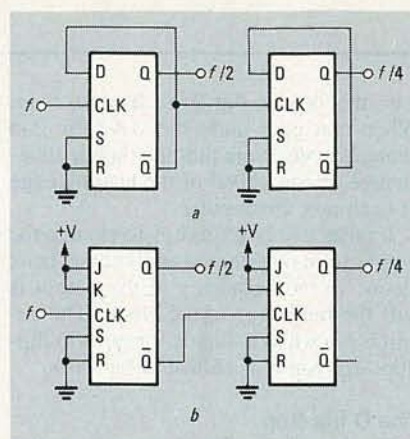

FIG. 11—TO DIVIDE FREQUENCY BY FOUR, you can use a pair of D (a) or JK (b) flip-flops.

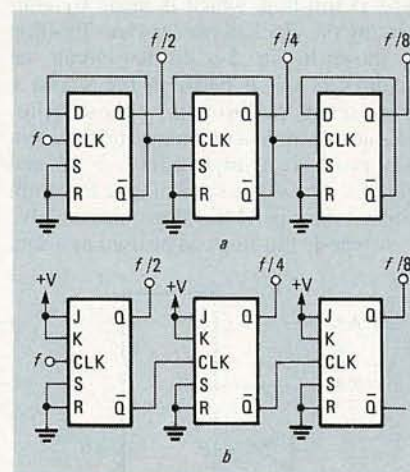

FIG. 12—TO DIVIDE FREQUENCY BY EIGHT, you can use three D (a) or JK (b) flip-flops.

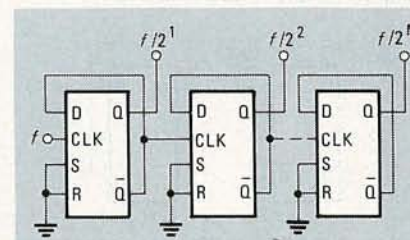

FIG. 13—TO DIVIDE FREQUENCY by an arbitrary factor  $2^n$ , use  $n$  stages.

zero by applying a high level to the RESET line.

### Glitches

A two-stage divide-by-four ripple counter, like that shown in Fig. 18-a, can have four possible output states, as shown in Fig. 18-b. Both outputs can be high, both can be low, one can be high and the other low, or the former low and the latter high. Before any clock pulses have been received, the  $Q_2$  and  $Q_1$  outputs are low. When the first pulse arrives,  $Q_1$  goes high. When the second pulse arrives,  $Q_2$  goes high and  $Q_1$  goes low. On the third pulse,  $Q_2$  and  $Q_1$  both go high. Last, on the fourth pulse,  $Q_2$  and  $Q_1$  both go low again.



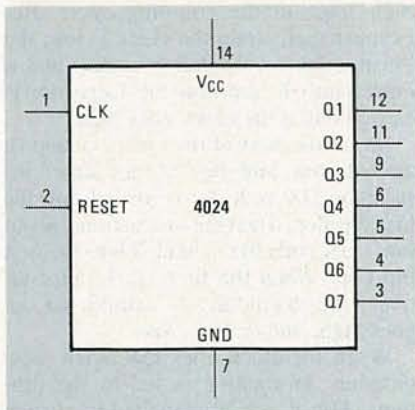

FIG. 14—PINOUT OF THE 4024 seven-stage ripple counter is shown here.

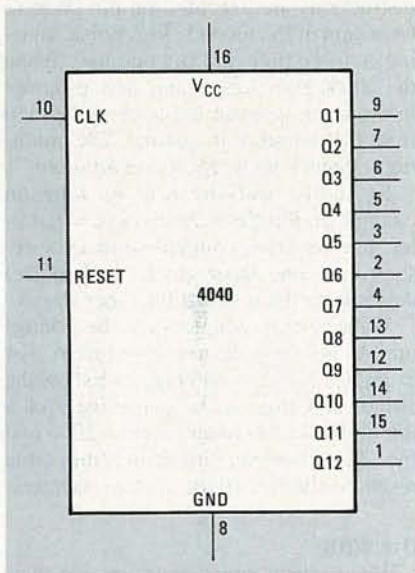

FIG. 15—PINOUT OF THE 4040 12-stage ripple counter is shown here.

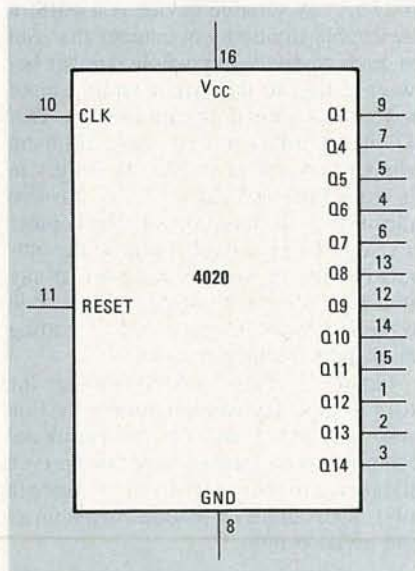

FIG. 16—PINOUT OF THE 4020 14-stage ripple counter is shown here.

Each of the four possible states can be decoded to provide four unique outputs by ANDING the outputs that are unique to each

state, as shown in Fig. 18-c. Because the ripple counter is an asynchronous device, however, the propagation delay between the two flip-flops may cause glitches to

### Up and down counters.

A standard ripple counter counts up—the decoded outputs increase in value with each succeeding clock pulse. It is possi-

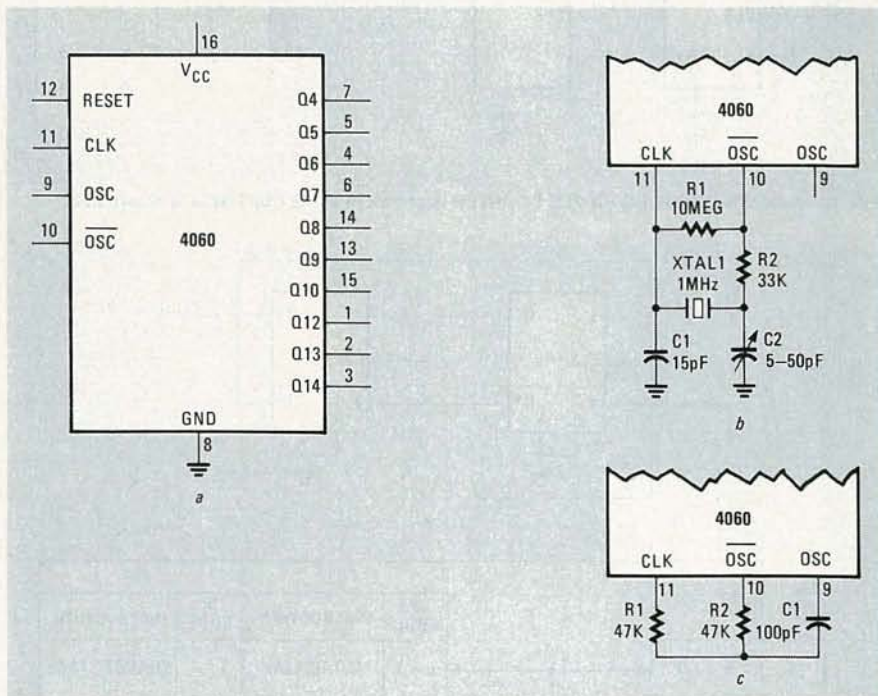

FIG. 17—THE 4060's PINOUT is shown in a; several oscillator connections are shown in b and c.

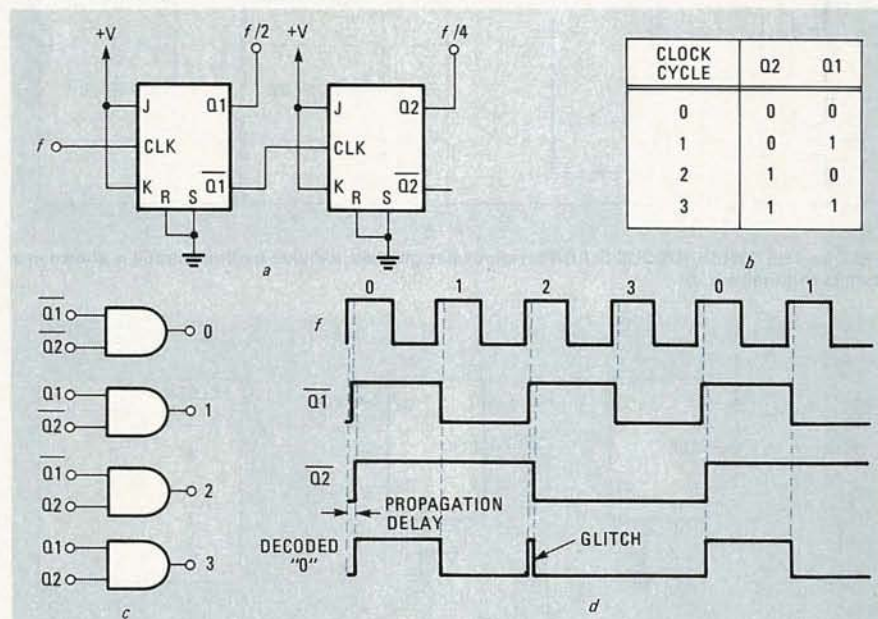

FIG. 18—GLITCHES may be generated when decoding a ripple counter like that shown in a. The  $Q_1$  and  $Q_2$  outputs respond to the input signal as shown in b. When they're combined as shown in c, a glitch can be generated, as shown in d.

appear in the decoded outputs, as shown in Fig. 18-d. Of course, those types of glitches are possible with any multi-stage ripple counter, and the greater the number of stages, the greater the total propagation delay becomes, and the greater the problem with glitches. The solution to the glitch problem is to use a clocked-logic device, which we'll discuss momentarily.

ble, however, to build a counter that works in the opposite direction. That type of counter is called a down (or a subtract) counter. The circuit is shown in Fig. 19-a; its truth table is shown in Fig. 19-b.

### Walking-ring (Johnson) counters

Ripple counters are useful where undecoded binary division is needed, but

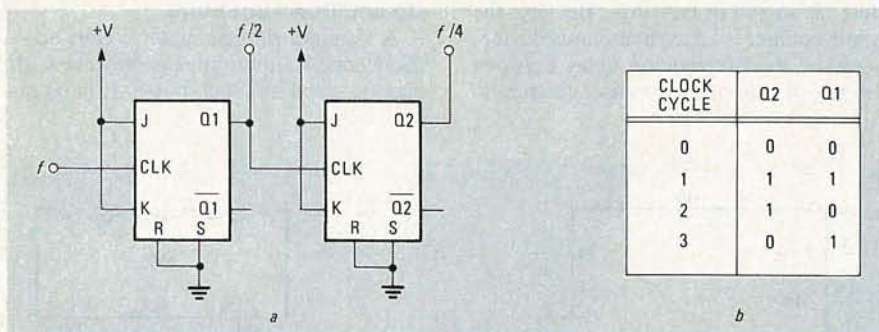
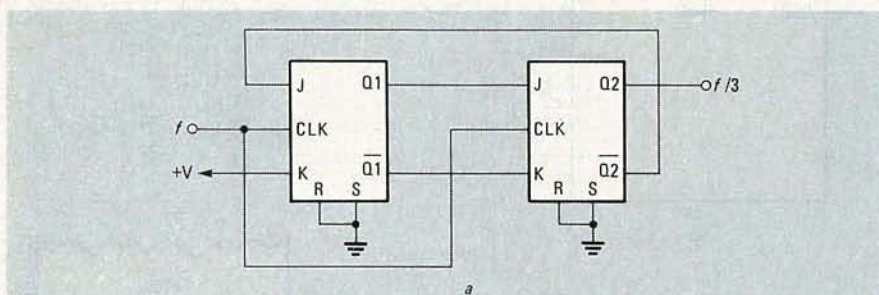

FIG. 19—A DOWN-COUNTING RIPPLE COUNTER is shown in a; the truth-table is shown in b.



CLK CYCLE	Q2	Q1	FF2		FF1	
			JK CODE	INSTRUCTION	JK CODE	INSTRUCTION
0	0	0	0 1	SET Q2 LOW	1 1	CHANGE STATE
1	0	1	1 0	SET Q2 HIGH	1 1	CHANGE STATE
2	1	0	0 1	SET Q2 LOW	0 1	SET Q1 LOW
0	0	0				

FIG. 20—THE SYNCHRONOUS COUNTER eliminates glitches; a divide-by-three circuit is shown in a, and its truth-table in b.

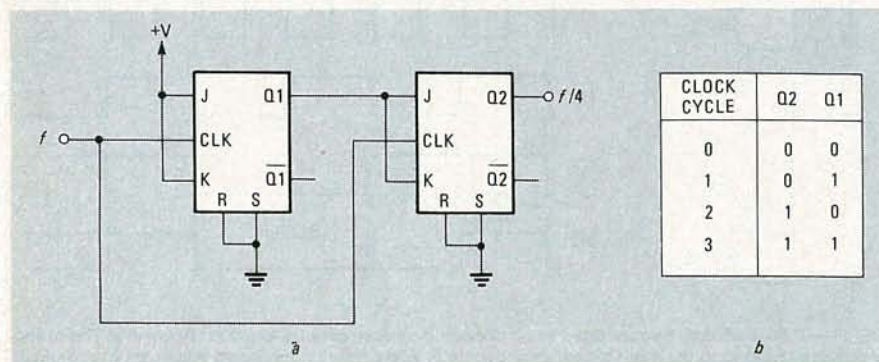

FIG. 21—A SYNCHRONOUS DIVIDE-BY-FOUR CIRCUIT is shown in a; its truth table is shown in b.

(because of glitches) not where decoded outputs are required. Fortunately, an alternative circuit, which is suitable for generating decoded outputs, is available. It is known as the walking ring or Johnson counter. It relies on the "programmable" nature of the JK flip-flop, which enables it to act as a SET (or a RESET) latch, as a

binary divider, or as a "do nothing" device. In a walking-ring counter, all flip-flops are clocked simultaneously, so it is also known as a synchronous counter.

Figure 20-a shows the circuit and Fig. 20-b the truth table of a synchronous divide-by-three counter. Note that the truth table shows the state of each flip-flop at

each stage of the counting cycle. Remember that, when the clock is low, the "instruction" is loaded (via the J and K inputs) into the flip-flop; the instruction is carried out as the clock goes high.

So, at the start of the cycle, Q2 and Q1 are both low, and the "change state" instruction (JK code 11) is loaded into the first flip-flop. Then the instruction "set Q2 low" (JK code 01) is loaded into the first flip-flop. When the first clock pulse arrives, the instruction is carried out, Q1 goes high, and Q2 stays low.

When the clock goes low again, new program information is fed to the flip-flops. Flip-flop 1 is instructed to change state (JK code 11), and flip-flop 2 is instructed to set Q2 high (JK code 10). Those instructions are executed on the positive transition of the second clock pulse, causing Q2 to go high and Q1 to go low. When the clock goes low again, new program information is again fed to each flip-flop from the output of its partner. The counting sequence then repeats *ad infinitum*.

So in the walking-ring or Johnson counter, all flip-flops are clocked in parallel, but are cross-coupled so that the response of one stage (to a clock pulse) depends on the states of the other stages.

Walking-ring counters can be configured to give any desired count ratio. For example, Fig. 21-a and Fig. 21-b show the circuit and truth table respectively of a divide-by-four counter. Figure 22-a and Fig. 22-b show the circuit and truth table respectively of a divide-by-five counter.

### The 4018

When synchronous counts greater than four are needed, it is usually economical to use an MSI IC rather than several 4027's. A suitable device is a 4018, a presettable divide-by-N counter that can be made to divide any whole number between 2 and 10 by cross-coupling input and output terminals in various ways. That IC incorporates a five-stage Johnson counter, has a built-in Schmitt trigger in its clock line, and clocks on the positive transition of the input signal. The counter is said to be presettable because the outputs can be set to a desired state at any time by feeding the inverted binary code to the Jam inputs (J1-J5) and then loading the data by taking pin 10 high.

Figure 23 shows how to connect the 4018 to give any whole-number division ratio between 2 and 10. No additional components are needed to obtain an even division ratio, but a two-input AND gate (a 4081, for example) is required to obtain an odd division ratio.

### Greater-than-ten division

Even division ratios greater than ten can usually be obtained simply by cascading suitably scaled counter stages, as shown in Fig. 24-a-Fig. 24-d. Non-standard and uneven division ratios can be

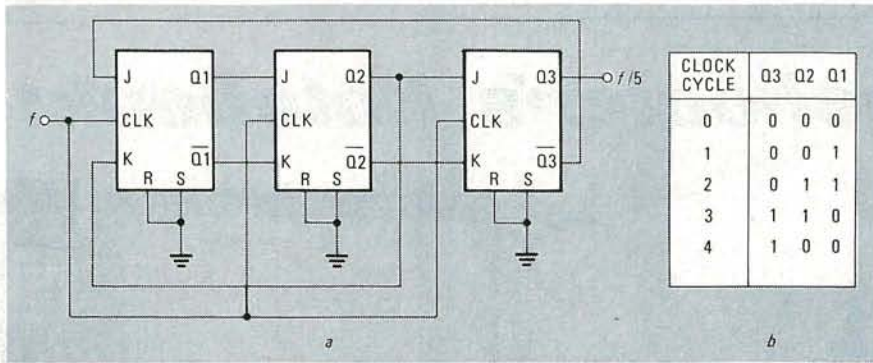

FIG. 22—A SYNCHRONOUS DIVIDE-BY-FIVE CIRCUIT is shown in *a*; its truth table is shown in *b*.

DIVISION RATIO	FEEDBACK CONNECTIONS
2	$\bar{Q}_1$ TO DATA
3	$\bar{Q}_1$ AND $\bar{Q}_2$ TO DATA
4	$\bar{Q}_2$ TO DATA
5	$\bar{Q}_2$ AND $\bar{Q}_3$ TO DATA
6	$\bar{Q}_3$ TO DATA
7	$\bar{Q}_3$ AND $\bar{Q}_4$ TO DATA
8	$\bar{Q}_4$ TO DATA
9	$\bar{Q}_4$ AND $\bar{Q}_5$ TO DATA
10	$\bar{Q}_5$ TO DATA

FIG. 23—TO OBTAIN AN ODD DIVISION RATIO with the 4018, an external AND gate must be used.

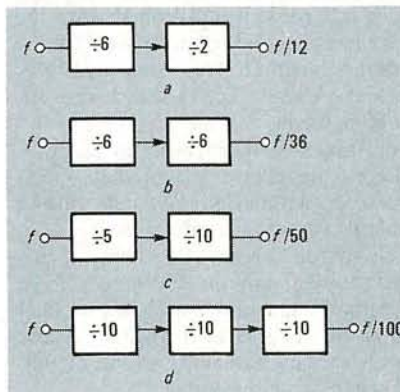

FIG. 24—A DIVISION RATIO OF arbitrarily large size may be obtained by cascading divider stages and multiplying the division factor. In *a* a divide-by-12 ( $2 \times 6$ ) circuit, in *b* a divide-by-36 circuit ( $6 \times 6$ ), in *c* a divide-by-50 ( $5 \times 10$ ), and in *d* a divide-by-1000 ( $10 \times 10 \times 10$ ) circuit.

obtained by using a standard synchronous counter (the 4018, for example) and decoding the outputs to generate suitable counter-reset pulses when the desired count is attained.

### Latches and registers

Now let's move away from counters and take a brief look at three other applications of the clocked master-slave flip-flop.

Figure 26 shows how to make a four-bit Serial-In/Serial-Out (SISO) shift register. A bit of binary data applied to the input is passed to the output of the first flip-flop on the application of the first clock pulse, to the output of the second on the second pulse, to the output of the third on the third pulse, and to the fourth (and final) output on the fourth pulse. The circuit can hold four bits of data at any given moment. The SISO register is useful for delaying binary signals, or for storing bits of binary data and unloading them (in serial form) when required.

Figure 27 shows how the previous cir-

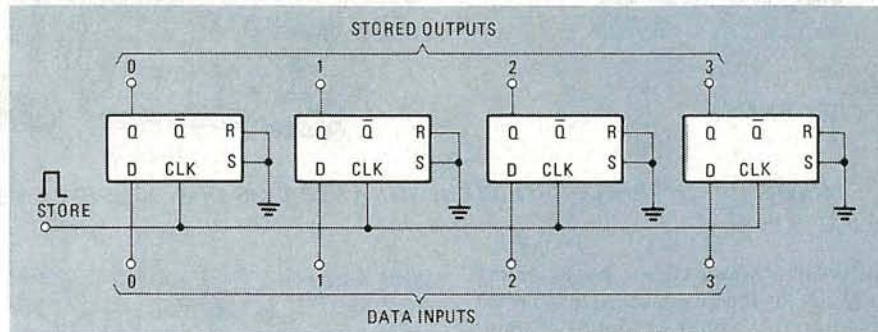

FIG. 25—TO STORE FOUR BITS OF DATA, all four inputs are clocked simultaneously.

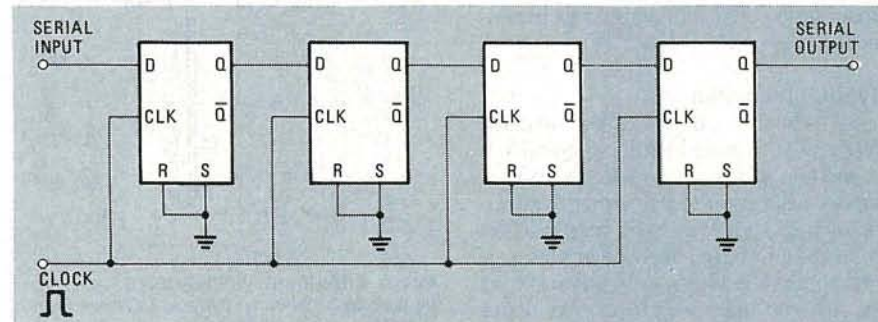

FIG. 26—FOUR TYPE-D FLIP-FLOPS are cascaded to create a four-bit SISO shift register.

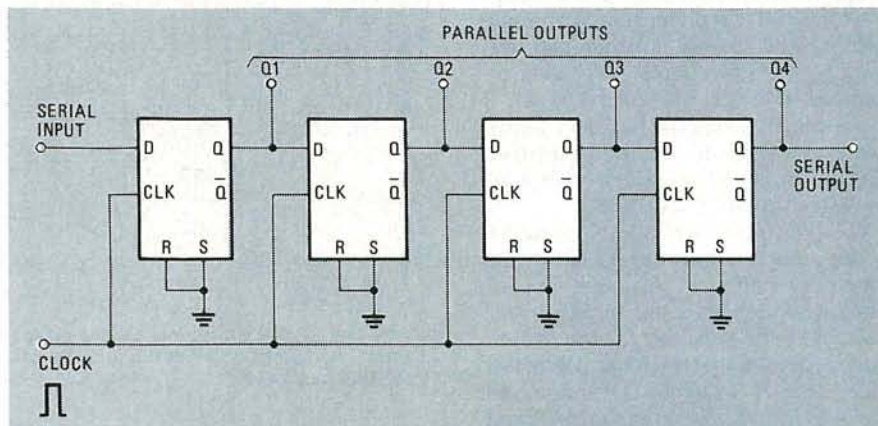

FIG. 27—FOUR TYPE-D FLIP-FLOPS are cascaded to create a four-bit SIPO shift register.

Figure 25 shows how to make a four-bit data latch from four D-type flip-flops. The data latch is useful for storing binary numbers or data. Input data is ignored until a positive-going STORE pulse is applied, at which point the latch stores the data and outputs it on the Q outputs.

The circuit can be converted to a Serial-In/Parallel-Out (SIPO) shift register simply by using the Q outputs of each flip-flop. The circuit might be useful, for example, in converting data transmitted from a remote location in serial form to the parallel form used by computers. R-E

## TV Troubleshooter's Notebook:

# BLACK VERTICAL BARS

JAY SHANE

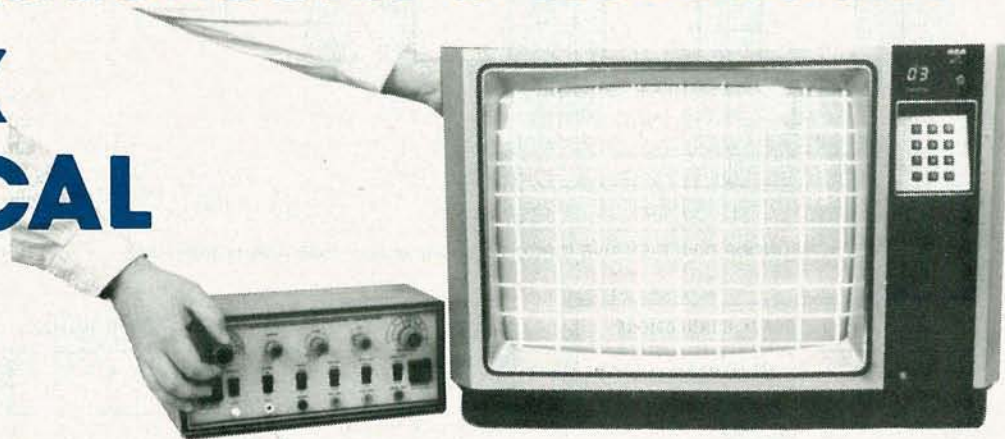

Here's a real "head-scratcher" from the files of a TV-service technician.

WE'VE BEEN SUBSTITUTING COMPONENTS in TV sets and radios since the first day we discovered it could be done. Though sometimes it's done to the detriment of good servicing, often a technician has no other choice. The following is an experience of that sort.

### Flyback fireworks

A Wards color TV, model GGY-12983A, came in with symptoms of no picture or sound, and it smoked. A cursory inspection revealed that the horizontal transistor was okay and that the flyback didn't have any swollen places or cracks in its shell. However, when the set was fired up there were fireworks under the chassis in the area of the flyback.

The receiver was stood on end to expose the full circuit panel. We immediately could see that a carbon path was burnt between two traces. Not being acquainted with this particular chassis, it was necessary to dig out the Sams folder. However, we were in for a surprise: Though the model was almost five years old it was still not listed.

The set's owner was a loyal customer, so since it was a quiet day we decided to search our folder file to see if we had servicing information for anything that was close to that chassis. Luckily, a similar one was found in Sams Photofact folder 2165-2; it was for a Wards model GNB-12914A,B. The component layout and the schematic numbering for the two sets were almost identical.

Now we could see that the carbon path ran from pin-7 of the flyback to the far side of a two-amp fuse, FS-501, located in the 117-volt line to pin 3 of the flyback. See Fig. 1.

It the set, those traces ran parallel, about 3/8-inch apart, for about three

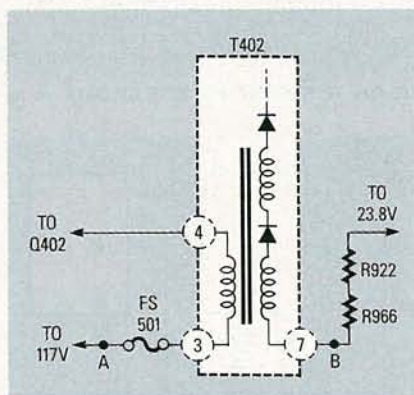

FIG. 1—ARCING BETWEEN POINTS A and B was caused by a defective flyback. Later we found that R966 was cracked, too.

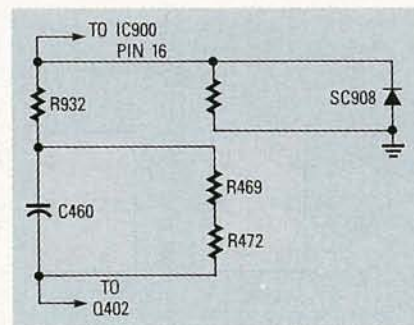

FIG. 2—THE BLACK BARS were caused by an abnormal horizontal pulse at the junction of R469, R932, and C460.

inches. Pin 7 is the return of the internal rectifiers in the flyback going to the 23.8-volt leg of the low-voltage power supply. The arc-over meant that excessive reverse current was flowing from the tripler section of the transformer.

Replacing the flyback was the only solution. No American manufacturer was listed so the part had to be ordered from

Montgomery-Ward at list. The customer was notified of the estimate for repairs and he gave the go-ahead.

When it was received, the replacement transformer turned out to be a substitute. The original was part 50 3015344-02, type B. Their data sheet showed the substitute to be a 361883-0003, type B. The two parts appeared to be identical in every respect.

### More problems

After the flyback was installed, excess solder and rosin were cleaned from the solder terminals with a wire brush. Each soldered terminal was then carefully checked for resistance to the nearest circuit component.

Satisfied that there were no circuitry leakages, the receiver was fired up. When it came on without any apparent further problems, it was placed on the cooking bench to run for several hours. That's when the new symptom developed: There were now four and a half black vertical bars at the left side of the screen. There was also a faint streaking in the picture and raster. What happened?

After some head scratching, we remembered that a similar symptom had shown up once in a totally different brand. The cause had something to do with pulse feed.

An analysis of the circuitry revealed an RC network between the horizontal-output transistor, Q-402, and pin 16 of the video/chroma processor, IC-900. That component is shown in Fig. 2.

Checking the horizontal pulse at the junction of R932, C460, and R469 with an oscilloscope showed that it was not normal; the pulse had excessive amplitude, and a sharp spike at its leading edge.

*continued on page 85*

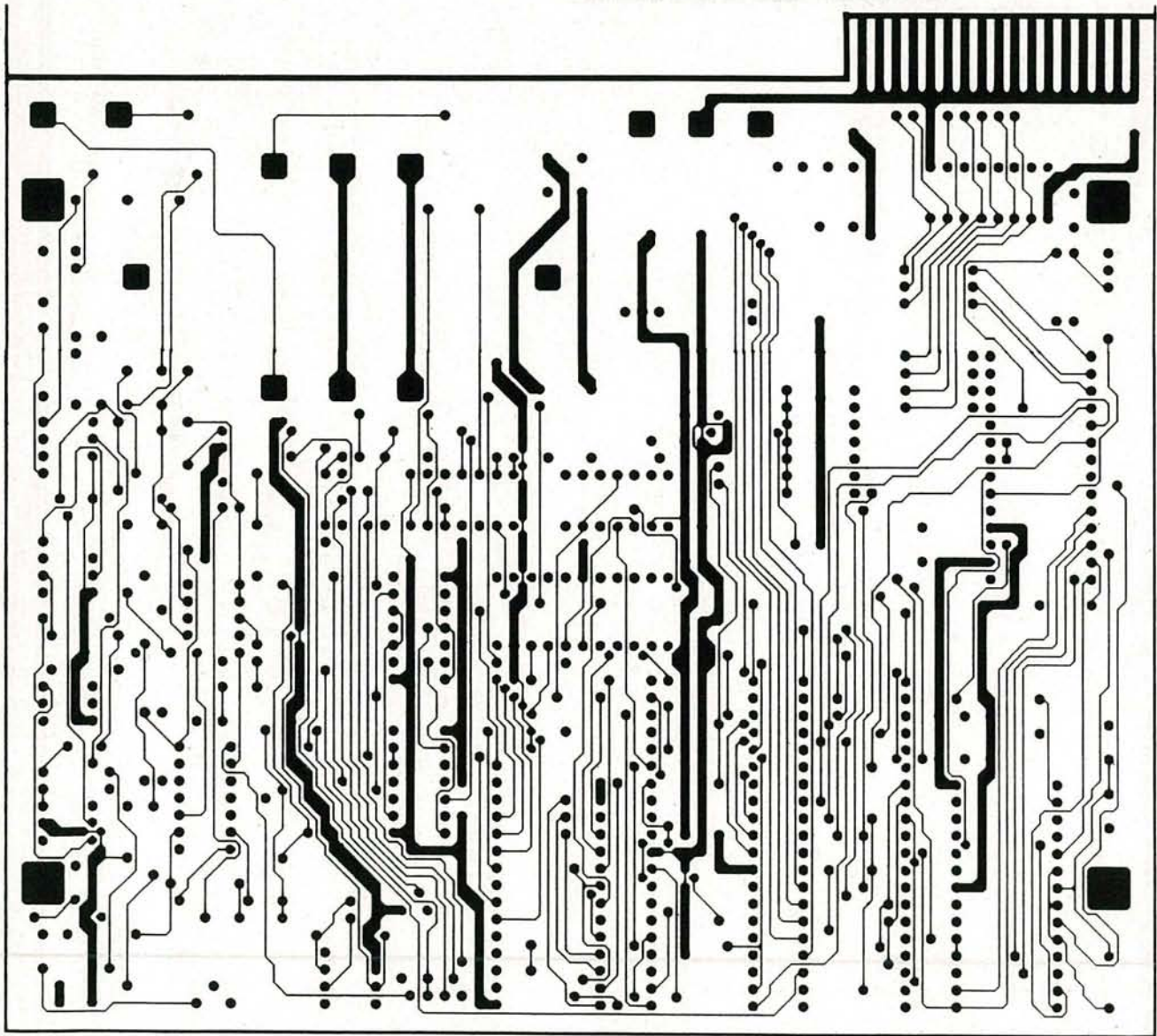

6.75 INCHES

THE SOLDER SIDE of the Phonlink PC board is shown here.

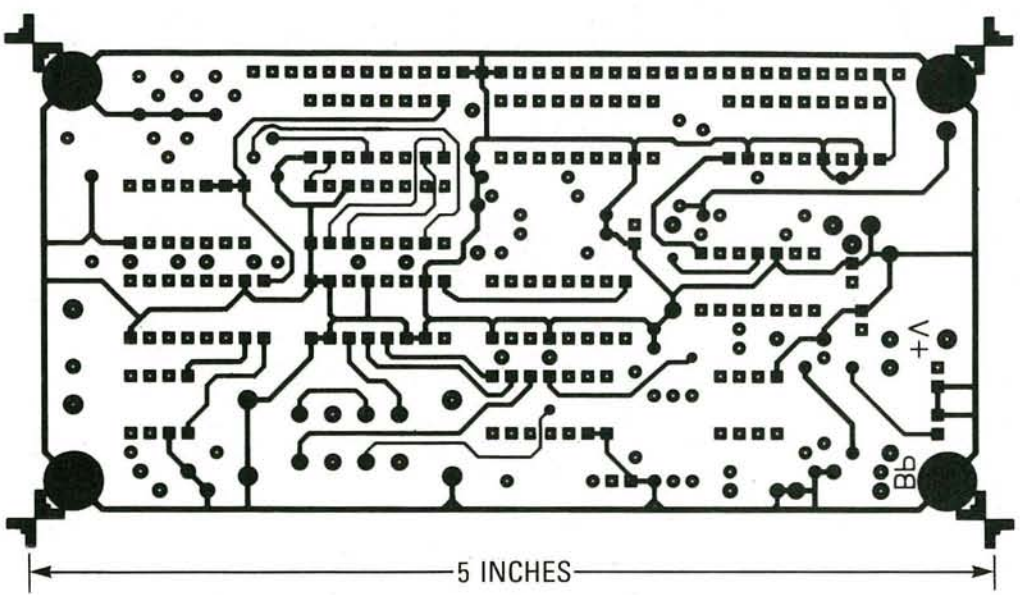

THE COMPONENT SIDE of the digital tachometer.

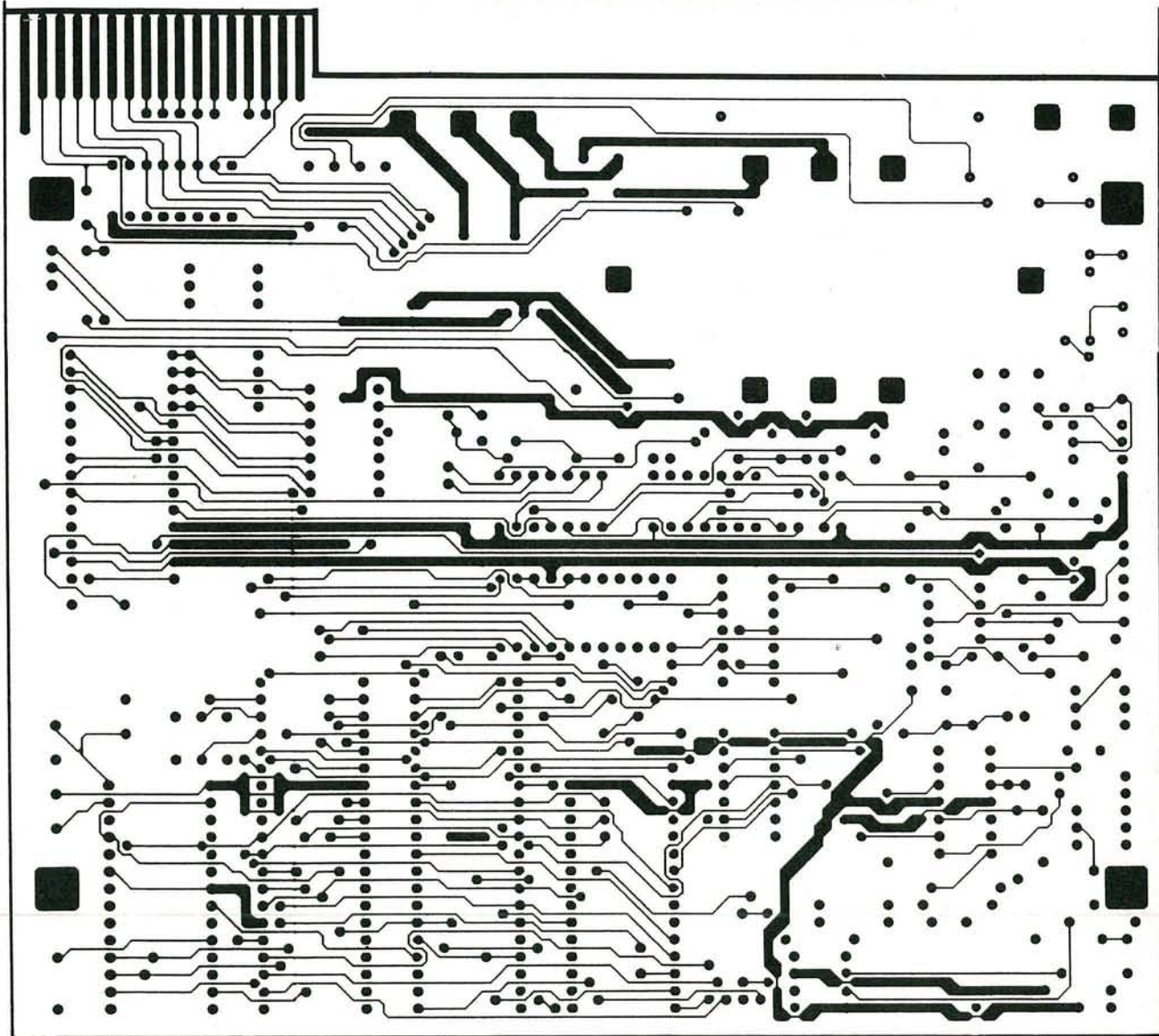

6.75 INCHES

THE COMPONENT SIDE of the double-sided Phonlink PC board.

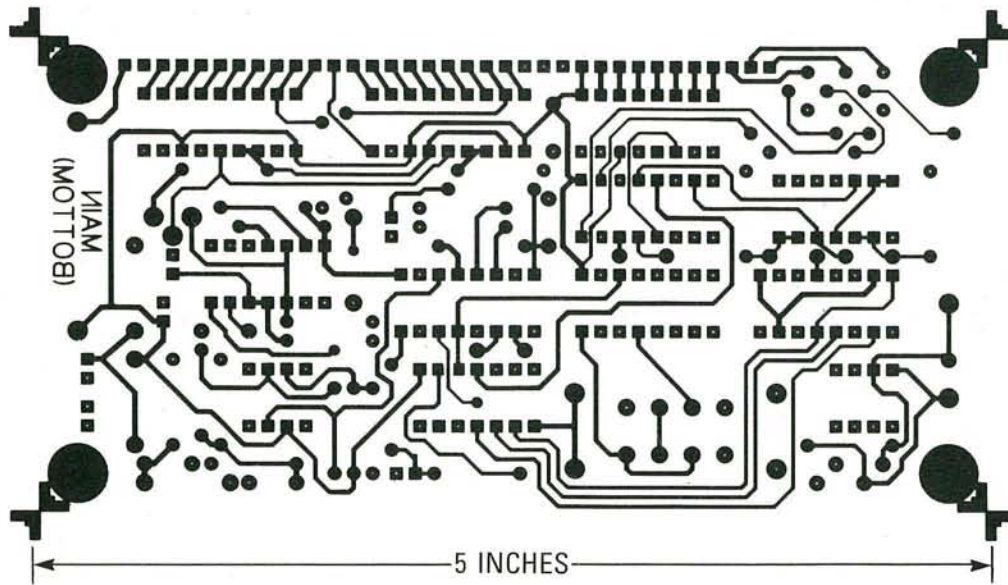

THE SOLDER SIDE of the digital tachometer is shown here.



One of the most difficult tasks in building any construction project featured in **Radio-Electronics** is making the PC board using just the foil pattern provided with the article. Well, we're doing something about it.

We've moved all the foil patterns to this new section where they're printed by themselves, full sized, with nothing on the back side of the page. What that means for you is that the printed page can be used directly to produce PC boards!

**Note:** The patterns provided can be used directly only for *direct positive photoresist methods*.

In order to produce a board directly from the magazine page, remove the page and carefully inspect it under a strong light and/or on a light table. Look for breaks in the traces, bridges between traces, and in general, all the kinds of things you look for in the final etched board. You can clean up the published artwork the same way you clean up your own artwork. Drafting tape and graphic aids can fix incomplete traces and doughnuts, and you can use a hobby knife to get rid of bridges and dirt.

An optional step, once you're satisfied that the artwork is clean, is to take a little bit of mineral oil and carefully wipe it

across the back of the artwork. That helps make the paper translucent. Don't get any on the front side of the paper (the side with the pattern) because you'll contaminate the sensitized surface of the copper blank. After the oil has "dried" a bit—patting with a paper towel will help speed up the process—place the pattern front side down on the sensitized copper blank, and make the exposure. You'll probably have to use a longer exposure time than you are used to.

We can't tell you exactly how long an exposure time you will need as it depends on many factors but, as a starting point, figure that there's a 50 percent increase in exposure time over lithographic film. But you'll have to experiment to find the best method for you. And once you find it, stick with it.

Finally, we would like to hear how you make out using our method. Write and tell us of your successes, and failures, and what techniques work best for you. Address your letters to:

**Radio-Electronics**  
Department PCB  
500-B Bi-County Blvd.  
Farmingdale, NY 11735

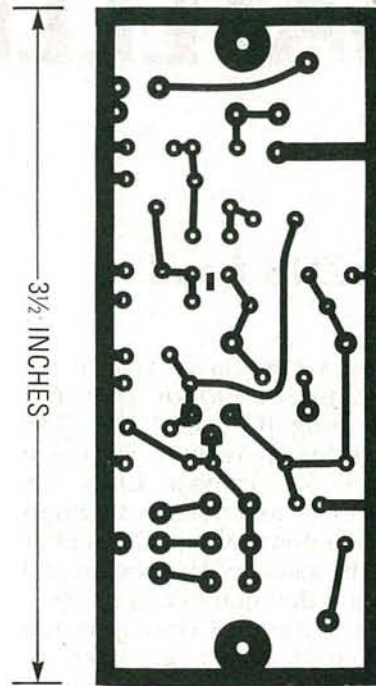

**THIS SHORTWAVE CONVERTER PC board cannot be made using the direct-etch method.**

# kePRO CIRCUIT MAKER

For art supplies, kits and economical equipment to produce at home professional quality print circuit boards...ask for the pro's - Kepro Circuit Systems, Inc. Kepro has been producing prototype and short run equipment, as well as providing PCB supplies to industrial companies for years. Their specialized experience and knowledge provides the home hobbyist an economical and convenient source of equipment and supplies for a professional, one-of-a-kind, printed circuit board.

Shears, etchers, sensitized and un-sensitized copperclad laminates, art supplies, kits and Keproclad...all you need to make a professional quality printed circuit board at home and at a cost you can afford.



**Kepro, your one stop source for at home PCB's.**

Write or call Kepro for their catalog and price list.  
**1-800-325-3878 or 1-314-343-1630 (MO)**  
630 Axminster Drive, Fenton, MO 63026-2992.

**KeproClad**  
by Kepro Circuit Systems, Inc.  
from \$3.90

For your next one of a kind PCB project

- Pre-sensitized
- Ready for exposure
- Copper Clad Laminates



**BENCHTOP ETCHER** \$820.00

**SHEAR** \$390.00

**ART SUPPLIES** from \$2.79

**CHEMICALS AND RESISTS**

For use with Kepro Clad

- Developers
- Strippers
- Etching solutions

Plating chemicals and supplies also available

# SATELLITE TV



**BOB COOPER, JR.,**  
SATELLITE-TV EDITOR

## The ZITS fraud

IN OUR LAST REPORT WE RELATED THE unveiling of a *VideoCipher*-descrambling IC called the ZITS (Zero Information Turn-on System) or European Chip. We noted that it functions by snaring a VC2000 authorization (ID) number from the satellite data stream and adopting that number as its own. In effect, the ZITS chip appeared to be outside the GI-controlled authorization system; and when it was installed in a descrambler, a home viewer could access scrambled transmissions without having to sign up and pay for any services.

It turns out that the ZITS chip is a fraud; the facts behind the apparently amazing chip are quite bizarre. And there's a lesson here for us all.

The European Chip was first introduced to the home-dish industry at a technical seminar held in mid-January, shortly after GI introduced the new consumer *VideoCipher* descrambler, the 2100E, shown in Fig. 1. Anyway, the demonstration was impressive. A *VideoCipher* unit was unplugged from the AC power source, the internal lithium battery (which contains the unit's ID) was disconnected, and nearly 100 pins on various IC's inside the VC2000 were purposely shorted to ground to ensure that the unit was "brain dead." Then the VC2000 was reloaded with three IC's that not only restored operation, but the original factory ID as well.

The primary claim of the unit's designers was that it did not have a real unit-ID number at all, and that, as the GI authorization system transmitted valid addresses

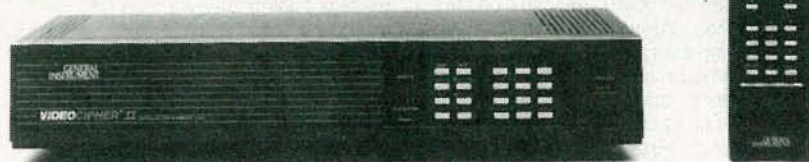

FIG. 1

(via satellite), the device read the data stream and picked off an address to adopt as its own.

They further claimed that, if the adopted address later became inoperative, the European Chip would simply search out another available address ID and adopt it as the unit's new address.

Many who considered themselves acquainted with the inner workings of *VideoCipher* and the U7/U30 software were not satisfied with that explanation. They felt that if it worked at all, the unit had to have some other explanation.

Around the time of the first demonstration, a chip-scam originating on the West Coast began to surface. Someone had managed to extract an ID number from a VC2000. That number was then merged into a U30 EPROM using something the creator called a "loader chip." The sellers of that system made claims similar to those of the Europeans: No authorization was required because the IC was adopting data-stream-transmitted ID numbers as its own. The IC from the West Coast turned out to be a fraud; upon analysis a unit-ID number removed from an "innocent" unit

was found buried inside the operational unit. In other words, the wonder-chip from the West Coast was not actually adopting any number at all; *it had its own number all along.*

The Europeans used similar tactics; using programming jumps, the unit-ID number was hidden from normal view in an obscure location in the EPROM's 16,384-byte address space. That was the end of the European Chip's claim to fame, but the mystery did not end there.

The unit-ID number discovered in the West Coast chips turned out to be the same unit-ID number found in the European Chip. In fact, as more and more chips were uncovered all over the U.S. and Canada, *they all had the same number* buried in various locations in the EPROM. It turned out that a single VC2000, belonging to a consumer in the midwest, was supporting thousands and thousands of clones!

Tracing the origin of the VC2000 in question was not difficult. A consumer, sympathetic to the scrambling battles, had loaned his VC2000 to a research group. After a month or so the unit was returned

to that person, seemingly intact. What he did not know was that, while the unit was out of his possession, the key was extracted and stored. Later, the key would be sold and re-sold, traded and re-traded, to perhaps a dozen or more clone suppliers all over the United States, and perhaps the world. The consumer continued to use his VC2000, unaware that his subscriptions to Showtime *et al* were also supporting a lively nationwide business.

The truth is that a unit's factory-installed ID number can be extracted by anyone who has key-extraction hardware and software. Extraction could even happen at an authorized distributor or dealer, because it's done with clip-on devices that leave no trail. Therefore the key can easily become a clandestine commodity traded without the knowledge of the innocent owner.

#### European extras

The European Chip was really a combination of both clone and musketeer technology. It relied upon the unit-ID number of an innocent box to turn on; then it used musketeer software to authorize not only the services that the innocent box actually subscribed to, but the balance of the services as well. Even the cable-only WOR service, which is not available to home-TVRO owners, was included in the European Chip service menu, because someone had

discovered a two-byte change in the software that enabled reception of WOR.

Exposure of the European Chip (and others operating under various names) as a fraud sent shock waves through the descrambling underground. That's because the capture of a single IC in a family would reveal the master ID number for the entire family, and that would allow GI to disable many systems simultaneously.

The danger of such discovery

has always been a problem with clone devices, so most clone-cells have been self-limited to 50 or fewer users per clone master. But claims made about the European Chip caused people to be less cautious about protecting clone-cell size.

Meanwhile GI has been tightening up on the flow of clone and musketeer IC's. Canadian musketeer suppliers have abandoned their system of shipping from Canada  
*continued on page 86*

## SEND COOP \$20



## and HE WILL SEND YOU \$63!

**NOPE** - not a new fangled 'chain letter'. TVRO pioneer Bob Cooper, Jr. has put together the most useful 'Data-pack' possible to bring you up to full speed on satellite television scrambling. It will cost you \$20 to receive all of the following valuable information:



**1) YOU RECEIVE** the 3 'current issues' of **CSD Magazine**; literally, 'the bible' of the home dish industry. The most complete insider look at the new equipment, scrambling strategies, worldwide satellite explosive growth anyplace. You receive 3 issues starting with the now-current issue. A great introduction to TVRO! This is an **\$18 value**.

**2) YOU RECEIVE** the current plus two recent back issues of **SCRAMBLE-FAX**, the hot-news 'Newsletter' that details the rapid changes taking place in scrambling, who is scrambling, how; who is working to break scrambling, their progress to date. This is a **\$30 value**.

**3) YOU RECEIVE** the special 180 page **COMMEMORATIVE EDITION OF Coop's Satellite Digest**, the full, unabridged history of home satellite television. This is the handiest, one-source reference recording the home dish industry, a **\$15 value**.

**YOU RECEIVE** all of the facts, all of the history, and all of the current, hard-to-find news about TVRO and scrambling. From Coop; the industry's most authoritative information source. Send your check or money order to the address below, or, with your Visa or Mastercharge card handy, call in your order to 305/771-0505 weekdays between 9 AM and 4 PM. Join the Coop team and learn ALL the facts today!

### CSD/Coop's Satellite Digest

P.O. Box 100858/Ft. Lauderdale, Fl. 33310

- Telephone 305-771-0505 -

**SCRAMBLE-FAX HOTLINE?** Call 305-771-0575 for 3 minute update NOW!

#### INTERESTED IN SCRAMBLING?

Bob Cooper's *CSD Magazine* maintains a 24 hour per day *Scramble-Fax-Hotline* telephone service (305/771-0575) which you may call to obtain a 3-minute recorded update on the latest happenings in the satellite scrambling world. *Scramble-Fax Newsletter* is also published to keep you abreast of the latest events in descrambling, including sources for descrambling chips and equipment. For information, write *Scramble Fax*, P.O. Box 100858, Ft. Lauderdale, FL. 33310 or telephone 305-771-0505.

If you have a dish of your own, tune in the Caribbean Super Station (Western 5, transponder 23) Tuesdays at 7 PM eastern for a special weekly Bob Cooper report. Also tune-in *Boresight* at 9 PM Thursday nights (Spacenet 1, transponder 9) for a weekly one-hour report on the activities in the home TVRO field.

# AUDIO UPDATE

## Unwanted sounds

YOU'VE JUST HELPED A FRIEND SET UP his new \$5,000 audio system. For the first week or so he is extremely pleased; then the complaints start to come in. It's not that he's complaining to you, but that his neighbors are complaining to him. It seems that your friend's new speakers—which are renowned for their deep, strong bass—are achieving a different sort of fame throughout his condo. The problem is described in slightly hysterical terms by the lady in the apartment below: "All I hear all night is this boom-boom-boom!" Even allowing for some hyperbole, the neighbor's complaint is probably not unwarranted. Is there a solution?

### Soundproofing.

Most people tend to confuse the techniques appropriate for soundproofing with those used for sound treatment. In general, the methods used for soundproofing (preventing noise originating inside a room from getting out—or noise from outside getting in) have little relevance to sound treatment (that is, adjusting the acoustic absorptive properties of a room). Soundproofing is by far the tougher problem.

Think of sound as vibrations of the air itself. Therefore, to keep sound out—or in—the first step is to make sure that insofar as is possible, all air transmission paths from one area to another are blocked. Those include seams around door edges, windows, ventilation ducts, etc. Most of the procedures used to prevent heat loss will also block sound. Measurements have shown that even

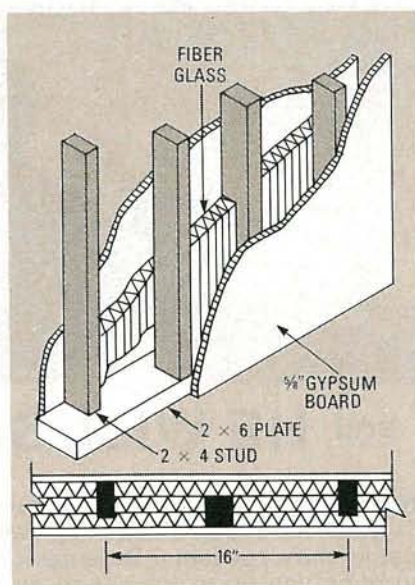

FIG. 1

the smallest air leakage path can defeat an otherwise effective sound-blocking approach.

Once the paths for airborne sound are located and eliminated—and that certainly isn't always easy—then you must minimize the vibrations in solids, which also serve to couple sound from one area to another. When acoustic vibrations (sound waves) impinge on a surface, they are likely to cause it to vibrate. In fact, sound waves vibrating your eardrums are essential to the hearing process. Sound gets through walls in two ways: vibratory transmission through a solid and/or diaphragmatic action.

A child's telephone consisting of two tin cans with a string stretched taut between them illustrates both principles in action. The acoustic energy from a voice causes the



LARRY KLEIN,  
AUDIO EDITOR

bottom of the can to act as a diaphragm that vibrates in response to the acoustic energy impinging on it. The mechanical vibration is transmitted by the taut string. At the receiving end, the vibrating string causes the receiving can-bottom diaphragm to vibrate the air and to recreate, more or less, the original sound. In much the same way, the walls of a room can act as a diaphragm to "pick up" sound and couple it to the next room either through the air spaces between the studs, or through the studs themselves.

### Eliminating the diaphragm

To eliminate diaphragmatic transmission, you have to eliminate (or dampen) the diaphragm. One very effective technique is to increase the mass of the walls in the transmission path so that they no longer are able to vibrate freely. For example, you can use heavy wall panels instead of thin ones and/or you can brace the panels with 2 x 4 studs at 10- or 12-inch intervals instead of using the standard 16-inch spacing. Or instead of studs and panels between interior rooms, you can use brick, concrete, cinder blocks, etc.; all of which are excellent barriers to impinging airborne vibration. However, anyone who has ever used a string telephone—or communicated to a building superintendent in the basement by hammering on a radiator—knows that solids can also serve as excellent sound-transmission paths.

To minimize such transmission, one can build up a wall or door using sandwiched layers of dif-

ferent types of materials to take advantage of the fact that vibration tends to be attenuated when traveling through the interfaces of different materials. (The double-glass windows with internal spacing used in recording-studio control rooms function on that principle.) Tests have shown that even the screws or nails used to hold panels to studs can provide transmission paths. For that reason, cementing panels in place with the mastic material commonly used to mount ceiling tiles is a preferred technique when resistance to sound transmission is important.

An excellent sound-isolating wall-construction technique has been described by Owens-Corning Fiberglass Corporation. Shown in Fig. 1, it consists of staggered vertical  $2 \times 4$ 's on a  $4 \times 6$  sole plate arranged so that the two sides of  $\frac{5}{8}$ -inch gypsum board partition wall are independently supported. Another 4 to 10 dB of sound attenuation can be achieved by filling the spaces between the walls with fiberglass insulation batting.

A one-inch layer of sand between closely spaced panels or beneath a false floor also forms an excellent inert high-mass sound barrier. For the same reason, sheet lead is used industrially as a popular sound-shielding material, either by itself or bonded to other materials.

Note that the lower frequencies, because of their greater energy content, are the ones that are most readily transmitted through walls and floors, and are therefore the most difficult to isolate or absorb. That's the reason why only the low "boom, boom, boom" (rather than the full audio range) was

heard by the lady downstairs—and probably in other adjacent apartments. The higher frequencies, which are readily absorbed and blocked by acoustical tile and other absorbing materials, seldom get through to the neighbors unless there is a direct air-leakage path such as an air shaft. You can see how the nature of the leaked sound provides a good clue as to the transmission path. If no highs are heard, air transmission is probably not at work.

## Decoupling the speakers

At this point, it should be apparent that eliminating low-frequency transmission through walls or floors is no simple matter. For most people, and particularly apartment dwellers, the need for massive construction or reconstruction probably eliminates most of the available techniques right at the outset. For that reason, the very best place to cut down vibratory transmission is right at

*continued on page 84*

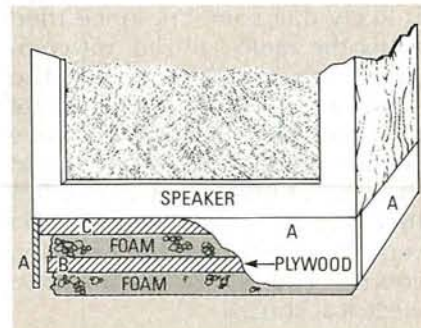

FIG. 2

## ELENCO PRODUCTS AT DISCOUNT PRICES!



20 MHz DUAL TRACE OSCILLOSCOPE  
**\$349** MO-1251

TWO  
100 MHZ  
SWITCHABLE  
PROBES  
INCLUDED



35 MHz DUAL TRACE OSCILLOSCOPE  
**\$498** MO-1252

Top quality scopes at a very reasonable price. Contains all the desirable features. Elenco's 2 year guarantee assures you of continuous service. Two 1x, 10x probes, diagrams and manual included. Write for specifications.

**MULTI METER with CAPACITANCE and transistor tester**  
**\$65** Model CM-1500  
Reads Volts, Ohms, Current, Capacitors Transistors & Diodes

**TRUE RMS 4 1/2 DIGIT MULTIMETER**  
**\$135** Model M-7000  
.05% DC Accuracy  
.1% Resistance with Freq. Counter & Deluxe Case

**AUTO RANGING plus MANUAL RANGING 3 1/2 DIGIT METER 28 FUNCTIONS FULLY PROTECTED**  
M-1180 .7% ACY \$36.95  
M-1182 .25% ACY \$39.95  
M-1181 .1% ACY \$42.95

**GF-8016 Function Generator with Freq. Counter**  
**\$219**  
• Sine, Square, Triangle, Pulse, Ramp, .2 to 2 MHz  
• Frequency .1 thru 10 MHz  
**GF 8015 without Freq. Meter \$169**

**10 MHz OSCILLOSCOPE**  
**\$199** S-3000  
10 MHz DC or AC  
Triggered Sweep  
Calibrated Vert & Hor  
Reads Volts & Freq

**BREADBOARD**  
Shown 9436  
9430 1,100 pins \$15  
9434 2,170 pins \$25  
9436 2,860 pins \$35

**Triple Power Supply XP-660**  
**\$14950**  
0-20V @ 1A  
0-20V @ 1A  
5V @ 5A  
Fully Regulated, Short Circuit Protected with 2 Limit Cont. 3 Separate Supplies.

**50 MHz LOGIC PROBE**  
**\$23** LP-700  
20 nec with memory

**LOGIC PULSER**  
**\$25** LP-600  
2 us pulse @ 1A

**3 Amp Power Supply XP-650**  
**\$11950**  
0-40V @ 1.5A  
0-20V @ 3A  
Fully regulated, short circuit protected current limit control

**DIGITAL LCR METER**  
Model LC-1800  
Measures: Inductors Capacitors, Resistors  
**\$148**  
Inductors .1µH to 200 H  
Capacitor .1PF to 200µF  
Resistor .01Ω to 20M Ω  
Ranges 6 Ind, 7 cap, 7 res

C&S SALES INC., 8744 W. North Ter. Niles, IL 60648  
800-292-7711 (312) 459-9040



15 DAY MONEY BACK GUARANTEE  
ASK FOR CATALOG  
2 Year Limited Guarantee! Add 5% for Postage (\$10 max.), IL Res., 7% Tax

CIRCLE 109 ON FREE INFORMATION CARD

JUNE 1987

# ANTIQUE RADIOS

## Restoring a classic

STARTING WITH THIS COLUMN, WE ARE going to change the focus of our discussions somewhat. In the past, we have primarily been interested in the history and evolution of radio, though we have also looked at topics ranging from cabinet styles to servicing. Now, we are going to look inside the radios themselves, including automotive radios, and study their circuitry. We'll also look at early Hi-Fi and FM circuitry, and early TV circuitry. Those whose interest is in restoring antique radios to operating condition will find these articles invaluable.

### Radio of the month.

We'll start our look at early-radio electronics with the General Electric A-53. That model, which was produced in 1934, was very popular in its day. The one in my own collection is shown in Fig. 1. While I've had the set a long time, it has never worked. Also, I have never attempted to restore it. Now, we'll take an in-depth look at the radio's circuitry and then try and restore it together.

One reason that I've shied away from restoring that radio is that it is obviously not in its original condition. There is a hole in the cabinet front where the band switch should be, and another hole, midway up on the right-hand side of the cabinet, where nothing should be. Looking at the rear of the set, on the back apron of the chassis is a jack and a switch that clearly are not part of the original circuit. See Fig. 2. They likely are part of a phono-input circuit that was added by a previous owner.

While we are concentrating on



FIG. 1

the electronics, we cannot ignore the cabinet. It too will need to be restored if the radio is to become something worthy of showing off. As far as the cabinet on our A-53 goes, I've seen worse, but I've also seen better. It will take at least two days to make the veneer patches and refinish the entire cabinet. One of the patches will be used to cover up the added hole. Of course, the grill cloth will have to be replaced.

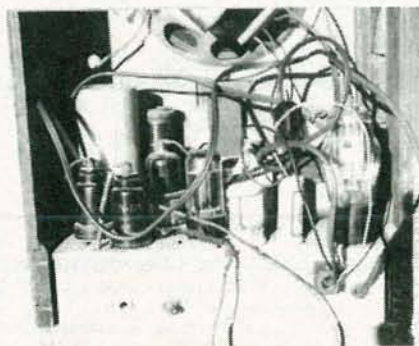

FIG. 2



RICHARD D. FITCH

### Determining condition

One thing that you might be wondering about is how I determined that the radio does not work. Obviously, the answer is that I tried it!

The safest route to follow in determining whether or not a radio will work is to test every part, and to look for shorts and opens before plugging the unit in. Many readers have written me saying that they indeed do that each and every time. Unfortunately, human nature being what it is, I am sure many more of you do not. Even if I strongly urged you to follow that route, few of you would, as most are just too impatient to see if our new find works. I must confess, I too fit that description in many instances.

In lieu of testing, you should at the very least examine the radio carefully to uncover any obvious problems. I call that determining whether or not the radio is in "apparent safe operation condition." Among other things, see if all the tubes are present and in the right place. Check the integrity of the line cord. Look for bare wires, or ones that appear to be unconnected. Finally, check the chassis bolts. If several or all are missing, it is likely that someone once tried to fix the radio but did not complete the job. If you see the slightest sign of trouble, **do not plug the radio in** until you have completely examined and tested the radio. Otherwise you risk further damaging your prize at the very least, and possibly exposing yourself and others to dangerous electrical shocks.

Determining that your radio is in

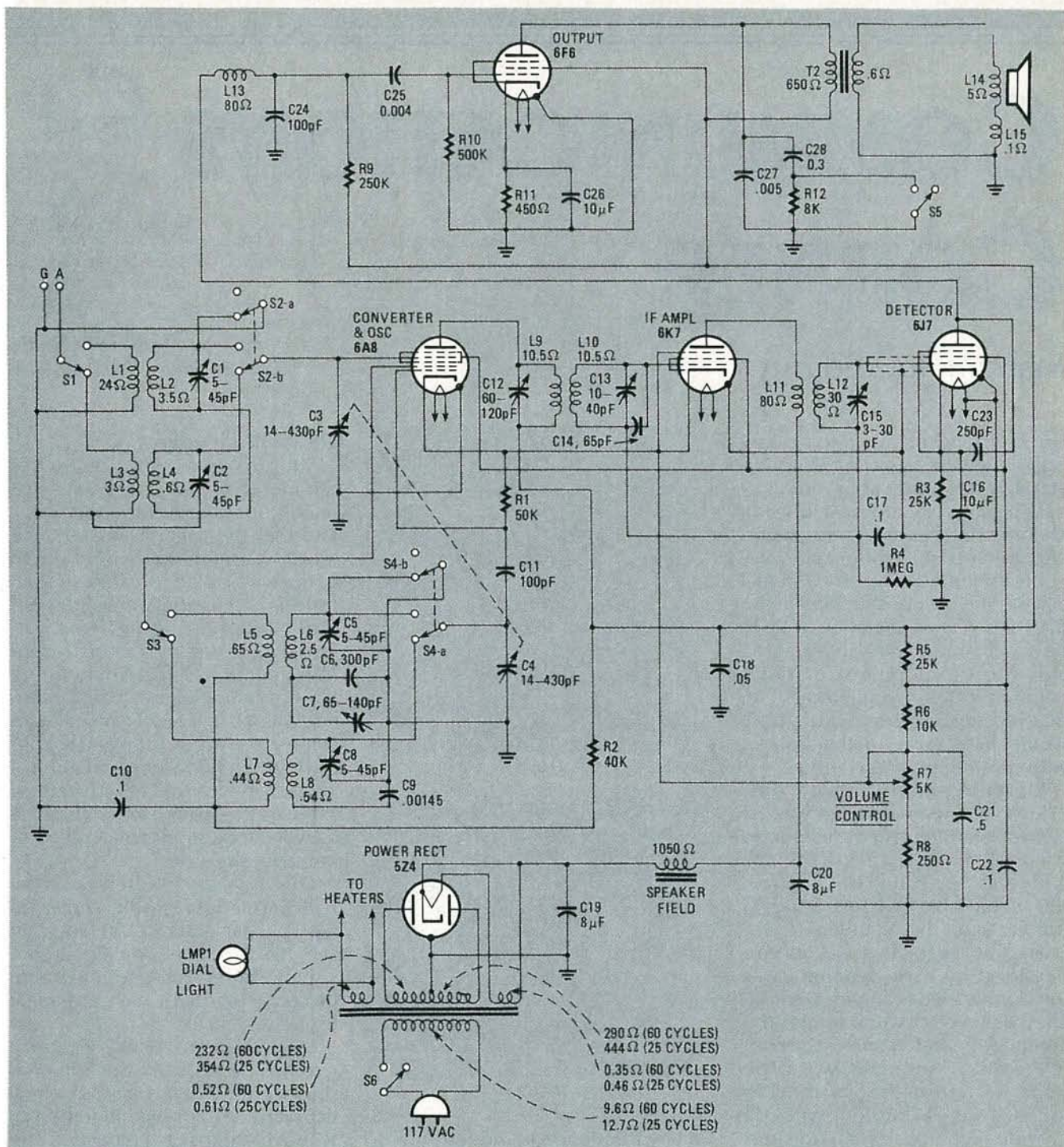

FIG. 3

"apparent safe operating condition" doesn't mean that other safeguards can be disregarded. When plugging in the radio, use an *isolated, fused receptacle*. Also, while the set is plugged in, don't handle the cabinet or chassis, and don't "stick your face" into the back of the cabinet to see if the tubes are lit.

### Getting to work

As we've said, one reason we did

not previously restore our A-53 was that it has been considerably altered, or mutilated, depending on the skills of whoever made the modifications we noted. Restoring 50-year old radios to their original condition offers enough problems without having to also figure out how someone else's circuits are supposed to work.

Nevertheless, the radio is still a good choice for restoration. For one thing, as you can see from the

schematic in Fig. 3, its use of superheterodyne circuitry identifies the A-53 as one of the better radios of its period. Further, despite its "man-made" defects, the cabinet is in relatively good shape.

Examining the circuit we see that it is a two-band unit. The missing band switch consists of S1-S4, and it is used to switch from the broadcast band to the 2.6-6.9-MHz shortwave band. The signal from

(Continued on page 84)

# COMMUNICATIONS CORNER



HERB FRIEDMAN,  
COMMUNICATIONS EDITOR

## Marconi lucked out.

ONE OF THE OBSTACLES FACED BY EARLY radio pioneers was a lack of understanding about the ways radio signals propagate, and how outside factors, such as the ionosphere, affect that propagation. Had Marconi attempted to push a signal across "the big pond" earlier in the day, or a few days earlier or later, he would most likely have failed and the development of radio communications would have been delayed several years. The *Titanic* would have gone to the bottom with no one the wiser.

Marconi simply lucked out. "Skip" was unknown, as was its cause, its effect, and its relation to frequency. Let us all thank the gods that "the band" was open on the memorable day that Marconi tried to span the Atlantic.

Another factor that was misunderstood by early pioneers was the significance of antenna length. They believed that the longer the antenna the better the reception. (Of course, antennas work the same for transmitting as they do for receiving.) While long wires do provide higher gain than do short wires, to many users that gain works in mysterious ways, often causing a weaker signal to be received at a specific location.

Early broadcasters soon understood the vagaries of the long-wire antenna. Unfortunately, many hobbyists and shortwave listeners still do not; poor reception, solely due to using a too-long wire, often is the result.

The term *long wire* is really relative. Although an antenna must be at least  $\frac{1}{2}$  wavelength long at 3.5 MHz to be considered a long wire

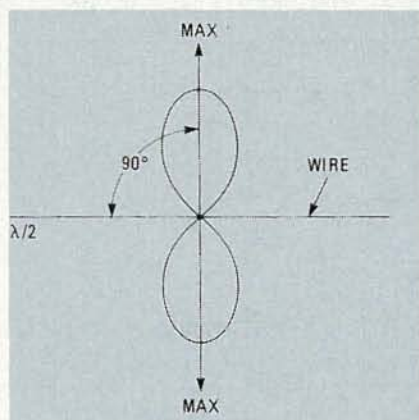

FIG. 1

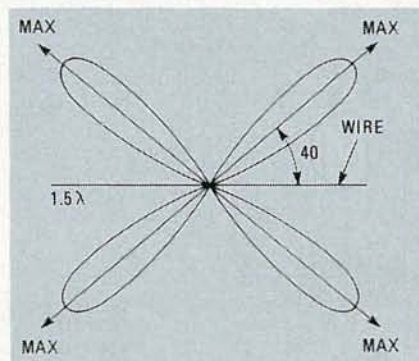

FIG. 2

at any frequency, in modern times we consider anything greater than  $\frac{1}{2}$  wavelength at the desired frequency to be a long wire.

Antennas longer than  $\frac{1}{2}$  wavelength have unusual sensitivity patterns. That's what causes high-gain TV antennas to poop out on signals arriving at a 90° angle, where gain should be greatest. The long-wire effect is also what causes multipath interference (TV ghosting) from water towers, tall buildings, and hills that are well off in the distance and to the side of the antenna.

## Different directions

The problems with long-wires are that they have more than one major lobe (maximum sensitivity), and that the precise angle of the lobe is determined by the length of the wire. To keep things simple, for this discussion we will not get into "doughnut" sensitivity patterns nor vertical radiation/reception angles (vertical angle being the effect that beams your antenna's signal to Mars instead of to some place on Earth). We will concentrate on horizontal radiation—the sensitivity (radiation) pattern as it would appear if we were in the heavens looking down on the antenna in question.

Our reference antenna is the half-wavelength dipole shown in Fig. 1. That antenna, as you can see, has two lobes, yielding a sensitivity pattern whose maximum lies on a line that's at a right-angle to the wire itself.

Now let's assume that we want a stronger signal from the antenna, so we stretch a wire across several backyards for an overall length of  $1\frac{1}{2}$  wavelengths at the desired frequency, as shown in Fig. 2.

As you can see, we now have four lobes, each more sensitive than the lobes of a half-wavelength antenna. But there is no such thing as a free lunch. The antenna cannot create gain; it simply compresses the width of the lobe, taking energy from the sides of the lobe and concentrating it along the lobe's axis. Notice that the  $1\frac{1}{2}$ -wavelength antenna in Fig. 2 is essentially dead to signals arriving directly into the antenna (at a 90° angle).



# R-E Engineering Admart

Rates: Ads are 2 1/4" x 2 7/8". One insertion \$825. Six insertions \$800 each. Twelve insertions \$775 each. Closing date same as regular rate card. Send order with remittance to **Engineering Admart**, Radio Electronics Magazine, 500-B Bi-County Blvd., Farmingdale, NY 11735. Direct telephone inquiries to Arline Fishman, area code-516-293-3000. **Only 100% Engineering ads are accepted for this Admart.**

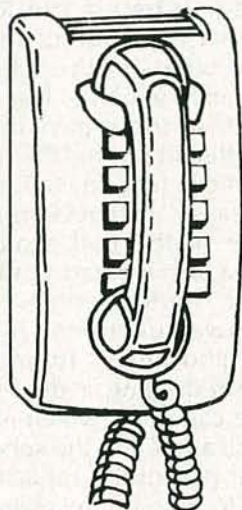

## CALL NOW AND RESERVE YOUR SPACE

- 6 x rate \$800.00 per each insertion.
- Reaches 239,312 readers.
- Fast reader service cycle.
- Short lead time for the placement of ads.

Call 516-293-3000 to reserve space. Ask for Arline Fishman. Limited number of pages available. Mail materials to: Engineering Admart, RADIO-ELECTRONICS, 500-B Bi-County Blvd., Farmingdale, NY 11735.

## DIAGNOSE VHS VCR MECHANICS

### WE'LL SHOW YOU HOW!

One of the most important VCR servicing tools for preventing tape damage is a precision torque gauge for Take-up, Stop, FF, and REW brake and clutch torque.

The New Tentel TQ-600 dial torque gauge comes complete with instructions and a specially modified cassette to allow critical readings to be made quickly and easily: Only \$139; and there's a 30 day money back guarantee if you aren't 100% satisfied. Tentel also manufactures other test instruments to make VCR mechanical testing fast and easy. Call or send for details and ordering information today!

Toll Free 800-538-6894

TENTEL Corp.

1506 Dell Ave

Campbell CA 95008



408-379-1881

800-538-6894 (except Calif.)

CIRCLE 185 ON FREE INFORMATION CARD

## Circuit Board Layout Made Easy!

Create and Revise  
P-C-B Artwork on your  
IBM or Compatible

- User Friendly
- Economical
- On-line Help Screen
- Supports Microsoft Mouse
- 2X artwork on printer

Requirements: IBM or compatible PC - 256K memory - CGA card - IBM graphics compatible printer.

**ONLY \$99.00**

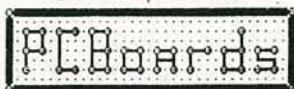

2145 Highland Ave./Ste. 201  
Birmingham, Al. 35205  
(205) 933-1122

DEMO DISK \$10.00

CIRCLE 191 ON FREE INFORMATION CARD

## 117 PRACTICAL IC PROJECTS BUILD YOU CAN

2645T—117 PRACTICAL IC PROJECTS YOU CAN BUILD.....

\$10.95. Dozens of fully-tested, ready-to-build circuits you can put together from readily-available, low cost IC's! There are a total of 117 IC circuits ranging from an audio mixer and a signal splitter to a tape-deck amplifier and a top-octave generator organ! From TAB Books. To order your copy send \$10.95 plus \$2.75 shipping to Electronic Technology Today Inc., P.O. Box 240, Massapequa Park, NY 11762-0240



## LINEAR IC EQUIVALENTS & PIN CONNECTIONS

Linear IC  
Equivalents  
and Pin  
Connections

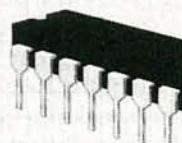

BP141—Shows equivalents & pin connections of a popular user-oriented selection of European, American and Japanese linear IC's 320 pages, 8 x 10 inches. \$12.50 Plus \$2.75 shipping. ELECTRONIC TECHNOLOGY TODAY INC., PO Box 240, Massapequa Park, New York 11762-0240.

If a shortwave listener was interested in receiving signals arriving at a right angle, simply extending the wire "for more gain," would instead result in a weaker received signal. To achieve higher gain, the wire would have to be repositioned so that one of the lobes was aimed at the desired station.

But many users report superior reception at all times when they switch to a long-wire. How can that be?

Often, the improvement is not due to improved sensitivity but to *diversity reception*, and the lis-

tener simply perceives better performance. Diversity reception has nothing to do with antenna gain. Instead, it comes about because different regions of a long-wire antenna respond differently to different phase relationships; those relationships are constantly changing because of changing ionospheric conditions. The effect is called *selective fading*. As the received signal fades out because of phase changes on one part of the antenna, it increases on another. The overall effect is an apparent improvement over the half-

wavelength antenna, which has its maximum sensitivity to only one phase relationship.

At even longer wavelengths the antenna creates major and minor lobes; Fig. 3 shows the sensitivity/radiation pattern for a two-wavelength antenna. Notice that we now have a total of eight lobes, with the major lobes getting closer to the wire's axis.

If you could make the wire sufficiently long, the major lobes would flatten to 20° from the wire's axis. Also, the lobes would be so narrow that at 33° from the axis the

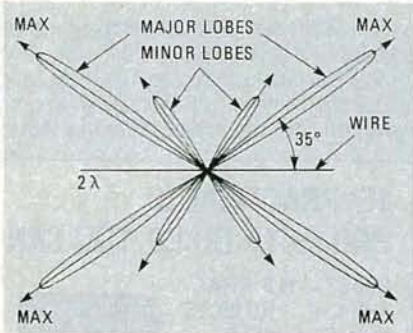

FIG. 3

antenna would have essentially no sensitivity.

Now, what does all that ancient theory on antennas have to do with modern technology? Simply go outside and look at your TV antenna. If it's the typical "all channel" moderate to deep-fringe model, many of the elements are long wires at the higher frequencies. Instead of having maximum forward at 90° to the elements, on some channels the maximum gain is out to the sides.

That is what explains unusual multipath ghosting. Imagine, if you will, that your city's master transmitting antenna is on a mountaintop due north of your receiving location, and that there is a water tower located to the northeast, some 10 miles away. As usual, you aim the receiving antenna directly at the transmitting antenna, and all channels are received with more than adequate signal strength. But one of the higher VHF channels has two distinct, widely separated images. Here's why: At that channel's frequency, the antenna is several wavelengths long. Because of that, a major lobe extends to the northeast, rather than due north (forward). Therefore, the reflected signal from the tower is actually being received with greater strength than the direct signal from the broadcasting antenna. To avoid such situations, better antenna installers adjust an antenna for best picture rather than by compass heading, even when they can literally see the transmitting antenna from the receiving site.

It's very difficult to change the rules of the game, no matter how ancient they are. At any frequency, a longer antenna is not necessarily a better one. **R-E**

## AUDIO UPDATE

*continued from page 79*

the speaker system itself, by minimizing its physical coupling to the floor or wall. You can do that by "floating" the offending speakers on structures built up of plywood and foam glued together as shown in Fig. 2. Alternately, a single 4-inch foam slab can be used.

As mentioned earlier, vibration tends to get decoupled when traveling between different materials such as the wood and foam layers. This is in addition to the losses in the foam itself. Make sure that there's sufficient clearance so that the 1/4-inch decorative plinth (A) does not touch panel (B) or the floor. The parts labeled (B) and (C) are 3/4-inch plywood, and the foam should be fairly dense and at least an inch thick. Some trial and error will probably be necessary before everything fits together properly. Keep in mind that isolation will be lost if any part of the plinth or the speaker touches the floor.

Any audiophile readers who believe in the "advantages" of speakers or speaker stands that use floor spikes for improved bass, should keep in mind that mechanical coupling to the floor is likely to cause the floor structure itself to vibrate and contribute coloration to the sound of the system. Although some people apparently like the sound of resonating floorboards, I prefer that my speakers sound straight (as designed), thank you. Of course, spurious vibration should be avoided in both the stands or the speaker cabinets themselves, but that is a different matter that is best handled by the cabinet manufacturer's bracing and damping.

The bottom line is this: There really aren't any simple after-the-fact fixes you can apply to existing structures to minimize sound-coupling between rooms, apartments, or floors. But if you block the higher frequency sounds with thermal-insulation techniques and use speaker mountings that prevent bass coupling to the building structure, you certainly can help minimize problems—not to mention complaints. **R-E**

## ANTIQUÉ RADIO

*continued from page 81*

the antenna is coupled to the control grid of the 6A8 converter and oscillator tube via the RF coil. (Note that the value of that coil, and the others in the schematic, are specified in ohms. That is not a misprint. In those days manufacturers often identified the coils in a schematic in that way to make servicing easier. By checking the resistance of the coil against the rating, a serviceman could spot open or shorted units.) The 6A8 serves two functions: local oscillator and mixer. Tuning is accomplished using a dual-ganged variable capacitor, which is designated C3 and C4 in the schematic. The rear part of the capacitor, C3, is used to tune the receiver to the desired frequency. The front part of the capacitor, C4, is used to tune the local oscillator so that, when mixed with the incoming signal in the 6A8, an IF of 465 kHz results.

The IF amplifier, which is built around a 6K7 tube, differs somewhat from more modern sets. The difference lies mainly in the design of the two IF transformers. The IF-input transformer has a tuned primary and a tuned secondary. The coils themselves sit within a shield located on the top of the chassis. However, their trimmer capacitors are located on the underside of the chassis. Turning to the IF-output transformer, only the secondary is tuned and the entire circuit is located on the underside of the chassis.

The output of the IF amp is coupled via the IF-output transformer to the detector stage, which is built around a 6J7. Volume is controlled in the radio by varying the IF gain using R7, which is a potentiometer, and R8, which is a fixed unit. Those resistors are located in the cathode circuit of the 6K7. Note the 1 megohm resistor (R4) in the grid circuit of the detector; that resistor is also connected to the grid return of the 6K7. Its purpose is to prevent overloading the 6J7 in the event that the volume control, R7, is turned up when a strong signal is received.

*continued on page 110*

## TROUBLESHOOTING TV

*continued from page 70*

The excessive amplitude and the spike were obviously upsetting something in the video processor.

Essentially, the RC network is there for amplitude reduction and wave shaping, so that seemed like a logical place to start. First, R472, a 150K, 1/2-watt unit, was removed and replaced with a 120-pF capacitor. Since, at that stage we were only doing some experimenting, and our whole approach could be wrong, the added component was just "tacked" in.

Since that little network physically lies just ahead of the flyback and very close to the focus lead emerging from the transformer it was important to make sure that the components were dressed well away from the focus lead. There was just about an inch of space for that. Making sure everything was clear and secure for a test run, the receiver was fired up.

At least we were in the ball park. The black bars were still present but in a sort of hazy way, with that half bar still present near the center of the screen. And the streaking was still there, with much less brightness. Instead of reducing the pulse, we had expanded it until over-blanking was taking place.

The next step was to reduce the value of the capacitor by about half to, say, 62 pF, and remove C460 completely from the circuit. That brought the brightness back to near normal and, for the most part, removed the black bars. But the half bar still was winking at us and the streaking still was present.

Next, R469, a 150K 1/2-watt resistor, was removed from the circuit and a 100K 1/2-watt unit was put in its place. That change completely removed and all traces of the black bars. The modified circuit is shown in Fig. 3.

### One last hurdle

Now to find the cause of the streaking: It looked like some sort of outside interference, but none of the other sets were being affected.

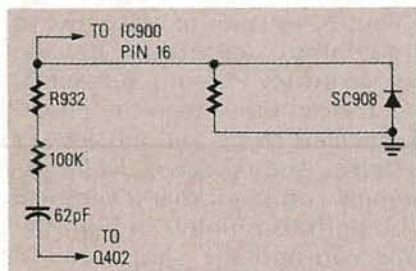
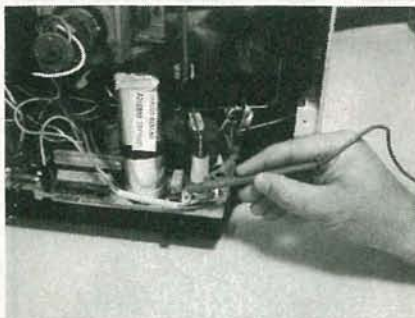

FIG. 3—DELETING C460, R469, and R472 and adding a 100K resistor and a 62-pF capacitor cured the black-bar problem. Modifying the circuit as described in the text cured the problem; the modified circuit is shown here.



PROBING THE SHADY AREAS near the flyback revealed a cracked resistor. It proved to be the cause of the mysterious streaking.

With a flashlight and magnifying glass the shadowy areas around the flyback were thoroughly investigated. Just when we were about to knock off for the day we noticed what appeared to be a crack in R966; see Fig. 1.

That resistor was removed and, sure enough, it was split, and it was open. The streaking was caused by the return of the internal rectifiers of the flyback arcing through that resistor back to the low-voltage supply. When the flyback failed, it probably took that resistor with it. Replacing R966 resolved the streaking problem and the set has worked fine ever since. **R-E**

## CABLE TV SPECIALS CONVERTERS

<b>JERROLD:</b>	<b>JRX-3 DIC—36 Channel Corded Remote.....</b>	<b>\$149.<sup>95</sup></b>
	<b>JSX-3 DIC—36 Channel Set Top.....</b>	<b>\$129.<sup>95</sup></b>
	<b>SB-3—'The Real Thing'.....</b>	<b>\$119.<sup>95</sup></b>
	<b>SB-3A-4 port.....</b>	<b>\$99.<sup>99</sup></b>

<b>ZENITH:</b>	<b>Z-TAC Cable Add-On.....</b>	<b>\$199.<sup>95</sup></b>
----------------	--------------------------------	----------------------------

<b>VIEW STAR:</b>	<b>EVSC-2010—60 Channel Wireless— with Parental Lockout.....</b>	<b>\$ 99.<sup>95</sup></b>
	<b>EVSC-2010 A-B—Same as above with A-B Switch.....</b>	<b>\$109.<sup>95</sup></b>
	<b>View Star 2501—60 Channel Wireless..... with Volume.....</b>	<b>\$119.<sup>95</sup></b>

## MISCELLANEOUS

<b>OAK:</b>	<b>N-12 Mini-Code.....</b>	<b>\$ 89.<sup>95</sup></b>
	<b>N-12 Mini-Code Vari-Sync.....</b>	<b>\$109.<sup>95</sup></b>
	<b>N-12 Mini-Code Vari-Sync Plus Auto On-Off ..</b>	<b>\$165.<sup>95</sup></b>

<b>JERROLD:</b>	<b>400 &amp; 450 Handheld Transmitters.....</b>	<b>\$ 29.<sup>95</sup></b>
-----------------	---	----------------------------

<b>HAMLIN:</b>	<b>MLD-1200.....</b>	<b>\$ 99.<sup>95</sup></b>
----------------	----------------------	----------------------------

<b>NEW ITEMS:</b>	<b>Ripco Tape Copy Stabilizer.....</b>	<b>\$149.<sup>95</sup></b>
-------------------	--	----------------------------

Scientific Atlanta..... **Call for Price**

<b>OAK:</b>	<b>E-13 Mini-Code Substitute.....</b>	<b>\$ 79.<sup>95</sup></b>
	<b>E-13 Mini-Code W/Vari-Syn.....</b>	<b>\$ 89.<sup>95</sup></b>

**ALL UNITS GUARANTEED. QUANTITY PRICES AVAILABLE.**

## UNITED ELECTRONIC SUPPLY

P.O. BOX 1206 • ELGIN, ILLINOIS 60121 • 312-697-0600

# Crystek Crystals

FOR OPTIMUM STABILITY  
AND RELIABILITY IN  
FREQUENCY MANAGEMENT

## QUARTZ CRYSTALS FOR

### Industrial Equipment/Instrumentation

- Micro-processor control
- Computers/Modems
- Test/Measurement
- Medical



### General Communications

- Channel element Service (VHF/UHF)
- Land Mobile 2-way
- Marine
- Aircraft
- Telemetry
- Monitors/Scanners/Pagers



### Amateurs/2-Meter/General Coverage CB/Hobbyist/Experimenter

**NEW**

## The Pulse of Dependable Communications

Crystek Crystals offers their new 16 page **FREE** catalog of crystals and oscillators. Offering state of the art crystal components manufactured by the latest automated technology. Custom designed or "off the shelf," Crystek meets the need, worldwide. Write or call today!



## CRYTEK CORPORATION

DIVISION OF WHITEHALL CORPORATION

2351/2371 Crystal Drive • Ft. Myers, FL 33907  
P.O. Box 06135 • Ft. Myers, FL 33906-6135

**TOLL FREE 1-800-237-3061**

PH 813-936-2109/TWX 510-951-7448/FAX 813-939-4226

**TOLL FREE IN THE U.S.A. EXCEPT FLORIDA, ALASKA, HAWAII**

CIRCLE 187 ON FREE INFORMATION CARD

## DOES YOUR DIGITAL CAPACITANCE METER DO THIS?

FULL 4 DIGIT 0.5 INCH LCD DISPLAY COMPLETELY AUTORANGING WITH 10 RANGE MANUAL CAPABILITY

**AND THIS**  
RANGE OF 0.0 pF TO 1 FARAD (999.9 mF)  
0.5% BASIC ACCURACY UP TO 100 uF

**AND THIS**  
READS DIELECTRIC ABSORPTION

**AND THIS**  
EXTENDED PSEUDO 5 DIGIT  
RESOLUTION ON SOME RANGES ONLY

**AND THIS**  
ABILITY TO ZERO LARGE CAPACITANCE  
VALUES UP TO 99.99 uF

**AND THIS**  
CALCULATES TRUE CAPACITANCE  
IF CAPACITOR IS LEAKY

**AND THIS**  
DIODE CLAMP AND FUSED  
PROTECTED INPUT.

**AND THIS**  
DISCHARGE RESISTOR IN OFF  
POSITION AT TERMINAL INPUTS.  
POWERED BY 9V BATTERY

**ONE YEAR PARTS &  
LABOUR WARRANTY**

**FOR ONLY THIS**



**AND THIS**  
IDENTIFIES TRANSISTORS (NPN, PNP)  
AND THEIR LEADS (E, B, C, ETC.)

**AND THIS**  
TESTS ZENER DIODES AND RECTIFIERS.  
UP TO 20V ZENER WITH AC ADAPTOR,  
ZENER VOLTAGE WITH 9V BATTERY  
DEPENDS ON ITS CONDITION

**AND THIS**  
AUTOMATICALLY CALCULATES LENGTHS  
OF CABLES IN FEET, METRES, MILES,  
KILOMETRES (THEORETICAL RANGE  
OF 9,999 MILES)

**AND THIS**  
ABILITY TO SORT CAPACITORS IN  
MANY DIFFERENT MODES

**AND THIS**  
ABILITY TO READ LEAKY CAPACITANCE  
(INSULATION RESISTANCE OR CURRENT)

**AND THIS**  
CALCULATES TIME CONSTANTS WITH  
USER DEFINED RESISTANCE VALUES

**AND THIS**  
HOLD FUNCTION FREEZES DISPLAY

### SHIPPING INSTRUCTIONS:

All units shipped out F.O.B. Buffalo NY via United Parcel Service (except Hawaii & Alaska) unless otherwise indicated (in which case shipments will be F.O.B. Canada)

PLEASE SEND ME		U.S. FUNDS
(QUANTITY) MC300(S) @	\$169.95	\$ _____
CARRYING CASE	\$ 16.95	\$ _____
AC ADAPTOR	\$ 9.95	\$ _____
SHIPPING AND HANDLING @ \$5.00 PER INSTRUMENT		\$ _____
[ ] CHECK [ ] MONEY ORDER		\$ _____
[ ] VISA [ ] MASTERCARD	TOTAL	\$ _____
[ ] CARD NO. _____		
EXPIRY DATE _____	SIGNATURE _____	
NAME _____		
ADDRESS _____		
CITY _____ STATE _____	ZIP CODE _____	

## SATELLITE TV

continued from page 77

ada because hundreds of IC's have been detained by U.S. Customs. The Canadian firms still operate from Canada, but they have begun shipping their wares from the U.S. side of the border.

### Conclusions

There are several conclusions to be drawn from all of that. First, several descrambling IC's being marketed may not be what they are made out to be. Second, those dealing the IC's may have considerable liability above and beyond that incurred in violating Federal statutes if customers awaken one day to find their Chip-equipped descrambler shut down.

Third, a serious effort to shut down various descrambling operations has begun. In late February and early March, GI indiscriminately shut off thousands of descramblers, without apparent regard to their legal status. They also discontinued distributing their model VC2000 units after finding that those could be breached with software modifications. The replacement VC2100 featured epoxy coating over several key areas. Unfortunately for the manufacturer, chemicals that could dissolve the epoxy soon were found and a Bahamian firm has announced a musketeer IC that can be used without dissolving the epoxy coating.

Even those providing information about descrambling are under investigation. Among those parties are this author. (For late breaking news regarding descrambling and the law, see "What's News," which can be found on page 6 in this issue—Editor.)

Fourth, in spite of all claims to the contrary, there does not appear to be any VideoCipher defeat mechanism other than the much-publicized clone and musketeer systems. And GI seems to be extremely confident that it can deal with both techniques in both the long run and the short run. In retrospect, VideoCipher may be less broken than bent, and GI may actually end up with the upper hand in this engagement. R-E

MODEL  
**MC300** Approx. Size  
7" x 4" x 1 1/4"  
**DAETRON**  
a division of Bergeron Technologies Inc.  
7686 KIMBEL STREET, UNIT 5  
MISSISSAUGA, ONT., CANADA  
L5S 1E9 (416) 676-1600

**DEALER ENQUIRIES INVITED**

CIRCLE 188 ON FREE INFORMATION CARD

# STATE OF SOLID STATE

## Instrumentation amplifiers



ROBERT F. SCOTT,  
SEMICONDUCTOR EDITOR

INSTRUMENTATION AMPLIFIERS ARE high-performance, high-gain op-amps used in applications that require precise, low-level signal amplification with low noise, accurate, closed-loop gain, and very low drift. The AD625, from Analog Devices, is a new precision programmable-gain instrumentation amplifier designed especially for:

1. Circuits requiring non-standard gain values not easily obtained from earlier instrumentation amplifiers such as the AD524 that featured programmable gains of 1, 10, 100, and 1000; and the AD624, with gains of 1, 100, 200, 500, and 1000.

2) Circuits requiring low-cost, precision software-programmable gain, and especially where low noise, low drift, and a high Common-Mode Rejection Ratio (CMRR) are desired.

The AD625 is a cost-effective device that uses three external resistors to set gain to any value from 1 to 10,000. Performance limitations are due mainly to those external resistors. The gain error contributed by the device is less than 0.5% and the temperature error is less 5ppm/°C. The CMRR is independent of feedback resistor matching.

A software-programmable gain amplifier can be designed around the AD625 by using a switch network such as a CMOS multiplexer. The on resistance of the switching network is not in the signal path, so the AD625 can provide 12-bit precision and can be programmed for gains between 1 and 10,000 in user-selected steps.

The AD625 provides highest pre-

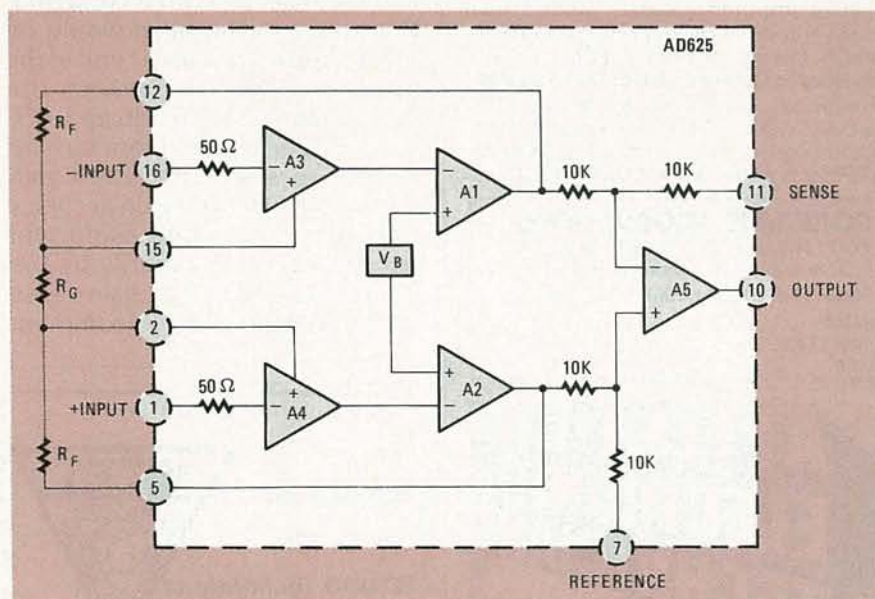

FIG. 1

cision with input offset voltage drift below  $0.25\mu\text{V}/^\circ\text{C}$ , output offset voltage drift below  $15\mu\text{V}/^\circ\text{C}$ , and maximum nonlinearity of 0.001% when gain is unity. All grades of the AD625 provide a 25-MHz gain-bandwidth product,  $5\text{V}/\mu\text{s}$  slew rate, and  $15\mu\text{s}$  settling time.

The AD625 comes in three accuracy grades (A, B, and C) for industrial ( $-25^\circ\text{C}$  to  $+85^\circ\text{C}$ ) temperature range, grades J and K for commercial ( $0$  to  $+70^\circ\text{C}$ ) temperatures, and S grade for temperatures in the  $-55^\circ\text{C}$  to  $+125^\circ\text{C}$  range.

A block diagram of the AD625 is shown in Fig. 1. A differential voltage appears at the outputs of A1 and A2. That voltage,  $A_V$ , is the product of the differential portion of the input voltage times the gain, or as shown,

$$A_V = 2(R_F/R_G) + 1$$

Amplifier A5 is a unity-gain circuit that removes any common-mode signal from the output signal, which appears at pin 10.

The transconductance of the preamp input stage is determined by the value of  $R_G$ . Transconductance and gain increase as  $R_G$  decreases. That has three major advantages. 1) It makes very high open-loop gain possible; 2) The gain-bandwidth product increases with gain, thereby optimizing frequency response. 3) Input-voltage noise is reduced to a value that is determined by the collector current of the input transistors.

The REFERENCE terminal (pin 7) may be used to offset the output up to  $\pm 10$  volts, for floating output loads or coupling to a circuit with an isolated ground.

The sense terminal (pin 11) is the

# Be an FCC LICENSED ELECTRONIC TECHNICIAN!



No costly school. No commuting to class. The Original Home-Study course prepares you for the "FCC Commercial Radiotelephone License". This valuable license is your "ticket" to thousands of exciting jobs in Communications, Radio-TV, Microwave, Computers, Radar, Avionics and more! You don't need a college degree to qualify, but you do need an FCC License.

**No Need to Quit Your Job or Go To School**  
This proven course is easy, fast and low cost! **GUARANTEED PASS** - You get your FCC License or money refunded. **Send for FREE facts now. MAIL COUPON TODAY!**

## COMMAND PRODUCTIONS

FCC LICENSE TRAINING, Dept. 90  
P.O. Box 2223, San Francisco, CA 94126

Please rush **FREE** details immediately!

NAME \_\_\_\_\_

ADDRESS \_\_\_\_\_

CITY \_\_\_\_\_ STATE \_\_\_\_\_ ZIP \_\_\_\_\_

# ATTENTION! ELECTRONICS TECHNICIANS

EARN YOUR **B.S.E.E. DEGREE**

**THROUGH HOME STUDY**

Our New and Highly Effective Advanced-Placement Program for experienced Electronic Technicians grants credit for previous Schooling and Professional Experience, and can greatly reduce the time required to complete Program and reach graduation. No residence schooling required for qualified Electronic Technicians. Through this Special Program you can pull all of the loose ends of your electronics background together and earn your B.S.E.E. Degree. Upgrade your status and pay to the Engineering Level. Advance Rapidly! Many finish in 12 months or less. Students and graduates in all 50 States and throughout the World. Established Over 40 Years! Write for free Descriptive Literature.

**COOK'S INSTITUTE OF ELECTRONICS ENGINEERING**



347 RAYMOND ROAD  
P.O. BOX 20345  
JACKSON, MISSISSIPPI 39209

feedback point for the output op-amp. Usually it is connected directly to the output at pin 10. But, if heavy load currents are drawn through long leads, voltage drop in the lead resistance can cause errors. To eliminate those errors, the sense terminal can be connected directly to the load. Doing so places the lead's IR drop inside the feedback loop.

Typical IC instrumentation amplifiers can swing  $\pm 10$  volts across a 2000-ohm load. However, when more current must be delivered to a heavier load, an output current-booster amplifier can be connected between the AD625 output and the load. In such a configuration the SENSE terminal would be connected to the "high" end of the load, thereby including the booster amp in the feedback loop.

Only three external resistors are needed to select any given gain from 1 to 10,000. The gain accuracy and gain temperature coefficient are determined primarily by the external resistors. The gain-sense current is insensitive to common-

TABLE 1—RESISTOR VALUES

Gain	$R_F$	$R_G$
1	20K	$\infty$
2	19.6K	39.2K
5	20K	10K
10	20K	4.42K
20	20K	2.1K
50	19.6K	806 $\Omega$
100	20K	402 $\Omega$
200	20.5K	205 $\Omega$
500	19.6K	78.7 $\Omega$
1000	19.6K	39.2 $\Omega$
4	20K	13.3K
8	19.6K	5.62K
16	20K	2.67K
32	19.6K	1.27K
64	20K	634 $\Omega$
128	20K	316 $\Omega$
256	19.6K	154 $\Omega$
512	19.6K	76.8 $\Omega$
1024	19.6K	38.3 $\Omega$

mode voltage, so the CMRR of the resistor-programmed AD625 is independent of the match of the two feedback resistors,  $R_F$ . A value of 20K is normally used for  $R_F$ . Values above 20K are not recommended because gain errors referred to the output increase with increased feedback resistance. Values below 10K can cause instability. See Table 1 for resistor values that can be used to set several gains with errors of only  $\pm 0.5\%$ .

Further technical and applications data on the AD625 (including programming by microprocessor) are included in the New Products section of the Analog Devices 1986 Update and Selection Guide. Write to Analog Devices, Two Technology Way, Norwood, MA 02062-9106.

## Ku-band amplifier modules

The new MC5875A, MC5875B, and MC5876A, MC5876B are modules developed for mass-production of low-cost Ku-band satellite data-link receivers. Both are two-stage GaAs FET/hybrid-IC amplifiers designed to be cascaded to provide excellent noise (2.5 dB) and gain (33 dB) performance over the 11.7 to 12.2-GHz band. Both the low-noise module (A) and the gain module (B) come in hermetically sealed packages.

Both devices from NEC are available from the exclusive North American sales agent, California Eastern Labs. For data and other information write California Eastern Laboratories, 3260 Jay Street, Santa Clara, CA 95054. **R-E**

You Can Be  
One Of The  
20,000 Technicians  
Certified By ISCET



The International Society Of Certified Electronics Technicians offers permanent certification by administering the CET exam with the FCC recognized communications option for \$20. A second exam on FCC regulations for a \$10 fee is required for a Radiotelephone License. Upon passing, technicians receive both a permanent Radiotelephone Operator Certificate and a CET Certificate issued by ISCET.

## ISCET Offers License Renewal

ISCET has developed a program for registration of those who currently hold a valid Radiotelephone Operator License. By sending a completed application, a photocopy of your FCC License, and \$10 your license will be renewed with the assurance of a recognized national technicians association behind it.

For More Information Contact:  
ISCET 2708 W. Berry, Ft. Worth, TX  
76109. (817) 921 - 9101

# Crack The Code

## #301 PARTS PACKAGE . . . . . \$39.95

Includes all the original resistors, capacitors, diodes, potentiometers, transistors, integrated circuits, LED's, Toko coil (E520HN-3000023) and Plessey SAW filter (SY323).

## #302 PC BOARD . . . . . \$12.95

Original 5 X 8.8 etched & drilled silk-screen PC board used in article.

## #304 AC ADAPTOR . . . . . \$12.95

Original (14 to 18 volt DC @ 200ma) AC adaptor used in article.

### SPECIALS

Add \$2.50 shipping & handling — \$4.50 for Canadian orders.  
We also offer quantity discounts on 5 or more units.

BOTH #301 and #302 . . . . . \$49.00

ALL THREE #301, #302, and #304 . . . . . \$59.00

60-CHANNEL

## CABLE CONVERTER . . . . .

WITH INFRARED REMOTE CONTROL

SC-60R CONVERTER

**\$69.95**



Add \$3.50 Shipping and Handling  
\$4.50 on Canadian Orders

Thousands of these converters sold nationally for \$119.95.

We offer you this same type of converter for only \$69.95.

All converters are NEW, with Full manufacturer's WARRANTY.

FEATURES:

- Full 60 Channel Capability
- Ultra-Stable Synthesized tuning
- Works on all TV models. Specify channel 3 or channel 2 output.
- Standard/HRC Switch for compatibility with all Cable Systems
- Will work with all types of external descramblers
- Cordless Infrared remote control
- Microprocessor controlled PLL

**ORDER TOLL FREE**  
**1-800-227-8529**

Inside MA: 617-695-8699  
VISA, MASTERCARD OR C.O.D.



Not available to Massachusetts residents due to state law.

**J & W**  
**ELECTRONICS, INC.**

P.O. BOX 800 • MANSFIELD, MA 02048

© Copyright 1986 by J & W Electronics, Inc.

JUNE 1987

## R-E ROBOT

continued from page 60

or you can investigate the use of incremental shaft encoders.

With the quadrature system, two pulse trains, 90° out of phase, are produced. Motor-direction information can be obtained by examining the relationship of the two waveforms; that is, to see which one is leading and which one is lagging. With proper decoding, spurious counts that may occur when the robot stalls or the motor shaft vibrates will be rejected.

A non-quadrature optical-feedback system can be implemented simply by attaching a disk with holes drilled around its circumference to the motor's back-shaft. A simple optical encoder can then be used to keep track of shaft rotation in the conventional way. Be sure that you drill as many holes as possible, for improved low-speed performance. You will have to condition the encoder's output signal to match TTL levels; that can be done with an LM393 comparator.

A quadrature encoder can be made from two optical sensors positioned so that the output waveforms are 90° out of phase. The sensors are properly positioned when the distance between the op-

## SOURCES

The following are available from Vesta Technology, 7100 W. 44th St., Wheatridge, CO 80033 (303-422-8088): Bare RE-Robot controller board, \$41; assembled and tested RE-Robot controller board, \$200; bare RPC board, \$41; assembled and tested RPC, fully populated for the robot function, \$294. Add \$8.00 shipping per board ordered. Colorado residents add appropriate sales tax. Mastercard and Visa accepted.

Optical encoders (100 counts/revolution, quadrature output) are available from EMC Corp., 373 Hillsboro Way, Goleta, CA 93117 (805-968-3060) for \$40 each. California residents must add appropriate sales tax.

tical centers is such that when one hole is centered on one encoder, another hole is covering 50% of the other encoder. With a typical system using using 0.25-inch sensor spacing, the hole pattern consists of 3/8-inch holes on 3/4-inch centers. That results in 12 holes on a 1.43-inch radius. That hole pattern is sufficient to give satisfactory feedback for operation at all but the lowest speeds.

Once again, the outputs of the two optical encoders should be conditioned with LM393 comparators. The circuit is then interfaced with the controller board and

the output signals are decoded.

## Terminal count

The progress of the motor is monitored using two counters of the 8253. One counter is clocked by the forward progress of the robot; the other counter is clocked by the reverse progress.

As mentioned, one of the features of the 8253 is that it is programmable. By loading the appropriate control word into the IC, the counters can be set to operate in one of six modes. For example, to generate the reference frequency we set up one of the 8253's counters to divide by a 16-bit number. That is the IC's mode 2. Here, we need to set up the remaining counters to operate in one of the IC's other modes, interrupt on terminal count (mode 0). In mode 0, the output goes high when the accumulated count has reached a value programmed into the counter. That output may be connected to a digital input for polled operation, but is connected to an interrupt input on the RPC for interrupt-driven operation. The counters can be interrogated by the RPC at any time during motor operations to ensure that the motor has not stalled or is not vibrating.

That's all for now. Next time we'll show you how to build and mount the board. We'll also look at some software considerations. **R-E**

## SEMICONDUCTOR TESTING

continued from page 63

defined as the forward transfer ratio in the common-source mode. It is expressed as:

$$y_{fs} = \frac{\Delta I_D}{\Delta V_{GS}}$$

where  $I_D$  is the drain current and  $V_{GS}$  is the gate voltage for an FET in a common-source configuration. A basic test circuit for  $y_{fs}$  is shown in Fig. 7

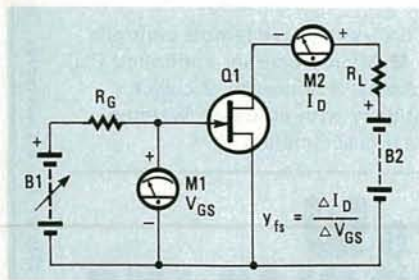

FIG. 7—A basic  $y_{fs}$  test configuration for FET's.

To measure  $y_{fs}$ , the gate is first DC-biased with a voltage and the resulting drain current ( $I_D$ ) indicated by meter M2 is noted. Then, the input voltage is

changed and the resulting change in the gate voltage ( $V_{GS}$ ) measured by meter M1, and the change in drain current measured by M2 are used to calculate  $y_{fs}$ .

Again, we must emphasize the word *change*. The static conditions under which the measurements are made are not anywhere near as important as the values of any changes.

Bear in mind that  $y_{fs}$  is not a gain factor, per se. Rather, it describes the *maximum* possible gain. Generally, the larger the  $y_{fs}$  value the greater the gain. Junction FET's have a fairly high forward transconductance, typically ranging from 4,000 to 10,000  $\mu\text{mhos}$ . MOSFET (Metal-Oxide Silicon Field Effect Transistor) gains tend to run higher, and dual-gate MOSFET gains are higher yet, wherein values up to 20,000  $\mu\text{mhos}$  are not uncommon.

## Dual gates

Dual-gate MOSFET's can be tested in three different ways. In the first kind of test we apply a signal to one of the gates and connect the unused gate to the drain.

By alternating the signal gate (by reversing the gate connections) we create a second distinct test configuration. In some cases, a voltage may be applied to the unused gate during the test; if so, that information is listed on the data sheet.

The third test configuration ties the two

gates together and treats them as one. That is the test most commonly used with dual-gate MOSFET's, and its result is shown on most data sheets. While the arrangement yields the highest  $y_{ss}$ , it also results in decreased bandwidth.

## Variations in $y_{fs}$

Technically,  $y_{fs}$  represents a resistive value that is influenced by the biasing voltage on the gate, which in turn influences the drain current,  $I_D$ . In spite of the variations in  $y_{fs}$ , the device's manufacturer arrives at a representative  $y_{fs}$  value by not applying a DC bias voltage to the transistor and by maintaining the input signal at 100 mV or less, a configuration that yields the highest  $y_{fs}$  value. Practically, however, that configuration serves little purpose, because with no DC bias on the gate the output signal may be severely distorted.

The effect of temperature on variations in gain should not be overlooked. As the ambient temperature increases, the leakage component through the semiconductor also increases, which affects  $I_D$ , which, in turn, affects  $y_{fs}$ . In all cases, the tests are made at 25°C. When tests are performed at elevated temperatures the results are listed separately in the data sheet.

Next month we'll look into the fascinating world of operational amplifiers. **R-E**



# COMPUTER DIGEST

VOL. 5 NO. 6 JUNE 1987

A NEW KIND OF MAGAZINE FOR ELECTRONICS PROFESSIONALS

## DESIGNING PC BOARDS ON YOUR PC

New programs make it easy

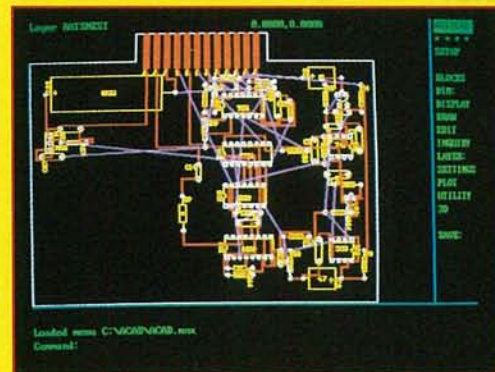
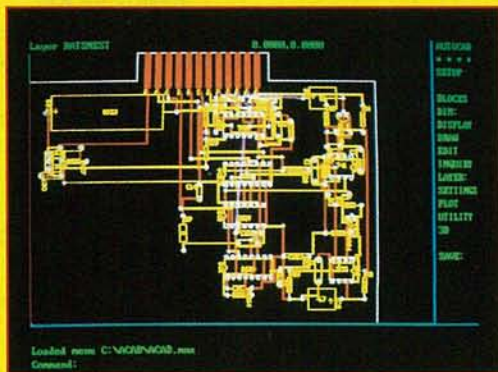
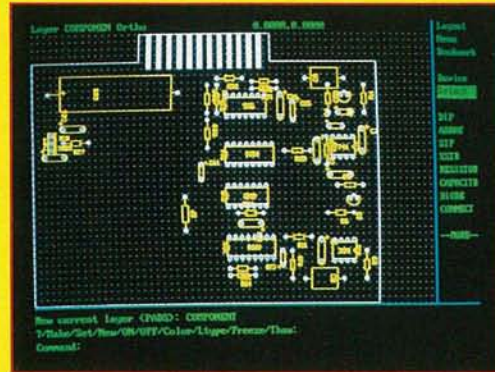
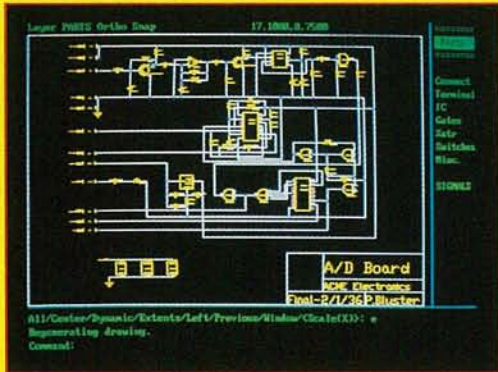

## THE KEYPROM

Sinking the software pirate

# CONTENTS

## JUNE 1987

Vol. 4 No. 6



### 97 DESIGNING PC BOARDS ON YOUR COMPUTER

CAD systems can make the job almost easy.

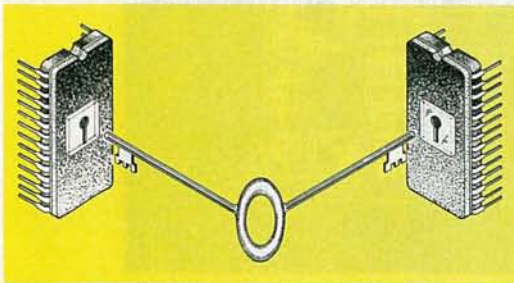

### 100 THE KEPROM: SINKING THE SOFTWARE PIRATE

A new type of hardware protection.

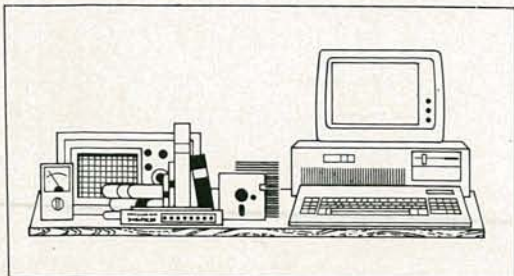

### 91 EDITOR'S WORKBENCH

Hardware: Microsolutions' Matchpoint PC  
Software: Software Masters' Visible  
Computer: 8088  
Etc.: New computer products

# COMPUTER DIGEST

**Larry Steckler,**  
EHF, CET: publisher & editor in chief

**Art Kleiman,**  
editorial director  
**Brian C. Fenton,**  
managing editor  
**Jeff Holtzman**  
technical editor  
**Byron G. Wels,**  
associate editor  
**Carl Laron,**  
associate editor  
**Robert A. Young,**  
assistant editor  
**Teri Scaduto**  
editorial assistant  
**Ruby M. Yee,**  
production director  
**Karen Tucker,**  
production advertising  
**Robert A. W. Lowndes,**  
production associate  
**Marcella Amoroso**  
production assistant  
**Andre Duzant,**  
technical illustrator  
**Jacqueline P. Cheeseboro**  
circulation director  
**Arline R. Fishman,**  
advertising director

ComputerDigest  
Gernsback Publications, Inc.  
500-B Bi-County Blvd.  
Farmingdale, NY 11735

### ADVERTISING SALES 516-293-3000

Larry Steckler  
Publisher

### NATIONAL SALES

Joe Shere  
1507 Bonnie Doone Terrace  
Corona Del Mar, CA 92625  
714-760-8967

Cover Photo by Herb Friedman

# EDITOR'S WORK- BENCH

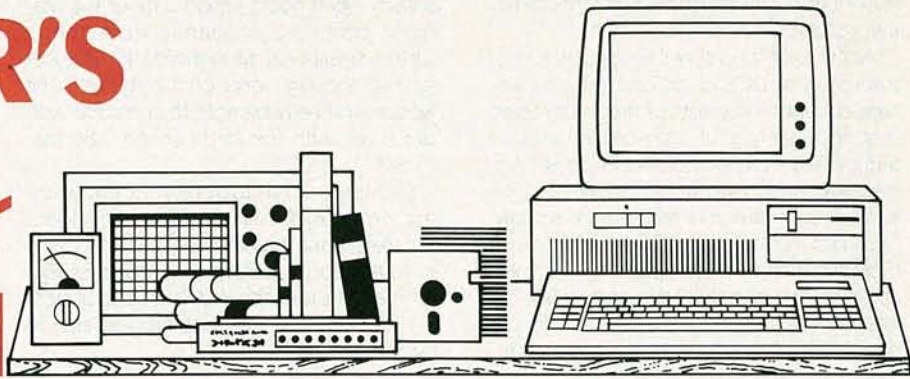

We've got reviews of several exciting products this month, including a well-done 8088/assembly-language tutorial and a disk-conversion package that allows you to read Apple disks on an IBM (or compatible) machine, along with brief spots on new releases of several industry standards. However, before getting to our reviews, we'd like to take time out to examine the chaotic state of IBM operating systems.

## IBM'S NEW OPERATING SYSTEM(S): THE M & M'S

From the user's standpoint, there are two kinds of operating systems: command-line based and icon based. Apple's Macintosh, based to a great extent on work done by a research subsidiary of the XEROX Corporation, is an icon-based system; the IBM-PC is a command-line based system.

Much ink has been spilled arguing the merits of one system over the other, but few would argue that icon-based systems are more appropriate for beginning and occasional users, and that command-line-based systems are more appropriate for medium and advanced users who are willing to forego the ease of use of the icon system for the speed of the command-line system.

The IBM-PC (and its close relatives) to date have used an operating system that is command-line based. However, it seems likely that the next generation of IBM/Microsoft operating systems will be oriented toward a Mac-style interface. The problem with that type of interface is simple: the 8088 microprocessor used in the IBM-PC, the IBM-PC XT, and millions of clones is too slow to handle a full graphics interface like Microsoft Windows.

However, the IBM-PC AT has a higher-powered microprocessor (the 80286) that allows Windows to run at acceptable speed. And the latest member of the 80xxx family, the 80386, is even more powerful

than the '286, so raw performance of Windows can theoretically improve by a factor of ten or so.

There's another problem. The '286 and '386 IC's can run standard MS-DOS applications as-is, but a large part of the inherent power of those microprocessors is thereby left untapped. On the other hand, the current generation of MS-DOS applications programs simply can't use the advanced features of the new IC's. What kinds of features? The M & M's: Memory and Multitasking. How much memory? Megabytes, gigabytes, terabytes (literally!) of memory. Multi-tasking? Why? So that you can run several programs simultaneously, and so that programmers can run several parts of the *same* program simultaneously.

Why would you want your computer to do more than one thing at a time? If all you use the machine for is to write letters to Aunt Sally and balance your checkbook, you don't need the M & M's. But if you do CAD, or manage large spreadsheets or databases, or do circuit design and analysis, then M & M's will become not optional but necessary as the next generation of software learns how to use the new hardware.

Why? Because, for example, the typical CAD program on an unenhanced PC runs slow. Speed may be acceptable on a '286 machine, but even then you don't get the snap out of it that you can get with, say, a well-designed wordprocessor on an '88 machine.

But speed isn't valuable in and of itself; it's a means to an end. And the kinds of things a fast microprocessor can be used for may surprise you. For example, how would you like to use a CAD program that had separate background processes that kept various views of the screen up to date? No more thirty-second screen redraws; switching views would happen instantaneously.

Or how would you like to use a circuit design/analysis program that allowed you

to enter components graphically, and in the background kept track of voltages and currents at all nodes? So if you needed to bias a transistor to a certain point, given the output of the preceding stage, the circuit would calculate resistor values instantaneously, and, based on that information, start calculating values for the next stage.

How about a wordprocessor that did real-time spelling checking, disk saves (in the background, of course) every five minutes or 2000 keystrokes? And (everybody's favorite) how about running a spreadsheet, a database manager, a communications program, and a wordprocessor simultaneously?

You can't do any of those things in an acceptable manner on the present generation of PC's (IBM or otherwise). The hardware is here (sort of), but the software isn't. Computers (UNIX-based systems and engineering workstations, for example) have been around for some time that can do multitasking, but the hardware is high-priced, and the software (especially the user interface) is in many ways less functional than what is available for PC's.

So where does all of that leave IBM and Microsoft? They're supposed to release new hardware and software by the time you read this. The new hardware probably will include a low-priced PC that will compete with foreign clones and with the PC compatibles released by Commodore and Atari. The new hardware will probably also include a '386 machine; indeed, IBM would be foolish not to get something to market quickly, because it has been reported that Compaq is selling 10,000 '386 machines per month! Last, there may be something in between, perhaps another '286 machine.

## New DOS

The new hardware is going to be nothing more than a high-priced bookend without software to take advantage of it. And, fortunately, Microsoft is slightly more open

about internal development than IBM; there has been some indication that DOS as we know it may split into three different operating systems.

At the lowest level we'll see some sort of extension of DOS 3. Speed may be enhanced, and some sort of graphics-based (not necessarily a full icon-based) user interface with more-comprehensible error messages and a built-in help system will be added. Both IBM and Microsoft have emphasized that the new DOS 3 will be much friendlier than (and compatible with) past versions, but hopefully the command-line interface will be retained. In any case, the new DOS 3 will be unable to take advantage of the M & M's, so don't expect to be able to run bigger spreadsheets or do multitasking. Power users will probably shun the new DOS because the graphics and help systems will eat up valuable system RAM and slow overall operations down.

At the next level we'll see an operating system for the '286 (which is used in the AT and in many accelerator cards), one that will allow specially-written programs to take advantage of the M & M's. However, 286-DOS (also unofficially called A-DOS, Advanced-DOS, DOS 5.0, and other names) will not allow traditional applications (those that can use only 640K of memory and those that write directly to video RAM) to use more memory or to do multitasking. Only new or adapted programs will be able to take advantage of the M & M's.

The '386 IC has a special mode that allows it to run multiple traditional applications simultaneously. The new '386 operating system (control program) will exploit the multitasking capability, but, like 286 DOS, will not allow traditional applications to access more than 640K of contiguous RAM. However, each traditional application will think it has a complete 640K machine at its disposal. But no particular application will be able to take advantage of extended resources (the M & M's) by itself. In addition, 386-DOS will be able to run other operating systems simultaneously, so it should be possible to build a UNIX-based engineering workstation that could run DOS applications in a UNIX window.

### Apple and IBM

Meanwhile, Apple has introduced two new Macintosh computers, one of which (the Macintosh II, shown in Fig. 1) uses a CPU (the 68020) that can compete directly with the '386. More significant is the fact that Apple has finally realized two things: (1) IBM is a force to be reckoned with, and (2) an open-architecture machine with expansion slots and good technical documentation (like the IBM-PC and like the original Apple II) is good for business in that it encourages third-party innovation.

The new Macintosh II is an open-architecture machine that will run IBM software (with the addition of a plug-in card containing an '88 or compatible micro-

processor). In addition, Apple has ported UNIX to run on the machine, and there have already been good reports about the machine from the academic community (UNIX's traditional stronghold). It's likely, at least in the high end of the market, that Apple will finally be able to compete with IBM (i. e., with the forthcoming '386 machine).

Similarly, Commodore's recently announced A2000 has a keyboard that looks remarkably like the new IBM keyboard, and a plug-in co-processor card that runs IBM software. Inside, the A2000 has four slots that accept IBM-compatible expansion cards.



FIG. 1

### Conclusions

The point is that IBM is slowly moving toward the ease-of-use features that Apple brought to the PC world, and Apple (as well as Commodore) is moving simultaneously toward IBM compatibility and the large base of quality software and hardware that exists to serve the IBM market. Perhaps the Hatfields and McCoys can make up after all.

For users, these are all good signs. We'll get software that is more powerful, more kinds of hardware to run it on, and, as different system designs converge, we'll have less trouble moving from system to system. And just as the M & M's will bring increased power to advanced users, that additional power will also be useful in creating "friendly" graphics-oriented systems for beginners and occasional users. So don't let anyone tell you that the average user doesn't need a '386 (or a 68020); he may need it more than the power user!

IBM has been hurt by the invasion of the Clones, but IBM (like few other companies) has the resources to develop the next generation of hardware and (with a little help from its friends) systems software. Whatever IBM does, it always takes the Clone makers six months to a year to catch up—and by then IBM is working on something new. So, even if it has lost some market share, IBM is still calling the shots. ♦♦♦



### MICROSOLUTIONS' MATCHPOINT-PC

Except by means of an expensive hardware emulator, it has not been possible to interchange disk files between Apple II- and IBM-compatible computers directly. (For the remainder of this review we'll use the term IBM to cover both IBM-made machines and clones.) Small businessmen with years of data generated on an Apple discovered that those files had to be recreated if the computer system was upgraded to an IBM. Similarly, the educational system, which has an enormous installed base of Apples, discovered that teachers could not prepare work at home on an IBM because even simple BASIC programs and text files could not be read by the school computers, and vice versa.

Although software that can convert virtually any CP/M or TRSDOS file to the MS-DOS format (and vice versa) has been available for several years, it wasn't available for the Apple II. Of the more than 100 brands of computers that are commonly used for education and business, only the Apple was foreclosed from the MS-DOS world.

But Apple/IBM incompatibility has finally been resolved by a device called the MatchPoint-PC, made by MicroSolutions (132 West Lincoln Highway, DeKalb, IL 60015.) It's a hardware/software package specifically designed for reading and writing, on an IBM, disk files written in AppleDOS and ProDOS, Apple Softcard CP/M, and just about any other CP/M format.

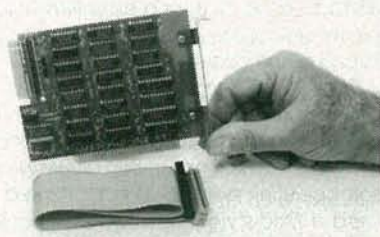

FIG. 2

The hardware part is a half-length controller board (Fig. 2) that you install in an otherwise unused slot. It connects between the IBM's floppy-disk controller and its floppy-disk drives. A cable (which is supplied) that will match either card-edge or header-type controller terminals con-

nects the MatchPoint-PC to the existing controller. The computer's original cable is moved from the controller to the MatchPoint-PC, thereby placing the MatchPoint-PC between the disk controller and the disk drives.

The supplied software, which consists of a program called MPOINT and a special version of Uniform—a "universal" CP/M disk format/read/write program that can handle more than 100 different disk formats—sets up the operating conditions for foreign (non MS-DOS) disk formats.

Running the MPOINT program allows the interface to recognize Apple II disk formats, and temporarily adds five new commands to MS-DOS. They are: ACOPY, ADEL, ADIR, AINIT (which formats a disk), and ATYPE. All commands function just like their MS-DOS equivalents (COPY, DEL, DIR, FORMAT, and TYPE).

### How to use it

In normal operation, the MatchPoint-PC is totally transparent; the computer functions exactly as it always did. In fact, placing an AppleDOS or ProDOS disk in a drive will result in a read error message.

However, MPOINT allows the computer to recognize a single physical drive as two logical drives. For example, assume that MPOINT is configured so that drive B: will be the Apple-compatible drive. When the command DIR B: is entered the computer will recognize only MS-DOS disks in drive B. But if the command ADIR B: is entered, the MatchPoint-PC hardware automatically treats drive B: as an Apple drive and reads in the Apple disk's directory. In short, the mode in which drive B: operates is automatically determined by the command you use. Figure 3 shows the ADIR screen display of an Apple disk on an IBM computer.

```

E:\APPLE>ADIR B:
MatchPoint-PC by Micro Solutions

Directory of Apple DOS diskette
Volume 254 in drive B:

  *A 004 HELLO
  *I 008 APPLESOFT
  *B 050 FPBASIC
  *B 063 FILER
  *B 018 FAST COPY
  *A 018 DISK TEST
  *A 009 DISK SPEED
  *B 010 OBJ.QUADCOPY
 79K bytes (316 sectors) available.

E:\APPLE>

```

FIG. 3

Here's another example. The command ACOPY B:WORK.TXT A: will copy the Apple file WORK.TXT from drive B: to an MS-DOS disk in drive A:. You could, of course, do it the other way around—MS-DOS (A:) to Apple (B:).

### Uniform

By using the Uniform program, drive B: can function as a CP/M drive (Apple or

otherwise) using the next higher drive designator. If your computer has two physical drives (A: and B:), drive B: will double as CP/M drive C:. If your computer already has a drive C: (a hard disk, perhaps), the created CP/M drive will be drive D:.

If that's confusing, perhaps a few examples will straighten things out. Assume the computer has two disk drives, A: and B:. If the selected Uniform mode is CP/M, the command COPY C:WORK.TXT A: will copy the Apple Softcard CP/M file WORK.TXT from drive C: (physical drive B:) to MS-DOS drive A:. And even though drive B: functions as CP/M drive C:, it also functions as MS-DOS drive B:.

Although an IBM computer can read Apple disk files, it cannot run binary programs. BASIC programs might be convertible, depending on how many machine-specific statements are used. Graphics programs, for example, will be particularly difficult to translate. Only ASCII text and data files are truly interchangeable between Apple and IBM machines. For example, SuperCalc files in an Apple CP/M format could be converted and then used on an IBM version of the program.

### UniDOS

There is one exception to the rule of binary-file incompatibility, and that is when MatchPoint-PC is used with Uniform and an additional program called UniDOS (also sold by MicroSolutions), which is a Z80 emulator for IBM machines. It allows an IBM to run Z80 and 8080 CP/M programs. The catch is that the CP/M program runs much slower on the IBM than it would on a true Z80 machine because UniDOS is only an emulator. So, for example, if you're upgrading from a CP/M to an IBM machine, you can continue to run your old CP/M software on the IBM.

### Half-tracking

Although MatchPoint-PC works extremely well and with little trouble, its Apple/IBM compatibility is limited by something known as "half-tracking," which refers to disk data written between tracks on the disk. Basically, it's as if the disk drive's read/write head, instead of stepping from track to track, stepped between tracks first. Half-tracking is used by some copy-protected Apple II software, which locates data or special encoding between the conventional tracks—in the half-tracks. IBM-type drives cannot step to the half-track location, hence, they cannot read nor write a half-track diskette. So, if you have Apple disks that are half-tracked, they will not be read by the MatchPoint-PC system. That's the only limitation we've found in MatchPoint-PC.

The MatchPoint-PC package, which includes the hardware interface, MPOINT, and UNIFORM retails for \$195. For orders or further information write directly to MicroSolutions. 



### SOFTWARE MASTERS' VISIBLE COMPUTER: 8088

I bought my first personal computer, a single-board 6502 machine, in 1979. After hooking the board up to a power supply, with shaking hands I turned it on. Not much happened—no smoke, anyway. The six-digit seven-segment LED display showed a row of zeros. After staring at those zeros a while I realized I was in trouble—big trouble. I had just purchased the most expensive gadget (about \$250) I had ever seen—and I didn't know the first thing about how to use it. It had no BASIC in ROM (one would be forthcoming), nor even an assembler, so programs had to be assembled by hand. And that was a difficult proposition for someone who had never even heard of hexadecimal numbering! It took me months just to learn how to add two numbers together!

Times have changed since 1979. Now anyone who wants to learn about microprocessors and machine- and assembly-language programming can do so without going gray in the process. How? With *The Visible Computer: 8088*, a disk-based self-teaching guide by Software Masters, P.O. Box 3638, Bryan, TX 77805.

*The Visible Computer* comes with a single floppy disk and a 350-page book. The disk contains more than 50 demonstration programs and a special program, called TVC, that functions as a combination assembler, debugger, and 8088 simulator. You can use TVC to run the demonstration programs, programs you write yourself, and commercial MS-DOS programs.

A beginner won't use TVC right away; he'll start off reading the book. The book contains 34 chapters and several appendices that cover numbering systems, basic logic (AND, OR, etc.), machine language, the stack, looping, arrays, the 8087 math coprocessor, interrupts, and more.

The book is well-written and well-illustrated; new topics are introduced at a rate that should be acceptable to most aspiring assembly-language programmers. The author (who is not named) has an irreverent style that will make you chuckle more than once. For example, Chapter 2 ("Alternate Numbering Systems") starts off like this: "If you bought *The Visible Computer* with the hope that it would somehow save you the effort of climbing Mount Hexadecimal,

picking you up magically and dropping you softly into the Valley of 8088 Machine Language on the other side, sorry, no can do." Later he offers an explanation for why we (normally) use decimal numbers: "... because people have 10 fingers, and for millions of years, fingers were all we had for representing numbers. On a planet where beings have two hands of four fingers each we can reasonably predict that their positional numbering system is based on the number 8."

That's not to say that the book's light-hearted approach prevents it from digging into some heavyweight material. In the chapter on interrupts there is a section entitled "An 8088 Goof." In it the author discusses a design error of the 8088 that was not caught until after the IC had been in production for some time. The error can cause memory locations to be overwritten at random, depending on when an interrupt occurs. Later versions of the 8088 have a fix, but a special programming technique is necessary to avoid trashing memory when using earlier models of the IC. The point is that the author is familiar with many of the subtle quirks (bugs) of the 8088 that can drive novice programmers crazy.

### Simulating the 8088

TVC is an 8088 simulator written mainly in Pascal. It comes up on-screen with several windows (starting in the upper left corner and working clockwise): the control window, the flags window, the status window, the disassembly window, and the processor window. See Fig. 4. Beneath the windows is the monitor area. Normally you enter commands in the monitor area; the results of those commands are displayed in the various windows.

The commands used to control TVC are similar to the corresponding commands in the MS-DOS DEBUG program, so if you already know DEBUG you'll have no trouble using TVC. On the other hand, if you don't know DEBUG, you can use TVC to learn it, and doing so is valuable, because most MS-DOS debuggers are based on DEBUG's command set.

Of course, TVC has a number of unique commands that allow you to step through programs step by step, examine and alter memory, assemble and disassemble programs, etc. The feature we like best is the simulator. You can set it up to display the machine state at one of several levels. The most detailed level (4) allows you to see what's happening inside the 8088 machine cycle by machine cycle. Or you can set it to stop between each instruction, or not at all.

You can also generate "interrupts" during simulation by pressing keys at the keyboard. A special command allows you to set the interrupt number that is generated. For example, to simulate an interrupt 9, you would issue the command INTR 9. Then, when you pressed a key during simulation, a pseudo-interrupt 9 would be generated.

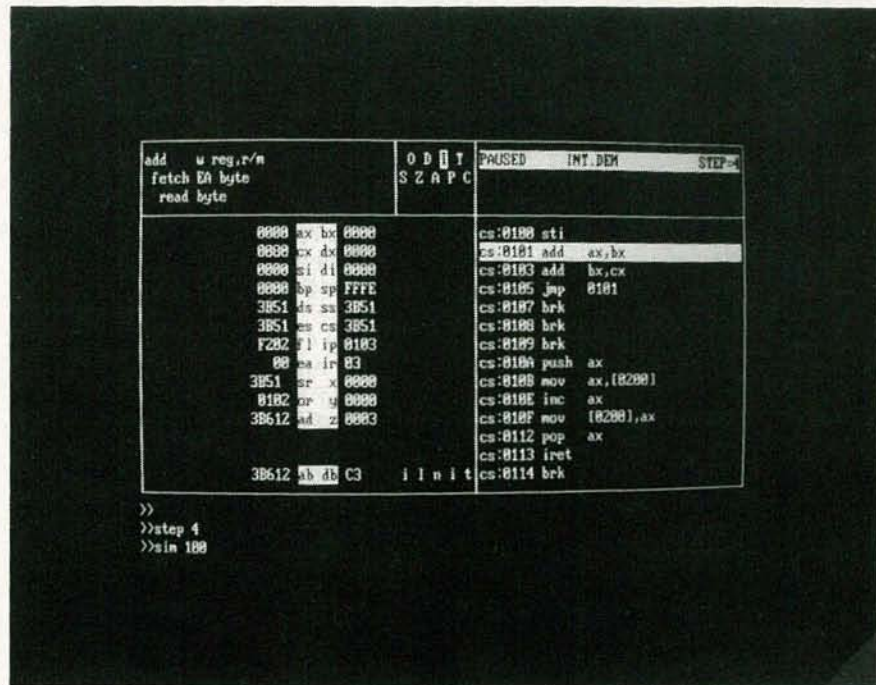

FIG. 4

To protect the beginner from himself, TVC has a privilege mode that must be entered via a special command. In non-privileged mode, the user is prevented from writing to system memory, output ports, etc.

Other commands allow you to load and save files, activate a calculator (that allows addition, subtraction, multiplication, and addition, and conversion between hex, decimal, and binary numbers), etc.

All in all, *The Visible Computer: 8088* provides a remarkably painless introduction to the 8088 microprocessor and assembly-language programming. So we heartily recommend it, a bargain at \$79.95.

Software Masters also publishes versions of the package that teach the 6502 microprocessor. Contact them for details. **▶◀**



### MICROPRO INTERNATIONAL, WORDSTAR PROFESSIONAL 4.0

It's been a long time in coming, but MicroPro (P. O. Box 7079, San Rafael, CA 94901-0079) has finally released an updated version of WordStar. The new version is much improved over version 3.31, and has features including what is probably the best spelling checker on the market, a built-in macro processor, extensive on-screen for-

matting, built-in table-of-contents and index generators, automatic indent (when editing program files), a very well done disk-based tutorial, and many more. The program is somewhat slow and doesn't make use of graphics modes, but for a mid-priced (\$495) package, you'll find it hard to beat. Let's just hope MicroPro doesn't wait four more years to release another version—and how about a built-in outliner!

### ASHTON-TATE, DBASE III PLUS

The last Ashton-Tate product we had occasion to use (some four years ago) was dBASE II on a CP/M machine. The program has evolved a great deal in those four years; dBASE III Plus (which runs only on IBM and compatible machines) is much polished and much enhanced over the previous version. For example, there are many many new programming commands and network support, but the more significant changes have occurred in the user interface.

dBASE III Plus has five user support systems: a disk-based tutorial; a program that helps you build a simple database automatically; another program that gives dBASE III Plus a menu-driven front end; extensive on-line help; and two thick manuals. The manuals constitute the weak link in the support system because it's hard to locate desired information quickly.

dBASE III Plus is a *de facto* standard in the microcomputer world. It's a powerful product with many features, so it's a serious contender for any moderate to complex database management job. The program lists for \$695 from Ashton-Tate (20101 Hamilton Ave., Torrance, CA 90502). **▶◀**

# DESIGNING PC BOARDS ON YOUR COMPUTER

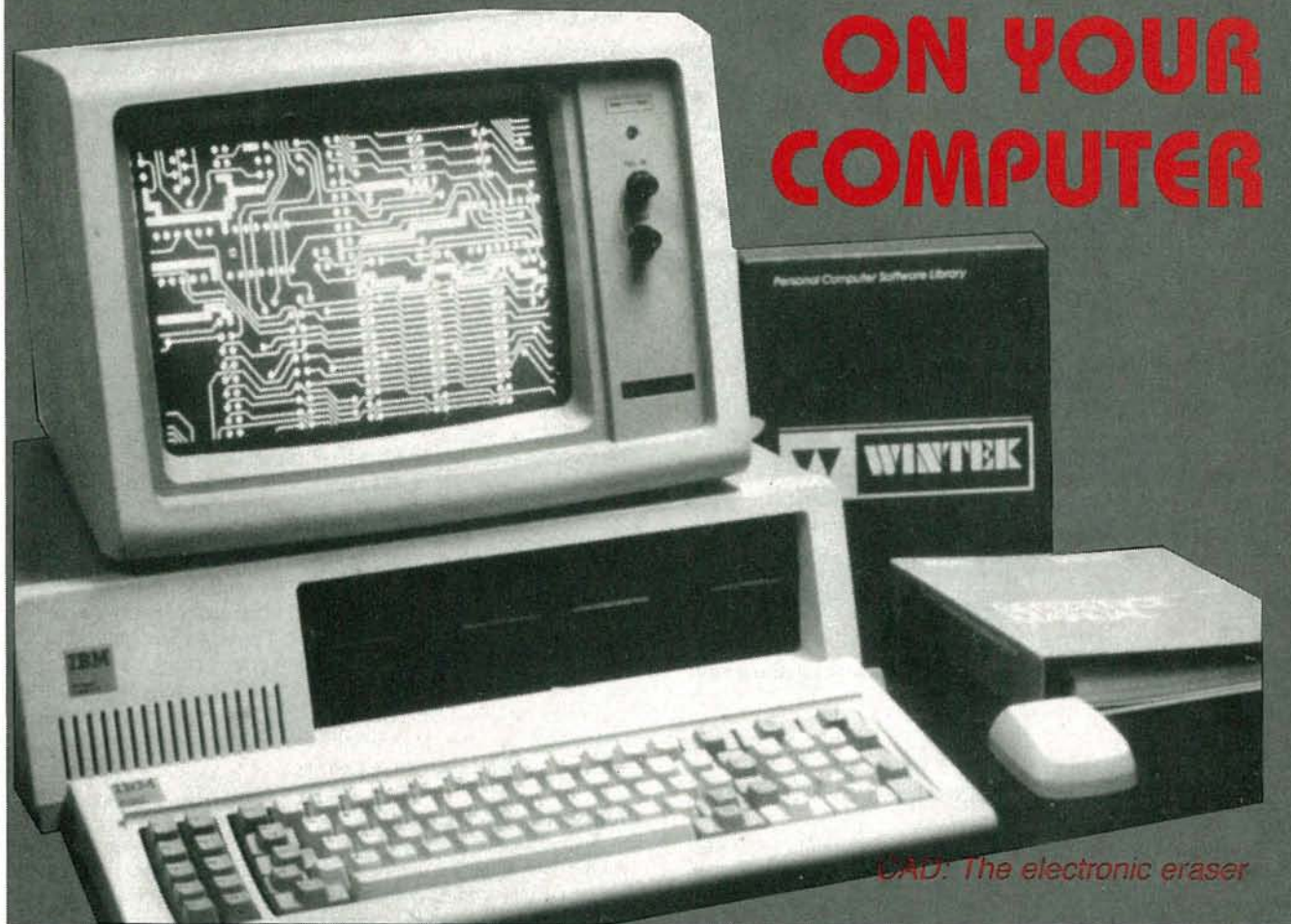

## ROBERT GROSSBLATT

It hasn't been long since the most sophisticated thing you could do on a home computer was save the Earth from an alien invasion. More practical (and more mundane) jobs like word processing, database management, and CAD were the exclusive property of mainframes and work stations. Why? Because they need lots of memory to work, and enough speed to provide a solution before the problem becomes obsolete.

However, the last several years have seen such a tremendous increase in computer technology that the difference between micro and mainframe machines is becoming more one of semantics than anything else. LSI and VLSI IC's have advanced micro-processors to the point where today's home computers are orders of magnitude more powerful than the mainframes used ten years ago. The bus width, instruction set, speed, and register structure of a modern CPU provides the perfect hardware environment for a new generation of sophisticated software.

One of the beneficiaries of this advance in computer power is the printed-circuit board designer. Anyone who has laid a board out by hand knows that routing traces is really a matter of repetitive trial and error. After the circuit design is finalized and the size and shape of the board have been defined, connecting all the components properly entails doing a great deal of experimenting. There

are many standard guidelines to follow, and every designer has his own bag of tricks, but there's no getting around the fact that the whole job is tedious, time consuming, and often incredibly boring.

The good news is that now there are several commercial printed-circuit board layout programs available for the home computer. But before you rush out to buy one, keep in mind the fact that there are vast differences in price and performance among them. How can you decide which is right for you? Keep reading. In this two-part article we are going to examine the features of several popular programs in detail. But before getting into specific features of specific programs, we're going to discuss the basics of PC-board design. That way, if you're new to CAD (Computer-Aided Design), you can get a feel for what it's all about. We'll talk about specific programs (those shown in Table 1) next time.

### The basics of CAD

Laying out a PC board (by hand or by computer) is not a random process; you must have definite information at hand, and you must follow rational procedures:

1. The circuit design must be finalized. You must know how the components are supposed to be connected, which signals are going off-board, sizes and shapes of on-board connectors, etc.

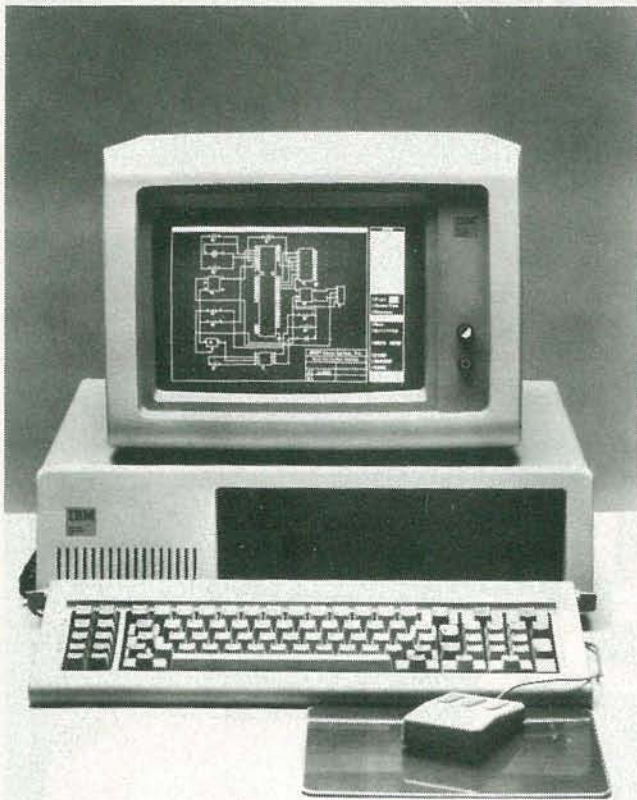

**THE SCREEN DISPLAY OF A Project: PCB layout is an accurate representation of the hardcopy that will appear.**

2. The board itself must be defined. You have to decide on its shape, edge connector and header positions, the number of layers, and so forth.

3. Next the parts have to be placed. Components that need shielding should be physically close; power, ground, and bus lines must be allowed for, and so on.

4. Trace width must be decided. A circuit that draws a great deal of current will need wider traces than an all-CMOS design.

5. The method of fabrication must also be known. The layout may vary depending on whether you're taping the board, doing it photochemically, having it commercially made, etc.

Some of those considerations may never have crossed your mind, but, if you examine the steps you follow in laying out a board by hand, you'll see that (perhaps unconsciously) you decide every one of those issues before sitting down to do the layout. The point is that, in order for a computer to design a PC board, it must know (i. e., you have to tell it), all the things we just listed.

### The routing program

The heart of any PC-board software is its routing package, the program that figures out how the traces should be laid out on the board. The routing program reads a file (that's created by another program) to get information on circuit connections and design rules, and then it goes ahead to solve all the topological problems for routing the board. The algorithms used to make connections vary from program to program, but they all do basically the same thing you would do if you were laying the board out by hand. A trace is started from one pin and keeps going until it finds an obstacle. It then moves to one side a bit and tries again. The process is repeated until it gets to the final destination. Sounds familiar, doesn't it?

Different routers have different success rates with a given set of parameters on the same board. It all depends on how sophisticated the software is: how thin a trace it can draw, the minimum distance it can set between traces, what kind of corners it can turn,

and, most important of all, how well the routing program was written to begin with.

The basic router is the "point-to-point" variety. When you use one, you indicate, for example, which two pins you want to connect, and the program tries to connect them. The interactive approach lets you control the order of traces, and it does all the tedious trial-and-error work for you. You can certainly lay out a board that way, but you'll have to be involved in every single step.

In a sense, the point-to-point router is a technician's version of "computer art" software. Using a computer art program, you would indicate two points on the screen and then connect them by entering the appropriate coordinates on a keyboard, by moving the cursor with the keyboard's directional (arrow) keys, by moving a mouse or joystick, or by drawing a line on a graphics tablet. Depending on the device or method used to create the line, the points would be connected by a straight line or by one having irregularities. The interactive basic router doesn't work much different, it just insures the connecting lines won't be irregular. Also, keep in mind that the more complex the board, the more difficult the job will be.

Remember that there's much more to laying out a board than just making connections. For example, let's say that you start at one corner of the layout and begin laying down traces. As the board fills up, it gets harder and harder to find paths to connect the pins. At some point you realize that you can simplify the routing of many traces by redoing much of the work you've already finished. So if you were doing everything by hand, you'd turn your pencil upside down and start erasing traces. That's exactly what you have to do with software that does point-to-point routing.

In fact, that's the biggest limitation of a point-to-point router. It doesn't know how or when to make the judgement that it's better off re-doing some work than sticking with a design and trying to work around it. That type of software only knows how to tie two points together—it can't optimize trace routing of the entire board. To do that, you need software that's several orders of magnitude smarter: what's called an auto-router.

### Automatic trace routing

An auto-router knows when it makes sense to throw away earlier parts of the layout. You can sit down and tell it how you'd like to tie particular pins together (that's called pre-routing), or you can let it handle the whole job by itself. It takes both connection and placement information from files (called *netlists*) and sets about doing the entire layout from start to finish. All you have to do is give the auto-router the name of the job and start it up.

The success rate of an auto-router depends, among other things, on how flexible it is. A versatile program will provide you with many options so you can tell it what the layout parameters are, how much time to spend on an individual trace, how convoluted the path of any one trace can be, at what point it should consider redoing work it's already done, etc., etc. The bottom line is that, the more control you have over the rules the auto-router follows, the more chance there is that it will route your board in a satisfactory manner.

### Feeding the router

No matter how sophisticated the router is, it's only one part of a complete PC-board layout package. You need some way to give it the information it must have to do the job. That information includes the following:

1. The components you're using.
2. How they're connected together.
3. The board's physical characteristics.
4. Where the parts are placed on the board.
5. The type of hardcopy output you want.

The way a PC-board layout program collects all that information is critical, because the data-gathering part of the package is usually the one the user spends the most time with.

The simplest approach is to provide a way to enter data in symbolic form via the keyboard. The data file thus created lists which pins are connected together. The shape of the board and its



TABLE 1—PROGRAMS DISCUSSED

<b>smARTWORKS</b>	The Wintek Corporation 1801 South Street Lafayette, Indiana 47904-2993 \$895.00 Copy Protected
<b>Project: PCB</b>	DASOFT Designs Systems, Inc. P.O. Box 8088 Berkeley, California 94707-8088 \$950.00 Hardware Locked
<b>The Autoboard System</b>	The Great Softwestern Company, Inc. 207 W. Hickory St. Suite 309 Denton, Texas 76201 \$2500.00 Requires AutoCAD
<b>AutoCAD</b>	Autodesk, Inc. 2320 Marinship Way Sausalito, California 94965 \$2850.00 (Version 2.5 or above)
<b>smARTCAD</b>	Creative Electronics 925 Fairwin Ave. Nashville, Tennessee 37216 \$395

component layout can be handled in the same way. You have to establish some sort of coordinate system and use it to indicate both the edges of the board and the location of each component. That data could be entered from the keyboard just as the circuit data was. The problem with this method is that it's slow, non-intuitive, and prone to hard-to-detect errors.

#### Graphics editor

Using a database manager or word processor to build the files needed by the router is one way to solve the problem, but a much slicker (and friendlier) way to get the job done is to use a graphics editor as the router's front end. It's much easier to draw the schematic and the board than it is to describe them. After all, everybody knows that one picture is worth a thousand words—to say nothing of hours and hours of work, as well.

The idea is to use software that knows how to translate graphic images (drawn by you) into the tabular data needed by the router. The approach is terrific from the user's point of view, but it's an enormous problem for programmers, because designing a graphics system is not something you whip out between breakfast and lunch.

Among other things, you have to contend with graphic display standards (or lack thereof), digitizers, printers, plotters, and the rest of the I/O can of worms. It's one thing to manipulate graphic data in memory, but getting that data out in a useful form is difficult, because there are almost as many I/O standards as there are peripherals on the market. And even after the I/O problems are solved, the software designer still faces the job of translating graphic data into files that can be read by the router.

#### The router

Most commercial PC-board software allows you to enter data via a graphics editor, and most gives you some provision for editing the netlists that are produced. If you pay attention to what you're doing, you can be reasonably sure that the router will work on exactly the circuit and layout you have in mind. What the router will produce, however, is something else altogether.

When you route a board by hand, the job is over when you put the last trace on the board. But with a router, the job's finished when it's completed as many traces as it can. The difference is more than merely semantic. Even if you're using the world's most sophisticated software, there's a good chance that the router won't be 100% successful. You'll still have to route a few traces by hand, and

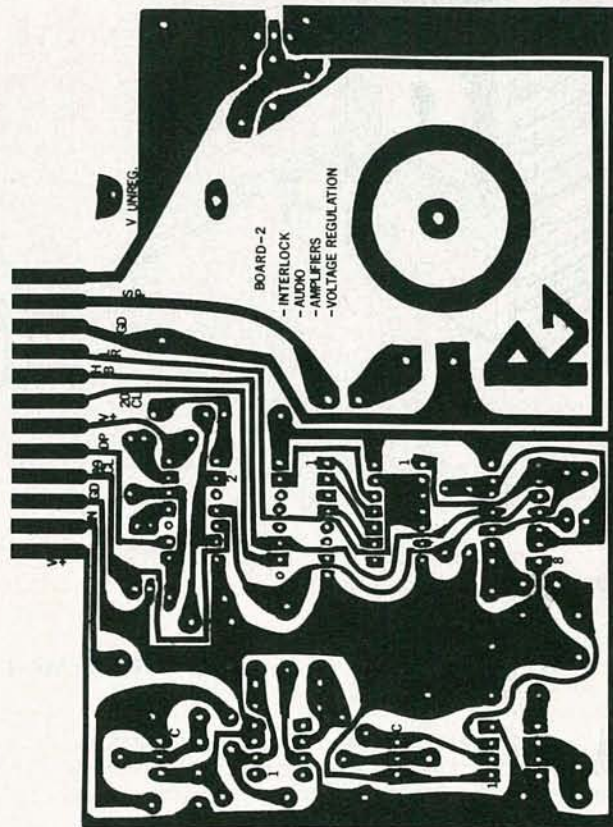

**EVEN THOUGH IT'S A GOOD JOB, this layout was obviously hand-drawn. Next month we'll do the layout by computer.**

when you reach that point, a good graphics editor becomes extremely important.

By the time the router finishes doing what it can, most of the traces will have been laid out, so adding the missing ones can turn out to be a tough job. In fact, if the graphics editor isn't very powerful, it can be an impossible job. You'll have to move and stretch many existing traces to be able to fit in the missing ones. And more than likely you'll want to re-route some of the work done by the router, because some of the paths it made may have overlooked more obvious routes. The reason for this is that the router doesn't think the way you do; *obvious* is a relative term.

#### Getting hardcopy

However the software goes about collecting and processing the data, eventually the layout must be put down on paper. It's all well and good to be able to take your circuit and generate a file that contains a description of the routed board, but the whole point of using a computer is lost if you can't get the answers out in a format you can use.

Just as you can enter data in several ways, you can get hardcopy output in several ways. You can send the image to a printer or a plotter and produce drawings for photochemical board production. Or you might want it in a data coordinate format to use with a numerical-control drilling machine. There are other options too, including files that can be processed further by other programs. And you must know before you start what you want by the time you're finished. So if you're considering a particular program, make sure it can provide the kind of output you want.

Next time we'll look at the capabilities of several programs. ▶◀

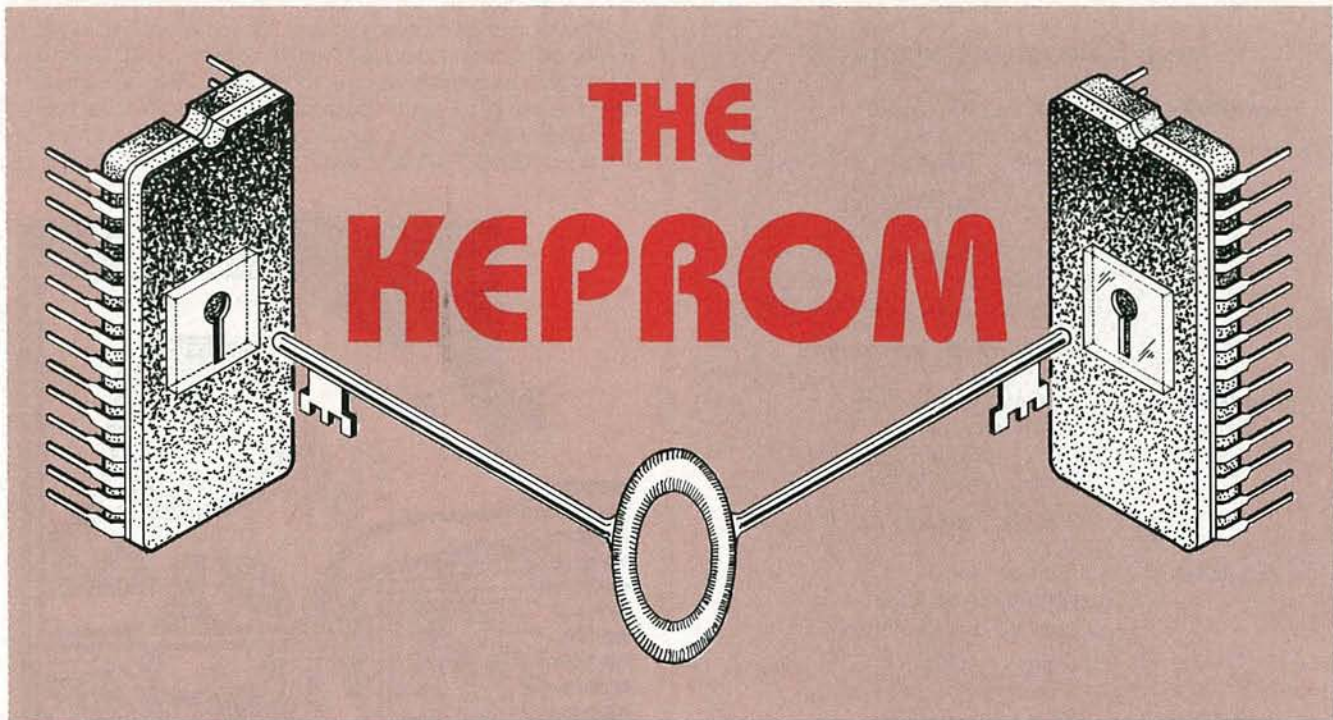

# Sinking The Software Pirates

JEFF HOLTZMAN, TECHNICAL EDITOR

Millions of dollars are lost every year because software pirates copy, use, and sometimes distribute popular computer programs. Until recently the usual method of protecting software from unauthorized distribution has been to provide that software on floppy disks that are copy-protected, or on special "key" disks that must be present whenever the program is running.

However, copy protection has not proven to be an effective means of halting the unauthorized usage and distribution of computer programs. Legitimate users find key disks inconvenient, but even more important, a number of companies sell programs that can copy so-called copy-protected disks with ease.

Intel Corporation (3065 Bowers Ave., Santa Clara, CA 95051) has come up with a hardware solution to the problem of copy protection. The solution involves use of two or more 27916 Keyed-access EPROM's (or KEPROM's for short). A factory-fresh 27916 functions just like a 27128 EPROM; the 27916 comes in a 28-pin package that is identical to that of a 27128. The 27916's pinout is shown in Fig. 1.

Inside, the 27916 contains 16,384 eight-bit bytes that may be programmed and erased using standard equipment and procedures. In addition, however, as shown in Fig. 2, the 27916 contains special circuitry that locks the KEPROM—that prevents all but a 528-byte boot area from being accessed until a special authentication sequence has been carried out. The authentication sequence involves the two-way transfer of an internally generated, 32-bit random number that is encrypted according to a designer-defined 64-bit key. If, after the transfer, the originating and receiving KEPROM's have not decrypted the same number, their memory arrays remain locked and unusable. Otherwise each functions just like a standard 27128 EPROM until the next power-down, or until a special reset code is received.

There are a number of ways of using the KEPROM's security features. Probably the most useful is to store the system's boot code in a KEPROM. Then, if the proper handshake sequence is not performed, the system will not come up. A limited number of users might have plug-in cartridges (computer game cartridges, for ex-

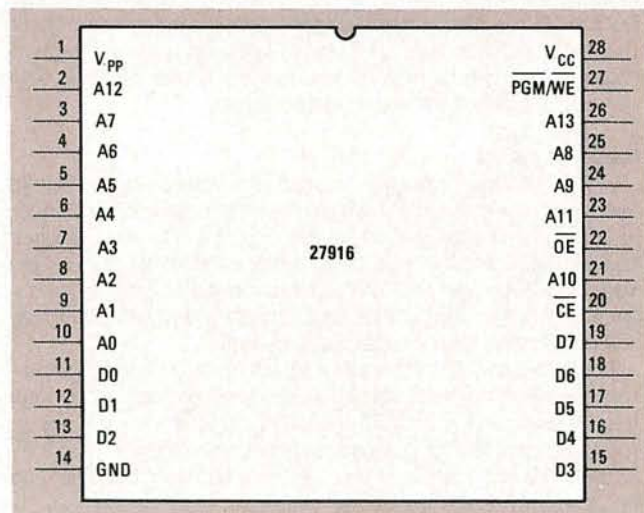

FIG. 3—THE PINOUT OF THE 27916 is functionally identical to that of the 27128.

ample), each of which would contain a KEPROM with the correct key. When a user inserted his cartridge, he would be able to boot the system. To perform that type of boot, both KEPROM's must have access to the data and address buses, as shown in Fig. 3.

A software publisher (like Microsoft) would find it difficult to use a KEPROM security system with present-day machines and a BASIC language program, for example. It takes two KEPROM's to perform the authentication handshake, so the BASIC cartridge should contain one KEPROM, and the other should be mounted on the system board. However, no present-day personal computers contain their boot software in KEPROM form. Retro fitting might be possible, but, to be most useful, a KEPROM-based security system must be designed in from the beginning.

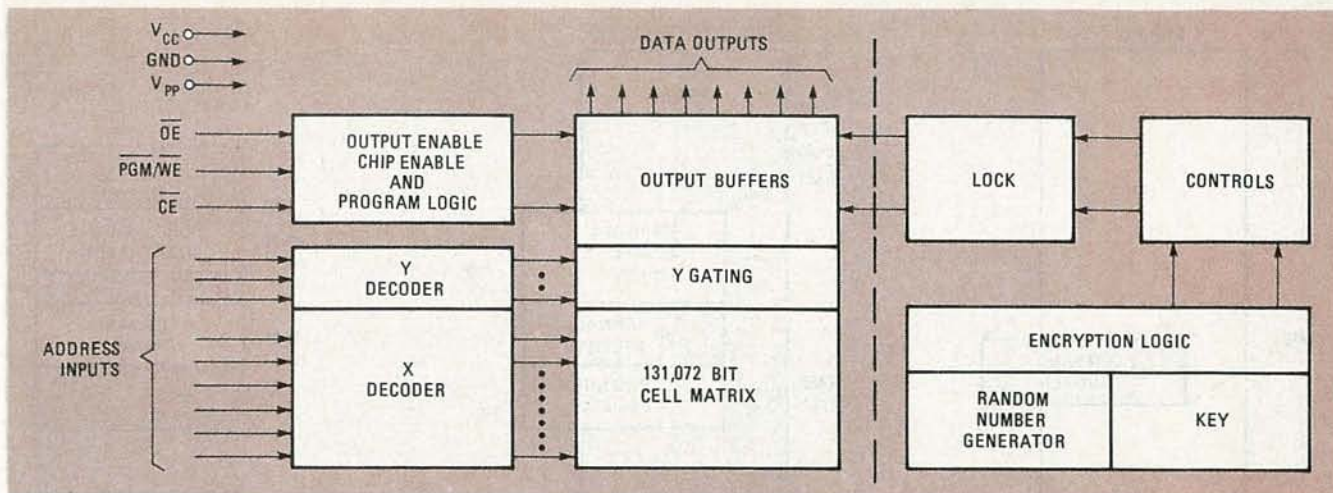

FIG. 2—BLOCK DIAGRAM OF THE 27916 reveals that half of the IC (shown to the left of the dashed line) is very similar to a standard EPROM. The other half (shown to the right of the dashed line) contains the extra logic, control, and memory cells.

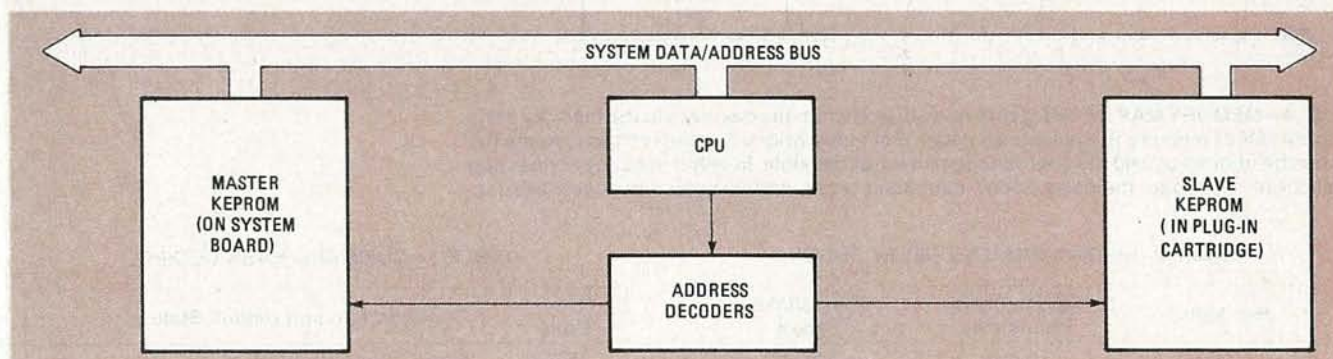

FIG. 3—A KEPRM-BASED SYSTEM requires normal access to the data and address buses.

### Configurations and states

A 27916 may be configured to operate in one of three different ways: as a 27128 EPROM, as a 27916 KEPRM, and as a 27916 Key Manager. As a 27128, no authentication process need be executed at power-up. But as a KEPRM or a Key Manager, the authentication process must be executed at power-up. As a Key Manager, the device can control as many as 1024 KEPRM's. In that configuration, the device holds 1024 eight-byte keys, so half of the 16,384-byte address space is unavailable for system and application software. Two programmable bits (that are not located in the regular 16,384-byte address space) determine the device's configuration.

When a 27916 is configured as a KEPRM or as a Key Manager, it can be in one of three different states: originator, recipient, or memory. It can enter the memory state only after the authentication process has been completed successfully. The other two states are used during authentication, which we'll discuss more fully below.

### Memory map

As shown in Fig. 4, the 27916 has a number of overlapping memory locations. As shown in Fig. 4-a, when a 27916 is in the memory state, and pin 24 is at a TTL high or low, the entire 16K of memory address space is available for normal read-only use. However, location 401 (all addresses are specified in hexadecimal notation) also contains a command register that controls the 27916's state. The possible states are listed in Table 1.

When a 27916 is in Originator or Recipient states, several other registers become accessible. Location 400 is an input/output register that is used to transfer the encrypted keys between two KEPRM's bit by bit. Locations 402 and 403 contain an optional key number that is used as an index, in a Key Manager system, to the proper key (of 1024 possible keys). Location 404 contains a Ready register that is used to synchronize key-bit transfers.

TABLE 1—COMMAND REGISTER CODES

Hex Value	Command
04	Enter Memory State
09	Enter Recipient State
31	Enter Originator State
29	Reset Default Recipient
31	Reset Default Originator
0B	Enter Recipient (Key-Manager Test)
33	Enter Originator (Key-Manager Test)
2B	Reset Default RE (Key-Manager Test)
33	Reset Default OR (Key-Manager Test)

Several additional registers become available when pin 24 (address line 9) is raised to 12 volts, as shown in Fig. 4-c. These locations need only be accessed during the manufacturing cycle, so you don't have to worry about 12-volt signals on your 5-volt system bus! Location 00 contains a manufacturer's code, and location 01 contains a device code. That information can be used by automatic programming machinery to select the proper programming voltages and algorithms.

Further, with pin 24 at 12 volts, a command mask register (location 401) and a programmable delay count register (location 405) can be written to. The delay count register determines the speed at which the authentication handshake occurs; legal values and corresponding handshake times are listed in Table 2. Slowing down the handshake process makes it more difficult for a would-be pirate to decode the sequence of operations.

The Command Mask Register controls the 27916's configuration

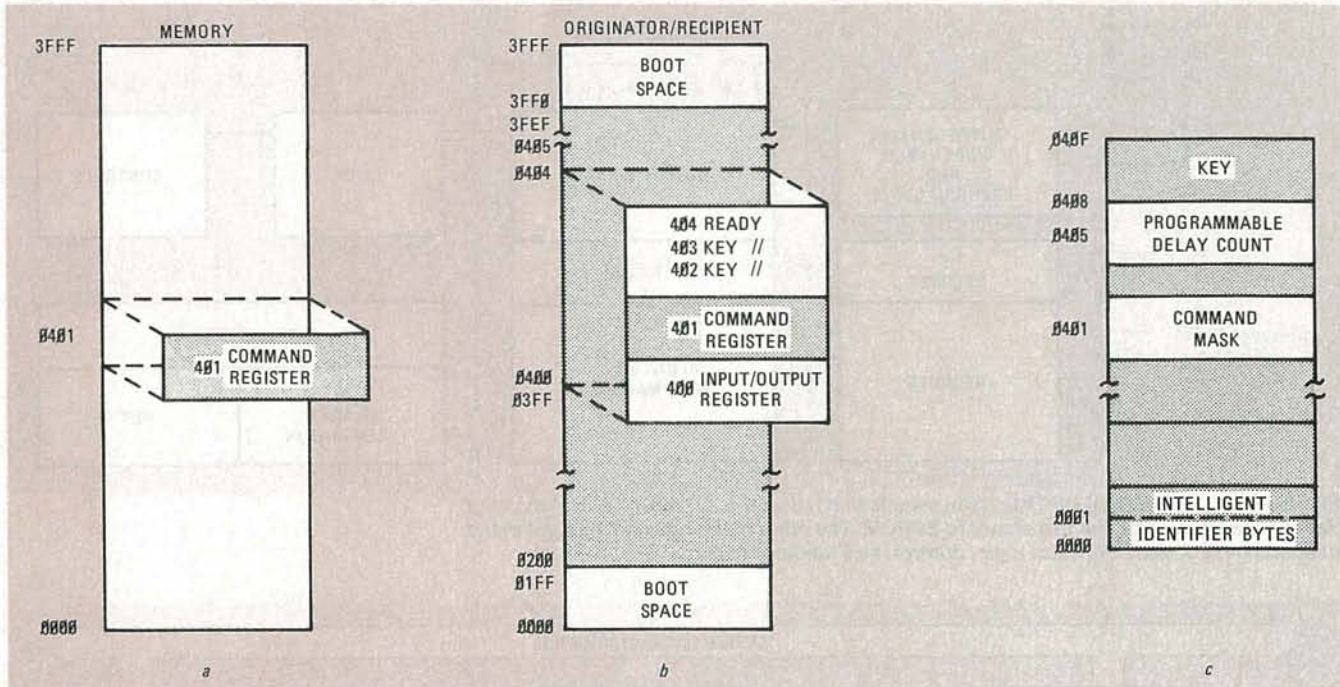

FIG. 4—MEMORY MAP OF THE 27916 reveals that when the device is in the memory state (a), all 16K of memory is available as usual. But in the originator and recipient states (b), only the boot areas and the control registers are accessible. In either state, by connecting pin 24 to +12 volts, the delay count, command mask, and ID bytes are accessible (c).

TABLE 2—PROGRAMMABLE DELAY CODES

Hex Value	Approximate Handshake	Handshake Speed
1F	10 sec.	Slowest
3F	6-8 sec.	Slower
7F	3-5 sec.	Slow
FF	0.15 sec.	Fast

(KEPROM, 27128, or Key Manager). It, by the way, is the third register that can be accessed at location 401; the normal memory cell and the command register are the other two. Legal values and corresponding configurations are shown in Table 3. Bit 0 of the Command Mask Register is the lock bit; bit 1 is the manager bit. If either bit is programmed with a value of 0, the 27916 cannot be read without first executing an authentication sequence. If the manager bit is programmed with a value of 0, the 27916 enters the Key Manager configuration. The lock bit is erasable, but the manager bit is not. Hence the Key Manager configuration is permanent.

### The authentication handshake

The overall system boot-up process is outlined in Fig. 5. First the two 27916's must be reset by writing the appropriate reset code (as shown in Table 1) to the command register. One 27916 goes into the originator state, and the other goes into the recipient state, according to the contents of their command masks (as shown in Table 3). The originator then generates a 32-bit random number and places a 00 in its ready register. The CPU reads a byte from the I/O register, polls the recipient's ready register, and transfers the byte to the recipient when it is ready. Although an entire eight-bit byte is transferred, only one bit is significant, so 32 separate transfers must take place to transfer the entire key.

The recipient encrypts the number according to its key, and then sends that number to the originator, using the same type of polling sequence. The originator then encrypts the original number and compares the two encrypted numbers. If they are equal, which they will be if the originator's and the recipient's keys are identical, the recipient can be placed in the memory state. Then the two

TABLE 3—COMMAND MASK CODING

Hex Code	Configuration and Default State
E0	Locked Key-Manager— Default Recipient
E1	Not Locked Key-Manager— Default Recipient
E2	Locked KEPROM— Default Recipient
E3	Not Locked KEPROM— Default Recipient
E4	Locked Key-Manager— Default Originator
E5	Not Locked Key-Manager— Default Originator
E6	Locked KEPROM— Default Originator
E7	Not Locked KEPROM— Default Originator

devices swap roles and the process repeats. If the numbers match, the new recipient can be placed in the memory state.

### The key

The key used to encrypt the random number is 64 bits long; hence there are about  $10^{19}$  possible keys. That fact alone makes it difficult for the would-be pirate to attempt to determine the key. The eight key bytes are programmed into memory locations 408–40F. After the 27916 is configured as a KEPROM or a Key Manager, the key bytes are completely inaccessible to the outside world.

### Usage considerations

First the 27916's normal memory space should be programmed, keeping in mind that the first 512 bytes must be used to perform the authentication sequence. The upper bytes of the 27916 (3FF0–3FFF) are also reserved for use with microprocessors like the 6502 whose reset and interrupt sequences use vectors in that area.

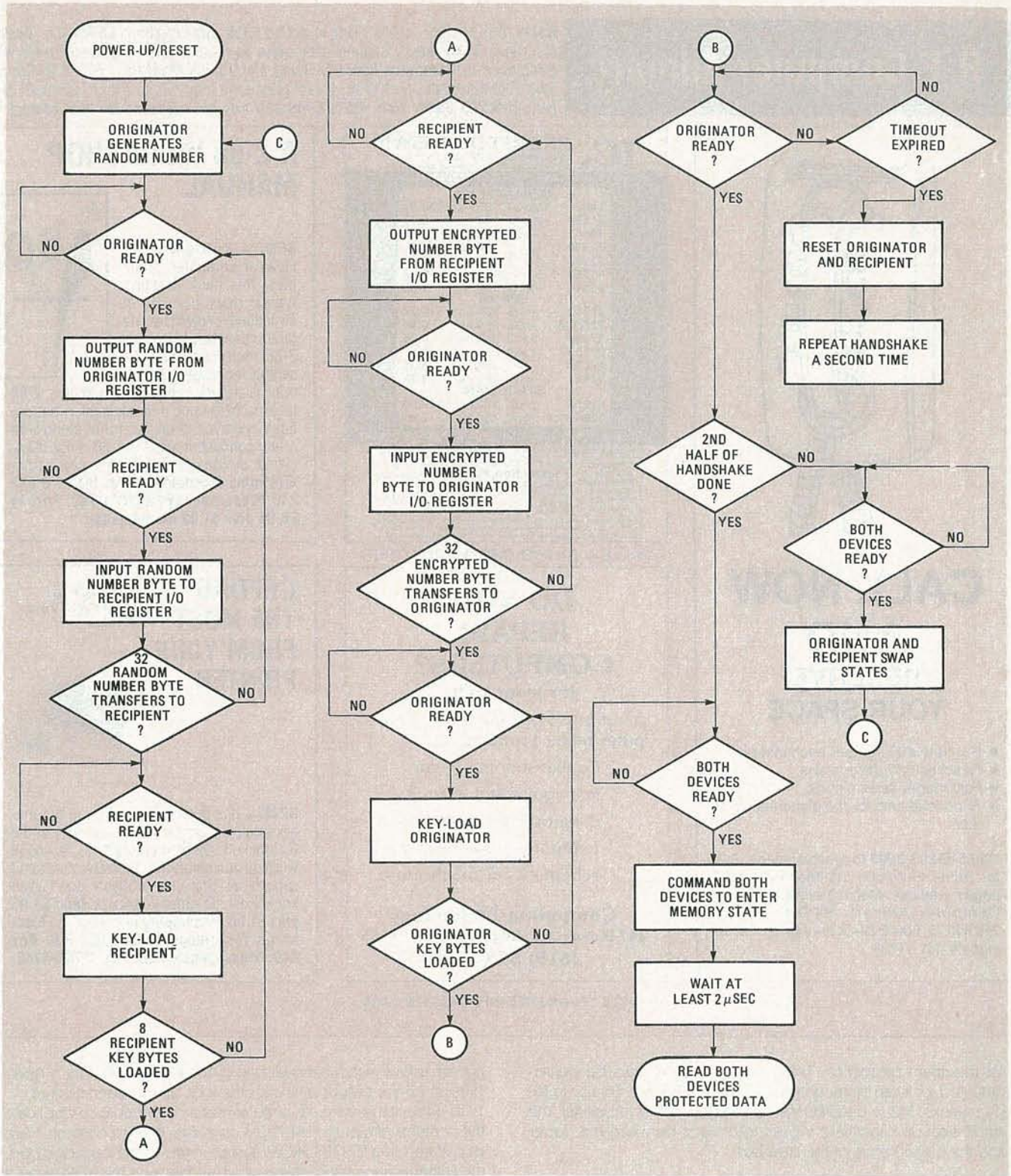

FIG. 5—FLOW CHART illustrates the proper boot-up sequence to enable the originator and recipient KEPROM's.

Then the Programmable delay counter should be programmed, if desired, and verified. The key (and the key number, if used) are programmed and verified next. Only then should the command mask be programmed. After that, the device will be locked, and access to its contents can only be gained after an authentication handshake. The Delay Counter, the Key bytes, the Key number, and the command mask are programmed more or less the same as normal, but pin 24 (A9) is connected to a 12-volt source.

As for hardware considerations, Intel recommends connecting a 0.1- $\mu$ F capacitor between  $V_{CC}$  and ground near each 27916, and one 4.7- $\mu$ F tantalum capacitor for every eight 27916's to compensate for voltage droop due to PC-trace inductance. The 27916 has a 250-ns access time, so it should be fully compatible with standard EPROM circuits and layouts.

Intel recommends that the 27916 in which the boot code is located should be soldered, and perhaps glued, to the PC board

# R-E Computer Admart

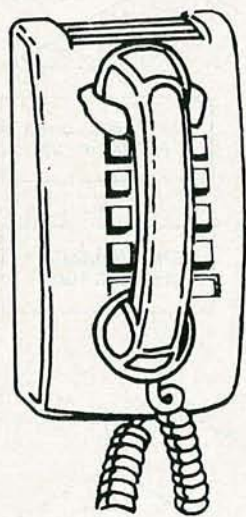

## CALL NOW AND RESERVE YOUR SPACE

- 6 × rate \$800.00 per each insertion.
- Reaches 239,312 readers.
- Fast reader service cycle.
- Short lead time for the placement of ads.

Call 516-293-3000 to reserve space. Ask for Arline Fishman. Limited number of pages available. Mail materials to: Computer Admart, RADIO-ELECTRONICS, 500-B Bi-County Blvd., Farmingdale, NY 11735.

Rates: Ads are 2 1/4" × 2 7/8". One insertion \$825. Six insertions \$800 each. Twelve insertions \$775. each. Closing date same as regular rate card. Send order with remittance to Computer Admart, Radio Electronics Magazine, 500-B Bi-County Blvd., Farmingdale, NY 11735. Direct telephone inquiries to Arline Fishman; area code 516-293-3000. Only 100% Computer ads are accepted for this Admart.

## ICs PROMPT DELIVERY!!!

SAME DAY SHIPPING (USUALLY)  
QUANTITY ONE PRICES SHOWN FOR MAR. 22, 1987  
OUTSIDE OKLAHOMA - NO SALES TAX

DYNAMIC RAM		
1Mbit	1000Kx1	100 ns \$30.00
51258	*256Kx1	100 ns 6.95
4464	64Kx4	150 ns 3.24
41256	256Kx1	100 ns 3.25
41256	256Kx1	120 ns 2.59
41256	256Kx1	150 ns 2.39
4164	64Kx1	150 ns 1.30
EPROM		
27512	64Kx8	200 ns \$11.75
27C256	32Kx8	250 ns 4.95
27256	32Kx8	250 ns 4.75
27128	16Kx8	250 ns 3.50
27C64	8Kx8	150 ns 4.85
2764	8Kx8	250 ns 3.25
STATIC RAM		
62256	32Kx8	120 ns \$12.95
6264LP-15	8Kx8	150 ns 2.95

640K MOTHERBOARD UPGRADE: Zenith 150, IBM PC XT, Compaq Portable & Plus; hp Vectra

\* STATE CALICLING FOR INFO COMP 8087 5 Mhz \$115.00 80287-8 8Mhz \$260.00

OPEN 6 1/2 DAYS, 7 AM-10 PM SHIP VIA FED-EX ON SAT

SUNDAYS & HOLIDAYS: SHIPMENT OR DELIVERY, VIA U.S. EXPRESS MAIL  
MasterCard VISA or UPS CASH COD  
Factory New, Prime Parts  $\mu$ P $\infty$   
MICROPROCESSORS UNLIMITED, INC.  
24,000 S. Peoria Ave. (918) 267-4961  
BEGGS, OK. 74421  
No minimum order. Please note that prices are subject to change. Shipping & insurance extra. & up to \$1 for packing materials. Orders received by 9 PM CST can usually be delivered the next morning, via Federal Express Standard Air @ \$6.00, or guaranteed next day Priority One @ \$13.00! All parts guaranteed.

CIRCLE 61 ON FREE INFORMATION CARD

## DO YOU REPAIR COMPUTERS? (or want to?)

Your one-stop source for computer repair products:

- trouble-shooting guides
- test equipment & tools
- diagnostic programs
- computer repair courses
- schematics & much more

**Computing Technology**  
247 Balsam St. Ridgecrest, CA 93555  
(619) 375-5744

CIRCLE 199 ON FREE INFORMATION CARD

## A Z-80 WORKSHOP MANUAL



BP112—Starting with a review of computer principles, this book describes typical machine-code instructions followed by a detailed description of the Z-80 instruction set. Assembly language programming is also discussed with examples. Z-80 hex machine-code and assembler instructions are given in tabular form, along with in-our connections for the Z-80 and its associated devices... Order your copy from **Electronic Technology Today Inc., PO Box 240, Massapequa Park, NY 11762. Price is \$6.95 plus \$1.00 for shipping.**

## GETTING THE MOST FROM YOUR PRINTER

Getting The Most From Your Printer



BP181—It is probable that 80% of dot-matrix printer users only ever use 20% of the features offered by their printers. This book will help you unlock the special features and capabilities that you probably don't even know exist. To order your copy send **\$6.95 plus \$1.50 for shipping** in the U.S. to **Electronic Technology Today Inc., P.O. Box 240, Massapequa Park, NY 11762-0240.**

for maximum protection. The "slave" 27916 can also be board-mounted, or it can be mounted in a plug-in cartridge. For use in 16-bit systems, the two KEPROM's can be connected in parallel; the authentication handshake would take place between the upper and the lower halves of the data bus.

### How safe is a KEPROM?

It might be possible, using a scanning electron microscope and other highly sophisticated equipment, to take a 27916 apart and duplicate the code it contained. Few people have access to that sort of equipment, but for military and other security-sensitive uses, the possibility that a KEPROM could be disassembled must be taken into account.

Another way of cracking a KEPROM involves using a logic analyzer. One could be attached to the system bus of a target computer and used to record the contents of the various memory devices in a system as they were accessed. But even if the complete contents of a locked memory system were obtained, they would

not be useful without knowledge of the key, and the key is never present on the output pins after the lock bit has been cleared.

To understand why, suppose someone were able to duplicate the contents of a plug-in KEPROM cartridge. If those contents were duplicated in a 27128 EPROM and plugged in the cartridge port, the authentication handshake would fail, because the 27128 would not echo the encrypted random number.

You might think that the recovered contents could be transferred to a blank KEPROM, and the key somehow discerned. But how? It would take (literally!) centuries to try all possible  $10^{19}$  keys one by one. Other methods using statistical analyses could be tried, or the key might be arrived at by cracking the encryption algorithm, but both are highly unlikely to yield results.

It's ironic that, just at the time when major software publishers like Microsoft and Ashton-Tate are dropping floppy-disk copy protection, Intel has developed the 27916. Whether those publishers will adopt hardware protection remains to be seen. It's highly unlikely that users will be happy with using plug-in cartridges.  $\blacklozenge$

# MARKET CENTER

## FOR SALE

**WHOLESALE** car-radio computer telephone audio video accessories antenna catalog (718) 897-0509 **D&WR**, 68-12 110th St., Flushing, NY 11375.

**RESTRICTED technical information:** Electronic surveillance, schematics, locksmithing, covert sciences, hacking, etc. **Huge selection. Free brochure MENTOR-Z**, 135-53 No. Blvd., Flushing, NY 11354.

## CLASSIFIED AD ORDER FORM

To run your own classified ad, put one word on each of the lines below and send this form along with your check to:

**Radio-Electronics Classified Ads**, 500-B Bi-County Boulevard, Farmingdale, NY 11735

**PLEASE INDICATE** in which category of classified advertising you wish your ad to appear. For special headings, there is a surcharge of **\$23.00**.

( ) Plans/Kits ( ) Business Opportunities ( ) For Sale  
( ) Education/Instruction ( ) Wanted ( ) Satellite Television

Special Category: \$23.00

### PLEASE PRINT EACH WORD SEPARATELY, IN BLOCK LETTERS.

(No refunds or credits for typesetting errors can be made unless you clearly print or type your copy.) Rates indicated are for standard style classified ads only. See below for additional charges for special ads. **Minimum: 15 words.**

1	2	3	4	5
6	7	8	9	10
11	12	13	14	15 (\$42.75)
16 (\$45.60)	17 (\$48.45)	18 (\$51.30)	19 (\$54.15)	20 (\$57.00)
21 (\$59.85)	22 (\$62.70)	23 (\$65.55)	24 (\$68.40)	25 (\$71.25)
26 (\$74.10)	27 (\$76.95)	28 (\$79.80)	29 (\$82.65)	30 (\$85.50)
31 (\$88.35)	32 (\$91.10)	33 (\$94.05)	34 (\$96.90)	35 (\$99.75)

We accept MasterCard and Visa for payment of orders. If you wish to use your credit card to pay for your ad fill in the following additional information (Sorry, no telephone orders can be accepted.):

Card Number

Expiration Date

Please Print Name

Signature

**IF YOU USE A BOX NUMBER YOU MUST INCLUDE YOUR PERMANENT ADDRESS AND PHONE NUMBER FOR OUR FILES. ADS SUBMITTED WITHOUT THIS INFORMATION WILL NOT BE ACCEPTED.**

**CLASSIFIED COMMERCIAL RATE:** (for firms or individuals offering commercial products or services) \$2.85 per word prepaid (no charge for zip code)...**MINIMUM 15 WORDS.** 5% discount for same ad in 6 issues; 10% discount for same ad in 12 issues within one year; if prepaid. **NON-COMMERCIAL RATE:** (for individuals who want to buy or sell a personal item) \$2.30 per word, prepaid....no minimum. **ONLY FIRST WORD AND NAME** set in bold caps at no extra charge. Additional bold face (not available as all caps) **50¢ per word additional (20% premium).** Entire ad in boldface, add **20% premium** to total price. **TINT SCREEN BEHIND ENTIRE AD:** add 25% premium to total price. **TINT SCREEN BEHIND ENTIRE AD PLUS ALL BOLD FACE AD:** add 45% premium to total price. **EXPANDED TYPE AD:** \$4.30 per word prepaid. All other items same as for STANDARD COMMERCIAL RATE. **TINT SCREEN BEHIND ENTIRE EXPANDED TYPE AD:** add 25% premium to total price. **TINT SCREEN BEHIND ENTIRE EXPANDED TYPE AD PLUS ALL BOLD FACE AD:** add 45% premium to total price. **DISPLAY ADS:** 1" x 2 1/4" — \$320.00; 2" x 2 1/4" — \$640.00; 3" x 2 1/4" — \$960.00. **General Information:** Frequency rates and prepayment discounts are available. **ALL COPY SUBJECT TO PUBLISHERS APPROVAL. ADVERTISEMENTS USING P.O. BOX ADDRESS WILL NOT BE ACCEPTED UNTIL ADVERTISER SUPPLIES PUBLISHER WITH PERMANENT ADDRESS AND PHONE NUMBER.** Copy to be in our hands on the 12th of the third month preceding the date of the issue. (i.e., August issue copy must be received by May 12th). When normal closing date falls on Saturday, Sunday or Holiday, issue closes on preceding working day.

**DESCRAMBLER** catalog all makes. Special combo Jerrold 400 and SB3 \$165. New cable descrambler kit \$39.00 (assembles in half hour). Send \$1.00. **MJ INDUSTRY**, Box 531, Bronx, NY 10461.

**TUBES!** 59¢. Year guarantee. Free catalog. Tube tester \$8.95. **CORNELL**, 4215 University, San Diego, CA 92105.

**TI-99/4A** software/hardware bargains. Hard-to-find items. Huge selection. Fast service. Free catalog **DYNA**, Box 690, Hicksville, NY 11801.

**VIDEO** scrambling techniques. The original "secret manual" covers sinewave, gatedpulse, and SSAVI systems. 56 pages of solid, useful, legible information. Only \$14.95. **ELEPHANT ELECTRONICS, INC.**, Box 41865-J, Phoenix, AZ 85080. (602) 581-1973.

**IS it true...**Jeeps for \$44 through the government? Call for facts! **1 (312) 742-1142**, ext. 4673.

**OLDTIME** radio programs on high quality tapes. Comedy! Adventure! Music! Free catalog. **CARL F. FROELICH**, Heritage Farm, New Freedom, PA 17349.

**LINEAR PARTS—transistors:** MRF454 \$15, MRF455 \$12, MRF477 \$11, MRF492 \$16.75, MRF421 \$22.50, SRF2072 \$13, SRF3662 \$25, 3800 \$18.75, 2SC2290 \$19.75, 2SC2879 \$25. **Tubes:** 6KD6 \$10.50, 6LQ6 \$9.75, 6LF6 \$9.75, 8950 \$16.75. Best prices on Palomar road noise mics, Ranger AR3300. New 16-page catalog listing radio/amplifier tricks—channel modification, PLL-sliders, peaking for range, hard-to-find linear parts—mail \$1.00 to: **RFPC**, Box 700, San Marcos, CA 92069. For same day parts shipment, call (619) 744-0728.

## CB RADIO OWNERS!

We specialize in a wide variety of technical information, parts and services for CB radios. 10M-FM conversions, repairs, books, plans, kits, high-performance accessories. Our 11th year! Catalog \$2.

**CBC INTERNATIONAL, P.O. BOX 31500RE, PHOENIX, AZ 85046**

**TV** tunable notch filters, free brochure. **D.K. VIDEO**, Box 63/6025, Margate, FL 33063. (305) 752-9202.

**FREE** power supply with **Assortment #103** (February '84 article, has printed circuit, TOKO coils(4), 2N3904(2), BFQ85, 7812, 74123, MC1330, 1N914, 1N5231B. **TELE-ASE-MAST ASSORTMENT #301** (October Article) Printed Circuit with all IC's, transistors, diodes. **Only \$25.00/each assortment. Five/\$112.50.** Shipping \$3.00. **1 (800) 821-5226 Ext. 426.** (orders) or write **JIM RHODES INC., P.O. Box 3421, Bristol, TN 37625.**

**TUBES**, name brands, new, 80% off list. **KIRBY**, 298 West Carmel Drive, Carmel, IN 46032.

**INDIVIDUAL** Photofact-folders #1 to #1400. \$3.00 postpaid. **LOEB**, 414 Chestnut Lane, East Meadow, NY 11554.

**VIDEO** copier (\$69.95) connects between two VCR's (stereo) and makes copies as good as the original. For info/order write or call **VIDEO VIBES**, 657 Ailerton Ave., Bronx, NY 10467. Tel. (212) 653-4644.

**NOTICE!** light controllers, rope lights, etc. Flyer \$1.00 **DESIGN SPECIALTY**, 2213 Chesley Dr., San Jose, CA 95130.

**TUNABLE** notch filters. Channels 2, 3, and 4 available. Send \$15 for sample. Specify channel. Money back guarantee. **DB ELECTRONICS**, P O Box 8644, Pembroke Pines, FL 33084.

**OLD** radio TV schematics. Send \$1.00, make, model. **RADIO MAPS**, P O Box 791, Union City, CA 94587.

**CHANNEL 3**—60db notch filter, 63.5MHz, \$19.95. All other channels \$29.95. Cable converter and accessory catalog \$1. (514) 739-9328. **CROSLY(A)**, Box 840, Champlain, NY 12919.

**ATTENTION** looking for surplus test equipment signal generator voltmeter oscilloscope. **J.B. ELECTRONICS**, 9518 Grand, Franklin Park, IL 60131.

**DECODE** nearly any gated pulse signal with our new super simple circuit. Works on In-band, Out-band, AM or FM pilot tone—use with Hamlin, Jerrold, Sylvania. Complete plans and theory only \$13.50 plus \$1.50 P&H. **ELEPHANT ELECTRONICS INC.**, Box 41865-J, Phoenix, AZ 85080. (602) 581-1973.

**INTEL, RCA, National, OKI, SGS**, and more. Factory prime and surplus parts catalog. **LYNBAR INDUSTRIES**, 205 Main, Box 822, St. Joseph, MI, 49085-0822.

**TEST** equipment, reconditioned. For sale. \$1.25 for catalog. **WALTER'S**, 2697 Nickel, San Pablo, CA 94806. (415) 724-0587.

THE BEST PLACE to BUY, SELL or TRADE NEW and USED EQUIPMENT  
**NUTS & VOLTS MAGAZINE**  
BOX 1111-E • PLACENTIA, CA 92670  
(714) 632-7721  
Join Thousands of Readers Nationwide Every Month  
**ONE YEAR U.S. SUBSCRIPTIONS**  
\$10.00 - 3rd Class • \$15.00 - 1st Class  
\$35.00 - Lifetime - 3rd Class

**NUTS & VOLTS**  
HAM GEAR COMPUTERS SOFTWARE SCANNERS • OPTICS TEST EQUIPMENT MICROWAVE SATELLITE AUDIO VISUAL NEW PRODUCTS COMPONENTS • KITS ANTIQUE ELECT. PUBLICATIONS PLANS • SERVICES

**USED** electronics, physics, mechanical, military, mathematics. Books, manuals, magazines, catalogs. 10 page list \$1.00: **SOFTWARE**, 1515 Sashabaw, Ortonville, MI 48462.

**THE AES-XT** compatible: completely assembled and tested, includes monitor and keyboard. One year warranty. \$699.00 + shipping. **ADVANCED ELECTRONICS**, 111 Bayou Bend Circle, Carencro, LA 70520. (318) 896-7248.

### PHONE RECORDER CONTROL

- Automatically records phone conversations when receiver is lifted.
- Interfaces your phone to any tape recorder.
- Meets all FCC requirements.
- Guaranteed to work.

Send 19.95 plus 3.00 shipping & handling to VISA, MASTER CHARGE, or COD to: **ELECTRONIC DEVICES**, 2429 Central Ave. St. Petersburg, FLA. 33173. Dealer inquiries welcomed.



**OSCILLOSCOPES** and reconditioned test equipment, Tektronix, H.P., etc. Free list. **CAL-SCOPE**, 983D Ponderosa Ave., Sunnyvale, CA 94086 (408) 730-4573.

**WANTED:** Western Electric, McIntosh, Marantz, RCA, Dynaco, Altec, Telefunken, JBL, tubes, speakers, amplifiers, (713) 728-4343. **MAURY**, 11122 Atwell, Houston, TX 77096.

**ZENITH, SSAVI**, ready to go \$100.00 plus shipping, order C.O.D. 1 (305) 752-9202.

**ROBOT!** kits. Books and Plans! Learn to build your own robots. Free catalogs contain hundreds of affordable robot systems. Explore the world of robotics today. Catalog: **CEARGS-ROBOTS!**, POB 458, Peterborough, NH 03458. (603) 924-3843.

**CB Tune-up manual Volume II.** Specific adjustments, modifications for peaking all popular CBs. Covers over 1300 radios. \$19.95, Visa, MasterCard to: **THOMAS PUBLISHING**, 127-R Westwood, Paris, IL 61944.

**POWER mosfet transistors.** First quality. Send stamped envelope for list. **ANZA INSTRUMENT CO.**, Box 60907, Palo Alto, CA 94306.

**GEARMOTORS!** 6-33 RPM at 3-12V, high torque robotics/hobby gearmotor, \$8.95 Ppd. **WHITE MFG.**, Box 2724, Taunton, MA 02780.

**PROPAGANDA broadcast tapes!** Authentic, rare recordings of WW-II shortwave broadcasts by "Tokyo Rose", "Axis Sally", others. Cassette \$9.95. **D-W RESEARCH**, 4548 Auburn Blvd., #231-C, Sacramento, CA 95841.

**FLASHLIGHT/screwdriver** light up your work, 5 interchangeable heads, 7" long, \$7.00 value only \$4.50. Batteries not included. **VANDY'S GIFTS**, 2311 Kentucky Street, Dept. 1, Racine, WI 53405. Satisfaction Guaranteed.

**AUCTION:** new WWII radio receivers, amplifiers, testers, etc. Antique furniture, glassware, bottles, etc. Send/call for listing. **CVAR**, PO Box 472, Hibbing, MN 55746. (218) 262-2320.

**THE workbench companion** a practical guide to TV tough dogs. RE ES ETD Indexes. Special tests for int. Flybacks and much more. \$29.95 plus \$2.50 S&H **FARRELL ELECTRONICS**, 127 Providence Ave., South Portland, ME 04106.

**CABLE TV equipment.** All major brands. Specializing in Scientific Atlanta, Jerrold, and Zenith, add-ons. Our units have worked where others have failed. Send \$3.00 for catalog to **K.D. VIDEO**, P.O. BOX 29538, MLPS, MN 55429.

**PLOTTER**, build your own. Software driven, two 1.8 degree steppers, pen up/down, RS232C, uses HPGL, has digitize mode. Maximum 32768 steps X and Y. You get 2 motors, CPU board assembled, power supply board and drawings to build a complete plotter. Send \$228.00 U.S. or \$295.00 Cdn, shipped UPS prepaid. **B-C-D ELECTRONICS**, P.O. Box 6326 Station F, Hamilton Ontario, Canada, L9C-6L9.

**CABLE television converter, descrambler and wireless remote control video equipment accessories catalog free.** **CABLE DISTRIBUTORS UNLIMITED**, 116- Main Road, Washington, AR 71862.

**Z-TAC** Zenith cable unit only \$175.00. Buy 5 at only \$150.00, or 10 at only \$125.00. These units do not use block converters, we install our own VHF tuner for excellent picture quality. UPS daily. COD accepted. All others shipped 2nd day air. 90 day warranty on units. Call for information or free catalog or write **AMCOM**, PO Box 68391, Virginia Beach, VA 23455. Phone: (804) 456-5505.

**Parts Express** INTERNATIONAL INC. HARDWARE AND ELECTRONICS

---



**MAGNIFIER LAMP**  
• 4" diopter magnifying lens  
• Uses up to a 60 watt bulb (not included). UL listed, 117VAC.  
#350-010 **\$2695**

**COPPER CLAD PC BOARD**

9" x 8" Double Sided #055-300	<b>\$150</b>
18" x 12" Double Sided #055-320	<b>\$395</b>



**RS-232 DATA SWITCH**  
• 2 position, rotary type • Fully shielded, FCC approved.  
#130-010 **\$2795**



**PIONEER HORN TWEETER**  
• Frequency response: 1800 to 15,000Hz • Power handling capabilities: 35W RMS, resonant frequency 2 kHz. 3 1/2" x 3 1/2".  
#270-050 **\$650** (1-8) **\$590** (10-UP)



**12" PIONEER WOOFER**  
• Power: 65W RMS • 11 oz. magnet  
• 25 to 2500 Hz response • 1 1/2" voice coil  
#290-100 **\$1550** (1-3) **\$1395** (4-10)



**TOROIDAL TRANSFORMER**  
• 120 volt primary, 2 - 20V, 5A secondaries. • 4 1/2" round • 4 lbs.  
#120-150 **\$1250** (1-3) **\$995** (4-UP)

**FREE CATALOG**

Our new 56 page catalog contains thousands of items that you need every day for do-it-yourself projects, product engineering, electronics repair and more. Call us today for your free copy and start saving!



**300 PIECE CAPACITOR KIT**



• A great assortment of different values and working voltages. Includes electrolytics, ceramics, mylars, and more!  
#020-920 **\$495**

---

**CALL TOLL FREE 1-800-255-3525**

In Ohio: 1-800-322-3525  
Local: (513) 222-0173

**PARTS EXPRESS INT'L INC.**  
340 East First St.  
Dayton, Ohio 45402



CIRCLE 195 ON FREE INFORMATION CARD

**WRITE FOR**  
**McGEE'S**  
**SPEAKER & ELECTRONICS CATALOG**  
1001 BARGAINS IN SPEAKERS  
toll free 1-800-346-2433 for ordering only.  
1901 MCGEE STREET KANSAS CITY, MO. 64108

**TUBES:** "Oldest," "latest". Parts and schematics. SASE for list. **STEINMETZ**, 7519 Maplewood Ave., RE Hammond, IN 46324.

**LASERS**, components and accessories. Free catalog, **M.J. NEAL COMPANY**, 6672 Mallard Ct., Orient, OH 43146.

**CABLE TV converters.** Scientific Atlanta, Jerrold, Oak, Zenith, Hamlin. Many others. "New" Video Hopper "The copy killer". Visa, M/C & Amex accepted. Toll free 1 (800) 826-7623. **B&B INC.**, 10517 Upton Circle, Bloomington, MN 55431.

**CABLE TV blowout viewstar 2501 volume, audio video ports, decoder loop, 129.95 buy a decoder take off \$10.00.** Star base decoder 1 \$99.00, 10 \$75.00, tri mode/bi state 1 \$100.00, 10 \$75.00, MLD 1200-3 1 \$9.00, 10 \$65.00, N-12 replacement 1 \$99.00, 10 \$61.00, better than original. Auto on off boards 1 \$65.00, 10 \$45.00, Scientific Atlanta decoder 1 \$140.00, 10 \$104.00, Pioneer 5000 decoder 1 \$140.00, 10 \$104.00, much more. Call or write for your free catalog, (402) 331-4957. All products guaranteed 90 days. **M.D. ELECTRONICS**, 5078 So. 108th #115, Omaha, NE 68108.

### PLANS AND KITS

**BUILD** this five-digit panel meter and square wave generator including an ohms, capacitance and frequency meter. Detailed instructions \$2.50. **BAGNALL ELECTRONICS**, 179 May, Fairfield, CT 06430.

**FREE catalog 99-cent kits**—audio, video, TV, computer parts. **ALLKIT**, 434 W. 4th St., West Islip, NY 11795.







**DESCRAMBLE** the latest video cassette copy protection scheme. Our simple Line Zapper circuit takes the jitter out of your picture. Complete plans and theory only \$13.95 plus \$1.50 postage and handling. PC board and complete kits also available. **ELEPHANT ELECTRONICS, INC.**, Box 41865-J, Phoenix, AZ 85080. (602) 581-1973.

**HI-FI speaker systems**, kits and speaker components from the world's finest manufacturers. For beginners and audiophiles. Free literature. **A&S SPEAKERS**, Box 7462, Denver, CO 80207. (303) 399-8609.

**VOICE** disguisers! FM bugs! SWL active antenna Receivers! More! Catalog \$1.00 (refundable). **XANDER ELECTRONICS**, Box 25647, Dept. 60M, Tempe, AZ 85282.

**\$14.95 COMPLETE REMOTE CONTROL KEYCHAIN+RECVR**  
100'S OF REMOTE PROJECTS COMPLETE W/ TRANSMITTER AND +3-15 VDC RECEIVER 30 DAYS RETURN POLICY CHECK, VISA OR M/C  
VISITECT INC. (415) 872-0128  
PO BOX 5442, SO.SAN FRAN. CA 94083-5442

**AMPLIFIER** breakthrough—the current amplifier drives loads push-pull without internal voltage gain. Fastest, quietest circuit in transistor electronics. Op amps now drive speakers. Plans for quieter, easier to construct audio amplifiers, all wattages, \$15. **AMPLIFIERS UNLIMITED**, Rt 2, Box 139, Highmore, SD 57325.

**STRANGE stuff**. Plans, kits, new items. Build satellite dish \$69.00. Descramblers, bugs, adult toys. Informational photo package \$3.00 refundable. **DIRIJO CORPORATION**, Box 212, Lowell, NC 28098.

**HOT** selling electronic products complete designs, schematics, marketing plans. Hobby? Profit? \$5.00 **NRG**, 11580 Oakhurst Rd., Largo, FL 33544.



**REMOVES VOCALS FROM RECORDS!**  
Now You can sing with the world's best bands!  
The Thompson Vocal Eliminator can remove most or virtually all of a lead vocal from a standard stereo record and leave the background!  
Write or call for a free brochure and demo record.  
**LT Sound, Dept. R-1, P.O. Box 338, Stone Mountain, GA 30086 (404) 493-1258**

**REMOTE** controlled car starters, garage door openers, vehicle security system, satellite systems. Send \$20.00 SASE: **HI-TECH INNOVATIONS**, RR1 Box 933, Sierra Vista, AZ 85635.

**ELECTRONIC** projects, components, PCB supplies, test instruments. Oscilloscopes \$219.00, multimeters \$7.95, power supplies \$69.95. Resistors 1 cent. 2 year guarantee. Call or send SASE for free catalog. **T.O.R.C.C.**, 1131 Tower, Schaumburg, IL 60195. (312) 490-1374.

**CABLE** television converter, descrambler and wireless remote control video equipment accessories catalog free. **CABLE DISTRIBUTORS UNLIMITED**, 116-P Main Road, Washington, AR 71862.

**CLOCK** for IBM-PC and compatibles. Complete module, no slots required, 10 year battery life, easy installation, software included, \$29. **ADVANCED ELECTRONICS**, P.O. Box 765, Corvallis, OR 97330.

**TOP QUALITY** imported, domestic kits, surplus, discount electronics, computer components. **FREE** catalog. **TEKTRASONIX**, 1120 Avenue of the Americas, 1/1 suite 4038, New York, NY 10036.

**DESCRAMBLING**, new secret manual. Build your own descramblers for **Cable and Subscription TV**. Instructions, schematics for SSAVI, gated sync, sinewave. (HBO, Cinemax, Showtime, etc.) \$8.95 + \$1.00 postage catalog. **CABLETRONICS**, Box 30502R, Bethesda, MD 20814.

**SATELLITE** descrambling manual, Video Cypher II. Schematics, thorough explanation of digital audio encoding, EPROM code, DES. (HBO, Cinemax, Showtime.) \$10.95 + \$1.00 postage. Catalog \$1.00 **CABLETRONICS**, Box 30502R, Bethesda, MD 20814.

**CRYSTAL** radio sets, plans, parts, kits, catalog \$1.00. **MIDCO**, 660 North Dixie Highway, Hollywood, FL 33020.

**CORDLESS** phone monitor. Simple instructions to modify cheap AM radio to receive entire 1.7 Mhz cordless phone band. No parts required, only a screwdriver. Also instructions how to monitor the new 46/49 Mhz frequencies. Only \$5.95 complete. **ADVANTAGE INC.**, Box 1086, Edgewater, FL 32032.

**MOBILE** telephone using your 2-way radio, plans \$9.95, with PC/bds \$24.95. **Countdown timer** hrs/min or min/sec. LED display, for lab, dark room, etc. Plans \$7.95 with PC/bds \$16.95. **Paging/control** using your 2-way radio, plans \$9.95 with PC/bds \$19.95. **CURRENT DEVELOPMENT CORP.**, Box 384, Westmoreland, NY 13490.

**UPGRADE** kit for line zappers \$19.95. Stops negative pictures, improves clarity. Complete with add-on board. Complete kits available. **C & C SPECIALTIES**, 1432 Heim, Orange, CA 92665. (714) 998-6866.

**CATALOG**: hobby/broadcasting/1750 meters/ham/CB: transmitters, antennas, scramblers, bugging devices, more! **PANAXIS**, Box 130-F6, Paradise, CA 95967.

V20-5		10.05 CPU's & CHIPS		RAM'S	
V20-5	14.95	8086	8.00	2016	1.50
V20-8	14.95	8088	7.50	2102-3	1.50
Z800A CPU	3.75	8155-2	2.75	2101A-4	1.50
Z800A CTC	1.95	8202	9.00	2111A	1.75
Z800A DART	5.25	8203	16.00	2112-1	1.95
Z800A DMA	5.50	8212	1.45	2114-2	1.00
Z800A P10	1.95	8214	3.75	2118-4	1.75
Z800A S10	5.50	8216	1.50	214-3	2.50
Z800B S10	9.95	8224	2.25	3242	6.00
82C43	2.75	8226	1.60	TMS3409	1.75
AMD2901	4.00	8237-5	6.50	MK4027-3	9.00
6502	2.75	8238	3.95	TMS4050N	1.75
6522	3.50	8250-A	6.75	MK4096-11	1.25
6800	1.75	8251-A	2.40	4108-3	1.60
6802	4.50	8253	1.75	4118-2	7.00
6803L	8.00	8255-A	1.85	4118-4	1.75
6809	5.50	8257	2.40	4164-15	1.75
6810	1.75	8259	2.40	4125E-15	2.75
6821	1.75	8272A	4.75	MK4802	5.00
6845	4.50	8275	9.00	Z8104-4	2.50
6850	1.75	8279-5	2.75	6116-3	1.60
6875	4.50	8288	4.75	6167P-3	4.50
07220-1	12.00	8355	12.95	8264LP-15	3.40
8031	2.75	8748	7.50	8118-12	4.95
8035	1.75	N516450	6.95	S2800	1.20
8048	5.00	TMS9927N	9.95		
8049	2.50	86000L8	8.00		
8054	2.50	8054	8.00		
8085A	2.75	IN5265	4.50		
		TP818542	3.50		
		82130	1.95		
		82131	1.50		
		MM1403	1.75		
		MM1404	1.75		
		MM5013	2.50		
		MM5015	2.50		
		MM5056	2.50		
		MM5058	2.50		
		MM5060	2.50		
		MM5062	2.50		
		MM5064	2.50		
		MM5066	2.50		
		MM5068	2.50		
		MM5070	2.50		
		MM5072	2.50		
		MM5074	2.50		
		MM5076	2.50		
		MM5078	2.50		
		MM5080	2.50		
		MM5082	2.50		
		MM5084	2.50		
		MM5086	2.50		
		MM5088	2.50		
		MM5090	2.50		
		MM5092	2.50		
		MM5094	2.50		
		MM5096	2.50		
		MM5098	2.50		
		MM5100	2.50		
		MM5102	2.50		
		MM5104	2.50		
		MM5106	2.50		
		MM5108	2.50		
		MM5110	2.50		
		MM5112	2.50		
		MM5114	2.50		
		MM5116	2.50		
		MM5118	2.50		
		MM5120	2.50		
		MM5122	2.50		
		MM5124	2.50		
		MM5126	2.50		
		MM5128	2.50		
		MM5130	2.50		
		MM5132	2.50		
		MM5134	2.50		
		MM5136	2.50		
		MM5138	2.50		
		MM5140	2.50		
		MM5142	2.50		
		MM5144	2.50		
		MM5146	2.50		
		MM5148	2.50		
		MM5150	2.50		
		MM5152	2.50		
		MM5154	2.50		
		MM5156	2.50		
		MM5158	2.50		
		MM5160	2.50		
		MM5162	2.50		
		MM5164	2.50		
		MM5166	2.50		
		MM5168	2.50		
		MM5170	2.50		
		MM5172	2.50		
		MM5174	2.50		
		MM5176	2.50		
		MM5178	2.50		
		MM5180	2.50		
		MM5182	2.50		
		MM5184	2.50		
		MM5186	2.50		
		MM5188	2.50		
		MM5190	2.50		
		MM5192	2.50		
		MM5194	2.50		
		MM5196	2.50		
		MM5198	2.50		
		MM5200	2.50		
		MM5202	2.50		
		MM5204	2.50		
		MM5206	2.50		
		MM5208	2.50		
		MM5210	2.50		
		MM5212	2.50		
		MM5214	2.50		
		MM5216	2.50		
		MM5218	2.50		
		MM5220	2.50		
		MM5222	2.50		
		MM5224	2.50		
		MM5226	2.50		
		MM5228	2.50		
		MM5230	2.50		
		MM5232	2.50		
		MM5234	2.50		
		MM5236	2.50		
		MM5238	2.50		
		MM5240	2.50		
		MM5242	2.50		
		MM5244	2.50		
		MM5246	2.50		
		MM5248	2.50		
		MM5250	2.50		
		MM5252	2.50		
		MM5254	2.50		
		MM5256	2.50		
		MM5258	2.50		
		MM5260	2.50		
		MM5262	2.50		
		MM5264	2.50		
		MM5266	2.50		
		MM5268	2.50		
		MM5270	2.50		
		MM5272	2.50		
		MM5274	2.50		
		MM5276	2.50		
		MM5278	2.50		
		MM5280	2.50		
		MM5282	2.50		
		MM5284	2.50		
		MM5286	2.50		
		MM5288	2.50		
		MM5290	2.50		
		MM5292	2.50		
		MM5294	2.50		
		MM5296	2.50		
		MM5298	2.50		
		MM5300	2.50		
		MM5302	2.50		
		MM5304	2.50		
		MM5306	2.50		
		MM5308	2.50		
		MM5310	2.50		
		MM5312	2.50		
		MM5314	2.50		
		MM5316	2.50		
		MM5318	2.50		
		MM5320	2.50		
		MM5322	2.50		
		MM5324	2.50		
		MM5326	2.50		
		MM5328	2.50		
		MM5330	2.50		
		MM5332	2.50		
		MM5334	2.50		
		MM5336	2.50		
		MM5338	2.50		
		MM5340	2.50		
		MM5342	2.50		
		MM5344	2.50		
		MM5346	2.50		
		MM5348	2.50		
		MM5350	2.50		
		MM5352	2.50		
		MM5354	2.50		
		MM5356	2.50		
		MM5358	2.50		
		MM5360	2.50		
		MM5362	2.50		
		MM5364	2.50		
		MM5366	2.50		
		MM5368			

**JERROLD** gated pulse theory. Twelve information-packed pages covering DI & DIC converter operation. Includes introduction to trimode system. \$6.95 plus \$1.50 postage and handling. **ELEPHANT ELECTRONICS, INC.**, Box 41865-J, Phoenix, AZ 85080. (602) 581-1973.

**PROJECTION TV**...Convert your TV to project 7 foot picture. Results comparable to \$2,500 projectors...Total cost less than \$30.00 plans and 8" lens \$21.95...Illustrated information **FREE**...**MACROCOMA-GJ**, Washington Crossing, PA 18977. Creditcard orders 24hrs. (215) 736-3979.

**Pay TV and Satellite Descrambling  
All New 6th Edition!**

Now 120 pages, 13 cable and 7 satellite systems. Bypasses, countermeasures. \$14.95. Experiments with Videocipher Bypasses. Turnons schematics. 4 free updates. \$12.95. Cable TV. Two-way security system design \$12.95. MDS/MMD Handbook. For hackers. Now 50 pages. \$12.95. Build Satellite Systems Under \$600. \$12.95. Any 3/#26. Spring catalog #1

**Shojiki Electronics Corp.** 1327A Niagara St.,  
Niagara Falls, NY 14303. COD's 716-284-2163

**SATELLITE TV**

**CABLE TV Secrets**—the outlaw publication the cable companies tried to ban. HBO, Movie Channel, Showtime, descramblers, converters, etc. Suppliers list included \$8.95. **CABLE FACTS**, Box 711-R, Pataskala, OH 43062.

**SATELLITE** systems \$349 up. VISA/MC available. Catalog \$3.00. **STARLINK, INC.**, 2603-16R Artie, Huntsville, AL 35805.

**SATELLITE TV** receiver kits! instructions, schematics! LNA's! Catalog \$1.00 (refundable): **XANDI ELECTRONICS**, Box 25647, Dept. 21P, Tempe, AZ 85282.

**Multi-Channel Microwave T.V. Receivers**



1.9-2.7 GHz Parabolic Dish 40" dB Gain  
**LIFETIME WARRANTY**  
Complete System \$89.95 (Shipping Incl.)  
Dealer Rates, Replacement Components  
& Expert Repairs Available

**K & S ELECTRONICS** Call now for same  
P.O. BOX 34522 day shipping!  
PHOENIX, AZ 85067 (602) 230-0640

VISA/MC/COD \$2 credit on phone orders!

**DESCRAMBLER** build our low cost satellite TV video only descrambler for all major movies and sports. Uses all Radio Shack parts. Order P.C. board and instructions by sending cheque, money order, or Visa for \$35.00 U.S. funds to: **VALLEY MICROWAVE ELECTRONICS**, Bear River, Nova Scotia, Canada, BOS-1BO. (902) 467-3577.

**10 1/2ft** satellite system, remote controlled, tracker, and descrambler with 1 yr free subscription to 20 channels. \$1495 plus UPS. Visa or Master Card accepted. 1 (602) 378-6275.

**BUSINESS OPPORTUNITIES**

**MECHANICALLY** inclined individuals desiring ownership of small electronics manufacturing business—without investment. Write: **BUSINESSES**, 92-R, Brighton 11th, Brooklyn, NY 11235.

**PROJECTION TV**...Make \$\$\$s assembling projectors...easy...results comparable to \$2,500 projectors. Total cost less than \$30.00. **PLANS**, 8" **LENS** and dealers information \$20.50. Illustrated information free. **MACROCOMA-GJX**, Washington Crossing, PA 18977. Creditcard orders 24hrs. (215) 736-2880.

**EASY**, lucrative. One man CRT rebuilding machinery. Free info: (815) 459-0666 **CRT**, 1909 Louise, Crystalake, IL 60014.

**YOUR own radio station!** AM, FM, cable. Licensed or unlicensed. **BROADCASTING**, Box 130-F6, Paradise, CA 95967.

**EARN** thousands with your own part time electronics business. I do. Free proof, information. **INDUSTRY**, Box 531, Bronx, NY 10461.

**BIG PROFITS ELECTRONIC ASSEMBLY BUSINESS**

Start home, spare time. Investment knowledge or experience unnecessary. **BIG DEMAND** assembling electronic devices. Sales handled by professionals. Unusual business opportunity.

**FREE: Complete illustrated literature**  
BARTA, RE-O Box 248  
Walnut Creek, Calif. 94597

**WANTED**

**INVENTORS!** AIM wants—ideas, inventions, new products, improvements on existing products. We present ideas to manufacturers. Confidentiality guaranteed. Call toll free 1 (800) 225-5800 for information kit.

**INVENTIONS**, ideas, new products wanted! Industry presentation/national exposition. Call free 1 (800) 528-6050. Canada, 1 (800) 528-6060. X831.

**WANTED** surplus inventories of ICs, transistors etc. No quantity too small or large. Call **WESTERN TECHNOLOGY**, (303) 444-4403. FAX (303) 444-4473.

**Cable TV Converters**

**Why Pay A High Monthly Fee?**

Jerrold Products include "New Jerrold Tri-Mode," SB-3, Hamlin, Oak VN-12, M-35-B, Zenith, Magnavox, Scientific Atlanta, and more. (Quantity discounts) 60 day warranty. For fast service C.O.D. orders accepted. Send SASE (60 cents postage) or call for info (312) 658-5320. **Midwest Electronics, Inc.**, **HIGGINS ELECTRONICS**, 5143-R W. Diversey, Chicago, IL 60639. MC/Visa orders accepted. No Illinois orders accepted. Mon.-Fri.-9 A.M.-6 P.M.CST

**SCIENTIFIC ATLANTA & TOCOM**

**SCIENTIFIC Atlanta** cable converters (original units), models—8500 and 8550, remote control...\$250.00. **TOCOM** descramblers \$225.00. **Guaranteed. N.A.S.**, (213) 631-3552.

**DO IT YOURSELF TV REPAIRS**

**NEW...REPAIR ANY TV...EASY.** Retired serviceman reveals secrets. Write **RESEARCH**, Rt. 3, Box 601B, Colville, WA 99114.

**CABLE TV DESCRAMBLERS**

**CABLE** television converter, descrambler and wireless remote control video equipment accessories catalog free. **CABLE DISTRIBUTORS UNLIMITED**, 116-C Main Road, Washington, AR 71862.

**EPROM PROGRAMMING**

**FREE** catalog. Your software/data installed in EPROM of your choice. Fast, low cost service. Write/call: **ROMULUS MICROCONTROL**, Dept. A, Box 8669, Rockville, MD 20856; (301) 540-8863.

**PRINTED CIRCUIT BOARDS**

**LOW** quotes, high quality, quick service. Single, double sided, multilayered boards. Prototypes through production quantities. Design/layout capabilities. Board assembly/turnkey facilities. Call or write for quotes and info. **T.O.R.C.C.C.**, 1131 Tower, Schaumburg, IL 60195, (312) 490-1374.

**Be a TV/VCR Repair Specialist**

Now you can train at home in spare time for a money-making career as a TV/VCR Repair Specialist. No previous experience necessary. No need to quit your job or school. Everything is explained in easy-to-understand language with plenty of drawings, diagrams and photos. We show you how to troubleshoot and repair video-cassette recorders and TV sets, how to handle house calls and shop repairs for almost any make of television or VCR. Tools are included with your course so you can get "hands-on" practice as you follow your lessons step by step. Send for free facts about the exciting opportunities in TV/VCR Repair and find out how you can start making money in this great career. **MAIL COUPON TODAY**

**ICS SCHOOL OF TV/VCR REPAIR**, Dept. DE057  
(SINCE 1981) Scranton, Pennsylvania 18515  
Please send me full information and color brochure on how I can learn TV/VCR Repair at home in my spare time. I understand there is no obligation and no salesman will visit me.

Name \_\_\_\_\_ Age \_\_\_\_\_  
Address \_\_\_\_\_  
City/State/Zip \_\_\_\_\_  
Phone (\_\_\_\_) \_\_\_\_\_

**EDUCATION & INSTRUCTION**

**TRAINING** in cable television technology. Prepare for the future. **CABLE CORRESPONDENCE COURSES INC.**, Post Office Box 1319, St. Charles, MO 63302.

**F.C.C. Commercial General Radiotelephone License.** Electronics home study. Fast, inexpensive! "Free" details. **COMMAND**, D-176, Box 2223, San Francisco, CA 94126.

**CASSETTE recorded home study** for new general class FCC license examinations. Also broadcasting and cablevision courses. **BOB JOHNSON TELECOMMUNICATIONS**, 1201 Ninth, Manhattan Beach, CA 90266.

**IBM** compatible software for basic circuit design and computation \$14.95. **GALLAGHER SOFTWARE**, P.O. Box 1958, Orleans, MA 02653.

**INVENTORS**

**INVENTORS!** Can you patent and profit from your idea? Call **AMERICAN INVENTORS CORPORATION** for free information. Over a decade of service. 1 (800) 338-5656. In Massachusetts or Canada call (413) 568-3753.

**DESCRAMBLER MODULE**

**COMPLETE** cable-TV decoder in a mini-module. Latest technology upgrade for Jerrold SB-3 or Radio-Electronics Feb. 1984 project. Available at very low cost. For literature, **SOUTHTECH DISTRIBUTING**. 1(800) 821-5226 Ext. 130.

**SB-3/TRI-BI/ZENITH**

**SB-3's**...\$74.00. **Tri-Bi's**...\$95.00. **Zenith** (Tags)...\$159.00. **SB-3's**...\$99.00. **N-12** (Varisync)...\$75.00. Call **N.A.S.**, (213) 631-3552.

**THANKS FOR HELPING TO KEEP UNITED WAY IN BUSINESS.**



# HOW THIS RAKE CAN SAVE YOUR LIFE

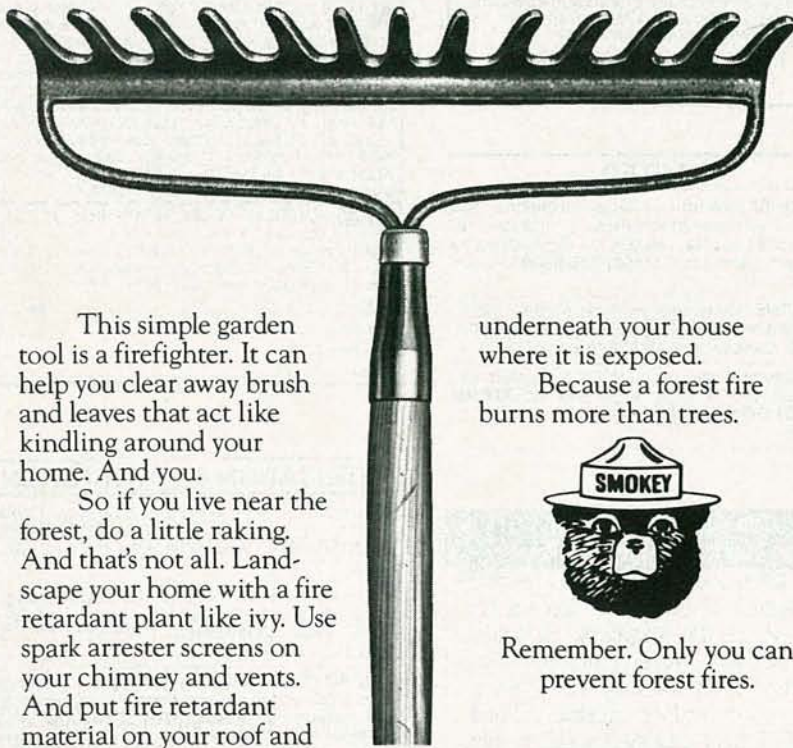

This simple garden tool is a firefighter. It can help you clear away brush and leaves that act like kindling around your home. And you.

So if you live near the forest, do a little raking. And that's not all. Landscape your home with a fire retardant plant like ivy. Use spark arrester screens on your chimney and vents. And put fire retardant material on your roof and

underneath your house where it is exposed.

Because a forest fire burns more than trees.



Remember. Only you can prevent forest fires.

**Ad Council** A Public Service of the Ad Council, the USDA, Forest Service and your State Forester.

## ANTIQUE RADIO

continued from page 84

Finally, the output of the detector is capacitively coupled to the 6F6 power-amplifier pentode. The output from that pentode's plate circuit is coupled to the loudspeaker's voice coil by T2.

Note the R-C network consisting of R12, C28, and C27, along with its associated switch, S5. That is a two-position tone control used to tailor the sound to the owner's preference. Such controls were not always included in radios of the period (or modern radios for that matter). As a result, the circuitry was often added by the owner. Details for doing that were available in Gernsback's **Radio Craft** and other electronics magazines of the day. One hint relating to that control: One of the things you should be sure to do once you've removed the chassis from the cabinet is to clean S5. Dirt on that switch can cause scratchy sound.

Next time we will get to work on restoring our radio. **R-E**

# GREAT VALUES • FAST SHIPPING • QUANTITY DISCOUNTS

## YAMATO 4001 3 1/2 DIGITAL MULTIMETER



WAS \$33.80  
NOW \$28!  
ONLY

The YAMATO 4001 is a 3 1/2 DIGIT COMPACT DIGITAL MULTIMETER, it employs FE type LCD, with large figures. Its ADVANTAGES: High accuracy in measuring. High impedance assures min. measuring error. One rotary switch allows fast & convenient operation. 26 measurement range enable wider application. Over-input indication & low battery life appears on display. LSI-circuit use provides high reliability and durability. Measurement possible even under strong magnetic field. Measures ONLY 6 3/4" x 3 1/4" x 1"

## TA-477 120W MOSFET POWER AMPLIFIER

BUILT A PROFESSIONAL AMP BY YOURSELF



This amplifier consists of three super low TIM differential stages, and Hitachi 2S349/2SK 134 match pair "MOSFET" as output component whose frequency response and transient response is superior to the other power transistor. Therefore this amplifier has high-fidelity and superior analytic power over the entire Audio Spectrum. It is suitable for reproducing classic and modern music. Heavy Duty Heat Sink with 28 radial fins is included!

Kit \$55.00  
Metal Cabinet/X'Former (Optional) \$26.00/\$19.88

## NF-CR BI-FET PRE-AMP



Match with TA-477 or other main power.

TA-2800  
WITH TREBLE, MID-RANGE AND BASS 3 WAY TONE CONTROL  
Kit \$44.50

## PROFESSIONAL COLOR LIGHT CONTROLLER SM-328

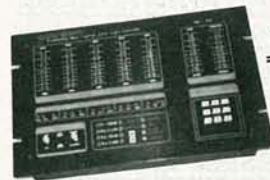

LIGHT UP YOUR LIFE!

NEW FOR 87

FEATURES:  
1. FOUR GROUPS OF INDEPENDENT OUTPUT SYSTEM 1000W/CH. MAX.  
2. PROFESSIONAL COLOR CONTROL SYSTEM (KEY-BOARD TYPE)  
3. INDEPENDENT DIMMER CONTROL  
4. SPEED CONTROL  
5. SPEED CONTROL  
6. AUTOMATIC CHASING PROGRAM AND CHASER  
7. FORWARD/BACKWARD CHASING OF SPECIAL CHASING EFFECT  
8. FORWARD/BACKWARD CHASING OF SPECIAL CHASING EFFECT  
9. FORWARD/BACKWARD CHASING OF SPECIAL CHASING EFFECT  
10. FORWARD/BACKWARD CHASING OF SPECIAL CHASING EFFECT  
11. FORWARD/BACKWARD CHASING OF SPECIAL CHASING EFFECT  
12. FORWARD/BACKWARD CHASING OF SPECIAL CHASING EFFECT  
13. FORWARD/BACKWARD CHASING OF SPECIAL CHASING EFFECT  
14. FORWARD/BACKWARD CHASING OF SPECIAL CHASING EFFECT  
15. FORWARD/BACKWARD CHASING OF SPECIAL CHASING EFFECT  
16. FORWARD/BACKWARD CHASING OF SPECIAL CHASING EFFECT  
17. FORWARD/BACKWARD CHASING OF SPECIAL CHASING EFFECT  
18. FORWARD/BACKWARD CHASING OF SPECIAL CHASING EFFECT  
19. FORWARD/BACKWARD CHASING OF SPECIAL CHASING EFFECT  
20. FORWARD/BACKWARD CHASING OF SPECIAL CHASING EFFECT  
21. FORWARD/BACKWARD CHASING OF SPECIAL CHASING EFFECT  
22. FORWARD/BACKWARD CHASING OF SPECIAL CHASING EFFECT  
23. FORWARD/BACKWARD CHASING OF SPECIAL CHASING EFFECT  
24. FORWARD/BACKWARD CHASING OF SPECIAL CHASING EFFECT  
25. FORWARD/BACKWARD CHASING OF SPECIAL CHASING EFFECT  
26. FORWARD/BACKWARD CHASING OF SPECIAL CHASING EFFECT  
27. FORWARD/BACKWARD CHASING OF SPECIAL CHASING EFFECT  
28. FORWARD/BACKWARD CHASING OF SPECIAL CHASING EFFECT  
29. FORWARD/BACKWARD CHASING OF SPECIAL CHASING EFFECT  
30. FORWARD/BACKWARD CHASING OF SPECIAL CHASING EFFECT  
31. FORWARD/BACKWARD CHASING OF SPECIAL CHASING EFFECT  
32. FORWARD/BACKWARD CHASING OF SPECIAL CHASING EFFECT  
33. FORWARD/BACKWARD CHASING OF SPECIAL CHASING EFFECT  
34. FORWARD/BACKWARD CHASING OF SPECIAL CHASING EFFECT  
35. FORWARD/BACKWARD CHASING OF SPECIAL CHASING EFFECT  
36. FORWARD/BACKWARD CHASING OF SPECIAL CHASING EFFECT  
37. FORWARD/BACKWARD CHASING OF SPECIAL CHASING EFFECT  
38. FORWARD/BACKWARD CHASING OF SPECIAL CHASING EFFECT  
39. FORWARD/BACKWARD CHASING OF SPECIAL CHASING EFFECT  
40. FORWARD/BACKWARD CHASING OF SPECIAL CHASING EFFECT  
41. FORWARD/BACKWARD CHASING OF SPECIAL CHASING EFFECT  
42. FORWARD/BACKWARD CHASING OF SPECIAL CHASING EFFECT  
43. FORWARD/BACKWARD CHASING OF SPECIAL CHASING EFFECT  
44. FORWARD/BACKWARD CHASING OF SPECIAL CHASING EFFECT  
45. FORWARD/BACKWARD CHASING OF SPECIAL CHASING EFFECT  
46. FORWARD/BACKWARD CHASING OF SPECIAL CHASING EFFECT  
47. FORWARD/BACKWARD CHASING OF SPECIAL CHASING EFFECT  
48. FORWARD/BACKWARD CHASING OF SPECIAL CHASING EFFECT  
49. FORWARD/BACKWARD CHASING OF SPECIAL CHASING EFFECT  
50. FORWARD/BACKWARD CHASING OF SPECIAL CHASING EFFECT  
51. FORWARD/BACKWARD CHASING OF SPECIAL CHASING EFFECT  
52. FORWARD/BACKWARD CHASING OF SPECIAL CHASING EFFECT  
53. FORWARD/BACKWARD CHASING OF SPECIAL CHASING EFFECT  
54. FORWARD/BACKWARD CHASING OF SPECIAL CHASING EFFECT  
55. FORWARD/BACKWARD CHASING OF SPECIAL CHASING EFFECT  
56. FORWARD/BACKWARD CHASING OF SPECIAL CHASING EFFECT  
57. FORWARD/BACKWARD CHASING OF SPECIAL CHASING EFFECT  
58. FORWARD/BACKWARD CHASING OF SPECIAL CHASING EFFECT  
59. FORWARD/BACKWARD CHASING OF SPECIAL CHASING EFFECT  
60. FORWARD/BACKWARD CHASING OF SPECIAL CHASING EFFECT  
61. FORWARD/BACKWARD CHASING OF SPECIAL CHASING EFFECT  
62. FORWARD/BACKWARD CHASING OF SPECIAL CHASING EFFECT  
63. FORWARD/BACKWARD CHASING OF SPECIAL CHASING EFFECT  
64. FORWARD/BACKWARD CHASING OF SPECIAL CHASING EFFECT  
65. FORWARD/BACKWARD CHASING OF SPECIAL CHASING EFFECT  
66. FORWARD/BACKWARD CHASING OF SPECIAL CHASING EFFECT  
67. FORWARD/BACKWARD CHASING OF SPECIAL CHASING EFFECT  
68. FORWARD/BACKWARD CHASING OF SPECIAL CHASING EFFECT  
69. FORWARD/BACKWARD CHASING OF SPECIAL CHASING EFFECT  
70. FORWARD/BACKWARD CHASING OF SPECIAL CHASING EFFECT  
71. FORWARD/BACKWARD CHASING OF SPECIAL CHASING EFFECT  
72. FORWARD/BACKWARD CHASING OF SPECIAL CHASING EFFECT  
73. FORWARD/BACKWARD CHASING OF SPECIAL CHASING EFFECT  
74. FORWARD/BACKWARD CHASING OF SPECIAL CHASING EFFECT  
75. FORWARD/BACKWARD CHASING OF SPECIAL CHASING EFFECT  
76. FORWARD/BACKWARD CHASING OF SPECIAL CHASING EFFECT  
77. FORWARD/BACKWARD CHASING OF SPECIAL CHASING EFFECT  
78. FORWARD/BACKWARD CHASING OF SPECIAL CHASING EFFECT  
79. FORWARD/BACKWARD CHASING OF SPECIAL CHASING EFFECT  
80. FORWARD/BACKWARD CHASING OF SPECIAL CHASING EFFECT  
81. FORWARD/BACKWARD CHASING OF SPECIAL CHASING EFFECT  
82. FORWARD/BACKWARD CHASING OF SPECIAL CHASING EFFECT  
83. FORWARD/BACKWARD CHASING OF SPECIAL CHASING EFFECT  
84. FORWARD/BACKWARD CHASING OF SPECIAL CHASING EFFECT  
85. FORWARD/BACKWARD CHASING OF SPECIAL CHASING EFFECT  
86. FORWARD/BACKWARD CHASING OF SPECIAL CHASING EFFECT  
87. FORWARD/BACKWARD CHASING OF SPECIAL CHASING EFFECT  
88. FORWARD/BACKWARD CHASING OF SPECIAL CHASING EFFECT  
89. FORWARD/BACKWARD CHASING OF SPECIAL CHASING EFFECT  
90. FORWARD/BACKWARD CHASING OF SPECIAL CHASING EFFECT  
91. FORWARD/BACKWARD CHASING OF SPECIAL CHASING EFFECT  
92. FORWARD/BACKWARD CHASING OF SPECIAL CHASING EFFECT  
93. FORWARD/BACKWARD CHASING OF SPECIAL CHASING EFFECT  
94. FORWARD/BACKWARD CHASING OF SPECIAL CHASING EFFECT  
95. FORWARD/BACKWARD CHASING OF SPECIAL CHASING EFFECT  
96. FORWARD/BACKWARD CHASING OF SPECIAL CHASING EFFECT  
97. FORWARD/BACKWARD CHASING OF SPECIAL CHASING EFFECT  
98. FORWARD/BACKWARD CHASING OF SPECIAL CHASING EFFECT  
99. FORWARD/BACKWARD CHASING OF SPECIAL CHASING EFFECT  
100. FORWARD/BACKWARD CHASING OF SPECIAL CHASING EFFECT

ONLY \$150.00  
Ass. with tested

## CORDLESS SOLDERING IRON RECHARGEABLE

YOU CAN USE IT ANYWHERE YOU LIKE



No. 620  
NEW!  
ONLY

Each set \$22.80

## 80W + 80W DC LOW TIM PRE-MAIN AMPLIFIER



TA-800 \$49.85  
METAL CABINET/X'FORMER \$26/\$22.00

FREE CATALOG

OFFICE HOURS:  
MON. - FRI. 9:30 to 5:00  
SAT. 10:00 to 5:00  
(PACIFIC TIME)

Over 2000 kits have sold in State!

## TALKING CLOCK

Clocks that really tell you time!



1. Talk: push button for voice announcement of time.
2. Read out: twelve hours system display for hour, minute, second (by color flash), AM & PM.
3. Display: three display modes of time, alarm time & date.
4. Alarm: on/off switch with thirty seconds voice alarm.
5. Snooze: reminder voice alarm of thirty seconds after 4 minutes of first voice alarm.
6. Volume: two level of voice output.
7. Language available: English

PARROT 8501 \$17.75  
COCKATOO 8502 \$15.90 NOT A KIT!  
MYNAH 8504 \$16.90

TERMS: \$10 min order • \$20 min charge card order • Check, money order or phone order accept • We ship UPS Ground • Add 5% of order total (min \$1.50) for shipping, outside LA and 10% (min \$2.50), outside USA and 20% (min \$5.00) • CA residents add sales tax • All merchandise subject to prior sale • Prices are subject to change without notice • Any goods proved to be defective, must be returned in original form with a copy of your invoice within 30 days for replacement.

SPECIAL VALUE

**MARK V ELECTRONICS INC.,**  
248 EAST MAIN STREET, SUITE 100,  
ALHAMBRA, CA 91801.  
TELEX: 3716914 MARK 5.

TOLL FREE  
1-800-423-3483

Only for order paid by Master or Visacard

INFORMATION: 1-818-282-1196  
MAIL ORDER: P.O. BOX 6610  
ALHAMBRA,  
CA 91802

CIRCLE 93 ON FREE INFORMATION CARD

# Radio Shack Parts Place™

## HOT VALUES AT HOBBY HEADQUARTERS—OUR STORE NEAR YOU

### Unusual LEDs

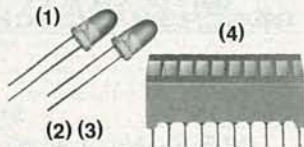

- (1) Super-Bright Red. Outputs 300 mcd. #276-066 ..... 99¢
- (2) Blinking Red. MOS driver and a red LED combo. Can drive several LEDs in series. #276-036 ..... 1.19
- (3) Blinking Green. #276-030, 1.19
- (4) Bar Graph Display. Ten bright red segments. #276-081 .... 2.99

### Sound Wars!



- (5) Tri-Sound Siren. Wiring options create three different 80 db outputs. 3 VDC. #273-072 ... 5.95
- (6) Pulsing or Continuous Piezo Buzzer. Screwdriver terminals. 4 to 28 VDC. #273-068 ..... 6.95
- (7) Electromechanical Buzzer. Extra loud! 12 VDC. #273-051 .. 1.89

### Save With Our "Hotline" Order Service

Save Postage! Our warehouse sends your order directly to the Radio Shack near you. We pay the shipping cost.

Save Time! Delivery time on most items is one week. Spend your free time on your projects, not driving!

Your Radio Shack store manager can Special-Order thousands of parts and accessories not listed in our catalog—tubes, linear and digital ICs, diodes, transistors, crystals, phono cartridges, and more. There's no minimum order requirement for this service!



### Resistor Kits



- (8) 1/4-Watt 5% Carbon Film. Set of 100, 13 values, 10 ohms to one meg. #271-311 ..... Set 1.98
- (9) 1/4-Watt 1% Metal Film. Set of 50, 12 popular values from 10 ohms to one meg. #271-309 ... Set 2.49
- (10) 1/4-Watt 5% Carbon Film. Big 500-piece set! 54 values, 10 ohms to 10 megohms. #271-312 .. Set 7.95

### 12V Transformers

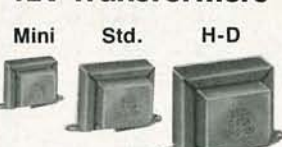

Type	Volts	Current	Cat. No.	Each
Miniature	12.6 CT	450 mA	273-1365	3.59
Standard	12.6 CT	1.2 A	273-1352	4.99
Heavy-Duty	12.6 CT	3.0 A	273-1511	6.99

### Experimenters! Put These LSI Chips to Work

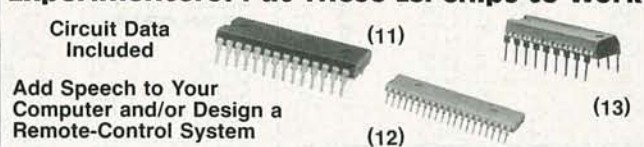

- (11) SPO256-AL2 Speech Synthesizer. This preprogrammed MOS device is easy to interface with most microprocessors. Includes detailed data and circuit interface examples. Requires 3.12 MHz crystal (available via our special-order "hotline," above). #276-1784 ..... 12.95
- (12) CTS256-AL2 Text-to-Speech. Translates ASCII from computer into control data for the synthesizer, above. With programming and circuit data. Requires 10 MHz crystal (special-order). #276-1786 ..... 16.95
- (13) SSI 202 Touch-Tone Decoder. Complete DTMF receiver on a chip. Heart of a remote control system! With data. #276-1303 ..... 12.95

### AC Power Strips

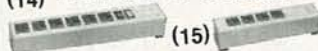

- Ideal for workbench! Have 6-ft. cord, 3-prong plug. UL listed AC.
- (14) 6-Outlet. #61-2619 .... 19.95
- (15) 4-Outlet. #61-2620 .... 14.95

### Mini 'Gators



1 3/8" long. Includes 5 red, 5 black. #270-374, Set 1.19

### Fuse Holder



Panel-Mount. For 1/4" x 1/4" fuses. UL recognized. #270-364 ..... 79¢

### Ceramic Capacitors

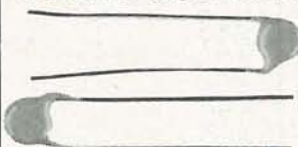

Low As 39¢ Pkg. of 2

Pkg. of 2, Only 39¢			Pkg. of 2, Only 49¢		
pF	WVDC	Cat. No.	µF	WVDC	Cat. No.
47	50	272-120	.001	500	272-126
47	50	272-121	.0047	500	272-130
100	50	272-123	.01	500	272-131
220	50	272-124	.047	50	272-134
470	50	272-125	.1	50	272-135

### Tantalum Caps



Low As 49¢ Each

IC pin spacing. 20% tolerance.

µF	WVDC	Cat. No.	Each
0.1	35	272-1432	.49
0.47	35	272-1433	.49
1.0	35	272-1434	.49
2.2	35	272-1435	.59
10	16	272-1436	.69
22	16	272-1437	.89

### Tool Set



You get all this: UL listed soldering iron, stand, solder, solder tool, pliers, cutter, 3 screwdrivers, heat sink. #64-2801, 14.95

### µ Relays



5 VDC Coil. 1/32 x 3/16 x 1/8" 1 amp SPDT contacts. #275-240 .... 1.69

### AC Switch

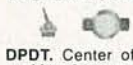

DPDT. Center off position. 6 amps at 250 VAC. #275-653 .... 2.49

On/Off Labeling Plates. #275-320, 6/69¢

### Hacker's Corner SPECIAL PURCHASES



**Sound/Color-Video RF Modulator.** Top quality, originally for TI 99/4 computer. Built-in TV/computer switch. 12 VDC. #277-1015 ... 4.95

**Plug-In 9 VDC Adapter.** What a deal! Efficient supply provides 9 VDC at up to 1 amp—or 13 VDC, no load. Prewired cord, barrel-type DC plug. UL listed. #277-1026 ... 4.95

### IC Breadboards



**Standard Modular Socket.** Total of 550 plug-in points. Accepts DIPs, discretes and 30 to 22-gauge solid wire. Two bus strips. Two or more snap together for more complex designs. 2 1/8" x 6". #276-174 ... 11.95

**Smaller Modular Socket.** 270 hookup points. Ideal for one or two-chip projects. #276-175 ..... 6.95

### Cooling Fans

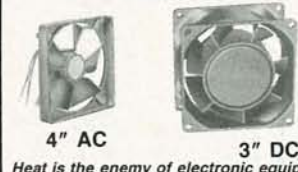

**4" AC**  
Heat is the enemy of electronic equipment. Use our quiet fans to increase airflow and extend the life of your computer, ham or hi-fi components.

**3" DC**  
4" 120 VAC Fan. Delivers up to 65 CFM. 11 watts. #273-241 ... 15.95

3" Brushless DC Fan. 27 CFM. Ideal for hum-sensitive circuits and portable equipment. 7 to 13.8 VDC. #273-243 ..... 14.95

### Autorange LCD Digital VOM



**69<sup>95</sup>**  
Folds Over For Travel

A remarkable value! You select the function, it selects the correct range. Features include automatic shut off when case is closed, auto polarity, detented hinge for best viewing angle, timesaving "beep" continuity test mode, plus 10-amp DC and AC current ranges. Fused and overload protected. With leads and owner's manual. Batteries extra. #22-193

Over 1000 items in stock: Binding posts, Books, Breadboards, Buzzers, Capacitors, Chokes, Clips, Connectors, Fuses, Hardware, ICs, Jacks, Knobs, Lamps, Multitesters, PC Boards, Plugs, Rectifiers, Relays, Resistors, Switches, Tools, Transformers, Transistors, Wire, Zener Diodes, more!

# Radio Shack®

A DIVISION OF TANDY CORPORATION  
Prices apply at participating Radio Shack stores and dealers

CIRCLE 78 ON FREE INFORMATION CARD

JUNE 1987

### NEC V20 & V30 CHIPS

Replace the 8086 or 8088 in Your IBM-PC and Increase Its Speed by up to 40%!

Part No.	Price
UPD70108-5 (5MHz) V20 Chip.....	\$ 9.95
UPD70108-8 (8MHz) V20 Chip.....	\$11.95
UPD70116-8 (8MHz) V30 Chip.....	\$14.95
UPD70116-10 (10MHz) V30 Chip.....	\$34.95

### 7400

Part No.	1-9	10+	Part No.	1-9	10+
7400.....	29	19	7485.....	65	55
7402.....	29	19	7486.....	45	35
7404.....	35	25	7489.....	2.05	1.95
7405.....	39	29	7490.....	49	39
7406.....	39	29	7493.....	45	35
7407.....	39	29	74121.....	45	35
7408.....	35	25	74123.....	59	49
7410.....	35	25	74125.....	55	45
7411.....	49	39	74126.....	75	65
7416.....	45	35	74143.....	4.05	3.95
7417.....	45	35	74150.....	1.35	1.25
7420.....	35	25	74154.....	1.35	1.25
7430.....	35	25	74158.....	1.59	1.49
7432.....	39	29	74173.....	.85	.75
7438.....	39	29	74174.....	.65	.55
7442.....	55	45	74175.....	.65	.55
7445.....	79	69	74176.....	.99	.89
7446.....	89	79	74181.....	1.95	1.85
7447.....	89	79	74189.....	2.05	1.95
7448.....	2.05	1.95	74193.....	.79	.69
7472.....	75	65	74198.....	1.85	1.75
7473.....	45	35	74221.....	.99	.89
7474.....	45	35	74273.....	2.05	1.95
7475.....	49	39	74324.....	.69	.59
7476.....	45	35	74367.....	.69	.59

### 74LS

74LS00.....	29	19	74LS165.....	.75	.65
74LS02.....	29	19	74LS166.....	.99	.89
74LS04.....	35	25	74LS173.....	.59	.49
74LS05.....	35	25	74LS174.....	.49	.39
74LS06.....	1.09	.99	74LS175.....	.49	.39
74LS07.....	1.09	.99	74LS189.....	4.59	4.49
74LS08.....	29	19	74LS191.....	.59	.49
74LS10.....	29	19	74LS193.....	.79	.69
74LS14.....	49	39	74LS221.....	.69	.59
74LS27.....	35	25	74LS240.....	.79	.69
74LS30.....	29	19	74LS243.....	.79	.69
74LS32.....	35	25	74LS244.....	.79	.69
74LS42.....	49	39	74LS245.....	.89	.79
74LS47.....	99	89	74LS259.....	.99	.89
74LS53.....	39	29	74LS273.....	.89	.79
74LS54.....	35	25	74LS279.....	.49	.39
74LS55.....	39	29	74LS322.....	4.05	3.95
74LS56.....	55	45	74LS365.....	.49	.39
74LS58.....	59	49	74LS366.....	.49	.39
74LS59.....	35	25	74LS367.....	.49	.39
74LS60.....	49	39	74LS368.....	.49	.39
74LS63.....	49	39	74LS373.....	.79	.69
74LS64.....	49	39	74LS374.....	.89	.79
74LS65.....	49	39	74LS377.....	.89	.79
74LS68.....	49	39	74LS393.....	.79	.69
74LS72.....	49	39	74LS397.....	.89	.79
74LS73.....	49	39	74LS590.....	6.05	5.95
74LS74.....	49	39	74LS624.....	2.05	1.95
74LS75.....	45	35	74LS629.....	2.29	2.19
74LS76.....	45	35	74LS640.....	1.09	.99
74LS77.....	45	35	74LS645.....	1.09	.99
74LS78.....	59	49	74LS670.....	1.09	.99
74LS79.....	59	49	74LS688.....	2.05	1.95

### 74S/PROMS\*

74S00.....	29	74S188.....	1.29
74S04.....	35	74S189.....	1.69
74S08.....	35	74S196.....	2.49
74S10.....	29	74S240.....	1.49
74S32.....	35	74S253.....	1.49
74S74.....	45	74S257.....	.79
74S85.....	1.79	74S283.....	1.49
74S86.....	35	74S288.....	1.49
74S124.....	2.95	74S373.....	1.49
74S174.....	.79	74S374.....	1.49
74S175.....	.79	74S472.....	2.95

### 74F

74F00.....	39	74F139.....	.89
74F04.....	39	74F157.....	.95
74F08.....	39	74F193.....	3.95
74F10.....	39	74F240.....	1.39
74F32.....	39	74F244.....	1.39
74F74.....	49	74F253.....	.99
74F86.....	59	74F373.....	1.39
74F138.....	89	74F374.....	1.39

### CD-CMOS

CD4001.....	19	CD4076.....	.65
CD4008.....	89	CD4081.....	.25
CD4011.....	19	CD4082.....	.25
CD4013.....	29	CD4093.....	.35
CD4016.....	29	CD4094.....	.89
CD4017.....	55	CD40103.....	2.49
CD4018.....	59	CD40107.....	.69
CD4020.....	59	CD40109.....	1.49
CD4024.....	49	CD4510.....	.69
CD4027.....	35	CD4511.....	.69
CD4030.....	29	CD4520.....	.75
CD4040.....	65	CD4522.....	.79
CD4049.....	29	CD4538.....	.79
CD4050.....	29	CD4541.....	.69
CD4051.....	59	CD4543.....	.79
CD4052.....	59	CD4553.....	4.95
CD4053.....	59	CD4555.....	.79
CD4059.....	3.95	CD4566.....	2.49
CD4063.....	1.95	CD4572 (MC14572).....	.39
CD4066.....	29	CD4583.....	.89
CD4069.....	25	CD4584.....	.39
CD4070.....	25	CD4585.....	.89
CD4071.....	25	MC14411P.....	8.95
CD4072.....	25	MC14490P.....	4.49

### COMMODORE CHIPS

Part No.	Price	Part No.	Price	Part No.	Price
WD1770 Disk Cont.....	19.95	6551 ACIA.....	3.29	8722 MMU.....	9.95
SI-3052P 5V Positive Voltage Reg. 2A.....	5.95	6560 VIC-I.....	10.95	*251104-04 Kernel ROM.....	10.95
6502 MPU w/Int. Clock.....	2.25	6567 VIC-II.....	14.95	318018-03 Basic ROM-C128.....	15.95
6504A CPU.....	1.95	6569 VIC PAL-N.....	14.95	318019-03 Basic ROM-C128.....	15.95
6507 CPU.....	4.95	6572 VIC PAL-N.....	14.95	318020-04 Kernel ROM-C128.....	15.95
6510 CPU.....	9.95	6581 SID.....	14.95	325302-01 64K ROM for 1540/1541 Drive.....	15.95
6520 PA.....	1.75	8360 Text Editing.....	10.95	*325572-01 Logic Array.....	24.95
6522 VIA.....	2.95	8501 MPU.....	10.95	*82S100PLA (90614-01)*.....	13.95
6523 TPI.....	7.95	8502 MPU.....	7.95	901225-01 Char. ROM.....	11.95
6526 CIA.....	14.95	8563 CRT Cont.....	15.95	901226-01 Basic ROM.....	11.95
6529 SPI.....	4.95	8564 VIC.....	15.95	901227-03 Kernel ROM.....	11.95
6532 128x8 RAM(I/O, Tim Ar.)	6.49	8566 VIC PAL.....	29.95	901229-05 Upgrade ROM (For 1541 Disk Drive).....	15.95
6545-1 CRT.....	2.49	8701 Clock Chip.....	9.95		
		*8721 PLA.....	14.95		

### MICROPROCESSOR COMPONENTS

MISCELLANEOUS CHIPS		6500/6800/68000 Cont.		8000 SERIES Cont.	
Part No.	Price	Part No.	Price	Part No.	Price
D765AC.....	4.49	6840.....	3.95	8228.....	2.49
WD1770.....	19.95	6843.....	2.95	8237-5.....	4.95
2661-3.....	5.95	6845.....	2.95	8243.....	2.25
WD9216.....	9.95	6850.....	1.49	8250A.....	5.49
Z80.....	1.25	6852.....	3.95	8250B (For IBM).....	6.95
Z80-CTC.....	1.95	6875.....	8.95	8251A.....	1.75
Z80-DART.....	4.95	MC68000LB.....	9.95	8253-5.....	1.95
Z80-PIO.....	1.79	MC68000L.....	19.95	8254.....	2.95
Z80A.....	1.35	8031.....	2.95	8257-5.....	2.49
Z80A-CTC.....	1.49	80C31BH.....	14.95	8259-5.....	1.95
Z80A-DART.....	4.95	8073.....	29.95	8272.....	4.49
Z80A-PIO.....	1.49	8080A.....	2.49	8279-5.....	2.25
Z80A-SIO/0.....	4.95	8085A.....	2.29	8285.....	10.95
Z80B.....	2.95	8086.....	2.95	8748.....	7.95
Z80B-CTC.....	3.49	8088-2.....	8.95	8749.....	9.95
Z80B-PIO.....	4.29	8087 (5MHz).....	125.00	8751.....	39.95
		8087-2 (8MHz).....	159.95	8755.....	14.95
		8088.....	6.49		
		85C02 (CMOS).....	8.95		
		6520.....	1.75		
		6522.....	2.95		
		6532.....	6.49		
		6551.....	3.29		
		6800.....	1.75		
		6802.....	3.49		
		6810.....	1.25		
		6821.....	1.29		

### DYNAMIC RAMS

Part No.	Function	Price
4116-15	16,384 x 1 (150ns)	.89
4128-20 (Piggyback)	131,072 x 1 (200ns)	4.49
4164-120	65,536 x 1 (120ns)	1.75
4164-150	65,536 x 1 (150ns)	1.15
4164-200	65,536 x 1 (200ns)	.95
TMS4416-12	16,384 x 4 (120ns)	4.25
8118	16,384 x 4 (120ns)	.69
41266-120	262,144 x 1 (120ns)	3.95
41266-150	262,144 x 1 (150ns)	2.75
50464-15	65,536 x 4 (150ns) (4464)	4.95
511000P-10	1,048,576 x 1 (100ns) 1 Meg.	39.95
514256P-10	262,144 x 4 (100ns) 1 Meg.	44.95

### STATIC RAMS

2016-12	2048 x 8 (120ns)	1.69
2102-2L	1024 x 1 (250ns) Low Power (91L02)	1.95
2114N	1024 x 4 (450ns)	.99
2114N-2	1024 x 4 (200ns)	1.05
2114N-2L	1024 x 4 (200ns) Low Power	1.49
21C14	1024 x 4 (200ns) (CMOS)	.49
2149	1024 x 4 (45ns)	4.95
5101	256 x 4 (45ns) CMOS	1.95
6116L-2P	2048 x 8 (120ns) Low Power CMOS	2.95
6116L-3	2048 x 8 (150ns) CMOS	1.89
6116L-3P	2048 x 8 (150ns) Low Power	1.95
6264P-12	8192 x 8 (120ns) Low Power CMOS	4.25
6264P-15	8192 x 8 (150ns) CMOS	3.59
6264P-15	8192 x 8 (150ns) Low Power CMOS	3.75
6514	1024 x 4 (350ns) CMOS (UPD444C)	4.49
43256-15L	32,768 x 8 (150ns) Low Power	24.95

### PROMS/EPROMS

1702A	256 x 8 (148s)	6.95
TMS2516	2048 x 8 (450ns) 25V	4.95
TMS2532	4096 x 8 (450ns) 25V	5.95
TMS2564	8192 x 8 (450ns) 25V	8.95
2708	1024 x 8 (450ns)	4.95
TMS2716	2048 x 8 (450ns) 3 voltage	9.95
2716	2048 x 8 (450ns)	3.75
2716-1	2048 x 8 (350ns) 25V	4.95
2732	4096 x 8 (450ns) 25V (CMOS)	6.49
2732A-20	4096 x 8 (200ns) 21V	4.25
2732A-25	4096 x 8 (250ns) 21V	3.95
2732A-45	4096 x 8 (450ns) 21V	3.75
27C32	4096 x 8 (450ns) 25V (CMOS)	6.49
2764-20	8192 x 8 (200ns) 21V	4.25
2764-25	8192 x 8 (250ns) 21V	3.75
2764A-25	8192 x 8 (250ns) 12.5V	4.25
2764-45	8192 x 8 (450ns) 21V	3.49
27C64	450ns) 21V (CMOS)	6.49
27C64-15	8192 x 8 (150ns) 21V (CMOS)	6.49
27128-20	16,384 x 8 (200ns) 128K 21V	4.95
27128-25	16,384 x 8 (250ns) 128K 21V	4.25
27128A-25	16,384 x 8 (250ns) 21V (CMOS)	4.95
2764-25	16,384 x 8 (200ns) 256K (12.5V)	6.95
27256-20	32,768 x 8 (200ns) 256K (12.5V)	5.95
27256-25	32,768 x 8 (250ns) 256K (CMOS) (12.5V)	8.95
272512-25	65,536 x 8 (250ns) 512K (12.5V)	19.95
68764	8192 x 8 (450ns) 25V	15.95
68766	8192 x 8 (350ns) 25V	16.95
74S387	256 x 4 PROM O.C.	1.29
74S471	256 x 4 PROM T.S.	4.65
NB25123	32 x 8 PROM T.S.	2.49

### SATELLITE TV DECRYPTER CHIP

The MM5321N is a TV camera sync generator designed to supply the basic sync functions for either color or monochrome 525 line/60Hz interfaced and camera video recorder applications. COLOR BURST GATE & SYNC ALLOW STABLE COLOR OPERATION

**MM5321N..... \$11.95**

# Worldwide • Since 1974

• QUALITY COMPONENTS • COMPETITIVE PRICING  
• PROMPT DELIVERY

Mail Order Electronics • Worldwide  
**Jameco**  
ELECTRONICS

## COMMODORE COMPATIBLE ACCESSORIES



### HESWARE 300 Baud Modem

For VIC-20 and C-64

• Connects directly to User Port • Manual Answer/Dial • Function keys defined for convenience • Includes Midwest Micro Associates communication software.

CM-1 (For VIC-20 and C-64) ~~\$34.95~~ \$24.95

**External Power Supply**  
CPS-10 (For C-64) . . . . . \$39.95

**Parallel Printer Interface**  
2K Buffer, Expandable to 10K!  
MW-350 (For VIC-20, C-64 & C-128) . . . \$54.95

## TRS-80/TANDY COMPATIBLE ACCESSORIES

**E-X-P-A-N-D TRS-80 MEMORY**  
All kits come complete with documentation

TRS-80 MODEL 4, 4P, & 4D 64K/128K EXPANSION  
TRS-64K-2 . . . . . \$7.95  
Expands Model 4 from 16K-64K or Model 4 (Gate Array Version), 4P and 4D from 64K-128K

TRS-64K-2PAL . . . . . \$14.95  
Expands Model 4 (Non-Gate Array Version) from 64K to 128K

TRS-80 MODEL 100 8K EXPANSION  
M1008K . . . . . \$19.95 ea. or 3 for \$54.95

## ZUCKERBOARD

**TANDY 1000 Expansion Memory Half Card**  
Expand the memory of your Tandy 1000 (128K Version) to as much as 640K. Also includes DMA controller chip.

TAN-EM256K Includes 256K RAM . . . . . \$ 99.95  
TAN-EM512K Includes 512K RAM . . . . . \$119.95

**Options for TAN-EM256K/512K**  
TAN-C Plug-In Clock option chip (only) . . . . . \$39.95  
TAN-D RAM Disk Printer Spooler Software (only) \$39.95

## NEW! Expansion Memory NEW! Half Card for TANDY 1000SX

TSX256K Includes 256K RAM . . . . . \$119.95

**TANDY 1000 Multifunction Board with Clock Calendar**  
Expand the memory on your Tandy 1000 (128K Version) to as much as 640K. Complete with an RS232 port, clock/calendar, RAM Disk Printer Spooler and on-board DMA controller chip.

MTAN-256K Includes 256K RAM . . . . . \$179.95  
MTAN-512K Includes 512K RAM . . . . . \$199.95

## NEW! Multifunction NEW! Board for TANDY 1000SX

M256K Includes 256K RAM . . . . . \$189.95

## UV-EPROM ERASER

Erases all EPROMs. Erases up to 8 chips within 21 minutes (1 chip in 15 minutes). Maintains constant exposure distance of 1". Special conductive foam liner eliminates static build-up. Built-in safety lock to prevent UV exposure. Compact - 9.00" L x 3.70" W x 2.60" H. Complete with holding tray for 8 chips.

DE-4 UV-EPROM Eraser . . . . . \$69.95  
UVS-11EL Replacement Bulb . . . . . \$19.95  
NCF-2 Cond. Foam 12x24x1/4 Hard Blk. \$ 8.95

## NOW YOU CAN BUILD AN IBM PC/XT COMPATIBLE!



**IBM Compatible Kit**  
IBM-64K(2) 64K RAM Chips (18) . . \$ 19.90  
KB83 83-Key Keyboard . . . . . \$ 29.95  
IBM-FCC Floppy Controller Card \$ 34.95  
IBM-Case Case . . . . . \$ 39.95  
IBM-MCC Monochrome Card . . . \$ 59.95  
IBM-PS Power Supply . . . . . \$ 69.95  
FD55B Disk Drive . . . . . \$109.95  
IBM-MON Monochrome Monitor \$ 99.95  
IBM-MB Motherboard . . . . . \$109.95

**FREE! QUICKSOFT PC WRITE WORD PROCESSING SOFTWARE INCLUDED!**

Weight: 48 lbs. **Regular List \$574.50**

**IBM-Special (Includes 9 items above) . . . \$499.95**



## IBM Special No. 2

Includes IBM AT style keyboard with tactile touch (KB5160, see below) and all the above items (except KB83) **Regular List \$604.50**  
Weight: 48 lbs.

**IBMSP2 . . . . . \$529.95**

## ADDITIONAL ADD-ONS AVAILABLE!

IBM-KB 83-Key Keyboard . . . . . \$ 59.95  
IBM-ENH Enhanced Keyboard . . . . . \$ 79.95  
IBM-ICB Integrated Color Board w/Printer Port . . . \$ 99.95  
IBM-EGA Enhanced Graphics 256K RAM . . . \$249.95  
IBM-20MBK 20MB Hard Disk Drive, Controller & Cable . . \$429.95  
IMFC Multifunction 0-384K RAM (without RAM) . . \$109.95  
EM-100 Expansion Memory Half Card (without RAM) . . \$ 59.95  
RS232HC RS232 Serial Half Card . . . . . \$ 29.95  
TTX-1410 14" RGB Color Monitor . . . . . \$299.95  
PM1200B-2 1200/300 Baud Half Card Modem without software . . \$129.95  
PM1200B-2S 1200/300 Baud Half Card Modem with Mirror Software . . \$159.95  
IBM is a registered trademark of IBM Computers

## NEW PRODUCTS!

### Turbo 4.77/8MHz Motherboard



### IBM PC/XT Compatible

• 75% faster than the IBM PC while in the turbo mode • Turbo Mode selectable through either software or hardware • Expandable to 640K (comes w/zero-K) • DTK/ERSO BIOS included

**TURBO . . . . . NEW! . . . . . \$129.95**

### IBM PC/XT/AT Compatible Keyboard

**NEW! AT Style Layout**

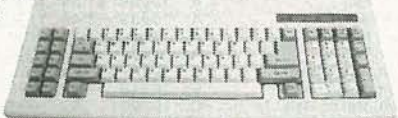

• Tactile touch keyswitches • AT style layout • Switch selectable between PC/XT or AT • Illuminated Caps Lock, Num Lock and Scroll Lock indicators • Low profile design • 8 1/2' foot cord • Manual included

**KB5160 . . . . . \$59.95**

### ZUCKERBOARD Monochrome Graphics Half Card

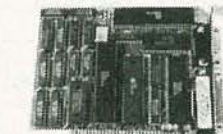

with Printer Port for IBM PC/XT/AT and Compatible Computers

• Full Hercules™ compatibility • Printer port adapter • High resolution graphics 720 x 348 pixels • Diagnostics program included • Fast refresh rate • 2-yr. warranty • Manual included

**MG201... NEW! ... \$89.95**

## APPLE COMPATIBLE ACCESSORIES



### Parallel Printer Card for Apple II, II+ and IIe

• Intelligent interface to most dot matrix graphics printers  
• Centronics standard  
• Advanced text printing

JE880 Parallel Printer Card . . . . . \$49.95  
JE883 64K Buffer for JE880 ~~\$69.95~~ \$59.95  
JE8803 JE880 and JE883 ~~\$169.90~~ \$99.95



### Extended 80-Column Card for Apple IIe

• 80 Col./64K RAM • Doubles amount of data your Apple IIe can display as well as its memory capacity • Ideal for word processing • Complete with instructions

**JE864 \$59.95**

### Additional Apple Compatible Products Available



### JE310 Fiber Optics Experimenter Kit

**NEW!** Educational device gives students and engineers hands-on experience with fiber optic technology  
• Step by step instructions • Includes transmitter & receiver circuits boards, as well as all nec. IC's, cables & connectors

**JE310 Fiber Optic Kit . . . . . \$19.95**



### JE450 Solderless Proto-Type Builder

• Provides user with quick and efficient system for breadboarding electronic circuits • Components & wire leads can be quickly inserted and removed without soldering or de-soldering • 3 regulated power supplies: 5V @ 1A, +5V to +15V @ .5A, -5V to -15V @ .5A • Power: 120VAC, 60Hz fused

**NEW!**  
**JE450 Solderless Proto-Type Builder . . . \$119.95**



### IBM Compatible! DISK DRIVES

Documentation Included  
FD55B Teac 5 1/4" DS 1/2-H (IBM PC/XT) . . . \$109.95  
JU-455 Panasonic 5 1/4" DS 1/2-H (IBM PC/XT) \$109.95  
JU-475 Panasonic 5 1/4" DS 1/2-H (IBM AT) . . \$119.95

## DATA BOOKS

30003 National Linear Data Book (82) . . . . . \$14.95  
30009 Intersil Data Book (86) . . . . . \$ 9.95  
30013 Zilog Data Book (85) . . . . . \$14.95  
30032 National Linear Supplement (84) . . . . \$ 6.95  
210830 Intel Memory Handbook (87) . . . . . \$17.95  
230843 Intel Microsystem Hndbk. Set (87) . . . \$24.95

## MUFFIN/SPRITE-STYLE FANS



MUF60 . . . . . \$9.95  
Torin Industries (4.68" sq., 60 cfm)  
SU2A1 . . . . . \$8.95  
EG&G Rotron (3.125" square, 20 cfm)

\$20 Minimum Order - U.S. Funds Only  
Shipping: Add 5% plus \$1.50 Insurance

California Residents: Add 6%, 6 1/2% or 7% Sales Tax  
We reserve the right to substitute IC manufacturers.

Data Sheets - 50¢ each  
Prices Subject to Change

Send \$1.00 Postage for a  
FREE Seasonal Flyer  
FAX 415-592-2503  
6/87



Send \$1.00 Postage for a  
FREE 1987 CATALOG  
Telex: 176043

1355 SHOREWAY ROAD, BELMONT, CA 94002 • PHONE ORDERS WELCOME 415-592-8097 ©1987 Jameco Electronics

# What's New at AMERICAN DESIGN COMPONENTS . . . ?

**W**e warehouse 60,000 items at American Design Components — expensive, often hard-to-find components for sale at a fraction of their original cost!

You'll find every part you need — either brand new, or removed from equipment (RFE) in excellent condition. But quantities are limited. Order from this ad, or visit our retail showroom and find exactly what you need from the thousands of items on display.

Open Mon. — Sat., 9–5

## THERE'S NO RISK.

With our full 90-day warranty, any purchase can be returned for any reason for full credit or refund.

### Insides of the COMMODORE COMPUTER



Commodore VIC 20 CPU board & mechanical keyboard. Guaranteed not to work. (For parts only.)  
Item #12144 **\$14.95** RFE

### Composite Video Monitors . . .



**12" Monitor**  
(Controls front panel mounted)  
12", green phosphor, high resolution (12 lines center) and bandwidth from 10Hz to 30 Hz ± 3dB. Op. volt.: 120/240VAC, 50/60Hz., 65VA max. Controls front panel mtd. Mfr — Motorola — Alpha Series  
Item #10043 **\$29.95** New

**15" Monitor**  
15" screen. Same specs as above.  
Item #10044 **\$34.95** New

### ADAM COMPUTER KIT (Less printer & w/o cabinet)



Build it yourself from subassemblies. No wiring nec. (just plugs together). Hook-up diagram included. Includes: Keyboard, 1 cassette digital data drive, 2 game controllers, power supply, all memory boards, and one cassette. Capable of running CP/M, has built-in word processor. Item #7410.  
Complete — **\$99.00**

### 3 1/2", 10Mb HARD DISK DRIVE (IBM® Compatible)

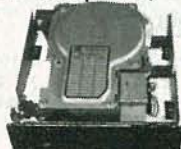

Fits standard 5 1/4" spacing. Shock mounted. High speed, low power. Mfr — MMI #MM212  
Item #9217 **\$179.00** New  
Controller Card for above  
Item #9984 **\$99.00**

### 115 CFM MUFFIN® FAN



**SPECIAL!**  
115 VAC/60 Hz., 21W., 28A., 3100 RPM; 5-blade model, aluminum housing. Can be mounted for blowing or exhaust.  
Dim.: 4 1/8" sq. x 1 1/2" deep.  
Item #5345 **\$5.95** RFE

### MECHANICAL KEYBOARDS . . .



**48-KEY — Timex Z81/1000**  
Item #6712 **\$5.95** New  
**66-KEY — Commodore C-16**  
Item #9394 **\$5.95** New  
**75-KEY — Timex or Adam**  
For computer upgrade . . .  
Item #7429 **\$5.95** New

### 5 1/4", 1.2 Mb. AT HALF HT. DISK DRIVE



**48/96 TPI  
(IBM® Compatible)**  
Double sided, single/double density; 80 track.  
Mfr — Panasonic #JU-475  
Item #10005 **\$129.00** New

### JOYSTICK CONTROLLERS



Fits Atari, Apple, Commodore, and our #10336 PCB300 Computer. Has 4-ft. cord with plug.  
Dim.: 3 1/2" sq. x 1 1/2" H.  
Item #12143 **\$5.95** New

### 115 VAC 27 CFM MINI FANS



50/60Hz.; 12W. Low noise level fans, can be mounted for blowing or exhaust.  
**1" Thin:** contains 9 plastic blades  
Dim.: 3 1/4" sq. x 1" deep  
Mfr — Toshiba #U9201B  
Item #10960 **\$7.95** New  
**1 1/2" Standard:** contains 7 metal blades.  
Mfr — Rotron #SU2A1  
Item #5970 **\$7.95** New

### 5 1/4" FULL HT. DISK DRIVES



**48 TPI (IBM® Compat.)**  
Double sided/double density, full height drive. 48 T.P.I., 80 tracks.  
Mfr — MPI-52S  
Item #7928 **\$79.95**  
**2 for \$150.00**  
**96 TPI, DS/Quad Density**  
Mfr — CDC #9409T  
Item #1893 **\$99.00**

### 5 1/4" 1/2 HT. DISK DRIVE



**DOS 3.2 Compatible**  
96 TPI, DS/QUAD DENSITY  
Tandon TM55-4 DS/Quad  
Item #1904 **\$79.00**  
**2 for \$150.00**

### EMI FILTER 6 Amp., 120/ 240 Volt



Provides the most effective attenuation of 'line-to-ground' and 'line-to-line' noise across the frequency range.  
Dim.: 2.62" x 1.98" x .81".  
Mfr — SAE (equiv. to Corcom type 6ECI)  
Item #10959 **\$4.95**  
**2 for \$9.00**

### RECORDING TAPE 7 1/2" Reel, 2400 ft.



Bulk erased. Major mfrs.: Ampex, Scotch, etc.  
Item #6711 — 1/4 Mil.  
**79¢ ea.; 3 for \$2.00**

### 12/24 VDC MUFFIN-TYPE FANS



8 W. Can be mounted for blowing or exhaust. Aluminum housing, brushless, ball-bearing type.  
**1" Thin:** 5 plastic blades with feathered edges.  
Mfr — Centaur #CUDC24K4-601  
Item #8541 **\$19.95** New  
**1 1/2" Standard:** 5 plastic blades  
Mfr — Centaur #CND24K4-601  
Item #12109 **\$14.95** RFE

### Rechargeable NICAD BATTERY BACKUPS



**12V @ 450 ma**  
Contains 10 AA cells. Recharge rate: 45 ma. 16–18 hours. Case with tab output connections.  
Dim.: 2 1/8" H x 1 1/4" W x 2 1/8" L  
Mfr — GE 123233 or equiv.  
Item #5443 **\$5.95** New  
**13.2V @ 1.65 AH**  
Contains 11 C cells.  
For model boats, toys, etc.  
Mfr — GE #41B035BB00101  
Item #5444 **\$15.95** New

### D-SUBMINIATURE SOLDERLESS CONNECTORS, CRIMP TERMINALS (Mfr — TRW)

Description	Fig.	9-Pin		15-Pin		25-Pin		37-Pin	
		Item #	Price	Item #	Price	Item #	Price	Item #	Price
Hood w/Metal Male	A	10998	\$1.29	11001	\$1.39	O/S	\$1.69	11002	\$2.09
Hood w/Metal Female	A	10999	1.49	11000	1.49	O/S	1.79	11003	2.19
Hood w/Plastic Male	A	11004	1.19	O/S	1.29	11007	1.59	11005	1.99
Hood w/Plastic Female	A	O/S	1.39	O/S	1.49	11008	1.79	11006	2.19
Chassis mount, Metal Male*	B	10747	.79	10745	.89	10735	1.19	10752	1.59
Chassis mount, Metal Female	B	10746	.89	10734	.99	10711	1.29	10888	1.69
Chassis mount, Plastic Male**	C	10890	.69	10910	.79	10732	1.09	10891	1.49
Chassis mount, Plastic Female	C	10728	.79	10731	.89	10724	1.19	10729	1.59
QC Hood w/Metal Male	D	11025	1.39	10029	1.49	11033	1.79	11037	2.19
QC Hood, Rt. Angle w/Metal Male	E	11026	1.39	11030	1.49	11034	1.79	11038	2.19
QC Hood w/Metal Female	D	11027	1.59	11031	1.69	11035	1.99	11039	2.39
QC Hood, Rt. Angle w/Metal Female	E	11028	1.59	11032	1.69	11036	1.99	11040	2.39
QC Hood w/Plastic Male	D	11009	1.29	11013	1.39	11017	1.69	11021	2.09
QC Hood, Rt. Angle w/Plastic Male	E	11011	1.29	11015	1.39	11018	1.69	11022	2.09
QC Hood w/Plastic Female	D	11010	1.49	11014	1.59	11019	1.89	11023	2.29
QC Hood, Rt. Angle, w/Plastic Female	E	11012	1.49	11016	1.59	11020	1.89	11024	2.29

QC = Quick connect; \*Without mounting device; \*\*Can be used with quick connect hoods

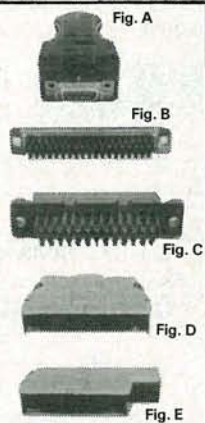

### ADAM PRINTER



Complete, less top cover plate. Friction feed. Takes standard paper 8 1/2" x 11". (Customer returns; tested — operational.)  
Item #8839 **\$69.50**

### COLECOVISION to ADAM EXPANSION KIT

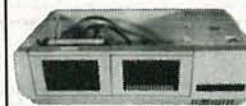

This expansion module just plugs into your ColecoVision. With printer power supply and data drive (both included), you will have a working Adam Computer. Adam keyboard, one Smart basic cassette and hook-up diagram also included.  
Item #9918 **\$59.50**

### ADAM Accessories . . .

**DATA DRIVE —**  
Item #6641  
**LAST CHANCE — \$19.95**  
**PRINTER POWER SUPPLY —**  
Item #6642 **\$14.95**  
**ASCII KEYBOARD —**  
Item #6643 **\$19.95**  
**CONTROLLERS (set of 4)**  
Item #7013 **\$9.95**  
**ADAM CASSETTES  
(Consisting of Buck Rogers  
& Smart Basic only.)**  
Item #7786  
**BAKER'S DOZEN — \$19.95**

### 140 VA MINI MICRO- COMPUTER REGULATOR



Provides voltage regulation and ultra-isolation for microprocessor-based equipment. Contains less than 3% harmonic distortion, better than 60 dB traverse noise rejection. Contains dual outlet for CPU & monitor, and 6 ft. line cord.  
Input: 95 — 130V, 60Hz.  
Output: 120V @ 1.17A  
Dimen.: 1 1/4" L x 4 3/4" H x 5 1/4" W  
Mtd on metal base with rubber ft.  
Mfr — Sola #63-13-114  
Item #9999 **\$99.00** New





# CORPORATION

# 8-0-344-453

AK, Puerto Rico - 218-61-6674    Telex - 62827914    FAX - 218-61-3300    TWX - 91050882 DIGI KEY CORP

**VISA**    **NATIONAL SEMICONDUCTOR • PANASONIC**  
**OK MACHINE • EWC, INC. • INTERSIL • AD**  
**EAC, INC. • J. W. MILLER • AAVD ENGINEER**  
**E. F. JOHNSON • ATLANTIC SEMICONDUCTOR**

256K (262,144 x 1) DRAM 150NS \$5.70/1; \$39.95/9

Factory Firsts

**DIODES • DIAMOND TOOL • UNGAR •**  
**ES • CW INDUSTRIES • AMDEK • G.E.**  
**IGAR • YAGEO • J. W. MILLER • LUXO**  
**3C CHEMICALS • ARIES • PLESSEY**

### INTEGRATED CIRCUITS

Part No.	Description	Price
7400 TTL	74115N (1)	1.60
7400 TTL	74115N (2)	2.25
7400 TTL	74115N (3)	2.90
7400 TTL	74115N (4)	3.55
7400 TTL	74115N (5)	4.20
7400 TTL	74115N (6)	4.85
7400 TTL	74115N (7)	5.50
7400 TTL	74115N (8)	6.15
7400 TTL	74115N (9)	6.80
7400 TTL	74115N (10)	7.45
7400 TTL	74115N (11)	8.10
7400 TTL	74115N (12)	8.75
7400 TTL	74115N (13)	9.40
7400 TTL	74115N (14)	10.05
7400 TTL	74115N (15)	10.70
7400 TTL	74115N (16)	11.35
7400 TTL	74115N (17)	12.00
7400 TTL	74115N (18)	12.65
7400 TTL	74115N (19)	13.30
7400 TTL	74115N (20)	13.95
7400 TTL	74115N (21)	14.60
7400 TTL	74115N (22)	15.25
7400 TTL	74115N (23)	15.90
7400 TTL	74115N (24)	16.55
7400 TTL	74115N (25)	17.20
7400 TTL	74115N (26)	17.85
7400 TTL	74115N (27)	18.50
7400 TTL	74115N (28)	19.15
7400 TTL	74115N (29)	19.80
7400 TTL	74115N (30)	20.45
7400 TTL	74115N (31)	21.10
7400 TTL	74115N (32)	21.75
7400 TTL	74115N (33)	22.40
7400 TTL	74115N (34)	23.05
7400 TTL	74115N (35)	23.70
7400 TTL	74115N (36)	24.35
7400 TTL	74115N (37)	25.00
7400 TTL	74115N (38)	25.65
7400 TTL	74115N (39)	26.30
7400 TTL	74115N (40)	26.95
7400 TTL	74115N (41)	27.60
7400 TTL	74115N (42)	28.25
7400 TTL	74115N (43)	28.90
7400 TTL	74115N (44)	29.55
7400 TTL	74115N (45)	30.20
7400 TTL	74115N (46)	30.85
7400 TTL	74115N (47)	31.50
7400 TTL	74115N (48)	32.15
7400 TTL	74115N (49)	32.80
7400 TTL	74115N (50)	33.45
7400 TTL	74115N (51)	34.10
7400 TTL	74115N (52)	34.75
7400 TTL	74115N (53)	35.40
7400 TTL	74115N (54)	36.05
7400 TTL	74115N (55)	36.70
7400 TTL	74115N (56)	37.35
7400 TTL	74115N (57)	38.00
7400 TTL	74115N (58)	38.65
7400 TTL	74115N (59)	39.30
7400 TTL	74115N (60)	39.95
7400 TTL	74115N (61)	40.60
7400 TTL	74115N (62)	41.25
7400 TTL	74115N (63)	41.90
7400 TTL	74115N (64)	42.55
7400 TTL	74115N (65)	43.20
7400 TTL	74115N (66)	43.85
7400 TTL	74115N (67)	44.50
7400 TTL	74115N (68)	45.15
7400 TTL	74115N (69)	45.80
7400 TTL	74115N (70)	46.45
7400 TTL	74115N (71)	47.10
7400 TTL	74115N (72)	47.75
7400 TTL	74115N (73)	48.40
7400 TTL	74115N (74)	49.05
7400 TTL	74115N (75)	49.70
7400 TTL	74115N (76)	50.35
7400 TTL	74115N (77)	51.00
7400 TTL	74115N (78)	51.65
7400 TTL	74115N (79)	52.30
7400 TTL	74115N (80)	52.95
7400 TTL	74115N (81)	53.60
7400 TTL	74115N (82)	54.25
7400 TTL	74115N (83)	54.90
7400 TTL	74115N (84)	55.55
7400 TTL	74115N (85)	56.20
7400 TTL	74115N (86)	56.85
7400 TTL	74115N (87)	57.50
7400 TTL	74115N (88)	58.15
7400 TTL	74115N (89)	58.80
7400 TTL	74115N (90)	59.45
7400 TTL	74115N (91)	60.10
7400 TTL	74115N (92)	60.75
7400 TTL	74115N (93)	61.40
7400 TTL	74115N (94)	62.05
7400 TTL	74115N (95)	62.70
7400 TTL	74115N (96)	63.35
7400 TTL	74115N (97)	64.00
7400 TTL	74115N (98)	64.65
7400 TTL	74115N (99)	65.30
7400 TTL	74115N (100)	65.95

### INTEGRATED CIRCUITS

Part No.	Description	Price
4000 CMOS	4001	1.10
4000 CMOS	4002	1.20
4000 CMOS	4003	1.30
4000 CMOS	4004	1.40
4000 CMOS	4005	1.50
4000 CMOS	4006	1.60
4000 CMOS	4007	1.70
4000 CMOS	4008	1.80
4000 CMOS	4009	1.90
4000 CMOS	4010	2.00
4000 CMOS	4011	2.10
4000 CMOS	4012	2.20
4000 CMOS	4013	2.30
4000 CMOS	4014	2.40
4000 CMOS	4015	2.50
4000 CMOS	4016	2.60
4000 CMOS	4017	2.70
4000 CMOS	4018	2.80
4000 CMOS	4019	2.90
4000 CMOS	4020	3.00
4000 CMOS	4021	3.10
4000 CMOS	4022	3.20
4000 CMOS	4023	3.30
4000 CMOS	4024	3.40
4000 CMOS	4025	3.50
4000 CMOS	4026	3.60
4000 CMOS	4027	3.70
4000 CMOS	4028	3.80
4000 CMOS	4029	3.90
4000 CMOS	4030	4.00
4000 CMOS	4031	4.10
4000 CMOS	4032	4.20
4000 CMOS	4033	4.30
4000 CMOS	4034	4.40
4000 CMOS	4035	4.50
4000 CMOS	4036	4.60
4000 CMOS	4037	4.70
4000 CMOS	4038	4.80
4000 CMOS	4039	4.90
4000 CMOS	4040	5.00
4000 CMOS	4041	5.10
4000 CMOS	4042	5.20
4000 CMOS	4043	5.30
4000 CMOS	4044	5.40
4000 CMOS	4045	5.50
4000 CMOS	4046	5.60
4000 CMOS	4047	5.70
4000 CMOS	4048	5.80
4000 CMOS	4049	5.90
4000 CMOS	4050	6.00
4000 CMOS	4051	6.10
4000 CMOS	4052	6.20
4000 CMOS	4053	6.30
4000 CMOS	4054	6.40
4000 CMOS	4055	6.50
4000 CMOS	4056	6.60
4000 CMOS	4057	6.70
4000 CMOS	4058	6.80
4000 CMOS	4059	6.90
4000 CMOS	4060	7.00
4000 CMOS	4061	7.10
4000 CMOS	4062	7.20
4000 CMOS	4063	7.30
4000 CMOS	4064	7.40
4000 CMOS	4065	7.50
4000 CMOS	4066	7.60
4000 CMOS	4067	7.70
4000 CMOS	4068	7.80
4000 CMOS	4069	7.90
4000 CMOS	4070	8.00
4000 CMOS	4071	8.10
4000 CMOS	4072	8.20
4000 CMOS	4073	8.30
4000 CMOS	4074	8.40
4000 CMOS	4075	8.50
4000 CMOS	4076	8.60
4000 CMOS	4077	8.70
4000 CMOS	4078	8.80
4000 CMOS	4079	8.90
4000 CMOS	4080	9.00
4000 CMOS	4081	9.10
4000 CMOS	4082	9.20
4000 CMOS	4083	9.30
4000 CMOS	4084	9.40
4000 CMOS	4085	9.50
4000 CMOS	4086	9.60
4000 CMOS	4087	9.70
4000 CMOS	4088	9.80
4000 CMOS	4089	9.90
4000 CMOS	4090	10.00
4000 CMOS	4091	10.10
4000 CMOS	4092	10.20
4000 CMOS	4093	10.30
4000 CMOS	4094	10.40
4000 CMOS	4095	10.50
4000 CMOS	4096	10.60
4000 CMOS	4097	10.70
4000 CMOS	4098	10.80
4000 CMOS	4099	10.90
4000 CMOS	4100	11.00
4000 CMOS	4101	11.10
4000 CMOS	4102	11.20
4000 CMOS	4103	11.30
4000 CMOS	4104	11.40
4000 CMOS	4105	11.50
4000 CMOS	4106	11.60
4000 CMOS	4107	11.70
4000 CMOS	4108	11.80
4000 CMOS	4109	11.90
4000 CMOS	4110	12.00
4000 CMOS	4111	12.10
4000 CMOS	4112	12.20
4000 CMOS	4113	12.30
4000 CMOS	4114	12.40
4000 CMOS	4115	12.50
4000 CMOS	4116	12.60
4000 CMOS	4117	12.70
4000 CMOS	4118	12.80
4000 CMOS	4119	12.90
4000 CMOS	4120	13.00
4000 CMOS	4121	13.10
4000 CMOS	4122	13.20
4000 CMOS	4123	13.30
4000 CMOS	4124	13.40
4000 CMOS	4125	13.50
4000 CMOS	4126	13.60
4000 CMOS	4127	13.70
4000 CMOS	4128	13.80
4000 CMOS	4129	13.90
4000 CMOS	4130	14.00
4000 CMOS	4131	14.10
4000 CMOS	4132	14.20
4000 CMOS	4133	14.30
4000 CMOS	4134	14.40
4000 CMOS	4135	14.50
4000 CMOS	4136	14.60
4000 CMOS	4137	14.70
4000 CMOS	4138	14.80
4000 CMOS	4139	14.90
4000 CMOS	4140	15.00
4000 CMOS	4141	15.10
4000 CMOS	4142	15.20
4000 CMOS	4143	15.30
4000 CMOS	4144	15.40
4000 CMOS	4145	15.50
4000 CMOS	4146	15.60
4000 CMOS	4147	15.70
4000 CMOS	4148	15.80
4000 CMOS	4149	15.90
4000 CMOS	4150	16.00
4000 CMOS	4151	16.10
4000 CMOS	4152	16.20
4000 CMOS	4153	16.30
4000 CMOS	4154	16.40
4000 CMOS	4155	16.50
4000 CMOS	4156	16.60
4000 CMOS	4157	16.70
4000 CMOS	4158	16.80
4000 CMOS	4159	16.90
4000 CMOS	4160	17.00
4000 CMOS	4161	17.10
4000 CMOS	4162	17.20
4000 CMOS	4163	17.30
4000 CMOS	4164	17.40
4000 CMOS	4165	17.50
4000 CMOS	4166	17.60
4000 CMOS	4167	17.70
4000 CMOS	4168	17.80
4000 CMOS	4169	17.90
4000 CMOS	4170	18.00
4000 CMOS	4171	18.10
4000 CMOS	4172	18.20
4000 CMOS	4173	18.30
4000 CMOS	4174	18.40
4000 CMOS	4175	18.50
4000 CMOS	4176	18.60
4000 CMOS	4177	18.70
4000 CMOS	4178	18.80
4000 CMOS	4179	18.90
4000 CMOS	4180	19.00
4000 CMOS	4181	19.10
4000 CMOS	4182	19.20
4000 CMOS	4183	19.30
4000 CMOS	4184	19.40
4000 CMOS	4185	19.50
4000 CMOS	4186	19.60
4000 CMOS	4187	19.70
4000 CMOS	4188	19.80
4000 CMOS	4189	19.90
4000 CMOS	4190	20.00
4000 CMOS	4191	20.10
4000 CMOS	4192	20.20
4000 CMOS	4193	20.30
4000 CMOS	4194	20.40
4000 CMOS	4195	20.50
4000 CMOS	4196	20.60
4000 CMOS	4197	20.70
4000 CMOS	4198	20.80
4000 CMOS	4199	20.90
4000 CMOS	4200	21.00
4000 CMOS	4201	21.10
4000 CMOS	4202	21.20
4000 CMOS	4203	21.30
4000 CMOS	4204	21.40
4000 CMOS	4205	21.50
4000 CMOS	4206	21.60
4000 CMOS	4207	21.70
4000 CMOS	4208	21.80
4000 CMOS	4209	21.90
4000 CMOS	4210	22.00
4000 CMOS	4211	22.10
4000 CMOS	4212	22.20
4000 CMOS	4213	22.30
4000 CMOS	4214	22.40
4000 CMOS	4215	22.50
4000 CMOS	4216	22.60
4000 CMOS	4217	22.70
4000 CMOS	4218	22.80
4000 CMOS	4219	22.90
4000 CMOS	4220	23.00
4000 CMOS	4221	23.10
4000 CMOS	4222	23.20
4000 CMOS	4223	23.30
4000 CMOS	4224	23.40
4000 CMOS	4225	23.50
4000 CMOS	4226	23.60
4000 CMOS	4227	23.70
4000 CMOS	4228	23.80
4000 CMOS	4229	23.90
4000 CMOS	4230	24.00
4000 CMOS	4231	24.10
4000 CMOS	4	

### Tenma 20MHz Dual Trace Oscilloscope

■ Two high quality 10:1 probes included. For detailed specifications call for a complete Tenma catalog.

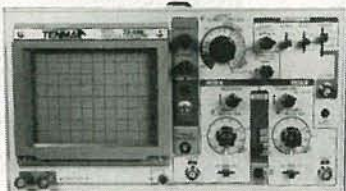

**2 YEAR LIMITED WARRANTY**

#72-320 ..... **\$369<sup>95</sup>** (ea.)

### Tenma 0-18V 3A Power Supply

■ Regulated outputs — constant volt or constant current, both are continuously variable ■ Can be connected in series or parallel for more voltage or current output ■ Reverse polarity and overload protected ■ Isolated output. For detailed specifications call for a complete Tenma catalog.



**1 YEAR LIMITED WARRANTY**

#72-420 ..... **\$115<sup>90</sup>** (ea.)

### Tenma RS-232 Break Out Box

■ Monitors individual communication interface lines ■ Detects the presence or absence of activity ■ Rewire RS-232 interfaces ■ Line powered ■ Dual-state LEDs monitor both positive and negative signal levels ■ 48 test points ■ For detailed specifications call for a complete Tenma catalog.



#72-440  
\$44<sup>80</sup> (ea.)  
**\$39<sup>95</sup>** (2-up)

# TENMA

## TEST EQUIPMENT

### Butane Soldering Iron

Portasol™ is the first butane-powered, portable soldering iron. It's not much larger than a felt marker and only seven inches long. As simple to use as a cigarette lighter. Easily refilled with butane. One filling lasts for 60 minutes. Adjustable, with 10-60 watt power. Replacement tip available.



#21-630  
\$34<sup>50</sup> (1-9) ..... **\$29<sup>95</sup>** (10-up)

Replacement Tip  
#21-635  
\$8<sup>95</sup> (1-3) ..... **\$7<sup>80</sup>** (4-up)

### Tenma Deluxe Anti-Static Desoldering Tool

■ Rugged metal construction ■ Anti-static tip ■ Nozzle cleaner ■ Lightweight and compact ■ Disassembles easily for cleaning ■ 7 3/4" long x 3/4" diameter



#21-590 ..... \$5<sup>90</sup> (1-3) ..... **\$4<sup>95</sup>** (4-up)

Replacement Tip  
#21-595 ..... \$2<sup>55</sup> (1-4) ..... **\$2<sup>20</sup>** (5-up)

### Tenma Neon Voltage Tester

■ Quickly detects live circuits from 60-500 volts AC and DC ■ Ideal for testing outlets, switches, fuses and house wiring ■ Dependable neon lamp indicates presence of voltage ■ Pocket clip attached to keep tester handy



#22-690 ..... \$1<sup>90</sup> (1-9) ..... **\$1<sup>45</sup>** (10-up)



**Be Sure To Call For Your FREE Catalog! Over 7,000 Items!**

### Tenma Compact DMM with Logic Probe

■ Measures DCV, ACV, DCA, ACA and resistance ■ Audible continuity tester, diode check and transistor hFe ■ Built-in logic tester compatible with DTL/TTL/HTL/CMOS ICs. Detects pulses as short as 25nsec ■ Accessories: Test leads, spare 2A fuse, instruction manual and carrying case ■ For detailed specifications call for a complete Tenma catalog.



**1 YEAR LIMITED WARRANTY**

#72-445  
**\$59<sup>80</sup>** (ea.)

### Tenma Anti-Static Work Mat

■ A must for the modern service shop ■ Used in conjunction with our #21-660 wrist strap to help eliminate static related problems ■ 18" x 26"

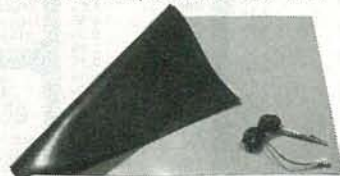

#21-655  
\$37<sup>60</sup> (1-4) ..... **\$33<sup>45</sup>** (5-up)

### Tenma Anti-Static Wrist Strap

■ Silver-plated monofilament fibers are woven into a comfortable elastic wrist strap, that gently conforms to the user's wrist for reliable contact to ground



#21-660  
\$10<sup>25</sup> (1-9) ..... **\$9<sup>45</sup>** (10-up)



**MCM ELECTRONICS**  
858 E. CONGRESS PARK DR.  
CENTERVILLE, OH 45459  
A PREMIER Company

SOURCE CODE: RE-33

© 1987, MCM Electronics

#### Terms:

- \$10 minimum order. \$1.00 charge for orders under \$10.
- \$20 minimum charge card order.
- Orders shipped UPS C.O.D.
- Most orders shipped within 24 hours.
- Sales office open 8:30 am to 7:00 pm Saturdays 10:00 am to 3:00 pm EST.
- For prepaid orders add \$2.75 for shipping and handling.
- Should shipping and handling charges exceed \$2.75, the balance due will be sent C.O.D.



JUNE 1987

# 1200B MODEM \$9995 FOR IBM W/ SOFTWARE 2400B MODEM \$19995

### STATIC RAMS

2101	256x4	(450ns)	1.95
5101	256x4	(450ns)(CMOS)	3.95
2102L-4	1024x1	(450ns)(LP)	.99
2112	256x4	(450ns)	2.99
2114	1024x4	(450ns)	1.09
2114L-4	1024x4	(450ns)(LP)	1.49
2114L-2	1024x4	(200ns)(LP)	1.49
2114L-15	1024x4	(150ns)(LP)	1.95
TMS4044-4	4096x1	(450ns)	1.95
TMM2016-150	2048x8	(150ns)	1.49
TMM2016-100	2048x8	(100ns)	1.95
HM6116-4	2048x8	(200ns)(CMOS)	1.89
HM6116-3	2048x8	(150ns)(CMOS)	1.49
HM6116LP-4	2048x8	(200ns)(CMOS)(LP)	1.95
HM6116LP-3	2048x8	(150ns)(CMOS)(LP)	2.05
HM6116LP-2	2048x8	(120ns)(CMOS)(LP)	2.95
HM6264P-15	8192x8	(150ns)(CMOS)	3.89
HM6264LP-15	8192x8	(150ns)(CMOS)(LP)	3.95
HM6264LP-12	8192x8	(120ns)(CMOS)(LP)	4.49

LP-Low power

### DYNAMIC RAMS

4116-250	16384x1	(250ns)	.49
4116-200	16384x1	(200ns)	.89
4116-150	16384x1	(150ns)	1.49
4116-120	16384x1	(120ns)	1.49
MK4332	32768x1	(200ns)	6.95
4164-200	65536x1	(200ns)(5v)	1.19
4164-150	65536x1	(150ns)(5v)	1.29
4164-120	65536x1	(120ns)(5v)	1.95
MCM6665	65536x1	(200ns)(5v)	1.95
TMS4164	65536x1	(150ns)(5v)	1.95
4164-REFRESH	65536x1	(180ns)(5v)(REFRESH)	2.95
TMS4416	16384x4	(150ns)(5v)	4.95
41128-150	131072x1	(150ns)(5v)	5.95
TMS4464-15	65536x4	(150ns)(5v)	6.95
41256-200	262144x1	(200ns)(5v)	2.95
41256-150	262144x1	(150ns)(5v)	2.95

5v-Single 5 Volt Supply REFRESH-Pin 1 Refresh

★★★★HIGH-TECH★★★★  
**NEC V20 UPD70108 \$1195**  
 REPLACES 8088 TO SPEED UP IBM PC 10-40%  
 \* HIGH-SPEED ADDRESS CALCULATION IN HARDWARE  
 \* PIN COMPATIBLE WITH 8088  
 \* SUPERSET OF 8088 INSTRUCTION SET  
 \* LOW POWER CMOS  
**8MHz V20 UPD70108-8 \$13.95**  
**8MHz V30 UPD70116-8 \$19.95**  
 ★★★★★SPOTLIGHT★★★★★

### EPROMS

2708	1024x8	(450ns)	4.95
2716	2048x8	(450ns)(5V)	3.49
2716-1	2048x8	(350ns)(5V)	3.95
TMS2532	4096x8	(450ns)(5V)	5.95
2732	4096x8	(450ns)(5V)	3.95
2732A	4096x8	(250ns)(5V)(21V PGM)	3.95
2732A-2	4096x8	(200ns)(5V)(21V PGM)	4.25
27C64	8192x8	(250ns)(5V)(CMOS)	5.95
2764	8192x8	(450ns)(5V)	3.49
2764-250	8192x8	(250ns)(5V)	3.95
2764-200	8192x8	(200ns)(5V)	4.25
MCM68766	8192x8	(350ns)(5V)(24 PIN)	17.95
27128	16384x8	(250ns)(5V)	4.25
27C256	32768x8	(250ns)(5V)(CMOS)	10.95
27256	32768x8	(250ns)(5V)	7.49

5V-Single 5 Volt Supply 21V PGM-Program at 21 Volts

## ORDER TOLL FREE 800-538-5000



### SPECTRONICS CORPORATION EPROM ERASERS

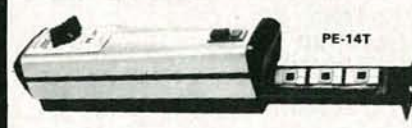

Model	Timer	Capacity Chip	Intensity (uW/Cm <sup>2</sup> )	Unit Price
PE-14	NO	9	8,000	\$83.00
PE-14T	YES	9	8,000	\$119.00
PE-24T	YES	12	9,600	\$175.00

### 8000

8035	1.49
8039	1.95
8080	2.95
8085	2.49
8087-2	169.95
8087	129.00
8088	6.95
8088-2	9.95
8155	2.49
8155-2	3.95
8748	7.95
8755	14.95
80286	129.95
80287	199.95

### 6500 1.0 MHz

6502	2.69
65C02 (CMOS)	12.95
6507	9.95
6520	1.95
6522	4.95
6526	26.95
6532	6.95
6545	6.95
6551	5.95
6561	19.95
6581	34.95

### 2.0 MHz

6502A	2.95
6520A	2.95
6522A	5.95
6532A	11.95
6545A	7.95
6551A	6.95

### 3.0 MHz

6502B	6.95
-------	------

### CRT CONTROLLERS

6845	4.95
68B45	8.95
6847	11.95
HC46505SP	6.95
MC1372	2.95
8275	26.95
7220	19.95
CRT5027	12.95
CRT5037	9.95
TMS9918A	19.95

### CRYSTALS

32,768 KHz	.95
1.0 MHz	2.95
1.8432	2.95
2.0	1.95
2.097152	1.95
2.4576	1.95
3.2768	1.95
3.579545	1.95
4.0	1.95
4.032	1.95
5.0	1.95
5.0688	1.95
6.0	1.95
6.144	1.95
6.5536	1.95
8.0	1.95
10.0	1.95
10.738635	1.95
12.0	1.95
14.31818	1.95
15.0	1.95
16.0	1.95
17.430	1.95
18.0	1.95
18.432	1.95
20.0	1.95
22.1184	1.95
22.95	1.95
24.0	1.95
27.0	1.95
32.0	1.95

### 74LS00

74LS00	.16
74LS01	.18
74LS02	.17
74LS03	.18
74LS04	.16
74LS05	.18
74LS08	.18
74LS09	.18
74LS10	.16
74LS11	.22
74LS12	.22
74LS13	.26
74LS14	.39
74LS15	.26
74LS20	.17
74LS21	.22
74LS22	.22
74LS27	.23
74LS28	.26
74LS30	.17
74LS32	.18
74LS33	.28
74LS37	.26
74LS38	.26
74LS42	.39
74LS47	.75
74LS48	.85
74LS51	.17
74LS73	.29
74LS74	.24
74LS75	.29
74LS76	.29
74LS83	.49
74LS85	.49
74LS86	.22
74LS90	.39
74LS92	.49
74LS93	.39
74LS95	.49
74LS107	.34
74LS109	.36
74LS112	.29
74LS122	.45
74LS123	.49
74LS124	2.75
74LS125	.39
74LS126	.39
74LS132	.39
74LS133	.49
74LS136	.39
74LS138	.39
74LS139	.39
74LS145	.99
74LS147	.99
74LS148	.99
74LS151	.39
74LS153	.39
74LS154	1.45
74LS155	.59
74LS156	.49
74LS157	.35
74LS158	.29
74LS160	.29
74LS161	.39
74LS162	.49
74LS163	.39
74LS164	.49

### 74HC00 HIGH SPEED CMOS

A new family of high speed CMOS logic featuring the speed of low power Schottky; 3ns typical gate propagation delay; combined with the advantages of CMOS: very low power consumption; superior noise immunity, and improved output drive.

74HC00	.59	74HC148	1.19
74HC02	.59	74HC151	.89
74HC04	.59	74HC154	2.49
74HC08	.59	74HC157	.89
74HC10	.59	74HC158	.95
74HC14	.79	74HC163	1.15
74HC20	.59	74HC175	.99
74HC27	.59	74HC240	1.89
74HC30	.59	74HC244	1.89
74HC32	.69	74HC245	1.89
74HC51	.59	74HC257	.85
74HC74	.75	74HC259	1.39
74HC85	1.35	74HC273	1.89
74HC86	.69	74HC285	4.99
74HC93	1.19	74HC368	.99
74HC107	.79	74HC373	2.29
74HC109	.79	74HC374	2.29
74HC112	.79	74HC390	1.39
74HC125	1.19	74HC393	1.39
74HC132	1.19	74HC4017	1.99
74HC133	.69	74HC4020	1.99
74HC138	.99	74HC4049	.89
74HC139	.99	74HC4050	.89

### 8200

8203	24.95
8205	3.29
8212	1.49
8216	1.49
8224	2.25
8237	4.95
8237-5	5.49
8250	6.95
8251	1.69
8251A	1.89
8253	1.89
8253-5	1.95
8255	1.69
8255-5	1.89
8259	1.95
8259-5	2.29
8272	4.95
8279	2.49
8279-5	2.95
8282	3.95
8284	2.95
8286	3.95
8288	4.95

### 6800 1.0 MHz

6800	1.95
6802	4.95
6803	9.95
6809	5.95
6809E	5.95
6810	1.95
6820	2.95
6821	1.95
6821	1.95
6840	6.95
6843	19.95
6844	12.95
6845	4.95
6847	11.95
6850	1.95
6883	22.95

### DISK CONTROLLERS

1771	4.95
1791	9.95
1793	9.95
1795	12.95
1797	12.95
2791	19.95
2793	19.95
2797	29.95
6843	19.95
8272	4.95
UPD765	4.95
M88876	12.95
M88877	12.95
1691	6.95
2143	6.95

### CRYSTAL OSCILLATORS

1.0MHz	5.95
1.8432	5.95
2.0	5.95
2.4576	5.95
5.0688	4.95
6.0	4.95
6.144	4.95
8.0	4.95
10.0	4.95
12.0	4.95
12.480	4.95
15.0	4.95
16.0	4.95
18.432	4.95
20.0	4.95
24.0	4.95

### BIT RATE GENERATORS

MC14411	9.95
BR1941	4.95
4702	9.95
COM8116	8.95
MM5307	4.95

### 74HC00 74HC200

74HC00: Operate at CMOS logic levels and are ideal for new, all-CMOS designs.

74HC200: Direct, drop-in replacements for LS TTL and can be intermixed with 74LS in the same circuit.

74HC00	.69	74HC166	3.05
74HC02	.69	74HC174	1.09
74HC04	.69	74HC193	1.39
74HC08	.69	74HC194	1.19
74HC10	.69	74HC240	2.19
74HC11	.69	74HC241	2.19
74HC12	.69	74HC244	2.19
74HC13	.69	74HC245	2.19
74HC32	.79	74HC257	.99
74HC74	.85	74HC259	1.59
74HC75	.95	74HC273	2.09
74HC138	1.15	74HC367	1.09
74HC139	1.15	74HC373	2.49
74HC154	2.99	74HC374	2.49
74HC157	.99	74HC393	1.59
74HC158	.99	74HC4017	2.19
74HC161	1.29	74HC4040	1.59
74HC164	1.39	74HC4060	1.49

### Z-80

Z80-CPU 2.5 MHz 1.69

### 4.0 MHz

Z80A-CPU	1.79
Z80A-CTC	1.89
Z80A-DART	5.95
Z80A-DMA	5.95
Z80A-PIO	1.89
Z80A-SIO/0	5.95
Z80A-SIO/2	5.95

### 6.0 MHz

Z80B-CPU	3.75
Z80B-CTC	4.25
Z80B-PIO	4.25
Z80B-DART	14.95
Z80B-SIO/0	12.95
Z80B-SIO/2	12.95
Z8671 ZILOG	19.95

### 2.0 MHz

68B00	4.95
68B02	5.95
68B09E	6.95
68B09	6.95
68B21	3.95
68B45	6.95
68B50	2.95
68B54	7.95

### UARTS

AY5-1013	3.95
AY3-1015	4.95
TR1602	3.95
2051	4.95
IM6402	6.95
IMS403	9.95
INS8250	6.95

### MISC.

TMS99531	9.95
TMS99532	19.95
ULN2003	.79
3242	7.95
3341	4.95
MC3470	1.95
MC3480	8.95
MC3487	2.95
11090	19.95
2513-001 UP	6.95
AY5-2376	11.95
AY5-3600 PRO	11.95

### SOUND CHIPS

76477	5.95
-------	------

# EGA CARD AND MONITOR NOW ONLY \$569!

## DISK DRIVES FOR APPLE COMPUTERS

**AP-150**  
\$99.95

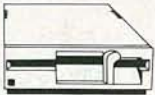

- 1/2 HT, DIRECT DRIVE
- 100% APPLE COMPATIBLE
- SIX MONTH WARRANTY

**AP-135**  
\$129.95

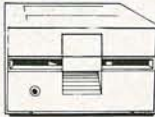

- FULL HT SHUGART MECHANISM
- DIRECT REPLACEMENT FOR APPLE DISK II
- SIX MONTH WARRANTY

**DOUBLE SIDED!**

**MAC535**  
\$249.95

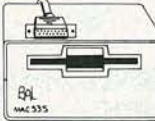

- 3.5" ADD-ON DISK DRIVE
- 100% MACINTOSH COMPATIBLE
- DOUBLE SIDED 800K BYTE STORAGE
- HIGH RELIABILITY DRIVE HAS AUTO-EJECT MECHANISM
- FULL ONE YEAR WARRANTY

**AD-3C**  
\$139.95

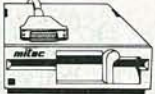

- 100% APPLE IIc COMPATIBLE, READY TO PLUG IN, W/ SHIELDED CABLE & MOLDED 19 PIN CONNECTOR
- FAST, RELIABLE SLIMLINE DIRECT DRIVE
- SIX MONTH WARRANTY

### DISK DRIVE ACCESSORIES

- FDD CONTROLLER CARD \$49.95
- IIc ADAPTOR CABLE \$19.95
- ADAPTS STANDARD APPLE DRIVES FOR USE WITH APPLE IIc

**KB-1000** \$79.95

- CASE WITH KEYBOARD FOR APPLE TYPE MOTHERBOARD
- USER DEFINED FUNCTION KEYS
  - NUMERIC KEYPAD WITH CURSOR CONTROL
  - CAPS LOCK
  - AUTO-REPEAT



**KEYBOARD-AP** \$49.95

- REPLACEMENT FOR APPLE II KEYBOARD
- CAPS LOCK KEY, AUTO-REPEAT
- ONE KEY ENTRY OF BASIC OR CP/M COMMANDS

**JOYSTICK CB-10** \$19.95

- SET X-Y AXIS FOR AUTO CENTER OR FREE MOVEMENT
- FIRE BUTTON FOR USE WITH GAME SOFTWARE
- ATTRACTIVE, SOLID, PLASTIC CASE INCLUDES ADAPTOR CABLE FOR IBM, APPLE II, IIe, IIc, ATARI AND VIC 20/64



### POWER STRIP

- UL APPROVED
- 15A CIRCUIT BREAKER

**\$12.95**

## CRT MONITORS FOR ALL APPLICATIONS



### CASPER EGA MONITOR

- EGA & CGA COMPATIBLE
- SCANNING FREQUENCIES: 15.75 / 21.85 KHz
- RES: 640 x 200 / 350
- 31mm DOT PITCH, 25 MHz
- 16 COLORS OUT OF 64
- 14", BLACK MATRIX SCREEN

**\$399.95**



### CASPER RGB MONITOR

- COLOR/GREEN/AMBER SWITCH ON REAR
- DIGITAL RGB-IBM COMPATIBLE
- 14" NON-GLARE SCREEN
- RESOLUTION: 640H x 240V
- 39mm DOT PITCH
- CABLE FOR IBM PC INCLUDED

**\$299.95**



### SAMSUNG MONOCHROME

- IBM COMPATIBLE TTL INPUT
- 12" NON-GLARE AMBER, LOW DISTORTION SCREEN
- RESOLUTION: 720H x 350V
- ATTRACTIVE CASE WITH SWIVEL BASE
- ONE YEAR WARRANTY

**\$119.95**



### FORTRONICS MONOCHROME

- IBM COMPATIBLE TTL INPUT
- 12" NON-GLARE SCREEN
- VERY HIGH RESOLUTION: 1100 LINES (CENTER)
- 25 MHz BANDWIDTH
- CABLE FOR IBM PC INCLUDED

**\$99.95**

TILT & SWIVEL MONITOR STAND \$12.95

WITH POWER CENTER \$39.95

## APPLE COMPATIBLE INTERFACE CARDS



### EPROM PROGRAMMER

- DUPLICATE OR BURN ANY 27xx SERIES EPROM (2716 TO 27128)
- MENU-DRIVEN SOFTWARE
- HIGH SPEED WRITE ALGO. RITHM

RP-525

\$59.95

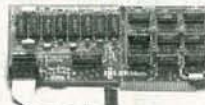

### 16K RAMCARD

- FULL 2 YEAR WARRANTY
- EXPAND YOUR 48K MACHINE TO A FULL 64K OF MEMORY
- CAN BE USED IN PLACE OF THE APPLE LANGUAGE CARD

RAM-CARD

\$39.95



### IC TEST CARD

- QUICKLY TESTS MANY COMMON ICs
- DISPLAYS PASS OR FAIL
- TEST 4000 & 74HC SERIES CMOS, 7400, 74LS, 74L, 74H & 74S

IC-TESTER

\$129.95

## MOLDED INTERFACE CABLES

6 FOOT, 100% SHIELDED, MEETS FCC



- IBM PARALLEL PRINTER CABLE 9.95
- CENTRONICS (MALE TO FEMALE) 15.95
- CENTRONICS (MALE TO MALE) 14.95
- MODEM CABLE (FOR IBM) 7.95
- RS232 SERIAL (MALE TO FEMALE) 9.95
- RS232 SERIAL (MALE TO MALE) 9.95
- KEYBOARD EXTENDER (COILED) 7.95
- APPLE II JOYSTICK EXTENDER 4.95

## SWITCH BOXES

ALL LINES SWITCHED, GOLD PLATED CONNECTORS, QUALITY SWITCHES

**2 WAY \$39.95**

- CONNECTS 2 PRINTERS TO 1 COMPUTER OR VICE VERSA

AB-P (CENTRONICS PARALLEL)

AB-S (RS232 SERIAL)



**3 WAY \$99.95**

- CONNECTS 3 PRINTERS TO 1 COMPUTER OR VICE VERSA

SWITCH-3P (CENTRONICS PARALLEL)

SWITCH-3S (RS232 SERIAL)



**300B MODEM \$49.95**

FOR APPLE OR IBM

- INCLUDES ASCII PRO-EZ SOFTWARE
- FCC APPROVED
- BELL SYSTEMS 103 COMPATIBLE
- INCLUDES AC ADAPTOR
- AUTO-DIAL
- DIRECT CONNECT
- CABLE FOR APPLE IIc \$14.95

## C. ITOH RITEMAN II PRINTER



- 160 CPS DRAFT, 32 CPS NLQ
- 9 x 9 DOT MATRIX
- SUPPORTS EPSON/IBM GRAPHICS
- FRICTION AND PIN FEEDS
- VARIABLE LINE SPACING AND PITCH

**\$219.95**

- IBM PRINTER CABLE \$9.95
- REPLACEMENT RIBBON CARTRIDGE \$7.95

## NASHUA DISKETTES

NASHUA DISKETTES WERE JUDGED TO HAVE THE HIGHEST POLISH AND RECORDED AMPLITUDE OF ANY DISKETTES TESTED (COMPARING FLOPPY DISKS, BYTE 9/84)

- N-MD2D DS/DD 5 1/4" SOFT \$9.90
- N-MD2F DS/QUAD 5 1/4" SOFT \$19.95
- N-MD2H DS/HD 5 1/4" FOR AT \$24.95
- N-FD1 SS/DD 8" SOFT \$27.95
- N-FD2D DS/DD 8" SOFT \$34.95

## BULK DISKETTE SALE

5 1/4" SOFT SECTOR, DS/DD W/TYVEC SLEEVES & HUB RINGS

**\$9.90** **69c ea** **59c ea**

BOX OF 10 BULK QTY 50 BULK QTY 250

## DISKETTE FILES

- 5 1/4" DISKFILE HOLDS 70 \$8.95
- 3 1/2" DISKFILE HOLDS 40 \$9.95



## Seagate

### 5 1/4" HARD DISK DRIVES

- ST-225 HALF HT 20MB 65ms \$275
- ST-238 HALF HT 30MB 65ms (RL) \$299
- ST-251 HALF HT 40MB 40ms \$599
- ST-277 HALF HT 60MB 40ms (RL) CALL
- ST-4038 FULL HT 30MB 40ms \$559
- ST-4096 FULL HT 80MB 28ms \$1195

### 1/2 HEIGHT FLOPPY DISK DRIVES

- 5 1/4" TEAC FD-55B DS/DD \$109.95
- 5 1/4" TEAC FD-55F DS/QUAD \$124.95
- 5 1/4" TEAC FD-55GFV DS/HD \$154.95
- 5 1/4" MITSUBISHI DS/HD \$129.95
- 3 1/2" TOSHIBA KIT DS/DD \$149.95

KIT INCLUDES MOUNTING HARDWARE TO FIT 5 1/4" & FACEPLATES FOR AT & XT

### DISK DRIVE ACCESSORIES

- TEAC SPECIFICATION MANUAL \$5.00
- TEAC MAINTENANCE MANUAL \$25.00
- 1/2 HT MNTG HARDWARE FOR IBM \$2.95
- MOUNTING RAILS FOR IBM AT \$4.95
- "Y" POWER CABLE FOR 5 1/4" FDDs \$2.95
- 5 1/4" FDD POWER CONNECTORS \$1.19

### DISK DRIVE ENCLOSURES WITH POWER SUPPLIES

- CAB-25V5 DUAL SLIMLINE 5 1/4" \$49.95
- CAB-1FH5 FULL HT 5 1/4" \$69.95
- CAB-25V8 DUAL SLIMLINE 8" \$209.95
- CAB-2FH8 DUAL FULL HT 8" \$219.95

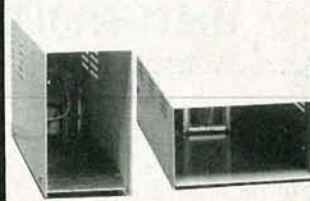

## BUILD STEVE CIARGIA'S INTELLIGENT EPROM PROGRAMMER

AS SEEN IN BYTE, OCT. 86

- STAND-ALONE OR RS-232 SERIAL OPERATION
- MENU SELECTABLE EPROM TYPES—NO CONFIGURATION JUMPERS
- PROGRAMS ALL 5V 27XXX EPROMS FROM 2716 TO 27512
- READ, COPY OR VERIFY EPROM
- UPLOAD/DOWNLOAD INTEL HEX FILES
- PROGRAMMER DRIVER USER MODIFIABLE

**ONLY \$199**

KIT INCLUDES PCB AND ALL COMPONENTS EXCEPT CASE & POWER SUPPLY

CALL FOR VOLUME QUOTES COPYRIGHT 1987 JDR MICRODEVICES

CIRCLE 181 ON FREE INFORMATION CARD

# EGA CARD AND MONITOR NOW ONLY \$569!

## QUALITY IBM COMPATIBLE MOTHERBOARDS

FROM MODULAR CIRCUIT TECHNOLOGY

**TURBO 4.77 / 8 MHZ \$129.95**

JDR PART #: MCT-TURBO

- 4.77 OR 8 MHZ OPERATION WITH 8088-2 & OPTIONAL 8087-2 CO-PROCESSOR
- DYNAMICALLY ADJUSTS SPEED DURING DISKETTE OPERATION FOR MAXIMUM THROUGHPUT AND RELIABILITY
- CHOICE OF NORMAL / TURBO MODE OR SOFTWARE SELECT PROCESSOR SPEED

**STANDARD 4.77 MHZ \$109.95**

JDR PART #: MCT-XTMB

- 8088 CPU, OPTIONAL 8087 CO-PROCESSOR
- 8 EXPANSION SLOTS
- EXPANDABLE TO 640K ON-BOARD MEMORY (0K RAM INSTALLED)
- ALL ICs SOCKETED-HIGHEST QUALITY PCB
- ACCEPTS 2764 OR 27128 ROMS

**BOTH WITH FREE MCT BIOS!**

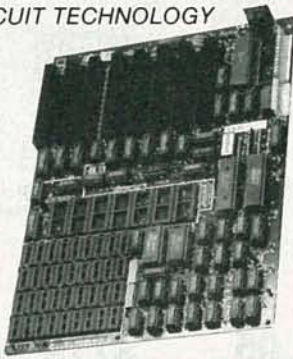

## EASYDATA MODEMS

All models feature auto-dial/answer/redial on busy, Hayes compatible, power up self test, touchtone or pulse dialing, built-in speaker, PC Talk III Communications software, Bell Systems 103 & 212A full or half duplex and more.

### INTERNAL

**EASYDATA-12H \$99.95**

1200 BUAD HALF CARD

**EASYDATA-12B \$119.95**

1200 BUAD 10" CARD

**EASYDATA-24B \$199.95**

2400 BUAD FULL CARD

### EXTERNAL

NO SOFTWARE INCLUDED

**EASYDATA-12D \$119.95**

1200 BUAD

**EASYDATA-24D \$219.95**

2400 BUAD

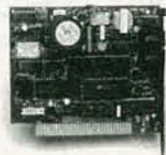

## FARADAY FDD CONTROLLER

JDR PART #: FAR-FDD

- SUPPORTS UP TO 4 INTERNALLY MOUNTED FDDs
- IBM COMPATIBLE, INTERFACES TO 360K OR 720K USING DOS 3.20
- INCLUDES CABLE FOR 2 DISK DRIVES

**\$24.95**

## IBM COMPATIBLE FLOPPY DISK DRIVE

JDR PART #: FDD-360

GOOD QUALITY DRIVES BY MAJOR MANUFACTURERS SUCH AS QUME, TANDON & CDC

- 5 1/4" HALF HEIGHT
- 360K STORAGE CAPACITY
- DS/DD
- 48 TPI

**\$69.95**

## IBM STYLE COMPUTER CASE

AN ATTRACTIVE STEEL CASE WITH A HINGED LID. FITS THE POPULAR PC/XT COMPATIBLE MOTHERBOARDS



- SWITCH CUT-OUT ON SIDE FOR PC/XT STYLE POWER SUPPLY
- CUT-OUT FOR 8 EXPANSION SLOTS
- ALL HARDWARE INCLUDED

**\$34.95**

SLIDE TYPE CASE \$39.95

## BUILD YOUR OWN 256K XT COMPATIBLE SYSTEM

- XT MOTHERBOARD \$109.95
- PRO-BIOS (A \$20 VALUE) FREE!
- 256K RAM \$28.95
- 130 WATT POWER SUPPLY \$69.95
- FLIP-TOP CASE \$34.95
- KEY TRONIC™ KEYBOARD \$49.95
- 360K DRIVE \$69.95
- FARADAY CONTROLLER \$24.95
- MONOCHROME ADAPTOR \$49.95
- FORTRONICS MONITOR \$99.95

TOTAL: \$536.15

## IBM COMPATIBLE KEYBOARDS

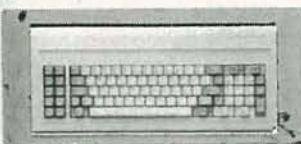

**MCT-5150 \$59.95**

- "5150" STYLE KEYBOARD
- FULLY IBM COMPATIBLE
- LED STATUS INDICATORS FOR CAPS & NUMBER LOCK
- LARGE, EASY TO REACH SHIFT & RETURN KEYS
- 83 KEY TYPEWRITER LAYOUT

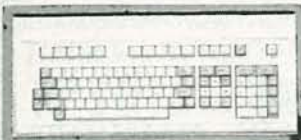

**MCT-5151 \$79.95**

- REPLACEMENT FOR KEY TRONIC™ KB-5151 KEYBOARD
- SEPARATE CURSOR & NUMERIC KEYPAD
- CAPS LOCK & NUMBER LOCK INDICATORS
- IMPROVED KEYBOARD LAYOUT



**MCT-5060 \$59.95**

- IBM AT STYLE LAYOUT
- SOFTWARE AUTONSENSE FOR XT OR AT COMPATIBLES
- EXTRA LARGE SHIFT & RETURN KEYS
- LED INDICATORS FOR SCROLL, CAPS & NUMBER LOCK
- AUTO REPEAT FEATURE

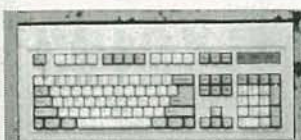

**MCT-5339 \$89.95**

- IBM ENHANCED STYLE LAYOUT
- SOFTWARE AUTONSENSE FOR XT OR AT COMPATIBLES
- 12 FUNCTION KEYS
- EXTRA LARGE SHIFT & RETURN KEYS
- LED INDICATORS FOR SCROLL, CAPS & NUMBER LOCK
- AUTO REPEAT FEATURE
- SEPARATE CURSOR PAD

## DISPLAY CARDS

FROM MODULAR CIRCUIT TECHNOLOGY

**MCT-EGA \$179.95**

100% IBM COMPATIBLE, PASSES IBM EGA DIAGNOSTICS

- COMPATIBLE WITH IBM EGA, COLOR GRAPHICS AND MONOCHROME ADAPTORS
- TRIPLE SCANNING FREQUENCY FOR DISPLAY ON EGA, STANDARD RGB OR HIGH RESOLUTION MONOCHROME MONITOR
- FULL 256K OF VIDEO RAM ALLOWS 640 x 350 PIXELS IN 16 OF 64 COLORS
- LIGHT PEN INTERFACE



**MCT-GG \$49.95**

COMPATIBLE WITH IBM COLOR GRAPHICS STANDARD

- SHORT SLOT CARD USES VLSI CHIPS TO INSURE RELIABILITY
- SUPPORTS RGB, COMPOSITE MONOCHROME & COLOR AND AN RF MODULATOR OUTPUT
- 320 x 200 COLOR GRAPHICS MODE
- 640 x 200 MONOCHROME GRAPHICS MODE
- LIGHT PEN INTERFACE



**\$49.95**

**MCT-MGP \$59.95**

COMPATIBLE WITH IBM MONOCHROME AND HERCULES GRAPHICS STANDARDS

- SHORT SLOT CARD USES VLSI CHIPS TO INSURE RELIABILITY
- PARALLEL PRINTER PORT, CONFIGURABLE AS LPT1 OR LPT2
- 720 x 348 GRAPHICS MODE
- LOTUS COMPATIBLE
- CAN RUN WITH COLOR GRAPHICS CARD IN THE SAME SYSTEM



**\$59.95**

**MCT-MG \$79.95**

COMPATIBLE WITH IBM MONOCHROME AND HERCULES GRAPHICS STANDARDS

- SERIAL PORT OPTION
- PARALLEL PRINTER PORT
- 720 x 348 GRAPHICS MODE
- 80 x 25 TEXT MODE
- LOTUS COMPATIBLE
- SELECTABLE TO RUN ALONG WITH COLOR GRAPHICS CARD IN THE SAME SYSTEM



**\$79.95**

**MCT-MONO \$49.95**

ANOTHER FANTASTIC VALUE FROM JDR!

- IBM COMPATIBLE TTL INPUT
  - 720 x 348 PIXEL DISPLAY
- PLEASE NOTE: THIS CARD WILL NOT RUN LOTUS GRAPHICS AND DOES NOT INCLUDE A PARALLEL PORT

MG-SERIAL OPTIONAL SERIAL PORT \$19.95

## EPROM PROGRAMMERS

FROM MODULAR CIRCUIT TECHNOLOGY

**MCT-EPROM \$129.95**

PROGRAMS 27xx AND 27xxx SERIES EPROMS UP TO 27512

- SUPPORTS VARIOUS MANUFACTURERS FORMATS WITH 12.5, 21 AND 25 VOLT PROGRAMMING
- MENU-DRIVEN SOFTWARE ALLOWS EASY MANIPULATION OF DATA FILES
- SPLIT OR COMBINE THE CONTENTS OF SEVERAL EPROMS OF DIFFERENT SIZES
- READ, WRITE, COPY, ERASE CHECK AND VERIFY WITH EASY ONE KEY SELECTION
- INCLUDES SOFTWARE FOR STANDARD HEX AND INTEL HEX FORMATS

4 GANG PROGRAMMER \$189.95

10 GANG PROGRAMMER \$299.95



MCT PRODUCTS CARRY A ONE YEAR WARRANTY

COPYRIGHT 1987 JDR MICRODEVICES

CIRCLE 182 ON FREE INFORMATION CARD

**1200B MODEM \$99<sup>95</sup>**

FOR IBM W/  
SOFTWARE

**2400B MODEM \$199<sup>95</sup>**

### MULTIFUNCTION CARDS

FROM MODULAR CIRCUIT TECHNOLOGY

#### MCT-MF

**\$84.95**

ALL THE FEATURES OF AST'S SIX PACK PLUS AT HALF THE PRICE!

- 0-348K DYNAMIC RAM USING 4164s
- INCLUDES SERIAL PORT, PARALLEL PRINTER PORT, GAME CONTROLLER PORT AND CLOCK/CALENDAR
- SOFTWARE FOR A RAMDISK, PRINT SPOOLER AND CLOCK/CALENDAR



#### MCT-ATMF

**\$139.95**

ADDS UP TO 3 MB OF 1 BIT RAM TO THE AT

- USER EXPANDABLE TO 1.5 MB OF ON-BOARD MEMORY (NO MEMORY INSTALLED)
- FLEXIBLE ADDRESS CONFIGURATION
- INCLUDES SERIAL PORT, PARALLEL PORT AND CLOCK/CALENDAR
- OPTIONAL PIGGYBACK BOARD PERMITS EXPANSION TO 3 MB



ATMF-SERIAL 2nd SERIAL PORT **\$24<sup>95</sup>**

MCT-ATMF-MC **\$29<sup>95</sup>**

PIGGYBACK BOARD (ZERO K INSTALLED)

#### MCT-MIO

**\$79.95**

A PERFECT COMPANION FOR OUR MOTHERBOARD

- 2 DRIVE FLOPPY DISK CONTROLLER
- INCLUDES SERIAL PORT, PARALLEL PORT, GAME PORT AND CLOCK/CALENDAR WITH BATTERY BACK-UP
- SOFTWARE FOR A RAMDISK, PRINT SPOOLER AND CLOCK/CALENDAR



MIO-SERIAL 2nd SERIAL PORT **\$15<sup>95</sup>**

#### MCT-IO

**\$59.95**

USE WITH MCT-FH FOR A MINIMUM OF SLOTS USED

- SERIAL PORT ADDRESSABLE AS COM1, COM2, COM3 OR COM4
- PARALLEL PRINTER PORT ADDRESSABLE AS LPT1 OR LPT2 (x378 OR x278)
- GAME PORT AND CLOCK/CALENDAR WITH A BATTERY BACK-UP



IO-SERIAL 2nd SERIAL PORT **\$15<sup>95</sup>**

#### MCT-ATIO

**\$59.95**

USE WITH MCT-ATFH FOR A MINIMUM OF SLOTS USED

- SERIAL PORT ADDRESSABLE AS COM1, COM2, COM3 OR COM4
- PARALLEL PRINTER PORT ADDRESSABLE AS LPTA OR LPTB (x378 OR x278)
- GAME PORT
- USES 16450 SERIAL SUPPORT CHIPS FOR HIGH SPEED OPERATION IN AN AT



ATIO-SERIAL 2nd SERIAL PORT **\$24<sup>95</sup>**

### RAM CARDS

FROM MODULAR CIRCUIT TECHNOLOGY

#### MCT-RAM

**\$69.95**

A CONTIGUOUS MEMORY SOLUTION FOR YOUR SHORT OR REGULAR SLOT

- SHORT SLOT, LOW POWER PC COMPATIBLE DESIGN
- CAN OFFER UP TO 576K OF ADDITIONAL MEMORY
- USER SELECTABLE CONFIGURATION AMOUNTS OF 192, 384, 512, 256 & 576K, USING COMBINATIONS OF 64 & 256K RAM



#### MCT-ATRAM

**\$149.95**

A POWER USER'S DREAM, 4MB OF MEMORY FOR THE AT

- USER EXPANDABLE TO 2MB OF ON-BOARD MEMORY
- USES FULL 16 BIT PARITY CHECKED MEMORY, 64K OR 256K DYNAMIC RAM
- FLEXIBLE STARTING ADDRESS, ROUND OUT CONVENTIONAL MEMORY TO 640K & ADD EXTENDED MEMORY ABOVE 1MB



MCT-ATRAM-MC **\$39<sup>95</sup>**

2MB PIGGYBACK BOARD (ZERO K INSTALLED)

#### MCT-EMS

**\$129.95**

2MB OF LOTUS/INTEL/MICROSOFT COMPATIBLE MEMORY FOR THE AT

- CONFORMS TO LOTUS/INTEL EMS
- USER EXPANDABLE TO 2 MB
- USES 64K OR 256K DYNAMIC RAM (NO MEMORY INSTALLED)
- USE AS EXPANDED OR CONVENTIONAL MEMORY, RAMDISK OR SPOOLER
- SOFTWARE INCLUDES EMS DEVICE DRIVERS, PRINT SPOOLER AND RAMDISK



MCT-ATEMS

AT VERSION OF THE MCT-EMS

**\$139<sup>95</sup>**

# Seagate

## HARD DISK SYSTEMS

### 20 MB 30 MB

**\$339**

**\$399**

Systems include half height hard disk drive, hard disk drive controller, cables and instructions. Drives are pre-tested and warranted for one year.

## Seagate 40 MB AT DRIVE

FAST 40ms ACCESS TIME



# \$599

### DISK CONTROLLER CARDS

FROM MODULAR CIRCUIT TECHNOLOGY

#### MCT-FDC

**\$34.95**

QUALITY DESIGN OFFERS 4 FLOPPY CONTROL IN A SINGLE SLOT

- INTERFACES UP TO 4 FDDs TO AN IBM PC OR COMPATIBLE
- INCLUDES CABLING FOR 2 INTERNAL DRIVES
- USES STANDARD DB37 CONNECTOR FOR EXTERNAL DRIVES
- SUPPORTS BOTH DS/DD AND DS/QD WHEN USED WITH DOS 3.2 OR JFORMAT



#### MCT-HDC

**\$89.95**

HARD DISK CONTROL FOR WHAT OTHERS CHARGE FOR FLOPPY CONTROL

- IBM XT COMPATIBLE CONTROLLER SUPPORTS 16 DIFFERENT DRIVE SIZES, INCLUDING 5, 10, 20, 30 & 40MB
- OPTIONS INCLUDE THE ABILITY TO DIVIDE 1 LARGE DRIVE INTO 2 SMALLER, LOGICAL DRIVES
- INCLUDES CABLING FOR 1 INTERNAL DRIVE



#### MCT-RLL

**\$119.95**

GET UP TO 50% MORE STORAGE SPACE ON YOUR HARD DISK

- INCREASES THE CAPACITY OF PLATED MEDIA DRIVES BY 50%
- RLL 2,7 ENCODING FOR MORE RELIABLE STORAGE
- TRANSFER RATE IS ALSO 50% FASTER; 750K/sec vs 500K/sec
- USE WITH ST-238 DRIVE TO ACHIEVE 30+ MB IN A HALF HEIGHT SLOT



#### MCT-FH

**\$139.95**

STARVED FOR SLOTS? SATISFY IT WITH THIS TIMELY DESIGN

- INTERFACES UP TO 2 FDDs & 2 HDDs
- CABLING FOR 2 FDDs & 1 HDD
- FLOPPY INTERFACE SUPPORTS BOTH DS/DD & DS/QD WHEN USED W/ DOS 3.2 OR JFORMAT
- ALL POPULAR HDD SIZES ARE SUPPORTED, INCLUDING 5, 10, 20, 30 & 40MB
- CAN DIVIDE 1 LARGE DRIVE INTO 2 SMALLER, LOGICAL DRIVES

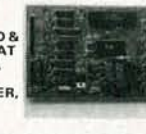

#### MCT-ATFH

**\$169.95**

FLOPPY AND HARD DISK CONTROL IN A TRUE AT DESIGN

- AT COMPATIBLE, CONTROL UP TO 2 360K/720K OR 1 2MB FDDs AS WELL AS 2 HDDs USING THE AT STANDARD CONTROL TABLES
- SUPPORTS AT STYLE FRONT PANEL LED TO INDICATE HD ACTIVITY
- 16 BIT BUSS PROVIDES RAPID DATA TRANSFERS
- FULLY SUPPORTED BY AT BIOS



# JDR Microdevices

110 Knowles Drive, Los Gatos, CA 95030

Toll Free 800-538-5000 • (408) 866-6200 • FAX (408) 378-8927 • Telex 171-110

THE JDR MICRODEVICES LOGO IS A REGISTERED TRADEMARK OF JDR MICRODEVICES. JDR INSTRUMENTS AND JDR MICRODEVICES ARE TRADEMARKS OF JDR MICRODEVICES. IBM IS A TRADEMARK OF INTERNATIONAL BUSINESS MACHINES.

**1200B MODEM \$99<sup>95</sup>**

FOR IBM W/  
SOFTWARE

**2400B MODEM \$199<sup>95</sup>**

**BARGAIN HUNTERS CORNER**

**KEY TRONIC™ \$49<sup>95</sup>**

- 5150 STYLE DEM KEYBOARD**  
 \* IMPROVED KEYBOARD LAYOUT  
 \* 83 KEYS, FULLY IBM COMPATIBLE  
 \* LED INDICATORS FOR CAPS & NUMBER LOCK

**NEW!**  
**TOSHIBA 3 1/2" FDD KIT**

- 360K, DOUBLE SIDED/DOUBLE DENSITY**  
 \* MOUNTING HARDWARE FOR 5 1/4" SLOT  
 \* FACEPLATES FOR BOTH AT & XT MACHINES

**\$149<sup>95</sup>**

**SPECIALS ENDS 6/30/87**

**PAGE WIRE WRAP WIRE PRECUT ASSORTMENT**

IN ASSORTED COLORS \$27.50  
 100ea: 5.5", 6.0", 6.5", 7.0"  
 250ea: 2.5", 4.5", 5.0"  
 500ea: 3.0", 3.5", 4.0"

**SPOOLS**

100 feet \$4.30 250 feet \$7.25  
 500 feet \$13.25 1000 feet \$21.95

Please specify color:  
 Blue, Black, Yellow or Red

**EXTENDER CARDS**

IBM-PC \$29.95  
 IBM-AT \$39.95

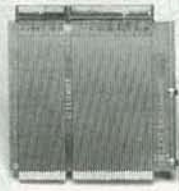

**WIRE WRAP PROTOTYPE CARDS**  
 FR-4 EPOXY GLASS LAMINATE  
 WITH GOLD-PLATED EDGE-CARD FINGERS



IBM-PR2 **IBM**

BOTH CARDS HAVE SILK SCREENED LEGENDS AND INCLUDES MOUNTING BRACKET

IBM-PR1 WITH +5V AND GROUND PLANE . . . \$27.95  
 IBM-PR2 AS ABOVE WITH DECODING LAYOUT \$29.95

**S-100**

P100-1 BARE - NO FOIL PADS . . . \$15.15  
 P100-2 HORIZONTAL BUS . . . \$21.80  
 P100-3 VERTICAL BUS . . . \$21.80  
 P100-4 SINGLE FOIL PADS PER HOLE . . . \$22.75

**APPLE**

P500-1 BARE - NO FOIL PADS . . . \$15.15  
 P500-3 HORIZONTAL BUS . . . \$22.75  
 P500-4 SINGLE FOIL PADS PER HOLE . . . \$21.80  
 7060-45 FOR APPLE IIe AUX SLOT . . . \$30.00

**SOCKET-WRAP I.D.™**

- \* SLIPS OVER WIRE WRAP PINS
- \* IDENTIFIES PIN NUMBERS ON WRAP SIDE OF BOARD
- \* CAN WRITE ON PLASTIC, SUCH AS IC #

PINS	PART#	PCK. OF	PRICE
8	IDWRAP 08	10	1.95
14	IDWRAP 14	10	1.95
16	IDWRAP 16	10	1.95
18	IDWRAP 18	5	1.95
20	IDWRAP 20	5	1.95
22	IDWRAP 22	5	1.95
24	IDWRAP 24	5	1.95
28	IDWRAP 28	5	1.95
40	IDWRAP 40	5	1.95

PLEASE ORDER BY NUMBER OF PACKAGES (PCK. OF)



**FRAME STYLE TRANSFORMERS**

12.6V AC CT 2 AMP 5.95  
 12.6V AC CT 4 AMP 7.95  
 12.6V AC CT 8 AMP 10.95  
 25.2V AC CT 2 AMP 7.95

**25 PIN D-SUB GENDER CHANGERS \$7.95**



**SWITCHING POWER SUPPLIES**

**PS-IBM \$69.95**

- \* FOR IBM PC-XT COMPATIBLE
- \* 135 WATTS
- \* +5V @ 15A, -12V @ 4.2A
- \* -5V @ .5A, -12V @ .5A
- \* ONE YEAR WARRANTY



**PS-IBM-150 \$79.95**

- \* FOR IBM PC-XT COMPATIBLE
- \* 150 WATTS
- \* +12V @ 5.2A, -5V @ 16A
- \* -12V @ .5A, -5V @ .5A
- \* ONE YEAR WARRANTY

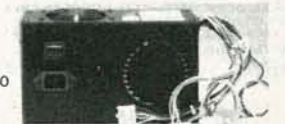

**PS-130 \$99.95**

- \* 130 WATTS
- \* SWITCH ON REAR
- \* FOR USE IN OTHER IBM TYPE MACHINES
- \* 90 DAY WARRANTY



**PS-A \$49.95**

- \* USE TO POWER APPLE TYPE SYSTEMS, 79.5 WATTS
- \* +5V @ 7A, -12V @ 3A
- \* -5V @ .5A, -12V @ .5A
- \* APPLE POWER CONNECTOR



**PS-1558 \$34.95**

- \* 75 WATTS, UL APPROVED
- \* +5V @ 7A, +12V @ 3A
- \* -12V @ 250ma, -5V @ 300ma



**CAPACITORS**

**TANTALUM**

1.0µf	15V .35	35V .45
6.8	15V .70	1.0 35V .45
10	15V .80	2.2 35V .65
22	15V 1.35	4.7 35V .85
.22	35V .40	10 35V 1.00

**DISC**

10µf	50V .05	680 50V .05
22	50V .05	.001µf 50V .05
27	50V .05	.0022 50V .05
33	50V .05	.005 50V .05
47	50V .05	.01 50V .07
68	50V .05	.02 50V .07
100	50V .05	.05 50V .07
220	50V .05	.1 12V .10
560	50V .05	.1 50V .12

**MONOLITHIC**

.01µf	50V .14	.1µf 50V .18
.047µf	50V .15	.47µf 50V .25

**ELECTROLYTIC**

RADIAL		AXIAL	
1µf	25V .14	1µf	50V .14
2.2	35V .15	10	50V .16
4.7	50V .15	22	16V .14
10	50V .15	47	50V .20
47	35V .18	100	35V .25
100	16V .18	220	25V .30
220	35V .20	470	50V .50
470	25V .30	1000	16V .60
2200	16V .70	2200	16V .70
4700	25V 1.45	4700	16V 1.25

**DATARASE EPROM ERASER \$34.95**

- \* ERASES 2 IN 10 MINUTES
- \* COMPACT-NO DRAWER
- \* THIN METAL SHUTTER PREVENTS UV LIGHT FROM ESCAPING



**1/4 WATT RESISTORS**

5% CARBON FILM ALL STANDARD VALUES FROM 1 OHM TO 10 MEG. OHM

10 PCS same value .05	100 PCS same value .02
50 PCS same value .025	1000 PCS same value .015

**RESISTOR NETWORKS**

SIP	10 PIN	9 RESISTOR	.69
SIP	8 PIN	7 RESISTOR	.59
DIP	16 PIN	8 RESISTOR	1.09
DIP	16 PIN	15 RESISTOR	1.09
DIP	14 PIN	7 RESISTOR	.99
DIP	14 PIN	13 RESISTOR	.99

**SPECIALS ON BYPASS CAPACITORS**

.01 µf CERAMIC DISC 100/\$5.00  
 .01 µf MONOLITHIC 100/\$10.00  
 .1 µf CERAMIC DISC 100/\$6.50  
 .1 µf MONOLITHIC 100/\$12.50

**BOOKS BY STEVE CIARCIA**

- BUILD YOUR OWN 280 COMPUTER \$19.95
- CIRCUIT CELLAR VOL 1 \$17.95
- CIRCUIT CELLAR VOL 2 \$18.95
- CIRCUIT CELLAR VOL 3 \$18.95
- CIRCUIT CELLAR VOL 4 \$18.95
- CIRCUIT CELLAR VOL 5 \$19.95

**MUFFIN FANS**

3.15" SQ. 14.95 3.63" SQ. 14.95  
 3.18" SQUARE 16.95  
**6' LINE CORDS**  
 2 conductor .39 3 conductor .99  
 3 conductor w/female socket .39  
**EMI FILTER \$4.95**

**WISH SOLDERLESS BREADBOARDS**

PART NUMBER	DIMENSIONS	DISTRIBUTION STRIP(S)	TIE POINTS	TERMINAL STRIP(S)	TIE POINTS	BINDING POSTS	PRICE
WBU-D	.38 x 6.50"	1	100	---	---	---	2.95
WBU-T	1.38 x 6.50"	---	---	1	630	---	6.95
WBU-204-3	3.94 x 8.45"	1	100	2	1260	2	17.95
WBU-204	5.13 x 8.45"	4	400	2	1260	3	24.95
WBU-206	6.88 x 9.06"	5	500	3	1890	4	29.95
WBU-208	8.25 x 9.45"	7	700	4	2520	4	39.95



**LITHIUM BATTERY**

AS USED IN CLOCK CIRCUITS

3 VOLT BATTERY \$3.95  
 BATTERY HOLDER \$1.49

**2 VOLUME SET**

**1986 IC MASTER**  
 THE INDUSTRY STANDARD  
**\$129.95**



Visit our retail store located at 1256 S. Bascom Ave. in San Jose, (408) 947-8881

**JDR Microdevices**  
 110 Knowles Drive, Los Gatos, CA 95030  
 Toll Free 800-538-5000 • (408) 866-6200  
 FAX (408) 378-8927 • Telex 171-110

PLEASE USE YOUR CUSTOMER NUMBER WHEN ORDERING

TERMS: Minimum order \$10.00. For shipping and handling include \$2.50 for UPS Ground and \$3.50 for UPS Air. Orders over 1 lb. and foreign orders may require additional shipping charges - please contact our sales department for the amount. CA residents must include applicable sales tax. All merchandise is warranted for 90 days unless otherwise stated. Prices are subject to change without notice. We are not responsible for typographical errors. We reserve the right to limit quantities and to substitute manufacturer. All merchandise subject to prior sale.

COPYRIGHT 1987 JDR MICRODEVICES

THE JDR MICRODEVICES LOGO IS A REGISTERED TRADEMARK OF JDR MICRODEVICES. JDR INSTRUMENTS AND JDR MICRODEVICES ARE TRADEMARKS OF JDR MICRODEVICES. IBM IS A TRADEMARK OF INTERNATIONAL BUSINESS MACHINES. APPLE IS A TRADEMARK OF APPLE COMPUTER.



SEND FOR  
**FREE**  
1987 CATALOG...  
48 PAGES!

★ QUALITY PARTS ★ DISCOUNT PRICES ★ FAST SHIPPING!

# ALL ELECTRONICS CORP.

## ALL ELECTRONICS CORP.

### 220 Vac COOLING FAN

ROTRON # MX77A3 Muffin XL 220 Vac 4 1/8" square metal frame fan.  
CAT# CF-220 \$6.50 ea  
10 for \$60.00 / 100 for \$500.00



### LIGHT ACTIVATED MOTION SENSOR

This device contains a photocell which senses sudden changes in ambient light. When an object or person passes within its field of view (about 5') it beeps for several seconds then resets. Could be used as a door annunciator or modified to trigger other devices. 5 1/2" x 4" x 1. Operates on 6 Vdc. Requires 4 AA batteries (not included).  
CAT# LSMD \$5.75 per unit



### SOUND EFFECTS BOARD

PC board with 2 1/4" speaker, 2 LEDs, IC, battery snap, other components 2 3/8" x 3". When switch is pushed board beeps and leds light. Operates on 9v battery (not included).  
Experimenter's delight\*  
CAT# ST-3 \$1.25 ea.



### MICRO-CASSETTE MECHANISM

Micro-cassette tape transport for standard MC60 or MC45 micro-cassettes. 3 Vdc operation. Contains: drive motor, belt, head, capstan, pinch wheel and other components. 3 1/2" X 2 1/4" X 5/8"  
CAT# MCMEC \$3.00 each 10 for \$27.50



### FUSES

3AG (AGC) SIZE  
1 1/4, 2, 2 1/2, 3, 4, 5, 6 AMP  
GMA SIZE  
1, 2, 3, 4, 5 AMP  
5 of any ONE amperage 75¢



### COMMODORE PRINTER PLOTTER

Commodore Model # 1520  
4 inch paper Four color X-Y plotter. Standard VIC serial interface allows easy connection to Commodore 64 computers. Up to 80 characters per line.  
CAT # COM-1520 \$49.95 each  
EXTRA pen sets \$1.50 per set.

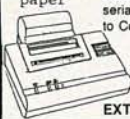

### EDGE CONNECTORS

ALL ARE .156" SPACING.



22 EDGE CONNECTOR \$1.25 ea  
solder lug style 10 for \$11.00  
22/44 EDGE CONNECTOR \$2.00 ea PC style 10 for \$18.00  
22/44 EDGE CONNECTOR solder lug style \$2.50 each  
28/56 EDGE CONNECTOR PC style \$2.50 ea  
38/72 EDGE CONNECTOR PC style \$3.00 each  
43/86 EDGE CONNECTOR PC style \$4.50 each

### 2K 10 TURN

MULTI-TURN POT SPECTROL #MOD 534-7161 \$5.00 EACH



### RELAYS

10 AMP SOLID STATE CONTROL: 3 - 32 vdc LOAD: 140 vac 10 amp SIZE: 2 1/2" x 3/4" x 7/8"  
\$9.50 EACH 10 FOR \$90.00



### ULTRA-MINIATURE 5 VDC RELAY

Fujitsu # FB211NED005M20 High sensitivity COIL: 120 ohms CONTACTS: 1 amp Mounts in 14 pin DIP socket \$1.25 each 10 for \$10.00



### MINIATURE 6 VDC RELAY

Aromat #RSD-6V Super Small S.P.D.T. relay Gold coil contacts rated 1 amp @ 30 vdc. Highly sensitive. TTL direct drive possible. 120 ohm coil. Operate from 4.3 - 6 vdc. COIL: 120 ohms \$1.50 each 10 for \$13.50



### 13 VDC RELAY

CONTACTS: S.P.N.C. 10 amp @ 120 vac Energize coil to open contact... COIL: 13 vdc 650 ohms



### SPECIAL PRICE \$1.00 each

### 4PDT RELAY

14 pin KH style... 3 amp contacts... USED but fully tested... \$1.70 each Specify coil voltage desired Either 24 vdc or 120 vac LARGE QUANTITIES AVAILABLE SOCKETS FOR KH RELAY 75¢ each



### WALL TRANSFORMER

11.5 Vdc 1.95 Amp. INPUT: 120 Vac SIZE: 3 3/4" X 2 7/8" X 2 5/8" CAT # DCTX-11519 \$6.50 each



### TRANSFORMERS

120 volt primaries  
5.6 volts @ 750 ma. \$3.00  
6.3 volt @ 600 ma. \$1.75  
12 V.C.T. @ 200 ma. \$2.00  
12 V.C.T. @ 400 ma. \$3.00  
12 V.C.T. @ 1 amp \$4.00  
12 V.C.T. @ 2 amp \$4.85  
12 V.C.T. @ 4 amp \$7.00  
18 volts @ 650 ma. \$2.00  
24 V.C.T. @ 200 ma. \$2.50  
24 V.C.T. @ 1 amp \$4.85  
24 V.C.T. @ 2 amp \$6.75  
24 V.C.T. @ 3 amp \$9.50  
24 V.C.T. @ 4 amp \$11.00



### PHOTO-FLASH CAPACITORS

170 MFD 330 Volt CAT# PPC-170 75¢ each  
400 MFD 330 Volt CAT# PPC-400 \$1.00 ea



### MINIATURE TOGGLE SWITCHES ALL ARE RATED 5 AMPS @ 125 VAC

S.P.D.T. (on-on) PC style non-threaded bushing 75¢ each 10 for \$7.00  
S.P.D.T. (on-on) Solder lug terminals. \$1.00 each 10 for \$9.00 100 for \$80.00  
S.P.D.T. (on-off-on) Solder lug terminals. \$1.00 each 10 for \$9.00 100 for \$80.00  
S.P.D.T. (on-off-on) PC lugs threaded bushing. \$1.00 each 10 for \$9.00 100 for \$80.00  
D.P.D.T. (on-on) Solder lug terminals. \$2.00 each 10 for \$19.00 100 for \$180.00



### COMPUTER GRADE CAPACITORS

1,400 mfd. 200 Vdc 3" x 2" dia. \$2.00  
6,400 mfd 60 Vdc 4 1/4" x 1 3/8" dia. \$2.50  
7,500 mfd 200 Vdc 5 3/4" x 3" dia. \$4.00  
12,000 mfd 40 Vdc 1 1/4" x 2" dia. \$2.50  
22,000 mfd 25 Vdc 4 3/4" x 2" dia. \$2.50  
48,000 mfd 10 Vdc 3" x 2 1/2" dia. \$2.50  
66,000 mfd 15 Vdc 3 3/4" x 3" dia. \$3.50  
72,000 mfd 15 Vdc 4" x 2" dia. \$3.50  
100,000 mfd 10 Vdc 6" x 2 1/2" dia. \$1.00



### S.P.S.T. TOGGLE SWITCH

CARLING (on-off) RATED: 10 amp @ 125 Vac. All plastic body and toggle.  
CAT# STS-1 \$1.00 ea.  
10 for \$8.50 100 for \$7.50  
LARGE QUANTITIES



### LED'S STANDARD JUMBO DIFFUSED T 1-3/4

RED 10 for \$1.50 100 for \$13.00  
GREEN 10 for \$2.00 100 for \$17.00  
YELLOW 10 for \$2.00 100 for \$17.00



### FLASHER LED

5 volt operation red jumbo T 1 1/4 size  
CAT# LED-4 \$1.00  
NEW GREEN FLASHER CAT# LED-4G \$1.00



### BI-POLAR jumbo T 1 1/4 size

2 for \$1.70



LED HOLDERS Two piece holder for jumbo LED 10 for 85¢ 100 for \$5.00



CLEAR CLIPLITE LED HOLDER Make LED a fancy indicator. Clear. 4 for \$1.00



### TELEPHONE COUPLING TRANSFORMER

Stancor # TTPC-8 or Triad # TY-304 P 600 ohms c.t. to 600 ohms c.t. P.C. board mount 3/4" x 5/8" x 3/4" \$1.25 each



### 3rd TAIL LIGHT ?

Sleek high-tech lamp assembly. Could be used as a third auto tail light, emergency warning light, or special-effects lamp. Red reflective lens is 2 3/4" x 5 1/2" is mounted on a 4" high pedestal with up-down swivel adjustment. Includes 12v replaceable bulb. CAT# TLB \$3.95 each.

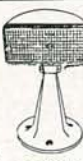

### 48 KEY ASSEMBLY FOR COMPUTER OR HOBBYIST

NEW T.I. KEYBOARDS. Originally used on computers, these keyboards contain 48 S.P.S.T. mechanical switches. Terminates to 15 pin connector. Frame 4" x 9"  
CAT # KP-48 \$3.50 each



### SPRING LEVER TERMINALS

Two color coded terminals on a sturdy 2 3/4" x 3 3/4" bakelite plate. Great for speaker enclosures or power supplies. 75¢ EACH 10 for \$6.00



### SOUND AND VIDEO MODULATOR

TI#UM1381-1 Designed for use with T.I. computers. Can be used with video cameras, games or other audio/video sources. Built in A/B switch enables user to switch from T.V. antenna without disconnection. Channel 3 or 4 selection. Operates on 12 Vdc. Hook-up diagram included.  
CAT# AVMOD \$5.00 each.



### RECHARGEABLE NI-CAD BATTERIES

AAA SIZE 1.25V 500MAH \$1.85  
AA SIZE 1.25V 500MAH \$1.85  
AA with solder tab \$2.00  
C SIZE 1.2V 1200MAH \$3.50  
SUB-C SIZE solder tab \$3.50  
D SIZE 1.2V 1200MAH \$3.50



### NI-CAD CHARGER TESTER

Will charge most every size Ni-cad battery available.  
Cat# UNCC-N \$12.50



### 8" 15 WATT SPEAKER

C.T.S Model 8B3079 Full range speaker, 100-10,000Hz. Ideal for PA systems. Mounting holes for line-matching transformer.  
CAT#SK-815 \$3.50 ea. Case of 8 pcs. \$25.00 per case



STORES  
LOS ANGELES, CA  
905 S. Vermont Ave.  
213 380-8000  
VAN NUYS, CA  
6228 Sepulveda Blvd.  
818 997-1806



MAIL ORDERS TO:  
ALL ELECTRONICS  
P.O. BOX 20406  
Los Angeles, CA 90006  
TWX - 101010163  
ALL ELECTRONIC

QUANTITIES LIMITED  
MINIMUM ORDERS \$10.00  
CALIF. ADD SALES TAX  
USA: \$3.00 SHIPPING  
NO C.O.D.I.  
FOREIGN ORDERS:  
INCLUDE SUFFICIENT  
SHIPPING

TOLL FREE ORDERS  
800-826-5432  
IN CA (800-258-6666)  
INFO # (213) 380-8000  
FAX - (213) 389-7073

### POLARITY SWITCH

external coaxial relay on a satellite TV system. IDEAL FOR THE EXPERIMENTER AS PARTS Heavy chassis box containing a 5 Vdc relay, CA 358 ohm amp and other parts. Catalog # RDPS \$1.75 each 10 for \$15.00



### SOLID STATE BUZZER

Star #SMB-06L 6 vdc TTL compatible. \$1.00 each 10 for \$8.00



JUNE 1987

# AMAZING SCIENTIFIC & ELECTRONIC PRODUCTS

**PLANS**—Build Yourself—All Parts Available In Stock

- LC7—BURNING CUTTING CO<sub>2</sub> LASER ..... \$ 20.00
- RUB4—PORTABLE LASER RAY PISTOL ..... 20.00
- TCC1—3 SEPARATE TESLA COIL
- PLANS TO 1.5 MEV ..... 20.00
- IOG1—ION RAY GUN ..... 10.00
- GRA1—GRAVITY GENERATOR ..... 10.00
- EML1—ELECTRO MAGNET COIL GUN/LAUNCHER ..... 6.00

**KITS**

- MFT1K—FM VOICE TRANSMITTER 3 MI RANGE ..... 49.50
- VWPMSK—TELEPHONE TRANSMITTER 3 MI RANGE ..... 39.50
- BTC3K—250.00 VOLT 10-14" SPARK TESLA COIL ..... 199.50
- LHC2K—SIMULATED MULTICOLOR LASER ..... 39.50
- BLS1K—100,000 WATT BLASTER DEFENSE DEVICE ..... 69.50
- ITM1K—100,000 VOLT 20" AFFECTIVE RANGE INTIMIDATOR ..... 69.50
- PSP4K—TIME VARIANT SHOCK WAVE PISTOL ..... 59.50
- PTG1K—SPECTACULAR PLASMA TORNADO GENERATOR ..... 149.50
- MVRPK SEE IN DARK KIT ..... 169.50

**ASSEMBLED**

- PG70H—MULTICOLOR VARIABLE MODE PLASMA GLOBE "7" ..... 425.00
- BTC10—50,000 VOLT—WORLD'S SMALLEST TESLA COIL ..... 44.50
- LGU40—1MW H<sub>α</sub> NE VISIBLE RED LASER GUN ..... 299.50
- TAT20 AUTO TELEPHONE RECORDING DEVICE ..... 24.50
- GPV10—SEE IN TOTAL DARKNESS IR VIEWER ..... 299.50
- LIST10—SNOOPER PHONE INFINITY TRANSMITTER ..... 169.50
- IPG70—INVISIBLE PAIN FIELD GENERATOR—MULTI MODE ..... 74.50

• CATALOG CONTAINING DESCRIPTIONS OF ABOVE PLUS HUNDREDS MORE AVAILABLE FOR \$1.00 OR INCLUDED FREE WITH ALL ABOVE ORDERS.

PLEASE INCLUDE \$3.00 PH ON ALL KITS AND PRODUCTS PLANS ARE POSTAGE PAID. SEND CHECK, MO, VISA, MC IN US FUNDS.

**INFORMATION UNLIMITED**  
P.O. BOX 715, DEPT. RE, AMHERST, NH 03031

## BUILDING A ROBOT?

**MOTION PACKAGE**  
DIRECT GEAR DRIVE FOR  
WHEELS 12 INCH OR LARGER

**ONLY 99<sup>00</sup>**

**INCLUDES:**  
2 EA DC MOTORS  
2 EA 16:1 GEARBOXES  
2 EA 24 TOOTH STEEL SPUR GEARS  
2 EA 60 TOOTH NYLON IDLE GEARS  
2 EA 235 TOOTH 12 INCH DRIVE GEARS

MOTOR, GEARBOX, & IDLE GEAR ARE PRE-ASSEMBLED. DRIVE GEAR IS READY TO MOUNT ON YOUR WHEEL.

VDC	RPM	NO LOAD	STALL	MPH	PARTIAL DATA LISTING SEND FOR COMPLETE LISTING
24	34	800 MA	10.0 AMP	1.25	
18	27	600 MA	7.5 AMP	.96	
12	18	500 MA	5.0 AMP	.64	
6	8	450 MA	2.5 AMP	.21	

SEND POSTCARD FOR COMPLETE LIST OF ROBOTICS PARTS

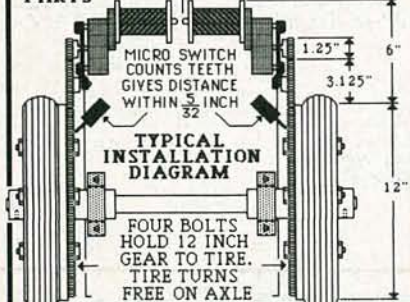

TERMS: C.O.D. OR PREPAID ONLY. PREPAID—ALLOW 2 WEEKS FOR CHECK TO CLEAR. C.O.D.—CASH OR CERTIFIED CHECK ONLY. ADD \$1.90 OFFER GOOD WHILE SUPPLIES LAST. STORE PRICE MAY DIFFER. PRICES MAY CHANGE.

**Silicon Valley Surplus**  
415-261-4662  
10AM-6PM CLOSED SUN & MON

4401 ORKPORT OAKLAND, CA. 94601  
415-261-4662  
HIGH ST. & 880

CIRCLE 192 ON FREE INFORMATION CARD

## ADVERTISING INDEX

RADIO-ELECTRONICS does not assume any responsibility for errors that may appear in the index below.

Free Information Number	Page	Free Information Number	Page
81	A.I.S. Satellite ..... 43	195	Parts Express ..... 106
108	AMC Sales ..... 28	101	Pomona Electronics ..... 3
203	Advanced Video ..... 42	—	RCA D&SP ..... 32
107	All Electronics ..... 123	78	Radio Shack ..... 111
—	Amazing Devices ..... 124	176	Regency ..... 11
201	American Design Components ..... 114, 115	177, 178	Sencore ..... 27, 29
98	Beckman Industrial ..... CV4	179, 180	Sencore ..... 31, 33
85	Blue Star Industries ..... 42	192	Silicon Valley Surplus ..... 124
109	C & S Sales ..... 79	74	Solid State Sales ..... 108
—	C.O.M.B. .... 26	94	Star Circuits ..... 43
60	CIE ..... 34	204	T S M ..... CV3
89	Cameo Enterprises ..... 42	92	Tektronix ..... CV2
194, 205	Circuit Cellar ..... 42, 43	185	Tentel ..... 83
—	Command Productions ..... 88	202	U.S. Cable/Movie Time ..... 41
79	Communications Electronics ..... 15	200	United Electronic Supply ..... 85
199	Computer Technologies ..... 104		
190	Cook's Institute ..... 88		
—	Coop's Satellite Digest ..... 77		
189	Crosley ..... 43		
187	Crystek ..... 86		
—	DAK Industries ..... 22-23, 24-25		
188	Daetron ..... 86		
127	Deco Industries ..... 42, 43		
95	Dick Smith Electronics ..... 38		
82	Digi-Key ..... 116		
—	Educate Publications ..... 5		
120	Elephant Electronics ..... 20		
100	Firestik II ..... 20		
121	Fluke Manufacturing ..... 10		
—	Fordham Radio ..... 14		
—	Grantham College of Engineering ..... 44		
62	Hameg ..... 21		
86	Heath ..... 13, 39		
—	ISCET ..... 88		
65	J & W ..... 89		
59	JDR Instruments ..... 7		
113, 181	JDR Microdevices ..... 118, 119		
182, 183	JDR Microdevices ..... 120, 121		
184	JDR Microdevices ..... 122		
114	Jameco ..... 112, 113		
104	Jan Crystals ..... 30		
115	Jensen Tools ..... 43		
—	Joseph Electronics ..... 12		
197	Kepro ..... 75		
87	MCM Electronics ..... 117		
198	MD Electronics ..... 43		
93	Mark V. Electronics ..... 110		
196	Mercer ..... 9		
61	Microprocessors Unltd. .... 104		
117	Mouser ..... 30		
—	NRI ..... 16		
186	NTS ..... 43		
110	Omnitron ..... 28		
191	PC Boards ..... 83		
—	Pacific Cable ..... 107		

Gernsback Publications, Inc.  
500-B Bi-County Blvd.  
Farmingdale, NY 11735  
(516) 293-3000  
President: Larry Steckler  
Vice President: Cathy Steckler

For Advertising ONLY 516-293-3000

Larry Steckler  
publisher  
Arline Fishman  
advertising director  
Shelli Weinman  
advertising associate  
Lisa Strassman  
credit manager  
Christina Estrada  
advertising assistant

**SALES OFFICES**

**EAST/SOUTHEAST**  
Stanley Levitan  
Eastern Sales Manager  
Radio-Electronics  
259-23 57th Avenue  
Little Neck, NY 11362  
718-428-6037, 516-293-3000

**MIDWEST/Texas/Arkansas/Okla.**  
Ralph Bergen  
Midwest Sales Manager  
Radio-Electronics  
540 Frontage Road—Suite 339  
Northfield, IL 60093  
312-446-1444

**PACIFIC COAST/ Mountain States**  
Marvin Green  
Pacific Sales Manager  
Radio-Electronics  
15335 Morrison St.—Suite 227  
Sherman Oaks, CA 91403  
818-986-2001

# T S M # 1 in EUROPE SINCE 1966

2065 boston post road larchmont n.y.10538 914-834-7190

Thank you for visiting us at the Summer C.E.S. in Chicago (Saturday, May 30 thru Tuesday, June 2, 1987). See show directory for our booth number. Welcome again!

**TSM KITS - A LIBRARY OF KITS AND ELECTRONIC APPLICATIONS.**

# 1 in Europe since 1966.  
presented in a unique, appealing video-type packaging covering various subjects such as amplifiers, alarms, pre-amplifiers, color organs, power supplies, measurement, car appliances, home appliances, receivers, etc . More than 60 kits available and more to come.

**MECANORMA: PCB TRANSFER SHEETS.**

Photo-engraving method  
Transfer symbols for direct etching.  
**SIEBER SCIENTIFIC**

Double-sided bread board for easy assembly - no soldering required  
professionnal heavy-duty models for teaching, design and quick evaluation.

**LA TOLERIE PLASTIQUE**  
wide range of tooled plastic boxes

flexible custom-design  
easy assembly  
**CIF LE CIRCUIT IMPRIME FRANCAIS**  
quick, professional etching machine



**TSM ELECTRONIC COMPONENTS**  
import/export  
large variety of brands  
full range of components

**TSM in America INC**  
2065 Boston Post Road  
Larchmont NEW YORK  
10538

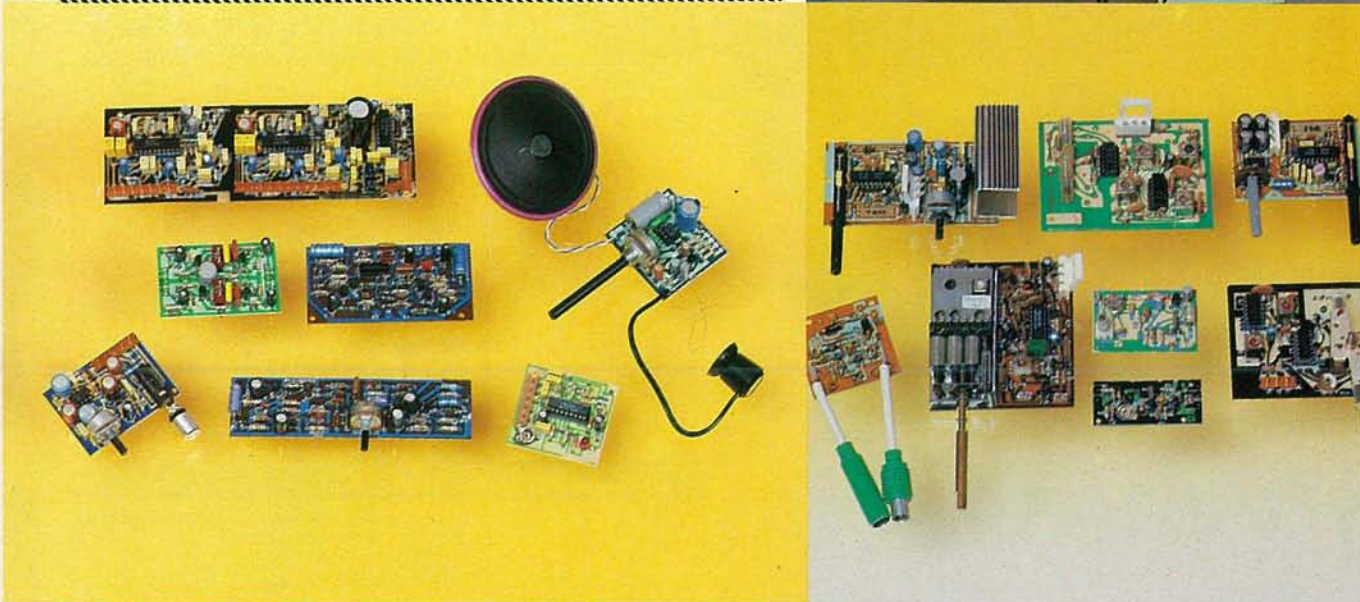
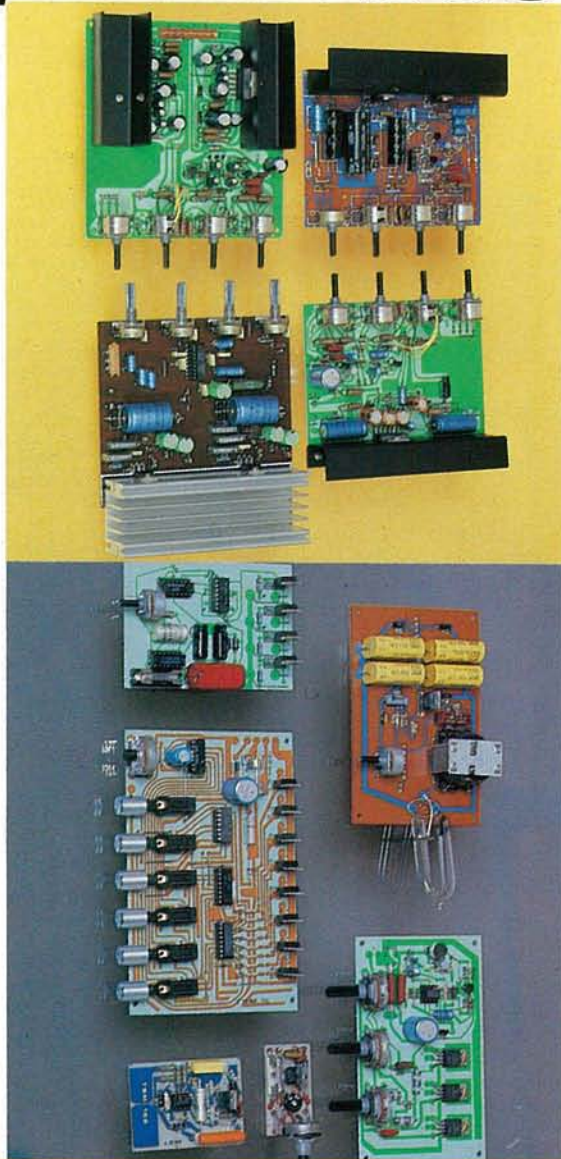

# More Functions. Smaller Budget.

*Beckman Industrial Circuitmate™ DMMs put hFE, Logic, Capacitance, Frequency and True RMS In Your Hand. For Less.*

**Get more, for less. It's a simple definition of value.** For DMMs, value means finding the combination of capabilities that meets your needs at the right price. Without losing sight of accuracy and reliability. If you want more functions at a low price, Beckman Industrial's Circuitmate™ Digital Multimeters are the best value around.

From the pocket-sized DM20L to the DM850, with true RMS capability and accuracy to 0.05% ± 1 digit, Circuitmate DMMs give you the functions you need.

For instance, the DM20L puts both a Logic Probe, a transistor gain function (hFE), and a full range of DMM functions in the palm of your hand. For only \$69.95.

Then there's the DM25L. Where else does \$89.95 buy you a Logic Probe, capacitance measurement, transistor gain function (hFE), and 24 DMM ranges including resistance to 2000 megohms? Nowhere else.

When high accuracy counts, there's the DM800 with a 4 1/2 digit display. The DM800



## DM20L Pocket-Size w/Logic \$69.95\*

TTL Logic Probe: 20MHz  
Hi/lo/off indications  
Detects 25nS pulse widths

hFE (NPN or PNP):  
1 range (1000)

DMM: Input Impedance—  
10 Megohms  
DCA/ACA-5 ranges  
(200µA to 2A)

Ohms-8 ranges (200 ohms  
to 2000 Megohms)

Continuity beeper



also gives you frequency counting. A full-function DMM, and more, doesn't have to cost over \$169.95. If it's a Circuitmate DM800.

Or, for a few dollars more, get true RMS (AC coupled) to let you accurately measure non-sinusoidal AC waveforms, and all the capability of the DM800, in the DM850.

Of course, there's a whole range of Circuitmate DMMs and service test instruments, including the DM78 autoranger that

## DM850 True RMS

4 1/2 digits. DCV accuracy is .05% +3 digits

True RMS

Frequency counter to 200KHz

Data Hold display capability

Continuity beeper

Built-in bail

Anti-skid pads

Price: DM850 (True RMS) . . . \$219.95\*  
DM800 (Average) . . . \$169.95\*



fits in a shirt pocket, yet gives you a full size 3 1/2 digit, 3/8" readout. Not to mention a complete line of accessories like test leads, current clamps, even probes that can extend your DMMs range and sensitivity. All designed to work flawlessly with your Beckman Industrial Circuitmate DMM.



## DM25L Capacitance, Logic, hFE \$89.95\*

TTL Logic Probe: 20MHz  
Hi/lo/off indications  
Detects 25nS pulse widths

Capacitance: 5 ranges  
(2nF to 20µF)

hFE (NPN or PNP):  
1 range (1000)

Continuity beeper

Built-in bail

Anti-skid pads

See your Beckman Industrial distributor and discover more DMM performance. For less.

\*Suggested list price (\$US) with battery, test leads and manual.

*In Service Instruments, We're The One.*

**Beckman Industrial™**

Beckman Industrial Corporation, Instrumentation Products Division  
A subsidiary of Emerson Electric Company  
630 Puente Street, Brea, CA 92621  
(714) 671-4800 • FAX: (714) 671-4874 • TLX: 188790  
© 1986 Beckman Industrial Corporation