

48783

**NEW!  
DIRECT-ETCH  
FOIL PATTERNS INCLUDED**

**THE RIGHT WAY TO  
HOOK UP YOUR VCR**

**\$1.95 AUGUST 1985  
IN CANADA \$2.25**

# Radio- Electronics®

**TECHNOLOGY - VIDEO - STEREO - COMPUTERS - SERVICE**

**Build a universal 64K  
printer buffer for  
your computer**

**Build R-E's infrared viewer  
and see in the dark!**

**How to design with digital IC's**

**Build the HiTech  
PC-IBM compatibility  
without the IBM price**

**How comb filters  
work to improve  
video-system performance**

**Electric shock  
and how it affects you**

**Special 16-page section:  
COMPUTERDIGEST**

Attention retailers:  
See page 26 for special  
display allowance plan.

**PLUS:**

- ★ **Robotics** ★ **State-Of-Solid-State**
- ★ **Drawing Board** ★ **Service Clinic**
- ★ **Equipment Reports**

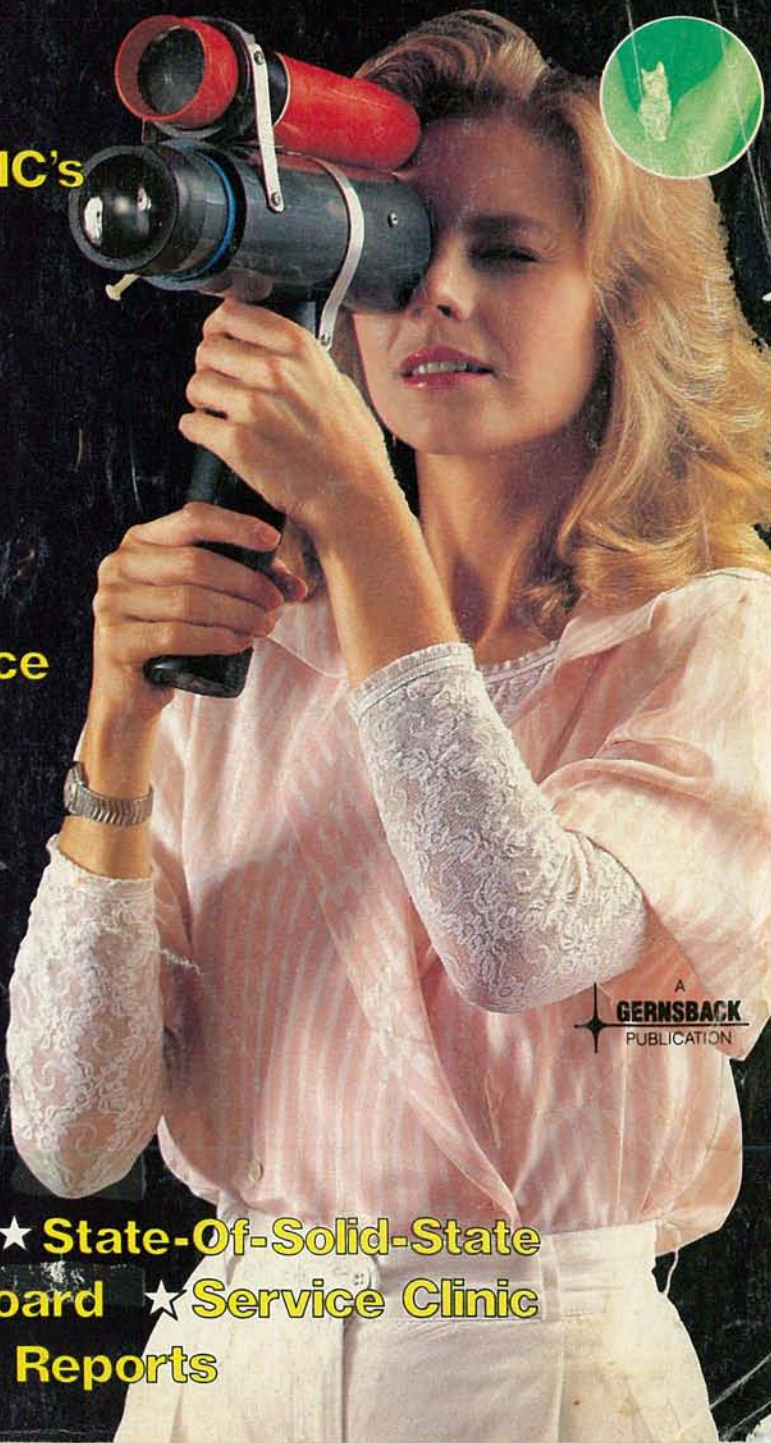

**A  
GERNSBACK  
PUBLICATION**



71896 48783



# Now! Tek quality and expert advice are just a free phone call away!

**The industry standard in CRT performance.**

Crisp, easy-to-read, bright CRT; 14kV accelerating potential, provides high writing rate and small spot size. Full size 8x10 cm display for measurement accuracy.

**Display controls are flexible and easy to use.**

Separate intensity controls reduce blooming in alternate sweep mode. Focus tracking minimizes control adjustment and BEAM FIND eliminates confusion.

**Vertical system provides measurement assurance.**

Flat transient response and high accuracy ensures true reproduction of your signals. Fast risetime and high bandwidth is well suited for a variety of measurement.

**Perform delayed sweep measurements accurately and easily.**

Both sweeps can be displayed alternately making differential measurements easy and accurate (1%). An interlocking SEC/DIV control simplifies set-up.

**Stable hands-off triggering.**

P-P AUTO detects signal peaks, then sets the trigger level for you. Display asynchronous signals using VERT MODE triggering. Independent TV field and line selection.

**Front panel laid out by function for ease of use.**

Color coding aids the user in operation. Functions and modes are placed logically. All nomenclature is clearly labeled, and protected behind a scratchless Lexan surface.



**Our direct order line gets you the industry's leading price/performance portables... and fast answers from experts!**

The 60 MHz single time base delay 2213A, the 60 MHz dual time base 2215A and the 100 MHz dual time base 2235 offer unprecedented reliability and affordability, plus the industry's first 3-year warranty\* on labor and parts, CRT included.

**The cost: just \$1275 for the 2213A, \$1525 for the 2215A, \$1750 for the 2235.**† Even at these low prices, there's no scrimping on performance. You

have the bandwidth for digital and analog circuits. The sensitivity for low signal measurements. The sweep speeds for fast logic families. And delayed sweep for fast, accurate timing measurements. All scopes are UL Listed and CSA approved.

**You can order, or obtain literature, through the Tek National Marketing Center.** Technical personnel, expert in scope applications, will answer your questions and expedite delivery. Direct orders include comprehensive 3-year warranty\*, operator's

manual, two 10X probes, 15-day return policy and worldwide service backup.

**Order toll free: 1-800-426-2200, Ask for Rick.**

In Oregon, call collect: (503) 627-9000. Or write Tektronix, Inc. P.O. Box 1700 Beaverton, OR 97075

**Tektronix®**  
COMMITTED TO EXCELLENCE





# COMPUTER BARGAIN

*You won't believe what you can now get for \$499. How about a \$2,500 computer system?*

*The \$499 professional-quality personal computer has two disk drives, 128K memory and a high-resolution green monitor. The photo also shows the optional software.*

**I realize that what you are about to read may seem incredible. I can understand. But occasionally there are indeed bargains and opportunities that only come once in a lifetime. I'm convinced that this is one of them.**

*By Joseph Sugarman, President*

The computers we are offering are not outdated rebuilt models from a company that no longer exists but brand new computers from an existing substantial company that provides service and support.

The unit's monitor is a 12" green phosphor, 80 characters x 25 lines bit-mapped graphics display with 640 x 300 points. If you know anything about computers this one piece of hardware is worth \$500 itself. The display is so beautiful when it displays either text or graphics that it will probably far surpass anything you've seen to date.

There are two 5 1/4" 400Kb disk drives, a full 93 key ASCII keyboard including 17 function keys and numeric pad, a 128K memory, standard printer and communications ports (two parallel and one serial), a realtime clock with battery back-up, and it is a Z80A-based system in a dual 8-bit format that actually operates faster than the IBM PC. The unit also reads Kaypro and DEC Rainbow and all CP/M floppy disk formats.

## ADVANCED SOFTWARE

The unit also comes with advanced communications software which provides automatic dial-up access to outside computer services or direct connection to a nearby host.

The operating system that comes with the unit is the powerful CP/M Plus—an improved release of CP/M which lets you use more available software than even the IBM. You have access to hundreds of popular software packages including word processing, spreadsheet, data base management, accounts receivable, billing, general ledger, client accounting, engineering, statistics, project management and dozens of other programs.

The entire system, complete with monitor, two disk drives, 128K memory, operating system and keyboard sells for only \$499. That's right, only \$499.

We realize that the thought of buying a professional-quality computer for only \$499

may raise serious questions. Why so cheap? What about service, warranty and repair? Let me address these concerns.

The manufacturer makes and sells high-resolution computer terminals to other computer makers for their expensive high-quality systems. Their terminals were so popular and were so well accepted that they thought they'd get into the rotten, dog-eat-dog consumer personal computer business which, as you might have heard, has claimed dozens of casualties. But this manufacturer decided not to become one of those casualties and sold us all his inventory.

## MAY HURT OTHERS

The only thing the manufacturer won't let us do is mention his name in this advertisement nor mention the name of the unit as it may hurt many of the other retailers who have sold this unit for thousands of dollars.

The limited warranty is a full 90 days and if anything goes wrong with the unit after that time, warranty repairs are as easy as sending your computer to the closest participating service organization or exchanging the unit's circuit boards with an overnight delivery service. The manufacturer is a substantial company and committed to servicing this product. In fact, if service is a concern, why not get two units and use the second for a backup?

There is also one big plus. With each unit, we'll give you a 2-week trial period. If, during that time, you are not completely satisfied with the operation, performance, value or even the looks of the unit, you may return it in its original carton, for a full \$499 refund.

So that's our offer—a brand-new, professional-grade computer system with the hardware and optional accessories that you'd expect from other systems costing more than \$2,500—all for only \$499. There are no strings attached, nothing else that you must buy or promise to buy in the future. It's just that simple.

## SOFTWARE AVAILABLE

JS&A also sells a complete line of software and can supply you with the famous word processing Wordstar program complete with Mail Merge which lets you merge your list of names and addresses onto standard form letters and which converts your unit into a professional word processor when you add a letter-quality printer—all for only \$299 which is far below the \$500 manufacturer's list price for this program.

If you also order the Wordstar word processing program, we'll also throw in, free of charge, "DR Graph" from Digital Research at no extra charge. This handy software program is a powerful graphics package that lets you convert your data into line, bar, and pie charts as well as step and scatter plots. And it's so simple to do with our computer.

## EXTRA BONUS

And as an extra software bonus we'll even add, free of charge, the Multiplan spreadsheet program which, in my judgment, is one of the easiest to use and most powerful of all the spreadsheets. In fact, *Infoworld Magazine* once gave it the Software Product of the Year Award.

Simply by purchasing the Wordstar program at the low price of \$299, I'll throw in, free of charge, the DR Graph and Multiplan software which all together give you the capability to use your computer as a full-blown word processor and a spreadsheet analyzer along with its graphics and strong communications capabilities. But there's more. Order the Wordstar program and I'll also include absolutely free, CBASIC—a program that helps you easily create your own programs.

There is a good chance that the 500 computers we have will sell out quickly. So JS&A reserves the right to return any order and the right to fill the orders for the computer and software first.

But please act now. Because of the low cost of this offer, I cannot accept credit cards or C.O.D.'s. Simply send your check or money order for either the computer hardware or the hardware and software using the order numbers shown in parentheses (IL residents add 7% sales tax) plus \$25 for postage and handling. Send your order to: JS&A Special Computer Offer at the address below.

Special Offer Computer (6048DO) . . . \$499  
Wordstar and Bonuses (6049DO) . . . \$299  
Note: A list of other popular software will be sent with each unit. Add \$25 for postage and handling.

**JS&A PRODUCTS THAT THINK®**

Dept. RA, One JS&A Plaza  
Northbrook, Illinois 60062

(312) 564-7000  
©JS&A Group, Inc., 1985



# Save up to \$220 on scanners with these valuable coupons.

See our full page ad in SCAN™ to find the scanner of your choice. Then send in the money saving coupon with your order and payment. Hurry, offer expires August 31, 1985.



## Consumer Products Division

P.O. Box 1045 □ Ann Arbor, Michigan 48106-1045 U.S.A.  
Call 800-USA-SCAN or outside U.S.A. 313-973-8888

**COUPON COUPON COUPON**

### SAVE \$45.00 Bearcat® 260-H

8-Band, 16 Channel, Mobile scanner

Regular Price \$274.00

**Now only \$229.00** plus \$7.00 shipping.

This coupon must be included with your prepaid order. Credit cards and quantity discounts are excluded from this offer. Offer valid only on prepaid orders mailed directly to Communications Electronics Inc., P.O. Box 1045 - Dept. SCAN, Ann Arbor, Michigan 48106-1045 U.S.A. Coupon expires August 31, 1985. Coupon may not be used in conjunction with any other offer from Communications Electronics Inc. Limit one coupon per scanner.

**COUPON COUPON COUPON**

### SAVE \$40.00 Regency® Z60-H

8-Band, 60 Channel, No crystal scanner

Regular Price \$249.00

**Now only \$209.00** plus \$7.00 shipping.

This coupon must be included with your prepaid order. Credit cards and quantity discounts are excluded from this offer. Offer valid only on prepaid orders mailed directly to Communications Electronics Inc., P.O. Box 1045 - Dept. SCAN, Ann Arbor, Michigan 48106-1045 U.S.A. Coupon expires August 31, 1985. Coupon may not be used in conjunction with any other offer from Communications Electronics Inc. Limit one coupon per scanner.

**COUPON COUPON COUPON**

### SAVE \$35.00 JIL SX-200-H

Multi-Band, 18 Channel, No crystal scanner

Regular Price \$189.00

**Now only \$154.00** plus \$7.00 shipping.

This coupon must be included with your prepaid order. Credit cards and quantity discounts are excluded from this offer. Offer valid only on prepaid orders mailed directly to Communications Electronics Inc., P.O. Box 1045 - Dept. SCAN, Ann Arbor, Michigan 48106-1045 U.S.A. Coupon expires August 31, 1985. Coupon may not be used in conjunction with any other offer from Communications Electronics Inc. Limit one coupon per scanner.

**COUPON COUPON COUPON**

### SAVE \$30.00 Regency® HX-650P-H



with 4 AAA batteries, carrying case and 6 crystal certificates

Regular Price \$124.00

**Now only \$94.00** plus \$10.00 shipping.

This coupon must be included with your prepaid order. Credit cards and quantity discounts are excluded from this offer. Offer valid only on prepaid orders mailed directly to Communications Electronics Inc., P.O. Box 1045 - Dept. SCAN, Ann Arbor, Michigan 48106-1045 U.S.A. Coupon expires August 31, 1985. Coupon may not be used in conjunction with any other offer from Communications Electronics Inc. Limit one coupon per scanner.

**COUPON COUPON COUPON**

### SAVE \$25.00 Regency® MX7000-H

10-Band, 20 Channel, AC/DC scanner

Regular Price \$449.00

**Now only \$424.00** plus \$7.00 shipping.

This coupon must be included with your prepaid order. Credit cards and quantity discounts are excluded from this offer. Offer valid only on prepaid orders mailed directly to Communications Electronics Inc., P.O. Box 1045 - Dept. SCAN, Ann Arbor, Michigan 48106-1045 U.S.A. Coupon expires August 31, 1985. Coupon may not be used in conjunction with any other offer from Communications Electronics Inc. Limit one coupon per scanner.



**COUPON COUPON COUPON**

### SAVE \$20.00 Regency® Z45-H

7-Band, 45 Channel, AC/DC scanner

Regular Price \$199.00

**Now only \$179.00** plus \$7.00 shipping.

This coupon must be included with your prepaid order. Credit cards and quantity discounts are excluded from this offer. Offer valid only on prepaid orders mailed directly to Communications Electronics Inc., P.O. Box 1045 - Dept. SCAN, Ann Arbor, Michigan 48106-1045 U.S.A. Coupon expires August 31, 1985. Coupon may not be used in conjunction with any other offer from Communications Electronics Inc. Limit one coupon per scanner.

**COUPON COUPON COUPON**

### SAVE \$15.00 Regency® Z30-H

6-Band, 30 Channel, No crystal scanner

Regular Price \$169.00

**Now only \$154.00** plus \$7.00 shipping.

This coupon must be included with your prepaid order. Credit cards and quantity discounts are excluded from this offer. Offer valid only on prepaid orders mailed directly to Communications Electronics Inc., P.O. Box 1045 - Dept. SCAN, Ann Arbor, Michigan 48106-1045 U.S.A. Coupon expires August 31, 1985. Coupon may not be used in conjunction with any other offer from Communications Electronics Inc. Limit one coupon per scanner.

**COUPON COUPON COUPON**

### SAVE \$10.00 Regency® Z10-H

6-Band, 10 Channel, No crystal scanner

Regular Price \$149.00

**Now only \$139.00** plus \$7.00 shipping.

This coupon must be included with your prepaid order. Credit cards and quantity discounts are excluded from this offer. Offer valid only on prepaid orders mailed directly to Communications Electronics Inc., P.O. Box 1045 - Dept. SCAN, Ann Arbor, Michigan 48106-1045 U.S.A. Coupon expires August 31, 1985. Coupon may not be used in conjunction with any other offer from Communications Electronics Inc. Limit one coupon per scanner.

**COUPON COUPON COUPON**

**COUPON COUPON COUPON**

CIRCLE 79 ON FREE INFORMATION CARD



# AUGUST '85

**Radio-  
Electronics**

Electronics publishers since 1908

Vol. 56 No. 8

- BUILD THIS**
- 49 **SEE-IN-THE-DARK VIEWER**  
With this infrared viewer, you'll never be in the dark again! **Robert Grossblatt**
  - 59 **BUFFER/CONVERTER FOR YOUR PRINTER**  
This is no standard 64K printer buffer. It's a serial-to-parallel and a parallel-to-serial converter, too. It can even be used to program EPROM's. **Bill Green**
  - 67 **PC COMPATIBLE COMPUTER**  
You can put together a computer that's compatible with the IBM PC without paying IBM's price. And since the motherboard can be bought already assembled, anyone can do it! **Elliott S. Kanter**
  - 75 **PC SERVICE**  
Now you can use PC foil patterns right from the magazine page!

- TECHNOLOGY**
- 16 **SATELLITE TV**  
Signal scrambling and the TVRO industry. **Bob Cooper, Jr.**
  - 57 **ALL ABOUT ELECTRIC SHOCK**  
The medical effects of electric shock on your body. **Ray Fish, Ph.D., M.D.**
  - 80 **ROBOTICS**  
Building a robotics lab for your experiments. **Mark J. Robillard**

- CIRCUITS AND COMPONENTS**
- 63 **COMB FILTERS FOR YOUR TV**  
All about comb filters and how they're used to derive RGB signal from NTSC composite video to improve system performance. **Neil W. Heckt**
  - 72 **DESIGNING WITH DIGITAL IC'S**  
An introduction to the flip-flop. **Joseph J. Carr**
  - 86 **DRAWING BOARD**  
Using dynamic RAM's successfully. **Robert Grossblatt**
  - 88 **STATE OF SOLID STATE**  
A new P-channel conductivity-modulated FET. **Robert F. Scott**

## RADIO

- 84 **ANTIQUÉ RADIOS**  
Looking beyond the cabinet. **Richard D. Fitch**

## VIDEO

- 12 **VIDEO NEWS**  
A review of the fast-changing video scene. **David Lachenbruch**
- 53 **HOOKING UP YOUR VCR**  
It's not difficult, but the more equipment and services you have, the more complex it gets. **Carl Laron**
- 90 **SERVICE CLINIC**  
Troubleshooting sync problems. **Jack Darr**
- 91 **SERVICE QUESTIONS**  
R-E's Service Editor answers your questions.

## COMPUTERS

- Following page 80
- COMPUTER DIGEST**  
Digitizing tablets, and more!

## EQUIPMENT REPORTS

- 38 **Global Specialties Oscilloscope Multiplexer**
- 44 **Hayes Smartmodem 2400**

## DEPARTMENTS

- 112 **Advertising and Sales Offices**
- 112 **Advertising Index**
- 113 **Free Information Card**
- 32 **Letters**
- 93 **Market Center**
- 6 **What's News**

Radio-Electronics, (ISSN 0033-7862) Published monthly by Gernsback Publications, Inc., 200 Park Avenue South, New York, NY 10003. Second-Class Postage paid at New York, NY and additional mailing offices. Second-Class mail authorized at Ottawa, Canada. One-year subscription rate U.S.A. and possessions \$15.97, Canada \$20.97, all other countries \$23.47. subscription orders payable in US funds only, international postal money order or check drawn on a U.S.A. bank. Single copies \$1.95. © 1985 by Gernsback Publications, Inc. All rights reserved. Printed in U.S.A. POSTMASTER: Please send address changes to RADIO-ELECTRONICS, Subscription Dept., Box 2520, Boulder, CO 80322. A stamped self-addressed envelope must accompany all submitted manuscripts and/or artwork or photographs if their return is desired should they be rejected. We disclaim any responsibility for the loss or damage of manuscripts and/or artwork or photographs while in our possession or otherwise.

AUGUST 1985



# COVER 1



Did you ever wish that you could see in the dark? You can't, of course, because your eyes are sensitive only to visible light. But with the see-in-the-dark viewer that we'll show you how to build, you'll be able to change that.

The viewer uses a special image-converter tube that is sensitive to infrared light and translates infrared wavelengths to visible wavelengths. In that way, it can be used to widen the visible portion of the electromagnetic spectrum. In other words, you'll be able to see objects illuminated with infrared light. The story begins on page 49.

# NEXT MONTH

THE SEPTEMBER ISSUE IS  
ON SALE AUGUST 6

## AUTOMOTIVE ELECTRONICS

Both under the hood and in the passenger compartment, your next car will contain a lot of electronic wizardry.

## BUILD AN IC TESTER/ANALYZER

This handy device will let you test IC's and digital circuits for proper operation. It makes a great teacher, too.

## HOW TO DESIGN PC BOARDS

Making a PC board can sometimes be difficult. But it's not as hard as doing the board design! We'll help make it easier.

## BUILD A 64K PRINTER BUFFER

We continue with construction details for the buffer and the EPROM programmer add-on.

The computer-controlled weather station we promised in this space last month will run in a future issue of Radio-Electronics.

As a service to readers, Radio-Electronics publishes available plans or information relating to newsworthy products, techniques and scientific and technological developments. Because of possible variances in the quality and condition of materials and workmanship used by readers, Radio-Electronics disclaims any responsibility for the safe and proper functioning of reader-built projects based upon or from plans or information published in this magazine.

Since some of the equipment and circuitry described in RADIO-ELECTRONICS may relate to or be covered by U.S. patents, RADIO-ELECTRONICS disclaims any liability for the infringement of such patents by the making, using, or selling of any such equipment or circuitry, and suggests that anyone interested in such projects consult a patent attorney.

## Radio-Electronics

Hugo Gernsback (1884-1967) founder  
M. Harvey Gernsback, editor-in-chief  
Larry Steckler, EHF, CET, publisher

### EDITORIAL DEPARTMENT

Art Kleiman, editor  
Brian C. Fenton,  
technical editor  
Carl Laron, WB2SLR,  
associate editor  
Robert A. Young, assistant editor  
Julian S. Martin, editorial associate  
Byron G. Wels, editorial associate  
Jack Darr, CET, service editor  
Robert F. Scott,  
semiconductor editor  
Herb Friedman,  
communications editor  
Earl "Doc" Savage, K4SDS,  
hobby editor  
Bob Cooper, Jr. satellite-TV editor  
Robert Grossblatt, circuits editor  
David Lachenbruch,  
contributing editor  
Mark J. Robillard, robotics editor  
Bess Isaacson, editorial assistant

### PRODUCTION DEPARTMENT

Ruby M. Yee, production manager  
Robert A. W. Lowndes,  
editorial production  
Karen Tucker, advertising production  
Geoffrey S. Weil, production traffic

### CIRCULATION DEPARTMENT

Jacqueline P. Weaver,  
circulation director  
Rita Sabalis,  
assistant circulation director  
Jacqueline Allen, circulation assistant

Cover photo by Robert Lewis

Radio-Electronics is indexed in  
*Applied Science & Technology Index*  
and *Readers Guide to Periodical Literature*.

Microfilm & Microfiche editions are  
available. Contact circulation department  
for details.

Advertising Sales Offices listed  
on page 112.





# Confidence is knowing your system has an ace in the hole.

## We bet the Fluke 8840A is the right 5½-digit multimeter for you.

It's easy to program and operate, and it's easy to integrate into your system. The 8840A is versatile; if your system changes, your DMM doesn't have to.

You get the functions you need. With



the best accuracy and fastest reading rates in its class.

You also get the security of Fluke's support to help bring your system on line quickly. Plus reliability and long-interval, in-place calibration for reduced down time.

All starting at **\$695**. IEEE-488 interface and true rms ac options are available for just **\$150** each.

Add it up, and you've got a great deal on a 5½-digit rack-mountable DMM. Why gamble on anything less?

For more information, contact your local Fluke representative or call toll-free **1-800-426-0361**.

FROM THE WORLD LEADER  
IN DIGITAL MULTIMETERS.

### Fluke 8840A

Autoranging Volts, Ohms, and Amps	
50 ppm basic dc accuracy (1 year)	
0.16% basic ac accuracy (1 year)	
2½, 20, and 100 readings/second	
-05 IEEE-488 interface option	\$150
-09 true rms ac option	\$150
Y8834 single rack kit	\$ 35
Y8835 dual rack kit	\$ 75

**FLUKE**®



# WHAT'S NEWS

## New D-cell charges itself

A new D-size battery offered by MJR Co. of Phoenix, AZ, carries its own built-in solar panel and will charge in bright sunlight at half the rate recommended for charging conventionally from a wall plug. Since each cell charges individually, the cells will charge whether they are connected in parallel or in series.

The new cell is claimed to have an exceptionally long service life—up to 1,000 full cycles. (Average use is said to be about 500 cycles in five years.) Voltage rating is 1.2 at 1.2 ampere hours, and the cell can be stored for years—regardless of charge state—with no appreciable loss of service life. It is priced at \$20.



THE MJR Ni-Cad SN2000 SOLAR RECHARGEABLE D-CELL, which in bright sunlight will charge at half the rate recommended for charging it from a wall plug.

## Author of Rider Manuals dies at age 85

John F. Rider, radio pioneer, inventor, author, and publisher, died Feb. 6, 1985, at age 85.

John Rider began as an author in the 1920's, writing feature articles and columns on radio, for several New York papers. He was associate editor of *Radio Engineering*

and managing editor of *Radio Listener Guide and Call Book*. In 1932 he joined Hugo Gernsback's *Radio-Craft* as Service Editor, and was with that magazine for some years.

He then started the firm of John F. Rider Publisher, and began putting out the famous Rider Manuals—anthologies of broadcast-

receiver schematics that became the bibles of the service technician for many years. He also wrote and published numerous books on radio-service subjects and instruments.

He developed a vacuum-tube voltmeter, the Rider VoltOhmyst, and invented an intermittent indicator, the Chanalyst. In World War II, John Rider served as Director of the Signal Corps Publication Agency, responsible for publishing the myriad instruction and service manuals covering all Signal Corps equipment. Retiring as a Lieutenant Colonel, after the war, he resumed operations at John F. Rider Publisher until his retirement, at which time he sold his company to Hayden Book Co.

Rider was an ardent stamp collector, specializing in 19th century stamps and covers, and wrote on philatelic subjects. He was internationally known as an expert in identifying counterfeit stamps.

## RCA and Sharp to join in VLSI manufacture

RCA Corporation and the Sharp Corp. have agreed to establish a joint venture to design, develop, and manufacture complementary metal oxide silicon (CMOS) very large scale integrated (VLSI) circuits in the United States.

The new concern will be called RCA/Sharp Microelectronics Inc. It will establish a CMOS integrated circuit design center to develop advanced memories, microprocessor gate arrays, standard cells, etc., for sale in the United States, Europe, and the Far East. The next step will be to build a facility in the United States for fabricating six-inch CMOS VLSI wafers. Construction is expected to start late in 1985. **R-E**



# FREE high tech catalog

**Heathkit**

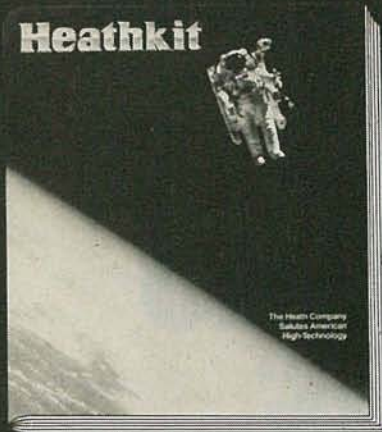

The Heath Company  
Satisfies America's  
High Technology

Metal  
Detector



Triple-Trace  
Oscilloscope/Time-  
Voltage Display



More than just a catalog, a trustworthy guide to what's new in computers and electronics.

Ever since radio grew into electronics, the illustrated Heathkit catalog has been a guide to new and exciting kit products for people like you to build. To enjoy and learn from, while saving money in the process.

What sets the Heathkit catalog apart is its range of high quality products and accurate information on every product offered. And that's a lot of products — over 450 separate items, including:

- Computer hardware and software
- Robots
- Precision test instruments
- Computerized weather instruments
- Solar hot water systems
- Automotive and home energy products
- Security devices
- Color TVs and video accessories
- Quality stereo components
- Amateur radio gear
- Educational courses that lead from the basics of electronics all the way to high tech.

Computerized  
Weather Station

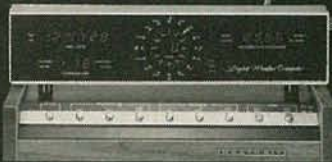

Ham Radio  
Transceiver



Discover  
the pride.

With Heathkit, you'll discover the pride of accomplishment that comes with creating handbuilt quality that is uniquely yours.

And you'll develop skills and abilities in many technologies as you follow the step-by-step directions through the building process.

You work confidently, always backed by our simple promise, "We won't let you fail."

If you don't have the latest Heathkit Catalog, you're missing something great, so mail the coupon now, while you're thinking about it.

Microprocessor  
Trainer & Course



Most  
Accurate  
Clock

Real Time  
Spectrum Analyzer



HERO<sup>®</sup> 1  
Robot



IBM-PC Compatible  
Computers



40-Channel  
Scanner

Send NOW for your  
**FREE Heathkit Catalog**  
It's the beginning of something great  
for the whole family.

Heath Company  
Dept. 020-326  
Benton Harbor, Michigan 49022  
Please send me the latest  
Heathkit Catalog Free.

Name \_\_\_\_\_

Address \_\_\_\_\_

City \_\_\_\_\_ State \_\_\_\_\_

Zip \_\_\_\_\_

CL774D



**Heathkit<sup>®</sup>**  
Heath  
Company

A subsidiary of Zenith Electronics Corporation  
CIRCLE 68 ON FREE INFORMATION CARD



*NRI Trains You At Home—As You Build*

# GET THE KNOW-HOW TO REPAIR EVERY COMPUTER ON THIS PAGE... AND MORE.

IBM is a Registered Trademark of International Business Machine Corporation.  
Epson is a Registered Trademark of Epson America, Inc.  
Apple and the Apple logo are Registered Trademarks of Apple Computer, Inc.  
Compaq is a Registered Trademark of COMPAQ Computer Corporation.  
© 1984 AT&T Technologies, Inc.



PHOTO: ELECTRONIC ARTS



# Your Own IBM-Compatible Computer

## Learn the Basics the NRI Way—and Earn Good Money Troubleshooting Any Brand of Computer

The biggest growth in jobs between now and 1995, according to Department of Labor estimates, will occur in the computer service and repair business, where demand for trained technicians will actually *double*.

You can cash in on this opportunity—either as a full-time corporate technician or an independent service-person—once you've learned all the basics of computers the NRI way. NRI's practical combination of "reason-why" theory and "hands-on" building skills starts you with the fundamentals of electronics, then guides you through advanced electronic circuitry and on into computer electronics. You also learn to program in BASIC and machine language, the essential languages for troubleshooting and repair.

## You Build—and Keep—a Sanyo MBC-550-2

The vital core of your training is the step-by-step building of the 16-bit Sanyo MBC-550-2 computer. Once you've mastered the details of this state-of-the-art machine, you'll be qualified to service and repair virtually every major brand of computer, plus many popular peripheral and accessory devices.

With NRI training, you learn at your own convenience, in your own home. You set the pace—without classroom pressures, rigid night-school schedules, or wasted time. You build the Sanyo MBC-550-2 from the keyboard

up, with your own personal NRI instructor and the complete NRI technical staff ready to answer your questions or give you guidance and special help whenever you need it.

## Learn MS/DOS Operating System

Praised by critics as the "most intriguing" of all the IBM-PC compatible computers, the new Sanyo uses the same 8088 microprocessor as the IBM-PC and features the MS/DOS operating system. As a result, you'll have a choice of thousands of off-the-shelf software programs to run on your completed Sanyo.

Your NRI course includes installation and troubleshooting of the "intelligent" keyboard, power supply, and disk drive, plus you'll check out the 8088 microprocessor functions, using machine language. You'll also prepare the interfaces for future peripherals such as printers and joysticks.



Your NRI course includes the Sanyo MBC-550-2 Computer with 128K RAM, monitor, disk drive, and "intelligent" keyboard; the NRI Discovery Lab®, teaching circuit design and operations; a Digital Multimeter; Bundled Spread Sheet and Word Processing Software worth \$1500 at retail—and more.

## 100-Page Free Catalog Tells More

Send the postage-paid reply card today for NRI's big 100-page color catalog on NRI's electronics training, which gives you all the facts about NRI courses in Microcomputers, Robotics, Data Communications, TV/Video/Audio Servicing, and other growing high-tech career fields. If the reply card is missing, write to the address below.

**NRI** SCHOOLS

McGraw-Hill Continuing  
Education Center  
3939 Wisconsin Avenue, NW  
Washington, DC 20016



We'll Give You Tomorrow.



# VIDEO NEWS



**DAVID LACHENBRUCH**  
CONTRIBUTING EDITOR

• **More videodisc players.** Laservision videodisc systems quietly gain more adherents. Ever since Pioneer's introduction of the combination videodisc and CD digital audio-disc system, hi-fi companies have been taking notice, and at least two are joining up and offering players (built by Pioneer). Those are Sansui and Luxman. Others, including such names as Proton, are expected to come along soon.

• **The format wars.** What we foreshadowed as a battle of formats (**Radio-Electronics**, July 1985) has now come to pass in the United States as well as in Europe and Japan. Toshiba, once a stalwart of the Beta group, introduced a line of three VHS recorders here; and although it still has Beta machines, the company made it clear at its sales meeting that it believes its future is in VHS.



At the same time, Sony brought its 8mm camcorder to the United States, and promised to follow up with home decks designed for the 8mm format. The camcorder, similar to the one it introduced in Japan, has single-speed recording and playback, accommodating the small cassettes that currently come in 30-, 60- and 90-minute lengths, but soon will be joined by a two-hour version. It has a solid-state CCD pickup with 250,000 picture elements and weighs 4.5 pounds without cassette and battery, about five pounds with. Sony's Chairman, Akio Morita, predicts that

8mm will become the most popular format in about three years.

Except for traditional film-camera manufacturers, such as Kodak, Polaroid, Canon, and Fuji, no companies have made as strong a commitment to 8mm as Sony. However, Sony isn't neglecting Beta. It introduced a new Beta line, heavily laced with SuperBeta machines capable of high-resolution pictures.

• **Hi-fi video tuners.** The first of the hi-fi receivers and tuners designed to pick up multichannel TV sound (MTS)—stereo and the separate audio program, or SAP—are now coming on the market. Panasonic's Technics brand is offering one complete audio-video receiver with built-in MTS at about \$550, and it also has two lower-priced audio receivers (at \$270 and \$320), which can accommodate the same adaptor used to convert some of Panasonic's TV sets to MTS. Sansui also is introducing an audio-video switching center for home-stereo systems containing MTS circuitry, and others are expected to follow shortly. The introduction of MTS TV stereo as an audio component means that high-quality stereo audio can be added to existing (non-stereo) TV sets via the home-audio system. Of course, it's necessary to have a hi-fi stereo system that is located in the same room as the television set.

• **Enter the 27-inch tube.** It's not exactly a surprise, since RCA signaled it more than a year ago, but the first 27-inch tube is now on the way in a deluxe stereo console. This RCA product is the first American-made flat-faced tube. The screen was computer-designed and has a completely flat appearance, although its contours more closely resemble a plateau than a flat plane. Other flat-faced tubes, all with square corners like the RCA tube, have been introduced in 14-, 20-, and 26-inch sizes by some Japanese manufacturers, although similar square-cornered tubes in those sizes by both Japanese and American manufacturers are also available with the traditional spherical faceplates that are easier to manufacture.

**R-E**



Electricity and water don't mix. At least not in our Heavy Duty Digital Multimeters. Because these Oops Proof™ instruments are protected by a system of seals to ensure contamination-free dependability in even the cruddiest conditions.

Other abuse-proof features include the best mechanical protection ever built into a precision Digital Multimeter. In fact, every one of our Oops Proof multimeters will survive a drop from ten feet onto a concrete surface!

All the Heavy Duty series meters measure up to 1000 volts AC and 1500 volts DC, with full overload protection to those maximum voltages even on the lowest range settings. Overload circuitry also provides transient protection to 6KV on all voltage ranges and up to 600 volts on all resistance ranges.

We also invented a unique, long-life rotary switch for our Digital Multimeters. You can actually feel the difference just by

rotating the function selector knob.

You'll find these features in a full line of Heavy Duty DMMs that offer a 4½ digit readout, 0.05% VDC accuracy, a 10-amp current range, a 2000-hour battery life, diode test, true RMS and temperature measurement. All this and a no-questions, one-year warranty.

You'll want to try one out, of course, so drop into your nearest electronics distributor and drop one.

***Our lips are sealed.***



CIRCLE 98 ON FREE INFORMATION CARD

© 1984 Beckman Industrial Corporation, A Subsidiary of Emerson Electric Company,  
630 Puente Street, Brea, CA 92621 (714) 773-8111.

**Beckman Industrial™**



# 49¢ Diskettes

## Name Brand Quality

### Toll-Free Ordering

### Fast Delivery

**Call Communications Electronics**

Diskette order desk

**800-USA-DISK**

In Canada 800-CA1-DISK

**Choose your brand**

**Choose your price**



**Super Disk**  
diskettes for as low as  
**\$0.49 each**



**Wabash**  
diskettes for as low as  
**\$0.72 each**



**BASF**  
diskettes for as low as  
**\$1.12 each**



**Memorex**  
diskettes for as low as  
**\$1.12 each**

Product Description	Super Disk Part #	CE quant. 100 price per disk (\$)	Wabash Part #	CE quant. 100 price per disk (\$)	BASF Part #	CE quant. 100 price per disk (\$)	Memorex Part #	CE quant. 100 price per disk (\$)
8" SSSD IBM Compatible 128B/S, 26 Sector	-----	-----	F111-Z	1.59	-----	-----	3062-Z	1.84
8" SSSD Shugart Compatible, 32 Hard Sector	-----	-----	F31A-Z	1.79	-----	-----	3015-Z	1.94
8" SSDD IBM Compatible (128 B/S, 26 Sectors)	-----	-----	F131-Z	1.89	-----	-----	3090-Z	2.19
8" DSDD Soft Sector (Unformatted)	-----	-----	F14A-Z	2.09	-----	-----	3102-Z	2.59
8" DSDD Soft Sector (256 B/S, 26 Sectors)	-----	-----	F144-Z	2.09	-----	-----	-----	-----
8" DSDD Soft Sector (512 B/S, 15 Sectors)	-----	-----	F145-Z	2.09	-----	-----	-----	-----
8" DSDD Soft Sector (1024 B/S, 8 Sectors)	-----	-----	F147-Z	2.09	-----	-----	3104-Z	2.59
5 1/4" SSSD Soft Sector w/Hub Ring	6431-Z	0.74	M11A-Z	0.89	-----	-----	-----	-----
5 1/4" SSSD Same as above but bulk product	6437-Z	0.54	M11AB-Z	0.79	-----	-----	-----	-----
5 1/4" SSSD 10 Hard Sector w/Hub Ring	-----	-----	M41A-Z	0.89	-----	-----	-----	-----
5 1/4" SSDD Soft Sector w/Hub Ring	6481-Z	0.84	M13A-Z	0.99	54974-Z	1.24	3481-Z	1.24
5 1/4" SSDD Same as above, but bulk product	6487-Z	0.64	M13AB-Z	0.89	-----	-----	-----	-----
5 1/4" SSDD 10 Hard Sector w/Hub Ring	-----	-----	M43A-Z	0.99	-----	-----	-----	-----
5 1/4" DSDD Soft Sector w/Hub Ring	6491-Z	0.94	M14A-Z	1.09	54980-Z	1.44	3491-Z	1.69
5 1/4" DSDD Same as above, but bulk product	6497-Z	0.74	M14AB-Z	0.99	-----	-----	-----	-----
5 1/4" DSDD 10 Hard Sector w/Hub Ring	-----	-----	M44A-Z	1.09	-----	-----	-----	-----
5 1/4" DSDD 16 Hard Sector w/Hub Ring	-----	-----	M54A-Z	1.09	-----	-----	-----	-----
5 1/4" DSDD Soft Sector 96 Tracks per inch	6501-Z	1.49	M16A-Z	2.49	-----	-----	3501-Z	2.49
5 1/4" DS High Density Soft Sector for IBM PC AT	-----	-----	M18A-Z	3.99	-----	-----	5500-Z	3.99
3 1/2" SSSD Soft Sector micro-floppy	-----	-----	C13A-Z	2.74	54112-Z	2.99	6100-Z	2.49

**For more information about this brand call:**

Lifetime warranty  
For more info on Super Disk call  
**800-USA-DISK**  
In Michigan 313-973-1111

Lifetime warranty  
For more info on Wabash call  
**800-323-9868**  
In Illinois 312-593-6363

Lifetime warranty  
For more info on BASF call  
**800-343-4600**  
In Massachusetts 617-271-4000

Lifetime warranty  
For more info on Memorex call  
**800-448-1422**  
Monday-Friday 9am-4pm ET

CIRCLE 263 ON FREE INFORMATION CARD







# SATELLITE TV



BOB COOPER JR.\*

## The scrambling snafu

IT ALL BEGAN INNOCENTLY ENOUGH—major premium programmer HBO elected to encrypt or “scramble” its transmissions to protect itself against the unauthorized use of those transmissions. To the unauthorized user, the video would be unwatchable (see Fig. 1). HBO had certain criteria in selecting a “scrambling system;” the system had to be “transparent” to the end user (ie. no visible degradation caused by the scrambling mechanism), it had to be cost effective, and it had to be unbeatable. Not many engineers felt you could have all three in one box, not in this decade at any rate.

But the Linkabit division of M/A-Com delivered and, to the surprise of most, the system did everything HBO requested, and more. There was no degradation; in fact, the Linkabit system actually could improve the signal quality under certain circumstances. (Linkabit claims that their system can increase the carrier-to-noise ratio by as much as 2 dB over traditional satellite transmission systems, primarily because the audio subcarriers are eliminated in favor of digital-audio signals transmitted within the video-information bandwidths. The designers claim that by eliminating the audio subcarriers, that portion of the transmission power normally used for audio is retained for use by the video carrier (scrambled). The system came out of the box at \$495 per cable-system descrambler and prices in the \$325 range (down to \$150) were forecast for a slightly simpler home version. And with

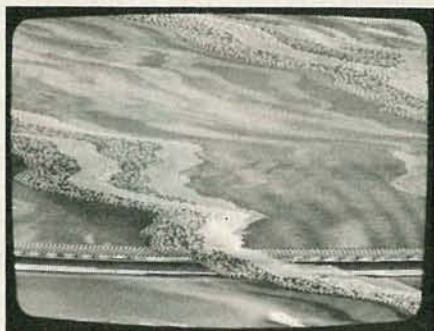

FIG. 1

“70,000,000,000” codes, well, no garage or basement tinkerer was apt to “break” the DES code system. Everything looked rosey, but then something nasty hit the fan.

### HBO and the home TVRO

The home-satellite terminal industry stood up, almost to the man, and revolted. Within just days of announcing and showing off the new HBO-paid-for and M/A-Com-created system, it was in serious trouble. And the entire scrambling situation was thrown into a cocked hat. Here's what happened.

HBO repeatedly said that when their scrambling system was in place, they would negotiate some type of deal with home TVRO owners. As the unveiling date came closer and closer, it became increasingly clear that the “some type of deal” would involve the local cable companies. HBO, it turned out, would only sell its home service through their local cable-television affiliates. That immediately placed fear into the hearts of local TVRO dealers who saw themselves in competition with the HBO affiliates; not only

for the potentially lucrative “service contracts,” but also for the actual sale of the home-terminal systems. Indeed, the cable trade press lately had been running numerous stories on how cable firms had successfully entered the TVRO distribution business. Those reports, telling of sales of 100-plus systems per month and back orders of hundreds of systems didn't make the cable retail operator threat any less palatable.

With the TVRO dealer segment already nervous about the announced way HBO planned to sell home users their service, the HBO-M/A-Com combine proceeded to “get into hot water” with the TVRO receiver manufacturers and importers. Nearly one year ago, M/A-Com had released some preliminary data that was designed to give TVRO receiver designers some assistance in planning future TVRO receivers. They said, in effect, that existing receiver designs must be modified to accommodate the special requirements of the Linkabit scrambling system. That year-old data told the industry that the special receiver requirements were related to the descrambling method or technique. The same preliminary data also suggested that those receiver modifications might add between \$2 and \$15 at the original equipment manufacturer level to home TVRO receivers.

Then the final design data came down. TVRO receiver designers had two choices—they could modify their existing receivers so that a stand-alone descrambler box could be added by the home

\* Publisher, CSD Magazine



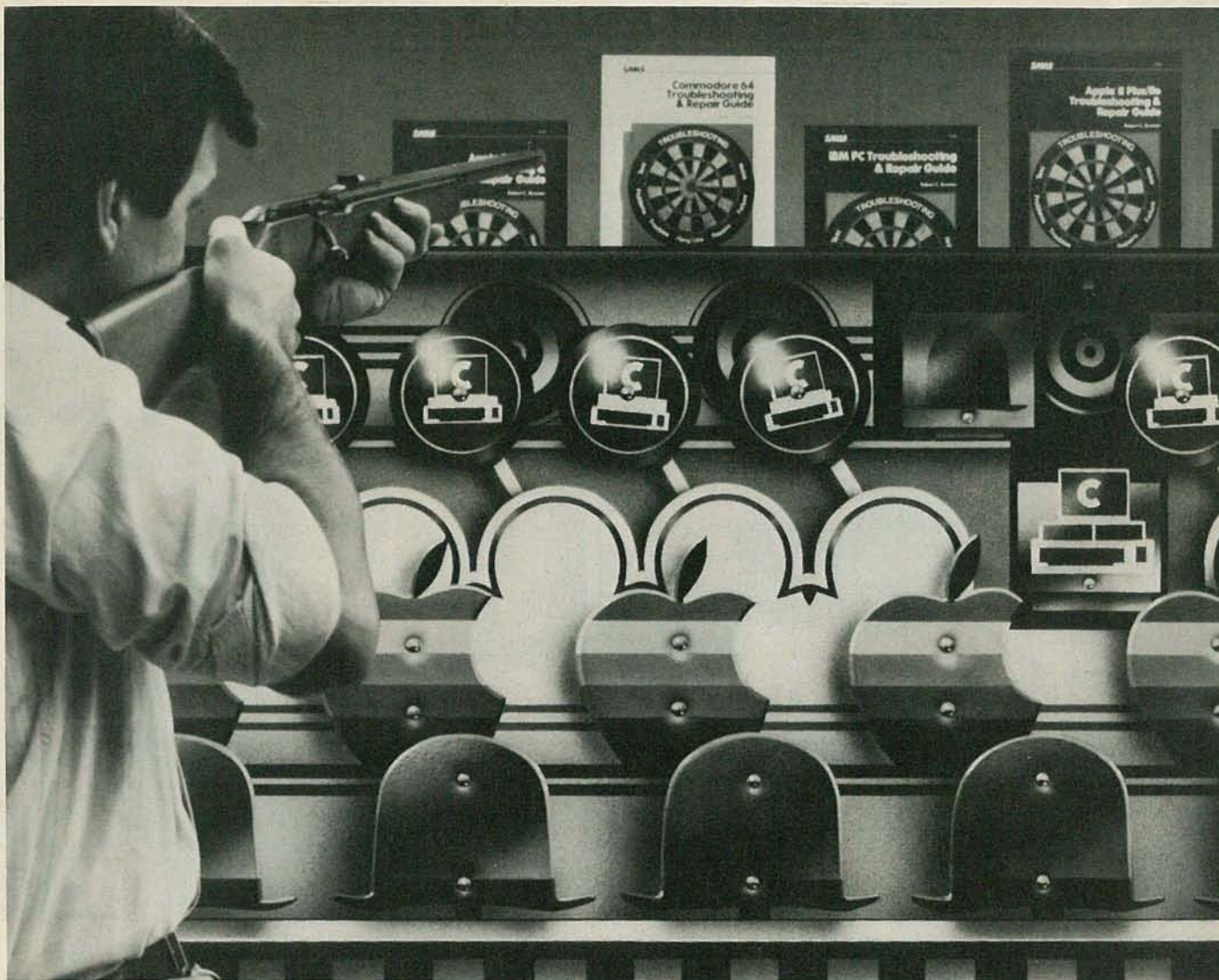

# No-trouble troubleshooting

Using computers is one thing. Repairing them is another. With a basic knowledge of electronics and Sams service data, repairing computers is no trouble at all.

For in-depth computer analysis and repair, choose Sams COMPUTERFACTS™. They're similar to Sams PHOTOFAC™ and provide detailed schematics and parts data for even your most intricate computer repairs.

For simple computer maintenance and troubleshooting, use Sams Troubleshooting & Repair Guides. They provide a "problem-solution" approach to servicing with flowcharts explaining each procedure step-by-step.

Together they make computer servicing quick and easy. And both cover today's most popular computers including Apple®, IBM®, and Commodore™.

Service computers the easy way with Sams

service data. Visit your local Sams dealer. Or call our toll-free number and ask for Operator 145.

Commodore 64 Troubleshooting & Repair Guide, No. 22363, \$18.95

IBM PC Troubleshooting & Repair Guide, No. 22358, \$18.95

Apple II Plus/IIe Troubleshooting & Repair Guide, No. 22353, \$19.95

Over 30 COMPUTERFACTS available for Apple, ATARI®, Commodore, Epson®, Hitachi®, IBM, Osborne®, Panasonic®, Rana Elite, Sanyo®, Texas Instruments and Zenith®. Ask your Sams dealer for details.



**800-428-SAMS**

In Indiana, call 317-298-5566

**SAMS**

Howard W. Sams & Co., Inc.  
4300 West 62nd Street  
Indianapolis, IN 46268

CIRCLE 256 ON FREE INFORMATION CARD



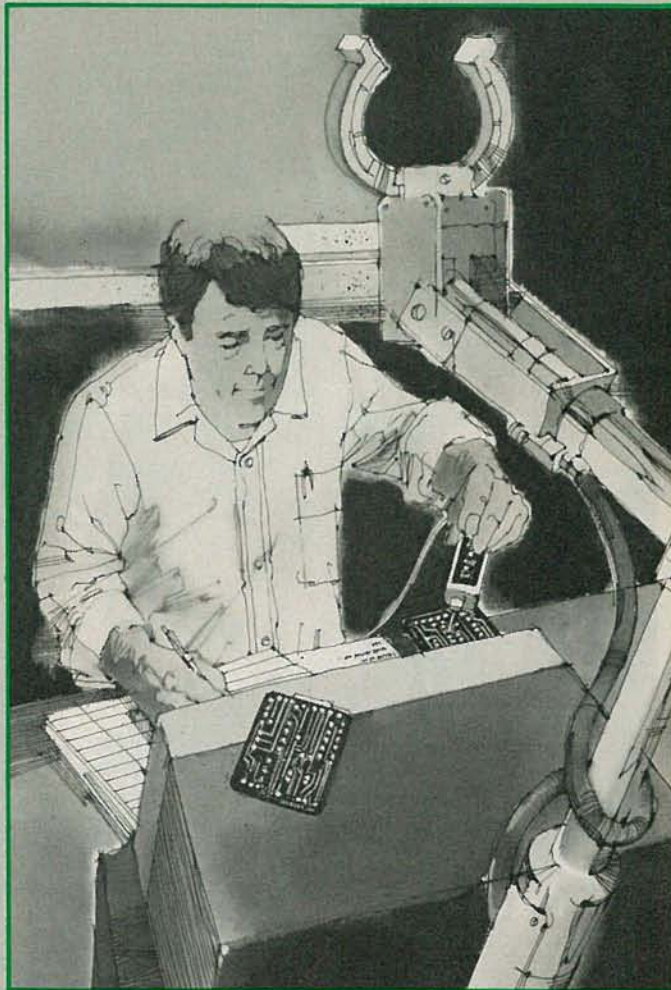
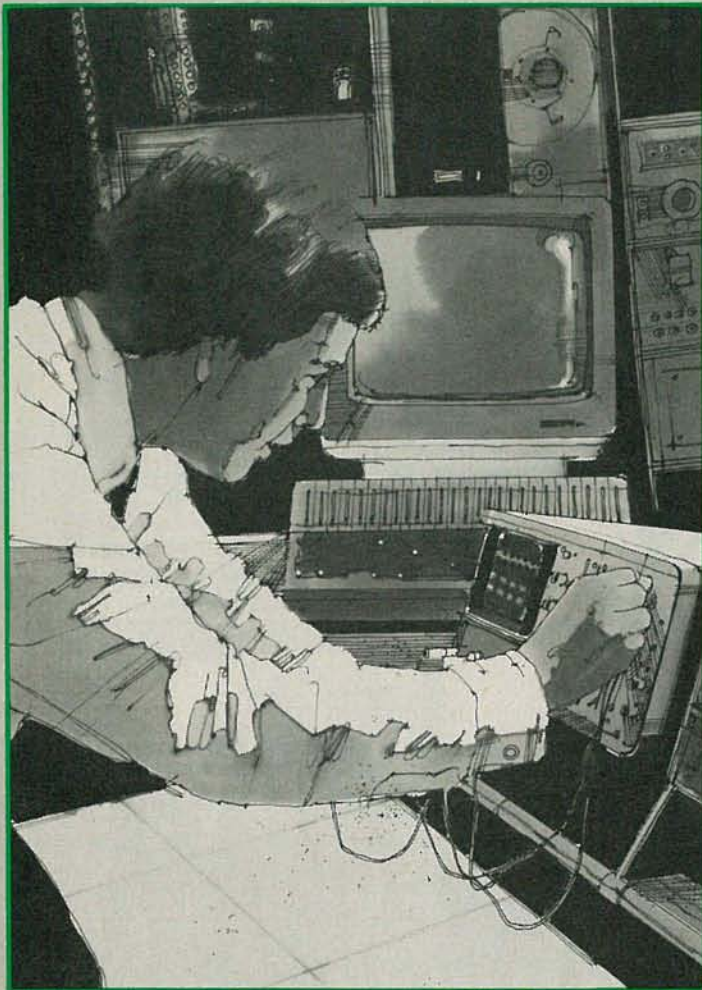

# What can you do Just about

## CIE can show you how.

Computer technology. Satellite communications. Cable television. Cellular radio. Digital electronics. Robotics. Just a few of the hottest career areas in electronics. The ones everybody is talking about. The ones that are changing the way we live, the way we do business, the way we entertain ourselves. The best way to start a career in any of them? By learning the basic electronics theory and principles of how they work from CIE.

## Join a leader.

Leading the world in specialized electronics training, CIE is the largest school of its kind with over 25,000 students at home and abroad. And with over 50 years of experience teaching electronics to thousands of men and women through proven

methods of independent study **without** classroom sessions.

## Learn as much as you want, when you want.

Whether you're interested in learning new skills or upgrading old ones, earning a diploma or an A.A.S. degree, CIE can match your needs with courses and programs that let you start where you want, go as far as you want from a basic beginner course all the way to CIE's Associate in Applied Science Degree in Electronics – a comprehensive program that prepares you for advanced electronics careers.

## Custom training equipment helps you learn.

CIE believes in the importance of learning by



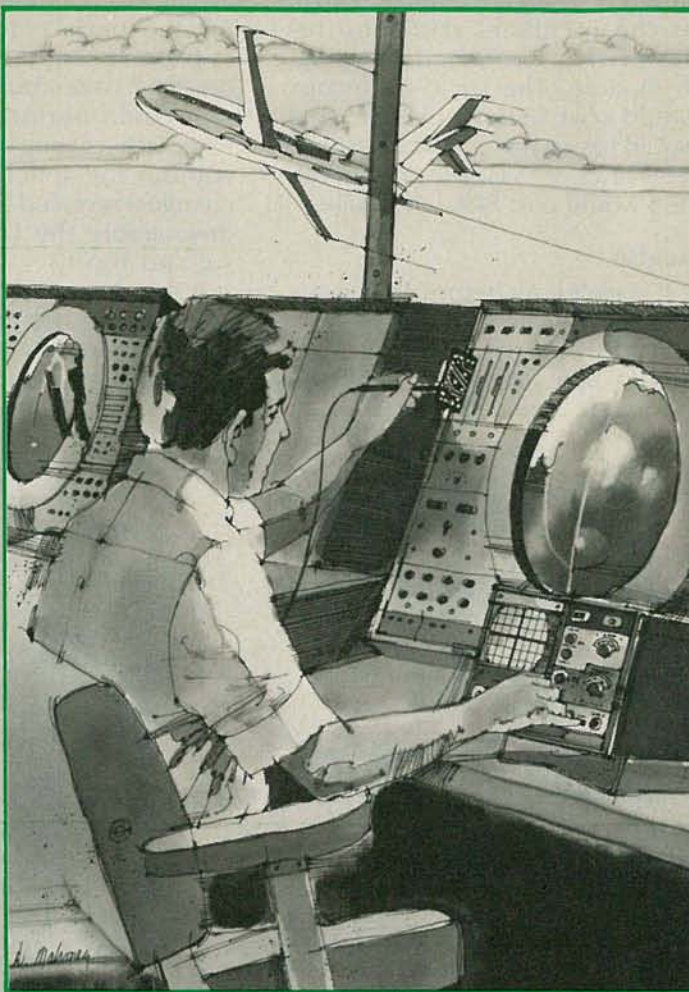
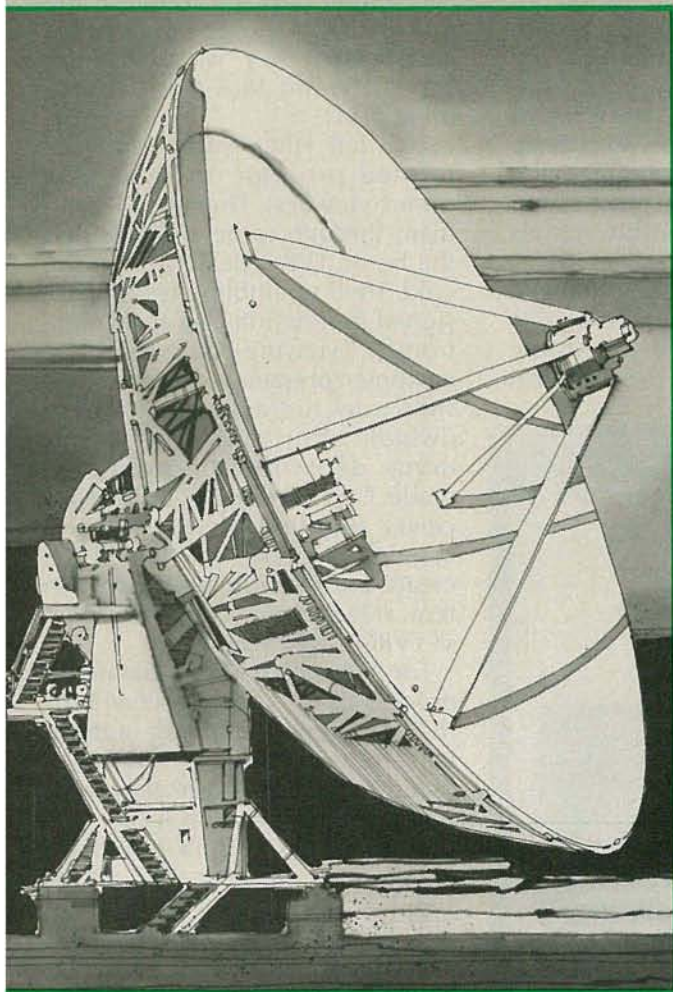

# with electronics? anything.

doing. So most of our courses include specialized training laboratories keyed to specific lessons for practical experience through teaching experiments. Our CIE Microprocessor, for example, comes fully assembled and ready to use to teach you how a computer CPU works through a series of experiments you perform on your own.

## Are you ready?

If you're ready to do something now about your future, there's no waiting to enroll with CIE. Get all the information you need to enroll simply by calling us toll-free at **1-800-321-2155** (in Ohio, 1-800-362-2105). Or mail in the handy reply coupon or card to Cleveland Institute of Electronics, 1776 East 17th Street, Cleveland, Ohio 44114.

### **CIE** World Headquarters

Cleveland Institute of Electronics, Inc.  
1776 East 17th Street • Cleveland, Ohio 44114

Please send me your CIE Off-Campus Studies Catalog, including details about the Associate Degree program. I understand there is no cost for the catalog and a CIE representative may call, but there is no obligation.

Print Name \_\_\_\_\_

Address \_\_\_\_\_ Apt. No. \_\_\_\_\_

City \_\_\_\_\_ State \_\_\_\_\_ Zip \_\_\_\_\_

Age \_\_\_\_\_ Area Code/Phone No. \_\_\_\_\_ / \_\_\_\_\_

Check box for G.I. Bill bulletin on Educational Benefits

Veteran  Active Duty

**MAIL TODAY!**

206 085



viewer or a service representative, or the receivers could be redesigned to accommodate a plug-in module. The stand-alone box would cost \$325 wholesale, and would have a nationally advertised retail price of \$395. The plug-in version would cost \$150 wholesale.

### Trouble

It wasn't long before somebody noticed that the special engineering requirements for TVRO receivers had little to do with the

actual descrambling; it turned out that the special requirements were in place so that the electronic addressing codes built into the system could perform. A series of tests with existing receivers (those without the special engineering changes) revealed that most would descramble the Linkabit signals with no effort.

It was becoming clear that the new receiver designs were merely to accommodate the electronic bookkeeping functions of the

scrambling package. And so, the receiver OEM's joined the dealers and together they "walked out" on the HBO and M/A-Com scrambling plans.

That left HBO with a very disjointed program to reach the home viewers. Their marketing plan, through cable affiliates, left the home TVRO dealer out in the cold. Their scrambling system, designed to function also as an electronic TV-viewing-bank where the customer prepaid for service and then saw his account balance dwindle after viewing programming, depended upon better-grade TVRO receivers. But the receiver suppliers were not interested in helping the two firms create an electronic-banking-system, at least not if it raised the cost of TVRO's appreciably.

For it also turned out that in the process of outfitting receivers for the newly proposed plug-in modules, for example, that very major receiver changes were required. The module required more current to operate than could be drawn from most receiver power supplies. But bigger power supplies generate more heat and more heat has to be dissipated somehow, or the electronics in the package will fry. Finally, the module was bulky; in fact, at  $11.5 \times 9 \times 1.77$  inches, it is larger than many of the complete TVRO receivers now available.

Finally, because the Linkabit scrambling system is based upon a very special security code (DES Algorithms), which is classified by the US government, the technology involved cannot leave the US. A TVRO receiver supplier, in Korea or Japan, for example, would have no way to test the receivers at their plant because the testing equipment is prevented from leaving the US because of its classified status.

And those are but the initial problems presented by the Linkabit system. Manufacturers quickly discovered that they would not be able to solve all of the problems presented by the system and stay in business. Since they naturally want to stay in business, they did the only thing they could do—reject the concept.

With HBO dependent upon the

## Our Twelve Inexpensive Ways To Look Inside Your ICs.

Testing and troubleshooting digital circuitry no longer requires expensive equipment and complex, time-consuming processes. Global Specialties offers a family of twelve inexpensive and easy-to-use logic-test products ranging from hand-held digital logic probes and pulsers to multi-point logic monitors.

These IC troubleshooting tools provide fast,

### Global Logic test family . . .

- LM-1 Clip Type 16 Ch. LM
- LM-2A Pocket Size 16 Ch. LM
- LM-4 Pocket Size 40 Ch. LM
- LP-1 Low Cost Dual State Probe
- LP-2 Dual State Probe
- LP-3 High Speed Probe
- LP-4 High Speed ECL Probe
- DP-1 Probe Type Digital Pulser
- LPK-1 Dual State Probe (Kit)
- DPK-1 Probe Type Digital Pulser (Kit)
- LTC-1 Logic Analyze Test Kit
- LTC-2 High Speed Logic Analyze Test kit

accurate testing of all logic families in laboratories, production, quality control and field service applications. We've advanced the design and use of logic probes and other digital test products.

Your local distributor can help you select the model which precisely fits your needs.

Call our Customer Service Dept., 800/572-1028 for the name of your local distributor.



### GLOBAL SPECIALTIES

An Interplex Electronics Company

70 Fulton Terrace  
New Haven, CT 06512-1819  
(203) 624-3103 TWX: 710-465-1227

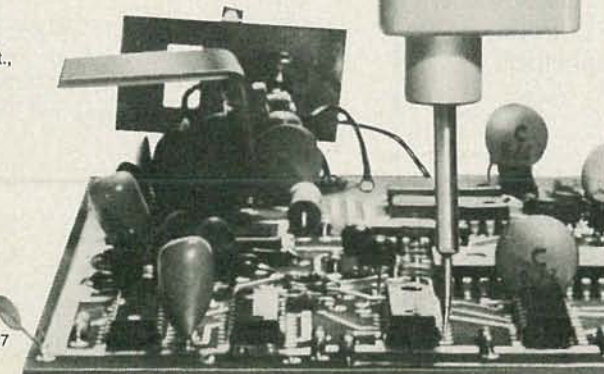

CIRCLE 62 ON FREE INFORMATION CARD



# New from B&K-PRECISION, for telephone service, test and repair

**COMPLETE TELEPHONE PRODUCT ANALYZER.** A total self-contained system for diagnostic testing, servicing and calibration of corded and cordless telephones, answering machines and automatic dialers. Performs every test you'll ever need to test and repair any phone product including verification of pulse and touch-tone numbers, measurement of frequency error and modulation deviation. **MODEL 1050 \$1695**



**MODEL 1050 \$1695**

**CORDLESS TELEPHONE TESTER.** Provides full servicing and calibration capability for base and portable phone units. All rf test and measurement functions. Replaces expensive FM generators and modulation monitors, yet performs all tests required for cordless phone system analysis and repair, including full frequency testing and alignment. Generates all prior and recently approved frequencies. **MODEL 1047 \$895**



**MODEL 1047 \$895**



**MODEL 1045 \$395**

**TELEPHONE PRODUCT TESTER.** For in-store consumer or service use. Tests handset cord, phone line cord, dial/redial functions, voice and dial number levels, ring function and voice quality of corded and cordless phones, answering machines and automatic dialers. **MODEL 1045 \$395**



**MODEL 1042 \$19.95**

**TELEPHONE LINE ANALYZER.** Quickly identifies a problem as external or in the phone itself. Tests for condition of external phone line, phone line cord, ring and line voltage levels and polarity. Easy to use, no batteries or external power needed. **MODEL 1042 \$19.95**

*These test instruments cover every possible level of service required for telephone products. They are equally useful for training. The instruction manuals provided offer a comprehensive course of training for service personnel and students. Call your nearest B&K-PRECISION distributor for off-the-shelf-delivery or additional information—or contact B&K-PRECISION.*

**B&K PRECISION DYNASCAN CORPORATION**

6460 West Cortland Street • Chicago, Illinois 60635 • 312 889-9087

International Sales, 6460 W. Cortland St. Chicago, IL 60635

Canadian Sales, Atlas Electronics, Ontario

South and Central American Sales, Empire Exporters, Plainview, NY 11803

CIRCLE 77 ON FREE INFORMATION CARD

AUGUST 1985

23



# RAG

## ELECTRONICS, INC.

New and Used Electronic Test Equipment  
Sales • Service • Rental • Leasing

### ■ Polaroid DS-34

Now you can get an instant picture in black & white or color from any oscilloscope screen. Includes CRT hood.  
\*Large hoods also available to fit computer terminals and CAD/CAM screens.

**\$369.00**



### LEADER Instruments Corporation

#### Audio Sine/Square Wave Generator

- Distortion from <0.03%
- 10 Hz to 1 MHz

**\$259.00**



**LAG-120B**



**BK PRECISION**

#### FUNCTION GENERATOR

**\$189.00**

#### MODEL 3010

- Sine, square and triangle output
- Variable and fixed TTL outputs
- 0.1 Hz to 1 MHz in six ranges
- Typical distortion under 0.5% from 1 Hz to 100 KHz
- Variable DC offset
- VCO input for sweep tests

## POWER SUPPLIES

### GLOBAL SPECIALTIES TRIPLE OUTPUT POWER SUPPLY



#### MODEL 1301

**\$198.00**

- Fully regulated triple output
- Fixed 5VDC, 1A
- V1 + 5 VDC to 18 VDC .5A
- V2 - 5 VDC to 18 VDC .5A
- Fully automatic current limiting

**BK PRECISION**

### TRIPLE OUTPUT POWER SUPPLY



#### MODEL 1650

**\$319.00**

- Functions as three separate supplies
- Exclusive tracking circuit
- Fixed output 5 VDC, 5A
- Two 0 to 25 VDC outputs at 0.5A
- Fully automatic, current-limited overload protection
- + and - terminals of each output are fully isolated, in all modes
- All three outputs may be connected in series or parallel for higher voltage or current



**ELECTRO INDUSTRIES, INC.**  
Precision Test Instruments

### DC POWER SUPPLY



**\$125.00**

**MODEL 3002A/0-30 VDC/0-2A**

### VIZ

#### MULTI-FUNCTION COUNTER



#### MODEL WD-755

**\$259.00**

- 5 Hz to 125 MHz
- 8 Digit LED Display
- Period Measurement 5 Hz to 2 MHz
- Totalizes to 99,999,999 Plus Overflow
- Frequency Ratio Mode
- Time Interval Mode
- Switchable Attenuator & Low Pass Filter



## Oscilloscope Probes

MODEL	ATTENUATION	BAND WIDTH (MHZ)	PRICE
2904	10X	100	\$35.00
2901	10X/1X	100/5	\$39.00
2205	10X	250	\$59.00
2960	10X	60	\$30.00



### VARIABLE TRANSFORMER

**\$145.00**



**MODEL 3PN1010V**

RAG CARRIES THE COMPLETE STACO VARIABLE TRANSFORMER LINE  
CALL US WITH YOUR REQUIREMENTS.

### DIGITAL CAPACITANCE METER

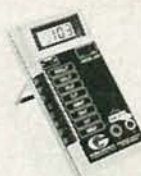

- Battery operated
- 3 1/2 digit LCD display
- Range 1 PF to 2,000 UF
- 0.2% basic accuracy

**GLOBAL MODEL 3000**  
**\$139.00**

CALL US TOLL FREE  
**1-800-732-3457**  
IN CALIFORNIA TOLL FREE  
**1-800-272-4225**

- Master Charge
- VISA ■ COD
- Money Order
- Check



ADD FOR SHIPPING AND INSURANCE

\$0 to \$250.00	\$4.50
\$251.00 to \$600.00	\$6.50
\$501.00 to \$750.00	\$8.50
\$751.00 to \$1000	\$12.50
over \$1000.00	\$15.00

COD's extra (required 25% deposit)

RAG ELECTRONICS, INC. / 21418 Parthenia Street / Canoga Park, CA 91304 / 1-818-998-6500



# SCOPE SPECTACULAR



## PORTABLE OSCILLOSCOPES



Model V-212 shown



Model V-1050F shown

**MODEL V-212**

DC to 20 MHz, 1 mV/div, Dual Trace  
Features 6" Rectangular CRT  
Full 2 year parts and labor warranty (w/two X10 probes).

**\$461.00**

**MODEL V-222**

DC to 20 MHz, 1 mV/div, Dual Trace, D.C. offset for DMM Output, Vertical Mode Trigger  
6" CRT (w/two X1/X10 probes).

**\$536.00**

**MODEL V-422**

DC to 40 MHz,  
other features same as V-222 (w/two X1/X10 probes)

**\$694.00**

**MODEL V-1050F**

DC to 100 MHz, .5 mV/div, Quad Trace, Delayed Sweep, Full T.V. Triggering, alternate time base (w/two X10 probes)

**\$1276.00**

**MODEL V-650**

DC to 60 MHz, 1 mV/div, tripple trace, delayed sweep, Full T.V. Triggering, variable trigger hold-off (w/two X10 probes)

**\$956.00**



## PORTABLE OSCILLOSCOPES

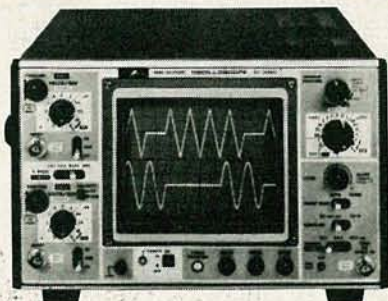

**MODEL SS-5702**

DC - 20MHz, 5 mV/div  
Dual trace  
6 inch rectangular internal graticule CRT.  
Includes 2 each X1/X10 probes and full factory warranty; 2 years on parts, labor and CRT.

**\$535.00**

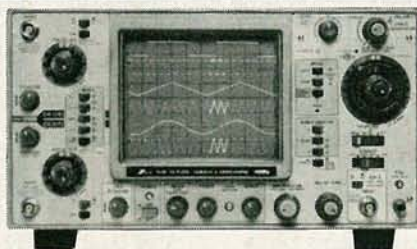

**MODEL SS-5705**

DC to 40MHz  
Vertical and horizontal deflection accurate within  $\pm 2\%$ . CRT acceleration voltage 12KV. 3 channels, 6 traces. High precision calibrator ( $\pm 1\%$ ). Fastest sweep rate: 10 ns.

**\$899.00**

- High sensitivity 1 mV/div
- CH1 signal output
- Beam finder
- Delayed sweep
- Alternate time base
- 2 ea. X1/X10 Probes



**MODEL 5711**

DC to 100MHz (typically over 120 MHz), 5 mV/div, True 4 channel input, eight trace, Delayed sweep, alternate time base, CRT acceleration voltage 20 KV, (w/saddle bag, front cover, 2 ea. X10 probes).

**\$1695.00**

**MODEL 5711D**

(5711 with counter and DMM).

**\$2495.00**

CIRCLE 126 ON FREE INFORMATION CARD



Linkabit scrambling system for its cable affiliates (more than 10,000 cable-system-version Linkabit units are now in the field and tested), HBO was caught between a rock and a hard place. The home TVRO industry was not taking their bait, and yet HBO was so far committed to the Linkabit system that it could not pull back.

Thus, the result was that HBO would scramble, but it was beginning to appear that home TVRO users would not be able to avail

themselves of the HBO signals. A task force put together by HBO to create a home-TVRO business back in the fall of 1983, officially disbanded this past spring. HBO might not be ready to throw in the towel with home viewers, but it was not going to continue funding the development of a program for home TVRO's either.

#### Showtime steps in

Into this mess stepped HBO-competitor Showtime. Showtime

#### TVRO dealer "Starter Kit" available

Bob Cooper's *CSD Magazine* has arranged with a number of TVRO equipment suppliers to provide a single-package of material that will help introduce you to the world of TVRO dealership. A short booklet written by Bob Cooper describes the start-up pitfalls to be avoided by any would-be TVRO dealer, in addition, product data and pricing sheets from prominent suppliers in the field are included. That package of material is free of charge and is supplied to firms or individuals in the electronics service business as an introduction to the 1984/85 world of selling TVRO systems retail.

You may obtain your *TVRO Dealer Starter Kit* free of charge by writing on company letterhead, or by enclosing a business card with your request. Address your inquiries to: *TVRO STARTER KIT*, P.O. Box 100858, Fort Lauderdale, FL 33310. That kit *not* available to individuals not involved in some form of electronics sales and service.

## SATELLITE TV/

# The First Five Years!



**THE MOST COMPLETE** report on the mushrooming home 'TVRO' industry ever compiled, written as only the 'father of TVRO' could have prepared. More than **1000 pages** (!) tracing the complete story of home TVRO, lavishly illustrated with equipment photos, schematic diagrams, equipment analysis reports. **Bob Cooper**, the first private individual to own and operate a TVRO (1976) has collected and polished hundreds of individual reports into a unique 'collector's edition' which clearly explains the TVRO phenomenon in North America. From Coop's first 20 foot 'monster' dish to the present day 5 foot 'C-band' TVROs, the fascinating growth of TVRO equipment and its legal status unfolds for you.

**THIS TWO VOLUME SET** totaling more than 1,000 pages is available for the first time to readers of **Radio-Electronics** at special discount pricing. **Originally sold** at \$100 per two-volume set, a limited supply is now available **ONLY** through this advertisement. **PLUS**, you will also receive a special extraordinary bonus; the 200 page (+) **October 1984** edition of **CSD/Coop's Satellite Digest**. This very special edition of CSD is a best-seller in the TVRO industry, with the most comprehensive collection of TVRO facts and figures ever compiled. Combined with the 1,000 page 'CSD ANTHOLOGY' report, you have instant reference to **everything** you will ever need to know about the state of the home TVRO industry. It is **MUST** reading for every person in, or thinking about 'getting into,' **any** segment of the home TVRO world.



- \_\_\_ SEND CSD ANTHOLOGY/2 Vols. + CSD Bonus.
- \_\_\_ SEND CSD October '84 Special Issue **ONLY**.

NAME \_\_\_\_\_ COMPANY \_\_\_\_\_

ADDRESS \_\_\_\_\_

CITY \_\_\_\_\_ STATE \_\_\_\_\_ ZIP \_\_\_\_\_

Payment: \$60 US funds (Anthology + Bonus), \$15 US funds CSD Oct. **ONLY**; payable "CSD ANTHOLOGY."  
Shipping charges prepaid. Enter order to: **CSD Anthology**, Radio-Electronics Magazine, 200 Park Av. S., New York, NY 10003; or call 305-771-0505 for credit card orders **ONLY**.

has never innovated new services (a matter of corporate philosophy), but the failure at HBO to pull together all of the diverse elements of the home-TVRO business seemed like an ideal marketing opportunity to the management at Showtime.

As a result, they have recently put together a task force of their own to attempt to solve the problems. Unfortunately, Showtime had previously committed itself to also use the same Linkabit scrambling system as HBO. How would Showtime resolve the series of problems that caused HBO to pull back? Tune in next month. **R-E**

#### TO MAGAZINE RETAILERS:

**Radio-Electronics Magazine** is pleased to announce its "Retail Display Allowance Plan" available to retailers interested in earning a display allowance on **Radio-Electronics Magazine**. To obtain details and a copy of the formal contract, please write to the Marketing Department, Kable News Company, Inc., 777 Third Avenue, New York, New York 10017, our national distributor, who will act as administrator of our plan. Under our Retail Display Allowance Plan, in consideration for fulfilling conditions of the agreement, you will be entitled to receive a display allowance. This plan will become effective for all issues you receive subsequent to written acceptance on our behalf of your application.



DATA PRECISION

HITACHI  
TRIPLETT

FLUKE

AWS

DORIC

HICKOK

VIZ R&B

# BK PRECISION DYNASCAN CORPORATION BREAKS THE PRICE BARRIER WITH THESE HIGH PERFORMANCE OSCILLOSCOPES

## 100 MHz Dual Trace/ Dual Time Base

- 1 mV/div sensitivity
- 23 calibrated sweeps
- Rectangular CRT with internal graticule and scale illumination
- Signal Delay Line

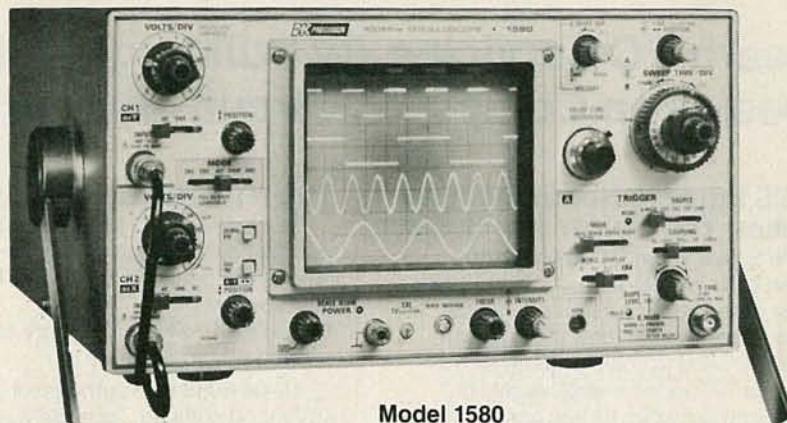

Model 1580

# \$995

Does not include probes  
(\$60.00 a pair when purchased with scope)

**QUANTITIES ARE LIMITED**

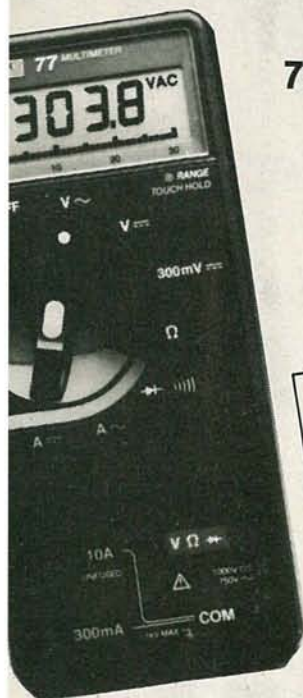

- 77
- 0.3% Accuracy
  - Manual or Autorange
  - 10A + mA Range
  - Beeper
  - "Touch-Hold" Function

Sale (with holster)  
**\$119.95**

**WE CARRY A FULL  
LINE OF FLUKE  
MULTI-METERS.  
IN STOCK NOW**

Sale ends August 85

# FLUKE 70 SERIES MULTIMETERS

- Analog Display • Rotary Knob • Volts AC & DC
- Resistance to 32 MΩ • 10 Amps • Diode Test
- 3200 Counts • Fast Autoranging • Function Annunciators in Display
- Power-Up Self Test • 2000+ Hour Battery Life w/ Power Down "Sleep Mode"
- New Test Leads • VDE & UL Approval



Sale  
**\$89.95**

75

- 0.5% Accuracy
- Manual or Autorange
- 10A + 300 mA



Sale  
**\$79.95**

73

and free C70  
holster

- 0.7% Accuracy
- Autorange Only
- 10 Amp Only



TOLL FREE HOT LINE  
**800-223-0474**

212-730-7030

26 WEST 46th STREET, NEW YORK, N.Y. 10036

THE TEST EQUIPMENT SPECIALISTS

# ADVANCE ELECTRONICS



# IF YOU WANT TO GET YOU HAVE TO GET INTO

## Learn PC Servicing By Building Your Own NTS/HEATH HS-151 Desk-Top Computer, Circuit-By-Circuit

### NTS Intrinsic Home Training Takes You Below The Surface

NTS gets you right down into the heart of computer circuitry. You learn how microprocessors function, how they are designed, how they operate and are used to solve problems. Your program includes a wide variety of tests and projects, as you assemble your PC. You experience the excitement of seeing your own skills grow, the security of knowing you really understand what makes a computer tick.

### A Career in PC Servicing

The world of computers is constantly expanding. Applications have spread from business to manufacturing, from industry to medical and scientific fields. Computer-aided design, engineering, and production have revolutionized drafting, graphics, and prototyping. Computer sales figures point to a continuing need for service technicians as well as installation and maintenance specialists. The type of training you receive will largely determine your ability to take advantage of these opportunities .... and nothing beats the practical, down-to-earth training you get from NTS.

### The NTS/HEATH 16-Bit HS-151

This desk-top PC is the most powerful and versatile ever offered in any home training program. Check the advanced features listed below:

1. 128 KB RAM user memory on board, expandable to 640 KB
2. 16-bit 8088 Microprocessor accepts advanced software, speeds word processing; also allows selection from the huge library of IBM software.
3. 5.25-inch floppy disk drive, double density, IBM formatted, stores up to 360 KB. (Expandable to dual disk drive, and optional 10.5 MB hard-disk drive.)
4. MS-DOS operating system, IBM compatibility, make a wide choice of software programs available.
5. Four open IBM-compatible slots provide for future expansion, printer, modem, etc. Will accept most peripheral boards designed for IBM-PC.
6. Two video outputs for color or monochrome display monitor. Your NTS course includes a high resolution monitor displaying 80 characters by 25 lines, or graphics.
7. Editing capabilities help you insert or delete characters and lines, erase, jump or smooth scroll, etc.

Your NTS training course will teach you to program on this outstanding PC, using lessons, texts, and diagrams to make full use of its capabilities. Catalog contains complete details.

**IBM  
Compatible**



*Learning circuitry through the construction of this equipment offers practical training for which there is no substitute. Test equipment is included.*

*Field servicing is interesting and rewarding. Technicians may work for a service company, manufacturer, or major users.*

*The NTS/HEATH HS-151 PC completed, includes monitor and full-function keyboard with calculator style keypad, and typewriter format.*





# NTS TO PC SERVICING A MICROCOMPUTER

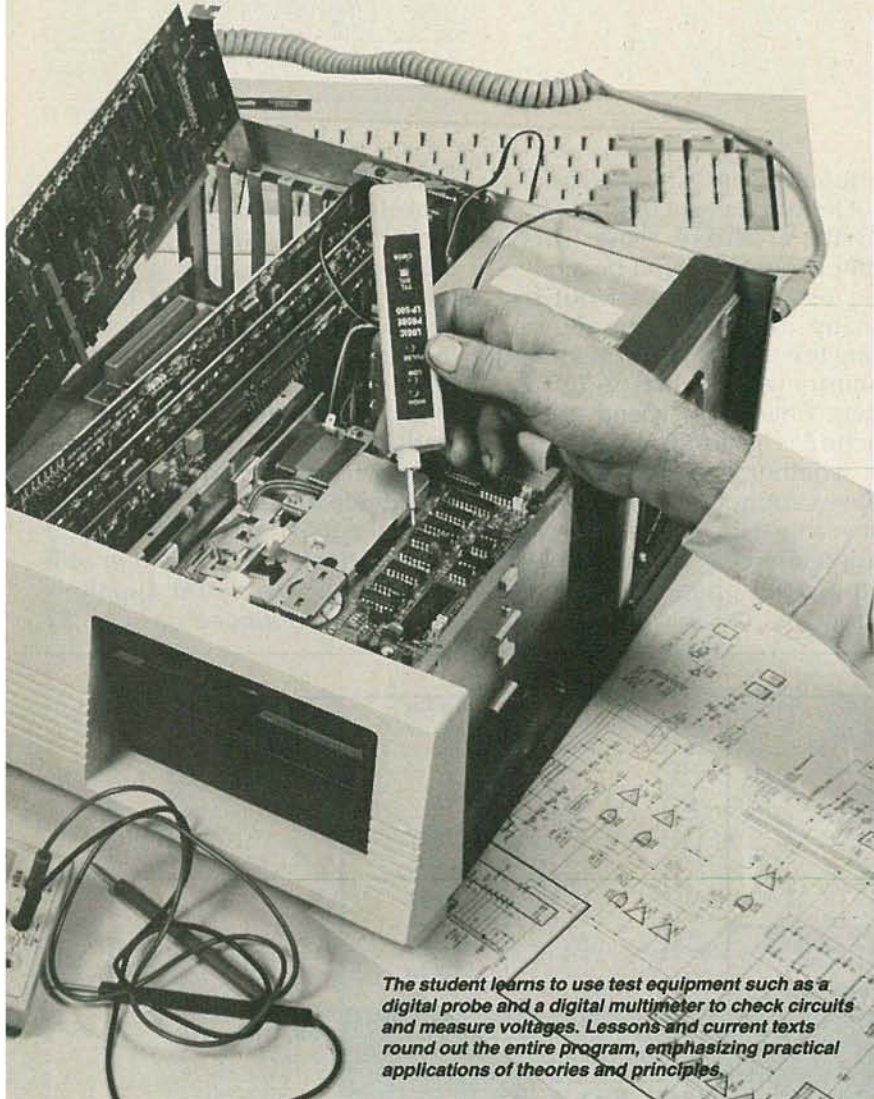

*The student learns to use test equipment such as a digital probe and a digital multimeter to check circuits and measure voltages. Lessons and current texts round out the entire program, emphasizing practical applications of theories and principles.*

*Installing the disk-drive in the PC is one of the final stages in the assembly of the microcomputer. Learning the use of test equipment to check circuits is an integral part of the training which, with field experience, develops invaluable career skills.*

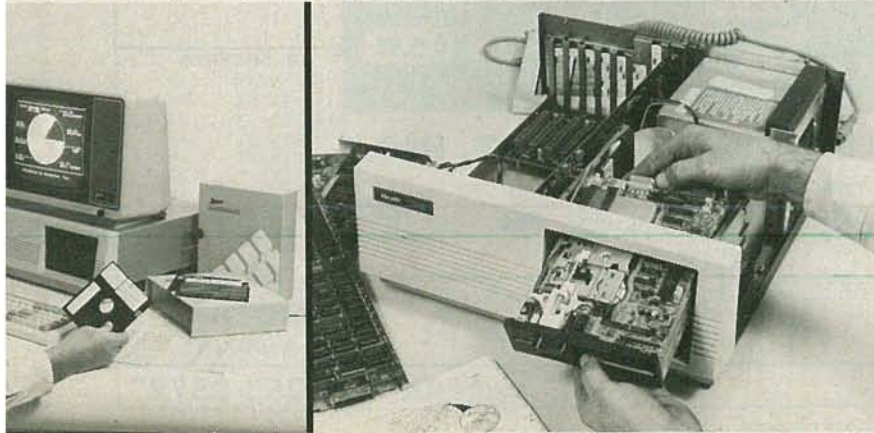

## NTS COURSES COVER MANY AREAS OF SPECIALIZATION IN ELECTRONICS:

**Robotics:** Build the NTS/HEATH Hero 1 Robot as you learn robotic programming. Robot is complete with arm and gripper, voice synthesizer. Robotics is becoming increasingly important in industry as almost daily news features attest.

**Video Technology:** Build one of the most advanced Color TV sets in America as you learn circuit diagnostics, and the use of digital test instruments. Course covers color TV, video tape recorders, computer fundamentals, solid-state devices.

**Industrial and Microprocessor Technology** covers circuit analysis, microprocessors and automation applications, lasers, and basic industrial robotics.

**TV & Radio Servicing** is a specialized course offering an excellent foundation in the use and application of both analog and digital test equipment as applied to the TV servicing field. Learn circuits, adjustments, trouble-shooting, and servicing of Color and monochrome monitors.

**Digital Electronics** offers the student the opportunity to get involved with computer concepts, computer technology fundamentals, and digital equipment by training on the NTS Compu-Trainer.

**Basic Electronics** is a course designed for those wishing to have an over-view of electronics in many of its aspects including radio receivers, solid state devices, and electronic components.

NTS Intronic training programs include a variety of superb equipment, most of which is classified as field-type, making the training practical and career oriented. Texts and lessons have been tested in our Resident School in Los Angeles to assure home study students their courses of training are easy to understand. NTS, now in its 80th. year, continues to be at the leading edge in Electronics home training.

\* IBM is a trademark of International Business Machines Corp.  
\* MS is a trademark of Microsoft Corp.  
If card is missing, simply write to the address shown below stating the course you are interested in. A FREE color catalog with all details will be sent to you by return mail.



TECHNICAL TRADE TRAINING SINCE 1905  
Resident and Home-Study Schools  
4000 So. Figueroa St., Los Angeles, CA 90037

AUGUST 1985







# FREE FIVE YEAR WARRANTY PLUS THE LOWEST HITACHI PRICES

## EQUALS **Joseph** electronics VALUE

<p style="text-align: center;"><b>20 MHZ</b></p> <p><b>HITACHI V222</b></p> <ul style="list-style-type: none"> <li>• Dual Trace</li> <li>• 1MV/Div. Sens Rectangular 6" CRT with Internal Graticule</li> <li>• Auto Focus</li> <li>• Vert Mode Triggering</li> <li>• DC Offset</li> <li>• Much More</li> <li>• Includes Probes and 5 Year Warranty</li> </ul>  <p style="text-align: center;"><b>Joseph</b> electronics</p> <p style="text-align: center;"><b>\$521<sup>00</sup></b></p> <p>(REG. \$715.00)</p>	<p style="text-align: center;"><b>40 MHZ</b></p> <p><b>HITACHI V422</b></p> <ul style="list-style-type: none"> <li>• This thin, light and compactly designed scope offers the same outstanding features as the V222 except greater bandwidth</li> <li>• Includes Probes and 5 Year Warranty</li> </ul>  <p style="text-align: center;"><b>Joseph</b> electronics</p> <p style="text-align: center;"><b>\$671<sup>00</sup></b></p> <p>(REG. \$925.00)</p>
<p style="text-align: center;"><b>60 MHZ</b></p> <p><b>HITACHI V650F</b></p> <ul style="list-style-type: none"> <li>• Dual Trace</li> <li>• Delay Sweep</li> <li>• 1MV Sens.</li> <li>• Rectangular 6" CRT with Internal Graticule</li> <li>• 10KV Acc.</li> <li>• Triple Trace</li> <li>• Channel 1 Output</li> <li>• Much more</li> <li>• Includes Probes and 5 Year Warranty</li> </ul>  <p style="text-align: center;"><b>Joseph</b> electronics</p> <p style="text-align: center;"><b>\$931<sup>00</sup></b></p> <p>(REG. \$1195.00)</p>	<p style="text-align: center;"><b>100 MHZ</b></p> <p><b>HITACHI V1050F</b></p> <ul style="list-style-type: none"> <li>• Quad Trace</li> <li>• Delayed Sweep</li> <li>• 500uv Sens.</li> <li>• Rectangular 6" CRT with Internal Graticule</li> <li>• 20KV Acc.</li> <li>• Auto Focus</li> <li>• 10X Mag.</li> <li>• And much more</li> <li>• Includes Probes and 5 Year Warranty</li> </ul>  <p style="text-align: center;"><b>Joseph</b> electronics</p> <p style="text-align: center;"><b>\$1241<sup>00</sup></b></p> <p>(REG. \$1595.00)</p>

FOR SIMILAR SAVINGS ON THE COMPLETE HITACHI LINE  
AND MORE THAN 100 OTHER MAJOR SUPPLIERS CALL

**800-323-5925** In Illinois **312-297-4200**

ORDER HANDLING CHARGES	
VALUE	ADD
\$0-999	\$10.00
\$1000-2499	\$15.00
\$2500-UP	\$20.00



**Joseph**  
electronics

8830 N. Milwaukee, Niles, Illinois 60648

AUGUST 1985



make your mailbox your own branch of Dick Smith Electronics

**ORDER TOLL FREE 1-800-332 5373 TOLL FREE**

**G'DAY**  
Now we're open in Redwood City we'd like to share some of our excitement with you.  
We sell heaps of products that are manufactured and supplied exclusively to us and because of our enormous buying power (over 300 outlets in Australia and New Zealand) our prices are extremely competitive.  
So, if you like to dabble, build the occasional kit, try out new circuits and do your own thing with a soldering iron, drop in and see us.

73's  
*John Bain*  
President  
VK2AIG/W

**Cap/Transistor Checker**



**\$99.95**

**Will even measure gain on transistors**

Cat Q-1500  
Not just the usual voltage, current and resistance ranges - though it's certainly got those - it also checks capacitors (2 ranges, up to a whopping 20uF) PLUS transistors and diodes. And even more: it's got an audible continuity checker.  
Plus other features - such as automatic zero of all ranges, high surge voltage protection, automatic over-range indication, high current measurement (10AC & DC)

**Pen Type Digital Multimeter**

From a fantastic 100Mohms input impedance, 16 ranges: DC - 0-500V - 3 ranges AC - 0-500V - 4 ranges

**\$54.95**

Cat Q-1450

Resistance 0-20Mohms - 6 ranges plus continuity tester.



Use these high precision stepping motors to make your own computer controlled robot arm or travelling robot. Stepping angle is a fine 1.8 degrees to give you a highly accurate control. Stepping motors have the enormous advantage that they are activated by a computer controlled pulse so you can program it for an exact movement and return and multiple repeats or a complex series of exact movements.  
Because these motors are so well designed and built they are extremely versatile and reliable under a wide variety of conditions.  
Normally motors of this type would cost a fortune but because we made a scoop purchase of the supplier's entire stock we are able to offer them at this fantastic "getting started in robotics price" of \$29.95 ea. If you buy four or more, and you will need them, we'll give a copy of the fascinating and extremely practical "Handbook of Advanced Robotics" (Cat B-1800 - normally \$13.95) Serious inventors and experimenters ask about our very favorable prices for larger quantities.  
Two types available: both 1.8 step angle 12V DC operating and base 2.22" x 1/4" shaft.  
Cat J-0015  
PH264.02: Draws 0.4A/ phase, 40.3 oz-in holding (single shaft) torque, length 1.54" and weight 0.8lb  
Cat J-0016  
PH266.02B: Draws 0.6A/phase, 83.3 oz-in holding torque (double shaft) length 2.3, weight 1.3lb

**\$29.95**  
**FREE BOOK WORTH \$13.95**  
With 4 stepping motors

**Australians At Play**

**\$29.95**



204 color pages

Australians have always been fun and leisure oriented people and when climates are directed at us, they have invariably been about our inability to take life too seriously. This book depicts just that. In words and stunning color photos. You'll be taken to the topless beaches, experience a week-end sailing the ocean, surfing the Barrier Reef, outback camping, cricket and much, much more.  
Cat B-9901

At last! 'No leak' Rechargeable

**BATTERIES** Cat S-3315  
**12V 3Ah \$7.95**  
**Gel Cell** 10 up \$6.95 ea



Designed especially for 'trickle charge' circuits such as burglar alarms and emergency supplies. Sealed to prevent leaks and mess.

**Gel Cell Chargers**

Cat S-3320  
**\$13.95**  
10 up \$12.95 ea



When you are recharging Gel Cells it is most important that careful attention is paid to the rate of duration of charge as exceeding the recommended limits may severely reduce the battery life. We stock two regulated chargers to suit the two Gel Cell batteries.

**12V 150 MA Gel Cell Charger** Cat M-9520  
Suits S3315 12V 1.6 A Gel Cell. Comes with alligator clips to make connection to your cell easier. Cat. M-9520

**\$34.95**

**12V 450 MA Gel Cell Charger** Cat M-9522  
Suits S3320 12V 3A Gel Cell. As above with higher capacity. Cat M-9522

**\$36.00**

**100 Watt Amp Module**

**\$19.95**

- 100 watts RMS; 5kHz at 100dB signal to noise ratio.
- the ultimate in simplicity; even the power transistors mount on the PCB.
- PCB heatsink bracket is supplied
- Hason-board fuse protection
- input sensitivity: 1V

Power supply circuit with speaker protection to suit 100W amp kit. Cat K-3438 \$44.95

Transformer to suit above. M-0144 \$19.95

**Handbook of Advanced Robotics**  
Edward L. Safford, Jr. 480 pages, 242 illustrations. The complete book of robots, from commercial applications to how-to's for building a hobby robot! Gives an insight into modern robotic applications in home, hobby, and commercial environments.  
Cat B-1800 Rec. retail \$15.95

Our price **\$13.95**

**DICK SMITH'S - WHERE THE ELECTRONICS ENTHUSIAST IS #1**



**19" RACK MOUNTING CASE**

**\$29.95**

Professional quality black instrument case fits standard 19" racks, overall they're 16.75" x 9.8" x 5.5". Supplied flat, assembly takes just a couple of minutes. Heavy gauge (0.12") front panel; top and bottom pre-punched for ventilation. Cat H-2481

**Transistor Tester**

speedy fault finding



**\$16.95**

Not just another Transistor Tester! This one tests the lot! Ideal for the beginner and serviceman alike, or in schools. Battery operated and supplied with one of our new 2" panel meters in a deluxe 'Speedy' box. Requires 9V battery Cat S-3006 75c extra. Cat K-3052

**3 Digit Counter**

The most versatile counter circuit around • Designed for maximum flexibility (display can be removed for external mounting) and with a very wide operating voltage (5-15V).  
Cat K-3451 **\$14.95**



- LED display
- Up to 2MHz counting speed
- Clock enable
- Very comprehensive manual included!

**Dick Smith Electronics books offer more Sine & Square wave Oscillator**

Covers frequencies from 15Hz to 150kHz. All parts are supplied including specially printed front panel, attractive 'Speedy' case and full instructions. 9V battery not included. **\$39.95**



Cat K-3469

**Fun Way 1 Volume 1**

Electronics should be fun, but far too often it is presented as a difficult, mysterious subject. The Fun Way series deals with this fascinating subject in an easy to understand, fun way. The first volume starts off with the very basics, assuming that you know absolutely nothing about electronics. It will show you what all the components look like and how to connect them into the circuit. No soldering is required and so is completely safe for even the youngest enthusiast.  
BOOK ONLY Cat B-2600 **\$4.95**



**The ideal introduction for beginners from 6-66! kits are educational as well as fun INSTRUMENT CASE**



Cat H-2505 **\$9.95**  
10 up \$8.95 ea

A superb case for all 'instrument' type projects, and many other besides. Case splits apart for ease of working, comes complete with 4 mouse-feet and assembly screws. Amazingly versatile allowing for various PCB mounting positions. Front & rear panel are moulded plastic for ease of working (they can be replaced with aluminium panel if required). Size approx. 8" x 6 1/2" x 2 1/2". Cat H-2505

**GREAT VALUE**

17 years of mailorder experience

**50 Ohm RG-51 AMATEUR** Cat W-2090 10c  
300 ft roll 8c/ft

For use up to 500MHz making it ideal for the marine radio installation, CB radio, amateur and two-way radio. Flexible with stranded center conductor and black insulation.

**Makes computer generated effects. Sound even more effective in stereo! Stereo Simulator**

Wish those old video movies had modern stereo sound? This low cost gadget turns almost any mono signal into amazingly good synthetic stereo! Cat K-3421 **\$14.95**

**LCD Panel Meter**

A versatile accurate panel meter using a large liquid crystal display for low power consumption. The PCB board design allows for maximum flexibility to cater for varied mounting arrangements. The low cost makes it ideally suited as a readout device on many projects, at both amateur and professional level.

**Incorporate module into other projects**

Features: • 3 1/2 digit LCD display • 200mV full scale reading • less than 1 digit accuracy • 100uV resolution • automatic polarity • input impedance greater than 10<sup>10</sup>ohms • 2pA input bias current • dual slope conversion method • internal 100ppm reference • 5V to 15V dc, 1mA @ 5V power supply. Cat K-3450 **\$29.95**



**\$29.95**

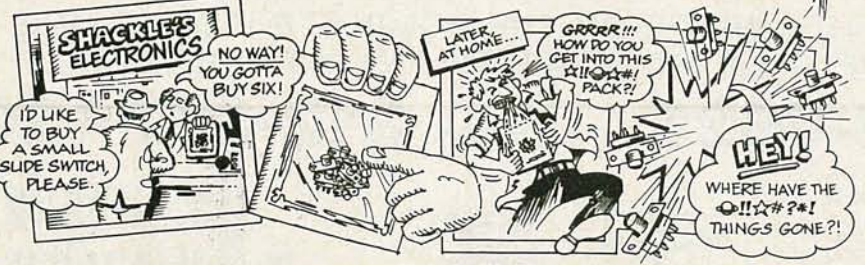

Dick Smith Electronics gives you the choice

**ORDER TOLL FREE 1-800-332 5373 ORDER TOLL FREE**

CIRCLE 95 ON FREE INFORMATION CARD



**-800-332 5373 ORDER TOLL FREE 1-800-332 5373**

**PROTOTYPE BOARDS**

**ENTHUSIASTS, SCHOOLS, LABORATORIES** are designing in so simple . . .

are birds nests. No more shorts. No more mess. Now you can build up those sible technology breakthroughs easily and simply with these breadboards. Soldering required - component leads simply push into holes (accepts most onent leads; larger components can have short lengths of tinned copper wire red to them).  
ng of the holes is designed to accept standard DIP packages, too - without gling the pins.  
one board isn't enough, add more . . . as many as you need! Male/Female lugs a smaller board as they stay together, too.  
NO EXTRA CHARGE. Each breadboard comes complete with a pad of layout sheets so you can transfer that fantastic circuit onto paper for the finished ckt.  
utely indispensable for the designer, engineer, nt . . . and especially for the hobbyist!  
are educational as well as fun!

**Mini Project Board**

3" x 2.4" x 3" one-piece board with 58 groups of 5 connected terminals, and 4 bus lines of 25 connected terminals.

All terminals are alpha-numerical coded so you can remember what you connect to what. Complete with self-adhesive pad so it won't slide around the table.

Cat P-4614  
10 up \$4.50 ea

**\$4.95**

**\$9.95**

Cat P-4615

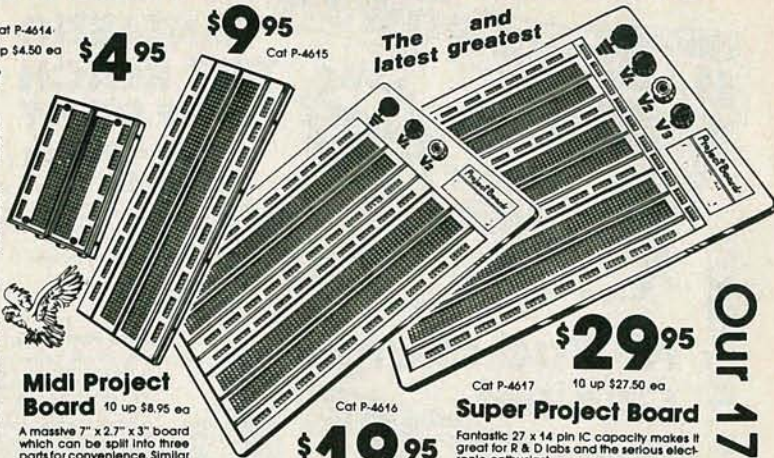

**Mid Project Board**

10 up \$8.95 ea

A massive 7" x 2.7" x 3" board which can be split into three parts for convenience. Similar to the Mini Board with alpha-numeric coding and adhesive back, but this one has 128 groups of 5 connected terminals plus 8 bus lines of 25 connected terminals. AND you get the large work sheet pad as well!

10 up \$15.95 ea

**Maxi Project Board**

8" x 6" x 8" one piece board with 256 connected terminals, 3 binding posts and 18 x 14 pin IC capacity - ideal for schools.

**Super Project Board**

10 up \$27.50 ea

Fantastic 27 x 14 pin IC capacity makes it great for R & D labs and the serious electronic enthusiast. Supplied with 4 binding posts and a whopping 2420 tie points to give amazing versatility. We've seen similar boards selling for 70% more and, because we buy direct from the manufacturer, we don't think you'll ever be able to beat this value.

**\$29.95**

**Membrane Switch Kits**

New! New! We thought you'd like these as they can be used for just about any application from design to finished project. Switching is normally open, momentary contact, push button type. Easy to assemble. Even our president can do it!

**SPECIFICATIONS**

- Circuit resistance: less than 150 ohms
- Contact rating: DC 24V max 5mA max
- Open Circuit Resistance: 100 MEG minimum
- Contact material: carbon in sides
- Life time: tested to one 3 million operations at 24V DC 5mA

- 4 key Cat K-3605 - \$4.95
- 12 key Cat K-3607 - \$6.95
- 16 key Cat K-3609 - \$8.95
- 80 key Cat K-3611 - \$39.95

**LATEST BUY COMPARE OUR PRICES**  
We've bought these direct from the manufacturers & passed the savings on to you. Schools, Universities, Colleges ring for bulk buying prices.

**Digital Trainer**

For breadboarding, Digital circuits, Flip-flops, multivibrators, counters, encoders, decoders, multiplexers, demultiplexers, sequencers, registers, LED and 7 segment LED displays, memory devices, etc. Specs: (1) AC power jack - DC +12V800mA; (2) Power switch AC adaptor/battery 1.5V x 4; (3) Pulse Sw: two bounce free push buttons; (4) Logic SW: eight logic level switches in DIP packages; (5) DC O/P: DC +5V 750mA for user; (6) B-023 breadboard: 1580 interconnected tie points; (7) LED display: eight LED buffered logic level indicators; (8) clock range selection 10-40KHz, 1K-20KHz. Power supply to suit (not included). M-9530 12V 1amp \$14.95. Comes complete with training manual. Cat P-4625

**\$129.95**  
10 up \$119.95 ea

**DICK SMITH'S - WHERE THE ELECTRONICS ENTHUSIAST IS #1 Fun Way 1**

**Each kit requires the book for instructions**  
**20 more fun projects to build in Fun Way Volume 2**

ou've built all the projects in Fun Way 1 and now you're looking for something bigger, better and more exciting. Here it is - Fun Way 2. It takes over where Fun Way 1 finishes. There's 20 exciting new projects to try. These ones are different though. They teach you how to solder onto a professional printed circuit board and also how to use a multimeter! All of these projects have been specially chosen to be "useful". Just have a look and you'll agree.

**BOOK ONLY B-2605 \$6.95**  
Now here's a gift bargain. Over \$28 worth of value for less than \$20! This pack has of value for less than \$20! This pack has of value for less than \$20! This pack has of value for less than \$20! This pack has of value for less than \$20!

<b>Flasher</b> Make it as the latest in electronic jewelry, or a burglar warning light. The choice is yours and it's easy! Cat K-2621 <b>\$2.95</b>	<b>Ding Dong Doorbell</b> Yes, it really sounds like a great old fashioned doorbell. But it's electronic, and you can build it! Cat K-2622 <b>\$4.50</b>	<b>Morse Code Trainer</b> You can turn the audible alarm into just about anything requiring sound. Even for Morsecode - and it's fun to learn! Cat K-2623 <b>\$4.50</b>	<b>Universal Timer</b> Eggs too hard? Time them with this great little timer. It really works - set it for a few seconds to 15 mins. Cat K-2624 <b>\$5.50</b>	<b>Electronic Dice</b> Just as much fun using it as it is building it! And it's really random - no cheating with this dice! Cat K-2625 <b>\$4.95</b>
<b>Mono Organ</b> Snazzy little circuit uses the back of the PCB as the keyboard! Play a tune - it's easy. Cat K-2626 <b>\$7.95</b>	<b>Radio</b> Build this set and learn about the fundamentals of radio. And when you'll have fun using it too! Cat K-2627 <b>\$7.95</b>	<b>Touch Switch</b> Ever wondered how lift buttons work? Build this kit yourself and you'll be able to work it out. Cat K-2628 <b>\$5.50</b>	<b>Mosquito Repeller</b> Do mosquitos really work? Build this one and find out. You won't hear it - but the mosquitos will! Cat K-2629 <b>\$4.95</b>	<b>Intercom Amplifier</b> Use it to make the intercom (project 18) or use as a general purpose amplifier. Really handy, good sound output too. Cat K-2630 <b>\$6.50</b>
<b>Wireless Mic</b> Just like the 'bugs' used in spy movies! Transmits to any standard FM radio in any other room or next door, etc. Hear it all! Cat K-2631 <b>\$6.50</b>	<b>Light Activated Switch</b> Useful in many security applications around the home. You could even use it to trigger a burglar alarm! Cat K-2632 <b>\$5.50</b>	<b>Metal/Pipe Locator</b> Extremely handy for locating pipes, wires, etc. in walls before drilling holes. Surprisingly simple for such an effective circuit! Cat K-2633 <b>\$6.50</b>	<b>Sound Activated Switch</b> Picks up sound and triggers. Use as a telephone bell extender or in security applications. Cat K-2634 <b>\$6.50</b>	<b>Home/Car Alarm</b> Very practical! You could use this alarm to protect your home and property! Uses any of the normal alarm triggering devices. Cat K-2635 <b>\$6.50</b>
<b>Electronic Siren</b> Just what you need! Also with the alarm and effects circuits - and Fun Way 2 tells you what to do! Cat K-2636 <b>\$4.95</b>	<b>LED Level Display</b> Hook it up to your stereo and it can warn you of dangerous overloads. Looks pretty nifty. The LED's light up in time to the music! Cat K-2637 <b>\$8.95</b>	<b>Intercom Unit</b> Build your own intercom. Use it around the home. Practical, simple to build with simple to use intercom amplifier (Project 10). Cat K-2638 <b>\$8.95</b>	<b>Led Counter Module</b> An introduction to the world of I.C.'s. This useful gadget can be used for counting applications - or just for fun! Cat K-2639 <b>\$7.95</b>	<b>Short Wave Receiver</b> Tune in to short wave stations or emergency services and amateurs etc. Easy and fun to build. Cat K-2640 <b>\$6.95</b>

See Vol. 1 for full instructions and explanations.

**Fun Way One Project Kit 1-10**  
Enables you to build any of the first ten projects in Fun Way One. And because the components are not soldered, they are all re-usable so you can build any other of the first ten projects too.  
Cat K-2600 **\$7.25**

**Continuity Indicator**  
**Transistor Tester**  
**Water Indicator**  
**Light/Dark Indicator**  
**The Flasher**  
An electronic Siren  
**Dog and cat communicator**  
**A decision maker**  
**Morse code communicator**  
**Music Maker**

**Fun Way One Project Kit 11-20**  
Contains the more specialised components required to complete the last ten projects (11-20) in Fun Way One. Note: you will also need the 1-10 kit to build the projects.  
Cat K-2610 **\$7.90**

**Sound Effects Generator**  
**A Crystal Set**  
**One Transistor Amplifier**  
**Beer Powered Radio**  
**Two Transistor Amplifier**  
**World's Simplest Transmitter**  
**Voice Transmitter**  
**CB Radio Receiver**  
**Amateur Radio Receiver**  
**Radio Booster Amplifier**

<b>Light and Sound</b> Other multi-talented effect. Sound effects, flashing lights - continuity tester, Morse code oscillator. . . it's the lot! Cat K-2665 <b>\$8.95</b>	<b>Two Up</b> Australia's national game - now done electronically because the original King George pennies and hard to get! Cat K-2661 <b>\$9.95</b>	<b>Cricket</b> Whaaaa! Hide it in a dark room and it starts chirping. Turn the light on and it stops. It's infuriating! Cat K-2663 <b>\$9.95</b>	<b>Mini Stereo Amp</b> Just the shot for "Walkie stereo" - now you can listen to it in your bedroom through speakers! Or make yourself a PA amplifier. Cat K-2667 <b>\$14.95</b>	<b>Minder</b> A multipurpose project for the car. "Lights on" warning, door open warning plus a pseudo burglar alarm. Cat K-2660 <b>\$7.95</b>
<b>Mini Colour Organ</b> Like a disco - but battery operated so it's safe! Connect to your radio, etc. for a LED lightshow. Cat K-2664 <b>\$12.95</b>	<b>Combination Time Lock Switch</b> Make it into a game . . . or use it as a real alarm component. It's that good! Just try getting into this one! Cat K-2666 <b>\$19.95</b>	<b>Lil Pokey</b> It's a barrel of fun to play. And you don't risk losing your shirt like the real thing! Cat K-2662 <b>\$19.95</b>	<b>Binary Bingo</b> A game of skill and reaction time - and a valuable teaching aid! It might sound pretty simple to play - but try it and see! Cat K-2668 <b>\$19.95</b>	<b>Mini Synth</b> Wow! A real musical synthesizer, with delay, frequency doubling & having tremolo unique voice generation. YOU as the note generator! Cat K-2669 <b>\$19.95</b>

**OVER 500,000 FUN WAY KITS SOLD!**

**Fun Way Volume 3**

**ONLY \$6.95**

When you've worked your way through Volumes 1 & 2 you're ready for the more complex projects described in full detail in this book. Then you could be ready for a job in electronics.  
Cat B-2610

\* Each kit requires the book for instructions



**READ ON... MORE GREAT BARGAINS AND NEW PRODUCTS OVERPAGE**

**-800-332 5373 ORDER TOLL FREE 1-800-332 5373**

CIRCLE 95 ON FREE INFORMATION CARD

**Our 17th year serving the electronics enthusiast**



# MASSIVE POWER



**NEW**

This beauty will supply up to 20 Amps all day to your test bench or amateur radio station. Ideal for 50 and 75 watt, 2 meter ham band linear amplifiers. It is a precision regulated DC supply with the added features of:

- Electronic overload protection with instant automatic reset
- Fuse protected
- Neon lighted on/off rocker switch

Cat. M-9547 Size: 11.5" x 7.75 x 4.375 Weight: 16lb

## ORDER TOLL FREE 1-800-332 5373

### FANTASTIC TEST BENCH POWER SUPPLY

### HEAVY DUTY SOLID-STATE 13.8V/4A Peak



Be served by an enthusiast like you at DSE



Regulated D.C. Power Supply, 13.8 VDC, 3/5 Amp. For home, lab, service bench, CB, stereo and auto radios, this is an extremely versatile unit. You'll wonder how you managed without it!

Input is 117VAC 60Hz 100W, and the output is fully regulated low ripple 13.8VDC to supply 3 Amps continuous and up to 5 Amps surge. The unit is fuse and double-short circuit protected with on/off switch and pilot light.

Cat. M-9545

Dick Smith Electronics - your one stop electronics shop

### LATEST TECHNOLOGY \$149

## High output Solar Panel

These solar panels utilize high technology actually designed for satellites that generate on average 20% more than the normal .45 volt cell. High density packaging gives extra high output. Encased aluminum substrate makes the panel temperature proof, shock proof and weather proof. Ideal for all sorts of uses to boat owners, amateur operators, technicians or anyone else that has to keep a 12V battery charged in an out of the way place.

1 Amp Output (10 volts) or 20V @ 500 MA Cat. Z-4845 10 up \$140.00  
 500 MA Output (10 volts) or 20V @ 250 MA Cat. Z-4844 10 up \$99.00

Both panels supplied with specification ideas wiring harness, cigarette lighter plug, lugs and suction cup with hook to suspend your solar panel.

**MADE IN U.S.A.**

## Ni-Cad charging Cabinet

**\$11.95**

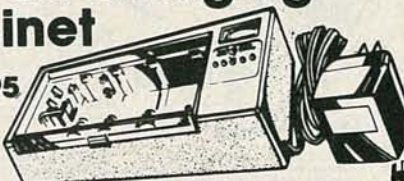

Can't charge NiCads inside the device? No problems: this incredibly versatile charging cabinet suits virtually all sizes and types of NiCad cell. Has a test meter to indicate charge and 5 LED indicators to show batteries are connected. Fully approved, complete with plug-pack. Cat. M-9519

## Our worldwide bulk buying power makes our prices look crazy. 1.2 & 2.2GHz Frequency Counters



We have been fortunate enough to make this exclusive direct buy. Compare the price of this state-of-the-art unit with older models.

MODEL 21 Cat Q-1315 **\$249.00**

There are two to models to choose from:

MODEL 22 Cat Q-1318 **\$499.00**

Compare with much more expensive models

# DICK SMITH'S - WHERE THE ELECTRONICS ENTHUSIAST IS #1

## FREE Battery Charging with the Solar Battery Chargers

Charge Batteries with Free Solar Power through Space Age Technology available from Dick Smith Electronics

Here is a convenient and safe way to revitalize worn down batteries. Pocket chargers start saving money the first time they are used. These pocket chargers are completely self contained, compact and easy to use.

- Button Cell Charger Brings new life to your button cells. M-9504 **\$19.95**
- 4 x AA Charger Can charge from 2 to 4 'AA' ni-cads complete with suction cup and hook for easy suspension. M-9502 **\$24.95**
- 2 x AA, C, or D Charger This one comes complete with C and AA adapter as well as suction cup and hook for easy suspension. M-9500 **\$29.95**



## Magazine File

A magazine binder, ideal for any magazines that cover 12 issues in one year. Hard spine with metal rods for placement of the magazines. Cat B-4045

**VALUE \$4.95**



**ILLUMINATED PUSH BUTTON** Lamp 12V @ 55mA As used in car burglar alarms, control panels, etc. Alternate action switch with inbuilt 12V globe. Square finish body, round mounting hole.

Features:  
 125V AC 3A  
 Body size: .55" x .55"  
 Mounting hole: .47"  
 Clearance: 1.57"  
 Cat S-1520  
 10 or more \$4.50 each

**\$4.90**

## Solder Stand with magnifier!

The helping hand when you need it most when you have a 'hot stick' in your hand! Heavy die-cast base, solder stand, clips for holding PCB, etc plus a unique magnifying lens for those close assembly jobs.

**BEAT THIS PRICE \$6.95**

Cat T-5710



We carry a huge range of electro, polyester, fanlials, ceramics and styros. Please ask when ordering and we will probably be able to supply your needs.



## DSE 2840

Primary: 117V, 60Hz  
 Secondary Voltage: 4.5-4.5V  
 Secondary Current: 150mA  
 Terminations: Flying Leads

**\$25**  
10 up \$22.25



## DSE 2851

Primary: 117V, 60Hz  
 Secondary Voltage: 6.3-6.3V  
 Secondary Current: 150mA  
 Terminations: Flying Leads

**\$25**



## DSE 2155

Primary: 117V, 60Hz  
 Secondary Voltage: 6.3, 7.5, 8  
 Secondary Current: 1 Amp  
 Terminations: Flying Leads

**\$5.95**



## DSE 6672

Primary: 117V, AC  
 Secondary Voltage: 15, 17.5, 20, 24, 27.5, 30 volts  
 Secondary Current: 1 Amp  
 Termination: Solder Lugs

**\$7.95**  
10 up \$6.95 ea

## IRRADIATED HEAT Shrinkable Electrical Tape \$3.75

For RF connectors, computer connectors or any connector or cable splice that has to be water proofed or insulated. When heated (a heat gun will serve excellently) there will be a 30% tightening around the object. Secondly the inner lines soften and flow into the tape wrappings. Ten strength 1200 PSI. Dielectric strength 9KV min. Co Black, 10' length.

Cat N-1365

## Giant Handbook of Electrical Circuits

Raymond A Collins-880 pages  
 Giant isn't the word: it's a whopping 880 pages! With 60 chapters covering everything from crystal sets to computer circuitry, you're sure to find what you want here!

Cat B-1780 **\$19.95**

## IC EXTRACTION TOOL

**\$2.95**

Cat. T-4650



The perfect way to remove IC's without damage. Works with all DIL packs, no bent pins and no static damage! Operates like a pair of tweezers - with hooks!

**Satisfaction Guaranteed or your money back.**

## Signal Injector

One of the handiest devices to have in your tool box. Check out both audio and RF circuits (harmonics extend to many MHz) simply and easily. Often the quickest method of fault finding (and one of the cheapest!) Self contained, with probe and earth clip. Cat Q-1270

**\$9.95**



# ORDER TOLL FREE 1-800-332 5373 ORDER TOLL FREE

CIRCLE 95 ON FREE INFORMATION CARD



# -800-332 5373 ORDER TOLL FREE 1-800-332 5373

## ATIC RAMS

DEVICE	Cat No	Description	PINS	Speed	Price	10 up	ea
2102	Z-9302	1024 x 1	16	350ns	99¢	89¢	
2114	Z-9306	1024 x 4	18	450ns	1.05	95¢	
16116P-4	Z-9308	2048 x 8/16K CMOS	24	200ns	3.49	2.95	

## NAMIC RAMS

Device	Cat No	Description	PINS	Speed	Price	10 up	ea
24116	Z-9310	16,384 x 1/MM5290N-3	16	200ns	1.00	90¢	
4164	Z-9312	65,536 x 1	16	150ns	3.95	3.50	
41256	Z-9314	262,144 x 1	16	150ns	10.95	9.95	

## ROMS

Device	Cat No	Description	PINS	Speed	Price	10 up	ea
2516	Z-9207	2048 x 8 16K/2716	24	450ns	4.95	4.75	
2532	Z-9208	4096 x 8 32K/2732	24	450ns	4.95	4.50	
2732A	Z-9209	4096 x 8 32K (21V) Intel	24	150ns	4.95	4.50	

## 00 SERIES

Device	Cat No	Description	PINS	Speed	Price	10 up	ea
1085-AH	Z-9385	CPU 8 bit N-Channel	40	5MHz	6.50	5.95	
8086	Z-9386	CPU 16 bit	40	5MHz	19.95	17.95	
8088	Z-9388	CPU 16 bit/8 bit Data Bus	40	14.95	12.95	11.95	
8235-5	Z-9453	Prog Internal Timer	40	7.50	6.50	5.50	
8255A	Z-9455	Prog Peripheral	24	4.95	6.50	5.50	
8284A	Z-9484	Clock Generator and Driver	40	5.49	4.50	4.00	
D8288	Z-9488	Bus Controller 8086/88	18	13.95	12.95	11.95	

## 00/6800 SERIES

Device	Cat No	Description	PINS	Speed	Price	10 up	ea
P6502	Z-9502	MPU with clock	40	1MHz	5.95	5.50	
6845	Z-9545	CRT controller	40	12.95	11.95	10.95	
6850	Z-9550	Asynchronous Comm Adaptor	40	3.75	3.55	3.25	

## LINEAR IC's

Type No.	Cat No.	Description	Price Ea	Price 10 up ea
TL555CP	Z-6144	CMOS timer	.69	.65
NE/DS555	Z-6145	Universal timer	.35	.30
NE555	Z-6146	Dual timer	.79	.75

## Light Emitting Diodes

Type No.	Colour	Size	Cat No.	Price Ea	Price 10 up	Intensity @ 20mA	Notes
LT2462-52	Rd./Gr.	0.2" diam	Z-4070	1.00	.90	40 2.5	3.0mCd Dual
ESBR5501	Red	0.2" diam	Z-4075	.95	.85	50 1.7	200mCd High Intensity
TL4211	Red	0.12" diam	Z-4077	.20	.10	40 2.1	3.5mCd Premium Quality
TL4231	Green	0.12" diam	Z-4079	.25	.20	40 2.1	5.0mCd Premium Quality
TL4291	Orange	0.12" diam	Z-4081	.30	.25	40 2.1	5.0mCd Premium Quality
TL4213	Red	0.2" diam	Z-4083	.30	.25	40 2.1	7.0mCd Premium Quality
TL4233	Yellow	0.2" diam	Z-4085	.20	.10	40 2.0	4.0mCd Premium Quality
TL4293	Orange	0.2" diam	Z-4089	.30	.25	40 2.1	9.0mCd Rect. Prem. Qual.
TL4253	Yellow	0.2" diam	Z-4091	.30	.25	40 2.1	1.2mCd Rect. Prem. Qual.
TL4293	Orange	0.08 x 0.2"	Z-4093	.30	.25	40 2.1	1.2mCd Rect. Prem. Qual.
TL3215S	Green	0.08 x 0.2"	Z-4097	.30	.25	40 2.1	1.2mCd Rect. Prem. Qual.
TL3235S	Red	0.08 x 0.2"	Z-4097	.30	.25	40 2.1	1.2mCd Rect. Prem. Qual.
TL3255S	Yellow	0.08 x 0.2"	Z-4097	.30	.25	40 2.1	1.2mCd Rect. Prem. Qual.

## Dick Smith

## Light Emitting Diodes

**Huge 132 Page Enthusiast's Catalog** • and much more - Rush Data • High Tech Kits • Books • Components • and much more - Rush 2.00 plus \$1.00 shipping for your copy today - or come into one of our stores and pick one up - We want to meet you!

## Out of the Inner Circle

240 pages  
Bill Landreth  
Well I tell you, if you never buy another book on computers, buy this one with one word - "The Crocker". The 19 year old ten by "The Crocker" who had apprehended by computer whiz kid apprehended by the F.B.I. and now author of the eye-opening inside story of America's secret "hacking" culture. This book will give you heaps of information about "computer hackers" and the art of "hacking". What's more, it even lets you know the secret to keeping potential hackers out of your system. A fantastic hacker's guide to computer security.  
Cat B-2370

## IT'S AMAZING... IT'S TRUE! WOW!

ONLY \$1.00 ea.

## 2V DC MOTORS

10 up 80¢ ea  
These little beauties are used in car cassette players they are robust and spin easily. They have plenty of torque so you can use them in all sorts of projects. The 3 flanges on most of our motors makes it extremely easy for mounting.

## Resistance Substitution Wheel

Convenient size with large, easy to read value selection that enables you to select values from 5 ohms to 1 M ohm in 36 steps by using most common divisions. Complete with leads and insulated crocodile clips.  
Cat Q-1410

## QUALITY NI-CAD Rechargeable Batteries

From \$1.49 ea (10 up price of AA)  
Ni-Cads work out much cheaper in the long run, especially if you buy them from Dick Smith Electronics.  
Type Cat No. Price each  
A S-3300 1.95  
AAA S-3305 1.95  
C S-3301 2.95  
D S-3303 2.95

## TOP QUALITY

Amazing VALUE!  
CAN'T READ OUR AD? \$6.00  
\$2 off for any customer who has difficulty reading this ad.  
2 1/2" double glass lens, stamp/coin viewer - excellent for inspecting hair-line cracks in PCB's.  
Cat Y-0500

## Compact Disc Library System

These very attractive modules are made of high-impact, tinted plastic that stack vertically or horizontally that stack vertically or horizontally with a very positive interlocking system so that they will not slip about or fall over. Your discs stack neatly in individual shelves. Two modules in each system hold up to 24 discs.  
Cat C-3830

## Flash Strobe

\$14.95  
10 up \$13.95 ea

A new idea... and a beauty! A bright blue flashing 'strobe' lamp (like on the top of your-know-what cars) which demands absolute attention. Placed outside the property (say under the eaves of the house) it will instantly show neighbours, Police, etc where the alarm is occurring (it's not always easy to tell from which direction a siren or bell is coming). Operates from 12 volts; use in conjunction with virtually any alarm controller via 'relay' output.  
Cat L-3000

As used in most cars - ideal replacements  
Price 10 up Ea  
Cat P-5102 \$1.20 \$1.10 2-way  
Cat P-5103 \$1.30 \$1.20 3-way  
Cat P-5105 \$1.40 \$1.20 4-way  
Cat P-5108 \$1.40 \$1.50 6-way  
Cat P-5112 \$2.20 \$2.00 2-way

PASSING BY OUR STORE? DROP IN PICK UP A CATALOG WE'D LOVE TO MEET YOU!

Here's how to find us

REDWOOD CITY  
UNIVERSITY AVE  
BANKERS BLDG  
WE ARE HERE  
OPENING JULY!

## 3 1/2 digit LCD driver Cat Z-6300

\$9.95 ea 10 up \$9.00 ea

## 74HC

Type No.	Cat No.	Price Ea	Price 10 up
74HC00	Z-5800	.55	.50
74HC02	Z-5802	.55	.50
74HC04	Z-5804	.55	.50
74HC08	Z-5808	.55	.50
74HC11	Z-5811	.55	.50
74HC14	Z-5814	.55	.50
74HC27	Z-5827	.55	.50
74HC30	Z-5830	.55	.50
74HC32	Z-5832	.55	.50
74HC74	Z-5874	.70	.65
74HC76	Z-5876	.70	.65
74HC85	Z-5885	\$1.30	\$1.20
74HC86	Z-5886	.65	.60
74HC123	Z-5910	\$2.20	\$2.00
74HC138	Z-5915	.95	.90
74HC157	Z-5920	.95	.90
74HC139	Z-5925	.95	.90
74HC165	Z-5930	\$1.90	\$1.70
74HC174	Z-5935	.99	.95
74HC221	Z-5940	\$2.50	\$2.40
74HC240	Z-5945	\$1.95	\$1.85
74HC244	Z-5950	\$1.75	\$1.65
74HC245	Z-5955	\$1.85	\$1.75
74HC367	Z-5960	.90	.80
74HC373	Z-5965	\$2.25	\$2.05

Sorry about no descriptions on some products - we ran out of room. This is only a small sample of our IC range - our new catalog will list the full range - with descriptions.

## IC SOCKETS

Why endanger valuable IC's by soldering them directly into circuit? Take the safe approach: use an IC socket! It makes service and repair of your project much, much easier too. There's an IC socket to suit all common IC's.

## VERY SENSIBLE!



THOUSANDS SOLD

The semi's listed here are only a tiny fraction of our huge range - please enquire about types and prices.

## SCR'S

Economy Type	Plastic Pack Vdrn	Use	Price Ea	Price 10 up
C103B	200	Small Current Sensitive Gate AC Switch	.44	.40
C106Y1	30		.29	.25
C106D	400		.80	.75
C122E	500		.80	.75
(BT151, TIC126E)	8		.95	.90

## RECTIFIER DIODES

Type No	Cat No	Price Ea	Price 10 up	PIV	Amp	Use
IN4002	Z-3202	.06	.05	100	1	General Purpose
IN4004	Z-3204	.10	.08	400	1	General Purpose
IN4007	Z-3207	.12	.10	1000	3	General Purpose
IN5404	Z-3222	.30	.25	400	3	General Purpose
IN5408	Z-3228	.30	.25	1000	3	General Purpose

## SILICON SMALL SIGNAL DIODE

Type No	Cat No	Price Ea	Price 10 up
IN914	Z-3120	.05	.04

## LIQUID CRYSTAL DISPLAY

Type No	Cat No	Price Ea	Price 10 up
LCD4.5	Z-4175	\$9.95	\$9.00

Everything for the electronics enthusiast for 17 years 60 stores in 3 countries

AUGUST 1985

**DICK SMITH ELECTRONICS**  
INCORPORATED IN THE STATE OF CALIFORNIA  
OVER 60 STORES IN 3 COUNTRIES  
-800-332 5373

Mail Order Center located at 390 Convention Way Redwood City CA 94063  
P.O. Box 8021 Redwood City CA 94063  
TELEX: 160488 DICKS USA FAX: 368 0140  
SHIPPING CHARGES U.S.A. 5% of merchandise total minimum \$2.50  
OUTSIDE U.S.A. 10% of merchandise total minimum \$5.00  
We generally ship UPS ground. If you require a faster service please contact us.  
Tax 6 1/2% Californian residents

**NEW STORE**  
2474 Shattuck Ave.  
(Between Dwight Way and Haste St.)  
Berkeley, CA 94704  
Telephone: (415) 486-0755

REDWOOD CITY  
UNIVERSITY AVE  
BANKERS BLDG  
WE ARE HERE  
OPENING JULY!

# ORDER TOLL FREE 1-800-332 5373

CIRCLE 95 ON FREE INFORMATION CARD



# EQUIPMENT REPORTS

## Global Specialties Corporation Model 8001 Scope Multiplexer

Display up to eight analog or digital signals at one time

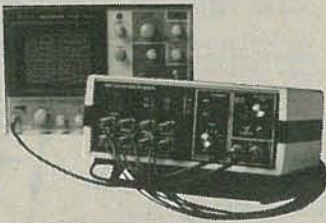

CIRCLE 5 ON FREE INFORMATION CARD

THE OSCILLOSCOPE IS AMONG THE most versatile troubleshooting tools an electronics technician or hobbyist can own. Even more versatile, however, is an oscilloscope

that is capable of displaying two or even more channels of data. But oscilloscopes that are capable of displaying four or more channels can get very expensive.

If you already own a single- or dual-channel scope, there is a more economical alternative. That is the Global Specialties (70 Fulton Terrace, PO Box 1942, New Haven, CT 06509) model 8001 scope multiplexer. That device allows you to display up to eight channels simultaneously on a single or dual channel scope.

### The 8001

The 8001 is housed in an attractive 4 x 10 x 7-inch case; the unit weighs 3¾ pounds. It requires a nominal 117-volt AC, 60 Hz power source.

## QUALITY COMPONENTS - NOT MAIL ORDER "SECONDS"

Send \$1.00 postage and handling for FREE COMPLETE CATALOG which includes coupon for \$1.00 OFF purchase.

### ARIES ZERO INSERTION FORCE SOCKETS -

cam actuated, true zero insertion - tin plated solder tail pins - capable of being plugged into dip sockets, including wire wrap.

Stock No.	No. Pins	1-9	10-49	50
11055	24	4.98	\$4.35	\$3.90
11056	28	5.15	4.50	4.05
11057	40	6.81	5.95	5.35
11058	64	12.02	10.50	9.45

IC-KOOLERS™ from UNITRACK™ dissipate over 2 watts of heat from IC's producing longer life and better performance. Just push IC-Kooler on heat is collected from top and bottom of IC and dissipated. Won't shake loose!



### WILD ROVER

Touch switch capsule. Operating motion is .005" without the use of a levered arm. Extremely fast on and off with low noise. Normally open - rated 115 VAC, 1.6 amp-30 milliohm resistance - .615 radius by .160 thick.

Stock No.	1-9	10 & Up
12098	\$1.42	\$1.28

SCREW MACHINED SOCKET PINS, loose, packaged in bags of 100. Stock No. 11310 is solder tail with gold collet tin shell. Stock No. 11311 is wire wrap with gold collet gold shell.

Stock No.	Description	1 Bag	5 Bags	10 Bags
11310	Bag of 100 solder tail pins	\$ 4.95	\$ 4.45	\$3.95
11311	Bag of 100 wire wrap pins	11.95	10.75	9.50

### 3 X 4 Elastomeric Keyboards

Each keyboard has a p.c. board, elastomeric pad with contacts, ABS bodies and double shot molded keys. Max rating: 12 VDC @ 20mA. Contact Res: less than 500 ohms. Bounce: less than 10 m sec.

Stock No.	Operating Force	Key Travel	Price
11291	120±40g	2.0±.5mm	\$4.95 \$4.50
11292	90±40g	1.5±.5mm	3.95 3.60

### TI WIRE WRAP SOCKETS

Tin plated phosphor bronze contact - 3 wrap

Stock No.	No. Pins	1-99	100-499	500
11301	8	\$4.00	\$3.36	\$3.30
11302	14	.59	.54	.45
11303	16	.64	.58	.48
11304	18	.73	.66	.55
11305	20	.99	.90	.75
11306	22	1.12	1.02	.85
11307	24	1.25	1.14	.95
11308	28	1.52	1.38	1.15
11309	40	2.05	1.86	1.55

### TI LOW PROFILE SOCKETS

Tin plated copper alloy 688 contact pins with gas tight seal.

Stock No.	No. Pins	1-24	25-99	100
11201	8	\$1.00	\$0.99	\$0.99
11202	14	.14	.13	.12
11203	16	.16	.15	.14
11204	18	.18	.17	.15
11205	20	.20	.18	.16
11206	22	.22	.20	.18
11207	24	.24	.22	.20
11208	28	.28	.26	.25
11209	40	.40	.37	.33

### SUB CUB I and SUB CUB II are high quality, complete LSI Counter Modules with LCD readouts.

6 Digit LSI Counter Modules with LCD Readouts and Associated Mounting Assemblies

Stock No.	Description	Price
51070	Complete Function Evaluation Kit (includes batteries but does not include display counter)	\$45.00
51071	Mounting P.C. Board only	7.50
51072	SUB-CUB I display counter module only	18.00
51073	SUB-CUB II display counter module only	24.00
51074	Panel Bezel	12.00
51075	Evaluation Kit for SUB-CUB II (does not include SUB-CUB II counter module)	25.00

### SINGLE ROW SOCKETS

Strip of 25 collet sockets/pins mount odd-center components easily. Gold plated contacts.

Stock No.	1-99	100	500	1000
10850	\$1.09	\$0.90	\$0.82	\$0.72

### PIN FORMING TOOL

puts IC's on their true row to row spacing. One side is for .300 centers. Flip tool over for devices .600 centers. Put device in tool and squeeze.

Stock No.	Price
11059	\$12.95
10200	\$14.95

### OPCOA

Single Digit Displays - Common Cathode

Stock No.	Color	1	100
12082	Red	\$1.12	\$0.99
12085	Green	1.84	1.63
12087	Yellow	1.92	1.70
12089	Orange	2.08	1.84

### OPTEL LCD's with pins

Stock No.	Description	1	10
47005	3 1/2 dig. .5"	\$5.95	\$5.50
47006	4 dig. .5"	5.95	5.50
47007	4 dig. .7"	11.90	11.00

### The Battery Just Wrap™ Tool

New battery powered tool wraps insulated wire around .025" square posts without need for pre-cutting and pre-stripping. Complete with bit and 100 ft. .30 AWG wire.

Stock No.	Description	Price
13340	Battery just-wrap tool with bit and 100 ft. .30 AWG wire	\$59.95
13341	Replacement bit	10.35
13342	100 ft. blue replacement wire	7.54
13343	100 ft. white replacement wire	7.54
13344	100 ft. yellow replacement wire	7.54
13345	100 ft. red replacement wire	7.54

### MICRO Charts

colorful 8 1/2" x 11" charts eliminate the need to stumble through manuals and summaries. Fully decoded - instant access - totally comprehensive - gives pin outs, cycle times, buy notes, etc.

Stock No.	Reference	Price
23010	Z80 CPU	\$5.95
23011	6800A/800A	5.95
23012	6502 (65XX)	5.95
23013	6548 and relatives	5.95
23014	547400 TTL Pinouts	5.95
23015	Basic Algorithms	5.95
23016	6006/6008A	5.95
23017	How to generalize from a sample	5.95
23018	Wordstar	5.95

### ONE TOOL DOES 8 thru 40 PINS!

Hand Tool 11059 \$12.95  
ANTI-STATIC MODEL 10200 \$14.95

### Scotchflex® Breadboard Systems Basic kit

comes with 24 various Dual Sockets, 40 various Plug Strips, wire and tools. Kit can be used with any of the six boards.

Stock No.	Description	Price
03500	Basic Kit	\$79.95
03511	Basic board, 4.5 x 5.5	19.50
03506	Intel SBC-8010 Board, 12 x 6.75	64.95
03507	Motorola M-6800 Board, 9.75 x 6	42.95
03508	S-100 Board, 10 x 5.3	36.95
03509	Z-80 Board, 7.7 x 5	39.95
03510	Eurocard Board, 6.3 x 3.9	21.95

**SINTEC CO.**

28 8th St., Box 410  
Frenchtown, NJ 08825



TOLL 800-526-5960  
FREE in NJ (201) 996-4093

We accept VISA, MC, C.O.D. CHECK, or M.O. INCLUDE SHIPPING CHARGES 0 to \$100 - \$3.00 \$100 to \$250 - \$4.00 over \$250 - \$5.00

CIRCLE 73 ON FREE INFORMATION CARD



# FREE high tech catalog



Most Accurate Clock uses NBS atomic clock signal to keep "perfect" UTS time.



Crossfire Visual Tuning Indicator tunes RTTY transmissions fast.



Build one of the finest multi-purpose ham rigs available and save.



New scanner with 40 programmable channels, 7 bands.



Microelectronics make the new HW-9 QRP CW transceiver small and light.



World's first low-cost handheld, microprocessor-controlled Real Time Spectrum Analyzer.



"Universal" terminal interfaces computer, ham station for RTTY.



General coverage receiver has exceptional selectivity and sensitivity.



Triple-trace oscilloscope speeds troubleshooting.



Learn computers, programming with Micro-processor Trainer and course.



World's only automatic antenna tuner with 18 presets.



*More than just a catalog, a trustworthy guide to what's new in electronics and computers*

News about important product innovations is packed into every page of the quarterly, full-color Heathkit catalog. For many years, the illustrated Heathkit Catalog has been a guide to new and exciting kit products for people like you to build. To enjoy and learn from them, while saving money in the process. What sets the Heathkit catalog apart is its range of high quality products and accurate information to help make your buying decisions easy. All you have to do is fill out the coupon to get your copy.



Heath Company  
Dept. 020-324  
Benton Harbor, Michigan 49022

YES! Please send me a copy of the all-new FREE Heathkit Catalog.

Name \_\_\_\_\_

Address \_\_\_\_\_

City \_\_\_\_\_ State \_\_\_\_\_

AM-444B Zip \_\_\_\_\_

**Heathkit**<sup>®</sup>  
Heath  
Company

A subsidiary of Zenith Electronics Corporation

CIRCLE 86 ON FREE INFORMATION CARD



Up to eight input signals can be fed to the unit via a grouping of eight front-panel mounted BNC connectors. Input frequencies of up to 20 MHz (-3 dB) and voltage levels of up to  $\pm 5$  (10-volts P-P centered about zero volts) can be accommodated. The unit can withstand input voltages of up to  $\pm 50$ -volts.

For input signals of greater than  $\pm 5$  volts, some degree of attenuation is needed. For signals of up to  $\pm 50$  volts, a 10:1 attenuator probe

can be used. For greater signal levels, or a different level of attenuation, a simple voltage-divider can be used. The excellent instruction manual (more on that in a moment) provides information on several different voltage divider circuits, including variable and calibrated types.

The unit provides two outputs for connection to a scope. To generate the vertical-output signal, the input signals are scanned sequentially and summed with the

Global		8001												
OVERALL PRICE														
EASE OF USE														
INSTRUCTION MANUAL														
PRICE/VALUE														
		1	2	3	4	5	6	7	8	9	10			
		Poor		Fair			Good			Excellent				

output of a staircase generator. The amplitude of the input-signal portion of the output signal can be varied from 0 to 75 mV by using the front-panel MULTIPLEXER GAIN control. That control affects the amplitude of all input signals equally. The scanning rate can be varied from 40 kHz to 1 MHz using the RATE control. That control is adjusted for minimum trace flicker.

The trigger output is used to supply a trigger signal to the scope. The unit uses the signal present on channel 1 to generate the scope trigger pulse. As such, all signals to be displayed should be time-related to the channel 1 signal; otherwise an asynchronous display will result. In addition, the lowest frequency signal should be connected to channel 1.

The trigger circuitry in the 8001 is limited to 10 MHz. At that point, the trigger signal becomes a positive DC voltage. For applications where the lowest signal of interest is greater than 10 MHz, the scope trigger must be connected directly to the signal source rather than the multiplexer.

The pulse width of the trigger signal is switch (internally located) selectable between 0.1 and 1.0  $\mu$ s. The trigger threshold level is variable between -5 and +5 volts. A POLARITY switch selects whether triggering will take place on the positive-or negative-going edge of the trigger signal.

The unit offers several options in terms of the trace display. Possible multiple-channel displays include all eight channels, the first four channels, or the last four channels. The multiplexer is also capable of a single-channel display. In that mode, only one trace is displayed at a time. Successive channels can be viewed by pressing the front-panel INCREMENT switch. A PUSH-TO-CALIBRATE switch

## Aces high with circuit builders.

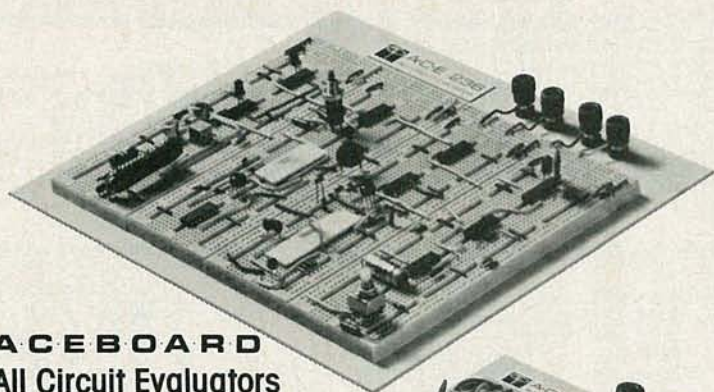

### ACEBOARD All Circuit Evaluators for solderless circuit building and testing.

A P PRODUCTS made the first solderless breadboard way back in 1968, and we still make them best. Because our experience taught us to avoid the pitfalls that can mean circuit errors. We do it by paying attention to details. Like using noncorrosive nickel-silver in our frankly superior terminals. And like sealing each contact cell with an adhesive-coated polyethylene foam that prevents short circuiting. That's why you can count on the reliability of our solderless boards when you specify any one of the 10 different ACEBOARD models that offer from 728 to 5424 tie points, and 2 to 36 buses.

A P PRODUCTS made the first modern solderless breadboard, and we still make the best.

Call Toll Free 800-321-9668 for the name of the distributor nearest you. In Ohio, call collect (216) 354-2101.



® A P PRODUCTS INCORPORATED  
9325 Progress Parkway  
P.O. Box 540  
Mentor, Ohio 44060  
(216) 354-2101  
TWX: 810-425-2250

CIRCLE 76 ON FREE INFORMATION CARD



# Where's Your **ELECTRONICS** Career Headed?

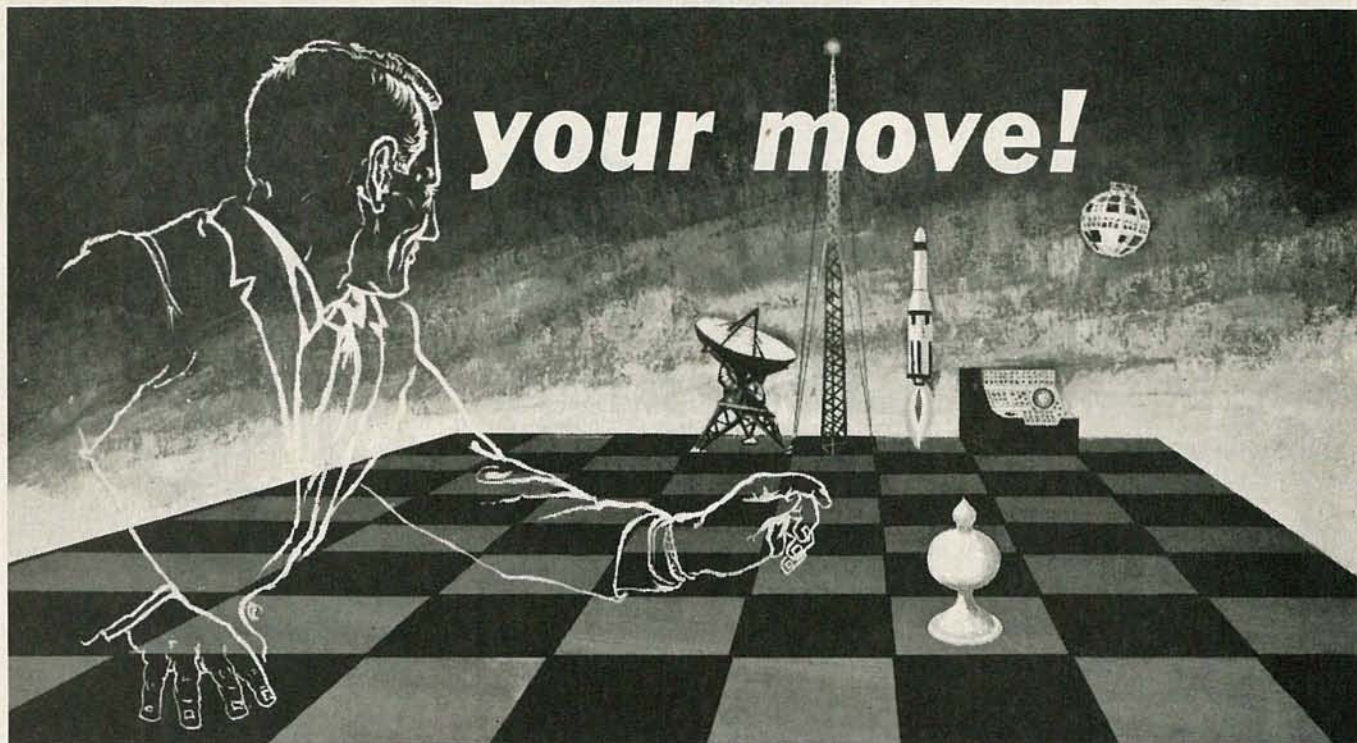

## The Move You Make Today Can Shape Your Future

Yes it's your move. Whether on a chess board or in your career, you should plan each move carefully. In **electronics**, you can *move ahead* faster and further with a

## B. S. DEGREE

Put professional knowledge and a COLLEGE DEGREE in your electronics career. Earn your degree through independent study at home, with Grantham College of Engineering. No commuting to class. Study at your own pace, while continuing your present job.

The accredited Grantham non-traditional degree program is intended for mature, fully employed workers who want to upgrade their careers . . . and who can successfully study electronics and supporting subjects through

### INDEPENDENT STUDY, AT HOME

Free Details Available from:

**Grantham College of Engineering**  
10570 Humbolt Street  
Los Alamitos, California 90720

### Independent Home Study Can Prepare You

Study materials, carefully written by the Grantham staff for independent study at home, are supplied by the College, and your technical questions related to those materials and the lesson tests are promptly answered by the Grantham teaching staff.

### Recognition and Quality Assurance

Grantham College of Engineering is accredited by the Accrediting Commission of the National Home Study Council.

All lessons and other study materials, as well as communications between the college and students, are in the English language. However, we have students in many foreign countries; about 80% of our students live in the United States of America.

**Grantham College of Engineering** R8-85  
10570 Humbolt Street, Los Alamitos, CA 90720

Please mail me your free catalog which explains your B.S. Degree independent-study program.

Name \_\_\_\_\_ Age \_\_\_\_\_

Address \_\_\_\_\_

City \_\_\_\_\_ State \_\_\_\_\_ Zip \_\_\_\_\_



# Radio-Electronics mini-ADS

zeros all traces to allow proper positioning on the scope.

The instruction manual that accompanies the unit is nothing fancy, but it performs its intended function very well. As the unit is extremely easy to use, a great deal of space is devoted to the theory of operation of the unit, and maintenance and calibration details. Interestingly, while a complete schematic diagram is provided, there is only a partial parts-placement diagram; only adjustments and test points for calibration are shown.

The model 8001 is covered by a 1-year warranty. It sells for \$450. R-E

## Hayes Smartmodem 2400

*Is 1200 baud communication fast enough for you?*



CIRCLE 6 ON FREE INFORMATION CARD

ONCE UPON A TIME THERE WAS ONLY one kind of modem—a 110-baud acoustically coupled type. Well, time marches on. The rubber cups went the way of whale bone corsets and common baud rates increased as inevitably as taxes. What started at 110 baud became 300, 300 became 1200, and now we've arrived at 2400-baud modems for home computers.

The latest advance has come from Hayes. They've been making top quality products since 1978, and have earned a reputation for innovative technology and reliability. The Smartmodem 2400 has all the features you could possibly think of and a few that might not have occurred to you.

First of all, like all Hayes products, this is an intelligent modem. It has an extensive command set you can use to control every aspect of its operation; commands may be issued either directly from



**THE WIRELESS TELEPHONE TRANSMITTER** model WTT-20 is only the size of a dime, yet transmits both sides of a telephone conversation with crystal clarity. Completely automatic Uses power from the telephone line itself. Never needs a battery! Up to ¼ mile range. Use with any FM radio. Complete kit only \$29.95. Tax included. FREE SHIPPING. DECO INDUSTRIES, Box 607, Bedford Hills, NY 10507. (914) 241-2827. CIRCLE 127 ON FREE INFORMATION CARD



**IntelliBurner EPROM-EEPROM & MICRO-CONTROLLER programmer \$299** Communicates through the serial port of any personal computer. Use your PC's modem software to read, verify, or program all popular EPROMs, EEPROMs and 87xx series micro controllers. Custom software included for IBM, CP/M or Radio Shack PCs. Other programmers from \$149. Bare PC boards with software from \$39. ROSS CUSTOM ELECTRONICS, 1307 Darlene Way #A12, Boulder City, NV 89005. 702-293-7426. CIRCLE 254 ON FREE INFORMATION CARD



**ZENITH SSAVI DESCRAMBLERS only \$169**; GATED PULSE & SINEWAVE decoders \$199 each. Reconditioned. Original equipment for UHF chs. 23,27,31, 48,50,51,54,57,60,67,68 etc. Quantity discounts. Surplus Cable TV equipment: Jerrold SB-3, Oak N-12, Zenith Z-Tac, Hamlin 1200, etc. Catalog \$1. 10 days satisfaction guarantee & 90 day warranty. AIS SATELLITE, P.O. Box 1226-E, Dublin, PA 18917. 1-800-643-2001 or 215-249-9411. CIRCLE 258 ON FREE INFORMATION CARD

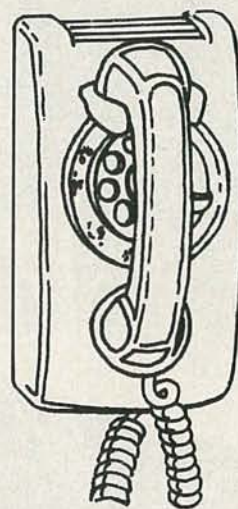

**CALL NOW  
AND  
RESERVE  
YOUR SPACE**

- 6 x rate \$650 per each insertion.
- Reaches 225,016 readers.
- Fast reader service cycle.
- Short lead time for the placement of ads.
- We typeset and layout the ad at not additional charge.

Call 212-777-6400 to reserve space. Ask for Arline Fishman. Limited number of pages available. Mail materials to: mini-ADS. RADIO-ELECTRONICS, 200 Park Ave. South, New York, NY 10003.



**ELECTRO IMPORTING CO. CATALOG.** This reprint of the historic 176-page catalog No. 20 gives you an accurate look at the state of electronics in 1918. Contains everything from a Zinc Spark Gap to a 1000-Mile Receiving Outfit. You can get your own copy of this modern antique, profusely illustrated, for only \$4.95 plus \$1.00 P&H. Order yours from R-E BOOKSTORE, Radio-Electronics, 200 Park Avenue South, New York, NY 10003.



# Radio-Electronics mini-ADS

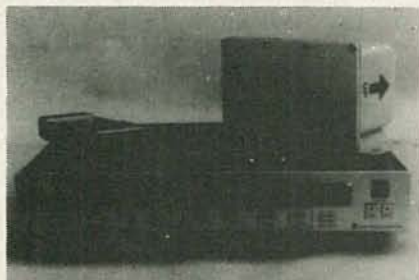

**SATELLITE TELEVISION RECEIVER SEMIKIT** with dual conversion downconverter. Features infrared remote control tuning, AFC, SAW filter, RF or video output, stereo output, Polorator controls, LED channel & tuning indicators. Install six factory assembled circuit boards to complete. **Semikit \$300.00**. Completed downconverter add **\$100**. Completed receiver and downconverter add **\$150**. **JAMES WALTER SATELLITE RECEIVER, 2697 Nickel, San Pablo, CA 94806. Tel 415-724-0587.**  
**CIRCLE 124 ON FREE INFORMATION CARD**



**SINGLE AND DUAL TRACE Scopes, Analog and Digital Multimeters, Power Supplies, High Voltage and Low Cap. Probes RF and Sine/Square Wave Generators, Digital Capacity Meters. EMCO ELECTRONICS, P.O. Box 327, Plainview, NY 11803. Send for your free catalog.**  
**CIRCLE 259 ON FREE INFORMATION CARD**

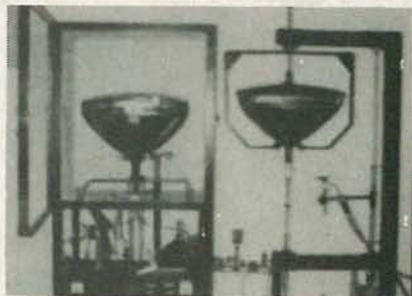

**ONE MAN CRT FACTORY, easy operation.** Rebuild CRT's for tv's, bus. machines, monitors, scopes, etc. Color, b&w, 20mm, foreign or domestic. 3x6 ft. space required. Profits??? Average CRT rebuilding costs—\$5. Sell for \$100 = \$95 profit; x 5 CRT's = \$475 daily; x 5 days = \$2375 weekly profit. Higher profits overseas. Investigate this opportunity today. We service the entire world. Contact: **CRT FACTORY, 1909 Louise St., Crystal Lake, Il. 60014, (815) 459-0666.**



**SUBSCRIPTION TV MANUAL.** This information packed book details the methods used by subscription TV companies to scramble and descramble video signals. Covers the Sinewave, Gated Pulse, SSAVI system, and the methods used by most cable companies. Includes circuit schematics, theory, and trouble shooting hints. **Only \$12.95 plus \$2.00 first class P&H. ELEPHANT ELECTRONICS INC., (formerly Random Access) Box 41770-R, Phoenix, AZ 85080**  
**CIRCLE 120 ON FREE INFORMATION CARD**

## CALL NOW AND RESERVE YOUR SPACE

- 6 x rate \$605 per each insertion.
- Reaches 235,323 readers.
- Fast reader service cycle.
- Short lead time for the placement of ads.
- We typeset and layout the ad at not additional charge.

Call **212-777-6400** to reserve space. Ask for Arline Fishman. Limited number of pages available. Mail materials to: mini-ADS. RADIO-ELECTRONICS, 200 Park Ave. South. New York, NY 10003.

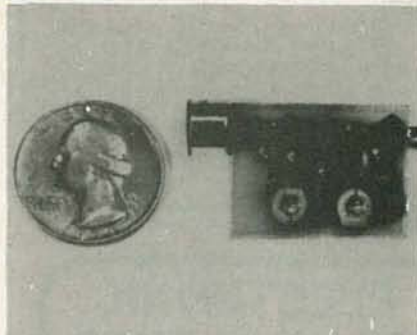

**THE MOST EXCITING KIT YOU WILL EVER BUILD** The model WAT-50 miniature FM transmitter uses a 4-stage circuit NOT to be confused with a simple wireless microphone. Up to 1 mile range. So sensitive, it will pick-up a whisper 50 feet away! Use with any FM radio. Complete kit only **\$29.95** tax incl. **FREE SHIPPING. DECO INDUSTRIES, Box 607, Bedford Hills, NY 10507. (914) 241-2827.**  
**CIRCLE 127 ON FREE INFORMATION CARD**



**MODERN ELECTRICS.** Miniature souvenir of the first publication ever produced by Gernsback Publications. This issue appeared in April 1908—just 75 years ago. You can own your own reprint of this unique first edition for just **\$2.50** plus 75c P&H. It's available from **R-E BOOKSTORE, Radio-Electronics, 200 Park Avenue South, New York, NY 10003**

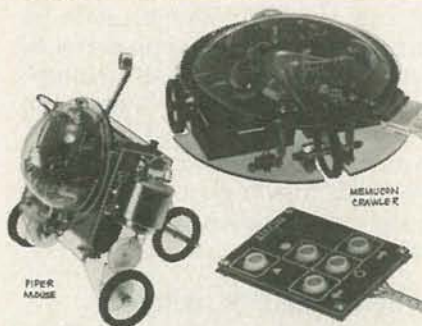

**INVASION OF THE ROBOTS.** NEW from ELECTROMANIA, the entire "MOVIT" ROBOT line. This month's specials: **PIPER MOUSE**, Command Whistle (included), turns left, stops, right, advances, \$39.95. **MEMOCON CRAWLER** Keyboard programmable Robot for lights, horn, movement, \$69.95. Both require assembly. Educational and fun. Master-Visa. **1-800-632-4441 NY STATE, 1-800-645-4441 Nationwide.**  
**CIRCLE 260 ON FREE INFORMATION CARD**



**TELEPHONE ANSWERING MODULE.** ENABLES ANY CASSETTE RECORDER TO ANSWER PHONE AND TAKE MESSAGES! This module automatically answers phone after 1 ring; sends "beep" signal; and activates your recorder for 20 second message. Fully assembled & tested. All patch cords included. Only **\$29.95**, tax included. **FREE SHIPPING.** 30 day money back guarantee. Dealer inquiries welcome. **REBEL ELECTRONICS, P.O. Box 15785, Plantation, Florida 33318.**  
**CIRCLE 262 ON FREE INFORMATION CARD**



# SUPER LONG PLAY TAPE RECORDERS

10 Hour Model — \$95.00\*  
14 Hour Model — \$159.00\*

Modified Panasonic Slimline, high quality, AC-DC Recorders provide 5 or 7 continuous hours of quality recording & playback on each side of cassette for a total of 10 or 14 hours depending on model. Built-in features include • Voice level control • Digital counter, etc. TDK DC 180 Cassette Furnished.

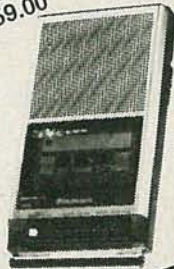

## PHONE RECORDING ADAPTER

Records calls automatically. All Solid state connects to your telephone jack and tape recorder. Starts recording when phone is lifted. Stops when you hang up.

\$24.50\*

FCC APPROVED

**VOX VOICE ACTIVATED CONTROL SWITCH**  
Solid state. Self contained. Adjustable sensitivity. Voices or other sounds automatically activate and control recorder. Uses either recorder or remote mike. \$24.95\*  
\* Add for ship & hdg. Phone Adapter & Vox \$1.50 ea. Recorders \$4.00 ea. Cal. Res. add tax. Mail order, VISA, MIC, COD's OK. Money Back Guarantee. Qty. disc. avail. Dealer Inquiries invited. Free data.  
**AMC SALES INC.** Dept A 9335 Lubec St., Box 928, Downey, CA 90421 (213) 869-8519

CIRCLE 108 ON FREE INFORMATION CARD

# ELECTRONIC COMPONENTS



176 PAGE

## FREE CATALOG

### MANUFACTURERS OF QUALITY ELECTRONIC COMPONENTS

- BATTERY CLIPS & HOLDERS
- CABLE SETS • CONNECTORS • CAPACITORS
- DISPLAYS • LEDs • FUSES • JACKS & PLUGS
- KNOBS • LAMPS • POTENTIOMETERS
- RF COILS • RELAYS • RESISTORS
- SWITCHES • SEMICONDUCTORS • SPEAKERS
- TEST EQUIPMENT • TRANSFORMERS • TOOLS
- WIRE & CABLE

OVER 15,000 DIFFERENT ITEMS IN STOCK!

- Sales and Order Desk Open from 6:00a.m. (PST)
- TERMS: C.O.D., Visa, MasterCard (Open Accounts Available)
- Phone and Mail Orders Welcome
- Catalogs Mailed Outside USA Send \$2.00

## MOUSER ELECTRONICS

11433 WOODSIDE AVE. SANTEE, CA 92071  
PHONE (619) 449-2222 TWX 910-331-1175

CIRCLE 117 ON FREE INFORMATION CARD

Hayes	Smartmodem 2400									
OVERALL PRICE	[Bar chart showing Hayes score of 5 and Smartmodem 2400 score of 6]									
EASE OF USE	[Bar chart showing Hayes score of 8 and Smartmodem 2400 score of 9]									
INSTRUCTION MANUAL	[Bar chart showing Hayes score of 8 and Smartmodem 2400 score of 9]									
PRICE/VALUE	[Bar chart showing Hayes score of 8 and Smartmodem 2400 score of 9]									
	1	2	3	4	5	6	7	8	9	10
	Poor			Fair			Good			Excellent

the keyboard or inside running programs. The command syntax itself is a curious carryover from the early days of telecommunications. All the commands have to be prefixed with the letters "AT" - just like the old Attention Codes from the era of teletypes and paper tape.

Everything from the baud rate to the speaker volume can be set by using the AT commands and the settings you select will be written into the Smartmodem's RAM. If the command is issued correctly, the modem will let you know by printing "OK" on the screen. And if you fumble on the keyboard, the modem will let you know by responding with the word "ERROR". In all, there are ten result codes that the modem can put on the screen. They range from letting you know if a dial tone is present on your line to whether or not the number you're calling is busy.

Hayes has also included a series of commands for testing both the modem and your terminal. You can tell the modem to do a local loopback to test your equipment, or loop the TELCO lines to test the equipment on the other end. As always, you'll get an indication on the screen to let you know exactly what's going on. All those messages not only make it easier to keep track of things; if you write your own modem software you'll find that they'll go a long way toward cutting down your programming time.

### Where's the DIP switch?

Configuring the modem for a particular set of communication settings is easy. All the parameters—baud rate, bit settings, how many rings to wait, etc. are stored in memory. How they're stored depends on whether you want them for just one session or decide to

keep them permanently. As with most modems, temporary storage is done by keeping the configuration in RAM. Unlike other modems, permanent storage does *not* involve setting any DIP switches!

Hayes has replaced the dreaded DIP switches with non-volatile memory. Permanently configuring the modem involves nothing more than telling it what settings you want and then issuing a "write" command. That's all there is to it! As an added bonus, since the factory default settings are in the modem's firmware, resetting it is only a matter of issuing another command. The idea of storing-system defaults in non-volatile memory is a great idea and we'd be surprised if it didn't start to show up in other peripheral devices. Printers, for example, could for that approach.

The Smartmodem 2400 is a stand-alone unit that's set up to accept a standard RS-232 connector, and a group of LED's on the front let you keep track of the modem's status.

At the moment there aren't a lot of dial-up services that can support 2400 baud, but that's the way it used to be when 1200 baud started to become popular. It's only a matter of time. And while you're waiting for your favorite bulletin boards to upgrade to 2400 baud, there are still a lot of advantages to the Smartmodem 2400. It has every possible feature you could want in a modem and it's incredibly easy to use.

The manual is well written, comprehensive, and goes over every aspect of the modem in an easy-to-understand, step-by-step fashion. The Smartmodem 2400 has a 2 year warrantee that can be extended to 4 years for a \$75 charge.

The modem has a retail price of \$899. That may seem a bit steep, but don't forget that every time you communicate at 2400 baud, you're cutting your connect time charges in half (at least)!

Hayes products have always been regarded as top-of-the-line modems, and one look at the Smartmodem 2400 will tell you why. In everything from the packaging to the product, this modem will set industry standards for years to come.

R-E



# REACH FOR RELIABILITY

REPLACEMENT  
**SK**  
SOLID STATES

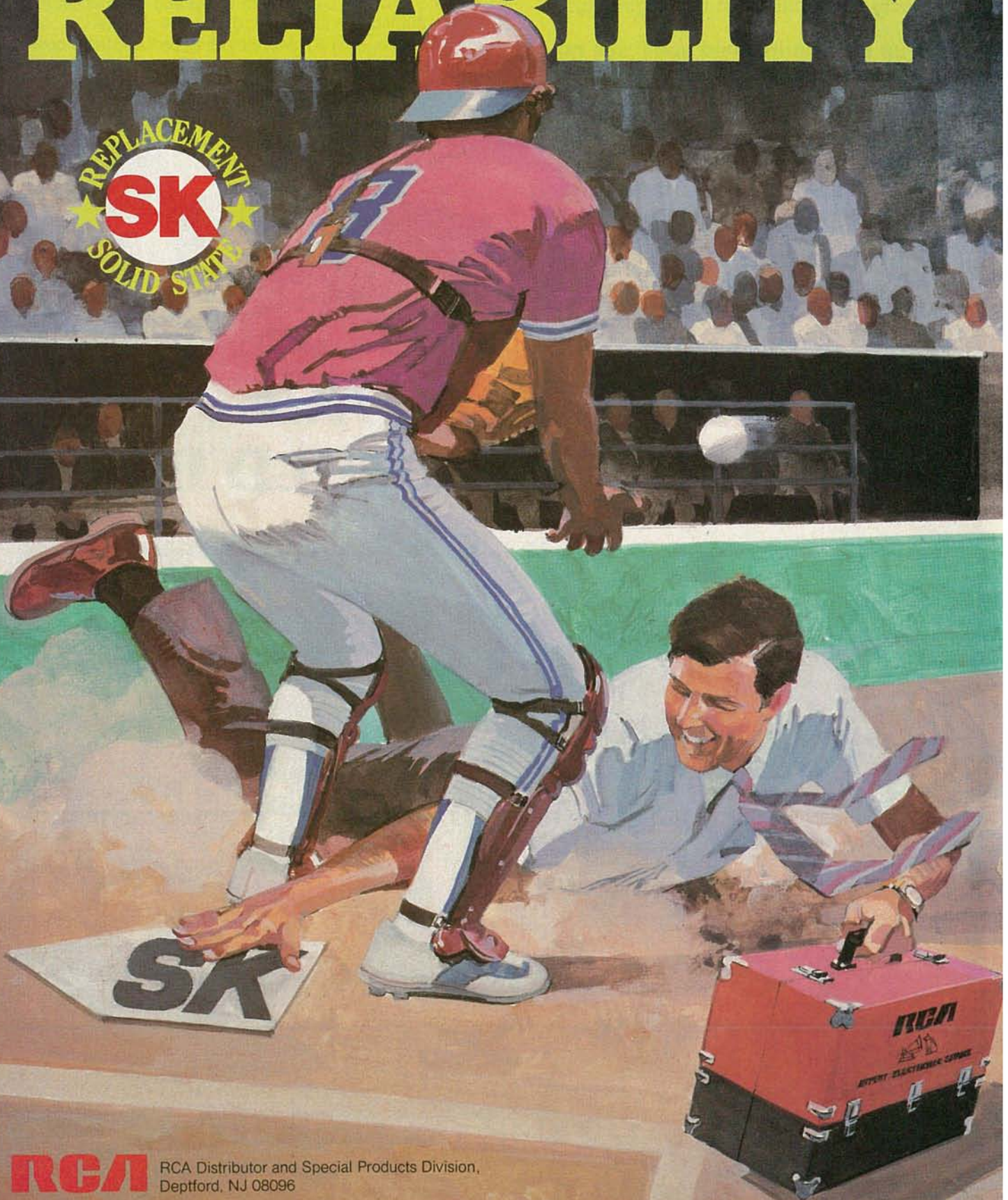

**RCA**

RCA Distributor and Special Products Division,  
Deptford, NJ 08096



## Iwatsu's Four Independent Channel Scope.

There's 30 years of oscilloscope design and manufacturing experience behind the SS-5710-11 Series. Experience that translates to 27,000 hours MTBF. Four independent channels with no trace shift. A 3 year warranty. And that's just the beginning.

### Add up our features and you'll see no other scope measures up.

The list starts with easy to read controls that make any Iwatsu scope, a pleasure to work with.

Then there's features like excellent linearity for high-frequency measurement. A special jitterless circuit, making it easier to trigger signals. Independent A and B triggers for digital applications. Plus a guaranteed time difference between channels.

### More reasons for choosing Iwatsu.

- 20 kV 6" CRT with auto focus
- Maximum sweep speed of 2ns
- Separate intensity controls for A & B sweep
- Wide operating temperature range from -10°C to 50°C
- SS-5711C includes an optional counter/timer
- SS-5711D comes with DMM and counter/timer
- 60MHz Model SS-5710 is our 4-channel scope...just \$1,245 including probes, front cover and pouch
- SS-5710 is also available with optional counter/timer as well as DMM



# HERE'S A FACE ANY ENGINEER COULD LOVE.

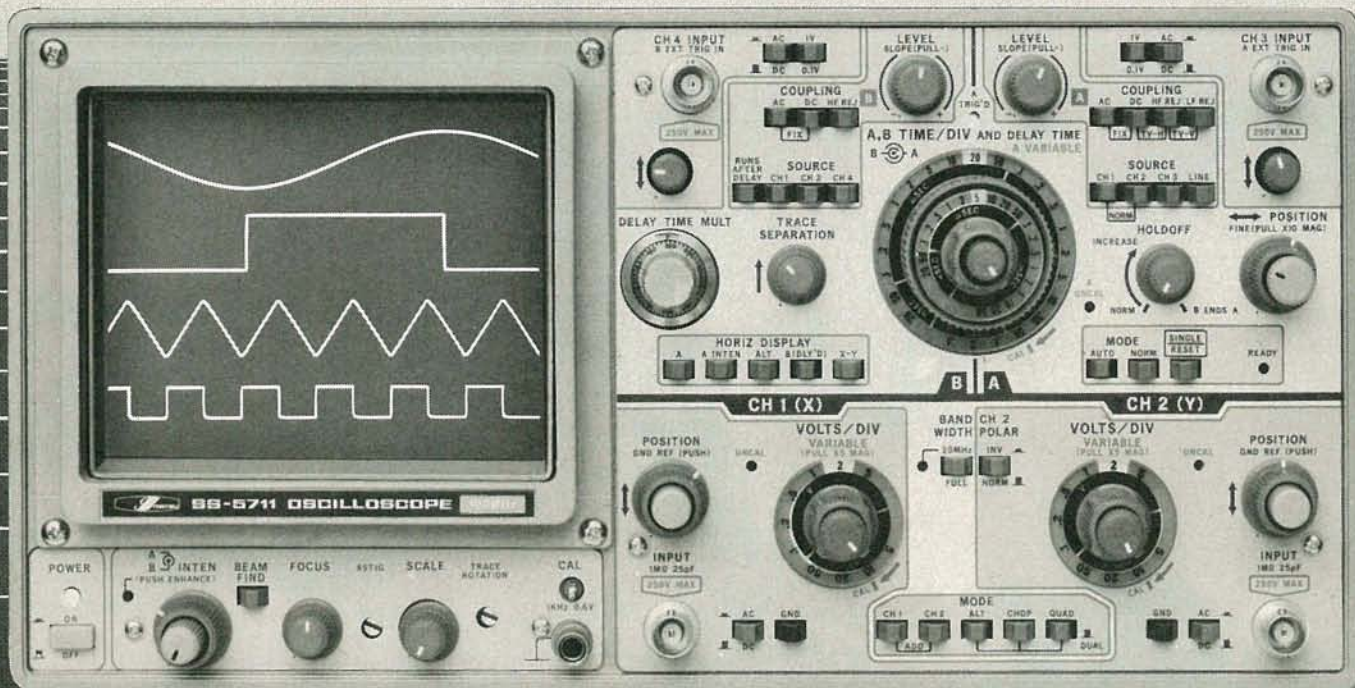

SS-5711 4-Independent Channel 100 MHz Scope including probes, pouch, and front cover: \$1,695.



**IWATSU INSTRUMENTS INC.**

430 COMMERCE BOULEVARD, CARLSTADT, NJ 07072 PHONE: (201) 935-5220, TWX: 710-989-0255

CIRCLE 64 ON FREE INFORMATION CARD



# BUILD THIS

## SEE-IN-THE-DARK

THE PHRASE "SEEING IN THE DARK" is a misleading one. With the possible exception of mystics and mutants, when the lights go out, we all walk into walls. Being able to see in the dark all depends on what you mean by "dark." The human eye is only sensitive to a very narrow band of the electromagnetic spectrum, as shown in Fig. 1. Figure 2 shows the eye's relative sensitivity to wavelengths in that narrow band.

The infrared portion of the electromagnetic spectrum is just below visible light and extends from about 700 to well past 10,000 millimicrons. The human eye is normally insensitive to electromagnetic radiation in that region. In order to produce a visible image using infrared light, then, we need a device that's both sensitive to infrared and able to translate an infrared image into one that the human eye can see. One such device is the RCA 6032 image converter tube, and that tube is the heart of the infrared viewer that we'll show you how to build.

The 6032 can be thought of as being divided into two parts. The front end is a photosensitive cathode that responds to infrared radiation in the range of 500 to 1200 millimicrons. Whatever image is focused on the cathode is reversed left-to-right and passed on to the second part of the tube. That is a small fluorescent screen on which the visible image is formed. Focusing the image on the screen is done electrostatically—a voltage is applied to the focus ring at the tube's center and controls the convergence and divergence of the electrons being aimed at the screen's phosphor. That is similar to the way the electron gun is focused in a television set.

### Building the viewer

The schematic of our viewer is shown in Fig. 3. As you can see, the circuit's only job is to produce the voltages that the image converter tube needs to operate. Before we start talking about how the circuit works and what's needed to actually build it, there are two things that have to be said.

**CAUTION! The tube needs about 12,000 volts to operate, and 12,000 volts is a very serious amount of voltage! Because of that, the utmost care must be**



## VIEWER

ROBERT GROSSBLATT

*"See in the dark"  
with this easy-to-build  
infrared viewer!*

**observed when working with this circuit. Any carelessness is dangerous, and could very possibly be fatal. BE VERY, VERY CAREFUL!**

That caution should be taken seriously, even though the circuit is powered by a 9-volt battery. That's because our power supply is capable of producing as much as 15,000 volts from a fresh battery. Also, although the tube only needs a handful of microamps to operate, the supply can produce over 200 microamps. There's a world of difference between 200 microamps at 10 volts and 200 microamps at 15,000 volts! Once again, 15,000 volts can be lethal, even if the current is negligible. Be careful!

Secondly, the tube itself is made of glass and, just as any other type of electronic tube, it contains a vacuum. Although the glass is thick and the tube is

strong, the tube will implode if punctured. Now, flying glass from such an occurrence is bad enough, but the phosphor on the screen can do you a lot of damage if it gets into a cut. To avoid any problems, handle the tube carefully and when you solder the high-voltage leads on the tube, make sure the iron is in contact with the tube for as short a time as possible. Tin the wire ahead of time and *never—repeat, never—*solder near the tube's glass seals.

Keeping those warnings in mind, let's take a look at the circuit.

The first stage of the power supply is an oscillator formed basically by Q1, Q2, and part of the primary of T1. Resistor R1 keeps the circuit unbalanced so that oscillation will start when power is first applied. The base current for the transistors is produced by induction in T1 and is limited by R2. The switching action of the transistors causes the induced voltage in T1 to switch polarity and that alternatively turns on Q1 and Q2 in turn. The two diodes, D1 and D2, are steering diodes for the base current.

When S1 is closed, current flows through R1 and T1. The base drive for the transistors comes from T1's stand-alone winding. Because the two transistors are being driven out of phase, the circuit begins to oscillate. That causes an induced voltage to appear across T1's secondary. How great that voltage will be depends on how much voltage is available from the battery. Assuming that the battery is between 7 and 9 volts, the induced voltage on T1's secondary will be between 200 and 300 volts.

That voltage is rectified by the full-wave bridge made from diodes D3 to D6. Capacitor C2 is charged through D7 and R3, setting the stage for the next part of the circuit's operation. Transistor Q3 is the center of a timing circuit with an R-C constant determined by the values of R6, R7, and C3. The 15-microsecond pulse produced by that part of the circuit fires SCR1, and causes C2 to discharge, inducing a high-voltage pulse in the secondary of T2. That voltage is rectified by D9.

The voltage produced by the discharge of C2 is boosted by the inductance of T2's primary and that negative overshoot causes the SCR to turn off. As soon as the SCR turns off, the whole process starts all over again.



The image-converter tube requires a high voltage in order to focus the image on the fluorescent screen. That voltage is applied via a voltage-divider circuit made up of R8 and R9. Don't forget that by the time power gets up to the tube, we're talking about some 12,000 volts at fairly high peak-current values. The values for those two resistors are extremely high because only flea power is needed at the focus ring of the tube. Excessive current can destroy the tube, so the resistor values are probably higher than you've ever seen before.

Getting the tube to produce a sharp image is a matter of providing the right voltage at the focusing ring. The value of 2000 megohms for R9 can be considered a final value, but the voltage will have to be adjusted by daisy-chaining resistors together to form R8. A value of 200 megohms is a good starting point; the optimum value, which varies from tube to tube, will be within 15% of that.

If the operation of the power supply seems familiar to you, it's probably because the same basic principles are used in the design of most automobile capacitive discharge systems. The same sort of

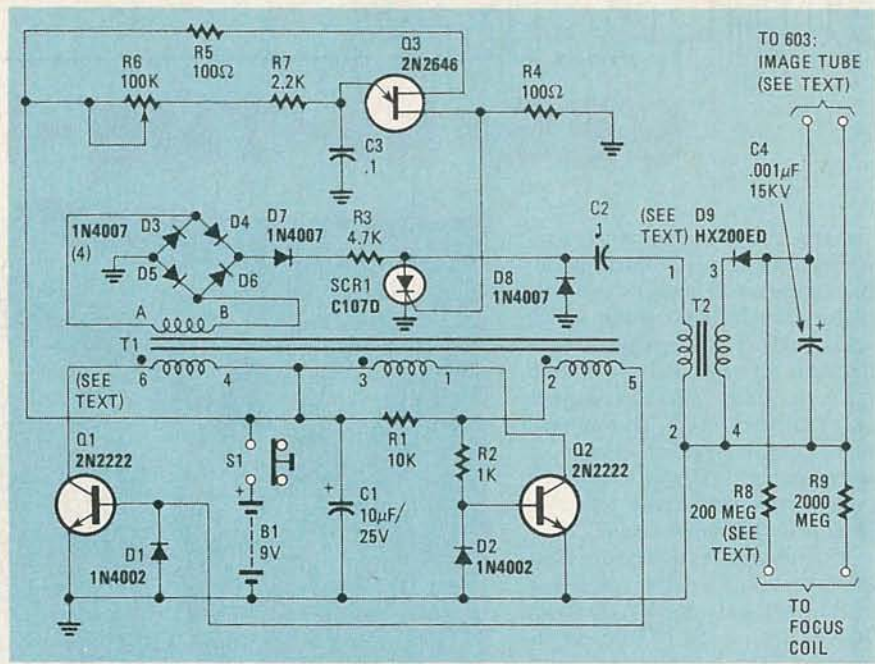

FIG. 3—THIS POWER SUPPLY can produce up to 15,000 volts from a single 9-volt nickel-cadmium battery.

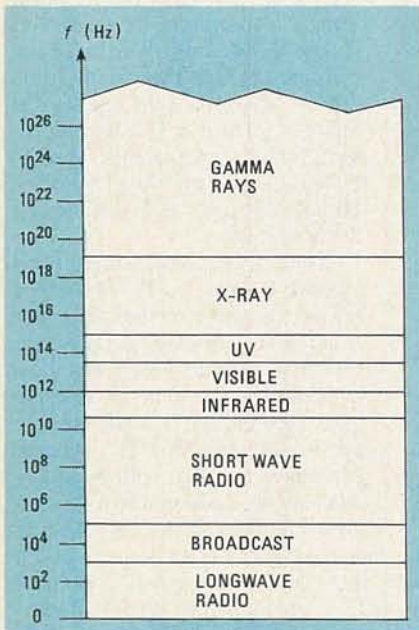

FIG. 1—VISIBLE LIGHT takes up only a small slice of the electromagnetic spectrum.

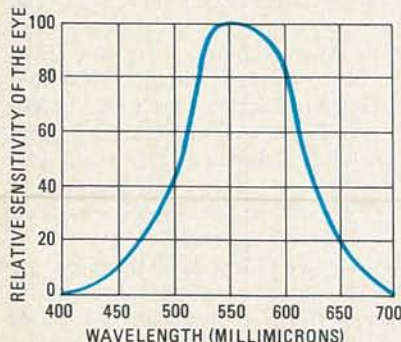

FIG. 2—THE EYE IS most sensitive to light in the range of 550 millimicrons.

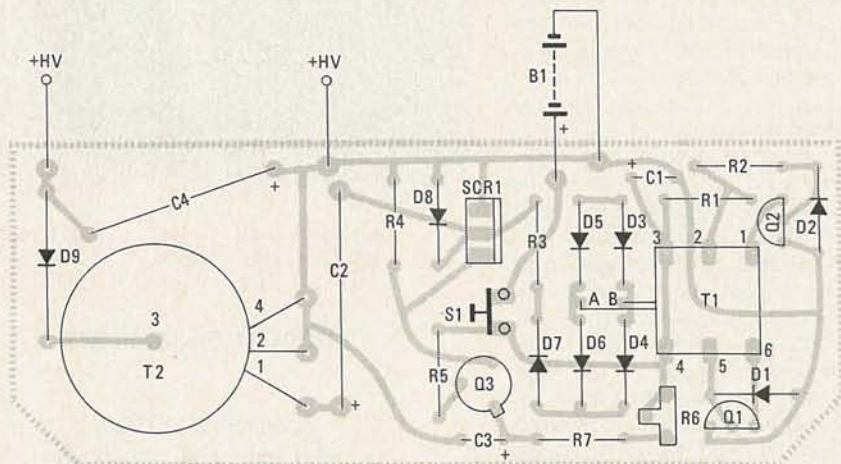

FIG. 4—IF YOU CHOOSE TO use a PC board, this parts-placement diagram should be followed.

pulsed high voltage is needed to make the spark plugs fire. And if you've ever fooled around under the hood of a car, you know that you can be knocked over backward by the juice at the plugs. Once again: **BE CAREFUL WHEN YOU ARE WORKING WITH THE HIGH VOLTAGES INVOLVED IN THIS PROJECT.**

### Construction

Building the circuit for the infrared viewer is relatively straightforward and can be done on either a perfboard or PC board. We recommend using a PC board; an appropriate pattern is provided in our "PC Service" section, on page 78, and the corresponding parts-placement diagram in Fig. 4.

Whatever method you choose, because we're dealing with high voltages, there are several considerations that are different from a low-voltage circuit:

- All solder joints must be clean and shiny. Because of the voltages involved, anything less than a perfect joint will cause arcing.
- Leads must be absolutely cut as short as possible.
- All the components on the board, and especially those that follow T1, should be locked in position with paraffin, varnish, or high-voltage putty.

The first step is to mount and solder the components onto the board. Do not, however, mount the high-voltage portion of the circuit (T2 and the circuitry on the secondary side of that transformer). Before building that part of the circuit, you need to verify that the balance of the project is operating correctly. When you mount the components on the board, pay attention to the polarities of the diodes and capacitors. Make sure that the transistors are correctly oriented and the transformer



leads are properly identified. Do your soldering only when you're sure that everything is correct.

The next step is to verify that everything to this point is operating correctly. Connect the leads from an ohmmeter to the battery clips and press S1. That is an easy way to make sure you don't have a short across the power supply. If that checks out fine, connect the power leads to a 6-volt supply and measure D7's anode voltage. You should see about 175 volts there, and the drain on the 6-volt supply should be no more than 75 mA. *Be very cautious* when you're taking those measurements. It may seem that 175 volts is a long way from 15,000 volts, but that voltage can still do a bit of damage.

Once everything checks out, you can mount and wire the rest of the circuit. If you don't get the proper readings, check your connections on the board again. The circuit is simple enough for you to be able to find your mistake without too much irritation.

Take the high-voltage leads and tape them down so that they're about a quarter of an inch apart. Connect the circuit to the 6-volt source again and you should see sparking at the output. You have to adjust R6 for the minimum spark rate. If you watch the current draw, you should see it drop as the sparking rate is reduced.

Once again a word of caution. Anytime you're adjusting a circuit that produces high voltage, you want to be absolutely sure to isolate yourself from the board. That means that a metal-bladed screwdriver, or anything else metal, for that matter, to make adjustments is a definite no-no. And contrary to popular belief, you don't want to use a wooden anything either. High voltages do weird things and that includes traveling through anything that is even the least bit conductive. Wood is porous, can absorb moisture from the air; the result can very well be you lying on the floor!

Once you've finished assembling the high voltage supply and you're sure it works, you're ready to tackle the image converter tube. But just as there was for the power supply, there are some precautions to keep in mind for this part of the assembly as well.

- When you're soldering connections to the various rings on the tube, do it as quickly as possible. Tin the wires before you solder the connections. If you apply too much heat for too long, you'll destroy the glass-to-metal seals on the tube.

- The tube is made of glass and contains a vacuum. The weakest points on the tube are at the small areas where the glass was sealed after the tube was assembled. **Keep your iron and any solder away from the glass in general and those seals in particular.** The glass can implode and the phosphor coating on the screen can cause you a great deal of trouble.

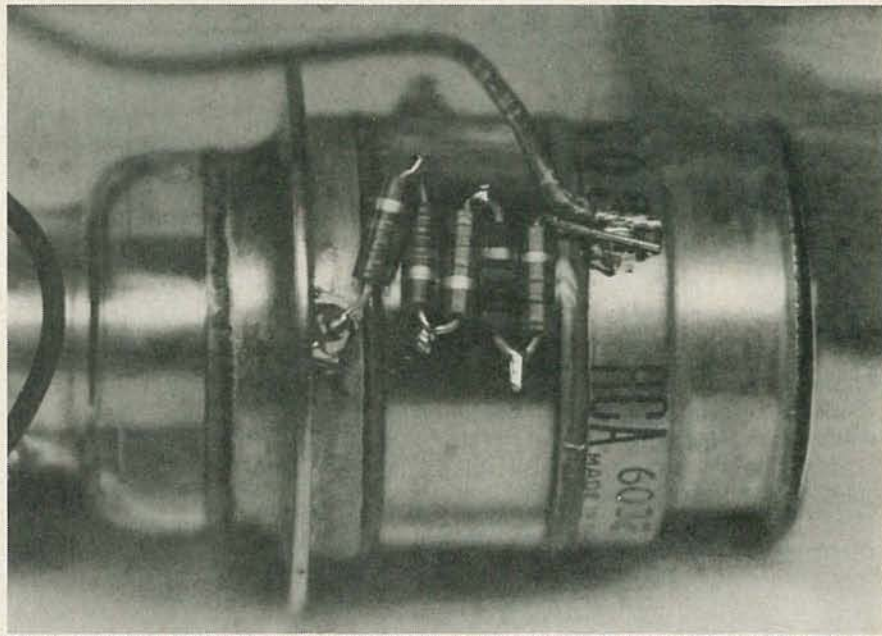

FIG. 5—SEVERAL RESISTORS will need to be daisy-chained to obtain the value needed for R8.

With those precautions in mind, solder R9 between the focus ring and the ring surrounding the fluorescent screen. Once you've done that, solder short pieces of wire to the ring surrounding the objective end of the tube and another point on the focus ring. Temporarily connect R8 across those pieces of wire as well as the high voltage leads from the power supply. Make sure that the lead coming from the D9-C4 junction on the power supply board is connected to the R8/objective end of the imaging tube and the other lead is connected both to ground on the board and the R9/eyepiece end of the tube.

When you've made sure that everything is hooked up properly, apply power to the circuit and you should see the phosphor at the eyepiece end of the tube glow with a green light. Turn off the power and fasten a piece of window screening flush against the objective end of the tube. Re-apply power and you should see an image of the screening on the phosphor screen. Your next step is to adjust the value of R8 to make the image as sharp as possible. Varying the voltage at the focusing ring changes the electrostatic focus of the tube. You'll have to experiment with a number of resistor combinations to find the value that produces the sharpest focus. As we said before, 200 megohms is the nominal value and the correct value for your tube is probably within plus or minus 15 percent of that.

Once you've daisy chained the resistors together and soldered them to the imaging tube (see Fig. 5), you have only one more final test to do before you can call it a wrap. Turn out the lights and apply power to the circuit again. What you're looking for here is evidence of high voltage leaks. Those will show up as small sparks or "corona." Note the places where they

show up and turn the power off. Wait a second or so for the circuit to discharge, then insulate those areas with high-voltage putty.

Believe it or not, once you've made sure that the focus is as sharp as you can make it, (or is at least acceptable to you), and there's no evidence of corona, the project is completed.

Now we come to the question of the case. You need a focusing lens in front of the tube and a viewing lens at the rear. In order for the front lens to focus a sharp image on the tube's objective, both the tube and the lens have to be on the same axis. And the same conditions apply to the

#### MEASURING WAVELENGTH

Whenever you're talking about the electromagnetic spectrum, some confusion can arise over the units used to refer to the wavelength of the radiation.

As you move up the spectrum from DC toward daylight, the frequency of the radiation will increase and the wavelength will decrease. Those two measurements are related by "c," the speed of light through:  $\lambda = K(f/c)$

where  $\lambda$  is the wavelength,  $f$  is the frequency in Hertz,  $c$  is the speed of light, and  $K$  is a constant determined by the medium through which the radiation is travelling.

Although you can refer to the wavelength in meters, by the time you get up to the visible part of the spectrum, the wavelengths are pretty small. Green light, for example, has a wavelength of about  $550 \times 10^{-9}$  meters. The two most common units of measurement for the upper reaches of the spectrum are the millimicron ( $10^{-9}$  meters) and the Angstrom ( $10^{-10}$  meters). The latter is named after the 19th-century Swedish physicist A. J. Angstrom.



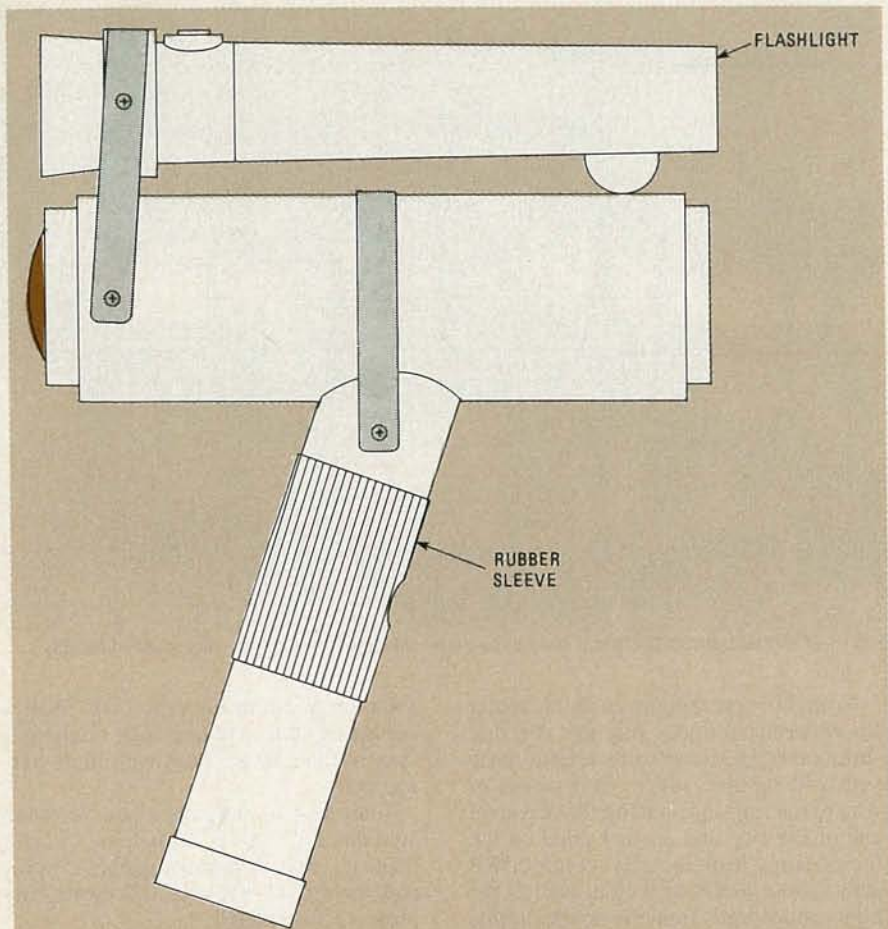

FIG. 6—THOUGH THE CASE is not critical, here is one that works well. The flashlight at the top is fitted with an infrared filter for use as a source of infrared light.

viewing lens at the rear. The easiest solution to the problem is to use a piece of tubing to hold the whole assembly. PVC tubing is perfect for that purpose.

A length of 2½-inch diameter PVC will hold the imaging tube if you shim the ends with 2⅜-inch tubing. The same 2⅜-inch tubing can also be used to mount the front and rear lenses. Use set screws to hold the 2⅜-inch tubes inside the main PVC enclosure.

One appropriate case is shown in Fig. 6. The optics in that unit are encased as just described. The PVC handle contains the power supply board and the battery. Once the board is mounted, cut a hole out over S1 so that it can be conveniently pressed. To prevent accidental contact with the board, slide a flexible rubber sheath (a section from an old bicycle tire inner tube will do) over the handle so that the hole is covered.

Note that there is nothing critical about the case. When designing and building a case for your unit, the only precaution is to make sure that no extraneous light can leak inside the tube, because that will degrade the quality of the image. Black tape or putty can take care of any light leaks.

Once you have the viewer assembled, you're ready to explore the world of in-

frared light. It's interesting, and somehow reassuring, to watch a television remote control. Yes, they really do put out bright flashes of previously invisible infrared. If you put an infrared filter in front of a flashlight, you'll be able to see in the dark by using the flashlight and peering through the viewer. (You'll note that the unit shown has such a flashlight mounted on it. That flashlight serves as an infrared light source. Also note that once the infrared filter is in place; the light emitted by the flashlight can not be seen by the naked eye.) Deep infrared filters are expensive but a piece of unexposed but developed Kodachrome will do almost as well. Use the ends that come back in the box along with your developed slides.

Infrared energy is also produced by heat. You can prove that by getting a steam iron nice and hot and putting it next to a piece of newspaper. Turn out the lights, look through the viewer, and you'll be able to read by the heat of the iron.

As to the quality of the image you see using the viewer, there are two limiting factors. Those are the "brightness" of the infrared source, and the quality of the optics used.

Turning first to the brightness of the source, the unit shown uses a common flashlight as described. That should be

## PARTS LIST

### All resistors ¼ watt, 10% unless noted

- R1—10,000 ohms
- R2—1000 ohms
- R3—4700 ohms
- R4, R5—100 ohms
- R6—100,000 ohms, potentiometer
- R7—2200 ohms
- R8—200 megohms, see text
- R9—2000 megohms, see text

### Capacitors

- C1—10µF, 25 volts, electrolytic
- C2—1µF, 400 volts, electrolytic
- C3—1µF, 25 volts, electrolytic
- C4—.001µF, 15 kV, ceramic

### Semiconductors

- Q1, Q2—2N2222 NPN transistor
- Q3—2N2646 FET transistor
- D1, D2—1N4002
- D3—D8—1N4007
- D9—MX200EP, 20-kV diode
- SCR1—C107D

### Other components

- B1—9-volt nickel cadmium battery
- S1—SPST, momentary pushbutton, normally open
- T1—12 to 400 volts, 10kHz switching transformer
- T2—11 kV pulse transformer, 400-volt primary

**Miscellaneous:** 6032 image tube (RCA), PC board, PVC tubing for case, focusing and viewing lenses, battery clip, flashlight, wire, solder, etc.

The following are available from Information Unlimited, PO Box 716, Amherst, NH 03031: Complete kit, including case and basic lenses, but minus the 6032 image tube, \$99.50; 6032 image tube, \$49.50; assembled and tested unit \$199.50; power board kit \$34.50; assembled power board, \$49.40; T1 alone, \$14.50; T2 alone, \$15.50; D9 alone, \$2.50; C4 alone, \$3.00; optional 75mm telephoto focusing lens with iris adjustment and C-mount, \$125.00; optional 50mm wide-angle focusing lens with C-mount, \$95.00.

sufficient in most cases. If not, a brighter source of light can be substituted, as long as an infrared filter is used as outlined above.

The optics (lenses) are much more critical. The standard optics supplied with the kit offered by the source mentioned in the Parts List are adequate for most hobbyist applications. If you require images with more sharpness and clarity, however, you will need to use higher quality, and more expensive lenses. Such lenses are also available from the source given in the Parts List.

The uses of infrared imaging are endless and eye opening. If you want to find out more about the subject, Kodak publishes a wonderful booklet called "Applied Infra Red Photography." Write to Kodak, Consumer Markets Division, Rochester, NY 14650. R-E



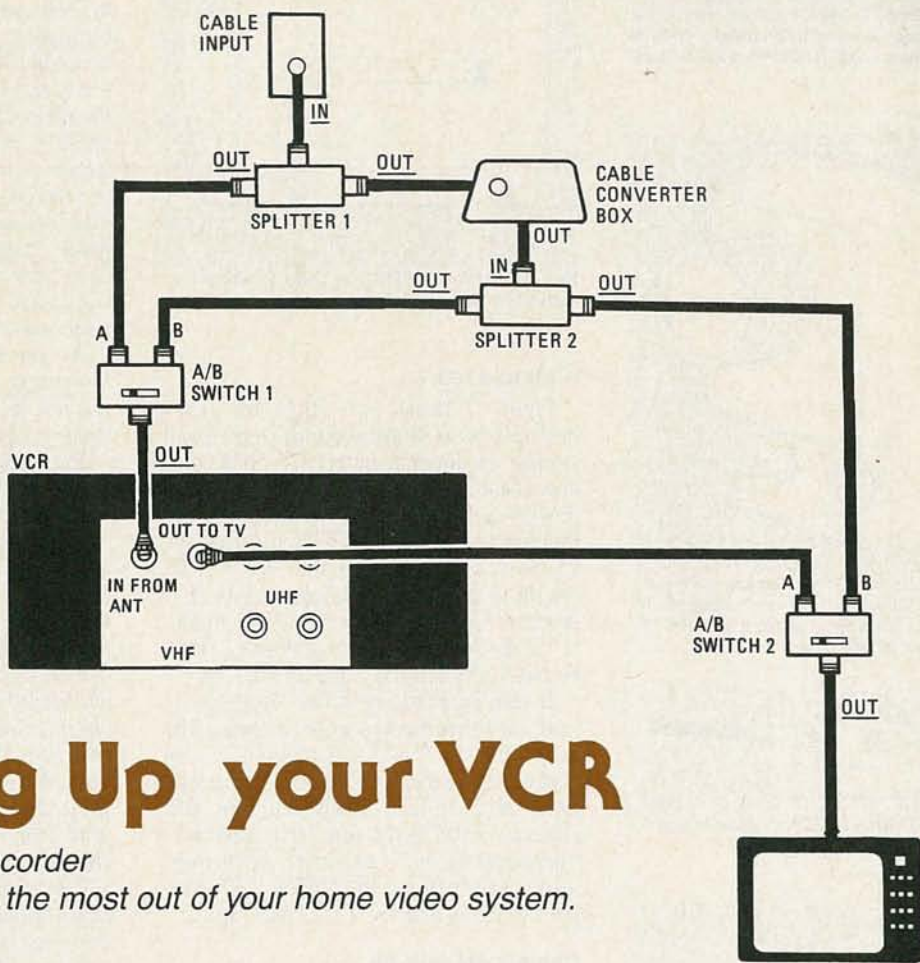

## Hooking Up your VCR

*Hook-up that video recorder the right way, and get the most out of your home video system.*

**CARL LARON**  
ASSOCIATE EDITOR

SO, YOU FINALLY BROKE DOWN AND bought yourself a VCR. Now that it's home, uncrated, and set up on a stand, it is time to hook it up to your antenna or cable system, and your TV. Sounds like a simple enough task, and maybe it is.

But then again, maybe it is not. That's especially true when you are dealing with cable-TV setups. Unless a cable-TV setup is wired correctly, you will lose one of the most attractive benefits of VCR ownership—the ability to watch one channel while recording another.

Finally, keep in mind that the VCR has a built in RF modulator. That, in essence, is a miniature TV transmitter. Thus, if the VCR is hooked up incorrectly—that is, its output is connected directly to a TV antenna—the output may very well be broadcast to your neighbors. That, of course, is a violation of FCC rules. And, it might get your neighbors annoyed if they don't care for your choice in programming.

In this article, we are going to show you the ins and outs of VCR hookups, ranging from the most simple to the very complicated. When we deal with cable hookups, both cable-ready and non-cable-ready, TV's and VCR's will be covered.

### Tools of the trade

As with any other job, there are certain "tools" you will need to get things done right. In VCR hookups, those tools consist of the various cables, adapters, splitters, and switches that an installation might call for.

Figure 1 shows the two types of cable you might need. In Fig. 1-a, a length of 75-ohm coax cable is shown; in Fig. 1-b, a length of 300-ohm twin-lead is shown.

The coax is used to connect the VCR's 75-ohm VHF output terminal to the set. While most newer sets are provided with a 75-ohm cable input (F-connector), many still use the familiar 300-ohm, two screw-terminal inputs, for use with twin lead. In such cases, the coax must be terminated with a 75-ohm-to-300-ohm adaptor, such as the one shown in Fig. 2.

Most VCR's use 300-ohm two screw-terminal outputs for the UHF-out connection. As such, it is most convenient to use standard twin lead to route a UHF signal from the VCR to the TV.

For the most part, twin lead is also used as the lead-in wire from the antenna to the set. To adapt the twin lead for connection to a VCR's 75-ohm input, a 300-ohm-

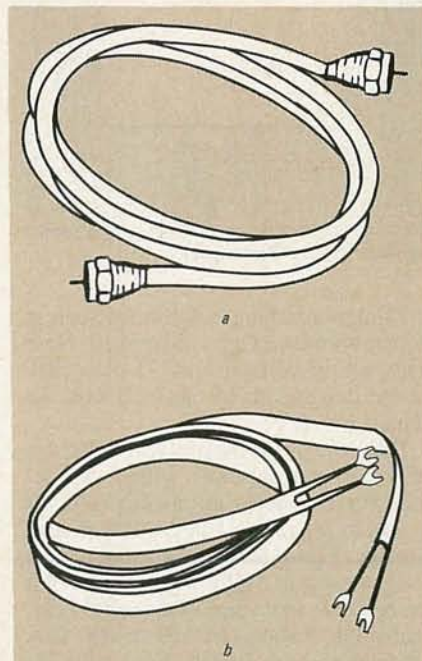

FIG. 1—TWO TYPES OF CABLE might be used in a home video setup. Those are 75-ohm coaxial cable, shown in a, or 300-ohm "twin-lead", shown in b.





FIG. 2—A 75-OHM-TO-300-OHM matching transformer or adaptor is used to connect a coaxial cable to the antenna input terminals at the back of a TV set.

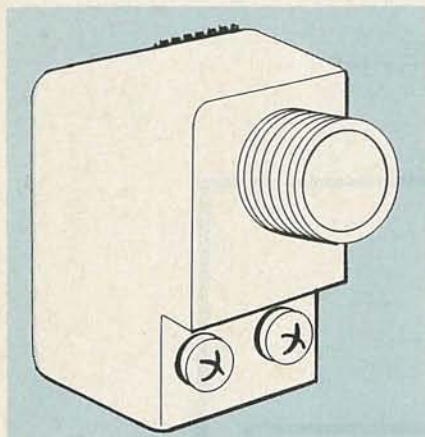

FIG. 3—IF YOUR ANTENNA uses a twin-lead down-lead, a 300-ohm-to-75-ohm adaptor is used to connect the down-lead to the VCR's 75-ohm antenna input terminal.

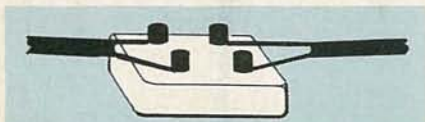

FIG. 4—AN ANTENNA BLOCK is used to splice two lengths of twin-lead together.

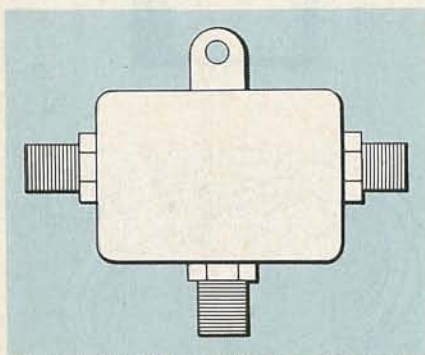

FIG. 5—A SIGNAL SPLITTER is used to send a signal to two different devices.

to-75-ohm matching transformer, such as the one shown in Fig. 3, is needed. Note that some installations use 75-ohm coax for the down-lead. In those set ups, no adaptor is needed.

There are a few other pieces of equipment that, in many cases, will prove valuable. Figure 4 shows an antenna block. It is used to splice two lengths of twin lead together. Figure 5 shows a splitter. That device is used to "split" a signal so that it can be fed to more than one device. And, finally, Fig. 6 shows an A/B switch. That is a two-position switch, used with 75-ohm coax. It is used to select between two signals or two devices.

And now on to the installations!

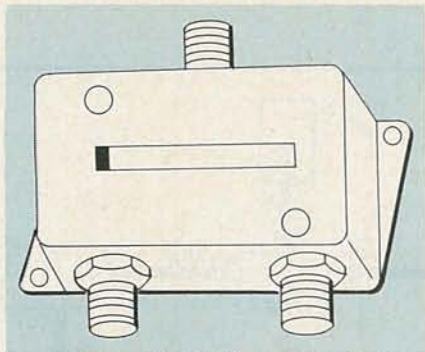

FIG. 6—AN A/B SWITCH is used to select between two different signal sources.

### A simple start

Figure 7 shows just about the most basic of our VCR installations. It involves simply an antenna with a 75-ohm coax down-lead, a VCR, and a TV set. The down-lead is connected to the antenna-input terminal on the VCR. A length of 75-ohm coax is run from the VCR's VHF output to the TV's VHF input. If the TV does not have a 75-ohm coax VHF input, a 75-ohm-to 300-ohm transformer must be used between the cable and the set.

If your antenna uses a twin-lead down-lead, the down-lead must be terminated in a 300-ohm-to-75-ohm adaptor before it is connected to the VCR. For UHF reception, the twin-lead down-lead from the antenna is attached to the UHF input terminals on the VCR and a length of twin lead is run between the VCR's UHF output terminals and the TV's UHF input.

### Cable installations

In the balance of this article, we'll turn our attention to the various cable installations that you might run into.

In cable installations, it is important to consider whether or not the set involved is "cable ready," and whether or not there are any premium channels (in cable-TV terminology, premium is another word for scrambled). Keep in mind that cable-ready sets are not capable of descrambling the premium services. For that you need a cable-company supplied descrambler, which is usually integrated with a conversion box. Cable-ready sets are good for viewing unscrambled services, and are handy to have in some of the more complex cable installations; that's because, as we'll soon see, they eliminate the need for a second conversion box.

As you might have gathered from the foregoing, descramblers and converters are not the same thing. Let's see what each is, and how they differ.

Early cable systems were capable of only supplying 12 channels of programming. That's because a standard television tuner is capable of receiving only 12 discrete frequencies in the 54-300 MHz VHF band. Granted, if UHF frequencies were used, an additional 68 channels of programming might be available. But, due to the high line losses at those frequencies (remember, it is *cable TV* we are talking about here), the use of UHF was impractical. In fact, if a cable system wanted to provide a UHF-TV station, it would have to downconvert the signal and send it out over the cable system on a VHF channel.

To add more channels of programming, cable operators resorted to the use of a converter box. A converter box is essentially an external tuner. It allows the selection of the frequencies "between" the channels. The selected frequency is then converted to a single VHF channel (usu-

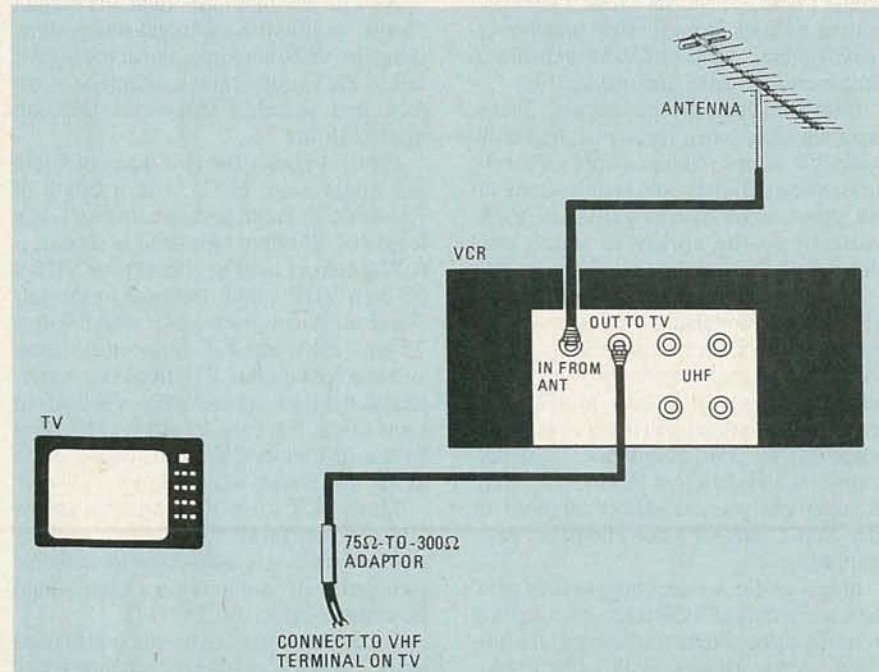

FIG. 7—CONNECTING AN OUTDOOR antenna to your home video system. This installation is among the most basic.



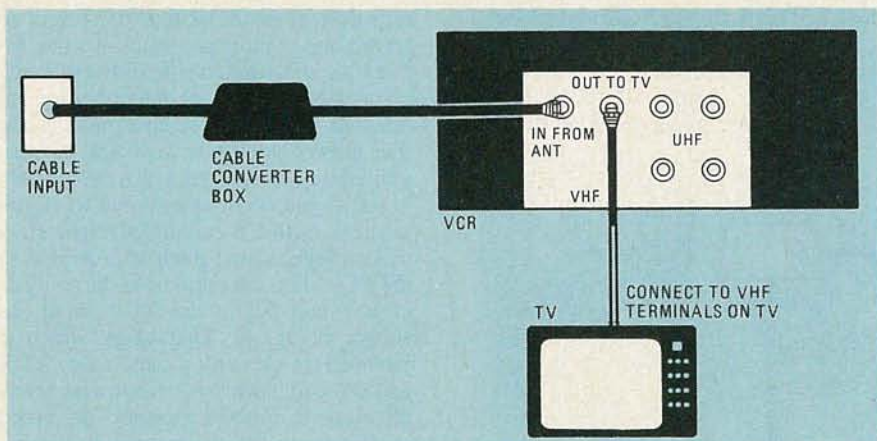

FIG. 8—CONNECTING A CABLE-TV FEED to your home video system. With this setup, you can only record and view the same scrambled or unscrambled signal.

ally either Channel 3 or 4) and fed by the converter to the set. Cable-ready sets are made "cable-ready" by using a tuner of the type found in cable converter-boxes.

Thus, essentially, a converter is a tuner that allows you to receive frequencies that are not available using a standard TV tuner. If the signal on a particular frequency is scrambled, the output of the converter will also be scrambled. That is, unless it is first fed to a descrambler.

Cable companies use many different scrambling/descrambling schemes, and for more information on them, you might want to refer to "Cable-TV Descrambling" in the February 1984 issue of *Radio-Electronics*. For our purposes, the descrambling scheme used is not important, just its result—the delivery of a normal, unscrambled TV signal to your set. For the installations discussed below, we will assume that the converter box in your cable-TV setup incorporates an appropriate descrambler.

Figure 8 shows the simplest cable installation; it allows an owner of a non-cable-ready set to view and record the same scrambled or unscrambled cable channel. (Note that 75-ohm coax is used throughout the installation. The cable signal is delivered from the cable output via that type of feed also. If your TV set does not have a 75-ohm input, you will need a 75-ohm-to-300-ohm adaptor. In all of the following installations, it will be assumed that coax is used, and that the lead to the TV is terminated properly.)

That installation robs you of one of the best features of a VCR—the ability to view one channel and record another. To do that, you need a more complex installation.

Owners of non-cable-ready sets may want to consider the installation shown in Fig. 9. That installation allows you to record one scrambled or unscrambled channel while watching another.

Let's trace that installation out. The signal from the cable system is fed into a two-way splitter. Each output of the splitter is fed into a separate converter box. The

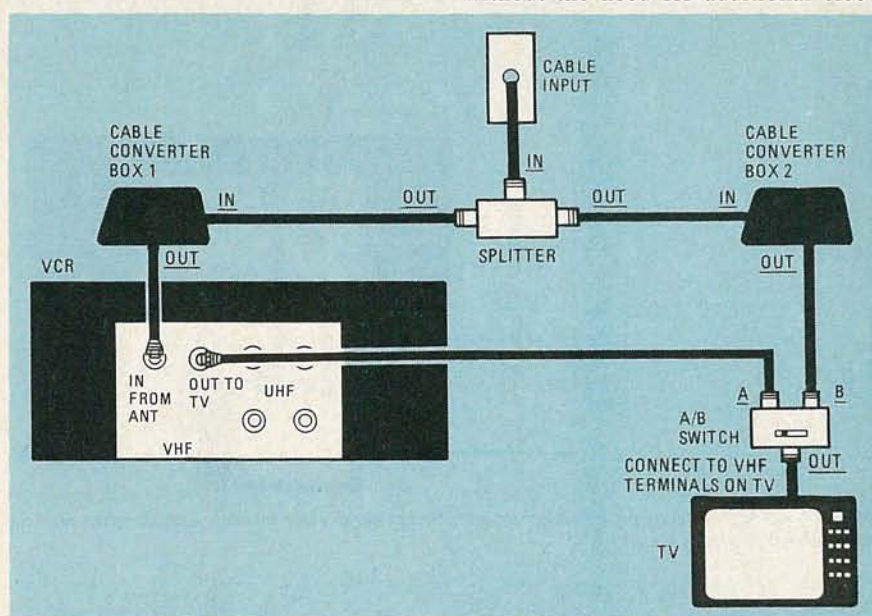

FIG. 9—TO RECORD ONE CHANNEL while viewing another, two cable-converter boxes are required. In this setup, the channels to be viewed may be either scrambled or unscrambled.

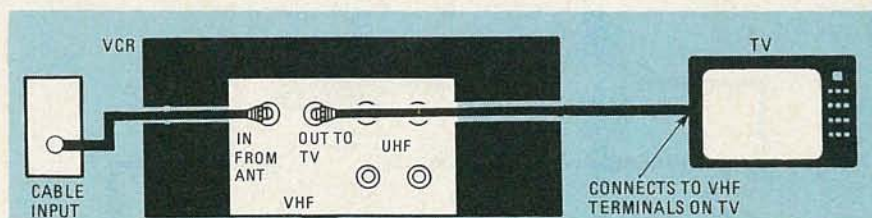

FIG. 10—A CABLE-READY VCR, when used with a cable-ready TV set, lets you treat the incoming cable signal as if it were an over-the-air one.

output from one box, labeled CONVERTER BOX 1 in Fig. 9, is fed into the VHF input on the VCR. From the VCR, the signal is fed to the TV through the A side of an A/B switch. The output of the second box, labeled CONVERTER BOX 2, is fed, via the B side of the A/B switch, to the set.

To record a scrambled or unscrambled channel, first set the output of the converter boxes to different channels (usually a choice of either Channel 3 or Channel 4 output is provided). Then set the channel selector on the VCR to the output channel selected for CONVERTER BOX 1. Next, se-

lect the channel to be recorded on that box. Finally, set the A/B switch to A and turn the TV selector to the output channel of the VCR (once again, that's most likely to be either Channel 3 or 4).

After you are sure that the desired channel is recording, you can switch the VCR output away from the set and view another channel via CONVERTER BOX 2. To do that, set the A/B switch to B. Then set the TV's channel selector to the output channel of CONVERTER BOX 2, and select the channel to be viewed on that converter.

Owners of cable-ready sets can eliminate one of the converter boxes used in the previous installation. That's possible because the cable-ready feature of the set allows you to view an unscrambled signal without the need for additional elec-

tronics. The required setup differs from the one in Fig. 9 only in that the converter box located between the splitter and the TV (via the A/B switch) has been removed.

### Cable-ready VCR's

In addition to cable-ready sets, many of the VCR's now on the market also feature cable-ready tuners. The following examples show some typical installations using that type of VCR.

If you do not wish to receive or record scrambled channels, a cable-ready VCR,



when used in tandem with a cable-ready TV set, can eliminate the need for a converter box altogether. Such an installation is shown in Fig. 10. If the TV set is not cable-ready, a converter box must also be

installed between the VCR and the set. That setup allows you to treat the cable signal just as you would an over-the-air one. In other words, all of the VCR's features, such as programmability (the fea-

ture that allows a VCR to be preset to record one or more programs at some future time and date) and the ability to watch one channel while recording another, are retained. In fact, that setup is the only one that allows the VCR to retain its programmability when used with a cable feed.

As should be obvious by now, if you wish to record a scrambled channel, a descrambled signal must be provided to the VCR. That means placing the converter box just before the VCR input, as shown in Fig. 11. That setup, which is intended for use with a cable-ready VCR and set, will allow you to record and view the same scrambled channel, or record one unscrambled channel while viewing another.

Our last example deals with a cable-ready VCR and a non-cable-ready TV set. That installation, shown in Fig. 12, allows you to record and view the same scrambled channel, or to record an unscrambled channel while viewing a different scrambled or unscrambled.

Let's trace that installation through. The cable input is first fed to SPLITTER 1. One output of that splitter is fed to the VCR via A/B SWITCH 1. The other output of the splitter is fed to a converter box. The output of the converter box is fed to SPLITTER 2. One output of that splitter is fed to the VCR via A/B SWITCH 2, while the other output is fed to the TV set via A/B SWITCH 2. The output of the VCR also is fed to the set via A/B SWITCH 2.

To record and view the same scrambled channel, first set A/B SWITCH 1 to B and A/B SWITCH 2 to A. Then, select the channel to be recorded and watched on the converter box, set the VCR to receive the output channel of the converter box, and set the TV to receive the VCR's output channel.

To record an unscrambled channel while watching another channel that is either scrambled or unscrambled, set both A/B switches to A. Select the channel to be recorded using the VCR's tuner. Once you've verified that the proper channel has been selected by monitoring it on the TV, set the VCR to record and set A/B SWITCH 2 to B. Set the TV to the output channel of the converter box and use that box to select the channel to be viewed.

There are, of course, many other ways to hook up a VCR system. But the ones we've shown here are among the simplest. Remember that it is best to use as few switches, splitters, and other devices as possible in an installation. That's because each device will cause some, albeit minimal, picture degradation due to their insertion losses. Also, the fewer the switches, splitters, or other devices in a circuit, the fewer the sites for potential problems. Finally, use good-quality components. For instance, a switch with poor isolation is good for little aside from producing headaches. **R-E**

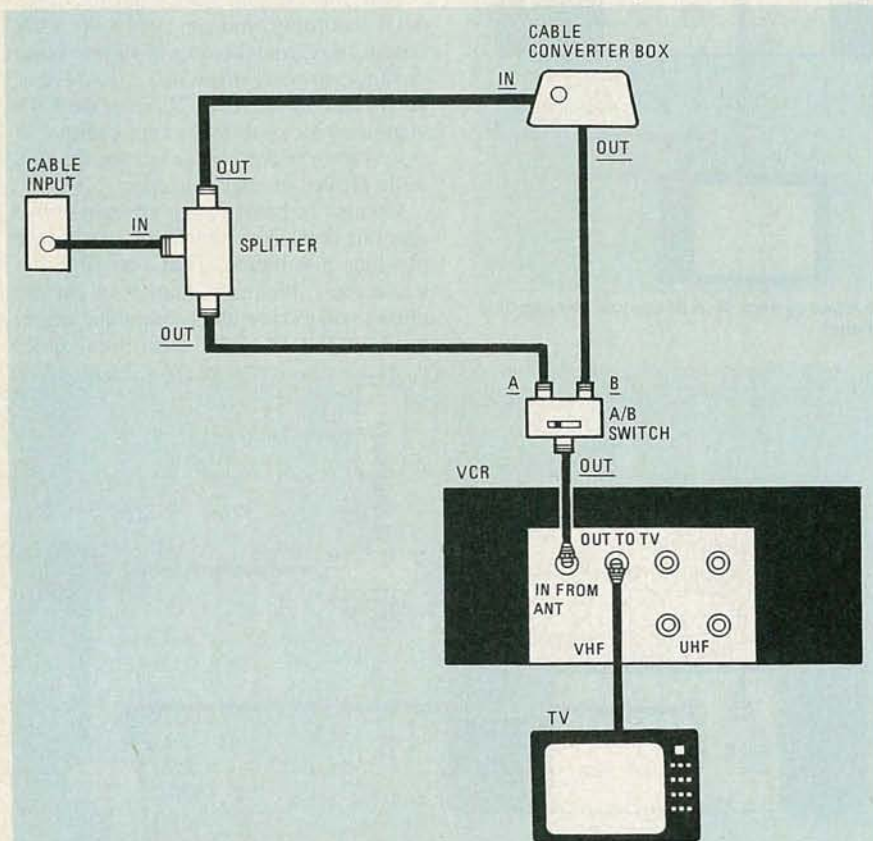

FIG. 11—THIS SETUP lets you record an unscrambled channel while viewing another scrambled or unscrambled channel.

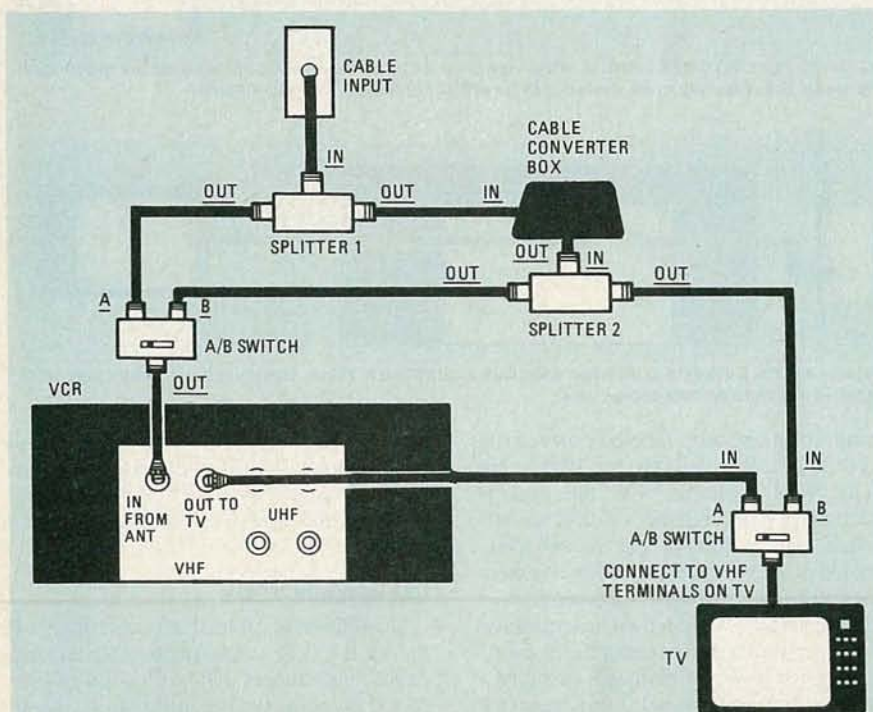

FIG. 12—THIS SETUP allows an owner of a cable-ready VCR and a non-cable-ready set to record and view the same scrambled channel, or to record an unscrambled channel while viewing a different scrambled or unscrambled channel.



## All About ELECTRIC SHOCK

*All about electrical shock, and how it can affect your body.*

RAY FISH, Ph.D., M.D.

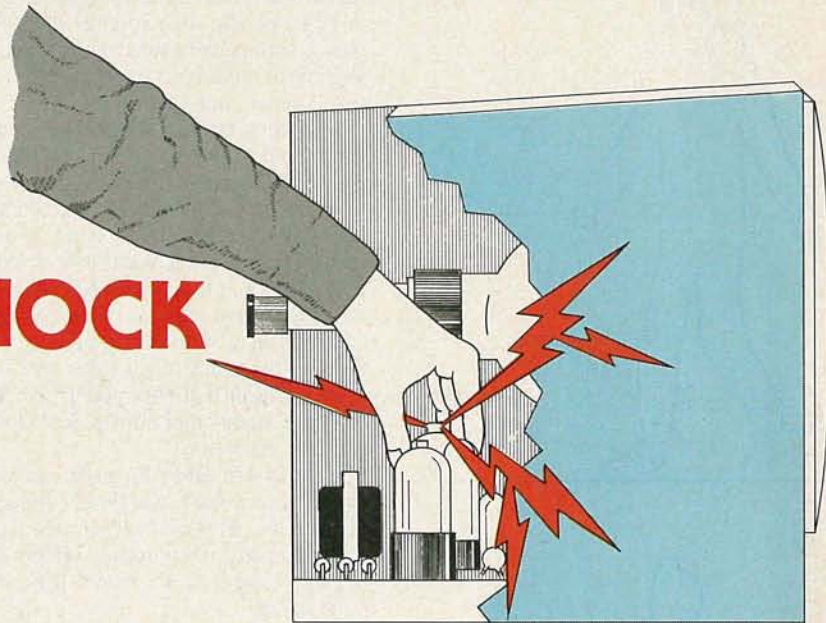

MOST OF US ARE FAMILIAR WITH THE effects of a mild electric shock—the sharp sting, the tingling sensation. The effects of a severe electric shock, however, can be much more devastating, even fatal. In this article, we are going to take a look at electric shock, and how it does its damage.

### All about shock

Put quite simply, electric shock is the passage of a current through the body. The human body, as shown in Fig. 1, can be modeled as a network of resistances. Simply touching a voltage source is not sufficient to cause a shock (see Fig. 2-a). That's because, no circuit is completed. For current to flow, another part of the resistance network that is the body must be in contact with a ground or a different voltage level (see Fig. 2-b).

To understand more about the effects of shock, it is sometimes more useful to construct more detailed models of the body. Consider the model of an arm shown in Fig. 3. An electric shock that is applied between the hand ( $R_{SKIN-1}$ ) and the elbow ( $R_{SKIN-2}$ ) must pass through three separate resistances. That's because, in addition to the resistance presented by the forearm,  $R_{FA}$ , the skin surface at the hand and the elbow also resist current flow. And even more complex electrical models of the body are often made. In those models, the body is broken down into more separate parts. The parallel resistances of bone, blood vessels, nerves, and other tissues are modeled by additional resistors. The different ways that high-frequency currents are passed through various tissues can be modeled by using capacitors and inductors. For our pur-

poses, however, the simple models we've shown you thus far are sufficient

The resistance to current flow at the skin surface depends on a number of factors. The area of contact is important. A flat piece of metal held against the skin will affect the resistance; pushing harder lowers the resistance. You can prove that to yourself by holding onto the leads from an ohmmeter. Holding them loosely will yield a reading of about 50,000 ohms; holding them more tightly will yield a reading of 10,000 ohms.

The surface of the skin is dry compared to lower layers, which causes it to offer a higher resistance. In order to reduce skin resistance, the top dry layer can be partially rubbed off with little discomfort.

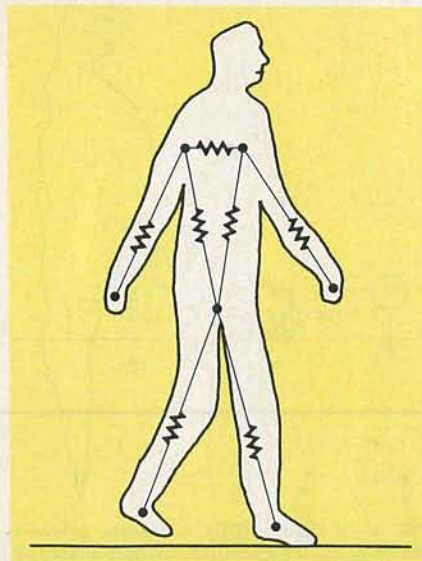

FIG. 1—A PERSON CAN be modeled as a network of resistances.

The skin surface can also be made more conductive by moistening it with water. Electrolyte solutions (such as sweat) are more effective than water in lowering skin resistance.

Those facts are taken into account when designing and using cardiac monitors and defibrillators. Some pre-packaged electrodes have an abrasive area that can be rubbed on the skin before the electrode is applied. The electrode has a relatively large (one square centimeter) surface area, which is covered by an electrolyte-containing electrode jelly.

Defibrillator paddles (a defibrillator is shown in Fig. 4) are used to deliver strong shocks that change the heart rhythm (For more about defibrillators and what they do, see the August 1984 issue of **Radio-Electronics**). The paddle surface area is roughly 50 square centimeters. Medical personnel are taught to apply about 20 pounds of force on each paddle when defibrillating (trying to apply more pressure than that causes some people to lose their balance).

Electrolyte-containing electrode jelly or saline-soaked pads are used to make uniform electrical connection between each paddle and the skin. Saline pads have the advantage of not leaving a slippery surface that makes chest compressions (CPR) difficult. The jelly may also coat the chest between the electrodes, giving an unwanted current path. Alcohol-soaked pads are not used because they might ignite. If no conductive medium is placed between the paddles and the chest wall, a spark and burns may occur. Even so, chest-wall burns sometimes occur even when proper defibrillation techniques and equipment are used.



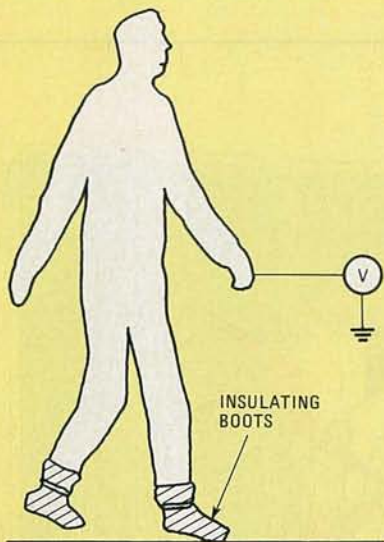

a

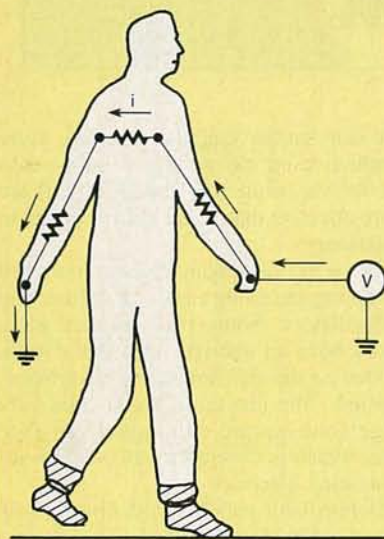

b

FIG. 2—MERELY TOUCHING a voltage source is not sufficient to cause shock. But when a person comes in contact with two voltage sources of different levels (such as 120 volts and ground), a circuit is completed and current flows.

### The effects of electrical shock

As you might expect with current flowing through a resistance, electrical shock causes the heating of tissues. Electrical shock heats body tissues in several ways. A high voltage can give flash burns due to arcing of current through the air to the body. The arcing may even cause your clothing to catch on fire. In either case you end up with a burn.

More commonly, heat is caused by the flow of current through the resistance of bodily tissues. Burns of tissues by electrical current itself often give painless round or oval gray areas with surrounding redness.

The heat delivered to each area of tissue depends on the current flowing in that area

and the resistance at that point. In some applications, such as defibrillation, a certain amount of current must be delivered. A large paddle area spreads the current over a surface area sufficiently large that skin burns are usually avoided (though, as noted above, not always).

With uncontrolled shock, burns can be significant. Temperatures up to 3000 degrees Centigrade may be generated. Much of the tissue damage with electrical burns is often under the skin. As such, many major electrical burns look deceptively minor at first. Deep injury to muscle and blood vessels is much more common than with other types of burns (such as those due to hot water and fires).

In addition to burns, electrical shock can have many other effects. Let's look at some of them next.

Contact with alternating (but not direct) current can cause a sustained contraction of muscles. That can prevent the victim from releasing the source of voltage, causing the damage to the body to be much more severe.

Electrical shock can cause death within minutes by stopping breathing or the beating of the heart. Breathing can be stopped by current passing through the respiratory centers of the brain. Electrical current passing through the heart itself can disrupt the heart's normal beating pattern. With severe shocks, such as those caused by lightning, the heart's electrical activity may cease altogether.

In cases where heart activity has been disrupted by an electrical shock, CPR should be performed to keep the brain from dying. When CPR has been performed, there have been reports of victims recovering after even hours of no spontaneous heart or respiratory activity.

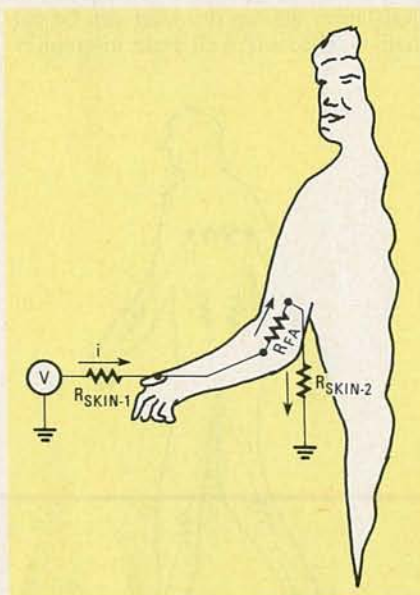

FIG. 3—WHEN A SHOCK is received between the hand and the elbow, resistance is offered by the skin at both the hand and the elbow, as well as by the arm itself.



FIG. 4—A DEFIBRILLATOR uses electrical shock to restore a heartbeat to normal.

The nervous system can be directly affected by electrical shock. Paralysis, amnesia, and other conditions all can result from nerve damage.

Kidney damage can occur if an electric current passes through that organ. Kidney damage can also occur if that organ is blocked by large amounts of a chemical (called mycoglobulin) that is released from muscle cells that are damaged by the passage of an electrical current.

Finally, large and small blood vessels may bleed or develop clots after electrical shock. That can lead to deeper and more extensive tissue damage than is apparent on initial inspection.

### Lightning

Lightning produces all of the above effects, and more. A person hit directly by lightning will, in all likelihood, be killed immediately. People who have been "hit by lightning" and have survived, are those who were fortunate enough to be victims only of a near miss. They were merely close enough to the lightning to receive severe electrical shocks.

If lightning hits a tree (or other object in the ground), a voltage gradient leading from the tree will exist along the ground. A cow standing facing the tree will receive more voltage between its legs than a cow standing with its side to the tree. People lying on the ground may develop burns on areas of the skin that were in contact with the ground. If the burns are not severe, they may resemble light red, fine paintings—small burns may resemble stick figures, while larger ones may look like evergreen bushes with thousands of needles on their branches. In addition to the burns, there may also be transient paralysis or transient loss of vision or hearing.

Serious effects of a lightning "strike" can include severe burns and cardiac arrest.

*continued on page 92*



# BUILD THIS



## Buffer/Converter for your Printer

*This buffer is more than just a 64K printer buffer—it's also a parallel-to-serial and serial-to-parallel converter. And you can expand it to program EPROM's, too!*

BY BILL GREEN

COMPUTERS CAN CERTAINLY GET THINGS done in a hurry. But when you hook one up to a printer, it can run at an amazingly *slow* speed. There is a way to speed things up, though. By using a printer buffer, you'll be able put your computer back to work even as a 20-page document is being printed.

The buffer we'll describe does a great job of freeing your speedy computer from your comparatively slow printer. But it does a great deal more, too! It's more versatile than standard buffers because it accepts either parallel or serial data from your computer(s), and it outputs that data in either parallel or serial form. So you can interconnect mismatched equipment and avoid the cost of separate adapters and the hassle of swapping cables.

The buffer has some other features not normally found in printer buffers. You can download Z80 machine code to customize its operation if you want special buffer features. You can even use it as a Z80 hardware development system. Plus, with the EPROM programmer option that we'll discuss, you can read, program, and duplicate 2716, 2732, and 2764 EPROM's.

This buffer is truly a universal printer buffer. It is designed to work with all popular computers and printers equipped with Centronics parallel and/or RS-232 serial ports. In addition, it will work directly with the user I/O port of the Commodore 64 and it will convert Com-

modore's non-standard code so that it can be used with a regular ASCII printer.

### The buffer hardware

The schematic of the printer buffer is shown in Fig. 1. As you can see, it is a dedicated application of the Z80 microprocessor (IC1). The Z80 was chosen for its low cost and because it interfaces easily with dynamic RAM (which is mandatory when large amounts of memory are required). The 64K RAM is made up of eight 1 × 64K dynamic RAM IC's, IC3-IC10.

The Z80 refreshes only 128-cycle RAM IC's. However, because 256-cycle 4164's are generally available for a better price, we added IC17 and IC18 to provide the eighth refresh line (RA7). If 128-cycle RAM's are used, those two IC's can be omitted. If you're not sure what type you have, play it safe and use the two IC's.

The Z80, of course, cannot do anything unless it has instructions to follow. The software instructions for the buffer are stored in IC2, a 2K × 8 EPROM. (See the parts list for information on how to order that EPROM.) The EPROM occupies 2K bytes in address area (0000H-07FFH), thus reducing the usable RAM from 64K to 62K. In addition, the area from 0800H-08FFH is reserved for the stack pointer and temporary scratchpad storage. Thus, the total usable RAM is 63,232 bytes.

The 16 address lines are multiplexed

onto the RAM address bus (MA0-MA7) by two 2- to 1-line data multiplexers, IC11 and IC12. The timing for the multiplexers, and the generation of the RAS (Row Address Strobe) and CAS (Column Address Strobe) signals for the RAM are handled by IC13, IC14, IC16, and one half of IC24 as is the generation of the chip-enable signal for the EPROM.

Three of the inverters in IC26, along with the 8-MHz crystal provide the buffered clock for refresh timing. That clock is divided by IC23 to give the 2-MHz clock required by the Z80.

Octal D-type latches, IC19 through IC22, are used for the I/O and status ports. The port-enable strobes are sent from IC25, a 3- to 8-line decoder that is used here as the I/O port decoder. One half of IC24 is wired as an R-S flip-flop. It provides the BUSY signal for the PARALLEL INPUT port when it is strobed by the parallel sending device. The BUSY line is cleared under software control by pin 11 of IC25 (ENABLE 04). Turning to the serial port, we see that IC27 is used as a line driver/receiver for serial I/O.

Switches S1-S4 are read by IC20. The FUNCTION SELECT switches (S1, S2 and S3) are three-position toggle switches that give us 27 possible unique combinations of inputs, outputs, and other functions. We'll explain how to use them shortly. One terminal of each SELECT switch is fed by pin 19 of IC19, which is switched high



FIG. 1—THE PRINTER BUFFER schematic. The heart of the circuit is IC1, a Z80 microprocessor running the program contained in IC2.

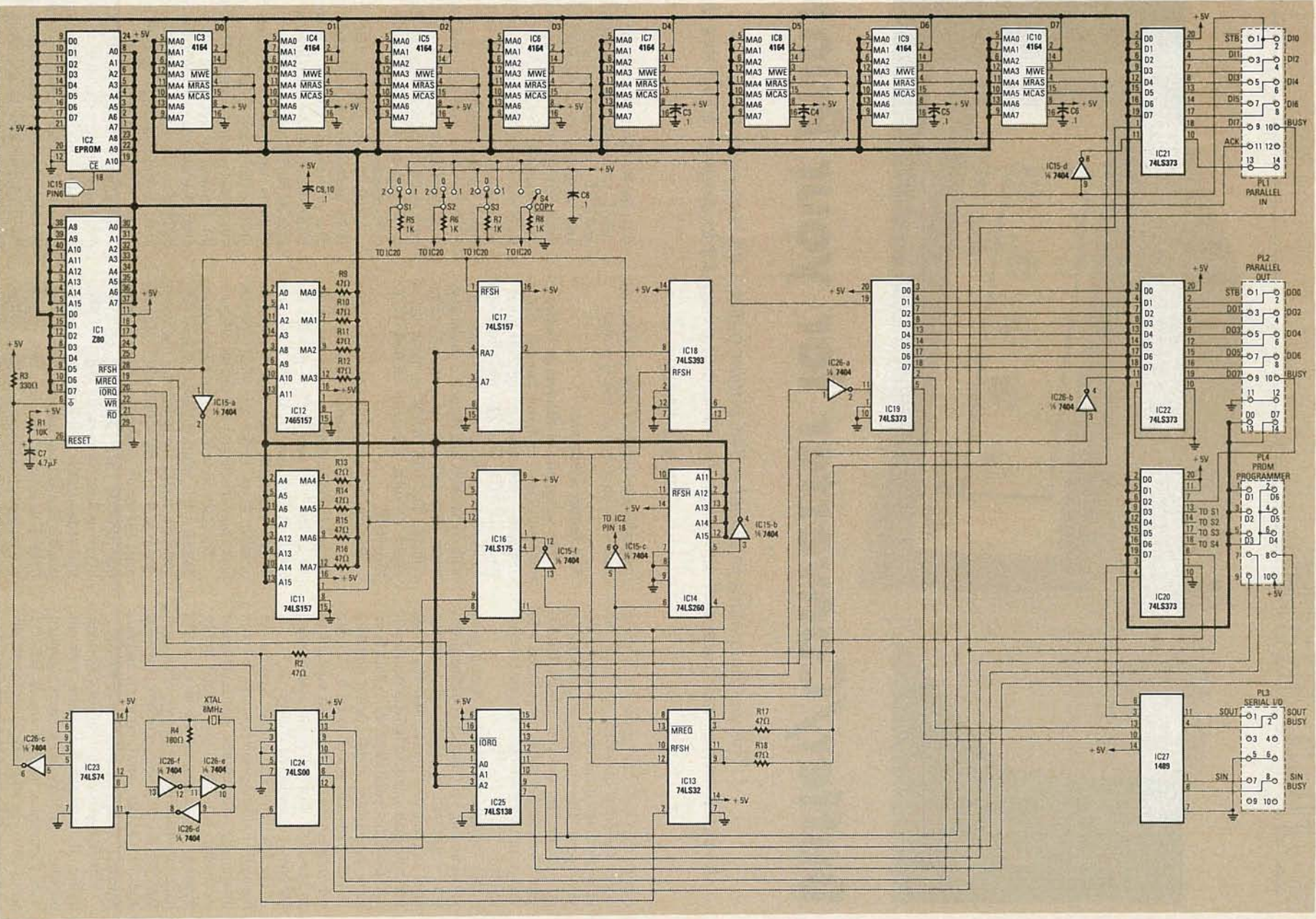



or low by the operating program at the appropriate time.

A power-on reset is provided by R1 and C7. Decoupling of the +5-volt supply is

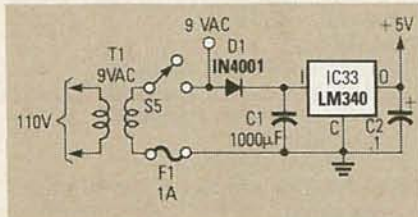

FIG. 2—THE POWER SUPPLY for the printer buffer. Although the supply is on the buffer board, it is shown separately due to space restrictions.

handled by eight .1-µF capacitors, C2-C6 and C8-C10.

Power for the buffer is provided by a simple half-wave rectified supply using a three-terminal IC regulator. The schematic is shown separately in Fig. 2. The AC input is obtained from a wall-mounted 9-volt AC transformer, which is switched by S5 and fused for 1 amp.

### The EPROM programmer

As an addition to the printer buffer, you can build the EPROM programmer/copier shown in Fig. 3. It connects to the buffer board through S01 (and PL2 and PL4 on the buffer board). An octal D-type latch, IC28, latches the high address lines and

the program-control lines to the EPROM. Another octal latch, IC22 (on the buffer board), latches the low address lines. The data sent to the EPROM is latched by IC29 and the data read from the EPROM is latched by IC30.

Part of IC31 and Q1, Q2 and Q3 switch the programming voltage  $V_{PP}$  on and off at the appropriate times. The seven switches in DIP switch S8 (the eighth switch is not used) are used to configure the programmer for the different types of EPROMS. The 5-to-25 volt converter provides the programming voltage. Since different EPROM's require different programming voltages, S8-g is used to select either 21 or 25 volts.

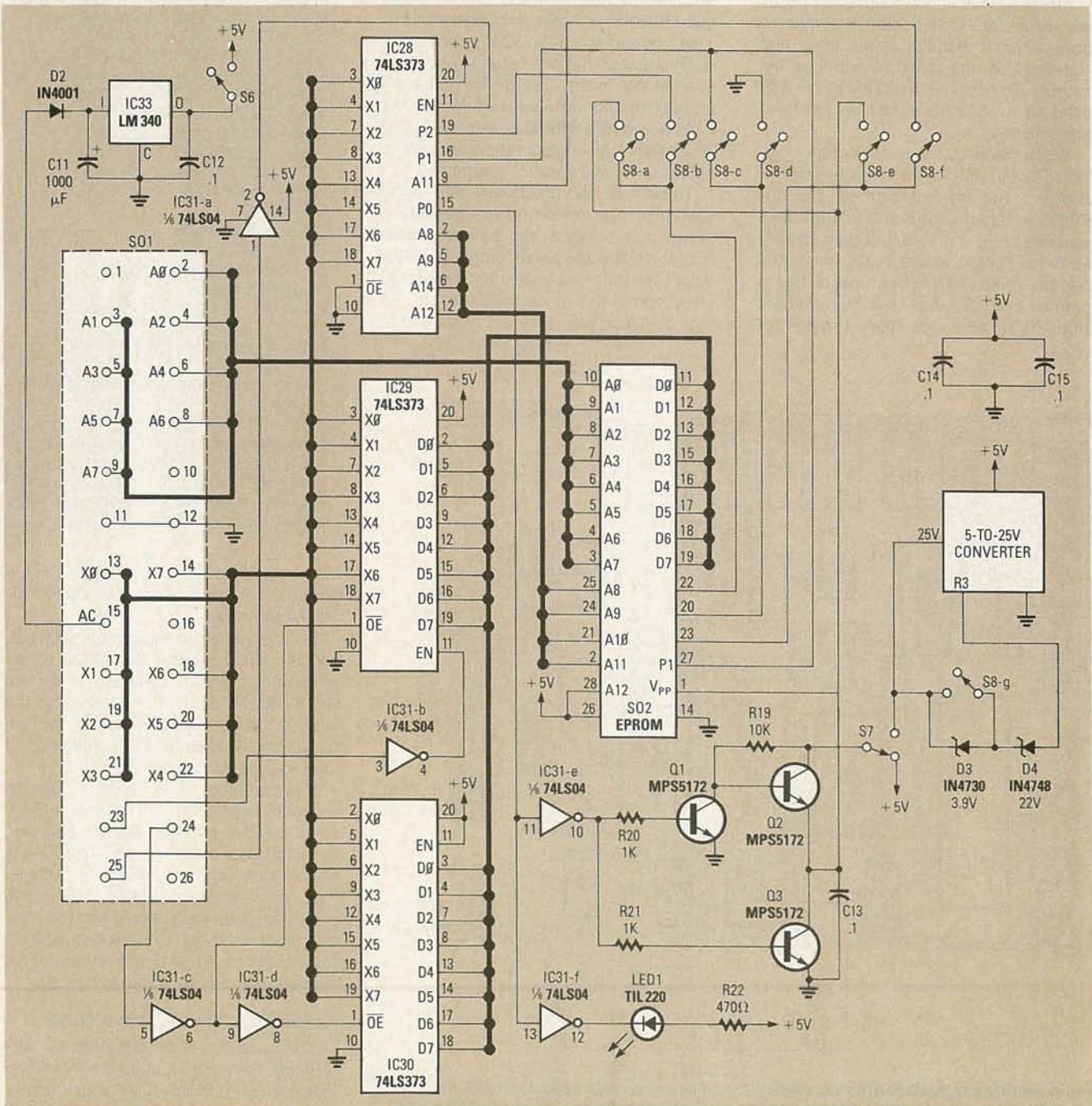

FIG. 3—THE EPROM PROGRAMMER is meant to be used as an extension to the printer buffer. Socket S01 plugs into PL2 and PL4 on the buffer board.



## The firmware

As we mentioned earlier, the operating instructions for the Z80 microprocessor are stored as machine code in IC2. While that code is too lengthy to list here, we can describe what it does.

When power is first applied, the stack pointer and the I/O ports are initialized. The FUNCTION SELECT switches (S1-S3) are then read and the selected function is jumped to. In the case of parallel input and output, the data is handled and stored with no modification. The BUSY lines are used for synchronization of data flow. It should be noted that incoming data will be sent to the output device any time the device is ready.

Since internal data is handled in parallel, and serial I/O data must be converted from serial to parallel at the input and converted from parallel to serial at the output. The conversion is done by the Z80 using delay routines based on the baud rate selected.

When the SERIAL INPUT function is selected (we'll tell you just how to select it shortly), the processor raises the  $\overline{SIN}$  BUSY line (ready), reads the SIN line until a start bit (high) is detected. It then sets  $\overline{SIN}$  BUSY low (busy), delays, and so on until 8 bits are stored in the buffer location that is pointed to by the data-in pointer and the stop bits are received. That process is re-

peated until all of the data has been received. The routine requires one start bit, 8 data bits, and one or two stop bits with no parity bit allowed. As is the case with parallel I/O, data will be sent out as soon as the output device is ready for it.

Serial output is similar to serial input except that the SOUT BUSY line is read until it goes high, indicating that the device is ready to accept data. Then, data are loaded from the buffer location pointed to by the data-out pointer and are sent out one bit at a time on the SOUT line. One start bit, eight data bits, and one stop bit are sent. No parity bit is sent.

While this printer buffer is universal in the sense that it can be used with both serial and parallel equipment, be aware that all serial ports are *not* created equal. That's because the RS-232 standard is not really a standard. For a better explanation of what that means, see Herb Friedman's articles in the October and November 1984 issues of *Radio-Electronics*. Those articles are a good general guide to interfacing serial and parallel equipment.

The DOWNLOAD function allows you to customize the operation of the buffer. When it is selected, the program reads both the serial and parallel input ports for data. (The only baud rate supported on the serial port in this mode is 1200 baud). As data are received, they are loaded into

## PARTS LIST—PRINTER BUFFER

### All resistors 1/4 watt, 5%

R1—10,000 ohms

R2, R9-R18—47 ohms

R3—330 ohms

R4—180 ohms

R5-8—1000 ohms

### Capacitors

C1—1000  $\mu$ F, 25 volts, electrolytic

C2-C6, C8-1C0—0.1  $\mu$ F ceramic disc

C7—4.7  $\mu$ F, 12 volts, electrolytic

### Semiconductors

IC1—Z80 microprocessor

IC2—EPROM with control software (Alpha 91341)

IC3-IC10—4164 64K  $\times$  1 dynamic RAM

IC11, IC12, IC17—74LS157 quad 2- to 1-line multiplexer

IC13—74LS32 quad NAND gate

IC14—74LS260 dual 5-input NOR gate

IC15, IC26—7404 hex inverter

IC16—74LS175 octal D-type flip-flop

IC18—74LS393 dual 4-bit binary counter

IC19-IC22—74LS373 octal D-type latch

IC23—74LS74 dual D-type flip-flop

IC24—74LS00 quad NAND gate

IC25—74LS138 3- to 8-line decoder

IC27—MC1489 line receiver

IC32—LM340 5-volt regulator

D1—1N4001

### Other components

S1-S3—SP3T toggle

S4—normally open pushbutton

S5—SPST toggle

PL1, PL2—14-pin right-angle male header

PL3—10-pin right angle male header

F1—1 amp fuse

T1—10 volts, 1 amp, wall mounted transformer

XTAL—8-MHz crystal

**Miscellaneous:**—Case (CM6-225, PacTec) heatsink for IC32, fuse clips, wire, mounting hardware, PC board, IC sockets, connectors for your computer and printer, etc.

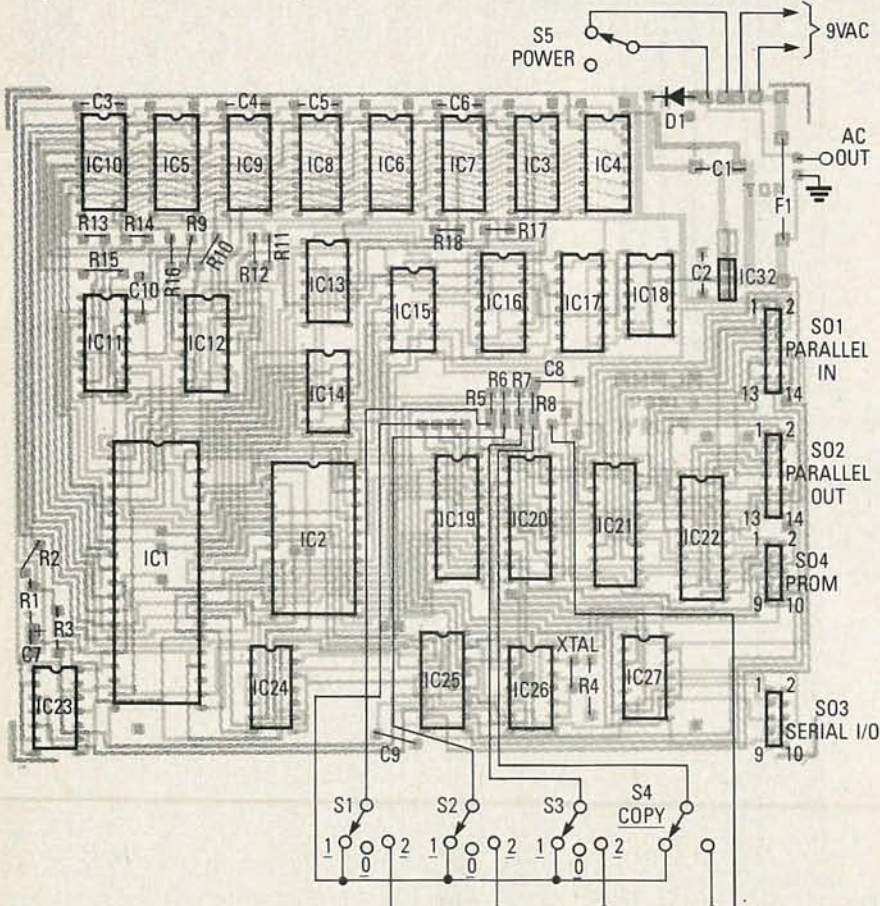

FIG. 4—PRINTER BUFFER PARTS PLACEMENT. Except for the five switches, all parts mount on the board. Most of the resistors are installed "standing up." See the text for information on how to mount the bypass capacitors near the RAM IC's.

memory. When the COPY switch (S4) is pressed, control is passed to the downloaded program.

If the PROM READ function is selected, address data are sent to the latches on the programmer board. Data are read from the EPROM address selected by the latched address data and sent into the buffer. It may then be read into a computer or used to program a blank EPROM.

Programming an EPROM is similar, except that data is sent to the buffer (1200 baud serial or parallel) and latched onto the EPROM's data bus after the address information. The programming voltage,  $V_{pp}$ , is switched on, and 50-millisecond pulses program each datum into the location addressed by the latched address lines. After each location is programmed, the datum at that location is verified.

## Assembling the universal buffer

The assembly of the buffer is not very difficult. Just keep in mind the following. When we say "install," we mean that the

(Continued on page 85)



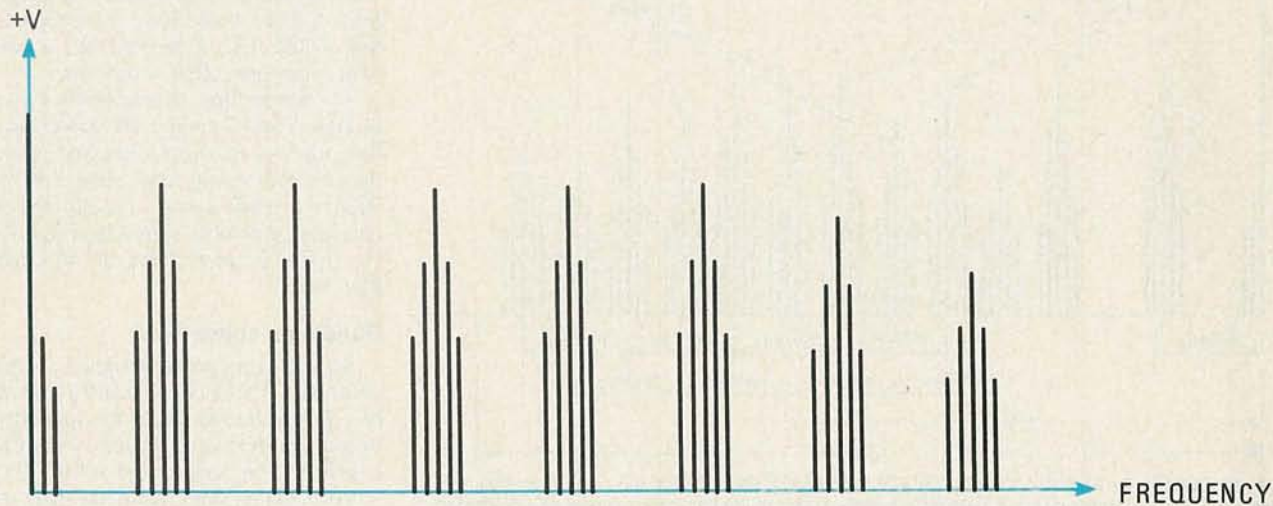

## COMB FILTERS for your TV

*Learn all about comb filters, how they work, and how they can be used to improve the performance of your video system.*

NEIL W. HECKT

COMB FILTERS ARE FREQUENTLY BEING used these days in video systems to separate the chrominance and luminance information from a composite video signal. In this article, we are going to learn more about comb filters and how they operate. We'll also look at an experimental NTSC decoder that you can build. It is used to derive RGB signals from a composite NTSC video input.

In order to understand how comb filters can separate the chrominance and luminance portions of an NTSC composite signal, we first need to understand more about the frequency spectrum of an NTSC composite signal. The NTSC signal is a "sampled data system" with sampling rates at 15734 Hz, 60 Hz, and 30 Hz; that is, the horizontal, field, and frame rates. As a result, the frequency spectrum of the luminance channel consists of a series of carriers spaced 15734 Hz apart, each having sidebands spaced 60 and 30 Hz about them (see Fig. 1). There are, of course, many more sidebands spaced about each carrier at multiples of 60 and 30 Hz than shown in Fig. 1, but for this discussion, the spectrum is simplified.

The frequency spectrum shown in Fig. 1 is for a monochrome signal and consists of the luminance information. For a color signal, in order to keep that signal compatible with the millions of black and white sets on the market, the chrominance information is cleverly "stuffed" into the empty frequencies between each of the

luminance carrier and sideband sets (see Fig. 2).

The chrominance information, like the luminance information has a spectrum that consists of a series of carriers spaced 15734 Hz apart, each having sidebands spaced about them. The chrominance carriers, however, are located at frequencies that are precisely midway between two adjacent luminance carriers. (It was not by accident that the color-burst frequency was chosen to be exactly 455 times the horizontal sweep frequency, divided by 2:  $(455 \times 15734)/2 = 3,579,485$  Hz. That frequency is exactly 227.5 15734-Hz carriers away from 0 Hz.) Because of that

arrangement, the total spectrum of the NTSC signal appears as a neatly interlaced set of luminance and chrominance carrier/sideband sets. There are, of course, many more of those carrier/sideband sets than shown here.

In a typical color-TV set, the chrominance information is separated from the luminance information by passing the composite spectrum through a chroma bandpass filter. That effectively removes all luminance information outside the passband; however, the luminance information that is within the passband remains (see Fig. 3).

Similarly, the chrominance informa-

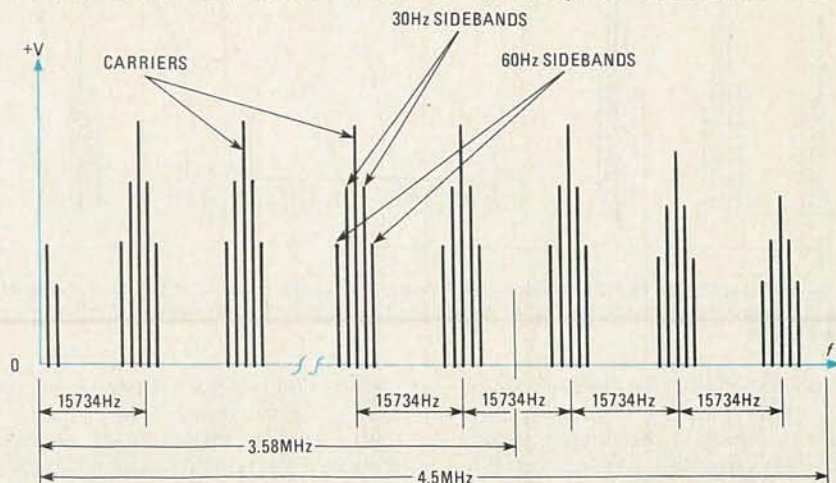

FIG. 1—THE FREQUENCY SPECTRUM OF LUMINANCE information consists of a series of carriers spaced 15,374 Hz apart, each having sidebands at 60 and 30 Hz on either side.



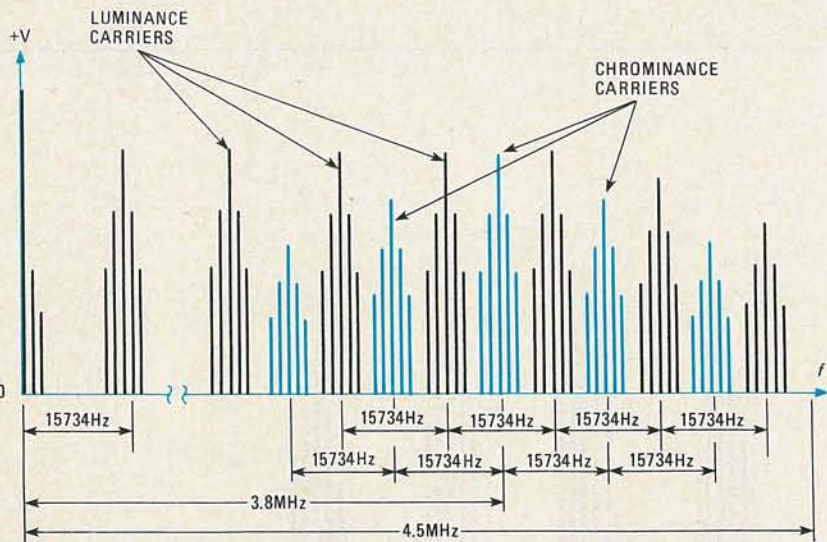

FIG. 2—IN ORDER TO ENSURE COMPATIBILITY with black-and-white TV sets, the chrominance information is located in the empty frequencies between each of the luminance carrier and sideband sets.

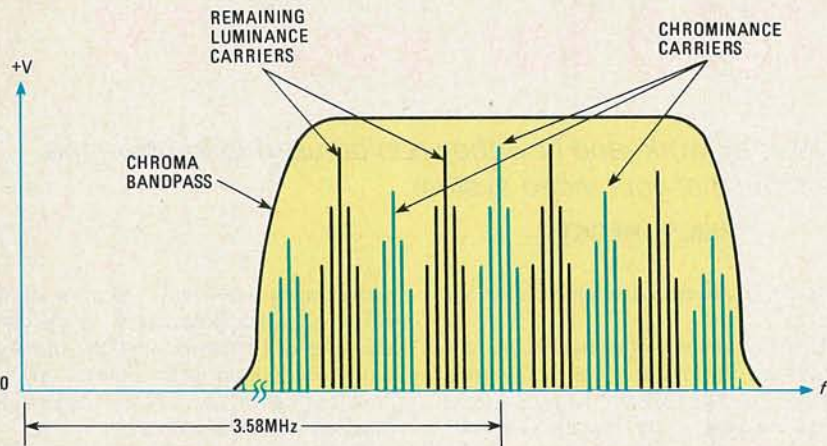

FIG. 3—USING A BANDPASS FILTER removes the luminance information that falls outside of the passband, but the luminance information that falls within the passband is not affected.

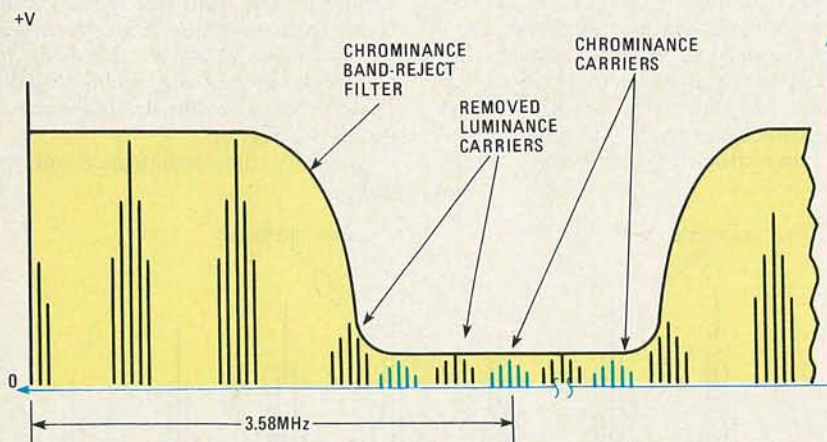

FIG. 4—USING A NOTCH FILTER to remove chrominance information also results in the removal of some of the luminance information. The lost luminance information consists of much of the fine detail of the picture.

tion is removed from the luminance information by passing the composite spectrum through a band-reject (notch) filter. That effectively removes the chrominance, but also removes some of the luminance information (see Fig. 4). That

removed luminance information contains much of the fine detail of the picture.

As should be obvious, then, an ideal luminance filter would be one that passes all of the luminance information and rejects the chrominance (see Fig. 5). An

ideal chroma filter would be one that passes all of the chrominance information while rejecting the luminance (see Fig. 6). Such a filter would have a characteristic that would look somewhat like a comb; hence they are called *comb filters*.

The comb-filter characteristics shown in Figs. 5 and 6 are greatly simplified. In fact, each of our luminance and chrominance filters would have about 280 teeth (nulls) in each comb. In addition, the chroma comb nulls would be offset 7867 Hz ( $15734/2$ ) away from the luminance filter nulls.

### Building a comb filter

Such a filter can be designed around a delay line. The delay time of the line must be equal to the period of the spacing between the teeth of the comb. For NTSC television, the period must be  $1/15734$  Hz = 63.5566  $\mu$ s, and that delay time must be very precise.

A simplified block diagram of a comb filter is shown in Fig. 7; let's see how that filter works.

Since the delay of the line is exactly  $1/15734$ , it will store exactly one cycle of a 15734 Hz sinewave. At 15374 Hz, the output of the delay line will be in phase and equal in amplitude to the input signal. Since both the input signal and the output of the delay line are fed to the Y (luminance) channel "adder," the amplitude of the output of that adder at 15374 Hz will be twice that of the input signal. That constitutes a peak in the filter response at 15734 Hz. Similarly, the C (chrominance) channel "subtractor" also sees two equal-amplitude in-phase signals at 15374 Hz. The C channel subtractor will thus produce zero output. That constitutes a null in the filter response at 15734 Hz.

At 7867 Hz ( $15734/2$ ), the delay line will have one half cycle stored in it. The output from the delay line is, at that time, 180 degrees out-of-phase with the input signal. That will cause the Y-channel adder produce a zero output (null), while the C-channel subtractor will generate a signal that has twice the amplitude of the input signal (peak).

At 31468 Hz ( $15734 \times 2$ ), the delay line stores two cycles, causing an identical effect as one cycle—a peak in the Y-channel filter characteristic and a null in the C-channel filter characteristic. At  $1\frac{1}{2}$  times 15734 Hz (23601 Hz), an effect identical to the half cycle effect causes a null in the Y channel and a peak in the C channel.

Thus, for every integer multiple of 15734 Hz, a peak is produced in the Y channel, and a null is produced in the C channel. At every integer multiple of 23601 Hz, there is a null in the Y channel and a peak in the C channel.

The filter we've just described is actually a little too good since it "combs" all the way from 0 to 4.5 MHz, and our desir-



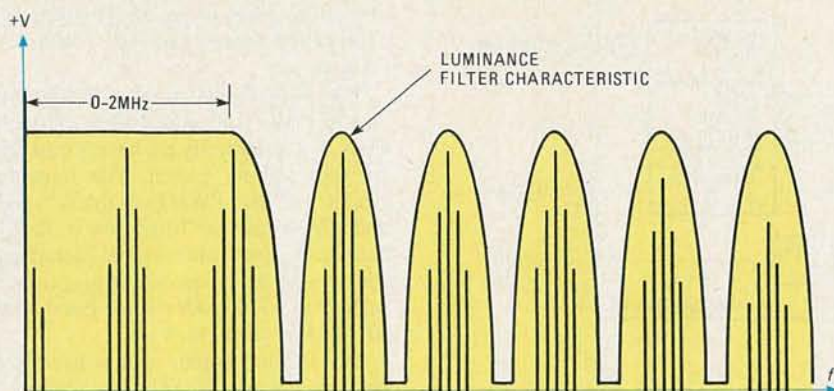

FIG. 5—AN IDEAL LUMINANCE FILTER would be flat to about 2 MHz, then comb every 15,734 Hz to 4.5 MHz.

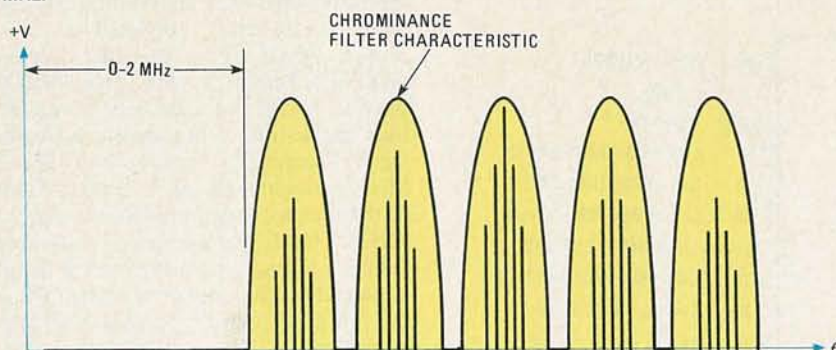

FIG. 6—AN IDEAL CHROMA FILTER would have zero response to about 2 MHz, then comb every 15,734 Hz to 4.5 MHz.

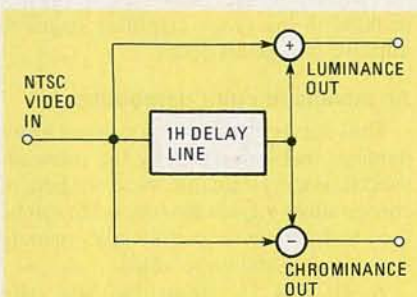

FIG. 7—A BASIC COMB FILTER can be built around a 1H-delay line. One drawback to the filter shown here is that it combs from 0 Hz.

ed response is to be flat in the first 2 MHz of the Y channel, and to have zero response in the first 2 MHz of the C channel. The reason we want flat response to 2 MHz in the luminance channel is because much of the low-frequency information (which represents horizontal line-to-line luminance differences) will otherwise be removed by the comb filter.

Figure 8 shows a more practical configuration for our filter. As is shown in that block diagram, the Y channel can be made essentially flat for the first 2 MHz by adding the first 2 MHz of the C channel to the Y channel. Since there is a peak in C for every null in Y, they tend to cancel out when added.

A 2 MHz lowpass filter in the C channel passes the first 2 MHz of the chrominance signal, which is then added back to the Y channel. That creates a Y-filter charac-

teristic that is essentially flat from 0 to 2 MHz, with combing from 2 to 4.5 MHz. The 4.5-MHz lowpass filter sets the Y-channel's upper passband edge at 4.5 MHz, which is just below the audio channel. Meanwhile, a 1-MHz bandpass filter in the C channel, centered at 3.58 MHz, restricts combing to just the chrominance frequency band.

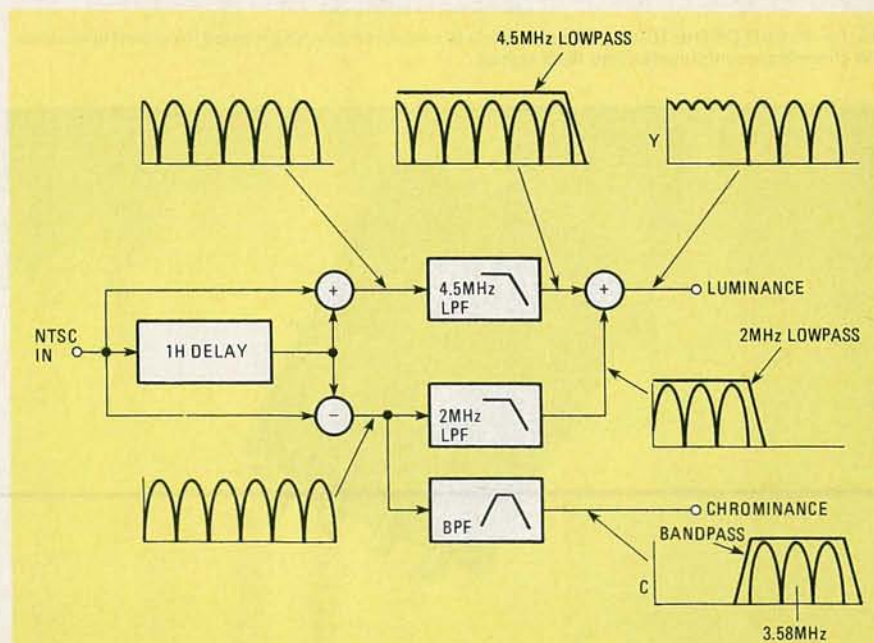

FIG. 8—A PRACTICAL COMB FILTER. In the luminance channel, this filter will have nearly flat response to 2 MHz; in the chrominance channel, this filter will have zero response to 2 MHz.

### The RCA PW600 module

The delay line used in the experimental comb filter NTSC decoder about to be described is part of an RCA PW600 module (see Fig. 9), which is used in some recent RCA color TV models. (For a schematic diagram of that module, see Howard W. Sam's Photofact Set 1945, folder 2, RCA chassis CTC101A, 1981 production.) The PW600 also contains some vertical detail enhancements.

The difficult part of any comb filter is the 1H delay line which, as mentioned earlier, must be very precise. The one onboard the PW600 is a sophisticated device; it is a charge-coupled analog shift register of 683 1/2-stages. The delay introduced by the shift register is purely a function of the frequency of the applied shift clock and number of stages. When a shift frequency of three times the color burst frequency (10.74 MHz) is used, the total delay is exactly 1H.

A charge-coupled shift register consists of a series of switches and storage capacitors. On each shift (or clock) signal, the charge of any particular capacitor is transferred to the next capacitor in line. The first capacitor in the device, of course, gets its charge from the applied input voltage. The process is very similar to the old "bucket brigade" used for fire fighting. Each person holds a bucket. The bucket of the first person in line is filled to some level. That person then empties his bucket into the bucket of the next person in line. The next person then empties his bucket into the bucket of the third person in line. Meanwhile, the first person has refilled his bucket and is ready to empty it into the bucket of the second person. That process is carried on continuously with the last person emptying his bucket on the fire.



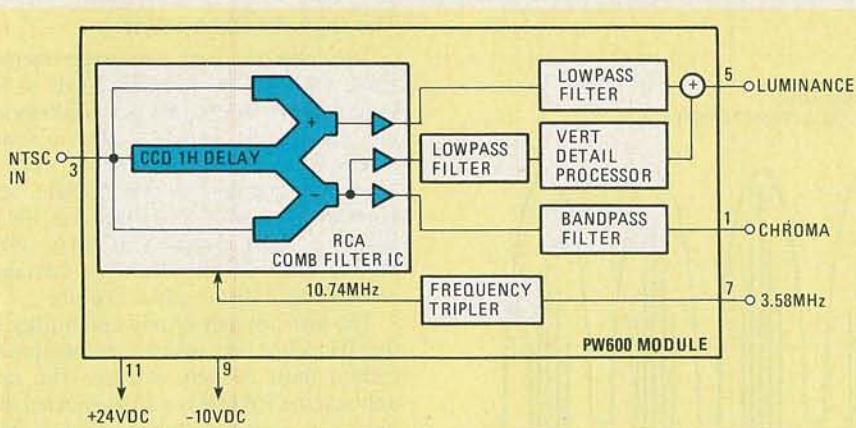

FIG. 9—THE PW600. This RCA module contains all of the components of our basic comb filter.

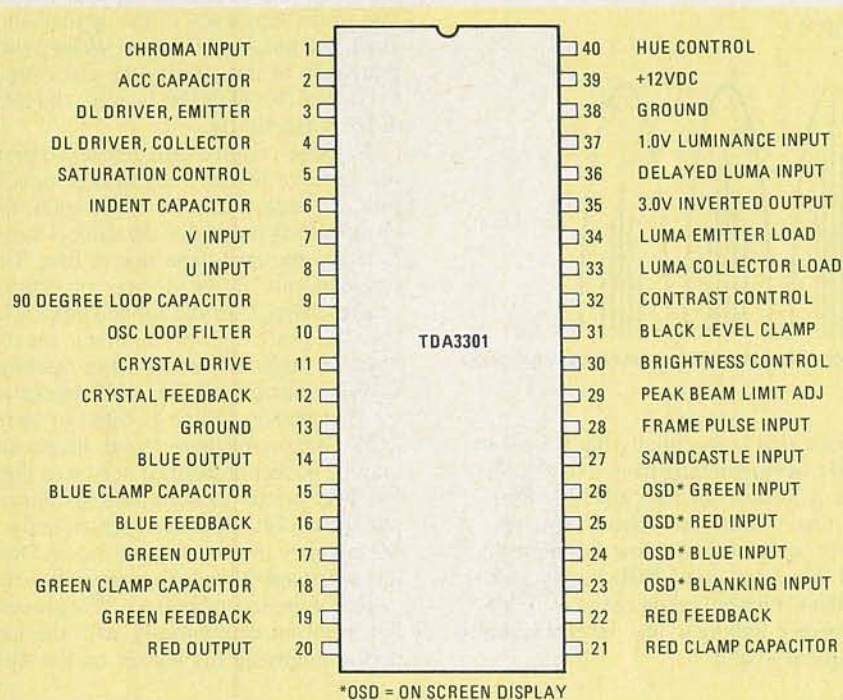
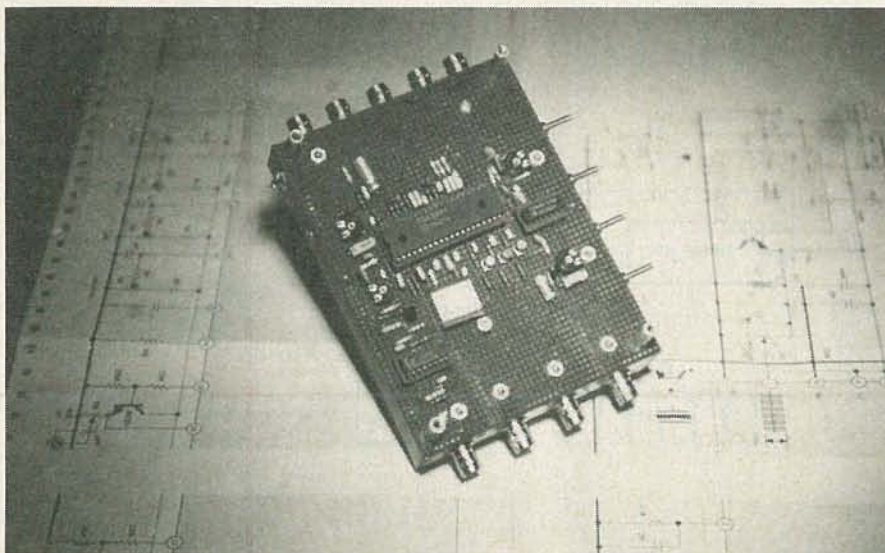

FIG. 10—PINOUT OF THE TDA3301. This Motorola IC contains everything needed to convert luminance and chrominance information into RGB signals.



THE TDA3301 is used in an experimental NTSC decoder that will be described in the next part of this article.

That similarity of charge-coupled devices to the old bucket-brigade has caused them to be called "bucket-brigade" devices as often as not.

The delay-line IC used in the PW600, also contains the adder and subtractor. Thus, it is essentially the basic comb filter we spoke about earlier. The remaining circuitry of the PW600 is the 4.5 MHz and 2 MHz lowpass filters, the 3.58 MHz bandpass filter, the vertical detail processor, and the frequency tripler for converting the 3.58-MHz color burst to the 10.74 MHz shift clock.

The PW600 inputs one volt peak-to-peak composite NTSC video and 3.58 MHz color burst reference, and outputs separated luminance and chrominance. It requires +24- and -10-volts DC.

Just a word about the vertical-detail processor. That is peculiar to the PW600 module, and is not used with all comb-filter applications. The combing action in the Y channel, at frequencies below 2 MHz, removed much of the vertical detail of the picture. Adding back the lower 2 MHz of the C channel restored the lost detail. It follows that if the vertical detail is added back at a greater level than originally received, then the vertical detail may be enhanced. The vertical-detail processor circuit is an amplifier having non-linear gain vs. frequency. The process can be compared to the use of high-frequency peaking in the video amplifier stages to improve horizontal detail.

### An advanced color demodulator

Thus far we have only separated chrominance and luminance by the most advanced process available. Next we have to convert those signals into ones that can be used to drive a color picture tube, namely RED, GREEN, and BLUE video.

A 40-pin IC demodulator, the TDA3301, has recently been introduced by Motorola (see Fig. 10). It contains everything needed to process the luminance and chrominance signals into RGB signals, and when used with the PW600, does it all without any inductors, tuned circuits, or luminance delay lines. The device is of European design, and is useable for either PAL or NTSC demodulator applications.

In addition to doing the color demodulation, it has RGB and blanking inputs that allow external mixing of computer information with the video picture.

The TDA3301 provides automatic black-level setup and beam-current limiting. It normally requires no oscillator adjustment, has three on-screen display inputs (RGB), a high-speed blanking input, and it operates from a single 12-volt DC supply.

That's all we have room for now. Next time, we'll show you how the PW600 and the TDA3301 can be used to build an NTSC decoder. R-E



*Now that we've introduced you to the HiTech PC-compatible computer, let's see how it's put together.*

ELLIOTT S. KANTER

**Part 2** WHEN WE LEFT OFF last time, we were just getting ready to configure the motherboard. The first step is to set the configuration switch SW1, which is a DIP switch that is made up of eight separate switches that we'll call SW1-1-SW1-8.

As we showed you last month, for our configuration the switches should be set as follows:

- SW1-1: OFF.
- SW1-2: ON.
- SW1-3: OFF.
- SW1-4: ON.
- SW1-5: OFF.
- SW1-6: OFF.
- SW1-7: OFF.
- SW1-8: ON.

Switch SW1-1 is always off for normal

operation, while SW1-2 is on unless an 8087 co-processor is being used.

Switches SW1-3 and SW1-4 are set depending on how much memory is installed. For 128K, they should be set off and on respectively. For 192K, they should be set on and off, respectively. For 256K, they should both be off.

Switches SW1-5 and SW1-6 are set depending on the display adapter used. They should both be on if no display adapter is used. If a color/graphics adapter (with  $40 \times 20$  resolution) is used, SW1-5 should be off, but SW1-6 on. For a resolution of  $80 \times 25$ , those settings should be reversed. If both adapters are used, or if a monochrome adapter is used, both SW1-5 and SW1-6 should be off.

Switches SW1-7 and SW1-8 are set de-

## **PC Compatible Computer**

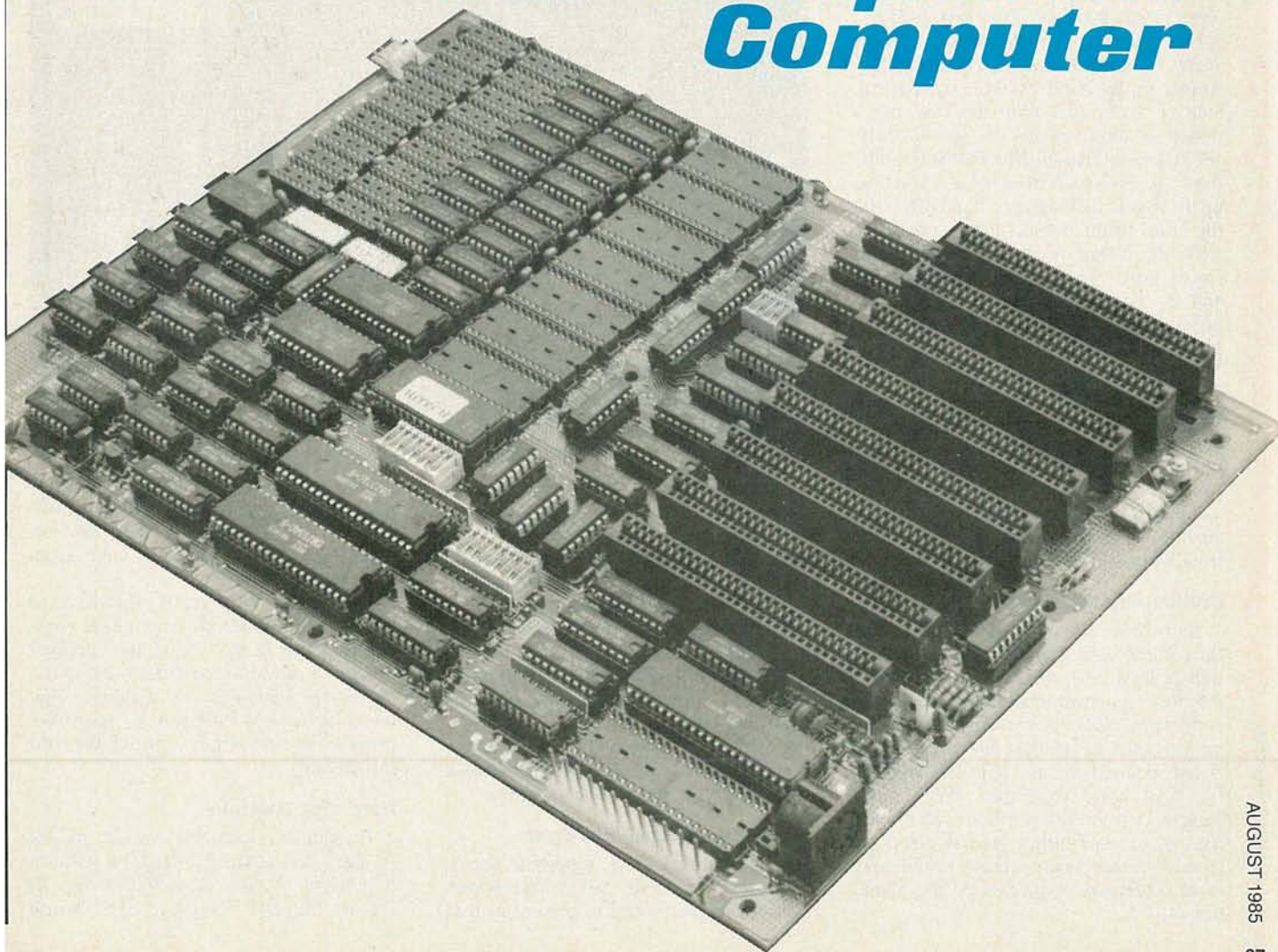



pending on how many floppy-disk drives are installed. For 1 drive, both should be on. For 2 drives, SW1-7 should be off, but SW1-8 should be on. For 3 drives, SW1-7 should be on, but SW1-8 should be off. For 4 drives, both should be off.

Two other DIP switches are located on the motherboard. Those switches are not numbered but their locations are labeled "FOR RAM EXPANSION" in Fig. 4. (For your convenience, Fig. 4, which appeared last time, will be repeated here.) Unless you have the necessary expertise to implement alternative ROM/EPROM's, don't disturb the settings.

Now it's time to insert the BIOS ROM in position U35. Be sure to observe the orientation of the notch or dot indicating pin 1.

Now that you have completed the switching configuration process, you're almost ready to install the board in the case. Before you do, locate the jumper block JP1. (See Fig 4.) If you are using the HiTech Power Supply, ensure that a jumper is in place from pins 2 to 3. That jumper enables the on-board power-on reset. If you are using the IBM power supply, install the jumper from pins 1 to 2.

The system board is now ready to be installed. It will be secured by a locking-type, plastic stand-offs and two, 6-32 x 1/4-inch screws. As noted in Fig. 4, one screw will be mounted with an insulating washer separating it from the component side of the board. With the case positioned as shown in Fig. 3 (see the July 1985 issue of **Radio-Electronics**), slide the system board in from the left and line up the plastic locking-type stand offs with the holes in the board. Those stand-offs will slide in their mounts making this task easier. When you have lined the board up and the stand-offs protrude through the holes, press down to lock the board into place.

Refer again to Fig. 4 and install the screw without the insulating washer where shown (point A). In a similar manner install the screw with the insulating washer where shown (point B). Take the two-wire cable coming from the speaker and plug it into the on-board connector as also shown in Fig. 4. That completes the installation of the system board.

### Configuring the disk drive

If you have not done so already, carefully unpack the floppy-disk drive. Position the drive as shown in Fig. 6 and locate the power connector and the data-cable connector. Using a screwdriver, gently pry out resistor pack RA1 and discard it; it is not required for use with the HiTech PC. Next, move the jumpers; they should be at the HS and DS1 positions. That's all there is to configuring your floppy-disk drive. If you have purchased a second disk drive, configure it in exactly the same manner.

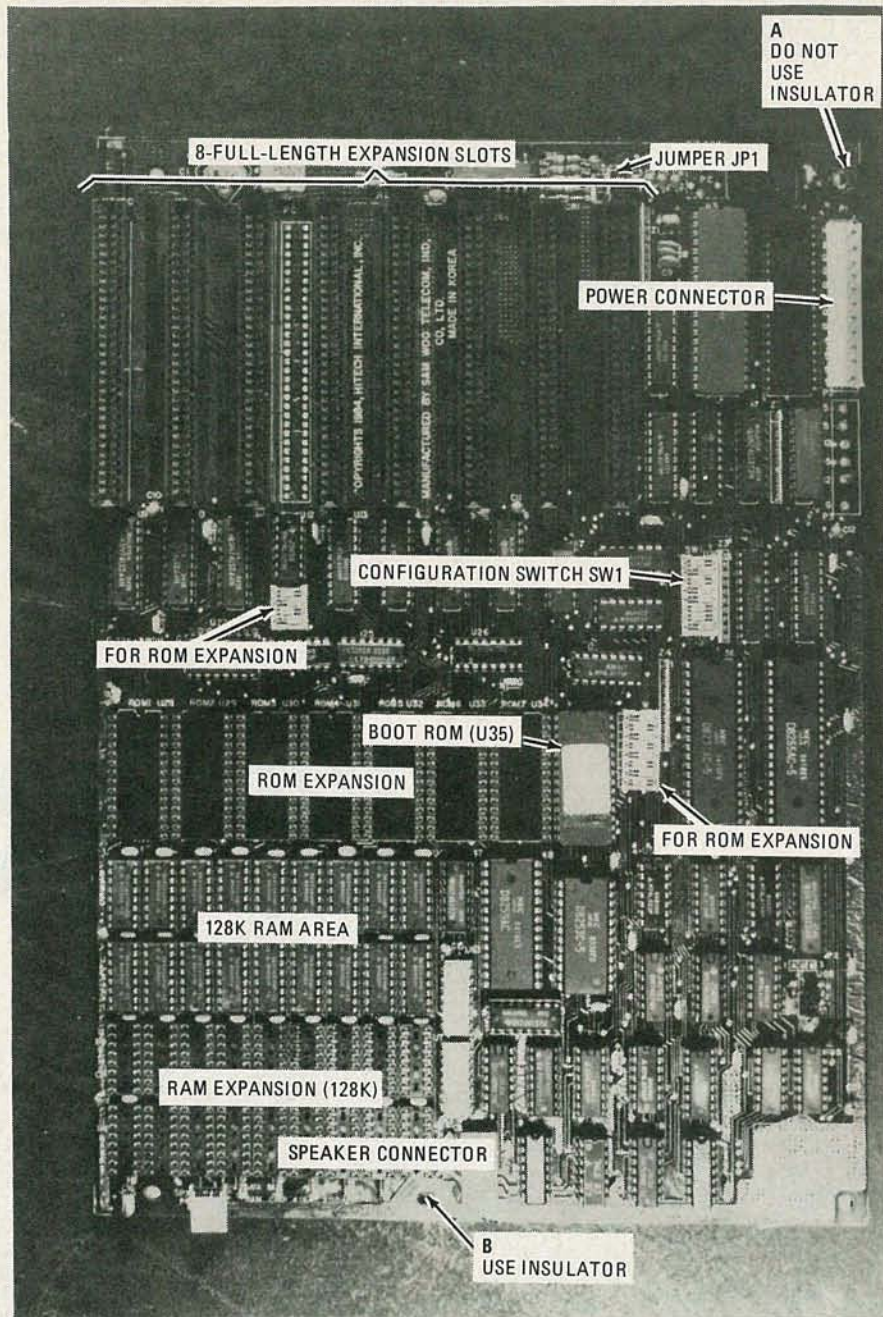

FIG. 4—THE HITECH MOTHERBOARD and some of the features you'll have to be familiar with.

You are now ready to install the floppy-disk drive in the case. Pop out the lower of the two plastic drive faceplates and carefully insert the disk drive, component-side down, through the front of the case. Secure the disk drive using two 6-32 x 1/4-inch screws in the slots (bracket) and tapped holes (disk drive) ensuring that the drive front is lined up with the front of the panel. The direction-indicating arrow on the front of the disk drive should be pointing up. That's all there is to installing the drive. If you have purchased a second disk drive, install it in a similar manner.

### Installing the hard-disk drive

Your hard-disk drive, despite its name, is fragile. You should take whatever precautions are necessary to prevent it from

jarring or dropping. (Damage can occur if it's dropped from heights as little as two inches!) Unpack the disk drive and remove the plastic front panel cover from your computer.

Refer to Fig. 7 and gently slide the drive into the right-hand side opening (as viewed from the front). Using the supplied mounting screws, secure the drive to the bracket as shown in the drawing. That completes the installation of the drive proper. The next step is to install the controller card.

### Hard-disk controller

If you have not done so already, unpack the hard-disk controller card and position it in front of you as shown in Fig. 8. Locate the DIP configuration switch



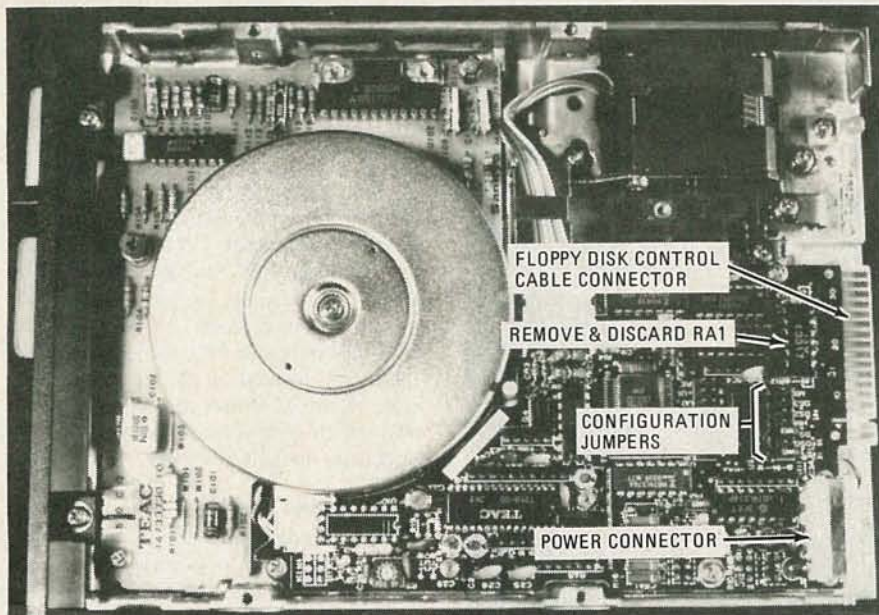

FIG. 6—THE FLOPPY-DISK DRIVE. The resistor network RA1 can be discarded. See the text for the proper jumper configuration.

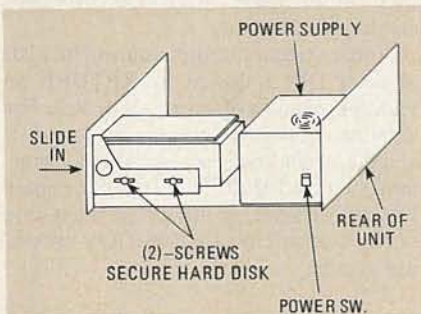

FIG. 7—MOUNTING THE HARD DISK and power supply is straightforward.

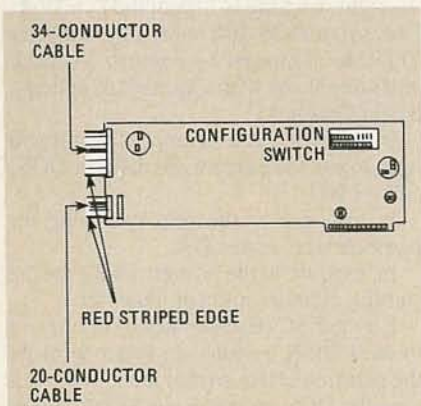

FIG. 8—THE HARD-DISK CONTROLLER CARD. The first four positions of the configuration switch should be set to off, and the last four should be set on.

SW1. (Note that this SW1 is *not* the same SW1 that we set on the system board.) The controller supplied with your computer is capable of accepting hard disks ranging in capacity from 10MB to 30MB. SW1 configures the card to the drive installed. In our case, we will be installing and configuring this card for a 10MB disk, so set SW1-1 through SW1-4 off and SW1-5

through SW1-8 on. That's all you have to do to configure the controller card. Don't change any jumpers on the card. You're now ready to install it, using Fig. 9 as a guide.

Using the supplied cables, plug the 20-pin and 34-pin cables into the card as shown with the red striped end of the cables pointing down toward the card-edge connector. Insert the card into a vacant slot near the hard-disk drive and route the cables as shown toward the hard disk. You will have to remove one of the

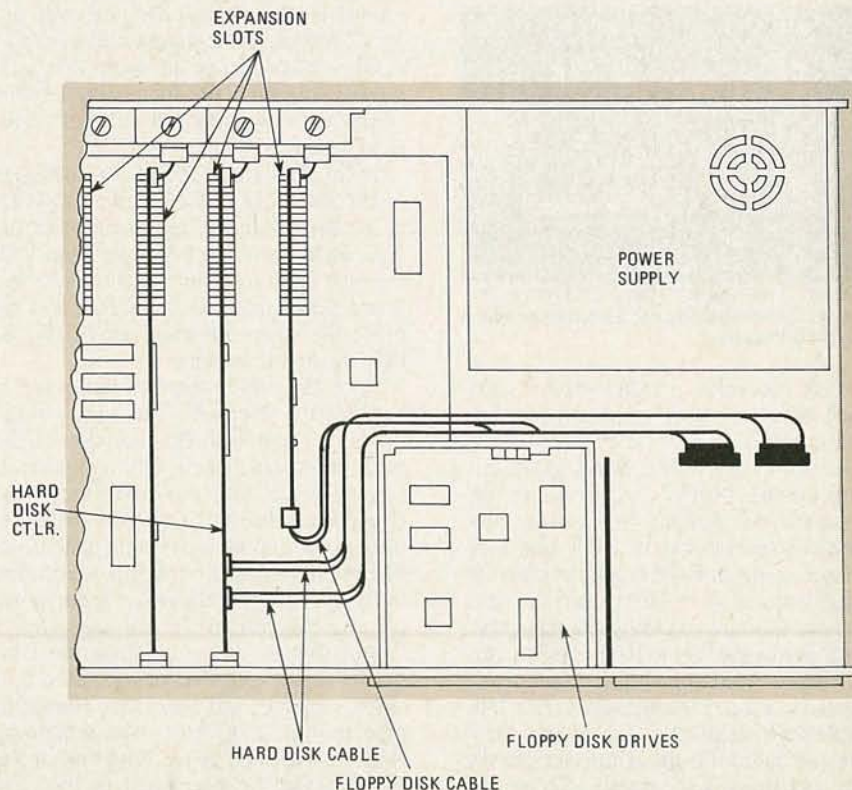

FIG. 9—ROUTING THE RIBBON CABLES for the disk drives is easy if you follow the layout shown.

back slot covers to install the card; save the screw and use it to secure the card with the cable end pointing towards the computer's front panel. Connect the remaining ends of the cables to the hard-disk drive. They are keyed and can only be inserted in the proper manner. Your hard-disk drive and controller card are now installed. We will format the disk shortly.

### Installing the power supply

Position the power supply so that the power switch is located to the right rear (as viewed from the front) and protrudes from the rear right hand side of the case. (Refer to Figs. 7 and 10.) Turn the case around and line up the four mounting holes with their corresponding holes in the rear panel. Using four 6-32 × 1-inch round-headed screws, secure the power supply to the rear of the case. Locate the two cable assemblies and connect them to the motherboard as shown. In a similar manner, connect one of the two, 4-line cable assemblies to the rear of the hard disk drive. The assembly's connector is keyed and can only be inserted the correct way.

The remaining 4-line cable assembly will be connected in a similar manner to the floppy disk drive. If you are using two drives, use the y-adapter and carefully match the color codes of the wires and crimp the adapter in place.

### The adapter cards

Now it's time to install a color-graphics/monochrome display card and a flop-



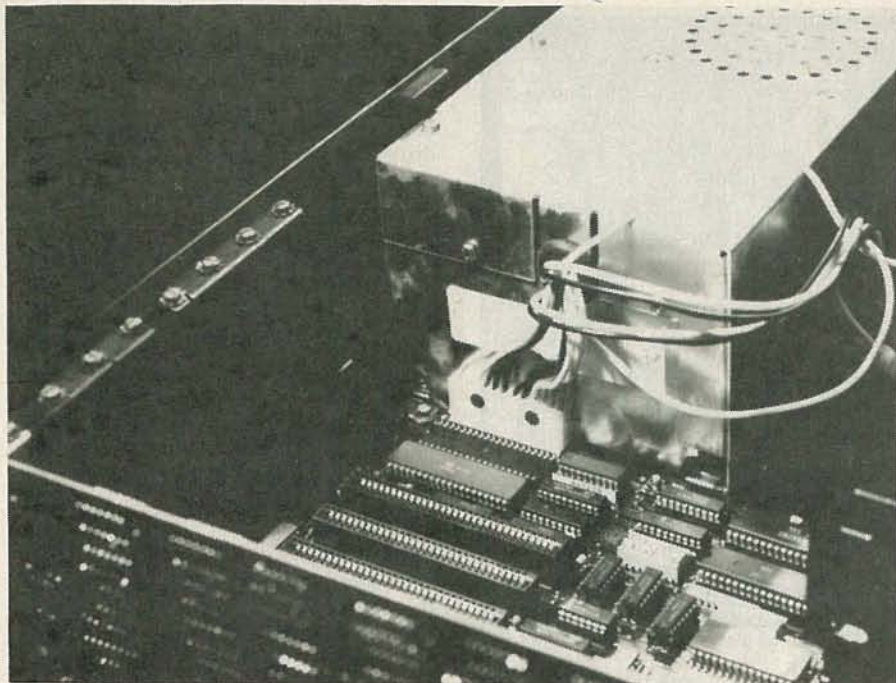

FIG. 10—THE POWER SUPPLY is shown connected to the motherboard. Note that the cables for the floppy- and hard-disk drives are not shown.

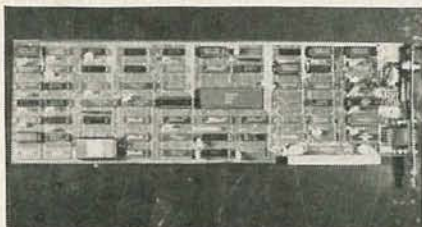

FIG. 11—THE COLOR graphics/monochrome adapter is fully compatible with the IBM system.

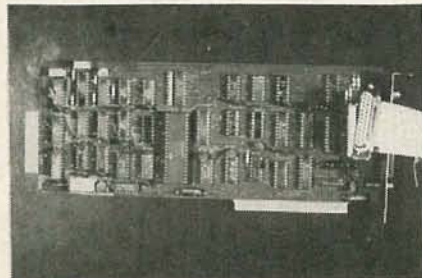

FIG. 12—THE FLOPPY-DISK CONTROLLER adapter shown here also comes equipped with a parallel printer port.

py-disk controller/parallel printer card. Each of those cards is packaged separately with necessary cables and instructions as to use. The color-graphics/monochrome display card shown in Fig. 11 should be installed in the first (left-most) expansion slot with the two connectors—one for RGB color, the other for composite video—visible from the rear. Remove the screw holding the rear panel cover corresponding to the first slot (right as viewed from the front). Discard the panel cover but retain the screw; it will be used later to secure the adapter card. Position the card with the connectors to the rear and press down firmly. Secure the rear panel bracket.

The last adapter card we'll install is the floppy-disk controller card with a parallel printer port. Remove the third and eighth rear panel covers and save the screws. The left-most opening will be used for the DB25 parallel printer port connector. The remaining (third) opening will be filled with the expansion-drive connector.

Refer to Fig. 12, the controller/printer adapter. The only required configuration would be to change the position of the jumper located nearest the card edge fingers. The purpose and possibilities of that configuration change are more than adequately covered in the documentation that comes with the card and will not be repeated here.

Position the card so that the gold fingers on the long edge of the board are directly above the connector and ensure that the plate attached to the board lines up with the now open rear slot. Firmly press the board down into the connector and replace the screw removed previously to hold the board in place.

Take the cable supplied and place it between the floppy-disk drive(s) and the controller card with the red edge of the cable pointed to the top of the computer. If you are using only one drive, locate the connector at the fold of the cable and press the connector onto the bottom disk drive. The red line should be visible toward the left as seen from the front of the computer (on the disk drive). If you are using a second floppy drive, position the connector at the split end of the cable in a similar manner and press this connector onto the top disk drive. The remaining connector located at the long end of the cable should be connected to the card adapter with the red edge line pointing to

the top or up. Route this cable as shown previously in Figure 9. That completes the installation of the floppy disk controller. To mount the DB25 parallel printer port, fasten this connector to the (supplied) bracket with the hardware supplied. Position that connector and bracket in the last opening and secure it with the remaining screw removed previously.

We're now ready to close up the case and try things out! Slip the case cover on from the front and secure with the four 6-32 × ¼-inch black flat head screws. Plug the connector from the keyboard into the socket located on the rear of the cabinet. Figure 13 shows the completed system which is also available ready to use under the name SAM 2001.

### The "smoke test"

Now hook up your monitor, plug everything in, slip your operating-system disk into drive A (the top drive), and turn the computer on. The screen display will show the self-test in progress. When the self-test is complete, it will instruct you to insert your system diskette in the drive and to press any key.

At the system prompt, you might wish to enter DIR followed by RETURN to view the contents of your system disk. For detailed information on your system disk and the various uses of the utilities it contains, consult the literature that comes with the diskette, or any of the many fine books available on the MS-DOS operating system.

### Formatting the hard disk

Now that everything seems to be working right, it's time to format the hard disk. Leave your DOS disk in drive A and enter "FDISK" followed by a return. A menu will present you with a number of options. Select Option 1.

In response to the prompt asking if you want to use the entire fixed disk for DOS, answer NO.

In response to the prompt asking for partition size, enter 303.

In response to the prompt asking for the starting cylinder number, enter 0.

Hit the ESC (Escape) key to return you to the FDISK options. In order to make the partition active so that the system will load the DOS on power-up, select option 2.

View the partition data and double check it. You will be prompted to enter the number of the partition you want to make active. Select 1. Then hit the ESC key to return to the FDISK options. Use the ESC key again to return to DOS.

Reboot your system by hitting CTRL ALT DEL (the control, alternate and delete keys) simultaneously.

Next we'll use the DOS command FORMAT to initialize the hard disk's directory. First type "FORMAT C:/S."



## ADD-ON BOARD SUPPLIERS

### ABM Computer Systems

3 Whatney  
Irvine, CA 92714  
714-859-6531

### Apstek Inc.

2636 Walnut Hill Lane Suite 335  
Dallas TX 75229  
214-357-5288

### AST Research, Inc.

2121 Alton Ave.  
Irvine, CA 92714  
714-863-1333

### Byad, Inc.

95 W. Algonquin Road  
Arlington Heights, IL 60005  
312-228-3400

### Chrislin Industries, Inc.

31352 Via Colina Suite 1  
Westlake Village, CA 91362  
213-991-2254

### IDE Associates, Inc.

7 Oak Park Drive  
Bedford, MA 01730  
800-257-5027

### MA Systems

2015 O'Tolle Ave.  
San Jose, CA 95131  
408-943-0596

### Maynard Electronics

430 E. Semoran Blvd.  
Casselberry, FL 32707  
305-331-6402

### Microlog, Inc

222 Route 59  
Suffern, NY 10901  
901-368-0353

### Orchard Technology

47790 Westinghouse Drive  
Fremont, CA 94539  
415-490-8586

### Personal Computer Products, Inc.

11590 W. Bernardo Court  
San Diego, CA 92127  
619-485-8411

### Persyst

17862 Fitch  
Irvine, CA 92714  
714-660-1010

### Profit Systems, Inc.

30200 Telegraph Rd. Suite 132  
Birmingham, MI 48010  
313-647-5010

### Quadram

4355 International Blvd.  
Norcross, GA 30093  
404-923-6666

### Tecmar

6225 Cochran Rd.  
Bolon, OH 44139-3377  
216-349-0600

## ORDERING INFORMATION

The following are available from HiTech International, Department R-E, 1180 Miraloma Way Suite M, Sunnyvale, CA 94086.

Part No.	Description	Price
RE-PCB W/IC	Motherboard with 128K RAM	\$525.00
RE-PS-130	130-watt power supply	175.00
RE-ROM	BIOS ROM	35.00
RE-CASE	Case (complete)	150.00
RE-5150	enhanced keyboard	150.00
RE-MON/DIS	RGB video card	175.00
RE-DISK DR.	Teac 360K disk drive	125.00
RE-CTRL-A	Disk controller/parallel port	175.00
RE-HARD DISK	10 megabyte drive with controller	650.00
RE-YAD	Y Adapter (to attach two drives)	5.00
<b>Total*:</b>		<b>2165.00</b>

\*Note that due to last-minute price changes by both IBM and HiTech, the price difference between their two compatible computers does not live up to the \$2000 claimed on last month's cover.



FIG. 13—THE COMPLETE HITECH COMPUTER is available fully assembled as the Sam 2001.

You'll be prompted to hit any key to begin formatting drive C. When you do, don't be surprised at the amount of time required to format the hard disk. You will be able to tell that the hard disk is working by the drive indicator light being illuminated. When formatting is complete, a status report will be displayed telling you the total disk space, the space marked as defective, and the space currently allocated to files. Note that the amount of space marked as defective must be ZERO. If any bad bytes are found, you should contact HiTech International.

As we have seen, the DOS command FORMAT is required to setup the hard disk, it also initializes it. Initialization could be disastrous if used at the wrong time. The same command is also used to format the floppy disks, so if you used it in error, the hard disk could in fact be erased. To prevent that from happening, change the name FORMAT.COM to FMT.COM. To do so type "RENAME FORMAT.COM FMT.COM."

Next create a batch file to format floppy diskettes. To do so type: "COPY CON: FORMAT.BAT FMT A%1." Then hit the F6 key. That program will enable you to format a diskette or to format and place DOS on your diskette. To only format the diskette type FORMAT; to both format and add DOS, type FORMAT/S.

That completes the formatting and configuration of your hard disk. You are now ready to enjoy your system.

### Add-ons, etc.

One of the advantages of building your own system is the ability to tailor accessories to your needs. There are a lot of companies making accessories for the IBM PC/XT and anything that fits the IBM, will work in your HiTech computer. To offer you some assistance, we are including a list of suppliers of accessories that will permit memory expansion, additional ports (serial, parallel, game, etc.) and the ability to configure additional memory as a RAM disk.

R-E



## DESIGNING WITH DIGITAL IC'S

This month we'll see how simple gates can be combined to form one of the basic circuits of digital electronics—the flip-flop.

JOSEPH J. CARR

**Part 5** IN PAST INSTALLMENTS of this series we have discussed logic families, interfacing methods, and elementary gates. Let's now expand our discussion to include combinations of gates. Such combinations of gates can, of course, perform more complex functions than simple gates alone. The first of such circuits that will be discussed are basic flip-flops, specifically two forms of set-reset flip-flops—the clocked set-reset flip-flop, and master-slave (which is also known as the load-transfer) flip-flop. But first, let's review the two basic gates that are used in these circuits—the NAND and NOR gates.

### NAND and NOR gates

The two basic gates used in our flip-flops are the NAND and NOR gates shown in Fig. 1. We've previously looked at how those gates operate, but let's briefly review that here:

For a NAND gate, a low on either input forces the output high. Thus, for the output to be low, a high must be presented to both inputs.

For a NOR gate, a high on either input forces the output low. Thus, a low must be presented to both inputs for the output to be high.

Most IC NAND and NOR gates are "quad" units; that is, there are four such gates in a single IC package. The 7400 TTL device, for example, is a "quad two-input NAND gate," while the 7402 is a TTL "quad two-input NOR gate." Both IC's contain four two-input gates that are independent of each other, except for power supply and ground connections.

### Set-reset (S-R) flip-flops

The set-reset flip-flop (also called the S-R flip-flop) is a bistable circuit, which means there are two stable output states. Those states are defined as follows: Set— $Q = \text{high}$ ,  $\bar{Q} = \text{low}$ ; reset— $Q = \text{low}$ ,  $\bar{Q} = \text{high}$

Unless otherwise specified, the set state always makes  $Q$  high, and the reset

state makes  $Q$  low. Of course,  $\bar{Q}$  is always the complement of  $Q$ .

Figure 2 shows the NAND gate version of the S-R flip-flop, while Table 1 is the truth table that describes circuit operation. The NAND-gate S-R flip-flop rules are summarized as follows:

A low applied to the set ( $s$ ) input forces  $Q$  high, and  $\bar{Q}$  low. A low applied to the reset ( $R$ ) input forces  $Q$  low and  $\bar{Q}$  high. A high applied to both  $R$  and  $S$  inputs simultaneously results in no change in the output state. Finally, a low applied to both inputs simultaneously is a disallowed state that confuses the circuit and produces an unpredictable output state.

Even a momentary low will force a change in the output state. Application of a constant low to either input will hold the commanded output state. That tactic is sometimes used to lock a particular state (set or reset) until some other circuit action is completed. The S-R flip-flop is bistable, so it will remain in either set or reset states until commanded to change by application of a low to the appropriate input.

Figure 3 shows several symbols used to denote S-R flip-flops in schematic diagrams. All three are used for NAND-logic S-R flip-flops, even though only Fig. 3-a and 3-b are technically correct (the inverted inputs of those figures comply with the active-low nature of the inputs). The symbol shown in Fig. 3-c is sometimes seen for NAND-logic S-R flip-flops, but is more properly associated with a NOR-logic S-R flip-flop. In *Radio-Electronics*, the symbol shown in Fig. 3-a is always used

TABLE 1

Inputs		Outputs	
S	R	Q	$\bar{Q}$
0	0	Disallowed	
1	0	0	1
0	1	1	0
1	1	No change	

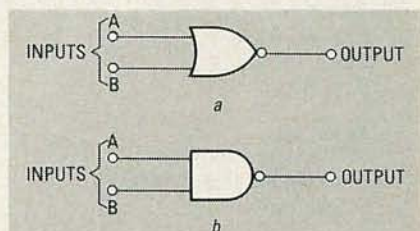

FIG. 1—SIMPLE NOR gates, such as the one shown in a, and NAND gates, such as the one shown in b, are the basic building blocks of flip-flops.

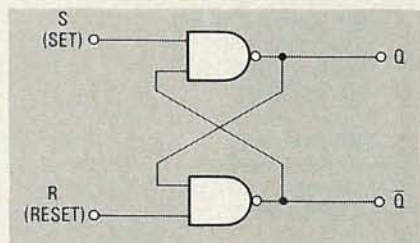

FIG. 2—THIS SET-RESET (S-R) FLIP-FLOP is fashioned out of two simple NAND gates.

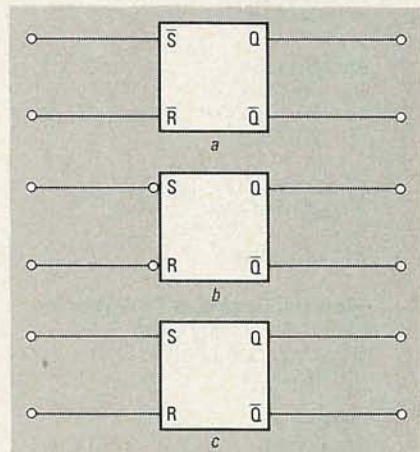

FIG. 3—THESE SYMBOLS are commonly used in schematic diagram to show S-R flip-flops. The symbol shown in a is used in this magazine.

to denote a NAND-logic S-R flip-flop.

An example of a NOR-logic S-R flip-flop is shown in Fig. 4, while the truth table is shown in Table 2. As you might expect, the NOR-logic S-R flip-flop operates in the opposite manner from the NAND-logic version of the circuit. That can be verified by examining the truth tables for the two circuits.

As in the previous case, only a momentary high need be applied to either input to make the NOR S-R flip-flop change output states.



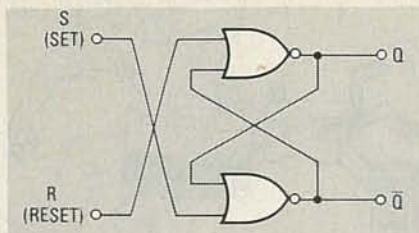

FIG. 4—NOR LOGIC can also be used to build an S-R flip-flop.

TABLE 2

Inputs		Outputs	
S	R	Q	$\bar{Q}$
0	0	No change	
1	0	1	0
0	1	0	1
1	1	Disallowed	

The S-R flip-flop can be used in a wide variety of applications. One such application is a digital version of a latching switch. Figure 5 shows such a switch based on the NAND-logic S-R flip-flop. The inputs are controlled by pushbutton switches, S1 and S2. Each is a normally-open type that closes when pushed. Since each input is strapped high with a 3300-ohm pull-up resistor, the input will be high as long as its associated switch is open, but will go low when that switch is closed. Once again, due to the nature of the circuit, a momentary low is all that is required for the output to change states.

Note in Fig. 5 that the switches and the outputs are labeled *START* and *STOP*. That labeling implicitly assumes that the circuit is used in a machine or instrument that needs "start" and "stop" commands. Assuming an initial state of the *STOP* output high and the *START* output low, pressing the *START* button will cause the

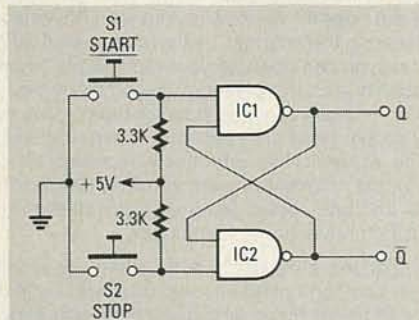

FIG. 5—THIS CIRCUIT can be used to issue "stop" and "start" instructions to a circuit or piece of machinery. Its operation is analogous to a latching switch.

outputs to change states; that is, the *START* output will go high and the *STOP* will go low. Those output states will remain "locked-in" even after the switch is released. They will reverse again only when the *STOP* button is pressed.

Ordinary S-R flip-flops sometimes suffer a problem that besets classical relay circuits: race conditions. In the classical version of the problem, relays that supposedly close simultaneously do not, with unpredictable results. Another problem is that noise impulses can create conditions that may cause the flip-flop to go into the opposite, incorrect state. There may also be a timing problem; that is, we may not want a circuit action to occur until a certain time. All of those problems are either solved or reduced by the use of the clocked S-R flip-flop shown in Fig. 6.

The clocked S-R flip-flop is made from a NAND-logic S-R flip-flop that is gated by a clock signal. Gates IC1 and IC2 are cross-coupled in the manner that is normal for NAND-logic S-R flip-flop circuits. The set (labeled A) and reset (B) inputs, however, are controlled by gates IC3 and IC4, respectively.

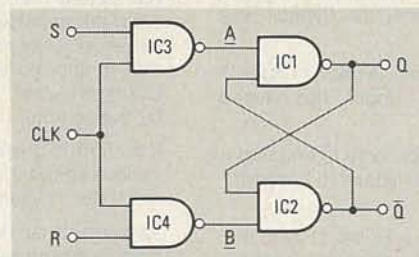

FIG. 6—IN A CLOCKED S-R FLIP-FLOP, the output will change states only when the clock input is held high.

Recall the operation of a NAND logic S-R flip-flop: if point A is momentarily grounded, the flip-flop is set (the Q output is high, the  $\bar{Q}$  is low); if point B is grounded, the flip-flop is reset (Q is low,  $\bar{Q}$  is high). Point A is controlled by gate IC3, while point B is controlled by gate IC4. But both IC3 and IC4 are controlled by the clock line. When the clock line is low, the outputs of IC3 and IC4 are locked high, and will not respond to changes on the other inputs (s and R). Those inputs are thus active only when clock is high. Note that the sense of the s and R is reversed from normal NAND-logic S-R flip-flops. Here, the those inputs are active-high rather than active-low.

The clocked S-R flip-flop solves some of the problems inherent in the regular S-R flip-flop circuit. In any event, the clocked version of the circuit permits synchronous operation (and changes are allowed to occur only at certain discrete times).

Another alternative for synchronous operation is the master-slave flip-flop (also call the load-transfer flip-flop) shown in Fig. 7. That circuit consists of a pair of clocked S-R flip-flops in cascade; i.e. the Q and  $\bar{Q}$  outputs of one S-R flip-flop, IC1, drive the s and R inputs of the second flip-flop, IC2. The clock inputs of the two flip-flops are driven out of phase with each other (one is high when the

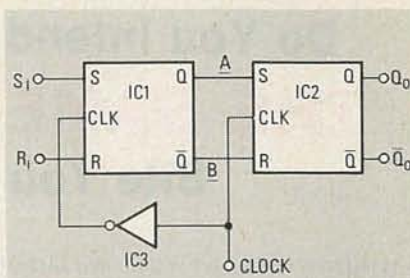

FIG. 7—THE MASTER-SLAVE FLIP-FLOP operates in a two-stage manner. When the clock signal is low, information presented to the inputs is latched into the first flip-flop. When the clock goes high, that information is passed to the second flip-flop, whose outputs change accordingly.

other is low). The CLK input of IC2 is driven directly by the master clock signal (also called load/transfer or L/T signal), while the CLK input of IC1 is driven by the inverted master clock signal.

Recall the operation of the normal clocked S-R flip-flop: The signals applied to either input will only cause an output change when the CLK input is high. Thus, when the master clock signal is low, IC2 is inactive (its CLK line is low) and IC1 is active (its CLK input is high). That situation permits loading of the master-slave flip-flop. State changes at either input of IC1 are reflected by the outputs of that gate.

When the master clock line goes high, the situation reverses—IC2 is active and IC1 becomes inactive. At that time, the outputs of IC1 are "read" by the inputs of IC2. Thus, those outputs will either set or reset the outputs of IC2.

## Clocking

Flip-flops are designed to be triggered in one of two ways—either on a leading or trailing edge of a clock signal, or when the clock signal reaches a certain positive or negative level.

Where triggering takes place is important because it tells us where the action of the flip-flop will occur. On a level-triggered flip-flop, the output state changes will occur when the clock is either high or low (according to design), but not during the transition between levels. Thus, a positive-level-triggered flip-flop is active only when the clock input is high; the clocked S-R flip-flop discussed earlier was an example of that type of triggering. Similarly, the negative-level-triggered device becomes active when the clock line is low.

An edge-triggered device acts during either low-to-high (positive edge triggered) or high-to-low (negative edge triggered) transitions. Although edge-triggered devices are not common in the type of circuits discussed thus far, they are used extensively in more complex flip-flops. Those devices will be the subject of our next article.

R-E



# How Many Times Do You Intend To Let "THE SAME DOG" Bite You ?

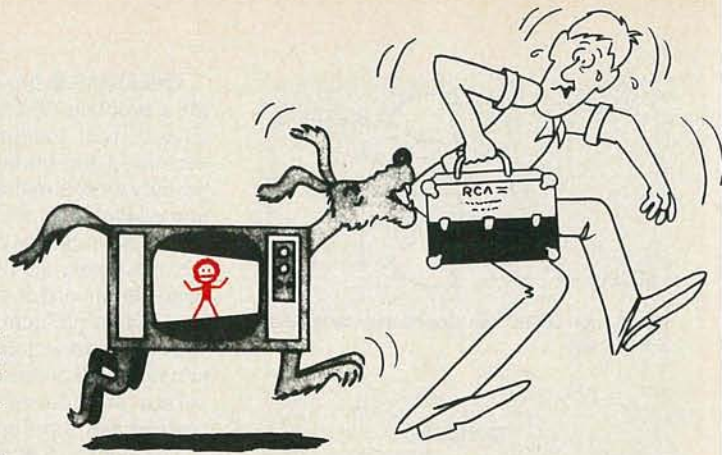

★ How many times have you worked all day long trying to diagnose the hi-voltage / LV regulator circuit of a set that is in shut down only to eventually find that a **shorted** video, color, vertical, tuner, AGC, or matrix circuit was causing the set to shut down and, to find that the hi-voltage / LV regulator circuit was working flawlessly all the time?

★ How many times have you spent the day looking for a **short** that was causing the set to shut down, only to eventually find that an **open** vertical, video, matrix circuit or, an **open** HV multiplier was to blame?

★ How many times have you worked all day on the same TV set, only to find out that the set's flyback transformer was defective?

★ How many flyback transformers have you replaced only to find that the original flyback was **not** defective?

★ How many horiz output transistors and Sony SG 613 **SCRs** have you destroyed while simply trying to figure out whether the flyback was good or bad?

★ How many times have you been deceived by your flyback "ringer"? Can you even count the number of hours that your "ringer" has caused you to waste?

★ How many times have you condemned a flyback, only to find that a shorted scan derived B+ source was causing the flyback to "appear" as though it were defective?

★ How many hours have you wasted, working on a TV set, only to find that the CRT had a dynamically shorted 2nd anode (to primary element)?

★ How many new sweep transformers have you unknowingly destroyed because a short existed in one of the scan derived B+ sources?

★ How many times have you said to yourself, "I could fix this --- thing if I could only get it to fire up long enough to lite the screen? --- without blowing an output transistor or a fuse."

★ How many additional bench jobs could you have gotten, had you been able to give an accurate, "on the spot" estimate on sets that were either in shut down or, not capable of coming on long enough for you to analyze them?

If you had been using our all new Super Tech HV circuit scanner, you would have had an accurate evaluation concerning all of the above in about one minute, at the push of **just one** single button.

It's true! Push just one test button and our HV circuit scanner will (1) Accurately prove or disprove the flyback, (2) Check for any possible shorts in any circuit that utilizes scan derived B+, (3) Check the scan derived power supplies themselves for shorted diodes and / or electrolytic capacitors, (4) Check for primary B+ collector voltage and, (5) Check the horiz output stage for defects.

Our HV circuit scanner works equally well on sets with integrated or outboard HV multipliers. It will diagnose any brand, any age, solid state TV set including Sony. The only exceptions are sets which use an SCR for trace and, another for retrace (i.e., RCA CTC 40 etc.). Our scanner will not work on these sets.

**In plain English**, our HV circuit scanner is even easier to operate than a "plain vanilla" voltmeter.

First off, when you're using a scanner, you **do not** remove the flyback in order to check it. In fact, you don't even unhook any of the wires that are connected to the flyback! All you do is:

(1) Remove the set's horiz output device, plug in the scanner's interface plug, then make one single ground connection. That's all you do to hook it up.

(2) If the primary LV supply is functional and, assuming that the emitter circuit of the horiz output stage has continuity, the scanner will tell you that it is ready to "scan" by illuminating the "ready" light, which is the white button on the test / run switch.

(3) Press the spring loaded (test) side of the test / run switch and the scanner will "look" for any type of a **short** that might exist anywhere on the secondary side of the flyback, including the HV multiplier, any circuit that relies on flyback generated B+ and, including the flyback itself (both primary and all secondary windings). It will simultaneously check for a shorted LV regulator device HV multiplier, or an open or "partially" open safety capacitor.

If a short or, an "excessive load" exists on one secondary winding, all other secondary windings will have "normal" output voltage in spite of the short. Only the shorted winding itself will have zero volts on it. This makes shorted scan derived B+ sources incredibly easy to isolate. During this test, the 2nd anode voltage is being limited to approx 5 kv by the scanner.

If a short is present, the red "flyback" light will either lite, or flash (at various speeds), depending on which type of a short exists. If no shorts exist, the "flyback" light will be green.

Assuming that the "flyback" light is green, no **shorts** exist and, it is now time (and safe), to begin looking for **open** circuits which might be causing the set to shut down due to flyback run-a-way. It only stands to reason that if no shorted conditions exist, then one (or more) circuits will have to be open, otherwise, the TV set would be working!

(4) Now that you know that no **shorts** exists, push the "run" side of the test / run switch (the side that latches). Provided all of the other circuits in the TV set are functional, the scanner will now put a picture on the set's CRT screen that has full vertical and horiz deflection, normal audio, video and color.

Keep in mind that during this test, your scanner is:

(1) Circumventing all horiz osc/driver related shut down circuits,

(2) Limiting the set's 2nd anode voltage to approx 20-25 kv,

(3) Substituting the set's horiz osc/driver circuit and, as a result eliminating any need that the set might have for an initial start up or B+ resupply circuit for the osc/driver.

Wait about 15 seconds for its filaments to warm up, then look at the CRT. Any circuits that are "**open**" will now produce an obvious symptom on the screen. Because the scanner has circumvented all of the set's shut down features, you can now use your old reliable "symptom to circuit analysis" technique to troubleshoot the problem, i.e., if the picture has no blue in it --- repair the blue video or blue matrix circuit. If the picture has only partial vertical deflection --- repair the vertical circuit, and so on. The scanner has effectively removed all of the stumbling blocks that would normally prevent you from diagnosing the problem. i.e., start up and shut down features, and allowed you to repair the TV set by using conventional techniques.

When you're using a scanner, all start up, shut down, dead set problems are easy to solve. You don't need anyone to tell you just how difficult these problems can be for those who don't have a scanner!!

Our Super Tech HV circuit scanner normally sells for only \$495<sup>00</sup>. Beginning July 4, 1985 thru August 31, they are on sale for only \$395<sup>00</sup>.

**VISA, MASTERCHARGE, C.O.D. ORDERS WELCOME**

DIEHL ENGINEERING • 6004 Estacado Ln. • Amarillo, TX 79109

PHONE (806) 359-1824 or (806) 359-0329

*Phone Orders Welcome*

*Since the Scanner only has two buttons to press, most technicians never need it but, our "Hot Line" is available to assist new owners in the operation of their scanner. Phone (806) 359-0320.*

CIRCLE 257 ON FREE INFORMATION CARD



# PC SERVICE

As anyone who has ever tried knows, one of the most difficult tasks in building one of the many construction projects featured in **Radio-Electronics** is making the PC board using just the foil pattern provided in the article. True, all sorts of kits and things are sold to let you lift a foil pattern from a magazine page. But, while some of them do work, most of them don't. What usually happens is that you wind up copying the artwork by hand.

Well, we're doing something about it.

We've moved all the foil patterns to a new section of the magazine. They'll be printed by themselves, full sized, with nothing on the back side of the page. What that means for you, is that the printed page can be used directly to produce PC boards!

Actually the method you'll need to use to etch directly from printed artwork is a little bit different from the one you're probably used to using to produce PC boards, but we've done some testing and it works!

In order to produce a board directly from the magazine page, you first need to do a little bit of work on the foil pattern. The first thing to do is remove the page from the magazine and carefully inspect it either under a good light or on a light table. As a matter of fact you should really do both of those since each one will show up different kinds of imperfections in the artwork. What you're looking for are breaks in the traces, bridges between traces, and in general, all the kinds of things you look for in the final etched board. You can clean up the published artwork the same way you

clean up your own artwork. Drafting tape and graphic aids can fix incomplete traces and doughnuts, and you can use a hobby knife to get rid of bridges and dirt.

Once you're satisfied that the artwork is clean, take a little bit of mineral oil and carefully wipe it across the back of the artwork. Don't get any on the front side of the paper (the side with the pattern) because you'll contaminate the sensitized surface of the copper blank. (If you *do* contaminate it, you won't notice anything when you make the exposure, but when you develop the board, the oil can act just like resist and keep the developer from dissolving the unwanted resist on the board.

After the oil has "dried" a bit—patting with a paper towel will help speed the

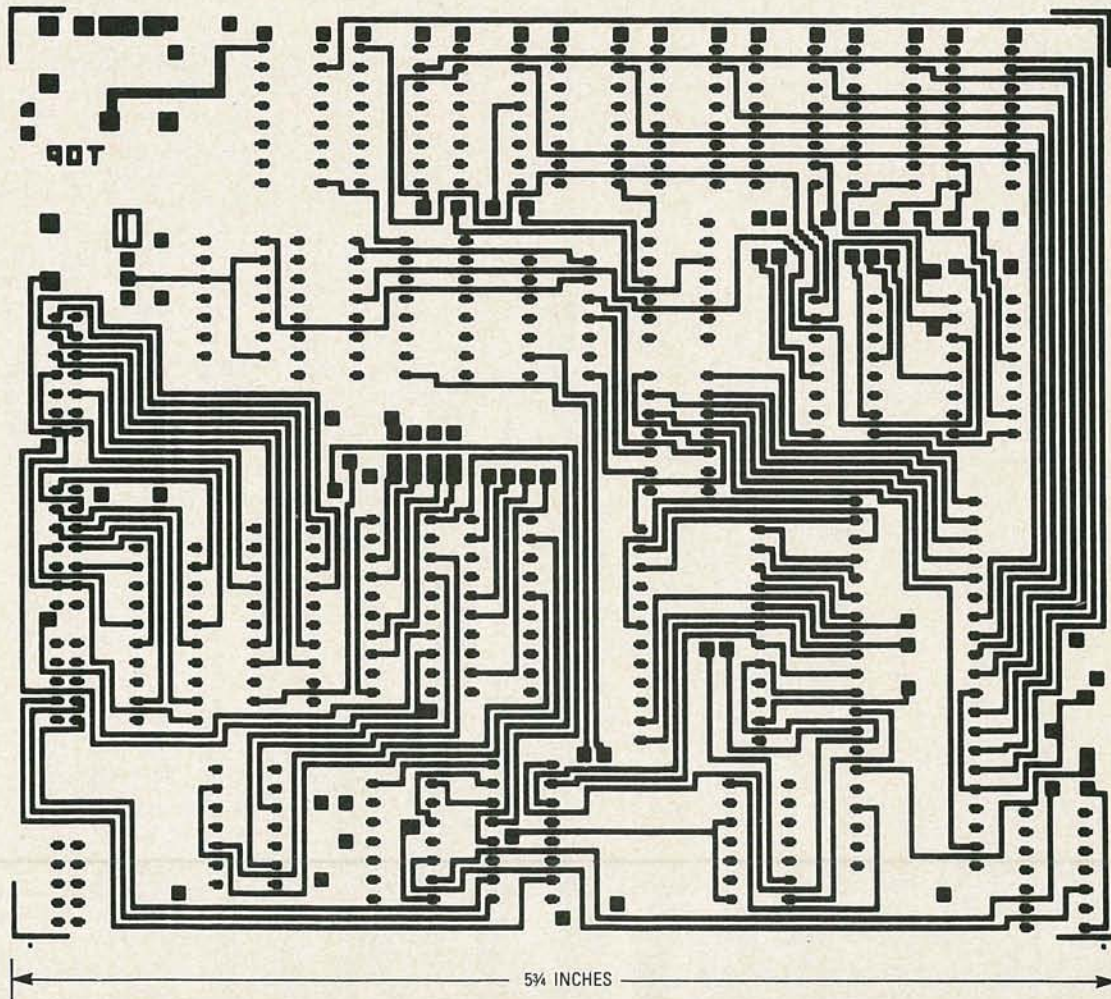

COMPONENT SIDE OF PRINTER BUFFER board is shown here in a full size mirror image. This side must go toward the board to be exposed. See page 59.



---

---

# PC SERVICE

process—place the pattern front side down on the sensitized copper blank, and make the exposure.

The mineral oil is optional, but it does do two things for you. It makes the paper much more translucent and it makes the foil pattern appear darker. A successful exposure depends on having as much contrast as possible in the exposure mask and that's exactly what the mineral oil does.

Even though the mineral-oil treated paper is translucent, it's still not anywhere as clear as lithographic film (which is what's normally used in producing PC boards). That means that you're going to have use a longer exposure time than you

are probably used to.

We can't tell you exactly how long to make the exposure time, because we don't have any idea what kind of light source you use. A simple rule of thumb is to figure that there's a 50 percent increase in exposure time over lithographic film. But that doesn't necessarily mean you'll need a 50 percent increase. If you're used to taping up a pattern on mylar sheets, you'll find that rubbing the paper with mineral oil makes it just about as translucent as mylar.

Note that sensitizers vary as well. Mineral oil isn't as transparent to ultraviolet light as it is to other parts of the spectrum. If your sensitizer wants to see ultraviolet,

you may find using mineral oil to be more trouble than it's worth.

You'll have to experiment to find the best method to use with the chemicals you're familiar with. And once you find it, stick with it. Don't forget the "three C's" of making PC boards—care, cleanliness, and consistency.

Finally, we would like to here how you make out using our method. Write and tell us of your success, and failures, and what techniques work best for you. Address your letters to:

**Radio-Electronics**  
Department PCB  
200 Park Avenue South  
New York, NY 10003



---

---

# PC SERVICE

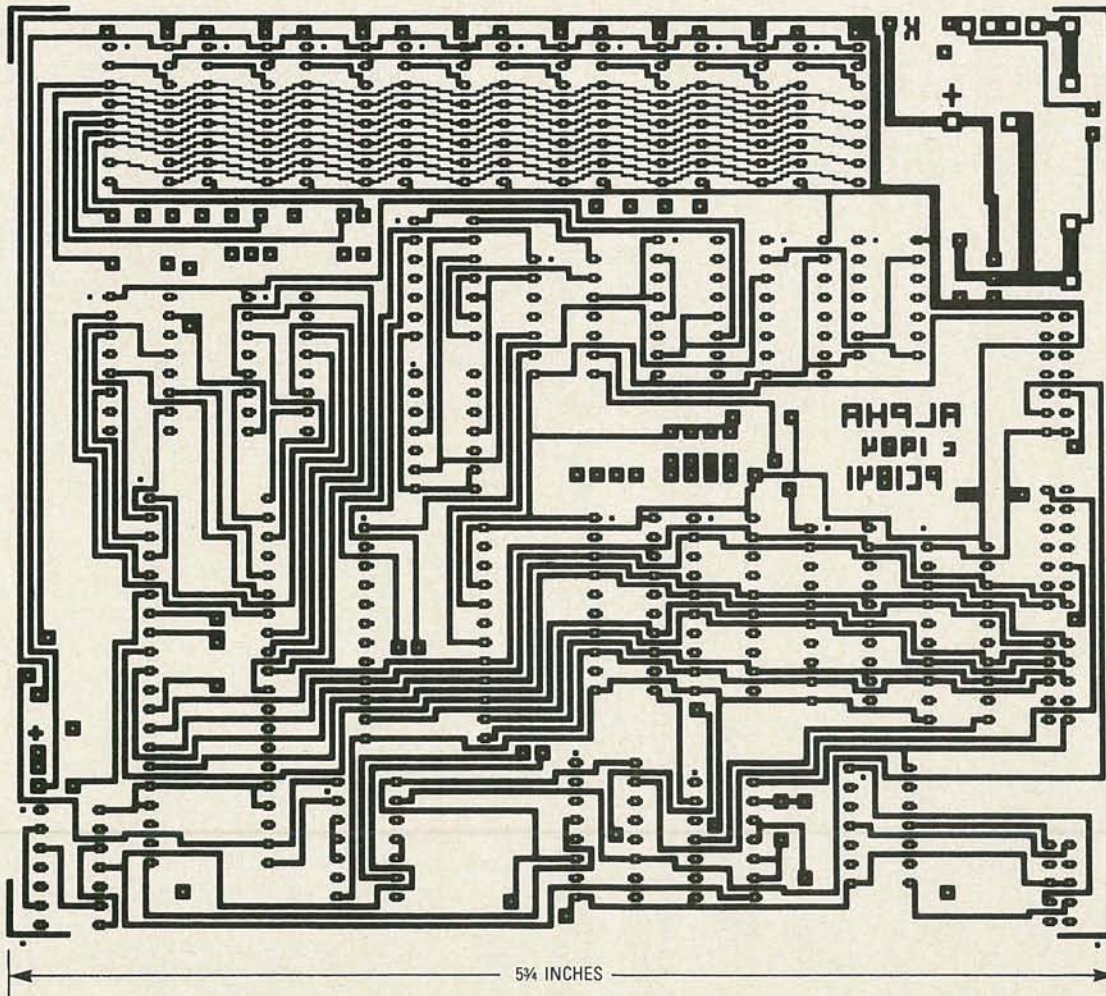

SOLDER SIDE OF PRINTER BUFFER board is shown here in a full size mirror image. This side must go toward the board to be exposed. See page 59.



---

---

# PC SERVICE

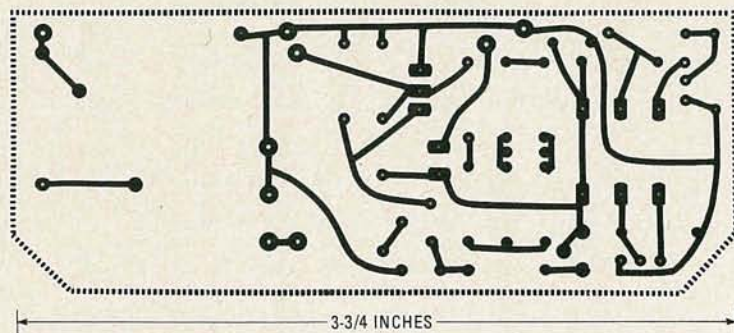

SOLDER SIZE OF THE INFRARED VIEWER board is shown here in a full-size mirror image. This side goes toward the board to be exposed. See page 49.







# ROBOTICS



MARK J. ROBILLARD  
ROBOTICS EDITOR

## Setting up a robotics design lab.

ANYONE WHO EXPERIMENTS WITH PERSONAL robots soon finds that plenty of space is a necessity. Although you may already have a workshop set up for your electronics experimentation, it just won't do for robotics. An area free of obstructions and large enough for your creation to wander about is what you need.

If, on the other hand, you experiment exclusively with arm-like mechanisms, some clear bench space is all that's called for. Even then, it may be necessary to move solder irons and various other tools each time you want put the machine to work.

Therefore, this month we'll turn our attention to setting up a small robotics laboratory. In no way, will our lab compare with a typically well outfitted, sophisticated university robotics laboratory. But, it will suffice for experimental purposes.

### Lab layout

When setting up a robotics lab, the first thing to consider is what equipment you'll need. The most important parts of any robotics lab are the power supplies. Typically you will need one or more supplies that can deliver at least 5 amps at 5 and 12 volts. The 12 volts is required to power motors; most motors on the market are designed to operate from a 12-24-volt supply. Note that a motor supply need not be well regulated. The 5-volt source is, of course, to power the robotic control circuits.

The current rating we just specified should be observed. The 12-volt supply will be used to power various motors, and those tend to use lots of power. Even though

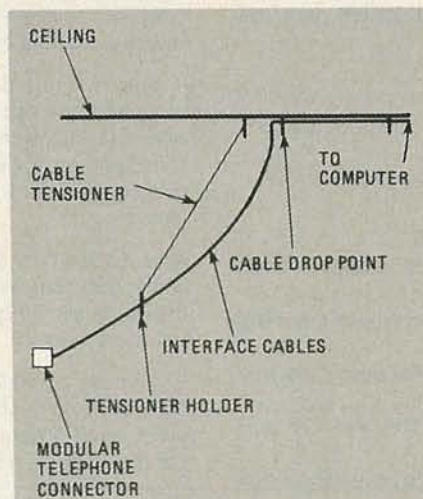
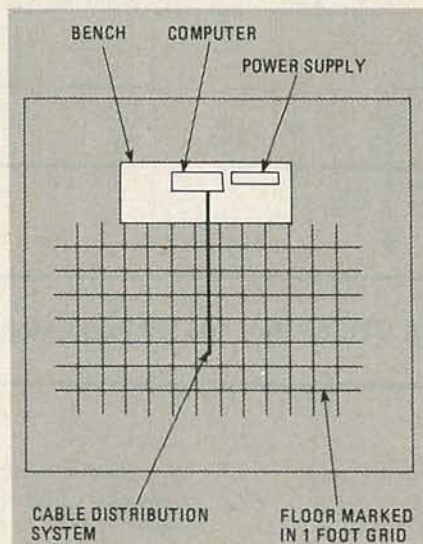

your robot will eventually be "scooting" around on battery power, it's nice not to worry about constantly having to charge batteries while experimenting.

The 5-volt supply should have sufficient power to handle any kind of logic circuitry that you might need. If you've a very so-

phisticated control system with many motor drivers and microprocessors in mind, you'll definitely need the 5 amps. Of course, if all you are working with is low-power CMOS logic, you probably won't draw anything more than about 1.5 amps. But with a 5-amp supply, you won't have to replace or upgrade the power supply as your robotic system expands.

The supply can be of the "home-brew" variety. (We'll show you to build a universal 5-amp power supply from a few simple components in the future.)

You'll also need (and may want to build) a workbench, and what I call a "cable-distribution system." Figure 1 shows the basic setup of a simple robot lab with a table in the upper half of the figure.

The table can be something as simple as two wooden horses supporting an unfinished door. Coming down from the center of the table is the cable-distribution system (a harness containing all the interface cables you could possibly need). Those cables make the task of debugging the robotic circuits (during experimentation) easier by allowing individual testing of the control circuits. The robot is tested by writing a simple BASIC program to it from an inexpensive computer to exercise the circuits.

Within the cable-distribution system, there should be two 4-wire, telephone-type hook-up cables with modular plugs on one end for connection to the control circuits. The other end should be terminated in a 25-pin D-type connector for easy connection to the serial port of a computer.

Why two serial cables? Con-



# COMPUTER DIGEST

VOL. 2 NO. 8 August 1985

NEW KIND OF MAGAZINE FOR ELECTRONICS PROFESSIONALS

## DIGITIZING TABLETS: Keyboards Aren't The Only Way To Enter Data



## Build The CASSETTE-TO-CASSETTE INTERFACE

For Drudgery-Free Tape Copying

A  
**GERNSBACK**  
PUBLICATION

## DELUXING THE COLOR COMPUTER

Make Your Color Computer Perform  
Like The Expensive Models



# Electronics Paperback Books



**SECRETS OF THE COMMODORE 64** ..... \$5.00. Masses of useful info and programming tips not found in any user's manual.



**INTRO TO PROGRAMMING THE ATARI 600/800 XL** ..... \$5.00. Perfect complement to the Atari user's manual. Even shows how to use animated graphics.



**COMPUTER TECHNOLOGY EXPLAINED** ..... \$5.00. Explanations for computer terms often encountered. A dictionary for computer lingo.



**INTRO TO Z-80 MACHINE CODE** ..... \$5.75. Speed up your programs. They may be harder to write, but it's worth learning how. Some demo programs are included.



**MICRO INTERFACING CIRCUITS—BOOK 2** ..... \$5.75. Interfacing sound and speech generators, temperature and optical sensors, motor controllers, and more.



**ANTENNA PROJECTS** ..... \$5.00. Practical radio antenna designs that deliver good performance and are relatively simple and inexpensive to build.



**WHITE'S RADIO LOG** ..... \$8.95. Up-to-date directory of North American AM, FM, & TV stations. Includes section on world-wide shortwave stations.



**CONFIDENTIAL FREQUENCY LIST, 6th edition** ..... \$13.95. Latest info on usual and exotic shortwave broadcast stations.



**25 SIMPLE AMATEUR BAND ANTENNAS** ..... \$4.50. Use them on the 60, 75, 90, and 120 meter bands. Also 150-1600 Hz.



**INTRODUCTION TO RADIO DXING** ..... \$5.00. Get into this fascinating hobby. This book tells you just about everything you need to know to get started.

**MICRO INTERFACING CIRCUITS—BOOK 1** ..... \$5.00. Practical add-ons transform your computer into control or measurement equipment.

**MICRO INTERFACING CIRCUITS—BOOK 2** ..... \$5.75. Interfacing sound and speech generators, temperature and optical sensors, motor controllers, and more.



**LONG DISTANCE TV DXING** ..... \$5.00. A practical and authoritative introduction to this unusual aspect of electronics.



**HOW TO DESIGN ELECTRONIC PROJECTS** ..... \$5.75. How to use standard circuit elements to make custom electronic projects.



**HOW TO GET YOUR ELECTRONIC PROJECTS WORKING** ..... \$5.00. How to find the faults in your projects, repair them and get them working.



**DESIGN & MAKE YOUR OWN PC BOARDS** ..... \$5.75. Everything you need to know before you make printed-circuit boards for your projects.



**INTERNATIONAL DIODE EQUIVALENTS** ..... \$5.75. Helps find replacements for rectifier diodes, triacs, thyristors, photo diodes and display diodes.



**INTERNATIONAL TRANSISTOR EQUIVALENTS** ..... \$7.50. Locates possible substitutes for a popular user-oriented selection of modern transistors. Japanese, European and American types.



**PRACTICAL ELECTRONIC BUILDING BLOCKS, Book 1** ..... \$5.75. Build the blocks and then combine them to form almost any custom project of your choice.



**PRACTICAL ELECTRONIC BUILDING BLOCKS, Book 2** ..... \$5.75. Amplifiers of all kinds to add to the circuits from Book 1 of this series.

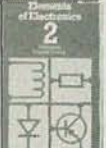

**THE SIMPLE ELECTRONIC CIRCUIT, Book 1** ..... \$5.75. Elements of Electronics. Fundamental electronics theory.

**ALTERNATING CURRENT THEORY, Book 2** ..... \$5.75. Elements of Electronics. Needed for comprehension of speech, music, radio, TV and more.

**ELECTRONIC SCIENCE PROJECTS** ..... \$5.75. Simple to complex, a group of projects with a strongly scientific flavor.

**CRYSTAL SET CONSTRUCTION** ..... \$4.50. A variety of crystal radio receivers for the experimenter and hobbyist.

## Affordable Prices



**SEMICONDUCTOR THEORY, Book 3** ..... \$5.75. Elements of Electronics. Leads into transistors and other semiconductor devices.



**HOW TO USE OP AMPS** ..... \$5.75. A source book of circuits and a reference book for design calculations.



**ELECTRONIC SYNTHESIZER PROJECTS** ..... \$4.50. How to assemble the elements of a synthesizer and then put them all together.



**ELECTRONIC TIMER PROJECTS** ..... \$5.00. Timing circuits to fit just about every application. Required for every experimenter.



**COUNTER DRIVER & NUMERICAL DISPLAY PROJECTS** ..... \$4.50. Numerical indicator devices make it easy to count, divide and display.



**SINGLE IC PROJECTS** ..... \$4.25. All projects in this book are based on one IC and are simple to construct. Great way to get started with ICs.



**POPULAR ELECTRONIC PROJECTS** ..... \$4.75. A collection of a wide range of electronic projects and circuits for the experimenter.



**IC PROJECTS FOR BEGINNERS** ..... \$5.00. Written especially for the less experienced experimenter. Complete parts layouts and wiring diagrams.



**POPULAR ELECTRONIC CIRCUITS, Book 1** ..... \$5.00. More circuits for hobbyists. Audio, radio, test, music, household and more.



**POPULAR ELECTRONIC CIRCUITS, Book 2** ..... \$5.75. More useful circuits. None of these projects duplicate those in Book 1 of this series.

CHECK OFF THE BOOKS YOU WANT

BOOKS LISTED BELOW ARE 25% OFF REGULAR CATALOG PRICE



THE MORE YOU BUY....THE MORE YOU SAVE....THE MORE YOU BUY .....



- STEREO QUADRAPHONY HANDBOOK ..... \$4.00 NOW \$2.25
- AUDIO ENTHUSIASTS HANDBOOK ..... \$3.00 Now \$2.60
- SOLID STATE NOVELTY CIRCUITS ..... \$3.50 Now \$2.60
- BUILD HI-FI AUDIO ACCESSORIES ..... \$5.50 Now \$2.60
- 28 TESTED TRANSISTOR PROJECTS ..... \$3.75 Now \$3.18
- 50 PROJECTS USING CA3130 ..... \$3.75 Now \$3.35
- PRACTICAL INTRODUCTION TO DIGITAL IC's ..... \$4.25 Now \$3.18
- FIRST BOOK OF PRACTICAL PROJECTS ..... \$3.75 Now \$2.80
- MAJOR SOLID-STATE HI-FI PROJECTS ..... \$3.00 Now \$2.25
- 50 CIRCUITS USING DIODES ..... \$3.50 Now \$2.80
- IC LM3900 PROJECTS ..... \$4.75 Now \$3.55
- 50 CIRCUITS USING 7400 IC's ..... \$3.00 Now \$3.35
- 50 SIMPLE LED CIRCUITS ..... \$4.25 Now \$3.18
- FIRST BOOK OF TRANSISTOR EQUIVALENTS ..... \$3.75 Now \$2.80
- ELECTRONIC PROJECTS FOR BEGINNERS ..... \$3.00 Now \$3.75
- 50 FET TRANSISTOR PROJECTS ..... \$4.50 Now \$3.35
- BEGINNERS GUIDE TO BUILDING ELECTRONIC PROJECTS ..... \$5.80 Now \$3.75
- ESSENTIAL THEORY FOR THE ELECTRONICS HOBBYIST ..... \$5.00 Now \$3.75

SPECIAL CLEARANCE SALE OFFER ENDS AUGUST 15, 1985

**ELECTRONIC TECHNOLOGY TODAY INC.**  
 P.O. Box 240, Massapequa Park, NY 11762-0240

Name \_\_\_\_\_  
 Address \_\_\_\_\_  
 City \_\_\_\_\_ State \_\_\_\_\_ Zip \_\_\_\_\_

Number of books ordered

Total Price of Books ..... \$ \_\_\_\_\_

Sales Tax (NY State Residents) ..... \$ \_\_\_\_\_

\*Shipping in U.S. only (\$1.00 1st two books, 40c ea additional) ..... \$ \_\_\_\_\_

TOTAL ENCLOSED ..... \$ \_\_\_\_\_

\*Canadian Shipping



# CONTENTS

Vol. 2 No. 8

August 1985

## 8 Digitizing Tablets

These handy digitizers solve lots of problems and in this expose, you learn all you need to know about the state-of-the-art.

**Marc Stern**

## 12 Cassette-to-Cassette Interface

Build this handy device and you can take the tedium out of copying computer cassette programs.

## 14 Deluxing The Coco.

Here's how you can upgrade your Radio Shack Color Computer by adding aftermarket items to make it perform like a top-of-the-line unit.

## 4 Editorial

Hackers

## 5 Letters

## 5 Computer Products

## 7 Software Review

"Seekeasy"

## 11 Computer Books

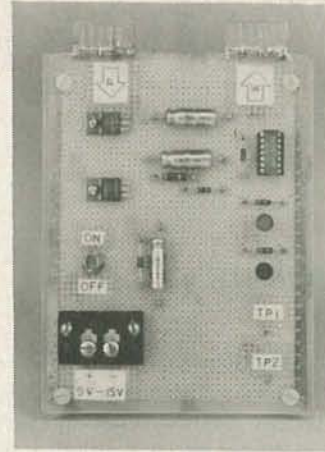

Page 12



Page 14

## ON THE COVER

Inputting without the classic keyboard can be done in many ways. Here we see the Koala Pad from Koala Technologies being used with an IBM computer. See page 8.

## COMING NEXT MONTH

### Touch Screens

Sensitive Video Display Terminals provide still another—simple—way to input information.

### Voice Reproduction

Here's how to get more than 5 seconds of synthesized speech with 16 K.

### Emulating Printer

The easy way to resolve problems of incompatibility!

**COMPUTER DIGEST** VOL. 2 NO. 8 August 1985  
NEW KIND OF MAGAZINE FOR ELECTRONICS PROFESSIONALS

**DIGITIZING TABLETS:**  
Keyboards Aren't The Only Way To Enter Data

**Build The CASSETTE-TO-CASSETTE INTERFACE**  
For Drudgery-Free Tape Copying

**DELUXING THE COLOR COMPUTER**  
Make Your Color Computer Perform Like The Expensive Models



# EDITORIAL

## Hackers.

■A "Computer Hacker" is a thief. A crook who uses his computer to attempt to break into other computers and leave evidence that he has done so. These low-lifes try to get into bank computers and louse up the records, one even got into a hospital's computer and did so much damage to the records that lives were actually jeopardized. They try to get into school computers and screw up those records too.

Some of them have successfully broken into classified government computer systems, endangering the security of our country. They form clubs and swap coded information, they have magazines that offer tips to improve their skills.

We'd like to go on record. We're anti-hacker. These thieves, for that's exactly what they are, are giving *all of us* a bad name. They've been getting a lot of publicity lately, and it's all bad. Sure, they try to come off as "boy genius" types that are so adept at using their computers that they can foil the most-professional anti-hacker security systems. But break down what they're doing and how they're doing it, and you see that all they do is nothing but drudgery, repeating and repeating with minor changes until they break in. There is nothing at all intelligent about what they do, and especially the way in which they do it. If they *do* manage to break a code, it's usually the result of a freak accident. Certainly not the product of any intelligence on their parts.

Hackers are morons with computers. They've got nothing else to occupy their minds, they're hungry for a little notoriety, and for my part, they should be treated as exactly what they are—crooks. There's no redeeming quality at all in them, they are *not* to be admired, and what they're doing hurts all of us.

How? I saw the same thing happen in amateur radio, later in CB. The good guys have to take the heat for the bad guys. Some guy with a signal squirter louses up every TV in the neighborhood, and any ham that tries to put up an antenna gets dirty looks from the neighbors.

It's the same with computers. If your neighbors know you have a computer, and they see the news stories about what the horrible hackers are doing, you're going to be painted by the same broad brush.

You may have a friend who hacks. If you do, do him a favor. Redirect his thinking into something more substantial. Get him involved in baseball, or stamp collecting, or introduce him to a girl.

Just get him away from his computer.

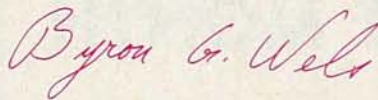

Byron G. Wels  
Editor

**ComputerDigest** is published monthly as an insert in Radio-Electronics magazine by Gernsback Publications, Inc., 200 Park Avenue South, New York, NY 10003. Second-Class Postage Paid at New York, N.Y. and additional mailing offices. All rights reserved. Printed in U.S.A.

A stamped self-addressed envelope must accompany all submitted manuscripts and/or artwork or photographs if their return is desired should they be rejected. We disclaim any responsibility for the loss or damage of manuscripts and/or artwork or photographs while in our possession or otherwise.

# COMPUTER DIGEST

**Hugo Gernsback** (1884-1967)

founder

**M. Harvey Gernsback**, editor-in-chief

**Larry Steckler**, CET, publisher

**Art Kleiman**, editorial director

**Byron G. Wels**, editor

**Brian C. Fenton**, technical editor

**Carl Laron**, associate editor

**Robert A. Young**, assistant editor

**Ruby M. Yee**, production manager

**Robert A. W. Lowndes**, production associate

**Karen Tucker**, production assistant

**Jacqueline P. Weaver**, circulation director

**Arline R. Fishman**, advertising coordinator

Gernsback Publications, Inc.  
200 Park Ave. South  
New York, NY 10003

Chairman of the Board:

M. Harvey Gernsback

President: Larry Steckler

## ADVERTISING SALES 212-777-6400

Larry Steckler  
Publisher

### EAST/SOUTHEAST

Stanley Levitan  
Radio-Electronics  
200 Park Ave. South  
New York, NY 10003  
212-777-6400

### MIDWEST/Texas/Arkansas/Okla.

Ralph Bergen  
Radio-Electronics  
540 Frontage Road—Suite 325  
Northfield, Illinois 60093  
312-446-1444

### PACIFIC COAST Mountain States

Marvin Green  
Radio-Electronics  
15335 Morrison St., Suite 227,  
Sherman Oaks, CA 91403  
818-986-2001



# LETTERS

## Can Someone Help?

I own a Timex 1000 and a TVRO Earth Station. I'm searching for a program to plot stationary satellite positions from different parts of the U. S. I'm sure lots of your readers would be interested in a program such as this.—William Scott, Manteca, CA.

*Bill, that sounds like a great idea! I'll refer it to our Software Review Editor, and if he can't come up with something, perhaps one of our readers can.*

## Archival Programs?

I don't know if anybody has ever done this before, but I've put my family tree on a disc, along with some personal annotations and I'd like to store this for posterity. How can I protect that

disk?—Martin Resnick, St. Paul, MN.

*We've never heard of this before Martin, so all we can do is make some suggestions: Begin by using the very-best quality disk that you can buy, and then wrap it in aluminum foil twice. The second sheet covers the wrapped and folded areas of the first sheet. This should help protect against stray magnetic fields. Put it between sheets of heavy cardboard to protect it from bending, and place it in an envelope sealed with heavy tape. Add a few packets of silica gel too. And good luck!*

## Understanding guy

I understand that mistakes can happen, Lord knows I've made my share too. But how can a reader

tell if there's a mistake in the project he's planning to build from a magazine? It isn't just your magazine—it happens in all of them! Is there a way to protect against this?—Roger Touhey, Sioux Falls, SD.

*Roger, thanks for being so understanding. Yes, authors can make mistakes, editors can let something slip, the proofreaders might not catch an error, and typesetters have been known to hit the wrong keys occasionally. Errors do creep in, despite our best efforts. But it doesn't happen as often as you might think, for we do try to be careful! One way is to save the "hot project" for a couple of months and watch the magazine for corrections.*

---

# COMPUTER PRODUCTS

For more details use the free information card inside the back cover

**COMPATIBLE VIDEO I/O BOARD**, model DT2803, is a video frame-grabber and display board for the IBM PC and PC/XT. The model DT2803 captures a 256 × 256 × 6 black-and-white image, and the R-G-B output handles 64 colors × 64 intensities and includes cursor control. In combination with the Videolab software package, the model DT2803 is ideal for applications in industrial robotics, inspection, and assembly, as well as medical imaging and graphic arts.

The Videolab package is an easy-to-use software for real-time video digitization and display with the DT2803. It is divided into two major sections: Videotutor and Videosub. Videotutor is an interactive, command-driven tutorial program that allows first-time users to become familiar with the model DT2803 video I/O board within a user-friendly programming environment. Videosub is a comprehensive



CIRCLE 21 ON FREE INFORMATION CARD

library of subroutines for user-defined applications programs; callable from BASIC (interpreted and compiled), C, PASCAL, and FORTRAN, Videosub supports all the functions of the model DT2803.

The model DT2803 board is shipped complete, with a comprehensive user manual and demonstration diskette, including sample programs. The single-unit price for the model DT2803 is \$1495.00. Videolab is

shipped on a single-sided, double density diskette, and includes a comprehensive user manual; the price is \$995.00.—Data Translation, 100 Locke Drive, Marlboro, MA 01752.

**PROTOTYPING BOARD**, the eZ Card, is a blank circuit board for computer hobbyists or engineers who wish to build a prototype board according to specific design. The board provides the means to interface prototype circuitry for the IBM-PC with several features. A switch-selectable address decoder frees the user to concentrate on design. Selector switches permit up to eight boards to be installed in a single PC system.

Two areas are available for building prototype circuits on this large, full-slot sized board, one of which is situated for installation of I/O connectors. The larger prototype area consists of a grid of over 2,300 plated-



through holes on 0.1-inch centers, suitable for installing over 60 wire-wrap sockets.

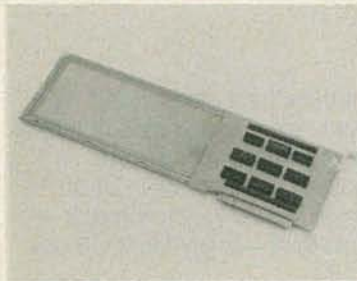

**CIRCLE 22 ON FREE INFORMATION CARD**

The *eZ Card* uses sockets for all buffer IC's and a gold-plated edge connector for maximum reliability of operation. A mounting bracket is provided for permanent installation into the PC system housing. The board comes with documentation that includes experimental circuits and related basic application programs for each circuit. It is priced at \$89.95—\$5.00 shipment from stock to four weeks.—*Sabadia Export Corporation*, PO Box 1132, Yorba Linda, CA 92686.

**DISK DRIVE**, the Commodore *SFD 1001*, is enclosed in a 1541-sized case and has a one-megabyte storage capacity on a double-sided, double



**CIRCLE 23 ON FREE INFORMATION CARD**

density format. A utility disk with 64 and 8032 utilities is included with the disk, and an optional serial IEEE connector and cabling is available. The *SFD 1001* is priced at \$399.95—*Progressive Peripherals & Software, Inc.*, 2186 South Holly, Denver CO 80222.

**PERSONAL-COMPUTER MODEM**, the *IntelliModem EXT*, is a standalone 300/1200 baud communications system suitable for use with any serial RS232-equipped computer or terminal. It features an exclusive voice-insert capability, which allows use of an ordinary phone to add integrated

voice to a personal-computer work station. The user may talk and listen, or send and receive data without having any need to hang up and redial.

A front-panel multicolor line-quality bargraph display dynamically monitors the telephone-line condition. Call-progress detection lets the modem electronically sense telephone-system



**CIRCLE 24 ON FREE INFORMATION CARD**

signals such as Busy, Dial Tone, Remote ringing, and Voice, and display those conditions on the computer screen. Thus, the user always knows what is happening as the call progresses.

The *IntelliModem EXT* is priced at \$499.00—*Bizcomp*, 532 Mercury Drive, Sunnyvale, CA 94086.

**EDUCATIONAL PROGRAM**, *In The Chips*, is available for owners of IBM PC, PCjr, and Commodore 64 home computers. It challenges both children and adults to create a profitable software business. An initial investment of \$100,000 is used to develop, inventory,

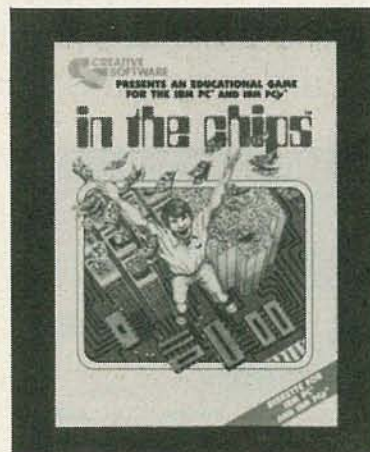

**CIRCLE 25 ON FREE INFORMATION CARD**

price, and advertise computer games. Using the joystick, players manipulate assistants, who go from building to building carrying out orders. At the end of each quarter, a balance sheet appears so that players can see how well their companies are doing.

*In The Chips* is priced at \$29.95.—*Creative Software*, 230 East Caribbean Drive, Sunnyvale, CA 94089.

**RADIATION SHIELD**, the *Eye-Guard*, is a device that protects people from the glare and radiation that is emitted



**CIRCLE 26 ON FREE INFORMATION CARD**

from video-display terminals (VDT's). The anti-glare screen is made from nylon netting while the anti-radiation shield is made with lead-impregnated acrylic. (*Eye-Guard* contains 30% lead by weight.)

*Eye-Guard* is affixed to the face of the terminal with Velcro tabs. It eliminates glare and cuts off all the X-rays, microwaves, and ultraviolet waves that VDT's emit. (It is estimated that a worker who sits in front of a black-and-white terminal for 35 hours per week could receive the equivalent of 30 chest X-rays in a year's time.)

The *Eye-Guard* is priced at \$129.95, and comes with a 100% money-back guarantee that it will stop even the worst case of eye fatigue resulting from unshielded VDT's.—*Langley-St. Clair Information Systems, Inc.*, 132 West 24th Street, New York, NY 10011.

**DISK MARKERS**, the *Diskrabe* (shown) and the *Label Pen* are designed specifically for use on computer software. The *Diskrabe* can be used directly on computer software disk sleeves for safe identification and reference. The ink is quick-drying and permanent, and the markings do not affect information on the disk itself. The *Label pen* is designed for use on slick-finish and other hard-to-mark labels currently being used on disks, diskettes, and VCR cassettes. The fine point and high-intensity permanent ink makes writing easier to read on small labels.



**CIRCLE 27 ON FREE INFORMATION CARD**

The *Diskrabe* is priced at \$2.50; the *Label Pen* costs \$1.00.—*Sanford Corporation*, 2740 Washington Boulevard, Bellwood, IL 60104. ◀▶



# SOFTWARE REVIEW

## Seekeasy

■SEEKEASY is a free-form database designed for rapid storage and retrieval of randomly-entered reference information.

Unlike conventional data management programs which cannot search using *keywords* having little relationship to the original data entries, SEEKEASY can locate entries if only a few characters of a *keyword* are correct.

For example, assume that it was possible to load a conventional database with randomly entered data, and over a period of time you had entered many references for an article on test equipment. Now you want to extract the data on a particular meter that you key in as *Simsun*. To the typical database there is no way it will know you mean *Simpson*. But a free-form database such as SEEKEASY will locate the closest matching string anywhere in the file, and in a few seconds it will match *Sim* to *Simpson* and extract the correct information.

In searching for data SEEKEASY doesn't care if the original entry, the search criteria, or both are incorrect. Somehow, it will locate the data quicker than you can look up the correct spelling of a *keyword(s)* in a dictionary because it attempts to match every possible string in the keyboard entry to every conceivable string in the data record. Assume you are using SEEKEASY as an electronic Rollodex and entered the continuous string record:

Buck Rogers, Colossal Mfg., 456 Third St., Muggersville, NY 11217, 1-212-555-5555. Manufactures gizmos.

You need to purchase gizmos but can't remember anything about the manufacturer. SEEKEASY will locate the data even if you make a mistake and key in *giztes* instead of *gizmo*. It might be buried in a screen display containing 99 other items with the string *giz*, but it will be on the screen.

While *giz* is a partial string, even a complete string locates many matched entries. If you wanted to extract the data on a *drill bit* and only entered *bit* as the *keyword*, SEEKEASY will locate *drill bit*, *drillbits*, *bridle bit*, *bitter*, *bite*, *illegal* and *illness* (the *ill* matches); it will locate the entry for your friend Bill (the *bil* match). SEEKEASY will often come up with a list of matches which have no relationship to what you're looking for,

but the desired data record will be in the list. The greater the degree of matching in one or more *keywords* the closer the desired data will be to the top of the listing. In the above instance, *Bill* would be well down on the list of matches.

The only limitation on matching are one and two letter words—they must be an exact match. An *A* cannot locate a *W* and *at* will not locate *an*. Other than these conditions anything goes.

Regardless of the number of records in a file—it might be thousands—SEEKEASY displays up to a maximum of 100 records at the rate of seven records per screen: pressing *RETURN* scrolls the next seven onto the screen. The speed with which SEEKEASY can locate a data record depends on the length of the data file and the storage media. Floppy disks are searched at 5-KB/second; hard disks at 7-KB/second, and RAMdisk at 10-KB/second. Dump a full 360-KB floppy data disk into a RAMdisk the longest it takes to locate a data record is 36 seconds.

SEEKEASY data records are limited to two lines of 155 characters. Records are prepared directly by SEEKEASY's own internal and somewhat rudimentary word processor, with editing done through the cursor positioning keys. While the simple editing commands don't make for much of a word processor, it does what's needed and beats having to prepare files with a separate word processor. Pressing *RETURN* enters the record in the data file and resets the program for the next data record, with the previous entry displayed at the top of the screen so the user can keep track of the entered records.

Old records can be deleted. A special *Check File* mode displays the free space on a disk in available characters, and the number of characters in the active data file. When the disk holding the data file is almost full, SEEKEASY prints warnings on the bottom line of the screen during store and edit operations. If the user insists on ignoring the warning (about 5-10 more records) SEEKEASY refuses to store additional records until more disk space is made available.

While the supplied manual generally refers to a single data file, the user can create several individual data files on the same disk, of which several or all can all be merged into larger files if desired.

Finally, SEEKEASY can find any 7/8 bit ASCII character in any data, .COM or .EXE file. If it's in a disk file and it's in ASCII SEEKEASY will find it.

SEEKEASY is entirely menu driven. A *CONTROL-T* prints hardcopy of either the screen display or the entire datafile.

That's all there is to SEEKEASY. There are no complex commands, no unusual text files, and no structure of any kind. But it is extremely fast and convenient. In fact, Seekeasy is so fast and easy to use that it can be learned from a short *doc* disk.

SEEKEASY, Price \$90 postpaid U.S. and Canada, \$18 for demo disk (refunded on purchase). Correlation Systems 81 Rockinghorse Road Rancho, Palos Verdes, CA 90274. Available for PC-DOS and MS-DOS Requires: DOS 2.0 or higher, 128K of RAM, One or more floppy drives, Monochrome or color monitor. ◀▶



# DIGITIZING TABLETS

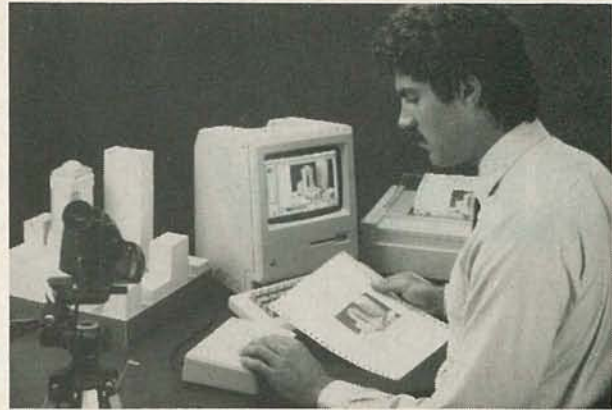

All you ever wanted to know about digitizing tablets—and didn't know who to ask!

## MARC STERN

■One of the long-sought developments in the world of microcomputers has been the marriage of hand input with the small-computer system. Hand input makes a small computer system more flexible. A hand input device allows anyone to work as if using a pen and paper.

In the last two years, this has come about thanks to the digitizing tablet. Manufactured by companies such as Koala and Pencept, Inc., digitabs take the theory of dynamic character recognition technology, an outgrowth of artificial intelligence research, and put it into practice.

A device such as Pencept's *Penpad* or Koala's *Koalapad* is actually a digitizer with a stylus or pen and a connection to its host computer. Such a device can easily send drawings, special commands and cursor controls to a host IBM Personal Computer or compatible, such as the Compaq. The *Penpad* can also double as a touch-pad or mouse.

## Older input methods

In the past, users relied on optical character



FIG. 1—UNIVERSAL PRODUCT CODES are one method of data input. Special readers interpret the strip and convert the information into useable data for a computer.

recognition devices (OCRs) or bar-code readers to input handwritten data from a sheet of paper into a small-computer system. While these methods of handling data-capture are fast compared to more laborious manual input methods, they still aren't totally acceptable.

One drawback with OCRs is that the hand-printing has to be recognizable to OCR optics or the input is unusable. Users receive special training to ensure their hand-printing styles match OCR specifications. OCRs also force users to invest in reading devices that are expensive and difficult to maintain in some environments. Finally, OCRs are incapable of instant information updates.

Instead of direct entry into a system, the information must first be printed on a special form and then read into the system for processing.

Bar-code readers can speed information input, but, like OCRs, need special equipment and software. Bar-code readers require a light wand or pen to read coding strips called Universal Product Codes (UPCs)

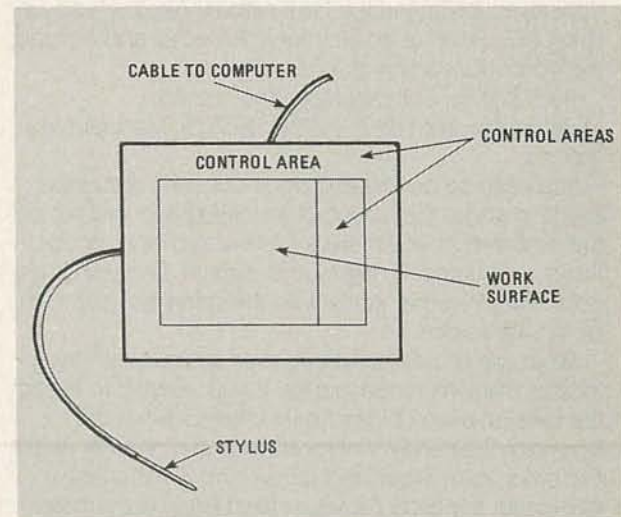

FIG. 2—WORKING WITH A STYLUS, a Digipad will turn written or printed information into data on a screen.



(See Figure 1.) These readings are interpreted by software that recognizes each UPC strip and determines its significance. Any time UPCs change, the reader's software is updated. For some users, bar-code readers are alternatives to OCRs

Digitizing tablets offer many advantages over both OCRs and bar-code readers. Like a bar-code reader, they allow quick information input to an IBM PC's 8088 central processor, but, unlike a reader, they have greater flexibility in the variety of input, much like an OCR. Although digipads (DIGitizing penPADS) are more sophisticated than either device, they boast a simple design, consisting of a writing tablet, pen or stylus, an interface board that slips into one slot in the PC and the software. (See Figure 2.)

Digipads are as easy to use as applying pen to paper. The computer keyboard is replaced by the tablet and stylus—attached to it by a cord—resembling the traditional clipboard-and-chained-pen. Digipads can recognize a variety of handwriting and can acknowledge capital letters A-Z, numerals 0-9, and other characters. Some pads, such as the *Penpad*, use fixed height reference points to determine if the input is capital or lowercase. *Penpad* assumes lowercase when uppercase letters are written at half-height (Fig. 3). These devices also handle deletions with special

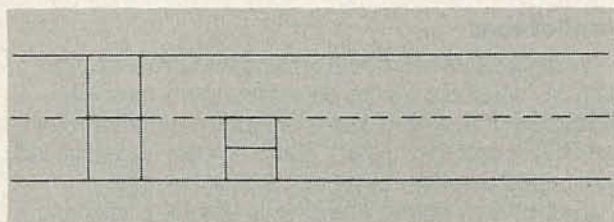

**FIG. 3—IN MOST CASES, letter height determines a letter is capitalized or is lower case.**

command characters or the input can be overwritten, as with a keyboard and screen. Digipads can enter calculations, documents, forms and more directly into the computer, bypassing third channels.

Digipads function as graphics digitizers by providing the computer with information about the location of the stylus relative to its surface. This is translated into a specific address in the computer's memory; the cursor is then moved to that location on the monitor. So it is possible to send freehand drawings or tracings such as map contours or circuit drawings to a host PC. You can use pre-prepared or hand-drawn forms and turn them into quality graphics with a few sweeps of the pen across the tablet's face. The digitizer's built-in intelligence blends both graphics and hand-printed text to create presentation-quality material.

Digipads can also function as touch pads. A touch pad is a low-resolution digitizer that recognizes when the stylus touches specified areas on its surface. On a device such as the *Penpad*, the pen is equipped with a pushbutton that acts as a trigger to transform it into a "mouse that writes." The "mouse-mode" offers quick cursor movement to any spot on a page, by drawing a line with the pen in the appropriate direction on the tablet. As it is moving, the *Penpad* analyzes penstrokes

as they are being made, identifies the characters being formed and presents them to the host computer in a manner indistinguishable from routine keyboard input.

### **Making it work**

The digipad recognizes characters that vary greatly in form through dynamic character recognition (DCR) technology. Using the *Penpad* as an example, the designers used both common generative and perceptive OCR rules to create the algorithm that allows *Penpad* to work. The generative rules deal with character formation; the perceptive rules describe the way people see characters. The first concept is based on set patterns of character generation (for example, the letter A is usually formed in a similar manner by most persons); while the second relies on the fact that most persons generally perceive letters or graphics in the same manner.

In many aspects, the digipad acts as a computer terminal, except that the writing tablet and pen, which form the basis of the unit, replace the keyboard. It supports a high enough X-Y resolution (200 points per inch) as well as a high enough point-sampling rate (200 points per second) to handle the rapid movements a user makes when writing with quick short strokes, as in forming small characters, or when using letters with long strokes (capital letters).

A digipad usually employs its own microprocessor—the *Penpad* uses an MC-68000—whose speed is fast enough to respond to up-and-down pen movements up to eight times per second.

A digitizing tablet is capable of capturing as much as 2,000 bits of raw data and this data must be processed before it is used by the computer. It is at this point that Read-Only Memory (ROM)-based firmware takes over. It preprocesses the raw data, removing unimportant hooks, loops, swirls and extraneous electronic noise. It standardizes the size of the characters that are printed on the tablet. Further processing cleans the raw data making it look like ink images on paper as closely as possible.

At this point, the generative and perceptual rules used by the device are brought into play. The algorithms used in the software determine which letters the data represent. The software must analyze the structure of the input and select the letter the structure represents. For example, the numeral 2 is almost always formed starting at the top, and this is the only way the software will recognize it, even though a normal-looking 2 might be formed starting at the bottom or from any other position. See Figure 4.

### **Systems revealed**

If you look at a typical digipad, you will see it's a little larger than the standard three-ring notebook. The writing surface is subdivided into grids, an example of which might be six boxes per inch horizontally and four per inch vertically. The digipad's surface is programmable and allows the user flexibility in resetting these parameters. A user can also define some areas of the digipad's surface to accept only certain characters and some digipads also are capable of



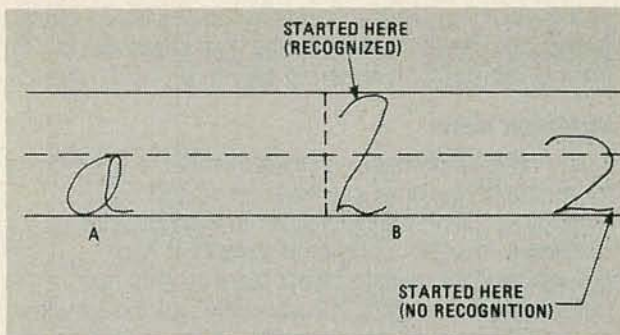

**FIG. 4—A DIGIPAD'S ALGORITHM can interpret hand-written data. Since letters are formed in the same manner, the program will recognize the loops of an "A." Likewise, it will recognize a "2" which is usually started at the top. If somebody starts a "2" at the bottom, the program can't recognize it.**

handling macros.

(Macros are programmable routines in which one stroke handles several functions. Suppose you have several complicated command sequences in a program which also has macro capability and you want to streamline things. Using the program's macro capability, you can establish a one- or two-key sequence to handle the multi-command sequence by opening the macro and entering all the complicated commands you must. When you are finished, you close the macro and either assign it a name or key and every time you need the complicated command sequence, rather than hitting many keys, you only have to hit one and the program handles it for you.)

Using a digipad's macro capability lets you transmit a string of user-defined characters at the touch of the stylus.

If you look at the surfaces of some digipads, you will see a control area. This area allows you total control of editing and alphanumeric, as well as program functions. It acts in place of the keyboard.

To work with an IBM PC or compatible system, you or the company providing the system will have to write a driver routine. It is this program which lets the digipad act as the "front end" of your system. With the PC, it's easy, because you can take advantage of DOS 2's (and higher) CONFIG.SYS routine. With this routine, you open a small text file and input the following line `DEVICE = XXXXX` and then close the file. You install this file on the disk you are using and the PC will look for it every time you boot your system. This structure is enough to tell the PC to install the digipad. The CONFIG.SYS routine also eliminates the need to write complicated patches to the operating system, although some manufacturers may do that for you in the software they provide for their pad.

Typically, a digipad is driven by a microprocessor. Whatever microprocessor is used, it gives the digitizer its capability. In an IBM-PC this controlling circuitry interfaces with the IBM bus through one of the expansion slots on the motherboard. This add-on board will contain the microprocessor and any ROM-based firmware needed by the system to handle its chores. For instance, the *Penpad's* 68000 microprocessor is on this board, as is its 128K of ROM

firmware, 128K of Random-Access memory for user input and 4K of nonvolatile memory used to store format and command information, as well as parameters for setup as a terminal. Input and output to the digipad is handled as straight ASCII information.

A typical digipad can be interfaced as either a serial or a parallel device. As a serial device, it can be made functionally equivalent to an RS-232C port—as is done with the *Penpad*—without tying up the port itself. The developers will locate the device's input at the memory address of a serial port and the system thinks there is a serial port attached, in reality, any other serial devices are free. The IBM-PC supports up to three serial ports and a digipad can reside at any of those locations. Usually, it will be port 2 or 3 because port 1 is taken up by a communications card.

As a parallel device, it is functionally equivalent to a peripheral such as a parallel printer and will reside at the printer's location in memory. Of course, a parallel device is capable of communicating at higher speeds than a serial device because of the parallel data stream used, but, a serial device can be used a greater distance away.

Typically, a digipad will operate in parallel with the keyboard and you can usually use it with the keyboard installed.

### Implications

A digipad will eliminate redundant keyboard input in many situations where data entry forms must be rekeyboarded or read into a computer system through an OCR. It provides instant, real-time data updating and will increase system efficiency and throughput.

Further, it will prove attractive in graphics, scientific or electronics work. In graphics, it gives a computer user the ability to design attractive lettering or figures quickly and easily, without the necessity of using a keyboard. It frees the designer to sit and use a device much like a pen and paper and the designer will be able to use the freeform methods he's used to. The same is true of the computer user who wants to design his own graphics output. In a scientific atmosphere, a digipad user can enter equations and computations from a "scratchpad" and could have the new information displayed immediately. An electronics enthusiast will be able to design a circuit on paper and have it immediately translated into a high quality output. If he makes any changes to the circuit, they will be displayed immediately.

The digipad will prove very attractive in situations which don't lend themselves to transition to keyboards or terminals. Data entry, in these environments, often lends itself more readily to the freeform modes allowed by handprinting, rather than the rigid standards imposed by a traditional keyboard. Often simple inventory can be handled more easily by a simple form than by a computer terminal.

Digipads provide an easy interface to computers and their capabilities. It speeds data entry time and allows much more freedom than a traditional keyboard. In the future, such devices will become more and more common for more users. ◀▶



# COMPUTER BOOKS

For more details use the free information card inside the back cover.

■ **MICROPROCESSOR BASED ROBOTICS**, By Mark J. Robillard. Howard W. Sams & Co., Inc., 4300 W. 62nd Street, Indianapolis, IN 46268. 220 pages including index. 8½ × 11 inches; softcover; \$16.95.

If you want to learn more about intelligent machines, this book serves as an excellent introduction to the subject. Designers, experimenters, and students will find the work equally valuable. Robillard dissects robotics into their logical, scientific areas of engineering, and shows how they can be made to achieve pseudo lifelike mechanization to control such things as mechanical, electrical, electronic or computer-based operations.

He covers specific subjects within each technical discipline and explains in detail, each robot-element of the construction. Many hands-on projects are included, making this an ideal classroom text.

CIRCLE 31 ON FREE INFORMATION CARD

■ **SOFTWARE MASTER FOR PFS: By Ted Leonsis and LIST Magazine.** Warner Software/Warner Books, 666 Fifth Avenue, New York, NY 10103. 221 pages, 8 inches × 9¼; softcover; \$14.95.

Software Master for PFS offers reviews of each program based on critical and lengthy interviews with actual users in the field. With added editorial comment on each program's documentation and tutorials by the authors, the result is useful and reliable.

CIRCLE 32 ON FREE INFORMATION CARD

■ **A HOBBYIST'S GUIDE TO COMPUTER EXPERIMENTATION: By John D. Lenk.** Prentice-Hall, Inc. Englewood Cliffs, NJ 07632. 283 pages including index. 6 × 9¼ inches; hardcover; \$25.95.

John D. Lenk is a long-time author in the electronics field, and in this work, it's easy to see why. The book is complete, innovative, and fascinating reading that will prompt you to attempt some of the experiments as soon as you put the book down. Everything is clearly explained, and lucidly illustrated with easy to follow diagrams and photographic illustrations. Prentice-Hall, the Publishers, have done the work proud.

CIRCLE 33 ON FREE INFORMATION CARD

■ **VIC 20 USER GUIDE: By John Heilborn & Ran Talbott.** Osborne/McGraw-Hill, Inc., 2600 Tenth Street, Berkely, CA 94710. 250 pages including index, 6½ × 9 inches; softcover; \$14.95.

If you own or plan to own a Commodore VIC 20 you'll find that this guide is an almost essential tool. You'll find detailed operating instructions, both for the basic computer and its peripherals.

CIRCLE 34 ON FREE INFORMATION CARD

■ **INTERFACING TO S-100 IEEE/696 MICROCOMPUTERS: By Sol Libes & Mark Garetz.** Osborne/McGraw-Hill, 630 Bancroft Way, Berkeley, CA 94710. 321 pages including index, 6½ × 9¼ inches, softcover; \$15.00.

The popularity and wide acceptance of the S-100 IEEE/696 Bus warranted the need for this new title. The book helps users expand the utility and power of their systems. It describes its mechanical, functional and electrical design along with bus interconnections, bussing techniques and interfacing to RAM, ROM and the real world. This is a must for any designer involved with the S-100 bus.

CIRCLE 35 ON FREE INFORMATION CARD

■ **FREE SOFTWARE FOR THE IBM-PC: By Bertram Gader & Manuel V. Nodar; Warner Books, 666 Fifth Ave., New York, NY 10103.** 466 pages including glossary. 5¼ × 8 inches, soft cover; \$8.95.

If you have or contemplate purchasing an IBMPC, then this book can quickly pay for itself. It's a listing of more than 600 software programs that you can get free via telephone hook-up. All are in the public domain, so there are no legal problems in availing yourself of them.

CIRCLE 36 ON FREE INFORMATION CARD

■ **COMPUTER COMMUNICATION TECHNIQUES: By E. G. Brooner & Phil Wells; Howard W. Sams & Co., Inc., 4300 West 62nd Street, Indianapolis, IN 46268.** 142 pages including index. 6 × 9 inches, soft cover; \$15.95.

This valuable text, fully illustrated with photographs and line drawings, will tell you how to get your computer to "talk" to another computer, what hardware and what software you need, how to tell what will or won't work with your computer. How to connect your computer to telephone lines, the "standards and protocols" used by information services and time-sharing networks, how to access and use information services such as CompuServe and The Source. How to use Videotex and teletext systems and how they operate.

CIRCLE 37 ON FREE INFORMATION CARD

■ **8088 ASSEMBLER LANGUAGE PROGRAMMING: THE IBM PC: By David C. Willen & Jeffrey I. Krantz; Howard W. Sams & Co., Inc. 4300 West 62nd Street, Indianapolis, IN 46238.** 235 pages including index. 8 × 9½ inches, soft cover; \$15.95.

This well-illustrated book teaches you how the IBM Personal Computer works, all about the 8088 microprocessor and other important computer components. ◀▶

CIRCLE 38 ON FREE INFORMATION CARD



# CASSETTE-TO-CASSETTE INTERFACE

Here's a way to make bulk copies of programs and save all that tedious work.

**BILL TULEJA**

■ Making back-up copies of programs on tape cassettes can be a real chore. The program must be loaded into the computer from your original cassette, then the blank back-up cassette must be swapped for the original and the program saved on the back-up. This process must be repeated for each program on the original. The circuit described here permits bulk back-up copying. It is an interface circuit that allows two Commodore cassette tape recorders to be connected for directly reading and writing.

The connection between a Commodore computer, and its data cassette recorder is shown in Figure 1. This shows the cassette recorder's cable connector as it would be seen if you held it looking into the hole in the connector housing with the contact fingers at the top of the hole. The edge-connector of a Commodore computer is also shown as it would plug into the cassette cable's connector socket—with the contacts on top of the board. Contacts are identified by the numbers 1 through 6 along with their function names and signal directions (the computer supplies power and ground to the cassette recorder so the direction of both of these signals is from the computer edge-connector to the cable connector attached to the recorder). Connections to pins 1, 2, 3 and 4 are needed to read data out of the data cassette recorder and connections to pins 1, 2, 3, and 5 are needed to write data into the recorder.

The Commodore cassette tape recorder does not use the two-frequency FSK (Frequency Shift Keyed) system found on many other computers, but uses a

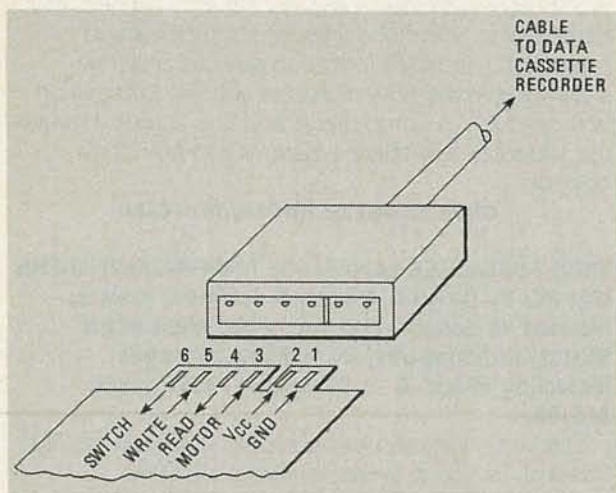

FIG.1—COMPUTER CIRCUIT BOARD edge-connector and cable connector from data cassette recorder showing pin numbers, function names and signal directions.

digital pulse sequence to store data. The interface shown in Figure 2 is a digital circuit. Using an external power supply, it provides the DC voltages and logic level signals needed to interface two Commodore data recorders.

The most important part of this circuit is IC3—a 74LS14 hex Schmitt-trigger inverter. Its main function is to accept a READ input on IC3 pin 1 and produce a WRITE output on IC3 pin 2.

The circuit (see Fig. 2) is powered externally by 9V to 15V brought into terminal strip TS1. Switch S1 provides power control so the external power supply does not have to be turned on and off. Diode D1 protects the circuitry against reverse polarity if the power supply is accidentally connected backwards to TS1. Capacitor C1 provides filtering for the inputs of the voltage regulators IC1 and IC2. IC1, R1 and R2 produce +6V for the cassette recorder motors. IC2 produces +5V for the logic in the cassette recorders and the circuitry on the interface board. Since IC3 contains six inverters, it was convenient to provide buffered outputs for driving LEDs. LED1 is on when connector pin 4 of the READ cassette is inputting a logic low. LED2 is on when the READ cassette is inputting a logic high. Test points TP1 and TP2 provide a buffered output for connecting an audio amplifier or oscilloscope to monitor.

## Construction

The prototype was assembled on a plug-in

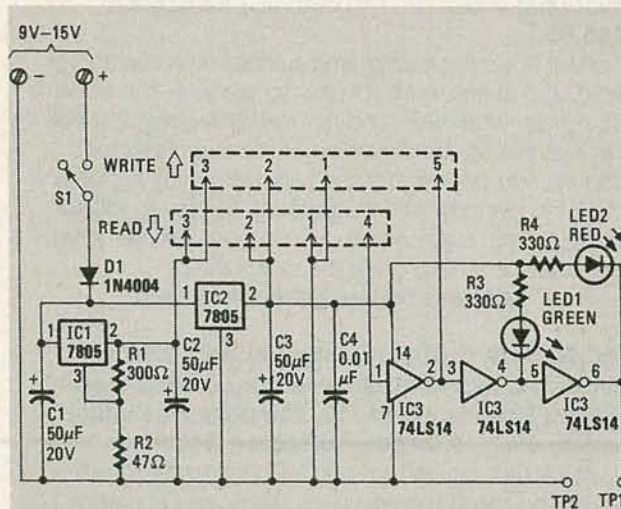
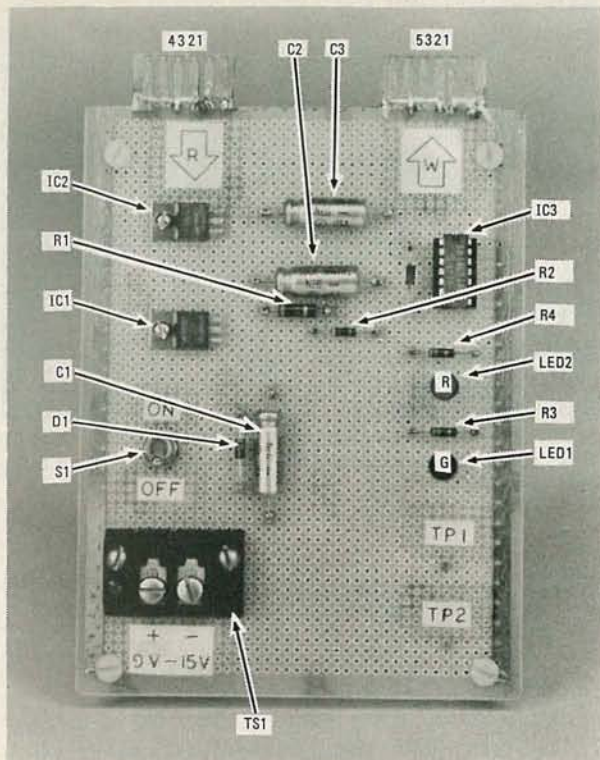

FIG.2—SCHEMATIC DIAGRAM OF INTERFACE through which two Commodore data cassette tape recorders can be interconnected to read out of one and write into the other.

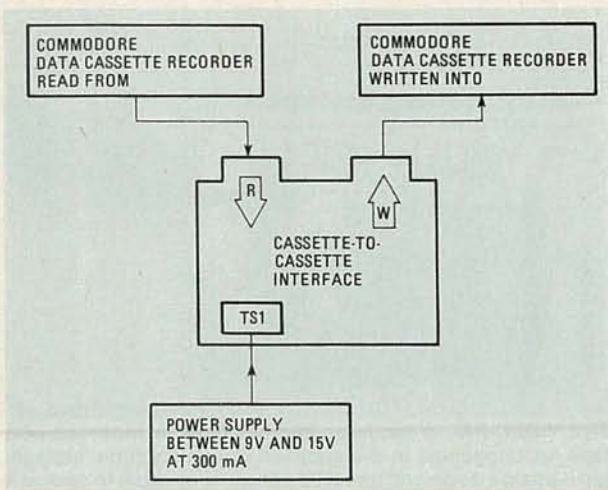



**FIG.3—COMPONENT LAYOUT** for point-to-point wiring of the interface board.

perboard having a 22-pin edge connector with 0.156-inch ( $\frac{3}{16}$ -inch) spacing between the centers of the connector pins. A coping saw was used to rim the circuit board edge connector to accommodate the cable connectors of two data cassette recorders. A slot must also be cut between pins 2 and 3 so the keyed cable connectors will fit on the circuit board.

Parts layout is not critical. Figure 3 identifies the component locations on the prototype. The components were mounted on flea clips and point-to-point wiring was used. It is advisable to use a 14-pin DIP socket to avoid soldering directly to the pins of IC3. Another perboard (without an edge connector) was fastened to the bottom of the interface board, using



**FIG.4—CASSETTE-TO-CASSETTE** interface showing connections to power supply and data cassette recorders.

spacers to protect the wiring side of the board.

### Testing

After construction is completed, check all wiring and verify that polarized components like D1, C1, C2 and C3 are installed correctly. Leave IC3 out temporarily.

### PARTS LIST

#### Resistors

All resistors are 1/4-watt 10% unless otherwise indicated

R1—300 ohms  $\pm 5\%$

R2—47 ohms

R3, R4—330 ohms

#### Capacitors

C1—C3—50  $\mu$ F, 20 volts electrolytic

#### Semiconductors

D1—1N4004 Diode

LED1—Green LED

LED2—Red LED

IC3—74LS14 Hex Schmitt-trigger

IC1, IC2—7805 5-volt regulator

#### Miscellaneous

Plug-in perboard with 22-pin edge connector with 0.156-inch spacing between centers of connector pins, 14-pin DIP socket, connectors, terminal strip, miniature toggle switch, mounting hardware.

and connect a power supply to terminal strip TS1 that can provide between 9V and 15V at 300mA (see Fig. 4). Close the power switch S1 and measure the DC voltages between pins 1 and 3 of both READ and WRITE connectors—pin 1 is the ground and pin 3 should be at +6V if IC1 is wired properly. Also measure the voltage between pins 1 and 2 of the connectors—pin 2 should be +5V if IC2 is working correctly. Measure the voltage between pins 7 and 14 of the socket for IC3—pin 7 is ground and pin 14 should be +5V. Open S1 and check that all voltages decrease to 0V.

Plug in IC3 and close S1 again—the red LED2 should be lit. Measure the voltage between pins 1 and 5 of the WRITE connector—pin 5 should be less than +0.5V. Use a clip-lead to short pins 1 and 4 together on the READ connector while still observing pin 5 on the WRITE connector—it should now measure more than +2.7V, the red LED2 should be off and the green LED1 should now be lit.

Turn S1 off and connect the READ and WRITE data cassette recorders to the interface board as shown on Figure 4. Insert your master cassette into the READ recorder and a blank cassette into the WRITE recorder. Turn S1 on, push RECORD and PLAY on the WRITE recorder and then push PLAY on the READ recorder.

A small audio amplifier and speaker can be connected across TP1 and TP2 for more convenient monitoring. A high-pitched tone appears on a cassette tape at the beginning of each program. This tone is used to synchronize the computer to the tape during a read operation to allow for variation in tape speed during a read from tape cassette. The sound of data which follows the tone can be described between a hiss and a buzz. ◀▶



# DELUXING THE RADIO SHACK COLOR COMPUTER



**AFTERMARKET UPGRADE AND RETROFIT ACCESSORIES** make Radio Shack's Color Computer into a full-blown business system.

*Aftermarket retrofits can upgrade the CoCo to a full business system.*

## Herb Friedman

■ While most home and family computers can be used for little more than games because they are simply too slow or inconvenient for "business use," Radio Shack's Color Computer—affectionately known as the CoCo—can be easily retrofitted into a high performance system suitable for "serious" use. Since the CoCo has been a popular gift, chances are there's one tucked away on a shelf because the kids are tired of using it for games. This is the perfect time to upgrade the CoCo so it can be used for business applications—the "serious use."

If you do the upgrade with Radio Shack hardware the system will eventually cost more than it's worth—it would be less expensive to purchase a new "business" computer. But you can come out ahead of the game by using CoCo retrofit kits and components available from non-Radio Shack sources.

The photographs show how to install the most

popular and useful retrofit and upgrades. The computer shown is the latest version of the basic \$99 CoCo, the one with minimum BASIC and only 16K of RAM. Since Radio Shack continuously changes the CoCo's design, your model might be different from the model shown in the photographs. In particular, Radio Shack eliminates IC sockets, so certain "plug in" retrofits may have to be soldered in your CoCo.

## Four major upgrades

There are four major upgrades for serious use of the CoCo. The first one is a conventional composite video monitor output; the second is expansion to 64k RAM; the third is an upgrade of BASIC to Extended Color Basic; the fourth is the addition of a disk system. Because the CoCo's conventional TV receiver screen display runs out of resolution at about 50 characters, which makes word processing somewhat less than convenient, the composite video monitor output is probably the most important upgrade because it

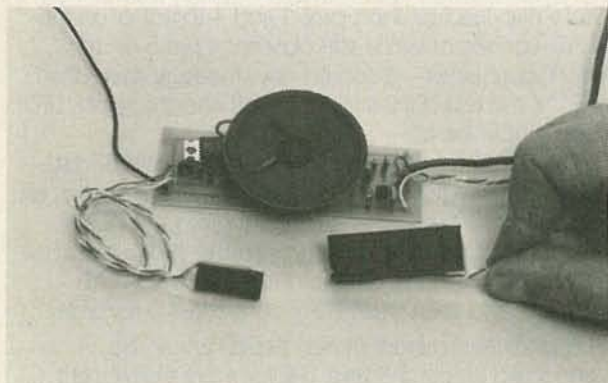

**THE FIRST THING YOU'LL NEED** is a composite video output so you can use a conventional monochrome monitor. The Video Pal retrofit provides an external video output and an internal sound system. It is prewired to sockets for the CoCo's video and sound ICs. These components are soldered rather than socketed in the latest CoCo. Mark the wires carefully and unsolder them from the sockets. They will be soldered directly into the CoCo.

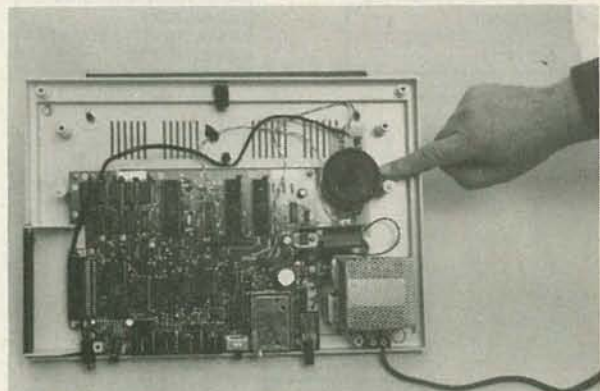

**THE VIDEO PAL** is too large and heavy to be mounted with tape, as suggested in the supplied documentation. Instead, flip it upside down and use RTV adhesive or caulk to secure it to the case directly in front of the power transformer. (Notice that the keyboard has been removed for protection.)



permits the use of a conventional wideband monochrome monitor that can display up to 80 razor-sharp characters.

Several composite output retrofit kits are available for under \$30. The Video Plus Composite Video Interface (Computerware, Box 66, Encinitas, CA 92024) is about the size of a postage stamp and has separate output cables for video and sound. (The sound output can be connected to a small solid-state amplifier.) The Video Pal (RGS Micro, Inc. (Main Street, Derby Line, VT 05830)—the retrofit shown in the photographs, which

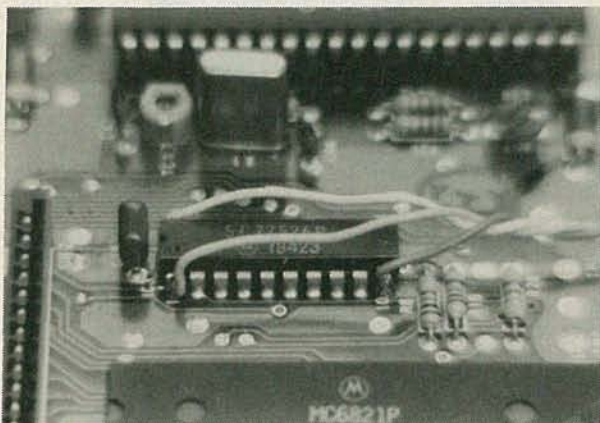

**SINCE YOU CAN'T USE THE COCO'S video and sound sockets, the connections from the Video Pal must be tack soldered to the terminals of the video and sound ICs. We really mean tack solder: No fancy wraps around the terminals, and the connection is made using a needle-point soldering tip and just a touch of solder. Make certain there are no solder bridges across adjacent terminals.**

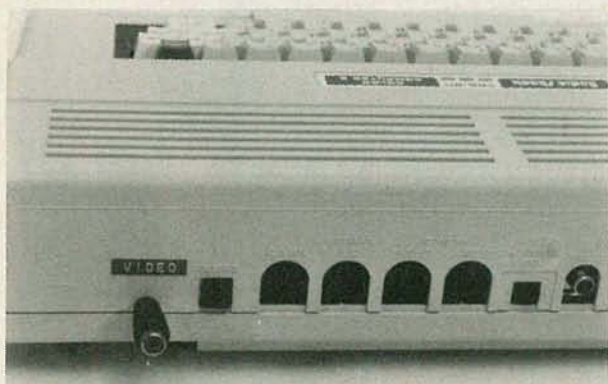

**CUT A NOTCH in the rear of the cover so the shielded cable terminated with a phono jack can pass through. The video monitor output can be used simultaneously with the TV output.**

also sells for under \$30—has a small on-board amplifier and speaker which eliminates the need for an external amplifier.

### The RAM upgrade.

64k of RAM is needed for both Extended Color Basic, a disk controller, and decent word processing capability. All you need to do to increase RAM from the supplied 16k to 64k is to substitute 4164 RAM chips for the eight existing RAM ICs and solder a wire across the "64k" solder pads at "J1," which is located at the

lower left of the main circuit board. If you get the RAM chips from Spectrum Projects (95-13 86th Drive, Woodhaven, NY 11421) they'll provide RAM upgrade documentation for the various models of the CoCo. While it's easy enough to substitute the 4164s because

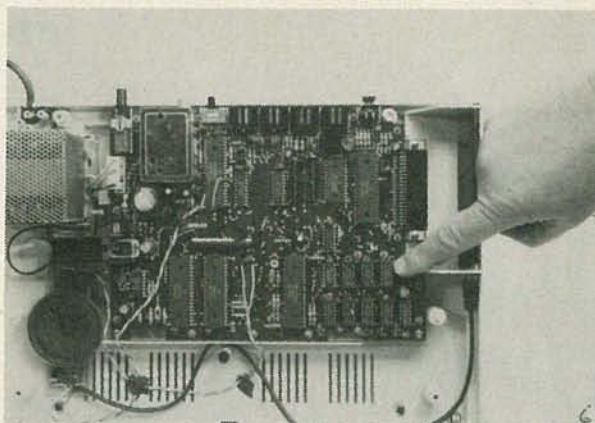

**THE FINGER POINTS to the eight socketed RAM ICs. Substitute 64k 4164 RAM chips and short circuit the 64k programming solder pads.**

the RAM is socketed, to avoid bending or damaging a terminal the use of an IC insertion tool is recommended. (Don't forget to wear a ground strap when handling ICs.)

### Extended color BASIC.

Serious programming, some professional quality software, and a floppy disk system requires the computer to have "Extended Color Basic." A prewired socket for this upgrade is built into the CoCo: All you

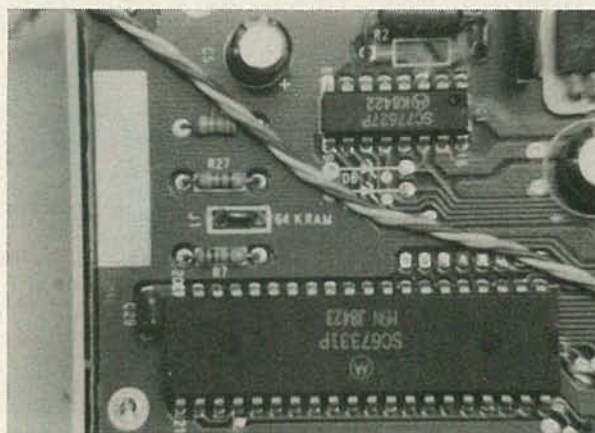

**THE 64K PROGRAMMING SOLDER PADS are labeled as J1-64k RAM. Just tack solder a small jumper across the pads to program the CoCo for 64k of RAM.**

have to do is obtain the IC and plug it in. While Radio Shack stores supposedly sell the part, in reality it's not the easiest thing to get, and Radio Shack charges for an installation you can do yourself in about 60 seconds. (Ten seconds if you already have the cabinet open.) You can purchase the same Extended Color Basic IC with do-it-yourself installation instructions (how to plug it in) from Spectrum Projects and other aftermarket suppliers of parts for the CoCo.



## The Floppy disk system.

Finally, we come to a disk controller and disk drives. Any drive that is compatible with IBM, Radio Shack or Zenith computers can be used with the CoCo; in

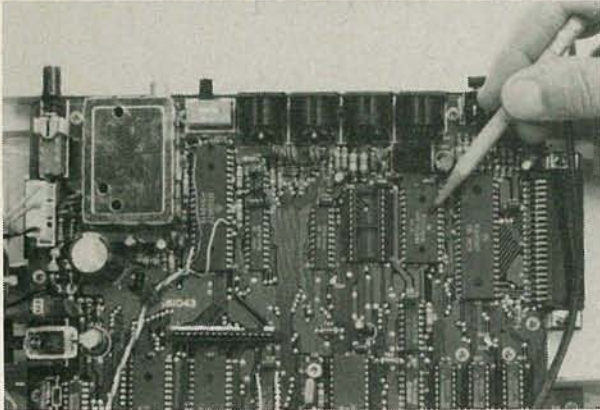

**THE PENCIL POINTS TO THE BASIC ROM.** The empty socket to its left is for the Extended Color BASIC ROM, which simply plugs into the empty socket. Do it yourself: There's no need for a factory installation of the Extended BASIC ROM.

particular, the Shugart SA400, which is flooding the market at ridiculously low prices because it won't work with the newer business-quality computers.

Combination disk drive cabinet/power supplies can be purchased for under \$50 from Software Support, Inc. (One Edgell Rd., Framingham, MA 01701). If you use a presently owned drive, or one of the surplus models such as the SA400, you'll need to provide a disk controller. The best buy is Radio Shack's own controller,

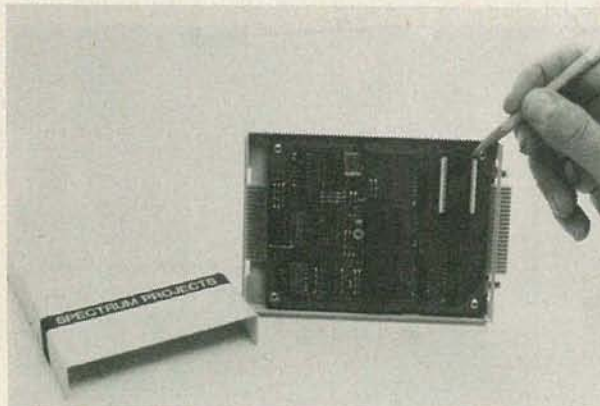

**PENCIL POINTS TO THE CLEARLY-LABELLED Radio Shack Disk Controller integrated circuit,** the primary reason why most aftermarket disk controllers work so well. But be careful, a controller that doesn't use Radio Shack's IC might not run some of the most popular software.

which as far as I know cannot be purchased independent from a package that also contains the first drive (Drive 0) except from Computer Plus (480 King Street, Littleton, MA 01460). Alternately, you can substitute an aftermarket disk controller, but unfortunately, one of the best known non-Radio Shack CoCo controllers won't run some of the most popular business-quality software such as Telewriter-64 and most of the Elite line of software. However, other

aftermarket disk controllers work well with all software because they actually include the same controller IC that Radio Shack uses. Also, the Radio Shack based controllers function directly with the 30 mSec. drives

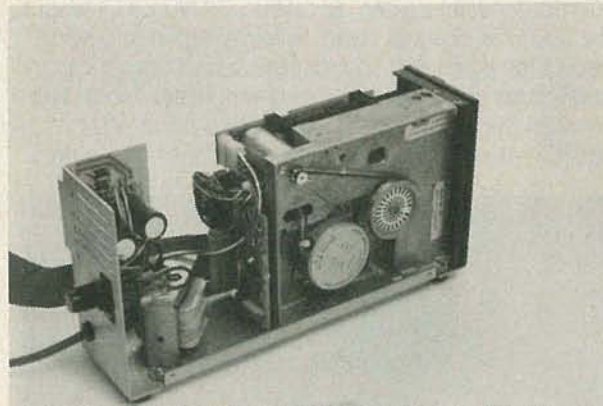

**THE CASE AND POWER SUPPLY ARE NEW,** the disk drive is a "surplus" SA400 that was purchased for a fraction of its usual price. The combination case and power supply sold by Software Support, Inc. has a little extra length and will fit any disk drive we have seen, including most hard disk units.

such as the SA400: The non-Radio Shack controller defaults for the newer mSec. drives and must be programmed for the slower drives. (A 30 Msec. controller works automatically with all drives from 30 to 5 mSec.) If you can't get Radio Shack's controller we suggest you get an aftermarket unit that uses Radio Shack's chip, or one that exactly duplicates the Radio

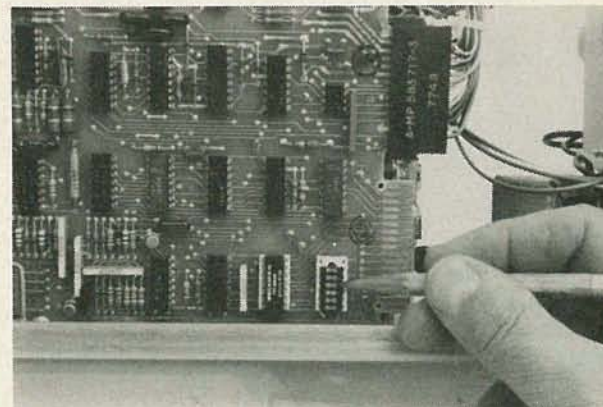

**IF YOU USE ONLY ONE floppy disk drive don't mess around trying to program the disk drive's selector jumpers.** If all the DIP jumpers on the drive selector block are left shorted the drive will automatically function as Drive 0. If you want to use two or more drives get one of Radio Shack's preprogrammed disk drive cables and use all jumpers on every drive, but make certain only Drive 0 has a terminating resistor block.

Shack IC. The aftermarket controller shown in the photographs is the DSS ULTRA Controller, which is sold by Spectrum projects (among others).

## On with the upgrades.

Let the photographs guide you through the upgrades, but keep in mind that the layout and/or design of your CoCo can be different from the one shown in the photographs. ◀▶



venience and flexibility is the answer. Say you have a control circuit hooked up and you want to experiment with an automated vision system. Instead of controlling them as a single unit, you might want to exercise them separately. That's where's the other cable comes in. It's unlikely that both cables will be needed, but you shouldn't have to upgrade the laboratory as your experiments become more sophisticated.

You'll also need a 50-conductor flat ribbon cable, terminating in a standard 50-pin D-type connector, for use in controlling parallel processing. If you build your robot in two parts, with separate motor-driver and controller boards, you may need several parallel lines to control the different drive circuits.

The cable assembly also contains the wires that feed power to the system. An extra power cable that I've added (and you may also find necessary) is a simple 2-wire AC cord with a TV chassis connector at one end. (You may know that type of cord as a "cheater cord".) That cable is used to supply AC power to a video camera that's used when doing vision experiments.

Once completed, the cable assembly should be positioned so that it runs from your workbench, along the ceiling, and then to the area where the robot is located. Be sure to provide enough slack in the cable to allow the robot to access the four corners of the lab space. The slack in the cable tends to lie on the floor and obstruct the robot's movement; therefore, a tensioner (elastic band attached to the cable to take up the slack) is needed.

When attaching the tensioner, suspend the wires from the ceiling, as shown in Fig. 2, and then place the elastic band so that the length of wire provided doesn't touch the floor. (An elastic band of the type used to hold luggage together works fine.)

### Floor layout

In doing vision experiments or path navigation, the floor should be marked off in known distances. An easy way to mark off distance on a floor is to use standard mask-

ing tape or drafting tape. Mark off the floor in 1-foot squares until you have completed a grid like that shown in Fig. 1. That allows you, with little effort, to see whether your robot has really moved.

### Types of robots

If you're new to robotics, your first project should be a small rover—a robot that moves around on two wheels—that can run forward, reverse, and turn left or right. (A future article in **Radio-Electronics** will cover the construction of a simple rover.) Although there are robot kits on the market, it is best to build it yourself to get the full benefit of your work.

Purchasing a robot, even the kit type, is a lot easier than building one, but you miss out on the learning experience of the building process. Even so, there's still lots of research that can be done. Completely assembled robots, with or without arms, and some complete with voice synthesizers and radio control interfaces are available at a lower cost than you think.

### Control systems

Computers make it a lot easier to control complex processes. All you need is a parallel interface tied between the robot and your computer. Building your own control system, however, can be much more fun. Simple switch boxes or very exotic microprocessor-based control systems are easily built.

In the coming months, some of the subjects that we'll cover are: simple path navigation and complex path navigation, manipulation of objects and, of course, vision. With vision systems, you can experiment with ways to pick out particular parts from a bin of many different types—a very complex experiment of the type currently being done in university laboratories. And since there's no clear solution to many of the problems confronted in robotics, you could be the first to come up with a gimmick that works.

Well, that's all we room for this month. Until next time, why not start building that laboratory so that we can get right into our first project.

R-E

**JAN**

**SEND FOR THIS FREE CATALOG NOW**

**SAVE MONEY HIGH QUALITY FAST DELIVERY**

We are utilizing the latest equipment and technology to maintain our quality at reasonable prices.

**JAN**

**CRYSTALS**

Since 1958

- General Communication
- Industry
- Marine VHF
- Scanners
- Amateur Bands
- CB Standard
- CB Special
- Microprocessor

**Call or Write**  
**JAN CRYSTALS**  
P.O. Box 06017  
Fort Myers  
FL 33906-6017  
**(813) 936-2397**

## Be an FCC LICENSED ELECTRONIC TECHNICIAN!

**Earn up to \$30 an hour and more!**

Learn at home in spare time. No previous experience needed.

No costly school. No commuting to class. The Original Home-Study course prepares you for the "FCC Commercial Radiotelephone License". This valuable license is your "ticket" to thousands of exciting jobs in Communications, Radio-TV, Microwave, Computers, Radar, Avionics and more! You don't need a college degree to qualify, but you do need an FCC License.

**No Need to Quit Your Job or Go To School**  
This proven course is easy, fast and low cost! **GUARANTEED PASS** - You get your FCC License or money refunded. **Send for FREE facts now. MAIL COUPON TODAY!**

**COMMAND PRODUCTIONS**  
FCC LICENSE TRAINING, Dept. 90  
P.O. Box 2223, San Francisco, CA 94126

Please rush **FREE** details immediately!

NAME \_\_\_\_\_  
ADDRESS \_\_\_\_\_  
CITY \_\_\_\_\_ STATE \_\_\_\_\_ ZIP \_\_\_\_\_

AUGUST 1985



## LETTERS

continued from page 32

probably OK. Do the tape-monitor outputs work? Then you have isolated the problem to the power output stage. And so on.

Finally, you can "shotgun" the unit—check all the components. It may sound like a chore, but you can physically remove all the parts in a section, check them out of circuit and replace them in a lot

less time than you might think. I recently repaired a switching-type power-supply module for a customer's commercial videogame, in the field, without a schematic, by simply removing all the semiconductors from the board and testing them. Two diodes, a transistor, and forty minutes later his game was back in operation and my service call was complete (and I got paid). Of course, the next morning I ordered a schematic for the module and received it three weeks later.

Good troubleshooting skills will get you through times with no schematics better than schematics will get you through times of no troubleshooting skills.

DOUGLAS ENZO McCALLUM  
East Lansing, MI

## MISSING DESIGN

I read with interest Ray Marston's article, "CMOS Clock Circuits", in the November 1984 issue, but noticed that he missed one design that has been my favorite for reasons of its simplicity; that design is shown in Fig. 1.

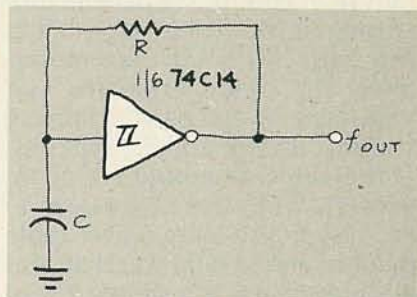

FIG. 1

Using the 74C14 gives you six oscillators to each IC package. Duty cycle is typically 50%, and frequency is given by the equation:

$$f_{OUT} = \frac{1}{RC \ln \left[ \left( \frac{V_{CC} - V_{TL}}{V_{CC} - V_{TU}} \right) \left( \frac{V_{TU}}{V_{TL}} \right) \right]}$$

where:  $V_{TU}$  = Upper trip point  
 $V_{TL}$  = Lower trip point

This oscillator was described by Gerald Buurma in "AN-140 CMOS Schmitt Trigger—A Uniquely Versatile Design Component", appearing in the 1977 National Semiconductor *CMOS Databook*.  
ANTHONY CHARLTON  
Cornwall Bridge, CT

## SCHEMATIC NEEDED

I have a PhoneMate Circle of Safety alarm system that needs some troubleshooting. I am in need of a circuit diagram or other service information. I checked with Sams *PhotoFacts*, and they never published any data on that system.

I am willing to pay the costs for any reproduction and postage. R-E  
ROBERT DINGLE  
657 Dell Ridge Drive  
Dayton, OH 45429

# Channel PLUS™

## VIDEO MULTIPLEXER

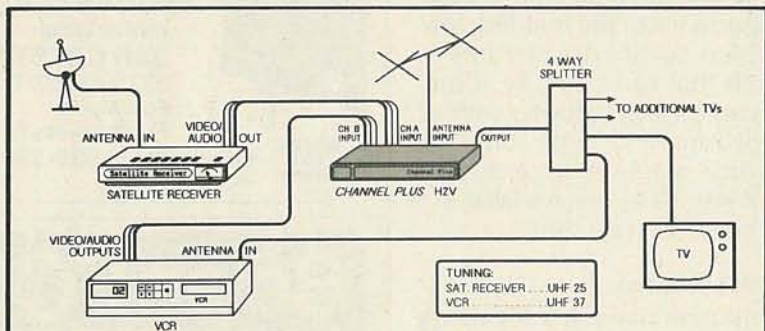

### SIMPLIFY DISTRIBUTION SYSTEMS



### TYPICAL HOME SYSTEM

In this system any TV can connect to the satellite receiver by simply tuning to UHF channel 25. The VCR can be viewed on UHF channel 37. All over-the-air stations can still be received on their normal channel numbers. The VCR can record from the satellite receiver by simply tuning to channel 25.  
Note: A **CHANNEL PLUS** H2V comes pretuned to channels 25 and 37. The user can easily change these assignments to any channel between 14 and 62.

- Combine many video sources on one wire
- Channel Plus is a frequency-agile modulator with built-in combiner—no filters or traps needed.
- Channel Plus uses UHF to avoid adjacent channel interference.
- Channel Plus improves picture & sound quality by using the direct video & audio outputs from VCRs, TVROs, cameras, etc.
- Channel Plus systems may be expanded to add more video sources.
- Watch VCR, TVRO, computer, cable box, VDP, camera, etc. from any TV by simply selecting its channel number.

 multiplex™  
technology, inc. 251 imperial highway, fullerton, ca 92635  
telephone (714) 680-5848 

CIRCLE 251 ON FREE INFORMATION CARD



# NOW YOU CAN TRAIN FOR A GREAT CAREER IN ELECTRONICS RIGHT IN YOUR OWN HOME...

...Or Train For One Of 32 Other Money-Making Careers Below

Get In On The "Boom Years"! Electronics And Microcomputers Are The Big-Demand Fields Of The 80's!

## HOME STUDY MAKES IT EASY TO START!

There's no need to quit your job or take time from your family or friends. As an ICS student, you learn at home, the hours you choose. You waste no time traveling to class or standing in registration lines. And you never miss a paycheck. But you are not alone. Although your lessons are especially written for home study, if you ever need a better understanding of something in your lessons, just phone or write to us and one of our instructors will get back to you with a detailed answer.

## HANDS-ON TRAINING AND EQUIPMENT INCLUDED WITH COURSE

The great thing about your training is that it's so complete. We start you at the very beginning... explain everything step-by-step. Your lessons are clearly written and fully-illustrated with photos, charts, diagrams, examples... whatever it takes to give you a total understanding of each subject or experiment. Everything you need to complete your training—books, lessons, equipment, testers—is included with your course at no extra cost.

FIRST FOLD HERE

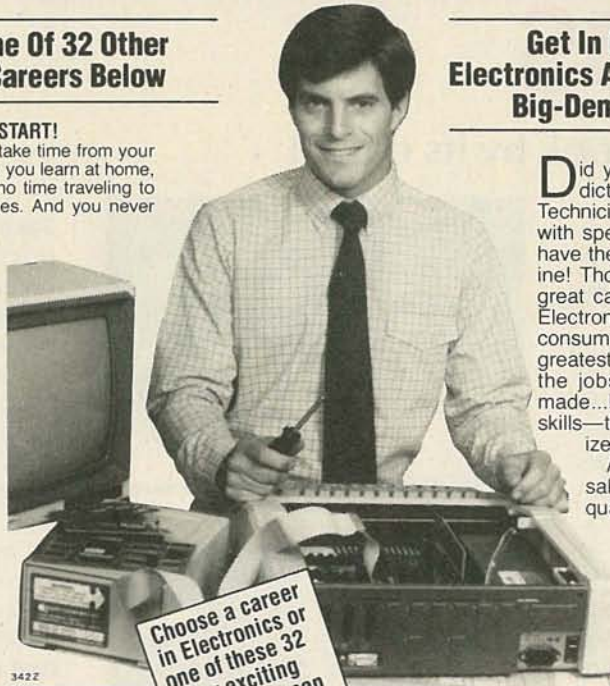

Choose a career in Electronics or one of these 32 other exciting careers you can train for at home in spare time.

Did you know the Department of Labor predicts a 40% increase in jobs for Electronics Technicians over the next ten years! And those with specialized training in microcomputers will have the same kind of opportunities! Just imagine! Those who start now and get in on these great careers will witness the "boom years" of Electronics... the years of biggest demand for consumer and industrial products...the time of greatest opportunity for job advancement. Yes, the jobs are there and there's money to be made...but only for those with knowledge and skills—the kinds of skills gained through specialized training.

Already many employers are offering top salaries and bonuses to attract the most qualified people. And as electronics and microcomputers become more vital in every aspect of our lives—industry, business, even in the home—it's easy to see why the future of electronics has no place to go but UP!

FIRST FOLD HERE

**NO POSTAGE NECESSARY** when you mail this **ENTIRE Postage-Paid ad To Mail**—Fold ad in following manner:

1. Remove entire page—tear out or cut on dotted line to left
2. Fold page in half on 1st fold lines
3. Fold page again, on 2nd fold lines
4. Tape or glue the 3 open sides and drop in the mailbox today.



**RUSH** me free facts and full information on how I can study at home for the career I have chosen. I understand I am under no obligation and no salesman will visit me. **CHECK ONE BOX ONLY.**

### TWO-YEAR BUSINESS DEGREE PROGRAMS

- Business Management
- Accounting
- Marketing
- Finance

### TWO-YEAR TECHNICAL DEGREE PROGRAMS

- Mechanical Engineering Technology
- Civil Engineering Technology
- Electrical Engineering Technology
- Electronics Technology

### CAREER DIPLOMA PROGRAMS

- Microcomputer Repair
- Basic Electronics
- TV/VCR Repair
- Computer Programming
- High School
- Catering/Gourmet Cooking
- Auto Mechanics
- Bookkeeping\*
- Hotel/Restaurant Management
- Drafting\*
- Veterinary Assistant\*
- Travel Agent\*
- Air Conditioning & Refrigeration
- Electrician
- Police Sciences\*
- Art
- Small Business Management
- Wildlife/Forestry Conservation\*
- Diesel Mechanics
- Gun Repair\*
- Motorcycle Repair\*
- Surveying & Mapping
- Small Engine Repair
- Fitness & Nutrition

\*These courses are offered by North American Correspondence Schools. Both North American and International Correspondence Schools are Accredited Members of the National Home Study Council in Washington D.C.

Dept. DES75

Name \_\_\_\_\_ Age \_\_\_\_\_  
 Address \_\_\_\_\_  
 City/State/Zip \_\_\_\_\_  
 Phone No. ( ) \_\_\_\_\_

NO POSTAGE NECESSARY IF MAILED IN THE UNITED STATES

**BUSINESS REPLY MAIL**

First Class Permit No. 1000 Scranton, PA 18515

Postage will be paid by addressee

**INTERNATIONAL CORRESPONDENCE SCHOOLS  
 NORTH AMERICAN CORRESPONDENCE SCHOOLS**  
 Scranton, PA 18515

REMOVE AND MAIL ENTIRE PAGE

REMOVE AND MAIL ENTIRE PAGE

SECOND FOLD HERE

SECOND FOLD HERE



# ANTIQU RADIO

You can't judge a book by its cover!

JUST AS YOU CAN'T JUDGE A BOOK BY its cover, you can't judge the condition of an antique radio's chassis, or even its type, by the cabinet. Most of the radios we've covered here have been of the pre-WWII, wooden-cabinet type; after all, those are this author's preference. There are other collectors who seem to prefer the plastic-cased table-top units from the 50's.

Now, you can be sure that all of those plastic-cased radio's are superheterodyne units (or can you? more on that in a moment), but what of the older radios? Before the superheterodyne, came the Tuned Radio Frequency (TRF) chassis. Although superheterodyne was a development of the late 20's, TRF remained on the scene through a good portion of the 30's. There were many reasons for that. For one thing, there were patent problems. In addition, a TRF chassis was simpler to manufacture, and therefore more economical. In the depression of the 1930's, a company that could produce an affordable radio had an edge. Later, because of increased crowding in the broadcast band, more shielding became necessary, increasing the cost of manufacturing a TRF chassis.

As you might imagine, though chassis designs changed in the 1930's, cabinet designs did not necessarily follow suit. The new superheterodyne chassis continued to be installed in wooden cabinets. Outwardly, unless you are familiar with the cabinet design, there is no way to tell whether that wooden cabinet houses a superheterodyne or TRF unit.

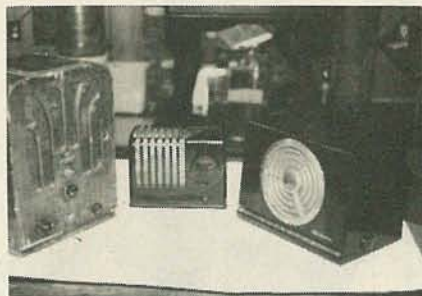

FIG. 1

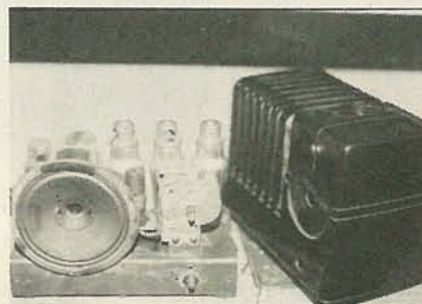

FIG. 2

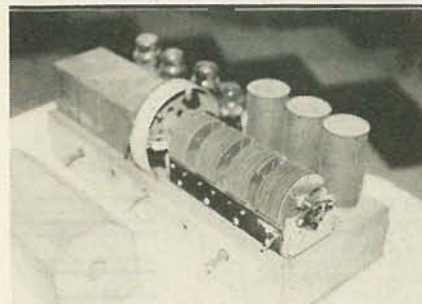

FIG. 3

As it turns out, you also can't always be sure that that plastic-cased table-top unit has a superheterodyne chassis either. One example is the little table-top radio that is shown in Fig. 1 (it is the unit in the center). That unit turned out to be not as modern as it first appeared. For one thing, the case, which at first look appeared to be plastic, was actually made of something that was more like



RICHARD D. FITCH

Bakelite. Secondly, and more important, it was not a superheterodyne unit. It was a genuine old-time TRF unit, complete with a series-connected filament string.

The five-tube chassis is a fairly simple one. As such, let's step back a moment and see what problems we might possibly run into when restoring or servicing it. First, after slipping the little chassis out of the bottom of the case (see Fig. 2), we can see the handy grid caps of the two RF tubes and the detector. The plate on the bottom of the chassis, besides its obvious uses, is part of the shielding. A heat-mutilated tube diagram was also located on the bottom plate.

If the filaments don't light, then one is likely to be open. Remember, since the filaments here are series-connected, one open filament will cause all of the filaments to fail to light. The best way to track down the open filament is to remove each tube from the chassis and test with a continuity tester.

If all of the tubes test out as good, but the filaments still don't light, the problem is likely in the power supply (assuming, of course, that you've checked out the tube sockets and the associated wiring). The transformer, line cord, and switch should be checked out for continuity and proper operation.

Anyway, the point of all of that is that you can't simply look at a radio and tell what you will find inside. Looking back at Fig. 1, the TRF unit in the center appears to be more modern than the two units flanking it, yet those other, larger units have more modern su-



perheterodyne chassis and are newer.

Finally, as you might infer from the discussion above, that tiny radio generates quite a bit of heat. The vents in the cabinet help cool the tube envelopes. The upper chassis parts dissipate their heat through the metal chassis and bottom shield. Thus, if you own one of those radios, or one of the many that were manufactured using a similar design, be aware of its heat-generating capabilities. While the metal bottom won't get hot enough to start a fire, it's not a good idea to display that unit on top of your piano or other piece of highly finished furniture. Also, it is important to keep the cabinet vents clear to ensure adequate air circulation.

### More on tuning capacitors

We've previously looked at tuning capacitors and mentioned that it was important that the plates on those be straight. This month, however, we are going to take look at deliberately bending those

plates, and why you might want to do that in some instances.

On some early radios, alignment was not done using a trimmer capacitor. Instead, the last plate on the tuning capacitor was divided by slots into as many as six sections by the manufacturer (see Fig. 3). Sections of those slotted end plates were bent in or out to align the tuned circuits.

The bending of those plates could be a tedious operation, and some sort of output meter was a big help if the job was to be done properly. And while some units provided a set screw to make the operation easier, many did not. That left you to your own devices if alignment was needed.

Note that even though those sectioned end plates are intended to be bent, they still cannot be allowed to touch the stator plates. As with all capacitors of this type the air dielectric between the plates must be there. If the plates touch, you will short the capacitor just as if you shorted the foil in a paper capacitor.

Incidentally, the type of capacitor shown in Fig. 3 is called a gang capacitor. It features several tuning capacitors on a single shaft. Such capacitors were not always used on the oldest sets. If you are lucky enough to get a real "antique" antique radio, it might have up to five tuning capacitors. Each of those had its own shaft and dial. As you might imagine, back then it was an evening's project just to tune in a station.

### Help!

I recently heard from a fellow collector who is in need of a power transformer for a Sylvania Model 29 electric tube tester. If any of you out there can help, please write and I will forward the information to him.

By the way, it goes without saying that I'm always glad to hear from fellow antique radio enthusiasts and collectors. Just write to me in care of this magazine and if you require a personal reply, please enclose a stamped self-addressed envelope. **R-E**

## PRINTER BUFFER

*continued from page 62*

indicated part should be inserted in the proper location, and should be properly oriented. The leads should be soldered and clipped, if appropriate. "Connect," as applies to wires, implies that you are to strip and tin the wire and insert it into the proper hole, solder it, and clip off the excess length. One caution: MOS devices should be handled properly to avoid damage from static discharge.

The easiest way to build the buffer is to use a printed-circuit board. You can buy one from the source mentioned in the Parts List, or you can etch your own. The foil patterns for the double-sided buffer and EPROM programmer boards are shown in our special "PC Service" section on page 75.

To assemble the buffer board, follow the parts-placement diagram in Fig. 4. Install sockets for all IC's (except the voltage regulator), but don't install the IC's in the sockets! If you are using 128-cycle refresh 4164's, do not install sockets for IC17 and IC18, instead install a jumper between pins 3 and 4 of the location for IC17. (If you're not sure what type of 4164 RAM's you have, install the two sockets.) Install PL1, PL2 (14-pin) and PL3 (10-pin) right-angle, double-row male header

strips on the board. If you plan to wire your computer and printer cables directly to the board—or if you plan to use chassis connectors on the back panel—do not install those header connectors. But if you plan to use the EPROM programmer board, then install PL4, a 12-pin header. Note that there are only 10 holes in the board for that connector! The right-angle part of the first two pins should be cut off. The bottom pin is left unconnected, but the top pin must be connected to the source of 9 volts AC indicated in Fig. 4.

Next install the fuse clips and the fuse. Install D1, keeping in mind that it's polarized. Install the resistors, noting that most are mounted vertically; they will not fit if mounted horizontally.

Next install all of the capacitors except C1. When installing C3, C4, C5 and C6, do not cut off the leads because they'll connect to the 5-volt bus. Instead, slip tubing over them, bend them down and install in the holes near pin 9 of the IC's on the solder side of the board. That's done to place the decoupling capacitance as close as possible to the power and ground pins of those IC's. Next, install the crystal, and the voltage regulator and its heatsink. Finish up the board by installing C1, spacing it 3/16" away from the board. That will allow just enough clearance for the mounting screw near C1.

At this point in time, all of the on-board components should be mounted. Our next

step is to turn our attention to the front-panel mounted switches. Unfortunately, we have run out of room for this month. So, that topic will be the first one we will tackle next time. In addition to that, we'll show you how to assemble the EPROM programmer option, and how to use our buffer/converter to its fullest possible advantage. **R-E**



"My husband built it as a refuge from noise, air pollution, the general unrest, and me."



# DRAWING BOARD



ROBERT GROSSBLATT

## Designing with dynamic RAM's

THE MORE THAT YOU MESS AROUND with memory, the more uses you find for it. And the more uses you find, the more memory you want. That kind of reasoning led to the development of the Dynamic RAM (DRAM). Computers, for example, are memory-hungry machines, and every IC manufacturer has jumped into the race to develop a memory that packs more storage in less space.

At first glance, DRAM seems to be the answer to everybody's memory problems. The cost per bit of storage is much lower than that of static RAM, and manufacturers are constantly finding new ways to stuff more storage space into a standard package.

In no time at all, DRAM went from 16K to 256K per package. While the initial cost per unit was high, prices have dropped dramatically. For instance, the price of a 4164, 64K × 1 DRAM went from \$50 to about \$5 in less than 5 years!

With all obvious advantages of DRAM—plenty of storage, small packages, all at a reasonable

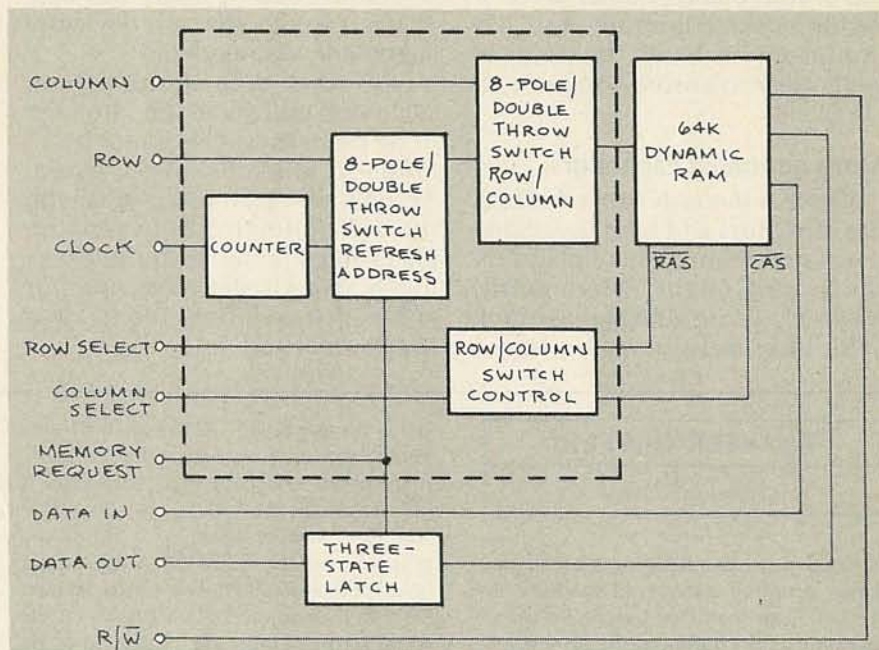

FIG. 2

price—why doesn't everyone use them? The answer is that they're a pain in the neck to use. Unless mountains of memory is an absolute necessity, you can save yourself plenty of brain damage by sticking to the reliable static RAM.

### Using dynamic RAM

There are two main hassles that must be dealt with to use DRAM's: data refresh and address multiplexing. The former is a consequence of the way data is stored, and the latter is a result of practical considerations.

When you start talking about packing up to 256K of storage (for now) in a single IC, you're rapidly going to run out of available pins. To illustrate, take a look at a 4164 and count the number of pins needed to make it work.

Since 4164 is organized in an 8K by 8K matrix, sixteen address lines are needed (8 rows and 8 columns) to access any particular bit in the matrix. Add to that pins for the I/O, power, ground, and a read/write control and we wind up needing 21 pins for a bare-bones memory.

Obviously, more pins are needed as storage capacity is increased. IC designers came up with a way to cut the pin count by using address multiplexing. That means that the internal row and column decoders are connected to the IC's address pins. The decoders are really latches that are controlled by the Row Address Strobe (RAS) and Column Address Strobe (CAS) pins on the IC.

That may sound complicated, but if you look at Fig. 1, you'll have a much clearer understanding. Al-

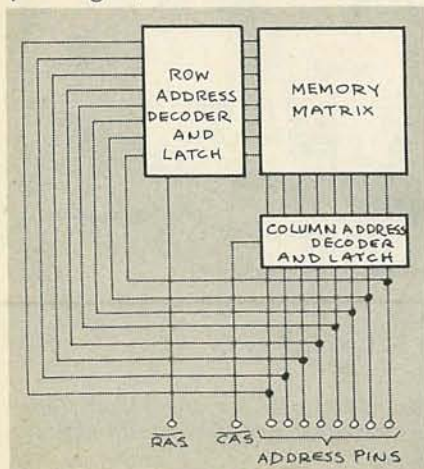

FIG. 1



though address multiplexing makes things theoretically simple, it creates nightmares from a practical point of view because of the very strict timing requirements. Things are further complicated by the second DRAM hassle—memory refresh.

DRAM uses tiny capacitors as memory-storage elements. But the charge on any one cell leaks quickly. Therefore, each cell must be refreshed at least once every two milliseconds.

There are three basic approaches to successfully using DRAM—gates only, dedicated IC's, and microprocessors. The first two approaches are similar. If you use only gates to take care of the basic RAM requirements, the block diagram of your circuit will be similar to Fig. 2. Notice that the system-address bus has been split into separate row and column lines going to the memory matrix.

Most modern DRAM's are set up so that when a cell is accessed in a particular row, the entire row of cells is automatically refreshed. If your circuit accesses each row often enough to meet the refresh requirements, then you don't have to worry about that problem. That kind of "hidden" refresh is the simplest solution to the whole problem.

But, not all circuits meet those requirements so the problem of refresh has to be (excuse the pun) addressed directly. In Figure 2, the row portion of the address bus goes through an 8-pole, double-throw switch that's controlled by a MEMORY REQUEST line. When that line is inactive, RAS (ROW ADDRESS SELECT) is enabled, read is selected, and the memory-address pins are connected to the output of the counter by the refresh switcher.

That counter cycles over and over at a rate fast enough to refresh the memory. When the memory is accessed, the correct address is put on the address bus; the refresh switcher disconnects the counter, and feeds the row information to the row/column switcher. The row and column data is clocked into the memory by the system logic that controls the row/column select, and the appropriate data is stored in the output data

latch. As soon as that happens, the memory-request line shifts back to the refresh setup.

If things are done too slowly, too quickly, or out of logical sequence, you'll probably lose your data and you're guaranteed to lose your temper. And that brings us to an unwritten law that should be immediately jotted down: You can't design with DRAM without using a data sheet.

The complexity of using DRAM has brought about a series of LSI IC's designed to take care of the whole business. Among those IC's are the 3200 series from Motorola and Intel, which contain all the circuitry needed to handle the refresh and address multiplexing requirements of mainstream DRAM's.

At a cost of under \$10, they can go a long way toward simplifying your memory-support circuitry. You should remember, however, that it's possible to do the whole job with a handful of logic IC's as well. For a first-time designer or experimenter, it's better to use the gates-only approach. It's a good exercise in digital design.

Most DRAM's generate valid data as soon as the addressing is completed, but lack the chip-select controls found in static RAM. As a result, three-state latches or some other type of arrangement are always necessary to manage the data from the memory. That's particularly true if data has to flow two ways on the system data bus.

Computers are always loaded with bidirectional buffers and drivers since data is constantly going to and from the memory. The last method for massaging DRAM brings us to the next topic that we'll cover—microprocessors. Instead of using tons of gates or dedicated IC's, the whole problem can be handled with a microprocessor and a little software.

In fact, some microprocessors, like the Z80, have built-in routines for refreshing DRAM. People constantly forget that computers are *only* one special application for microprocessors. When we come back next time, we'll see how they can be used to control RAM, keyboards, power supplies, and even the light on the back porch. R-E

## CABLE TV CONVERTER REPAIR

- ▷ ALL MAKES
- ▷ ALL MODELS
- ▷ 7 DAY TURNAROUND
- ▷ FLAT RATE PRICING BY MODEL

CALL FOR INFORMATION

### "THE CONVERTER SHOP"

794 Franklin Lakes Ave.  
Franklin Lakes, NJ 07417  
Tel. (201) 848-8229

## Learn micro-processing with the new MICRO-PROFESSOR 1P



Students, engineers or technicians—  
upgrade your micro-processing skills  
with the new Micro-Professor 1P.

### The MPF-1P features:

- extensive software support
- more built-in memory
- improved keyboard
- larger display

Three tutorial guides help cover all capabilities. The ideal training tool! MPF-1P will deliver you into the growing world of micro-processing. Invest now!

Plus—FREE GIFT Only \$179.95

Check this box for FREE Z-80 Microprocessor Programming and Interfacing textbook when you order within 7 days. \$12.95 value. (Include \$5.00 postage & handling)

**ETRONIX**

Dept. RE0895  
14803 N.E. 40th  
Redmond, WA 98052

For immediate action call TOLL FREE:

**1-800-426-1044**

Full money back guarantee.

CIRCLE 111 ON FREE INFORMATION CARD



# STATE OF SOLID STATE

## A new COMFET

THE WORLD'S FIRST P-CHANNEL COMFET has been announced by RCA's Solid-State Division and RCA Labs at Princeton, NJ. The new COMFET (Conductivity Modulated Field-Effect Transistor) complements the N-channel COMFET. (See the September 1984 issue of *Radio-Electronics* for more on that device.) Switching speed, forward blocking voltage, and on-resistance characteristics are similar for the N- and P-channel types.

An unusual feature of the P-channel COMFET is that its chip area is the same as that of the N-channel device. Normally, in conventional MOSFET technology, the P-channel devices require a larger chip area than N-channel devices because of the mobility of "holes" (the primary current carriers) is less than the mobility of electrons (the primary current carriers in a conventional N-channel MOSFET).

In the new device, the conductivity modulation effect nullifies the mobility factor, permitting both chips to have the same on-state resistance with the same size die. Since they have identical active areas, their input capacitances are identical, thus permitting their use in complementary applications found in many types of power-control circuits. The P-channel device can also be used alone in variety of power-switching applications.

Another noteworthy characteristic of the P-channel COMFET is its extremely low DC on-resistance (0.35 ohm at 20 amps) at forward blocking-voltages between 200 and 400 volts (see Fig. 1). That is the lowest on-resistance of any P-channel power MOSFET, including

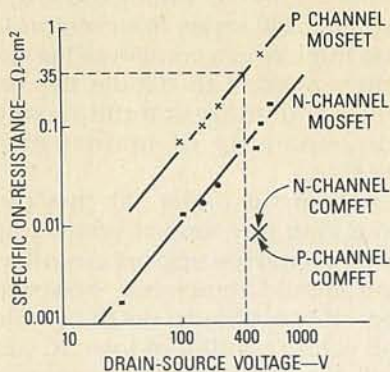

FIG. 1

those with blocking voltages of only 100 volts. Furthermore, its on-resistance can be as much as 25 times lower than that of a conventional P-channel MOSFET having a comparable blocking voltage.

Generally, a COMFET and a conventional power MOSFET operate in basically the same manner. However, in a conventional MOSFET, the on-resistance increases with the increasing drain-to-source voltage capability. That limits its use as a power-switching device above 200 volts. In a COMFET, that limitation is negated by greatly increasing the conductivity of the epitaxial drain region through the injection of minority carriers due to the additional P- or N-type substrate. Now, in a typical N-channel COMFET, the on-resistance is typically about  $\frac{1}{10}$  that of a conventional MOSFET with the same chip area, and maybe as little as  $\frac{1}{25}$  of that value.

### DC/DC converter/inverter

The SI7660, from Siliconix, is a highly efficient low-voltage CMOS DC/DC power converter/inverter



ROBERT F. SCOTT

intended for use as a voltage inverter. However, with the addition of a few components, the inverter circuit can be rearranged to provide several voltage levels at once. Voltage inversion, voltage doubling, supply splitting, and simultaneous inversion and doubling are possible with the device.

The SI7660 operates as a low-cost negative power supply for low-current applications, and it is less expensive, smaller, and uses fewer parts than a dedicated negative power supply. With the addition of only two capacitors and a small-signal diode, the device performs voltage conversion for an input range of +1.5 to +10.0 volts to a complementary output range of -1.5 to -10.0 volts.

The device's output source-resistance is low and allows a drain current of up to 40 mA with a 5-volt input. The low output source-resistance provides high conversion efficiency—95% at 10 mA or 99.7% with no load.

The SI7660 contains a voltage regulator, R-C oscillator, voltage-level translator, four power MOS switches, and a logic network on a single IC. The logic network senses the most negative voltage in the device and ensures that the output N-channel switch substrates are not forward-biased. The oscillator, when unloaded, oscillates at a nominal frequency of 12 kHz for an input supply voltage range of 1.5 to 10.0 volts. The osc terminal may be connected to an external capacitor to lower the frequency, or it may be driven by an external clock. The LV terminal may be tied to ground to bypass the internal regulator and improve



low-voltage operation. At +3.5 to +10.0 volts, the regulator is made operational by leaving the LV pin open.

The SI7660 is available in TO-99 and 8-pin DIP packages. In 100-piece lots, the cost is \$2.73 each for TO-99-packaged units; as an 8-pin DIP, the cost is \$1.89 each.—**Siliconix Inc.**, 2201 Laurelwood Road, Santa Clara, CA 95054

### Transistor Selection Guide.

Ferranti's 6-page *MOSFET Selection Guide and Cross Reference List* offers design data on complementary N- and P-channel transistors. Arranged as an easy-to-read chart, it provides data on key parameters of over 150 MOSFET-devices in TO-92, TO-39, TO-220, and TO-3 packages.

Included in the guide are low-voltage threshold devices for telecommunications, superfast (1-ns) switching devices, and high-voltage, low-leakage devices for use in test instruments. It also contains key parameters of the various devices covered, among those specifications are: continuous current,  $I_D$ ; breakdown voltage,  $BV_{DSS}$ , and on-resistance,  $R_{DS(on)}$ .

The guide also includes a cross-reference to help the user in selecting equivalent or near-equivalent devices.—**Ferranti Semiconductors**, 87 Modular Ave., Comack, NY 11725

### New power MOSFET family

RCA has introduced a new family of power MOSFET's designed to operate directly from logic supply-voltage levels of +5 volts. Called logic-level power MOSFET's or L<sup>2</sup>FET devices, they are the first designed specifically to produce full-current outputs with a 5-volt gate drive.

The new L<sup>2</sup>FET family includes 32 N-channel devices with current ratings ranging from 1 to 15 amperes, and  $V_{DSS}$  ratings ranging from 50 to 200 volts. The devices are available in TO-3, TO-39, and TO-220 packages. Prices in 100-piece lots range from about \$0.75 to \$4.00. For copies of the L<sup>2</sup>FET data sheet, call RCA's toll-free number: 1-800 526-2177; or write **RCA, Solid State Div.**, Route 202, Somerville, NJ 08876.

### Fast-turn-off SCR's

Recently Motorola introduced a series of SCR's that can turn off ten to twenty times faster than standard types. This latest line of SCR's, available in TO-220 packages, consists of 28 devices included in the MCR2080-A (8 amps) and MCR2150-A (15 amps) series with repetitive reverse voltages ranging from 200 to 800 volts. The maximum turn-off time is 4.0  $\mu$ s for devices in the MCR2150-A series and 6.0  $\mu$ s for those in the MCR2080-A series. The turn-off time for the non-"A" devices is 10 $\mu$ s. Prices for the 8-amp, 200-volt version start at \$0.87 in 100 piece lots, and range up to \$4.84 for a 15-amp, 800-volt part.—**Motorola Semiconductor Products Inc.**, PO Box 20912, Phoenix, AZ 85036.

### Op-amp power buffer

The LT1010 is a fast op-amp buffer that has unity voltage gain but can amplify an op-amp's output current from typically +10 mA to +150 mA. It makes fast amplifiers less sensitive to capacitive loading, reduces thermal feedback in precision DC coupled amplifiers, and is recommended for a number of fast and slow applications.

When incorporated within the op-amp's feedback loop, the buffer can isolate almost any reactive load. Applications include driving headphones or long cables, powering small motors, operating proportional actuators, and use in operational amplifier based power supplies.

The LT1010 has a 20-MHz bandwidth and a 100 V/ $\mu$ s slew rate. Its quiescent current is 5 mA, while its output can swing  $\pm 10$  volts into a 75-ohm load. It maintains its inherent high stability while working into capacitive loads exceeding 1  $\mu$ F. The device operates from a single supply of at least 4.5 volts or from dual supplies delivering up to a total of  $\pm 22$  volts.

Diagrams including such applications as track-and-hold, voltage and current regulators, integrators, and power-supply splitters are included in the 16-page LT1010 data sheet and application note.—**Linear Technology Corp.**, 1630 McCarthy Blvd., Milpitas, CA 95035-7487.

R-E

# McIntosh®

Get all the newest and latest information on McIntosh stereo equipment from McIntosh Laboratory.



Send For Your Stereo Information

McIntosh Laboratory Inc.  
East Side Station P.O. Box 96  
Binghamton, N.Y. 13904-0096

RE

Name \_\_\_\_\_  
Address \_\_\_\_\_  
City \_\_\_\_\_ State \_\_\_\_\_  
Zip \_\_\_\_\_  
Phone Area Code \_\_\_\_\_

CIRCLE 67 ON FREE INFORMATION CARD



# SERVICE CLINIC



JACK DARR  
SERVICE EDITOR

## Troubleshooting sync problems

IN RUMMAGING THROUGH THE OLD mailbag, I find that many of our readers are experiencing difficulties related to sync signals. Although we have covered that subject before, it appears that it's time to go over it again.

In your letters, several of you have provided voltage readings, etc., but make no mention of the sync waveforms: For sync-related problems, an oscilloscope is one instrument that's almost indispensable. When symptoms like poor vertical sync, weave or hum in the sync, and other such problems show up, it's time to look at the sync waveform. (That's before you draw any conclusions as to its cause.) A scope is the only instrument that allows you to view the waveforms. And since you've got to see the signals before you can tell anything about them, the scope is the only way to go.

I'm not saying that it's impossible to fix a sync problem without a scope, only that the job is easier with one! The scope lets you see what the sync separator is doing, and whether the correct signal is being sent to the points where it's needed. No other instrument can do that.

### Repairing sync problems

When correcting troubles that appear to be sync related, use your scope to make sure that all the inputs to the sync separator are correct. The proper amplitude is usually shown on the schematic. (The horizontal sync is governed by the phase of the signal, while the vertical sync depends on its amplitude.)

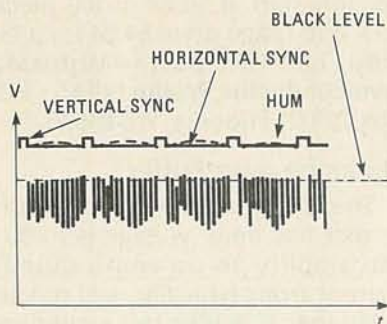

FIG. 1

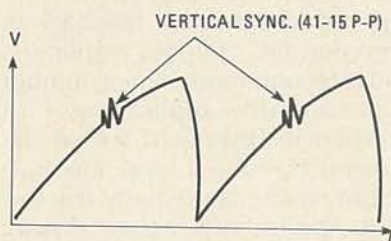

FIG. 2

First check the signals at the output of the sync separator: That's where the signal first appears as sync only. You should use a time base of about 50-Hz. That allows you to see the horizontal-sync signal as a straight line (blur!) with the vertical sync showing up as little pips above it. Figure 1 shows the composite sync as seen at the output of a sync separator.

The horizontal sync is the waveform just below and parallel to the black level reference; the dashed rippling lines indicate hum in the sync. If there is any bending or ripple in the signal, look out. Ripple in the horizontal sync may mean that some of the 60-Hz hum (from the AC line) is getting into the signal. Such an occurrence is bound to show up as weaving or bending in the raster.

As for that other important sig-

nal, since the vertical sync is dependent on amplitude, you must be sure that it is high enough. If it is too low, you'll have rolling in the video and poor vertical hold. I have found sync troubles that were caused by a low video input to the sync separator. If the signal is too low, the separator can't shear the sync off properly. That usually causes vertical sync problems, with horizontal sync OK.

Always be sure to trace the sync signal through any amplifier stages; they too can contribute to vertical-sync problems. With the scope properly connected across the input to the vertical oscillator, turn the set's vertical-hold control (if there is one) until the picture rolls down slowly. Figure 2 should give you some idea of what you should see. It shows the vertical sync—the tiny squiggle riding on the waveform—which should measure about 4–5 volts peak-to-peak.

If that signal is not there, find out why! You can always look at the sync, both vertical and horizontal, and see what is wrong. For instance if the horizontal-sync waveform has video in it, the video can be seen on the rising portion of the sync. Such problems are almost always located in the sync separator.

Video can show up in the sync when, for instance, the video input to the sync separator is not high enough to allow the separator to clip off the upper 25% of it, where the sync is found. Because of that, the separator cuts too deeply into the waveform allowing some of the video to sneak into the



sync signal. A "dirty sync" (as that condition is called) can cause all of those mysterious cases of jitter (weaving, etc.) in the raster.

So, whenever you get a set with really mind-boggling symptoms, get out the scope first and follow the waveform through the circuits, looking very closely for any and all of the things just mentioned. Once you find the point where trouble first shows up, then get out your trusty voltmeter and check for the correct DC voltages. The sync separator is one stage that is extremely critical as to voltages. If the schematic calls for 25 or 112 volts at a particular point, make sure that that voltage is there. Once you've found a voltage that's missing or incorrect, that's when you get the ohmmeter and start checking resistors.

So, don't let that scope just sit there gathering dust. Instead, use it to make the most useful test of all on any stage—signal in vs. signal out—the true test of whether any particular stage is working the way it should. R-E

## SERVICE QUESTIONS

### LOW BRIGHTNESS AND CONTRAST

*A Midland TV, model 10M46, has completely out-foxed. The set shows low contrast and brightness, with little control over the brightness. The 40-volt Zener diode off the low side of the tripler is missing. Any help you can give me will be deeply appreciated.—G.P., Los Angeles, CA*

That Zener diode is part of the automatic brightness limiter (ABL). The schematic shows it with dotted lines to suggest that it's not necessarily included in all models, so we need not concern ourselves with it.

As for the brightness control, it varies the base voltage of the video emitter follower (Q700) and that, in turn, causes the collector voltage to vary. The coupling that exists from Q700 through Q701 and Q702 right on into the three color outputs and the kine, translates control movements into brightness changes.

Start at the control itself and

work your way forward to see where the voltage swing disappears. Now back to the ABL; that stage basically consists of Q703 tied to the video preamp. In normal operation, that circuit senses changes in beam current and influences the bias of transistor Q701. So in tracking down your problem, look to that circuit as a possible trouble spot.

### SERVICING AN ELECTRONIC FLASH

*How can I check the SCR's in my electronic flash unit. I would also like to know how I can get a schematic of the circuit.—W.W., Charleston, WV*

To easily check SCR's, first connect the negative lead of an ohmmeter—set on the  $\times 1$  scale—to the cathode of the SCR and its positive lead to the anode. The meter should show an infinite (very high) resistance reading. Short the gate lead to the anode and observe the reading. The displayed resistance should drop: A reading of 15–50 ohms is normal.

With the anode still connected to the ohmmeter, disconnect the gate lead. The reading should be unchanged until either the anode or cathode is disconnected. When either the anode or cathode is disconnected, the display should then return to the infinite resistance reading. As for service information on your unit, I can only suggest that you contact the manufacturer.

### PICTURE PULLING AND TEARING

*I have a Magnavox T982-12 chassis that shows a dark vertical bar running down the left side (just off center) of the screen, accompanied by pulling and tearing in the picture. The filters in the 148-volt B+ supply have been replaced. And I've also tried new vertical, horizontal, and signal modules. Please help!—R.N., AZ*

Have you checked the low-voltage supply filters?—I see at least four in the schematic. The trouble sounds like something that you might expect from a dirty supply. Your letter describes distorted waveforms coming from the horizontal module. That's another reason to look to that module for the cause. R-E

## TYPEWRITER/ COMPUTER PRINTER

### IT DOES IT ALL!



### SILVER-REED EXD 15

This breakthrough machine offers you unprecedented versatility in a compact, quiet easily carryable package. In fact, many machines twice the size don't offer half as much.

The EXD 15 lets you print on either regular or thermal paper. It has an ultra-high quality 31 dot thermal printing head for true letter quality printing. And, it even lets you choose from 6 different print styles—including automatic underline and oversize letters. Best of all, the EXD 15 is made by Silver-Reed and that's your assurance of the ultimate in quality.

"FULL FACTORY GUARANTEE"

SAVE OVER \$200

- Typewriter/Computer Printer
- Over 180 Characters
- 6 Print styles & Pica & Elite
- Correction Print Mode
- 16 Character Status Display
- Ribbon or Thermal Print

List Price \$395.00 **ONLY \$159**

Computer Interface \$40  
(Specify serial RS232C or Parallel Centronics)  
"Add \$7.50 shipping charges"

MASTERCARD • VISA  
or send check w/order

CERTIFIED ASSOC.

1912 W. 170th St.  
Hazel Crest, IL 60429

Call your order today  
(312)335-0043 M-F 9am-5pm

### SEE YOUR DEALER TODAY

FROM



HERE'S A TIP  
THAT'S PERFECT!

AM/FM AUTO RADIO  
AND CB

## 'Firestik' II

GOLDEN SERIES

BARE-HANDS TUNABLE  
"NO TOOLS NEEDED"  
HIGH PERFORMANCE ANTENNAS

ALSO ANTENNAS FOR  
CORDLESS TELEPHONES  
MONITOR SCANNERS

Dealer & Distributor Inquiries Invited  
SEND FOR FREE CATALOG

'Firestik' Antenna Company  
2614 East Adams/Phoenix, AZ 85034

Name \_\_\_\_\_  
Street \_\_\_\_\_  
City \_\_\_\_\_  
State \_\_\_\_\_ Zip \_\_\_\_\_

Serving the CB and  
Communications Market Since 1962.

**5-YEAR REPLACEMENT WARRANTY**

CIRCLE 100 ON FREE INFORMATION CARD



## ELECTRIC SHOCK

continued from page 58

### Microshock

Microshock is electrical shock caused by very small amounts of current. As is shown in Table 1, currents of less than 1 milliampere are usually of no consequence. If a shock is delivered directly to the heart, however, even 20 microamperes of current can be dangerous. Current can be delivered directly to the heart through a pacemaker wire. Wires for use with external (temporary) pacemakers

TABLE 1—EFFECTS OF A 60 Hz ELECTRIC SHOCK

Current held one second	Effect (current applied to skin, unless otherwise noted)
20 $\mu$ A	Ventricular fibrillation if applied directly to the heart
1 mA	Sensation
5 mA	Maximum harmless current
1–10 mA	Mild to moderate pain
10–20 mA	May cause muscular contractions, preventing release from shock source
30 mA	Breathing may stop
75–300 mA	Ventricular fibrillation may occur
5 A	Burns tissues

## Radio-Electronics REPRINT BOOKSTORE

- Build Your Own Satellite TV Receiver ..... \$7.00
- 8-Ball Satellite TV Antenna ..... \$5.00
- Build Your Own Robot ..... \$12.00
- TV Descrambler (January, February 1981) \$3.00
- Radio-Electronics back issues (1984) ..... \$3.00 (February 1984 not available)
- Radio-Electronics back issues (1983) ..... \$3.50 (January, February 1983, May 1983 not available) Write in issues desired.
- Radio-Electronics back issues (1982) ..... \$3.50 Write in issues desired.
- Radio-Electronics back issues (1981) ..... \$4.00 (Jan., Feb., March, Dec. 1981 not available) Write in issues desired.
- Etch your own PC boards ..... \$3.00
- Hands On Electronics #1 ..... \$3.00
- RE Annual '85 ..... \$2.50
- VCR Repairs ..... \$3.00
- IBM Typewriter to

- Computer Interface ..... \$3.00
- Special Projects (Spring 1981) ..... \$4.50
- Special Projects #4 (Summer 1982) ..... \$4.50
- Special Projects #5 (Winter 1983) ..... \$4.00
- Special Projects #6 (Spring 1983) ..... \$4.00
- Special Projects #7 (Summer 83) NOT AVAILABLE
- Special Projects #8 (Fall 83) ... NOT AVAILABLE
- Special Projects #10 (Spring 84) ..... \$4.00
- Radio-Electronics Annual 1983 ..... \$3.50
- Radio-Electronics Annual 1984 ..... \$2.50
- How to Make PC Boards ..... \$2.00
- All About Kits ..... \$2.00
- Modern Electrics (Vol. 1. #1 ..... \$2.25 April 1988)
- Electro Importing Co. Catalog ..... \$4.95 (1918) (176 pp)
- Low Frequency Receiving Techniques ..... \$6.00 Building and using VLF Antennas
- New Ideas - 42 circuits for experimenters .. \$3.75

To order any of the items indicated above, check off the ones you want. Complete the order form below, include your payment, check or money order (DO NOT SEND CASH), and mail to Radio-Electronics, Reprint Department, 200 Park Ave. South, New York, NY 10003. Please allow 4-6 weeks for delivery.

If you need a copy of an article that is in an issue we indicate is unavailable you can order it directly from us. We charge 50¢ per page. Indicate the issue (month & year), pages and article desired. Include payment in full, plus shipping and handling charge.

ARTICLE \_\_\_\_\_

PAGES \_\_\_\_\_

MONTH \_\_\_\_\_

YEAR \_\_\_\_\_

TOTAL PAGES \_\_\_\_\_

@50¢ each

TOTAL PRICE \_\_\_\_\_

#### MAIL TO: Radio-Electronics

Reprint Department, 200 Park Ave. South, New York, NY 10003

All payments must be in U.S. funds

Total price of order ..... \$ \_\_\_\_\_

Sales Tax (New York State Residents only) ..... \$ \_\_\_\_\_

Shipping & Handling (U.S. & Canada only) (Includes FIRST CLASS POSTAGE) \$1.00 per item \$ \_\_\_\_\_

All other countries (\$2.00 per item, sea mail) ..... \$ \_\_\_\_\_

(\$4.00 per item, air mail) ..... \$ \_\_\_\_\_

Total Enclosed ..... \$ \_\_\_\_\_

Name \_\_\_\_\_

Address \_\_\_\_\_

City \_\_\_\_\_ State \_\_\_\_\_ Zip \_\_\_\_\_

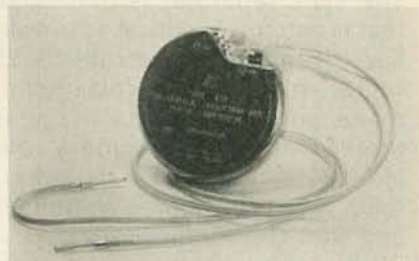

FIG. 5—IF A PACEMAKER'S LEADS accidentally contact a voltage source, it is easy to deliver a dangerous voltage (greater than 20 mA) to the heart.

come out of the body through the chest wall or through veins that lead to an arm, the neck, or elsewhere (see Fig. 5). If such a wire were touched by a person who was holding onto a light switch, electric bed frame, television set, or other appliance, many microamperes could be conducted to the pacemaker wire.

Many appliances will supply a good fraction of a milliampere to someone who is grounded. To see that for yourself, connect an ammeter between the metal parts of an appliance and ground. (Start on a high range to protect the meter.) Unless there is a very good third wire ground, significant currents will be measured.

### Why electrical shock occurs

It is easy to receive an electrical shock. All that is required is to come into contact with two different voltages. Electrical shock can occur in a variety of settings. Electronics technicians and hobbyists can be exposed to many situations in which shock can occur. Capacitors and CRT's, for instance, store large voltages for days or longer. Tools held in the hand may conduct electric currents from objects touched. High voltages may arc across space to cause shocks.

Even if you are someone who doesn't do much electronics work or experimenting, there are many "opportunities" around the house to receive a shock. Damaged line cords, defective appliances, or accidents, such as dropping an AC-powered radio into a full bathtub, can quickly teach anyone about the dangers of electrical shocks. **R-E**



# MARKET CENTER

## FOR SALE

**CABLE-TV Secrets**—the outlaw publication the cable companies tried to ban. HBO, Movie Channel, Showtime, descramblers, converters, etc. Suppliers list included. \$8.95. **CABLE FACTS**, Box 711-R, Pataskala, OH 43062.

**RESISTORS** 1/4W, 1/2W 5% C.F. 3 cents. 1% metal-films, custom wirewounds, capacitors and other components. **JR INDUSTRIES**, 5834-H Swancreek, Toledo, OH 43614.

**FREE** catalog featuring scanner accessories, carrier/subcarrier detectors, voice scramblers, unusual kits. **CAPRI ELECTRONICS**, Route 1R, Canon, GA 30520.

## CLASSIFIED AD ORDER FORM

To run your own classified ad, put one word on each of the lines below and send this form along with your check to:

**Radio-Electronics Classified Ads**, 200 Park Avenue South, N.Y., N.Y. 10003

**PLEASE INDICATE** in which category of classified advertising you wish your ad to appear. For special headings, there is a surcharge of \$20.00.

( ) Plans/Kits ( ) Business Opportunities ( ) For Sale  
( ) Education/Instruction ( ) Wanted ( ) Satellite Television

Special Category: \$20.00

### PLEASE PRINT EACH WORD SEPARATELY, IN BLOCK LETTERS.

(No refunds or credits for typesetting errors can be made unless you clearly print or type your copy.) Rates indicated are for standard style classified ads only. See below for additional charges for special ads. **Minimum: 15 words.**

1	2	3	4	5
6	7	8	9	10
11	12	13	14	15 (\$37.50)
16 (\$40.00)	17 (\$42.50)	18 (\$45.00)	19 (\$47.50)	20 (\$50.00)
21 (\$52.50)	22 (\$55.00)	23 (\$57.50)	24 (\$60.00)	25 (\$62.50)
26 (\$65.00)	27 (\$67.50)	28 (\$70.00)	29 (\$72.50)	30 (\$75.00)
31 (\$77.50)	32 (\$88.00)	33 (\$82.50)	34 (\$85.00)	35 (\$87.50)

We accept MasterCard and Visa for payment of orders. If you wish to use your credit card to pay for your ad fill in the following additional information (Sorry, no telephone orders can be accepted.):

Card Number \_\_\_\_\_ Expiration Date \_\_\_\_\_

Please Print Name \_\_\_\_\_

Signature \_\_\_\_\_

**IF YOU USE A BOX NUMBER YOU MUST INCLUDE YOUR PERMANENT ADDRESS AND PHONE NUMBER FOR OUR FILES. ADS SUBMITTED WITHOUT THIS INFORMATION WILL NOT BE ACCEPTED.**

**CLASSIFIED COMMERCIAL RATE:** (for firms or individuals offering commercial products or services) \$2.50 per word prepaid (no charge for zip code)...**MINIMUM 15 WORDS.** 5% discount for same ad in 6 issues; 10% discount for same ad in 12 issues within one year; if prepaid. **NON-COMMERCIAL RATE:** (for individuals who want to buy or sell a personal item) \$2.00 per word, prepaid....no minimum. **ONLY FIRST WORD AND NAME** set in bold caps at no extra charge. Additional bold face (not available as all caps) **50¢ per word additional (20% premium).** Entire ad in boldface, add 20% premium to total price. **TINT SCREEN BEHIND ENTIRE AD: add 25% premium to total price.** **TINT SCREEN BEHIND ENTIRE AD PLUS ALL BOLD FACE AD: add 45% premium to total price.** **EXPANDED TYPE AD: \$3.75 per word prepaid.** All other items same as for STANDARD COMMERCIAL RATE. **TINT SCREEN BEHIND ENTIRE EXPANDED TYPE AD: add 25% premium to total price.** **TINT SCREEN BEHIND ENTIRE EXPANDED TYPE AD PLUS ALL BOLD FACE AD: add 45% premium to total price.** **DISPLAY ADS:** 1" x 2 1/4" — \$270.00; 2" x 2 1/4" — \$540.00; 3" x 2 1/4" — \$810.00. **General Information:** Frequency rates and prepayment discounts are available. **ALL COPY SUBJECT TO PUBLISHERS APPROVAL. ADVERTISEMENTS USING P.O. BOX ADDRESS WILL NOT BE ACCEPTED UNTIL ADVERTISER SUPPLIES PUBLISHER WITH PERMANENT ADDRESS AND PHONE NUMBER.** Copy to be in our hands on the 15th of the third month preceding the date of the issue. (i.e., August issue copy must be received by May 15th). When normal closing date falls on Saturday, Sunday or Holiday, issue closes on preceding working day.

## Power Problems?

**SURGES! SPIKES! RFVEM! BLACKOUTS! BROWNOUTS!**

**AEGIS™** Power Conditioning Equipment... THE SOLUTION! Protects Computers & High-tech Equipment From Damaging Voltage Surges, Lost Data, & Costly Down Time.

**SPIKE—SPIKER®**  
Transient Voltage Surge & Spike Suppressors & Noise Filters • Eleven Models—All Models Rated 120V, 15A  
Priced From \$29.95

**LINE—SAVER™**  
Standby Uninterruptible & Emergency Power Systems. Self-Contained Batteries, Compact Design, Completely Automatic.  
Priced From \$495.00

Call or write for free literature.  
Dealer inquiries invited.

### INSTANT ORDER LINE

800-524-0400  
TWX 501-651-2101  
IN PENNA. 215-837-0700

**KALCO®**

6584 Ruch Rd., Dept. Fe  
Bethlehem, PA 18017

MADE IN USA

**THE Intelligence Library**—Restricted technical information & books on **electronic surveillance, surveillance-device schematics, lock-picking, investigation, weapons, identification documents, covert sciences**, etc. The best selection available. **Free brochures.** **MENTOR**, (Dept. Z), 135-53 No. Blvd., Flushing, NY 11354.

**WHOLESALE MATV/CATV** equipments, antenna, accessories, cartridges, radios, speakers, cables. (718) 897-0509, **D&WR**, 68-12 110 Street, Flushing, NY 11375.

**TI-99/4A** software/hardware bargains. Hard-to-find items. Huge selection. Fast service. Free catalog. **DYNA**, Box 690, Hicksville, NY 11801.

**TUBES**, new, unused. Send self-addressed, stamped envelope for list. **FALA ELECTRONICS**, Box 1376-2, Milwaukee, WI 53201.

**FREE Automotive Security Catalog.** Largest selection available. Do-it-yourself pagers, alarms, hood/locks, glass detectors. Allow 4 weeks for delivery, or for rush send \$1.00. **AUTOMOTIVE SECURITY EQUIPMENT COMPANY**, Dept. 1, P.O. Box 382, Plainview, NY 11803.

**INDIVIDUAL** photofact folders. No. 1 to no. 1400, \$3.00 postpaid. **LBT**, 414 Chestnut Lane, East Meadow, NY 11554.

**DESCRAMBLERS** for downconverters. High gain. Send \$2.00. **RB ELECTRONICS**, P.O. Box 643, Kalamazoo, MI 49005.

**ELECTRONICS** catalog. Over 4,500 items. Parts & components. Everything needed by the hobbyist or technician. \$2.00 postage & handling (States only), refundable with first \$15.00 order. **T & M ELECTRONICS**, Dept. R, 472 East Main Street, Patchogue, NY 11772, (516) 289-2520.

**WANTED:** Cash for old tubes, speakers, amplifiers. Western Electric, McIntosh, Marantz, RCA, Cunningham, Altec, JBL, Tannoy, Quad. (713) 728-4343. **MAURY**, 11122 Atwell, Houston, TX 77096.

**TUBES**, hard-to-find. Send self-addressed stamped envelope for list. **AUDIO VIDEO STOP**, 7477 Village Parkway, Dublin, CA 94568.

**FREE** catalog. Electronic, electrical, parts, tools, controls, switches, relays, tech books, manuals. **JS CHRISTIANSON, INC.**, 120 Oser Ave., Hauppauge, NY 11788.

**NEW**...Convert any portable television into a giant five foot picture screen. Guaranteed. Only \$24.50. **QUEEN ENTERPRISES**, P.O. Box 159, Toronto, Ontario M6M 4Z2.

**FREE** catalog 99-cent kits—audio, video, TV, computer parts. **ALLKIT**, 434 W. 4th St., West Islip, N.Y. 11795.

## CB MODIFICATIONS

Increase channels, range, privacy! We specialize in frequency expanders, speech processors, FM converters, PLL & slider tricks, how-to books, plans, kits. Expert mail-in repairs & conversions. 16-page catalog \$2.

**CBC INTERNATIONAL, P.O. BOX 3 PHOENIX, AZ 85046 (602) 996-**

AUG 1

94

RAD



# Govt. SURPLUS ELECTRONIC EQUIPMENT CATALOG

New ITEMS . . . New BARGAINS!

**FREE** SEND TODAY FOR FREE COPY  
OF CATALOG WS-85 AND  
SUPPLEMENT • ADDRESS: DEPT RE

**FAIR RADIO SALES**  
1016 E EUREKA • Box 1105 • LIMA, OHIO • 45802

**CIRCUIT** boards: your artwork, quick delivery, reasonable. **ATLAS CIRCUITS**, Dept. A, P.O. Box 892, Lincoln, NC 28092. (704) 735-3943.

**TUNABLE** notch filters, brochure, \$1.00. **D.K. VIDEO**, Box 63/6025, Margate, FL 33063. (305) 752-9202.

**SECURE** your home with our sound activated switch. Easy to build. Turns lights and/or radio on at any attempted break-in and off when it's safe. For plans and parts list send \$5.00 to **J.R. ELECTRONICS**, P.O. Box 99A, Marietta, GA 30061.

**ASSORTMENT #102**—Toko coils (1) 144LY-120K, (1) E520HN-3000023 and (2) BKAN-K5552AXX transformers, (1) BFQ85 Sub., and (1) AC adapter only \$15.00. For fast free shipping, use MasterCard/VISA and call toll free 1-800-821-5226, ext. 426 (orders only) or write **JIM RHODES, INC.**, 1025 Ransome Lane, Kingsport, TN 37660.

**CABLE-TV** Source Book—a complete listing of suppliers for hard-to-find converters, descramblers, technical information, schematics and much, much more. Full refund if not satisfied. Send \$4.95 to **CABLE**, Box 12505-R, Columbus, OH 43212.



## WRITE FOR McGEE'S SPEAKER & ELECTRONICS CATALOG

1001 BARGAINS IN SPEAKERS  
toll free 1-800-346-2433 for ordering only.  
1901 MCGEE STREET KANSAS CITY, MO. 64108

**CATALOG:** TV descramblers, microwave converters, satellite systems, many types, kits or built, hobby kits also, \$1.00. **MINUTE KITS**, Box 531, West SQ., Bronx, NY 10461

**TECHNICA** 140/channel cable converter fully remote sound and video unit only \$149.00, Jerrold LCC58 converter only \$79.00, Jerrold DRZ450 converter 90/channel auto tuning only \$89.00. All units carry full manufacturer's warranty, specials while they last. For catalogue send \$3.00. Thanks. **RED-COAT ELECTRONICS**, P.O. Box 28504, Jamaica, NY 11428. (718) 459-5088.

**CABLE** units Starbase \$109.95. Hamlin MLD-1200, \$109.95. OMC/N-12 \$89.95. Z-Tac (3in3out) \$209.95. Outdoor quality notch filters \$29.95. Please specify channel #2 or 3, when ordering. Add 5% Shipping. Personal checks require 3-4 weeks clearing. Send S.A.S.E. for product flyer to **LUNAR ELECTRONICS**, P.O. Box 662, Hunt Valley, MD 21030.

**GET** the Blue Box Handbook! \$26.00 ppd. **MONEYTREE SYSTEMS**, P.O. Box 266, Lawton, OK 73502-0266.

**TUBES**, name brands, new, 80% off list, **KIRBY**, 298 West Carmel Drive, Carmel, IN 46032.

**CAR** stereo, C.B.'s radar detectors, alarms, accessories. Dirt cheap! Free catalog. **ELECTROMANIA**, 51B Sunrise Highway, Lynbrook, NY 11563.

**ROBOTS** "Movit" line. Easily assembled. You control. Great fun, educational. **ELECTROMANIA**, 51A Sunrise Highway, Lynbrook, NY 11563.

**CORDLESS**—phone interference? We've got the answer. Have a radar speeding ticket? We can help. Home phone extension in your car? You can have it. 50-page color catalog airmailed \$3.00. **DBE**, P.O. Drawer G, Waikiki, HI 96815. MC/VISA orders (808) 395-7458.

**CABLE** and **Subscription-TV** secret manual. Build your own descramblers, converters—HBO, Showtime, Movie Channel, UHF. Latest theory, schematics, instructions, suppliers. Send \$8.95 to **CABLETRONICS**, Box 30502R, Bethesda, MD 20814

**ROBOT** Heathkit HERO-1 w/arm, voice. Newly assembled, tested; \$1365.00. Phone, **R. THORNTON**, (419) 226-3175, (8-4).

**PICTURE Flyer** list quality electronics surplus at low prices. Since 1970. Send for the last 3 issues. **STAR-TRONICS**, Box 683, McMinnville, OR 97128.

**FREE "Mini-Catalog"** featuring lasers, microwave, stepper motors, LCD displays, CRT's. Send 44-cent S.A.S.E.: **COMPUTER PARTS MART**, 3200 Park Blvd., Palo Alto, CA 94306. (415) 493-5930.

**CONVERTERS** all types for all systems. Lowest prices anywhere, quantity discounts; dealer inquiries accepted. Free catalog, **PG VIDEO CORP.**, 61 Gatchell St., Dept. RE, Buffalo, NY 14212.

**TUBES**, TV, radio, 90% off retail. Send for list. **GRAY**, 4415 Indianapolis, East Chicago, IN 46312.

### PLANS AND KITS

**CATALOG:** Hobby, radio broadcasting, CB, lowfers. Transmitters, linears, active antennas, converters, scramblers, bugging devices, more! **PANAXIS**, Box 130-F8, Paradise, CA 95969.

**DESCRAMBLER** plans. New design decodes gated sync suppressed signals—newest pilotless method. Circuit boards, most parts from Radio Shack. Detailed theory, drawings, schematics, instructions \$14.95 plus \$2.00 shipping. **DIRIJO CORP.**, Box 212, Lowell, NC 28098.

★ ★ ★ ★ ★ ★ ★ ★ ★ ★ **WM. B. ALLEN'S** ★ ★ ★ ★ ★ ★ ★ ★ ★ ★

# HOLIDAY FLUKE BONANZA

## 70 SERIES ANALOG/DIGITAL

73.....	\$ 75
75.....	\$ 88
77.....	\$115

## 8020B SERIES 3 1/2 DIGIT DMM

8020B.....	\$174
8021B.....	\$139
8022B.....	\$135
8024B.....	\$217
8026B.....	\$174

## 4 1/2 DIGIT DMM

8060A.....	\$305
8062A.....	\$257

## DIGITAL COUNTERS

1900A (80MHz).....	\$358	1911A (250 MHz).....	\$589
1910A (125MHz).....	\$497	1912A (520MHz).....	\$719

REDEEM YOUR SPECIAL FLUKE REVIEW  
80TK \$25-OFF COUPON AT WM. B. ALLEN

20 SERIES  
Analog/Digital  
FLUKE 25.....\$200  
FLUKE 27.....\$228

SPECIAL  
INTRODUCTORY  
PRICES ON  
80TK  
TEMPERATURE  
ACCESSORY

SAVE NOW ON  
THE FIRST CHOICE OF  
PROFESSIONALS  
WORLDWIDE



CALL TOLL FREE

**800 535-9593**

LOUISIANA TOLL FREE 800 462-9520

TOTAL ELECTRONICS CENTER • OVER 70,000 ITEMS IN STOCK

**WM. B. ALLEN SUPPLY CO. INC.**  
**ALLEN SQUARE**

300 BLOCK NORTH RAMPART STREET, NEW ORLEANS, LOUISIANA 70112

CIRCLE 103 ON FREE INFORMATION CARD







# THE BEST PRICES

**TOP QUALITY DISKS, w/leave-label-bar, lifetime warranty!**  
 5 1/4" 5DD, for Apple II, Commodore, TRS-80, #M212 10/98.20  
 5 1/4" 8DD, for IBM-PC and compatibles #M222 10/99.10  
 5 1/4" QUAD for Sanyo, Eagle #M240 10/10.90  
 3 1/2" 5DD, for Mac, etc. #M250 10/92.90  
 8" 5DD, unformatted #M260 10/912.00

5 1/4" DIK SLEEVES, white, #BLUVEE 10/65 100/45  
 DISK NOTCHER, allows access to 2nd side #NN1 \$9.99  
 100-KEY ASCII KEYBOARD, #KEYB, #M210 10/98.20  
 RECHARGEABLE AA NI-CAD Batteries, fresh #BANI #12  
 RS232 MALE CONNECTORS, #DE25, solder-type #DE25M \$2  
 RS232 FEMALE CONNECTORS, #DE25, solder-type #DE25F \$3  
 HOOD FOR ABOVE #DE25H \$1.50  
 RS232 MALE CONNECTORS, #DE25, wire-wrap #DE25M \$2.95  
 2 SIDE COPPER CLAD, 1/4" (66) #6652 2/91  
 -12V VOLTAGE REGULATORS, pwr-tab #7912T 2/81  
 +12V VOLTAGE REGULATORS, pwr-tab #7912T 2/81  
 HAND HELD LOGIC PROBE, #SHOT, low rate, #LP-1 \$19  
 SOLAR CELLS 3.5" #300A #300CELL \$1.95  
 SOLAR CELLS 3.5" #500A #500CELL \$2.50, 3/810  
 MUFFIN-TYPE FANS, 110V, r/f #MUFFIN \$3  
 MUFFIN FAN GRILLES, #EG25 2/81  
 NEON MINI FANS, 110V 3" sq x 1.5" #TA300 \$9  
 12-14 VDC PLUS-12V ADAPTER, #M240 \$1.95  
 10 AMP POWER ROCKER SWITCH, wired, new #10ASN 4/81  
 SUBMINI SPOT MICROSWITCHES, w/lever, Cherry, #EG3 4/81  
 4 COND JACKETED TELEPHONE WIRE, #EG24 5/91 \$2  
 3 COND HEAVY DUTY LINE CORDS, 12' #M212 12/71 \$1  
 1K 10 TURN PRECISION LINE POT, 1/4" shaft #10KPT 4/81  
 1K 10 TURN PRECISION LINE POT, 1/4" shaft #10KPT 4/81  
 3 COND STEREO PLUGS 1/4" RIGHT ANGLE #3CONDPL 2/81  
 ALLIGATOR CLIPS #BOOTS, #red, #blk, #wh, #20 4/92  
 ALLIGATOR CLIPS #BOOTS, #red, #blk, #wh, #20 4/92  
 9V BATTERY SNAPS, insulated, w/wire leads #9VSNAP 10/81  
 #BZ5 SERIAL CABLE, #WALEZ, #BZ5M \$5  
 6 AMP 50PVT BRIDGE RECTIFIERS #6AMP 2/81  
 16K DYNAMIC RAMS 200nsec, r/f #4116 3/81  
 64K DYNAMIC RAMS 150nsec, r/f #4164 1/81 7/81  
 STATIC RAMS r/f, #2114 2/81  
 6 VOLTS #300MA RECHARGEABLE BATTERIES, sealed, #6VRB \$3  
 2A STANDARD FUSES, #AG 1/2" 20/81  
 1/2A SLD-BLD FUSES, #AG #M2L 5 10/81  
 1A SLD-BLD FUSES, #AG #M2L 5 10/81  
 3A SLD-BLD FUSES, #AG #M2L 5 10/81  
 2" SPEAKER 8 ohms #2SPKR \$1  
 MODULAR TELEPHONE WALL OUTLET BOXES #TEC30 \$1.95  
 MODULAR TELEPHONE V ADAPTERS, (2 fem-1 male) #TEC23 \$1.95  
 IN-LINE MODULAR COUPLERS (dual female) #TEC34 \$1.50  
 14 PIN SOLDER-TYPE IC SOCKETS #14ST 10/81  
 22 PIN SOLDER-TYPE IC SOCKETS #22ST 10/81  
 28 PIN SOLDER-TYPE IC SOCKETS #28ST 10/81  
 RED-SIZED RED LEADS 10/81  
 HIGH SPEED SWITCHING DIODES #1N4148 20/81  
 HI-SPEED NPN SWITCHING TRANSISTOR #2N4401 10/81  
 15A 200PRV TRIAC, power tab #5C1518 2/81  
 12VOLT 1 WATT ZENER #1N4742A 8/81  
 2500PF 200V RECTIFIER, DOG #1N4001 2/81

**ASSORTMENTS**  
 IC'S, mixed types, lots of good numbers! #ASTICS 20/81  
 NINETY PADLOCK SWITCHES #NINETY 8/81  
 TRIMMER POT'S, some precision #ASTRIM 6/81  
 LAMP'S mixed sizes, voltages, types #ASTLAMP 20/81  
 CRYSTALS, mixed large and small #ASTCRYST 10/81  
 RELAYS, mixed voltages, types #ASTREL 5/81  
 TANTALUM CAPS, axial lead, #ASTTAN 10/81  
 COILS, audio, rf, lg & small #ASTCOIL 10/81

HOW TO ORDER: Order by phone or mail, or at our retail stores, pay by MC, Visa, Amex, COD, check, min order \$20, include \$3 shipping and handling, 30 DAY MONEY BACK SATISFACTION GUARANTEE! Send for FREE FLYER! (Free removed from equip.)

**UNITECH (800)343-0472**  
 IN MASS: (617)UNI-TECH  
 20R HURLEY ST. CAMBRIDGE, MA 02141

CIRCLE 261 ON FREE INFORMATION CARD

## SATELLITE TELEVISION

**BUILD your own Satellite-TV receiving system and save! Instruction manuals, schematics, circuit boards, parts kits! Send stamped envelope for complete product listing: XANDI, Box 25647, Dept. 21P, Tempe, AZ 85282.**

### SATELLITE TV VIEWERS

Get the most complete weekly listings. Send \$1 for sample copy.

**Satellite TV Week**

P.O. Box 308E, Fortuna, California 95540  
 800-358-9997 (U.S.) • 800-556-8787 (Calif.)  
 707-725-2476 (all others)

SATELLITE systems \$595.00, color catalog \$1.00. Dealer discounts. STARLINK, Inc., 1122R Park Plaza, Huntsville, AL 35801.

**UNSCRAMBLE**—Canadian & American satellites. Watch the good stuff. Plans \$19.95—boards & plans \$30.00—units completed \$298.00—kits available—details and order forms \$3.00. SCRAMCO, 8688 Royal Drive, Noblesville, IN 46060.

SATELLITE systems and accessories. Dishes, receivers, LNAs, actuators. Top brands, low prices. \$5.00 catalog. B&T ELECTRONICS, P.O. Box 3156, Grand Rapids, MI 49501.

SATELLITE-TV system \$600.00! I'll tell you how I did it. Send \$5.00 to RALTEC, 2805 Carriage Ct., Carrollton, TX 75006.

**BUILD a better satellite antenna for less.** Commercial quality—complete plans for accurate parabolic dish, 12' (or smaller). Send \$9.95 to CABLETRONICS, Box 30502R, Bethesda, MD 20814.

SATELLITE reception systems at dealer prices. Limited lifetime warranty on dish. Contact: SATELLITE TV OUTLET, INC., 4747 W. Tuscarawas Street, Canton, OH 44708. (216) 478-0440.

**ENJOY SATELLITE TV**

**DO-IT-YOURSELF AND SAVE**  
 Electronic Know-how not required.  
 Easy to build from our plans or kits.  
 Lowest prices on satellite electronics.  
 Send \$1 for catalog or \$8.95 for "Consumer Guide to Satellite Television."  
 GFI-D14, Box 9108  
 Missoula, MT 59807



**1985 Official Satellite Directory & Buyer's Guide.** Hailed as the most valuable Satellite Directory & Buyer's guide for the industry. Lists over 1,000 satellite companies and thousands of products. Need information on manufacturers, distributors, associations, trade publications? It's all there and more. For free information, write OFFICIAL SATELLITE DIRECTORY & BUYER'S GUIDE, P.O. Box 2772, Dept. #202, Palm Springs, CA 92263.

SATELLITE Descramblers. Lowest prices anywhere! Dealer inquiries welcome. Send \$3.00 for catalog. We ship C.O.D.'s. STARVIEW INC., P.O. Box 103, Rexford, NY 12148.

VIDEOTAPE, instructions for site testing, assembly aiming, tracking troubleshooting any TVRO. \$59.95. Info. \$3.00. VIDSAT, Box 1200, M.P.O., Saint John, N.B., Canada E2L 4G7.

UNIQUE Satellite-TV Manual for dealers/hobbyists. Includes step-by-step instructions for system installation & tuning, purchasing, marketing, complete list of distributors & equipment plus more. Rush \$19.95 to SATELLITE COM. NETWORK, 204 W. 20th St., New York, NY 10011.

## BUSINESS OPPORTUNITIES

**MECHANICALLY** inclined individuals desiring ownership of small electronics manufacturing business—without investment. Write: BUSINESSSES, 92-R, Brighton 11th, Brooklyn, NY 11235.

**YOUR own radio station!** AM, FM, cable. Home operation possible. BROADCASTING, Box 130-F8, Paradise, CA 95969.

**US \$8.00** including disk, thousand name brand programs for Apple, IBM-PC, details U.S. \$1.00, RELIANT, P.O. Box 33610, Sheungwan, Hong Kong.

## BIG PROFITS ELECTRONIC ASSEMBLY BUSINESS

Start home. spare time. Investment knowledge or experience unnecessary. BIG DEMAND assembling electronic devices. Sales handled by professionals. Unusual business opportunity.

FREE: Complete illustrated literature  
 BARTA, RE-O Box 248  
 Walnut Creek, Calif. 94597

HOW to start a small electronics shop at home. Make extra money. Build as large as you want. How to get business, manage the shop, calculate profit. Tax tips. \$12.95, plus \$2.00 P&H. WO-MACK, Box 1651, Melbourne, FL 32902.

## EDUCATION & INSTRUCTION

**LEARN how to use a computer.** Train at home in spare time! No previous experience needed! Learn computer programming, computer applications and operations...even computer games. Use hundreds of programs already available or learn to write your own. Experts explain everything in easy-to-understand language with step-by-step directions. Call for free facts! 1-800-862-6262, extension 56 or write ICS COMPUTER SCHOOL, Dept. DEC45, Scranton, PA 18515.

**COPY** of U.S. Navy Basic Electronic Course, 8 parts \$5.00 each. CARLTON'S ELECTRONICS, 1632 N. LeClaire, Chicago, IL 60639.

## FINEST QUALITY SOLDER

**SN 60/40 Rosin Core (RA)**

One lb. Reels	
16 swg. (.064)	\$7.95
18 swg. (.048)	\$8.45
19 swg. (.040)	\$8.95
20 swg. (.036)	\$9.45
21 swg. (.032)	\$9.95
1/2 lb. Reels	
22 swg. (.028)	\$5.95
24 swg. (.022)	\$7.95

**SN 62 (2% Silver)**  
 Rosin Core  
 21 swg. (.031) \$19.95

**FREE Freight On All Orders Over \$25**  
 Under \$25 add \$2.50 per order. Minimum order \$10.

**FREE Desoldering Wick**  
 with each pound of solder

Check Money Order VISA  
 MasterCard N.Y. State residents add appropriate sales tax.

**SolderCraft** Call TOLL FREE 800-645-4808  
 P.O. Box 668 R, Jenkintown, N.Y. 11753  
 IN NYS (516) 334-2660

## WANTED

**INVENTIONS**, ideas, new products wanted! Industry presentation/national exposition. Call free (1-800) 528-6050. Arizona, (1-800) 352-0458. X831.

**TOCOM 55** plus descrambler equipment, schematics, conversion and servicing information. J.P., 114 Evans Road, Norristown, PA 19403.

## REEL-TO-REEL TAPES

**AMPEX** professional series open reel tape, 1800- or 2400-foot on 7-inch reels, used once. Case of 40, \$45.00. 10 1/2 x 3600 feet and cassettes available. MasterCard/Visa. VALTECH ELECTRONICS, Box 6-RE, Richboro, PA 18954 (215) 322-4866.

## INVENTORS!

**CAN** you profit from your idea? Call us today regarding the marketing of your invention, or write for your free information package. Over a decade of service. AMERICAN INVENTORS CORPORATION, 82 Broad Street, Dept. RE, Westfield, MA 01086, (413) 568-3753. (Not an answering service.) Offices nationwide.

## DO-IT-YOURSELF TV REPAIR

**NEW!...Repair any TV...Easy.** Anyone can do it. Write, RESEARCH, Rt. 3, Box 601 BR, Colville, WA 99114.

**MASTERCARD AND VISA** are now accepted for payment of your advertising. Simply complete the form on the first page of the Market Center and we will bill.

RADIO-ELECTRONICS

**JAM IT!**  
 Even the Very Best Radar Detector Can't Protect You from the Newest Radar



**NEW MODEL J3111 RADAR JAMMER**

**THE ULTIMATE IN RADAR PROTECTION**

**Radar Jammer:** Compact under-dash unit causes speed radar guns to read out a percentage of your true speed, or whatever speed you dial in. Or, new "SCRAMBLE" mode will prevent radar from obtaining any reading. Activated by Whistler, Escort, or other detector. Best defense against instant on radar. Operates on both X and K bands. WARNING: This device is not legal for use against police radar, and is not FCC approved.

**Transmitters:** The heart of the jammer is the microwave oscillator (transmitter). In the past, these were very expensive, and limited to only about 100 milliwatts of power. We now have our own Low Cost, High Power Transmitters up to 300 milliwatts or more. Please call for prices.

**Radar Detectors:** We highly recommend using a remote detector that is mounted so that nothing is readily visible to either the police, or thieves. (A dash mount detector is an invitation to thieves and an irritation to police!) We agree with Motor Trend and Autoweek that WHISTLER SPECTRUM is the best detector available, and we know of no other remote detector that is even in the same LEAGUE as the SPECTRUM REMOTE. Order the best for yourself now. (Our detectors are already modified for direct connection to the jammer.)

**ORDER TODAY—MONEY BACK GUARANTEE**

Complete Literature & Plans Pkg.	\$ 14.95
Set of Circuit Boards	40.00
X and K-band Microwave Oscillators (Transmitters)	Call
Whistler Spectrum (modified for use with Jammer)	259.00
Whistler Spectrum Remote (modified)	259.00
Modify your Spectrum for use w/jammer	55.00

CALL or send the following information:  
 • Items Ordered • Name • Shipping Address  
 • Payment: Check, Money Order, VISA or MC (include card number, expiration date, and signature)  
 SEND TO: Oregon Microwave Inc., 9513 S.W. Barber Blvd. #1095  
 Portland, OR 97219 ORDER LINE: (503) 626-6764  
 \*Formerly Philips Instrument Design Co.

CIRCLE 255 ON FREE INFORMATION CARD



**NATIONAL SEMICONDUCTOR • PANASONIC QUALITY** - Name brand products from nationally recognized manufacturers. **MAKING • EWC, INC. • INTERSIL • A I** **SERVICE** - Computerized order processing and inventory control. **OK, INC. • J. W. MILLER • AAVI ENGINE** **SAVINGS** - Volume Discounts • OEM Quantity Pricing • Toll Free 800 Number **E. F. JOHNSON • ATLANTIC SEMICONDUCTOR**

**DIODES • DIAMOND TOOL • UNGAR • RIES • CW INDUSTRIES • AMDEK • G.E. UNGAR • YAGEO • J. W. MILLER • LUXO GC CHEMICALS • ARIES • PLESSEY**

**INTEGRATED CIRCUITS**

Part No.	Manufacturer	Price
LM001	LM001	1.43
LM002	LM002	1.43
LM003	LM003	1.43
LM004	LM004	1.43
LM005	LM005	1.43
LM006	LM006	1.43
LM007	LM007	1.43
LM008	LM008	1.43
LM009	LM009	1.43
LM010	LM010	1.43
LM011	LM011	1.43
LM012	LM012	1.43
LM013	LM013	1.43
LM014	LM014	1.43
LM015	LM015	1.43
LM016	LM016	1.43
LM017	LM017	1.43
LM018	LM018	1.43
LM019	LM019	1.43
LM020	LM020	1.43
LM021	LM021	1.43
LM022	LM022	1.43
LM023	LM023	1.43
LM024	LM024	1.43
LM025	LM025	1.43
LM026	LM026	1.43
LM027	LM027	1.43
LM028	LM028	1.43
LM029	LM029	1.43
LM030	LM030	1.43
LM031	LM031	1.43
LM032	LM032	1.43
LM033	LM033	1.43
LM034	LM034	1.43
LM035	LM035	1.43
LM036	LM036	1.43
LM037	LM037	1.43
LM038	LM038	1.43
LM039	LM039	1.43
LM040	LM040	1.43
LM041	LM041	1.43
LM042	LM042	1.43
LM043	LM043	1.43
LM044	LM044	1.43
LM045	LM045	1.43
LM046	LM046	1.43
LM047	LM047	1.43
LM048	LM048	1.43
LM049	LM049	1.43
LM050	LM050	1.43
LM051	LM051	1.43
LM052	LM052	1.43
LM053	LM053	1.43
LM054	LM054	1.43
LM055	LM055	1.43
LM056	LM056	1.43
LM057	LM057	1.43
LM058	LM058	1.43
LM059	LM059	1.43
LM060	LM060	1.43
LM061	LM061	1.43
LM062	LM062	1.43
LM063	LM063	1.43
LM064	LM064	1.43
LM065	LM065	1.43
LM066	LM066	1.43
LM067	LM067	1.43
LM068	LM068	1.43
LM069	LM069	1.43
LM070	LM070	1.43
LM071	LM071	1.43
LM072	LM072	1.43
LM073	LM073	1.43
LM074	LM074	1.43
LM075	LM075	1.43
LM076	LM076	1.43
LM077	LM077	1.43
LM078	LM078	1.43
LM079	LM079	1.43
LM080	LM080	1.43
LM081	LM081	1.43
LM082	LM082	1.43
LM083	LM083	1.43
LM084	LM084	1.43
LM085	LM085	1.43
LM086	LM086	1.43
LM087	LM087	1.43
LM088	LM088	1.43
LM089	LM089	1.43
LM090	LM090	1.43
LM091	LM091	1.43
LM092	LM092	1.43
LM093	LM093	1.43
LM094	LM094	1.43
LM095	LM095	1.43
LM096	LM096	1.43
LM097	LM097	1.43
LM098	LM098	1.43
LM099	LM099	1.43
LM100	LM100	1.43

**1% METAL FILM RESISTORS**

Part No.	Value	Price
100	100	1.43
101	101	1.43
102	102	1.43
103	103	1.43
104	104	1.43
105	105	1.43
106	106	1.43
107	107	1.43
108	108	1.43
109	109	1.43
110	110	1.43
111	111	1.43
112	112	1.43
113	113	1.43
114	114	1.43
115	115	1.43
116	116	1.43
117	117	1.43
118	118	1.43
119	119	1.43
120	120	1.43
121	121	1.43
122	122	1.43
123	123	1.43
124	124	1.43
125	125	1.43
126	126	1.43
127	127	1.43
128	128	1.43
129	129	1.43
130	130	1.43
131	131	1.43
132	132	1.43
133	133	1.43
134	134	1.43
135	135	1.43
136	136	1.43
137	137	1.43
138	138	1.43
139	139	1.43
140	140	1.43
141	141	1.43
142	142	1.43
143	143	1.43
144	144	1.43
145	145	1.43
146	146	1.43
147	147	1.43
148	148	1.43
149	149	1.43
150	150	1.43

**How To Order:** Take any standard value (20% and add ".0" (2.20K), the OHM-RAY resistor number. Order by quantity or lot.

100 = 100 for 100 to 99.99¢  
1000 = 1000 for 99.99¢ to 999.99¢  
10000 = 10000 for 999.99¢ to 9999.99¢

Price quantities and prices as low as 99.99¢, contact DigKey.

**5% Carbon Film Resistors**

Part No.	Value	Price
100	100	1.43
101	101	1.43
102	102	1.43
103	103	1.43
104	104	1.43
105	105	1.43
106	106	1.43
107	107	1.43
108	108	1.43
109	109	1.43
110	110	1.43
111	111	1.43
112	112	1.43
113	113	1.43
114	114	1.43
115	115	1.43
116	116	1.43
117	117	1.43
118	118	1.43
119	119	1.43
120	120	1.43
121	121	1.43
122	122	1.43
123	123	1.43
124	124	1.43
125	125	1.43
126	126	1.43
127	127	1.43
128	128	1.43
129	129	1.43
130	130	1.43
131	131	1.43
132	132	1.43
133	133	1.43
134	134	1.43
135	135	1.43
136	136	1.43
137	137	1.43
138	138	1.43
139	139	1.43
140	140	1.43
141	141	1.43
142	142	1.43
143	143	1.43
144	144	1.43
145	145	1.43
146	146	1.43
147	147	1.43
148	148	1.43
149	149	1.43
150	150	1.43

**WIRE WRAP DIP SOCKETS**

Part No.	Value	Price
100	100	1.43
101	101	1.43
102	102	1.43
103	103	1.43
104	104	1.43
105	105	1.43
106	106	1.43
107	107	1.43
108	108	1.43
109	109	1.43
110	110	1.43
111	111	1.43
112	112	1.43
113	113	1.43
114	114	1.43
115	115	1.43
116	116	1.43
117	117	1.43
118	118	1.43
119	119	1.43
120	120	1.43
121	121	1.43
122	122	1.43
123	123	1.43
124	124	1.43
125	125	1.43
126	126	1.43
127	127	1.43
128	128	1.43
129	129	1.43
130	130	1.43
131	131	1.43
132	132	1.43
133	133	1.43
134	134	1.43
135	135	1.43
136	136	1.43
137	137	1.43
138	138	1.43
139	139	1.43
140	140	1.43
141	141	1.43
142	142	1.43
143	143	1.43
144	144	1.43
145	145	1.43
146	146	1.43
147	147	1.43
148	148	1.43
149	149	1.43
150	150	1.43

**1% CARBON FILM RESISTOR VALUES IN OHMS**

Part No.	Value	Price
100	100	1.43
101	101	1.43
102	102	1.43
103	103	1.43
104	104	1.43
105	105	1.43
106	106	1.43
107	107	1.43
108	108	1.43
109	109	1.43
110	110	1.43
111	111	1.43
112	112	1.43
113	113	1.43
114	114	1.43
115	115	1.43
116	116	1.43
117	117	1.43
118	118	1.43
119	119	1.43
120	120	1.43
121	121	1.43
122	122	1.43
123	123	1.43
124	124	1.43
125	125	1.43
126	126	1.43
127	127	1.43
128	128	1.43
129	129	1.43
130	130	1.43
131	131	1.43
132	132	1.43
133	133	1.43
134	134	1.43
135	135	1.43
136	136	1.43
137	137	1.43
138	138	1.43
139	139	1.43
140	140	1.43
141	141	1.43
142	142	1.43
143	143	1.43
144	144	1.43
145	145	1.43
146	146	1.43
147	147	1.43
148	148	1.43
149	149	1.43
150	150	1.43

**WATT'S CARBON FILM RESISTOR ABSTRACT**

Part No.	Value	Price
100	100	1.43
101	101	1.43
102	102	1.43
103	103	1.43
104	104	1.43
105	105	1.43
106	106	1.43
107	107	1.43
108	108	1.43
109	109	1.43
110	110	1.43
111	111	1.43
112	112	1.43
113	113	1.43
114	114	1.43
115	115	1.43
116	116	1.43
117	117	1.43
118	118	1.43
119	119	1.43
120	120	1.43
121	121	1.43
122	122	1.43
123	123	1.43
124	124	1.43
125	125	1.43
126	126	1.43
127	127	1.43
128	128	1.43
129	129	1.43
130	130	1.43
131	131	1.43
132	132	1.43
133	133	1.43
134	134	1.43
135	135	1.43
136	136	1.43
137	137	1.43
138	138	1.43
139	139	1.43
140	140	1.43
141	141	1.43
142	142	1.43
143	143	1.43
144	144	1.43
145	145	1.43
146	146	1.43
147	147	1.43
148	148	1.43
149	149	1.43
150	150	1.43





# GOOD NEWS

For cable accessories,  
there's no place like Sone.



- JERROLD RSX WIRED REMOTE\*** This 36 Channel Remote features: fine tuning control-20 foot cord-90 day warranty.
- JERROLD JRX WIRED REMOTE\*** This 36 Channel Remote features: 20 foot cord-fine tuning control-90 day warranty.
- JERROLD RSC WIRED REMOTE\*** This 30 Channel Remote's features include: 20 foot cord-fine tuning control-90 day warranty.
- EAGLE EVSC-2000 REMOTE CABLE TV CONVERTER** You can choose from up to 60 cable TV Channels with this powerful unit. Other features include: last channel recall-favorite channel scan-remote control.
- DW-63K ELECTRONIC VIDEO SELECTOR** This sophisticated video selector allows you to connect up to 6 different inputs and 3 outputs. Features include: LED monitor display-soft touch keyboard.
- VIEWSTAR VSS-1000 REMOTE TV CONVERTER WITH VOLUME CONTROL** Expand the excitement of cable TV viewing with this 67 Channel unit. Features include: fine tuning control-last channel recall-remote control.
- CABLE TV BLOCK CONVERTER** Program your VCR to record one channel while you watch another. This unit also restores control functions and fine tunes for offset channels.
- CHANNEL SCAN WIRELESS REMOTE CONTROL** A fully assembled, easy to install remote control for your TV. Features include: channel changer and illuminated channel indicator.
- DW-42K ELECTRONIC VIDEO SELECTOR** This unit can handle up to 4 different inputs and 2 outputs. Features include: LED display monitor-soft touch keyboard.

\* Factory Refurbished

Check method of payment <input type="checkbox"/> VISA <input type="checkbox"/> MASTERCARD <input type="checkbox"/> C.O.D. (Cash)	Quantity Prices	1 piece	3 pieces	10 pieces	Total
Credit card number _____ Expiration date _____	1. Jerrold RSX	\$44	\$40	\$35	\$
Signature _____ Name _____	2. Jerrold JRX	\$49	\$44	\$39	\$
Address _____	3. Jerrold RSC	\$39	\$35	\$30	\$
City _____ State _____ Zip _____	4. Eagle EVSC	\$99	\$89	\$79	\$
For CableMaster, please list the descrambler used by your Cable Company	5. DW-63K	\$69	—	\$52	\$
	6. Viewstar	\$119	\$109	\$99	\$
	7. Block	\$19	\$15	\$11	\$
	8. Channel Scan	\$49	\$44	\$39	\$
	9. DW-42K	\$45	—	\$39	\$
	10. CableMaster	\$149	—	\$145	\$
	For larger quantities or catalog, please call or write.				

Sone Associates • 5 Broadway - Suite 201 • Troy, N.Y. 12180 • (518) 274-0608

CIRCLE 8 ON FREE INFORMATION CARD

## CABLE TV FILTER "CYLINDERS"

**SUPER** powered notch filters. Equivalent of **able** company "cylinders". Eliminate undesirable signals. Any channel 2 through 8; 14(A) through 22(I). (Please specify.) Send \$20.00 each. **Money back guarantee.** Quantity discounts, **CATV**, Box 17621, Plantation, FL 33318.

## Quality Microwave TV Antennas

Multi-Channel 1.9 to 2.7 GHz  
40dB Gain True Parabolic 20 Inch Dish  
Complete System \$84.95 (Shipping incl.)  
Dealerships, Qty. Pricing, Replacement Parts

**Phillips-Tech Electronics**  
P.O. Box 34772 • Phoenix, AZ 85067

(802) 947-7700 (\$3.00 Credit all phone orders!)

LIFETIME WARRANTY MasterCard • Visa • C.O.D.'s

## PRINTED-CIRCUIT BOARDS

**PRINTED-circuit boards.** Quick prototypes, production, design, reflow solder. Send print or description for quote to **KIT CIRCUITS**, Box 235, Clawson, MI 48017.

**PRINTED-circuit boards** double-sided with plated-through holes or single-sided. No set-up charge. **CAUDILL, INC.**, 205 East Westwood Ave., Highpoint, NC 27262. (919) 884-0229.

## EPROM PROGRAMMING

**HOBBYISTS:** Pretested **EPROM's** sold with your programming installed. Program listing provided. Fast service. Write or call: **ROMULUS MICRO-CONTROL**, Box 8669, Rockville, MD 20856, (301) 540-8863.

## GRAPHIC EQUALIZERS, ETC.

**NOISE** eliminators, expanders, power meters, others. Twelve-24 bands/channel equalizers from \$89.00. Kit see **R-E 5-6/78, 2/80, 3-4/81.** Catalog: **SSS**, 856R Lynnrose, Santa Rosa, CA 95404. (707) 546-3895.

## SUPER LIGHTS

**AS** seen on the television show, Knight Rider, six lights going side to side varying according to the speed of engine. \$1.00 for information, \$9.95 for low power plans, \$14.00 for high power plans, send check or money order to: **SUPER SYSTEMS**, Box 1063, Drexel Hill, PA 19026.

## CABLE-TV

**DEALERS** wanted: Channel 2, 3, and 4 notch filters. Money back guarantee. Send \$15.00 for sample and quantity price list. Specify channel(s). **GARY KURTZ**, P.O. Box 291394, Davie, FL 33329.

THE BEST PLACE TO BUY, SELL or  
TRADE NEW and USED EQUIPMENT  
**NUTS & VOLTS MAGAZINE**  
BOX 1111-E • PLACENTIA, CA 92670  
(714) 632-7721

Join Thousands of Readers Nationwide  
Every Month

**ONE YEAR U.S. SUBSCRIPTIONS**  
\$10.00 - 3rd Class • \$15.00 - 1st Class

\$35.00 - Lifetime - 3rd Class

## NUTS & VOLTS

HAM GEAR  
COMPUTERS  
SOFTWARE  
SCANNERS • OPTICS  
TEST EQUIPMENT  
MICROWAVE  
SATELLITE  
AUDIO VISUAL  
NEW PRODUCTS  
COMPONENTS • KITS  
ANTIQUE ELECT.  
PUBLICATIONS  
PLANS • SERVICES

THANKS FOR  
HELPING TO KEEP  
UNITED WAY  
IN BUSINESS.



United Way



# WE HAVE QUALITY PARTS, DISCOUNT PRICES AND FAST SHIPPING!

### TRANSFORMERS



120 volt primaries

5.6 VOLTS @ 750 MA	\$3.00
6 VOLTS @ 150 MA	\$1.25
12 VCT @ 200 MA	\$2.00
18 V. @ 650 MA	\$3.50
18 VOLTS @ 1 AMP	\$4.50
24 VOLTS @ 250 MA	\$2.50
24 VCT @ 1 AMP	\$4.50

### LINE CORDS

**TWO WIRE**  
6' 18ga TWO WIRE  
3 FOR \$1.00

**THREE WIRE**  
8 FOOT 18ga THREE WIRE  
\$2.00 EACH

### MIKE CONNECTOR



5 CONDUCTOR IN-LINE PLUG AND CHASSIS MOUNT JACK. TWIST LOCK STYLE. SAME AS SWITCHCRAFT 12CL5M. \$2.50 PER SET

### 7 CONDUCTOR RIBBON CABLE



SPECTRA-STRIP RED MARKER STRIP. 28 GA STRANDED WIRE. \$5.00 PER ROLL (100 FT.)

### REVERBERATION UNIT



ACCUTRONICS COIL SPRING TYPE UNITS. USED IN ELECTRONIC ORGANS TO PROVIDE ACOUSTIC DELAY SOUND EFFECTS. INPUT IMPEDANCE 8 OHMS, OUTPUT IMPEDANCE 2250 OHMS. 4 1/2" x 16 1/4" x 1 1/4". \$7.50 EACH

### WALL TRANSFORMER



ALL ARE 115 VAC PLUG IN

4 VDC @ 70 MA	\$2.00
6 VAC @ 500 MA	\$3.50
6 VDC @ 750 MA	\$6.50
9 VDC @ 500 MA	\$5.00
9 VAC @ 1 AMP	\$3.00
12.5 VAC @ 265 MA	\$2.50
17 VAC @ 500 MA	\$4.00
24 VAC @ 250 MA	\$3.00

### MULTI-SWITCHES

**3 STATION NON-INTERLOCKING**  
3 - 2PDT SWITCHES. EACH OPERATES INDEPENDENTLY.  
1 1/4" BETWEEN MOUNTING CENTERS.  
\$1.75 EACH

**5 STATION INTERLOCKING**  
MADE BY ALPS. 3 - 2PDT AND 2 - 6PDT SWITCHES ON FULLY INTERLOCKING ASSEMBLY. 3/16" BETWEEN MOUNTING CENTERS.  
\$2.50 EACH

**5 STATION NON-INTERLOCKING**  
SAME AS ABOVE, EXCEPT EACH SWITCH OPERATES INDEPENDENTLY.  
\$2.50 EACH

### METER

0 - 15 V.D.C.

THIS 2-1/4" SQUARE METER MEASURES 0-15 VDC. \$4.50 EACH

### 2K 10 TURN

MULTI-TURN POT SPECTROL #MOD 534-7161 \$5.00 EACH

### SOUND AND VIDEO MODULATOR FOR T.I. COMPUTER



T.I. # UM1381-1. DESIGNED FOR USE WITH T.I. COMPUTERS. CAN BE USED WITH VIDEO SOURCES. BUILT-IN A/B SWITCH CHANNEL 3 OR 4 SELECTION SWITCH. OPERATES ON 12 VDC. HOOK UP DIAGRAM INCLUDED. \$10.00 EACH

### SPRING LEVER TERMINALS



TWO COLOR CODED TERMINALS ON A STURDY 2 3/4" x 3 3/4" BAKELITE PLATE. GREAT FOR SPEAKER ENCLOSURES OR POWER SUPPLIES.  
\$1.00 EACH 10 FOR \$9.00

### TI SWITCHING POWER SUPPLY

TI # 1053214-2  
COMPACT, WELL-REGULATED SWITCHING POWER SUPPLY DESIGNED TO POWER TEXAS INSTRUMENTS COMPUTER EQUIPMENT.  
INPUT: 14VAC-25. VAC AT 1A  
OUTPUT: +12VDC AT 350MA  
+ 5VDC AT 1.2A  
- 5VDC AT 200MA  
SIZE: 4 1/4" x 4 1/4" x 1 1/4" \$5.00 EACH



### SUB-MINIATURE D TYPE CONNECTOR



SOLDER TYPE SUB-MINIATURE CONNECTORS USED FOR COMPUTER HOOK UPS.  
DB-15 PLUG \$2.75  
DB-15 SOCKET \$4.00  
DB-15 HOOD \$1.50  
DB-25 PLUG \$2.75  
DB-25 SOCKET \$3.50  
DB-25 HOOD \$1.25

### ROTARY SWITCH

1 POLE 6 POSITION  
1 1/4" DIA x 1 1/2" HIGH  
75¢ EACH  
10 for \$6.00

### PUSHBUTTON POWER SWITCH



DOUBLE POLE POWER SWITCH PUSH-ON, PUSH-OFF. \$1.00 EACH

### EDGE CONNECTORS

ALL ARE .156" SPACING

**10 PIN EDGE CONNECTOR**  
TRW #50-10-A-20 \$2.00 EACH

**22/44 TIN**  
P.C. STYLE, NO MOUNTING EARS. \$1.50 EACH 10 FOR \$14.00

**22/44 GOLD**  
P.C. STYLE \$2.00 EACH 10 FOR \$18.00

**28/56 GOLD**  
28/56 GOLD PLATED CONTACTS .156 CONTACT SPACING. \$2.50 EACH 10 FOR \$22.00

### 120V INDICATOR

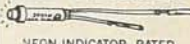

NEON INDICATOR. RATED 120 V 1/3 W. MOUNTS IN 5/16" HOLE. RED LENS.  
75¢ EACH  
10 FOR \$7.00  
100 FOR \$65.00

### SWITCHES

**MINI-PUSH BUTTON**  
S.P.S.T. MOMENTARY NORMALLY OPEN 1/4" BUSHING  
35¢ EACH  
10 FOR \$3.25  
100 FOR \$30.00

SPECIFY COLOR: RED, BLACK, WHITE, YELLOW.

### GEL CELL BATTERY



12 VDC @ 2.6 AMP HOUR  
5 3/8" x 2 1/4" x 3 3/4"  
\$25.00 EACH

**FREE!** SEND FOR **NEW 1985** 48 PAGE CATALOG **FREE!**

### 13.8 VOLT REGULATED POWER SUPPLY

THESE ARE SOLID STATE FULLY REGULATED 13.8 VDC POWER SUPPLIES. ALL FEATURE 100% SOLID STATE CONSTRUCTION, FUSE PROTECTION, L.E.D. POWER INDICATOR.  
2 AMP CONSTANT, 4 AMP SURGE.  
UL LISTED \$18.00 EACH



### RELAYS

**SOLID STATE RELAY**  
HEINEMANN ELECTRIC #101-5A-140-5 AMP CONTROL. 3-32VDC LOAD; 140VAC 5 AMPS SIZE. 2" X 1" X 3/4" HIGH  
\$5.00 EACH 10 FOR \$45.00

### COMPUTER GRADE CAPACITORS



2,000 mfd. 200 VDC 1 3/4" DIA. x 5" HIGH \$2.00  
3,600 mfd. 40 VDC 1 3/8" DIA. x 3 3/4" HIGH \$1.00  
6,400 mfd. 60 VDC 1 3/8" DIA. x 4 1/4" HIGH \$2.50  
31,000 mfd. 15 VDC 1 3/4" DIA. x 4" HIGH \$2.50  
72,000 mfd. 15 VDC 2" DIA. x 4 3/8" HIGH \$3.50  
185,000 mfd. 6 VDC 2 1/2" DIA. x 4 1/2" HIGH \$1.50

CLAMPS TO FIT CAPACITORS 50¢ ea.

### SLIDE POTS



100K linear taper 2" LONG  
1 5/8" TRAVEL 75¢ EACH  
500K linear taper 2 7/8" LONG  
1 3/4" TRAVEL 75¢ EACH  
DUAL 100K audio taper 3 1/2" LONG  
2 1/2" TRAVEL \$1.50 EACH

### L.E.D.'S STANDARD JUMBO DIFFUSED

RED 10 FOR \$1.50  
GREEN 10 FOR \$2.00  
YELLOW 10 FOR \$2.00

**FLASHER LED 5 VOLT OPERATION RED JUMBO SIZE \$1.00 EACH**

**BI POLAR LED 2 FOR \$1.70**

**LED HOLDERS**  
TWO PIECE HOLDER FOR JUMBO LED 10 FOR 65¢ 200 FOR \$10.00

**CLEAR CLIPLITE HOLDER**  
MAKE LED A FANCY INDICATOR. CLEAR. 4 FOR \$1.00

### DC CONVERTER



DESIGNED TO PROVIDE A STEADY 5 VDC @ 240 MA FROM A BATTERY SUPPLY OF 3.5 TO 6.25 V.  
2 1/16" X 1 1/16" X 1 1/16" HIGH. \$1.50 EACH

### 1N4148 SPECIAL

.45" SPACING P.C. LEADS  
1000 FOR \$10.00  
10,000 FOR \$85.00

**KEY ASSEMBLY 5 KEY \$1.00 EACH**  
CONTAINS 5 SINGLE-POLE NORMALLY OPEN SWITCHES. MEASURES 3 3/4" LONG

**6 KEY \$1.25 EACH**  
CONTAINS 6 SINGLE-POLE NORMALLY OPEN SWITCHES. MEASURES 4 1/4" LONG

### MINIATURE 6 VDC RELAY



SUPER SMALL SPDT RELAY. GOLD COBALT CONTACTS.  
RATED 1 AMP AT 30 VDC; HIGHLY SENSITIVE, TTL DIRECT DRIVE POSSIBLE. OPERATES FROM 4.3 TO 6 V. COIL RES. 220 OHM.  
1 3/16" x 13/32" x 7/16" AROMAT # RSD-6V  
\$1.50 EACH 10 FOR \$13.50

### CRYSTALS

CASE STYLE HC33/U  
2 MHZ COLORBURST 3579.545 KC \$3.50 EACH \$1.00 EACH

**METAL OXIDE VARISTOR**  
POPULAR GE # 130LA10A VARISTOR. 5/8" DIAMETER. \$1.25 EACH

### TRANSISTORS

2N706	4 FOR \$1.00
2N2222A	3 FOR \$1.00
PN2222	4 FOR \$1.00
2N2904	3 FOR \$1.00
2N2905	3 FOR \$1.00
2N2907	3 FOR \$1.00

### 3 1/2" SPEAKER



8 OHM IMPEDANCE, FULL RANGE SPEAKER. 8 OZ MAGNET. 4" DIAGONAL MOUNTING CENTERS.  
\$2.50 EACH  
10 FOR \$20.00

### 8" P.A. SPEAKERS



C.T.S. MODEL 883079 \$5.00 EACH  
8 OHMS COIL  
3.0 OZ FERRITE MAGNET  
TYPICAL RESPONSE RANGE: 80 - 10,000 HZ.  
POWER RATING 15 WATTS MAX.  
DRILLED TO MOUNT LINE MATCHING TRANSFORMERS. CASE OF 8 SPEAKERS \$32.00

### 13 VDC RELAY



CONTACT: S.P.N.C. 10 AMP @ 120 VAC ENERGIZE COIL TO OPEN CONTACT...  
COIL: 13 VDC 650 OHMS  
SPECIAL PRICE \$1.00 EACH

### 4 PDT RELAY



14 pin style  
3 amp contacts  
24 volt d.c. or 120 volt a.c. coil  
Used but fully tested \$1.70 EACH  
specify coil voltage  
LARGE QUANTITIES AVAILABLE  
SOCKETS FOR RELAY 50¢ each

### MINIATURE TOGGLE SWITCHES

ALL ARE RATED 5 AMPS @ 125 VAC

**S.P.D.T. (on-on)**  
P.C. STYLE, NON-THREADED BUSHING 75¢ EACH 10 FOR \$7.00

**S.P.D.T. (on-off-on)**  
SOLDER LUG TERMINALS \$1.00 EACH 10 FOR \$9.00  
P.C. LUGS, THREADED BUSHING \$1.00 EACH 10 FOR \$9.00

**S.P.D.T. (on-off-on)**  
SOLDER LUG TERMINALS \$1.00 EACH 10 FOR \$9.00  
P.C. LUGS, THREADED BUSHING \$2.00 EACH 10 FOR \$18.00

### SOLID STATE BUZZER



STAR #SMB-06L. 6VDC. TTL COMPATIBLE. \$1.00 EACH 10 FOR \$9.00

## ALL ELECTRONICS CORP.

TOLL FREE ORDERS ONLY 1-800-826-5432 (ORDER ONLY) (IN CALIFORNIA 1-800-258-6666)  
ALASKA, HAWAII, OR INFORMATION (213) 380-8000

905 S. VERMONT AVE. P.O. BOX 20406 LOS ANGELES, CA 90006  
6228 SEPULVEDA BLVD. VAN NUYS, CA 91411

QUANTITIES LIMITED  
MINIMUM ORDER \$10.00  
USA: \$3.00 SHIPPING  
FOREIGN ORDERS: INCLUDE SUFFICIENT SHIPPING  
CALIF. RES. ADD 6.12%  
NO C.O.D!

SECOND LOCATION!

AUGUST 1985



**12 MILLION PC IC CLEARANCE**  
CALL FOR QUANTITY DISCOUNTS

**7400**

Part No.	Price	Part No.	Price
SN7400N	14.29	SN74159N	24.95
SN7401N	14.29	SN74160N	16.59
SN7402N	14.29	SN74161N	16.59
SN7403N	14.29	SN74162N	16.59
SN7404N	14.29	SN74163N	16.59
SN7405N	14.29	SN74164N	16.59
SN7406N	14.29	SN74165N	16.59
SN7407N	14.29	SN74166N	16.59
SN7408N	14.29	SN74167N	16.59
SN7409N	14.29	SN74168N	16.59
SN7410N	14.29	SN74169N	16.59
SN7411N	14.29	SN74170N	16.59
SN7412N	14.29	SN74171N	16.59
SN7413N	14.29	SN74172N	16.59
SN7414N	14.29	SN74173N	16.59
SN7415N	14.29	SN74174N	16.59
SN7416N	14.29	SN74175N	16.59
SN7417N	14.29	SN74176N	16.59
SN7418N	14.29	SN74177N	16.59
SN7419N	14.29	SN74178N	16.59
SN7420N	14.29	SN74179N	16.59
SN7421N	14.29	SN74180N	16.59
SN7422N	14.29	SN74181N	16.59
SN7423N	14.29	SN74182N	16.59
SN7424N	14.29	SN74183N	16.59
SN7425N	14.29	SN74184N	16.59
SN7426N	14.29	SN74185N	16.59
SN7427N	14.29	SN74186N	16.59
SN7428N	14.29	SN74187N	16.59
SN7429N	14.29	SN74188N	16.59
SN7430N	14.29	SN74189N	16.59
SN7431N	14.29	SN74190N	16.59
SN7432N	14.29	SN74191N	16.59
SN7433N	14.29	SN74192N	16.59
SN7434N	14.29	SN74193N	16.59
SN7435N	14.29	SN74194N	16.59
SN7436N	14.29	SN74195N	16.59
SN7437N	14.29	SN74196N	16.59
SN7438N	14.29	SN74197N	16.59
SN7439N	14.29	SN74198N	16.59
SN7440N	14.29	SN74199N	16.59
SN7441N	14.29	SN74200N	16.59
SN7442N	14.29	SN74201N	16.59
SN7443N	14.29	SN74202N	16.59
SN7444N	14.29	SN74203N	16.59
SN7445N	14.29	SN74204N	16.59
SN7446N	14.29	SN74205N	16.59
SN7447N	14.29	SN74206N	16.59
SN7448N	14.29	SN74207N	16.59
SN7449N	14.29	SN74208N	16.59
SN7450N	14.29	SN74209N	16.59
SN7451N	14.29	SN74210N	16.59
SN7452N	14.29	SN74211N	16.59
SN7453N	14.29	SN74212N	16.59
SN7454N	14.29	SN74213N	16.59
SN7455N	14.29	SN74214N	16.59
SN7456N	14.29	SN74215N	16.59
SN7457N	14.29	SN74216N	16.59
SN7458N	14.29	SN74217N	16.59
SN7459N	14.29	SN74218N	16.59
SN7460N	14.29	SN74219N	16.59
SN7461N	14.29	SN74220N	16.59
SN7462N	14.29	SN74221N	16.59
SN7463N	14.29	SN74222N	16.59
SN7464N	14.29	SN74223N	16.59
SN7465N	14.29	SN74224N	16.59
SN7466N	14.29	SN74225N	16.59
SN7467N	14.29	SN74226N	16.59
SN7468N	14.29	SN74227N	16.59
SN7469N	14.29	SN74228N	16.59
SN7470N	14.29	SN74229N	16.59
SN7471N	14.29	SN74230N	16.59
SN7472N	14.29	SN74231N	16.59
SN7473N	14.29	SN74232N	16.59

**74LS**

Part No.	Price	Part No.	Price
74LS00	14.29	74LS244	14.29
74LS01	14.29	74LS245	14.29
74LS02	14.29	74LS246	14.29
74LS03	14.29	74LS247	14.29
74LS04	14.29	74LS248	14.29
74LS05	14.29	74LS249	14.29
74LS06	14.29	74LS250	14.29
74LS07	14.29	74LS251	14.29
74LS08	14.29	74LS252	14.29
74LS09	14.29	74LS253	14.29
74LS10	14.29	74LS254	14.29
74LS11	14.29	74LS255	14.29
74LS12	14.29	74LS256	14.29
74LS13	14.29	74LS257	14.29
74LS14	14.29	74LS258	14.29
74LS15	14.29	74LS259	14.29
74LS16	14.29	74LS260	14.29
74LS17	14.29	74LS261	14.29
74LS18	14.29	74LS262	14.29
74LS19	14.29	74LS263	14.29
74LS20	14.29	74LS264	14.29
74LS21	14.29	74LS265	14.29
74LS22	14.29	74LS266	14.29
74LS23	14.29	74LS267	14.29
74LS24	14.29	74LS268	14.29
74LS25	14.29	74LS269	14.29
74LS26	14.29	74LS270	14.29
74LS27	14.29	74LS271	14.29
74LS28	14.29	74LS272	14.29
74LS29	14.29	74LS273	14.29
74LS30	14.29	74LS274	14.29
74LS31	14.29	74LS275	14.29
74LS32	14.29	74LS276	14.29
74LS33	14.29	74LS277	14.29
74LS34	14.29	74LS278	14.29
74LS35	14.29	74LS279	14.29
74LS36	14.29	74LS280	14.29
74LS37	14.29	74LS281	14.29
74LS38	14.29	74LS282	14.29
74LS39	14.29	74LS283	14.29
74LS40	14.29	74LS284	14.29
74LS41	14.29	74LS285	14.29
74LS42	14.29	74LS286	14.29
74LS43	14.29	74LS287	14.29
74LS44	14.29	74LS288	14.29
74LS45	14.29	74LS289	14.29
74LS46	14.29	74LS290	14.29
74LS47	14.29	74LS291	14.29
74LS48	14.29	74LS292	14.29
74LS49	14.29	74LS293	14.29
74LS50	14.29	74LS294	14.29
74LS51	14.29	74LS295	14.29
74LS52	14.29	74LS296	14.29
74LS53	14.29	74LS297	14.29
74LS54	14.29	74LS298	14.29
74LS55	14.29	74LS299	14.29
74LS56	14.29	74LS300	14.29
74LS57	14.29	74LS301	14.29
74LS58	14.29	74LS302	14.29
74LS59	14.29	74LS303	14.29
74LS60	14.29	74LS304	14.29
74LS61	14.29	74LS305	14.29
74LS62	14.29	74LS306	14.29
74LS63	14.29	74LS307	14.29
74LS64	14.29	74LS308	14.29
74LS65	14.29	74LS309	14.29
74LS66	14.29	74LS310	14.29
74LS67	14.29	74LS311	14.29
74LS68	14.29	74LS312	14.29
74LS69	14.29	74LS313	14.29
74LS70	14.29	74LS314	14.29
74LS71	14.29	74LS315	14.29
74LS72	14.29	74LS316	14.29
74LS73	14.29	74LS317	14.29
74LS74	14.29	74LS318	14.29
74LS75	14.29	74LS319	14.29
74LS76	14.29	74LS320	14.29
74LS77	14.29	74LS321	14.29
74LS78	14.29	74LS322	14.29
74LS79	14.29	74LS323	14.29
74LS80	14.29	74LS324	14.29

**74S/PROMS\***

Part No.	Price	Part No.	Price
74S00	14.29	74S244	14.29
74S01	14.29	74S245	14.29
74S02	14.29	74S246	14.29
74S03	14.29	74S247	14.29
74S04	14.29	74S248	14.29
74S05	14.29	74S249	14.29
74S06	14.29	74S250	14.29
74S07	14.29	74S251	14.29
74S08	14.29	74S252	14.29
74S09	14.29	74S253	14.29
74S10	14.29	74S254	14.29
74S11	14.29	74S255	14.29
74S12	14.29	74S256	14.29
74S13	14.29	74S257	14.29
74S14	14.29	74S258	14.29
74S15	14.29	74S259	14.29
74S16	14.29	74S260	14.29
74S17	14.29	74S261	14.29
74S18	14.29	74S262	14.29
74S19	14.29	74S263	14.29
74S20	14.29	74S264	14.29
74S21	14.29	74S265	14.29
74S22	14.29	74S266	14.29
74S23	14.29	74S267	14.29
74S24	14.29	74S268	14.29
74S25	14.29	74S269	14.29
74S26	14.29	74S270	14.29
74S27	14.29	74S271	14.29
74S28	14.29	74S272	14.29
74S29	14.29	74S273	14.29
74S30	14.29	74S274	14.29
74S31	14.29	74S275	14.29
74S32	14.29	74S276	14.29
74S33	14.29	74S277	14.29
74S34	14.29	74S278	14.29
74S35	14.29	74S279	14.29
74S36	14.29	74S280	14.29
74S37	14.29	74S281	14.29
74S38	14.29	74S282	14.29
74S39	14.29	74S283	14.29
74S40	14.29	74S284	14.29
74S41	14.29	74S285	14.29
74S42	14.29	74S286	14.29
74S43	14.29	74S287	14.29
74S44	14.29	74S288	14.29
74S45	14.29	74S289	14.29
74S46	14.29	74S290	14.29
74S47	14.29	74S291	14.29
74S48	14.29	74S292	14.29
74S49	14.29	74S293	14.29
74S50	14.29	74S294	14.29
74S51	14.29	74S295	14.29
74S52	14.29	74S296	14.29
74S53	14.29	74S297	14.29
74S54	14.29	74S298	14.29
74S55	14.29	74S299	14.29
74S56	14.29	74S300	14.29

**CA—LINEAR\***

Part No.	Price	Part No.	Price
CA300N	14.29	CA3130N	14.29
CA301N	14.29	CA3140N	14.29
CA302N	14.29	CA3150N	14.29
CA303N	14.29	CA3160N	14.29
CA304N	14.29	CA3170N	14.29
CA305N	14.29	CA3180N	14.29
CA306N	14.29	CA3190N	14.29
CA307N	14.29	CA3200N	14.29
CA308N	14.29	CA3210N	14.29
CA309N	14.29	CA3220N	14.29
CA310N	14.29	CA3230N	14.29
CA311N	14.29	CA3240N	14.29
CA312N	14.29	CA3250N	14.29
CA313N	14.29	CA3260N	14.29
CA314N	14.29	CA3270N	14.29
CA315N	14.29	CA3280N	14.29
CA316N	14.29	CA3290N	14.29
CA317N	14.29	CA3300N	14.29
CA318N	14.29	CA3310N	14.29
CA319N	14.29	CA3320N	14.29
CA320N	14.29	CA3330N	14.29
CA321N	14.29	CA3340N	14.29
CA322N	14.29	CA3350N	14.29
CA323N	14.29	CA3360N	14.29
CA324N	14.29	CA3370N	14.29
CA325N	14.29	CA3380N	14.29
CA326N	14.29	CA3390N	14.29
CA327N	14.29	CA3400N	14.29
CA328N	14.29	CA3410N	14.29
CA329N	14.29	CA3420N	14.29
CA330N	14.29	CA3430N	14.29
CA331N	14.29	CA3440N	14.29
CA332N	14.29	CA3450N	14.29
CA333N	14.29	CA3460N	14.29
CA334N	14.29	CA3470N	14.29
CA335N	14.29	CA3480N	14.29
CA336N	14.29	CA3490N	14.29
CA337N	14.29		



**Commodore Accessories**



**RS232 Adapter for VIC-20 and Commodore 64**

The JE232CM allows connection of standard serial RS232 printers, modems, etc. to your VIC-20 and C-64. A 4-pole switch allows the inversion of the 4 control lines. Complete installation and operation instructions included.  
• Plugs into User Port • Provides Standard RS232 signal levels • Uses 6 signals (Transmit, Receive, Clear to Send, Request to Send, Data Terminal Ready, Data Set Ready).  
**JE232CM . . . . . \$39.95**

**VOICE SYNTHESIZER FOR COMMODORE VIC-20 AND C-64**  
Plug-In - Talking in Minutes!  
**JE520CM . . . . . \$99.95**

**TRS-80 Accessories**



**MPI 5 1/4" DISK DRIVE**  
• Use as a second disk drive • Single-density • Single/double density • Full-height drive • 48 TPI • Documentation included • Weight: 3.7 lbs.

**MPI51S . . . \$89.95 or 2 for \$159.95**

**EXPAND TRS-80 MEMORY TRS-80 MODEL I, III**

Each Kit comes complete with eight MMS250 (UPO164116) 16K Dynamic RAMs and documentation for conversion. Model 1: 16K equipped with Expansion Interface can be expanded to 48K with 2 Kits. Model III: Can be expanded from 16K to 48K using 2 Kits. Each Kit will expand computer by 16K increments.

**TRS-16K3 200ns (Model III) . . . . . \$6.29**  
**TRS-16K4 250ns (Model I) . . . . . \$5.49**

**TRS-80 COLOR AND COLOR II**

Easy to install Kit comes complete with 8 each 4164N-20 (200ns) 64K Dynamic RAMs and documentation for conversion. Converts TRS-80 Color Computers with D, E, ET, F and NC circuit boards to 32K. Also converts TRS-80 Color Computer II to 64K. Flex DOBS or OS-9 required to utilize full 64K RAM on all computers.

**TRS-64K-2 . . . . . \$17.95**

**TRS-80 MODEL IV & 4P**

Easy to install Kit comes complete with 8 each 4164N-20 (200ns) 64K Dynamic RAMs and conversion documentation. Converts TRS-80 Model IV computers from 16K to 64K. Also expands Model 4P from 64K to 128K.

**TRS-64K-2 . . . . . \$17.95**

**TRS-64K2PAL (Model IV only) . . . . . \$38.95**  
(8 - 4164's with PAL Chip to expand from 64K to 128K)

**• TRS-80 Model 100\* • NEC • Olivetti**  
\*ALSO COMPATIBLE WITH NEC PC-8201A AND OLIVETTI M10  
Easy to install module plugs right into the socket increasing memory in 8K increments. Complete with module and documentation for conversion.  
**M1008K (TRS-80 Model 100 Expansion) . . . . . \$49.95**  
**NEC8KR (NEC PC-8201A & Olivetti M10) Please Specify \$49.95**

**PROMETHEUS MODEMS**

**Intelligent 300/1200 Baud Modem with Real Time Clock/Calendar**

The ProModem™ is a Bell 212A (300/1200 baud) intelligent stand-alone modem. Full featured expandable modem. Standard features include Auto Answer and Auto Dial, Help Commands, Programmable Intelligent Dialing, Touch Tone™ & Pulse Dialing and More. Hayes command set compatible, plus an additional extended command set. • Shown w/alphanumeric display option.

**PM1200 RS-232 Stand-Alone Unit. . . . . \$319.95**

**OPTIONS FOR ProModem 1200**

**PM-COM (ProCom Communication Software) . . . . . \$79.95**  
Please specify Operating System.  
**PM-OP (Options Processor) . . . . . \$79.95**  
(Options Processor Memory - 18K) . . . . . \$ 4.50  
**PMO-16K (Options Processor Memory - 16K) . . . . . \$ 4.00**  
**PMO-32K (Options Processor Memory - 32K) . . . . . \$ 5.00**  
**PMO-64K (Options Processor Memory - 64K) . . . . . \$18.00**  
**PM-ALP (Alphanumeric Display) . . . . . \$79.95**

**PM-Special (incl. Options Processor, 64K Memory and Alphanumeric Display) . . . . . \$169.95**

**SALE! • MONITORS • SALE!**

**12" Monochrome Green Monitor for APPLE II, II+, IIe and IIC\***



Also compatible with other computer systems.  
**FEATURES:**  
• 75 sq. in. viewing screen  
• High resolution display  
• 80 character x 24 line display format  
• LED power indicator  
• Attractive, computer-matched styling  
• Brightness control  
• Easy access controls in back of unit  
• Complete with tilt/swivel monitor stand

• Input signal: composite video  
• Input impedance: 75 Ohm -  
• 1000 x 800 resolution  
• 12° 90 degree deflection green  
• 35W • Weight: 20 lbs.

**MON-12G . . . . . \$79.95**

**Muffin-Style and Sprite Style Fans**

**MUF60 (4.68" sq, 80cmm) . . . . . \$ 9.95**  
**PWS2107F (3.125" sq, 32cmm) . . . . . \$14.95**

**\*\*\*\*\* APPLE Accessories \*\*\*\*\***



**APPLE\* Compatible CARDS**

**16K RAM Card (Language Card)**

The ARC-16K RAM Card allows the Apple® II and II+ computers to expand from 48K to 64K. Complete with instructions. Key: (a)

**ARC-16K . . . . . \$39.95**

**Z-80 CP/M Card**

The AZ80-1 is Soft-card compatible. Used with CP/M related programs. Software not included. Key: (a,b)

**AZ80-1 . . . . . \$49.95**

**EPROM Burner Card**

The AEB-2 allows user to program and work with standard EPROMs (2716, 2732 & 2764). Easy to use, on-board firmware. Menu contains the following options: Write, Read, Copy, Compare, Blank-Check and Monitor. Complete with instructions. Key: (a,b)

**AEB-2 . . . . . \$69.95**

**80-Column Card w/Soft Switch**

The A80-C is an 80-column card designed for the Apple® II and II+ computers. The card is equipped with a soft switch which allows easy hookup for any monitor. The A80-C also features inverse video capabilities. This card is similar to the Videx™ 80 column card. Complete with instructions. Key: (a)

**A80-C . . . . . \$74.95**

**Super Serial Card**

The ASSC-P is a serial card with a printer mode. It generates standard RS-232C signals and is similar to the Apple® Super Serial Card. Complete with instructions. Key: (a,b)

**ASSC-P . . . . . \$99.95**

**Parallel Graphics Printer Card w/64K Buffer**

The APC-64K is a parallel graphics printer card with a 64K buffer and graphic dump capabilities. Complete with instructions. Key: (a,b)

**APC-64K . . . . . \$129.95**

**80-Column/64K RAM Card**

Extended 80-Column/64K RAM Card expands memory by 64K to give 128K when used with programs like VisiCalc™. Complete with instructions. Key: (b)

**JE864 . . . . . \$79.95**

\*APPLE, APPLE II, II+, IIe, IIC and Macintosh are registered trademarks of APPLE Computers  
\*VisiCalc is a registered trademark of Visi Corp. Inc. \*Videx is a registered trademark of Videx Inc.

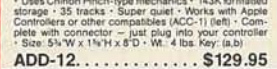

**APPLE™ Compatible 5 1/4" Half-Height Disk Drive**  
• Uses Shugart SA390 mechanics • 143K formatted storage • 35 tracks • Super quiet • Works with Apple Controllers or other compatibles (ACC-1) (left) • Complete with connector - just plug into your controller  
• Size: 5 1/4" x 1 1/4" x 1 1/2" • Wt.: 4 lbs. Key: (a,b)

**APPLE™ Compatible 5 1/4" Disk Drive & Controller Card**  
• Uses Shugart SA390 mechanics • 143K formatted storage • Color matches Apple Computer • Works with Apple Controller or other Apple-compatible controllers (ACC-1) • Complete with connector - just plug into your disk controller card - 35 tracks • Size: 6" W x 3 1/4" H x 8-9/16" D • Wt.: 4 lbs. Key: (a,b)

**ADD-514 (Disk Drive) . . . . . \$149.95**

**ACC-1 (Controller Card) . . . . . \$ 49.95**

**ADD-12 . . . . . \$129.95**

**ADD-1Ic . . . . . \$129.95**

**Additional Apple\* Compatible Products**

**APF-1** Cooling Fan with surge protection • Key: (a,b) . . . . . \$ 39.95  
**JE164** Numeric/Aux. Keypad - 23 accessible functions • Key: (b) . . . . . \$ 49.95  
**EAEC-1** Expanded Apple Enclosure Case only • Key: (a) . . . . . \$ 59.95  
**KHP4007** Switching Power Supply • Key: (a) . . . . . \$ 59.95  
**KB-A68** 68-Key Apple Keyboard only • Key: (a) . . . . . \$ 79.95  
**MON-12G** 12" Green Monitor with swivel stand • Key: (a, b & I/c) . . . . . \$ 79.95  
**JE520AP** Voice Synthesizer - Plug-in, User Ready • Key: (a,b) . . . . . \$119.95  
**KB-EA1** Apple Keyboard and Case • Key: (a) . . . . . \$134.95  
**PM1200A** Prometheus Internal Modem - 2 cards • Key: (a,b) . . . . . \$299.95  
**PM1200M** Prometheus Macintosh Ext. Modem • Key: (Macintosh) . . . . . \$369.95

**General Application Power Supplies**

**Power/Mate Corp. REGULATED POWER SUPPLY**  
• Input: 105-125/210-250VAC @ 47-63Hz • Line regulation: ±0.05% • Three mounting surfaces • Over-voltage protection • UL recognized • CSA certified

Part No.	Output	Size	Weight	Price
EMA5/6B	5V@3A/6V@2.5A	4 1/2" L x 4" W x 2 1/2" H	2lbs.	\$29.95
EMA5/6C	5V@6A/6V@5A	5 1/2" L x 4" W x 2 1/2" H	4lbs.	\$39.95

**KEPCO/TDK 4-OUTPUT SWITCHING POWER SUPPLY**  
• Ideal for disk drive needs of CRT terminals, microcomputers and video games • Input: 115/230VAC, 50/60Hz • Output: +5V @ 5A, +12V @ 1.8A, +12V @ 2A, -12V @ 0.5A • UL recognized • CSA certified • Size: 7 1/2" L x 6-3/16" W x 1 1/4" H • Weight: 2 lbs.

**MRM 174KF . . . . . \$49.95**

**4-CHANNEL SWITCHING POWER SUPPLY**  
• Microprocessor, mini-computer, terminal, medical equipment and process control applications • Input: 90-130VAC, 47-440Hz • Output: +5VDC @ 5A, -5VDC @ 1A, +12VDC @ 1A, -12VDC @ 1A • Line regulations: ±0.2% • Ripple: 30mV p-p • Load regulation: ±1% • Overcurrent protection • Adj. 5V main output = 10% • Size: 6 1/2" L x 1 1/2" W x 4-15/16" H • Weight: 1 1/2 lbs.

**FCS-604A . . . . . \$69.95**

\$10 Minimum Order - U.S. Funds Only CA Residents: Add 6 1/2% Sales Tax Shipping: Add 5% plus \$1.50 Insurance Send \$1 Postage for FREE 1985 Jameco Catalog Prices Subject to Change Send stamped, self-addressed envelope to receive a Monthly Sales Flyer - FREE!



1355 SHOREWAY ROAD, BELMONT, CA 94002  
8/85 PHONE ORDERS WELCOME - (415) 592-8097 - Telex: 176043

**IBM Accessories**



**8-Foot Parallel Printer Cable IBM-8PC (DB25 Male to Centronics 36-pin Male) . . . . . \$19.95**

**6-Foot Serial Printer/Modem Cable MMS-2206 (DB25 Male to DB25 Male) . . . . . \$14.95**  
**MFS-2206 (DB25 Male to DB25 Female) . . . . . \$15.25**

**5-Foot Keyboard Extension Cable for IBM-PC and XT Computers IBM-KEC . . . . . \$9.95**

**MEMORY EXPANSION KITS**

**IBM PC, PC XT and Compatibles**  
The IBM64K Kit will increase memory in 64K byte increments. The Kit is simple to install - just insert the 9 - 64K RAM chips in the provided sockets and set the 2 groups of switches. Conversion documentation included.

**IBM64K (Nine 200ns 64K RAMs) . . . . . \$19.95**

**IBM PC AT**

Each kit comes complete with nine 128K dynamic RAMs and documentation for conversion.

**IBM128K (Nine 250ns 128K RAMs) . . . . . \$133.95**

**IBM PCXT Equivalent 130 Watt Power Supply UPGRADE YOUR PC!**

• Input: 110V @ 60Hz • Output: +5VDC @ 15A, -5VDC @ 0.5A, +12VDC @ 4.2A, -12VDC @ 0.5A • Plug compatible connectors • Fits into IBM PC • Weight: 6 lbs.

**IBM-PS . . . . . \$159.95**

**Prometheus Modems**

The ProModem 1200B/BS is a 1200/300 baud modem card which plugs into IBM PC and XT. Provides a third serial comport. Two versions available: 1200B (without software) and 1200BS (with software). The PM1200BS is supplied with powerful MITE communications software from Mycroft Labs.

**PM1200B (without Software) . . . . . \$239.95**  
**PM1200BS (with MITE Software) . . . . . \$274.95**

**IBM Compatible! DISK DRIVES**



**Documentation Included**

**RFD480 (Remex 5 1/4" DS full-ht.) . . . . . \$ 89.95**  
**FD55B (Teac 5 1/4" DS half-ht.) . . . . . \$139.95**  
**SA455 (Shugart 5 1/4" DS half-ht.) . . . . . \$139.95**  
**TM100-2 (Tandon 5 1/4" DS full-ht.) . . . . . \$159.95**

**5 1/4" DISK DRIVE ENCLOSURES**

Complete with power supply, switch, power cord, fuseholder and connectors

**DDE-1FH (Houses 1 full-ht. 5 1/4" drive) . . . . . \$69.95**  
**DDE-2HH (Houses 2 1/2-ht. 5 1/4" drives) . . . . . \$79.95**

**General Application Keyboards**

**Mitsumi 54-Key Unencoded All-Purpose Keyboard**

• SPST keyswitches • 20 pin ribbon cable connection • Low profile keys • Features: cursor controls, control, caps (lock), function, enter and shift keys • Color (key-caps): grey • Weight: 1 lb. • Pinout incl. • Size: 13 1/2" L x 4 1/4" W x 1 1/4" H

**KB54 . . . . . \$14.95**

**74-Key ASCII Cherry Keyboard**

• 7-bit parallel ASCII • Full Upper Case, Full Lower Case except l, m, n, o and p • Cursor keypad • SPST mechanical keyswitches • 26-pin header connector • Color: white • Size: 18" L x 6 1/4" W x 1 1/4" H • Spec included

**KB8201 . . . . . (1700 available) . . . . . \$29.95**

**UV-EPROM ERASER**

**8 Chips - 21 Minutes**



**1 Chip - 15 Minutes**

Erases all EPROMs. Erases up to 8 chips within 21 minutes (1 chip in 15 minutes). Maintains constant exposure distance of one inch. Special conductive foam liner eliminates static build-up. Built-in safety lock to prevent UV exposure. Compact - only 9.00" L x 3.70" W x 2.60" H. Complete with holding tray for 8 chips.

**DE-4 UV-EPROM Eraser . . . . . \$74.95**  
**UVS-11EL Replacement Bulb . . . . . \$16.95**



# Parts

**TOLL FREE**  
**800-854-8230**  
Calif. Residents  
**714-558-8813**

## OUR POLICY

- No surcharge for VISA or Mastercard.
- No sales tax. • All shipments insured.
- Your card is Not charged until we ship.
- Same day FEDEX shipment is available.
- Volume purchasing agreements available.
- Government agencies, corporate and Institutional PO's accepted.
- Orders subject to availability.
- All items have manufacturer warranty. Some warranties up to 5 years.
- Pricing subject to change w/o notice.
- Returns or cancellations may be subject to restocking fee.
- ACP Retail Store pricing may vary.
- We are not responsible for typos.

### UPS POWER SUPPLY

Back Up Power for your IBM, Apple or Compatible  
UPS-PC 200 Watts \$277.00  
UPS-ST 425 Watts 455.00  
UPS-AT 1000 Watts 975.00

### A-B PRINTER SWITCH

An AB Switch allows use of two printers with your computer system. We stock over 15 different configurations.  
AB Switch (Centronics) \$59.00  
AB Switch (DB25) 59.00

### COLOR VIDEO CARDS

Planitronica Color Plus \$375.00  
IBM Color Card 227.00  
IBM Mono Card w/parallel 218.00  
5TB Graphics Plus 389.00  
Starbit Multiplay Card 345.00  
Evers Graphics Edge 345.00

### SPECIAL BUY

Shugart SA 4004 14" 28MB Hard Disk  
**\$499.00**

### DRIVE CABINETS

IBM Style Hard disk with power supply and fan \$195.00  
Dual Hard Disk w/zipper sup & fan 295.00  
Dual 5 1/4" Full Height vertical mount 85.00  
Dual 5 1/4" Full Height horizontal mount 99.00  
Dual 5 1/4" Thinline w/zipper sup & fan 80.00  
Single 5 1/4" Full Height w/zipper sup & fan 60.00  
Single 5 1/4" Thinline w/zipper sup & fan 60.00

### PERYSYST CARDS

Persyst Mono Combo - NEW! \$335.00  
Persyst Color Combo - NEW! 335.00  
Persyst Bob Board 445.00  
Persyst Shortport Color Call  
Persyst Mini Mono Call  
Persyst + 1 Time Spectrum w/64K 179.95  
Persyst 192K Rainbow DEC Card 149.95

### MODEM SPECIAL

Hayes Smartmodem Compatible  
1200 Baud. External. Sold for 399.00  
**\$219.00**

### INTERISL STD-BUS BOARDS

IBS3100 280 CPU LIST AC90  
IBS3101 280 Univ. CPU 200 69.95  
IBS3110 6808 CPU 200 79.95  
IBS3216 16K CMOS RAM 810 99.95  
IBS3218 16K Static RAM 200 39.95  
IBS3220 16K CMOS RAM 710 119.95  
IBS3330 280 PIC (D mounting) 210 49.95  
IBS3331 Universal PIC 240 49.95  
IBS3340 Opto Para. Input 300 119.95  
IBS3400 Floppy Controller 215 79.95  
IBS3410 SAS (DMA) W/BI Inter. 285 99.95  
IBS3500 Trac 210 99.95  
IBS3510 Opto-In Input 275 119.95  
IBS3520 SPET Relay 150 69.95  
IBS3521 DPDT Relay 190 89.95  
IBS3600 Arithmetic 375 149.95  
IBS3610 EPROM Programmer 240 79.95  
IBS3700 Sync/Async 265 69.95  
IBS3711 Univ. Sync/Async 245 69.95  
IBS3720 REMOADCs 315 149.95  
IBS3800 12 Bit AD 720 209.95

### TRANSISTORS/DIODES

PN2222A 795.00 1N3904 1181.00  
PN2369A 511.00 1N3906 1111.00  
PN918 311.00 TIP29A 271.00  
2N2128A 45 TIP30A 211.00  
2N2219A 45 TIP31A 211.00  
2N2905 45 TIP32A 211.00  
2N2907 25 1N4148 251.00  
2N3055 69 1N751 51.00  
2N3638 41/0 1N4002 121.00  
2N3638 41/0 1N4004 101.00  
2N3772 1.69 1MPO2222 1.49

### OPTO ISOLATORS

MCT-2 5.59 4N33 5.89  
MCT-6 1.39 4N35 1.25  
MCT-66 5.59 4N37 1.25  
MCA-255 1.69 1N4002 1.21  
4N25 65 TIL117 79  
4N27 65 SP5K3 29  
4N28 69 4N25 51.00

### LED LAMPS

1-99 100  
Jumbo Red \$ .99 \$ .89  
Jumbo Green 17 49  
Jumbo Yellow 17 15  
Mini Size Red 10 09  
Mini Size Green 19 16  
Mini Size Yellow 19 16

### SPECIAL VALUES!

MC8M805 EPROM NEW! 89.95  
6116201E-150mS 1019.95  
DB-25P Male 1019.95  
DB-25P Female 1029.50  
2732A-2 1029.50  
2716C-450mS 1024.50  
2764-450mS 1029.95

### CALL ACP FOR ALL YOUR VOLUME IC REQUIREMENTS

### CAPACITORS

01uF DISC BYPASS CAPACITOR 100055.50  
1 uF DISC BYPASS CAPACITOR 100016.50  
01uF MONOLITHIC CAPACITOR 100012.50  
1 uF MONOLITHIC CAPACITOR 100014.25

### CORCOM EMI FILTER

STD CORCOM 3 Conductor Filter \$4.50  
Line Cord & Connector - 6 foot 1.49  
Line Cord & Connector - 8 foot 1.49  
Line Cord & Connector - 6 foot 1.49

### MUFFIN FANS

Over 10,000 In Stock  
Torn 3" TA200 Fan NEW! 89.95  
Line Cord 4.68" Muffin Fan NEW! 12.95  
12VDC Fan NEW! 19.95  
Finger Guards added 1.49  
Power Cords added 1.49

### IC SOCKETS

SOLDERTAIL 1-99 100  
8 Pin STLP \$ 1.13 \$ 1.10  
14 Pin STLP 15 11  
18 Pin STLP 17 12  
24 Pin STLP 20 19  
28 Pin STLP 23 22  
22 Pin STLP 28 27  
24 Pin STLP 29 27  
28 Pin STLP 33 32  
38 Pin STLP 45 36  
40 Pin STLP 48 42  
64 Pin STLP 64 3.25

### EDGE CONNECTORS

5-100 ST 1-99 100  
5-100 WW 4.75 4.10  
44 Pin ST 2.75 2.60  
44 Pin WW 4.75 4.25  
72 Pin ST 6.50 6.10  
72 Pin WW 7.25 6.95

### D-SUBMINIATURE

DB25S (Female) 1-24 25  
DB25M (Male) \$3.10 \$2.90  
Mtg Hdw 5.25 5.75  
DB37P (Male) 5.25 5.10  
Mtg Hdw 5.99 5.99  
DO20S (Female) \$8.95 \$8.65  
DO50P (Male) 6.00 5.75  
Mtg Hdw 5.99

### WIREWRAP (GOLD)

8 Pin WW/L 5.49 5.40  
14 Pin WW/L 6.22 6.49  
18 Pin WW/L 6.55 6.55  
20 Pin WW/L 38 77  
22 Pin WW/L 38 77  
24 Pin WW/L 1.25 1.17  
28 Pin WW/L 1.49 1.39  
40 Pin WW/L 1.89 1.75

### TEXT/DZIF ZERO INSERTION

16 Pin 56 75 24 Pin \$7.85 28 Pin \$8.95  
(We Stock All Types of Sockets)

### IDC CONNECTORS

IDC TYPE	ACP NO	NUMBER OF CONTACTS					
		10	20	26	34	40	50
Solder Header	IDHxS	.79	1.20	1.65	2.10	2.40	3.00
Rt Angle Solder Header	IDHxSR	.79	1.20	1.65	2.10	2.40	3.00
Ribbon Header Socket	IDxSx	.75	.95	1.35	1.50	1.85	2.10
Ribbon Header	IDMxx	—	5.25	5.95	6.75	7.25	8.25
Ribbon Edgecard	IDExx	1.70	2.15	2.50	2.60	3.70	3.95
Wirewrap Header	IDHxW	1.80	2.90	3.75	4.25	4.95	6.50
Rt Angle WW Header	IDHxWR	1.99	3.10	4.10	4.20	4.60	7.15

NOTE: To order insert number of contacts in place of xx in ACP part number.  
ORDER QUANTITY OF 50pcs (mixed) AND TAKE AN ADDITIONAL 10% OFF.

### OKIDATA PRINTERS

Okidata 20 Color Printer \$139.00  
Plug-N-Print for Okidata 20 69.00  
Okidata 182 (120cps, Graphics) 259.00  
Okidata 192 (160cps, Graphics) 259.00  
Okidata 193 (160cps, 15" Paper) 549.00  
Okidata 92 (160cps, Graphics) 249.00  
Okidata 93 (160cps, 15" Paper) 249.00

### OKIDATA PRINTERS

Okidata 84 (200cps, Parallel) \$799.00  
Okidata 84 (200cps, Serial) 949.00  
Tractor for Okidata 192 44.00  
Tractor for Okidata 92 54.00  
2K Serial Board for Okidata 192/193 69.00  
3K Serial Board for Okidata 92/93 99.00  
Extra Ribbon 5.00

### 8800

8800A 519.95 6810 5 2.85 8850 5 3.25  
8800B 10 39.95 6820 3 7.75 8860 5 3.95  
8800C 2.90 6821 2.90 8870 5 3.95  
8802 7.75 6828 14.50 8875 6 7.5  
8803 18.95 6840 12.75 8880 2.20  
8809E 9.50 8845 11.95 89047 22.95

### 6500

6502 54.50 6504 36.75 6522 55.25  
6505A 4.90 6507 9.75 6532 37.95  
6502B 9.50 6508 4.25 6551 11.50

### 8000

8035 5 3.75 8214 5 3.75 8259 6 6.75  
8039 5 7.75 8216 1.95 8271 69.95  
8000A 2.95 8224 2.20 8275 29.95  
8005A 4.90 8226 1.95 8279 6 7.5  
8006A 8.95 8228 3.40 8282 5.25  
8008 24.50 8237 13.75 8283 6.25  
8007-2 129.95 8237-5 15.95 8284 5.40  
8008 17.50 8238 4.25 8285 6.45  
8009 88.95 8243 3.90 8287 6.45  
8155 6 7.5 8250 10.50 8288 11.99  
8156 6 7.5 8251 1.25 8289 44.95  
8155 26.95 8251A 5.95 8292 12.95  
8202 33.95 8253 6.75 8741 27.95  
8203 27.95 8255 4.25 8748 24.50  
8205A 3.25 8256A 3.25 8750 24.50  
8212 1.95 8257 5.75 8755A 34.95

### Z-80

2.5MHz "A" 4.0MHz "B" 6.0MHz

Z80-CPU 2.25 2.75 3.75 6.25  
Z80-DART 2.50 3.75 6.25 17.95  
Z80-DMA 8.95 8288 3.40 8282 5.25  
Z80-PIO 2.95 3.50 9.50 9.50  
Z80-SIO/0 1.95 9.50 22.95  
Z80-SIO/1 8.50 9.50 22.95  
Z80-SIO/2 8.50 9.50 22.95  
Z80-SIO/3 8.50 9.50

### DISK CONTROLLERS

28030 34.95 28001 34.95 28132 53.95  
28530 54.95 28002 54.95 28671 37.95

### DISK CONTROLLERS

UPD78524.95 1797 521.95 6843 529.95  
1771 15.95 2791 32.95 8272 19.95  
1791 22.75 2792 32.95 8274 19.95  
1793 21.50 2793 32.95 8274 19.95  
1795 21.50 2797 27.95 8216 12.95

### CRT CONTROLLERS

6845 811.95 8275 328.50 TM59918 539.50  
6845 17.95 7220 34.95 8350 39.95  
6847 11.50 9027 17.95 8545 14.95  
46505 14.75 5037 21.95 8002 10.95  
88047 19.50 NEC7220 Graphics 34.95

### UARTS/UARTS

1602B 33.95 2350 5.85 UM603 6 6.75  
1013A 3.95 8250 10.50 TM55501 14.95  
1015A 6.75 IM0402 7.75 2651 6.95

### EPROMS

1702 (1mS) 5.50 2732A-4 (450mS) 5 4.50  
2708 (450mS) 3.65 2732A (250mS) 8.95  
2758 (5V) 3.50 2732A-2 (200mS) 8.95  
2716 (450mS) 3.75 2764 (450mS) 4.50  
2716 (300mS) 5.50 2764 (250mS) 6.50  
2716 (150mS) 5.50 2764 (200mS) 8.50  
2716 (75mS) 5.50 2764 (150mS) 8.50  
2732 (450mS) 4.60 MCM8974A (450mS) 19.95  
2732 (300mS) 5.60 MCM8976 (350mS) 21.95  
2732 (150mS) 6.50 MCM8976 (150mS) 21.95  
2732 (75mS) 6.00 2712B (250mS) 15.95

### CMOS EPROMS

27C16 27C32 27C32 89.95  
27C16 89.95 27C64 12.95

### STATIC RAMS

2101 (450mS) 81.88 MK4118 54.95  
21102 (450mS) .99 TMM2016-2 (200mS) 3.10  
2102-1 (450mS) .79 TMM2016-1 (150m) 3.95  
21102-2 (200mS) 1.39 TMM2016-1 (100mS) 3.00  
2111 (450mS) 2.75 HM6116P-4 (200mS) 5.25  
2112 (450mS) 2.75 HM6116P-3 (150mS) 3.25  
2114 (450mS) 1.45 80550 HM6116P-2 (120mS) 5.75  
2114-L4 (450m) 1.69 80120 HM6116P-4 (LP) 3.95  
2114-L3 (200m) 1.79 80130 HM6116P-3 (LP) 3.95  
2114-L2 (200m) 1.89 80130 HM6116P-2 (LP) 3.95  
2147 (85mS) 4.50 28132 (200mS) 82.95  
4044-4 (450mS) 3.25 HM6264P-1 (150) 14.95  
4044-3 (300mS) 3.75 HM6264P-1 (LP) 16.95  
4044-2 (200mS) 4.25 745189 (25mS) 32.95  
UPD410 (100mS) 3.75 93415 (20mS) 3.95  
5101 (CMOS) 3.50 93425 (20mS) 3.95

### DYNAMIC RAMS

4027 (250mS) 51.29 TMS4408 (200mS) 58.95  
1103 (300mS) 79 TMS4418 (150mS) 57.75  
4118A-2 (150mS) 1.29 80 935 41256-10 (150m) 9.95  
4118N-2 (200mS) 1.19 80 935 41256-20 (200m) 7.99  
4118N-4 (250mS) 80 935 41256-40 (300mS) 1.85  
4164N-150 (150m) 1.59 91115 TMS4000 (300mS) 1.85  
4164N-200 (200m) 1.49 91010 MMS280 (300mS) 1.85  
4164N-120 (120mS) 6.25 UPD411 (200mS) 1.85  
TMS4164 (150mS) 5.95 MMS288 (250mS) 1.85

### DISK SPECIAL (IBM PC DSD)

\$1.00 "IBM PC" DSD  
EACH 100 Rings  
PACKAGE 1/2" Trvc Cover Supply Limited  
OF 25 Major Mfg.

### 5 1/4" DISKETTES

VERBATIM 525-01 S/SD 32.95 119.95  
VERBATIM 550-01 DSD/D (BM) 27.95 34.95  
MAXELL MD-1 S/SD (AR) 19.95 17.95  
MAXELL MD-2 DSD/D (BM) 24.95 22.95  
MAXELL MD-2 S/SD (AR) 46.95 43.95  
DYSAK 1041D S/SD (AR) 39.95 36.95  
DYSAK 1042D DSD/D (BM) 34.95 31.95  
ACP S/SD (AR) 14.95 12.95  
ACP DSD/D (BM) 37.95 29.95  
VERBATIM 5 1/4" MP-350 (MAC) 30.00 29.00  
MAXELL 3 1/2" MICROFLOPPY (MAC) 30.00 31.00

### 8 1/2" DISKETTES

VERBATIM 8 1/2" S/SD 38.95 26.95  
VERBATIM 8 1/2" DSD/D 27.95 32.95  
DYSAK 8 1/2" S/SD 39.95 37.95  
DYSAK 8 1/2" DSD/D 42.95 47.95

### 5 1/4" DISK TUB

\$8.95 \$14.95 \$9.95

### CMOS

4000 5 26 4003 5 65 4009 57.00 4505 8.95  
4001 22 4029 75 4060 85 4506 1.10  
4002 22 4030 35 4066 39 4507 1.10  
4006 79 4031 3.25 4068 28 4508 1.90  
4007 22 4032 2.15 4070 35 4510 7.79  
4008 95 4034 1.91 4071 28 4511 7.79  
4009 89 4035 79 4072 28 4512 7.79  
4010 30 4037 1.95 4073 28 4514 1.18  
4011 24 4040 75 4075 28 4515 1.79  
4012 35 4041 89 4081 29 4555 1.95  
4013 35 4042 65 4077 35 4518 8.95  
4014 75 4043 85 4078 25 4520 7.75  
4015 39 4044 89 4081 29 4555 1.95  
4016 35 4046 80 4082 29 4556 9.95  
4017 65 4047 89 4085 95 4566 1.35  
4018 79 4048 99 4086 95 90C95 1.50  
4019 39 4049 35 4093 45 90C97 4.99  
4020 69 4050 34 4094 2.95 MC14408 12.95  
4021 69 4051 75 4098 1.90 MC14409 12.95  
4022 69 4052 75 4099 1.85 MC14410 9.95  
4023 25 4053 75 4501 69 MC14411 11.95  
4024 29 4054 3.95 4502 95 MC14412 12.95  
4025 25 4056 2.95 4503 49 MC14413 4.95

### 74000

74000 29 74C74 8.15 74C161 11.15 74C373 23.35  
74002 29 74C85 1.89 74C175 1.15 74C374 2.35  
74003 29 74C11 1.15 74C242 1.15 74C375 1.15  
74008 35 74C93 1.15 74C244 1.89 74C922 4.45  
74C10 35 MORE 74C IN STOCK - ALSO IN CATALOG

### LINEAR

LM105AH \$3.95 NE590 32.45 LM3509 96  
LM300H 99 NE520 74 LM3914 32.95  
LM301N 35 LM709N 55 LM3915 2.95  
LM301H 1.89 LM709H 1.90 LM3916 2.95  
LM302 1.95 LM710 89 MCM4024 3.75  
LM302H 4.75 LM711 75 MCM4044 3.75  
LM307N 40 LM715 3.95 RKA431 3.75  
LM723N 65 LM723N 65 RKA136 1.79  
LM1310N 1.65 LM723H 75 RKA151 3.75  
LM1310C 62 LM733 98 CA3023 2.75  
LM1312 7.75 LM739 1.85 CA3028 1.25  
LM1318N 1.45 LM741N 33 CA3029 1.85  
LM1318H 1.55 LM741H 29 CA3029 2.85  
LM1320 1.95 LM741H 29 CA3030 2.85  
LM330N 95 LM748 55 CA3080 1.10  
LM339N 95 LM1014 1.15 CA3081 1.60  
LM340 (see VTR) LM1302 1.90 CA3082 1.60  
LM348N 95 LM1



# MCM ELECTRONICS

WE HAVE WHAT YOU NEED AT  
THE PRICES YOU WANT!

CALL TOLL FREE  
**1-800-543-4330**

(IN OHIO 1-800-762-4315)

(IN HAWAII OR ALASKA 1-800-858-1849)



**TENMA®**  
**DROP PROOF  
DIGITAL  
MULTIMETER**

- DC input impedance 10M ohm
- Shock-mounted LCD display
- Overload protection ■ Auto polarity ■ Backed by our 1-year limited warranty ■ For more specifications see MCM catalog #10, page 122

#72-057 **\$29<sup>95</sup>** each

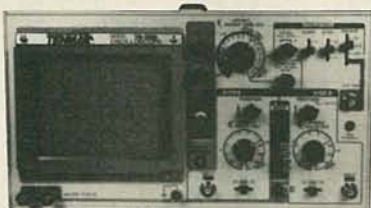

**TENMA®**  
**20 MHZ DUAL TRACE  
OSCILLOSCOPE**

- Two High Quality 10:1 probes included
- Backed by our 2-year limited warranty
- For specifications see MCM catalog #10, page 121

#72-320 **\$389<sup>95</sup>**

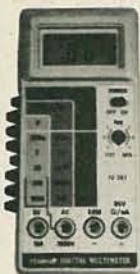

**TENMA®**  
**3 1/2 DIGIT LDC  
MULTIMETER**

- DC input impedance 10M ohm
- Diode and HFE transistor tests
- Overload protection ■ Auto polarity ■ Backed by our 1-year limited warranty ■ For more specifications see MCM catalog #10, page 122.

#72-050 **\$36<sup>80</sup>** (10-up)  
\$39.80 (1-9)



**TENMA®**  
**15 MHZ DUAL TRACE  
BATTERY OPERATED  
OSCILLOSCOPE**

- Two High Quality 10:1 Probes included ■ Backed by our 2-year Limited Warranty ■ Internal rechargeable batteries provide 2 hours of continuous operation without the need for any outside power source. ■ For specifications see MCM Catalog #10, page 121

#72-335 **\$489<sup>95</sup>**



**TENMA®**  
**DIGITAL  
CAPACITANCE  
METER**

- Measures capacitors from 0.1pF to 1999mFd ■ Accuracy 0.5% typical ■ Fuse protected
- Checks capacitors in and out of circuit ■ Backed by our 1-year limited warranty ■ For more specifications see MCM catalog #10, page 122

#72-040 **\$54<sup>95</sup>** (2-up)  
\$59.80 each



**TENMA®**  
**35 MHZ DUAL TRACE  
OSCILLOSCOPE**

- Two High Quality 10:1 probes included
- Backed by our 2-year limited warranty
- For specifications see MCM catalog #10, page 121

#72-330 **\$569<sup>00</sup>**

**HIGH VOLTAGE  
TRIPLER**



- Replaces: ECG® 526, ECG® 523
- Zenith 212-141-021/212-141-031/212-141-04/212-141-05 ■ Two-year warranty

#ERS526A **\$995** (10-up)  
\$12.90 (1-9)

**INFRARED DETECTOR CARD**

- Used for testing TV, VCR and other infrared remote controls ■ Test area will glow pale orange if infrared is present



#72-005 **\$395** (6-up)  
\$4.50 (1-5)

**REPLACEMENT FOCUS DIVIDER  
FOR SANYO AND SEARS**

- Replaces Sanyo Part #ESPA-98-F1 #Z0064
- Also replaces #ESPA 94 and ECG® 568



#33-748 **\$1180** (10-up)  
\$13.95 (1-9)

**BE SURE TO CALL  
FOR YOUR FREE  
132  
PAGE  
CATALOG!  
OVER  
5,000  
ITEMS!**



We have the Largest Selection of Original Japanese Semiconductor in the Country!

**We Also Have**... a full line of test equipment, computer accessories, telephone accessories, speakers, television parts, flybacks, yokes, switches, fuses, lamps, capacitors, resistors, cartridges, styl, wire, CATV equipment, and many more. **Over 5,000 items AT THE LOWEST PRICES AROUND!**

**Terms:**



- \$10 minimum order. \$1.00 charge for orders under \$10.
- \$20 minimum charge card order.
- Orders shipped UPS C.O.D.
- Most orders shipped within 24 hours.
- Sales office open 8:30 am to 7:00 pm. Saturdays 10:00 am to 3 pm. EST.
- For prepaid orders add \$2.75 for shipping and handling.
- Should shipping & handling charges exceed \$2.75, the balance due will be sent C.O.D.



**MCM  
ELECTRONICS**  
858 East Congress Park Drive  
Centerville, Ohio 45459  
513-434-0031

SOURCE NO. RE-12



# PARTIAL LISTING ONLY- PLEASE CALL OR WRITE FOR FREE CATALOG.

## STATIC RAMS

2112	256x4 (450ns)	2.99
2114	1024x4 (450ns)	8/9.95
2114-25	1024x4 (250ns)	8/10.95
2114L-4	1024x4 (450ns)(LP)	8/12.95
2114L-3	1024x4 (300ns)(LP)	8/13.45
2114L-2	1024x4 (200ns)(LP)	8/13.95
TMM2016-200	2048x8 (200ns)	3.25
TMM2016-150	2048x8 (150ns)	3.75
TMM2016-100	2048x8 (100ns)	4.75
HM6116-4	2048x8 (200ns)(cmos)	3.69
HM6116-3	2048x8 (150ns)(cmos)	3.95
HM6116LP-4	2048x8 (200ns)(cmos)(LP)	3.95
HM6116LP-3	2048x8 (150ns)(cmos)(LP)	4.25
HM6264P-15	8192x8 (150ns)(cmos)(LP)	9.75

LP = Low Power

## DYNAMIC RAMS

4116-250	16384x1 (250ns)	8/6.95
4116-200	16384x1 (200ns)	8/8.95
4116-150	16384x1 (150ns)	8/10.95
4164-200	65536x1 (200ns)(5v)	9/10.50
4164-150	65536x1 (150ns)(5v)	9/13.50
TMS4164	65536x1 (150ns)(5v)	4.95
41256-200	262144x1 (200ns)(5v)	5.25
41256-150	262144x1 (150ns)(5v)	5.50

5v = Single 5 Volt Supply

## EPROMS

2708	1024x8 (450ns)	3.95
2716	2048x8 (450ns)(5v)	3.50
2716-1	2048x8 (350ns)(5v)	4.95
TMS2532	4096x8 (450ns)(5v)	4.95
2732	4096x8 (450ns)(5v)	3.95
2732A-4	4096x8 (400ns)(5v)(21vPGM)	4.95
2732A-35	4096x8 (350ns)(5v)(21vPGM)	4.95
2732A	4096x8 (250ns)(5v)(21vPGM)	6.95
2732A-2	4096x8 (200ns)(5v)(21vPGM)	10.95
2764	8192x8 (450ns)(5v)	4.25
2764-250	8192x8 (250ns)(5v)	4.95
2764-200	8192x8 (200ns)(5v)	6.95
27128	16384x8 (250ns)(5v)	7.95
27256	32768x8 (250ns)(5v)	12.95

5v = Single 5 Volt Supply  
21vPGM = Program at 21 Volts

## SPECTRONICS CORPORATION EPROM ERASERS

Timer	Chip Capacity	Intensity (uW/Cm <sup>2</sup> )		
PE-14	9	8,000	83.00	
PE-14T	X	9	8,000	119.00
PE-24T	X	9	9,600	175.00

## 8000

8035	5.95
8039	5.95
8080	3.95
8085	4.95
8085A-2	11.95
8087-3	129.00
8087-6	119.00
8088	19.95
8155	6.95
8155-2	7.95
8156	6.95
8748	24.95
8755	24.95

## 8200

8203	39.95
8205	3.50
8212	1.80
8216	1.75
8228	3.49
8237-5	15.95
8243	4.45
8250	10.95
8251A	4.49
8253	6.95
8253-5	7.95
8255	4.49
8255-5	5.25
8259	6.90
8259-5	7.50
8272	19.95
8275	29.95
8279	6.95
8282	6.50
8284	5.50
8286	6.50
8288	14.95

## Z80

2.5 Mhz

Z80-CPU	2.49
Z80-CTC	2.95
Z80-PIO	2.95
Z80-SIO/0	9.95

4.0 Mhz

Z80A-CPU	2.49
Z80A-CTC	3.95
Z80A-DART	8.95
Z80A-PIO	3.95
Z80A-SIO/0	10.95

6.0 Mhz

Z80B-CPU	8.95
----------	------

## 6500

6502	4.95
6520	2.95
6522	5.49
6532	9.95
6551	9.95
6502A	5.95
6522A	9.95
6551A	11.95

## 6800

68000-8	39.95
6800	2.95
6802	7.95
6809	8.95
6809E	8.95
6821	2.95
6845	12.95
6850	3.25
6883	22.95

## DISK CONTR

1771	15.95
1791	23.95
1793	23.95
UPD765	19.95

## INTERFACE

8T26	1.59
8T28	1.98
DM8131	2.95
DP8304	2.29

## CLOCK CHIPS

MM5314	4.95
MM5369	1.95
MM58167	8.95
MSM5832	3.95

## DATA ACQ

ADC0804	3.49
ADC0809	4.49
ADC0817	9.95
DAC0808	2.95
MC1408L8	2.95

## SOUND CHIPS

76477	3.95
76488	5.95
AY3-8910	12.95
SSI263	39.95

## 74LS00

74LS00	.24	74LS157	.65
74LS01	.25	74LS158	.59
74LS02	.25	74LS160	.69
74LS03	.25	74LS161	.65
74LS04	.24	74LS163	.65
74LS05	.25	74LS164	.69
74LS08	.28	74LS165	.95
74LS09	.29	74LS166	1.95
74LS10	.25	74LS169	1.75
74LS11	.35	74LS173	.69
74LS12	.35	74LS174	.55
74LS13	.45	74LS191	.89
74LS14	.59	74LS192	.79
74LS20	.25	74LS193	.79
74LS21	.29	74LS194	.69
74LS26	.29	74LS195	.69
74LS27	.29	74LS197	.79
74LS32	.29	74LS221	.89
74LS33	.55	74LS240	.95
74LS37	.35	74LS241	.99
74LS38	.35	74LS242	.99
74LS40	.25	74LS243	.99
74LS42	.49	74LS244	1.29
74LS47	.75	74LS245	1.49
74LS51	.25	74LS251	.59
74LS73	.39	74LS253	.59
74LS74	.35	74LS257	.59
74LS75	.39	74LS258	.59
74LS76	.39	74LS259	2.75
74LS85	.69	74LS260	.59
74LS86	.39	74LS266	.55
74LS90	.55	74LS279	.49
74LS92	.55	74LS280	1.98
74LS93	.55	74LS283	.69
74LS107	.39	74LS290	.89
74LS109	.39	74LS293	.89
74LS112	.39	74LS299	1.75
74LS122	.45	74LS323	3.50
74LS123	.79	74LS365	.49
74LS124	2.90	74LS367	.45
74LS125	.49	74LS368	.45
74LS126	.49	74LS373	1.39
74LS132	.59	74LS374	1.39
74LS136	.39	74LS377	1.39
74LS138	.55	74LS390	1.19
74LS139	.55	74LS393	1.19
74LS145	1.20	74LS640	2.20
74LS148	1.35	74LS645	2.20
74LS151	.55	74LS670	1.49
74LS153	.55	74LS682	3.20
74LS154	1.90	74LS688	2.40
74LS155	.69	81LS95	1.49
74LS156	.69	25LS2521	2.80

## 7400

7400	.19	7492	.50
7401	.19	7493	.35
7402	.19	74100	1.75
7403	.19	74107	.30
7404	.19	74116	1.55
7405	.25	74121	.29
7406	.29	74122	.45
7407	.29	74123	.49
7408	.24	74125	.45
7409	.19	74126	.45
7410	.19	74132	.45
7411	.25	74145	.60
7413	.35	74148	1.20
7414	.49	74150	1.35
7416	.25	74151	.55
7417	.25	74153	.55
7420	.19	74154	1.25
7421	.35	74155	.75
7425	.29	74157	.55
7427	.29	74159	1.65
7430	.19	74161	.69
7432	.29	74163	.69
7437	.29	74164	.85
7438	.29	74165	.85
7442	.49	74166	1.00
7445	.69	74173	.75
7447	.69	74174	.89
7448	.69	74175	.89
7473	.34	74185	2.00
7474	.33	74192	.79
7475	.45	74193	.79
7476	.35	74194	.85
7483	.50	74259	2.25
7485	.59	74367	.65
7489	2.15	74368	.65
7490	.35	74393	1.35

## 74S00

74S00	.32
74S02	.35
74S04	.35
74S05	.35
74S08	.35
74S10	.35
74S11	.35
74S20	.35
74S32	.40
74S37	.88
74S74	.50
74S86	.50
74S112	.50
74S124	2.75
74S132	1.24
74S133	.45
74S138	.85
74S139	.85
74S140	.55
74S151	.95
74S153	.95
74S157	.95
74S158	.95
74S161	1.95
74S163	1.95
74S174	.95
74S175	.95
74S240	2.20
74S241	2.20
74S244	2.20
74S280	1.95
74S287	1.90
74S288	1.90
74S373	2.45
74S374	2.45
74S471	4.95

## ★★★HIGH-TECH★★★

### 27256

- \* 32K x 8 EPROM
- \* SINGLE 5 VOLT SUPPLY
- \* SINGLE LOCATION & HIGH SPEED PROGRAMMING
- \* 250ns ACCESS TIME

**\$12.95**

## ★★★SPOTLIGHT★★★

## CRYSTALS

32.768Khz	1.95
1.0Mhz	3.95
1.8432	3.95
2.0	2.95
2.4576	2.95
3.579545	2.95
4.0	2.95
5.0	2.95
5.0688	2.95
6.0	2.95
6.144	2.95
8.0	2.95
10.0	2.95
10.738635	2.95
14.31818	2.95
15.0	2.95
16.0	2.95
17.430	2.95
18.432	2.95
20.0	2.95

## UARTS

AY5-1013	3.95
AY3-1015	6.95
TR1602	3.95
2651	8.95
IM6402	7.95

## BIT-RATE GENERATORS

BR1941	11.95
4702	12.95
COM8116	10.95
14411	11.95

## MISC.

3242	7.95
MC3470	4.95
MC3487	2.95
AY5-3600 PRO	11.95
HD46505SP	15.95
CRT5027	19.95

## LINEAR

TL084	2.19	NE564	2.95
LM301	.34	LM565	.99
LM307	.45	LM566	1.49
LM308	.69	NE592	.98
LM309K	1.25	LM733	.98
LM310	1.75	LM741	.35
LM311	.64	LM747	.69
LM317T	1.19	LM1310	1.49
LM317K	3.95	MC1330	1.69
LM318	1.49	MC1372	6.95
LM323K	4.95	LM1458	.59
LM324	.59	LM1488	.69
LM331	3.95	LM1489	.69
LM334	1.19	LM1496	.85
LM335	1.40	LM1800	2.37
LM336	1.75	LM1812	8.25
LM337T	1.95	LM1889	1.95
LM338K	3.95	ULN2003	1.29



**PARTIAL LISTING ONLY- PLEASE CALL OR WRITE FOR FREE CATALOG.**

**CAPACITORS  
ELECTROLYTIC  
RADIAL AXIAL**

.47uf	50v	.14	10	50v	.16
10	50v	.15	22	16v	.14
47	35v	.18	47	50v	.20
100	16v	.18	100	15v	.20
220	35v	.20	150	25v	.25

**50v MONOLITHIC**

.01uf	.14	.1	.18
.047	.15	.47	.25

**50v DISC**

10pf	.05	470	.05
22	.05	560	.05
25	.05	680	.05
27	.05	820	.05
33	.05	.001uf	.05
47	.05	.0015	.05
56	.05	.0022	.05
68	.05	.005	.05
82	.05	.01	.07
100	.05	.02	.07
220	.05	.05	.07
330	.05	.1	.12

**BYPASS CAPS**

.01uf disc	50v	100/6.00
.1uf disc	12v	100/8.00
.01uf mono	50v	100/12.00
.1uf mono	50v	100/15.00

**ACCESORIES & PERIPHERALS  
FOR IBM**

MAXIMIZER Memory Multifunction	259.95
HAYES SMARTMODEM 1200B	419.95
130W POWER SUPPLY	159.95
TEAC FD-55B 1/2 Ht. Disk Drive, DS/DD	119.95
MPI-B52 5 1/4" FDD, DS/DD	109.95
PROTOTYPE CARD	27.95
PROTOTYPE CARD With Decoding	29.95

**FOR APPLE**

JDR 16K RAM CARD	39.95
EPROM PROGRAMMER RP525	79.95
PRINTMAX Parallel printer interface	49.95
BAL-500 1/2 Ht. Disk Drive, Teac Mechanism	159.95
BAL-525 1/2 Ht. Disk Drive, Alps Mechanism	139.95
MITAC AD-1 Full Height, Shugart Mechanism	149.95
DISK CONTROLLER CARD	49.95
VIEWMAX-80 80 Column For Apple II+	159.95
VIEWMAX-80e 80 Column For Apple IIe	129.95
THUNDERCLOCK Official PRODOS Clock	129.95
KRAFT JOYSTICK	39.95
60W POWER SUPPLY	49.95

**MISCELLANEOUS**

ZENITH ZVM-123 15 MHz Green Monitor	105.00
NEC JB1201M 20 MHz Green Monitor	169.00
BMC BM-AU9191U Comp. 13" Color Monitor	279.00
NASHUA DISKETTES SS/SD Box of 10	19.95
VERBATIM DATALIFE DISKETTES DS/DD	34.95
DISKETTE FILE Holds 70 Diskettes	9.95

**BARGAIN HUNTERS CORNER**

**DYNAMIC RAMS**

**4164 200ns \$ .99 ea.**  
100 PIECE MINIMUM

**41256 150ns**  
**\$5.50 ea.**

**SPECIALS END 7/31/85**

**SWITCHING POWER SUPPLIES**

<b>PS-ASTEC</b>	<b>PS-3</b>
MODEL AA 12110	ASTEC AA11190
+12V @ 2A	+5V @ 4A
-12V @ .1A	+12V @ 2.5A
+5V @ 2.5A or	-5V @ .25A
5A if 12V not used	-12V @ .30A
<b>19.95</b>	<b>39.95</b>

**5 1/4" DISK DRIVES**

TANDON TM100-2	DS/DD	159.95
SHUGART SA400L	SS/DD	199.95
MPI B52	DS/DD	109.95
TEAC FD55B 1/2 Ht.	DS/DD	119.95
TEAC FD55F 1/2 Ht.	DS/Quad	139.95

**8" DISK DRIVES**

SIEMENS FD200-8	DS/DD	180.00
SIEMENS FD100-8	SS/DD	129.00

**BEST SELLING IDC CONN.**

<b>RIBBON HEADER SOCKETS</b>			
IDS 20	2.25	IDS 40	1.99
IDS 26	1.39	IDS 50	2.25
IDS 34	1.59		

**RIBBON EDGE CARDS**

IDE 20	2.25	IDE 40	3.80
IDE 26	2.65	IDE 50	3.95
IDE 34	2.75		

**LIGHT EMITTING DIODES  
JUMBO DISPLAYS**

1.99	100-up	MAN-72 CA 3"	.99
RED	.10	MAN-74 CC 3"	.99
GREEN	.18	FND-500 CC 5"	1.49
YELLOW	.18	FND-507 CA 5"	1.49

**IC SOCKETS**

1-99		100
8 pin ST	.13	.11
14 pin ST	.15	.12
16 pin ST	.17	.13
18 pin ST	.20	.18
20 pin ST	.29	.27
22 pin ST	.30	.27
24 pin ST	.30	.27
28 pin ST	.40	.32
40 pin ST	.49	.39
64 pin ST	4.25	call
ST-SOLDERTAIL		
8 pin WW	.59	.49
14 pin WW	.69	.52
16 pin WW	.69	.58
18 pin WW	.99	.90
20 pin WW	1.09	.98
22 pin WW	1.39	1.28
24 pin WW	1.49	1.35
28 pin WW	1.69	1.49
40 pin WW	1.99	1.80
WW-WIREWRAP		
16 pin ZIF	4.95	call
24 pin ZIF	5.95	call
28 pin ZIF	6.95	call
ZIF-TEXTOL		
(Zero Insertion Force)		

**DISKETTE FILE**

**\$8.95** IF PURCHASED WITH 50 DISKETTES OR MORE \$9.95 if purchased alone

- SMOKED ACRYLIC CASE WITH SIX INDEXED DIVIDERS
- RUGGED, HIGH QUALITY CONSTRUCTION
- HOLDS 70 5 1/4" DISKETTES, WITH ROOM TO SPARE



**NASHUA DISKETTES 5 1/4" SOFT SECTOR  
DOUBLE SIDED, DOUBLE DENSITY WITH HUB RINGS**

BULK PACKAGED IN FACTORY SEALED BAGS OF 50. INCLUDES DISKETTE SLEEVES AND WRITE PROTECT TABS. IDEAL FOR SCHOOLS, CLUBS, AND USERS GROUPS. THIS IS A SPECIAL PURCHASE. SO QUANTITIES ARE LIMITED. 5 YEAR WARRANTY.

**\$1.39 ea. QTY 250**   **\$1.49 ea. QTY 100**   **\$1.59 ea. QTY 50**

**D-SUBMINIATURE**

DESCRIPTION	ORDER BY	CONTACTS				
		9	15	25	37	
SOLDER CUPS	MALE	DBxxP	1.19	1.59	1.90	2.85
	FEMALE	DBxxS	1.50	1.85	2.25	3.90
RT. ANGLE	MALE	DBxxPR	1.65	2.20	3.00	4.83
PC SOLDER	FEMALE	DBxxSR	2.18	3.03	3.00	6.19
IDC	MALE	IDBxxP	2.95	3.90	4.75	6.95
RIBBON CABLE	FEMALE	IDBxxS	3.25	4.29	5.25	7.95
HOODS	BLACK	HOOD-B	---	---	.99	---
	GREY	HOODxx	.89	.99	.99	1.09

**MOUNTING HARDWARE-\$1.00**

ORDERING INSTRUCTIONS: INSERT # OF PINS INTO "xx"

**9000**

9334	2.50
9368	3.95
9602	1.50

**INTERASIL**

ICL7107	12.95
ICL7660	2.95
ICL8038	3.95

**DIP SWITCHES**

4 position	.85
6 position	.90
7 position	.95
8 position	.95

**TRANSISTORS**

2N2222	.25	PN2907	.13
PN2222	.10	2N3055	.79
2N2905	.50	2N3904	.10
2N2907	.25	2N3906	.10

**DISCRETE**

1N751	5.1v zener	.25
1N759	12.0v zener	.25
1N4148	(1N914) switching	25/1.00
1N4004	400PIV rectifier	10/1.00
KBP02	200PIV 1.5a bridge	.45
4N33	OPTO-ISOLATOR	1.75

**RIBBON CABLE**

CONTACTS	SINGLE COLOR		COLOR CODED	
	1'	10'	1'	10'
25	.45	4.00	1.32	11.80
34	.61	5.40	1.65	14.50
50	.89	7.50	2.50	22.00

**36 PIN CENTRONICS**

CEN36 MALE SOLDER CUP	7.95
IDCEN36 MALE RIBBON CABLE	8.95
IDCEN36F FEMALE RIBBON CABLE	8.95

**VOLTAGE REGULATORS**

7805T	.75	7915T	.85
78M05C	.35	7805K	1.39
7808T	.75	78H05K	9.95
7812T	.75	7812K	1.39
7815T	.75	7912K	1.49
7824T	.85	78L05	.69
7905T	.85	79L05	.79
7912T	.85	79L12	.79

C, T=TO-220, K=TO-3, L=TO-92

**CMOS**

4001	.25	4027	.45	4066	.39	4538	1.95
4002	.25	4028	.69	4069	.29	4543	1.19
4011	.25	4029	.79	4070	.35	4553	5.79
4012	.25	4040	.75	4071	.29	4584	.75
4013	.38	4042	.69	4081	.29	74C00	.35
4015	.39	4046	.85	4082	.29	74C04	.35
4016	.39	4047	.95	4093	.49	74C14	.59
4017	.69	4049	.35	4503	.65	74C74	.65
4018	.79	4050	.35	4511	.85	74C906	.95
4020	.75	4051	.79	4518	.89	74C922	4.49
4023	.29	4053	.79	4520	.79	74C923	4.95
4024	.65	4060	.89	4528	1.19	74C926	7.95

VISA

**ORDER TOLL FREE**

**800-538-5000**

**800-662-6279 (CA)**

MasterCard

Copyright 1985 JDR Microdevices

AUGUST 1985



# Get Ahead of the Gang



Whether you're faced with a monumental decision—or a routine one—the free Consumer Information Catalog can offer concrete advice.

There are more than 200 government booklets listed in the Catalog. And they can help you... improve your job, health, or financial profile... start a business or a car... plan a house or a diet. And many of these booklets are free.

So order your free Catalog today. Any way you look at it, you'll be head and shoulders above the crowd. Just send your name and address to:

**Consumer Information Center  
Dept. MR, Pueblo, Colorado 81009**

U.S. General Services Administration

## COMPUTER PAPERBACK BOOKS Great Books For The Computer Hobbyist CHECK OFF THE BOOKS YOU WANT

**PROGRAMMING THE ZX SPECTRUM**...\$7.50. Make this color computer do its stuff. With this book in hand, it's easy.

**AN INTRODUCTION TO PROGRAMMING THE ATARI 800/800XL**...\$5.00. This text is designed to complement the information supplied by the manufacturer. Essential reading for all Atari owners.

**DIGITAL IC PROJECTS**...\$5.00. Simple & more advanced projects intended to help develop a knowledge of digital circuits.

**DIGITAL IC PROJECTS**...\$5.00. Simple & more advanced projects intended to help develop a knowledge of digital circuits.

**A PRACTICAL INTRODUCTION TO MICROPROCESSORS**...\$5.00. The reader will construct his own simple microprocessor circuit and experiment with it to learn more about how microprocessors work.

**AN INTRODUCTION TO BASIC PROGRAMMING TECHNIQUES**...\$5.00. Based on the author's own experience in learning Basic & helping others to learn to program & understand the language.

**20 PROGRAMS FOR THE ZX SPECTRUM & 16K ZX81**...\$5.00. Included with each program is a detail flow chart for both games and practical applications in filing, statistics and engineering.

**A MICRO-PROCESSOR PRIMER**...\$4.50. We start by designing a small computer and look at how the microprocessor plays its role in making the unit work effectively.

**THE 6809 COMPANION**...\$5.00. Discusses the features of the 6809 and a reference work for 6809 programmers.

**ART OF PROGRAMMING THE 16K ZX81**...\$6.25. What happens when you add the pens when you add the RAM pak. Scrolling, PEEK, POKE, Page graphics and more.

**ELEMENTS OF ELECTRONICS VOL. 4—MICROPROCESSORS & CIRCUITS**...\$7.50. Comprehensive guide to the elements of microprocessor systems. An economical & interesting initiation into the world of microprocessors.

**MICRO INTERFACING CIRCUITS—BOOK 1**...\$5.75. In-depth coverage of how the experimenter can interface all kinds of his home computer to transform it into a sophisticated piece of control equipment.

**EASY ADD-ON PROJECTS FOR SPECTRUM, ZX81, & TRUM. ZX81, & TRUM.**...\$8.50. Pulse detector, picture digitizer, 5-key pad, model controller, light pen and more.

**A Z-80 WORKSHOP MANUAL**...\$6.95. Describes typical machine-readable instructions followed by a detailed description of the Z-80 instruction set. Assembly-language programming is also covered.

**BASIC & PASCAL IN PARALLEL**...\$4.25. Develops programs in both languages simultaneously. Sample programs illustrate structure.

**PRACTICAL COMPUTER EXPERIMENTS**...\$4.50. Fits in the background to the microprocessor by constructing typical computer circuits in discrete logic.

**SECRETS OF THE COMMODORE 64**...\$5.00. Presents masses of useful info and programming tips.

**AN INTRODUCTION TO PROGRAMMING THE ORIC-1**...\$5.00. A new authoritative manual for owners of this new personal computer.

ELECTRONIC TECHNOLOGY TODAY INC. 8/85

P.O. Box 240, Massapequa Park, NY 11762-0240

Number of books ordered

Total Price of Books \_\_\_\_\_

Sales Tax (NY State Residents only) \_\_\_\_\_

\*Shipping in U.S. only (\$1.00 1st two books, 40c ea additional)

TOTAL ENCLOSED \_\_\_\_\_

Name \_\_\_\_\_

Address \_\_\_\_\_

City \_\_\_\_\_ State \_\_\_\_\_ Zip \_\_\_\_\_

# DON'T BLAME THE SOFTWARE!

Our Isolators eliminate equipment interaction, clean up interference, curb damaging power line spikes and lightning bursts.



### ISO-1 ISOLATOR

3 isolated sockets; quality spike suppression; basic protection. . \$81.95

### ISO-3 SUPER-ISOLATOR

3 dual isolated sockets; suppressor; commercial protection. . . . . \$122.95

### ISO-17 MAGNUM ISOLATOR

4 quad isolated sockets; suppressor; laboratory grade protection. . \$213.95

**ESP Electronic Specialists, Inc.**  
171 S. Main, Natick, MA 01760 (617) 655-1532  
Toll Free Order Desk 1-800-225-4876  
MasterCard, VISA, American Express

CIRCLE 60 ON FREE INFORMATION CARD

# ACTIVE RECEIVING ANTENNA

Gives excellent reception, 50 KHz to 30 MHz.

New MFJ-1024 Active Receiving Antenna mounts outdoors away from electrical noise for maximum signal.

Gives excellent reception of 50 KHz to 30 MHz signals. Equivalent to wire hundreds of feet long. Use any SWL, MW, BCB, VLF or Ham receiver.

High dynamic range RF amplifier. 54 in. whip. 50 foot coax. 20 dB attenuator prevents receiver overload. Switch between two receivers. Select auxiliary or active antenna. Gain control. "ON" LED. Remote unit, 3x2x4 in. Control, 6x2x5 in. 12 VDC or 110 VAC with optional adapter, MFJ-1312, \$9.95.



**\$129.95**  
(+\$4.00 shipping)

Order from MFJ and try it. If not delighted, return within 30 days for refund (less shipping). One year unconditional guarantee.

Order today. Call TOLL FREE 800-647-1800. Charge VISA, MC. Or mail check, money order. Write for free catalog. Over 100 products.

**CALL TOLL FREE 800-647-1800**

Call 601-323-5869 in Miss., outside continental USA, tech/order/repair info. TELEX 53-4590.

**MFJ ENTERPRISES, INCORPORATED**

Box 494, Mississippi State, MS 39762

CIRCLE 105 ON FREE INFORMATION CARD



# Radio Shack Parts Place

## The Store for Builders. Over 1000 Items in Stock

### Check These Great Values in Computer Connectors

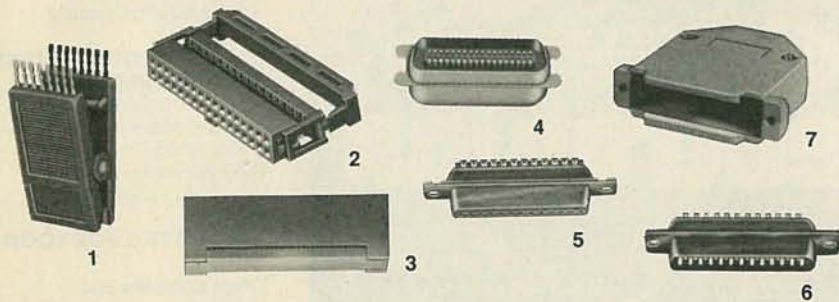

(1) **IC Test Clip.** For DIP ICs, up to 16 pins. Convenient because it allows you to easily access individual IC pins on a crowded board. Ideal for use with our micro test clips, #270-370. #276-1982 ..... **3.99**

(2) **34-Position Header.** With strain relief for ribbon cable. Fits parallel printer port of many computers. #276-1525 ..... **3.19**

(3) **Card-Edge Connector.** 34 positions, solderless type. For disk drives. #276-1564 ..... **4.95**

(4) **NEW LOW PRICE! Printer Connector.** Solder-type 36-position with heavy-duty metal shielding. Was \$6.99. #276-1534 ..... **4.99**

**Solder-Type Subminiature "D" Connectors.** Ideal for building your own RS-232C cables.

Fig.	Type	Positions	Cat. No.	Each
5	Sub-D Male	25	276-1547	2.99
6	Sub-D Female	25	276-1548	3.99
7	Hood for Above	25	276-1549	1.99

### Speech Synthesizer IC



**SPO256-AL2.** This MOS LSI device uses a program stored in its built-in 16K ROM to synthesize natural sounding speech. Easy to interface with most computers. 28-pin DIP with detailed data. Requires crystal and low-cost external components available through Radio Shack. #276-1784 ..... **12.95**

### Solar Energy Project

**9<sup>95</sup>**



Silicon solar cell pre-wired to a precision DC motor. Ideal for building model windmills, boats, school science projects. With color wheels, mini propeller, booklet. #277-1201

### 4000-Series CMOS ICs



With Pin-Out and Specs

Type	Cat. No.	Each
4001	276-2401	.99
4011	276-2411	.99
4013	276-2413	1.19
4017	276-2417	1.49
4049	276-2449	1.19
4066	276-2466	1.19

### Ceramic Disc Capacitors

Low As **39¢** Pkg. of 2



- Hi-Q Design
- Moistureproof
- 50 WVDC Minimum

pF	Cat. No.	Pkg. of 2	µF	Cat. No.	Pkg. of 2
4.7	272-120	.39	.001	272-126	.49
47	272-121	.39	.005	272-130	.49
100	272-123	.39	.01	272-131	.59
220	272-124	.49	.05	272-134	.59
470	272-125	.49	.1	272-135	.59

### Electronics Textbook

**NEW! 7<sup>95</sup>**



**Basic Electronics Technology.** The "hows" and "whys" of modern electronics presented in plain language. Learn how semiconductors work as amplifiers, oscillators, in power supplies, radio/TV, computers. Illustrated. 464 pages. #62-1394

### 64K Dynamic RAM

**NEW! 3<sup>95</sup>**  
Each



**4164.** Highest quality and factory fresh. 150 ns access. Ideal for expanding the memory of many popular microcomputers. #276-2506

### MOV Transient Protectors

Protect computers and sensitive electronics from damaging power-line "spikes".



Power Diss.	Cat. No.	Each
600 mW	276-570	1.59
1 watt	276-568	1.69

### Flatted Lever Switches

Rated 6 amps at 125 VAC. Body: 3/8 x 7/16 x 1/4". Mount in 1/4" diameter hole.



**SPDT.** #275-635 ..... **2.39**  
**DPDT.** #275-636 ..... **2.69**  
**DPDT Momentary.** Spring return to center-off position. #275-637 ..... **2.89**

### Replacement Transistors



Type	Cat. No.	Each
2N1305	PNP 276-2007	1.19
MPS2222A	NPN 276-2009	.79
PN2484	NPN 276-2010	.89
MPS3904	NPN 276-2016	.69
TIP31	NPN 276-2017	.99
TIP3055	NPN 276-2020	1.59
MPS2907	PNP 276-2023	.79
MJE34	PNP 276-2027	1.49
2N3053	NPN 276-2030	.99
MPS3638	PNP 276-2032	.79
TIP120	NPN 276-2068	1.29
2N3055	NPN 276-2041	1.99
MJ2955	PNP 276-2043	2.19
2N4401	NPN 276-2058	.59
MPSA42	NPN 276-2061	.69
2N3819	N-FET 276-2035	.99
MPF102	N-FET 276-2062	.99
IRF511	V-FET 276-2072	2.79
2SC1308	NPN 276-2055	6.95

### Fold-Up Autoranging LCD Multimeter



**79<sup>95</sup>**

**Our Best!**  
**The DVM**  
**That "Thinks"**

You choose the function and it selects the correct range and polarity for you. Features a jumbo 1 1/16" display. "Beep" continuity function and diode/semiconductor junction test really save time. Handy pushbutton ohms zero adjust. Automatic power-off when case is shut conserves batteries. With test leads, owner's manual. Batteries extra. #22-193

### TV RF Modulator Chassis

**SPECIAL PURCHASE**

**4<sup>95</sup>**

Selectable channel 3/4 output. 5-pin DIN plug accepts video, audio and 12 VDC power inputs. On/off switch has built-in TV antenna/modulator switching. #277-1015



### Continuity Tester Chassis

**SPECIAL PURCHASE**

**1<sup>95</sup>**

Circuit continuity produces a warbling tone. Many possible uses including alarms, signalling, testing. With leads. Requires 9V cell. Hurry! #277-1014

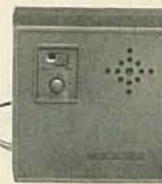

Over 1000 items in stock: Binding posts, Books, Breadboards, Buzzers, Capacitors, Chokes, Clips, Connectors, Fuses, Hardware, ICs, Jacks, Knobs, Lamps, Multitesters, PC Boards, Plugs, Rectifiers, Relays, Resistors, Switches, Tools, Transformers, Transistors, Wire, Zener Diodes, and more!

**Radio Shack**  
A DIVISION OF TANDY CORPORATION

Prices apply at participating Radio Shack stores and dealers



This will be coming to you when you subscribe to **Radio-Electronics**

• **HELPFUL CONSTRUCTION ARTICLES...**

Test Equipment  
Hi-Fi Accessories  
Telephone Accessories  
Music Synthesizers  
Computer Equipment  
Automotive Equipment  
Intruder Alarms-  
Home & Car  
Video Accessories

• **NEWS ON NEW TECHNOLOGY**

Computers  
Microprocessors  
Satellite TV  
Teletext  
Automotive Electronics  
Speech Synthesizers  
IC Applications

• **FASCINATING "HOW TO DO IT" ARTICLES...**

Build Your Own Projects  
Make Your Own PC Boards  
Wiring Techniques  
Soldering and Desoldering  
Design and Prototyping

SPECIAL SECTION  
SATELLITE TV  
BUYERS GUIDE

SPECIAL  
16-PAGE TEAR OUT  
COMPUTER DIGEST

# Radio-Electronics

COMPUTERS - VIDEO - STEREO - TECHNOLOGY - SERVICE

**BUILD THIS SATELLITE TV STEREO DEMODULATOR.**  
R-E's add-on for your satellite TV receiver tunes you into stereo audio. ➔

**RECHARGEABLE BATTERIES.**  
How to choose the one that best suits your needs.

**BUILD A COMPUTERIZED IC TESTER.**  
With this automated tester you can quickly weed out your faulty digital IC's.

**ELECTRONICS IN MEDICINE.**  
How images of the human body are produced.

**SATELLITE TV COMPONENT BUYERS GUIDE.**  
What's available if you want to piece together your satellite receiver system.



**PLUS:**

- ★ Drawing Board
- ★ State-Of-Solid-State
- ★ Hobby Corner
- ★ New Idea
- ★ Service Clinic
- ★ Equipment Reports



• **HOW YOU AND THE COMPUTER CAN BE FRIENDS...**

Getting Started  
Programs, Circuit  
Design, Games  
A/D-D/A Interfacing  
Peripheral Equipment

• **NEW AUDIO DIMENSIONS FOR YOUR PLEASURE...**

Noise-Reduction Devices  
How to Connect that  
Extra Add-On  
Hi-Fi Accessories  
New Technology

• **TV WONDERS FOR YOUR FUTURE...**

Latest Receivers and  
Circuits  
The Home Entertainment  
Center  
Projection TV  
Satellite TV Receivers  
Jack Darr's Monthly  
Service Clinic  
Service Problems and  
Solutions

• **REGULAR MONTHLY FEATURE**

**DESIGNERS NOTEBOOK**  
by Robert Grossblatt  
**HOBBY CORNER**  
by "Doc" Savage, K4SDS  
**STATE-OF-SOLID-STATE**  
by Bob Scott  
**WHAT'S NEWS**, new  
products, stereo news  
**VIDEOGAMES**, new  
products, game reviews  
and **NEW IDEAS**, **STEREO  
PRODUCTS**, **NEW  
COMPUTER PRODUCTS  
FOR HOME/JOB** and  
**MUCH MORE!**

**Radio-Electronics** covers all aspects of the fast moving electronics field...featuring  
**COMPUTERS • VIDEO • STEREO  
TECHNOLOGY • SERVICE  
COMMUNICATIONS • PROJECTS**

# Get it all!

Subscribe today to **Radio-Electronics**! Don't miss a single issue and...see subscription card in back of this issue for big savings.

When you select one of the subscription offers listed on the handy coupon—you'll be assured of having your copy reserved, even if it sells out on the newsstand. Make sure you get all the excitement in every issue of **Radio-Electronics**, every month, by filling in and mailing your subscription card today.







## AMAZING DEVICES

**PERSONAL DEFENSE AND PROPERTY PROTECTION UTILIZE SPACE AGE TECHNOLOGY. CAUTION THESE DEVICES CAN BE HAZARDOUS AND MAY SOON BE ILLEGAL.**

**PHASORS**

**POCKET PAIN FIELD GENERATOR — IPG50**  
 Assembled ..... \$64.50  
 IPG50 Plans ..... \$8.00 IPG5K Kit/Plans ..... \$44.50  
**PHASOR PAIN FIELD CROWD CONTROLLER — PPF10**  
 Assembled ..... \$250.00  
 PPF10 Plans ..... \$15.00 PPF1K Kit/Plans ..... \$175.00  
**BLASTER** - Provides a plasma discharge capable of puncturing a can. Produces a 100,000 WATT PULSE.  
 BLS10 ASSEMBLED ..... \$89.50  
 BLS10 PLANS \$10.00 BLS1K KIT/PLANS ..... \$69.50  
**PLASMA STUN GUN** - Very intimidating and affective 5 to 10 feet 100,000 VOLTS  
 ITM10 ASSEMBLED ..... \$99.50  
 ITM10 PLANS \$10.00 ITM1K KIT/PLANS ..... \$69.50

**LASERS**

**RUBY LASER RAY GUN** — Intense visible red beam burns and welds hardest of metals. **MAY BE HAZARDOUS.**  
**RUBAll Parts Available for Completing Device** \$15.00  
**CARBON DIOXIDE BURNING, CUTTING LASER** — Produces a continuous beam of high energy. **MAY BE HAZARDOUS.**  
**LCS All Parts Available for Completing Device.** \$15.00  
**VISIBLE LASER LIGHT GUN** — produces intense red beam for sighting, spotting, etc. Hand held complete.  
 LGU3 Plans \$10.00 (Kit & Assembled Units Available)  
**IR PULSED LASER RIFLE** — Produces 15-30 watt infra-red pulses at 200-2000 per sec.  
 LRG3 All Parts & Diodes Available ..... \$10.00  
**BEGINNERS LOW POWER VISIBLE LASER** — Choice of red, yellow, green — provides an excellent source of monochromatic light.  
 LHC2 Plans ..... \$5.00 LHC2K Kit ..... \$34.50

**SECURITY**

**SNOOPER PHONE** — Allows user to call his premises and listen in without phone ever ringing.  
 SNP20 Assembled ..... \$89.50  
 SNP20 Plans ..... \$9.00 SNP2K Plans/Kit ..... \$59.50  
**LONG RANGE WIRELESS MIKE** — Miniature device clearly transmits well over one mile. Super sensitive, powerful.  
 MFT1 Plans ..... \$7.00 MFT1K Plans/Kit ..... \$49.50  
**WIRELESS TELEPHONE TRANSMITTER** — Transmits both sides of phone conversation over one mile, shuts off automatically.  
 VWPM5 Plans ..... \$8.00 VWPM5K Plans/Kit ..... \$39.50  
**TALK & TELL AUTOMATIC TELEPHONE RECORDING DEVICE** — Great for monitoring telephone use.  
 TAT20 Assembled ..... \$24.50  
 TAT20 Plans ..... \$5.00 TAT2K Plans/Kit ..... \$14.50

Our phone is open for orders anytime. Technicians are available 9-11 a.m., Mon-Thurs for those needing assistance or information. Send \$1.00 for catalog of hundreds more similar devices. Send check, cash, MO, Visa, MC, COD to: **INFORMATION UNLIMITED**  
 DEPT R8 • P.O. Box 716, Amherst, N. H. 03031 Tel: 603-673-4730

**CIRCLE 72 ON FREE INFORMATION CARD**

# cable TV

## DESCRAMBLER PARTS

We stock the exact parts and PC Board for Radio Electronic's February Article on building your own Cable TV Descrambler.

**#701 PARTS PACKAGE ..... \$29.95**  
 Includes all the original resistors, capacitors, diodes, transistors, integrated circuits, coils and IF transformers (BKAN-K5552AXX).

**#702 PC BOARD ..... \$12.95**  
 Original etched & drilled silk-screened PC Board used in the article.

**#704 AC ADAPTOR ..... \$12.95**  
 (14 volts DC @ 285MA)

**Both #701 & #702 ..... \$39.00**

**FREE!!** Reprint of Radio Electronics Article on Building Your Own Cable TV Descrambler with any purchase.

Add \$4.00 Postage & Handling

**TOLL FREE**  
 1-800-227 8529 (Orders Only)  
 1-617-339-5372 (Information)

## J & W ELECTRONICS, INC.

P.O. Box 800  
 Mansfield, MA 02048

**CIRCLE 65 ON FREE INFORMATION CARD**

# DON'T COUNT ON THIS ALONE TO SAVE YOUR LIFE.



**FIRST AID**

First-aid kits are fine for some emergencies. But what if you were choking? Having a heart attack? Or a stroke? This kit would be useless. Call the Red Cross. We'll teach you and your employees how to save a life. From work-safety to CPR, you can count on the Red Cross. We'll help. Will you?



**USE YOUR READER SERVICE CARD**

A Public Service of This Publication 

## FREE 1985 CATALOG

JUST CLIP AND RETURN THIS COUPON

### THIS MONTH'S SPECIALS





4116	16K	150ns	1.25
4164	64K	150ns	1.75
41256	256K	150ns	7.95
2708	1K x 8	350ns 8K	5.95
2716	2K x 8	450ns 16K	3.60
2732A	4K x 8	300ns 32K	4.90
2764	8K x 8	300ns 64K	4.95
27128	16K x 8	300ns 128K	7.95
27256	32K x 8	250ns 256K	17.95
27512	64K x 8	250ns 512K	85.50





**WE ALSO STOCK...**

- Books • Breadboard & Accessories
- Capacitors • Chemicals • Connectors
- Crystals • Plugs & Jacks • Fans
- Enclosures • Filters • Fuses • Heat Shrink Tubing • Heat Sinks • Kits
- Knobs • Peripherals • Probes • Opto
- PCB Products • Potentiometers
- Power Supplies • Relays • Resistors
- Cable Assemblies Sockets...

**USA**  
 P.O. BOX 9100  
 WESTBOROUGH, MASS  
 1-800-343-0874



**CANADA**  
 5651 FERRIER ST.  
 MONTREAL, QUEBEC  
 1-800-361-5884

MAIL ORDERS PROCESSED WITHIN 24 HOURS

YOUR ELECTRONIC COMPONENTS CENTER

CURRENT DATE CODE PRODUCTS VOLUME DISCOUNTS

**SELF SERVE STORES LOCATED NEAR YOU. JUST CALL...**

WESTBOROUGH 366-9684	OTTAWA 728-7900	EDMONTON 438-5888
BELLEVUE 881-8191	TORONTO 977-7692	CALGARY 235-5300
MONTREAL 731-7441	DOWNSVIEW 630-0400	VANCOUVER 438-3321 8 RE

**CIRCLE 51 ON FREE INFORMATION CARD**

## DON'T FORGET



**USE YOUR READER SERVICE CARD**

RADIO-ELECTRONICS



The idea behind our family of "Black Boxes" is to offer you as broad a selection of material and container sizes, in an almost infinite number of connector combinations to select from. All designed to make your life as a designer just a bit easier.

And now that you have an idea of our depth and variety, you should also be aware that the "Black Boxes" we design and manufacture are considered by electronic design engineers to be right at the top. No question. A superior product? You know you've got

that. And you should know, also, that we make sure you receive fast service and specified quantity through your favorite electronic parts distributor. After all, we wrote the book. And it's free. Our products are described

and illustrated in our 1985 general catalog. Just call (714) 623-3463 or 623-6751. Or, write to us at ITT Pomona Electronics, a division of ITT Corporation, 1500 E. Ninth St., Pomona, CA 91769.



Pomona Electronics  
CIRCLE 101 ON FREE INFORMATION CARD

# Pomona wrote the book on "Black Boxes". Don't miss it.





# PERFORMANCE

## SCOPE HAND-HELD DIGITAL CAPACITANCE and MULTIMETERS

- 0.5% DC Accuracy
- Highest Quality
- Highest Performance
- Lowest Prices

# THE ULTIMATE TEST



**Model DCM-602**  
**\$7995**

**3 1/2 Digit Capacitance Meter**  
8 ranges with full scale values to 2000 uF  
**FEATURES** • Broad test range - 1 pF to 2000 uF • LSI circuit provides high reliability and durability • Lower power consumption • Crystal time base  
• Protected from charged capacitors  
• Frequency range - 800 Hz to 8 Hz



**Model DVM-634**  
**\$4875**

7 functions, 32 ranges.  
Transistor measurement included.

### 3 1/2 Digit Multimeters

**FEATURES** • DC Voltage 100 uV - 1000 V • AC Voltage 100 uV - 750 V • AC/DC Current 200 uA - 10 Amps • Resistance 20 Megohms • Capacitance (DVM 636/638) 1 pF - 20 uF  
• Overload Protection • Auto-decimal LCD readout • Polarity indication • 3000 hour battery life with 9V transistor battery • Low battery indication



**Model DVM-638**  
**\$7995**

11 functions, 38 ranges.  
Includes logic level detector, audible visual continuity, capacitance and conductance measurement.



**Model DVM-636**  
**\$6275**

8 functions, 37 ranges.  
Capacitance measurement included.

ASK FOR FREE CATALOG.  
Money orders, checks accepted. C.O.D.'s require 25% deposit.



# Fordham

Toll Free  
**800-645-9518**  
In NY State 800-832-1446

260 Motor Parkway, Hauppauge, NY 11788

Service and Shipping Charge Schedule FOR ORDERS	ADD
\$25-250 .....	\$4.50
\$251-500 .....	\$6.50
\$501-750 .....	\$8.50
\$751-1,000 .....	\$12.50
\$1,001 and up .....	\$15.00