

48783

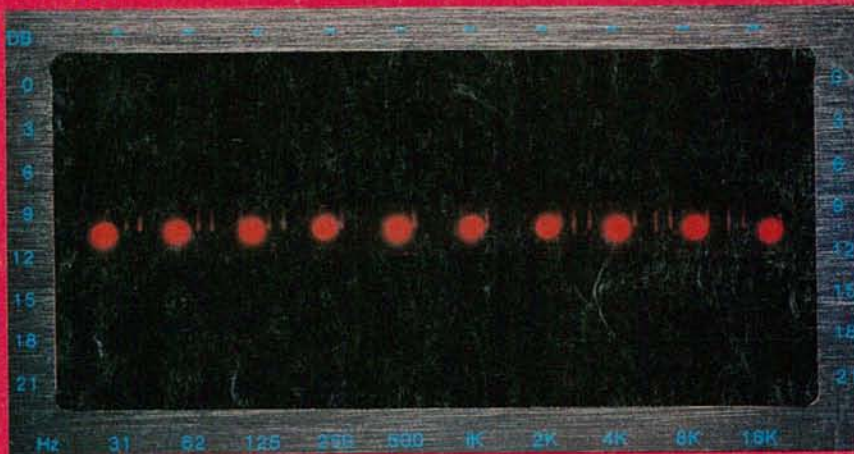
**PUT A TELEPHONE IN YOUR CAR-  
CELLULAR TECHNOLOGY  
HAS ARRIVED!**

\$1.95 APR. 1985  
IN CANADA \$2.25

# Radio- Electronics®

TECHNOLOGY - VIDEO - STEREO - COMPUTERS - SERVICE

**Build R-E's real-time  
spectrum analyzer  
and match  
your hi-fi's  
response  
to your  
listening  
room. ▶**



**How to improve your scanner's  
performance with a custom  
antenna  
you can  
build  
yourself.**

**Build R-E's  
add-on sync  
separator for your  
oscilloscope and  
view rock-steady  
video signals.**



**How to  
design  
your own  
microprocessor-  
based projects  
with easy to use  
single-IC  
computers.**

**Step-by-step  
guide to repairing  
videodisc players.**

**How to use CMOS  
digital IC's effectively.**

**Special 16-page tear-out section.**

A  
**GERNSBACK**  
PUBLICATION

**COMPUTERDIGEST**

**PLUS:**

- ★ Hobby Corner
- ★ Equipment Reports
- ★ Drawing Board
- ★ Service Clinic
- ★ New Idea
- ★ Antique Radios





# Now! Tek quality and expert advice are just a free phone call away!

## 100 MHz dual time base scope.

Easy-to-read CRT; bright, full-sized 8x10 cm; 14 kv accelerating potential complete with BEAM FIND, separate A/B dual intensity controls, FOCUS and TRACE ROTATION.

## Wide range vertical sensitivity.

Choose from 2 mV/div (1x probe) to 50 V/div (10x probe); color-keyed for 1x and 10x probes; variable control increases scale factor by 2.5 to 1.

## Two 100 MHz, high sensitivity channels.

3.5 ns risetime; dc to  $\geq$  100 MHz bandwidth from 5 V/div to 5 mV/div; extended sensitivity of 2 mV/div at  $\geq$  90 MHz.

## A/B sweep selection.

Calibrated A sweeps from 50 ns/div to 0.5 s/div; B sweeps from 50 ns/div to 50 ms/div; variable control for up to 2.5 to 1 reduction and 10x magnification for sweeps to 5 ns/div.

## Dual time base measurements.

Select either A or B sweeps, or both alternately with A intensified by B.

## B trigger slope and level.

Use B trigger level to select B-triggered or run-after-delay modes; use B TRIGGER SLOPE to select transitions.



## Our direct order line gets you the industry's leading price/performance portables... and fast answers from experts!

The 60 MHz single time base delay 2213A, the 60 MHz dual time base 2215A and the 100 MHz dual time base 2235 offer unprecedented reliability and affordability, plus the industry's first 3-year warranty\* on labor and parts, CRT included.

**The cost: just \$1200 for the 2213A, \$1450 for the 2215A, \$1650 for the 2235.**† Even at these low prices, there's no scrimping on performance. You

have the bandwidth for digital and analog circuits. The sensitivity for low signal measurements. The sweep speeds for fast logic families. And delayed sweep for fast, accurate timing measurements. All scopes are UL Listed and CSA approved.

**You can order, or obtain literature, through the Tek National Marketing Center.** Technical personnel, expert in scope applications, will answer your questions and expedite delivery. Direct orders include comprehensive 3-year warranty\*, operator's

manual, two 10X probes, 15-day return policy and worldwide service backup.

## Order toll free: 1-800-426-2200, Ask for Rick.

In Oregon, call collect (503) 627-9000.  
Or write Tektronix, Inc.  
P.O. Box 500, Delivery Station Y6-088  
Beaverton, OR 97077

**Tektronix**  
COMMITTED TO EXCELLENCE



# VIDEO ACCESSORIES

■ Highest quality ■ Highest performance ■ Lowest prices

## bp VIDEO-CINE CONVERTER

The BP Video-Cine Converter is an optical device that allows the easy transfer of slides, 8mm or 16mm movie film to VCR tape. The Video-Cine Converter's precision optics put the image from your movie or slide projector on a high-contrast, rear projection screen. Your video camera shoots that image, can color-correct faded pictures, add narration to other sound. Can be used with any video camera or slide projector. If your video camera lacks close-up capability, you will need a macro lens attachment.

MODEL V-1701 **\$34<sup>95</sup>**



# FOR ULTIMATE VIEWING

## TEKNIKA WIRELESS REMOTE CONTROL TV TUNER & CABLE CONVERTER WITH VOLUME CONTROL

Model 6510  
**\$169<sup>95</sup>**



Wireless remote control with volume for cable TV, VHF-UHF antenna systems upgrades any TV to 140 channel capability.

- Works with any TV set • Quick, easy installation • Off-air and cable compatible
- Quartz frequency synthesizer tuning • Direct access/memory scan selector • Ultra-compact, hand-held wireless remote control

## bp 61 CHANNEL WIRELESS REMOTE CONTROL Model V7661 **\$79<sup>95</sup>**



Wireless remote control on/off, channel selection and fine tuning.

- Works with any TV • 61 channel capability
- Microcomputer controlled PLL operation
- Converter panel controllable for channel up, down, on/off, fine tuning. • LED display
- Compatible with CATV systems.

## bp STABILIZER/IMAGE ENHANCER/RF CONVERTER/VIDEO FADER/2-WAY DISTRIBUTION AMPLIFIER

Model V1880 **\$99<sup>95</sup>**



Hook-up cable kit  
**\$11.75**

The most versatile, all-in-one video processor. Can be used as a video guard remover for video tapes, enhancer, video to RF converter, professional video fade in and out and a dual output distribution amplifier.

## bp VIDEO SWITCH

Model V4804 **\$49<sup>95</sup>**



Record a pay channel while viewing a standard channel. You can also connect an antenna/cable, VCR, video disc player, home computer and video game.

## bp VIDEO TAPE REWINDER

Model V7777 VHS **\$49<sup>95</sup>**

Model V7778 BETA **\$49<sup>95</sup>**



Reduce wear and tear of your VCR heads with the AC powered circuit protected rewinders, LED power-on indicators.

Charge it with VISA/MASTERCARD. Phone orders accepted.

# Fordham

260 Motor Parkway, Hauppauge, NY 11788

Toll Free  
**800-645-9518**  
In NY State 800-832-1446

### Service and Shipping Charge Schedule

FOR ORDERS	ADD
\$25-250 .....	\$4.50
\$251-500 .....	\$6.50
\$501-750 .....	\$8.50
\$751-1,000 .....	\$12.50
\$1,001 and up .....	\$15.00



# NEW!

## uniden® Bearcat®

# Rebates!

Communications Electronics™, the world's largest distributor of radio scanners, celebrates 1985 with big savings on Bearcat scanners. Uniden Corporation of America, the manufacturer of Bearcat scanners is offering huge consumer rebates on their great line of scanners, when purchased from CE between February 1 and March 31, 1985.

### Bearcat® 300-G

List price \$549.95/CE price \$344.00/\$10.00 rebate  
Your final cost is a low \$334.00

**7-Band, 50 Channel • Service Search • No-crystal scanner • AM Aircraft and Public Service bands • Priority Channel • AC/DC Bands: 32-50, 118-136 AM, 144-174, 421-512 MHz.** The Bearcat 300 is the most advanced automatic scanning radio that has ever been offered to the public. The Bearcat 300 uses a bright green fluorescent digital display, so it's ideal for mobile applications. The Bearcat 300 now has these added features: Service Search, Display Intensity Control, Hold Search and Resume Search keys, Separate Band keys to permit lock-in/lock-out of any band for more efficient service search.

### Bearcat® 20/20-G

List price \$449.95/CE price \$274.00/\$5.00 rebate  
Your final cost is a low \$269.00

**7-Band, 40 Channel • Crystalless • Searches AM Aircraft and Public Service bands • AC/DC Priority Channel • Direct Channel Access • Delay Frequency range 32-50, 118-136 AM, 144-174, 420-512 MHz.** Find an easy chair. Turn on your Bearcat 20/20 and you're in an airplane cockpit. Listening to all the air-to-ground conversations. Maybe you'll pick up an exciting search and rescue mission on the Coast Guard channel. In a flash, you're back on the ground listening as news crews report a fast breaking story. Or hearing police and fire calls in your own neighborhood, in plenty of time so you can take precautions. You can even hear ham radio transmission, business phone calls and government intelligence agencies. Without leaving your easy chair. Because you've got a Bearcat 20/20 right beside it.

The Bearcat 20/20 monitors 40 frequencies from 7 bands, including aircraft. A two-position switch, located on the front panel, allows monitoring of 20 channels at a time.

### Bearcat® 210XL-G

List price \$349.95/CE price \$209.00/\$35.00 rebate  
Your final cost is a low \$174.00

**6-Band, 18 Channel • Crystalless • AC/DC Frequency range 32-50, 144-174, 421-512 MHz.** The Bearcat 210XL scanning radio is the second generation scanner that replaces the popular Bearcat 210 and 211. It has almost twice the scanning capacity of the Bearcat 210 with 18 channels plus dual scanning speeds and a bright green fluorescent display. Automatic search finds new frequencies. Features scan delay, single antenna, patented track tuning and more.

### Bearcat® 260-G

List price \$399.95/CE price \$274.00/\$5.00 rebate  
Your final cost is a low \$269.00

**8-Band, 16 Channel • Priority • AC/DC Frequency range 30-50, 138-174, 406-512 MHz.** Keep up with police and fire calls, ham radio operators and other transmission while you're on the road with a Bearcat 260 scanner. Designed with police and fire department cooperation, its unique, practical shape and special two-position mounting bracket makes hump mounted or under dash installation possible in any vehicle. The Bearcat 260 is so ruggedly built for mobile use that it meets military standard 810c, curve y for vibration rating. Incorporated in its rugged, all metal case is a specially positioned speaker delivering 3 watts of crisp, clear audio.

### FREE Bearcat® Rebate Offer

Get a coupon good for a \$35.00 rebate when you purchase a Bearcat 210XL; \$30 rebate on model 201; \$20 rebate on models 180 and 100; \$10 rebate on models DX1000 or 300; \$5 rebate on models 20/20 or 260. To get your rebate, mail rebate coupon with your original dated sales receipt from Communications Electronics and the Bearcat model number from the carton to Uniden. You'll receive your rebate in six to eight weeks. Offer valid only on purchases made between February 1, 1985 and March 31, 1985. All requests must be postmarked by April 15, 1985. Limit of one rebate per household. Special rebate coupon must accompany all rebate requests and may not be reproduced. Offer good only in the U.S.A. Void where taxed or prohibited by law. Resellers, companies and employees of Uniden, their advertising agencies, distributors and retailers are not eligible for this rebate. Please be sure to send in the correct amount for your scanner. Pay the listed CE price in this ad. Do not deduct the rebate amount since your rebate will be sent directly to you from Uniden. Orders received with insufficient payments will not be processed and will be returned. Offer subject to change without notice.

### NEW! Bearcat® 201-G

List price \$279.95/CE price \$189.00/\$30.00 rebate  
Your final cost is a low \$159.00

**9-Band, 16 Channel • Crystalless • AC only Priority • Scan Delay • One Key Weather Frequency range 30-50, 118-136 AM, 146-174, 420-512 MHz.** The Bearcat 201 performs any scanning function you could possibly want. With push button ease, you can program up to 16 channels for automatic monitoring. Push another button and search for new frequencies. There are no crystals to limit what you want to hear.

### NEW! Bearcat® 180-G

List price \$249.95/CE price \$164.00/\$20.00 rebate  
Your final cost is a low \$144.00

**8-Band, 16 Channel • Priority • AC only Frequency range: 30-50, 138-174, 406-512 MHz.** Police and fire calls. Ham radio transmissions. Business and government undercover operations. You can hear it all on a Bearcat 180 scanner radio. Imagine the thrill of hearing a major news event unfold even before the news organizations can report it. There's nothing like scanning to keep you in-the-know, and no better way to get scanner radio performance at a value price than with the Bearcat 180.

### Bearcat® 100-G

**The first no-crystal programmable handheld scanner.**  
List price \$449.95/CE price \$229.00/\$20.00 rebate  
Your final cost is a low \$209.00

**8-Band, 16 Channel • Liquid Crystal Display Search • Limit • Hold • Lockout • AC/DC Frequency range: 30-50, 138-174, 406-512 MHz.** The world's first no-crystal handheld scanner has compressed into a 3" x 7" x 1 1/4" case more scanning power than is found in many base or mobile scanners. The Bearcat 100 has a full 16 channels with frequency coverage that includes all public service bands (Low, High, UHF and "T" bands), the 2-Meter and 70 cm. Amateur bands, plus Military and Federal Government frequencies. Wow...what a scanner!

The Bearcat 100 produces audio power output of 300 milliwatts, is track-tuned and has selectivity of better than 50 dB down and sensitivity of 0.6 microvolts on VHF and 1.0 microvolts on UHF. Power consumption is kept extremely low by using a liquid crystal display and exclusive low power integrated circuits.

Included in our low CE price is a sturdy carrying case, earphone, battery charger/AC adapter, six AA ni-cad batteries and flexible antenna. Order your scanner now.

### Bearcat® DX1000-G

List price \$649.95/CE price \$499.00/\$10.00 rebate  
Your final cost is a low \$489.00

**Frequency range 10 kHz to 30 MHz.** The Bearcat DX1000 shortwave radio makes tuning in London as easy as dialing a phone. It features PLL synthesized accuracy, two time zone 24-hour digital quartz clock and a built-in timer to wake you to your favorite shortwave station. It can be programmed to activate peripheral equipment like a tape recorder to record up to five different broadcasts, any frequency, any mode, while you are asleep or at work. It will receive AM, LSB, USB, CW and FM broadcasts.

There's never been an easier way to hear what the world has to say. With the Bearcat DX1000 shortwave receiver, you now have direct access to the world.

### Uniden® PC22-G

List price \$159.95/CE price \$99.00

The Uniden PC22 is a 40 channel AM remote mobile CB radio. It's the answer for today's smaller cars which don't always provide adequate space for mounting. Since all the controls are on the microphone, you can stash the "guts" in the trunk. The microphone has up/down channel selector, digital display, TX/RX indicator and external speaker jack. Dimensions: 5 1/4" W x 7 7/8" D x 1 1/2" H. 13.8 VDC, positive or negative ground.

### QUANTITY DISCOUNTS AVAILABLE

Order two scanners at the same time and deduct 1%, for three scanners deduct 2%, four scanners deduct 3%, five scanners deduct 4% and six or more scanners purchased at the same time earns you a 5% discount off our super low single unit price.

### Uniden® PC55-G

List price \$89.95/CE price \$59.00

The Uniden PC55 40 Channel CB radio is a full featured transceiver that boasts a super-compact case and a front-panel mike. It has ANL, PA-CB, Channel 9 and RF Gain switches. LED "S"/RF meter, TX lite, PA & external speaker jacks. Dimensions: 6" W x 6" D x 1 1/4" H. ±13.8 VDC. The Uniden PC55...now at a special low price.



Choose from many different models.

### OTHER RADIOS AND ACCESSORIES

RD55-G Uniden visor mount Radar Detector.....\$119.00  
RD95-G Uniden remote mount Radar Detector.....\$139.00  
FB-E-G Frequency Directory for Eastern U.S.A.....\$12.00  
FB-W-G Frequency Directory for Western U.S.A.....\$12.00  
BC-WA-G Bearcat Weather Alert!.....\$39.00  
A60-G Magnet mount mobile antenna.....\$35.00  
A70-G Base station antenna.....\$35.00  
Add \$3.00 shipping for all accessories ordered at the same time.  
Add \$3.00 shipping per scanner antenna.

### BUY WITH CONFIDENCE

To get the fastest delivery from CE of any product in this ad, send or phone your order directly to our Scanner Distribution Center. Michigan residents please add 4% sales tax or supply your tax I.D. number. Written purchase orders are accepted from approved government agencies and most well rated firms at a 10% surcharge for net 10 billing. All sales are subject to availability, acceptance and verification. All sales on accessories are final. Prices, terms and specifications are subject to change without notice. All prices are in U.S. dollars. Out of stock items will be placed on backorder automatically unless CE is instructed differently. A \$5.00 additional handling fee will be charged for all orders with a merchandise total under \$50.00. Shipments are F.O.B. Ann Arbor, Michigan. No COD's. Most products that we sell have a manufacturer's warranty. Free copies of warranties on these products are available prior to purchase by writing to CE. International orders are invited with a \$20.00 surcharge for special handling in addition to shipping charges. Non-certified checks require bank clearance.

**Mail orders to:** Communications Electronics, Box 1045, Ann Arbor, Michigan 48106 U.S.A. Add \$7.00 per scanner, radar detector or CB or \$12.00 per shortwave receiver for U.P.S. ground shipping and handling in the continental U.S.A. For Canada, Puerto Rico, Hawaii, Alaska, or APO/FPO delivery, shipping charges are three times continental U.S. rates. If you have a Visa or Master Card, you may call and place a credit card order. Order toll-free in the U.S. Dial 800-USA-SCAN. In Canada, order toll-free by calling 800-221-3475. WUI Telex CE anytime, dial 671-0155. If you are outside the U.S. or in Michigan dial 313-973-8888. Order today.

Scanner Distribution Center™ and CE logos are trademarks of Communications Electronics™. Ad # 010285-G  
† Bearcat is a registered trademark of Uniden Corporation.  
Copyright © 1985 Communications Electronics

For more information call  
**1-800-SCANNER**

For credit card orders call  
**1-800-USA-SCAN**

**COMMUNICATIONS  
ELECTRONICS™**

**Consumer Products Division**  
P.O. Box 1045 □ Ann Arbor, Michigan 48106-1045 U.S.A.  
Call 800-USA-SCAN or outside U.S.A. 313-973-8888



## BUILD THIS

- 43 REAL-TIME SPECTRUM ANALYZER**  
Learn more about your stereo system, and how to get the most out of it, with this useful tool. **Roger Cota and Lloyd Addington**
- 51 VIDEO SYNC SEPARATOR**  
This oscilloscope upgrade lets you really see what those video signals look like. **Steve Pence**
- 59 THREE HIGH-PERFORMANCE SCANNER ANTENNAS**  
Pull in those signals that you've been missing with one of these high-performance designs. **Loren Freburg**

## TECHNOLOGY

- 8 VIDEO NEWS**  
Tomorrow's news and technology in this quickly changing industry. **David Lachenbruch**
- 12 SATELLITE TV**  
Today's satellite receivers. **Bob Cooper, Jr.**
- 48 CELLULAR MOBILE TELEPHONES**  
All about the system that is revolutionizing mobile telephone communications. **Marc Stern**

## CIRCUITS AND COMPONENTS

- 40 NEW IDEAS**  
Making electronic music.
- 63 HOW TO DESIGN MICROPROCESSOR-BASED PROJECTS**  
Add some "intelligence" to your next project. **Tom Fox**
- 75 DESIGNING WITH DIGITAL IC'S**  
Part 2. A look at CMOS and CMOS devices, and the special handling that they require. **Joseph J. Carr**
- 78 HOBBY CORNER**  
A simple antenna tuner. **Earl "Doc" Savage, K4SDS**
- 84 DRAWING BOARD**  
Automatic data sequencing. **Robert Grossblatt**

## VIDEO

- 67 SERVICING VIDEODISC PLAYERS**  
Part 4. This month, we conclude our series on videodisc players and how to troubleshoot and service them. **John D. Lenk**
- 90 SERVICE CLINIC**  
What's "new" in TV. **Jack Darr**
- 90 SERVICE QUESTIONS**  
Radio-Electronics' service editor answers readers questions.

## RADIO

- 82 COMMUNICATIONS CORNER**  
Odds and ends. **Herb Friedman**
- 88 ANTIQUE RADIOS**  
Restoring those antiques. **Richard D. Fitch**

## COMPUTERS

- Following page 80 **COMPUTER DIGEST**  
High-speed modems, inexpensive add-ons for your IBM, using your computer to design resonant circuits, and lots more!

## EQUIPMENT REPORTS

- 27 Alden Model 9321 Weatherchart Recorder**
- 30 MFJ Enterprises MFJ-989 Antenna Tuner**

## DEPARTMENTS

- 112 Advertising and Sales Offices**
- 112 Advertising Index**
- 113 Free Information Card**
- 20 Letters**
- 95 Market Center**
- 38 New Products**
- 6 What's News**



# COVER 1



It never seems to fail: Those brand new speakers, that sounded so wonderful in the showroom, sound so disappointing when you set them up in your listening room. The explanation for that is simple: Your system has to be adjusted to accommodate your listening room. An equalizer can help, but only if it's adjusted properly to correct the response of the loudspeakers. That's where our real-time spectrum analyzer comes in. It can turn the job of adjusting an equalizer from a frustrating one to an easy one. Find out more about it, including how to build it, starting on page 43.

# NEXT MONTH

ON SALE APRIL 11

## COMPUTER-CONTROLLED ROBOT

Use a popular personal computer to operate a robot arm.

## SERVICING CORDLESS PHONES

All about those devices and how to troubleshoot and repair them.

## OPTOCOUPERS

Learn how to use those versatile devices in your circuit designs.

## STEREO POWER METER

More than a meter, it also disconnects your speakers from your system at the first sign of trouble.

AND LOTS MORE!

As a service to readers, Radio-Electronics publishes available plans or information relating to newsworthy products, techniques and scientific and technological developments. Because of possible variances in the quality and condition of materials and workmanship used by readers, Radio-Electronics disclaims any responsibility for the safe and proper functioning of reader-built projects based upon or from plans or information published in this magazine.

Since some of the equipment and circuitry described in RADIO-ELECTRONICS may relate to or be covered by U.S. patents, RADIO-ELECTRONICS disclaims any liability for the infringement of such patents by the making, using, or selling of any such equipment or circuitry, and suggests that anyone interested in such projects consult a patent attorney.

## Radio-Electronics®

Hugo Gernsback (1884-1967) founder  
M. Harvey Gernsback, editor-in-chief  
Larry Steckler, CET, publisher

### EDITORIAL DEPARTMENT

Art Kleiman, editor  
Brian C. Fenton, technical editor  
Carl Laron, WB2SLR, associate editor  
Robert A. Young, assistant editor  
Julian S. Martin, editorial associate  
Byron G. Wels, editorial associate  
Jack Darr, CET, service editor  
Robert F. Scott, semiconductor editor  
Herb Friedman, communications editor  
Earl "Doc" Savage, K4SDS, hobby editor  
Bob Cooper, Jr. satellite-TV editor  
Robert Grossblatt, circuits editor  
David Lachenbruch, contributing editor  
Lou Frenzel, contributing editor  
Bess Isaacson, editorial assistant

### PRODUCTION DEPARTMENT

Ruby M. Yee, production manager  
Robert A. W. Lowndes, editorial production  
Dianne Osias, advertising production  
Karen Tucker, production traffic

### CIRCULATION DEPARTMENT

Jacqueline P. Weaver, circulation director  
Rita Sabalis, assistant circulation director  
Jacqueline Allen, circulation assistant

Cover photo by Robert Lewis

Radio-Electronics is indexed in *Applied Science & Technology Index* and *Readers Guide to Periodical Literature*.

Microfilm & microfiche editions are available. Contact circulation department for details.

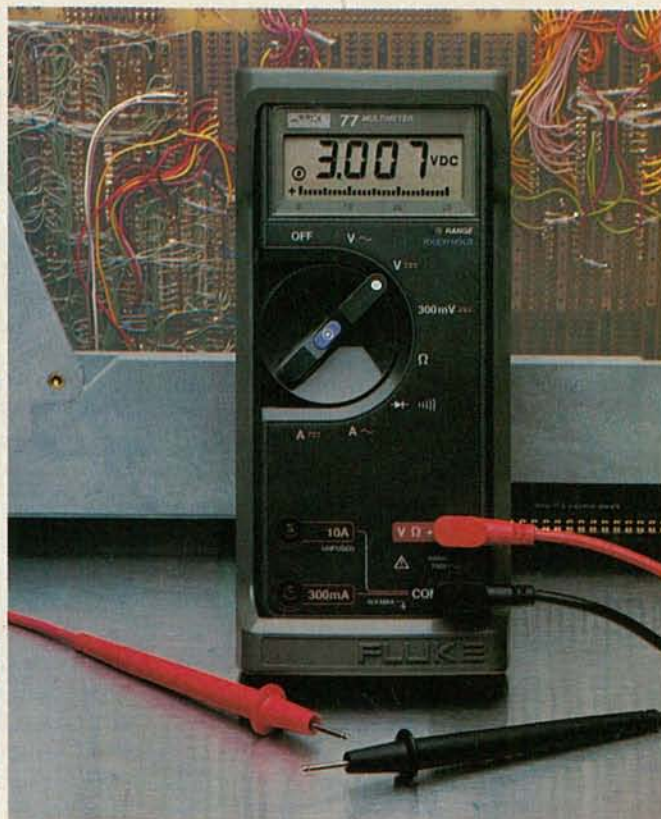
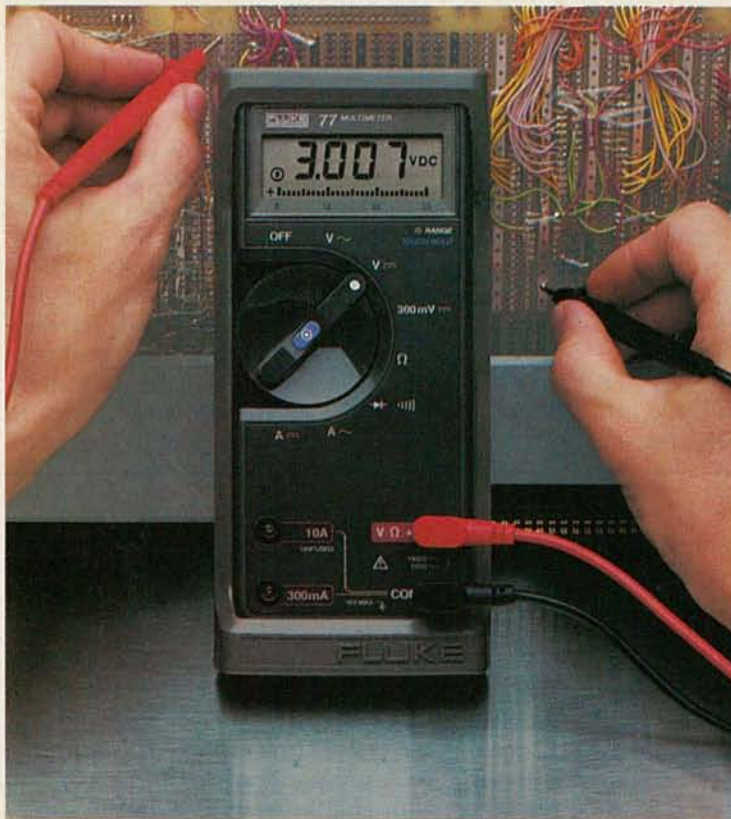
Advertising Sales Offices listed on page 128.





# You touch.

# It holds.



**\$129\*** gets you the world's first handheld digital/analog multimeter with "Touch Hold."

### The Fluke 77

Its unique "Touch Hold" function automatically senses and holds readings, leaving you free to concentrate on positioning test leads without having to watch the display.

Then, when you have a valid reading, it signals you with an audible beep.

The Fluke 77 is perfect for those test situations where accessibility is a problem, or when extra care is needed for critical measurements.

It's the top model in the world champion Fluke 70 Series line — the first industrial quality autoranging multimeters to combine digital and analog displays. These tough, American-made meters feature a three-year warranty and 2000+ hour battery life.

So call now for the complete story on the Fluke 77 with "Touch Hold." Because if you don't deserve the world's first, who in the world does?

For the name of your distributor or a free brochure, call our toll-free hotline anytime **1-800-227-3800, Ext. 229.**

From outside the U.S., call 1-402-496-1350, Ext. 229.

FROM THE WORLD LEADER IN DIGITAL MULTIMETERS.



FLUKE 73	FLUKE 75	FLUKE 77
\$85*	\$99*	\$129*
Analog/digital display	Analog/digital display	Analog/digital display
Volts, ohms, 10A, diode test	Volts, ohms, 10A, mA, diode test	Volts, ohms, 10A, mA, diode test
Autorange	Audible continuity	Audible continuity
0.7% basic dc accuracy	Autorange/range hold	"Touch Hold" function
2000+ hour battery life	0.5% basic dc accuracy	Autorange/range hold
3-year warranty	2000+ hour battery life	0.3% basic dc accuracy
	3-year warranty	2000+ hour battery life
		3-year warranty
		Multipurpose holster

\* Suggested U.S. list price, effective July 1, 1984.  
 \*\* Patent pending.



Copyright © 1984, John Fluke Mfg. Co., Inc. All rights reserved. Ad No. 4701-77

CIRCLE 252 ON FREE INFORMATION CARD

APRIL 1985

5



# WHAT'S NEWS

## **Comsat, Mitsubishi announce agreement**

Comsat Technology Products (CTP), the equipment manufacturing arm of Comsat Satellite Corp, has signed a teaming agreement with Mitsubishi Electric Corp of Tokyo, Japan, to manufacture and market low-cost, small-aperture Ku-band earth stations for use in high-speed document distribu-

tion and private data-networks.

Mitsubishi will produce the RF portion of the terminals, and CTP will be responsible for making the digital, signal processing components, and for integrating and marketing the complete earth stations.

According to CTP president A.W. Perigard, the introduction of small-aperture, low-cost earth sta-

tions has led many U.S. companies to begin planning for large electronic mail and data networks to take advantage of the efficiencies of satellite communications. The combination of Mitsubishi's price-competitive microwave components and CTP's signal-processing equipment and system integration, he believes, should ensure the success of the venture.

## **New magnesium batteries hold promise for future**

A dry cell with a shelf life of at least five years and a voltage output of 1.9 is promised as a result of research in magnesium battery design culminating in a recent patent application by ACR Electronics of Hollywood, FL. In addition, the new battery would have greater capacity for its size, lower internal resistance, and a higher peak discharge rate than present dry cells.

Magnesium's greater tendency toward chemical reaction—which is the cause of its higher voltage—

also forms a protective layer on its surface when the battery is idle. This inhibits the "local action" or spontaneous internal discharge, that runs down a zinc-carbon battery when not in use. But this film, which so greatly increases shelf life, takes time to break down when the circuit is "turned on." The delay can last as much as a minute before the load breaks down the protective film and current rises to normal. A second problem is that the chemical reac-

tion in the cell builds up gas, which must be vented.

Research by ACR has reduced or eliminated those problems. An improved electrolyte produces water instead of gas, and other improvements have reduced the "current-on" delay to less than 0.3 seconds.

A unique feature of the magnesium batteries is their "inside-out" construction. Instead of the negative zinc can, the carbon positive element is cast in one piece to serve both as container and positive center pole. The negative element is an extruded magnesium cylinder that fits concentrically between the center carbon electrode and "can." This positioning also reduces the length of the electrical paths in the cells, reducing internal resistance.

Although magnesium batteries have been used for some years in special applications, such as marine markers and rescue lights, and in several space programs, they are not yet quite ready for general consumer use. A number of problems remain—among which are adaption of radio equipment or flashlight bulbs to the 1.9-volt rating of the new cell. But it is reasonable to suppose that we will in time have a flashlight that can remain idle in the car for years and still supply top performance. **R-E**



**NEW MAGNESIUM BATTERY** features an "inside-out" construction. The positive element serves as both the center electrode and the battery can.



# New from B&K-PRECISION, for telephone service, test and repair

**COMPLETE TELEPHONE PRODUCT ANALYZER.** A total self-contained system for diagnostic testing, servicing and calibration of corded and cordless telephones, answering machines and automatic dialers. Performs every test you'll ever need to test and repair any phone product including verification of pulse and touch-tone numbers, measurement of frequency error and modulation deviation. **MODEL 1050 \$1695**



**MODEL 1050 \$1695**

**CORDLESS TELEPHONE TESTER.** Provides full servicing and calibration capability for base and portable phone units. All rf test and measurement functions. Replaces expensive FM generators and modulation monitors, yet performs all tests required for cordless phone system analysis and repair, including full frequency testing and alignment. Generates all prior and recently approved frequencies. **MODEL 1047 \$895**



**MODEL 1047 \$895**



**MODEL 1045 \$395**

**TELEPHONE PRODUCT TESTER.** For in-store consumer or service use. Tests handset cord, phone line cord, dial/redial functions, voice and dial number levels, ring function and voice quality of corded and cordless phones, answering machines and automatic dialers. **MODEL 1045 \$395**



**MODEL 1042 \$19.95**

**TELEPHONE LINE ANALYZER.** Quickly identifies a problem as external or in the phone itself. Tests for condition of external phone line, phone line cord, ring and line voltage levels and polarity. Easy to use, no batteries or external power needed. **MODEL 1042 \$19.95**

*These test instruments cover every possible level of service required for telephone products. They are equally useful for training. The instruction manuals provided offer a comprehensive course of training for service personnel and students. Call your nearest B&K-PRECISION distributor for off-the-shelf-delivery or additional information—or contact B&K-PRECISION.*

**B&K PRECISION DYNASCAN CORPORATION**

6460 West Cortland Street • Chicago, Illinois 60635 • 312 889-9087

International Sales: 6460 W. Cortland St., Chicago, IL 60635

Canadian Sales: Atlas Electronics, Ontario

South and Central American Sales: Empire Exporters, Plainview, NY 11803

CIRCLE 77 ON FREE INFORMATION CARD



# VIDEO NEWS



**DAVID LACHENBRUCH**  
CONTRIBUTING EDITOR

● **Here comes Super Beta.** Around midyear, Sony and other Beta VCR manufacturers are scheduled to introduce "Super Beta," a new version of the Beta system, which is claimed to achieve a 20% increase in picture resolution. Super Beta recorders use standard Beta cassettes, but shift the carrier signal frequency upward by 800 kHz resulting in a wider luminance bandwidth for a sharper picture with more detail. In addition, the system has special video noise reduction and emphasis circuitry.

Super Beta produces a picture with more than 300 lines of horizontal resolution and about 45dB signal-to-noise, according to Sony estimates. Thus it falls short of the super-high-band VCR's mentioned previously in this column as being in the works. However, the picture is extremely good, and it particularly excels for home editing—demonstrations showed that a fourth-generation Super Beta tape was at least as good as a second-generation tape made on a standard Beta recorder. The Beta group claims complete compatibility—that is, tapes recorded on Super Beta can be played back on standard Beta recorders and standard tapes can be played on Super Beta machines.

● **More 8mm VCR's.** The first VCR's in the new 8mm video format to be sold here were combination camera-recorders, or camcorders, by Eastman Kodak, General Electric, and Polaroid. Now along come the first "separates"—tiny portable decks designed for use with miniaturized video cameras and with separate tuner-timers.

The little decks weigh about four pounds or so, including battery, and use the new 8mm cassettes. The Sanyo unit, priced at \$1,100, including tuner-timer, has a two-speed switch to double the playing time of a 90-minute cassette. Canon's Canovision deck is priced at \$900, the companion programmable tuner-timer at \$300.

● **35-inch color tube.** The world's biggest direct-view color picture tube, a 35-inch model, will be introduced in the United States this fall in a new set by Mitsubishi. The TV console will sell for around \$3,000, but the company promises future models at lower prices. The tube is 22.4 inches deep, weighs 110 pounds, has center brightness of 170 foot-lamberts with resolution comparable to Mitsubishi's best 25-inch—330 lines horizontally on broadcast TV, 400 on video input. Power consumption of the set will be 180 watts as compared with 160 watts for Mitsubishi's 25-inch models.

The largest picture tube in any set previously offered in the United States was 30 inches in a special Sony 35th Anniversary model console produced in a limited run of 1,000 sets, retailing at \$10,000. The biggest tubes scheduled for production in the United States measure 27 inches diagonally and won't be available until 1986.

● **TV extenders.** Two new gadgets are designed to make it easy to add more TV sets to your home without having to string up cable. Rabbit, by Envision Systems, Santa Monica, Cal., connects to a VCR's video and audio outputs and puts them on an FM carrier for transmission to television sets throughout the house via the electrical wiring. One transmitter and one receiver cost \$100, extra receivers are \$40. Quantec International, Salt Lake City, offers a low-power transmitter that connects to the RF output of a VCR, game, computer, or videodisc player and is said to permit tuning on any rabbit-equipped TV set up to 40 feet away.

**R-E**





# ADVANCE ELECTRONICS

IS PROUD TO INTRODUCE

## **Beckman Industrial™** 9000 SERIES

### HIGH PERFORMANCE PROFESSIONAL

# OSCILLOSCOPES

**9060 60 MHz** • Dual Trace with Delayed Sweep • 1mV Vertical Sensitivity • 8 Traces • 12KV Acceleration Voltage • XY Mode • Channel 1 Output • 3 Vertical Inputs • Service Manual included

**9100 100MHz** • Dual Trace With Delayed Sweep • 1mV Vertical Sensitivity • 8 Traces •  $\leq 3.5nS$  Rise Time • 18KV Acceleration Voltage • XY Mode • Channel 1 Output • 3 Vertical Inputs

ENGINEERED SO THAT SPECIFICATIONS ARE MET IN THE FIELD NOT JUST ON THE DRAWING BOARD



**SPECIAL 3 YEAR EXTENDED WARRANTY\***



**Circuitmate™**  
model UC10 universal counter.

- 5Hz to 100MHz.
- Two Input Channels.
- Measures Frequency, Period, Frequency Ratio, Time Interval, and Unit Count.
- 20mV Input Sensitivity to 100 MHz.
- 4 Selectable Gate Times.
- 14 LED Indicators.
- 8-Digit LED Display.

**Circuitmate™**  
model FG2 function generator.

- 7 Ranges: 0.2 Hz to 2 MHz.
- Outputs: Square, Triangle, Sine, Waves and TTL Pulses.
- Duty Cycle Control.
- VCF Input.
- Variable/Fixed Attenuators.
- Variable DC Offset Control.
- Inversion Feature.



\*These new Oscilloscopes are so reliable that we are offering a **SPECIAL 3 YEAR WARRANTY** when you purchase these scopes from **ADVANCE ELECTRONICS**

**AVAILABLE NOW**  
**CALL FOR PRICES**



TOLL FREE HOT LINE  
**800-223-0474**

212-730-7030  
26 WEST 46th STREET, NEW YORK, N.Y. 10036

THE TEST EQUIPMENT SPECIALISTS

**ADVANCE**  
**ELECTRONICS**





PHILIPS

KEITHLEY

WESTON



Non-Linear Systems



BK PRECISION

LEADER



- 77
- 0.3% Accuracy
  - Manual or Autorange
  - 10A + mA Range
  - Beeper
  - "Touch-Hold" Function

Sale (with holster)  
**\$119<sup>95</sup>**

WE CARRY A FULL LINE OF FLUKE MULTI-METERS. IN STOCK NOW

Sale ends April 85

# FLUKE 70 SERIES MULTIMETERS

- Analog Display • Rotary Knob • Volts AC & DC • Resistance to • 32 MΩ • 10 Amps • Diode Test • 3200 Counts • Fast Autoranging • Function Annunciators in Display • Power-Up Self Test • 2000+ Hour Battery Life w/ Power Down "Sleep Mode" • New Test Leads • VDE & UL Approval



**\$99<sup>00</sup>**

75

- 0.5% Accuracy
- Manual or Autorange
- 10A + 300 mA Range
- Beeper

**\$79<sup>95</sup>**

and free C70 holster

73

- 0.7% Accuracy
- Autorange Only
- 10 Amp Only



4 1/2 DIGIT MULTIMETERS

**\$349<sup>00</sup>**

MODEL 8060A



- Frequency measurements to 200KHz
- dB measurements
- Basic dc accuracy 0.4%; 10 μV, 10 nA and 10 mΩ sensitivity
- Relative measurements
- True RMS
- High-speed Beeper

## THE NEW FLUKE 27 SERIES WORLDS TOUGHEST METER



**NOW IN STOCK!**



INDUSTRIAL TRANSISTOR TESTER  
**\$199<sup>95</sup>**



MODEL 520B

- Now with HI/LO Drive
- Works in-circuit when others won't
- Identifies all three transistor leads
- Random lead connection
- Audibly and visually indicates GOOD transistor



70 MHz Dual Time Base SCOPE

MODEL 1570



**\$995<sup>00</sup>**

PRICE DOES NOT INCLUDE PROBES

- 1mV/division sensitivity to 70 MHz
- 500 μV/division cascade sensitivity
- Four-input operation provides trigger view on 4 separate inputs
- Alternate time base operation
- Switching power supply delivers best efficiency and regulation at lowest weight



MODEL 830

CAPACITANCE METERS  
**\$199<sup>95</sup>**

- Automatically measures capacitance from 0.1pF to 200mF
- 0.1pF resolution
- 0.2% basic accuracy
- 3 1/2 digit LCD display



MODEL 820

**\$159<sup>95</sup>**

- Resolves to 0.1pF
- 4 digit easy-to-read LED display
- Fuse protected against charged capacitors
- Overrange indication



# BECKMAN'S CIRCUITMATE<sup>®</sup> ALL UNDER \$100

AVAILABLE NOW...



**\$64<sup>95</sup>**

Circuitmate DM 20—  
3½-digit, pocket-size  
multimeter; 0.8% Vdc  
accuracy, diode test,  
hFE test, conductance,  
10 amps AC and DC  
ranges, auto-polarity  
auto-zero, auto-  
decimal



**\$69<sup>95</sup>**

Circuitmate DM-40 —  
3½-digit multimeter;  
0.8% Vdc accuracy,  
diode test, auto-  
polarity, auto-zero,  
auto-decimal



**\$89<sup>95</sup>**

Circuitmate DM 45 —  
3½-digit multimeter;  
0.5% Vdc accuracy,  
diode test, continuity  
beeper, 10 amps AC  
and DC ranges, auto-  
zero, auto-polarity,  
auto-decimal



**\$79<sup>95</sup>**

Circuitmate DM-25—  
3½ digit, pocket-size  
multimeter; 0.5% Vac  
accuracy, diode test,  
capacitance, continuity  
beeper, conductance,  
10 amps AC and DC  
ranges, auto-polarity,  
auto-zero, auto-  
decimal



The DM73 is the smallest digital  
multimeter on the market. Its  
probe-style design makes it ideal  
for taking measurements in hard-  
to-reach test areas.

**SALE**  
**\$59.<sup>95</sup>**

- Small Size
- Complete Autoranging
- "Touch Hold"
- Audible continuity checking



**\$76<sup>95</sup>**

The DM 77 gives you  
the convenience of  
autoranging plus 10  
amps ac/dc  
measurement  
capability. You simply  
select the function  
you want, and the  
DM 77 automatically  
sets the required  
range.

...Quality and Performance  
Beckman and 4½ Digits...

True RMS



MODEL 4410

**\$239<sup>00</sup>**

AVAILABLE NOW!

BECKMAN does it  
again...a true RMS  
4½ DMM w/1 year  
calibrated cycle at  
a 3½ digit price.



**NEW**  
Beckman  
Circuit-mate  
DM10

**\$39<sup>95</sup>**

in stock now

**BK PRECISION**

POWER SUPPLIES



**\$299<sup>95</sup>**

MODEL  
1601

- Isolated 0-50VDC, continuously variable; 0-2A in four ranges
- Fully automatic shutdown, adjustable current limit
- Perfect for solid state servicing



**\$329<sup>95</sup>**

MODEL 1650

- Functions as three separate supplies
- Exclusive tracking circuit
- Fixed output 5VDC, 5A
- Two 0 to 25VDC outputs at 0.5A
- Fully automatic, current-limited overload protection



MODEL  
3010

FUNCTION GENERATORS

**\$189<sup>95</sup>**

MODEL  
3020

**\$319<sup>95</sup>**

SWEEP FUNCTION

- Sine, square and triangle output
- Variable and fixed TTL outputs
- 0.1 Hz to 1MHz in six ranges
- Push button range and function selection
- Typical sine wave distortion under 0.5% from 1 Hz to 100kHz
- Four instruments in one package — sweep generator, function generator, pulse generator, tone-burst generator
- Covers 0.02Hz-2MHz
- 1000:1 tuning range
- Low-distortion high-accuracy outputs



TOLL FREE HOT LINE  
**800-223-0474**

212-730-7030

26 WEST 46th STREET, NEW YORK, N.Y. 10036

THE TEST EQUIPMENT SPECIALISTS

**ADVANCE  
ELECTRONICS**



# SATELLITE TV



BOB COOPER, JR.\*  
SATELLITE TV EDITOR

## TVRO receivers and remote controls

AS WE BEGAN TO SEE IN LAST MONTH'S column, the TVRO receiver of today has changed greatly over the past five years or so.

Take the IF portion of the receiver, for example. The basic receiver must develop a significant "bulk gain" in the lowest IF segment—as much as 50 dB of gain at 70 MHz (in 1980). In the IF section, we also find single-channel filtering networks that eliminate (with bandpass filter sections) any signal energy on adjacent satellite channels. Up to 50% of the total receiver in 1980 was wrapped up with parts in the IF segment.

The 1984/85 TVRO receiver uses amplifier stages constructed from a few IC's; gone are the discrete transistors, and associated resistors and capacitors. The mixture of coils and capacitors that once made up elaborate bandpass filters have been replaced by SAW-filter devices. As a result, today's IF stages may have only a dozen (or fewer!) parts.

As we all know, fewer parts usually mean fewer dollars per receiver (in parts and labor). And any reduction in parts typically results in an improvement in mean-time-between-failures and, eventually, lower cost to the consumer. Before the end of 1985, we can expect to see a complete single IC that accepts the 70-MHz IF and "spits" out demodulated video and audio.

### Enter remote control

The early TVRO terminals of 1979/80 not only lacked remote-control capabilities, but they were probably impossible to control even locally (manually)! At that

\* PUBLISHER, CSD MAGAZINE



FIG. 1

time, all TVRO-system components (dish mover, receiver, etc.) were manufactured by different companies, who made no effort to make their respective products capable of communicating with the other components that made up the system.

### TVRO dealer "Starter Kit" available

Bob Cooper's *CSD Magazine* has arranged with a number of TVRO equipment suppliers to provide a single-package of material that will help introduce you to the world of TVRO dealership. A short booklet written by Bob Cooper describes the start-up pitfalls to be avoided by any would-be TVRO dealer, in addition, product data and pricing sheets from prominent suppliers in the field are included. That package of material is free of charge and is supplied to firms or individuals in the electronics service business as an introduction to the 1984/85 world of selling TVRO systems retail.

You may obtain your *TVRO Dealer Starter Kit* free of charge by writing on company letterhead, or by enclosing a business card with your request. Address your inquiries to: *TVRO STARTER KIT*, P.O. Box 100858, Fort Lauderdale, FL 33310. That kit *not* available to individuals not involved in some form of electronics sales and service.

That meant that every function was separate, requiring separate (unrelated) pieces of hardware to accomplish each task. For example: *Channel selection* was one function; *audio selection* was another (although the circuitry might have been located in the receiver cabinet); *fine tuning* was a separate function (within the basic receiver); *polarity selection* was another function, and *satellite selection*, yet another.

As TVRO systems progressed, synthesized tuning eliminated the need for a manual fine-tuning control, and memories made audio subcarrier tuning a thing of the past—you tuned it but once when the receiver was first set up. Polarization selection also went away when receivers were either "hard wired" or equipped with memory tied to the receiver's channel-selection switch. That allowed the correct polarization to be automatically selected when a new channel was tuned.

Now we're left with satellite selection and the basic channel selection. In many modern receivers, those two functions are combined into a single step; you tell the receiver what satellite you want and which transponder (channel) all in a series of strokes on a keypad. The receiver's memory, interfaced to the antenna drive unit, along with polarization switching does it all for the user. The system can be infrared controlled or (UHF) wireless or hard-wire controlled.

### What's available

A number of receiver packages, like those from Arunta and Con-



### ECG® LED Lamps

Philips ECG has LED lamps in shapes and sizes for virtually any application. They're available in round, rectangular, triangular and square shapes. They come in red, yellow, green, or even in two colors. And there's a choice of clear and diffused reds. Some have jeweled lenses. And some are even available as flashing LEDs with the flasher circuit built in.

In addition, long-life, shock-resistant, vibration-resistant, LED replacements for incandescent cartridge indicator lamps are also available in red, yellow or green. Common applications: All LED indicator applications. LED cartridges are ideal replacements for cartridge-type incandescent lamps. CIRCLE 297 ON FREE INFORMATION CARD



### ECG® High-Voltage Rectifier and Voltage Divider Network

Philips ECG's ECG568 is a high-voltage rectifier used in Sanyo and Sears TV sets to supply high voltage to the picture tube. It also contains a voltage divider network which supplies focus voltage to the picture tube.

Common applications: For use in television service and repair. CIRCLE 298 ON FREE INFORMATION CARD

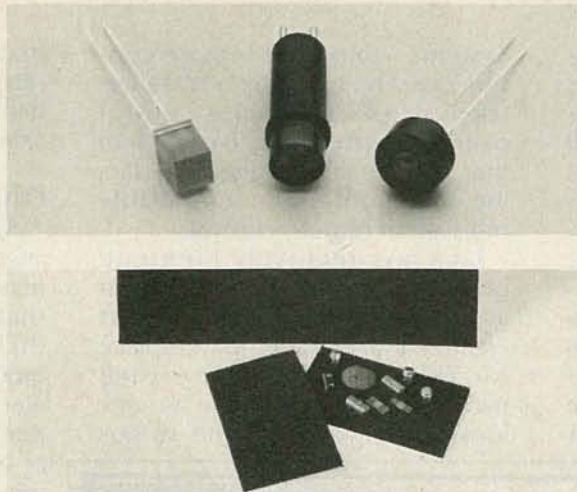


### EMF® Transient Voltage and RF Interference Suppressors

EMF transient voltage surge suppressors by Philips ECG clamp voltage spikes on 120 VAC line to levels safe for all electronic equipment. They can handle up to 40% greater surge current than other suppressors. Single outlet suppressors are available in both two- and three-prong versions.

The multiple outlet EMF315 incorporates both a spike suppressor and a PI filter to suppress RF interference on the AC line. RF interference causes audio and video degradation and causes digital equipment to function imperfectly.

Common applications: Electronic equipment such as hi-fi and television, stereo, computers or other line-operated electronic equipment subject to voltage surges and radio frequency interference from the AC line. CIRCLE 299 ON FREE INFORMATION CARD



### ECG® A-STAT Material

Philips ECG has two sizes of anti-static foam that will prevent damage to semiconductors from static electricity. The A-STAT 12 measures 12" x 12" and is perfect for bench use. The A-STAT 2 measures 3" x 5" and can be carried in the tool box. When semiconductors are kept in A-STAT foam, static electricity is shunted through the foam instead of into the semiconductor, where it could have caused damage.

Common applications: Essential for semiconductor protection on the workbench or in the field.

CIRCLE 271 ON FREE INFORMATION CARD

# The one thing we make that you have to replace every year.



### The new and expanded ECG® Semiconductors Master Guide.

Your new Master Guide will be looking as dog-eared as the old one before long. Because this year the Master Guide has been expanded to include more than 400 new products and almost 25,000 new cross references. The Master Replacement Guide for 1985. 656 pages. Over 3,500 different ECG devices that provide replacement coverage for more than 227,000 industry types. And everything in the book is cross-referenced so you can find what you're looking for fast, and be sure it fits. Plus, everything we make meets or exceeds the original JEDEC or application specs. So it

works. It's the only book you'll need. But you'll need a new one every year.

To get a copy of the new Master Guide, go to your nearest Philips ECG distributor. For his name and location, just call: 1-800-225-8326 (in Mass., 617-890-6107).

**If it's ECG, it fits. And it works.**

## Philips ECG

A North American Philips Company

*Dedicated to Excellence.*

CIRCLE 68 ON FREE INFORMATION CARD



ifer, have the complete control system built into the basic receiver. Intersat and Arunta provide hand-held remote-units that allow full system control from your favorite easy-chair, or any other place within "sight" of the receiver.

The makers of the more sophisticated dish-mover systems, recognizing that not all receivers are equipped with remote-control capabilities, designed expandable dish-control units—like the *Tracker IV*, from Houston Tracker

Systems—that offer remote control. (See Fig. 1.) Such units feature (UHF wireless) remote control over the antenna-drive system that, with dealer-installed interfacing, allow otherwise unavailable full system remote-control.

Like any relatively high-end package, such frills do not come in at low-end prices. And that has created a far broader marketplace for TVRO systems than existed back in 1979/80. Let's take a quick look at what you get in the various

home TVRO-system price ranges—from low-end, no-frills packages to the more sophisticated high-end systems.

### Price range

Starting with the least expensive *install-it-yourself* systems, the market starts off with packages that feature 4.5–6-foot antenna dishes, equipped with non-motorized mounts and simplistic electronics that retail for just under \$1,000 (\$995) in many sections of North America. Many marketing experts feel that such systems may be the wave of the future (offering 20 to 30 channels of satellite TV to the "average" user.)

The next sizable range of systems comes in at around \$1995. These systems (usually dealer-installed) are simply slight upgrades of the no-frills packages. The system may contain a slightly larger antenna with polar-mount, and hand-operated dish mover. Dealers who know what they are doing seldom install the lower priced system.

Then we have the motor-driven systems—priced in the \$2995 region—that feature higher-quality receivers, but few remote-control functions. An industry study in the late spring of 1984 showed the average system selling for just under \$3000 nationwide.

Now we come to the high-end packages, selling for as high as \$5995 in some parts of the country, that feature full remote control, receivers with memory, and stereo audio, with all the frills and do-dads that American and Japanese engineers have been able to create. Between the low-end and high-end price ranges (\$995–\$5995), there is an extremely wide selection of systems. Next time, we'll see how all of what has happened shapes up in the marketplace. **R-E**

## SATELLITE TV/

### The First Five Years!



**THE MOST COMPLETE** report on the mushrooming home 'TVRO' industry ever compiled, written as only the 'father of TVRO' could have prepared. More than **1000 pages** (!) tracing the complete story of home TVRO, lavishly illustrated with equipment photos, schematic diagrams, equipment analysis reports. **Bob Cooper**, the first private individual to own and operate a TVRO (1976) has collected and polished hundreds of individual reports into a unique 'collector's edition' which clearly explains the TVRO phenomenon in North America. From Coop's first 20 foot 'monster' dish to the present day 5 foot 'C-band' TVROs, the fascinating growth of TVRO equipment and its legal status unfolds for you.



**THIS TWO VOLUME SET** totaling more than 1,000 pages is available for the first time to readers of **Radio-Electronics** at special discount pricing. **Originally sold** at \$100 per two-volume set, a limited supply is now available **ONLY** through this advertisement. **PLUS**, you will also receive a special extraordinary bonus; the 200 page (+) **October 1984** edition of **CSD/Coop's Satellite Digest**. This very special edition of CSD is a best-seller in the TVRO industry, with the most comprehensive collection of TVRO facts and figures ever compiled. Combined with the 1,000 page 'CSD ANTHOLOGY' report, you have instant reference to **everything** you will ever need to know about the state of the home TVRO industry. It is **MUST** reading for every person in, or thinking about 'getting into,' **any** segment of the home TVRO world.

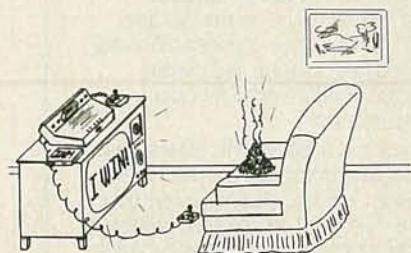
\_\_\_ **SEND CSD ANTHOLOGY/2 Vols. + CSD Bonus.**  
\_\_\_ **SEND CSD October '84 Special Issue ONLY.**

NAME \_\_\_\_\_ COMPANY \_\_\_\_\_

ADDRESS \_\_\_\_\_

CITY \_\_\_\_\_ STATE \_\_\_\_\_ ZIP \_\_\_\_\_

Payment: \$60 US funds (Anthology + Bonus), \$15 US funds CSD Oct. ONLY; payable "CSD ANTHOLOGY."  
Shipping charges prepaid. Enter order to: **CSD Anthology**, Radio-Electronics Magazine, 200 Park Av. S., New York, NY 10003; or call 305-771-0505 for credit card orders ONLY.



DANBY



Electricity and water don't mix. At least not in our Heavy Duty Digital Multimeters. Because these Oops Proof™ instruments are protected by a system of seals to ensure contamination-free dependability in even the cruddiest conditions.

Other abuse-proof features include the best mechanical protection ever built into a precision Digital Multimeter. In fact, every one of our Oops Proof multimeters will survive a drop from ten feet onto a concrete surface!

All the Heavy Duty series meters measure up to 1000 volts AC and 1500 volts DC, with full overload protection to those maximum voltages even on the lowest range settings. Overload circuitry also provides transient protection to 6KV on all voltage ranges and up to 600 volts on all resistance ranges.

We also invented a unique, long-life rotary switch for our Digital Multimeters. You can actually feel the difference just by

rotating the function selector knob.

You'll find these features in a full line of Heavy Duty DMMs that offer a 4½ digit readout, 0.05% VDC accuracy, a 10-amp current range, a 2000-hour battery life, diode test, true RMS and temperature measurement. All this and a no-questions, one-year warranty.

You'll want to try one out, of course, so drop into your nearest electronics distributor and drop one.

***Our lips are sealed.***





*NRI Trains You At Home—As You Build*

# GET THE KNOW-HOW TO REPAIR EVERY COMPUTER ON THIS PAGE... AND MORE.

IBM is a Registered Trademark of International Business Machine Corporation.  
Epson is a Registered Trademark of Epson America, Inc.  
Apple and the Apple logo are Registered Trademarks of Apple Computer, Inc.  
Compaq is a Registered Trademark of COMPAQ Computer Corporation.  
© 1984 AT&T Technologies, Inc.





# Your Own IBM-Compatible Computer

## Learn the Basics the NRI Way—and Earn Good Money Troubleshooting Any Brand of Computer


The biggest growth in jobs between now and 1995, according to Department of Labor estimates, will occur in the computer service and repair business, where demand for trained technicians will actually *double*.

You can cash in on this opportunity—either as a full-time corporate technician or an independent service-person—once you've learned all the basics of computers the NRI way. NRI's practical combination of "reason-why" theory and "hands-on" building skills starts you with the fundamentals of electronics, then guides you through advanced electronic circuitry and on into computer electronics. You also learn to program in BASIC and machine language, the essential languages for troubleshooting and repair.

## You Build—and Keep—a Sanyo MBC-550-2

The vital core of your training is the step-by-step building of the 16-bit Sanyo MBC-550-2 computer. Once you've mastered the details of this state-of-the-art machine, you'll be qualified to service and repair virtually every major brand of computer, plus many popular peripheral and accessory devices.

With NRI training, you learn at your own convenience, in your own home. You set the pace—without classroom pressures, rigid night-school schedules, or wasted time. You build the Sanyo MBC-550-2 from the keyboard



up, with your own personal NRI instructor and the complete NRI technical staff ready to answer your questions or give you guidance and special help whenever you need it.

## Learn MS/DOS Operating System

Praised by critics as the "most intriguing" of all the IBM-PC compatible computers, the new Sanyo uses the same 8088 microprocessor as the IBM-PC and features the MS/DOS operating system. As a result, you'll have a choice of thousands of off-the-shelf software programs to run on your completed Sanyo.

Your NRI course includes installation and troubleshooting of the "intelligent" keyboard, power supply, and disk drive, plus you'll check out the 8088 microprocessor functions, using machine language. You'll also prepare the interfaces for future peripherals such as printers and joysticks.

Your NRI course includes the Sanyo MBC-550-2 Computer with 128K RAM, monitor, disk drive, and "intelligent" keyboard; the NRI Discovery Lab<sup>®</sup>, teaching circuit design and operations; a Digital Multimeter; Bundled Spread Sheet and Word Processing Software worth \$1500 at retail—and more.

## 100-Page Free Catalog Tells More

Send the postage-paid reply card today for NRI's big 100-page color catalog on NRI's electronics training, which gives you all the facts about NRI courses in Microcomputers, Robotics, Data Communications, TV/Video/Audio Servicing, and other growing high-tech career fields. If the reply card is missing, write to the address below.

**NRI** SCHOOLS

McGraw-Hill Continuing  
Education Center  
3939 Wisconsin Avenue, NW  
Washington, DC 20016



We'll Give You Tomorrow.



# LETTERS

WRITE TO:

LETTERS  
Radio-Electronics  
200 Park Ave South  
New York, NY 10003

## INTERFACING THE ZX81

This letter is in response to the article "Interfacing the ZX81," (*Radio-Electronics* September, 1984). The article makes the following statement in reference to interfacing a relay to a microprocessor system: "The disadvantage of this configuration is...mechanical relays that can be controlled with logic-levels signals typically can only handle loads up to 0.5 amp at 120 volts." While that is what I'd call a close guess (assuming you use a relay with a coil voltage of five volts), the following circuit may be helpful to readers who

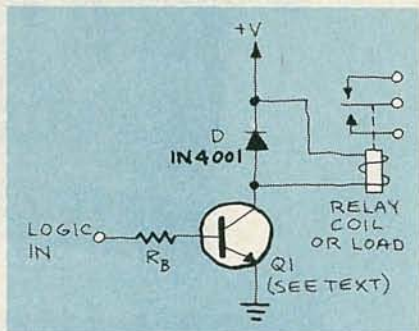


FIG. 1

have a variety of relays available.

In my area of the country there are many high current relays (3-10+ amps) available at surplus

stores for peanuts. While it is true they do not all operate at five volts, by the circuit shown in Fig. 1, I have been able to control various relays with coils of 5-30 volts DC. That circuit will energize the relay (or other load) if a logic one is written to the base of Q1 via a 8155, 8755, etc.

The first step is to determine the collector current,  $I_C$ , required. That, of course, is simply the current needed to energize the relay. To be on the safe side, choose a value that is twice that for  $I_C$ . Pick an NPN transistor that will satisfy that requirement, and use that

## PRICE SLASHERS

ONLY \$59.95  
FACTORY  
REFURBISHED

### CONVERTERS



- 60 Channel Capacity
- P.L.L. Tuning
- 6 Channel Memory
- TV On-Off Feature
- Infra-Red Wireless Remote Control

#### OTHER MODELS ALSO AVAILABLE

Jerrold JRX-3 \$49.95\* Jerrold DRX-3 \$69.96\*  
Jerrold RSC-3 \$39.95\*

\*Reconditioned Units With 30 Day Warranty

### VIDEO SWITCHERS



DW42K  
\$49.95



DW63K  
\$74.95

- MasterCard & Visa Add 5%
- Checks - Allow 14 Working Days
- Freight Charges: Sent Collect
- Order 20 or More - Freight Prepaid
- Special Price on New Factory Fresh Units - \$69.95
- Warranty Not Valid After 15 Days From Receipt

#### Phoenix Electronics

1 Midwood • Allendale, NJ 07401  
(201)848-8229

## Protect PCB's During Wave Soldering!

Chemask is the peelable latex based solution that prevents solder from adhering to component-free holes, gold fingers, switches, pins, posts and edge connectors. It's non-staining, leaves no residue, and is stable to rosin and water soluble fluxes, cleaning solutions and contact with molten solder to 510°F, 266°C.

Pin-pointing applicator applies Chemask exactly where you need it. It dries in just 30 minutes and stays put without "creeping" until you're ready to simply "lift and peel". Whether removed immediately or left on to protect through assembly operations, it always stays pliable.

Send for literature and sample today.



**Chemtronics Inc.**  
681 Old Willefs Path  
Hauppauge, NY 11788  
800-645-6244  
In NY 516-582-3322



CIRCLE 54 ON FREE INFORMATION CARD



Others say, "Buy this or that and it will double your production or, your money back in thirty days". But the fact is, when it comes to troubleshooting start up, shut down, hi-voltage, or any type of flyback related problem - - - including open or shorted B+ paths for video, vertical, audio, chroma, matrix, tuner circuits, etc., any circuit that relies on flyback generated B+ voltage or, any type of a dynamic short in a CRT - - - in any set that uses a horiz output transistor (any brand, any age, any chassis that you can come up with);

JUST ONE  
**SUPER TECH**

WILL OUT PERFORM **ANY AMOUNT** OF OTHER EQUIPMENT  
**BY SEVEN TO ONE**

# \$10,000 CHALLENGE

Let a third party choose 24 various brand TV sets that have bonifide major problems in any of the above circuits. Let our competitor bring **all** of the test equipment that he has ever sold, as well as his **entire** engineering staff. If one man with a **Super Tech** can't troubleshoot **21** of these sets down to circuit level faster than their **entire team** can do likewise to just **three** sets, we will hand them \$10,000 in cash. If they get beat, they give us permission to publicize the results! This offer is not limited to our competitors. Factory engineering teams or anyone else for that matter is welcome to try. The one using the **Super Tech** won't even need a schematic!! Are we serious about this challenge? - - - You bet we are !!

## THE ABOVE FIGURES ARE CONSERVATIVE!

In about 15 seconds, you can hook up a **Super Tech** to almost any TV set. All you do is pull the horiz output transistor, plug **Super Tech** into the empty socket, then make one ground connection. In the time it takes to push four buttons, you know exactly which circuit has failed with 100% accuracy! (That's 9 points of the game when you're working on late model sets.)

THE ENTIRE TEST - - - INCLUDING HOOK-UP  
TAKES ABOUT 30 SECONDS!!

**SHOULDN'T YOU BE USING A SUPER TECH**  
**AT ONLY \$995°° - - - CAN YOU AFFORD NOT TO?**

Call and give us your Visa or Master Charge card number. We'll send your Super Tech prepaid. Use it for thirty days. If Super Tech doesn't do everything we say it will, send yours back and call your bank to cancel the sale. You have nothing to lose! The thing is, if we can only get a **Super Tech** in your hands, it will make your job so much easier, you won't even consider being without it. The manual that comes with your Super Tech even explains how the circuit that you are working on operates. C.O.D. orders welcome, prepaid orders deduct 5%.

**DIEHL ENGINEERING • Ph. (806) 359-1824**

**6004 Estacado Lane • Amarillo, TX 79109**

CIRCLE 269 ON FREE INFORMATION CARD



transistor's base current,  $I_B$ , and beta,  $h_{fe}$ , to determine the value of  $R_B$ . That can be found from:

$$I_B = I_C/h_{fe}$$

$$R_B = V_L/I_B$$

where  $V_L$  is the worst case logic voltage. For TTL circuits, the value of  $V_L$  is 2.5 volts.

ROBERT PARENT  
Boyceville, WI

### EASY PC BOARD REPAIRS

"How to Repair PC Boards," by Robert Grossblatt, (Radio-Elec-

tronics, July 1984) was an interesting and helpful article on repairing damaged PC boards. However, preferably one should try not to damage a PC board, thereby avoiding the repair tasks outlined in your article. We have found, from experience, that a lot of damage to PC boards is caused by inconvenient desoldering methods, especially those that use an idling soldering iron and excessive temperature influence over a prolonged period of time while re-

moving components.

A product that might be of help to your readers is desoldering braid. Desoldering braids, well known in industrial applications, and to do-it-yourself electronics hobbyists, do avoid many problems. The desoldering braids allow only a gradual increase of the temperature level when the desoldering operation is being made. The solder joint is "protected" by the original cold wick and the laminate therefore is not exposed to severe heat stress.

ERNEST SPIRIG, PRESIDENT  
S.A.T. INC.

Agawam, MA

## Texas Instruments Understanding Series.™

# Books about today's science and technology...for everyone.

Only \$14.95 each.



Novice, professional, technician or hobbyist, there's an Understanding Series title just for you. Each book is a self-contained volume that takes you through the material step-by-step. For the newcomer, it's a quick and easy way to learn. Practitioners will find it an ideal way to catch up, keep pace and review. You'll like the look, too. These editions will make attractive additions to any reference library. Information-intensive, with color illustrations, they're easy to read. And marginal notes speed and simplify summary or review. The Understanding Series. Exciting, timely subjects in an inviting new format. Check your choices on the coupon and mail it, today.



**TEXAS  
INSTRUMENTS**

Creating useful products  
and services for you.

### ADDRESS CHANGE

The article "Build the Tele-Toll Timer", published in the November 1984 issue of **Radio-Electronics**, listed the address of Mendakota Products, Ltd., supplier of a kit of parts for the project, as PO Box 20HC, 1920 W. Commonwealth Ave., Fullerton, CA 92633. Readers may now write to Mendakota Products Ltd. at their new address: PO Box 2296, 1001 W. Imperial Highway, La Habra, CA 90631.—Editor

### LONGER VCR WARRANTIES

There are a couple of interesting items in your November issue. One is the Editorial. The problem reminds me of the one some years ago with garage-door openers. That was solved by having an arrangement where an individual code was picked by each user. Application of that method to VCR's might be a little more difficult, but it can be done. That method could also solve another potential problem: If I have two VCR's in the same location, and they are of the same make, how can I select one of the two to the exclusion of the other? That would not be solved by standardization of codes, as you suggest, but might be if I could choose the codes myself.

The other item is in "Video News." The statement is made that the service record of VCR's already compares with that of color TV. If this is true, why aren't the manufacturers more generous with their warranties? Color TV's come with a one-year warranty on the set

*continued on page 26*

Please send me the following titles  
@ \$14.95 each:

# of copies

- \_\_\_ Understanding Automation Systems LCB8472
- \_\_\_ Understanding Automotive Electronics LCB8475
- \_\_\_ Understanding Communications Systems LCB8474
- \_\_\_ Understanding Computer Science LCB8452
- \_\_\_ Understanding Data Communications LCB8483
- \_\_\_ Understanding Digital Electronics LCB8471
- \_\_\_ Understanding Digital Troubleshooting LCB8473
- \_\_\_ Understanding Microprocessors LCB8451
- \_\_\_ Understanding Solid State Electronics LCB8453
- \_\_\_ Understanding Telephone Electronics LCB8482

Add \$1.25 per book, postage and handling. Prices subject to change without notice.

Enclose check or money order with sales tax (except AK, DE, NH, OR). Foreign orders must be in U.S. dollars and include shipping charges. Sorry, no phone orders.

© 1985 Texas Instruments Incorporated

Mail to:

Texas Instruments Incorporated  
Information Publishing Center  
P.O. Box 225474, M/S 8218  
Dallas, Texas 75265

Name \_\_\_\_\_

Address \_\_\_\_\_

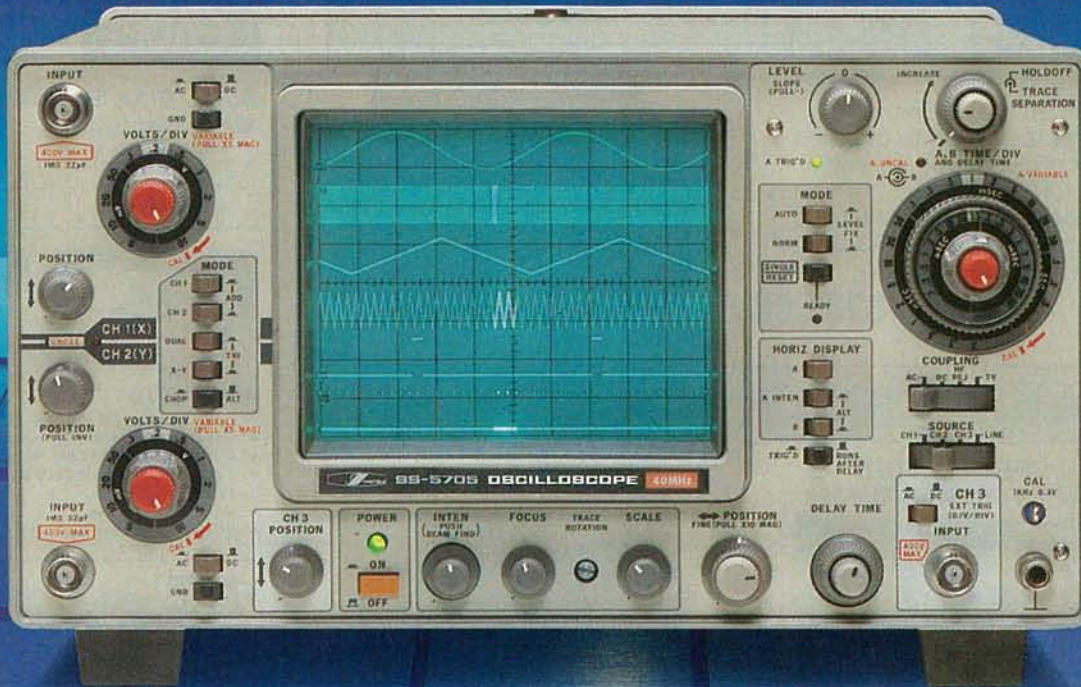
City \_\_\_\_\_

State \_\_\_\_\_ Zip \_\_\_\_\_

2122  
RE485



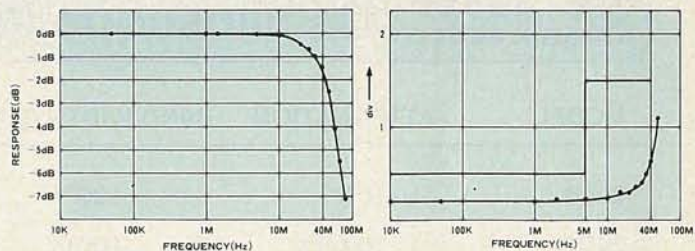
# SS-5705, THE ALL-NEW 3-INPUT 6-TRACE 40 MHz OSCILLOSCOPE FROM IWATSU



DC to 40 MHz

- H and V axes accurate to within  $\pm 2\%$
- CRT with 12 kV accelerating voltage for bright traces
- Three input channels, six traces: an enlarged delayed sweep waveform can be displayed for each channel for a total of 6 simultaneous traces. Each channel has its own position control.
- Maximum delay jitter of 1/20,000
- Fastest sweep rate of 10 ns/div
- Jitterless circuitry for stable high frequency signals observation.
- High sensitivity: 1 mV/div
- CH 1 signal output: 50 mV/div (into 50  $\Omega$ )
- High-stability calibrator with frequency and voltage accurate to within  $\pm 1\%$ .
- Stable observation of video signals possible
- Traces do not shift when the attenuator is switched
- Pushbutton controls for easier operability and improved reliability.
- Accuracy guaranteed in temperatures ranging from 10 to 35°C (50 to 95°F).
- Variable holdoff for triggering when observing complicated waveforms.
- FIX triggering
- Beam finder

- Frequency response extends beyond 40 MHz rating
- Superb trigger sensitivity freezes even low level signals.



- Single sweep: essential if waveforms are to be photographed.
- Trace rotation control allows compensation for inclination of traces due to terrestrial magnetism.
- Two probes provided as standard accessories: both switchable between 10:1 and 1:1.
- Wide range of optional extras for more diverse applications.
- Compact and lightweight: 282W x 152H x 403D mm (11-1/8" x 6" x 15-7/8"), 7.2 kg (15.9 lbs).



**IWATSU INSTRUMENTS INC.**

430 Commerce Boulevard, Carlstadt, NJ 07072 Phone: (201) 935-5220 TLX: 7109890255

CIRCLE 64 ON FREE INFORMATION CARD



# RAG ELECTRONICS, INC.

## ■ Polaroid DS-34

Now you can get an instant picture in black & white or color from any oscilloscope screen. Includes CRT hood.  
\*Large hoods also available to fit computer terminals and CAD/CAM screens.

**\$369.00**



## LEADER Instruments Corporation

### Audio Sine/Square Wave Generator

- Distortion from <0.03%
- 10 Hz to 1 MHz

**\$259.00**



**LAG-120B**



## BK PRECISION

### FUNCTION GENERATOR

**\$189.00**

#### MODEL 3010

- Sine, square and triangle output
- Variable and fixed TTL outputs
- 0.1 Hz to 1 MHz in six ranges
- Typical distortion under 0.5% from 1 Hz to 100 KHz
- Variable DC offset
- VCO input for sweep tests

## POWER SUPPLIES

### GLOBAL SPECIALTIES TRIPLE OUTPUT POWER SUPPLY



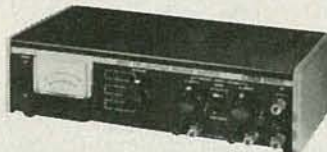
#### MODEL 1301

**\$219.00**

- Fully regulated triple output
- Fixed 5VDC, 1A
- V1 + 5 VDC to 18 VDC .5A
- V2 - 5 VDC to 18 VDC .5A
- Fully automatic current limiting

## BK PRECISION

### TRIPLE OUTPUT POWER SUPPLY



#### MODEL 1650

**\$319.00**

- Functions as three separate supplies
- Exclusive tracking circuit
- Fixed output 5 VDC, 5A
- Two 0 to 25 VDC outputs at 0.5A
- Fully automatic, current-limited overload protection
- + and - terminals of each output are fully isolated, in all modes
- All three outputs may be connected in series or parallel for higher voltage or current

## ELECTRO INDUSTRIES, INC. Precision Test Instruments



### DC POWER SUPPLY

**\$125.00**

MODEL 3002A/0-30 VDC/0-2A

## VIZ

### MULTI-FUNCTION COUNTER



#### MODEL WD-755

**\$259.00**

- 5 Hz to 125 MHz
- 8 Digit LED Display
- Period Measurement 5 Hz to 2 MHz
- Totalizes to 99,999,999 Plus Overflow
- Frequency Ratio Mode
- Time Interval Mode
- Switchable Attenuator & Low Pass Filter

## STACO ENERGY PRODUCTS CO.

### VARIABLE TRANSFORMER

**\$145.00**



#### MODEL 3PN1010V

RAG CARRIES THE COMPLETE STACO VARIABLE TRANSFORMER LINE  
CALL US WITH YOUR REQUIREMENTS.

## PROBE MASTER Oscilloscope Probes

MODEL	ATTENUATION	BAND WIDTH (MHZ)	PRICE
2904	10X	100	\$35.00
2901	10X/1X	100/5	\$39.00
2205	10X	250	\$59.00
2960	10X	60	\$30.00

### DIGITAL CAPACITANCE METER



- Battery operated
- 3 1/2 digit LCD display
- Range 1 PF to 2,000 UF
- 0.2% basic accuracy

**GLOBAL MODEL 3000 \$139.00**

CALL US TOLL FREE

**1-800-732-3457**

IN CALIFORNIA TOLL FREE

**1-800-272-4225**

- Master Charge
- VISA ■ COD
- Money Order
- Check



ADD FOR SHIPPING AND INSURANCE

\$0 to \$250.00	.....\$4.50
\$251.00 to \$600.00	.....\$6.50
\$501.00 to \$750.00	.....\$8.50
\$751.00 to \$1000.	.....\$12.50
COD's extra (required 25% deposit) over \$1000.00	.....\$15.00

RAG ELECTRONICS, INC. / 21418 Parthenia Street / Canoga Park, CA 91304 / 1-818-998-6500



# SCOPE SPECTACULAR



## PORTABLE OSCILLOSCOPES



Model V-212 shown

**MODEL V-212**

DC to 20 MHz, 1 mV/div, Dual Trace  
Features 6" Rectangular CRT  
Full 2 year parts and labor warranty (w/two X10 probes).

**\$461.00**

**MODEL V-222**

DC to 20 MHz, 1 mV/div, Dual Trace, D.C. offset for DMM Output, Vertical Mode Trigger  
6" CRT (w/two X1/X10 probes).

**\$536.00**

**MODEL V-422**

DC to 40 MHz,  
other features same as V-222 (w/two X1/X10 probes)

**\$694.00**



Model V-1050F shown

**MODEL V-1050F**

DC to 100 MHz, .5 mV/div, Quad Trace, Delayed Sweep, Full T.V. Triggering, alternate time base (w/two X1/X10 probes)

**\$1276.00**

**MODEL V-650**

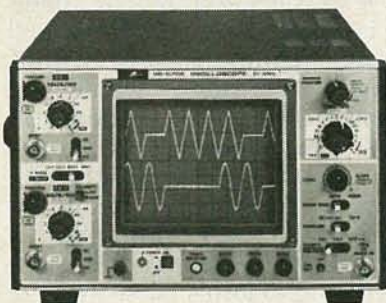
DC to 60 MHz, 1 mV/div, triple trace, delayed sweep, Full T.V. Triggering, variable trigger hold-off

**\$956.00**

CIRCLE 254 ON FREE INFORMATION CARD



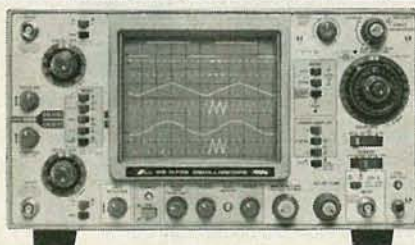
## PORTABLE OSCILLOSCOPES



**MODEL SS-5702**

DC - 20MHz, 5 mV/div  
Dual trace  
6 inch rectangular internal graticule CRT.  
Includes 2 each x1/x10 probes and full factory warranty; 2 years on parts, labor and CRT.

**\$535.00**

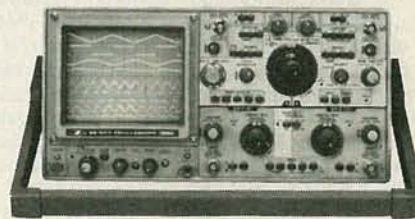


**MODEL SS-5705**

DC to 40MHz  
Vertical and horizontal deflection accurate within  $\pm 2\%$ . CRT acceleration voltage 12KV. 3 channels, 6 traces. High precision calibrator ( $\pm 1\%$ ). Fastest sweep rate: 10 ns.  

- High sensitivity 1 mv/div
- CH1 signal output
- Beam finder
- Delayed sweep
- Alternate time base
- 2 ea. X1/X10 Probes

**\$899.00**



**MODEL 5711**

DC to 100MHz (typically over 120 MHz), 5 mV/div, True 4 channel input, eight trace, Delayed sweep, alternate time base, CRT acceleration voltage 20 KV, (w/saddle bag, front cover, 2 ea X1/X10 probes).

**\$1695.00**

**MODEL 5711 D**

(5711 with counter and DMM).

**\$2495.00**



## LETTERS

continued from page 22

and two years on the picture tube. Audio recorders also usually have a one-year warranty. That contrasts with the "generous" 90 day one for the VCR's. In recent years models that are programmable for three or more weeks with up to eight programs have become available. In fact, I believe some new ones

claim one year. If the three-week capability is defective, the buyer cannot be sure in less than six or eight weeks, if he makes careful tests. Then there is the time spent in servicing, and then again time to test, as well as the need to check all the other functions. I don't believe most purchasers expect to spend a lot of time trying out the special features. It seems that a one-year warranty would be fairer.  
DAVID C. HESS  
Downers Grove, IL

## ADDITIONAL BATTERY INFORMATION

As a Reliability Engineer for a minicomputer manufacturer who uses large quantities of lead-acid type rechargeable batteries, I enjoyed seeing the articles on "Rechargeable Batteries" (*Radio-Electronics*, September and October 1984). My experience has been with lead-acid "gell cell" and "sealed lead-acid" types, which are also manufactured by Globe-Union and Gates in addition to the sources you listed. I wish to contribute additional information.

**Safety:** First and foremost, those batteries have very high current capacity and, if shorted, will cause the shorting conductor to heat to the point of melting or ignition. The battery may melt the object across the terminals, may explode, or ignite any flammable materials nearby. Never use hot-melt glue, cardboard, or similar flammables to fabricate batteries from lead-acid cells. Use extreme care to protect exposed terminals from accidental contact across metal surfaces (including metal shelves and table tops.) Batteries or cells shorted in this manner are usually destroyed in seconds.

**Shelf life:** Shelf life is long on lead-acids, but not infinite. Our procedures call for six-month testing of shelf-stored batteries and recharging if the battery measures below 2.0 volts per cell (2.15 volts per cell is considered full charge and 1.5 volts after storage is unusable and will not recharge.) Shelf life is best insured by fully charging any battery prior to prolonged storage, generally at a 24-hour charging rate, and by maintaining a temperature suited to shelf storage. Six months is the shelf figure normally used at 75°F or room temperature. That figure is greatly extended at lower temperatures such as 40–50°F or reduced at elevated temperatures of 90–100°F.

**Usage:** Another point about lead-acids: If they are used in a deep-discharge cycle, recharging must begin within six hours of the discharge time. Most batteries held in deep discharge for longer periods cannot be recharged and must be replaced.

JAMES V. GREER

Perkin-Elmer Oceanport, NJ R-E

## Because they are built to last... Global breadboarding sockets are guaranteed for a lifetime.

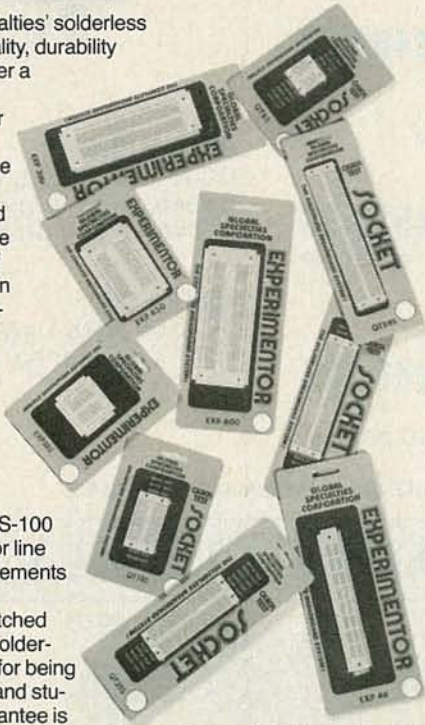
For more than a decade, Global Specialties' solderless breadboarding has set the standard for quality, durability and dependable performance. Now, we offer a lifetime guarantee. If a Global breadboarding socket fails to perform according to your needs, you merely return it to Global Specialties. We will send you a replacement free of charge. *No questions asked.*

This unconditional guarantee is offered because our breadboarding sockets provide outstanding performance, indefinitely. All of our sockets are made in the United States in our own factory, employing the latest equipment, manufacturing methods and quality control procedures. Each socket and bus strip is molded of high quality plastic material to provide superior strength and durability. Precision-formed contacts and tie-points made from nickel-silver assure excellent contact every time.

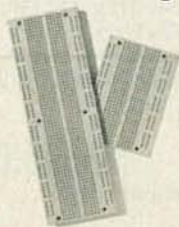
Seven sockets and three bus strips are included in our QT Series. Our new UBS-100 and UBS-500 models and our Experimentor line include socket and bus strip contact arrangements in single modular breadboards.

The industry's largest selection, unmatched quality and economy have earned Global solderless breadboarding sockets the reputation for being number one with professionals, hobbyists and students. Now, the unconditional lifetime guarantee is your assurance that when you buy from Global you receive maximum durability and trouble-free performance. Unlike some manufacturers who require that you purchase by mail, our nationwide network of distributors permits you to see and inspect our products before you buy.

See your electronics distributor or for the name of your local distributor, call our . . . Customer Service Department, toll-free 1-800-572-1028.



### Introducing the UBS Series



Two new solderless breadboarding sockets have been added to the Global line. The new UBS-100 is now the largest socket in the line, with 840 tie-points and the smaller UBS-500 has 430 tie-points. Each includes two rows of bus strips on each side for power and ground connections and the UBS sockets are made of the highest grade plastic material to insure maximum resistance to warping and breaking.



**GLOBAL SPECIALTIES**  
An Interplex Electronics Company

70 Fulton Terrace  
New Haven, CT 06512-1819  
(203) 624-3103 TWX: 710-465-1227

Europe: Phone Saffron-Walden,  
England, 0799-21682, TLX: 817477.

CIRCLE 62 ON FREE INFORMATION CARD



# EQUIPMENT REPORTS

## Alden Model 9321 Weatherchart Recorder

Keep an eye on the weather with this chart recorder. It's available in kit form, too.



CIRCLE 5 ON FREE INFORMATION CARD

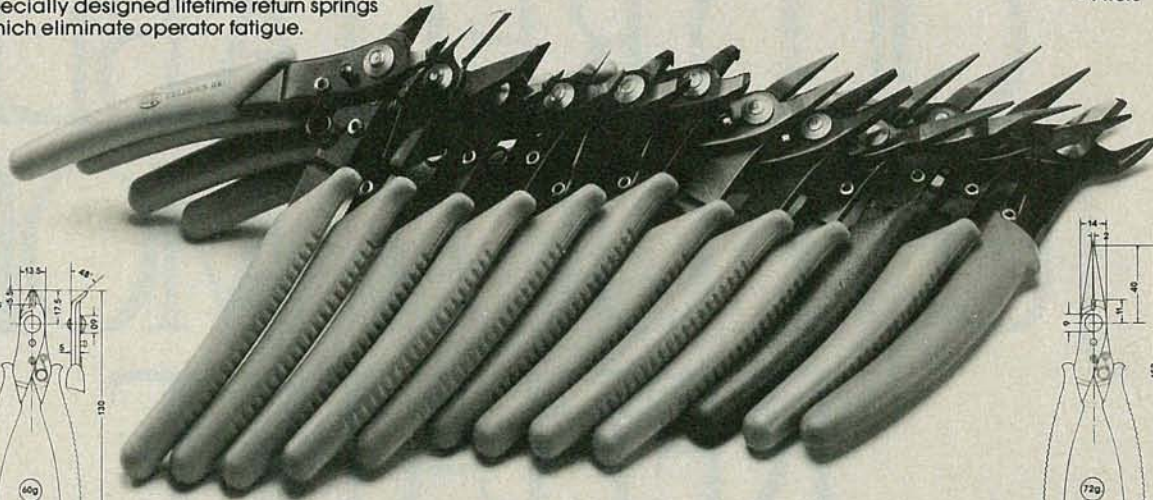
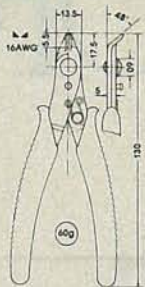
DOES YOUR MIND COME TO ATTENTION when you hear weather reports of storms brewing at sea? If you are an avid sailor, or you're just into weather forecasting as a hobby, you need to know all there is to know about what's happening "out there."

One way to keep track of the ocean's surface weather, ice formations, the condition of the Gulf Stream, or anything else having to do with the "big ponds," is through the Alden model 9321 Weatherchart Recorder (Alden Electronics, Washington St., Westborough, MA 01581.)

This unique line of 12 lightweight and comfortable precision cutters, pliers and crimpers are specially adapted to meet the demanding requirements of the electronic industries. All the tools feature custom contoured ribbed handles which provide a non-slip gripping surface, and specially designed lifetime return springs which eliminate operator fatigue.

## Precision Pliers, Cutters and Crimpers

- Flush cutters
- Semi-flush cutters
- Reverse cutters
- Cutter/crimper
- Cutter/bender
- Pliers



3455 Conner Street, Bronx, New York, 10475, U.S.A.  
Telex 125091 OK NYK. Telex 232395 OK NY UR.  
Phone (212) 994-6600.



APRIL 1985

CIRCLE 262 ON FREE INFORMATION CARD



The Alden Weatherchart Recorder is a facsimile printer specifically designed to recreate the charts broadcast on shortwave frequencies by marine radiofacsimile stations throughout the world. The North and South Atlantic and Pacific oceans, the Indian ocean, the Antarctic, the Red Sea, the Persian Gulf, and coastal waters are all served by the radiofacsimile broadcasts.

The charts are broadcast on many different frequencies, from 4 MHz to approximately 20 MHz. (A directory of the stations, frequencies, and time of operation is supplied with the recorder.) The facsimile signals, which are easily recognized by their distinctive ding-dong sound, can be received on any shortwave receiver capable of upper-sideband reception. The tones are converted to hard-copy printouts by the Alden Weatherchart Recorder.

The chart recorder is housed in a plastic cabinet that measures 17 $\frac{1}{16}$  × 3 $\frac{5}{8}$  × 10 $\frac{1}{4}$  inches. It weighs a shade over 10 pounds. It is

ALDEN		9321												
OVERALL PRICE														
EASE OF USE														
INSTRUCTION MANUAL														
PRICE/VALUE														
		1	2	3	4	5	6	7	8	9	10			
		Poor		Fair			Good			Excellent				

powered by 117-volts AC. The input to the recorder is 600 ohms balanced, available at a terminal strip located on the rear. An accessory matching transformer is provided for unbalanced receiver outputs, such as a headphone jack. However, we connected the recorder's 600-ohm input directly to a receiver's 4-ohm headphone output and had no difficulty of any kind in driving the recorder. It is possible that some receivers might require the matching transformer, but we tried several, ranging from a budget-priced "shortwave radio" to a top-of-the-line communica-

tions receiver, and always got good results without the matching transformer.

The top of the recorder has the main power switch, the start switch, two LED's that serve as tuning indicators, and a framing switch that centers the pictures on the paper.

The charts are created on a roll of 11-inch wide electrosensitive paper that is supplied in a cylindrical cassette that mounts near the front of the machine. (You tear off the charts as needed.) Motor-driven rollers located in front of the cassette feed the paper out. The image is traced on the paper by a stylus assembly located between the cassette and the rollers that "burns" the image into the paper. As you would expect from the method of creating the image, the paper is damp because it contains a conductive fluid. The electric current representing the image passes through the paper and the stylus, causing a burn where they touch.

The recorder responds to FSK

# OLD RELIABLE JUST GOT MORE RELIABLE.



(Frequency Shift Keying) frequencies of 1500 Hz ("white") and 2300 Hz ("black"). While the machine can be started and stopped manually, it also operates under tone control, broadcast from the radiofacsimile stations.

### How it works

The receiver is first pretuned to the desired station by adjusting the receiver's tuning control until the "white" tuning indicator flickers most of the time and the "black" indicator flickers occasionally. The actual tuning adjustment isn't critical; as long as the tuning indicator lights appear to be "in the ballpark" the recorder works properly. Once the tuning is set for a particular station, it does not have to be readjusted because the recorder can accommodate a rather broad receiver drift. (We got excellent results from a low-cost receiver.) Prior to broadcasting weather charts, the radiofacsimile station transmits an automatic start signal that shifts 1500 Hz and 2300 Hz at a 300 Hz rate for 5 sec-

onds. The recorder starts, prints the chart, and is automatically stopped when the station broadcasts the same tones, but at an alternating rate of 450 Hz for 5 seconds.

Part of the initial setup procedure requires adjusting the framing so the picture is "centered" on the paper, thereby avoiding loss of part of the picture. That is done by observing the print as it is made by the stylus and pressing the FRAME switch until the chart is centered on the paper. The FRAME switch causes the framing to change in small discrete increments, and we found about five to seven increments was all it normally took to center the chart.

Once the chart is framed, the framing procedure does not have to be repeated as long as the same station is received.

The recording rate is 120 spm (Scans Per Minute). It takes approximately 15 minutes to receive a 10- x 12-inch chart. A station might broadcast several charts followed by an "end" tone, which stops the

recorder. The cycle will be repeated the next time a chart is broadcast.

The Alden Weatherchart Recorder (which is also available in kit form) is supplied with two paper cassettes, three spare stylus belts, the audio matching transformer, two spare fuses, and a selection of notably good manuals. The operator's manual is superb; it is clear, concise, unwordy, and is well illustrated. Also supplied is a directory of worldwide facsimile stations, a guide to understanding radiofacsimile weather charts, and a technical manual that includes the step-by-step kit assembly.

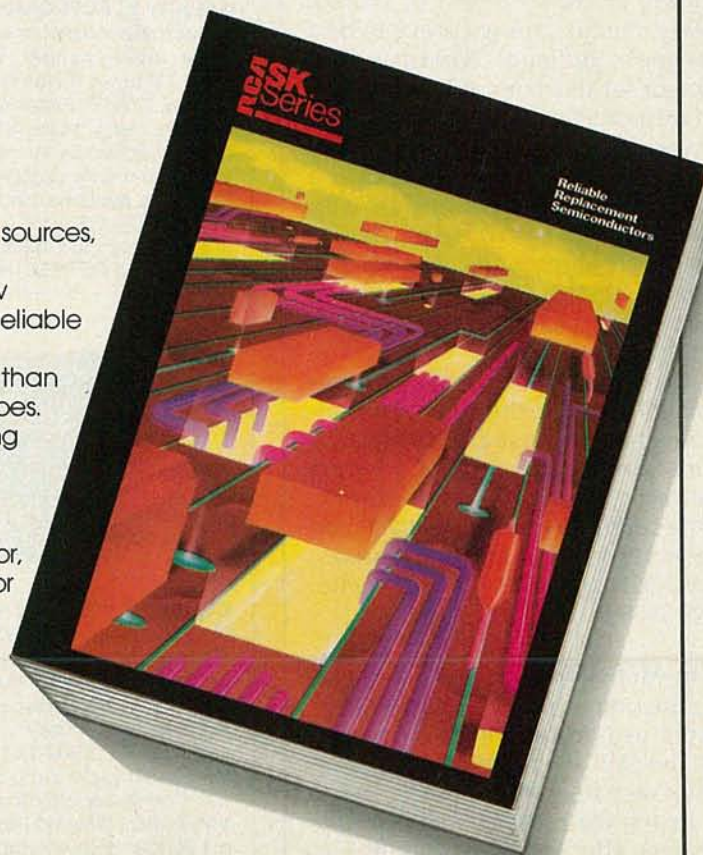
Like all other professional equipment, the Alden Weatherchart Recorder doesn't come cheap. The kit version is priced at \$995, the wired version (the model we tried) sells for \$1995. This is such highly specialized equipment that its value can only be judged in terms of its necessity. But, if you're into weather studies for business or a hobby it's worthwhile looking into. **R-E**

## RCA's new SK Guide. More pages. More solid state replacements.

When it comes to replacement semiconductor sources, RCA is one of a kind. RCA is actually in the business of manufacturing semiconductors and we publish a new cross-reference every year. This new RCA SK Guide to Reliable Replacement Semiconductors has everything you need to make fast, accurate replacements. More than 2,500 SK and KH types replace over 206,000 industry types. RCA is the line of integrity with unsurpassed engineering excellence.

So when you need to make a solid state replacement, reach for reliability. Reach for the RCA SK Guide, SKG202D, available at your RCA SK Distributor, or mail \$2.95 in check or money order to RCA Distributor and Special Products Division, Box 597, Woodbury, N.J. 08096.

**RCA** SK Replacement  
Solid State





# Radio-Electronics mini-ADS

## MFJ Enterprises MFJ-989 Antenna Tuner

Get peak performance at almost any frequency with almost any antenna, feedline combination.



CIRCLE 6 ON FREE INFORMATION CARD

AS ANY RADIO AMATEUR OR SHORT-wave listener knows, for best performance, the antenna-feedline system and receiver or transmitter must be matched as perfectly as possible. If you operate at only a single frequency, that does not present that much of a problem, as an antenna can be cut and tuned for peak performance at that frequency.

But if you operate over a wide variety of frequencies, or worse, several bands, things prove to be a bit more difficult. Antennas may be cut for use over an entire band of frequencies, such as 40 meters, but such an antenna will only provide peak performance over a narrow range of frequencies, with performance dropping off markedly at the ends of the band. That effect is even more pronounced if a trapped multi-band antenna is used.

Those problems can be minimized through the use of an antenna tuner. Those devices let you tune almost any type of antenna system to maximum efficiency. One such tuner is the MFJ-989 Versa-Tuner V, from MFJ Enterprises, Inc. (921 Louisville Rd., Starkville, MS 39759).

### The MFJ-989

The unit is intended for amateur radio use, but could also be used by the SWL who demands top performance from his receiving setup. A match for today's smaller transceivers, the unit measures 10.5 ×



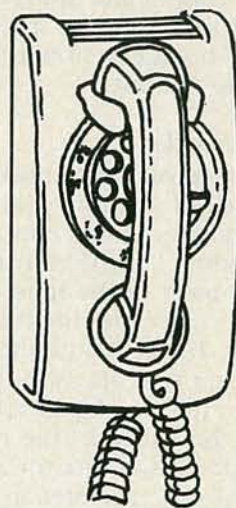
**MODERN ELECTRICS.** Miniature souvenir of the first publication ever produced by Gernsback Publications. This issue appeared in April 1908—just 75 years ago. You can own your own reprint of this unique first edition for just \$2.50 plus 75c P&H. It's available from **R-E BOOKSTORE, Radio-Electronics, 200 Park Avenue South, New York, NY 10003**



**GALAXY ELECTRONICS, INC.** the leader in microwave announces the new **dual-polarity, multi-channel, wide-band microwave TV tuner.** Tunes entire 800 MHz from 1.9 to 2.7 GHz. Receive sports, education, religious, news, movie programming, & more is being added to this frequency spectrum almost on a daily basis in most major cities. **Complete systems from \$69.95. GALAXY ELECTRONICS, INC., 5644 North 53rd Avenue, Glendale, AZ 85301. 602-247-1151. CIRCLE 253 ON FREE INFORMATION CARD**



**CONVERT YOUR TV to a High Quality Monitor/Receiver...TRVM kit** Features: Dual Mode operation on transformer isolated B&W or Color Sets • High Resolution Direct Video • Up to 80 characters per line • Wide Bandwidth • Easy installation • Low cost...\$34.95...DVM-1 kit with Audio available for "Hot Chassis" sets...\$64.95. Kits usable with Computers, VCR's and Video Cameras. **VAMP INC., Box 411 Los Angeles, California 90028. (213) 466-5533 CIRCLE 255 ON FREE INFORMATION CARD**



## CALL NOW AND RESERVE YOUR SPACE

- 6 × rate \$650 per each insertion.
- Reaches 225,016 readers.
- Fast reader service cycle.
- Short lead time for the placement of ads.
- We typeset and layout the ad at no additional charge.

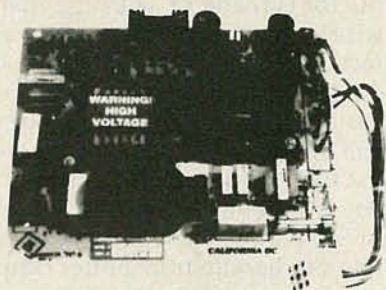
Call **212-777-6400** to reserve space. Ask for Arline Fishman. Limited number of pages available. Mail materials to: mini-ADS, RADIO-ELECTRONICS, 200 Park Ave. South, New York, NY 10003.



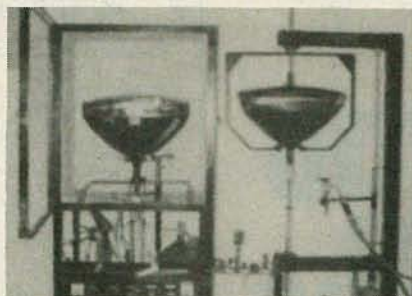
**ELECTRO IMPORTING CO. CATALOG.** This reprint of the historic 176-page catalog No. 20 gives you an accurate look at the state of electronics in 1918. Contains everything from a Zinc Spark Gap to a 1000-Mile Receiving Outfit. You can get your own copy of this modern antique, profusely illustrated, for only \$4.95 plus \$1.00 P&H. Order yours from **R-E BOOKSTORE, Radio-Electronics, 200 Park Avenue South, New York, NY 10003.**



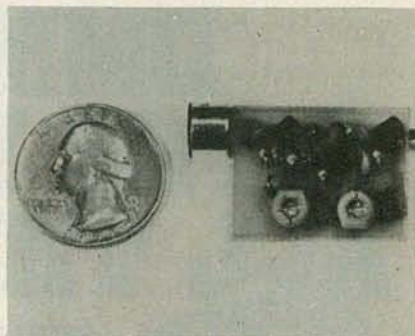
# Radio-Electronics mini-ADS



**CALIFORNIA-DC REGULATED SWITCHING POWER SUPPLY** +5v dc @ 5 amp + 12v dc @ 2.8 amp + 12v dc @ 2 amp -12v dc @ .5 amp 115-230v ac input, fused. EMI filtered. Removable DC Power Harness and Schematics included. 7.4" x 6.2" x 1.7" ht. Visa/MC/M.O./check; when clears. **\$37.50 ea.** (Free shipping in U.S.) **1-800-327-7182/305-830-8886. POWER PLUS, 130 Baywood Ave., Longwood, FL 32750.** (Call for quantity price).  
CIRCLE 125 ON FREE INFORMATION CARD



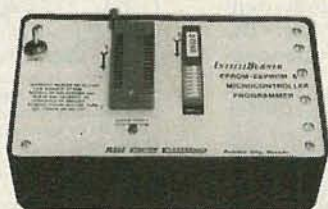
**ONE MAN CRT FACTORY**, easy operation. Rebuild CRT's for tv's, bus. machines, monitors, scopes, etc. Color, b&w, 20mm, foreign or domestic. 3x6 ft. space required. Profits??? Average CRT rebuilding costs—\$5. Sell for \$100 = \$95 profit; x 5 CRT's = \$475 daily; x 5 days = \$2375 weekly profit. Higher profits overseas. Investigate this opportunity today. We service the entire world Contact: **CRT FACTORY, 1909 Louise St., Crystal Lake, IL 60014, (815) 459-0666.**



**THE MOST EXCITING KIT YOU WILL EVER BUILD** The model WAT-50 miniature FM transmitter uses a 4-stage circuit NOT to be confused with a simple wireless microphone. Up to 1 mile range. So sensitive, it will pick-up a whisper 50 feet away! Use with any FM radio. Complete kit only **\$29.95** tax incl. **FREE SHIPPING. DECO INDUSTRIES, Box 607, Bedford Hills, NY 10507.**  
CIRCLE 263 ON FREE INFORMATION CARD



**ZENITH SSAVI DESCRAMBLERS** only \$169; **GATED PULSE & SINEWAVE** decoders \$199 each. Original equipment for UHF chs. 23,27,31,51,54,57,68, etc. Quantity discounts. Surplus Cable TV equipment: Jerrold SB-3, Oak N-12, Zenith Z-Tac, Hamlin 1400, etc. Complete **Satellite Systems** at \$845 and up; Installation and program guide, \$3. Dealers welcomed. Catalog \$1. Visa/MasterCard. Satisfaction guaranteed. **AIS SATELLITE, P.O. Box 1226-E, Dublin, PA 18917. 1-800-643-2001 or 215-249-9411.**  
CIRCLE 264 ON FREE INFORMATION CARD



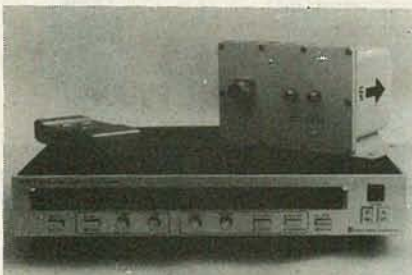
**IntelliBurner EPROM-EEPROM & MICROCONTROLLER programmer** \$299 Communicates through the serial port of any personal computer. Use your PC's modem software to read, verify, or program all popular EPROMs, EEPROMs and 87xx series micro controllers. Custom software included for IBM, CP/M or Radio Shack PCs. Other programmers from \$149. Bare PC boards with software from \$39. **ROSS CUSTOM ELECTRONICS, 1307 Darlene Way #A12, Boulder City, NV 89005. 702-293-7426.**  
CIRCLE 266 ON FREE INFORMATION CARD



**SUBSCRIPTION TV MANUAL.** This information packed book details the methods used by subscription TV companies to scramble and descramble video signals. Covers the Sinewave, Gated Pulse, SSAVI system, and the methods used by most cable companies. Includes circuit schematics, theory, and trouble shooting hints. **Only \$12.95** plus \$2.00 first class P&H. **ELEPHANT ELECTRONICS INC., (formerly Random Access) Box 41770-R, Phoenix, AZ 85080.**  
CIRCLE 120 ON FREE INFORMATION CARD



**R & D SHEET METAL WORKER** new multi-purpose machine now with 6" male dies and removable female dies. A complete R&D in-house shop at 1/3rd the cost. Over (1500) worldwide industrial/government/educational. Call today—**TELEX 4996168 POC NPT, PACIFIC ONE CORP., STE K510 513 Superior Ave., Newport Bch., CA 92663. (714) 645-5962.**  
CIRCLE 118 ON FREE INFORMATION CARD



**SATELLITE TELEVISION RECEIVER SEMIKIT** with dual conversion downconverter. Features infrared remote control tuning, AFC, SAW filter, RF or video output, stereo output, Polorator controls, LED channel & tuning indicators. Install six factory assembled circuit boards to complete. **Semikit \$400.00.** Completed downconverter add \$100. Completed receiver and downconverter add \$150. **JAMES WALTER SATELLITE RECEIVER, 2697 Nickel, San Pablo, CA 94806. Tel 415-724-0587.**  
CIRCLE 124 ON FREE INFORMATION CARD



**TELSTONE'S TRK-957 KIT** makes breadboarding a low-power, central office quality DTMF detection system easy and inexpensive. The included M-957 receiver decodes 12 or 16 digits and operates from 5 to 12V dc. Its sensitivity, wide dynamic range, noise immunity, and low power consumption are ideal for telephone switching, computer and remote control applications. **Only \$24.75.** To order, call: **TELSTONE, 1-800-227-3800, ext. 1130.**

CIRCLE 122 ON FREE INFORMATION CARD



# NO OTHER DMM GIVES YOU ALL THIS...



## SMALLEST SIZE

Our new AWS Model DM-2000 is the smallest Rotary Switch DMM available today. (4.8" x 2.8" x 0.9", Wt. 7 oz.) Size was a prime consideration in the design of the DM-2000. Its compact size fits comfortably in one hand, easily in a toolkit, and of course, right in your pocket. Still, the LCD incorporates large 0.5" easy to read digits.

**MORE FUNCTIONS** The truly unique 3½ digit AWS DM-2000 is capable of reading 8 functions: • DC Volts • AC Volts • DC Current • Resistance • Conductance • Diode Test • HFE Test • Battery Test.

**MORE RANGES** The new AWS DM-2000 offers you an amazing 22 ranges! DC Volts: 200mV/2V/20V/200V/1000V. AC Volts: 200V/750V. DC Current: 200µA/2mA/20mA/200mA/10A. Resistance: 200Ω/2KΩ/20KΩ/200KΩ/2MΩ/20MΩ. Conductance: 2µS. Diode: 2KΩ. HFE Test: 0-1000. Battery Test: 2Vdc.



**PLUS A.W. SPERRY INSTRUMENT QUALITY** The AWS DM-2000 boasts 0.5% basic DC Volt accuracy and an "OFF" position, making it ideal for the professional engineer, technician or hobbyist. All ranges are overload protected. Special solid state protection on all resistance ranges protects the instrument and end-user up to 250Vac/dc without blowing the fuse.

# FOR JUST \$54.95!

So put the new AWS DM-2000 to work for you now. Call your local distributor or contact A.W. Sperry Instruments Inc., P.O. Box 9300, Smithtown, NY 11787. 800-645-5398 Toll Free (N.Y., Hawaii, Alaska call collect 516-231-7050).

## A.W. SPERRY INSTRUMENTS INC. The Measurable Advantage.

See us at National Plant Eng. Show Booth #495

CIRCLE 50 ON FREE INFORMATION CARD



**CONSUMER**  
New solid-state and digital TV sets, stereos, and viderecorders are tougher to repair than old-fashioned tube type sets and require special training for the service technician who works on them.

Only a few states have laws requiring competency tests for licensing technicians who repair consumer electronics, but fifteen years ago the International Society of Certified Electronic Technicians (CET) began its own certification program to qualify these technicians and those in industry. To carry the CET designation, technicians must have four years experience and pass a rigid examination on general electronics and a specific area of expertise such as audio or radio-TV.

Many consumers look for a Certified Electronic Technician in the shop when they need any electronic item repaired.

### Free Consumer Checklist

A consumer checklist for selecting a service shop is available free by sending a stamped, self-addressed envelope to: Checklist, ISCEET, 2708 West Berry, Fort Worth, TX 76109. The list reminds consumers to check such items as "Does the business have the parts for your particular brand?," "Did you get an estimated price?," and "Did you check this company with the Better Business Bureau?"



Modern electronic equipment such as digital TVs or stereos should be repaired by specially trained people.

available free by sending a stamped, self-addressed envelope to: Checklist, ISCEET, 2708 West Berry, Fort Worth, TX 76109. The list reminds consumers to check such items as "Does the business have the parts for your particular brand?," "Did you get an estimated price?," and "Did you check this company with the Better Business Bureau?"

4.75 × 14.5 inches and uses a 99-turn roller inductor. That 36-µH inductor is made of 14-gauge plated wire with a silver-plated roller contact. The balance of the tuning circuit is made up of two 250-pF variable capacitors. That circuit will allow you to tune an antenna for top performance at just about any frequency in the HF amateur or SW bands. The components are rated to handle transmitter output powers to 3 kilowatts.

	MFJ-989									
OVERALL PRICE	1	2	3	4	5	6	7	8	9	10
EASE OF USE	1	2	3	4	5	6	7	8	9	10
INSTRUCTION MANUAL	1	2	3	4	5	6	7	8	9	10
PRICE/VALUE	1	2	3	4	5	6	7	8	9	10
	Poor		Fair			Good			Excellent	

The MFJ-989 is housed in a sturdy aluminum box. The capacitors and roller inductor are all set from the front panel. The inductor features a turns indicator.

The unit can handle 50-ohm coaxial cable and balanced 300-ohm feedlines, as well as end-fed longwire antennas. The type of feed or antenna is selected by a front-panel switch. That switch also allows you to bypass the tuning circuit, if so desired.

Also built into the unit is a 300-watt, 50-ohm dummy load. That dummy load is rated at 300-watts for 30 seconds and 100 watts for 1.5 minutes.

The unit also features an accurate VSWR/power-meter. That meter can be user-calibrated via two controls on the front panel.

Overall, we have found the unit to be an excellent performer. It will tune an antenna system for peak performance for both transmission and reception. In all fairness, the unit seems a bit pricey at \$329.95, but the quality of construction seems equally high.

One last note, MFJ's documentation appears brief, but it is readable and provides you with more than enough information about the unit. It even provides you some brief operating hints, as well as some theory of operation. R-E



One tree can make  
3,000,000 matches.



One match can burn  
3,000,000 trees.



A Public Service of This Magazine  
& The Advertising Council



The family of Dip Clip test clips we manufacture grows larger every year. With that kind of selection to choose from, you're sure to find just the right one to fill the bill for your particular test needs.

Also, be aware that the Dip Clips we design

and manufacture are considered by electronic design engineers to be right at the top. No questions.

A superior product? You know you've got that. And you should know, also, that we make sure you receive fast service and

specified quantity through your favorite electronic parts distributor.

After all, we wrote the book.

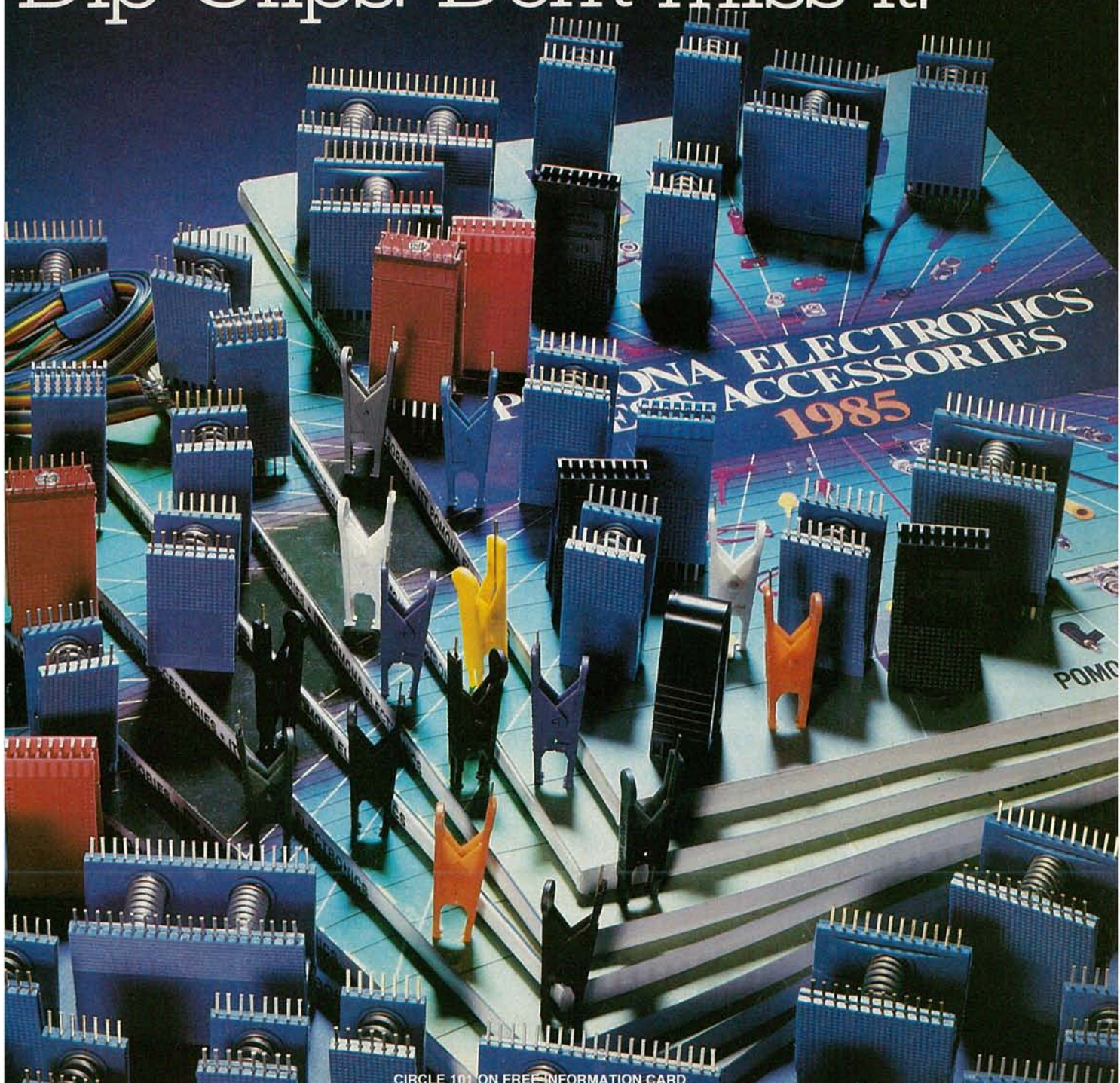
And it's free. Our products are described and illustrated in our 1985 general catalog. Just call (714) 623-3463

or 623-6751. Or, write to us at ITT Pomona Electronics, a division of ITT Corporation, 1500 E. Ninth St., Pomona, CA 91769.

**ITT**

Pomona Electronics

# Pomona wrote the book on Dip Clips.™ Don't miss it.



CIRCLE 101 ON FREE INFORMATION CARD



# IF YOU WANT TO GET YOU HAVE TO GET INTO

## Learn PC Servicing By Building Your Own NTS/HEATH HS-15<sup>+</sup> Desk-Top Computer, Circuit-By-Circuit

### NTS Intrinsic Home Training Takes You Below The Surface

NTS gets you right down into the heart of computer circuitry. You learn how microprocessors function, how they are designed, how they operate and are used to solve problems. Your program includes a wide variety of tests and projects, as you assemble your PC. You experience the excitement of seeing your own skills grow, the security of knowing you really understand what makes a computer tick.

### A Career in PC Servicing

The world of computers is constantly expanding. Applications have spread from business to manufacturing, from industry to medical and scientific fields. Computer-aided design, engineering, and production have revolutionized drafting, graphics, and prototyping. Computer sales figures point to a continuing need for service technicians as well as installation and maintenance specialists. The type of training you receive will largely determine your ability to take advantage of these opportunities .... and nothing beats the practical, down-to-earth training you get from NTS.

### The NTS/HEATH 16-Bit HS-151

This desk-top PC is the most powerful and versatile ever offered in any home training program. Check the advanced features listed below:

1. 128 KB RAM user memory on board, expandable to 640 KB
2. 16-bit 8088 Microprocessor accepts advanced software, speeds word processing; also allows selection from the huge library of IBM software.
3. 5.25-inch floppy disk drive, double density, IBM formatted, stores up to 360 KB. (Expandable to dual disk drive, and optional 10.5 MB hard-disk drive.)
4. MS-DOS operating system, IBM compatibility, make a wide choice of software programs available.
5. Four open IBM-compatible slots provide for future expansion, printer, modem, etc. Will accept most peripheral boards designed for IBM-PC.
6. Two video outputs for color or monochrome display monitor. Your NTS course includes a high resolution monitor displaying 80 characters by 25 lines, or graphics.
7. Editing capabilities help you insert or delete characters and lines, erase, jump or smooth scroll, etc.

Your NTS training course will teach you to program on this outstanding PC, using lessons, texts, and diagrams to make full use of its capabilities. Catalog contains complete details.



*Learning circuitry through the construction of this equipment offers practical training for which there is no substitute. Test equipment is included.*

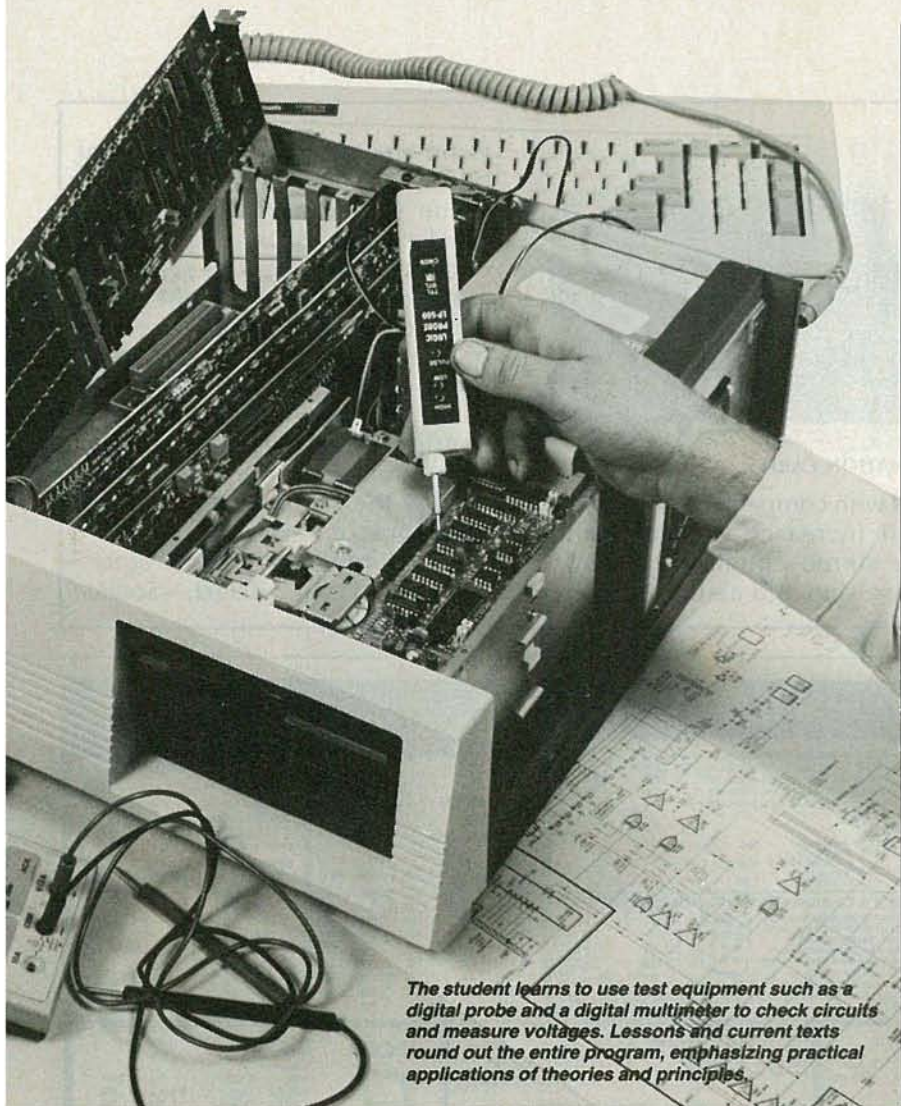
*Field servicing is interesting and rewarding. Technicians may work for a service company, manufacturer, or major users.*

*The NTS/HEATH HS-151 PC completed, includes monitor and full-function keyboard with calculator style keypad, and typewriter format.*





# INTO PC SERVICING A MICROCOMPUTER



*The student learns to use test equipment such as a digital probe and a digital multimeter to check circuits and measure voltages. Lessons and current texts round out the entire program, emphasizing practical applications of theories and principles.*

## NTS COURSES COVER MANY AREAS OF SPECIALIZATION IN ELECTRONICS:

**Robotics:** Build the NTS/HEATH Hero 1 Robot as you learn robotic programming. Robot is complete with arm and gripper, voice synthesizer. Robotics is becoming increasingly important in industry as almost daily news features attest.

**Video Technology:** Build one of the most advanced Color TV sets in America as you learn circuit diagnostics, and the use of digital test instruments. Course covers color TV, video tape recorders, computer fundamentals, solid-state devices.

**Industrial and Microprocessor Technology** covers circuit analysis, microprocessors and automation applications, lasers, and basic industrial robotics.

**TV & Radio Servicing** is a specialized course offering an excellent foundation in the use and application of both analog and digital test equipment as applied to the TV servicing field. Learn circuits, adjustments, trouble-shooting, and servicing of Color and monochrome monitors.

**Digital Electronics** offers the student the opportunity to get involved with computer concepts, computer technology fundamentals, and digital equipment by training on the NTS Compu-Trainer.

**Basic Electronics** is a course designed for those wishing to have an over-view of electronics in many of its aspects including radio receivers, solid state devices, and electronic components.

NTS Intronic training programs include a variety of superb equipment, most of which is classified as field-type, making the training practical and career oriented. Texts and lessons have been tested in our Resident School in Los Angeles to assure home study students their courses of training are easy to understand. NTS, now in its 80th. year, continues to be at the leading edge in Electronics home training.

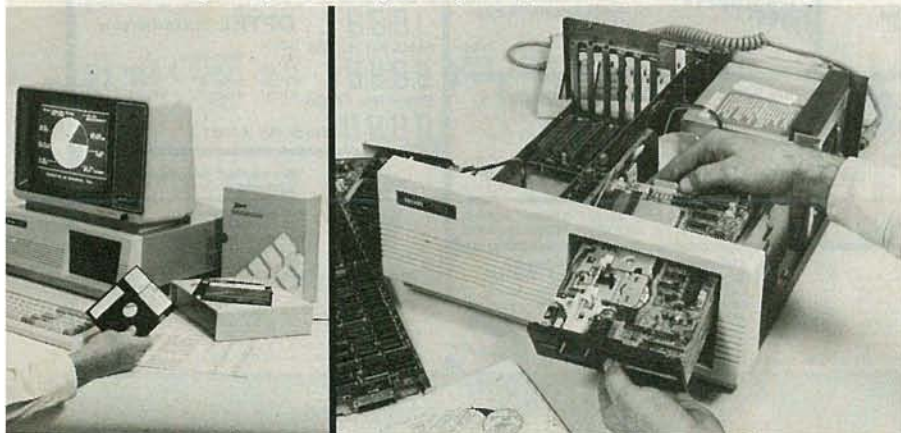
\* IBM is a trademark of International Business Machines Corp.  
\* MS is a trademark of Microsoft Corp.

If card is missing, simply write to the address shown below stating the course you are interested in. A FREE color catalog with all details will be sent to you by return mail.

**NTS NATIONAL  
TECHNICAL  
SCHOOLS**

TECHNICAL TRADE TRAINING SINCE 1905  
Resident and Home-Study Schools

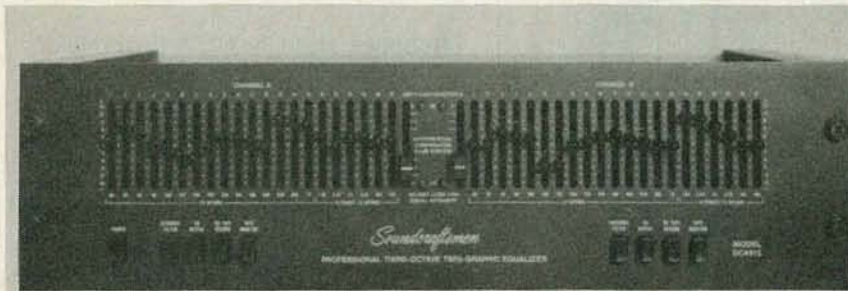
4000 So. Figueroa St., Los Angeles, CA 90037



*Installing the disk-drive in the PC is one of the final stages in the assembly of the microcomputer. Learning the use of test equipment to check circuits is an integral part of the training which, with field experience, develops invaluable career skills.*



# NEW PRODUCTS



CIRCLE 11 ON FREE INFORMATION CARD

**THIRD-OCTAVE STEREO EQUALIZER**, is designed to handle the problem of balancing in-out signal levels, which is especially impor-

tant with compact discs because of their increased dynamic range. The stereo equalizer minimizes phase shift and assures that there

is no degradation of the tonal qualities of the music.

The same balancing requirement extends to Direct-to-Disc recordings, where the dynamic range is substantially higher than FM broadcasts and ordinary records and tapes. The new equalizer is also suited for use with dbx and other types of expander/compressor accessories, where dynamic range is increased, thus making the signal-level balancing function so critical.

The *Third-Octave Stereo Equalizer* is priced at \$599.00.—Sound-

## QUALITY COMPONENTS NOT MAIL ORDER "SECONDS"

Send \$1.00 postage and handling for FREE COMPLETE CATALOG which includes coupon for \$1.00 OFF purchase.

**ARIES ZERO INSERTION FORCE SOCKETS** - cam actuated, true zero insertion - tin plated solder tail pins - capable of being plugged into dip sockets, including wire wrap.

Stock No. of	No. Pins	1-9	10-49	50
11055	24	4.98	\$4.35	\$3.90
11056	28	5.15	4.50	4.05
11057	40	6.81	5.95	5.35
11058	64	12.02	10.50	9.45

**IC-COOLERS** from UNITRACK® dissipate over 2 watts of heat from IC's producing longer life and better performance. Just push IC-cooler on - heat is collected from top and bottom of IC and dissipated. Won't shake loose!



**WILD ROVER** Touch switch capsule. Operating motion is .005" without the use of a levered arm. Extremely fast on and off with low noise. Normally open - rated 115 VAC, 1.6 amp-30 milliohm resistance - .615 radius by .160 thick.

Stock No.	1-9	10 & Up
12098	\$1.42	\$1.28

**SCREW MACHINED SOCKET PINS**, loose, packaged in bags of 100. Stock No. 11310 is solder tail with gold collet tin shell. Stock No. 11311 is wire wrap with gold collet gold shell.

Stock No.	Description	1 Bag	5 Bags	10 Bags
11310	Bag of 100 solder tail pins	\$ 4.95	\$ 4.45	\$ 3.95
11311	Bag of 100 wire wrap pins	11.95	10.75	9.50

**3 X 4 Elastomeric Keyboards** Each keyboard has a p.c. board, elastomeric pad with contacts, ABS bodies and double shot molded keys. Max rating: 12 VDC @ 20mA.

Stock No.	Operating Voltage	Key Travel	Price
11291	120V-400V	2.05-5mm	\$4.95 \$4.50
11292	80V-400V	1.52-5mm	3.95 3.60

**TI WIRE WRAP SOCKETS** Tin plated phosphor bronze contact - 3 wrap

Stock No.	No. Pins	1-99	100-499	500
11301	8	\$ .40	\$ .36	\$ .30
11302	14	.59	.54	.45
11303	16	.64	.58	.48
11304	18	.73	.66	.55
11305	20	.99	.90	.75
11306	22	1.12	1.02	.85
11307	24	1.25	1.14	.95
11308	28	1.52	1.38	1.15
11309	40	2.05	1.86	1.55

**TI LOW PROFILE SOCKETS** Tin plated copper alloy 688 contact pins with gas tight seal.

Stock No.	No. Pins	1-24	25-99	999
11201	8	\$ .10	\$ .09	\$ .08
11202	14	.14	.13	.12
11203	16	.16	.15	.14
11204	18	.18	.17	.15
11205	20	.20	.18	.16
11206	22	.22	.20	.18
11207	24	.24	.22	.20
11208	28	.28	.26	.25
11209	40	.40	.37	.33

**SUB CUB I and SUB CUB II** are high quality, complete LSI Counter Modules with LCD readout. Modules plug in p.c. board (Stock No. 51071). Complete function evaluation kit (Stock No. 51070) contains: p.c. board, 4.5V battery and variable frequency oscillator to supply train of count pulses. Stock No. 51070 has LATCH, RESET and TEST functions (3 buttons). P.C. board unplugs for bread-board work.

**6 Digit LSI Counter Modules with LCD Readouts and Associated Mounting Assemblies**

Stock No.	Description	Price
51070	Complete Function Evaluation Kit (includes batteries but does not include display counter)	\$45.00
51071	Mounting P.C. Board only	7.50
51072	SUB-CUB I display counter module only	18.00
51073	SUB-CUB II display counter module only	24.00
51074	Panel Bezel Evaluation Kit for SUB-CUB II (does not include SUB-CUB II counter module)	12.00
51075	DATA SHEET	.25

**SINGLE ROW SOCKETS** Strip of 25 collet sockets/pins - mount odd-center components easily. Gold plated contacts.

Stock No.	1-24	25	50
10240	\$1.70	\$1.50	\$1.30

Both styles breakable to any number of contact positions wanted.

Strip of 40 pins with single beam sockets. Tin plated contacts.

Stock No.	1-99	100	500	1000
10850	\$1.09	\$ .90	\$ .82	\$ .72

**OPCOA** Single Digit Displays - Common Cathode

Stock No.	Color	1	100
12082	Red	\$ 1.12	\$ .99
12085	Green	1.84	1.63
12087	Yellow	1.92	1.70
12089	Orange	2.08	1.84

Right Angle Socket for Above Displays

Stock No.	1	100
11010	\$1.24	\$ .99

**OPTEL** LCD's with pins

Stock No.	Description	1	10
47005	3 1/2 dig., 5"	\$ 5.95	\$ 5.50
47006	4 dig., 5"	5.95	5.50
47007	4 dig., 7"	11.90	11.00

Stock No. 47006

**The Battery Just Wrap™ Tool** New battery powered tool wraps insulated wire around .025" square posts without need for pre-cutting and pre-stripping. Complete with bit and 100 ft. .30 AWG wire.

Stock No.	Description	Price
13340	Battery just-wrap tool with bit and 100 ft. .30 AWG wire	\$59.95
13341	Replacement bit	10.35
13342	100 ft. blue replacement wire	7.54
13343	100 ft. white replacement wire	7.54
13344	100 ft. yellow replacement wire	7.54
13345	100 ft. red replacement wire	7.54

**MICRO Charts** - colorful 8 1/2" x 11" charts eliminate the need to stumble through manuals and summaries. Fully decoded - instant access - totally comprehensive - gives pin outs, cycle times, buy notes, etc., etc.

Stock No.	Reference	Price
23010	Z80 CPU	\$5.95
23011	8080A/8085A	5.95
23012	8082 (85A)X	5.95
23013	8084 and relatives	5.95
23014	54/7400 TTL Pinouts	5.95
23015	Basic Algorithms	5.95
23016	8086/8090A	5.95
23017	How to generalize from a sample	5.95
23018	Wordstar	5.95

**PIN FORMING TOOL** puts IC's on their true row to row spacing. One side is for 300 centers, Flip tool over for devices 500 centers. Put device in tool and squeeze.

Stock No.	Price
11059	\$12.95
10200	\$14.95

NEW! ANTI-STATIC MODEL

**Scotchflex® Breadboard Systems** Basic kit comes with 24 various Dual Sockets, 40 various Plug Strips, wire and tools. Kit can be used with any of the six boards.

Stock No.	Description	Price
03500	Basic Kit	\$79.95
03511	Basic Board, 4.5 x 5.5	19.50
03506	Intel 580-8010 Board, 12 x 6.75	64.95
03507	Motorola M-6800 Board, 9.75 x 6	42.95
03508	S-100 Board, 10 x 5.3	36.95
03509	Z-80 Board, 7.7 x 7.5	39.95
03510	Eurocard Board, 6.3 x 3.9	21.95

**OK MACHINE AND TOOL**

**IC INSERTION/EXTRACTION KIT** Includes DIP IC extractors and inserters to accommodate all ICs from 14 to 40 pins. Tools that engage conductive surfaces are CMOS safe and include grounding lugs.

Stock No.	Price
13309	\$41.34

**SOCKET WRAP ID** Dip socket - sized plastic panels with numbered holes in pin locations. Slip onto socket before wire wrapping to identify pins. Also write on them for location, IC part number, function, etc. Simplifies initial wire wrapping, troubleshooting and repair.

Stock No.	Price
13295	14 pin
13296	16 pin
13297	18 pin
13298	20 pin
13299	22 pin
13300	24 pin
13301	28 pin
13302	40 pin
13303	36 pin

\$1.95 per pack

**THERMOPROBE: Identifies Dead Components - Replaces Volt Meters!** Identify dead components which do not emit heat. Just point thermistor probe within 1/16" of board - move over components and see which are dead.

Stock No.	Price
22300	\$21.95

**SINTEC** co.

28 8th St., Box 410  
Frenchtown, NJ 08825



TOLL 800-526-5960  
FREE in NJ (201) 996-4093

We accept VISA, MC, C.O.D., CHECK, or M.O.  
INCLUDE SHIPPING CHARGES - 0 to \$100 - \$3.00  
\$100 to \$250 - \$4.00  
over \$250 - \$5.00



craftsmen, 2200 So. Ritchey, Santa Ana, CA 92705.

**VHF PORTABLE RADIO**, model 70-152, is a 2-way FM portable radio with an RF power output of 5 watts (switchable to 2 watts). It has a one-piece molded 500-mAH battery pack and an earphone jack. The radio measures 6<sup>3</sup>/<sub>16</sub> inches high × 2<sup>3</sup>/<sub>8</sub> inches wide × 1<sup>5</sup>/<sub>8</sub> inches deep and weighs approximately 24 ounces with battery pack and 6-inch helical antenna.

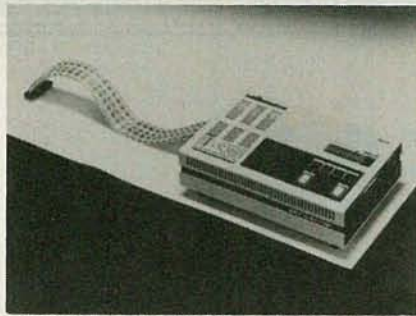


CIRCLE 12 ON FREE INFORMATION CARD

Operating over a frequency range of 150-174 MHz, the model 70-152 is available with optional tone-coded squelch, leather carrying case, and optional 3-inch "stubby" helical antenna. A vehicular charger is available in addition to one-unit, two-unit, and eight-unit desktop chargers.

The model 70-152 is priced at less than \$350.00.—**Midland International Corp.**, 1690 N. Topping, Kansas City, MO 64120.

**IN-CIRCUIT EMULATOR**, the model ICD-178 8048 is a stand-alone device and emulates the entire 8048 family in one unit (to 11 MHz). It has 4K of emulation memory, a 2K × 32-bit real-time trace buffer, three hardware and eight software breakpoints, a built-in PROM programmer for the 8748 and 8749, an external event probe

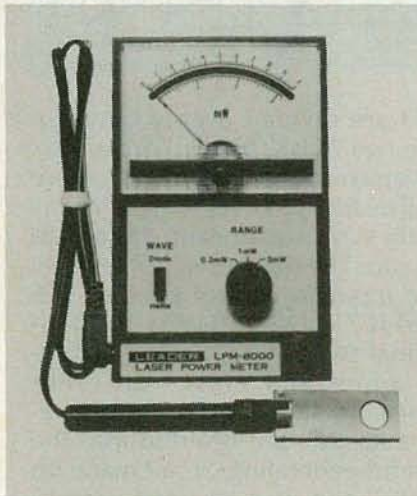


CIRCLE 13 ON FREE INFORMATION CARD

for triggering logic analyzers, and an external breakpoint probe for TTL signals. It can also be connected to the IBM PC with an optional software package that turns the PC into a complete development system for the 8048 family.

The model ICD-178 8048 is priced at \$4995.00.—**ZAX Corporation**, 2572 White Road, Irvine, CA 92714.

**LASER POWER METER**, model LPM-8000 provides a fast, convenient method of measuring the power output from laser devices used in many compact audiodisc and videodisc players.



CIRCLE 14 ON FREE INFORMATION CARD

Two wavelength and three power-measuring ranges are available on the model LPM-8000, giving the instrument versatility. This laser power meter, which consists of a main body and a sensor connected by cable, is small-size, light-weight, and battery-operated for portability. It is priced at \$225.00.—**Leader Instruments Corporation**, 380 Oser Ave., Hauppauge, LI, NY 11788. R-E

## ADVICE ON ELECTRONICS TRAINING?



### ASK OUR STUDENTS.

"I'm getting hands-on experience and a thorough understanding of electronics." —JOE AGUIS

"I got my FCC License before graduation." —MICHAEL MARCUS

"I like the job placement help and financial aid." —DEBORAH PHILPART

"The atmosphere is relaxed, while the instruction is exceptional!" —MIKE FEINSINGEN

"I look forward to a better job in a short time." —BRIAN TURNER

Find out more about the largest system of private training schools in the U.S....our specialized Associate Degree programs...and our job placement success record.

Mail the coupon or call TOLL-FREE.

**800-327-2009**

Dept. R485

Florida call 305-491-7171



**National Education Center**  
4801 N. Dixie Highway  
Fort Lauderdale, FL 33334

- Yes! I want details on training in **Electronics Technology.**
- Check other courses of interest.
- Radio/TV Broadcasting
- Commercial Art
- Business Administration
- Computer Information Systems

Name \_\_\_\_\_

Phone \_\_\_\_\_

Address \_\_\_\_\_

City \_\_\_\_\_

State, Zip \_\_\_\_\_

Dept. R485

BR9

APRIL 1985

39



# NEW IDEAS

## Making electronic music—automatically!

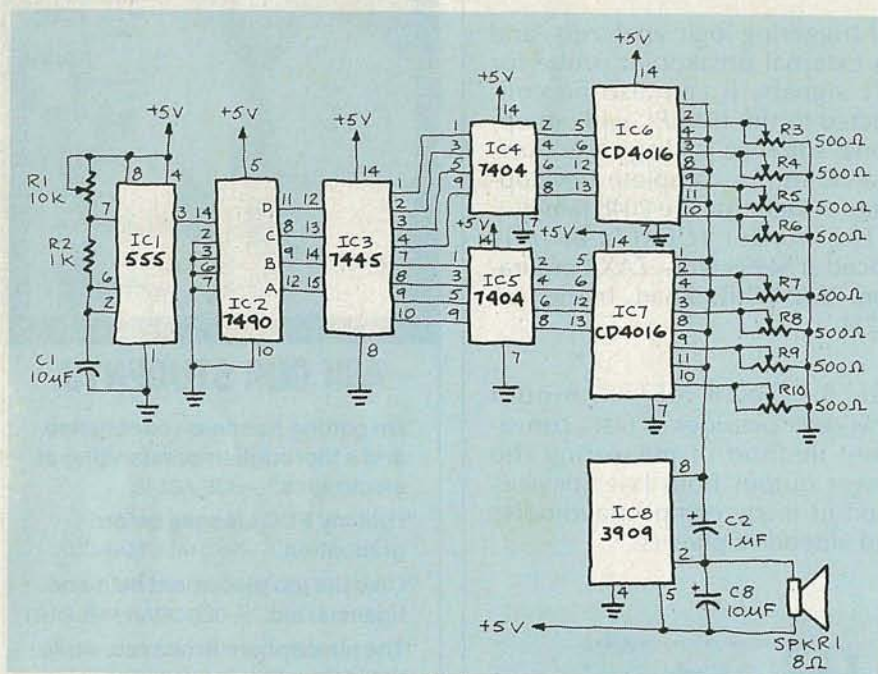


FIG. 1

BUILDING ELECTRONIC CIRCUITS TO produce musical notes and tones is fast becoming a favorite pastime of electronics hobbyists. Such circuits have gained popularity among school-aged children for class projects, as well.

Figure 1 shows a circuit you can build "from scratch" using any construction method you choose. It's made of several IC's and a few discrete components, and none of the parts used should prove hard to come by.

### How it works

IC1, a 555 timer, is set up as an astable multivibrator to produce the signal that triggers IC2, a 7490 decade counter. That IC, in turn, produces a BCD output that is fed to IC3, a 7445 BCD-to-decimal decoder/driver. Because IC3's output is positive, it's necessary to invert the signal before feeding it to the rest of the circuit. That's handled by two hex inverters, IC4 and IC5.

Note that the eight outputs of

IC3 are divided evenly between the two 7404's. Since there are six inverters in each package, there will be four left over for you to play with. What you do with them is up to you. The outputs of IC4 and IC5 are input to control pins on IC6 and IC7 (CD4016 CMOS quad bilateral switches). As those switches open and close, different resistances (as set by potentiometers R3-R10) are inserted into the sound-generating circuit made up of IC8 and its associated components. Note that IC8, which is a 3909 LED flasher also makes a fine sound generator.

The frequency at the outputs of IC6 and IC7 are adjusted to various rates, using potentiometers R3-R10, to produce the desired tones. Capacitors may be placed in series with the potentiometers to produce a sloping sound instead of a straight tone.

Two other tones may be added using the pin 5 and pin 6 outputs of IC3. To do so, simply route those

two outputs through inverters and switches as done with the other eight. If you include the extra outputs, it will be necessary to add another CD4016 bilateral switch with potentiometers connected in the same way as the others.

The negative-going output signals of IC6 and IC7 are fed through a common bus to pin 8 of IC8. Filtering for the input signal is provided by capacitor C2. Capacitor C3, connected across the output at pin 2 and the supply controls the speaker output. C3 may be replaced by a potentiometer if desired—*Artur Manhica*

### NEW IDEAS

This column is devoted to new ideas, circuits, device applications, construction techniques, helpful hints, etc.

All published entries, upon publication, will earn \$25. In addition, for U.S. residents only, Panavise will donate their *model 333*—The Rapid Assembly Circuit Board Holder, having a retail price of \$39.95. It features an eight-position rotating adjustment, indexing at 45-degree increments, and six positive lock positions in the vertical plane, giving you a full ten-inch height adjustment for comfortable working.

I agree to the above terms, and grant **Radio-Electronics** Magazine the right to publish my idea and to subsequently republish my idea in collections or compilations of reprints of similar articles. I declare that the attached idea is my own original material and that its publication does not violate any other copyright. I also declare that this material has not been previously published.

Title of Idea

Signature

Print Name

Date

Street

City

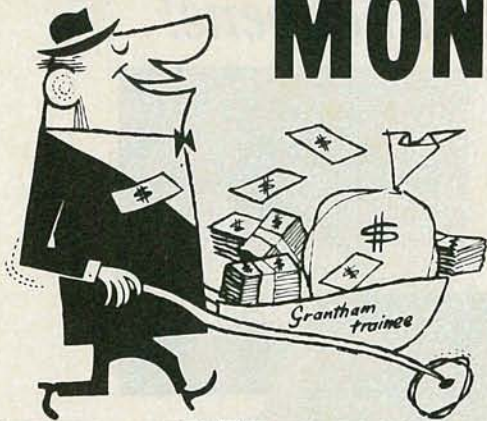
State

Zip

Mail your idea along with this coupon to: **New Ideas Radio-Electronics**, 200 Park Ave. South, New York, NY 10003



# MAKE MORE MONEY



# TRAIN FOR ELECTRONICS

You say you're *already* trained in electronics but that you're *not* making enough money??? Well then, maybe you don't have an accredited bachelor's degree to prove that your education is *up to snuff!* Check out the Grantham Independent-Study B. S. Degree Program. It could make a *dollars and sense* difference in your electronics career.

Grantham offers this program, complete but without laboratory, to electronics technicians whose objectives are to upgrade their level of technical employment. Since the field of electronics is so enormous, opportunity for advancement is always present. Promotions and natural turnover make desirable positions available to the man who is ready to *move up*.

**Grantham College of Engineering**  
10570 Humbolt Street  
Los Alamitos, California, 90720

**This booklet  
FREE!**

This free booklet explains the Grantham B.S. Degree Program, offered by independent study to those who work in electronics.



for  
**FREE  
Booklet  
CLIP  
COUPON  
and mail in  
envelope or  
paste on  
postal  
card.**

## *Do You REALLY Want to Make More Money?*

Yes it does take *work* and a few sacrifices to climb up the electronics ladder to where the bigger money is. But, if that's where you want to be, then that's what you must do — *work* harder at learning and getting the right credentials, even if it takes a few sacrifices. A *B. S. degree* and the knowledge that rightly goes along with it can give you powerful ladder-climbing equipment in your search for *success in electronics*.

The accredited Grantham non-traditional B.S. Degree Program is intended for mature, fully-employed workers who want to upgrade their electronics careers.

## *Put Professional Knowledge and a COLLEGE DEGREE in your Electronics Career through Independent Home Study*

Study materials, carefully written by the Grantham College staff for independent study at home, are supplied by the College. Your technical questions related to these materials and the lesson tests are promptly answered by the Grantham home-study teaching staff.

## *Recognition and Quality Assurance*

Grantham College of Engineering is accredited by the Accrediting Commission of the National Home Study Council, as a degree-granting institution.

All lessons and other study materials, as well as communications between the college and students, are in the English language. However, we have students in many foreign countries; about 80% of our students live in the United States of America.

**Grantham College of Engineering** R-4-85  
10570 Humbolt Street, Los Alamitos, CA 90720

Please mail me your free catalog which explains your B.S. Degree independent-study program.

Name \_\_\_\_\_ Age \_\_\_\_\_

Address \_\_\_\_\_

City \_\_\_\_\_ State \_\_\_\_\_ Zip \_\_\_\_\_



# Regency Scanners

*bring you all the action... as it happens!*



Regency Scanners bring you the local news . . . as it happens. From bank hold-ups to three alarm fires. It's on-the-scene action. While it's happening, from where it's happening . . . in your neighborhood.

You can even listen to weather reports, business and marine radio calls. Plus radio telephone conversations that offer more real life intrigue than most soap operas. And with some models, there's even more.

### The Z family

Introducing the Z series scanners from Regency. Four exciting new programmable scanners that offer you a variety of options to fit your personal needs.

First, there's the Z 10, a basic ten channel scanner that covers the six public service bands. It lets you hear your choice of over 15,000 frequencies at the touch of a finger. Or, if you prefer, locate new,

active frequencies using the search function.

If you like the Z 10 but need more channels, step up to the Z 30. It gives you all the same features with a thirty channel memory and, surprise, a programmable alarm clock that stays on even when the power switch is turned off.

For the guy who wants to tune into the aircraft and tower transmissions, we've got the Z 45. It's got the same coverage as the Z 30 with the addition of the aircraft band with forty-five total channels.

And then there's the top of the

line Z 60. It covers all the public service bands plus aircraft and FM radio broadcasts with sixty total channels.

Common to all the Regency Z scanners is a contemporary simulated wood grain cabinet and a bright, easy-to-read vacuum fluorescent display with prompting messages. They even come preprogrammed with frequencies so you can scan "right out of the box".

### Backed by Regency

Regency stands behind the Z family with a full one year parts and labor warranty. And a tradition of building great scanners. So stop in your Regency dealer today for a demonstration, or write us at the address below for a full line color brochure.



**Regency**<sup>®</sup>

ELECTRONICS, INC.  
7707 Records Street  
Indianapolis, IN 46226-9989

CIRCLE 268 ON FREE INFORMATION CARD



# BUILD THIS



## Real-Time Spectrum Analyzer for your Hi-Fi

AFTER YOU SET UP AND LISTEN TO YOUR stereo speakers in your living room, you realize that they don't give the full, just-right sound that you were hoping for. They don't sound nearly as good as they did in the stereo showroom. That situation has become a much-repeated one because your stereo system requires help in obtaining a correct response depending on the room in which it's placed.

That's why the equalizer has become a standard component of the audio system. But the equalizer isn't of any help unless it's adjusted properly to correct the response of the loudspeakers. Adjusting the equalizer for maximum performance can be a tedious and frustrating job. But it doesn't have to be. Proper equalizer adjustment can be done easily in the stereo listening room by using a real-time analyzer.

We'll show you how to build an audio-spectrum analyzer that displays a picture of any audio signal spectrum in 10 octaves. It is an economical, lab-style measuring tool capable of calibrating a wide variety of levels. For those of you with rack-mounted systems, rest assured that the PC board fits into a 19-inch rack-mountable chassis.

### Why use an analyzer?

The addition of the real-time audio analyzer to your stereo system, PA, or recording console allows you to see what you're hearing. You can use it as a tool when taping: to match tapes with the original source, or to discover the playback characteristics of a tape machine. Because it reveals the spectral content of the music played, it can be used as an educational, entertaining, and colorful display.

Total system/environment control can

*Once you can see the response of your stereo system, you can control it better with your equalizer and flatten your speaker response.*

**ROGER COTA and LLOYD ADDINGTON**

be realized by using the analyzer with an equalizer. Analyzing the frequency response of your listening area and adjusting your equalizer is simplified because the ten octave filters are tuned to the standard ISO center frequencies that are used in most equalizers. Music can be analyzed, tape copies can be compared to originals, and equalization of live vocal or instrumental sound can be optimized. Because unwanted extraneous noise will be displayed, it can be removed. When using a microphone with a known frequency response, the built-in diagnostic signal generator provides a visual display of the reproduction characteristics in the listening environment.

The analyzer, with its several input connectors and selectable input mode, allows a variety of hookup options. For example, you can use it with a receiver, preamp, tape recorder/player, equalizer, microphone, compact disc player, home satellite receiver, mixing board or recording console. The 81-LED display forms a picture of any audio signal over a 21-dB range of energy in 3-dB steps in each of the ten standard ISO octaves.

### The basics of our analyzer

Figure 1 is a block diagram of the analyzer. As you can see, there are two possible input sources, line and microphone. (As we'll soon see, there is really a third possible input source that can be selected by a front-panel rotary switch.

In the LINE mode, the analyzer will accept standard line-level (1-volt nominal) signals from devices such as preamps, receivers, tape machines, consoles, etc. In the MIC mode, the analyzer accepts the output of a dynamic microphone, which is fed into the built-in preamp. We'll see how and when to use that input shortly.

The front-panel LEVEL control sets the level of the input signal so that the highest-level signal is still in the range of the LED display. The input signal is amplified by the input driver and separated into the ten octaves by the analog bandpass-filter networks. The signals are then rectified and filtered so that the RMS amplitudes can be determined. Next the signals are multiplexed together by the diode analog multiplexer, amplified, and fed to an analog-to-digital (A/D) converter.

Logic circuitry is used to control both the diode multiplexer and the multiplexed display driver. The control logic consists of a timer, a divider, and a 1-of-10 decoder.

The A/D converter takes the analog voltage and drives the 80-LED display. Each LED-step vertically represents a gain in amplitude of 3 dB. The horizontal axis of the LED matrix represents frequency. When a signal in any frequency range drives the device higher than the 21-dB range, the OVERSCALE LED lights. When that happens, simply use the LEVEL control to bring the signal back into the range of the analyzer.



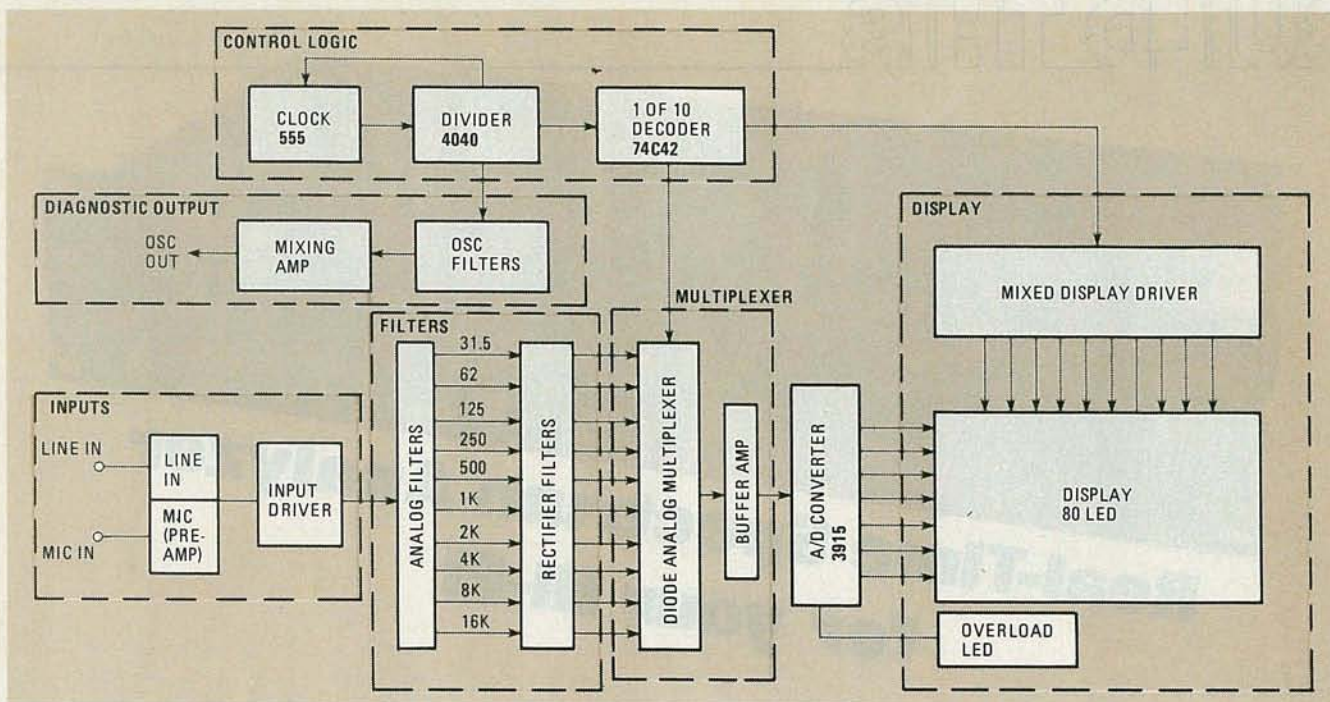


FIG. 1—AUDIO ANALYZER BLOCK DIAGRAM. The diagnostic output can also be used as an input to the analyzer for calibration purposes.

A *diagnostic sweep signal*, which is used to calibrate the equalizer, is controlled by the clock and the divider. A 555 timer is used as an oscillator, which is filtered to obtain frequencies for testing at all 10 octaves. The generated signals are mixed together, filtered, and then sent to the oscillator output. That output can be fed to speakers (via the stereo system) and picked up by a microphone in order to calibrate the equalizer. That diagnostic signal can also be chosen as an input by the front-panel mode switch. That lets you view the response of the analyzer as all the frequencies are swept.

### How the circuit works

Figure 2 is the schematic of the analyzer. As you can see there, a three-position rotary switch, S1, selects the appropriate input. The LINE input is configured to allow either separate right- and left-channel inputs or a balanced input. In other words, the input can be the right channel and ground, the left channel and ground, or the right plus left for balanced line in. In either case, the input signal goes into a line buffer or mixing amplifier made up of R11-R15, C6, C7, and IC1-b.

A microphone input is also included for low-impedance dynamic microphones. Since the output of a dynamic microphone is at a very low level, the signal must be preamplified. The microphone preamp section is made up of R2, R3, R8, R9, C2, C56, IC1-c, and IC1-d. If you want to use a condenser microphone, then you'll have to add R1, R4, R5 and C1, as shown in the dashed box in Fig. 2.

The 100K front-panel LEVEL control,

R113, sets the input level for the input driver stage (which consists of R16, R18, R19, C13, and IC4-a.) That stage supplies a low-impedance signal source for the analog filters. Each basic filter has the same configuration, but the frequency is selected by the value of the capacitors. Figure 3 shows the basic filter, while Table 1 gives the values of C and corresponding filter frequencies.

The rectifier filters and the diode multiplex network are identical for all frequencies. The output of the analog filter op-amp is rectified by a small-signal diode in series with a 10K resistor and a 1- $\mu$ F capacitor connected to the negative supply. For the 30-Hz frequency, for example, the rectifier filter is D5, R52, and C14. The diode multiplexer buffer amp IC4-b is driven by the diode networks and consists of R17, R20, R21, and IC4-b.

The control logic determines which frequency's signal is presented to the multiplexer buffer amp. The 555 timer, IC8, is controlled by R74, R75, and C44 to operate as a 16-kHz oscillator, triggered and reset on the trailing edge of each pulse.

The output of the 555 feeds IC5, a 4040 12-stage ripple-carry binary counter. As the counter counts up, resets and repeats, the output pin 1 is fed back through R80 and C3 to the frequency-modulating pin 5 of IC8. That causes the oscillator's output to warble up and down about 1/2 octave. The output pins of IC5 (pins 2, 3, 4, and 13) are fed to IC6, a 74C42 BCD-to-decimal decoder. The 74C42 converts the signal at its A, B, C, and D inputs to a logic zero on the appropriate output from 0-9. Those outputs are connected both to the

diode multiplexer and the display multiplexing network. As the 74C42 counts from 0-9 it enables each of the frequencies in turn to feed through the multiplexer buffer amp, thereby presenting each octave's analog voltage to IC7, an A/D converter. Resistors R77 and R78 form a voltage divider to provide IC7 with a reference voltage; the IC senses the analog voltage input and fires the output LED corresponding to that voltage. Each output corresponds to a 3 dB step in a 21 dB range.

At the same time, the 74C42 enables the particular octave to be sensed by the A/D, it also enables the display driver for that frequency. The multiplexed display driver consists of PNP transistors Q2-Q11, which are biased by R81-R90.

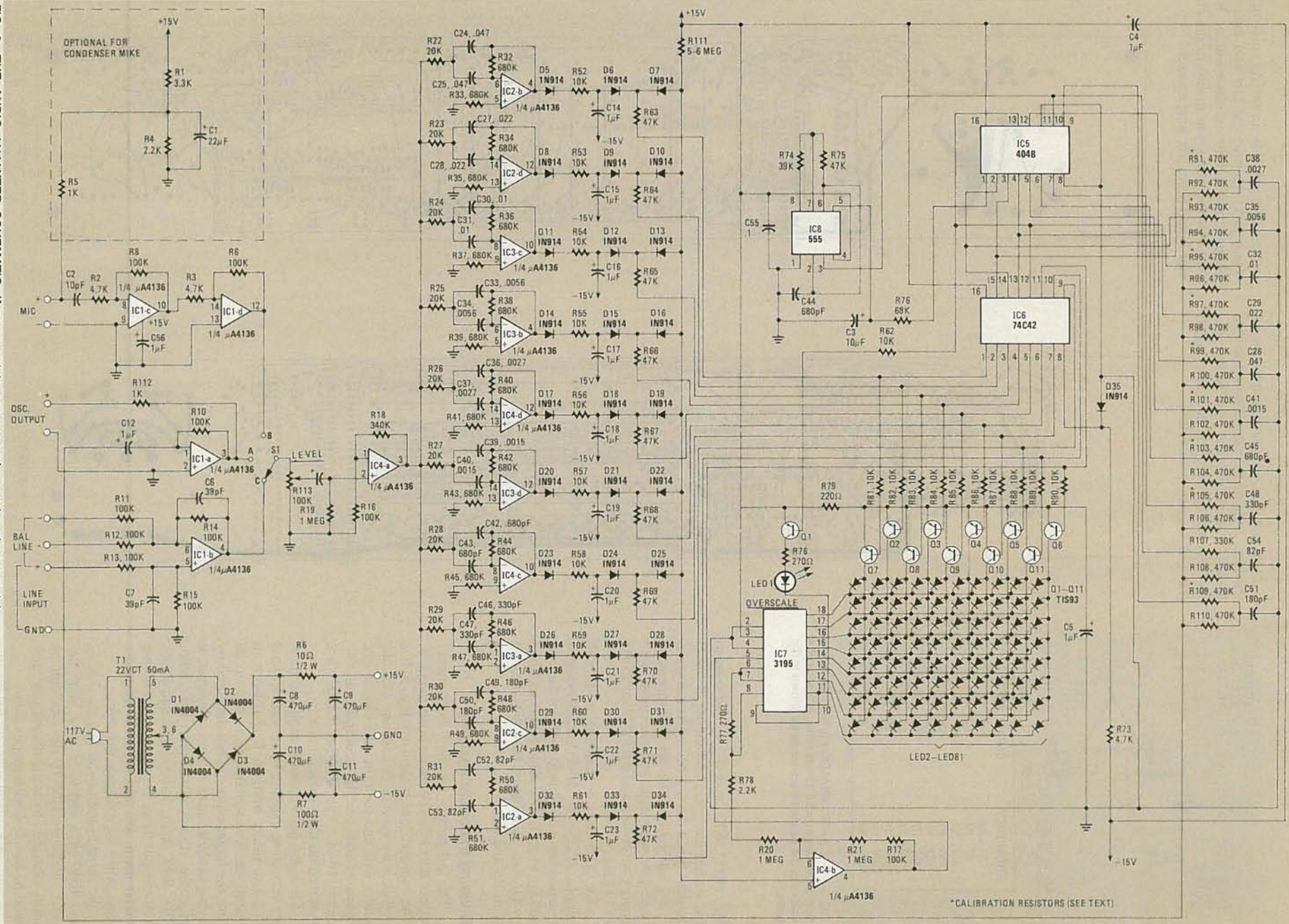
Overscale is indicated by Q1, R76, and D36. The base of Q1 is enabled by the 4040 (IC5), and the collector is connected to the output of the A/D converter corresponding to the highest analog level. When that output is activated the transistor is forward biased and turns on D36, the OVERSCALE LED.

The diagnostic sweep signal is generated and controlled by the logic circuitry as well. Ten oscillator filters are formed by R91-R110 and C26, C29, C32, C35, C38, C41, C45, C48, C51, C54. Those filters convert the squarewave outputs of IC5 to ramp waves. Table 1 shows the relationship between filter capacitance and frequency.

The 555 timer fires and pulses a signal to the first filter then, as the counter counts, the 16 kHz is divided down to produce a center oscillating frequency for all the octaves. The resulting signals are presented to the mixing amp formed by



FIG. 2—THE AUDIO ANALYZER SCHEMATIC. If you want to use a condenser (or electrostatic) microphone, the components shown in the dashed box must be installed.





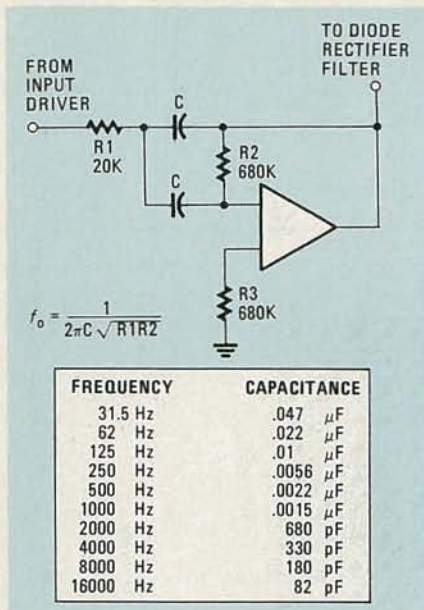


FIG. 3—THE BASIC ANALOG FILTER configuration is the same for all frequencies. However, the values of the capacitors change as shown in the table.

R10, R112, C12, and IC1-a, and then to the output terminals and the input-select switch. Since the top-octave frequency is being warbled, all the octave frequencies warble, giving a diagnostic signal with energy across the audio band from 25 Hz to 19 kHz.

The I081 uses a standard  $\pm 15$  volt supply. A 22-volt, 50-mA center-tapped transformer is used to step down the line voltage to a useable value that is rectified by D1-D4, and filtered by C8-C11 along with R6 and R7.

### Building the audio analyzer

The foil pattern for the "component" side of the circuit board is shown in Fig. 4. The "solder" side is shown in Fig. 5. It is not entirely correct to call one side the solder side and the other the circuit side because each side has components soldered to it. The display LED's are mounted on the "solder" side.

Since the parts count is high and parts are very close together be *very careful* not to cause solder bridges. It also helps to install the lower-profile parts first to be sure the larger parts are not damaged by trying to solder around them. However, at this time, do not install R91, R93, R95, R97, R99, R101, R103, R105 and R109. You can put them in position, but do not solder them. We will return to those devices when we calibrate the unit.

We should remind you that the 74C42 and 4040 (IC6 and IC5) are CMOS devices. Because CMOS devices can be easily damaged by static discharges, they must be handled with proper care.

A parts-placement diagram for the audio-analyzer circuit board is shown in Fig.

6. Note that the LED's are mounted on the "solder" side of the circuit board so that they'll be seen from the front of the cabinet. As with any diodes, be sure to install them in the proper direction.

Note that you'll be installing some off-board jacks such as the line and microphone inputs and the oscillator output. Be sure that the wires you mount in the circuit-board holes are long enough!

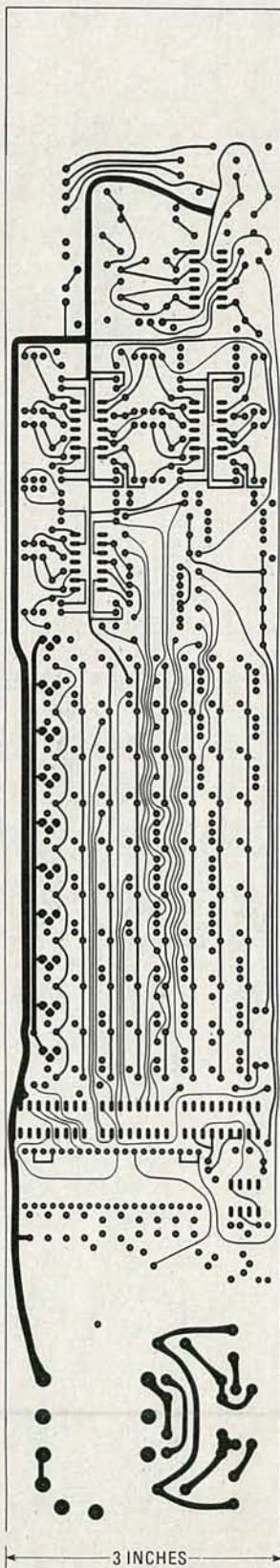


FIG. 4—THE COMPONENT SIDE of the analyzer circuit board is shown here half-sized.

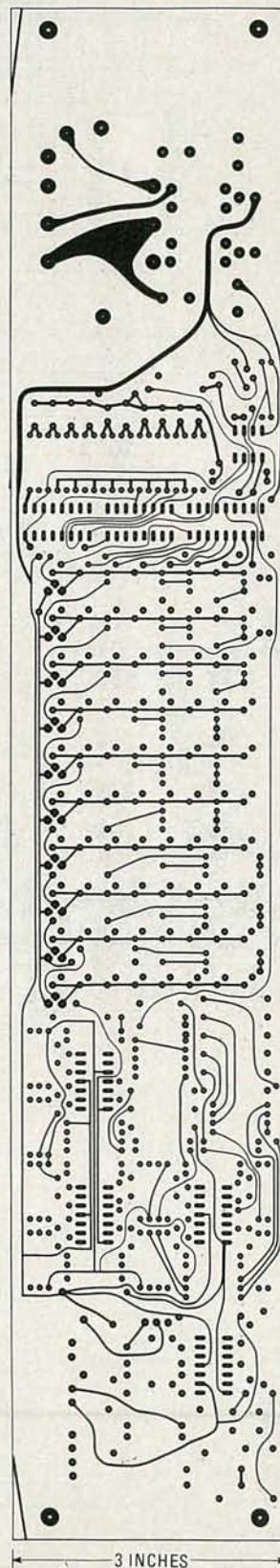


FIG. 5—THE SOLDER SIDE of the analyzer circuit board is shown here half-sized.



## PARTS LIST

All resistors are ¼ watt, 5% carbon-film types unless otherwise indicated.

- R1—3300 ohms (Optional)  
 R2, R3, R73—4700 ohms  
 R4—2200 ohms (Optional)  
 R5—1000 ohms (Optional)  
 R6—10 ohms, ½ watt, 5%  
 R7—100 ohms, ½ watt, 5%  
 R8—R17—100,000 ohms  
 R18—390,000 ohms  
 R19—R21—one megohm  
 R22—R31—20,000 ohms  
 R32—R51—680,000 ohms  
 R52—R62, R81—R90—10,000 ohms  
 R63—R72, R75—47,000 ohms  
 R74—39,000 ohms  
 R76, R77—270 ohms  
 R78—2200 ohms  
 R79—220 ohms  
 R80—6800 ohms  
 R91, R93, R95, R97, R99, R101, R103, R105, R109—Put in 470,000-ohm units but do not solder them! These are calibrating resistors. See the text for details.  
 R92, R94, R96, R98, R100, R102, R104, R106, R108, R110—470,000 ohms  
 R107—330,000 ohms  
 R111—5.6 megohms  
 R112—1000 ohms  
 R113—100,000 ohms, linear potentiometer

### Capacitors

- C1—22µF, optional  
 C2, C3—10µF  
 C4, C5, C12—C23, C56—1µF, 50 volts, electrolytic  
 C6, C7—39 pF, ceramic disc  
 C8—C11—470 µF, 35 volts, electrolytic  
 C24, C25, C26—0.047 µF, Mylar  
 C27, C28, C29—0.022 µF, Mylar  
 C30, C31, C32—0.01 µF, Mylar  
 C33, C34, C35—0.0056 µF, Mylar  
 C36, C37, C38—0.0027 µF, Mylar  
 C39, C40, C41—0.0015 µF, Mylar  
 C42, C43, C44, C45—680 pF, ceramic disc  
 C46, C47, C48—330 pF, ceramic disc  
 C49, C50, C51—180 pF, ceramic disc  
 C52, C53, C54—82 pF, ceramic disc  
 C55—0.1 µF, ceramic disc

### Semiconductors

- IC1—IC4—µA4136 quad op-amp (Fairchild, or Exar XR4136)  
 IC5—4040 ripple-carry binary counter  
 IC6—74C42—4- to 10-line decoder  
 IC7—3915 dot/bar display driver  
 IC8—555 timer  
 Q1—Q11—TIS93 (ECG159)  
 D1—D4—1N4004  
 D5—D35—1N914  
 D36—D116—miniature red LED

### Other components:

- S1—2 pole, 3 position rotary switch  
 T1—transformer, 22 volts, 50 mA center-tapped

The following are available from COTA, 3314 H Street, Vancouver, WA 98663 (206) 693-3834: Circuit board and 28 page manual, \$38.50. All orders should add \$4.50 shipping and handling.

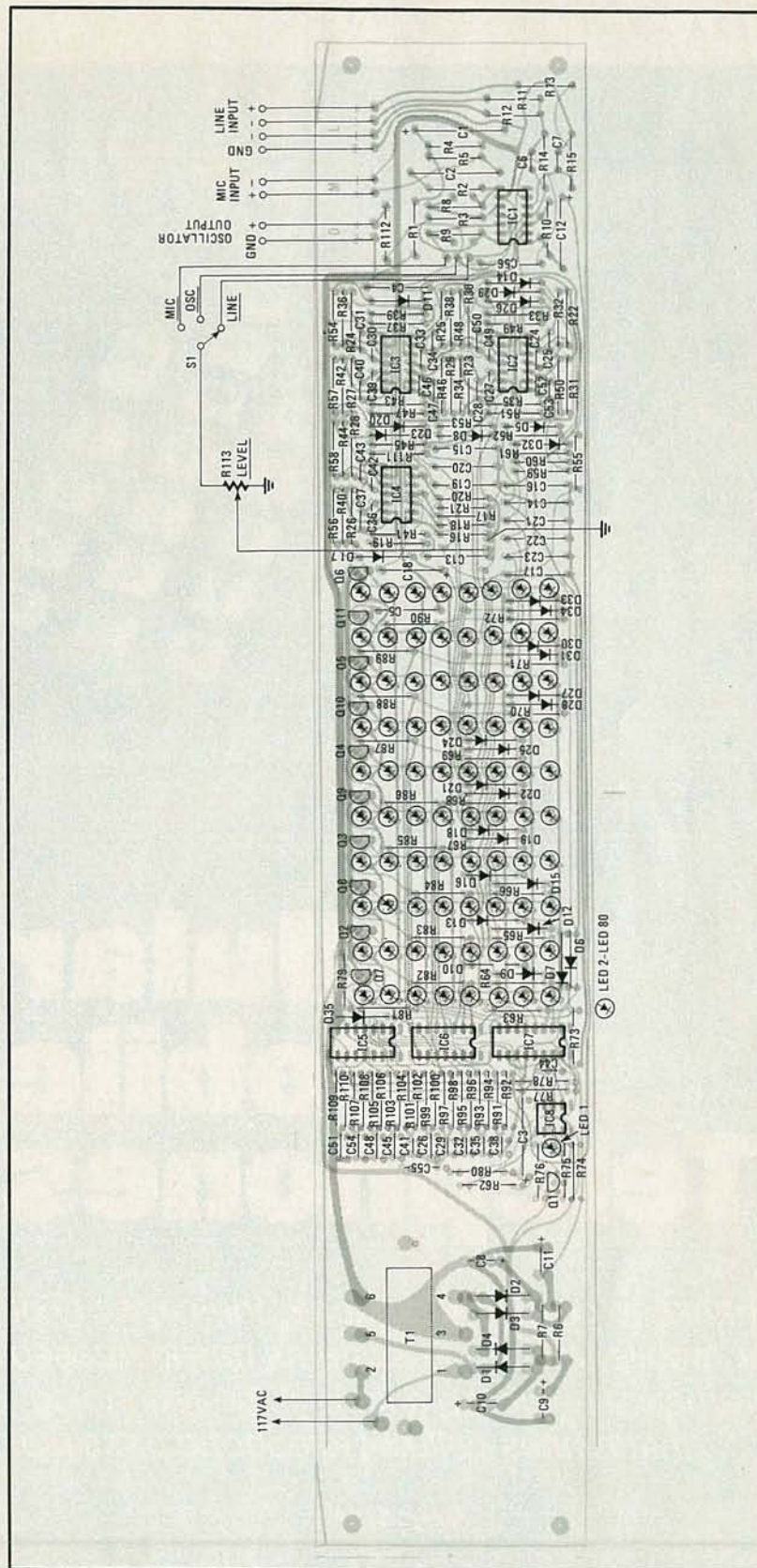


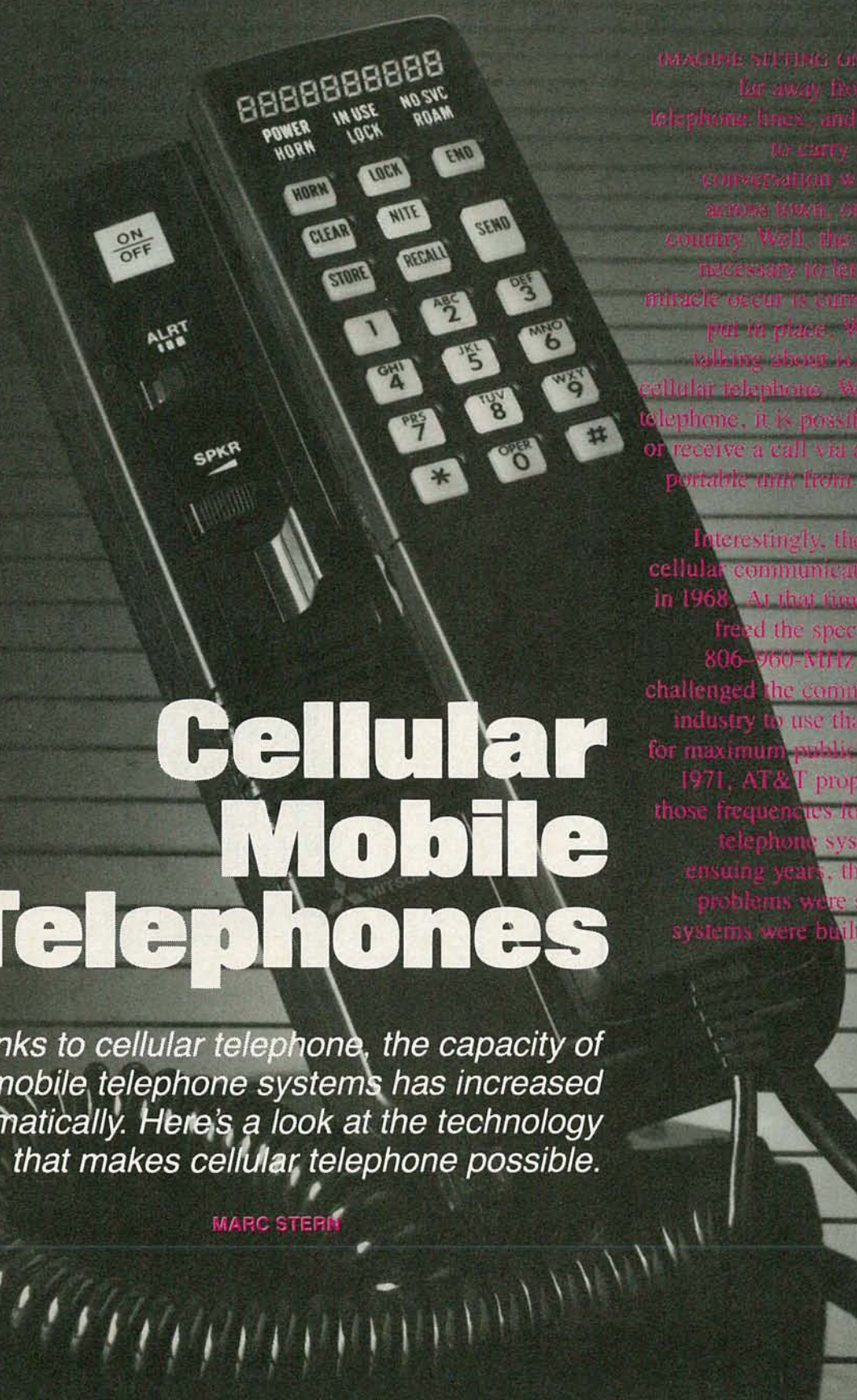
FIG. 6—PARTS PLACEMENT DIAGRAM. Note that the LED's are mounted on the solder side of the board so they can be seen when it is mounted in a cabinet.

The front-panel components, such as the mode switch and level potentiometer also have to be wired. All the details are shown in the parts-placement diagram of Fig. 6. The same is true for the connections to switch S1.

The circuit board bolts onto a chassis using the same type of bolts that hold the faceplate on a standard 3½" × 19" rack mount chassis. Since everything but the select switch and level control are circuit-  
*continued on page 93*



# HOW IT WORKS



IMAGINE SITTING ON A BEACH, far away from home or telephone lines, and being able to carry on a phone conversation with a friend across town, or across the country. Well, the technology necessary to let that minor miracle occur is currently being put in place. What we are talking about is, of course, cellular telephone. With cellular telephone, it is possible to place or receive a call via a mobile or portable unit from almost any location.

Interestingly, the history of cellular communications began in 1968. At that time, the FCC freed the spectrum in the 806-960-MHz region and challenged the communications industry to use that spectrum for maximum public benefit. In 1971, AT&T proposed using those frequencies for a cellular telephone system. In the ensuing years, the technical problems were solved, test systems were built, and rules

## Cellular Mobile Telephones

*Thanks to cellular telephone, the capacity of our mobile telephone systems has increased dramatically. Here's a look at the technology that makes cellular telephone possible.*

MARC STERN



for the cellular industry were issued. In 1983, the first commercial cellular system started operation.

### The cellular telephone system

To understand how cellular telephone works, it is necessary to discard some long-held ideas about mobile telephone. In conventional mobile telephone systems, a single central base-station is used to transmit a powerful signal over an area of up to 50 miles (see Fig. 1). In that system, only a single conversation may be held over a given frequency or channel in the service area.

In cellular systems, several low-power transmitters, with their associated receivers, are scattered about an area. Each transmitter operates at a power level sufficient only to cover a small area, called a cell (hence the name). If cells are sufficiently far apart, they can simultaneously use the same set of frequencies. (To ensure proper separation, adjacent cells are assigned different sets of frequencies.) Thus, where only one conversation could occur at a time over a given frequency in a service area, now hundreds could take place over the same coverage area.

Also, instead of using fairly high-powered mobile units—25 watts or more—to carry on conversations, each cellular mobile unit is lower powered ranging from 0.6 to 3 watts. In addition, the cellular system makes handheld portable phones both practical and possible.

Finally, the last notion that must be discarded about traditional mobile-phone systems is a low number of users. In traditional VHF-based radiotelephone systems, due to the low number of conversations that are possible at a time, the saturation level for the system is about 1,200 mobile units. That means that there are few people who can actually use the mobile phone system, and there is usually a long waiting list in any urban area. With cellular telephone, though, as many as 100,000 can make use of the system.

### A Cell Is Born

Central to the cellular radiotelephone system is the concept of a cell. That is the service area of one transmitter/receiver and it is just one part of a larger network. As shown in Fig. 2, at the center of the cell is the *cell site*, which consists of a low-power transmitter, a receiver, and an electronic switching center that links the cell to the rest of the cellular system. Each of those cell sites, in turn, is linked to a *Mobile Telephone Switching Office (MTSO)*, which is the ultimate arbiter of the entire cellular network. The MTSO, in turn, links the cellular system with the wire telephone system run by the local phone company.

The electronics that makes the cellular system possible is located at the cell site. In addition to the transceiver (transmitter-

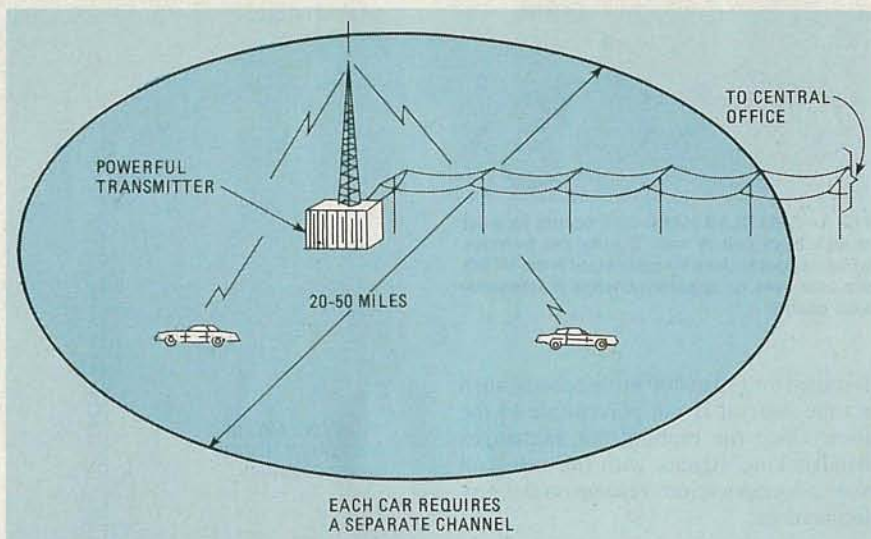


FIG. 1—CONVENTIONAL MOBILE TELEPHONE SERVICE uses one central base station to transmit a powerful signal over an area of up to 50 miles in diameter. Only one two-way conversation at a time can be held over a given channel in the coverage area and the number of channels is limited.

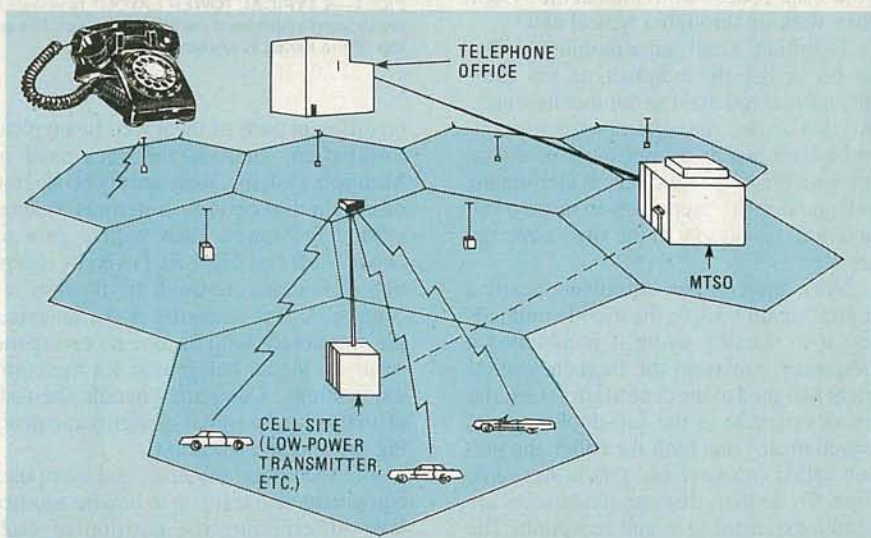


FIG. 2—CELLULAR MOBILE TELEPHONE SERVICE is provided through a system that is composed of three major elements: cell sites, a mobile telephone switching office (MTSO), and dedicated interconnecting circuits. In the cellular system, the coverage area is divided into small areas called cells, hence the name.

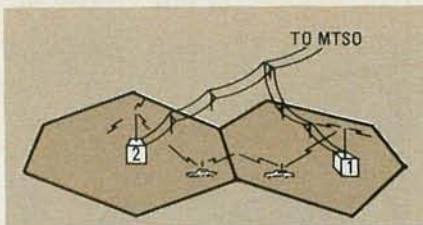
receiver) needed for the cellular system, at each site is a sophisticated computer system that not only controls the transmitter, but also the mobile units—in conjunction with the mobile unit's internal microprocessor and circuitry—as well as the local switching operation to the MTSO.

For the cellular system to work, when a car moves from cell to cell, there must be an orderly transition; communications must be transferred cleanly from cell to cell, and the mobile unit must only communicate via one cell site at a time. To achieve that aim, each cell site is assigned a set-up channel, which only handles data signals, in addition to a given number of voice channels. The set-up channel, which is used by all of the mobile units in

the cell, is used to initiate calls and assign a user to a voice channel. The receiver in a subscriber's mobile unit scans all of the set-up channels in a system and selects the one that is the strongest. Communications then commence via that cell site and only that cell site.

Transitions between cell sites (see Fig. 3) are handled by the cell site electronics. The mobile unit monitors the voice channel for a "hand-off" signal. That signal is sent by the cell site when the signal strength at the cell site drops below a certain level and it has been determined that another cell site is receiving a stronger signal (each cell site has a scanning receiver for that purpose). The hand-off signal instructs the mobile unit to change frequencies. During the change, the audio





**FIG. 3—CELLULAR HAND-OFF** occurs as a car moves from cell to cell. During the transfer, which is coordinated by equipment in the MTSO, the user sees no apparent change in transmission quality.

is muted for 150 to 400 milliseconds; such a time interval is not perceptible to the user. Once the mobile unit exchanges handshaking signals with the new cell site, communications resume on the new frequencies.

### A closer look

Let's look more closely at the cellular radiotelephone system to see how all the electronics and computers do their tasks. And what better way to look at the system than walking through a typical call?

To initiate a call, all a mobile user has to do is lift the handset of his radiotelephone and dial the number he wants. At that time, the microprocessor-controlled unit sends a brief burst of digital information to the transceiver, alerting the cell site that the user wants to make a call and that it is present in the site's coverage area.

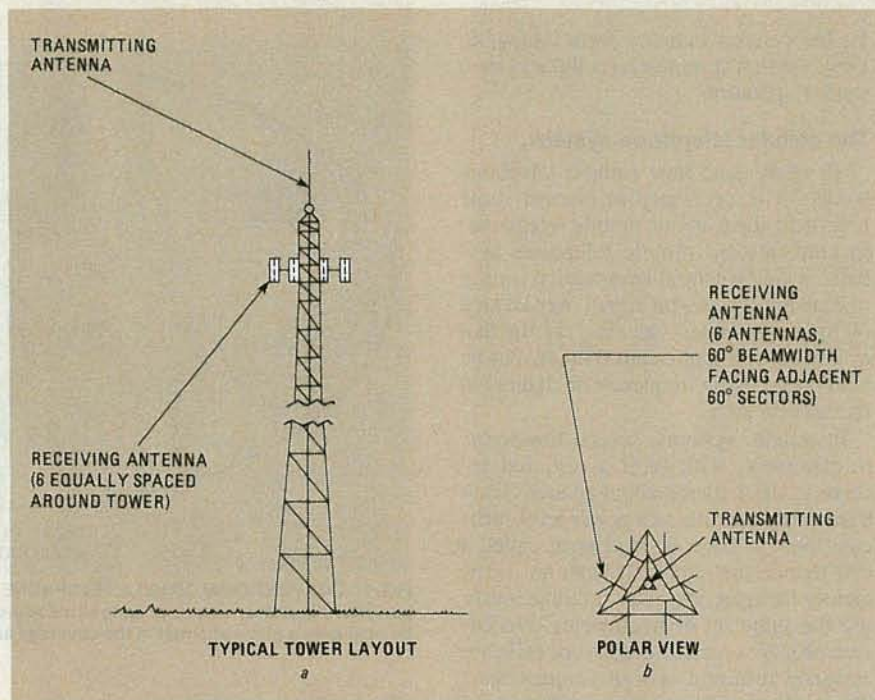
Next, the cell site equipment sends a digital signal back to the mobile unit telling it to standby while it is assigned a frequency pair from the frequency allotment assigned to the central site. (Cellular phones operate in the full-duplex mode, which means that both the caller and person called can hear and talk at the same time. To do that, discrete frequencies are used for transmission and reception. The typical frequency separation between transmit and receive is 45 MHz. Spacing between channels is 30 kHz and there are 666 duplex channels in all.)

### Continuous contact

One of the interesting capabilities of the cellular radiotelephone system is its ability to provide continuous coverage across a large geographic expanse.

In order to do that as a mobile station moves from one area to another, the entire cellular system must know the exact location of that mobile system and it must be ready to enable a hand-off of that mobile between cell sites—all without the user being aware of it.

To do that requires some interesting computerized gyrations. Look at a cell site tower, such as the one used in the Motorola system and shown in Fig. 4, and you will see something interesting—the transmit and receive antennas are located



**FIG. 4—A TYPICAL TOWER LAYOUT** is shown in a. Note that the transmitting and receiving antennas are located at different parts of the tower. The arrangement of the receiving antennas, as seen from the top of the tower, is shown in b.

on different parts of the tower. In a typical installation, such as the ones used in Motorola systems, there are six 60-degree directional receiving antennas spaced around the tower, each with a gain of about 17 dB (see Fig 4-b). Diversity reception techniques are used. In diversity reception, signal strengths at the antennas are monitored, with the one receiving the strongest signal being used for the communications. Computers handle the task of analyzing the signal strengths and making the antenna selection.

The receiving antennas and computer equipment also team up to handle another task—determining the position of each communicating mobile unit in the cell. To do that, the computer samples the received signal strength at each antenna, and uses a special direction-finding algorithm to determine the exact location of the mobile unit.

Monitoring continuously, that information is constantly updated and is fed back to the master computer at the MTSO. The computer at the MTSO is the arbiter that takes the information on the location of the mobile unit and if the signal strength falls below a certain level—about 17 dB (carrier-to-interference-and-noise)—the MTSO decides its time for a hand-off between cells.

While all of that is going on, the computer in the MTSO is also polling nearby cell sites, asking them which one is receiving the mobile unit the strongest. The cell sites, in turn, look for the signal and reply. Using the information received from the cell sites, the MTSO orders the

call to be switched to the most appropriate cell. At the same time, the mobile unit switches frequencies to a pair that is available in the new cell site. The frequency pair in the old cell site is then freed.

Monitoring the received signal strength is not only important in determining the location of the mobile unit, but it is also important in keeping the power levels within the cellular system down. Signal strength is monitored by the cell site, and when it exceeds a certain level, the cell site orders the mobile unit to cut back on the output power. Thus, the potential for interference is very small.

### Cost

At the moment, cellular service isn't inexpensive. Most units are selling in the \$2000–\$3000 range, though prices for equipment will likely drop as more and more units come on the market. As you might expect at that price, most cellular telephones are loaded with bells and whistles. Multi-phone-number memories, last number redial, digital readouts, horn alert (used to alert the user to a call while he is out of the car), and LED status lights used to indicate such things as no service in a particular area are all found on typical cellular phones. As to monthly charges, including access charges and time on the system, those are currently averaging out at about \$150.

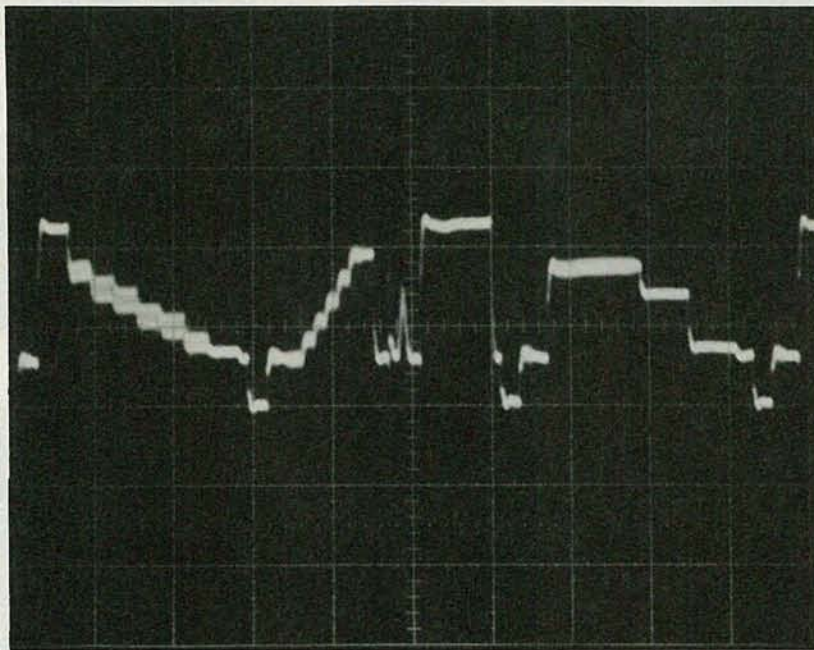
Overall, cellular radio is an exciting concept whose time has come. It promises truly portable telecommunications, which will keep anyone in touch wherever they go.

R-E



# BUILD THIS

## VIDEO SYNC SEPARATOR FOR YOUR



# OSCILLOSCOPE

STEVE PENCE

*With this oscilloscope upgrade, you can stabilize your display of video signals and see what they really look like.*

IF YOU'VE EVER WORKED WITH TELEVISIONS or video recorders, you know how difficult it can be to trigger an oscilloscope to provide a really stable display—especially if you want to examine one line of video. And what's even more frustrating is that when you do finally obtain a good display, the part of the waveform you want to examine seems to be just beyond reach. It seems that no combination of position control, sweep rate, and expansion will get you just where you want to be.

If you own a triggered-sweep oscilloscope, there is a solution! We'll show you how to add a video-sync separator and delayed-trigger capability to your oscilloscope. With your upgraded oscilloscope, you'll *really* get to see those

video signals.

The circuit can be broken down into four major sections:

- Input buffer/amplifier and video clamp circuit.
- Video-sync separator.
- Digital vertical-pulse separator.
- Trigger-delay section.

The block diagram of Fig. 1 shows the various sections of the circuit and how they relate to each other. The basic concept of the circuit is to extract the vertical-sync pulse from the video signal and use it to trigger a scope. However, the trigger pulse is not applied directly to the scope. Instead, it is first delayed by a user-adjustable period of time.

Since the scope will not begin its trace until it is triggered at the end of the delay

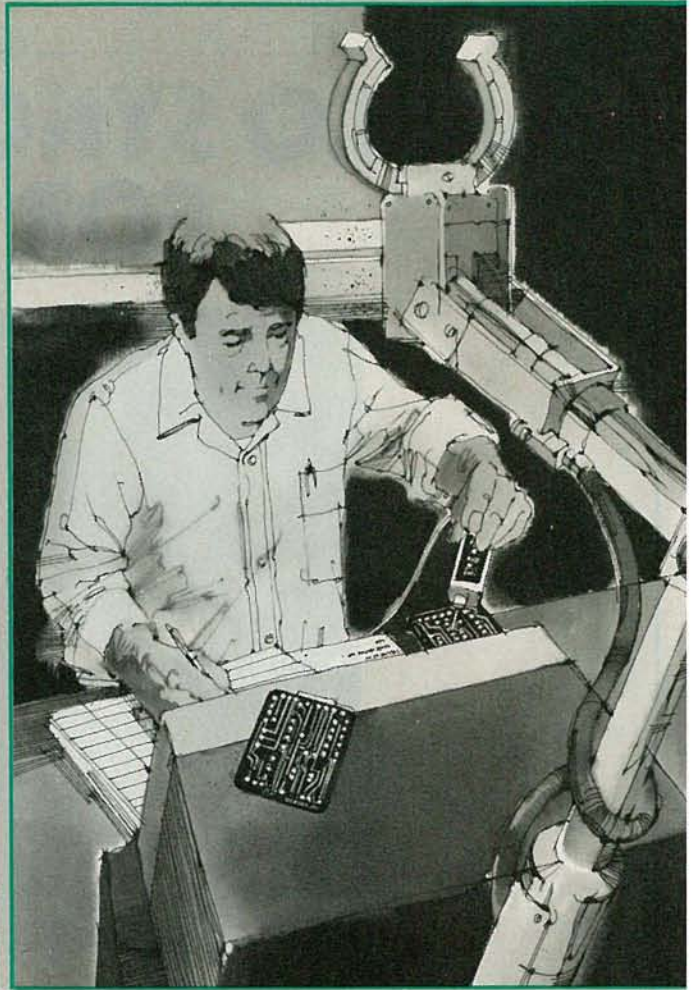
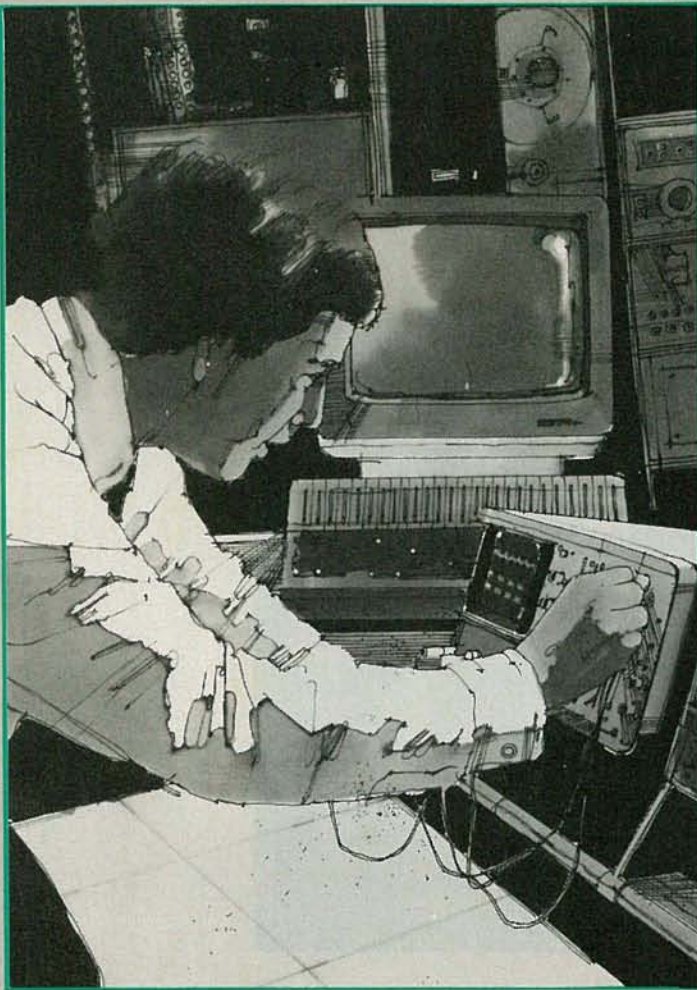
time, and since we have control over the length of the delay after the trigger event (which is a vertical-sync pulse), we can examine any part of the waveform that occurs after that event in great detail.

A useful feature of this upgrade is a clamped video output. The clamp circuit forces the tips of all the sync pulses to line up at the same DC level. So even as the brightness of the scene changes and the average video-voltage level changes, the displayed waveform will remain on exactly the same baseline, making amplitude measurements much easier.

### A look at the circuit

The schematic of the sync-separator circuit is shown in Fig. 2. We'll start our description of the circuit at J1, the video





# What can you do Just about

## CIE can show you how.

Computer technology. Satellite communications. Cable television. Cellular radio. Digital electronics. Robotics. Just a few of the hottest career areas in electronics. The ones everybody is talking about. The ones that are changing the way we live, the way we do business, the way we entertain ourselves. The best way to start a career in any of them? By learning the basic electronics theory and principles of how they work from CIE.

## Join a leader.

Leading the world in specialized electronics training, CIE is the largest school of its kind with over 25,000 students at home and abroad. And with over 50 years of experience teaching electronics to thousands of men and women through proven

methods of independent study **without** classroom sessions.

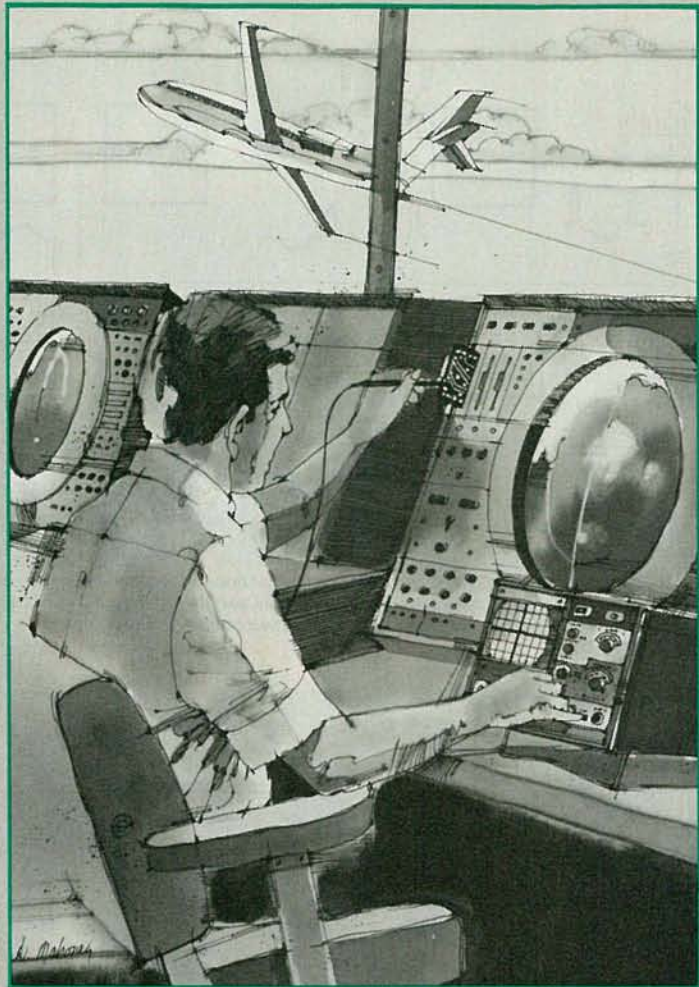
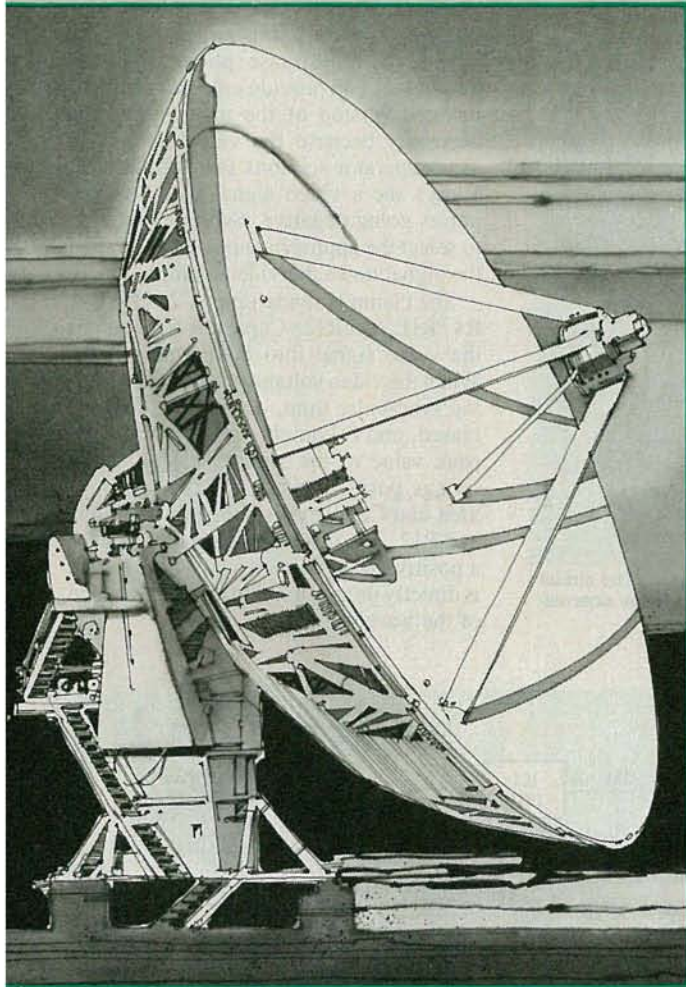
## Learn as much as you want, when you want.

Whether you're interested in learning new skills or upgrading old ones, earning a diploma or an A.A.S. degree, CIE can match your needs with courses and programs that let you start where you want, go as far as you want from a basic beginner course all the way to CIE's Associate in Applied Science Degree in Electronics – a comprehensive program that prepares you for advanced electronics careers.

## Custom training equipment helps you learn.

CIE believes in the importance of learning by





# with electronics? anything.

doing. So most of our courses include specialized training laboratories keyed to specific lessons for practical experience through teaching experiments. Our CIE Microprocessor, for example, comes fully assembled and ready to use to teach you how a computer CPU works through a series of experiments you perform on your own.

## Are you ready?

If you're ready to do something now about your future, there's no waiting to enroll with CIE. Get all the information you need to enroll simply by calling us toll-free at **1-800-321-2155** (in Ohio, 1-800-362-2105). Or mail in the handy reply coupon or card to Cleveland Institute of Electronics, 1776 East 17th Street, Cleveland, Ohio 44114.

## **CIE** World Headquarters

**Cleveland Institute of Electronics, Inc.**  
1776 East 17th Street • Cleveland, Ohio 44114

- Please send me your CIE Off-Campus Studies Catalog, including details about the Associate Degree program. I understand there is no cost for the catalog and a CIE representative may call, but there is no obligation.

Print Name \_\_\_\_\_

Address \_\_\_\_\_ Apt. No. \_\_\_\_\_

City \_\_\_\_\_ State \_\_\_\_\_ Zip \_\_\_\_\_

Age \_\_\_\_\_ Area Code/Phone No. \_\_\_\_\_ / \_\_\_\_\_

Check box for G.I. Bill bulletin on Educational Benefits

- Veteran  Active Duty

**MAIL TODAY!**

RE-07



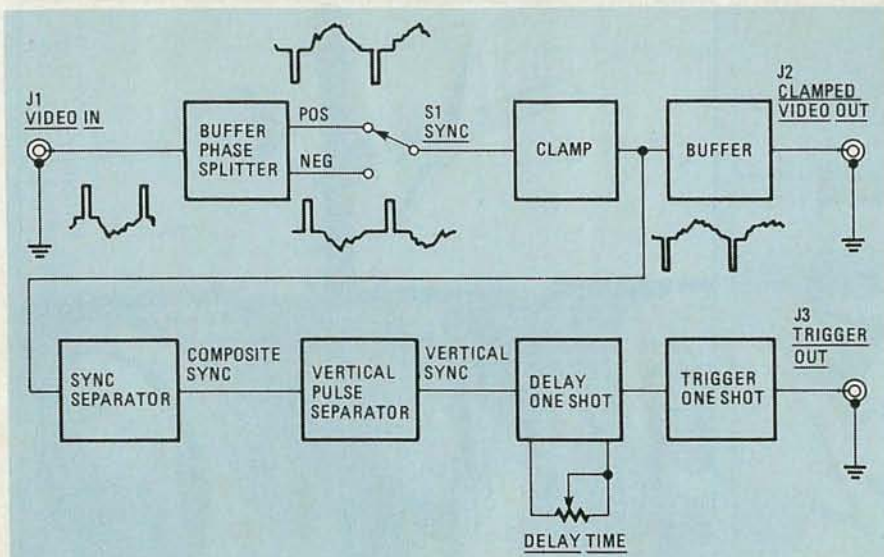


FIG. 1—THIS BLOCK DIAGRAM shows the main sections of the oscilloscope upgrade. The circuit extracts the vertical-sync pulses from a video signal and then delays it's application to the external-trigger input of the scope. Note that a clamped-video output is also available.

input. Diodes D1 and D2 provide over-voltage protection for the gate of Q1, which is a simple phase splitter. The splitter—which can provide either a normal or inverted version of the input signal—is necessary because the video-clamp and sync-separator sections that follow must always see a video signal with its sync pulses going negative. Switch S1 is used to select the appropriate polarity and send the signal on to the video clamp.

The clamp is made up of C2, D3, D4, R4, R11, and R12. Capacitor C2 couples the video signal into the clamp circuit. When the video voltage goes negative during sync-pulse time, diode D3 is forward biased, and C2 quickly charges up to the peak value of the signal. As the signal swings positive, diode D3 is reverse biased and C2 must discharge through R11 and R12. The discharge current produces a positive bias, voltage across R12 which is directly proportional to the peak voltage of the waveform.

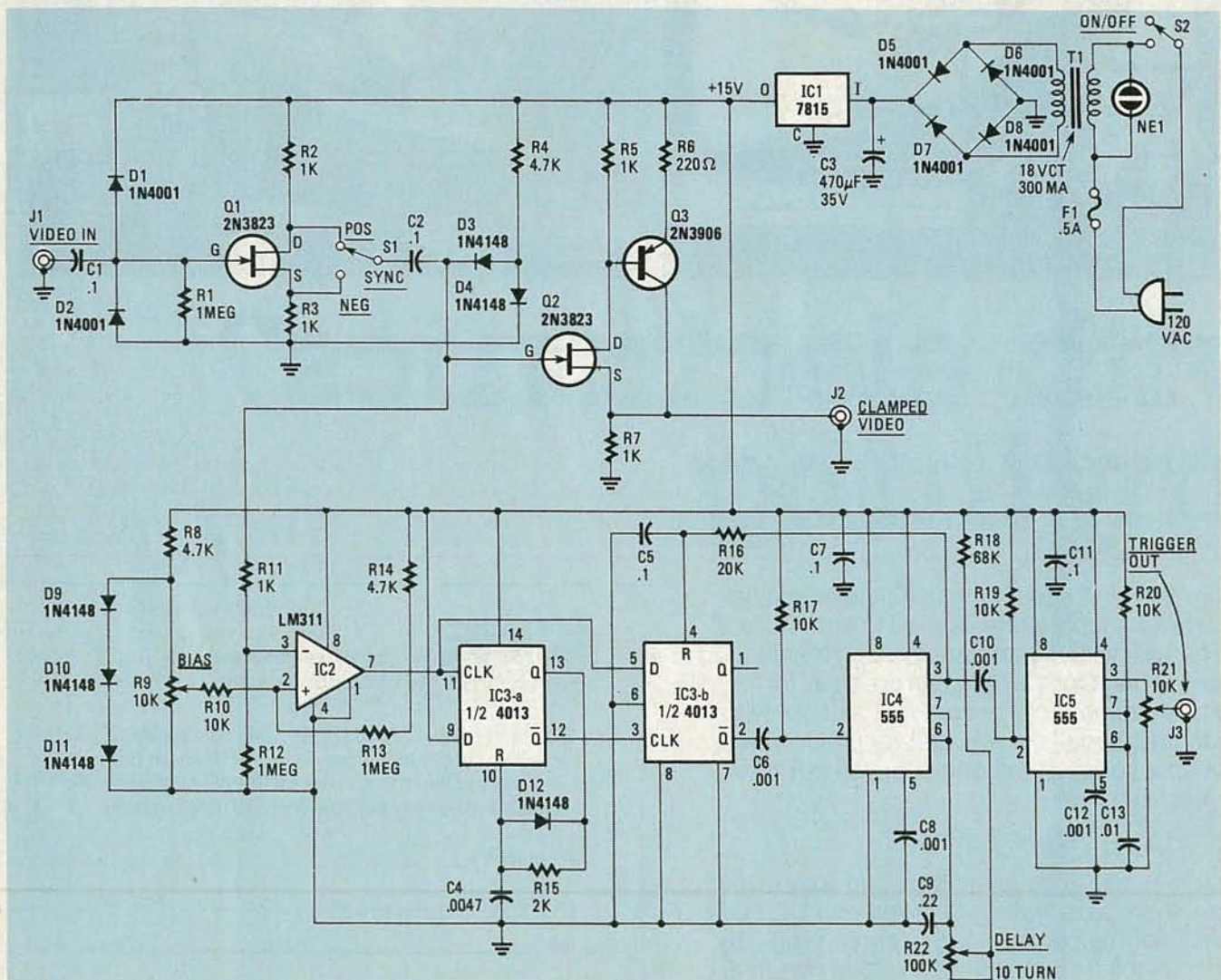


FIG. 2—SCHEMATIC OF THE SYNC SEPARATOR. The "heart" of the circuit is made up of IC2-IC5. The composite-sync output of IC2 is fed to IC3, a dual flip-flop, which outputs vertical-sync pulses. Those pulses are then delayed by IC4 and sent to IC5, which is configured as a one-shot. The output pulse of IC5, which is 100 microseconds, is sent to the scope's trigger circuit.



The C2-R12 time constant is quite long (.1 second) with respect to one horizontal time period. Because of that, the bias voltage remains essentially constant for the full period of the line. The effect of the bias is to force all of the sync pulse-tips to line up at the same level. Resistor R4 and diode D4 provide a +0.6-volt reference level for D3, which prevents the clamped signal from going below ground potential.

Transistor Q2 and Q3 form a wideband high-input-impedance buffer/amplifier that couples the clamped video output to the oscilloscope's vertical-input channel.

As we go through the discussion of the rest of the circuit, you'll find it helpful to study the timing diagrams of Figs. 3 and 4.

IC2 is a straightforward differential comparator that separates the sync pulses from the video information. The bias voltage on pin 2, the non-inverting input of IC2, is set by trimmer potentiometer R9. With the bias voltage properly set, the output (pin 7) will switch or change state only during the sync-pulse time, effectively stripping off the video and leaving only composite-sync signals, as shown in Fig. 3.

From IC2, the composite sync goes to IC3-a and IC3-b, both halves of a dual D-type CMOS flip-flop. That circuit separates the vertical-sync pulses from the horizontal by detecting the duty cycle change that occurs during the vertical-sync pulse time. Since IC2 is set up as an inverting comparator, the composite-sync pulses at its output are now positive-going. The rising edge of each horizontal-sync pulse clocks the input (pin 11) of IC3-a. Since the D input is tied to a high logic-level, those rising edges clock a high level into the Q output and a low logic-level into the  $\bar{Q}$  output. When the Q output goes high, capacitor C4 begins charging up through R15. Diode D12 is reverse biased at this time and has no effect.

After about 10 microseconds, the voltage across C4, and thus the voltage at pin 10 (RESET) will be high enough to reset the flip-flop, forcing the Q output low again. That allows C4 to discharge rapidly through D12, bringing the sequence to an end. The result is that IC3-a is actually a one-shot with a period of approximately 10 microseconds—about twice as long as a standard horizontal-sync pulse.

The  $\bar{Q}$  output of IC3-a drives the CLOCK input of IC3-b. That means that the rising edge seen at the CLOCK input corresponds to the end of the 10-microsecond time period. Note that the D input of IC3-b is not tied high. Instead, it is connected to the composite-sync output of IC2. As a result, whenever IC3-a is triggered by the horizontal-sync pulses, the D input of IC3-b will be low when the rising edge occurs at its clock input. Since the D input of IC3-b is low when the clock pulse oc-

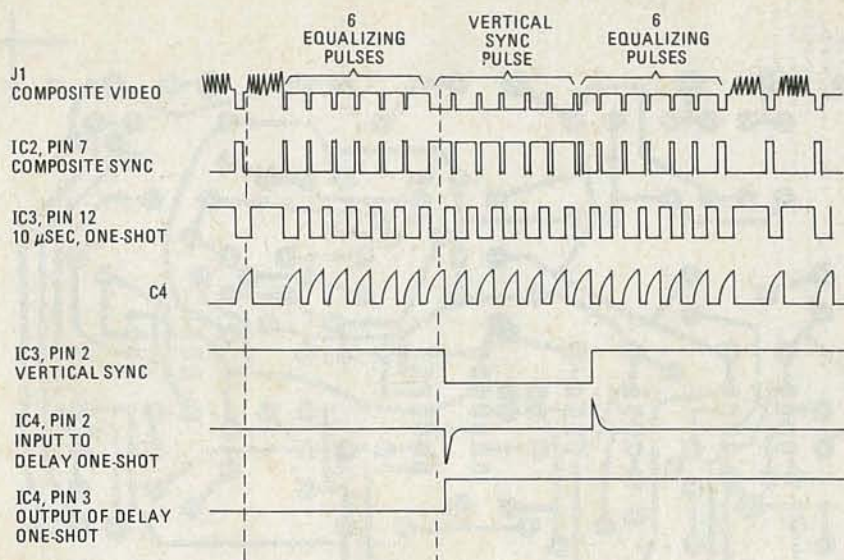


FIG. 3—THIS TIMING DIAGRAM shows how signals at various parts of the circuit are related. It should help you to follow the schematic and understand the operation of the circuit.

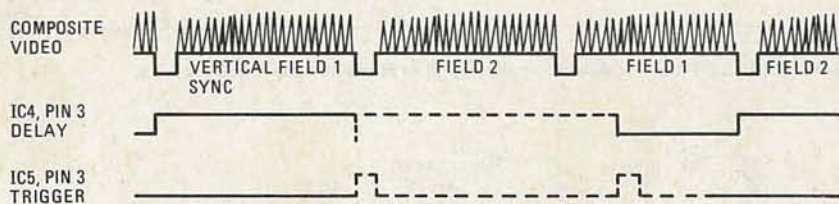


FIG. 4—TIMING DIAGRAM shows the relationship of vertical pulses to the delay and trigger output. The dotted lines indicated the range of delay that is available.

curs, no change takes place at the  $\bar{Q}$  output.

The duty cycle of a vertical-sync pulse is much wider than that of the horizontal pulses. Therefore, when a vertical-sync pulse triggers IC3-a, the D input of IC3-b will still be high at the end of the 10-microsecond period. Since the D input is at a high logic-level when the clock pulse occurs,  $\bar{Q}$  of IC3-b will go low. The  $\bar{Q}$  output will stay low as long as the duty cycle seen at the D input is longer than that of a horizontal-sync pulse.

So, at the  $\bar{Q}$  output of IC3-b we will see a negative-going pulse that corresponds to vertical sync. The falling edge of that pulse is differentiated by C6 and R17 and is used to trigger the delay one-shot, IC4. With the DELAY potentiometer R22 at minimum resistance, IC4 has a time period of 16.5 milliseconds—just about the same length of time as one complete field. With R22 at maximum resistance, the time period is 40 milliseconds, which is equivalent to approximately 2½ fields.

At the end of IC4's time period, wherever it might be set, the output at pin 3 goes low. This edge is differentiated by C10 and R19 and used to trigger the last one-shot; IC5. The period of that monostable is fixed at 100 microseconds. The pulse is routed to J3 and used to trigger the EXTERNAL TRIGGER input of the oscilloscope.

Resistor R16 and capacitor C5 help reduce jitter on long delays. A slightly delayed version of the DELAY one-shot's output is applied to the RESET input (pin 4) of IC3-b. That guarantees that no spurious pulses will appear at its output until well after the delay period.

A minimum time delay of 16.5 milliseconds is used to ensure that the scope is not triggered on consecutive fields. If that were allowed to happen, the display would show the even and odd fields superimposed on one another.

### Building the sync separator

The sync separator/trigger delay can be built as a free-standing, self-contained unit. Of course, you also have the option of installing the circuit inside an oscilloscope. The layout of the circuit is not critical, and if you're careful, you can build it on perforated construction board and use point-to-point wiring. Using a printed-circuit board is a better way to go, however. A foil pattern for a single-sided board is shown in Fig. 5. (See the Parts List for information on availability of a pre-etched and drilled board.)

Figure 6 shows a parts-placement diagram, including both on-board and off-board components. Figure 7 shows a photograph of the author's prototype that can be used as a guide. As indicated in the parts-placement diagram, be sure to con-



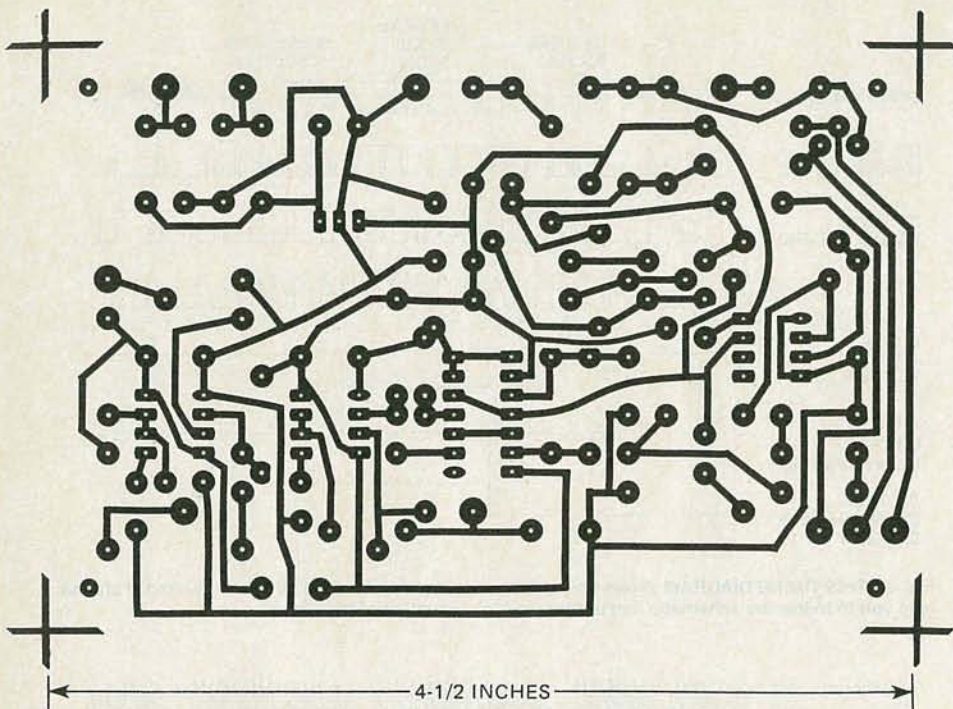


FIG. 5—THE SINGLE-SIDED BOARD is small enough to fit inside many oscilloscopes.

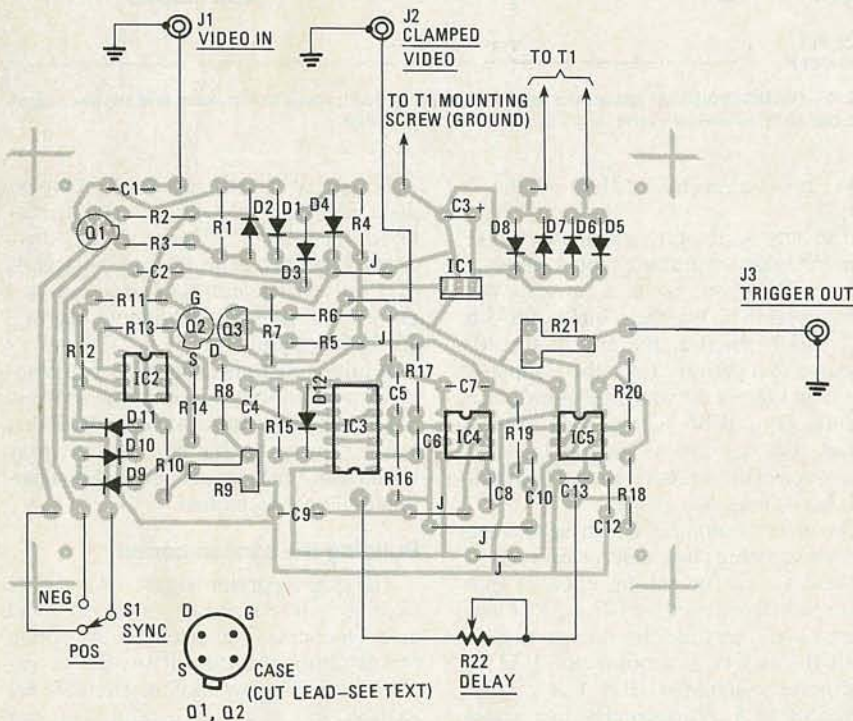


FIG. 6—PARTS PLACEMENT DIAGRAM. Note that before you install Q1 or Q2, you should cut the case lead. Also note that the board's ground should be connected to a transformer mounting screw.

nect a wire from the board's ground to one of the transformer's mounting screws. Don't forget to install the 5 jumper wires on the PC board.

Be careful when installing IC3. It is a CMOS type and is therefore static-sensitive. Note that it's also oriented opposite to that of all the others.

The case lead of transistors Q1 and Q2 should be cut off prior to their installa-

tion. The proper lead is pointed out in the parts-placement diagram.

#### Checkout and setup

After the unit is assembled, apply power and check the power-supply voltage. If that's correct, proceed by connecting a source of video to the input. An ideal source is the video output of a VCR. If you don't have a VCR or other video

#### Resistors, 1/4-watt, 5% unless otherwise noted

R1, R12, R13—1 megohm  
 R2, R3, R5, R7, R11—1000 ohms  
 R4, R8, R14—4700 ohms  
 R6—220 ohms  
 R9, R21—10,000 ohms, trimmer potentiometer  
 R10, R17, R19, R20—10,000 ohms  
 R15—2000 ohms  
 R16—20,000 ohms  
 R22—100,000 ohms, ten-turn potentiometer

#### Capacitors

C1, C2, C7, C11—0.1  $\mu$ F, ceramic disc  
 C3—470  $\mu$ F, 35 volts, electrolytic  
 C4—0.0047  $\mu$ F, 10%, polyester film  
 C5—0.1  $\mu$ F, 10%, polyester film  
 C6, C8, C10, C12—0.001  $\mu$ F, 10%, polyester film  
 C9—0.22  $\mu$ F, 10%, polyester film  
 C13—0.01  $\mu$ F, 10%, polyester film

#### Semiconductors

IC1—7815 15-volt regulator  
 IC2—LM311 comparator  
 IC3—4013 dual D-type flip-flop  
 IC4, IC5—555 timer  
 Q1, Q2—2N3823  
 Q3—2N3906  
 D1, D2, D5—D8—1N4001  
 D3, D4, D9—D12—1N4148

#### Other components

F1—fuse, 1/2 amp  
 J1—J3—Female BNC jack  
 NE1—neon lamp, 110 volts  
 S1—SPDT toggle switch  
 S2—SPST toggle switch  
 T1—110:18 volts AC, 300 mA

**Miscellaneous:** fuse holder, line cord, printed-circuit board, ground lug, case, etc.

The following are available from Elephant Electronics, Box 41770-P, Phoenix, AZ 85080: A complete kit (DT-1) consisting of all items listed above, \$49.95. The printed-circuit board is available separately for \$12.95. Arizona residents must include 6% sales tax.

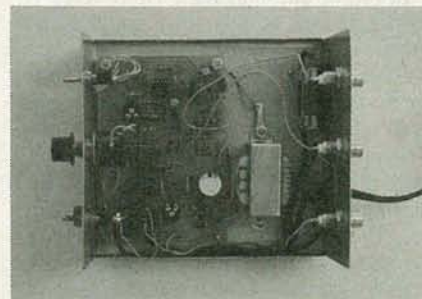


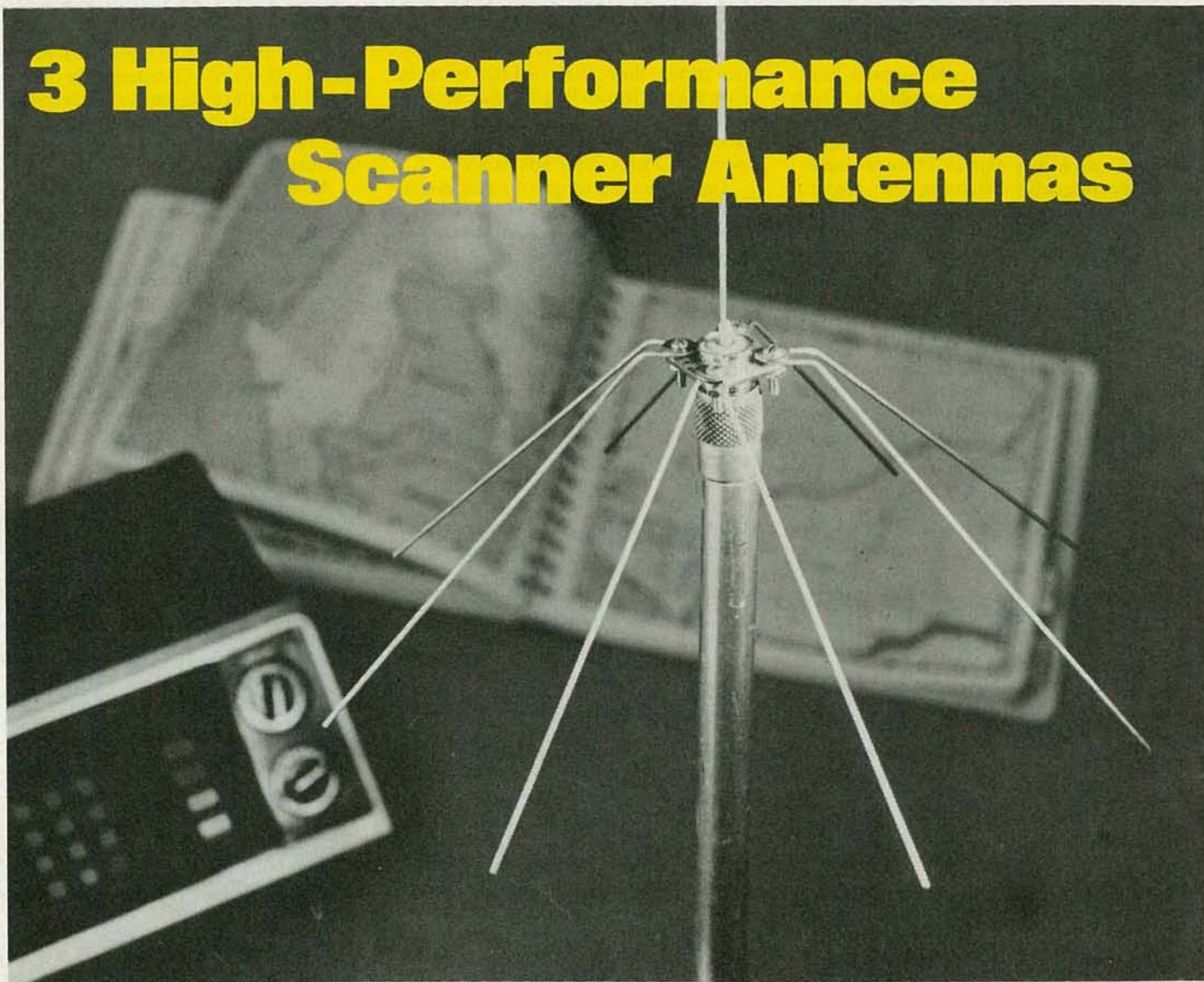
FIG. 7—THE AUTHOR'S PROTOTYPE, shown here with its top removed, was built as a stand-alone unit. If you want to use a smaller box, you might consider using a wall-mount transformer.

source available, then the output of your TV's video detector will do nicely. Determine whether the sync pulses are positive- or negative-going and set the SYNC switch accordingly. Connect the CLAMPED VIDEO output of the project to the vertical input of the oscilloscope. You

*continued on page 94*



## 3 High-Performance Scanner Antennas



*Are you still using your scanner's built-in antenna? Build one of these custom antennas and pull in those weak signals you've been missing!*

### LOREN FREBURG

IF YOU'VE RECENTLY BOUGHT A SCANNER/monitor, you've probably become hooked on eavesdropping. You have also probably come to the realization that the skimpy little antenna that screws into the top of the unit has serious limitations. Reception from highway-patrol mobile units may come and go. Fire department transmissions from portable units may be inaudible from just a few miles away. And sometimes you may hear *only* the base station side of a conversation in a neighboring town.

If you've had similar experiences, an external antenna may be just what you

need. Not the general-purpose (do-everything-half-way) type, but one designed to be optimum for the frequency you are most interested in, and yet provide good reception on the other frequencies!

There are three limitations to the built-in antenna. First, the height is too low. High-frequency radio waves tend to travel in straight lines, so low positioning limits the antenna's performance. Rooftop mounting allows the antenna to "see" farther because the horizon is more distant. The higher you can get your antenna, the better. Second, the length of the filaments are arbitrarily chosen and possibly too short. A correctly designed antenna is of a particular length. If an antenna isn't made

to that particular length then, generally speaking, the longer the antenna, the better. Built-in antennas obviously don't meet that criterion. A third problem with built-in antennas is that reflections from nearby objects upset performance. Anything that is electrically conductive can absorb radio-frequency (RF) energy and then re-radiate it, causing interference or signal drop out. Such re-radiators include any thing metallic from house-wiring to pipes, and even metal picture frames.

A well designed outdoor antenna can overcome all those problems. The three antennas that we'll be describe, *ground plane*, *extended double-Zeppelin* and *coaxial collinear*, offer the best perfor-



mance, and ease of construction at a low cost. They all share two characteristics: they are vertically polarized (mobile units require vertical antennas) and they're omnidirectional.

There are several public service bands that you're probably interested in. Those bands are shown in Table 1. The bands are divided that way because radio frequencies are widely separated between bands. The frequency determines the physical size of a particular type of antenna. Table 2 shows the typical antenna height of each antenna for a given band.

### Antenna theory

Electromagnetic radiation travels at a velocity of 186,000 miles per second (C) in free space or a vacuum, and more slowly through other substances—for example, about  $\frac{2}{3}$  the free-space velocity through solid polyethylene. (The velocity in a particular medium divided by the velocity in free space is termed the *velocity factor*.)

That radiation travels in a wave-like motion; the distance between successive waves is defined as a *wavelength*. (The symbol for wavelength is  $\lambda$ ). Frequency is defined as the number of waves passing a given point in one second. So a wavelength (in miles) is equal to 186,000 miles per second divided by the frequency or number of waves per second.

One wavelength, in miles, is expressed as  $\lambda = 186,300/f$ , where  $\lambda$  is the wavelength in miles and  $f$  is the frequency in hertz. Likewise, wavelength can be expressed in meters:  $\lambda = 3 \times 10^5/f$ , where  $\lambda$  is the wavelength in meters and  $f$  is the frequency in hertz.

Because we're working with distance measured in feet and frequency in megahertz (MHz), the formula can be rewritten as:  $\lambda = 984/f$ , where  $\lambda$  is expressed in feet and  $f$  in MHz. For example, a frequency of 984 MHz has a wavelength of one foot. (As the frequency increases the wavelength decreases. The opposite is true as frequency decreases.)

Resonance is another point that we should consider. Resonance is defined as a

state in which the natural response frequency of a circuit coincides with the frequency of the applied signal. In other words, it's a condition in which a minimum amount of energy is needed to maintain current flow. That condition exists in an antenna when its length is exactly one-half wavelength ( $\lambda/2$ ) long. Only a small amount of additional energy is needed to overcome losses in the conductor.

Let's take the analogy of a playground swing (a rather crude example of resonance, but it will illustrate our point). If a swing is pushed gently once every pass, its motion is sustained indefinitely with little additional energy. But, if the swing is pushed at a rate that doesn't exactly coincide with its movement, the smooth-flowing motion is interrupted. (You might say that it has met some resistance.) Thus, maximum performance is obtained when the antenna is at, or at least near, resonance.

Before we leave our swing, let's consider polarization from the simplest point of view. Although not a strict mathematical explanation, the similarity gives some idea of its importance. A properly timed push, whether from the back or the side, will maintain motion. However, our swing is designed for front-to-back motion (you might say it's polarized). Likewise, an antenna is polarized. Current should flow along a conductor, not across it.

Antenna impedance is a difficult concept to grasp because it doesn't really exist. It is only the mathematical quantity obtained by dividing the instantaneous voltage by the instantaneous current, which varies all along the antenna conductor. In a theoretical antenna in free space, the current at the end is zero and the voltage is at maximum. Thus, the impedance is seen to be infinite.

At a point on the conductor where the voltage is zero and the current at maximum, the impedance is zero. The importance of antenna impedance becomes apparent when we attempt to transfer energy in a antenna to a feedline and then to a receiver or scanner. Maximum energy transfer occurs when the impedances are matched—ideally, a 50-ohm monitor connected via 50-ohm feedline to the point on the antenna where the impedance is also 50 ohms.

That allows all energy picked up by the antenna to be transferred to the scanner, assuming there are no other losses. The same applies for transmitting antennas, except for power differences. A proper transmitting antenna is a proper receiving

antenna, and visa versa.

The radiation pattern of a transmitting antenna is a three-dimensional representation of its relative efficiency in radiating power in different directions, as shown in Fig. 1. (Don't be concerned with the terminology, which appears to be describing a transmitting, rather than a receiving, antenna: The functions and terminology are interchangeable.)

An antenna that radiates equally well in all directions can be represented by a sphere, with the antenna being a point at the very center. Such an antenna, which exists only in theory, is called an *isotropic radiator*.

The fundamental resonant antenna (one-half wavelength long) is called a *dipole* when the feedline is connected to its center. Such antennas radiate energy in a figure-8 pattern, with a tiny hole in the center as shown in Fig. 1-a. The dipole runs through that hole.

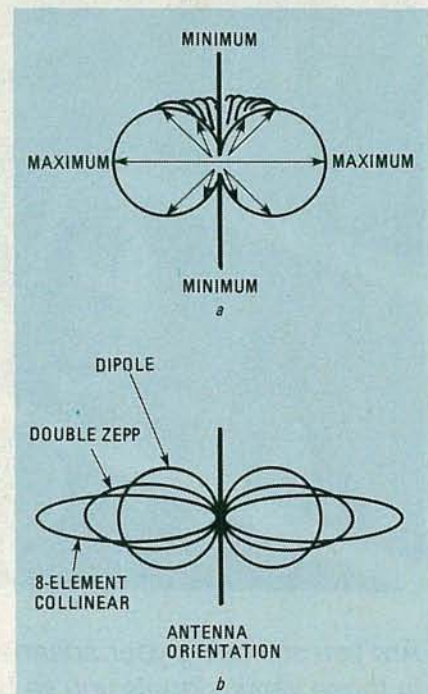


FIG. 1—ANTENNA RADIATION PATTERNS: *a* shows that the radiation pattern of a dipole is most intense at a point perpendicular to its center; *b* compares directional patterns for the three antenna types.

Figure 1-a also shows that maximum radiation (maximum sensitivity in receiving antennas) is in a direction perpendicular to the orientation of the dipole. Moving toward the ends of the dipole, signal pickup is at minimum. The dipole is usually wired at its center because the theoretical impedance is 73.14 ohms, and that is a convenient value to match to a feedline.

The gain of a particular antenna is an expression of the amount of energy radiated (or picked up) in the direction of the highest gain, and compared to a reference antenna. Let's use, for example, the hypo-

TABLE 1  
PUBLIC SERVICE BANDS

Band	Frequency Range	Wavelength
VHF-low	30-50 MHz	33 ft. - 20 ft.
VHF-high	118-136 MHz	8 ft. - 7 ft.
	148-174 MHz	6.6 ft. - 5.7 ft.
UHF-low	410-470 MHz	
UHF-high	470-512 MHz	2 ft

TABLE 2  
TYPICAL ANTENNA LENGTHS

Band	Ground Plane	Extended Double-Zepp	Coaxial-Collinear
VHF-low	6 ft. + radials	32 ft.	80 ft.
VHF-high	1½ ft. + radials	8 ft.	20 ft.
UHF	6 inches + radials	2½ ft.	6½ ft.



thetical isotropic antenna (which radiates equally well in all directions) as our reference standard. If both the isotropic antenna and a dipole each radiate all of their energy, the dipole will have some gain because its energy is concentrated in fewer directions. Thus, the gain of an antenna is a function of its radiation pattern.

A high-gain antenna has a radiation pattern that's highly directional. Antenna gain is expressed in decibels (dB):  $\text{dB} = 10 \log P_A/P_R$ , where  $P_A$  is the power density or field strength of the antenna being compared and  $P_R$  is the field strength of the reference antenna. But how do we get a gain with our antenna if we need reception from all directions? We don't really need reception from all directions, just all compass directions. Signals from above or below us are not needed, and that's the key to unlocking better performance.

If the dipole antenna is positioned vertically as shown in Fig. 1-a, its radiation pattern wraps around it (like a coil wrapped around a stick) and there is 2.14 dB gain relative to the theoretical isotropic radiator. To obtain more gain the pattern must be compressed, making it flatter and wider. One way to flatten out the pattern is to stack half-wave dipoles and connect them so that the currents are additive (in phase).

Both the extended double Zeppelin and the coaxial-collinear antennas are variations of the stacked-dipole technique. Their radiation patterns are shown in Fig. 1-b, along with that of the dipole type. (Note that the ground plane antenna, which is our third antenna type, is simply a dipole that has been modified).

### Antenna design

Until now, we've been talking only theory; but, in the real world, there are additional considerations. The antenna diameter itself must be taken into account at the higher frequencies. That's because a "fat" antenna acts electrically as though it were physically longer. Thus, the antenna must be made shorter than theory indicates. Table 3 shows the correction factor that the calculated wavelength must be multiplied by to obtain more accurate results.

Another factor affecting antenna performance is the presence of the ground beneath an antenna, which acts like an "electrical mirror." The reflected RF reaches the antenna later than the signal strike the antenna directly. Those late-arriving signals are added to the first, and either increase or decrease antenna current, depending upon the length of the delay.

That delay depends on the proximity of the antenna to reflective materials like nearby buildings, metal objects, bodies of water, and ground. All have similar reflective properties, and their effect is a function of their conductivity. Because of the

**TABLE 3**  
CORRECTION FOR DIAMETER OF ROD OR TUBING

Ratio $\left( \frac{\text{Wavelength}}{\text{Antenna Diameter}} \right)$	Correction Factor
50	0.945
70	0.950
100	0.955
200	0.960
400	0.965
1000	0.970
4000	0.970

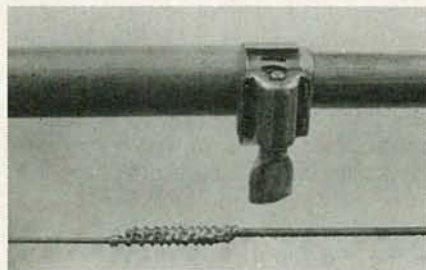
complex and often unpredictable nature of reflections, they are best avoided.

One way to minimize ground reflection problems is to make an artificial ground an integral and therefore predictable part of the antenna system. That's an important feature of the *ground plane* antenna.

Design theory must be combined with the available materials to make an antenna. The antennas described here use commonly available materials, and building them requires a minimum amount of tools. The antenna elements themselves are made from brass brazing rods, aluminum tubing, or coaxial cable.

Brazing rods are available from welding supply houses or someone who does brazing (such as auto repair or machine shops). Aluminum tubing can be bought in most hardware stores and home improvement centers. Coaxial cable and connectors can be obtained from electronics supply houses and the miscellaneous materials may be picked up at your local hardware store.

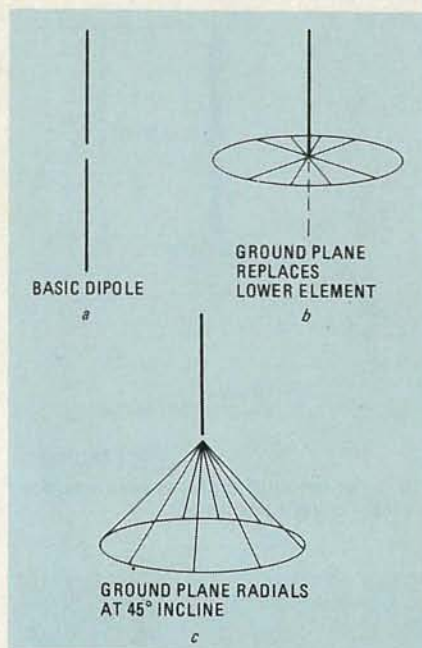
It should be emphasized that when designing an antenna, the dimensions are only a starting point. Use your imagination to combine the measurements with materials that you feel comfortable with or have on hand. Remember, materials can be modified. For instance, two brazing rods are easily soldered together to make longer elements so long as the joint is *first* wrapped with copper wire (see Fig. 2). Likewise, two pieces of tubing may be telescoped if necessary.



**FIG. 2—TWO BRAZING RODS** may be soldered together if longer elements are needed.

### Ground plane

One of the most common communications antennas is the *ground plane*. (Figure 3 shows how dipole evolves into a ground plane antenna). In Fig. 3-a, we have the basic dipole. An artificial ground



**FIG. 3—THE EVOLUTION** of the ground plane antenna: a shows the basic dipole; in b, the lower half of the dipole is replaced by a ground plane, and c shows the ground plane bent downward at a 45° angle.

(ground-plane) replaces the lower half of the dipole in Fig. 3-b and functions much like a reflector. It has about 1.8 dB less gain than a dipole, but often outperforms a dipole in spite of that. That's because it is less affected by reflections from the ground, which can cancel out antenna current.

The ground plane itself is usually made of wire extending from the base of the vertical element. The ideal antenna would have a continuous ground, perhaps made from a sheet of copper. A series of wires, or radials, approximates that condition. The more radials used, the closer we approach the ideal.

The wires can be self-supporting if made from a stiff rod or tubing. The impedance of a ground plane antenna is about 30 ohms when the plane is flat. By lowering the radials by 45° (as shown in Fig. 3-c) its impedance is made close to 50 ohms, which matches available coaxial cable and typical scanner/monitors. Also, lowering the radials lowers the radiation pattern, which effectively increases its gain.

A ground plane may be made from a coaxial chassis connector and wire. Figure 4 shows how to find the correct length for the radials and antenna element to be mounted on the connector. The antenna element and radials are made from brass brazing rods, which are available in 3-foot lengths and in diameters from 1/16 to 1/4 inch. The rods are fairly rigid, yet may be bent as needed. They're easy to solder, certainly an advantage when elements longer than 3 feet are needed. Use thinner rods for extensions and thicker rods next to the coaxial connector.



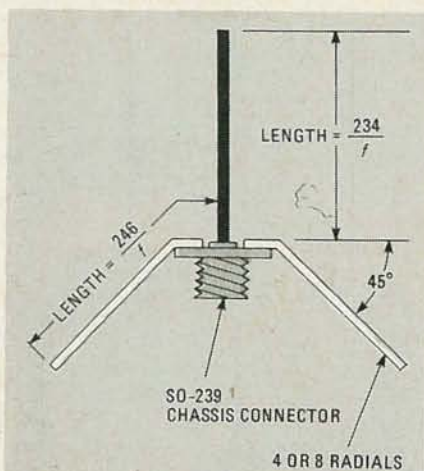


FIG. 4—THE GROUND PLANE antenna is built on a coaxial chassis connector.

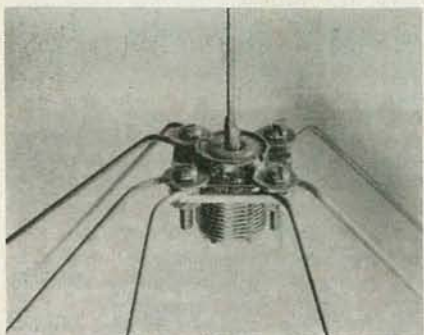


FIG. 5—GROUND PLANE antenna-base; brazing rods form the artificial ground and antenna element.

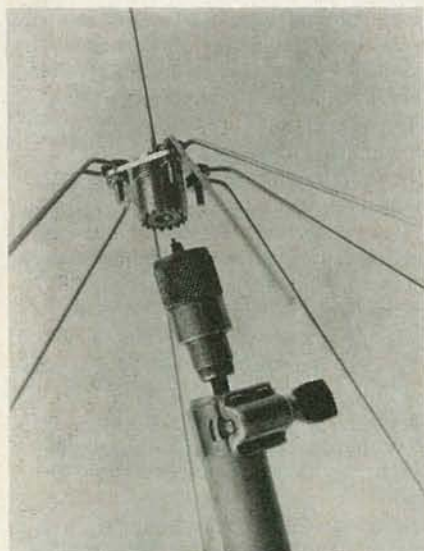


FIG. 6—THE GROUND PLANE antenna's connecting cable is run through the center of the tubing.

The vertical element should be  $\lambda/4$  long. Cut the rod about  $1/2$  inch longer initially, and do the final cut after soldering to the chassis connector. Note that the ground-plane radials are each 5% longer than  $\lambda/4$ . That length includes the distance contributed by the base. Again, the final cutting is done after installation.

Don't forget to correct the lengths of the various elements for the diameter of material you're using.

Figure 5 shows how the radials and element are connected. It is best to use eight radials as shown. Four radials will work but not as well. Bend them downward  $45^\circ$  and space evenly around the fitting. Solder the vertical element to the center pin of the fitting.

Now prepare the mast by making four  $1\frac{1}{2}$  inch lengthwise cuts in a piece of tubing. The inside diameter of the tubing should be close to the diameter of the plug (about  $3/4$  inch). The plug will be held in the end of the tubing. Connect the plug to the cable and insert the assembly in the slit end of the tubing, as shown in Fig. 6. Then secure the assembly in place with a hose clamp.

The antenna may now be screwed onto the plug and moved to its final location. The ground plane is easily self-supporting when designed for the VHF (high) and UHF bands. However, when the lengths of the elements are 6 feet, as with the VHF low band, a little wind can really whip those rods around.

That problem is easily solved by adding a little bracing. The radials may be supported by  $1 \times 1$  inch piece wood or lightweight tubing. Support is not needed all the way to the ends, about half to a third of the length should do. The vertical element must be braced with non-conductive material like a wooden dowel, 1-inch square piece of wood, plastic PVC tubing or similar material.

### Extended double-Zeppelin

The extended double-Zeppelin antenna is a frequently-used modification of the design originally used in World War II Zeppelins, which is where the antenna got its name. The Zeppelin, or Zepp antenna is a resonant, end-fed antenna with a two-wire transmission line. The design presented here has an antenna element connected to each conductor, hence the name double-Zepp.

In the double-Zepp design, three half-wavelength sections are connected end to end, as shown in Fig. 7. The induced currents in the two outside elements flow toward the center conductor. Any induced current in each of the center  $\lambda/4$  sections (phase-reversing stub) flow in opposite directions relative to each other, so their sum is zero.

That means that resulting current in the center section will be due only to the current induced in the antenna itself. When the antenna elements are close together, as shown in Fig. 7-a, those elements interact, reducing the total current flow and the gain of the antenna.

That problem is overcome by wider spacing (see Fig. 7-b). Of course, the element is now longer than a half-wavelength. That means that part of the current

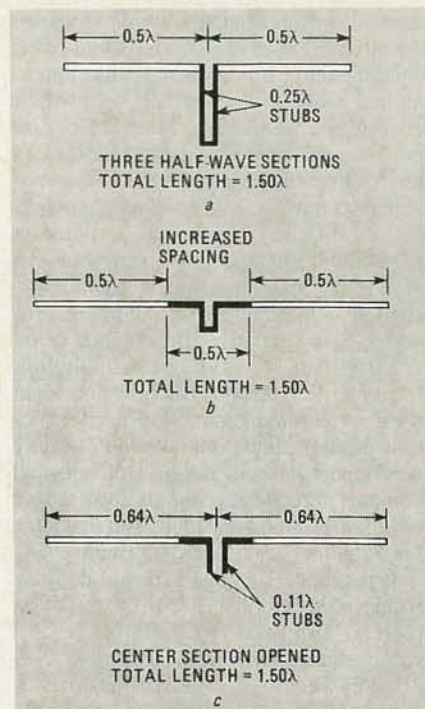


FIG. 7—THE EVOLUTION of the extended double-Zeppelin antenna. In each case, the total length is equal to  $1.5 \lambda$ .

is out of phase, which reduces the total current and gain. When the spacing between the ends of each element is  $0.28 \lambda$  of a wavelength, the increased gain, due to wider spacing, more than makes up for the lower gain caused by the short, out-of-phase sections. So the gain of the antenna is at maximum.

Figure 7-c shows the extended double-Zepp with an opening in the center conductor, which is the low-impedance point. However, its impedance is still several times greater than the desirable 50 ohms. A closer match may be obtained by using a standard television transformer-balun, the type used to connect 75-ohm coaxial cable to either a 300-ohm antenna or 300-ohm television input.

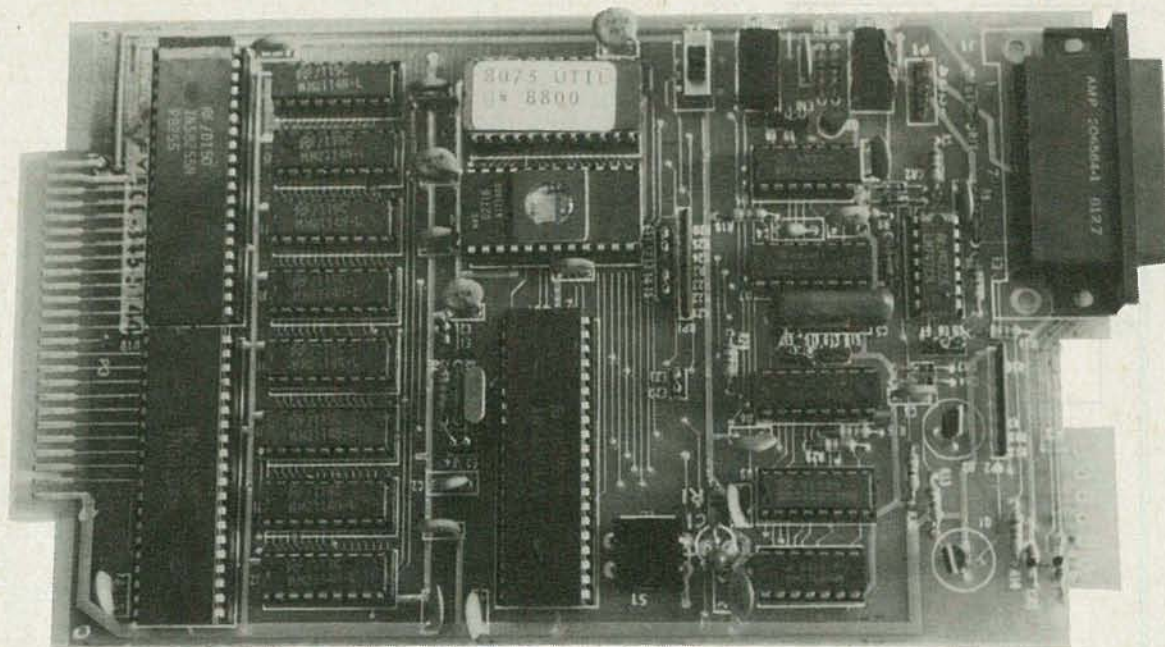
The vertical, center-fed Zepp is made of tubing, which allows the feedline to be run down its center where it cannot affect antenna performance. The tubing's diameter must be large enough to handle the coaxial cable, and the bolts that will hold it to the mast. A tubing diameter of  $3/4$ -inch is fine.

Unfortunately, while there's still much more we want to show you, that is all we have room for this month. When we continue, we will conclude our look at the extended double-Zeppelin by showing you how to calculate the length of the various sections for the frequencies of interest, and how to efficiently build that antenna.

Also, we'll look at what criteria you should consider when selecting which antenna to use, and at some installation notes.

R-E





## How to Design Microprocessor-based Projects

Make your next project "intelligent." Use a single-chip microcomputer to control it.

TOM FOX

ARE YOU FASCINATED BY MICRO-processor-controlled, semi-intelligent gadgets like robots that avoid obstacles, microwave ovens that monitor the food as it cooks, and cars that adjust the engine so that it's working as efficiently as possible? Have you come up with hundreds of control-computer applications that you'd like to try? (But you can't picture tying up your powerful personal computer for control applications?)

There is a way to design computer-controlled "smart" devices without tying up your expensive personal computer. It's easy if you use a device called a *microinterpreter*.

In this article, we'll show you how to design almost any computer-controlled device your imagination can dream up—even if you've never worked with microprocessors before! That's because you don't have to learn machine or assembly language and you don't have to invest gobs of money in expensive and complex development systems in order to design a computer-controlled machine. As long as you have some knowledge of electricity

and digital logic circuits you should be on your way. But some familiarity with the BASIC programming language, as well as binary and hexadecimal numbers will come in handy too.

To get you on your way toward designing practical, semi-intelligent machines, we will describe, in detail, the design of a such a device: a "burglar outwiter." As its name implies, the purpose of the outwiter is to fool a potential burglar into thinking someone (or something) is home when actually no one is there.

### What's a microinterpreter?

If you have ever used today's microcomputers, you probably realize that they're fairly easy to use. However, microprocessors—the brains of the microcomputer—have a notorious confusing nature about them. What is it that turns a complex, often mind boggling, microprocessor into an easy-to-use microcomputer? *Software!* Although it seems at times you can do magic with it, there is nothing magical about software. It's merely a list of detailed instructions that

tell the microprocessor exactly what to do.

That's the same thing that makes a microinterpreter easier to use than a microprocessor. A microinterpreter is basically a single IC that contains both a microprocessor and software. The software in microinterpreters is contained in ROM (*Read-Only Memory*).

Before we go any further, we should point out that microprocessors with a built in high-level language are not universally called "microinterpreters." A few semiconductor companies refer to those IC's as single-chip microcomputers. However, that name is not only clumsy, it is unnecessarily vague since many of those same companies call microprocessors that have no built in high-level language "single-chip microcomputers." National Semiconductor refers to their INS8073—the device that we'll examine in detail—as a microinterpreter. This seems to be the best name available, and we will stick to it.

You might be thinking that there must be a catch somewhere. Microinterpreters



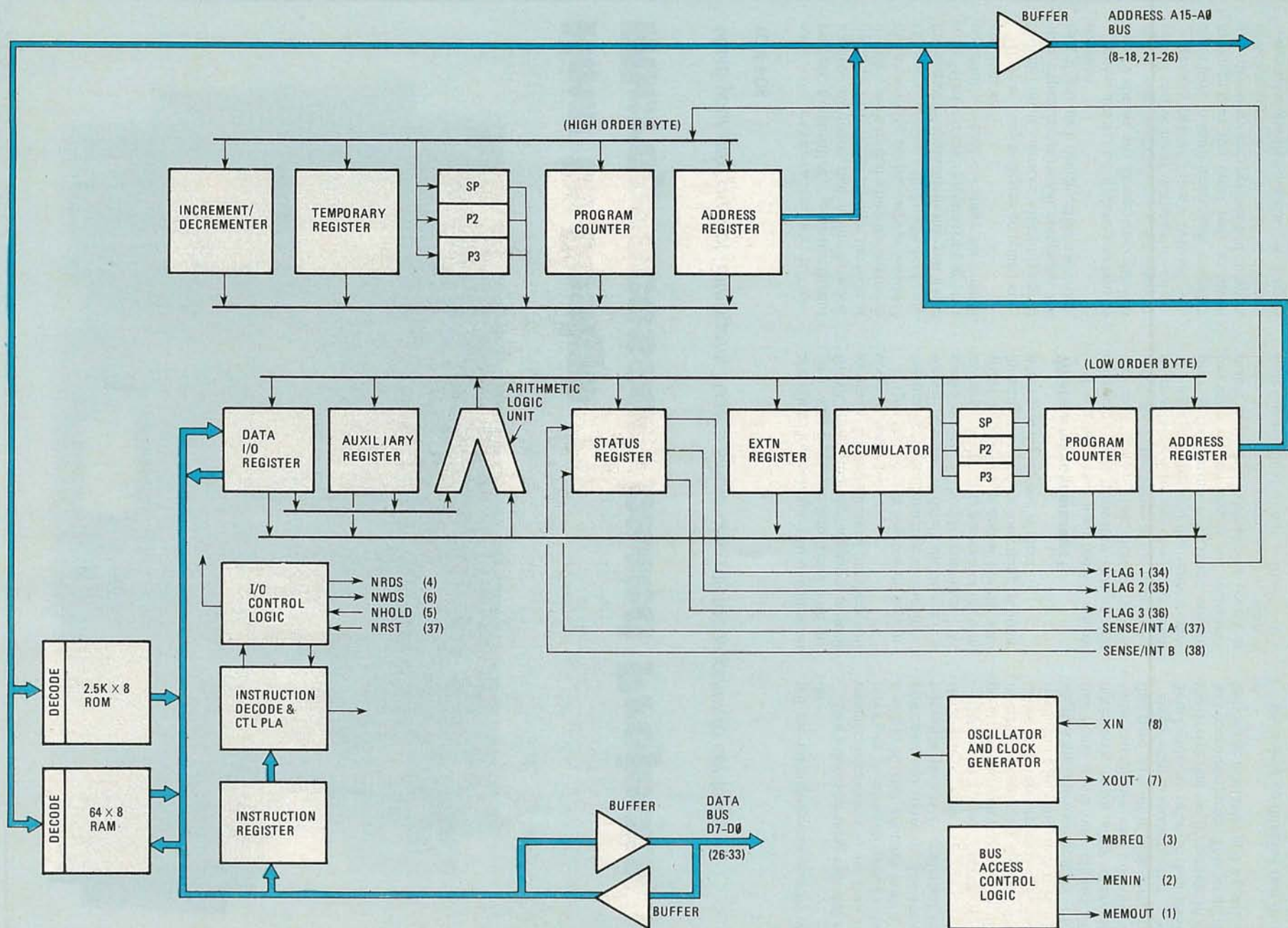


FIG. 1—BLOCK DIAGRAM OF THE INS8073 from National Semiconductor. Note that the microinterpreter contains 2.5K of ROM and 64 bytes of RAM.



seem almost too good; they must have a few bad points. Well in certain applications, they do. For example, if you're planning to design a revolutionary new personal computer that will take the peel right off the Apple, you probably should look past microinterpreters—they are relatively slow. That's because the interpreter (located in ROM) must convert the simple English-like commands into complicated machine language. And it must do that line by line as the program is running. That process takes a bit of time.

The good news is that the microprocessors in microinterpreters are so fast that for most control or monitor applications, they're much faster than the situation requires. But in those applications where a jiffy is several microseconds too long, you can program the time-consuming subroutines in assembly language. But that's enough talking in generalities—let's look at a specific device: the INS8073. Its block diagram is shown in Fig. 1.

### The INS8073 microinterpreter

As we mentioned earlier, a microinterpreter is basically a microprocessor that understands a high-level language. Such microinterpreters fall into two general categories: ones that understand Tiny BASIC and ones that understand a form of stripped-down Forth.

Forth was developed in the early 1970's for real-time control of astronomy equipment. Because of that, it is an excellent language for microinterpreters since one of their primary uses is in control applications. Forth's main advantage, compared to Tiny BASIC, is that it is faster. However, unless you have already programmed in Forth, you'll have to spend a considerable amount of time learning the language. While Forth enthusiasts might write some letters to the contrary, most people would agree that Tiny BASIC is easier to learn than Forth.

Even if you have never programmed a computer before, you'll be able to write a program that works using BASIC in less time than with just about any computer language there is. It's true that many BASIC programs might not be very elegant. Nonetheless, if the program does what we want it to, then it's just fine. After all, that's what we're after—to get the job done.

Another advantage of BASIC is that it is the most widely used language among microcomputer users. (*Apple II, Timex, Sinclair 1000, Commodore 64* and many other popular computers all have a form of BASIC built-in.) So there is an excellent chance that you are at least mildly acquainted with BASIC. And if you are, your job in learning how to design smart machines with microinterpreters is nearly half done.

In our quest for simplicity, we will examine only one microinterpreter: the

INS8073. However, you will be able to apply much of what we say to other devices. That IC, though relatively simple in architecture, has noteworthy features like 16-bit hardware multiply and divide. However, the best thing about the 8073 is that its language (National Semiconductor's Tiny BASIC) is a true gem. While we will describe that language in more detail later in this article, a few highlights will be given here.

National Semiconductor's Tiny BASIC includes DO-UNTIL commands. That type of loop control was borrowed from PASCAL and is unusual for Tiny BASICs. The ON command simplifies the handling of interrupts, which is important when designing smart machines. Another convenient instruction is DELAY, which can be used to pause program execution for a user-determined length of time. This BASIC includes a RND function, which we will use extensively when we design our burglar outwiter.

National Semiconductor's Tiny BASIC handles strings and uses the operator (which simplifies transferring data back and forth between the program and memory locations or input/output ports). There are other unusual features of a Tiny BASIC, which we'll discuss in more detail later. Actually, if it were not for its restriction to integer numbers and 26 variable names, National Semiconductor could leave out the adjective "tiny" from the language's name and hear few complaints.

The 8073 has already been chosen by designers for a number of commercial applications. For instance, it is the "brain" of RB Robot Corp's *RB5X* robot and has been used for precision measurement of conditions in oil wells and testing the feasibility of the digital design of FM tuners.

### Inside the INS8073

The INS8073 microinterpreter is an INS8072 8-bit microprocessor that contains Tiny BASIC in its 2.5K on-chip ROM. It has a 16-bit address bus and requires a single 5-volt supply voltage. Other features of interest to us include an on-board clock, TTL compatibility and 64 bytes of on-board RAM. (Yes, more RAM would be nice.)

There are some attributes of the 8070 series of microprocessor that affect us only indirectly. Those include 8 and 16-bit arithmetic, logic and stack-manipulation instructions, hardware multiply and divide, and single-instruction ASCII-to-decimal conversion. The 8072/8073's multiprocessing feature will not be used.

A feature of the IC that simplifies its use as a stand-alone, real-time controller, is the provision for automatic execution of ROM (or EPROM) at power-up or on reset. The 8073 also contains firmware that allows easy interfacing to a RS-232 terminal.

The INS8073 "understands" ASCII

(the American Standard Code for Information Interchange) so programs can be simply and quickly modified without the need for costly and awkward assemblers, text editors, debuggers and development systems—all you really require is a terminal (or a computer and terminal software) to enter a program into the microinterpreter's RAM.

Figure 1 is a block diagram that shows the architecture of the INS8070. Since this article is primarily concerned with the design of microprocessor-controlled equipment using only Tiny BASIC, we will ignore the fact that the 8073 has a machine level instruction set. However, if we are to design real working circuits, we must examine the IC's pin configuration as well as the function of each pin in some detail.

### Pin functions of the 8073

Figure 2 shows the pinout of the INS8073. While we could go through the pins, starting at pin 1 and explaining each pin's function in sequential order, we will start at the easy part first—the power supply connections.

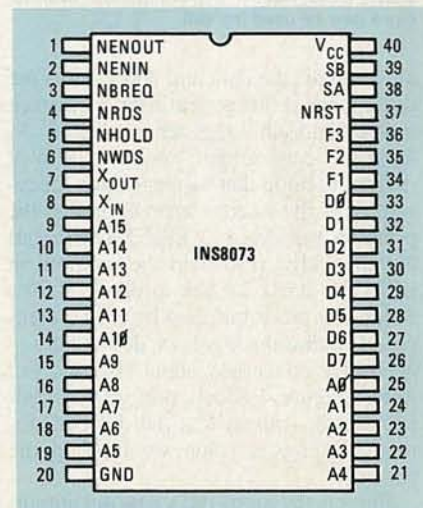


FIG. 2—PIN CONFIGURATION of the INS8073.

Pin 20 is the GROUND pin. It should always be connected to the logic power supply's ground. Pin 40 must be connected to a well-regulated voltage source (+5 volts with respect to pin 20). That voltage shouldn't vary by more than  $\pm 5\%$  (so you have a permissible range from 4.75 to 5.25 volts). The power supply should be able to supply a minimum of 250 ma.

Pins 26–33 are the connections for the bidirectional 8-bit data bus. (The most significant bit, D7, is connected to pin 26.) The data bus is three-state, which in this case means that it is basically disconnected from the circuit except for external write operations. The data bus can drive one standard TTL load or several LS-TTL loads. Pins 9–19 and 21–25 are the address-bus pins. That is also a three-state bus.



In order to use the on-board oscillator, an external crystal must be connected to pins 7 and 8. Figure 3 shows how. If you prefer to drive the IC with an external clock (it must be TTL compatible), connect the signal to pin 8. Pin 7 provides a buffered clock output with either an external or internal clock.

Pin 37 is the RESET pin. It is simple in concept, but extremely important. When it is brought low (below 1 volt) several things happen. Any in-process operations

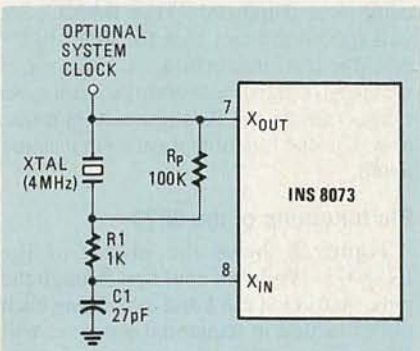


FIG. 3—A INTERNAL OSCILLATOR is contained in the INS8073. Here it is shown configured for a 4-MHz clock rate. A TTL-compatible external clock may be used instead.

are aborted, the data and address bus are disconnected, the program counter, stack pointer, and status register are cleared. As far as we're concerned, however, the most important thing that happens upon the resetting of the microinterpreter is that the program we stored in EPROM will start automatically. (Provided the program in EPROM starts at hex address 8000.) Since that pin is buffered by a TTL compatible Schmitt trigger, we do not have to be overly concerned about rise and fall times. Figure 4 shows one way of connecting this pin so that the device automatically resets when we turn on the power.

Pin 4 is the READ DATA STROBE output. It is a three-state output that goes low when the microinterpreter is reading from external memory.

Other than those times, the output is effectively disconnected from the rest of the circuit. In some circuits, a 10K pull-up resistor should be connected from +5V to pin 4. The READ DATA STROBE output is connected to some address-decoding circuits so that input data is present on the data bus only during an external read operation.

Pin 6, the WRITE DATA STROBE, is similar in function to pin 4. The primary difference is that this pin goes low during external-memory write operations. Like pin 4, a 10K pull-up resistor is sometimes connected to this pin. That output is required so that external memory (or output) devices know when the information on the data bus is valid.

Pins 38 and 39 are the INS8070's two

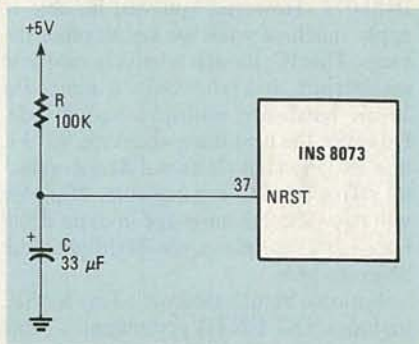


FIG. 4—POWER-ON RESET. If pin 37 of the INS8073 is connected as shown, it will automatically execute a program stored in EPROM (starting at address 8000) at power-up.

interrupt pins. Both act as interrupt-request pins. (The 8073 does not have the equivalent of a non-maskable interrupt.) In order for an interrupt to be serviced, first the input to one of those pins must go from high to low. (It is edge, not level triggered). Also, the least-significant bit

in the status register must be 1. (The status register is accessible through the NSC Tiny Basic STAT function.) Pin 38 has priority over pin 39 if both interrupts occur at roughly the same time.

In addition to acting as inputs for interrupts, both pins serve as sense inputs. Here we are mainly concerned with pin 38, which will accept serial ASCII input data. The input data must first be converted to TTL levels.

The remaining pins will be briefly described in sequential order. Don't worry if the description is a bit confusing, the functions these pins provide will not be implemented in our project. Nonetheless, some of these pins must be connected to ground or +5V for proper operation of the microinterpreter. Refer to the notes given in the description of each pin for their proper use in our project.

**Pin 1: ENABLE OUTPUT.** The 8073 controls that output as follows. 1) If pin 3 (BUS REQUEST) is low, but the 8073 is not holding it low, then pin 1 is brought to the same logic level as pin 2, the ENABLE INPUT. 2) If pin 3 is low because the 8073 is holding it low, pin 1 goes high. 3) Pin 1 is always high if pin 3 is high. Note: Pin 1 can be left unconnected.

**Pin 2: ENABLE INPUT.** 1) If this pin is high, the 8073 sets pin 1 high and is denied access to the bus. 2) If pin 2 is low and the 8073 is holding pin 3 low, pin 1 goes (or stays) high and the 8073 has access to the bus. 3) If pins 2 and 3 are both low and the 8073 is not holding pin 3 low, pin 1 is set low and the 8073 is denied access to the bus. Note: Pin 2 should be connected to ground.

**Pin 3: BUS REQUEST.** This is the bi-directional bus request input/output. It already has been referred to. Like pins 1 and 2, pin 3 is used in direct memory access (DMA) and multiprocessing applications. This pin should be connected to a +5V power supply through a 10K pull-up resistor.

**Pin 5: HOLD INPUT.** The primary application of pin 5 is to allow the use of slow memories and peripherals. It is also used for single memory cycle extension. Setting that pin low causes the 8073 to extend an external read or write cycle. Note: In the burglar outwitter that we'll describe, pin 5 is connected to +5 volts through a 10K pull-up resistor.

**Pins 34, 35 and 36: Flags 1, 2, and 3 outputs.** These flag outputs can be set by writing into the appropriate flag bits located in the status register. These pins can be left unconnected.

Next month, we'll describe, in some detail, the language of the 8073 microinterpreter—National Semiconductor's Tiny BASIC. We will also take a look at a commercially available demo/development board, which greatly simplifies designing with this exciting microinterpreter.

R-E

#### MICROINTERPRETER MANUFACTURERS

**Fairchild Camera and Instrument Corp.**  
Semiconductor Groups  
464 Ellis Street  
Mountain View, CA 94042

**Fujitsu America**  
910 Sherwood, Suite 23  
Lake Bluff, IL 60044

**Hitachi America, Ltd.**  
1800 Bering Drive  
San Jose, CA 95131

**National Semiconductor Corp.**  
2900 Semiconductor Drive  
Santa Clara, CA 95051

**NEC Electronics USA Inc.**  
Microcomputer Division  
One Natick Executive Park  
Natick, MA 01760

**OKI Semiconductor, Inc.**  
1333 Lawrence Expressway, Suite 401  
Santa Clara, CA 95051

**Panasonic**  
Matsushita Electric Corp., Industrial Division  
1 Panasonic Way  
Secaucus, NJ 07094

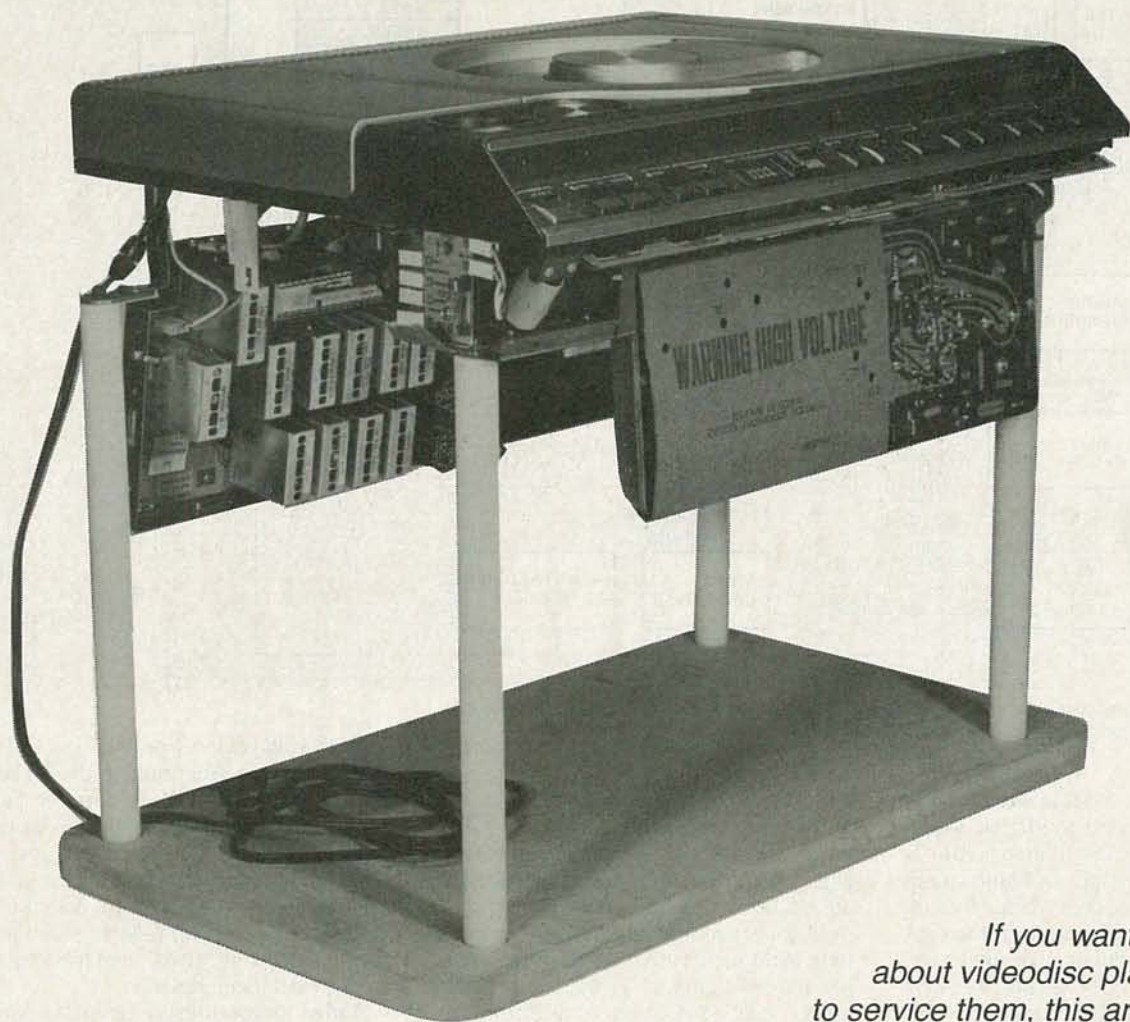
**Rockwell International**  
Microelectronic Device Division  
PO Box 3669, 3310 Miraloma Avenue  
Anaheim, CA 92803

**Texas Instruments**  
Semiconductor Group  
PO Box 225012, M/S 308  
Dallas, TX 75265

**Zilog, Inc**  
1315 Dell Ave  
Campbell, CA 95008



# Servicing Videodisc Players



JOHN LENK

*If you want to learn more about videodisc players and how to service them, this article is for you. This month we conclude our look at CED players.*

**Part 4** LET'S CONTINUE OUR look at troubleshooting typical CED player failures. For your convenience, we've reprinted Fig. 14 and Table 2 from February's issue.

**Pickup electronics.** As shown in Fig. 14, the pickup electronics (resonator, preamp, AFT) are part of the arm assembly. Generally, the preamp and AFT circuits are serviceable, but the resonator is not. The disc signal causes a 915-MHz resonator signal to be amplitude modulated and peak detected to produce the FM vid-

eo and audio carrier-signals. Those signals are preamplified from about 10 mV to about 300 mV, and applied to the demodulators. An AFT voltage is also returned to the resonator, and keeps the resonator on frequency.

If the player is operating, but you get neither video or audio, look for a 5-MHz FM signal at the input and output of the preamps, and for an AFT voltage at the resonator. If there is no 5-MHz FM at the preamp output, the problem is in the arm. If the preamp output is good, check the

wiring between the arm and the demodulators.

If you get both audio and video playback, but there is interference, try applying an external AFT signal and see if that clears the problem. The external AFT should be taken from a variable 0 to 12-volt DC supply. If you get a good signal with an external AFT, the AFT circuits are the likely culprits.

**Audio demodulator circuits.** As shown in Fig. 14, to recover disc audio-signals, the 716 and/or 905 kHz carrier is







cutting the demodulator off. Next, check for any adjustments in video. Generally, the 5.25-MHz VCO is adjustable. Likewise, the demodulator output is usually adjustable (through a video-level-adjust, or some similar control).

If you get video, but it is noisy and weak, with dropouts (but with good audio), check for excessive defect-gate pulses from the video demodulator to the comb filter.

**Comb-filter/defect-corrector circuits.** Those circuits prevent dropouts in the displayed picture that result from momentary loss of video carrier (caused by contamination or defects in the disc). That is done by recirculating the previous horizontal line of the video signal when a defect occurs. The circuits also separate the 0- to 3-MHz luminance signals from the 1.53-MHz buried-subcarrier chroma signals.

If you get no video or chroma, but audio is good, check for proper inputs. There should be both baseband video and defect-gate-pulses from the video demodulator, and a 1.53-MHz signal from the video converter. If the inputs are present, but there are no chroma and/or luminance outputs (typically about 1 volt) to the video converter, the comb-filter/defect-corrector is probably at fault (although there are buffer circuits between the corrector and converter in some players).

If you are getting both luminance and chroma, but there are excessive dropouts (but with good audio), try adjustment. Generally, there is a delayed-video-adjust or similar control. Note that that adjustment controls the amplitude of the recirculated horizontal line, not the delay time (which is provided by a fixed delay line, typically 63.6  $\mu$ s or 1H).

**Video converter circuits.** Once the buried-subcarrier-chroma signals are separated from the luminance signals by the comb filter, the 1.53-MHz chroma signals are up-converted to the standard 3.58-MHz color subcarrier. That is done in the converter by heterodyning the 1.53-MHz chroma signal with a 5.11-MHz VXCO signal. The resultant 3.58-MHz chroma is then added to the combed luminance, producing the composite video (which is applied to the RF modulator through buffers).

The 1.53-MHz signal is also used by the system control and DAXI circuits. So, before you get too far into the converter circuits, check that the 1.53-MHz signal is present, and on-frequency. You will need a 7-digit counter, and should get  $1.535625 \pm 225$  Hz (with the player in PAUSE).

If the 1.53 MHz is absent or abnormal, check for 5.11-MHz and 3.579545-MHz signals at the converter. Adjust those signals if necessary. In some players, the 3.58 MHz is adjustable, but not the 5.11-MHz. If the 1.53 MHz clock is good, but

TABLE 2—CED TROUBLESHOOTING GUIDE

Symptom	Circuits To Check
Player totally inoperative, or turntable on but no picture	Power supply and switch control
Caddy can not be loaded/unloaded	Mechanical adjustments
Player will not turn off	Mechanical adjustments
No playback	Stylus lifter/cleaner and pickup electronics
No or noisy audio	Audio demodulator
No or noisy video	Video demodulator and video converter
Picture and/or color instability	Time-base corrector
Wrong color, picture not in sync	Comb filter/defect corrected
Soundbeats in picture	NLAC circuits
No RF output	RF modulator
Picture and audio repeat, visual search inoperative or incorrect	DAXI signal circuits
Rapid access inoperative or incorrect	DAXI, system control, time display
VISUAL SEARCH OR RAPID ACCESS problems	Stylus kicker and servo control

you are having video problems, start tracing circuits as follows.

Check for luminance of about 400 mV and chroma of about 200 mV to the converter, and a composite video of about 2.5-volts peak-to-peak to the RF modulator. In most units, the composite video from the converter to the RF modulator can be adjusted by a modulation-depth-adjust or similar control. Likewise, either or both the chroma and luminance from the comb filter to the video converter can be adjusted (on most players).

**Time-base corrector circuits.** The video-converter circuits also provide time-base correction. During playback, eccentricities and warpage of the disc cause phase and frequency modulation of the recovered video signal. Such modulation can result in tint and color changes in the chroma, and horizontal instability in the luminance signals. The time-base correction circuits modulate the frequency and phase of the 5.11-MHz VXCO, and maintain the disc-to-stylus velocity (by moving the stylus forward or backward along the disc groove). High-frequency and static time-base errors in chroma are corrected by controlling the 5.11-MHz VXCO. Mid-frequency (1 to 300 Hz) correction of both luminance and chroma is done by the armstretcher circuit.

Instability or wiggles in the picture can be caused by incorrect armstretcher gain. So the first step is to try correcting horizontal instability problems by setting the armstretcher gain according to the service literature. If that does not cure the problem, make sure that there is an armstretcher error-signal between the converter and armstretcher transducer on the pickup arm. If not, start at the converter and trace the signal to the transducer (through a series of drivers and amplifiers).

If you are getting an error signal to the transducer, see if the signal varies when the disc speed varies. Monitor the voltage at the transducer (about 2 to 10 volts), and slow the disc down by touching the edge of the disc with your finger. (Touch only

the edge and *do not* press hard!) The voltage should change. You can also check the armstretcher-transducer function by confirming that the stylus moves (about 0.01 inch) when you touch the disc.

Before you tear into the time-base circuits, trying to locate a wrong-color, changing-tint, or picture-not-in-sync fault, make sure that the turntable is locked to the line frequency. You can make a quick check of turntable speed by inserting a test disc and operating the player under a fluorescent light. The inner diameter of most CED test discs has black and white wedges on the label. If the turntable is turning at 450 rpm, the strobe effect causes the white wedge to appear at the same point with each flash of the light, producing a stable image. If the white wedges revolve, the turntable is not in sync. The most common causes of that problem are mechanical. With power off, and disc removed, spin the turntable by hand (gently). If you hear grinding or dragging, or if the turntable does not revolve easily, check for dry bearings, or other mechanical binding (such as bent motor-magnet poles).

**RF-modulator circuits.** The RF-modulator circuits are usually easy to troubleshoot (if you have audio/video inputs, but no RF output, the problem is in the RF modulator). Of course, you must make sure the antenna switch is good, and that the set you are watching is tuned to the correct channel. However, the matter of adjusting the RF-modulator circuits is not that simple. The Channel 3/4 tank-circuits are external from the modulator IC, and must be adjusted separately. The same is true for any sound trap and band-pass filter-circuits. Always use the recommended procedures for those adjustments. For example, you should recheck tank-circuit frequencies after an RF-modulator IC has been replaced, but it is generally not necessary to adjust the trap and filter circuits (unless you have replaced parts in the traps and filters). Keep in mind that those trap and filter circuits prevent undesired player signals from passing to



# Professional Books That Help You Get Ahead—And Stay Ahead!

## Join the **Electronics and Control Engineers' Book Club**® and...

- Keep up with current technology
- Sharpen your professional skills
- Be ready for new career opportunities
- Boost your earning power

**THE MCGRAW-HILL COMPUTER HANDBOOK: Applications, Concepts, Hardware, Software.** Edited by H. Helms. 992 pp., 475 illus. Everything you need to know about today's computer science and engineering is here in this massive treasure trove of information. Covers everything from Boolean algebra to hardware selection techniques to artificial intelligence. 279/721 Pub. Pr., \$84.50 Club Pr., \$49.95

**TRANSDUCERS: Theory and Applications.** By J.A. Allocca and A. Stuart. 497 pp., 328 illus. Thoroughly describes and illustrates the theory and operation of all important transducers used in industrial, communication, medical, and other applications. Photographs, drawings, and diagrams are included throughout this outstanding introduction to a key element in electronic instrumentation. 582997-5 Pub. Pr., \$29.95 Club Pr., \$24.95

**ANTENNA ENGINEERING HANDBOOK, 2/e.** Edited by R. C. Johnson and H. Jasik, with contributions by 57 recognized authorities. 1,408 pp., 946 illus. This widely acclaimed Handbook gives you the guidance you need to solve problems in antenna design and application. It provides detailed information on physical fundamentals, patterns, structures, and design techniques for practical modern antennas. 322/910 Pub. Pr., \$95.00 Club Pr., \$62.50

**INTRODUCTION TO RADAR SYSTEMS.** By M. I. Skolnik. 2nd Ed., 698 pp., 244 illus. Covering every radar fundamental and all important changes, this EE text exposes you fully to the systems themselves—and to their applications! Topics include radar equation, CW and frequency-modulated radar, MTI, pulse-doppler, tracking radar, receivers, displays, duplexers, noise, and more. 579/091 Pub. Pr., \$43.00 Club Pr., \$32.25

**MICROPROCESSOR APPLICATIONS HANDBOOK.** Editor-in-Chief, D. F. Stout. 472 pp., 284 illus. At last—a reference guide to microprocessor applications to help you make your systems timely, versatile, and cost-effective. 617/988 Pub. Pr., \$41.95 Club Pr., \$31.45

**MICROPROCESSOR AND MICRO-COMPUTER DATA DIGEST.** By W. H. Buchsbaum and G. Weissenberg. 336 pp., 93 block diagrams, 106 pin configurations. If you work with electronic devices that use microprocessor or microcomputer integrated circuits, this much-needed book contains all the detailed technical data for every microprocessor IC that is currently listed as a "standard," off-the-shelf item. 582835-9 Pub. Pr., \$29.95 Club Pr., \$22.50

**HANDBOOK OF ELECTRIC POWER CALCULATIONS.** Edited by A. Seidman, H. Mahrous and T. G. Hicks. 448 pp., 300 illus. Here are 285 tested and proven procedures for handling the electric power problems most frequently encountered in actual practice. You'll find ingenious, time-saving ways to calculate fuel costs, motor efficiency, and power output. 560/617 Pub. Pr., \$41.50 Club Pr., \$31.50



New members!  
Any one of these great professional books for only **\$289** as a premium with your 1st selection!

Spectacular values up to **\$95.00**

**HANDBOOK OF PRACTICAL ELECTRICAL DESIGN.** By J. F. McPartland. 416 pp., 300 illus. This volume provides a step-by-step explanation of designing electrical systems for industrial, commercial, and residential applications. Packed with helpful tips for saving time and complying with code requirements from branch circuits to wiring size. 456/95X Pub. Pr., \$40.95 Club Pr., \$27.50

**DIGITAL LOGIC DESIGN.** By B. Holdsworth. 338 pp., 192 illus. All of the recent advances in digital design techniques are presented here in depth. It's both a text covering basic concepts and a practical guide to design techniques for combinational, clock-driven, and event-driven circuits. 582852-9 Pub. Pr., \$39.95 Club Pr., \$27.50

**ELECTRONIC COMMUNICATIONS SYSTEMS.** By W. D. Stanley. 566 pp., illus. Emphasizing the signal-processing functions of modulation and demodulation operation, this book presents the essentials of electronic communications in a logical, step-by-step sequence. 582834-0 Pub. Pr., \$25.95 Club Pr., \$20.95

**MODERN ELECTRONIC CIRCUITS REFERENCE MANUAL.** By J. Markus. 1,264 pp., 3,666 circuit diagrams. Complete with values of components and suggestions for revisions—plus the original source of each circuit in case you want additional performance or construction details. 404/461 Pub. Pr., \$76.95 Club Pr., \$57.95

**ELECTRONICS ENGINEERS' HANDBOOK, 2/e.** Edited by D. G. Fink & D. Christiansen. 2,272 pp., 2,189 illus. This updated and enlarged edition covers all the latest knowledge in the field, including new advances in integrated circuits, pulsed and logic circuits, laser technology, telecommunications, and much more. 209/812 Pub. Pr., \$83.50 Club Pr., \$63.95

**DIGITAL CIRCUITS AND MICRO-PROCESSORS.** By H. Taub. 608 pp., heavily illus. This fast-paced, carefully written guide gives you thorough explanations of all the basic principles of digital systems and logic design—plus a solid introduction to microprocessors and microprocessor-based designs. 629/455 Pub. Pr., \$37.00 Club Pr., \$26.50

**RADIO HANDBOOK.** By W. Orr. 22nd Ed., 1,136 pp., more than 1,300 illus. The latest edition of what is universally regarded as the best liked and most useful communications reference in the industry. It's a handy "course" in communications, a fact-packed reference, and a how-to guide—all in a single book! 582442-6 Pub. Pr., \$21.95 Club Pr., \$17.95

**INTRODUCTION TO MICROWAVE ELECTRONICS.** By T.C. Edwards. 76 pp., illus., softbound. Eliminating unnecessary theory and mathematics, this book provides you with a lucid overview of microwave engineering and the devices and circuits being used today. Helpful even if you have only limited experience with microwave electronics. 583030-2 Pub. Pr., \$14.95 Club Pr., \$10.95

**PRACTICAL DIGITAL DESIGN USING ICs, 2/e.** By J. D. Greenfield. 717 pp., illus. This revised and expanded Second Edition of a popular guide shows how to get the most out of a wide range of popular integrated circuits. What's more, it contains the specialized knowledge today's designer needs to interface ICs with microprocessors. 582853-7 Pub. Pr., \$25.95 Club Pr., \$19.95

**ENGINEERING NETWORK ANALYSIS** By G. H. Hostetter. 912 pp., 372 illus. Emphasizing real-world applications, this comprehensive book covers the full range of analytical techniques for everything from source-resistor networks to switched networks. Brings you fully up to date on all the latest developments. 582966-5 Pub. Pr., \$35.50 Club Pr., \$27.95

**STANDARD HANDBOOK FOR ELECTRICAL ENGINEERS, 11/e.** By D. G. Fink and H. Beaty. 2,448 pp., 1,414 illus. Today's most widely used source of electrical engineering information and data serves you as no other single work when you need detailed, timely, and reliable facts. 209/74X Pub. Pr., \$79.95 Club Pr., \$62.95



**MICROWAVE SEMICONDUCTOR CIRCUIT DESIGN.** By W.A. Davis. 416 pp., heavily illus. Provides in-depth coverage on microwave circuit analysis, passive microwave components, impedance transformers and circuits, broadband directional couplers, mechanical realization of selected transmission lines, CAD, CAM and CAT, characteristics of amplifiers and oscillators, noise, statistical thermodynamics and PN junction theory.  
58044-2 Pub. Pr., \$47.50 Club Pr., \$35.50

**INTRODUCTION TO RADIO FREQUENCY DESIGN.** By W. H. Hayward. 383 pp., illus. This comprehensive volume prepares you to actually design HF, VHF, and UHF equipment and enables you to follow much of the current literature. Structured equation sets make it easy to write programs for small computers or calculators.  
582748-4 Pub. Pr., \$29.95 Club Pr., \$24.75

**McGRAW-HILL ENCYCLOPEDIA OF ELECTRONICS AND COMPUTERS.** By S. P. Parker, Editor-in-Chief. 960 pp., 1,266 illus., outsized 8 1/2 x 11 format. It's a single-volume library that covers the entire world of electronics from Edison's pioneering work in electricity right up to optical fiber communications, control systems, lasers, radar, TV receivers, artificial intelligence, and computer storage technology.  
454/876 Pub. Pr., \$67.50 Club Pr., \$41.50

**ELECTRONICS ENGINEERING FOR PROFESSIONAL ENGINEERS' EXAMINATIONS.** By C. R. Hafer. 336 pp., more than 200 illus. Actually two books in one—a quick preparation manual to help you pass your P.E. exams on the first try and a rich source of practical electronics engineering information and know-how.  
254/303 Pub. Pr., \$32.50 Club Pr., \$25.50

**McGRAW-HILL CONCISE ENCYCLOPEDIA OF SCIENCE AND TECHNOLOGY.** Editor-in-Chief S. P. Parker and the Staff of the McGraw-Hill Encyclopedia of Science and Technology. 2,065 pp., 1,600 illus. This volume serves every need for understanding today's science and technology. Written by over 3,000 of the world's topmost experts, including 19 Nobel Prize winners, it covers 75 disciplines from Acoustics to Zoology. A 30,000-entry index and cross-references throughout make it a snap to find the information you're looking for.  
454/825 Pub. Pr., \$95.00 Club Pr., \$66.50

**COMPUTER METHODS FOR CIRCUIT ANALYSIS AND DESIGN.** By J. Vlach and K. Singhal. 656 pp., 148 illus. Computational methods have become an integral part of circuit analysis and design. And a solid understanding of the basics of computer-aided design is a must for engineers who want to achieve their career objectives. This self-teaching book provides that know-how in a logical, easy-to-follow presentation.  
582855-3 Pub. Pr., \$42.50 Club Pr., \$33.95

**ELECTRONIC NOISE.** By A. Ambrózy. 281 pp., illus. The data you'll find here will help you understand and cope with noise in all types of circuits. Covers noise parameters of linear networks, measurement techniques, effects of nonlinear transfer characteristics, and more.  
011/249 Pub. Pr., \$39.95 Club Pr., \$30.75

Be sure to consider these important titles as well!

**LARGE SCALE INTEGRATION: Devices, Circuits, and Systems.** By M. J. Howes & D. V. Morgan  
582851-0 Pub. Pr., \$35.95 Club Pr., \$29.95

**MICROWAVE SEMICONDUCTOR ENGINEERING.** By J. F. White.  
582553-8 Pub. Pr., \$32.50 Club Pr., \$25.95

**MICROPROCESSOR SUPPORT CHIPS: Theory, Design, and Applications.** By T. J. Byers.  
095/183 Pub. Pr., \$39.50 Club Pr., \$31.00

**ENGINEERING FORMULAS, 4/e.** By K. Gieck.  
232/199 Pub. Pr., \$16.95 Club Pr., \$13.50

**ELECTRONICS CIRCUITS NOTEBOOK.** Edited by S. Weber.  
192/448 Pub. Pr., \$35.50 Club Pr., \$27.50

**ANALYSIS AND DESIGN OF DIGITAL INTEGRATED CIRCUITS.** By D. A. Hodges and H. G. Jackson.  
291/535 Pub. Pr., \$31.00 Club Pr., \$23.95

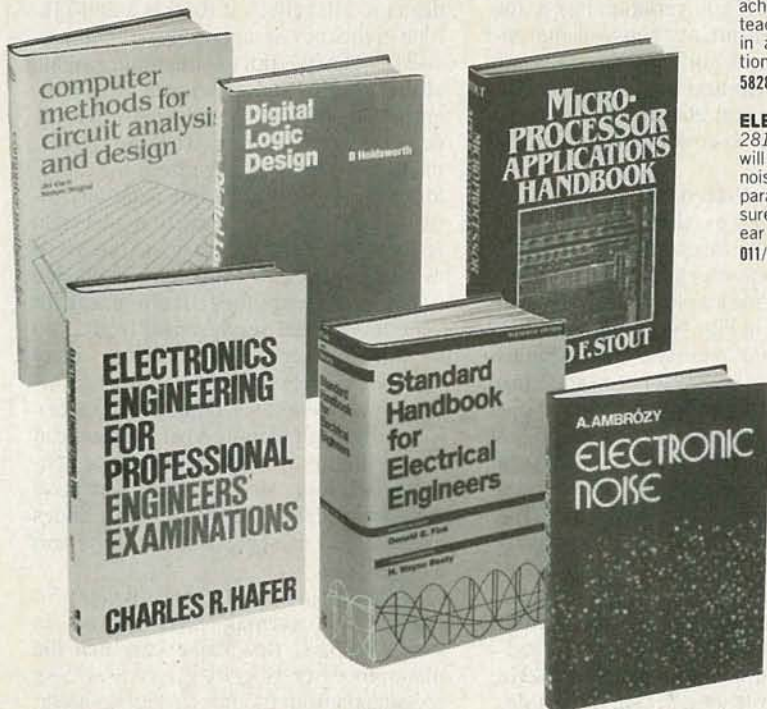
**HANDBOOK OF OPERATIONAL AMPLIFIER CIRCUIT DESIGN.** By D. E. Stout & M. Kaufman.  
617/97X Pub. Pr., \$39.50 Club Pr., \$29.00

**ENGINEERING MATHEMATICS HANDBOOK, 2/e.** By J. J. Tuma.  
654/298 Pub. Pr., \$34.50 Club Pr., \$26.95

**DIGITAL COMMUNICATIONS.** By J. Proakis.  
509/271 Pub. Pr., \$37.50 Club Pr., \$29.50

**SIGNALS AND SYSTEMS.** By A. Oppenheim, A. Willsky, and I. Young.  
582674-7 Pub. Pr., \$32.50 Club Pr., \$25.95

**MAINTAINING AND REPAIRING VIDEOCASSETTE RECORDERS** By R. L. Goodman.  
582895-2 Pub. Pr., \$14.95 Club Pr., \$12.50



## Why YOU should join now!

■ **BEST AND NEWEST BOOKS IN YOUR FIELD** — Books are selected from a wide range of publishers by expert editors and consultants to give you continuing access to the best and latest books in your field.

■ **BIG SAVINGS** — Build your library and save money too! Savings ranging up to 30% or more off publishers' list prices — usually 20% to 25%.

**BONUS BOOKS**—You will immediately begin to participate in our Bonus Book Plan that allows you savings up to 70% off the publishers' prices of many professional and general interest books!

■ **CONVENIENCE** — 12-14 times a year (about once every 3-4 weeks) you receive the Club Bulletin FREE. It fully describes the Main Selection and Alternate Selections. A dated Reply Card is included. If you want the Main Selection, you simply do nothing — it will be shipped automatically. If you want an Alternate Selection — or no book at all — you simply indicate it on the Reply Card and return it by the date specified. You will have at least 10 days to decide. If, because of late delivery of the Bulletin you receive a Main Selection you do not want, you may return it for credit at the Club's expense.

As a Club member you agree only to the purchase of three books (including your first selection) during your first year of membership. Membership may be discontinued by either you or the Club at any time after you have purchased the first selection plus two additional books.

**Other McGraw-Hill Book Clubs:**  
Architects' Book Club • Byte Book Club • Chemical Engineers' Book Club  
• Civil Engineers' Book Club • Mechanical Engineers' Book Club

For more information, write to:  
McGraw-Hill Book Clubs, P.O. Box 582, Hightstown, New Jersey 08520

### MAIL THIS COUPON TODAY

**McGraw-Hill Book Clubs**  
**Electronics and Control Engineers'**  
**Book Club®**  
P.O. Box 582, Hightstown, New Jersey 08520

Please enroll me as a member and send me the two books indicated, billing me for the \$2.89 premium and my first selection at the discounted member's price, plus local tax, shipping, and handling charges. I agree to purchase a minimum of two additional books during my first year of membership as outlined under the Club plan described in this ad. A shipping and handling charge is added to all shipments.

Write Code No. of  
\$2.89 selection here

Write Code No. of  
first selection here



Signature \_\_\_\_\_

Name \_\_\_\_\_

Address/Apt. # \_\_\_\_\_

City \_\_\_\_\_

State \_\_\_\_\_ Zip \_\_\_\_\_

This order subject to acceptance by McGraw-Hill. All prices subject to change without notice. Offer good only to new members.

E33719



the TV set (and to the antenna!).

**Time-indication circuits.** Elapsed program-time, shown on an LED time display, is developed when the microprocessor decodes the DAXI signal, and produces a corresponding binary code. A decoder/driver decodes the binary information and activates the LED's. During RAPID ACCESS (when the stylus is lifted), there is no DAXI. Instead, the microprocessor receives pulses from an optical sensor that produces an output as the arm moves rapidly across the disc.

If there is no (or an incorrect) time display, make sure that you are getting good DAXI signals to the microprocessor. If the time display is incorrect only using RAPID ACCESS, the problem is likely in the optical sensor.

**DAXI-signal circuits.** Operation of the entire player is controlled by the microprocessor, which decodes the DAXI signal to determine the video field being played and the elapsed time. Locked grooves are also determined by checking the DAXI code for a repeating or decreasing DAXI number (indicating a "skip back"). The microprocessor causes the stylus to exit locked grooves by activating stylus-kicker circuits. So if you are troubleshooting a "locked groove" problem (audio/video repeats) and either RAPID ACCESS or VISUAL SEARCH are inoperative, start by checking for good DAXI signals.

Typically, the control signals from the microprocessor to the DAXI IC are 16ms and about 400 $\mu$ s in width. Wider DAXI control (DCNT) signals (say 800 $\mu$ s), usually indicates DAXI problems (most likely in the DAXI IC or VDO—vertical detail—IC, or possibly in the circuits between the comb-filter/defect-corrector and the DAXI IC). The DAXI-status (DSTAT) signals from the DAXI IC to the microprocessor are also at 16ms, and the width is not critical. Again, the problem can be in the DAXI IC and/or microprocessor.

**Stylus-kicker circuits.** Those circuits are used to move the stylus two grooves on the disc (either forward or reverse), and occur during a locked groove condition and in VISUAL SEARCH. When the microprocessor senses a locked groove condition (the DAXI numbers keep repeating or decreasing), the microprocessor applies kicker pulses through a ramp generator (Fig. 16) and amplifier circuits to the stylus-kicker coils on the arm to move the stylus forward out of the locked groove. The direction of the pulse (and corresponding stylus movement) is determined by direction-switch-circuits. When the microprocessor receives VISUAL-SEARCH commands from the front panel controls (FORWARD or REVERSE), the microprocessor produces a series of stylus-kick-pulses that are timed to maintain two grooves of movement with each kick.

Failure in the kicker circuits usually shows up as a failure to escape from a locked groove, or no VISUAL SEARCH, or VISUAL SEARCH in one direction only. To make a quick check of both the kicker and VISUAL SEARCH circuits, look for pulses at the kicker coils on the arm while pressing the VISUAL SEARCH buttons. If you get no pulses, make sure that the microprocessor is getting VISUAL-SEARCH commands, and then trace the signals from the microprocessor to the kicker coils.

If you get pulses at the coils, but the pulses have no overshoot, the kicker coils are possibly open. (On most players, you must replace the entire arm if the kicker coils are bad.) If you get no pulses at the coils, trace the circuits between the microprocessor and coils. If the coils are operative, but the arm does not move during VISUAL SEARCH, the problem is probably with the servo control rather than the kicker.

**Servo control-circuits.** The servo control-system moves the arm (through gears) across the disc (either forward or reverse) in response to signals applied through the error-amplifier/servo-control circuits shown in Fig. 14. In normal PLAY, the servo motor receives drive signals generated by stylus sensors (on the arm) and a servo detector. The servo drive-signal is generated by sensing the position of the stylus relative to the center of the arm assembly. A 260-kHz signal from the detector is applied to two stylus sensors. The signal is inverted by one sensor, generating a 180-degree out-of-phase signal. As the stylus moves closer to one sensor, the stylus picks up the 260-kHz signal from that sensor. The servo signal from the stylus is compared to the original 260-kHz signal to generate an error signal that decreases as the stylus moves closer to the inside sensor, and vice versa. The error signal is amplified to drive the servo and, thus, control arm movement.

During either VISUAL SEARCH or RAPID ACCESS, the error signal is overridden or inhibited by the microprocessor, (which applies continuous drive signals to the servo motor). In VISUAL SEARCH, the microprocessor produces the servo drive-signals to move the arm forward or reverse, and also produces kicker pulses to move the stylus (two grooves per kick) as described. In RAPID ACCESS, the microprocessor produces servo drive-signals that move the arm rapidly, and also removes the stylus-lifter voltage, allowing the lifter spring to raise the stylus. That prevents damage to the stylus and disc during rapid movement. (Also note that the stylus lifts automatically when power is removed, and during load/unload by a switch that is actuated when the spine is not in the normal play position.)

If the arm does not move during PLAY, operate the VISUAL-SEARCH-FORWARD controls and monitor the voltage to the

servo motor. Typically, one motor lead will be grounded while the other lead is "hot" (about 20 volts). Then operate the VISUAL-SEARCH-REVERSE control. The previously grounded motor lead should now be at 20 volts, while the previously hot lead should be ground. If the voltages are present, but the motor does not operate, you have found the problem. If the voltages are absent or abnormal, trace the voltage back to the microprocessor (through the error amplifier/servo control-circuits).

If the arm moves during VISUAL SEARCH, but not during PLAY, the problem is likely in the stylus sensors and/or servo detector. First check if there is a 260-kHz (that frequency is approximate; the precise frequency is not too important) signal at the detector and/or sensors. The presence of a 260-kHz signal shows that the detector oscillator is working. Next, monitor the error voltage from the detector to the servo drive while manually rotating the main servo reduction gear (that is usually the largest gear in the servo assembly). The error signal should change (in phase and amplitude). If not, check for bent or damaged servo-sensor leads, and for incorrect servo adjustments. Usually there are at least two servo adjustments (servo position and detector balance). Carefully straightening a bent sensor lead may restore proper operation. If the sensor leads look fine, suspect defective varactor diodes in the sensor. If the diodes are bad, you must replace the entire arm assembly.

If the arm moves during VISUAL SEARCH and normal PLAY, but not in RAPID ACCESS, first make sure that the microprocessor is getting RAPID-ACCESS commands from the front-panel controls. Then trace signals from the microprocessor to the servo motor and stylus lifter. That is essentially the same system that's used during PLAY and VISUAL SEARCH. It is the input to the error-amplifier/servo-control circuits that is different for RAPID ACCESS.

**Mechanical problems.** As in the case of LV, use the manufacturer's procedures for all mechanical adjustments and disassembly/reassembly. Generally, the service manuals are very good in that respect. Also, unless there has been excessive wear or outright physical damage, CED players are usually more rugged than LV ones, and do not require extensive mechanical adjustment. One exception to that is when you must replace major mechanical components, such as the arm assembly, servo-gear mechanism, or caddy-door load/unload components.

Finally, we have covered only the highlights of videodisc service here. If the procedures described do not cure the fault, you may have other, possibly serious problems and you must consult the manufacturer's literature. **R-E**



# DESIGNING WITH DIGITAL IC'S

Here's a look at CMOS, one of the most popular of the logic families, and the special handling that CMOS devices require.

JOSEPH J. CARR

**Part 2** LAST TIME WE DISCUSSED several of the popular digital IC logic families. This time, we will continue our discussion of logic families by looking at the complementary metal oxide semiconductor (CMOS) logic family.

Before we get into the details on the internal workings of CMOS devices, we should mention some of the benefits of the CMOS logic family. CMOS circuits are very forgiving with regards to noise, they use extremely small amounts of power when they're in standby, and their power-supply requirements are very uncritical. That makes them very easy to work and experiment with.

## MOSFET transistors

The transistors used in CMOS devices are Metal Oxide Semiconductor Field Effect Transistors (MOSFET); those are also sometimes called Insulated-Gate Field Effect Transistors (IGFET). Those transistors differ markedly from the NPN and PNP bipolar transistors used in other IC digital logic families.

There are two basic types of MOSFET—depletion mode and enhancement mode—each of which are found in two different polarities, N-channel and P-channel. All of those terms are explained below.

Figure 1 shows a cross section of a basic depletion-mode MOSFET. There are three electrodes on that device: drain, source, and gate. The drain and source are ohmic contacts at either end of a "channel" of semiconductor material. In this example, an N-type semiconductor is

used, so the device is an N-channel depletion-mode MOSFET. The gate is a metalized contact that is separated from the channel by a thin layer of insulating oxide material (hence we can see where the names "insulated gate" and "metal oxide semiconductor" come from).

A depletion-mode transistor is a normally-on device. That is, when the voltage applied to the gate is zero, current will flow in the channel at a level determined by the drain-source applied voltage and the channel resistance.

Applying a potential to the gate (of correct polarity, depending upon channel material) causes charge carriers to be driven away from the gate region leaving a depletion zone that is essentially free of carriers. Thus, the material in the depletion zone becomes a high resistance insulator. The depletion zone is created by the effect of the electrical field generated by the gate voltage. Changing the size of the depletion zone effectively changes the size (thus the DC resistance) of the charge-carrier channel. We find, therefore, that the resistance between drain and source varies with the voltage applied to the gate.

Figure 2 shows an enhancement-mode MOSFET (N-channel) under two conditions. In Fig. 2-a the gate voltage is zero. Since that type of MOSFET is normally off, the enhancement (conductive) zone is minimized, and the drain-source channel resistance is maximum. In Fig. 2-b, on the other hand, a voltage is applied to the insulated gate, which creates an electric field within the channel. That voltage draws charge carriers toward the gate,

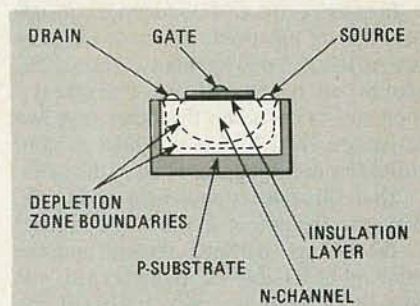


FIG. 1—CROSS SECTION of a basic N-channel, depletion-mode MOSFET transistor. The gate is insulated from the channel by a thin layer of oxide material.

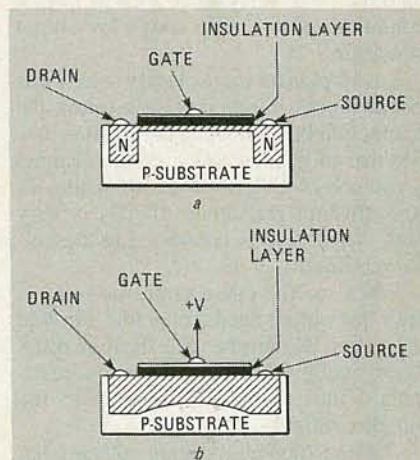


FIG. 2—AN ENHANCEMENT-MODE MOSFET transistor. When the gate voltage is zero, as shown in a, the drain-to-source resistance is at a maximum. When a voltage is applied to the gate, as shown in b, charge carriers are drawn toward the gate, decreasing the drain-to-source resistance.

thereby decreasing the drain-source resistance (i.e. the channel is "enhanced").

In both types of MOSFET's, the channel resistance is varied by the voltage applied to the gate. In an analog circuit, that resistance may vary continuously between limits according to the applied signal voltage. Digital circuits, however, have only two signal levels (high and low), so the MOSFET's used in CMOS devices tend to



be all the way on, or all the way off.

The usual schematic symbols for depletion-mode and enhancement-mode transistors are shown in Figs. 3a and 3b, respectively.

### CMOS devices

The term "complementary" in CMOS implies that those digital IC logic devices contain complementary MOSFET transistors (i.e. one or more transistor pairs consisting of an N-channel and a P-channel device). Figure 4 shows a typical CMOS inverter, which consists of one N-channel and one P-channel MOSFET. The drain-source paths (channels) are connected in series, while the gates are in parallel.

In essence, the CMOS inverter consists of a pair of electronic resistors in series across the DC power supply. Those "resistors" are configured such that one is a high resistance when the other is a low resistance; which one is which is controlled by the voltage applied to the gate.

That situation is shown in Fig. 5. Note that the output signal of the inverter is the voltage between ground and the junction of R1 and R2. In each case, one resistance will be very high (in the megohm range) and one is very low (about 200 ohms). Thus, the output will be essentially +V or -V. Since most CMOS devices use positive logic designations, +V represents a high output condition and -V represents a low output condition.

Let's look a bit more closely at how this circuit works. Since it is an inverter, the output will be high when the input is low. For that to happen, R1 (i.e. the channel resistance of Q1) is very low, while R2 (the channel resistance of Q2) is very high. Thus, +V is connected to the output terminal.

When, on the other hand, the input is high, the output needs to be low. For that to happen, R1 must become the high resistance, while R2 becomes the low resistance. Thus, -V is connected to the output terminal.

The transition point (input voltage) that causes either high-to-low or low-to-high output changes is the mid-point voltage between -V and +V. In many practical situations, we find that the absolute values of -V and +V are equal. There is no reason, however, why we can't use unequal voltages for -V and +V. In fact, in many cases CMOS devices are operated from TTL-style power supplies and thus will use +5 volts DC for +V and 0 volts DC for -V. Some designers set +V to zero and then use a negative voltage for -V. The normal range of  $\pm V$  is 0 to  $\pm 15$  volts DC with some operating to  $\pm 18$  volts DC.

### CMOS part numbers

The generic type numbers for CMOS

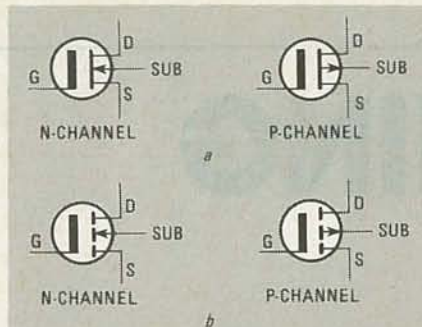


FIG. 3—STANDARD SCHEMATIC SYMBOLS for depletion-mode MOSFET transistors are shown in a, enhancement-mode MOSFET transistors in b.

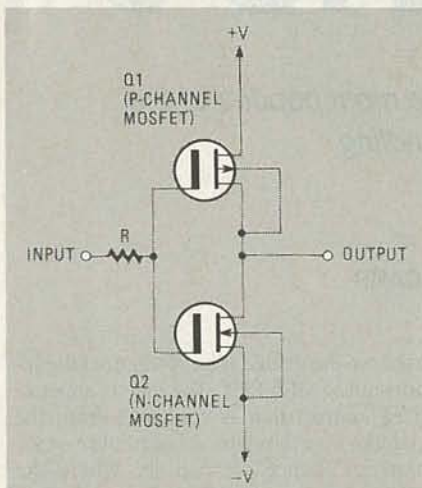


FIG. 4—THIS TYPICAL CMOS INVERTER consists of one N-channel and one P-channel MOSFET transistor.

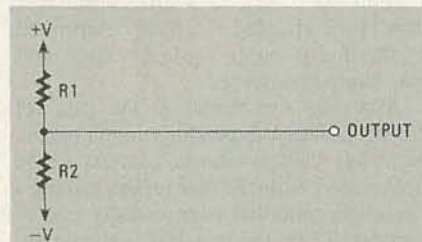


FIG. 5—IN EFFECT, a CMOS inverter acts like a pair of resistors wired across a DC power source. The output is taken from the junction of the transistors. The relative values of the resistors depends on whether the input to the inverter is high or low.

digital logic integrated circuits are in either the 4000 range (i.e. 4049) or 4500 range (i.e. 4528). There are also special devices that carry unique house-type numbers.

There are two general series of CMOS devices, designated "A" and "B." The A series are the original type of CMOS and may or may not carry an "A" suffix to the type numbers. Thus, both 4001 and 4001A can be assumed to be series-A devices. All series-B devices carry a "B" suffix (i.e. 4001B).

The principal difference between A- and B-series devices is that B-series

CMOS IC's contain internal zener diodes that shunt high voltage static charges around delicate gate insulators. That reduces (but does not eliminate) the potential for damage from electrostatic discharge (we'll talk more about that problem in a moment).

There are also other differences. The B-series devices generally have higher operating frequencies, faster rise-times, and greater drive capability than A-series devices.

### Electrostatic discharge damage

All semiconductor devices potentially can be damaged by high voltage static charges; CMOS devices and other MOSFET semiconductors seem particularly sensitive to electrostatic discharge (ESD) damage.

Static electricity is created by the "triboelectric effect," that is, by creating excess electrons on the surface of an insulating material by mechanical rubbing. Because of that, static electricity can be generated without conscious effort. Table 1 shows typical voltages generated by ordinary activities. With 35 kilovolts generated by walking across a carpet, it's no wonder that you get a shock when you grab the doorknob!

Note that working at the bench on a dry day can generate 6000 volts of static. Let's compare that figure with the typical voltages that will damage electronic devices. Table 2 shows those values. Note that many of these devices can be severely damaged by potentials that are generated even under "muggy" (70% relative humidity) conditions.

Figure 6 shows the anatomy of a CMOS failure. Figure 6-a shows an enlarged drawing of a MOSFET-gate region. When a static charge hits, it punches a hole in the insulating oxide (Fig. 6-b). Normally, the failure is immediate and catastrophic. Metal from the gate electrode and semiconductor material from the channel fill the void and short the gate to the channel.

At other times, the failure is delayed, often for many months or even years. In those cases, the metallization of the void is not initially sufficient to short out the device. As time goes on, however, metallic ions and semiconductor material will migrate into the void. When that process goes on long enough, a short will develop and the IC or MOSFET will be destroyed. To the user, the result is what appears to be merely a premature failure of the IC; the real culprit, a static discharge, is rarely blamed.

### ESD protection

Damage from static electricity can be controlled or even eliminated through the use of proper strategy. The aim of most techniques is to keep all pins of the device at the same potential. If excessive voltages cannot develop between pins of the



TABLE 1

ACTIVITY	STATIC VOLTAGE GENERATED (V)	
	15% Relative Humidity	70% Relative Humidity
Walking Across Carpet	35,000	1,500
Handling PVC Bag	20,000	1,200
Sitting In Polyurethane Chair	18,000	1,500
Working at Workbench	6,500	150

TABLE 2

Device	Breakdown Voltage (V)
VMOS IC	30—1500
MOSFET Transistor	100—200
GaAs FET Transistor	100—300
JFET Transistor	140—7000
Bipolar Op-amp	200—2000
CMOS IC	250—3000
Bipolar Transistor	380—7000

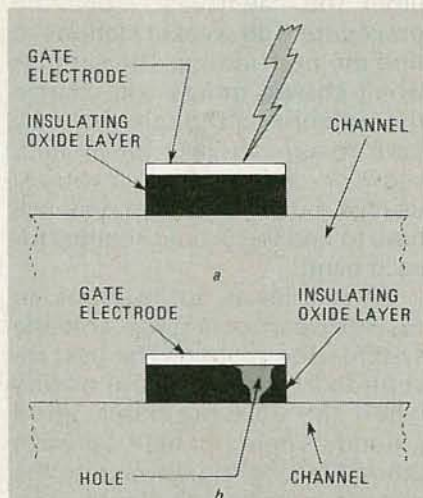


FIG. 6—ANATOMY OF A static-discharge caused CMOS failure. In a, we see the discharge striking the CMOS device. In b, the hole that results is shown. Either immediately, or after several months or years, metal from the gate and semiconductor material will fill the hole, shorting the gate to the drain.

IC, then damage will not occur. Other methods are just common sense. One basic rule that should be followed is don't handle CMOS or Schottky devices more often than is necessary.

CMOS devices are usually shipped in containers that serve to reduce the chance of static discharge damage. Since the aim is to keep all pins at the same potential, in some cases, especially in the hobbyist market, devices or groups of devices are shipped wrapped in aluminum foil. Most commercial sources, plus those amateur/hobbyist dealers who sell in quantities, will ship CMOS either mounted on black conductive foam, or inside of sleeves made of anti-static plastic. Blister-pack distributors often use a tiny-piece of conductive foam material to hold pins at the same potential. It is prudent to keep the

CMOS in the containers (or on the foam) in which they were shipped until it is time to use them.

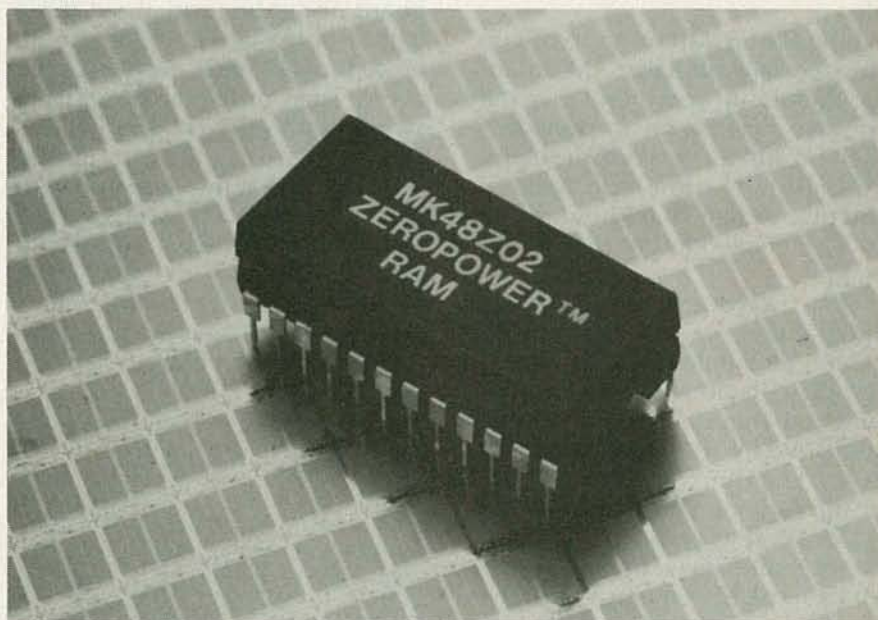
Some texts tell you to ground yourself to prevent static damage. While that strategy might, in fact, prevent static damage to the CMOS devices, it could also kill you! If there is any source of 117 volts AC around the bench, then it may seek ground through your grounded body—turning you into a blown fuse!

One method that works for many hobbyists is to increase the relative humidity. Just step into your bathroom and turn on the shower. When condensation from the

and become ineffective—or very dangerous.

For years, hospitals faced a similar problem in operating rooms. Explosive anesthesia agents (ether, cyclopropane, etc.) could be set off by sparks from an electrostatic discharge. To counter that problem, they used conductive, high resistance-to-ground floors; conductive, high resistance shoes or shoe covers, and all cotton garments. That may be extreme for most electronics situations, but may be appropriate in very dry regions if electrostatic discharge seems to be an otherwise unsolvable problem.

Tools such as soldering irons should have a grounded tip in order to prevent electrostatic charge build-up. Also, the finished product (printed wiring boards that contain CMOS devices) should be handled in the same way that you would handle the IC's themselves. Store the PC boards on conductive foam, or in static treated plastic bags. It is a myth that all CMOS devices become safe to handle when "in the circuit;" some do, some



CMOS TECHNOLOGY MAKES POSSIBLE this low-power RAM with internal battery backup.

steam starts to form on the bathroom mirror, you can begin to install the CMOS devices in their sockets.

A better alternative is to ground yourself, and separately ground your work surface, through a high resistance. A resistance of 2 to 10 megohms will serve to drain off electrostatic charges while also limiting current flow to a relatively safe value in the event of an accidental contact with the AC power. Use a 2-watt (or higher) resistor for that. We are not really worried about the wattage rating in this case, but rather, the voltage rating (yes, that's right, resistors carry a voltage rating). Lower wattage resistors have lower voltage ratings, so may short out

don't (it depends on the circuit configuration).

In conclusion, CMOS digital logic technology competes favorably with TTL. In fact, most large-scale designs contain a mix of CMOS and TTL devices. The technology selected for a design may be a trade-off between speed, power consumption, drive capacity, noise immunity, and other factors. In general, where operating speed is more important, the choice leans toward TTL, but if low power consumption is an important consideration, then CMOS looks more favorable.

Next time, we'll turn our attention to simple gates, the building blocks of digital electronics.

R-E



# HOBBY CORNER



EARL "DOC" SAVAGE, K4SDS,  
HOBBY EDITOR

## Tuning antennas

UNDER ORDINARY CIRCUMSTANCES most people think only transmitting antennas require tuning. Many believe that any old piece of wire or built-in antenna serves well for receiving. There are, however, times when you'll need to tune a receiving antenna to get the best signal strength (reception) possible.

John Owen (MI) wants to put up an especially effective AM antenna. Well John, you didn't give me enough information to provide a specific answer to your problem, but here are a few principles of antenna design that should help get you headed in the right direction.

First, however, I should point out that the subject of antennas is indeed a complex one. The most complete treatment I know is contained in *The ARRL Antenna Book* published by The American Radio Relay League (Newington, CT 06111). Perhaps you can find that publication at your local library. The examples given therein are for amateur (ham) frequencies but the theory, explanations, and formulas apply to any frequency, including AM.

To make a long story short (oversimplified), an effective antenna should be: Mounted high above ground and as clear of surrounding objects as practical; its electrical configuration correct for the frequency at which it's to be used, and finally, its impedance should match that of the receiver or transmitter to which it is connected.

Getting a wire high and clear is simply a matter of putting it up as best you can. Sometimes, the highest and clearest you can get is in the attic or under the eaves of your house—if that's the best you

can do, use it. Other than special cases, making an antenna both resonant and impedance-matched is usually accomplished with an "antenna tuner." There are many designs for tuners.

Figure 1 shows an antenna tuner that's variable over a wide range. The coil, L1, is wound on a cardboard or plastic form about three inches in diameter. There should be 40 turns of wire, evenly spaced over a span of five inches. Use a switch with at least 12 positions and connect it as shown in Fig. 1-a.

If you cannot find a switch with that many contacts, you can use two (or more) switches connected as shown in Fig. 1-b. Actually, you can get even better results by having a lever run across the top of the coil, thereby, providing a "tap" on

every turn of the coil.

To use the tuner, place it between the receiver and the antenna as shown. Then find a weak station and manipulate the controls for greatest signal strength (volume). You may have to repeat the procedure with weaker stations to find the best setting. The settings won't change unless you change the antenna, although you may have to vary them a bit in rain, snow, or ice conditions. If you are using a multi-band radio, you will have to find the proper settings for each band.

Oh yes, let us not overlook an essential part of a good antenna system—the ground. The best reception (or transmission) occurs when the antenna has a good ground. Where possible, an earth ground (a long rod driven into the ground) is best. If that's not practical, connect the ground wire to a water pipe (be sure it is metallic all the way to the earth).

Good luck, John. I hope you can now receive many DX (distant) stations.

### Stacked antennas

Jad Sherbo (MD) has asked about connecting two or more TV antennas to pick up some of the more distant stations. Indeed, antennas can be "stacked," as it is called, to increase their effectiveness. Yagi antennas, for example, (the type usually used for TV reception) can be mounted one above the other and connected to a common coax or twin-lead feed line. Wiring harnesses are available for some commercial TV antennas.

There are too many variables in determining optimum separation of the antennas and the proper

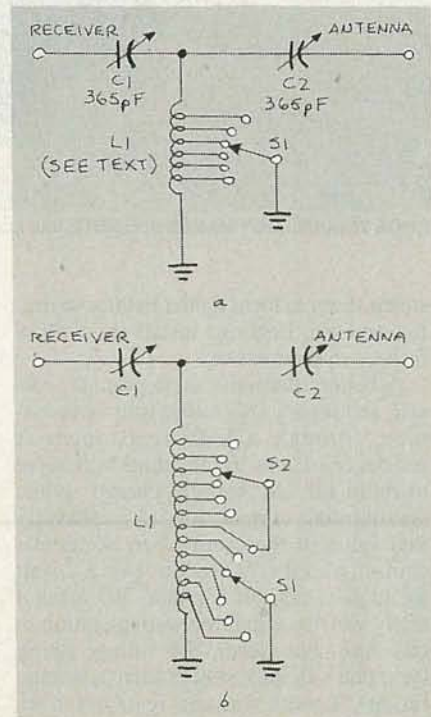


FIG. 1



Now electronics technicians can get into VCR Servicing quickly and easily

# Learn professional VCR servicing at home or in your shop with exclusive videotaped demonstrations

Today, there are more than 10 million VCRs in use, with people standing in line to have them serviced. You can bring this profitable business into your shop with NRI professional training in VCR servicing. This top-level training supports the industry's claim that the best technicians today are those who service VCRs.

## Integrated Three-Way Self-Teaching Program

In one integrated program, NRI gives you a study guide, 9 instructional units, 2 hours of video training tapes accompanied by a 32-page workbook that pulls it all together. At home or in your shop, you'll cover all the basic concepts of video recording, mechanical and electronic systems analyses, and the latest troubleshooting techniques. Your workbook and instructional units also contain an abundance of diagrams, data, and supplementary material that makes them valuable additions to your servicing library.

## The "How-To" Videotape

Your NRI Action Videocassette uses every modern communications technique to make learning fast and easy. You'll enjoy expert lectures and see animation and video graphics that make every point crystal-clear. You'll follow the camera eye into the heart of the VCR as step-by-step servicing techniques are shown. Both electronic and mechanical troubleshooting are covered . . . including everything from complete replacement and adjustment of the recording heads to diagnosing micro-processor control faults.

## Plus Training On All The New Video Systems

Although your course concentrates on VCRs covering Beta, VHS, and 3/4" U-Matic commercial VCRs, NRI also brings you up to speed in other key areas. You'll get training in capacitance and optical video disc players, projection TV, and video cameras. All are included to make you the complete video technician. There's even an optional final examination for NRI's VCR Professional Certificate.



Covers Beta and VHS  
systems with actual  
instruction on  
videotape.

## The Best Professional Training

This exclusive self-study course has been developed by the professionals at NRI. NRI has trained more television technicians than any other electronics school! In fact, NRI has consistently led the way in developing troubleshooting techniques for servicing virtually every piece of home entertainment equipment as it appears in the marketplace.

## Satisfaction Guaranteed . . . 15-Day No-Risk Examination

Send today for the new NRI Self-Study Course in VCR Servicing for

Professionals. Examine it for 15 full days, look over the lessons, sample the videotape. If you're not fully satisfied that this is the kind of training you and your people need to get into the profitable VCR servicing business, return it for a prompt and full refund, including postage. Act now, and start adding new business to your business.

## Special Introductory Offer

This complete VCR training course with two hour videotape is being offered for a limited time only, on orders received from this ad, at our low introductory price of \$179.95. Save \$20 by acting now!

NRI Training For Professionals  
McGraw-Hill Continuing Education Center  
3939 Wisconsin Avenue Washington, DC 20016

**YES!** Get me started in profitable VCR servicing. Rush me my NRI self-study course in VCR Servicing for Professionals. I understand I may return it for a full refund within 15 days if not completely satisfied.

PLEASE SPECIFY TAPE FORMAT DESIRED  VHS  BETA

Name (please print) \_\_\_\_\_

Company \_\_\_\_\_

Street \_\_\_\_\_

City/State/Zip \_\_\_\_\_

Enclosed is my  check  money order for \$179.95 (D.C. residents add 6% tax) Make check payable to NRI

Charge to  VISA  MasterCard \_\_\_\_\_

Interbank Number \_\_\_\_\_

Card Number \_\_\_\_\_ Expiration Date \_\_\_\_\_

Signature \_\_\_\_\_

(required for credit card sales)



NRI Training For Professionals  
McGraw-Hill Continuing  
Education Center  
3939 Wisconsin Avenue  
Washington, DC 20016

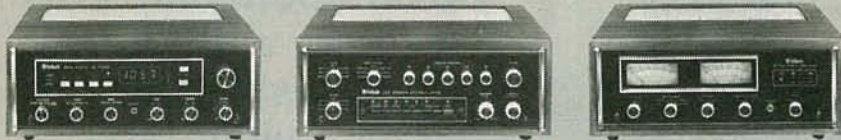
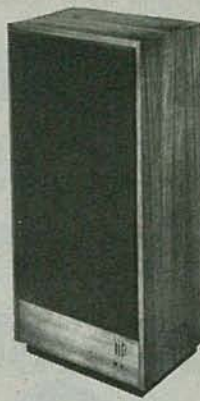
2600-045



**FREE**

# McIntosh STEREO CATALOG and FM DIRECTORY

Get all the newest and latest information on the new McIntosh stereo equipment in the McIntosh catalog. In addition you will receive an FM station directory that covers all of North America.



**SEND  
TODAY!**

McIntosh Laboratory Inc.  
East Side Station P.O. Box 96  
Binghamton, N.Y. 13904-0096

RE

NAME \_\_\_\_\_  
ADDRESS \_\_\_\_\_  
CITY \_\_\_\_\_ STATE \_\_\_\_\_ ZIP \_\_\_\_\_

If you are in a hurry for your catalog please send the coupon to McIntosh.  
For non rush service send the **Reader Service Card** to the magazine.

CIRCLE 67 ON FREE INFORMATION CARD

matching of their feed points for me to tell you exactly how to use those you may have on hand. Your best bet is to get a commercial harness to suit your antennas or to study *The ARRL Antenna Book* mentioned above. I hope you too can pull in many DX stations, Jad.

### 12-to-6 volt converter

There are many devices that we would like to operate from a car's 12-volt electrical system. Some require 12 volts; they are no problem. Others require some lesser voltage, so we must drop the auto's supply voltage to a level that's usable by the device.

David Housel (NJ) wants to run a tape recorder that requires 6 volts DC from his auto's 12-volt system. There are several ways to approach that problem. However, you should select one that overcomes two difficulties: First, an automobile battery's output can vary from 12 to 13.8 volts under normal circumstances. Second, the load requirements of the device can vary, for example, when the re-

order motor is turned on and off.

The circuit should maintain a constant voltage regardless of how those factors change. In cases such as yours, I use a simple circuit based on a 7805 voltage regulator. In addition to a constant output, that IC provides overload and short-circuit protection. Of course that unit is a 5-volt, 1-amp regulator, but when placed in a circuit like that in shown in Fig. 2-a, it can be tricked into providing other voltages as well.

In that circuit, as the arm of potentiometer R1 is moved from the upper end toward ground, the output varies from 5 to about 10 volts. All you have to do, David, is to set the wiper of R2 for 6 volts and connect your cassette machine. If your recorder draws 0.5 amp or more, be sure to mount the 7805 on a heat sink.

While you are making that little circuit, though, why not add a few more components and make it more versatile? By adding a switch and two more resistors, you can have a choice of three commonly

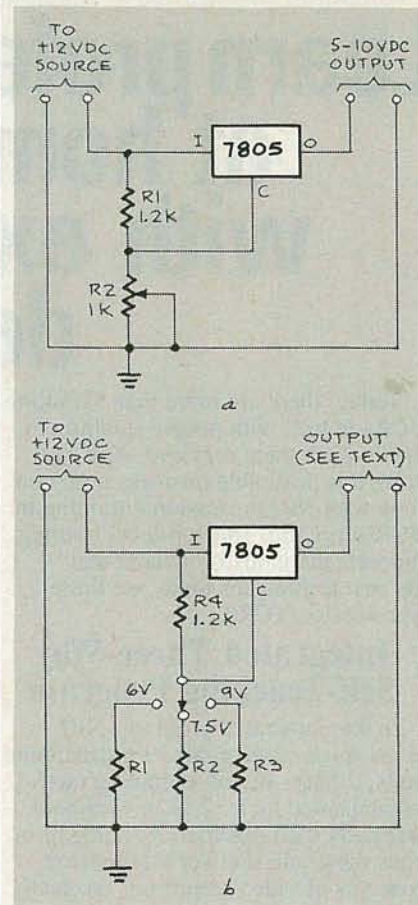


FIG. 2

used voltages: 6, 7.5, and 9 volts as shown in Fig. 2-b. The values of the two additional resistors are determined in the same way as the first.

Also, slightly modifying that arrangement, you can string the resistors in series and tap off the needed voltages at different points along the divider. In that way, R1 sets the voltage level to 6, the sum of R1 and R2 determines the next, and all three take care of the finally tap. Just be sure to check the output voltages before closing the unit and using it.

R-E

### SOUTHSIDE TV SERVICE



"It's tripled our business! Our name and address is on every page."



# COMPUTER DIGEST

VOL. 2 No. 4

April 1985

NEW KIND OF MAGAZINE FOR ELECTRONICS PROFESSIONALS

## THE NEW HIGH-SPEED MODEMS

How they work, how they evolved, all you need to know

A  
GERNSBACK  
PUBLICATION



## RESONANT CIRCUIT DESIGN

Involved in designing resonant circuits?  
Let your computer do the work.

## INEXPENSIVE IBM'S

Our cost-conscious Herb Friedman shows how to shave expenses



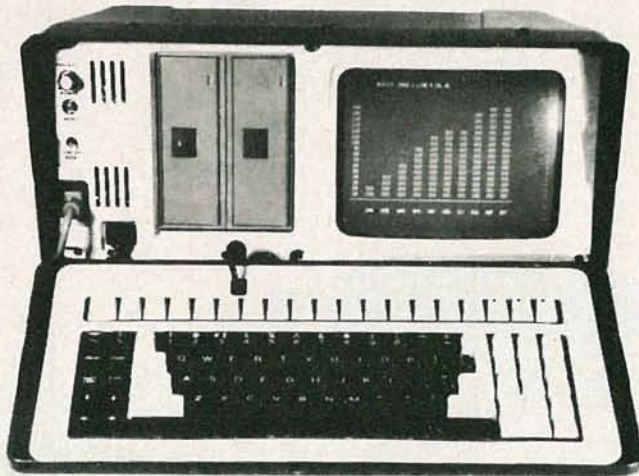
# ZORBA

## PORTABLE COMPUTER

### THE EXPERTS' CHOICE

#### FEATURES:

- 9" GREEN OR AMBER CRT
- 19 INDEPENDENT 55 PROGRAMMABLE FUNCTION KEYS
- TWO 400K DSDD DRIVES
- 64K BYTES 200 NS RAM
- C BASIC COMPILER
- IEEE 488 BUS MASTER PORT
- 24.6 LBS
- CPM 2.2 OPERATING SYSTEM
- M80 (L80, LIB80, CREF80)
- SOURCE CODE OF THE BIOS PLUS UTILITIES
- DATA COMMUNICATIONS SETUP PACKAGE
- SERIAL & PARALLEL PRINTER PORT
- DATA COMMUNICATION PORT



#### OPTIONS:

- 16 BIT 256K RAM UPGRADE (8088 CPU) \$600.00
- 800K DSQD 96TPI DRIVES \$300.00
- COMPOSITE VIDEO OUTPUT \$100.00
- SOFT VINYL CASE \$25.00
- TUTOR KIT; \$15.00 (CPM, WORDSTAR, CALCSTAR)
- SCHEMATIC SET \$5.00
- 10MB HARD DISK DRIVE

VISA/MC

# \$799.00

W/O Bundle

BUNDLED WITH  
WORDSTAR, MAIL MERG, SPELLSTAR,  
DATA STAR, REPORTSTAR, CALCSTAR

DEALER INQUIRIES INVITED

# \$999.00

With Bundle

#### General Specifications

ZORBA is the lowest cost full featured portable computer. This light weight computer is ruggedly packaged in a convenient carrying case. The case surrounds a strong inner chassis which further protects the Z80A based computer with its two double sided double density disk 400K drives, large easy to read 9" display screen and well designed detachable keyboard.

ZORBA uses CP/M, the industry standard operating system, which means that a wide range of existing software is readily available to the user.

The ZORBA users manual covers operation of the unit, all supplied software and all interface and internal information. A system diskette is supplied with all system files and utilities. A second diskette contains the sources for all ZORBA software including BIOS, SETUP, FORMAT, and PATCH.

#### Keyboard

Keyboard communicates serially with CPU Detachable with 2 foot coiled cord  
95 keys in standard QWERTY format  
13 Key Numeric pad  
Independent Caps Lock and Shift Lock  
55 Software programmable function keys  
All keys auto-repeat after 1 second delay  
All Standard cursor and terminal control keys

#### Disk System

Controller: WD1793  
Drives: 5.25 Double Sided,  
Double Density, 400K  
48 TPI

Built-in disk interchange formats: Xerox 820 (SD, DD), Kaycomp (DD), DEC VT-180 (SD), Osborne (SD) and IBM-PC (eg. CPM/86) and Televideo 802 (Read/Write and Format compatibility) (Expandable to 61 Formats)

#### Specifications

##### General Mechanical and Electrical

Width -17.5 inches (44.45 cm)  
Height - 9.0 inches (22.86 cm)  
Depth -16.0 inches (40.64 cm)  
Weight -24.6 pounds (11.1 Kg)  
Power -80-130 VAC or 190-245 VAC  
50/60 Hz  
170 watts max

##### Display

Display Tube:  
9" diagonal, Green or Amber  
High resolution display circuitry  
60 Hz refresh rate

##### Display Format:

25 lines x 80 columns  
5x7 Character Font with full descenders  
128 ASCII Characters  
8x9 32 Characters Graphic Font  
2K Memory Mapped Display Buffer

#### CPU Board

Z80A CPU running at 4 Mhz with no wait states  
64K bytes of 200 ns RAM (58K after CP/M loaded)  
16K bytes of EPROM (2732) can be switched in and out by software  
12K available for user EPROMS  
8275 CRT controller, DMA driven  
1793 Floppy disk controller, SMC data separator  
Bipolar proms configure 10 addresses  
Fully structured interrupts prioritized by bipolar proms

#### Interfaces

- Full asynchronous RS232 port with modem control. Baud rates and data translation and protocol programmable
- Full asynchronous full duplex RS232 port with hardware handshake (for printers). Baud rates and protocol programmable. (Serial Printer Port)
- One 8 Bit parallel port with independent strobe and ready lines. Supports Centronics interface with an available adaptor cable.
- IEEE 488 Bus Master Port (ie: General Purpose Instrumentation Bus) not Software Supported.
- 21 Standard Software Programmable Baud Rates: 45.5 to 19,200 BPS



**GEMINI ELECTRONICS, INC.**

130 Baywood Avenue, Longwood, Florida 32750  
305-830-8886 800-327-7182

CIRCLE 261 ON FREE INFORMATION CARD



# CONTENTS

Vol. 2 No. 4

April 1985

## 7 The New High-Speed Modems

Bring your knowledge up to date with this in-depth study on how the new modems evolved, how they work, and what their applications are. **Marc Stern**

## 12 Resonant Circuit Design

If you're involved in designing resonant circuits, why not put your computer to work and save a lot of time and effort?

**Lawrence G. Friedman**

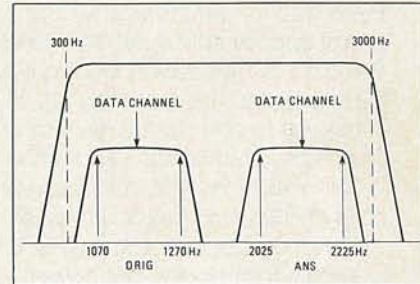
## 13 Inexpensive IBM's

Obsolete doesn't necessarily mean "worthless." Here's how you can take advantage of "built-in obsolescence" to get many years of excellent service at a lower price. **Herb Friedman**

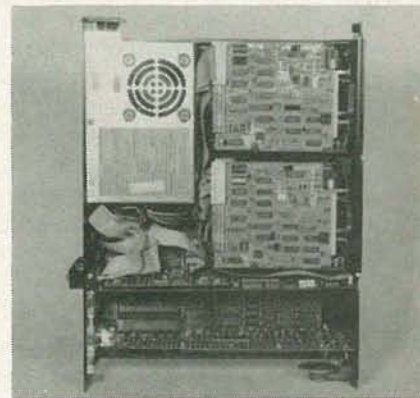
## 4 Editorial

## 5 Letters

## 5 Computer Products



See page 7.




See page 13.

## ON THE COVER

The 2400 BPS Smartmodem transfers data across regular telephone lines and offers a link between mainframe and personal computers. The unit has expanded capabilities to monitor the progress of a call, distinguishing between a busy signal, no dial tone or no answer. For additional information on modems, see page 7.

**COMPUTER DIGEST** VOL. 2 No. 4 April 1985  
NEW KIND OF MAGAZINE FOR ELECTRONICS PROFESSIONALS

**THE NEW HIGH-SPEED MODEMS**  
How they work, how they evolved, all you need to know



**RESONANT CIRCUIT DESIGN**  
Involved in designing resonant circuits? Let your computer do the work.

**INEXPENSIVE IBM'S**  
Our cost-conscious Herb Friedman shows how to shave expenses



# EDITORIAL

## Computers and the CB Syndrome.

■Let's face it—Electronics swings in wide patterns of interest that flare up almost spontaneously, set the world afire, and then ignominiously die out. The business got a swift boot out of high fidelity when that first burst on the scene, and this was taken up, in turn, by stereo. Audio-type magazines flourished to cater to the interests of those who followed these trends. Then there was a stabilization, and a wide-spread moderating.

Just about that time, reverberation came into being, and the artificial echo chamber was added to audio systems. Audio came back to life.

Things lay quiet for some time. Oh, the die-hards and purists continued to pursue their hobby, but it wasn't quite like the "good old days." Then Citizens Band Radio came along, and it was bigger than audio ever was. Everybody got involved. Every car had a CB rig. Housewives were forming networks to gossip over the air. Teenagers were making dates over the CB. And CB, once the realm of truckers alone, was now everybody's property. You could hear the bands bristling with phony southern accents as the kids tried to emulate the truckers. The language the CB'ers developed was as unique as some of their "handles." And of course, magazines catering to the new interest flourished as well.

Then, as suddenly as it appeared, the interest in CB died off. People who once craved an occasional "Good buddy, how's it look over your shoulder," as they drove down the road, were just as happy listening to the BC radio. Now when you see a car ahead of you on the road, you begin by asking "Hey good buddy, got your ears up?"

Now it's computers, and again, everybody from school kids that have just learned how to read, on through graduate engineers, are taking up the computer cudgel. Magazines have sprung up and died out. Is the computer to face a like fate as all its forebears?

No. The computer, thanks to its innate value, will never exhaust the interest that holds its practitioners spellbound. Because of its extreme versatility, the computer is going to be with us for many, many years to come, and we at **ComputerDigest** hope to continue to bring you the latest news and developments in this astounding field. ◀▶



Byron G. Wels  
Editor

**ComputerDigest** is published monthly as an insert in Radio-Electronics magazine by Gernsback Publications, Inc., 200 Park Avenue South, New York, NY 10003. Second-Class Postage Paid at New York, N.Y. and additional mailing offices. All rights reserved. Printed in U.S.A.

A stamped self-addressed envelope must accompany all submitted manuscripts and/or artwork or photographs if their return is desired should they be rejected. We disclaim any responsibility for the loss or damage of manuscripts and/or artwork or photographs while in our possession or otherwise.

# COMPUTER DIGEST

**Hugo Gernsback** (1884-1967)

founder

**M. Harvey Gernsback**, editor-in-chief

**Larry Steckler**, CET, publisher

**Art Kleiman**, editorial director

**Byron G. Wels**, editor

**Brian C. Fenton**, technical editor

**Carl Laron**, associate editor

**Robert A. Young**, assistant editor

**Ruby M. Yee**, production manager

**Robert A. W. Lowndes**, production associate

**Dianne Osias**, production assistant

**Karen Tucker**, production assistant

**Jacqueline P. Weaver**, circulation director

**Arline R. Fishman**, advertising coordinator

Gernsback Publications, Inc.

200 Park Ave. South

New York, NY 10003

Chairman of the Board:

M. Harvey Gernsback

President: Larry Steckler

## ADVERTISING SALES 212-777-6400

Larry Steckler

Publisher

### EAST/SOUTHEAST

Stanley Levitan

Radio-Electronics

200 Park Ave. South

New York, NY 10003

212-777-6400

### MIDWEST/Texas/Arkansas/Okla.

Ralph Bergen

Radio-Electronics

540 Frontage Road—Suite 325

Northfield, Illinois 60093

312-446-1444

### PACIFIC COAST

#### Mountain States

Marvin Green

Radio-Electronics

15335 Morrison St., Suite 227,

Sherman Oaks, CA 91403

818-986-2001



# LETTERS

## LIKES "PRINTER PROBLEMS"

I found the "Printer Problems" articles in **ComputerDigest** to be very useful. How about more hardware and interconnect related articles?—Warren W. Munro, Aiea, HI.

*Right, Warren. We've got lots of those in the works right now. Keep watching for them; they'll be appearing regularly.*

## A ROBOT NAMED "BYRON?"

I named my robot Byron immediately after soldering in the last connection and powering him up. This in recognition of a kindred spirit. Hope you don't mind. Byron isn't finished yet as he has a total lack of mobility. At least he knows who his maker is! WORKING!!!—T. E. Deagle, Boydton, VA

*We all had a good laugh here in the office over that one, T. E. The general impression is that you did well. I don't have too much in the way of mobility either, but at least your Byron works!*

## BUILD YOUR OWN COMPUTER?

I have good skills, have been an electronics hobbyist all my life, and was wondering about the idea of building my own computer from scratch. Would I save money on this? How would I best go about it? By the way, I don't want to build from a kit, either.—J. Mahoney, Sioux Falls, S.D.

*We can't really recommend this course of action. While it could be done, it would not be economically feasible, compared with buying a used or refurbished unit. Do let us know what you decide, and share what you learn with our readers. We'll all be very interested!*

## UNUSUAL REQUEST!

I know a lot of people have been buying **Radio-Electronics** and ripping out and throwing away **ComputerDigest**. You may not believe this, but I buy the magazine, rip out **Computer-**

**Digest** and throw **Radio-Electronics** away! I hate to see it go to waste each month, and was wondering if one of your non-readers might like to split the cost with me for a subscription?—S. Brandt, Caspar, WY  
*Any takers?*

## PROTECTING INVENTIONS

I've invented a computer-oriented device I'd like to protect, but can't afford a patent. Any suggestions?—Sam Dixon, San Francisco, CA

*There are several "ideas." If it's sufficiently interesting, get it published in a magazine like **ComputerDigest**. The magazine and its contents are copyrighted, and it gives you proof of prior published art. Another old saw is to write up a description and mail it to yourself in a sealed, registered letter to later be able to prove earlier discovery. The smart money suggests investing in a good patent attorney and playing it really safe! ◀▶*

# COMPUTER PRODUCTS

For more details use the free information card inside the back cover

**SURGE/SPIKE SUPPRESSOR**, model 061, is designed to protect computers, microprocessor-based instruments,



CIRCLE 21 ON FREE INFORMATION CARD

sensitive electronic and audio equipment, and scientific instrumentation from high-voltage transients and surges by instantaneously sensing and suppressing them.

The model 061 features suppression capabilities of 6,000 amperes maximum surge current, with an energy absorption of 70 joules. It is designed for use on any standard 120-volt AC line, and responds to common and differential mode transients and surges at once. There are 4 three-wire grounded outlets and a main ON/OFF lighted rocker; the unit plugs directly into any 3-prong grounded outlet to provide maximum convenience. It is priced at \$59.95.—**PMC Industries, Inc.**, 9353 Activity Road, San Diego, CA 92126.

## DAISY-WHEEL PRINTER,

The *Alphapro 101*, is a 20 character-per-second printer that uses standard Diablo and Qume-compatible print wheels and ribbon cartridges. It uses an intelligent printer cartridge to adapt



CIRCLE 22 ON FREE INFORMATION CARD

it to all popular personal computers, including those with Centronics



ports—such as the IBM, PC, PCjr, and compatibles; those with RS232 ports, such as the Apple IIe and the IIc, and others, such as Apple's Macintosh.

The *Alphapro 101* features path-seeking logic to maximize printing speed and a 93-byte memory buffer (4000 bytes optional). True proportional spacing, boldface, double strike, knockout, phantom face, superscripts and subscripts, and reverse line feeds are also supported. It is priced at \$399.95.—**Alphacom, Inc.**, 2323 Bascom Ave., Campbell, CA 95008.

### EDUCATIONAL PROGRAM,

*Bumblebee*, is designed to introduce children age 6 and up to the disciplines of computer programming in a game-like format.



CIRCLE 23 ON FREE INFORMATION CARD

The player controls Bartholomew ("Bart") the bee by giving him instructions that enable him to move from flower-to-flower and pick up "pollen points." The bee's flight must be carefully designed, or he will bump into walls or be caught by "Olga," the evil garden spider. If Bart returns safely to the beehive, the screen lights up in a colorful graphic display.

*Bumblebee* features increasing levels of difficulty, some of them requiring the construction of more complicated flight patterns. The disk-based program is priced at \$29.95.—**Creative Software**, 230 East Caribbean Drive, Sunnyvale, CA 94089.

**RADIO INTERFACE CARD**, model *PCI-2000*, is a plug-in card for the IBM-PC, which interfaces the computer to a shortwave radio for copying radio-teleprinter and Morse-code signals. Examples of signals that could be copied include weather information, news services, and amateur radio communications. The model *PCI-2000* can also transmit Morse and teleprinter



CIRCLE 24 ON FREE INFORMATION CARD

signals in applications where two-way radio communications are required. It is priced at \$595.00, including software.—**HAL Communications Corp.**, Box 365, Urbana, IL 61801.

**CO-PROCESSOR BOARD**, for the IBM, PC and XT, the *Trackstar*, supports Apple DOS 3.3, Pro-DOS, Apple Pascal and Apple CP/M 2.2. With the addition of the *Trackstar*, the IBM user can access the vast library of Apple games, educational and business programs, and the extensive library of CP/M business software.



CIRCLE 25 ON FREE INFORMATION CARD

Additional features include a full 80-column mode, connector for an Apple-compatible disk drive to overcome copy-protection problems, both RGB and composite output and support of the language card features. *Trackstar* is priced at \$695.00.—**Diamond Computer Systems, Inc.**, 3380 Montgomery Drive, Santa Clara, CA 95054.

**TRAINING PROGRAM**, *The Desk Organizer*, is for use with the IBM PC, and designed for training secretaries. *The Desk Organizer* files anything the user needs to remember, for instant recall at any time; dials phone calls, retrieves phone numbers, inserts access codes; writes and prints memos, letters, reports; calculates with a visual

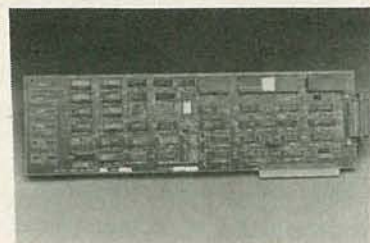


CIRCLE 26 ON FREE INFORMATION CARD

calculator and an electronic tape, stores and runs equations and formulas; transfers data automatically from mode to mode; organizes, alphabetizes, indexes, cross-references, and manages time with chimes to remind the user of commitments.

*The Desk Organizer* is priced at \$195.00.—**Warner Software**, 666 Fifth Avenue, New York, NY 10103.

**DATA COMMUNICATIONS BOARD**, the model *WD4025*, features the universal CCITT X.25 LAPB protocol, and is designed to be compatible with the IBM PC, XT, AT, and compatibles. It will link computers at the same site, or scattered across the country via dial-up, or leased lines through a packet



CIRCLE 27 ON FREE INFORMATION CARD

switching network. It will also provide a gateway connection for the Local Area Networks (LAN).

Pricing for the model *WD4025* without software in OEM quantity is \$385.00; pricing with software is \$695.00.—**Western Digital Corporation**, 2445 McCabe Way, Irvine, CA 92714.

**TAX SOFTWARE**, the *Personal Planner*, can calculate tax liabilities for 1984 through 1987. It organizes all relevant tax information, keeping everything available for instant evaluation. It can be used for such tasks as retirement planning, investing, IRA contributions, home buying, two-income planning, and even checking a federal tax return.



CIRCLE 28 ON FREE INFORMATION CARD

*The Personal Planner* carries a suggested retail price of \$49, and is tax-deductible.—**CPAids**, 1061 Fraternity Circle, Kent, OH 44240. ◀▶



# MODEMS

*All about the newest high-speed modems; where they are and how they work.*

## MARC STERN

■For those who maintain that the higher the baud (communications) rate the more bandwidth is needed, 9600-baud communications may seem like an impossibility over the standard phone system, which is limited to 3 KHz of bandwidth, or the range of average voice conversation. After all, 9600-baud is a 3200 percent increase over 300-baud. But, modem manufacturers have done it.

### Frequency Shift Keying

As recently as three years ago, the state of the art in digital communications was 300-baud. The typical 300-baud 103A modem of 1981 used two pairs of arbitrary frequencies for send and receive (originate and answer), 1070 to 1270 Hz for originate and 2025 to 2225 Hz for answer. (See Fig. 1) These are the tones emitted by both modems during a call. You can hear them if you listen closely during dial-up. The 300-baud modem also used Frequency Shift Keying (FSK) to represent the digital data being transmitted. (The 103A standard defined the originate-answer tones needed for data transmission, as well as the parameters needed for communication. All modems which adhered to this standard could communicate, one in the originate mode and the other in the answer mode.)

Fig. 2 shows a graphic representation of FSK. In this type of data transmission, the modem's circuitry modulates the carrier frequency to one level to represent a digital 0 and to another to represent a digital 1. You can actually hear the data stream of 1s and 0s if you listen to the phone line during a low-speed (300-baud) transmission. This type of transmission relies on a UART (Universal Asynchronous Receiver/Transmitter) as well as the circuitry which takes the digital signals from the UART and transforms them into audio signals which are compatible with the phone system.

The reason digital data must be turned into audio is that the phone system is geared toward voice audio with its bandwidth of 3 KHz. Since it is, data must be

turned into its audio analogs and FSK is used to produce those analogs.

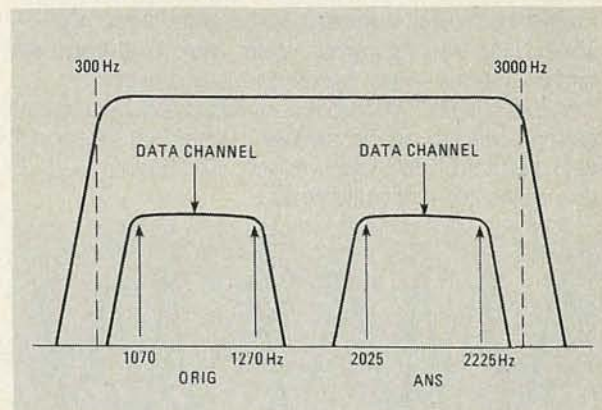
Let's see what happens when you begin digital communications at 300-baud (300-bits-per-second). First, your computer establishes a connection with the remote computer system or terminal with which you want to communicate. With today's intelligent modems, you just call up a program in your computer and command it to dial the remote system. After the dialing and the call are completed, you will hear a tone emanate from your modem. It is the originate carrier and is transmitted for a length of time as your modem patiently waits for the answer tone. When it hears the answer tone, the modem latches onto it and your system is connected to the remote system. These tones are generated by the modulator section of the modem.

Now the communications program in your computer waits for your action. If you are the originator of the call, the chances are good you will either be uploading or downloading information. Let's say you are sending—UPloading—a file to the remote system. If you are, you will be asked for the filename which you select. You then hit the appropriate keys on the keyboard and the transmission begins. While you were choosing the file, unknown to you, the program was putting the modem's UART into a *ready* state.

(A computer works in a parallel mode within the confines of its box with all data moving along in 8-bit chunks, unless you have a 16-bit computer and then it moves along in 16-bit or 24-bit chunks.)

With the UART ready, the file transfer session begins. The UART takes the parallel data and turns it into serial data, holding each piece of data in place until it is ready to be sent by the transmitter section of the modem. The UART has the necessary storage registers to do this.

At this point, the UART begins releasing the data to the transmitter section, where the data are changed from their digital forms into their audio analogs and it is then frequency modulated through the phone system.



**FIG.1—THE 300-BAUD ORIGINATE/ANSWER modem uses two sets of discrete frequencies to establish communications. When the modem originates a call, the tone is between 1070 and 1270 KHz. The answering modem emits a tone in the 2025 to 2225 KHz range. The top and bottom frequencies correspond to mark and space, two timing parameters used in asynchronous communication.**



## Receiving

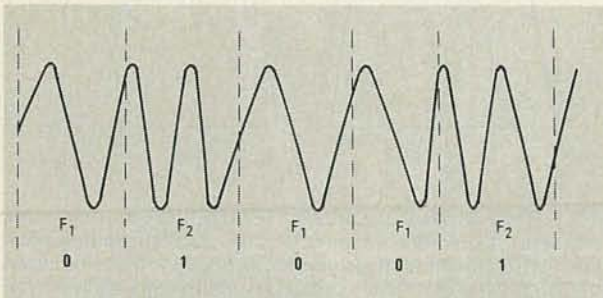
Let's see what happens when audio information is received.

On the receiving side, the modem takes the audio information it is receiving and turns it back into digital form. The receiving circuitry sends this information to its own UART, where each bit of information is held in storage until the particular digital word is formed. When that 8-bit word is formed, it is sent to the computer's information bus and on into digital storage. The action of the UART and its associated circuitry is so fast that you think everything is happening instantly, but it isn't. If you could slow this circuitry's time reference enough you would see that each digital event is distinct in itself. However, the speed with which each event occurs is so high—microseconds—that it appears instantaneous.

In the 1981-1982 period, data transmission was limited to the 300-baud rate because the circuitry for higher-speed transmission still hadn't migrated to the average microcomputer user. It was beginning to make its appearance, but was still too expensive for the average computerist. It took developments in large-scale integration (LSI) to make this possible. These developments included UARTs which could handle data at 1200-baud asynchronously, as well as microcircuitry which could create the proper modulation needed so the modem would recognize high-speed transmission.

## Asynchronous transmission

Asynchronous simply means data transmission without tight timing constraints and it is important to note it here. At this time, the highest speed thought possible for asynchronous communication was 300-baud (300 bits per second). At higher speeds, it was thought that tight timing requirements were needed so both the transmitting and receiving modems could operate reliably. It was also believed that you needed a specially dedicated, conditioned—clean—phone line so that data transmission would be error-free. It was assumed the phone system was too noisy for reliable high-speed data transmission. Therefore those high-speed links which existed—there were 1200-baud and higher systems—were synchronous and used dedicated lines. Synchronous systems required special timing codes to be inserted as "header" information for each packet of data that was sent. The timing requirements were quite strict.



**FIG.2—FREQUENCY-SHIFT KEYING** uses shifts in frequency to denote digital information. One frequency level denotes digital 0 and the second denotes digital 1.

## Phase Shift Keying

Phase Shift Keying (PSK) takes advantage of the natural period of an audio frequency wave and, rather than using a set of discrete frequencies to define digital 1s and 0s, PSK represents data bits by using the changing phase of the signal and superimposing two or more data bits for each cycle.

## Visualize a sine wave

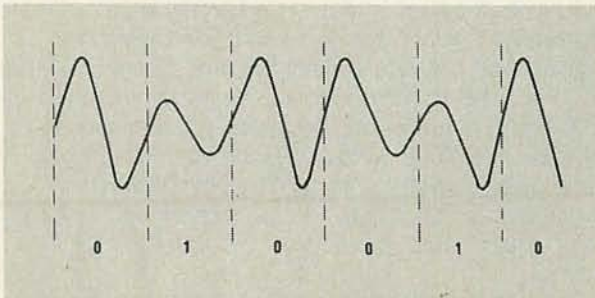
The best way to envision this is to think of a sine wave, showing the entire period of an audio signal. Now, put a dot at the 0 point and another at the 180-degree point. These two points represent the digital 1 and 0, or the binary system used in data communications. This system is called Coherent Phase Shift Keying and relies on defined reference points to represent data. It differs from FSK in that FSK relies on using the carrier frequency to represent one digital bit of information—0, for instance—and a higher frequency to which it shifts to represent the other—1, for example.

To explain this more fully, let's say you are using traditional FSK to transmit data. Since you are using an audio-frequency range, you are also creating sidebands, or the sum and difference of the carrier and the modulation rate. For example, let's say the modem uses an 1800 Hz carrier and you are sending data at 1200-baud. Because the modem is using this set of parameters, you will find sidebands at 3000 Hz— $1800 + 800$ —and 600 Hz— $1800 - 1200$ —and therefore higher-speed transmission can fit within the constraints imposed by the phone system.

With low-speed (300-baud) and FSK, you are simply using one-half the cycle to define the data you are transmitting. This is the key difference between modes. FSK uses the 1800 Hz point, for example, to define 0 and the 2100 Hz point or upper sideband ( $1800 + 300$ ) to define 1. The lower sideband or 1500 Hz point is unused. Further, this type of modulation does not take full advantage of the 3000 Hz bandwidth of the phone system, while higher speed and PSK do. Low speed and FSK only uses about 600 Hz of bandwidth— $2100 - 1500$  Hz—leaving 2400 Hz unused.

## Another way to go

Coherent Phase Shift Keying isn't the only way of handling high-speed data communications. There are two others which are equally as valid and interesting, Amplitude Modulation (AM) and Differentially Coherent



**FIG.3—WITH AMPLITUDE MODULATION**, the difference in amplitude of the modulating signal determines the digital information flow.

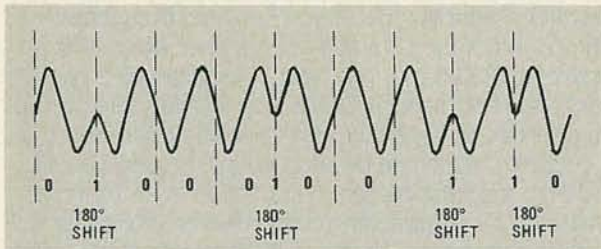


### Phase Shift Keying (DCPSK).

With Amplitude Modulation, the amplitude of the carrier is the determining factor. By varying the amplitude of the carrier, with one level representing a digital 1 and another representing a 0, you can have effective data communication.

To represent this, think of the traditional AM sine wave and then superimpose a modulating signal upon it. The difference in amplitude of the modulating signal determines the 1 and 0. (See Fig. 3).

Another form of Amplitude Modulation, is simple on-off keying where the digital 1 or 0 is determined simply by switching the carrier on and off. While we



**FIG. 4—HIGH-SPEED MODEMS, which use phase-shift keying, use changing phase relationships to attain their speed while remaining within the constraints of the phone system. Figure 4 demonstrates this using a 180-degree phase shift.**

call this Amplitude Modulation, it's really Interrupted Continuous Wave (ICW).

### DCPSK

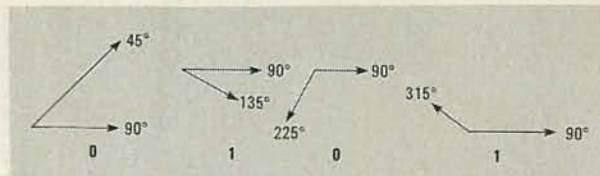
With this said, let's move on to Differentially Coherent Phase Shift Keying (DCPSK). It is unlike Coherent Phase Shift Keying in that the necessity of identifying specific locations on the sine wave is discarded in favor of encoding data using the phase change between two signal elements.

And because there's an almost unlimited potential for encoding data during phase changes (See Fig. 4), you can see it would be possible to increase data transmission speed without increasing bandwidth. Large-scale integrated circuitry handles the necessary detection and decoding of data.

### How DCPSK works

Let's take a closer look at DCPSK for a better understanding of this concept by first comparing it to coherent PSK. As we have noted, coherent PSK relies on establishing reference points on the sine wave's cycle. For instance, this type of modulation technique may use the 0 and 180 degree points, with a 0 degree phase shift representing the digital 0 and a 180 degree shift representing the 1. The circuitry in the receiver requires phase coherence capability so it can demodulate the signal. DCPSK, on the other hand, does away with the necessity of absolutely identifying the reference points in the shift of an audio wave cycle. Instead, data are encoded in terms of the phase change between successive parts of the audio wave.

To see this more clearly, envision the coherent PSK



**FIG. 5—DEMONSTRATING THAT ENCODED BITS OF DATA—two bits—using a phase shift relationship of 45 degrees is one of many possibilities. Here data are encoded at 45, 135, 225, and 315 degrees on the signal cycle. Each is still separated by 90 degrees.**

waveform with data points at 0 and 180, or the type of waveform you might see if you scoped a 1200-baud modem. Change the waveform slightly to encode data at different spots on the wave. The difference in phase between these insertion points is what defines the digital 1s and 0s needed for data communication. For instance, with DCPSK, you may have data inserted at 0 degrees, 90 degrees, 180 degrees and 270 degrees, or a two-fold increase in communication speed since two full digital bits are represented on the wave. This is called a dibit, with 0 and 180 representing one set of 1s and 0s and 90 and 270 representing the second set. We only used these points for easy reference because there is no hard and fast rule defining where the information is to be inserted. It can be anywhere on the waveform. (See Fig. 5)

On the receiving side, the DCPSK discards the necessity for fixed reference points, relying, instead, on the relationship between the changing phase between the signal elements.

By now you should be able to see the possibilities inherent with DCPSK. By using the change in phase, you can take advantage of as many as four, eight or 16 phases on the signal and this, in turn, allows you to group two, three and four bit groups of data. It gives you a fourfold increase in the amount of data transmitted within the constraints imposed by the phone system. You are taking full advantage of the bandwidth available and all the while the phone system still thinks you are using a 1200-baud modem because you are still relying on the same bandwidth we noted in our earlier example (600 and 3000 Hz or the sum and difference of the 1800 carrier and 1200 Hz modulating signal.)

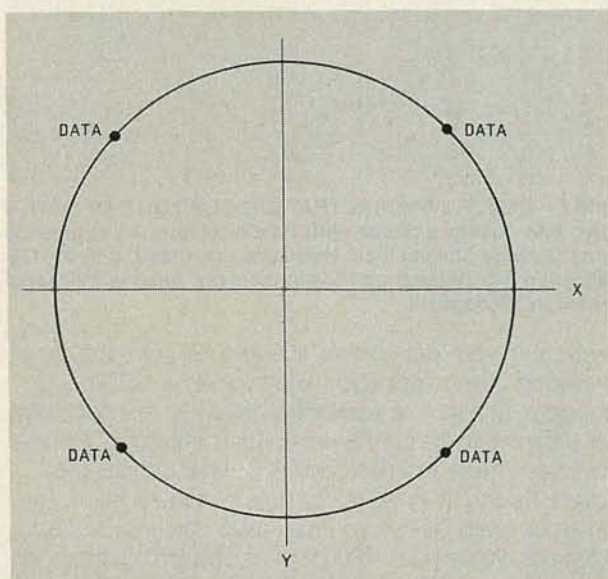
Since this type of communication relies on timing shifts, it requires synchronous operation. It also uses multilevel data coding in the modem. Research has found a relationship between the amount of data you send per signaling period, also called the bandwidth compression ratio. It is  $\log_2 M$ , where M is the number of levels (signal elements per cycle). This type of coding can be applied to any form of modulation.

The one drawback with DCPSK is that as you increase the amount of digital data within a waveform, you need a higher signal-to-noise ratio in the receiver. This is usually handled by either increasing the power of the transmitter or lowering noise levels.

### Introducing Quadrature AM

It is possible to combine Amplitude Modulation with DCPSK. Also known as Quadrature Amplitude

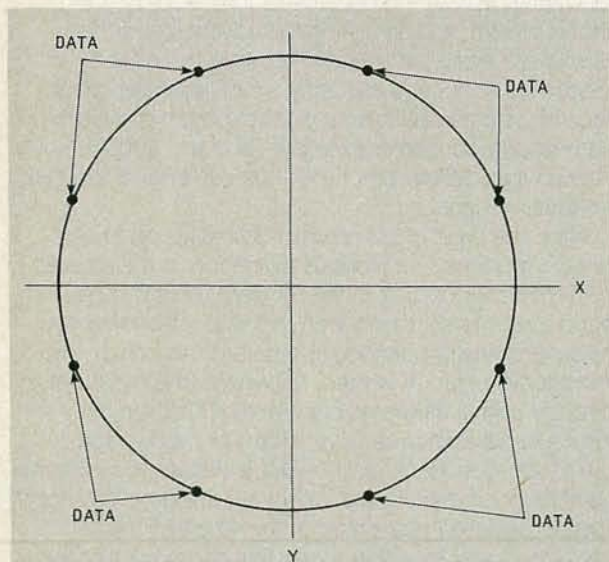




**FIG.6—TO SIMPLIFY MATTERS, the relationship of data in a 2400-bit modem is shown as it would appear on an oscilloscope. Note the relationship of the four insertions of data.**

Modulation, it can use a two-level AM, four-phase scheme to encode three data bits and achieve high-speed communications. It is also possible to use a two-level AM, eight-phase scheme to encode four bits of data per cycle. You can see where the name quadrature came from since it relies on the four-phase relationship.

At 1200-baud, the standard 212A modem takes advantage of coherent PSK for its high-speed, 1200-baud mode and uses FSK for 300-baud. (Bell standard 212A, which defines the characteristics for 1200-baud asynchronous communication. All 212A modems share the same standards so they can talk with one another. This standard supercedes the older Bell 202 standard.)



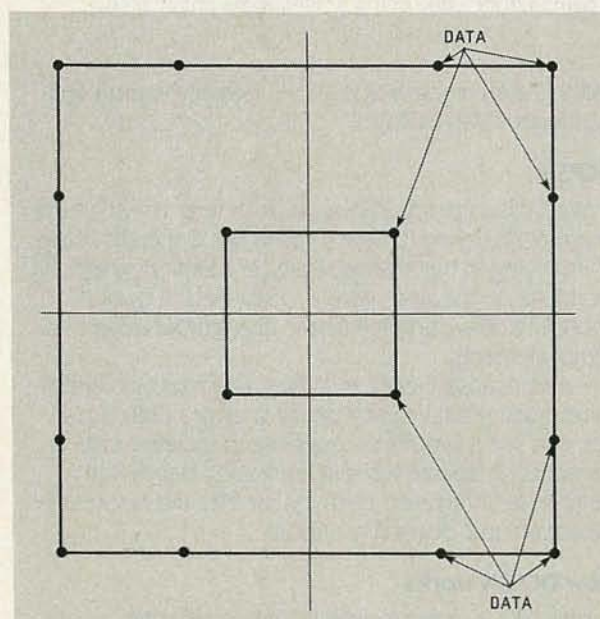
**FIG.7—BY COMPRESSING THE DATA, another bit can be inserted, effectively doubling the modem's speed to 4800-baud. By compressing the data, another bit can be inserted, effectively doubling the modem's speed to 4800-baud. The relationship, as it would appear on an oscilloscope, is shown above.**

This type of modem is capable of recognizing both FSK and PSK.

### Dibits and Tribits

The jump from 1200 to 2400 is achieved by using a dibit—two bits of data. The dibit—00, 01, 11, 10, for instance—is used to encode one of four specific phase shifts. For instance, a 2400-baud modem will function using four-level DCPSK modulation with a phase change of 45 degrees between bits. Pictorially, it can be seen in Fig. 6. Since there are now four bits of information, rather than two, the amount of information is effectively doubled, though the phone system thinks the modem is communicating at 1200-baud.

Inserting another data bit and increasing the number to three—a tribit—means you can effectively double the speed of the communications once again. This makes it 4800-baud. This type of modem relies on eight-level or diagonal DCPSK and requires three bits of information to define the eight specific phase shifts. The tribit pattern can be seen in Fig. 7. Again, you are adding one extra piece of information at each phase shift point—compressing data—allows a manifold increase in speed. This type of scheme operates using eight data patterns which look much like triangles when superimposed on one another. Although it would seem



**FIG.8—THE RELATIONSHIP OF THE FOUR bits of data inserted at various points on a signal cycle in a 9600-baud modem is shown. These points not only determine the phase relationship, but also the relative amplitude of the signal.**

that you would only be increasing speed to 3600 baud, you now have eight levels of data and six bits of information per cycle,  $8 \times 6 = 48$ .

Moving from this point, speed again doubles to 9600-baud. This type of modem uses Quadrature Amplitude Modulation and uses four consecutive data bits to define both the amplitude of the signal and phase changes. It also determines the absolute phase of the signal element. You can see the relationship of all the elements in this realm in Fig. 8. ◀▶



# Radio-Electronics Software Store

## Peachpak™ 4 —A complete accounting package for small business

Designed for the small business with limited micro-computer capacity. Peachpak 4 consists of three interactive business application packages: General Ledger, Accounts Receivable, and Accounts Payable. It is designed for a dual floppy disk drive system.

**General Ledger** is the center of the Peachpak 4 system. Used with the other Peachpak 4 modules, General Ledger gives you the ability to maintain a complete financial picture of your business.

The flexible chart of accounts setup allows you to incorporate your current accounting books; the automatic posting of transactions from other Peachpak 4 modules minimizes errors and saves time.

General Ledger offers the following features:

- Allows five-digit account number
- Offers you automatic repeating journal entries
- Allows up to 99 departments
- Identifies transactions posted to General Ledger by eight user-defined source codes
- Allows year-to-date total up to \$21,000,000.00

General Ledger provides these reports: Balance Sheet, Income Statement, Trial Balance, Examine Account Status Report, Transaction Register, Chart of Accounts List, and various other reports.

**Accounts Receivable** helps you prepare bills for and obtain timely collections from your customers. It prints invoices, statements, and ageing reports and maintains customer account information, sales taxes, and the accounting detail for posting to General Ledger.

By closely monitoring your customers' bill-paying activity, you can achieve better cash flow control. The system eliminates duplication of efforts since statements or invoices are generated as the information is entered. The automatic posting of summary transactions eliminates reposting errors.

Accounts Receivable:

- Prints statements and invoices
- Provides detail or summary Ageing Report
- Posts summary transactions to the General Ledger
- Allows automatic customer billing option

- Allows you to enter sales transactions without having to print an invoice
- Provides for balance-forward customers, open-item customers, or a combination
- Prints sales or dunning messages on statements
- Handles ten different types of transactions
- Allows year-to-date total up to \$21,000,000.00



**Accounts Receivable** provides these reports: Aged Receivables Report, Customer Statement, Invoices, Transactions Report, Examine Customer Activity Report, Customer Accounting Listing, General Ledger Transaction Register, and several control reports.

**Accounts Payable** can be used as an independent application or in conjunction with General Ledger. Besides maintaining a complete file for each vendor, it will help determine which invoices should be paid, subject to your criteria.

By supplying instant information on your accounts, Accounts Payable enables you to save money by claiming all eligible discounts. It also helps you keep vendor accounts current.

By allowing you to select automatic payment of invoices based on your selection of discount and due dates, Accounts Payable helps you manage your cash flow better.

Accounts Payable:

- Prints checks with a detailed check stub listing all invoices paid by that check
- Automatically calculates discount allowed
- Shows amounts due each vendor classified into six time periods on ageing report
- Allow you to enter monthly items for automatic posting of recurring invoices
- Allows entry of prepaid invoices to properly maintain accurate vendor information
- Allows optional automatic posting to Peachpak 4 General Ledger in summary
- Distributes each invoice to a maximum of eight General Ledger expense accounts
- Has an option to prohibit deletion of invoices
- Allows year-to-date total up to \$21,000,000.00

Accounts Payable provides these reports: Cash Requirements Report, Aged Payables Report, Open Invoice Report, Examine Vendor Status Report, Vendor File List, Check Register, Transaction Register, General Ledger Transaction Register, and various control reports.

Available for: (MS-DOS 16-bit hardware) Columbia MPC, COMPAQ™ Portable Computer, Corona PC™, Eagle®PC, IBM®PC, Texas Instruments Professional Computer™, Zenith Z-100; (Apple 8-bit hardware) Apple®II+, Apple®Ile

Memory: MS-DOS (version 1.0 or later) with 64K RAM. In addition, special versions are available for the Apple II computer with 16K RAM card and Microsoft Z80 Softcard, both 40-column and 80-column displays.

Language: Runs on compiled Microsoft BASIC version. The Apple version requires Microsoft BASIC 5.2.

Disk: Requires two floppy disk drives

list price \$395.00  
pay only \$296.00

### Radio-Electronics Software Store

200 Park Avenue South  
New York, NY 10003

check one

- Peachpak 4—MS-DOS
- Peachpak 40—Apple II with 40-column card
- Peachpak 80—Apple II and Apple ILe with 80-column card

Total Price of Software ..... \$ \_\_\_\_\_  
Sales Tax (NY State Residents Must Include) ..... \_\_\_\_\_  
Shipping (\$2.00 per item) ..... \_\_\_\_\_  
TOTAL ENCLOSED (Sorry, No COD's) ..... \$ \_\_\_\_\_

Name \_\_\_\_\_  
Address \_\_\_\_\_  
City \_\_\_\_\_ State \_\_\_\_\_ ZIP \_\_\_\_\_

**SORRY - NO CREDIT CARD OR COD ORDERS**



# RESONANT CIRCUIT DESIGN

*If you're designing resonant circuits, try putting your computer to work!*

**LAWRENCE G. FRIEDMAN**

■ "Resonant Circuit Design" is a generic BASIC program specifically intended for technicians and experimenters who work with RF circuits or RF filters. "Resonant Circuit Design" will calculate the F, C and L (Frequency, Capacitance, and Inductance) values for a resonant

and the maximum size solid enamel-insulated wire that can be used to wind the coil. This part of the program also recycles, so if you don't like the answer(s) you can specify other dimensions and the computer will automatically recalculate the number of turns and the maximum size wire.

If you want to use a specific size wire you can recycle the parameter section and vary the dimensions of the coil until the desired wire size is indicated.

The program listing is for clarity and universality rather than memory conservation or "pretty printing." In some instances I have taken the "long way 'round" to insure the program will run on most, if not all, modern personal computers—including the pocket-sized portable models.

Possible "translation" problems are indicated in lines 10 and 20. If your computer uses different commands or symbols for CLEAR SCREEN and exponentiation,

## PROGRAM

```
10 REM. CLS = "CLEAR SCREEN"
20 REM. SOME COMPUTERS USE [ INSTEAD OF
  ^ FOR EXPONENTIATION
30 CLS
40 PRINT "RESONANT CIRCUIT DESIGN"
50 PRINT "By Lawrence G. Friedman"
60 FOR X=1 TO 500:NEXT X
70 CLS
80 PRINT TAB(10) "MENU":PRINT
90 PRINT "TO DETERMINE L, C, OR F ENTER 1"
100 PRINT "TO CALCULATE COIL PARAMETERS
  ENTER 2
110 INPUT A
120 IF A=1 GOTO 160
130 IF A=2 GOTO 320
140 CLS:PRINT "RE-ENTER":PRINT:GOTO90
150 IF A=2 GOTO 320
160 CLS:CLEAR
170 INPUT "ALSO CALCULATE COIL PARAMETERS
  (Y/N?);A$
180 CLS
190 PRINT "ENTER A'0' FOR UNKNOWN VALUE"
200 PRINT
210 INPUT "ENTER F IN MHZ>";F
220 INPUT "ENTER L IN UH>";L
230 INPUT "ENTER C IN PF>";C
240 IF F=0 THEN PRINT 1000/(6.238 *
  SQR(L*C));"MHZ"
250 IF L=0 THEN Z=25330/((F^2)*C)
260 IF L<>0 THEN Z=L
270 IF L=0 THEN PRINT 25330/((F^2)*C);"UH"
280 IF C=0 THEN PRINT 25330/((F^2)*L);"PF"
290 IF A$="N" THEN 200
300 IF A$="n" GOTO 200
310 GOTO 390
320 CLS:CLEAR
330 PRINT "COIL PARAMETERS"
340 FOR X=1 TO 1000:NEXT X
350 PRINT:PRINT
360 IF Z<>0 GOTO 390
370 INPUT "ENTER L IN UH>";L
380 LET Z=L
390 INPUT "ENTER COIL DIAM. IN INCHES";D
400 LET D=D/2
410 INPUT "ENTER COIL LENGTH IN INCHES>";G
420 T=SQR((Z*((9*D)+(10*G)))/D)
430 PRINT T;"TURNS"
440 W=T/G
450 C$="IS THE LARGEST WIRE SIZE."
460 IF W<18.9 THEN PRINT "#16";C$:GOTO 540
470 IF W<23.6 THEN PRINT "#18";C$:GOTO 540
480 IF W<29.4 THEN PRINT "#20";C$:GOTO 540
490 IF W<37 THEN PRINT "#22";C$:GOTO540
500 IF W<46.3 THEN PRINT "#24";C$:GOTO 540
510 IF W<50 THEN PRINT "#26";C$:GOTO 540
520 IF W<72.7 THEN PRINT "#28";C$:GOTO 570
530 IF W<80.5 THEN PRINT "#30";C$:GOTO 540
540 PRINT:INPUT "REPEAT PARAMETER DESIGN
  (Y/N?);R$
550 IF R$="Y" GOTO 390
560 IF R$="y" GOTO 390
570 INPUT "REPEAT L,C,F CALCULATION
  (Y/N?);P$
580 IF P$="Y" GOTO 160
590 IF P$="y" GOTO 160
600 END
```

circuit and then go on to calculate the design of an air-wound coil using the calculated or a preselected inductance value.

The program automatically recycles: If the calculated inductor and capacitor values aren't to your liking, you can substitute different known values over and over until you get practical answers.

Finally, you select the coil's dimensions and the program will calculate the required number of turns

make the required changes to the program.

To keep the program reasonably short error-trapping is used only for line 110 where there is the possibility of an incorrect keyboard entry. Other than the keyboard entries ahead of line 140, if you deliberately try to trick the computer with false entries or data the computer will respond with a false answer. But give the program the data it asks for and it will crank out correct values as fast as you can handle them. ◀▶



# INEXPENSIVE IBM'S

*Third-party hardware can mean big savings and added performance for your IBM PC.*

**HERB FRIEDMAN**

■While calling the IBM PC a home-and-family computer stretches the limits of the imagination (because of its price, for one thing), it is true that for business use—even for a kitchen-table operation—the IBM PC is the way to go. Why? Because most high-performance software is written first for the IBM PC. This makes the PC a very attractive machine in the eyes of many. And if you require some highly-specialized software, chances are that you'll find it ready and waiting if you have a PC to run it.

Unfortunately, an IBM PC is expensive, and gets more so as you add accessories. In fact, you cannot even use an IBM PC until you have spent several hundred, or even a thousand dollars for peripherals and accessories. Essentially, the PC works on the same principle as the Barbie Doll: the basic doll is relatively inexpensive or affordable; it's Barbie's clothes and accessories, not to forget the boyfriend Ken doll and his accessories, that eat up the budget. (Barbie and Ken dress better than I do!)

But there are ways you can save anywhere from \$300 to over \$1000:

- Plan carefully so you don't duplicate features.
- Be patient and shop around.
- Have a moderate (at least!) understanding of what you need and what you can substitute for.
- Assemble your own IBM PC system, substituting third-party components—hardware not manufactured by IBM—wherever it won't affect, or will actually improve overall performance.

Besides saving money, you'll end up with a PC having many more features than IBM offers and a model that's customized for your particular needs. The minimum IBM PC configuration that can be purchased (at the time this article was prepared) has 64K RAM and one double-sided disk drive. It retails for \$1815. But for real computing power you'll need a second disk drive (\$425, IBM's price). And if you intend to run a printer you'll need at least one printer adapter, which costs \$75 (parallel) or \$100 (serial). Something missing? Right! There's no video output or monitor. An IBM color/graphics adapter, which has a composite output suitable for color or monochrome, will cost \$245, and

the least expensive "recommended for IBM" monochrome monitor will cost about \$150. So for a computer with two drives, a video monitor and a printer output you would have spent at least \$2710, only to discover that few programs run in 64K RAM: you'll often need at least 128K, preferably 256K. IBM charges \$100 for each 64K of RAM, so your total bill will be \$3010, and you won't even have a serial output for a modem, or a printer. Now if you have read the advertisements in the big city newspapers and the mail order catalogs, you have probably discovered you can purchase a "standard" PC system for well under IBM's price, often saving in the area of \$300 to \$700 depending on the specific hardware you select—or what the dealer insists you *must* purchase.

Is this a discount on the IBM computer? Usually not. In many instances the dealer is using an IBM "bare system," which comes with only 64K of RAM, a keyboard and nothing else. He fleshes the system out using third-party hardware and peripherals. Third-party hardware is the stuff that isn't sold by IBM. For example, IBM charges \$425 for a single disk drive with the IBM logo etched on the front panel. You can purchase a Tandon 100-2 or CDC-9409 disk drive without the IBM logo for about \$200, a savings of approximately \$225 per drive. Let's look at another example. IBM gets \$100 per 64K RAM. The Great Salt Lake Computer Company (1780 West 2300 South, Salt Lake City, UT 84119) sells the 64K kits for about \$50, or \$150 for three kits, a savings of \$150 when expanding the system from 64K to 256K. As you can see, this isn't one of those articles on how to save pennies: we're talking about a lot of money, often the difference between whether you, your business, or your school can afford an IBM PC; and we haven't even started discussing extra features yet.

## **The basics**

First things first, you must get a bare system, officially called "System Unit 64K," whose part number 5150104 is often shortened to simply "...104." This isn't the easiest of things to locate. At the time this article was prepared it was no longer on the price list of some IBM



product centers, and neither the local Computerland nor Sears Business Systems would sell one to an individual. (They don't want to sell you one because they don't want you building up a complete computer system for less money than they will charge you.) However, business is business, and advertisements offering a "bare PC" are appearing with increasing frequency.) Even some IBM product centers suggest they will be selling them in early 1985 when the anticipated demand for the IBM PC slackens.

If you are offered a bare PC at any price—list or discounted—take extreme care to be certain you are getting a PC2—the latest version—which is socketed for 256K RAM in 64K modules, each module consisting of nine (yes, 9) ICs (only 64K is provided in the bare unit). The earlier PC, often called the PC1, was socketed for only 64K RAM in 16K modules. Do not accept a PC1. You want a PC2.

Okay, you now have a computer, but there's no display. First thing you'll need is a monochrome monitor. Amber screens are all the rage, but many users find them difficult to use hour after hour. We suggest the monochrome green-screen Zenith ZVM-121, which sells in the discount price range of \$90-\$115. It has excellent bandwidth, delivers sharp characters from corner to corner, and is the monitor we use when photographing real-time computer video displays. It is in no way the equal of the IBM monochrome display, but it doesn't sell for the IBM's price of \$620 (the cost of the IBM monitor plus the required monochrome adapter).

You'll need something that generates an output from the computer for the video display. For that we suggest the \$245 IBM Color/Graphics Monitor adaptor, which provides either a 40 or 80 character "composite" (color output also suitable for monochrome), and an RGB color output. Just connect your monochrome monitor to the composite output's phono-type jack. While there are third-party color/graphic monitor boards, they aren't all that much better and they cost about the same as the IBM. And why not go with IBM when the price is about the same? There are other boards that

deliver a better graphic display, but they are much more expensive and justified only if you have a need for graphics.

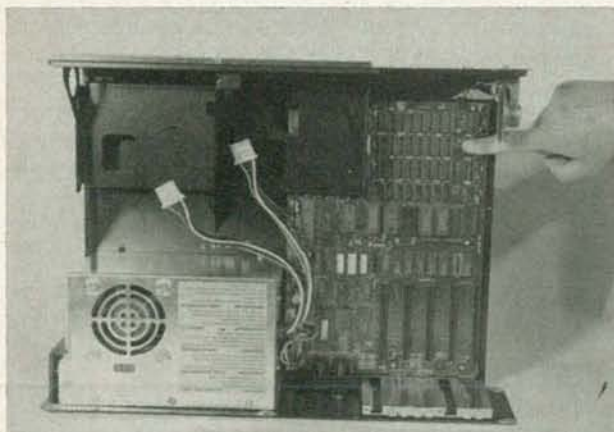
### Disk drives

Next, you'll need disk drives and a disk controller. Many sources sell the Tandon 100-2 and/or CDC-9409 drives for about \$200. Find the least expensive source, but if possible—even if it costs a few dollars more—buy them from an outfit that provides installation instructions on how to set the drives' internal jumpers, and which terminating resistor block to remove. If you try to go-it-alone you can spend weeks trying to determine what's wrong, and the IBM service center isn't going to help you with third-party hardware. For this article we obtained the drives from Conroy-Lapoint (12060 Garden Place, Portland, OR 97223), who provides notably good instructions for their disk drives and user-installed RAM upgrades.

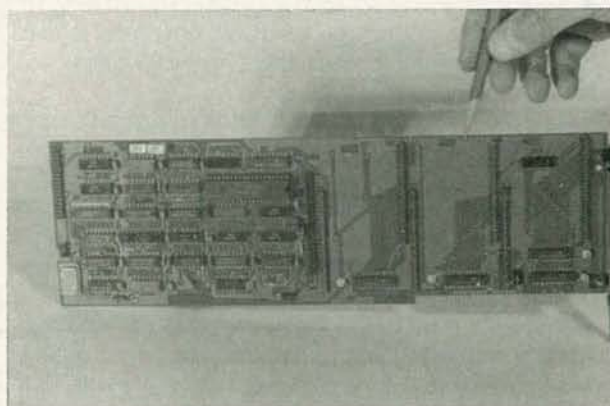
### The disk controller

Disk drives need a disk controller to tell them what to do. IBM's own disk controller (called a "disk adapter") now costs only \$100—a fantastic value. However, the disk controller takes up one of the five available slots, while the color/graphics monitor adapter takes up another slot: leaving three slots for everything else. If you add a printer and a serial output adapter there's just one slot left for future expansion inside the main cabinet. But the disk controller is a plug-in board, and like other plug-ins such as the parallel and serial adapters, calendar/clocks, and RAM upgrades, they are available from third-party sources.

In fact, greater computer flexibility is attained—though it costs a few dollars more—by using multi-function boards (adapters) from third-party sources. For example, a Maynard disk controller, which can be purchased for as little as \$169, is also available with a serial or a parallel printer adapter. Or—and this is preferable—you can use Maynard's *Sandstar* disk interface (approximately \$200), which can accept any combination of up to three additional modules: serial or parallel interfaces, a battery-powered clock/calendar, or a game port. The *Sandstar* interface equipped with a serial and parallel interface is the one we used and recommend. At the minimum, it saves at

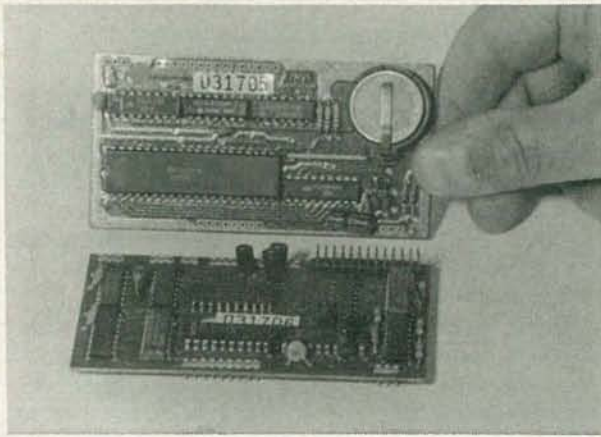


**FIG.1—THIS IS THE MINIMUM PC system you can get. The finger points to the three rows of empty sockets that the user can populate with low-cost IC's to upgrade the supplied 64K of RAM to 256K.**



**FIG.2—THE PENCIL POINTS to one of three empty module locations on a Sandstar disk controller board. Any of the available modules will fit any location.**





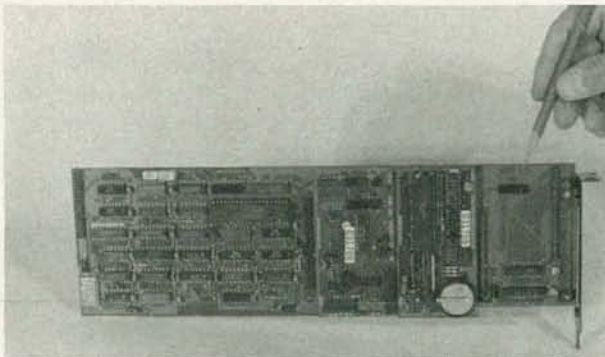
**FIG.3—THE CLOCK/CALENDAR MODULE (top) is non-volatile because it is powered by its own on-board rechargeable battery. Like the parallel printer module (bottom), it plugs directly into the disk controller board.**

least two, possibly three slots. The extra position on our Sandstar controller was used for a battery-powered clock/calendar. We actually had four functions in a single slot. (Because of recent IBM price cuts for their disk controller, we anticipate third-party controllers will be discounted for additional savings.)

#### Still more computer power

Before you run out to purchase your hardware, stop and reflect on what kind of system you'll want to end up with. Will you want a RAMdisk—memory that can function as a disk drive? For that you'll need extra memory and the software. If all you need is extra RAM you can get just a memory expansion adapter from IBM, assuming you have an available slot.

On the other hand, a board called the *Captain*, from Tecmar, Inc. (6225 Cochran Rd., Cleveland, OH 44139) provides the extra memory as well as serial and parallel ports, and a battery clock/calendar. But be careful not to duplicate existing functions. If you started out with a Sandstar disk controller you might already have the needed ports: You might only need extra memory, which is available as a separate memory-only board. To avoid the extra costs of duplicate functions, determine the kind of computer system you hope to end up with



**FIG.4—THIS IS HOW the disk controller board looks with the calendar/clock and parallel printer adapter installed. The pencil points to the remaining module location, which can be used for a serial I/O, another parallel port, or a game port.**

before you make any purchases. If you think you'll want or need the extra memory, use the Tecmar board with its serial and parallel ports, and the basic (no ports) Maynard disk controller, or the IBM controller—which is a best buy at \$100. There are several other sources for memory/port/calendar boards, among them Quadram and AST. More or less, they offer the same features: extra memory, serial and parallel ports, a game (paddle) port, and a battery-powered clock/calendar. An extra "plus" for the non-IBM multi-function boards is that they are usually supplied with a "free" software package that often includes high performance utilities. But there is software, and then there is *good* software.

For example, some of the "free" software which partitions part of RAM into a disk emulator (RAMdisk) simply assigns a drive letter to the partitioned memory. On the other hand, The Tecmar software lets the user substitute the RAMdisk for an existing drive, and then automatically moves the assignment of the existing drives up one notch: if the user assigns the RAMdisk as the B: drive, the software automatically makes the original B: drive into drive C:.

This doesn't sound like much, but if your software is always looking for a data file on drive B: it will default correctly if you copy the necessary files from what is now drive C: to RAMdisk B:. If the RAMdisk is any old assignment, software that defaults to B: will never work correctly out of the RAMdisk. (You can pull off the same trick using PC DOS 2.0 and 2.1, but it's easier if done automatically by the RAMdisk software.)

Software for multi-function memory boards also often permits the RAM to serve as a printer spooler. Again, there is software, and then there is *good* software. Some spooler software doesn't permit disk access for the foreground program while the spooler is in the background. Other software programs the extra RAM on the multi-function card to function as an independent spooler, allowing disk access by the foreground program. Make certain you understand exactly what you are getting in the way of spooler software. As a general rule of thumb, the multi-function boards are primarily super-high resolution graphics adapters, or memory boards with I/O ports, calendars and game ports. If you don't anticipate needing more than the basic 256KB of RAM it's questionable whether a multi-function board will be worth the money. You might be better off with a multi-I/O board—an adapter with any combination of up to four serial or parallel ports. Just eliminating the memory capacity (empty sockets) from a multi-function board can save \$50 or more.

#### Putting it all together

We have wandered around a little to give you an idea of the kinds of savings to be made, and the various kinds of hardware available from third-party sources. It's now time to assemble our PC.

First things first. Take the cover off the bare PC by removing the six screws on the rear apron and sliding the cover forward. Then remove the covers for the disk drive compartments: simply pop the two speed nuts off the plastic posts on the rear of the covers. The RAM and other ICs used on the plug-in boards are extremely



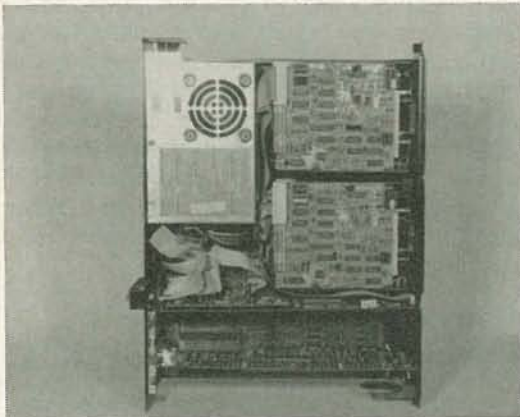
sensitive to static voltage surges; any static electricity in your body must be discharged to ground before you handle any components. Before you do anything else make certain you have a grounding bracelet connected from your wrist to a true electrical ground. If you don't have a grounding bracelet, make one by splicing a 1-megohm resistor in series with a length of wire, solder a small clip to one end of the wire and connect the opposite end to the electrical ground. Attach the clip to your metal watchband, or the metal buckle if your watch has a leather or plastic band. If you don't wear a watch, make some provision to ground yourself because the RAM and the accessory boards usually lose their warranty if they are "blown" by static electricity. Handle nothing if you aren't grounded.

The next step in assembling your "cheaper and better" PC is to install the extra RAM into the empty sockets, making certain the notch on the end of the IC faces the rear of the chassis. Once again, we suggest you make 256KB of RAM the minimum configuration, so fill the three rows of empty sockets.

Next, install the graphics/monitor adapter in any slot except the one closest to the power supply and check out the computer before you install any other boards or accessories. (At each step of the way you must be certain the computer works before you go on to the next step). The monitor adapter installs the same as all the other boards: Select a slot, install the small plastic guide that's supplied with the adapter by simply pressing it into the matching holes on the front of the chassis, and seat the board in its slot. (Note, you must remove the matching slot cover on the rear apron before you seat the adapter in its socket.)

There are two internal DIP switches that must be set to correspond to the amount of memory and the number of disk drives. Remember, at this stage you have no drives. The instructions supplied with IBM's color/monitor board show how to set the switches.

Plug in the monitor and fire up the computer. If it



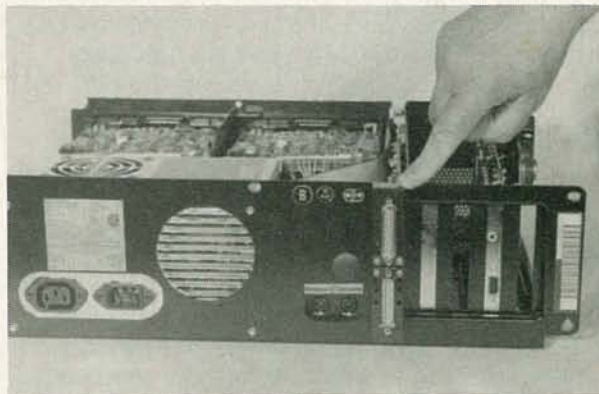
**FIG.5—OUR MINIMAL DO-IT-OURSELVES configuration before further upgrading. The disk drives have been installed, along with the disk controller and graphics/monitor adapter boards. Both parallel and serial modules are installed on the disk controller card, which now provides four functions in a single slot. What appears to be a *rat's nest* of ribbon wire from the parallel and serial modules is just fine; don't try for neatness—Just position the wire wherever it will fit.**

works, install the disk drives and their controller board. The disk controller board must be installed in the slot nearest the power supply.

The standard controllers are supplied with the necessary connecting cables and notably excellent installation instructions, so there's no necessity to go into details here. Take note, however, that the cable is twisted at one of the two drive connectors: this is normal. It accommodates a clever system IBM used to avoid errors when programming each drive's disk selection jumpers.

Unlike the programming of the drive-select jumpers for other computers, IBM programs both drives exactly the same with a "shorting bar" across drive select #2. Do not use any other shorting bars on the drive-select socket. Only drive A: uses a terminating "resistor block" that resembles an IC. Pull the block from the B: drive. Some disk suppliers such as CONROY-LAPOINT provide complete instructions on how to set up the drives.

Install the drives in their compartments. Secure any modules you plan to use with the controller on the disk adapter board along with all connecting cables, then install the controller in the last slot, the one immediately adjacent to the power supply. Connect the power plugs (part of the bare PC) to the drives, and then the ribbon cable from the controller. The cable goes to drive B: first; the end of the cable goes to drive A:. It might appear reversed but that's the way to do it.



**FIG.6—MORE SLOT CONSERVATION. The parallel and serial connectors are installed on a single mounting adapter to avoid "killing" a slot position just for a connector.**

Set the DIP switches on the motherboard for two disk drives. Next, using IBM's DOS 2.0 or 2.1 (which you must purchase), check that everything works correctly. There will be a long delay after you turn the power switch on as the computer checks its RAM. After what seems like an eternity (actually a few seconds), disk drive A: will start and load the DOS (Disk Operating System).

If everything checks out, install your multi-function boards one at a time, testing every function before installing the next board. If you have done your planning carefully you will probably have every feature you want or need and still have at least one slot open for future expansion. ◀▶



# B&K OSCILLOSCOPES

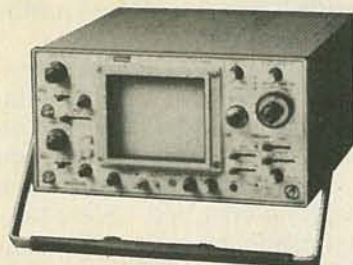
LOWEST PRICES  
OFF-THE-SHELF  
DIRECTLY TO YOU

CALL TOLL FREE  
FOR FAST DELIVERY

## 800-645-9518

In New York State 800-832-1446

### B&K 100 MHz DUAL TRACE, DUAL TIME BASE OSCILLOSCOPE



Model 1580  
**\$1249<sup>95</sup>**  
(Reg. \$1,595.00)

**FEATURES** • 1 mV/div sensitivity • 23 calibrated sweeps • Rectangular CRT with internal graticule and scale illumination • Signal Delay Line • Video Sync Separators • 20 MHz Limiter • X-Y Operation • Z axis input • 16 kV Accelerating Voltage • X10 Sweep Mag-

nification • Delayed Sweep/Dual Time Base • Single Sweep • V Mode - display two signals unrelated in frequency • Sum and Difference Capability • Channel 1 Output • Includes Probes

### B&K 80 MHz QUAD INPUT DUAL TIME BASE OSCILLOSCOPE



Model 1570  
**\$1095<sup>00</sup>**  
(Reg. \$1395.00)

**FEATURES** • 1 mV/div sensitivity to full bandwidth • 500 uV/div cascade sensitivity to 40 MHz • 22 calibrated sweeps • Rectangular CRT with internal graticule and scale illumination • 12 kV accelerating voltage • Mode - display four signals unrelated in frequency •

Alternate timebase operation • Signal delay line • 20 MHz bandwidth limiter • Lighted pushbutton function switching • Video sync separators • Includes probes

### B&K 60 MHz TRIPLE TRACE OSCILLOSCOPE



Model 1560  
**\$899<sup>95</sup>**  
(Reg. \$1150.00)

**FEATURES** • 1 mV/div sensitivity • 22 calibrated sweeps • Rectangular CRT with internal graticule and scale illumination • Signal delay line • Video sync separators • X-Y operation • Z axis input • 16 kV accelerating voltage • X10 sweep

magnification • Delayed sweep dual time base • Single sweep • Auto focus • V mode-displays two signals unrelated in frequency • Sum & difference capability • Channel 1 output • Includes probes

### B&K 40 MHz DUAL TRACE OSCILLOSCOPE

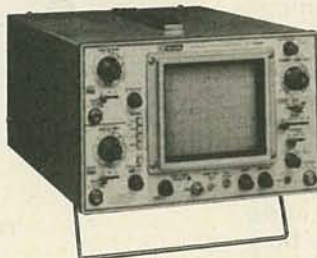


Model 1540  
**\$799<sup>95</sup>**  
(Reg. \$950.00)

**FEATURES** • 1 mV/div sensitivity • 21 calibrated sweeps • Rectangular CRT with internal graticule and scale illumination • Signal delay line • Video sync separators • X-Y operation • Z axis input • 12 kV accelerating voltage • X10 sweep

magnification • Delayed sweep/dual time base • Single sweep • Auto focus • V mode-displays two signals unrelated in frequency • Sum & difference capability • Channel 1 output • Includes probes

### B&K 20 MHz DUAL TRACE TRIGGERED SWEEP OSCILLOSCOPE



Model 1522  
**\$569<sup>95</sup>**  
(Reg. \$695.00)

**FEATURES** • 1 mV/div sensitivity • 20 calibrated sweeps • Rectangular CRT with internal graticule and scale illumination • Video sync separators • X-Y operation • Z axis input • 6kV accelerating voltage • X10 sweep magnification • Auto sweep • V mode-displays two signals unrelated in frequency • Sum & differ-

ence capability • Channel 1 output • Includes probes

### MASTERCARD/VISA ACCEPTED



### PHONE ORDERS ACCEPTED

#### Service and Shipping Charge Schedule

FOR ORDERS	ADD
\$501-750 .....	\$8.50
\$751-1,000 .....	\$12.50
\$1,001 and up .....	\$15.00

# Fordham

260 Motor Parkway, Hauppauge, New York 11788



# COMMUNICATIONS CORNER



HERB FRIEDMAN,  
COMMUNICATIONS EDITOR

## Communication odds-n-ends

THE MAILBAG USUALLY BRINGS A steady stream of information, devices, and procedures that by themselves would not justify a full column, or even half a column for that matter. But because they are often things that may be useful to communications technicians, every once in a while we put them all together even if they're unrelated. This time we'll start out with a look at portable telephones.

A few years ago telephone manufacturers were almost climbing the walls because there were only four authorized channels for mobile telecommunication services. The way they told it, the switched telephone system—the thing I usually call the dial-up system—would eventually sound like the Tower of Babel as neighbors accessed each other's phone.

From the rock-bound coast of Maine to the sunny shores of California, newspapers have entertained us with articles telling of people cruising through neighborhoods trying to determine whose portable telephone they could access to make free long-distance calls.

I've tried to track down that illusive service thief, but each report that I've followed turned out to be ninth hand. And as you might expect, I've never located anyone whose phone was actually accessed by the "phantom of the portable telephone." (No doubt, tomorrow's mailbag will bring in a stack of mail from people whose best friends have illegally accessed their portable telephones.) In addition, there is another problem: People are constantly being harassed by the interminable clicking caused by some one else's

portable telephone or other device in the same building.

Well, as the FCC said when petitioned for more channels: "Technology will take care of the problem." And that's just what happened. The most modern portable telephones use digital encoding—a digital burst transmitted when any key on the unit is pressed. The base unit (which contains the dialer) doesn't respond until it senses the correct code. Therefore, no one can creep through the neighborhood looking for free access to long-distance service, and the folks watching "Dallas" on the TV won't be disturbed by dial-clicking (from the

ing up the phone causes the decoder to automatically reset the system. If either the base or remote unit does not receive the correct code it remains in the standby or muted condition.

While I haven't seen tone-encoded versions of portable telephones, some readers have inquired about them, so I expect they do exist. They would work the same as the tone-encoded walkie-talkies, using either a continuous sub-audible tone, or DTMF (Touch-Tones). Speaking personally, digital is probably cheaper, and certainly the wave of the future.

### New modem uses old idea

Every once in a while I get letters suggesting that I leave the stone age. And a recent column on new uses for carrier-current transmissions—signals broadcast through electric power-lines—was no exception! That discussion brought with it the usual assortment of letters taking me to task for trying to resurrect ideas from the 1930's. Well, this time we're resurrecting old ideas to enhance modern communications systems.

The latest modem for computers is the Line Carrier Modem (LCM), which uses the powerline to carry the computer signals. The LCM contains a miniature transmitter and receiver whose I/O connects to the powerline through the same linecord that powers the modem; the computer connects to the LCM through the standard RS-232 connector. It works the same way as the conventional computer and modem setup used with the dial-up telephone system.

The primary functional dif-

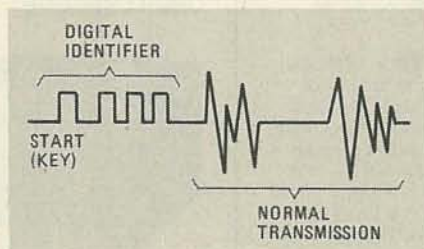


FIG. 1

telephone relays) or calls intended for their neighbors.

Figure 1 is a representation of the waveforms you might expect to see for one encoding system used in portable telephones. Whether it's the base unit transmitting to the portable handset or vice-versa, a digital identifier is automatically transmitted when the device is first keyed, which activates the receivers in both the headset and base.

The receiver responds only after the correct code is sensed, and only then is the system ready to handle the normal telephone chit-chat. At the end of the call, hang-



ference between standard arrangements and the LCM system is that the signals in an LCM system travel from computer to computer through the powerline rather than telephone wires. That means that for communications between computers, you don't have to make a telephone call, and neither do you have to stretch direct wires between two computers. Instead, you simply plug the LCM into the nearest convenience outlet.

For more information on the powerline modems, write to Global Computer Supplies, 9138 Hemlock Drive, Hempstead, NY 11550. (They also have a nifty fiber-optic modem. How's that for the other extreme?)

### Telephone repair

Since the government's smashing victory over AT&T—giving them exactly what they wanted in the first place—the consumer is left with a telephone system that provides poorer service, charges higher rates and, more important, is difficult to obtain repairs from.

In a brilliant move, AT&T split its telephone hardware between two separate companies. That means if a customer—like some sweet little old lady with no knowledge of telephone electronics—calls the wrong people, she not only doesn't get her telephone repaired, but also gets smacked with a bill for \$40 or \$50 because she called the wrong people!

In short, AT&T managed to unload all responsibility for their products by making repair a gamble; guess wrong and it will cost you a good part of your weekly salary or monthly pension. The elderly or infirm, the poor, and anyone just getting by on a small fixed income are going to need help from someone when their telephones won't work.

Given a vacuum, someone must fill it and it is conceivable that they'll turn to the people who keep their TV's running. It's very likely that the TV serviceman will eventually double as a telephone repairman because his is the only service people can rely on.

Think it's farfetched? Then take a look at the latest advertisements for B&K test instruments. Their model 1042 telephone line ana-

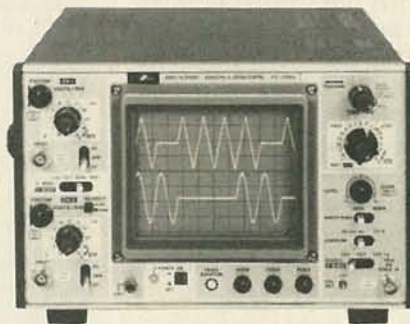
lyzer (\$19.95) will test the incoming line for proper voltages and ring signals, as well as the loop. Carry one of those in your tool box along with a "real telephone" (a Bell Systems model 500 or equivalent) and you can help any customer get a service call straightened out while AT&T and the local operating company play their little game.

Since it's likely that everyone will eventually purchase telephone equipment from third-party sources (what AT&T was after

from the beginning), B&K's 1042 can put you in a position to handle your own household telephone service.

Undoubtedly I'll be receiving mail from B&K in the next few days with information on their model 1045 tester, which tests just about everything having to do with wired and wireless phones. Because of its nearly \$400 price tag, I feel that it deserves a little more space. So, we'll save it for another time. R-E

## AN INNOVATIVE 20 MHz OSCILLOSCOPE THAT EMPHASIZES OPERABILITY \$535\*



IWATSU

SS-5702

DC-20 MHz OSCILLOSCOPE

- 6-inch rectangular, parallax-free CRT
- TV-V trigger
- Variable sweep length
- Double Lissajous figure
- 1 mV/div to 10 V/div sensitivity
- 100 ns/div to 0.2 s/div sweep
- Differential input with ADD mode

\*User price, including probes.

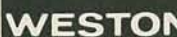
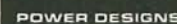
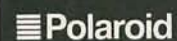
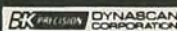
**im**

The Professional Test Equipment Source

**The Instrument Mart**

295 Community Drive, Great Neck, New York 11021  
(516) 487-7430 Outside N.Y. (800) 645-6535

Sales, Service, Rental/Leasing Programs  
... and Pre-Owned Test Equipment also Available





# DRAWING BOARD



ROBERT GROSSBLATT

## Automatic data sequencing

IN OUR LAST DISCUSSION OF MEMORIES, we mapped out the design criteria for our demonstration circuit. We've taken care of keyboard data entry with the binary keyboard encoder that we've already built. This time, we'll see what must be added to that circuit to make it do something useful. After all, what good is the encoder without having some way of storing and/or manipulating its output data.

Since one of the design criteria is automatic sequencing of the address and data, we'll need something in the circuit that automatically does one thing after another. The problem of data sequencing was addressed when we built the binary keyboard encoder, which was designed to continuously scan a series of switches in search of a depressed key.

### Automatic sequencing scheme

Since we'll be sequencing both address and data, we also need

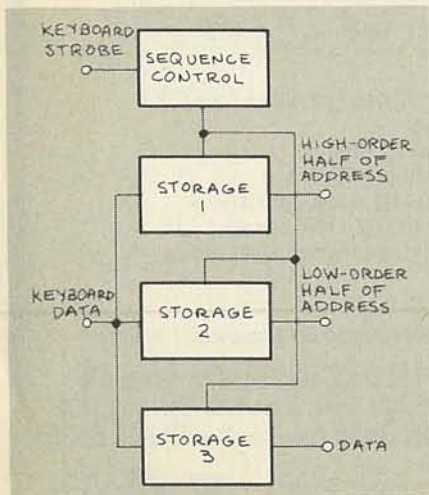


FIG. 1

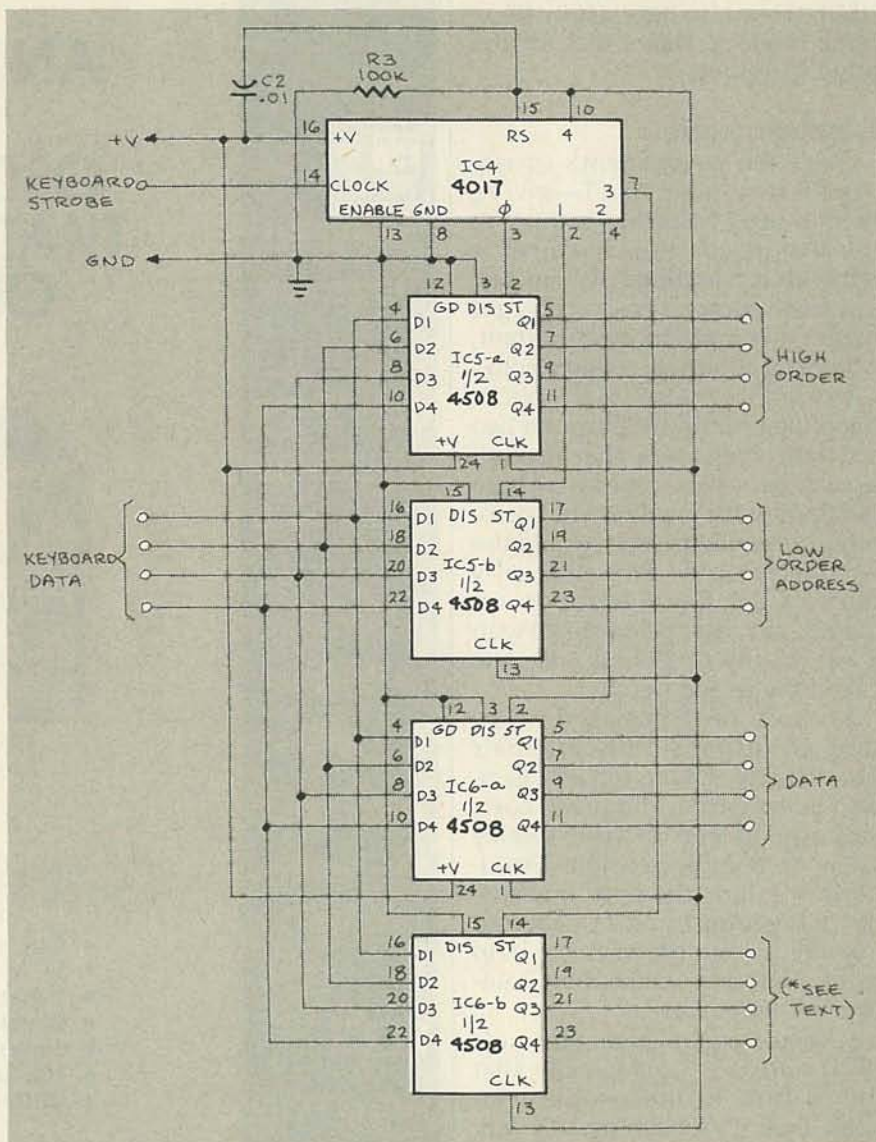


FIG. 2

some way to let the circuit know which is which. The easiest way to keep track of what's stored where is to store the low and high order halves of the address, plus the data separately. Given all that, let's take

a look at Fig. 1, a tentative solution to the problem.

The data coming out of last month's keyboard are fed to a series of latches, each of which is four bits wide. Since the 5101 (the



static RAM that we'll be using for storage) has eight address pins and four data inputs, we'll need three latches to handle the job. You can get IC's that are 4-bit latches, but a "neater" way is to use a 4508. It's a 24-pin IC that is really two 4-bit hold-and-follow latches in one package. By using that IC, we'll only need two 4508's and have one latch left over for any brainstorms we might come up with in the future.

The easiest way to sequence things is to use a 4017 binary counter, an IC you should be really familiar with by now. We spent some time discussing that IC in November and December, 1983. Now that we have the cast of characters for this portion of the circuit, let's put them together and see how they fit into our design.

#### How it works

Figure 2 is a schematic of the circuit we'll use to sequence the binary in information from the keyboard encoder that we built last month. It consists of a 4017 counter/driver and two 4508 dual 4-bit latches. (If you're wondering about the parts numbering, I'm keeping things in line with last month's circuit to avoid confusion.)

The action of the 4017 is (or should be) self explanatory. One thing that does deserve a bit of attention, however, is the way the clocking is being done. The 4017 sequences on the positive going (ground to +V) half of the incoming clock pulse.

Note that the four data lines (0-3) of the 4017 are connected to the STROBE inputs of the latches. That is done to sequentially enable each latch. Also notice that the DISABLE pins of each latch is tied to ground: That means that the outputs of the 4508's are permanently enabled. However, there is no data output unless the strobe input is high.

The 4508 can provide a three-state output, but there is no need for it because there's no common output-bus. Each latch will be used to control different parts of the memory and will, therefore, be connected to different pins. (But keep the three-state option in mind because many applications

# VIZ: THE ISOLATION SOURCE



**VIZ WP-30** Isolated Power Source/  
Monitor ISO-V-AC II

- \*5A max current;  
650 VA max power
- \*Two large, color coded  
taut band meters
- \*Leakage tester with alarm
- \*Output relay protected  
with manual reset
- \*Overload LED indicator
- \*Two grounded AC outlets

## ISOLATED AC POWER SOURCES

The new VIZ WP-29A Monitor ISO-V-AC and the WP-30 ISO-V-AC II give you more power and more accurate line monitoring for your service, quality control or educational applications.

Voltage in the WP-29A is continuously variable from 0 to 150 V, with current ranging from 0 to 2.25A maximum. (0 to 150V, 5A maximum in the WP-30). Plus large 3½" taut band meters monitor AC line voltage, load voltage and load current with an accuracy of  $\pm 2\%$ . Leakage is less than 0.1mA (lower than established ANSI limits!)

For your safety, our isolated power sources are protected with thermal overload devices and grounded metal cases.

VIZ has 9 Isolated AC Power Sources in all; no one else offers you more! Simply put, VIZ is the Isolation Source!

Electro '85 - Booth 3114 • EDS '85 - Booth D13



*The New Power in Test Equipment*

**VIZ TEST EQUIPMENT** division of VIZ Manufacturing Co.,  
335 E. PRICE STREET, PHILADELPHIA, PA 19144  
215/844-2626 TLX: 710-670-2626 800/523-3696

CIRCLE 260 ON FREE INFORMATION CARD



Learn micro-processing with the new  
**MICRO-PROFESSOR 1P**



Students, engineers or technicians—  
upgrade your micro-processing skills  
with the new Micro-Professor 1P.

**The MPF-1P features:**

- extensive software support
- more built-in memory
- improved keyboard
- larger display

Three tutorial guides help cover all capabilities. The ideal training tool! MPF-1P will deliver you into the growing world of micro-processing. Invest now!

**Plus—FREE GIFT** Only **\$179.95**

Check this box for FREE Z-80 Microprocessor Programming and Interfacing textbook when you order within 7 days. \$12.95 value. (Include \$5.00 postage & handling)

**ETRONIX**

Dept. RE0485  
14803 N.E. 40th  
Redmond, WA 98052

For immediate action call TOLL FREE:

**1-800-426-1044**

Full money back guarantee.



CIRCLE 111 ON FREE INFORMATION CARD

# cable TV

## DESCRAMBLER PARTS

We stock the exact parts and PC Board for Radio Electronic's February Article on building your own Cable TV Descrambler.

**#701 PARTS PACKAGE ..... \$29.95**

Includes all the original resistors, capacitors, diodes, transistors, integrated circuits, coils and IF transformers (BKAN-K5552AXX).

**#702 PC BOARD ..... \$12.95**

Original etched & drilled silk-screened PC Board used in the article.

**#704 AC ADAPTOR ..... \$12.95**

(14 volts DC @ 285MA)

**Both #701 & #702 ..... \$39.00**

**FREE!!** Reprint of Radio Electronics Article on Building Your Own Cable TV Descrambler with any purchase.

Add \$4.00 Postage & Handling

TOLL FREE

1-800-227 8529 (Orders Only)

1-617-339-5372 (Information)

**J & W  
ELECTRONICS, INC.**

P.O. Box 800  
Mansfield, MA 02048

CIRCLE 65 ON FREE INFORMATION CARD

require that feature, which is not found on all latches.)

When power is turned on, all four latches are cleared by the R-C pulse generated by R3 and C2. Also at turn-on, pin 3 (output "0") of the 4017 goes high and enables the inputs of the first latch. The circuit then sits there and waits patiently for you to press a key on the keyboard. In other words, any data presented to the input of IC5-a will now be transferred to its output.

When a key is pressed, encoded data enters IC5-a and is passed on to its outputs (which is connected to 4 address inputs on the 5101 CMOS static RAM). At the same time, the strobe line goes from high to low and remains in that state so long as the switch is held down.

After the key is released, the strobe line returns to the high state and the 4017 advances by one count. That disables the first latch (IC5-a) and enables IC5-b, the next latch in the chain. The same action is repeated for each successive latch.

When putting the circuit together (and you should), note that the 4017 counts on the release of the switch rather than on the pressing of the switch. You could make things happen when the key is first pressed if you want, but it would take a bit more hardware and, quite honestly, I can't think of one reason for doing things that way.

When data comes off the keyboard, they are sequentially stored in each latch automatically. Now, automation is a wonderful thing, but there are times when you want a little more control. In our case, automation means that there's no way to go back. Put another way, if you hit the wrong key, there's no way to correct it. That's the penalty you pay for not designing things to work with an "enter" key.

If you feel that you'd like to be able to go back, or you want to actually strobe the data into the latch separately, all you have to do is put a clear switch into the circuit, or clock the 4017 with a separate switch. How to go about doing such things is a good exercise to see if you really have a clear

understanding of all the things we've done so far. Design it yourself and try it out. As for me, I'm all in favor of automation.

When you add extra features to the circuit, keep in mind all the design rules we've discussed. Write everything down, from the criteria to the actual hardware you're putting in the circuit. As I said before, bad habits are hard to break, and any circuits designed with bad habits have a way of going up in smoke!

You'll notice that we have an extra latch left over. Since all we're handling is four data-bits and eight address-bits, the last latch seems to be an unavoidable waste of hardware. Why not put in some brain burning time until next time; see if you can think of some use for it? I've already got something slick in mind—how about you?

### Feedback

Before we end this month's discussion, there's a piece of important business that requires immediate attention. I thought that I'd taken care of it some time ago, but it seems that it needs a little bit of clearing up and now's as good a time as any.

I've received several letters lately that contain more or less the same comment. Several of you have said, "I like what you're doing but" (followed by): "I know a way to do it better;" "I know a way to do it easier;" "I can do it with fewer parts;" "My way uses a lot less power," and other such statements.

I guess there's some confusion about what you're supposed to get from this column. There are many schematics of workable circuits drawn and explained here, but the point of them *isn't* to compile a list of construction projects or, for that matter, anything like the sort of thing you'd see in the many books dealing with the 555 timer.

If you look over some of our past discussions, like the ones on the 4018, which began in January, 1984, you'll realize there's much more to it than just figuring out how to generate sinewaves. After all, our final circuit only had a handful of parts and was far short of what is needed for any really serious audio measurements. Not only that,



but we spent three months or so putting it together!

Once and for all, let me state what I thought was obvious: The point of these discussions is *not* to show you how to build anything in particular, but merely to show you how to build anything in general. More often than not, the reason what works out well on paper falls apart in practice is because the approach to the project is wrong!

Getting something from *brainstorm* to *breadboard* must be done in a rigorous, systematic way, or the chances of success are just about non-existent. Listing design criteria and flowcharting the initial idea are as important to the final design as deciding how long the power cord should be. Without a scientific, well documented approach to the problem, you might as well forget the whole thing and take up stamp collecting.

Besides emphasizing the method of design, I've tried to pick areas that interest me and, I hope, you as well. Using neglected IC's and coming up with the "bare bones" of useful circuits is only a side benefit. The main benefit is to show how any design problem is handled.....in a very structured, step-by-step way.

Bad habits will do you in every time. Not keeping notes and a listings of what you started out to do, are doing, and expect to wind up with is a guaranteed way to screw yourself up. Breadboards have a really nasty habit of turning into a "rat's nest" of wires with parts placed on the board as you think about adding them.

Imagine getting a working, breadboarded version of some circuit and then being forced to leave it alone for a couple of weeks. When you finally get back to it, figuring out which wires go where, and why certain parts were used, is just about impossible unless you have taken good notes.

I'm sure that many of you out there can figure out better, simpler, or less power-hungry circuits than the ones finally developed here. In fact, I'd be surprised if you couldn't, and somewhat disappointed if you didn't. Remember Grossblatt's Fifth Law: There's always a better way!

R-E

# FREE famous high tech catalog

More than just a catalog, a trustworthy guide to what's new in computers and electronics.



Metal Detector

For many years, the Heathkit catalog has been a guide to new, exciting kit products for people like you to build. To enjoy. Learn from. And save money.

Triple-Trace Oscilloscope  
Computerized Weather Station



Ham Radio Transceiver

What sets this catalog apart is its range of high quality products and accurate information on every product.

Over 450 interesting items - Computer hardware and software • Robots • Precision test instruments • Computerized weather instruments • Solar hot water • Automotive and home energy products • Security devices • Color TVs • Video recorders, cameras and accessories • Stereo components

• Amateur radio gear • Electronics courses leading from basic electronics to high tech.

Microprocessor Trainer & Course



Real Time Spectrum Analyzer



Most Accurate Clock

40-Channel Scanner



With Heathkit, you'll discover a special pride of accomplishment by creating hand-built quality that is uniquely yours.

You'll build your kit with confidence too, knowing you're backed by our simple promise, "We won't let you fail."

If you don't have the latest Heathkit Catalog, the whole family is missing something great.

HERO® Robot



IBM PC- Compatible Computers



Send NOW for your FREE Heathkit Catalog

**Heathkit**  
Heath Company

Heath Company, Dept. 020-282  
Benton Harbor, Michigan 49022

Please send me the latest Heathkit Catalog Free.

Name \_\_\_\_\_

Address \_\_\_\_\_

City \_\_\_\_\_ State \_\_\_\_\_

Zip \_\_\_\_\_

A subsidiary of Zenith Electronics Corporation

CL-777C

CIRCLE 86 ON FREE INFORMATION CARD

APRIL 1985

87



# ANTIQUE RADIOS

## Restoring antique radios

PREVIOUSLY, WE STEPPED BACKWARD IN time a half century or so, and saw that what was then new technology has today become an intriguing hobby. It's perhaps a new adventure for the modern computer genius, but it's a return of old memories for the more mature radio and TV servicemen, or hobbyist. No matter what category you fall into, the objective remains the same—to make that old radio look and work like new.

Once you've discovered that old treasure and taken it home, you'll want to set it up in the living room for all to see. That's when the temptation to plug it in and see if it works sets in. But there are a few things that should be taken care of first!

### Preparation for restoration

The first you should do is set the unit outside your house or shop, so that it can be cleaned and fumigated—yes, fumigated. Any item that has been just lying around dormant—who knows where—for over 30 years should be cleaned before being brought into your home or shop.

During that preliminary cleaning, take care not to destroy any valuable information. Things like tube diagrams, schematics, and model numbers can be lost forever because of carelessness. It's a good idea to cover anything that you may want to keep.

The unit should be treated with insecticide inside and under the cabinet, but try not to spray the speaker cone. After that, it should be covered for a few days to protect it from the weather and left outside to ventilate. (Have you ever smelled one of those old



FIG. 1



FIG. 2

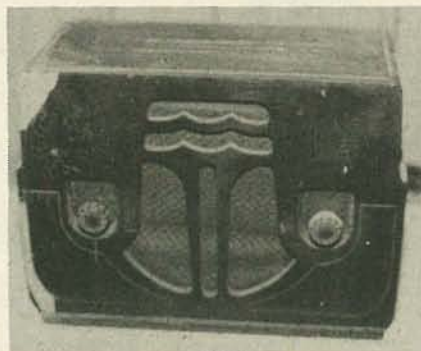


FIG. 3

units after it has been sitting in a damp basement for a while?) Once done, you can brush out the loose dirt and "anything else" you might find. Your radio should now be presentable enough to go into the house.



RICHARD D. FITCH

Once the set is reasonably clean, you should be able to see any obvious defects; for instance, there may be cracks or scratches in the wood. Also, make sure that there aren't any tube sockets without tubes or tubes in the wrong sockets.

Any wires sticking out of a hole in the chassis should be suspect to you. Also make sure that the big dynamic speaker is in place, though that's something that should have checked out before buying the set.

As when working with any other electrical or electronic device, your own safety should be of primary concern. Many 40 to 50 year-old radios may not have their original circuitry. Modifications in the set can be extremely hazardous, as can missing knobs, or frayed wires.

If the set is missing a knob and you don't have a spare, at least wrap some tape around the shaft before plugging the set in. Frayed power cords are also potentially dangerous.

Until a few simple tests are made, it's best not to touch any conductive part of the unit once it's plugged in. That includes chassis bolts (see Fig. 1), which will probably be sticking out from the bottom of the cabinet.

Besides the shock hazards, the early radio serviceman often suffered painful burns from hot (temperaturewise) components. Many old radios had large wire-wound tapped resistors sticking straight up on the chassis, as shown in Fig. 2, which were so placed to dissipate heat through the back of the cabinet.

Those resistors were about as in-



the-way as they could be, and there was no way to stick your hand into the cabinet without being burned. The old rectifier tubes were also favorite "get-burned-on" components. Most other components in radios, including the power transformer, shouldn't get hot enough to cause injury. If they are excessively hot, the parts are either shorted or in a faulty circuit.

### Turning it on

Before plugging in a strange old radio, it's usually best to turn the power switch on. Then you can plug the line cord into a receptacle momentarily and not have to physically touch the set. If the panel light comes on when the set is plugged in, approach it cautiously, making sure the set is positioned so that you can look into the back of the cabinet to see the chassis.

If there is any smoke or a strange smell coming from the unit, unplug it immediately. All those who are experienced in electronics are familiar with the different odors emitted by various smoldering components. Find out where the smoke or smell is coming from and don't plug the radio back in before you've corrected the problem. If you do, you may burn up a component that's difficult to replace.

Further, if when the set is turned on you get no audio, there should at least be a slight audible hum coming from the speaker. If the hum is objectionable (excessively loud) or non-existent, you have a problem. (The individual problems will be discussed in a future article.) No hum at all may not be as serious as an objectionable hum.

If the power supply seems to be working and there is no hum, check the speaker wires. Also check to make sure that the speaker is not unplugged. Even a damaged speaker with a torn cone and an off-center voice coil should emit some kind of sound. Check all wires going to the speaker array. That could be anywhere from two wires on up, depending on how many other components are mounted to or near the speaker.

With all the tubes and panel lamps lighted, you should—provided there is also a slight

hum—hear some music (or *something*) through that old electro-dynamic loudspeaker. If not, try feeding a quick signal to the unit through a grid capacitor or the antenna terminal. For the best signals, check that the band switch isn't tuned to one of the shortwave frequencies.

Also, some old radios have separate volume controls and power switches. Make sure power is turned on and the volume control is turned all the way up. Despite the massive size and tube complement, many radios won't play without an external antenna (one that's outside the set, not necessarily outside the house). Any short piece of wire, makes a fine temporary antenna. You don't have to be authentic and go out the window and across the roof (as was necessary in times past).

In the 1930's, some manufacturers went all out to include special features in their radios. Multi-bands, treble and bass controls, and tuning eyes can be found on many old radios. Any of those con-

trols can contribute to a no-signal condition or excessive hum. Some of the smaller "budget-priced" sets produced during that era may not include extra features.

Those budget sets, like the one shown in Fig. 3, were designed to make it possible for almost everyone to own a radio during the depression era (1930's). While the chassis in those sets were adequate, the cabinets that the units were housed in didn't seem to hold up as well as their console counterparts. That might be the reason why old console-model radios seem easier to come by today than the smaller types. If you do find one of the smaller units, you'll need to have a little more patience when restoring the cabinet.

Before closing, we have an announcement to make. If you have old radio parts and/or information that you'd like to share, or perhaps are in need of the same, write to this column and let us know. We'll do our best to match up those that need with those that have something to share. **R-E**



- for
- COST SAVINGS through volume
  - PROMPT SERVICE large inventory
  - HIGH STABILITY specialized experience

ON  
QUALITY CRYSTALS FOR

General Communications • Industry  
Marine VHF • Amateur Bands  
Scanners • CB Standard • CB Special  
Microprocessor

**TELL US YOUR NEEDS**  
Call or write for FREE CATALOG



**JAN CRYSTALS**  
P.O. Box 06017  
Fort Myers  
FL 33906-6017  
(813) 936-2397

Since  
1965



CIRCLE 104 ON FREE INFORMATION CARD

SEE YOUR DEALER TODAY

FROM



HERE'S A TIP  
THAT'S PERFECT!

AM/FM AUTO RADIO  
AND CB

**'Firestik' II**  
GOLDEN SERIES

BARE-HANDS TUNABLE  
"NO TOOLS NEEDED"  
HIGH PERFORMANCE ANTENNAS

ALSO ANTENNAS FOR  
CORDLESS TELEPHONES  
MONITOR SCANNERS

Dealer & Distributor Inquiries Invited  
SEND FOR FREE CATALOG

'Firestik' Antenna Company  
2614 East Adams/Phoenix, AZ 85034

Name \_\_\_\_\_  
Street \_\_\_\_\_  
City \_\_\_\_\_  
State \_\_\_\_\_ Zip \_\_\_\_\_

Serving the CB and  
Communications Market Since 1962.

**5-YEAR REPLACEMENT WARRANTY**

CIRCLE 100 ON FREE INFORMATION CARD



# SERVICE CLINIC



JACK DARR

## Some "new" developments

LOOK AT ONE OF THE NEWER SETS ON the market and you'll find lots of new circuits and devices, but you'll also find "new" circuits and devices that are merely redesigned old ones. One such device is an optocoupler. The first ones were pretty bulky; they used a pilot lamp and a selenium photoelectric cell located at opposite ends of a tube about 3 inches long and half an inch in diameter. When the pilot lamp was on, it generated a signal in the selenium cell.

The early optocouplers were fairly bulky, and were not too good when it came to frequency response. Those devices have been refined and miniaturized now. The newer ones are made in an IC package and use a LED as the light source and a phototransistor as the photoelectric cell. They are also more useful at higher frequencies.

With those devices, the isolation between input and output is extremely good. So, they are used in several new sets to couple the horizontal drive signal to the output stage. They are also used to isolate the two grounds—the AC ground of the line-connected DC power supply, and the signal ground of the rest of the circuitry.

Figure 1 shows the optocoupler used in a Sylvania chassis. In that circuit you can see the two grounds. The emitter of the driver transistor is the power-supply ground. The other ground in the circuit is the signal ground and is isolated from the other ground in the circuit.

Testing an optocoupler for proper operation is simple. Just

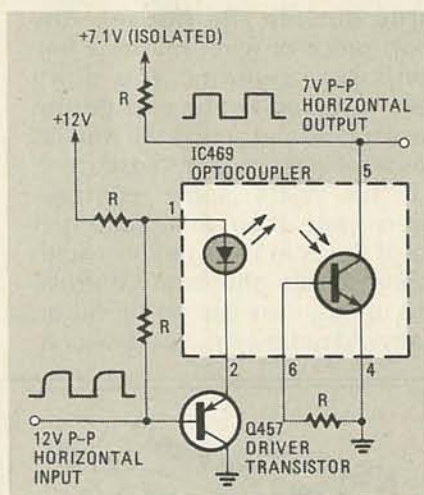


FIG. 1

use a scope to look at the input and output signals. If they are the same, everything is fine.

### Stereo TV

Now let's get to something that really seems to be new. That is stereo TV sound. But stereo sound is not really new, and stereo TV sound is basically just the same as the stereo FM we have been working on for a long time. The sound carrier, at 4.5 Mhz, carries the L + R signal, as well as the pilot carrier for use in demodulation. It just that we are not used to seeing the circuitry in a TV chassis.

One new wrinkle that has been added is SAP, or Separate Audio Program. That can be used to provide a channel of "alternate" audio programming. It can be used to provide a second language sound track for a program, or for audio programming that has nothing at all to do with the video programming.

As to the stereo decoding pro-

cess, the TV sound carrier is picked off at the video detector, as usual. The 4.5 MHz carrier is then fed to a buffer stage to build it up a little, then on to the FM detector, and, finally, to the stereo decoder module. The process of detection seems to be identical to that used in FM stereo, with a pilot carrier to help in the separation.

There doesn't seem to be anything new or radical in the decoder, and the servicing of which should be just as easy as any FM stereo system. That is, check for the presence of the pilot signal, and the two (L and R) outputs. Most of the circuitry is contained within IC's, so troubleshooting will mainly consist of seeing that the inputs and the outputs to all of the IC's is correct.

Be that as it may, it looks as if TV stereo sound has finally arrived, after years of complaining about the quality of TV sound. The new audio circuits should not be difficult to service, once you get used to the slightly different frequencies used. And, thank goodness, no new equipment will be needed for troubleshooting and servicing stereo TV's. **R-E**

## SERVICE QUESTIONS

### ROLLING, UNDERSIZED PICTURE

*On a GE 19YA I replaced the horizontal output transistor and the flyback. When I finally got a picture, it was undersized and rolled intermittently. The voltage coming out of*



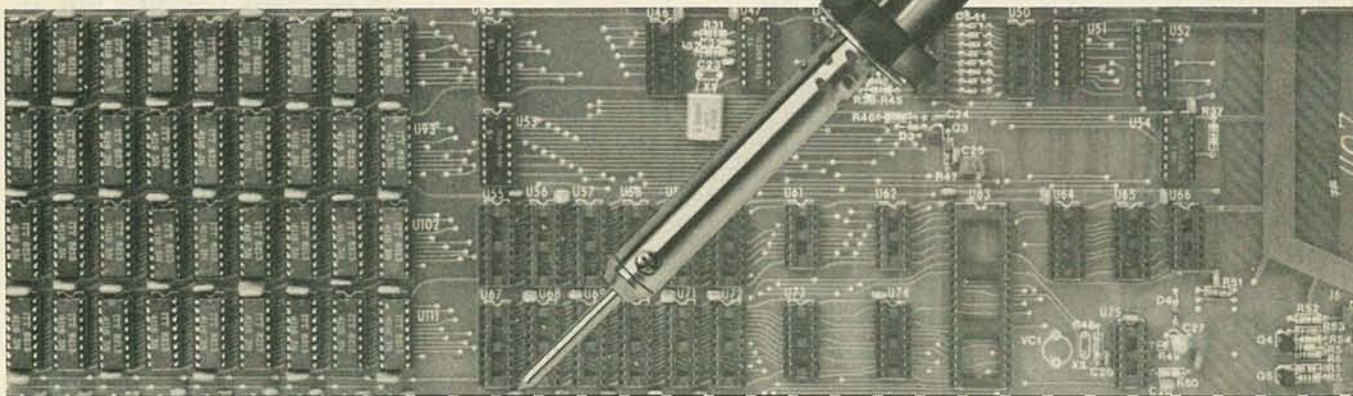
# SEE THE LATEST HIGH TECHNOLOGY SOLDERING TECHNIQUES DEMONSTRATED ON VIDEOCASSETTE!

Keep up to date with the newest techniques for soldering integrated circuits and chip components with this 15-minute, information-packed videocassette prepared by the Electronic Industries Association/Consumer Electronics Group.

Produced under the supervision of professional electronics technicians and engineers from leading electronics manufacturers, the tape focuses up close on actual work bench situations. It shows you the latest tools and equipment... and step-by-step it demonstrates proper soldering techniques, showing you how to work more quickly, safely and efficiently while servicing even the most sensitive electronics products.

Produced by EIA/CEG as a service to the industry, the tape is available for only \$15—one of the best investments you can make to stay on top in your own work or to train others in the rapidly changing electronics field.

Send in the coupon for your cassette today to  
EIA/Consumer Electronics Group  
Dept. PS, P.O. Box 19100  
Washington, D.C. 20036



Make check or money order payable to  
Electronic Industries Association.

Please Send Me  
The EIA/CEG  
High Technology  
Soldering Tape @ \$15 prepaid.

- VHS FORMAT  
 BETA FORMAT

QUANTITY
----------

TOTAL
\$

NAME \_\_\_\_\_

COMPANY \_\_\_\_\_

STREET \_\_\_\_\_

CITY \_\_\_\_\_ STATE \_\_\_\_\_ ZIP \_\_\_\_\_



# Be an FCC LICENSED ELECTRONIC TECHNICIAN!



Earn up to \$600 a week and more!

Learn at home in spare time. No previous experience needed.

No costly School. No commuting to class. The Original Home-Study course that prepares you for the FCC Radiotelephone license exam in your spare time! An FCC Government license is your "ticket" to thousands of exciting jobs in Communications, Radio & TV, Mobile two-way, Microwave, Computers, Radar, Aerospace and more. You don't need a college degree to qualify, but you do need an FCC License. **No need to quit your job or go to school!** You learn how to pass the FCC License exam at home at your own pace with this easy-to-understand, proven course. It's easy, fast and low cost! **GUARANTEED PASS**—You get your FCC License or money refunded. Write for free details. Soon you could be on your way to being one of the highest workers in the electronics field. **Send for FREE facts now. MAIL COUPON TODAY!**

## COMMAND PRODUCTIONS

FCC LICENSE TRAINING, Dept. 90  
P.O. Box 2223, San Francisco, CA 94126

Rush FREE facts on how I can get my FCC License in spare time. No obligation. No salesman will call.

NAME \_\_\_\_\_

ADDRESS \_\_\_\_\_

CITY \_\_\_\_\_ STATE \_\_\_\_\_ ZIP \_\_\_\_\_

## CAN/AM SATELLITE TV DESCRAMBLER

Works on Everything

Fully Assembled & Tested

No Internal Connections to Receiver

Works on both American & Canadian Birds

For Use with TVRO's Only

Modulator Installed, Baseband Output Optional

**\$395.00**

Tampa Electronic Supply  
9207 N. 14th St.  
Tampa, FL 33612  
(813)933-5795

*the power supply is low. How can I isolate problems in the scan supply? What can I look for?—D.D., Huntington, WV*

Your trouble is not in the scan supply, but in the low-voltage supply. You are getting 95 volts where you should be getting 140 volts. I have a strong feeling that C904A, the input filter, is open.

### SNOWY PICTURE

*An RCA CTC-43A that I'm working on has snow in the picture. The RF-AGC control has some effect, but not much. I checked all resistors in the RF Amp. and AGC circuits to no avail.—R.C., La Crosse, WI*

Of course, you realize that a weak RF amp, 20S4, would give you snow, and of course, because it's an expensive little bugger, you don't want to go out and buy one just on a hunch. Hook an external DC supply to the AGC post on the tuner. Sweep up and down the operational voltage by a volt or two. If you cannot get rid of the snow, you have tuner trouble. If you do get rid of it, then go back to the AGC circuit to find out why it is not doing automatically what you can do manually.

### BLOWING FUSE

*On a Samsung TV, I replaced the open .8 amp fuse which blew again a week later. All components in the power supply checked good. Do you think something might be breaking down under load?—G.S., Philadelphia, PA*

Sure, but it's not an easy thing to find until it breaks down for keeps. On the other hand, you might have one of those borderline cases in which the fuse is simply underrated. I am strictly opposed to playing around with circuit designs, but raising the fuse value by 0.2 amp to a 1 amp will give you that extra edge without compromising safety. If the new fuse blows again, then all doubt about breakdown will be removed. **R-E**

### HOT FLYBACK

*The 6JE6 current in this set is normal at 210 millamps. I have a good picture with good brightness and no picture shrinking. Yet, the flyback transformer runs hot to touch after 30 minutes of operation. What could cause this?—V.G.T., Philippines*

In every instance that I can remember, a hot flyback meant a defective flyback, and that usually also meant shrinking picture, focus problems, and low high-voltage. Heat can be a relative thing. What you feel is "hot to touch" may be normal heat build-up after 30 minutes of play. My advice to you is to do nothing for now. Just observe. If the flyback is indeed on the way out, you'll know it soon enough. However, if nothing further happens, you are mis-diagnosing.

### REPAIRING VCR's

*With the proliferation of VCR's in the home, there seems to be a real opportunity growing. In your opinion, what equipment is basic in VCR servicing?—J.J., Haddon Heights, NJ*

The basic equipment is what every TV repair shop should already have. A good meter is, of course, essential, as is a wide-band scope and color generator. Then there is a matter of quality: An NTSC color generator is more useful than a keyed-rainbow generator and a triggered scope more useful than a conventional one. For high-output and high-grade VCR servicing, one would need to go into a frequency counter and sweep/marker generator for alignment purposes. An analyst, or signal-injector, would make the high-tech workbench complete.

### SLOW GUNS

*We are having a problem with an old Fleetwood color set that is defying logic. The symptom is all green on the left edge of the raster, caused by a slow coming on of the red and blue guns. Picture and color are otherwise perfect. We've checked every part in the RGB circuit, demodulator and video output.—P.D., Waterloo, Ont.*

Anything that might be wrong in the signal circuits would be evident over the entire screen, not just one side. Your statement about the slow emission of the red and blue makes me think of a poor kine. Why not run a purity check to see if you can clean up the raster? Another thought: You might have defective blanking or filtering, showing up as green simply because that is the strongest component. **R-E**



## SPECTRUM ANALYZER

continued from page 47

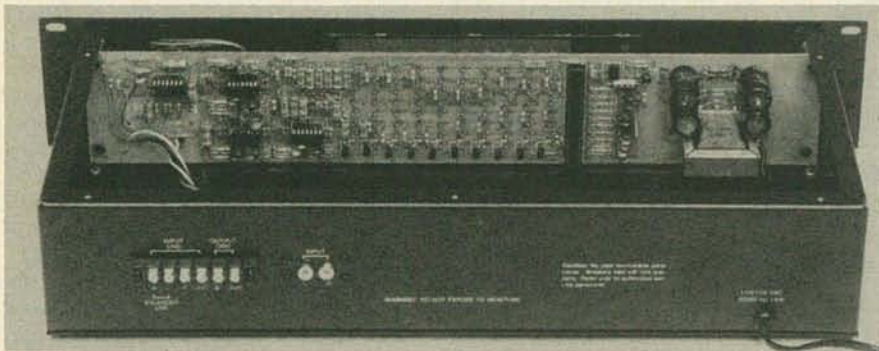


FIG. 7—THE COMPLETED ANALYZER, mounted in a 19-inch rack cabinet. Since most of the components are mounted on the circuit board, there is a lot of room inside the cabinet.

board mounted, the depth of the switch and potentiometer will determine the length of the standoffs you'll require. If you use very low-profile parts for that section, you'll be able to bolt the circuit board very close to the faceplate. That will give excellent visibility to the LED's. A red plastic filter may be glued on the back of the window for a professionally finished display.

### Calibrating the analyzer

The following resistors should be placed in position but not soldered: R91, R93, R95, R97, R99, R101, R103, R105 and R109. To calibrate the analyzer:

- The unit should be powered up with the selector switch in the oscillator-output position (AUX). That will display the oscillator output.
- The LEVEL potentiometer, R113, should be adjusted until the LED's make the straightest possible horizontal line with one LED lit per octave. The level should be played up and down until the straightest line is achieved.
- It is normal for some of the LED's to be higher or lower than what is desired.
- Table 1 lists the resistors for each respective octave. Using the chart, replace the resistor for the lowest octave that has a LED too low with a 430K calibrating resistor. Be sure to remove power from the unit anything you replace resistors!
- Readjust the level control for the straightest possible line. Since all of these parts are interactive, each change may al-

TABLE 1

Octave	Resistor
31.5	R99
62	R97
125	R95
250	R93
500	R91
1K	R101
2K	R103
4K	R105
8K	R109

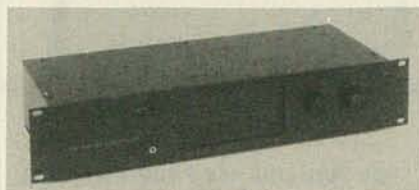


FIG. 8—THE REAL-TIME AUDIO ANALYZER as seen from the front. It is very clean in appearance and will look right at home with your stereo system.

ter the line. Repeat the process for all of the LED's that are too low, lowest octaves first, until all that is remaining is a straight line and LED's that are too high.

- The procedure is again repeated for the high LED's, beginning with the lower octaves. The resistors removed for the high LED's are to be replaced with 520K calibrating resistors.

To re-iterate, the steps are to: a) Find the lowest octave that has a LED too low. b) Find the resistor number for that octave. c) Replace that resistor with a 430K calibrating resistor. d) Readjust level control for straightest line. e) Repeat until only straightest line with LED's too high remain. f) Find the lowest octave that has a LED too high. g) Replace that resistor with a 520K ohm calibrating resistor. h) Readjust level control for straightest line. i) Repeat until only a horizontal straight line of LED's is visible.

The audio analyzer is now calibrated. The calibration resistors can now be soldered in place and the leads clipped to proper length.

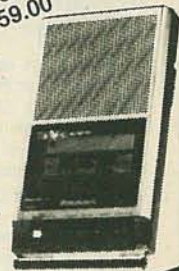
The addition of the real-time analyzer to a stereo system, PA, or recording console allows you to see what you're hearing (or what you're not hearing). It can be used as a tool when taping (to match tapes with the original source, or to discover the playback characteristics of a tape machine). As it reveals the spectral content of the music played it can be enjoyed as an educational, entertaining, and colorful display.

R-E

## SUPER LONG PLAY TAPE RECORDERS

10 Hour Model — \$95.00\*  
14 Hour Model — \$159.00\*

Modified Panasonic Slimline. high quality. AC-DC Recorders provide 5 or 7 continuous hours of quality recording & playback on each side of cassette for a total of 10 or 14 hours depending on model. Built-in features include • Voice level control. • Digital counter, etc. TDK DC 180 Cassette Furnished.



### PHONE RECORDING ADAPTER

Records calls automatically. All Solid state connects to your telephone jack and tape recorder. Starts recording when phone is lifted. Stops when you hang up. \$24.50\*  
FCC APPROVED



### VOX VOICE ACTIVATED CONTROL SWITCH

Solid state. Self contained. Adjustable sensitivity. Voices or other sounds automatically activate and control recorder. Uses either recorder or remote mike. \$24.95\*  
\*Add for ship & hdg. Phone Adapter & Vox \$1.50 ea. Recorders \$4.00 ea. Cal. Res. add tax. Mail order, VISA/M/C, COD's OK. Money Back Guarantee. Qty. disc. avail. Dealer Inquiries invited. Free data. © AMC SALES INC. Dept A 9335 Lubec St., Box 928, Downey, CA 90421 (213) 869-8519



CIRCLE 108 ON FREE INFORMATION CARD



## AN AFFORDABLE VOCODER

Our VOCODER with 8 bands of resolution makes electronic instruments speak with remarkable intelligibility. Features by-pass select, mic signal mix, noise reduction, sibilance enhancement, hi/lo gain option, fuzz option, mono/stereo select and more. Requires a +/-15v. DC supply @ +/-75ma. Our easy to assemble kit, is only \$99.95 plus \$3 shipping. Other special effects kits include, Reverb, limiters, EQ, Hyperflange & Chorus, Quadra fuzz, synchronizers and more.

Ask for our FREE Catalog.

**PAiA Electronics, Inc.**

Dept R 1020 W. Wilshire, Okla City, OK 73116  
inquiries (405) 843-9626  
orders (800) 654-8657

CIRCLE 90 ON FREE INFORMATION CARD

APRIL 1985

93



# KeproClad

by Kepro Circuit Systems, Inc. T.M.

## At Home Professional Quality Fine Line PCB's.

Introducing an easy, inexpensive, step by step method for the home production of professional quality printed circuit boards without a major equipment investment—KeproClad, by Kepro, makers of quality industrial equipment and supplies. KeproClad was designed for the home user who needs professional results with:

### A Simple Circuit Board;

Use KeproClad unsensitized copper-clads. These boards come in 2 popular sizes with 1 sided foil, a marking pen, all for a suggested retail price as low as \$3.50.

### A Fine Line Detailed Board;

Use KeproClad photosensitized copper-clads. Available in 2 sizes with 1 or 2 sided foil. These copperclads use the latest technology of negative acting dry-film photoresist. This material is rugged, yet holds extremely fine detail. It comes with a premeasured amount of developer and sells for as little as \$3.90 (suggested retail).

Other KeproClad products such as a photo reversal kit for making negative film, etch, tin plating solution and photo flood lamps are all available at your local distributor. (For the distributor nearest you, call or write:

### KEPRO CIRCUIT SYSTEMS, INC.

630 Axminister Drive., Fenton, MO 63026-2992  
In MO 314-343-1630 Toll Free 800-325-3878

CIRCLE 270 ON FREE INFORMATION CARD

# Qualitone

## PUBLIC ADDRESS AMP SPECIALS

### Panasonic



15 WATT  
4 INPUT  
MIXER

**107<sup>90</sup>**  
No. WA-300

### BOGEN



60 WATT  
**219<sup>90</sup>**  
No. C60B



120 WATT  
No. PRO-120

**265<sup>90</sup>**



WE SELL TO THE DEALER ONLY!  
C.O.D. ORDERS - 800-434-2490

FOR FULL LINE 164 PAGE CATALOG  
PLEASE USE BUSINESS CARD  
OR LETTERHEAD

### QUALITONE INDUSTRIES INC.

DEPT. C - 696 LOCUST ST. - BOX 214  
MT. VERNON, NEW YORK 10552

## SYNC SEPARATOR

*continued from page 58*

should see a DC level of about 2.5 volts with all of the sync-pulse tips lining up at that level.

Set the DELAY control and BIAS trimmer potentiometer R9 fully counterclockwise. Remove the clamped video from the input to the scope and observe the signal at pin 2 of IC3. Slowly adjust R9 until you see a clean, negative-going pulse approximately 200 microseconds wide.

Next set R21 fully clockwise and observe the trigger output. Here you should see a positive-going pulse 100 microseconds wide. Adjust the amplitude of that pulse with R21 to a level compatible with the external-trigger input of your scope. (That's usually about 5 volts peak.)

### Applications

To use the unit, apply a video signal to the input. Connect the CLAMPED VIDEO output to the vertical input of the oscilloscope, set the SYNC switch to the appropriate polarity, and connect the TRIGGER OUTPUT to the external-trigger input of your oscilloscope. Adjust the scope's trigger level control for reliable triggering.

You should now see a clamped video waveform on the screen. By adjusting the delay control, you should be able to move the display to any part of the waveform you desire. The display can be expanded as much as you like by simply increasing the sweep rate of the timebase.

When powered up, the circuit will lock on to one or the other of the two fields in a random manner. In order to observe the other field simply flip the SYNC switch to the opposite position and back again. Do that until the desired field is locked in. (Flipping the switch disrupts the operation of the sync separator, allowing the circuit again to randomly select a field to lock onto.)

If your oscilloscope is a dual-trace model with an "alternate" mode, you can display both the odd and even fields at the same time. Replace R18 with a 220-ohm resistor to reduce IC4's minimum delay time to zero. That will allow the vertical pulse of each consecutive field to trigger the scope instead of every other field. If, for example, the vertical pulse of field 1 triggers channel 1 of the scope, it will be displayed on channel 1. The next trigger pulse will trigger the alternate scope channel (2) and field 2 will be displayed on channel 2.

A display of that type allows you to see the half-line offset between the two fields. It also allows you to compare the VITS waveforms that normally ride on lines 17 and 18 of both fields. (VITS stands for Vertical Interval Test Signal.) See if you can find VITS's on a local TV signal. **R-E**

## New, 1985 circuit and section approach guarantees successful BETA and VHS VCR repair and maintenance!

**COMPLETE GUIDE TO MODERN VCR TROUBLESHOOTING AND REPAIR**, by John Lenk, pub. Feb. '85, 288 pp., 199 illus., 6 x 9" (16035-8) \$24.95

Here's your time and money-saving guide to foolproof servicing and trouble-shooting techniques for the older and the latest VCR's. Jam-packed with proven, hands-on tips, practical troubleshooting methods and 100's of handy, time-saving diagrams, this all new for '85 guide, with its structured, logical approach to troubleshooting ensures time-saving, effective VCR repair and maintenance.

**COMPLETE GUIDE TO LASER VIDEODISC PLAYER TROUBLESHOOTING AND REPAIR**, by John Lenk, pub. Jan. '85, 336 pp., 224 illus., 6 x 9" (16081-2) \$28.95

This practical guide gives you extensive fix-it coverage of the two most popular types of home entertainment VDP's—Laser Vision and both the old and the new models of Capacitance Electronic Disc. Plus, manufacturers recommendations from Hitachi, Magnavox, Sylvania, Sanyo and Sony greatly ease troubleshooting, with helpful hints on interpreting service literature, analyzing trouble symptoms, performing checkout procedures, isolating the trouble to a circuit, and more!

NAME .....  
ADDRESS .....  
CITY ..... STATE ..... ZIP .....

I prefer to charge my  Visa  Mastercard  
Card Number ..... Expiration Date .....  
Signature .....

**Save!** If payment, plus your state's sales tax, accompanies your order, Prentice-Hall pays all postage and handling charges. Same 15-day return privilege, full refund guaranteed.

To receive your FREE 15-day trial copies, mail this coupon to: PRENTICE-HALL, INC., Book Distribution Center, Route 59 at Brook Hill Drive, West Nyack, New York 10995

Dept. 1

D-CGMV-JW(3)

# DON'T FORGET



USE  
YOUR  
READER  
SERVICE  
CARD

CIRCLE 256 ON FREE INFORMATION CARD



# MARKET CENTER

## PLANS AND KITS

**PRINTED-circuit boards.** Quick prototypes, production, design, reflow solder. Send print or description for quote to **KIT CIRCUITS**, Box 235, Clawson, MI 48017.

**FREE catalog, 99-cent kits**—audio, video, TV, computer parts. **ALLKIT**, 434 West 4th Street, West Islip, NY 11795.

**HI-FI speaker kits, auto speaker systems and speaker components** from the world's finest manufacturers. For beginners and experts. Free literature. **A & S SPEAKERS**, Box 7462R, Denver, CO 80207 (303) 399-8609.

**CABLE-TV converters:** Jerrold, Hamlin, SB-3, Mini-Code, & more. UHF converters: Deluxe II sine-wave kits \$95.00, gated pulse add/on \$70.00. Complete units \$195.00, with gated pulse \$255.00.

(Quantity discounts.) Repairs of all converters & cable boxes. Send S.A.S.E. (54 cents postage) or call for info. 1 (312) 637-4408. **HIGGINS ELECTRONICS**, 5143 W. Diversy, Chicago, IL 60639. Mail order only. **No. Illinois orders accepted.**

**PROJECTION TV**...Convert your TV to project 7 foot picture...Results comparable to \$2,500.00 projectors...Total cost less than \$30.00...Plans and 8" lens \$19.95...Illustrated information **free**. **MACROCOMA-GH**, Washington Crossing, PA 18977. Creditcard orders 24 hours, (215) 736-3979.

**CATALOG:** Hobby, radio broadcasting, CB, lowers. Transmitters, linears, active antennas, converters, scramblers, bugging devices, more! **PANAXIS**, Box 130-F4, Paradise, CA 95969.

**DIGITAL Klock Kit** plays 1-of-12 melodies each quarter hour. Displays time, date, and other features...Send \$2.50 for assembly plans and pricing to **KERBER KLOCK KO.**, 36117 Hillcrest, Eastlake, OH 44094.

**DESCRAMBLER** plans. New design decodes gated sync suppressed signals—newest pilotless method. Circuit boards, most parts from Radio Shack. Detailed theory, drawings, schematics, instructions \$14.95 plus \$2.00 shipping. **DIRIJO CORP.**, Box 212, Lowell, MA 28098.

**DIGITAL oscilloscope**—build for \$200.00. Plans \$5.00. **MIKE MCGLINCHY**, 2280 California, Apt.#12, Mountain View, CA 94040.

**EPROM programmer**—2716/2732/8748+. Operates alone (keypad, display, 2K RAM) or with computer download (RS232 interface). Basic kit includes bare circuit board, system PROM and documentation. \$70.00. Free details. **BG ELECTRONICS**, PO Box 703, Seabrook, MD 20706.

**SURPLUS** water minder for your plant. Put this project together and watch LED flashes whenever plant soil is dry. Need 9V battery. Send \$2.50 to **ETHIO-ELECTRONICS**, 1537 N.E. 107th, Seattle, WA 98125.

**FREE Survival Catalog**—50+ survival publications—electronics, computers, energy, weapons, medical, financial!!! **CONSUMERTRONICS**, 2011-RE Crescent, Alamogordo, NM 88310.

## SATELLITE TELEVISION

**SATELLITE-TV receiver breakthrough!** Build your own system and save! Instruction manuals, schematics, circuit boards! Send stamped envelope: **XANDI**, Box 25647, Dept. 21K, Tempe, AZ 85282.

**PCB for Satellite Stereo Project** in October article is now only \$15.00. **JIM RHODES, INC.**, 1025 Ransome Lane, Kingsport, TN 37660.

**SATELLITE Television information service.** 104 channel program guide, existing satellites, satellite launchings next few years, basic system theory, recommended dish sizes, LNA's. Send \$2.50 to **SAT/FLORIDA INFO**, 2910 SE 19 Ave., Gainesville, FL 32601.

## ENJOY SATELLITE TV

### DO-IT-YOURSELF AND SAVE

Electronic Know-how not required.  
Easy to build from our plans or kits.  
Lowest prices on satellite electronics.  
Send \$1 for catalog or \$8.95 for  
"Consumer Guide to Satellite Television."  
**GFI-D14, Box 9108**  
Missoula, MT 59807



## SATELLITE TV VIEWERS

Get the most complete weekly listings.  
Send \$1 for sample copy.

**Satellite TV Week**

P.O. Box 308E, Fortuna, California 95540  
800-358-9997 (U.S.) • 800-556-8787 (Calif.)  
707-725-2476 (all others)

## CLASSIFIED AD ORDER FORM

To run your own classified ad, put one word on each of the lines below and send this form along with your check to:

**Radio-Electronics Classified Ads**, 200 Park Avenue South, N.Y., N.Y. 10003

**PLEASE INDICATE** in which category of classified advertising you wish your ad to appear. For special headings, there is a surcharge of \$20.00.

( ) Plans/Kits ( ) Business Opportunities ( ) For Sale  
( ) Education/Instruction ( ) Wanted ( ) Satellite Television

Special Category: \$20.00

### PLEASE PRINT EACH WORD SEPARATELY, IN BLOCK LETTERS.

(No refunds or credits for typesetting errors can be made unless you clearly print or type your copy.) Rates indicated are for standard style classified ads only. See below for additional charges for special ads. **Minimum: 15 words.**

1	2	3	4	5
6	7	8	9	10
11	12	13	14	15 (\$37.50)
16 (\$40.00)	17 (\$42.50)	18 (\$45.00)	19 (\$47.50)	20 (\$50.00)
21 (\$52.50)	22 (\$55.00)	23 (\$57.50)	24 (\$60.00)	25 (\$62.50)
26 (\$65.00)	27 (\$67.50)	28 (\$70.00)	29 (\$72.50)	30 (\$75.00)
31 (\$77.50)	32 (\$88.00)	33 (\$82.50)	34 (\$85.00)	35 (\$87.50)

We accept MasterCard and Visa for payment of orders. If you wish to use your credit card to pay for your ad fill in the following additional information (Sorry, no telephone orders can be accepted.):

Card Number

Expiration Date

Signature

**IF YOU USE A BOX NUMBER YOU MUST INCLUDE YOUR PERMANENT ADDRESS AND PHONE NUMBER FOR OUR FILES. ADS SUBMITTED WITHOUT THIS INFORMATION WILL NOT BE ACCEPTED.**

**CLASSIFIED COMMERCIAL RATE:** (for firms or individuals offering commercial products or services) \$2.50 per word prepaid (no charge for zip code)...**MINIMUM 15 WORDS.** 5% discount for same ad in 6 issues; 10% discount for same ad in 12 issues within one year; if prepaid. **NON-COMMERCIAL RATE:** (for individuals who want to buy or sell a personal item) \$2.00 per word, prepaid...no minimum. **ONLY FIRST WORD AND NAME** set in bold caps at no extra charge. Additional bold face (not available as all caps) 50¢ per word additional (20% premium). Entire ad in boldface, add 20% premium to total price. **TINT SCREEN BEHIND ENTIRE AD:** add 25% premium to total price. **TINT SCREEN BEHIND ENTIRE AD PLUS ALL BOLD FACE AD:** add 45% premium to total price. **EXPANDED TYPE AD:** \$3.75 per word prepaid. All other items same as for STANDARD COMMERCIAL RATE. **TINT SCREEN BEHIND ENTIRE EXPANDED TYPE AD PLUS ALL BOLD FACE AD:** add 45% premium to total price. **DISPLAY ADS:** 1" x 2 1/4" — \$270.00; 2" x 2 1/4" — \$540.00; 3" x 2 1/4" — \$810.00. **General Information:** Frequency rates and prepayment discounts are available. **ALL COPY SUBJECT TO PUBLISHERS APPROVAL. ADVERTISEMENTS USING P.O. BOX ADDRESS WILL NOT BE ACCEPTED UNTIL ADVERTISER SUPPLIES PUBLISHER WITH PERMANENT ADDRESS AND PHONE NUMBER.** Copy to be in our hands on the 15th of the third month preceding the date of the issue. (i.e., August issue copy must be received by May 15th). When normal closing date falls on Saturday, Sunday or Holiday, issue closes on preceding working day.



**SATELLITE** Locator Program; IBM-PC and compatibles. Aim your dish accurately, diskette, manual: \$15.00. **DMA SYSTEMS**, Box 606, Londonderry NH 03053.

**SATELLITE** TV systems. Best prices. Catalog \$1.00. **STARLINK, INC.**, 1122 Park Plaza, Suite 41, Huntsville, AL 35801.

**SATELLITE** receivers \$229.00, motorized dish drives \$99.00. I.S.T.V., 4970 Apache Pocatello, ID 83204, (208) 232-8013, guaranteed.

**MICROWAVE** antennas. Multi-channel 20" dish, \$89.95. Complete units. Quantity pricing. **MIKE RETZ**, 4021 Gilbert, Dallas, TX 75219. (214) 528-0309.

**SATELLITE** TV complete systems, component parts, and accessories. Send for free catalog. **EARTH VIEW**, Dept. C, Box 849, Anadarko, OK 73005.

### BUSINESS OPPORTUNITIES

US \$8.00 including disk thousand name brand programs for Apple IBM-PC details **RELIANT**, PO Box 33610, Sheungwan, Hong Kong.

**MECHANICALLY** inclined individuals desiring ownership of small electronics manufacturing business—without investment. Write: **BUSINESSES**, 92-R, Brighton 11th, Brooklyn, NY 11235.

**BURGLAR** alarms—booming business. Get in now. Information package \$2.00, **DYNAMIC SECURITY**, PO Box 1456-G, Grand Rapids, MI 49501.

**PROJECTION TV**...Make \$\$\$'s assembling projectors...Easy...Results comparable to \$2,500.00 projectors...Your total cost less than \$20.00... **Plans, 8" lens & dealer's information \$17.50...** Illustrated information free... **MACROCOMA GHX**, Washington Crossing, PA 18977. Creditcard orders 24 hours (215) 736-2880.

### EDUCATION & INSTRUCTION

**FCC Commercial General Radiotelephone License Correspondence Course. 60 individual lessons for \$89.50. Payment plan. Results guaranteed! Details free. AMERICAN TECHNICAL INSTITUTE, Box 201, Cedar Mountain, NC 28718.**

**FCC license** test primer computer program. Learn general radiotelephone license Q & A's the fun and easy way on the Apple II, IBM and Commodore PCs. Specify make and model, \$34.50. **ACETEST SYSTEMS**, PO Box 266, Savage, MN 55378.

### WANTED

**INVENTIONS**, ideas, new products wanted! Industry presentation/national exposition. Call free (1-800) 528-6050. Arizona, (1-800) 352-0458. X831.

### PRINTED CIRCUIT BOARDS

**PRINTED** circuit boards, double sided with plated through holes or single sided. No set up charge. **CAUDILL INC.**, 205 East Westwood Ave., Highpoint, NC 27262, (919) 884-0229.

**PRINTED** circuit boards. 8" x 10" max. Send us your positive, any size (please specify), thru component side artwork, along with a certified check or money order for \$15.00 & \$3.00 shipping, and we will send you a fiberglass board, with your artwork, the same day. Send us your hole specs, we'll drill it for free. Double sided boards, \$30.00. **EJS LABORATORY**, 11908 Detroit Ave., Cleveland, OH 44107, (216) 529-1611.

### P.C. BOARDS AND ART SERVICES

**FACE PLATES ENCLOSURES**  
WRITE OR CALL  
For Literature or Quotes

Let us quote you on any stage of your product from proto types to production.

**FABTRON DIV.**  
P.O. Box 925  
Columbia, TN 38401  
(615) 381-1143

**MASTERCARD AND VISA** are now accepted for payment of your advertising. Simply complete the form on the first page of the Market Center and we will bill.

### CB MODIFICATIONS

Increase channels, range, privacy! We specialize in frequency expanders, speech processors, FM converters, PLL & slider tricks, how-to books, plans, kits. Expert mail-in repairs & conversions. 16-page catalog \$2.

**CBC INTERNATIONAL, P.O. BOX 31500RE, PHOENIX, AZ 85046 (602) 996-8700**

### EPROM PROGRAMMING

**HOBBYISTS:** EPROM's sold with your programming installed. Listing provided. Fast service. Write or call: **ROMULUS MICROCONTROL**, Box 8669, Rockville, MD 20856, (301) 540-8863.

Your ad could be selling merchandise for you in this space. The price is a remarkable \$270. To place your order, call any **Radio-Electronics** salesman: Stan Levitan (212) 777-6400, Marvin Green (818) 986-2001, Ralph Berger (312) 446-1444.

### BIG PROFITS ELECTRONIC ASSEMBLY BUSINESS

Start home. spare time. Investment knowledge or experience unnecessary. **BIG DEMAND** assembling electronic devices. Sales handled by professionals. Unusual business opportunity.

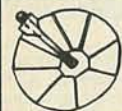
FREE: Complete illustrated literature  
BARTA, RE-O Box 248  
Walnut Creek, Calif. 94597



**SUPER LED's**  
2 amp. rating w/heat sink  
ME2 IR (a) 25A pulse  
ME5 IR (b)  
MV4 RED (a) \$4.95 each  
6-32 stud

### RESISTOR SALE

OUR IMPORTER SHIPPED THE 1/4W 5 PERCENT RESISTORS IN PACKS OF 200 INSTEAD OF THE 100 PACKS WE USUALLY GET. WE HAVE ALL THE STANDARD VALUES FROM 1 TO 4.7 MEGS.  
EACH 200 PAK \$2.35  
FIVE PAKS \$11.00  
25 or more—only \$2 ea.



this item not sold in Calif.

HI-GAIN, LO-NOISE 2.1-2.5 Ghz. MICROWAVE RECEIVING SYSTEM. COMPLETE READY TO INSTALL—INCLUDES A 20" DISH, DOWN CONVERTER AND POWER SUPPLY WITH ALL CABLES AND INSTR. FOR EASY INSTALLATION. 12 MONTHS PARTS AND LABOR GUARANTEE.  
**\$74.95**

send for FREE FLYER

### TRANSISTOR BONANZA

FIRST QUALITY—NEW T092 PNP DEVICES MADE FOR A LARGE COMPUTER COMPANY. THESE HOUSE NUMBERED PARTS ARE NOT SECONDS OR REJECT PARTS...  
**100 for \$6**

WE WELCOME VISA-MC PHONE ORDERS. ORDERS RECEIVED BEFORE NOON (PACIFIC) WILL BE SHIPPED UPS THAT DAY...

### MEMORY SALE

	MS	ea.	3 for
4164 dyn 1x64k	300	\$4.00	\$8.00
4164 " "	150	4.20	8.40
4116 " 1x16k	150	1.75	3.50
6116 stat 8x 2k	150	6.95	13.90
2114 " 4 x 1k	150	2.30	4.60

### GERMANIUM SIGNAL DIODES

LOW FORWARD VOLTAGE—IDEAL FOR TTL CIRCUITS. HALF INCH LEADS. ALL DIODES PRIME.....  
**1 OUNCE over 100 \$3.50**

### BUY A POUND

UNTESTED DIGITAL INTEGRATED CIRCUITS THESE ARE MARKED AND CONTAIN SOME HOUSE NUMBERS. WE HAVE REPORTS OF A GOOD YIELD OF FUNCTIONAL 74XX AND DTL IC's. PUT YOUR TESTER TO PROFITABLE USE...  
**HUNDREDS of IC's \$10**

### SILICON SIGNAL DIODES

HIGH QUALITY (ALL PRIME), SIGNAL DIODES. MARKED WITH INXXX OR WITH COLOR CODE. FULL LEADS...  
**10 OUNCES over 1000 \$7.95**

**BABYLON ELECTRONICS** 4811 Myrtle Ave. Sacramento, CA 95841

(916) 334 2161  
we pay post on orders for \$15 or more payment must be in U.S. funds. Foreign orders must include post BAC, MC are not prepaid and shipping is added.

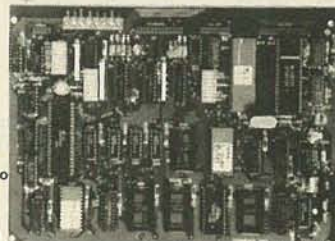
ALL SALES SUBJECT TO THE TERMS OF OUR 90 DAY LIMITED WARRANTY. FREE COPY UPON REQUEST.

**DISK DRIVE SPECIAL:** Remex #RFD 480 5 1/4 In. 2/3 Height. New In Box. 40 Track, DS-DD. Compare At Up To \$159 Ea. Our Price \$59.95 or Two For \$95.00. Limited Qty.

### THE NEW ZRT-80 CRT TERMINAL BOARD!

A LOW COST Z-80 BASED SINGLE BOARD THAT ONLY NEEDS AN ASCII KEYBOARD, POWER SUPPLY, AND VIDEO MONITOR TO MAKE A COMPLETE CRT TERMINAL. USE AS A COMPUTER CONSOLE, OR WITH A MODEM FOR USE WITH ANY OF THE PHONE-LINE COMPUTER SERVICES.

- FEATURES:
- \* Uses a Z80A and 6845 CRT Controller for powerful video capabilities.
  - \* RS232 at 16 BAUD Rates from 75 to 19,200.
  - \* 24 x 80 standard format (60 Hz).
  - \* Optional formats from 24 x 80 (50 Hz) to 64 lines x 96 characters (60 Hz).
  - \* Higher density formats require up to 3 additional 2K x 8 6116 RAMS.
  - \* Uses N.S. INS 8250 BAUD Rate Gen. and USART combo IC.
  - \* 3 Terminal Emulation Modes which are Dip Switch selectable. These include the LSI-ADM3A, the Heath H-19, and the Beehive.
  - \* Composite or Split Video.
  - \* Any polarity of video or sync.
  - \* Inverse Video Capability.
  - \* Small Size: 6.5 x 9 inches.
  - \* Upper & lower case with descenders.
  - \* 7 x 9 Character Matrix.
  - \* Requires Par. ASCII keyboard.



BLANK PCB WITH 2716 CHAR. ROM, 2732 MON. ROM  
**\$49.95**  
SOURCE DISKETTE - ADD \$10  
SET OF 2 CRYSTALS - ADD \$7.50

WITH 8 IN. SOURCE DISK! (CP/M COMPATIBLE)  
**\$99.95** (COMPLETE KIT, # ZRT-80 2K VIDEO RAM)

### Digital Research Computers

P.O. BOX 461565R • GARLAND, TEXAS 75046 • (214) 225-2309

Call or write for a free catalog on Z-80 or 6809 Single Board Computers, SS-50 Boards, and other S-100 products.

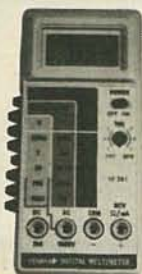
TERMS: Add \$3.00 postage. We pay balance. Orders under \$15 add 75¢ handling. No C.O.D. We accept Visa and MasterCard. Texas Res. add 5-1/8% Tax. Foreign orders (except Canada) add 20% P & H. Orders over \$50 add 85¢ for insurance.



# MCM ELECTRONICS

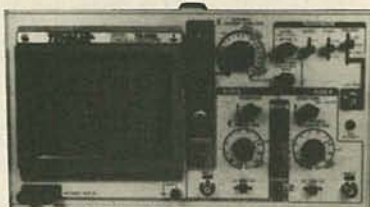
WE HAVE WHAT YOU NEED AT  
THE PRICES YOU WANT!

CALL TOLL FREE  
**1-800-543-4330**  
(IN OHIO, 1-800-762-4315)



**TENMAR®**  
**3 1/2 DIGIT LDC  
MULTIMETER**  
■ DC input impedance 10M ohm  
■ Diode and HFE transistor tests  
■ Overload protection ■ Auto  
polarity ■ Backed by our 2-year  
limited warranty ■ For more  
specifications see MCM catalog  
#9, page 118

#72-050 **\$3680**  
\$39.80 (1-9) (10-up)



**TENMAR®**  
**20 MHZ DUAL TRACE  
OSCILLOSCOPE**

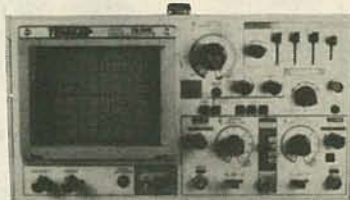
■ Two High Quality 10:1 probes included  
■ Backed by our 2-year limited warranty  
■ For specifications see MCM catalog  
#9, page 118

#72-320 **\$38995**



**TENMAR®**  
**DROP PROOF  
DIGITAL  
MULTIMETER**  
■ DC input impedance 10M ohm  
■ Shock-mounted LCD display  
■ Overload protection ■ Auto  
polarity ■ Backed by our 2-year  
limited warranty ■ For more  
specifications see MCM catalog  
#9, page 124

#72-057 **\$2995**  
\$33.80 each (2-up)



**TENMAR®**  
**35 MHZ DUAL TRACE  
OSCILLOSCOPE**

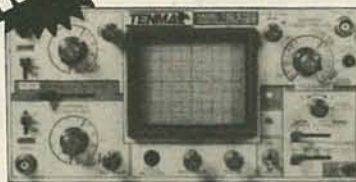
■ Two High Quality 10:1 probes included  
■ Backed by our 2-year limited warranty  
■ For specifications see MCM catalog  
#9, page 118

#72-330 **\$56900**



**TENMAR®**  
**DIGITAL  
CAPACITANCE  
METER**  
■ Measures capacitors from 0.1pF  
to 1999mFd ■ Accuracy 0.5%  
typical ■ Fuse protected  
■ Checks capacitors in and out  
of circuit ■ Backed by our 2-year  
limited warranty ■ For more  
specifications see MCM catalog  
#9, page 118

#72-040 **\$5495**  
\$59.80 each (2-up)



**TENMAR®**  
**15 MHz DUAL TRACE  
BATTERY OPERATED  
OSCILLOSCOPE**

■ Two High Quality 10:1 Probes  
included ■ Backed by our 2-year Limited  
Warranty ■ Internal rechargeable batteries  
provide 2 hours of continuous operation  
without the need for any outside power  
source. ■ For specifications see Supplement  
#4 of Catalog #9.

#72-335 **\$54995**

## PORT SWITCHES



#83-600  
RS232 type

#83-610  
36-pin  
Centronics type



Eliminates the need to plug and unplug cables when you need to use a different printer or CRT. Enables you to easily access one printer from different computers, or access multiple printers from one computer with the turn of a switch. Two different models:

25 pin RS232 female type: Connect up to 4 peripherals to a single I/O port.

36 pin Centronics type: Connect up to 2 printers or modems to a single port. All 36 conductors are switched pin for pin.

\$74.80 (1-3)

**\$6995**  
(4-up)

**BE SURE TO CALL  
FOR YOUR FREE  
128  
PAGE  
CATALOG!  
OVER  
4,800  
ITEMS!**



**We Also Have**... a full line of test equipment, computer accessories, telephone accessories, speakers, television parts, flybacks, yokes, switches, fuses, lamps, capacitors, resistors, cartridges, styli, wire, CATV equipment, and many more. **Over 4,800 items AT THE LOWEST PRICES AROUND!**

### Terms:



- \$10 minimum order. \$1.00 charge for orders under \$10
- \$20 minimum charge card order
- Orders shipped UPS C.O.D.
- Most orders shipped within 24 hours
- Sales office open 8:30 am to 6:00 pm. Saturdays 10:00 am to 3 pm. EST.
- For prepaid orders add \$2.50 for shipping and handling
- Should shipping & handling charges exceed \$2.50 the balance due will be sent C.O.D.



**MCM ELECTRONICS**  
858 East Congress Park Drive  
Centerville, Ohio 45459  
513-434-0031

SOURCE NO. RE-8

We have the Largest  
Selection of Original  
Japanese Semiconductors  
in the Country!



## FOR SALE

**CABLE-TV Secrets**—the outlaw publication the cable companies tried to ban. HBO, Movie Channel, Showtime, descramblers, converters, etc. Suppliers list included. \$8.95. **CABLE FACTS**, Box 711-R, Pataskala, OH 43062.

**RESISTORS** ¼W&½W5% 3 cents. 1% metal films, precision custom wirewounds, \$1.00 refundable to: **JR INDUSTRIES**, 5834-B Swancreek, Toledo, OH 43614.

**FREE** catalog featuring scanner accessories, carrier/subcarrier detectors, voice scramblers, unusual kits. **CAPRI ELECTRONICS**, Route 1R, Canon, GA 30520.

**THE Intelligence Library**—Restricted technical information & books on electronic surveillance, surveillance-device schematics, lock-picking, investigation, weapons, identification documents, covert sciences, etc. The best selection available. **Free brochures**. **MENTOR**, (Dept. Z), 135-53 No. Blvd., Flushing, NY 11354.

**CABLE** television, copy of Federal laws \$10.00. **ROBERTS**, PO Box 63/6025, Margate, FL 33063.

**DIGITALKALKER** Speech Synthesizer has 136 word vocabulary. Interfaces with parallel port of your computer. PCB and plans \$12.00. **JIM RHODES, INC.**, 1025 Ransome Lane, Kingsport, TN 37660.

**WHOLESALE** F-59 cable connector \$80.00/1000. Free MATV catalog, S.A.S.E. (212) 897-0509, **D&WR**, 68-12 110 Street, Flushing, NY 11375.

**TI-99/4A** software/hardware bargains. Hard-to-find items. Huge selection. Fast service. Free catalog. **DYNA**, Box 690, Hicksville, NY 11801.

**TUBES**, new, unused. Send self-addressed, stamped envelope for list. **FALA ELECTRONICS**, Box 1376-2, Milwaukee, WI 53201.

**FREE** Pay-TV reception. "How-To" book. HBO, Showtime, Cinemas. \$5.00. **DIPTRONICS**, Box 80 (E5), Lake Hiawatha, NJ 07034.

**FREE** Automotive Security Catalog. Largest selection available. Do-it-yourself pagers, alarms,

hood/locks, glass detectors. Allow 4 weeks for delivery, or for rush send \$1.00. **AUTOMOTIVE SECURITY EQUIPMENT COMPANY**, Dept. 1, PO Box 382, Plainville, NY 11803.

**COCO** owners—Free color computer software and hardware catalogue. **SPECTRUM**, Box 9866, San Jose, CA 95157-0866.

**INDIVIDUAL** photofact folders. No. 1 to no. 1400, \$3.00 postpaid. **LBT**, 414 Chestnut Lane, East Meadow, NY 11554.

**DESCRAMBLERS** for downconverters. High gain. Send \$2.00. **RB ELECTRONICS**, PO Box 643, Kalamazoo, MI 49005.

**TOKO** Coil set (four) \$8.00. **BFQ85** substitute transistor \$2.00. **JIM RHODES, INC.**, 1025 Ransome Lane, Kingsport, TN 37660.

**TOKO** coils and printed circuits. Quantity discounts. **JIM RHODES, INC.**, 1025 Ransome Lane, Kingsport, TN 37660.

**ELECTRONICS** catalog. Over 4,500 items. Parts & components. Everything needed by the hobbyist or technician. \$2.00 postage & handling (States only),

**THIS IS A BOLDFACE EXPANDED AD.** If you like this format, request it. Your cost is \$3.75 per word, plus 45% for the boldface and tint background.

## UNLOCK THE POWER OF YOUR TIMEX OR SINCLAIR COMPUTER

We can help you realize your computer's potential without spending a fortune!

Ask about our Floppy Drive Interface

CALL or Write for free catalog to:

Research Service Labs  
P O Box 19124 OKC, OK 73144  
(405) 745-9322

Phone hrs: 9-9 M,Th 9-5 Tu,W,F

refundable with first \$15.00 order. **T & M ELECTRONICS**, Dept. R, 472 East Main Street, Patchogue, NY 11772, (516) 289-2520.

**CORDLESS**—phone interference? We've got the answer. Have a radar speeding ticket? We can help. Home phone extension in your car. You can have it. 50 page color catalog airmailed \$3.00. **DBE**, PO Drawer G, Waikiki, HI 96815, MC/VISA orders (808) 395-7458.

**CABLE-TV** converters, police radar detectors, and scanners. Send \$1.00 for catalog. **GREAT LAKES COMM., INC.**, 0-2026 Chicago Dr., Jenison, MI 49428

**TRANS-AM ELECTRONICS**: This month's specials include 24 volt plug in transformer 1.3 amps \$3.95. Burroughs Keyboard \$4.95. 383 Canal Street, New York, NY 10013, (212) 226-3893.

## FINEST QUALITY SOLDER

SN 60/40 Rosin Core (RA)

One lb. Reels  
16 swg (.064) \$7.95  
18 swg (.048) \$8.45  
19 swg (.040) \$8.95  
20 swg (.036) \$9.45  
21 swg (.032) \$9.95

½ lb. Reels  
22 swg (.028) \$5.95  
24 swg (.022) \$7.95  
SN 62 (2% Silver)  
Rosin Core  
21 swg (.031) \$19.95

**FREE Freight On All Orders Over \$25**  
Under \$25 add \$2.50 per order.  
Minimum order \$10.

**FREE** Desoldering Wick with each pound of solder

Check Money Order VISA  
MasterCard N.Y. State residents add appropriate sales tax.

**SolderCraft** Call TOLL FREE 800-645-4808  
P.O. Box 668 R. Jenico, N.Y. 11753  
IN NYS (516) 334-2860

## MICROWAVE TV ANTENNA SYSTEMS

Freq. 2.1 to 2.7 GHz . 34 db Gain +

COMPLETE SYSTEMS:

(as Pictured)

Commercial 40"

Rod Style \$99.95

Parabolic 20"

Dish Style \$79.95

COMPONENTS

Down Converters

(either style) \$34.95

Power Supplies \$24.95

(12V to 16V. DC+)

Data Info (Plans) \$ 9.95

CALL OR WRITE FOR KITS, PARTS, OR MORE INFORMATION

Shipping & Handling Add \$5.00  
We Repair Most Types Down Converters & Power Supplies

**Phillips-Tech Electronics**

P.O. Box 34772

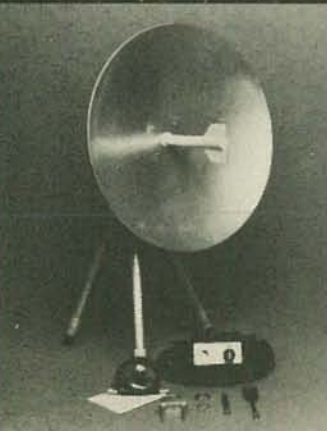
Phoenix, AZ 85067

(602) 947-7700

Special Quantity Pricing Dealers Wanted



LIFETIME LIMITED WARRANTY PARTS & LABOR



## MICRO MART

508 Central Ave.  
Westfield, N.J. 07090  
(201) 654-8008

### UHF-TV PREAMP

(As featured in Radio Electronics March/May articles, 1982)

This inexpensive antenna mounted preamp can add more than 25 dB of gain to your system. Lots of satisfied customers and repeat orders for this high quality kit, which includes all component parts, PCB, Case, Power Supply and Balun \$34.50 Assembled Version \$57.50

COILS FOR RADIO ELEC'S FEB 84 TV PROJECT.  
TOKO M'S T-1,T-2, L-1(12UH) & L-2(1.07UH)  
COMPLETE SET OF ALL 4 COILS..... 8.50  
ROTARY SWITCH POSITION, 5A 125V) 3/1.00  
MC1350- PRIME (MOTO)..... 1.19  
8F8-85 TRANSISTOR..... 1.50  
5N 3055 TRANSISTOR..... .30  
DISC CAPS .001uf..... 20/1.00  
PRECISION TRIM POTS-100 ohm,500 ohm,1k,2k,5k,10k,20k,50k,100k,200k,500k,1M..... 3/1.95  
7812 VOLTAGE REGULATOR (PRIME) TO-220..... .39  
7812 VOLTAGE REGULATOR (PRIME)..... .39  
7805 VOLTAGE REGULATOR (PRIME)..... .39  
7805 VOLTAGE REGULATOR (PRIME)..... .39  
7824 VOLTAGE REGULATOR (PRIME)..... .39  
TAPPED TRANSFORMER (7A) 7.5,9,15,18V 80.95  
WALL PLUG TRANSFORMER 24V 525MA..... 83.95  
4164 DYNAMIC RAM (NEC 84 DATE CODE, PRIME)  
IDEAL FOR IBM PC'S & CLONES(150ns)..... 3.95  
1.0MHZ CRYSTALS..... 1.95  
JUMBO RED LED'S-DIFFUSED LENS, PRIME (12)  
NO COSMETIC DEFECTS, ALL 100%.....15/1.00,  
100/4.00, 1,000/15.50,  
555 TIMERS- PRIME, (11)..... 3/1.00  
8 PIN IC SOCKETS..... 15/1.00  
47uf 25V RADIAL..... 10/1.00  
TEXAS INSTR. 8944A KEYBOARDS - INC DATA FOR  
PINS MADE WHEN EACH KEY DEPRESSED..... 4.95  
CLOCK MODULE- CRYSTAL CONTROLLED, GREEN  
DISPLAY/12VDC/TIME SET SWITCHES/DATA-4.95  
LUMINISCENT/PHOSPHOR LEVEL REGULATOR  
ELEC FOR AUTOMOBILE OR ANY FLUID LEVEL  
APPLICATIONS. INCLUDES EC 82, ALL PARTS,  
& INSTRUCTIONS- 82, 82S, PROJECT CASE 82  
POTS - 1 MEG, LINEAR TAPER..... 5/1.00  
DIP SWITCH- 3 POSITION..... 10/1.00  
MOTION DETECTOR BOARDS-82 EACH..... 7/10.00  
MOTION DETECTOR IC'S/ULN2232/13/82, 20/8/10  
BLACK, PLASTIC PROJECT BOX FOR ABOVE-1.95  
EXTENSIVE CONSTRUCTION ARTICLE FOR DET. #1  
1,000 PC RESISTOR ASS'T (130 VALUES) 1/2W 83  
7808 VOLTAGE REGULATORS..... 10/1.00  
22uf 30V MONOLITHICS..... 20/1.00

.33uf 100V DIP MYLAR..... 10/1.00  
4.7uf 40V RADIAL..... 15/1.00  
TRIM POTS-PIHER PT10V,HDR,3/8"-MIX/MATCH,  
100 OHM, 1K, 10K, 25K, 50K, 100K, 200K..... 4/1.00  
LM1310'S..... 2/1.00  
C24047..... .95  
LM330(ULN2280)..... .95  
MOLEX PINS - 7 PIN/STRIP-500/4.00, 1,000/8.00  
HEAT SENSITIVE SWITCHES..... 10/1.00  
2N5308..... 10/1.00  
LED MOUNTING CLIPS/PRIMS..... 15/1.00  
ZENER DIODES 20V 1W..... 20/1.00  
1N4002'S..... 20/1.00  
ZEMITH TV REPLACEMENT IC SPECIAL 84 EACH  
221-42, 221-43, 221-45, 221-48, 221-49,  
221-74, 221-87, 221-94, 221-104, 221-105,  
221-10A  
221-132..... 2.50  
221-140(INDUSTRIAL REPLACEMENT#845)..... 4.90  
REPLACEMENT #844(CA5217),2B PIN IC..... 8.90  
25C1172(TOSHIBA)-HOP12, OUTPUT..... 1.75  
3.579545MHZ COLOR BURST CRYSTAL..... .85  
2732 EPROMS..... 1.95  
TRANSFORMERS - 6 TV 1.2AMP..... 2.50  
1uH FIXED CHOKE, RFC-102..... 3/1.00  
ADJUSTABLE COIL 0-60uH..... 2.50  
ADJUSTABLE COIL 7-12uH..... 2.50  
22MAG & 27MAG WIRE..... 50/1.00  
VOLTAGE-HAZE SWITCHING REGULATOR KIT  
THIS PROJECT FEATURES ADJUSTABLE DC/DC,  
OUTPUT 1.1-24 TO 14/30VDC, STEP UP, DOWN  
AND INVERSION MODES..... 18.50  
CHIP CAPS- SET OF 4, 2 EACH 2.7k,3.9k, 1.00  
ZENER DIODES - 13V 1W, GLASS..... 20/1.00  
BNC "T" CONNECTOR (AMPHENOL)UG-274..... .95  
10,000uf 40V COMPUTER GRADE MALLORIN..... 1.75  
FREQUENCY COUNTER IC-INTERSL 7225..... 9.00  
CRYSTAL-CONTROLLED PULSE GENERATOR KIT  
YOU PICK THE FREQUENCY FROM 1 Hz TO ANY  
MULTIPLE OF 10 UP TO 1 MHz (SAME KIT AS  
FEATURED IN RADIO ELEC'S SPECIAL EDITION  
MAGAZINE), PRIME, 84..... 39.95  
MINIATURE GEAR MOTOR(AURORA)..... 4/1.00  
10,000uf 75V COMPUTER GRADE CAP..... 1.95  
5,600uf 25V LYTIC (COMPUTER GRADE) 3/1.00  
11uf 50V MONOLITHIC..... 10/1.00  
22/44 PIN CONNECTOR(FURPHY)22-44HTI 2/1.00  
22/44 (WIREWRAP-GOLD)NSM22/3-2H 2/1.00  
LM545, PRIME, HOUSE#SL60505..... 2/1.00  
VOLT-OHM METER IC-1K OHM, 0-300V..... 4.95  
AMMETER IC-15 A.C. AMPERES..... 4.95  
CA5452 (PRIME)..... 3/1.00  
LM339 (PRIME)..... .85

**MICRO-CONTROLLER BOARD (KIT/\$119.50)**

Terms: MICRO-MART accepts Visa, MC and telephone COD's. Minimum order \$10.00. Shipping—U.S. orders, \$2.00. Canada and other countries \$3.50 (includes ins.). Shipping rate adjusted where applicable. NJ residents add 6% sales tax.

**MICRO-MART • 508 CENTRAL AVE., WESTFIELD, NJ 07090 • (201) 654-8008**



# ADVANCED COMPUTER PRODUCTS, INC.

64K UPGRADE \$24.95

SINCE 1976

AT RAM	\$22.95
256K RAM	15.95
512K RAM SET	24.95

1985 CATALOG Send \$1.00

## MAIL ORDER PRICING ONLY

# NOW LIQUIDATING GAVILAN COMPUTERS

## CALL FOR GAVILAN 8/16 LINE COMPUTERS

### See Below - GAVILAN SPECIALS

Corporate Buyers ... Call For Volume Quotes!

IF YOU DON'T SEE IT HERE CALL TOLL FREE

### APPLE COMPATIBLE PERIPHERALS

ALS CP/M 3.0 PLUS CARD	\$320.00	BUFFERED GRAPPLER	\$180.95
COEX 10K RAM CARD	39.95	GRAPPLER SUPER SERIAL	SALE \$119.95
COEX PAR. PRINTER CARD w/CABLE	49.95	VIDEO 7 RGB I/O	189.95
COEX 80 COL. EXT. 64K CARD	99.95	APPLE IIc SERIAL CABLE	36.95
IS PRASO II (I/O)	139.95	APPLE IIc KEYBOARD	49.95
KENNINGTON SYSTEM SBAVER	99.95	APPLE IIc I/O POWER SUPPLY	59.95
KENNINGTON CP SBAVER	39.95	APPLE IIc DISK CONTROLLER	49.95
KRAFT JOYSTICK	49.95	APPLE IIc COOLING FAN SYSTEM	49.95
MCT SPEED DEMON	249.95	STREET CASH II SPEECH SYSTEM	99.95
MICROSOFT Z-80 SOFTCARD	247.95	TITAN ACCELERATOR I CARD	449.95
GRAPPLER PLUS	119.95	WIZARD NO COLUMN CARD	SALE 99.00

**FARADAY IBM PC®**  
CPU Board w/48K MS DOS Compatible  
**\$349.95**

**ROCKWELL AIM**  
6502 Single Board Computer  
**\$249.00**

### IBM PC HARDWARE

AST "COMBIQUIP" 64K	\$199.00	KEYTRONIC 8150/1	158.00/199.00
SIGMA "MAXIMIZER" 64K	219.00	MOUSE SYSTEM MOUSE W/ISW	149.95
SIGMA DISK CONTROLLER	109.95	QUADBOARD W/48K	545.00
HARD DISK CONTROLLER	249.95	TECMAR GRAPHICS MASTER	643.00
10 MB INTERNAL HARD DISK	695.00	TECMAR CAPTAIN 64K	319.00
10 MB EXTERNAL HARD DISK	699.00	CURTIS PC PEDESTAL	79.00
15 MB INTERNAL HARD DISK	849.00	POS or QUADROHE ADAPTOR	9.00
15 MB EXTERNAL HARD DISK	1049.00	TILT and SWIVEL STAND	21.00
80 WATT BOOSTER SUPPLY	149.95	SYSTEM STAND	21.00
120 WATT IBM SUPPLY	159.95	EXTENSION CABLE IBM MONO	38.00
PC COMPATIBLE KEYBOARD	99.00	KEYBOARD EXTENSION CABLE	28.00
IBM PC CHASSIS	129.95	SURGE SUPPRESSORS	39.00
PLANTRONICS "COLORPLUS"	329.00	CURTIS PC PEDESTAL	79.00
10 MB INT. TAPE STREAMER	1150.00	EMERALD (I/ME)	49.00
PERYST MONO CARD	199.00	SAPPHIRE (PEACH)	59.00
PARADISE MONO/COLOR	409.95	RUBY (ORANGE)	69.00
HERCULES MONO CARD	369.00	HERCULES MONO CARD	369.00

### PRINTERS

BROTHER HP-1615 (10cps)	SALE \$399.00
BROTHER HP-2615 (20cps)	SALE 599.00
BROTHER HP-3615 (30cps)	SALE 890.00
NEW! BROTHER M2024 (24cps)	1299.00
COEX 80/PT (80cps)	SALE 149.00
EPSON RX-800/PT (100cps)	SAVE 159.95
EPSON MX-80/PT (100cps)	SAVE 159.95
EPSON FX-80 (160cps)	SAVE 150.00
EPSON FX-100 (160cps)	SAVE 150.00
MACINTOSH IIc SERIAL I/O	115.00
OKidata 62P (160cps)	SALE 399.95
OKidata 83P (160cps)	619.95
OKidata 84P (200cps)	699.00
OKidata 230P (300cps)	1895.00
TERMINA P1351 (24cps)	1295.00
STAR GEMINI 100 (120cps)	329.00
STAR GEMINI 100PC	329.00
STAR GEMINI 15X	379.00
STAR GEMINI 15XP	449.00
SPECIAL STAR STAR-40 THERMAL	399.95
NEC 8027A PORTABLE PRINTER	399.95
PANASONIC 1091	SALE 359.00

### MONITORS

AMDEK 3000 (GREEN)	\$139.95
AMDEK 3000 (AMBER)	149.95
AMDEK 310A (IBM AMBER)	169.95
CALL FOR COLOR & NEW MODEL	189.95
PGS 10-12 (H-RES)	59.95
PGS MAX-12 (IBM GREEN)	199.95
PGS DOUBLER BOARD	199.95
TAXAN 420 (H-RES IBM)	399.00
ZENITH 122A/123G	89.95
ZENITH 21M131/135	99.95
SANYO 5000 (MED-RES)	379.00
SANYO 7500 (H-RES)	279.00
SANYO (LOOKALIKE) 12" AMBER SALE	74.95

### MODEMS

BIZCOMP "PC INTELLIMODEM" (INT)	\$349.95
HAYES SMARTMODEM 1200 (EXT)	459.95
HAYES SMARTMODEM 1200B (INT)	399.95
HAYES SMARTMODEM 300 (EXT)	209.95
HYPERSMARTMODEM APPLE IIc	249.95
PROMETHEUS 1200M (MACINTOSH)	469.95
PROMETHEUS 1200 (PC EXT)	359.95
NOVATION ACCESS 1-2-3	389.95
CAT COMMUNICATIONS SYSTEM	419.95
APPLE COMP. LOW COST MODEM (300) 49.95	

### HARD DISKS

SEAGATE ST056 5mb	\$269.00
SEAGATE ST419 15mb	449.00
SEAGATE 15mb/12 (ST2)	449.00
CM 10, 15, 22mb	149.95
RODIME 10, 15, 22mb	149.95
SEAGATE SA06A (5mb)	249.95
SYQUEST REMOVABLE	Call

**SUPER SAVER SHUGART SA604 HARD DISK 5Mb \$149.95**  
NEW FACTORY QTY 100 139.95  
DIRECT QTY 100 129.95

### DISK DRIVES

TEAC 50B	\$129.95
MITSUBISHI 4851	149.95
SHUGART 485	124.95
TANDON TM100-2	109.95

### DRIVE CABINETS

5 1/4" CASE POWER SUPPLY	\$69.95
5 1/4" DUAL I/O w/POWER SUPPLY	79.95
8" DUAL CASE w/POWER SUPPLY	139.95
8" THINLINE DUAL w/POWER SUPPLY	199.95
5 1/4" HIGH HARD DISK	199.95

### APPLE DISK DRIVES

APPLE IIc COMPATIBLE	\$174.95
APPLE IIc COMPATIBLE 1/2 HIGH	184.95
MICROPSD APPLE IIc DRIVE	219.95
APPLE IIc to APPLE IIc ADAPTOR	29.95
APPLE IIc DISK CONTROLLER	49.95

### TEXTTOOLZ ZIP INSERTION

16 Pin \$6.75	24 Pin \$7.85	28 Pin \$9.95
---------------	---------------	---------------

### MAIL ORDER PRICING ONLY

6800					
680000	\$48.95	6810	\$ 2.85	6850	\$ 3.25
680001	69.95	6820	3.75	6860	5.65
6800	2.90	6821	2.90	6860	7.90
6802	7.75	6826	14.50	6875	8.75
6803	18.95	6840	12.75	6880	2.20
6809E	14.50	6845	14.95		

6500					
6502A	\$4.50	6504	\$6.75	6522	\$6.75
6502A	6.90	6507	9.75	6532	9.75
6502B	9.50	6520	4.25	6561	11.50

8000					
8035	\$ 5.75	8214	\$ 3.75	8259	\$ 5.75
8039	6.75	8216	1.95	8271	69.95
8060A	2.95	8224	2.20	8277	26.95
8065A	4.90	8226	1.95	8278	8.75
8065B	9.95	8228	3.40	8283	6.25
8086	24.50	8237	14.75	8283	6.25
8087	129.95	8237.5	18.95	8284	5.50
8088	29.50	8238	4.25	8286	6.50
8169	88.95	8243	3.95	8287	6.45
8165	6.75	8240	10.50	8288	14.95
8156	6.75	8251	4.25	8289	44.95
8185	28.95	8251A	8.95	8292	12.95
8202	23.95	8253	6.75	8274	27.95
8203	37.95	8255	4.25	8748	24.50
8204	29.95	8256A	6.95	8748	24.50
8212	1.95	8257	5.75	8755A	9.50

Z-80				
Z80-CPU	2.95	4.35	9.50	
Z80-CTC	3.75	4.75	12.25	
Z80-DART	-	9.50	17.95	
Z80-DMA	12.95	11.95	17.95	
Z80-PIO	2.95	1.25	12.50	
Z80-SIO	11.95	12.75	-	
Z80-SIO/2	11.95	12.75	36.95	
Z80-SIO/9	11.95	12.75	-	

DISK CONTROLLERS					
UD785	\$24.95	1797	\$29.95	6843	\$32.95
1771	19.95	2791	49.95	8272	24.95
1781	24.75	2793	49.95	8991	11.95
1783	26.50	2795	49.95	2143	12.95
1795	26.50	2797	29.95	9216	12.95

CAPACITORS				
01uf DISC BYPASS CAPACITOR	100x5.50			
1 uf DISC BYPASS CAPACITOR	100x6.50			
01uf MONOLITHIC CAPACITOR	100x11.25			
1 uf MONOLITHIC CAPACITOR	150x12.25			

TRANSISTORS/DIODES				
MCT-2	\$1.50	4N33	\$1.25	
MCT-6	55	4N37	1.25	
MCT-66	55	4N37	1.25	
MCA-255	1.69	4N38	3.80	
4N26	65	TL117	11.00	
4N27	65	TL117	11.00	
4N28	60	4N25	51.00	

OPTO ISOLATORS				
MCT-2	\$1.50	4N33	\$1.25	
MCT-6	55	4N37	1.25	
MCT-66	55	4N37	1.25	
MCA-255	1.69	4N38	3.80	
4N26	65	TL117	11.00	
4N27	65	TL117	11.00	
4N28	60	4N25	51.00	

EPROMS				
1702 (1mb)	\$ 3.90	2732A (450ns)	\$ 6.50	
2708 (450ns)	3.65	2732A (250ns)	8.95	
2758 (5V)	5.50	2732A (200ns)	12.50	
2716 (450ns)	3.75	2764 (450ns)	6.50	
2714 (450ns)	3.50	2764 (250ns)	7.50	
2516 (5V)	5.50	2764 (200ns)	17.50	
TMS2716	5.50	TMS2764 (450ns)	12.95	
TMS2722	7.00	MCM68764 (450ns)	34.95	
2732 (250ns)	10.25	MCM68764 (250ns)	39.95	
2732 (200ns)	8.25	27128 (250ns)	22.95	
2732 (150ns)	10.95	27128 (300ns)	21.50	
2732 (100ns)	12.95	27128 (350ns)	22.95	

STATIC RAMS				
2101 (450ns)	\$2.29	MK4118	\$4.95	
2102 (450ns)	.99	TM2016-2 (200ns/14)	\$4.95	
2102 (2 (250ns))	1.39	TM2016-1 (100ns/16)	4.95	
2111 (450ns)	2.75	HM1616P-4 (200ns/7.5)	6.10	
2112 (450ns)	2.75	HM1616P-3 (150ns/9.5)	4.95	
2114 (450ns)	1.45	89120 (300ns)	8.85	
2114L (450ns)	1.69	89120 (150ns)	8.85	
2114L (300ns)	1.79	89120 (75ns)	8.85	
2114L (200ns)	1.89	89120 (30ns)	8.85	
2147 (60ns)	4.60	2132 (300ns)	32.95	
2044 (450ns)	3.25	HM1626P-15 (150ns/32.95)		
4044 (300ns)	3.75	HM1626P-15 (LP) 39.95		
4044 (150ns)	4.50	2132 (150ns)	1.85	
UPD410 (100ns)	3.75	9341A (50ns)	2.90	
5101 (CMOS)	3.50	93425 (90ns)	3.95	

DYNAMIC RAMS				
4027 (250ns)	\$1.29	TM54416 (150ns)	\$9.75	
1103 (300ns)	.79	41256-10 (150ns)	17.95	
4116N-2 (150ns)	1.80	81395 (200ns)	15.95	
4116N-3 (200ns)	1.85	81395 (150ns)	15.95	
4116N-4 (250ns)	1.45	81395 (100ns)	15.95	
4164N-150 (150ns/5.95)	9.29	MM5200 (300ns)	1.85	
4164N-200 (200ns/4.95)	9.29	MM5200 (150ns)	1.85	
4164N-120 (120ns)	8.49	MM5298 (250ns)	1.85	
TM54164 (150ns)	9.95			

GAVILAN SPECIALS				
8 or 16 LINE COMPUTERS	Call			
16 LINE BY 80 LDC DISPLAY	\$79.95			
8 LINE BY 80 LDC DISPLAY	39.95			
THERMAL PRINTER MECHANISM	24.95			
QWILAN/IBM KEYBOARDS	14.95			
8 1/2 x 11 T				



# DoKay

COMPUTER  
PRODUCTS,  
Inc.

## APPLE ACCESSORIES

80 Column Apple II+ ...	149.95
80 Column Apple IIE ...	129.95
Z80 Apple II+ .....	89.00
Z80 Apple IIE .....	89.00
16K Card .....	39.95
Cooling Fan .....	38.95
Power Supply .....	74.95
Joystick .....	29.95
RF Modulator .....	13.95
Disk Drive .....	199.00
Controller Card .....	59.95
Paddles .....	7.95

## Reg. Power Supply Model 4A/PS (99/4) 3 DC Outputs:

12V @ .4A, +5V @ 1.1A  
-5V @ .2A Highly Filtered

6.95



## MEMORY EXPANSION KIT



4164 150ns  
9 for \$29.97

ORDER TOLL FREE

(800)  
538-8800

(CALIFORNIA RESIDENTS)

(800)  
848-8008



Telex: 756440

VISIT OUR RETAIL STORE

2100 De La Cruz Blvd  
Santa Clara, CA 95050  
(408) 988-0697

## RADAR JAMMER!



- Causes speed radar guns to read out either: —a percentage of your true speed, or whatever speed you dial in
- Activated by your Escort and most other detectors
- Especially effective against instant-on radar
- Operates on both X and K bands (not FCC approved)
- MONEY-BACK GUARANTEE**, if not satisfied.

WARNING: The device described in this literature is not legal for use against police radar.

Complete literature & plans package, send \$14.95 to:

**Philips Instrument Design Co. Inc.**

9513 S.W. Barbur Blvd. #109S, Portland, OR 97219  
VISA and M/C order line: (503) 626-6764

**SURPLUS** PRC-6 radio \$18.00 ea., \$30.00 for two, antenna \$2.50 ea., add \$5.00 shipping and handling. Operation check \$5.00 ea. Write for quantity price. **MINITRON**, POB 285, Beltsville, MD 20705.

**UNIQUE booklet**, "How neurocell (body) converts signals/pulses-circuit & computer simulation." Check/money order \$7.95, **TRONLETT INC.**, Box 355, Montreal North, Canada H1H 5L4.

**NORELCO PAX System**, code TM200/20M, phones: 53 line circuits 110-159, staff location calling 08; 09, call party 8; 9, 4 party conference PA., NJ., DEL., Call (609) 691-1075, others call (800) 257-7043.

**WIRED** and wireless infra red remote control cable-TV converter box \$49.95 and up. Pioneer, Sylvania. **CABLE TV PRODUCTS**, PO Box 1334, Jonesboro, AR 72403. 1-(501) 932-1122.

**WANTED:** Cash for old tubes, speakers, amplifiers. Western Electric, RCA, Cunningham, McIntosh, Marantz, Quad, Tannoy, JBL, Altec, Dynaco, Leak, (713) 728-4343. **MAURY**, 11122 Atwell, Houston, TX 77096.

**SURGE** suppressors to protect your sensitive electronic equipment write **DENA ELECTRONIC SYSTEMS**, PO Box 922, Waynesboro, PA 17268.

**XL721 PC boards**. Write for details. Available: large quantities only. **ELECTRONIC DEVELOPMENT LAB**, Box 1560, Pinellas Park, FL 33565.

**GUARANTEED** quality surplus components for less. Free flyer. **ELECTRONIX LTD.**, 3214 South Norton, Sioux Falls, SD 57105.

**25,000** receiving tubes \$3.00 each. Send stamped envelope for list. **FOX**, 22661 Glenwood, Mt. Clemens, MI 48043.

**IMPORTS**—Stereos, boosters, equalizers, speakers, tools, more! S.A.S.E. for listing, **CONNELLY**, 329-76th N. Bergen, NJ 07047.

**APPLE II+** compatible cards: Z80 \$39.95, disk controller \$35.95, EPROM programmer \$49.95, RS-232C \$42.95, 16K-RAM \$34.95, 5 amp power supply \$39.95, RF modulator \$5.95. Great prices on IBM items too! Free listing, 3 month warranty. **KOMPUTECH**, Box 597, Alexandria Bay, NY 13607

**POLICE** descramblers for scanners, telephone devices, etc. Free catalog. **KRYSTAL KITS**, Box 445, Bentonville, AR 72712.

## MICROWAVE TV ANTENNAS

BUY FACTORY DIRECT & SAVE!



COMPLETE & PACKAGED from  
180 DAY GUARANTEE  
SUPER HI GAIN UNITS AVAILABLE  
SATELLITE SYSTEMS IN STOCK  
\*\*DEALERS WANTED\*\*  
service is our trademark

\$69<sup>95</sup>

**NEPTUNE COMMUNICATIONS INC.**

CALL 1-718-357-3970 ups shippable c.o.d.

THE BEST PLACE TO BUY, SELL or  
TRADE NEW and USED EQUIPMENT

**NUTS & VOLTS MAGAZINE**  
BOX 1111-E • PLACENTIA, CA 92670  
(714) 632-7721

Join Thousands of Readers Nationwide  
Every Month

ONE YEAR U.S. SUBSCRIPTIONS  
\$10.00 - 3rd Class • \$15.00 - 1st Class

\$35.00 - Lifetime - 3rd Class

## NUTS & VOLTS

HAM GEAR  
COMPUTERS  
SOFTWARE  
SCANNERS • OPTICS  
TEST EQUIPMENT  
MICROWAVE  
SATELLITE  
AUDIO VISUAL  
NEW PRODUCTS  
COMPONENTS • KITS  
ANTIQUE ELECT.  
PUBLICATIONS  
PLANS • SERVICES

**THIS IS AN EXPANDED TYPE AD.** Notice how it stands out on this page. To get your ad set in this type style mark your classified ad order, "Expanded-type ad," and calculate your cost at \$3.75 per word.

**DESCRAMBLE** cable-over-the-air programs—kits \$97.95—plans \$9.95—details \$1.00—**MINUTE**, Box 531, Westchester Station, Bronx, NY 10461.

**VIDEO** Hook-Up Diagram Manual—shows how to hook-up TV, VCR, satellite, stereos, multi-sets. \$6.00. **NORTHSTAR VIDEO SERVICES**, Dept. R, PO Box 1992, Hollywood, FL 33020.

**ALPHANUMERIC** vacuum fluorescent display Model SG20. Includes all timing, refresh and character generation circuitry. TTL/CMOS compatible. Serial and parallel port. 5VDC power. \$85.00 in single quantity. Free manual. **TOMANTRON, INC.**, 17942 S. 66th Avenue, Tinley Park, IL 60477. (312) 532-7430.

**STATE-of-the-art.** Toroidal power transformers and transformer kits. 50 types in stock 20-600VA. Highest quality. Free catalog. **TOROID CORP.**, 6000 Laurel-Bowie Rd., Bowie, MD 20715.

**MOTION** control: Amazing selection (Steppers, DC & AC, Servo, Linear motors) etc., also **Opto-Electronics**. Send S.A.S.E. for free catalog. **COMPUTER PARTS MART**, 3200 Park Blvd., Palo Alto, CA 94306. (415) 493-5930.

**TAPE**—We're cheaper! Ampex/Scotch 2400/7" reels, first quality, used once. \$0.79/ea + shipping. **COMPUTER PARTS MART**, 3200 Park Blvd., Palo Alto, CA 94306. (415) 493-5930.

**UHF** descrambler, gated and sinewave. Lowest price semikit. Free information. **VISTA**, 717 Front St., Lisle, IL 60532.

**CANADIAN.** Pay TV and Satellite descrambler manual. For all areas. All systems described. Schematics for both hobbyists and purchasers. \$11.95 or send \$1.00 for brochure. **SHOJIKI ELECTRONICS CORP.**, 1327 Niagara St., Niagara Falls, NY 14303. C.O.D.'s call (716) 282-1001. Add \$1.50.

**3,000** tips color TV repairs, 31 brands, 116 pages. Send \$21.00. **TONY FERNANDEZ**, Box 54-6110, Surfside, FL 33154.

**ZENITH SSAVI MANUAL.** Original manual used by technicians. Theory of scrambling, schematics, parts list, repair. For UHF and cable. For speedy delivery send \$15.00 cash or money order. **BAY STATE ELECTRONICS**, PO Box 263, Accord, MA 02018.

Your ad could be selling merchandise for you in this space. The price is a remarkable \$250. To place your order, call any **Radio-Electronics** salesman: Stan Levitan (212) 777-6400, Marvin Green (818) 986-2001, Ralph Berger (312) 446-1444.

## HOME ROBOTS

**PERSONAL** robots, kits and books. Literature \$1.00 (refundable). **CAL ROBOT**, 16200 Ventura Blvd., #223, Encino, CA 91436, (818) 905-0721.

## REEL-TO-REEL TAPES

**AMPEX** professional series open reel tape, 1800- or 2400-foot on 7-inch reels, used once. Case of 40, \$45.00. 10 1/2 x 3600 feet and cassettes available. MasterCard/Visa. **VALTECH ELECTRONICS**, Box 6-RE, Richboro, PA 18954 (215) 322-4866.

## SINE WAVE QUESTIONS?

**TROUBLE** shooting, alignment, antenna hookup, improvements manual, \$6.00. **STV authorization control**, \$3.00. Both, \$8.00. **SIGNAL**, Box 2512-R, Culver City, CA 90231.

## CABLE TV

**DEALERS** wanted: Channel 2, 3, and 4 notch filters. Money back guarantee. Send \$15.00 for sample and quantity price list. Specify channel(s). **GARY KURTZ**, PO Box 291394, Davie, FL 33329.









**YOUR ELECTRONIC COMPONENTS CENTER**

**TOLL FREE: 1-800-343-0874**

Did you receive our new 1985 catalog?

NAME \_\_\_\_\_  
 ADDRESS \_\_\_\_\_  
 CITY \_\_\_\_\_  
 STATE \_\_\_\_\_  
 ZIP CODE \_\_\_\_\_

MAIL COUPON TO:  
 4RE USA: P.O. Box 9100  
 Westborough, Mass. 01581  
 CANADA: 5651 Ferrier St.  
 Montreal, Quebec H4P 1N1

WRITE FOR  
**McGEE'S**  
**SPEAKER & ELECTRONICS CATALOG**  
 1001 BARGAINS IN SPEAKERS  
 Tel.: 1 (816) 842 5092  
 1901 MCGEE STREET KANSAS CITY, MO. 64108

Your ad could be selling merchandise for you in this space. The price is a remarkable \$250. To place your order, call any Radio-Electronics salesman: Stan Levitan (212) 777-6400, Marvin Green (818) 986-2001, Ralph Berger (312) 446-1444.

**SERVICE - ORDERS PROCESSED IN 24 HOURS**  
**QUALITY - CURRENT DATE CODES • LEADING MFR'S.**  
**SAVINGS - VOLUME DISCOUNTS • TOLL FREE NO.**  
**SELF SERVE - STORES ARE OPEN AT 8:00 AM**

SEMICONDUCTORS • PASSIVE COMPONENTS • DATA BOOKS  
 CRYSTALS • CHEMICALS • POWER SUPPLIES • HARDWARE  
 TEST INSTRUMENTS • BREADBOARDING • SOCKETS • SOLDER  
 SWITCHES • MICROCOMPUTERS • TOOLS • TRANSFORMERS • KITS  
 WIRE & CABLE • HEAT SINKS • RELAYS • FANS • CAPACITORS

LINEARS					CMOS						
ACT #	Qty	Pkg	Price	ACT #	Qty	Pkg	Price	ACT #	Qty	Pkg	Price
06101	301AHC	2	1.50	06125	1489APC	8	2.95	06300	4000	4	1.00
06102	301ATC	3	1.00	06077	2207PC	1	1.80	06305	4001	4	1.00
06126	305HC	2	1.50	06060	2211PC	1	1.80	06310	4001	25	5.70
06128	307TC	3	1.20	00061	2240PC	1	1.25	06315	4002	4	1.00
06130	308ATC	1	1.00	06100	3086PC	2	1.05	06320	4006	2	1.00
06132	308TC	2	1.00	06215	3136PC	2	1.30	06325	4007	4	1.00
06085	308HC	1	1.25	06200	3302PC	2	1.00	06330	4009	2	1.10
06007	309KC	1	1.15	06205	3403PC	2	1.20	06335	4010	2	1.10
06008	311HC	1	1.49	06093	3524PC	1	1.50	06340	4011	4	1.00
06103	311TC	3	1.10	06210	3000PC	2	1.30	06345	4011	25	5.70
06015	317JC	2	1.50	06072	4151TC	1	1.00	06350	4012	4	1.00
06098	317KC	1	2.30	06094	4194KC	1	9.00	06355	4013	3	1.00
06014	318TC	1	1.00	06078	4195TC	1	1.00	06360	4013	12	3.65
06081	319PC	1	1.25	06220	4558TC	3	1.20	06365	4014	2	1.40
06016	323KC	1	3.45	06095	6118PC	1	1.30	06370	4015	2	1.10
06025	324PC	3	1.15	54005	9636ATC	1	2.05	06375	4016	3	1.10
06134	337JC	3	1.15	54006	9637ATC	1	2.05	06380	4017	2	1.25
06042	339PC	3	1.15	54007	9638TC	1	2.35	06385	4017	8	4.80
06045	348PC	2	1.30	54009	AM1498L-8	1	1.89	06390	4018	2	1.25
06126	353TC	2	1.49	54012	AM26L531PC	1	1.95	06395	4019	3	1.10
06104	358TC	3	1.10	54096	AM26L532ACN	1	1.95	06400	4020	10	6.45
06105	393TC	3	1.25	54013	AM26S10PC	1	1.69	06405	4020	10	6.45
06106	555TC	3	1.00	54016	DAC-08CP	1	1.75	06410	4021	2	1.25
06117	555TC	12	3.70	54115	DAC-08CP	5	8.15	06415	4022	2	1.25
06107	566PC	2	1.10	54102	DAC-08CO	1	2.25	06420	4023	4	1.10
06050	567TC	2	1.40	54019	MC1350P	1	1.00	06425	4024	2	1.10
06140	592PC	2	1.15	54025	MC3340P	1	1.10	06430	4025	4	1.00
06034	709TC	2	1.95	54138	MC3423P	1	1.00	06435	4026	1	1.00
06145	709HC	2	1.95	54030	MC3486N	1	1.75	06440	4027	3	1.10
06085	714TC	1	2.95	54031	MC3487P	1	1.75	06445	4028	2	1.15
06150	714HC	1	2.30	54093	N8126AN	1	90	06450	4029	2	1.25
06058	723HC	2	1.60	54094	N8178N	1	1.00	06455	4030	4	1.10
06059	723PC	3	1.15	54099	NE5532AP	1	1.50	06460	4034	1	1.55
06039	725TC	1	2.05	54034	NE5534AP	1	1.55	06465	4035	2	1.25
06064	733PC	2	1.80	54035	SN76477N	1	3.79	06470	4040	2	1.15
06041	739PC	1	1.40	54036	SN76488N	1	5.10	06475	4041	2	1.10
06122	741HC	2	1.60	54037	SN76499N	1	6.45	06480	4042	2	1.15
06076	741TC	3	1.00	54400	ULN2002AN	2	1.30	06485	4043	2	1.10
06049	741PC	2	1.10	54401	ULN2003AN	2	1.30	06490	4044	2	1.10
06051	748TC	2	1.10	54024	ULN2004AN	2	1.10	06495	4046	2	1.30
06090	759JC	1	2.00	54148	XRL555CP	1	1.00	06500	4047	2	1.10
06082	1458TC	3	1.20	54076	XR558PC	1	1.70	06505	4048	3	1.20
06099	1488PC	3	1.15	54072	XR2206CP	1	3.50	06510	4049	12	3.65
06097	1488PC	12	4.40	54077	XR8038CP	1	2.85	06515	4050	3	1.00
06057	1489APC	3	1.15	54069	XR13600CP	1	1.40	06520	4050	12	3.65

LINEAR BIFETS			CRYSTALS			UARTS			
ACT #	Qty	Pkg Price	ACT #	Qty	Pkg Price	ACT #	Qty	Pkg Price	
54139	TL022CP	1 1.00	68001	1.0000	5.00	49001	AV3-1015D	0-25K BAUD	5.39
54403	TL061CP	2 1.45	68003	1.8432	2.75	49005	AV5-1013A	0-40K BAUD	3.89
54097	TL062CP	1 1.00	68016	2.0000	2.85				
54041	TL064CN	1 1.50	68081	2.4576 HC23	2.85				
54042	TL071CP	2 1.00	68081	2.4576 HC18	2.95				
54117	TL071CP	10 4.35	68008	3.579545 HC18	1.75				
54043	TL072CP	2 1.50	68009	3.579545 HC33	2.00				
54098	TL072CP	8 3.55	68011	4.0000	1.50				
54044	TL074CN	1 1.45	68027	4.0320	2.85				
54118	TL074CN	5 6.75	68019	4.91520	1.25				
54045	TL075CN	1 2.25	68020	5.0000	1.85				
54141	TL080CP	2 1.00	68012	5.0688	1.95				
54142	TL081CP	2 1.00	68021	6.0000	1.50				
54048	TL092CP	2 1.30	68022	6.1440	1.50				
54049	TL094CN	1 1.25	68023	8.0000	1.35				
54050	TL170CLP	1 1.00	68004	10.0000	1.85				
54051	TL172CLP	2 1.00	68013	10.7388	1.50				
54099	TL191CN	1 2.30	68032	12.0000	1.40				
54100	TL494CN	1 1.55	68026	14.31818	1.80				
54059	TL497ACN	1 1.50	68014	15.0000	1.50				
54144	TL507CP	1 1.00	68015	16.0000	1.50				
54044	TL555CP	3 1.00	68023	18.0000	1.50				
			68025	18.4320	1.50				
			68007	20.0000	1.75				
			68010	32.7680KHZ	1.00				

SOCKETS			MICROPROCESSORS		
ACT #	Qty	Pkg Price	ACT #	Qty	Pkg Price
23085	8 PINS	1 1.10	12001	6502	4.75
23086	14 PINS	7 1.10	12005	6522	6.35
23087	16 PINS	6 1.10	12021	6850	3.20
23084	18 PINS	5 1.30	12014	6802PC	7.50
23088	20 PINS	5 1.19	12023	8085APC	5.85
23089	22 PINS	5 1.42	12038	8284APC	5.50
23090	24 PINS	4 1.19	12053	8088DC	23.70
23091	28 PINS	4 1.30	41001	Z80-CPU	4.99
23092	40 PINS	3 1.42	12073	65008PC	47.95

Partial listing only • Call us for your complete requirements

**ORDERING INFORMATION**  
 Use only the 5 digit ACT # when ordering. Some packages contain multiples other than one. Please note that these multiples will not be broken. Pkg'd Quantity is One (1) unless otherwise indicated.

M P.O. Box 9100  
 A Westborough, Mass. 01581  
 I Mass. 01581  
 L (617) 366-0500

D 5651 Ferrier St.  
 R Montreal, Quebec  
 S Canada, H4P 1N1  
 E (514) 731-7441  
 S 1-800-361-5884

133 Flanders Rd.  
 WESTBOROUGH, Mass.  
 S 01581  
 T (617) 366-9684

MONTREAL (514) 731-7441  
 OTTAWA (613) 728-7900  
 TORONTO (416) 977-7692

DOWNSVIEW (416) 630-0400  
 CALGARY (403) 235-5300  
 VANCOUVER (604) 438-3321  
 EDMONTON (403) 438-5858

CONVENIENT SELF SERVE ELECTRONICS  
 STORES OPEN AT 8:00 A.M.

**TS-1000 SOFTWARE**

TS-1000 2K software. Loan breakdown, checkbook balancer, savings balancer, bargraph, robot driver-train design, addition quizard, multiplication quizard. \$9.99 each, postpaid, check/MO/Visa/MasterCard. Guaranteed. **STURDIVANT LABORATORIES**, Box 116RE, Bedford, MI 49020.

**INVENTORS!**

CAN you profit from your idea? Call us today regarding the marketing of your invention, or write for your free information package. Over a decade of service. **AMERICAN INVENTORS CORPORATION**, 82 Broad Street, Dept. RE, Westfield, MA 01086, (413) 568-3753. (Not an answering service.) A fee based marketing company, offices nationwide.

**NEWSLETTERS**

**ELECTRONIC Systems Newsletter** is a monthly publication written especially for the electronics hobbyist/experimenter. Fascinating projects, new ideas, sources. Free details. **AF PUBLISHING**, Dept. R2, PO Box 524, So. Hadley, MA 01075.

**DO-IT-YOURSELF TV REPAIR**

NEW!...Repair any TV...Easy. Anyone can do it. Write, **RESEARCH**, Rt. 3, Box 601 BR, Colville, WA 99114.

**SCANNERS**

JOIN 30,000 other scanner owners in the nation's largest not-for-profit association of scanner owners. Bi-monthly publication with tech tips, fascinating true stories, news of new listening adventures. Plus member benefit package including car rental discounts, no-extra-cost insurance coverage, free classified ad service, and more. Send just \$9.75 for 10-month trial membership to: **SCANNER ASSOCIATION OF NORTH AMERICA**, 240-A Fencil Lane, Hillside, IL 60162.

**CABLE TV "CYLINDERS"**

**SUPER powered notch filters.** Equivalent of cable company "cylinders". Eliminate undesirable signals. Any channel 2 through 8; 14(A) through 22(I). (Please specify.) Send \$20.00 each. **Money back guarantee.** Quantity discounts, **CATV**, Box 17621, Plantation, FL 33318.

**THIS IS AN EXPANDED-TYPE AD WITH A TINT SCREEN.** See how it jumps out on the page. To order your ad in this format calculate the cost at \$3.75 per word for the expanded-type and add 25% for the tint background.

**MASTERCARD AND VISA** are now accepted for payment of your advertising. Simply complete the form on the first page of the Market Center and we will bill.



# WE HAVE QUALITY PARTS, DISCOUNT PRICES AND FAST SHIPPING!

## TRANSFORMERS

120 volt primaries

5.6 VOLTS @ 750 MA \$3.00  
6 VOLTS @ 150 MA \$1.25  
12 VCT @ 200 MA \$2.00  
18 V. @ 650 MA \$3.50  
18 VOLTS @ 1 AMP \$4.50  
24 VOLTS @ 250 MA \$2.50  
24 VCT @ 1 AMP \$4.50

## TRANSFORMER WALL

ALL ARE 115 VAC PLUG IN

4 VDC @ 70 MA \$2.00  
6 VDC @ 500 MA \$5.00  
9 VAC @ 1 AMP \$3.00  
2.5 VAC @ 265 MA \$2.50  
17 VAC @ 500 MA \$4.00  
24 VAC @ 250 MA \$3.00

## SPRING LEVER TERMINALS

TWO COLOR CODED TERMINALS ON A STURDY 2 3/4" x 3 3/4" BAKELITE PLATE. GREAT FOR SPEAKER ENCLOSURES OR POWER SUPPLIES.

\$1.00 EACH 10 FOR \$9.00

## TI SWITCHING POWER SUPPLY

TI # 1053214-2 COMPACT, WELL-REGULATED SWITCHING POWER SUPPLY DESIGNED TO POWER TEXAS INSTRUMENTS COMPUTER EQUIPMENT.

INPUT: 14VAC - 25. VAC AT 1A  
OUTPUT: +12VDC AT 350MA  
+5VDC AT 1.2A  
-5VDC AT 200MA

SIZE: 4 3/4" X 4 1/4" X 1 1/4" \$5.00 EACH

## LINE CORDS

TWO WIRE 6' 18ga TWO WIRE 3 FOR \$1.00

THREE WIRE 8 FOOT 18ga THREE WIRE \$2.00 EACH

## MULTI-SWITCHES

3 STATION NON-INTERLOCKING 3-2PDT SWITCHES. EACH OPERATES INDEPENDENTLY.

1 3/4" BETWEEN MOUNTING CENTERS. \$1.75 EACH

5 STATION INTERLOCKING

MADE BY ALPS 3-2PDT AND 2-6PDT SWITCHES ON FULLY INTERLOCKING ASSEMBLY. 3/4" BETWEEN MOUNTING CENTERS. \$2.50 EACH

5 STATION NON-INTERLOCKING SAME AS ABOVE, EXCEPT EACH SWITCH OPERATES INDEPENDENTLY. \$2.50 EACH

## MIKE CONNECTOR

5 CONDUCTOR IN-LINE PLUG AND CHASSIS MOUNT JACK. TWIST LOCK STYLE. SAME AS SWITCHCRAFT 12CL5M. \$2.50 PER SET

## METER

0 - 15 V.D.C. THIS 2-1/4" SQUARE METER MEASURES 0-15 VDC. \$4.50 EACH

## SUB-MINIATURE D TYPE CONNECTOR

SOLDER TYPE SUB-MINIATURE CONNECTORS USED FOR COMPUTER HOOK UPS.

DB-15 PLUG \$2.75  
DB-15 SOCKET \$4.00  
DB-15 HOOD \$2.75  
DB-25 PLUG \$2.75  
DB-25 SOCKET \$3.50  
DB-25 HOOD \$1.25

## "PARALLEL" PRINTER CONNECTOR

SOLDER STYLE 36 PIN MALE USED ON "PARALLEL" DATA CABLES. \$5.50 EACH

## I.D.C. MALE

SAME AS ABOVE. WILL PRESS FIT ON STANDARD RIBBON CABLE. \$8.00 EACH

## 7 CONDUCTOR RIBBON CABLE

SPECTRA-STRIP RED MARKER STRIP. 28 GA STRANDED WIRE. \$5.00 PER ROLL (100 FT.)

## 2K 10 TURN

MULTI-TURN POT SPECTROL #MOD 534-7161 \$5.00 EACH

## ROTARY SWITCH

1 POLE 6 POSITION 1 1/4" DIA x 1 1/2" HIGH 75¢ EACH 10 for \$6.00

## PUSHBUTTON POWER SWITCH

DOUBLE POLE POWER SWITCH. PUSH-ON, PUSH-OFF. \$1.00 EACH

## SWITCHES MINI-PUSH BUTTON

S.P.S.T. MOMENTARY NORMALLY OPEN 1/4" BUSHING. 35¢ EACH 10 FOR \$3.25 100 FOR \$30.00

SPECIFY COLOR: RED, BLACK, WHITE, YELLOW.

## REVERBERATION UNIT

ACCUTRONICS COIL SPRING TYPE UNITS. USED IN ELECTRONIC ORGANS TO PROVIDE ACOUSTIC DELAY SOUND EFFECTS. INPUT IMPEDANCE 8 OHMS, OUTPUT IMPEDANCE 2250 OHMS. 4 1/2" x 16 1/4" x 1 1/4" \$7.50 EACH

## SOUND AND VIDEO MODULATOR FOR T.I. COMPUTER

T.I. # UM1381-1. DESIGNED FOR USE WITH T.I. COMPUTERS. CAN BE USED WITH VIDEO SOURCES. BUILT-IN A/B SWITCH. CHANNEL 3 OR 4 SELECTION SWITCH. OPERATES ON 12 VDC. HOOK UP DIAGRAM INCLUDED. \$10.00 EACH

## 48 KEY ASSEMBLY FOR T.I. COMPUTER

NEW TEXAS INSTRUMENTS KEYBOARD. UNENCODED. 48 S.P.S.T. MECHANICAL SWITCHES. TERMINATES TO 15 PIN CONNECTOR. SOLID METAL FRAME 4" X 9". \$6.50 EACH 2 FOR \$11.00

## EDGE CONNECTORS

ALL ARE .156" SPACING

10 PIN EDGE CONNECTOR TRW #50-10-A-20 \$2.00 EACH

22/44 TIN P.C. STYLE. NO MOUNTING EARS. \$1.50 EACH 10 FOR \$14.00

22/44 GOLD P.C. STYLE \$2.00 EACH 10 FOR \$18.00

28/56 GOLD 28/56 GOLD PLATED CONTACTS .156 CONTACT SPACING. \$2.50 EACH 10 FOR \$22.00

## 120V INDICATOR

NEON INDICATOR. RATED 120 V 1/3 W. MOUNTS IN 5/16" HOLE... RED LENS. 75¢ EACH 10 FOR \$7.00 100 FOR \$65.00

GEL CELL BATTERY 12 VDC @ 1.2 AMP HOUR 4" X 1 13/16" X 2 1/8" \$15.00 EACH

# FREE! SEND FOR NEW 1985 48 PAGE CATALOG FREE!

## 13.8 VOLT REGULATED POWER SUPPLY

THESE ARE SOLID STATE FULLY REGULATED 13.8 VDC POWER SUPPLIES. ALL FEATURE 100% SOLID STATE CONSTRUCTION, FUSE PROTECTION, L.E.D. POWER INDICATOR.

2 AMP CONSTANT, 4 AMP SURGE.

UL LISTED \$18.00 EACH

## RELAYS SOLID STATE RELAY

HEINEMANN ELECTRIC #101-5A-140-5 AMP CONTROL 3-32VDC LOAD: 140VAC 5 AMPS SIZE: 2" X 1" X 3/4" HIGH \$5.00 10 FOR \$45.00

## COMPUTER GRADE CAPACITORS

2,000 mfd. 200 VDC 1 3/4" DIA. x 5" HIGH \$2.00

3,600 mfd. 40 VDC 1 3/8" DIA. x 3 3/4" HIGH \$1.00

6,400 mfd. 60 VDC 1 3/8" DIA. x 4 1/4" HIGH \$2.50

31,000 mfd. 15 VDC 1 3/4" DIA. x 4" HIGH \$2.50

72,000 mfd. 15 VDC 2" DIA. x 4 3/8" HIGH \$3.50

185,000 mfd. 6 VDC 2 1/2" DIA. x 4 1/2" HIGH \$1.50

CLAMPS TO FIT CAPACITORS 50¢ ea.

## SLIDE POTS

100K linear tape 2" LONG 1 5/8" TRAVEL 75¢ EACH

500K linear taper 2 7/8" LONG 1 3/4" TRAVEL 75¢ EACH

DUAL 100K audio taper 3 1/2" LONG 2 1/2" TRAVEL \$1.50 EACH

## CRYSTALS

CASE STYLE HC33/U 2 MHZ COLORBURST 3579.545 KC \$3.50 EACH \$1.00 EACH

METAL OXIDE VARISTOR G.E. # V82ZA12 50 VOLTS, NOMINAL D.C. VOLTAGE 5/8" DIAMETER 2 FOR \$1.50

## L.E.D.'S STANDARD JUMBO DIFFUSED

RED 10 FOR \$1.50  
GREEN 10 FOR \$2.00  
YELLOW 10 FOR \$2.00

FLASHER LED 5 VOLT OPERATION RED JUMBO SIZE \$1.00 EACH

BI POLAR LED 2 FOR \$1.70

LED HOLDERS TWO PIECE HOLDER FOR JUMBO LED 10 FOR 85¢ 200 FOR \$10.00

CLEAR CLIPLEIT HOLDER MAKE LED A FANCY INDICATOR. CLEAR. 4 FOR \$1.00

## DC CONVERTER

DESIGNED TO PROVIDE A STEADY ±5 VDC @ 240 MA FROM A BATTERY SUPPLY OF 3.5 TO 6.25 V.

2 1/16" X 1 1/16" X 1 1/16" HIGH. \$1.50 EACH

## 1N4148 SPECIAL

.45" SPACING P.C. LEADS 1000 FOR \$10.00 10,000 FOR \$85.00

## KEY ASSEMBLY

5 KEY \$1.00 EACH CONTAINS 5 SINGLE-POLE NORMALLY OPEN SWITCHES. MEASURES 3 3/4" LONG

6 KEY \$1.25 EACH CONTAINS 6 SINGLE-POLE NORMALLY OPEN SWITCHES. MEASURES 4 1/4" LONG.

## MINIATURE 6 VDC RELAY

SUPER SMALL SPDT RELAY. GOLD COBALT CONTACTS. RATED 1 AMP AT 30 VDC. HIGHLY SENSITIVE. TTL DIRECT DRIVE POSSIBLE. OPERATES FROM 4.3 TO 6 V. COIL RES. 220 OHM.

1 3/16" x 1 3/32" x 7/16" AROMAT # RSD-6V \$1.50 EACH 10 FOR \$13.50

## 13 VDC RELAY

CONTACT: S.P.N.C. 10 AMP @ 120 VAC ENERGIZE COIL TO OPEN CONTACT... COIL: 13 VDC 650 OHMS SPECIAL PRICE \$1.00 EACH

## TRANSISTORS

2N706 4 FOR \$1.00  
2N2222A 3 FOR \$1.00  
PN2222 4 FOR \$1.00  
2N2904 3 FOR \$1.00  
2N2905 3 FOR \$1.00  
2N2907 3 FOR \$1.00

## POWER SUPPLY W/ PRE-AMP

THIS SUPPLY WAS USED TO POWER AN 8 TRACK/CASSETTE UNIT. IT WILL SUPPLY APPROX. 18 VDC AND INCLUDES A SMALL PRE-AMP TO BOOST SIGNAL LEVEL. RCA PLUGS FOR LINE IN/OUT. \$4.50 EACH

## 4 PDT RELAY

14 pin style 3 amp contacts 24 volt d.c. or 120 volt a.c. coil Used but fully tested \$1.70 EACH specify coil voltage LARGE QUANTITIES AVAILABLE SOCKETS FOR RELAY 50¢ each

## MINIATURE TOGGLE SWITCHES

ALL ARE RATED 5 AMPS @ 125 VAC

S.P.D.T. (on-on) P.C. STYLE. NON-THREADED BUSHING. P.C. STYLE 75¢ EACH 10 FOR \$7.00

S.P.D.T. (on-off) NON-THREADED BUSHING. P.C. STYLE 75¢ EACH 10 FOR \$7.00

S.P.D.T. (on-on) SOLDER LUG TERMINALS \$1.00 EACH 10 FOR \$9.00 100 FOR \$80.00

S.P.D.T. (on-off) P.C. LUGS. THREADED BUSHING. \$1.00 EACH 10 FOR \$9.00 100 FOR \$80.00

D.P.D.T. (on-on) SOLDER LUG TERMINALS \$2.00 EACH 10 FOR \$19.00 100 FOR \$180.00

## 3 1/2" SPEAKER

8 OHM IMPEDANCE. FULL RANGE SPEAKER. 8 OZ MAGNET. 4" DIAGONAL MOUNTING CENTERS. \$2.50 EACH 10 FOR \$20.00

## SOLID STATE BUZZER

STAR #SMB-06L. 6VDC. TTL COMPATIBLE. \$1.00 EACH 10 FOR \$9.00

# ALL ELECTRONICS CORP.

TOLL FREE ORDERS ONLY 1-800-826-5432 (ORDER ONLY) (IN CALIFORNIA 1-800-258-6666) ALASKA, HAWAII OR INFORMATION (213) 380-8000



905 S. VERMONT AVE. P.O. BOX 20406 LOS ANGELES, CA 90006  
6228 SEPULVEDA BLVD. VAN NUYS, CA 91411

QUANTITIES LIMITED MINIMUM ORDER \$10.00 USA \$3.00 SHIPPING FOREIGN ORDERS INCLUDE SUFFICIENT SHIPPING CALIF RES ADD 6 1/2% NO C.O.D.

APRIL 1985



7400

74F00

NEW 74ALS00

DISK CONTROLLERS

Table with 3 columns: Part No., Price, and Function. Lists various 7400 series logic chips like 7400, 7401, 7402, etc.

Table with 3 columns: Part No., Price, and Function. Lists various 74F00 series logic chips like 74F00, 74F01, 74F02, etc.

Table with 3 columns: Part No., Price, and Function. Lists various 74ALS00 series logic chips like 74ALS00, 74ALS01, 74ALS02, etc.

Digitaltalker logo and introductory text for DT1050 disk controllers.

DT1050 - Applications: Teaching aids, applications, classic automotive, microcomputers, language translators, etc.

DT1050 Digitaltalker Processor Chip... \$34.95 ea. MM54104 Processor Chip... \$14.95 ea.

DT1057 - Expands the DT1050 secondary from 137 to over 200 words. Int. 2 ROMs and opt. Part No. DT1057... \$24.95 ea.

MICROPROCESSOR COMPONENTS

New Super Low Prices!

MICROPROCESSOR CHIPS

Table with 3 columns: Part No., Price, and Function. Lists microprocessor chips like 8080, 8085, 8088, 8088A, etc.

MICROPROCESSOR COMPONENTS

New Super Low Prices!

DYNAMIC RAMS

Table with 3 columns: Part No., Price, and Function. Lists dynamic RAM chips like 1103, 1104, 1105, etc.

Table with 3 columns: Part No., Price, and Function. Lists various 74LS series logic chips like 74LS00, 74LS01, 74LS02, etc.

Table with 3 columns: Part No., Price, and Function. Lists various 6500 series logic chips like 6502, 6505A, 6505B, etc.

Table with 3 columns: Part No., Price, and Function. Lists various EPROM chips like 2708, 2716, 2732, etc.

INTERISIL

Table with 3 columns: Part No., Price, and Function. Lists various Interisil chips like 70458R, 70459R, 70460R, etc.

30009 1983 INTERISIL Data Book (1356 p.) \$9.95

74HC High Speed CMOS

Table with 3 columns: Part No., Price, and Function. Lists various 74HC series logic chips like 74HC00, 74HC01, 74HC02, etc.

Table with 3 columns: Part No., Price, and Function. Lists various 74S/PROMS series logic chips like 74S00, 74S01, 74S02, etc.

Table with 3 columns: Part No., Price, and Function. Lists various 8000 series logic chips like 8000, 8001, 8002, etc.

Table with 3 columns: Part No., Price, and Function. Lists various PROM chips like 2708, 2716, 2732, etc.

Table with 3 columns: Part No., Price, and Function. Lists various 74C-C/MOS series logic chips like 74C00, 74C01, 74C02, etc.

CA-LINEAR

Table with 3 columns: Part No., Price, and Function. Lists various CA series linear chips like CA3019, CA3020, etc.

CD-CMOS

Table with 3 columns: Part No., Price, and Function. Lists various CD series CMOS chips like CD4001, CD4002, etc.

SPECIAL FUNCTION

Table with 3 columns: Part No., Price, and Function. Lists various special function chips like DS90C01, DS90C02, etc.

LINEAR

Table with 3 columns: Part No., Price, and Function. Lists various linear chips like TL071CP, TL072CP, etc.

Low Profile (Pin) Sockets

Table with 3 columns: Part No., Price, and Function. Lists various low profile sockets like 14-pin, 16-pin, etc.

Soldertail (Gold) Standard

Table with 3 columns: Part No., Price, and Function. Lists various soldertail sockets like 14-pin, 16-pin, etc.

Wire Wrap Sockets

Table with 3 columns: Part No., Price, and Function. Lists various wire wrap sockets like 14-pin, 16-pin, etc.

Header Plugs (Gold)

Table with 3 columns: Part No., Price, and Function. Lists various header plugs like 14-pin, 16-pin, etc.

Shipping: Add Plus \$1.50 Insurance. Send \$1.00 for FREE Literature Catalog. Spec Sheets - 30¢ each.

MasterCard, ameco ELECTRONICS, VISA. 1355 SHOREWAY ROAD, BELMONT, CA 94002. 4/85 PHONE ORDERS WELCOME - (415) 592-8097 - Telex: 176043

30009 1982 Nat. Linear Data Book (1952 pp.) \$11.95

CIRCLE 114 ON FREE INFORMATION CARD



Commodore Accessories

RS232 ADAPTER FOR VIC-20 AND COMMODORE 64



The JE232CM allows connection of standard serial RS232 printers, modems, etc. to your VIC-20 and C-64. A 4-pole switch allows the inversion of the 4 control lines. Complete installation and operation instructions included.

- Plugs into User Port
- Provides Standard RS232 signal levels
- Uses 6 signals (Transmit, Receive, Clear to Send, Request to Send, Data Terminal Ready, Data Set Ready)

**JE232CM.....\$39.95**

VOICE SYNTHESIZER FOR APPLE AND COMMODORE



**Great Educating Tool!**

- Over 250 word vocabulary - affixes allow the formation of more than 500 words
- Built-in amplifier, speaker, volume control, and audio jack
- Recreates a clear, natural male voice
- Plug-in user ready with documentation and sample software
- Case size: 7 1/4" L x 3 3/4" W x 1-3/8" H

Part No.	Description	Price
JE520CM	For Commodore 64 & VIC-20	\$114.95
JE520AP	For Apple II, II+, and IIe	\$149.95

Computer Memory Expansion Kits

**IBM PC, PC XT and Compatibles**  
Most of the popular Memory Boards (e.g. Quadram™ Expansion Boards) allow you to add an additional 64K, 128K, 192K or 256K. The IBM64K Kit will populate these boards in 64K byte increments. The Kit is simple to install - just insert the 5 - 64K RAM chips in the provided sockets and set the 2 groups of switches. Complete conversion documentation included.

**IBM64K (Nine 200ns 64K RAMs).....\$33.49**

**IBM PC AT**  
Each kit comes complete with nine 128K dynamic RAMs and documentation for conversion.

**IBM128K (Nine 250ns 128K RAMs).....\$199.95**

**APPLE IIe**  
Extended 80-column/64K RAM Card. Expands memory by 64K to give 128K when used with programs like VisiCalc™. Fully assembled and tested.

**JE864.....\$99.95**

**TRS-80 MODEL I, III**  
Each Kit comes complete with eight MM5290 (UPD416/4116) 16K Dynamic RAMs and documentation for conversion. Model I: 16K equipped with Expansion Interface can be expanded to 48K with 2 Kits. Model III: Can be expanded from 16K to 48K using 2 Kits. Each Kit will expand computer by 16K increments.

TRS-16K3 200ns (Model III).....\$6.29  
TRS-16K4 250ns (Model I).....\$5.49

**TRS-80 MODEL IV & 4P**  
Easy to install Kit comes complete with 8 ea. 4164N-20 (200ns) 64K Dynamic RAMs and conversion documentation. Converts TRS-80 Model IV computers from 16K to 64K. Also expands Model 4P from 64K to 128K.

TRS-64K-2.....\$29.95  
(Converts the Model IV from 16K to 64K or will expand the Model 4P from 64K to 128K)

TRS-64K2PAL (Model IV only).....\$49.95  
(8 - 4164's with PAL Chip to expand from 64K to 128K)

**TRS-80 COLOR AND COLOR II**  
Easy to install Kit comes complete with 8 ea. 4164N-20 (200ns) 64K Dynamic RAMs and documentation for conversion. Converts TRS-80 Color Computers with D, E, ET, F and NC circuit boards to 32K. Also converts TRS-80 Color Computer II to 64K. Flex DOS or OS-9 required to utilize full 64K RAM on all computers.

TRS-64K-2.....\$29.95

**INDUSTRIES**

**PROTECT YOURSELF... DATASHIELD® Surge Protector**

Eliminates voltage spikes and EM-RFI noise before it can damage your equipment or cause data loss. 6-mo. warranty. Power dissipation (100 microsecond): 2,000,000 watts.

Model	DESCRIPTION	PRICE
Model 100	4 Sockets, On/Off Switch.....	\$49.95
Model 85	6 Sock., Super Filters, On/Off Switch.....	\$59.95
Model 100	6 Sock., Super Filters, Low Volt. Alarm.....	\$69.95
Model 110AMS	6 Sockets, Super Filters, Auto. Master Switch.....	\$99.95

**DATASHIELD® Back-Up Power Source**

Protect your computer from black-outs, brown-outs, power surges and line noise. P711 PC200 is designed for PCs with floppy disk memory, the XT300 for hard disk memory and the AT800 for multi-user systems. A typical complete PC for each of these standbys will be supported for 15 to 75 minutes after power is lost. Weight (PC200: 24 lbs.) - (XT300: 37.5 lbs.) - (AT800: 72 lbs.)

PC200 (200 Watt Rating).....	\$299.95
XT300 (300 Watt Rating).....	\$399.95
AT800 (800 Watt Rating).....	\$799.95

ProModem 1200 and Options



Intelligent 300/1200 Baud Telephone Modem with Real Time Clock/Calendar

The ProModem™ is a Bell 212A (300/1200 baud) intelligent stand-alone modem. Full featured expandable modem. Standard features include Auto Answer and Auto Dial, Help Commands, Programmable Intelligent Dialing, Touch Tone™ and Pulse Dialing & More. Hayes command set compatible plus an additional extended command set. Shown w/ alphanumeric display option.

Part No.	Description	Price
PM1200	RS-232 Stand Alone Unit.....	\$349.95
PM1200A	Apple II, II+ and IIe Internal Unit.....	\$369.95
PM1200B	IBM PC and Compatible Internal Unit.....	\$269.95
PM1200BS	IBM PC & Comp. Int. Unit w/ProCom Software.....	\$319.95
MAC PAC	Macintosh Package. (Includes PM1200, Cable, & ProCom Software).....	\$399.95

OPTIONS FOR ProModem 1200

PM-COM	(ProCom Communication Software).....	\$79.95
PM-OP	(Options Processor).....	\$79.95
PMO-16K	(Options Processor Memory - 16K).....	\$10.95
PMO-32K	(Options Processor Memory - 32K).....	\$20.95
PMO-64K	(Options Processor Memory - 64K).....	\$39.95
PM-ALP	(Alphanumeric Display).....	\$79.95
<b>PM-Special</b>	(Includes Options Processor, 64K Memory and Alphanumeric Display).....	<b>\$189.95</b>

KEYBOARDS

**Mitsumi 54-Key Unencoded All-Purpose Keyboard**

- SPST keyswitches - 20 pin ribbon cable connection
- Low profile keys - Features: cursor controls, control, caps (lock), function, enter and shift keys
- Color (keycaps): grey; Wt.: 1 lb. Pinout included

**KB54.....\$14.95**

13 1/4" L x 4 1/4" W x 3/4" H

**76-Key Serial ASCII Keyboard**

- Simple serial interface - SPST switching - Operates in upper and lower case - Five user function keys: F1-F5 - Six finger edge card connection - Color (keys): tan - Weight: 2 lbs. - Data included

**KB76.....\$29.95**

16-9/16" L x 6 1/4" W x 1 1/4" H

**Apple Keyboard and Case for Apple II and II+**

- Keyboard: Direct connection with 16-pin ribbon connector - 26 special functions - Size: 14 1/4" L x 5 1/2" W x 1 1/4" H
- Case: Accommodates KB-A68 - Pop-up lid for easy access - Size: 15 1/2" W x 18" D x 4 1/4" H

**KB-AE1 Apple Keyboard and Case (pictured above).....\$134.95**  
**KB-A68 68-Key Apple Keyboard only.....\$79.95**  
**EAEC-1 Expanded Apple Enclosure Case only.....\$59.95**

**Apple Keyboard and Case for Apple II and II+**

- Keyboard: Direct connection with 16-pin ribbon connector - 26 special functions - Size: 14 1/4" L x 5 1/2" W x 1 1/4" H
- Case: Accommodates KB-A68 - Pop-up lid for easy access - Size: 15 1/2" W x 18" D x 4 1/4" H

**Apple Keyboard and Case for Apple II and II+**

- Keyboard: Direct connection with 16-pin ribbon connector - 26 special functions - Size: 14 1/4" L x 5 1/2" W x 1 1/4" H
- Case: Accommodates KB-A68 - Pop-up lid for easy access - Size: 15 1/2" W x 18" D x 4 1/4" H

**Apple Keyboard and Case for Apple II and II+**

- Keyboard: Direct connection with 16-pin ribbon connector - 26 special functions - Size: 14 1/4" L x 5 1/2" W x 1 1/4" H
- Case: Accommodates KB-A68 - Pop-up lid for easy access - Size: 15 1/2" W x 18" D x 4 1/4" H

POWER SUPPLIES

**TRANSACTION TECHNOLOGY, INC. 5VDC @ 1 AMP Regulated Power Supply**

- Output: +5VDC @ 1.0 amp (also +30VDC regulated) - Input: 115VAC, 60 Hz
- Two-tone (black/beige) self-enclosed case - 6 foot, 3-conductor black power cord - Size: 6 1/2" L x 7" W x 2 1/4" H - Weight: 3 lbs.

**PS51194.....\$14.95**

**Power/Mate Corp. REGULATED POWER SUPPLY**

- Input: 105-125/210-250 VAC at 47-63 Hz - Line regulation: ±0.05% - Three mounting surfaces - Overvoltage protection - UL recognized - CSA certified

Part No.	Output	Size	Weight	Price
EMA5/6B	5V@3A/6V@2.5A	4 1/4" L x 4" W x 2 1/4" H	2 lbs.	\$29.95
EMA5/6C	5V@6A/6V@5A	5 1/4" L x 4 1/4" W x 2 1/4" H	4 lbs.	\$39.95

**KEPCO/TDK 4-OUTPUT SWITCHING POWER SUPPLY**

- Ideal for disk drive needs of CRT terminals, microcomputers and video games - Input: 115/230VAC, 50/60Hz - Output: +5V @ 5 AMP, +12V @ 1.8 AMP, +12V @ 2 AMP, -12V @ 0.5 AMP - UL recognized - CSA certified - Size: 7 3/4" L x 6-3/16" W x 1 1/4" H - Weight: 2 lbs.

**\$59.95 each or MRM 174FK.....2 for \$99.95**

**Switching Power Supply for APPLE II, II+ & IIe™**

- Can drive four floppy disk drives and up to eight expansion cards
- Short circuit and overload protection - Fits inside Apple computer
- Fully regulated +5V @ 5A, +12V @ 1.5A, -5V @ 5A, -12V @ 5A
- Direct plug-in power cord included - Size: 9 1/4" L x 3 1/2" W x 2 1/4" H - Weight: 2 lbs.

**KHP4007 (SPS-109).....\$59.95**

**4-CHANNEL SWITCHING POWER SUPPLY**

- Microprocessor, mini-computer, terminal, medical equipment and process control applications - Input: 90-130VAC, 47-440Hz - Output: +5VDC @ 5A, -5VDC @ 1A, +12VDC @ 1A, -12VDC @ 1A - Line regulations: ±0.2% - Ripple: 30mV p-p - Load regulation: ±1% - Overcurrent protection - Adj: 5V main output - 10% - Size: 6 3/4" L x 1 3/4" W x 4-15/16" H - Weight: 1 1/2 lbs.

**FCS-604A.....\$69.95**

\$10.00 Minimum Order - U.S. Funds Only  
California Residents Add 6 1/2% Sales Tax  
Shipping - Add 5% plus \$1.50 Insurance  
Send S.A.S.E. for Monthly Sales Flyer!

Spec Sheets - 30c each  
Send \$11.00 Postage for your  
FREE 1985 JAMECO CATALOG  
Prices Subject to Change

MasterCard **Jameco ELECTRONICS** VISA

1355 SHOREWAY ROAD, BELMONT, CA 94002  
4/85 PHONE ORDERS WELCOME - (415) 592-8097 Telex: 176043

Apple Accessories



5 1/4" APPLE™ Direct Plug-In Compatible Disk Drive and Controller Card

The ADD-514 Disk Drive uses Shugart SA390 mechanics - 143K formatted storage - 35 tracks - Compatible with Apple Controller & ACC-1 Controller - The drive comes complete with connector and cable - just plug into your disk controller card - Size: 6" L x 3 1/2" W x 8-9/16" D - Weight: 4 1/2 lbs.

**ADD-514 (Disk Drive).....\$169.95**  
**ACC-1 (Controller Card).....\$49.95**

More Apple Compatible Add-Ons...

APF-1	(Cooling Fan with surge protection).....	\$39.95
KHP4007	(Switching Power Supply).....	\$59.95
JE614	(Numeric/Aux. Keypad for IIe).....	\$59.95
KB-A68	(Keyboard w/Keypad for II & II+).....	\$79.95
MON-12G	(12" Green Monitor w/wheel stand).....	\$99.95
JE864	(80 Col. +64K RAM for IIe).....	\$99.95
ADD-12	(5 1/4" Half-Height Disk Drive).....	\$179.95

DISK DRIVES



Documentation Included **Best Buys!**

MPI515	(MPI 5 1/4" SS full-ht.).....	\$89.95
RFD480	(Remex 5 1/4" DS full-ht.).....	\$129.95
TM100-2	(Tandon 5 1/4" DS full-ht.).....	\$159.95
FD55B	(Teac 5 1/4" DS half-ht.).....	\$149.95
SA455	(Shugart 5 1/4" DS half-ht.).....	\$159.95
FDD100-8	(Siemens 8" SS full-ht.).....	\$139.95
PKC-5	(5 1/4" Power Cable Kit).....	\$2.95
PKC-8	(8" Power Cable Kit).....	\$3.95

UV-EPROM Eraser

**8 Chips - 21 Minutes**

**1 Chip - 15 Minutes**

Erases all EPROMs. Erases up to 8 chips within 21 minutes (1 chip in 15 minutes). Maintains constant exposure distance of one inch. Special conductive foam liner eliminates static build-up. Built-in safety lock to prevent UV exposure. Complete only 9.00" L x 3.70" W x 2.60" H. Complete with holding tray for 8 chips.

**DE-4 UV-EPROM Eraser.....\$74.95**  
**UVS-11EL Replacement Bulb.....\$16.95**

JE664 EPROM PROGRAMMER



**8K to 64K EPROMS - 24 & 28 Pin Packages**  
Completely Self-Contained - Requires No Additional Systems for Operation

- Programs and validates EPROMs - Checks for properly erased EPROMs
- Emulates PROMs or EPROMs - RS232C Computer Interface for editing and program loading - Loads data into RAM by keyboard - Changes data in RAM by keyboard - Loads RAM from an EPROM - Compares EPROMs for content differences - Copies EPROMs - Power Input: 115VAC, 60Hz, less than 10W power consumption - Enclosure: Color-coordinated, light tan panels with molded and pieces in mocha brown - Size: 15 1/4" L x 8 1/2" D x 3 1/4" H - Weight: 5 1/2 lbs.

The JE664 EPROM Programmer emulates and programs various 8-Bit Word EPROMs from 8K to 64K-Bit memory capacity. Data can be entered into the JE664's internal 8K x 8-Bit RAM in three ways: (1) from a ROM or EPROM; (2) from an external computer via the optional JE665 RS232C BUS; (3) from its panel keyboard. The JE664's RAMs may be accessed for emulation purposes from the panel's test socket to an external microprocessor. In programming and emulation, the JE664 allows for examination, change and validation of program content. The JE664's RAMs can be programmed quickly to all "1"s (or any value), allowing unused addresses in the EPROM to be programmed later without necessity of "UV" erasing. The JE664 displays DATA and ADDRESS in convenient hexadecimal (alphanumeric) format. A "DISPLAY EPROM DATA" button changes the DATA readout from RAM word and is displayed in both hexadecimal and binary code. The front panel features a convenient operating guide. The JE664 Programmer includes one JM15A Jumper Module (as listed below).

**JE664-A EPROM Programmer.....\$995.00**  
Assembled & Tested (Includes JM16A Module)

**JE665 - RS232C INTERFACE OPTION** - The RS232C Interface Option implements computer access to the JE664's RAM. This allows the computer to manipulate, store and transfer EPROM data to and from the JE664. A sample program listing is supplied in MBASIC for CP/M computers. Documentation is provided to adapt the software to other computers with an RS232C port. 9600 Baud, 8-bit word, odd parity with 2 stop bits.

**EPROM Programmer w/JE665 Option JE664-ARS.....\$1195.00**  
Assembled & Tested (Includes JM16A Module)

**EPROM JUMPER MODULES** - The JE664's JUMPER MODULE (Personality Module) is a plug-in Module that pre-sets the JE664 for the proper programming pulses to the EPROM and configures the EPROM socket connectors for that particular EPROM.

JEM4 EPROM	JEM4 EPROM	Programming	EPROM MANUFACTURER	PRICE
JM00A	2708	25V	AMD, Motorola, Nat. Inst. TI, AMD, Hitachi, Matsushita	\$14.00
JM16A	2716, 2762, 2716 (7)	25V	Intel, Motorola, Nat. Inst. TI, AMD, Hitachi, Matsushita	\$14.00
JM18B	2762, 2716 (8 V)	30V - 35V + 12V	Motorola, TI, Hitachi, ONI	\$14.00
JM23A	2762, 2716	25V	Motorola, TI, Hitachi, ONI	\$14.00
JM23B	2732	25V	AMD, Fujitsu, NEC, Hitachi, Intel, Mitsubishi, National	\$14.00
JM23C	2732A	21V	Fujitsu, Intel	\$14.00
JM64A	2764, 2716	21V	Motorola	\$14.00
JM64B	2764	21V	Intel, Fairchild, ONI	\$14.00
JM64C	2762, 2716	25V	TI	\$14.00



CPU's & SUPPORT CHIPS		INTER FACE DRIVERS	
Z80A CPU 4.75	8155-2 8.00	AY5-1013A	3.75
Z80B CPU 9.00	8202 19.95	AY5-1015D	5.75
Z80A CTC 4.50	8212 3.00	8148	9.00
Z80A DART 9.00	8214 4.50	8149	9.00
Z80A P10 4.50	8216 3.00	8168	9.00
Z80A S10 9.95	8225 3.50	8170	9.00
82C43	10.00 8237 16.00	8171	9.00
AMD2901	8.95 8238 3.95	8172	9.00
6502	4.75 8250 10.95	8173	9.00
6800	2.50 8251 8.00	8174	9.00
6803L	12.95 8253 8.00	8175	9.00
6809	8.95 8255A-5 8.00	8176	9.00
6810	4.00 8257 8.00	8177	9.00
6821	4.00 8259 8.00	8178	9.00
6845	13.95 8272A 25.00	8179	9.00
6850	3.50 8275 2.50	8180	9.00
6875	4.50 8279 5.00	8181	9.00
07220-1	24.00 8288 17.00	8182	9.00
8035	8.95 8255 12.95	8183	9.00
8080A	4.75 8748 20.00	8184	9.00
8085A	8.00 TMS9277NL 9.95	8185	9.00
8086	16.00 8800CLB 39.50	8186	9.00

SHIFTS REGISTERS		DISC CONTROLLERS	
MM1402	1.75 D765C 10.00	1795	17.00
MM1403	1.75 1771	1796	17.00
MM1404	1.75 1771	1797	17.00
MM5013	2.50 1791	1798	17.00
MM5055	2.50 1793	1799	17.00
MM5056	2.50 1793	1800	17.00
MM5057	2.50 2102-3	1801	17.00
MM5058	2.50 2102-4	1802	17.00
MM5060	2.50 2102-5	1803	17.00
TP18542	3.50 2112-1	1804	17.00
82S126	1.95 2112-2	1805	17.00
82S130	1.95 2118-2	1806	17.00
82S131	1.95 2147-3	1807	17.00
TP8285166	9.50 2147-3	1808	17.00
82S181	3.95 TMS3409	1809	17.00
82S181	3.95 TMS4027-3	1810	17.00
745474	3.95 TMS4027-3	1811	17.00
7208	3.75 TMS4050NL	1812	17.00
27126	22.50 MK4096-11	1813	17.00
2716 + 5V	3.75 4108-3	1814	17.00
2732A	6.95 4116-2	1815	17.00
2764	7.95 4118-4	1816	17.00
3341A	2.95 MK4802	1817	17.00
3628A-3	3.00 26104-4	1818	17.00
6331	1.95 6116-3	1819	17.00
7643-5	3.95 8118-12	1820	17.00
8256-5	1.25 6167P-3	1821	17.00
AM9214C	2.95	1822	17.00

RAM'S		NO. 30 WIRE WRAP WIRE SINGLE STRAND	
TP18542	3.50 2112-1	1804	17.00
82S126	1.95 2112-2	1805	17.00
82S130	1.95 2118-2	1806	17.00
82S131	1.95 2147-3	1807	17.00
TP8285166	9.50 2147-3	1808	17.00
82S181	3.95 TMS3409	1809	17.00
82S181	3.95 TMS4027-3	1810	17.00
745474	3.95 TMS4027-3	1811	17.00
7208	3.75 TMS4050NL	1812	17.00
27126	22.50 MK4096-11	1813	17.00
2716 + 5V	3.75 4108-3	1814	17.00
2732A	6.95 4116-2	1815	17.00
2764	7.95 4118-4	1816	17.00
3341A	2.95 MK4802	1817	17.00
3628A-3	3.00 26104-4	1818	17.00
6331	1.95 6116-3	1819	17.00
7643-5	3.95 8118-12	1820	17.00
8256-5	1.25 6167P-3	1821	17.00
AM9214C	2.95	1822	17.00

CRYSTALS	
DA008EC	3.75 LM380 1.20 LM1310 1.40
TL062CP	.96 LM384 1.60 LM1391 1.00
TL064CN	1.50 LM386 1.00 1456 .80
LM702	1.25 LM387 1.25 1458 .50
TL064	1.50 LM393 .75 LM1398 1.75
LM201	7.75 LF398A 3.00 AD2700LD 4.95
LM301/748	5.00 LM555 .50 LM2901 .95
LM307	.45 LM556 .90 CA3018 1.95
LM308	.66 558 1.75 CA3078A 1.50
LM310	1.10 564 2.50 CA3080 1.00
LM311	7.75 565 .90 CA3098 1.75
LM318	1.25 566 1.25 CA3094 1.30
LM319	1.30 567 .85 CA3130 1.00
LM324	.75 5692 .95 CA3140 1.00
LM339	.90 709C .80 CA3822 3.75
LM348	.90 LM710 .60 LM3909 .80
LF351	.80 733 .95 4136 .85
LF353	1.25 741CV .60 5596A 1.50
LF355	.90 747 .50 8700CJ 5.95
LF356	1.25 CA38 1.75 LM1308 9.95
LM358	.70 LM798CT .60
LM370	1.60
LM377	1.60

TOGGLE SWITCHES	
IN4148 (IN914)	15/1.00
L1411-IR DETECTOR	3/51.00
FP 100 PHOTO TRANS	.50
RED LED's 2"	8/51.00
YEL, GREEN or AMBER LARGE LED's 2"	6/51.00
RED-YELLOW BIPOLAR LED	.90
RED-YELLOW BIPOLAR LED	.90
MLED2R IR LED	.40
MLED14B PHOTO DIODE	.60
MCD2 OPTO ISOLATORS	.60
1 WATT ZENERS: 3.3, 4.7, 5.1, 5.6, 6.8, 8.2, 9.1, 10, 12, 15, 18, or 22V	6/51.00

DIP SWITCHES	
CTS 206-4	4 POSITION .75
CTS 206-7	7 POSITION .95
CTS 206-8	8 POSITION .95
CTS 206-10	10 POSITION 1.25

EPOXY GLASS VECTOR BOARD	
1/16" thick with 1/10" spacing	
4 1/2" x 6 1/2" ..... \$2.40	
SCR's	
1.5A	6A 35A 110A
100	35 40 1.40
200	40 50 1.80
400	60 70 2.40 12.00
600	80 1.00 3.60 15.00
600	1.00 1.20 3.60

C/MOS	
74C00	50 74C007 .90
74C02	40 74C015 1.10
74C04	40 74C021 3.50
74C10	40 4001 .30
74C14	.60 4002 .30
74C20	40 4008 .95
74C22	40 4008 .90
74C26	1.25 4011 .30
74C74	80 4009 .40
74C76	75 4010 .45
74C83	1.20 4012 .30
74C86	40 4013 .35
74C93	1.00 4014 .75
74C154	3.00 4015 .40
74C157	1.70 4017 .75
74C161	1.10 4018 .75
74C174	1.10 4019 .40
74C192	1.40 4020 .75
74C193	1.40 4022 .75
74C245	1.75 4023 .35
74C301	40 4024 .65
74C303	80 4025 .30

74S SERIES	
74S02	.35 74S85 1.25
74S03	.35 74S86 1.25
74S04	.35 74S89 2.00
74S05	.35 74S112 1.00
74S08	.35 74S113 60
74S09	.45 74S124 2.20
74S10	.35 74S133 .45
74S11	.35 74S135 .85
74S15	.35 74S138 .80
74S20	.35 74S139 80
74S30	.35 74S151 .90
74S32	40 74S153 1.25
74S40	40 74S157 .90
74S42	.85 74S158 .90
74S51	.35 74S161 1.75

TTL IC SERIES	
7400	.20 7474 .35
7401	.20 7475 .45
7402	.20 7476 .35
7403	.20 7480 .45
7404	.30 7483 .50
7405	.30 7485 .50
7406	.40 7486 .35
7407	.60 7489 1.90
7408	.25 7490 .55
7409	.25 7491 .50
7410	.20 7492 .50
7411	.25 7493 .50
7412	.25 7494 .60
7413	.35 7495 .55
7414	.50 7496 .60
7415	.20 7497 .50
7425	.30 74116 1.20
7426	.30 74121 .45
7427	.30 74122 .45
7430	.20 74123 .50
7432	.30 74125 .45
7437	.30 74126 .45
7438	.30 74145 .60
7440	.20 74147 1.20
7442	.50 74148 1.20
7445	.20 74157 .55
7446	.70 74151 .55
7447	.70 74153 .55
7448	.70 74154 1.50
7450	.20 74155 .75
7472	.25 74157 .55
7473	.35 74160 .85
7476	.70 74161 .70

DISC CAPACITORS	
1UF 35V	10/\$1.00 100/\$8.00
10UF 35V	16/\$1.00 100/\$5.00

PRINTED CIRCUIT BOARD	
4" x 6" DOUBLE SIDED EPOXY BOARDRED 1/16" THICK	\$6.00 ea.
4" x 6" DOUBLE SIDED EPOXY BOARDRED 1/16" THICK	\$5.62/60

FULL WAVE BRIDGE	
PRV 2A	6A 25A
1.00	1.40
2.00	8.0 1.30 2.20
4.00	1.00 1.65 3.30
6.00	1.30 1.90 4.40

SILICON POWER RECTIFIERS	
PRV 1A	3A 12A 50A 125A 240A
100	.05 .14 .35 .90 5.00 6.00
200	.06 .17 .50 1.30 7.00 9.00
400	.09 .25 .65 1.50 10.00 12.00
600	.11 .30 .80 2.00 13.00 15.00
800	.13 .35 1.00 2.50 16.00 18.00
1000	.20 .45 1.25 3.00 20.00 26.00

REGULATORS	
78L05 or 12	.50 4.00 LM337T .95
LM3095	.75 LM338K .55 75
LM317T	.75 340T 5, 6, 8, 9, 12
20T 5, 12, 15 or 24	85 15, 18 or 24V .75
78M5, 12 or 15	.50 723
333K (LA1405)	.75 LAS1412 + 12V 3A \$3.95

TANTALUM CAPACITORS	
.22UF 35V	5/\$1.00 15UF 16V 3/\$1.00
.47UF 35V	5/\$1.00 30UF 6V 5/\$1.00
.68UF 35V	5/\$1.00 33UF 15V .50
1UF 20V	5/\$1.00 47UF 20V .85
2.2UF 20V	5/\$1.00 68UF 16V \$1.00
3.3UF 20V	4/\$1.00 200UF 20V \$1.75
4.7UF 35V	4/\$1.00 150UF 16V \$1.30
6.8UF 20V	4/\$1.00 330UF 10V \$1.75
10UF 20V	— \$4.00
22UF 10V	— \$3.00

TRANSISTOR SPECIALS	
TIP 31B NPN Si TO-220	\$.40
TIP 32B PNP Si TO-220	\$.40
TIP 34 PNP Si	\$.95
TIP 111	\$.50
TIP 121 PNP Si U84	\$.60
TIP 141 NPN Si U87	\$.100
TIP 145	\$.135
BU206	\$.175
2N404 PNP GE TO-5	3/51.00
2N1307 PNP GE TO-5	\$.40
2N2906 PNP Si POWER DARL	53.00
2N2222 NPN Si TO-18	7/51.00
2N2907 PNP Si TO-18	7/51.00
2N2907 PNP Si TO-18	7/51.00
2N3055 NPN Si TO-3	\$.60
MJE3055T	\$.60
2N3904 NPN Si TO-92	7/51.00
2N4306 PNP Si TO-92	7/51.00
2N4908 PNP Si TO-92	\$.100
2N109 PNP Si TO-220	\$.55
2N2222 NPN SWITCHING POWER	\$.95
MR-8004 CM RF TRANSISTOR NPN S	\$.75
HEP 8014 - PNP GE TO-3	\$.85

74LS SERIES	
74LS00	.30 74LS109 .40
74LS01	.30 74LS112 .40
74LS02	.30 74LS113 .40
74LS03	.30 74LS114 .40
74LS04	.35 74LS123 .75
74LS05	.35 74LS125 .60
74LS06	.35 74LS126 .60
74LS09	.35 74LS132 .60
74LS10	.30 74LS136 .40
74LS11	.35 74LS137 .60
74LS12	.35 74LS138 .60
74LS13	.35 74LS139 .60
74LS14	.50 74LS147 2.20
74LS15	.35 74LS151 .55
74LS20	.30 74LS153 .55
74LS21	.30 74LS155 .70
74LS22	.35 74LS162 .70
74LS26	.30 74LS157 .65
74LS27	.30 74LS158 .60
74LS28	.35 74LS160 .70
74LS30	.30 74LS161 .65
74LS32	.35 74LS162 .70
74LS37	.35 74LS163 .65
74LS38	.35 74LS164 .70
74LS40	.30 74LS165 .70
74LS42	.30 74LS166 1.75
74LS47	.75 74LS169 1.50
74LS51	.30 74LS170 3.00
74LS54	.30 74LS172 .70
74LS74	.40 74LS174 .55
74LS74	.40 74LS175 .55
74LS75	.40 74LS181 2.00
74LS76	.40 74LS190 .90
74LS83	.60 74LS191 .90
74LS85	.70 74LS192 .80
74LS86	.40 74LS193 .80
74LS92	.55 74LS195 .70
74LS93	.55 74LS196 .70
74LS95	.75 74LS197 .75
74LS96	.85 74LS221 .90
74LS107	.40 74LS240 .95

MULTI TURN TRIM POTS	
50 OHM	3/\$2.00
100 OHM	—
1000 OHM	5K 20K 100K

TERMS: FOB CAMBRIDGE, MASS SEND CHECK OR MONEY ORDER MINIMUM TELEPHONE. C.O.D. PURCHASE ORDER OR CHARGE \$20.00. MINIMUM MAIL ORDER \$5.00.	
SEND \$25 FOR OUR CATALOG FEATURING TRANSISTORS & RECTIFIERS 145 HAMPSHIRE ST. STAFF, CAMBRIDGE, MASS. 02138	

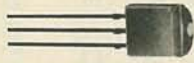
## QUALITY SPECIALS



# Radio Shack Parts Place

## We Have What You Need for Projects and Repairs

### Replacement Transistors



Type	Cat. No.	Each
2N1305 PNP	276-2007	1.19
MPS2222A NPN	276-2009	.79
PN2484 NPN	276-2010	.89
MPS3904 NPN	276-2016	.69
TIP31 NPN	276-2017	.99
TIP3055 NPN	276-2020	1.59
MPS2907 PNP	276-2023	.79
MJE34 PNP	276-2027	1.49
2N3053 NPN	276-2030	.99
MPS3638 PNP	276-2032	.79
TIP120 NPN	276-2068	1.29
2N3055 NPN	276-2041	1.99
MJ2955 PNP	276-2043	2.19
2N4401 NPN	276-2058	.59
MPSA42 NPN	276-2061	.69
2N3819 N-FET	276-2035	.99
MPF102 N-FET	276-2062	.99
IRF511 V-FET	276-2072	2.59
IRFD123 V-FET	276-2073	1.49
2SC1308 NPN	276-2055	7.95

### 1/4 Watt, 5% Resistors

Pkg. of 5 **39¢**



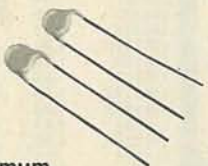
Ohms	Cat. No.	Ohms	Cat. No.
10	271-1301	10k	271-1335
100	271-1311	15k	271-1337
150	271-1312	22k	271-1339
220	271-1313	27k	271-1340
270	271-1314	33k	271-1341
330	271-1315	47k	271-1342
470	271-1317	68k	271-1345
1k	271-1321	100k	271-1347
1.8k	271-1324	220k	271-1350
2.2k	271-1325	470k	271-1354
3.3k	271-1328	1 meg	271-1356
4.7k	271-1330	10 meg	271-1365
6.8k	271-1333		

### Ceramic Disc Capacitors

Low As

**39¢**

Pkg. of 2



- Hi-Q Design
- Moistureproof
- 50 WVDC Minimum

pF	Cat. No.	Pkg. of 2	µF	Cat. No.	Pkg. of 2
4.7	272-120	.39	.001	272-126	.39
47	272-121	.39	.005	272-130	.39
100	272-123	.39	.01	272-131	.39
220	272-124	.39	.05	272-134	.49
470	272-125	.39	.1	272-135	.49

### 4000-Series CMOS ICs



With Pin-Out and Specs

Type	Cat. No.	Each
4001	276-2401	.99
4011	276-2411	.99
4013	276-2413	1.19
4017	276-2417	1.49
4049	276-2449	1.19
4066	276-2466	1.19

### TTL Digital ICs

With Pin-Out and Specs

Type	Cat. No.	Each
7400	276-1801	.89
7404	276-1802	.99
7408	276-1822	1.29
7447	276-1805	1.59
7490	276-1808	1.09

### Operational Amplifiers

Type	Cat. No.	Each
741 (Single)	276-007	.89
MC1458 (Dual)	276-038	.99
LM324 (Quad)	276-1711	1.29
TL082 (Dual)	276-1715	1.89
TL084 (Quad)	276-1714	2.99
LM3900 (Quad)	276-1713	1.39
LM339 (Quad)	276-1712	1.49
TLC271 (Single)	276-1748	1.59
TLC272 (Dual)	276-1749	2.19
TLC274 (Quad)	276-1750	2.99

### Power Transformers

120 VAC Primaries

Type	Volts	Current	Cat. No.	Each
PC Mini	12.0 CT	120 mA	273-1360	2.49
Miniature	6.3	300 mA	273-1384	2.59
Miniature	12.6	300 mA	273-1385	2.79
Miniature	25.2	300 mA	273-1386	3.49
Miniature	12.6 CT	450 mA	273-1365	3.59
Miniature	25.2 CT	450 mA	273-1366	3.99
Standard	6.3	1.2 A	273-1351	3.99
Standard	12.6 CT	1.2 A	273-1352	4.99
Standard	25.2	1.2 A	273-1353	5.99
Heavy-Duty	12.6 CT	3.0 A	273-1511	5.99
Heavy-Duty	25.2 CT	2.0 A	273-1512	6.29
Heavy-Duty	18.0 CT	2.0 A	273-1515	6.99

CT = Center Tap

### Plug-In PC Boards

**Multi-Purpose Board.** Poly-glass material withstands circuit mods. 4 1/2 x 4" with 1/16" grids. **276-152** ..... 2.99



**Three-Voltage Source Board.** As above, but with 3 busses. Ideal for op-amp circuits. **276-154** ..... 2.99

**44-Position Card-Edge Socket.** Solder type with mounting tabs. Accepts boards above. **276-1551** ..... 2.99



### Voltage Regulators



Type	Adjustable	Cat. No.	Each
LM723	0 to 40 VDC	276-1740	.99
LM317T	1.2 to 37 VDC	276-1778	2.79

Type	Fixed Output	Cat. No.	Each
7805	+5 VDC	276-1770	1.59
7812	+12 VDC	276-1771	1.59
7815	+15 VDC	276-1772	1.59
7905	-5 VDC	276-1773	1.59

### Rocker Switches

Rated 6 Amps  
At 125 VAC



Size: 1 3/16 x 3/4 x 1 3/8".  
Mount in 3/4" round panel hole.  
SPST. 275-690 ..... 1.89  
DPDT. 275-691 ..... 2.49

### Understanding Data Communications

Only **3.95**



An easy-to-understand step-by-step course covering methods of transmitting data electronically. Topics include local area networks, synchronous and asynchronous modes, fiber optic links and more. Illustrated. 256 pages. **62-1389** ..... 3.95

### Fold-Up Autoranging Multimeter



**79.95**

Our Best!  
The DVM  
That "Thinks"

Automatic range-setting, polarity reverse, power-off, Big 1 1/2" LCD display. "Beep" continuity. Diode/semi junction test. Pushbutton ohms zero adjust. With leads, manual. Batteries extra. **22-193** ..... 79.95

### Digital Logic Probe

**19.95**



Simultaneous Tone Output  
Frees Eyes for Fast Testing

Lets you "peek inside" TTL, LS and CMOS digital circuits. Color-coded LEDs indicate high, low or pulsed logic states. Simultaneous tone output. Overload and polarity protected. **22-302** ..... 19.95

### SPECIAL PURCHASE!

#### Power Supply Chassis

Only **4.95**



Why Pay More?

A compact switching power supply with super clean DC output. Made for TI 99/4 computer. Input: 18 VAC (use our #273-1515 transformer). Outputs: 12 VDC at 400 mA, +5 VDC at 1.1 amp, -5VDC at 200 mA. Compare our low price! **277-1016** ..... 4.95

#### Computer Keyboard

Only **2.95**



Made for TI 99/4 computer. This very high quality QWERTY board has 48 full-stroke keys and comes with a schematic showing X-Y electrical layout. 15-pin type AMP 1-640441-5 connector. Hurry—they won't last long at this low price! **277-1017** ..... 2.95

Over 1000 items in stock: Binding posts, Books, Breadboards, Buzzers, Capacitors, Chokes, Clips, Connectors, Fuses, Hardware, ICs, Jacks, Knobs, Lamps, Multitesters, PC Boards, Plugs, Rectifiers, Relays, Resistors, Switches, Tools, Transformers, Transistors, Wire, Zener Diodes, and more!

**Radio Shack**  
A DIVISION OF TANDY CORPORATION

Prices apply at participating Radio Shack stores and dealers



**PARTIAL LISTING ONLY- PLEASE CALL OR WRITE FOR FREE CATALOG.**

**STATIC RAMS**

2112	256x4 (450ns)	2.99
2114	1024x4 (450ns)	8/9.95
2114-25	1024x4 (250ns)	8/10.95
2114L-4	1024x4 (450ns)(LP)	8/12.95
2114L-3	1024x4 (300ns)(LP)	8/13.45
2114L-2	1024x4 (200ns)(LP)	8/13.95
TMM2016-200	2048x8 (200ns)	3.25
TMM2016-150	2048x8 (150ns)	3.75
TMM2016-100	2048x8 (100ns)	4.75
HM6116-4	2048x8 (200ns)(cmos)	3.69
HM6116-3	2048x8 (150ns)(cmos)	3.95
HM6116LP-4	2048x8 (200ns)(cmos)(LP)	3.95
HM6116LP-3	2048x8 (150ns)(cmos)(LP)	4.25
HM6264P-15	8192x8 (150ns)(cmos)(LP)	17.95

LP = Low Power

**DYNAMIC RAMS**

4116-250	16384x1 (250ns)	8/6.95
4116-200	16384x1 (200ns)	8/8.95
4116-150	16384x1 (150ns)	8/10.95
4164-200	65536x1 (200ns)(5v)	9/24.95
4164-150	65536x1 (150ns)(5v)	9/25.95
TMS4164	65536x1 (150ns)(5v)	7.95

5v = Single 5 Volt Supply

**EPROMS**

2708	1024x8 (450ns)	3.95
2716	2048x8 (450ns)(5v)	3.95
2716-1	2048x8 (350ns)(5v)	4.95
TMS2532	4096x8 (450ns)(5v)	4.95
2732	4096x8 (450ns)(5v)	4.25
2732A-4	4096x8 (400ns)(5v)(21vPGM)	4.95
2732A-35	4096x8 (350ns)(5v)(21vPGM)	4.95
2732A	4096x8 (250ns)(5v)(21vPGM)	6.95
2732A-2	4096x8 (200ns)(5v)(21vPGM)	10.95
2764	8192x8 (450ns)(5v)	4.95
2764-250	8192x8 (250ns)(5v)	5.25
2764-200	8192x8 (200ns)(5v)	8.95
27128	16384x8 (250ns)(5v)	13.95

5v = Single 5 Volt Supply  
21vPGM = Program at 21 Volts

**SPECTRONICS CORPORATION**

**EPROM ERASERS**

	Timer	Chip Capacity	Intensity (uW/Cm <sup>2</sup> )	
PE-14		9	8,000	83.00
PE-14T	X	9	8,000	119.00
PE-24T	X	9	9,600	175.00

**8000**

8035	5.95
8039	5.95
8080	3.95
8085	4.95
8085A-2	11.95
8087	129.00
8088	19.95
8155	6.95
8155-2	7.95
8156	6.95
8748	24.95
8755	24.95

**8200**

8203	39.95
8205	3.50
8212	1.80
8216	1.75
8228	3.49
8237-5	15.95
8243	4.45
8250	10.95
8251A	4.49
8253	6.95
8253-5	7.95
8255	4.49
8255-5	5.25
8259	6.90
8259-5	7.50
8272	19.95
8275	29.95
8279	6.95
8282	6.50
8284	5.50
8286	6.50
8288	14.95

**Z80  
2.5 Mhz**

Z80-CPU	2.49
Z80-CTC	2.95
Z80-PIO	2.95
Z80-SIO/0	9.95

**4.0 Mhz**

Z80A-CPU	2.49
Z80A-CTC	3.95
Z80A-DART	8.95
Z80A-PIO	3.95
Z80A-SIO/0	10.95

**6.0 Mhz**

Z80B-CPU	8.95
----------	------

**6500**

6502	4.95
6520	2.95
6522	5.49
6532	9.95
6551	9.95
6502A	5.95
6522A	9.95
6551A	11.95

**6800**

68000-8	39.95
6800	2.95
6802	7.95
6809	8.95
6809E	8.95
6821	2.95
6845	12.95
6850	3.25
6883	22.95

**DISK CONTR**

1771	15.95
1791	23.95
1793	23.95
UPD765	19.95

**INTERFACE**

8T26	1.59
8T28	1.98
DM8131	2.95
DP8304	2.29

**CLOCK CHIPS**

MMS314	4.95
MMS369	1.95
MMS8167	8.95
MSM5832	3.95

**DATA ACQ**

ADC0804	3.49
ADC0809	4.49
ADC0817	9.95
DAC0808	2.95
MC1408L8	2.95

**SOUNDCHIPS**

76477	3.95
76488	5.95
AY3-8910	12.95
SSI263	39.95

**74LS00**

74LS00	.24	74LS157	.65
74LS01	.25	74LS158	.59
74LS02	.25	74LS160	.69
74LS03	.25	74LS161	.65
74LS04	.24	74LS163	.65
74LS05	.25	74LS164	.69
74LS08	.28	74LS165	.95
74LS09	.29	74LS166	1.95
74LS10	.25	74LS169	1.75
74LS11	.35	74LS173	.69
74LS12	.35	74LS174	.55
74LS13	.45	74LS191	.89
74LS14	.59	74LS192	.79
74LS20	.25	74LS193	.79
74LS21	.29	74LS194	.69
74LS26	.29	74LS195	.69
74LS27	.29	74LS197	.79
74LS32	.29	74LS221	.89
74LS33	.55	74LS240	.95
74LS37	.35	74LS241	.99
74LS38	.35	74LS242	.99
74LS40	.25	74LS243	.99
74LS42	.49	74LS244	1.29
74LS47	.75	74LS245	1.49
74LS51	.25	74LS251	.59
74LS73	.39	74LS253	.59
74LS74	.35	74LS257	.59
74LS75	.39	74LS258	.59
74LS76	.39	74LS259	2.75
74LS85	.69	74LS260	.59
74LS86	.39	74LS266	.55
74LS90	.55	74LS279	.49
74LS92	.55	74LS280	1.98
74LS93	.55	74LS283	.69
74LS107	.39	74LS290	.89
74LS109	.39	74LS293	.89
74LS112	.39	74LS299	1.75
74LS122	.45	74LS323	3.50
74LS123	.79	74LS365	.49
74LS124	2.90	74LS367	.45
74LS125	.49	74LS368	.45
74LS126	.49	74LS373	1.39
74LS132	.59	74LS374	1.39
74LS136	.39	74LS377	1.39
74LS138	.55	74LS390	1.19
74LS139	.55	74LS393	1.19
74LS145	1.20	74LS640	2.20
74LS148	1.35	74LS645	2.20
74LS151	.55	74LS670	1.49
74LS153	.55	74LS682	3.20
74LS154	1.90	74LS688	2.40
74LS155	.69	81LS95	1.49
74LS156	.69	25LS2521	2.80

**7400**

7400	.19	7492	.50
7401	.19	7493	.35
7402	.19	74100	1.75
7403	.19	74107	.30
7404	.19	74116	1.55
7405	.25	74121	.29
7406	.29	74122	.45
7407	.29	74123	.49
7408	.24	74125	.45
7409	.19	74126	.45
7410	.19	74132	.45
7411	.25	74145	.60
7413	.35	74148	1.20
7414	.49	74150	1.35
7416	.25	74151	.55
7417	.25	74153	.55
7420	.19	74154	1.25
7421	.35	74155	.75
7425	.29	74157	.55
7427	.29	74159	1.65
7430	.19	74161	.69
7432	.29	74163	.69
7437	.29	74164	.85
7438	.29	74165	.85
7442	.49	74166	1.00
7445	.69	74173	.75
7447	.69	74174	.89
7448	.69	74175	.89
7473	.34	74185	2.00
7474	.34	74192	.79
7475	.45	74193	.79
7476	.35	74194	.85
7483	.50	74259	2.25
7485	.59	74367	.65
7489	2.15	74368	.65
7490	.35	74393	1.35

**74S00**

74S00	.32
74S02	.35
74S04	.35
74S05	.35
74S08	.35
74S10	.35
74S11	.35
74S20	.35
74S32	.40
74S37	.88
74S74	.50
74S86	.50
74S112	.50
74S124	2.75
74S132	1.24
74S133	.45
74S138	.85
74S139	.85
74S140	.55
74S151	.95
74S153	.95
74S157	.95
74S158	.95
74S161	1.95
74S163	1.95
74S174	.95
74S175	.95
74S240	2.20
74S241	2.20
74S244	2.20
74S280	2.95
74S287	1.90
74S288	1.90
74S373	2.45
74S374	2.45
74S471	4.95

**★★★★HIGH-TECH★★★★**

**μPD765 FLOPPY DISK CONTROLLER**

- \* AS USED IN IBM PC
- \* SUPPORTS UP TO FOUR 5 1/4" OR 8" DISK DRIVES
- \* SINGLE OR DOUBLE DENSITY, SINGLE OR DOUBLE SIDED
- \* DMA OR NON-DMA OPERATION

**\$19.95**

**★★★★SPOTLIGHT★★★★**

**CRYSTALS**

32.768Khz	1.95
1.0Mhz	3.95
1.8432	3.95
2.0	2.95
2.4576	2.95
3.579545	2.95
4.0	2.95
5.0	2.95
5.0688	2.95
6.0	2.95
6.144	2.95
8.0	2.95
10.738635	2.95
14.31818	2.95
15.0	2.95
16.0	2.95
17.430	2.95
18.432	2.95
20.0	2.95

**UARTS**

AY5-1013	3.95
AY3-1015	6.95
TR1602	3.95
2651	8.95
IM6402	7.95

**BIT-RATE GENERATORS**

BR1941	11.95
4702	12.95
COM8116	10.95
14411	11.95

**MISC.**

3242	7.95
MC3470	4.95
AY5-3600 PRO	11.95
HD46505SP	15.95
CRT5027	19.95

**LINEAR**

TL084	2.19	NE564	2.95
LM301	.34	LM565	.99
LM307	.45	LM566	1.49
LM308	.69	NE592	.98
LM309K	1.25	LM733	.98
LM310	1.75	LM741	.35
LM311	.64	LM747	.69
LM317T	1.19	LM1310	1.49
LM317K	3.95	MC1330	1.69
LM318	1.49	MC1372	6.95
LM323K	4.95	LM1458	.59
LM324	.59	LM1488	.69
LM331	3.95	LM1489	.69
LM334	1.19	LM1496	.85
LM335	1.40	LM1800	2.37
LM336	1.75	LM1812	8.25
LM337T	1.95	LM1889	1.95
LM338K	3.95	ULN2003	1.29
LM339	.99	XR2206	3.75
LM348	.99	XR2211	5.25
LM350K	4.95	CA3146	1.85



**PARTIAL LISTING ONLY- PLEASE CALL OR WRITE FOR FREE CATALOG.**

**CAPACITORS**

ELECTROLYTIC					
RADIAL			AXIAL		
.47uf	50v	.14	10	50v	.16
10	50v	.15	22	16v	.14
47	35v	.18	47	50v	.20
100	16v	.18	100	15v	.20
220	35v	.20	150	25v	.25

**50v MONOLITHIC**

.01uf	.14	.1	.18
.047	.15	.47	.25

**50v DISC**

10pF	.05	470	.05
22	.05	560	.05
25	.05	680	.05
27	.05	820	.05
33	.05	.001uf	.05
47	.05	.0015	.05
56	.05	.0022	.05
68	.05	.005	.05
82	.05	.01	.07
100	.05	.02	.07
220	.05	.05	.07
330	.05	.1	.12

**BYPASS CAPS**

.01uf disc	50v	100/6.00
.1uf disc	12v	100/8.00
.01uf mono	50v	100/12.00
.1uf mono	50v	100/15.00

**IC SOCKETS**

1-99 100		
8 pin ST	.13	.11
14 pin ST	.15	.12
16 pin ST	.17	.13
18 pin ST	.20	.18
20 pin ST	.29	.27
22 pin ST	.30	.27
24 pin ST	.30	.27
28 pin ST	.40	.32
40 pin ST	.49	.39
64 pin ST	4.25	call
ST=SOLDERTAIL		
8 pin WW	.59	.49
14 pin WW	.69	.52
16 pin WW	.69	.58
18 pin WW	.99	.90
20 pin WW	1.09	.98
22 pin WW	1.39	1.28
24 pin WW	1.49	1.35
28 pin WW	1.69	1.49
40 pin WW	1.99	1.80
WW=WIREFRAP		
16 pin ZIF	4.95	call
24 pin ZIF	5.95	call
28 pin ZIF	6.95	call
ZIF=TEXTTOOL (Zero Insertion Force)		

**ACCESORIES & PERIPHERALS**

**FOR IBM**

MAXIMIZER Memory Multifunction	259.95
HAYES SMARTMODEM 1200B	419.95
130W POWER SUPPLY	159.95
TEAC FD-55B 1/2 Ht. Disk Drive, DS/DD	129.95
MPI-B52 5 1/4" FDD, DS/DD	109.95
PROTOTYPE CARD	27.95
PROTOTYPE CARD With Decoding	29.95

**FOR APPLE**

JDR 16K RAM CARD	39.95
EPROM PROGRAMMER RP525	79.95
PRINTMAX Parallel printer interface	49.95
BAL-500 1/2 Ht. Disk Drive, Teac Mechanism	169.95
BAL-525 1/2 Ht. Disk Drive, Alps Mechanism	139.95
MITAC AD-1 Full Height, Shugart Mechanism	179.95
DISK CONTROLLER CARD	49.95
VIEWMAX-80 80 Column For Apple II+	159.95
VIEWMAX-80e 80 Column For Apple IIe	129.95
THUNDERCLOCK Official PRODOS Clock	129.95
KRAFT JOYSTICK	39.95
60W POWER SUPPLY	49.95

**MISCELLANEOUS**

ZENITH ZVM-123 15 MHz Green Monitor	105.00
NEC JB1201M 20 MHz Green Monitor	169.00
BMC BM-AU9191U Comp. 13" Color Monitor	279.00
BMC BX-80 PRINTER	199.95
NASHUA DISKETTES SS/SD Box of 10	19.95
VERBATIM DATALIFE DISKETTES DS/DD	34.95
DISKETTE FILE Holds 70 Diskettes	9.95

**BARGAIN HUNTERS CORNER**

41256	266K	200ns	\$13.95
4164	64K	200ns	\$24.95

HM6264	8Kx8	100ns	CMOS	\$17.95
TMM2016	2Kx8	100ns	CMOS	\$3.25
HM6116	2Kx8	100ns	CMOS	\$3.69

27128	16Kx8	100ns	\$13.95
2764	8Kx8	150ns	\$4.95
2732	4Kx8	450ns	\$4.25

MATH CO. PROCESSOR CHIP	8087-3	100ns	\$129.00
-------------------------	--------	-------	----------

**SPECIALS ENDS 4/30/85**

**SWITCHING POWER SUPPLIES**

P3-ASTEC	P3-3
MODEL AA 12110	ASTEC AA11190
+12V @ 2A	+5V @ 4A
-12V @ .1A	+12V @ 2.5A
+5V @ 2.5A or	-5V @ .25A
5A if 12V not used	-12V @ .30A
<b>19.95</b>	<b>39.95</b>

**5 1/4" DISK DRIVES**

TANDON TM100-2	DS/DD	159.95
SHUGART SA400L	SS/DD	199.95
MPI B52	DS/DD	109.95
TEAC FD55B 1/2 Ht.	DS/DD	129.95
TEAC FD55F 1/2 Ht.	DS/Quad	139.95

**8" DISK DRIVES**

SIEMENS FD200-8	DS/DD	180.00
SIEMENS FD100-8	SS/DD	129.00

**BEST SELLING IDC CONN.**

RIBBON HEADER SOCKETS			
IDS 20	2.25	IDS 40	1.99
IDS 26	1.39	IDS 50	2.25
IDS 34	1.59		

RIBBON EDGE CARDS			
IDE 20	2.25	IDE 40	3.80
IDE 26	2.65	IDE 50	3.95
IDE 34	2.75		

**LIGHT EMITTING DIODES JUMBO DISPLAYS**

RED	1-99	100-up	MAN-72 CA .3"	.99
GREEN	.10	.09	MAN-74 CC .3"	.99
YELLOW	.18	.15	FND-500 CC .5"	1.49
	.18	.15	FND-507 CA .5"	1.49

**D-SUBMINIATURE**

DESCRIPTION	ORDER BY	CONTACTS				
		9	15	25	37	
SOLDER CUPS	MALE	DBxxP	1.19	1.59	1.90	2.85
	FEMALE	DBxxS	1.50	1.85	2.25	3.90
RT. ANGLE	MALE	DBxxPR	1.65	2.20	3.00	4.83
	FEMALE	DBxxSR	2.18	3.03	3.00	6.19
IDC	MALE	IDBxxP	2.95	3.90	4.75	6.95
	FEMALE	IDBxxS	3.25	4.29	5.25	7.95
HOODS	BLACK	HOOD-B	---	---	.99	---
	GREY	HOOD	.89	.99	.99	1.09

**MOUNTING HARDWARE-\$1.00**  
FOR ORDERING INSTRUCTIONS, SEE IDC CONN. ABOVE.

**9000**

9334	2.50
9368	3.95
9602	1.50

**INTERSIL**

ICL7107	12.95
ICL7660	2.95
ICL8038	3.95

**DIP SWITCHES**

4 position	.85
6 position	.90
7 position	.95
8 position	.95

**TRANSISTORS**

2N2222	.25	PN2907	.13
PN2222	.10	2N3055	.79
2N2905	.50	2N3904	.10
2N2907	.25	2N3906	.10

**DISCRETE**

1N751	5.1v zener	.25
1N759	12.0v zener	.25
1N4148	(1N914) switching	25/1.00
1N4004	400PIV rectifier	10/1.00
KBP02	200PIV 1.5a bridge	.45
4N33	OPTO-ISOLATOR	1.75

**RIBBON CABLE**

CONTACTS	SINGLE COLOR		COLOR CODED	
	1'	10'	1'	10'
25	.45	4.00	1.32	11.80
34	.61	5.40	1.65	14.50
50	.89	7.50	2.50	22.00

**36 PIN CENTRONICS**

CEN36 MALE SOLDER CUP	7.95
IDCEN36 MALE RIBBON CABLE	8.95
IDCEN36F FEMALE RIBBON CABLE	8.95

**VOLTAGE REGULATORS**

7805T	.75	7915T	.85
78M05C	.35	7805K	1.39
7808T	.75	78H05K	9.95
7812T	.75	7812K	1.39
7815T	.75	7912K	1.49
7824T	.85	78L05	.69
7905T	.85	79L05	.79
7912T	.85	79L12	.79

C, T-TO-220, K-TO-3, L-TO-92

**CMOS**

4001	.25	4027	.45	4066	.39	4538	1.95
4002	.25	4028	.69	4069	.29	4543	1.19
4011	.25	4029	.79	4070	.35	4553	5.79
4012	.25	4040	.75	4071	.29	4584	.75
4013	.38	4042	.69	4081	.29	74C00	.35
4015	.39	4046	.85	4082	.29	74C04	.35
4016	.39	4047	.95	4093	.49	74C14	.59
4017	.69	4049	.35	4503	.65	74C74	.65
4018	.79	4050	.35	4511	.85	74C906	.95
4020	.75	4051	.79	4518	.89	74C922	4.49
4023	.29	4053	.79	4520	.79	74C923	4.95
4024	.65	4060	.89	4528	1.19	74C926	7.95

VISA

**ORDER TOLL FREE**

**800-538-5000**

**800-662-6279 (CA)**

MasterCard

© Copyright 1985 JDR Microdevices

CIRCLE 113 ON FREE INFORMATION CARD

APRIL 1985

109



## Build this Satellite TV Stereo Processor and enjoy programs in stereo on your home satellite TV.



MFJ-3201K **Anyone with a home satellite TV system can receive TV and audio programs in stereo.** Much of the programming is in stereo. That includes Movie Channel, Disney Channel, Nashville Network, ESPN, MTV, Arts and Entertainment, Country Music TV, PTL and more.

A built-in stereo synthesizer lets you enjoy stereo even if the program is not in stereo.

It has both discrete and matrix capabilities, tunable left and right channels, narrow and wide bandwidths. Plugs into raw video or audio subcarrier jack of satellite TV receiver. Left and right audio output for your stereo amplifier. Sharp ceramic filtering, low distortion 3089 FM demodulator IC. 110 VAC. 8x10x6 inches. Complete kit includes all components, PC board, cabinet. Assembled MFJ-3201, \$149.95.

Examine this kit for 10 days. If not delighted return within 10 days for refund (less shipping). Order today. Call Toll Free 800-647-1800. Charge VISA, MC or mail check, money order.

**CALL TOLL FREE... 800-647-1800**

Call 601-323-5869 in MS, outside continental USA.

**MFJ ENTERPRISES INCORPORATED**  
921 Louisville Rd., Starkville, MS 39759

CIRCLE 105 ON FREE INFORMATION CARD

## THE BEST PRICES

5 1/4" TOP QUALITY DISKS 55/DD, fully guar. 10/\$8.80  
COMPUTER MONITORS, 12" grn, rfe, repairable minor prob \$5  
5 1/4" DISK JACKETS, white, generic 12/81  
COMPUTER PAPER tears to 8 1/2", white, 2400/case \$29  
AS ABOVE, LETTER QUAL, CLEAN FEED, 2600/case \$29  
SATISFACTION GUARANTEED OR YOUR MONEY BACK!!!  
SILIBERT 201, 11ke 801, 85/50 B, rfe, guaranteed, \$49  
5 MBYTE MINIWINCHESTERS, rfe, guar, nds alignment \$68  
DAK KEYBOARD SWITCHES, SPST-NO 20/81  
ROSCHEX PAR SUPPLY #5V62, 5A, 1-2M2, -5V6, 12V8, 5A, \$7.77  
2 SIDE COPPER CLAD, FR4 20x8" 88, 10/87  
HAND HELD LOGIC PROBE, LPI, detects 1-shot, low rate, \$19  
SOLAR CELLS 3" 800ma \$1.35, 4" 1000ma \$2.50  
SOLAR CELLS 4" 1500ma \$3.50, 3/810  
BANANA JACKS, HI Smith #1509, 8/81 100/99  
25AMP 200VPT RECTIFIER, DOS IN2121, 2/81  
HEAVY DUTY HEATSINK, FOUR TO-315 size 4x6.5x1.25", 3/81  
DELAY LINES, your choice 75, 100, 200ns 2/81  
MUFFIN FANS, 110V, new \$7, rfe \$4  
3 MUFFIN FANS ON A RACK, 110V, rfe \$9  
TELEPHONE HANDSETS, brown, modular, new, Bell type #1  
TOLLLESS METAL PROJECT BOXES 3.5x2.5x1.25", 4/81  
ASST'D IC'S, mixed types, lots of good numbers! 20/81  
ASST'D MINI TOGGLES/PADDLES 5/81  
3PDT MINI-TOGGLES ALCO, 110V, rfe, bushing, w/hware 3/81  
ALCO 1-POLE 8-POSITION MINI ROTARY \$1  
10 AMP POWER ROCKER SWITCH, wired, new 4/81  
4 COND JACKETED TELEPHONE WIRE, 24ga, 501/82  
2 COND TWISTED WIRE, AM20 stranded, 50ft/1.50  
SOLID STATE TIME DELAY RELAY DPDT, 10A contacts \$2.95  
DPST-NO RELAY, 12VDC coil, 30A contacts \$1  
3PDT RELAY, 12VDC coil, 10A contacts \$1  
DPST-NO RELAY, 200V coil, 25A contacts \$1  
3 COND HEAVY DUTY LINE COILS, AM18B, 2/81  
3 COND STEREO PLUGS 1/4", RIGHT ANGLE 2/81  
FUSES, 3AG (AGC) 1/2, 1, 2, or 6 Amp, 25/81  
SILICO FIBERS, 3400, 1/2 or 1 Amp, 10/81  
CLAIREX PHOTOCELLS CL703L, 500 ohms 1/2, 20K 8/81  
ENI FILTERS: 2 amp: \$1.95; 3 amp \$2.95  
2.5V LAMPS, screw in, round bulb 10/81  
DISC CAPACITORS, 1uF (100V or 050V) 30/81  
ALLIGATOR CLIPS W/BOOTS 1-red, 1-blk, 1" 29cpr; 2" 49cpr.  
9V BATTERY SNAPS, insulated, w/wire leads 10/81  
MALE TO FEMALE BNC CABLE, ALL 25 PINS WIRED THRU #12  
50VPT BRIDGE RECTIFIERS, 2A 3/81; 6A 2/81; 25A \$1  
1000uF 25V ELECTROLYTIC CAPACITORS, axial, 4/81  
15,000uF COMPUTER GRADE CAPACITOR, 25V, 25c 10/82  
4" CABLE TIES, locking 20/81  
IM414B SWITCHING DIODES 20/81  
2N2005 AUDIO NPN POWER TRANSISTORS 2/81  
EPRONS, +5V rfe 2754: \$3.50, 2732: \$3.27 16 or 2708: \$9.99  
DYNAMIC RAMS rfe, 4116-200ns: \$4.41, 4164-150ns: \$2.22  
80K, 83, 810, or 2/82, P101 or 45, DWA 7/50  
SEE NEXT LAST OR NEXT MONTH'S AD FOR FULL IC LIST!  
IC SOCKETS, 14, 16, 22, 24, or 40 pin solder tail, 14-A-PIN!  
16 PIN WIREWRAP IC SOCKETS, 2-12 pin, 6/81  
6 VOLT 450MAH RECHARGEABLE BATTERIES, sealed, #3  
INSULATED SOLDERLESS TERMS: 5/32" push-on feet, AMG14-16,  
5/32" push-on feet, AMG16-22, 3/32" push-on feet, AMG24-26, 20/81  
ASST'D TRIMMER POTS, some precision 6/81  
ASST'D COMPUTER GRADE CAPACITORS 4/81  
100K AUDIO POTS 1/4", 4/81  
PULSE TRANSFORMERS 6/81  
12 VOLT 1 WATT ZENER 8/81  
STICK-ON CABLE CLAMPS 20/81  
RACK PANELS, alum., 19"x8.5" \$1  
MUFFIN FAN GRILLES 2/81  
HEATSINK-ISA 50VPT BRIDGE \$1

HOW TO ORDER: Order by phone or mail, or at our retail store, pay by MC, Visa, Amex, CDD, check, min order \$20. Include approx 10% for shipping, bal refunded. GUARANTEED SATISFACTION OR YOUR MONEY BACK within 30 days of receipt. Send for our FREE FLYER, or circle reader service. (rfe=removed from equipment)

**UNITECH** 20 HURLEY ST. CAMBRIDGE, MA 02141 TEL: (617) "UNI-TECH"

CIRCLE 267 ON FREE INFORMATION CARD

## DON'T BLAME THE SOFTWARE!

Our Isolators eliminate equipment interaction, clean up interference, curb damaging power line spikes and lightning bursts.



- ISO-1 ISOLATOR**  
3 isolated sockets; quality spike suppression; basic protection. . \$81.95
- ISO-3 SUPER-ISOLATOR**  
3 dual isolated sockets; suppressor; commercial protection. . . . . \$122.95
- ISO-17 MAGNUM ISOLATOR**  
4 quad isolated sockets; suppressor; laboratory grade protection. . \$213.95

**ESP** Electronic Specialists, Inc.  
171 S. Main, Natick, MA 01760 (617) 655-1532  
Toll Free Order Desk 1-800-225-4878  
MasterCard, VISA, American Express

CIRCLE 60 ON FREE INFORMATION CARD

**NICAD BATTERY ZAPPER KIT**  
This is one of the most useful and money saving kits you can buy! The Nicad Zapper kit repairs those nicads that you no longer use because they won't recharge. Many nicads quit taking a charge after a period of time because they grow internal "Whiskers". The only way to make them take a charge again is to "blow" these "whiskers". This small kit operates from 6VDC (4 AA cells, etc.) and produces 300VDC which it applies momentarily to the nicad to "blow the whiskers" without damaging the battery. Repairs about 90% of nicads in sizes from AA to C cells. After zapping, the nicad is ready to be fully charged again and again (just like it did when it was new). The nicad zapper produces absolutely amazing results! Stop throwing those expensive nicads away! The kit comes with all parts, PC board and instructions (less batteries and case).  
C6278 \$14.95

**STYLISH CASE**  
Here's the case you need to make that professional looking project. Ultra-stylish black case with chrome edged front bezel. Complete with screws. Size: 4 1/2" x 3 3/4" x 1 1/2". \$12.95.  
C6252 \$4.95

PHONE ORDERS: 303-973-7291

**120 VAC Xenon Strobe Kit**  
C3071  
\$10.95

Complete variable rate strobe light kit produces brilliant flashes of light. Operates from standard 120VAC. Reliable design—thousands of these are in use throughout the world! Overall size of completed board 3 1/4" x 2 3/4" x 3/16".

**BOX OF ELECTRONICS**  
Super surprise of resistors, capacitors, IC's, transistors, sub-assemblies, diodes, switches, pots, etc. in a 6"x6"x5 1/2" box. Lots of "Gonies"! Note, because of shipping costs we can only ship this via UPS.  
C6282 \$10.00

**GOLD FAST CHARGE AA NICAD**  
Brand new fast charge nicads by Gold can be recharged within only 3 hours. Standard 500ma rating. Great for use in any application as they can be fully charged or standard charged.  
C6299 \$1.49

**2732 EPROM**  
Blank Hitachi 450NSEC Eprom  
C4972 \$2.95

SEND FOR YOUR FREE COPY OF OUR 1985 CATALOG LISTING:

\*Over 70 electronic kits which include parts and pc board!  
\*A million dollars worth of hand held games at great way prices!  
\*Tremendous electronic bargains!



**CHANEY electronics, inc.**  
P.O. BOX 27038 DENVER, COLORADO 80227

- Minimum AD Order \$9.00
- Please include \$2.00 for postage (UPS)
- VISA MC accepted
- Phone orders are welcome

Send for our free catalog of unique items

CIRCLE 109 ON FREE INFORMATION CARD

## HIGH QUALITY UP TO 75dB GAIN MICROWAVE TV SYSTEM

Varible from 1.9 to 2.5 GHz

The latest advance in microwave technology with a SNOW-FREE PICTURE.

- Two Models to choose from.
- Both Models Include:
- 20" Parabolic Dish
  - Pre-assembled Probe with Down Converter
- Power Supply and Coax Switch
  - 60' of RG-59/U Coax with Connector
  - Transformer for 75 to 300 Ohms
  - All Mounting Hardware for Fast and Easy Installation

**20" Fiberglass Dish**  
Up to 55dB Gain  
Special \$98<sup>95</sup>

**20" Aluminum Dish**  
Up to 55dB Gain  
Low Priced \$98<sup>95</sup>

Add 10% for Foreign orders or U.S. Parcel Post

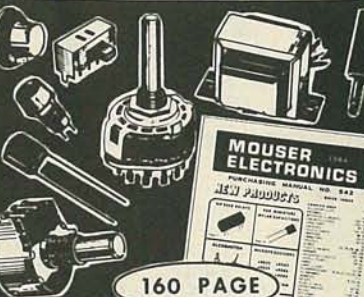
High Gain Yagi Antenna with Down Converter and Power Supply. Complete System, Ready to Use. \$89<sup>95</sup>

Send \$2.00 for Catalog. Refundable with first purchase. Available thru Mail and Phone Orders Only 20% deposit for C.O.D. CA Res add 6.25% Tax. Send Cashiers Check or Money Order to: (Personal Checks, allow 2-5 weeks to clear)

**PROFESSIONAL VIDEO, Inc.**  
4670 Hollywood Blvd., Hollywood, Calif. 90027  
For C.O.D. Orders Call (213) 219-0227

CIRCLE 119 ON FREE INFORMATION CARD

## ELECTRONIC COMPONENTS



**FREE CATALOG**

**MANUFACTURERS OF QUALITY ELECTRONIC COMPONENTS**

- BATTERY CLIPS & HOLDERS
- CABLE SETS • CONNECTORS • CAPACITORS
- DISPLAYS • LEDs • FUSES • JACKS & PLUGS
- KNOBS • LAMPS • POTENTIOMETERS
- RF COILS • RELAYS • RESISTORS
- SWITCHES • SEMICONDUCTORS • SPEAKERS
- TEST EQUIPMENT • TRANSFORMERS • TOOLS
- WIRE & CABLE

OVER 15,000 DIFFERENT ITEMS IN STOCK!

- Sales and Order Desk Open from 6:00a.m.(PST)
- TERMS: C.O.D. Visa, MasterCard (Open Accounts Available)
- Phone and Mail Orders Welcome
- Catalogs Mailed Outside USA Send \$2.00

**MOUSER ELECTRONICS**  
11433 WOODSIDE AVE. SANTEE CA 92071  
PHONE (619) 449-2222 TWX 910-331-1175

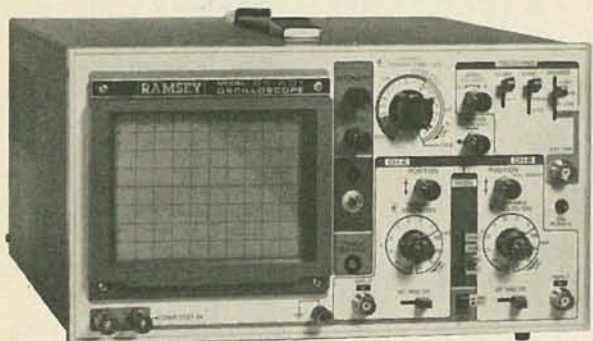
CIRCLE 117 ON FREE INFORMATION CARD



# RAMSEY

# THE FIRST NAME IN ELECTRONIC TEST GEAR

**NEW**



## 20 MHz DUAL TRACE OSCILLOSCOPE

Unsurpassed quality at an unbeatable price, the Ramsey oscilloscope compares to others costing hundreds more. Features include a component testing circuit for resistor, capacitor, digital circuit and diode testing • TV video sync filter • wide bandwidth & high sensitivity • internal graticule • front panel trace rotator • Z axis • high sensitivity x-y mode • regulated power supply • built-in calibrator • rock solid triggering

\*USA—Add \$10.00 per unit for postage, overseas orders add 15% of total order for insured surface mail.

**\$399<sup>95</sup>\***

high quality hook on probes included



## 45 MHz DUAL SWEEP OSCILLOSCOPE

The Ramsey 625 is a dual time base, delayed sweep unit that includes a built-in signal delay line to permit clear viewing during very short rise times of high frequency waveforms. Other features include: variable trigger holdoff • 20 calibrated sweep time ranges from 0.5 s/div to 0.2 μs/div • fully adjustable sweep time • X5 sweep magnification • five trigger sources: CH1, CH2, LINE EXternal and INTERNAL (V mode) • front panel x-y operation, Z axis input • sum difference of CH1, and CH2 waveforms displayed as single trace • sweep gate and sweep output • auto focus • single sweep

\*Same as unit to left.

**\$799<sup>95</sup>\***

high quality hook on probes included



## RAMSEY D-1100 VOM MULTITESTER

Compact and reliable, designed to service a wide variety of equipment. Features include • mirror back scale • double-jeweled precision moving coil • double overload protection • an ideal low cost unit for the beginner or as a spare back-up unit.

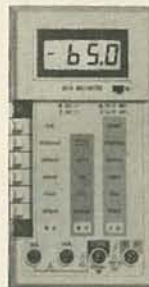
**\$19<sup>95</sup>** test leads and battery included



## NEW RAMSEY 1200 VOM MULTITESTER

Check transistors, diodes and LEDs with this professional quality meter. Other features include: decibel scale • 20K volt metering system • 3 1/2" mirrored scale • polarity switch • 20 measuring ranges • safety probes • high impact plastic case

**\$24<sup>95</sup>** test leads and battery included



## RAMSEY D-3100 DIGITAL MULTIMETER

Reliable, accurate digital measurements at an amazingly low cost • in-line color coded push buttons, speeds range selection • abs plastic tilt stand • recessed input jacks • overload protection on all ranges • 3 1/2 digit LCD display with auto zero, auto polarity & low BAT. indicator

**\$49<sup>95</sup>** test leads and battery included



## CT-70 7 DIGIT 525 MHz COUNTER

Lab quality at a breakthrough price. Features • 3 frequency ranges each with pre amp • dual selectable gate times • gate activity indicator • 50mV @ 150 MHz typical sensitivity • wide frequency range • 1 ppm accuracy

**\$119<sup>95</sup>** wired includes AC adapter

CT-70 kit ..... \$99.95  
BP-4 nicad pack ..... 8.95



## CT-90 9 DIGIT 600 MHz COUNTER

The most versatile for less than \$300. Features 3 selectable gate times • 9 digits • gate indicator • display hold • 25mV @ 150 MHz typical sensitivity • 10 MHz timebase for WWV calibration • 1 ppm accuracy

**\$149<sup>95</sup>** wired includes AC adapter

CT-90 kit ..... \$129.95  
OV-1 0.1 PPM oven timebase ..... 59.95  
BP-4 nicad pack ..... 8.95



## CT-125 9 DIGIT 1.2 GHz COUNTER

A 9 digit counter that will outperform units costing hundreds more. • gate indicator • 24mV @ 150 MHz typical sensitivity • 9 digit display • 1 ppm accuracy • display hold • dual inputs with preamps

**\$169<sup>95</sup>** wired includes AC adapter

BP-4 nicad pack ..... 8.95



## CT-50 8 DIGIT 600 MHz COUNTER

A versatile lab bench counter with optional receiver frequency adapter, which turns the CT-50 into a digital readout for most any receiver • 25 mV @ 150 MHz typical sensitivity • 8 digit display • 1 ppm accuracy

**\$169<sup>95</sup>** wired

CT-50 kit ..... \$139.95  
RA-1 receiver adapter kit ..... 14.95



## DM-700 DIGITAL MULTIMETER

Professional quality at a hobbyist price. Features include 26 different ranges and 5 functions • 3 1/2 digit, 1/2 inch LED display • automatic decimal placement • automatic polarity

**\$119<sup>95</sup>** wired includes AC adapter

DM-700 kit ..... \$99.95  
MP-1 probe set ..... 4.95



## PS-2 AUDIO MULTIPLIER

The PS-2 is handy for high resolution audio resolution measurements, multiplies UP in frequency • great for PL tone measurements • multiplies by 10 or 100 • 0.01 Hz resolution & built-in signal preamp/conditioner

**\$49<sup>95</sup>** wired

PS-2 kit ..... \$39.95



## PR-2 COUNTER PREAMP

The PR-2 is ideal for measuring weak signals from 10 to 1,000 MHz • flat 25 db gain • BNC connectors • great for shifting RF • ideal receiver/TV preamp

**\$44<sup>95</sup>** wired includes AC adapter

PR-2 kit ..... \$34.95



## PS-1B 600 MHz PRESCALER

Extends the range of your present counter to 600 MHz • 2 stage preamp • divide by 10 circuitry • sensitivity: 25mV @ 150 MHz • BNC connectors • drives any counter

**\$59<sup>95</sup>** wired includes AC adapter

PS-1B kit ..... \$49.95

### ACCESSORIES FOR RAMSEY COUNTERS

- Telescopic whip antenna—BNC plug ..... \$ 8.95
- High impedance probe, light loading ..... 16.95
- Low pass probe, audio use ..... 16.95
- Direct probe, general purpose use ..... 13.95
- Tilt ball, for CT-70, 90, 125 ..... 3.95



PHONE ORDERS CALL  
**716-586-3950**

TELEX 466735 RAMSEY CI

TERMS: • satisfaction guaranteed • examine for 10 days; if not pleased, return in original form for refund • add 6% for shipping and insurance to a maximum of \$10.00 • overseas add 15% for surface mail • COD add \$2.50 (COD in USA only) • orders under \$15.00 add \$1.50 • NY residents add 7% sales tax • 90 day parts warranty on all kits • 1 year parts & labor warranty on all wired units.

**RAMSEY**

RAMSEY ELECTRONICS, INC.  
2575 Baird Rd.  
Penfield, N.Y. 14626

APRIL 1985

CIRCLE 70 ON FREE INFORMATION CARD

111



# SPARTAN Electronics Inc



CALL (516) 499-9500 MAIL

6094 Jericho Tpke. Commack, N.Y. 11725

**CTC9R Philips Remote Cable Converter**

• Micro computer technology • Quartz controlled IC's lock in picture & prevent drift • 50 channel selections • Programmable time on & off • 24 hour LED digital clock • Favorite channel memory & recall plus scan • Wireless hand held "infra-red" transmitter system • Automatic line tune • Adaptable to any brand television • One year warranty service.

**\$139.95**

**RS232 TRANSMISSION LINE TESTER**

Features: \* Male to Female connector for easy insertion into RS232 Line. \* Test 7 Lines (TD, RD, RTS, CTS, DSR, CD, DTR) using LED's to indicate status of each. \* Directly powered by RS232 Line no AC power needed.

**\$23.95**

**SOUND ACTIVATED SWITCH MODEL R-1 \$29.95**

For Home Security. Hears a Noise. Turns On Lights!

When lights turn on, intruders are frightened away...ask any policeman. The new SOUND activated SWITCH automatically turns on lights at any sound, so it looks like you're home even when you're not. SOUND activated SWITCH protects your home better than timers. It turns on lights at the sound of an attempted break-in, and automatically turns them off when it's safe.

SOUND activated SWITCH. It's the lightwatchman you can't afford to be without.

• Entry Hall • Nursery • Sick Room • Family Room • Stairways and Halls • Children's Rooms • Attics • Basements • Garage • Closets

**REFURBISHED MONITORS**

9" and 12" Bell & Howells or GBC Commercial Grade as low as \$10.00 off with a purchase of 2 refurbished monitors **\$39.95**

**RS232 TRANSMISSION LINE TESTER**

Features: \* All 25 Signal lines accessible. \* Dual Color: Red Green

Accessories: 1 Cable 10' male to Female Extension Jumper Set: 6 Straight 1 T-Jumper Vinyl Case

Call for quantity prices. **\$169.95**

**Jerrold 58 Channel Wireless Remote Converter \$109.95**

**Jerrold 36 Channel Remote CATV Converter w/on/off Fine Tuning \$94.95**

**40 Channel VHF to UHF Block Converter**

28.95 Ea. 24.95 4 & up

Deluxe Version - Features fine tuning knob, matching X former & 2 cables \$38.95

**BEFORE YOU PAY \$\$ FOR A TELEPHONE SERVICE CALL, TEST IT YOURSELF**

Telephone Line Analyze Model #1042 **BK PRECISION**

- Tests telephone line functions that affect telephone operation
- Verifies line and ring voltage levels
- Checks condition of telephone line from central office to user's telephone jack
- Verifies telephone line polarity that can affect polarity sensitive telephones

**\$19.95**

**PROFESSIONAL TELEPHONE PRODUCT TESTER**

Features: **MODEL 1045**

- Provides basic operation tests for corded and cordless telephones, answering machines, and automatic dialers
- Checks telephone line cords and handsets cords for continuity, shorts and interferences
- Verifies number dialed and redial for pulse or touch-tone telephones
- Provides low and normal level ring test sequence
- Verifies full voice and DTMF (Dual Tone Multiple Frequency) levels are above minimum required level
- Can be used by the consumer without the aid of a salesperson—an easy-to-follow instruction card is provided with the tester
- Can be used by the salesperson to demonstrate operation and features of telephone products and to screen returns before making an exchange

**\$335.95**

Dealers Welcome

Visa MC BAC Amex All above prices include 4% cash discount C.O.D. money order check Add for Shipping

Min Order \$25.00	to 75.00	\$2.50
International shipping Add 1	76.00 to 250.00	\$4.50
Prices subject to change without notice	251.00 to 500.00	\$6.00
COD 2.00 Extra	501.00 to 750.00	\$8.50
Add 1 shipping for monitors	751.00 to 1000.00	\$12.00
	Over 1000.00	\$12.50

**(516) 499-9500**

Mon Th Tu W F Sa  
9-8 9-6 9:30-5

## ADVERTISING INDEX

RADIO-ELECTRONICS does not assume any responsibility for errors that may appear in the index below.

Free Information Number	Page	Free Information Number	Page		
264	A.I.S. Satellite	31	116	Philips Tech	98
50	A.W. Sperry	32	—	Phoenix Electronics	20
108	AMC Sales	93	265	Pocket Technology	CV3
—	Active Electronics	102	101	Pomona Electronics	33
—	Advance Electronics	9,10,11	125	Power Plus	31
106	Advanced Computer Products	99	256	Prentice-Hall/College Division	94
107	All Electronics	103	119	Professional Video	110
72	Amazing Devices	106	—	Qualitone Industries	94
77	B&K Precision	7	254	RAG Electronics	24,25
251	Babylon	96	—	RCA Dis. & Special Prod.	28,29
98	Beckman Instruments	15	78	Radio Shack	107
—	CIE	52	70	Ramsey Electronics	111
—	CRT	31	268	Regency	42
109	Chaney	110	266	Ross Custom	31
54	Chemtronics	20	73	Sintec	38
—	Command Productions	92	74	Solid State Sales	106
79	Communications Electronics	2	75	Spartan Electronics	112
—	Coop's Satellite Digest	14	257	Tampa Electronic Supply	92
263	Deco Industries	31	—	Tektronix	CV2
269	Diehl Engineering	21	122	Teltone	31
82	Digi-Key	101	—	Texas Instruments	22
—	Digital Research Computers	96	267	Unitech	110
110	Dokay	100	255	VAMP	30
—	Elec. Industry Association	91	260	VIZ	85
60	Electronic Specialists	110			
120	Elephant Electronics	31			
111	Etronix	86			
100	Firestik II	89			
252	Fluke Manufacturing	5			
—	Fordham Radio	1,81, CV4			
253	Galaxy	30			
261	Gemini Electronics	CD2			
62	Global Specialties	26			
258	Goldsmith Scientific	106			
—	Grantham College of Engineering	41			
86	Heath	87			
64	IWATSU	23			
63	Instrument Mart	83			
65	J & W	86			
113	JDR Microdevices	108,109			
114	Jameco	104,105			
124	James Walter Satellite Rec.	31			
104	Jan Crystals	89			
270	Kepro Circuit Systems	94			
87	MCM Audio	97			
105	MFJ	110			
—	McGraw Hill Book Club	70			
67	McIntosh Labs	80			
259	Micro-Mart	98			
117	Mouser	110			
—	NRI	16,79			
—	NTS	34			
—	National Educational Center	39			
262	OK Industries	27			
118	Pacific One	30			
90	Paia	93			
68,271,297,298,299	Philips ECG	13			

Gernsback Publications, Inc.  
200 Park Ave. South  
New York, NY 10003  
(212) 777-6400  
Chairman of the Board:  
M. Harvey Gernsback  
President: Larry Steckler

### ADVERTISING SALES 212-777-6400

Larry Steckler  
publisher  
Shelli Weinman  
advertising associate  
Arline Fishman  
advertising coordinator  
Lisa Strassman  
credit manager  
Donna Sala  
credit associate  
Naomi Matten  
advertising assistant

### Sales Offices

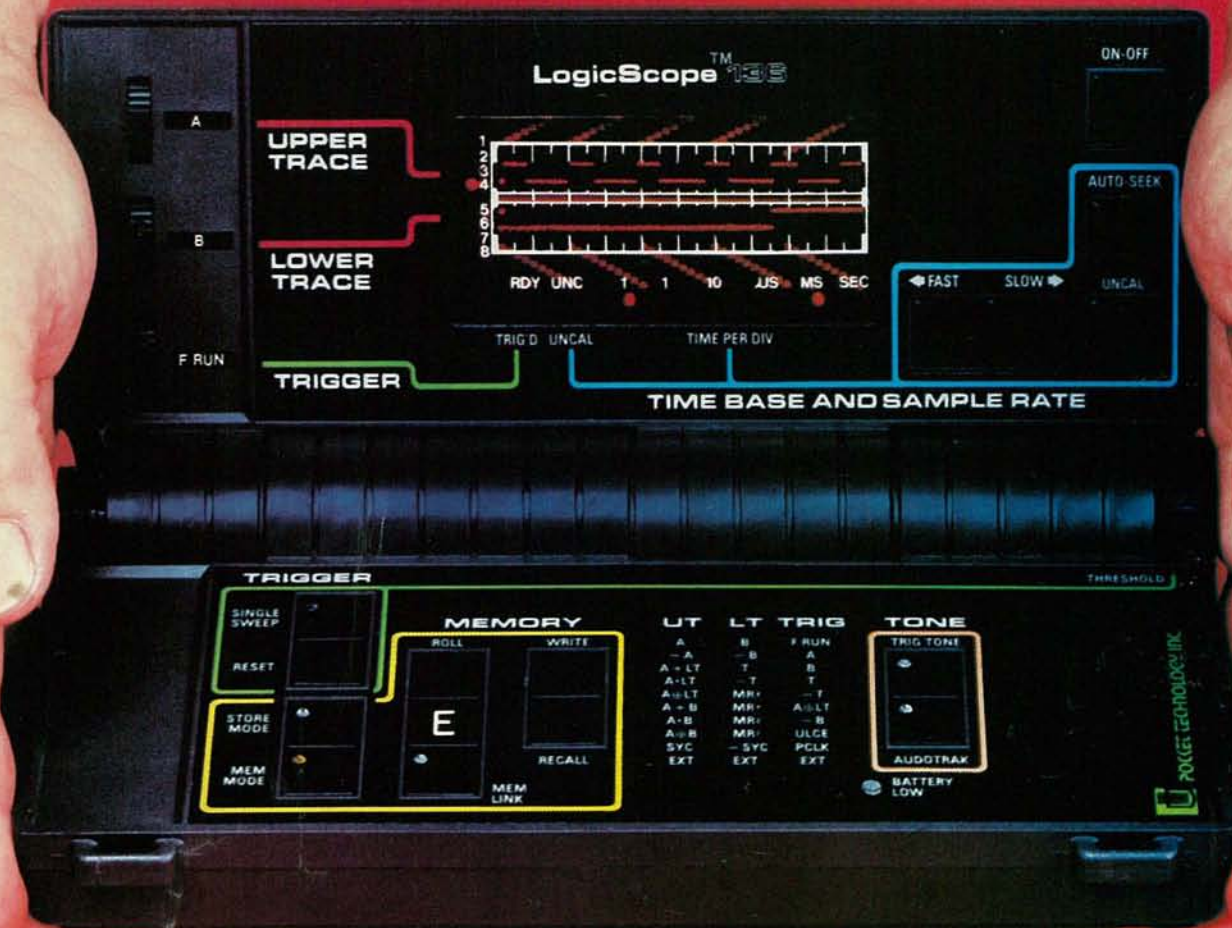
**EAST/SOUTHEAST**  
Stanley Levitan  
Radio-Electronics  
200 Park Ave. South  
New York, NY 10003  
212-428-6037, 212-777-6400

**MIDWEST/Texas/Arkansas/Okla.**  
Ralph Bergen  
Radio-Electronics  
540 Frontage Road—Suite 325  
Northfield, IL 60093  
312-446-1444

**PACIFIC COAST/ Mountain States**  
Marvin Green  
Radio-Electronics  
15335 Morrison St.—Suite 227  
Sherman Oaks, CA 91403  
818-986-2001



Here's The Savvy-est True Dual Trace 10 MHz  
Digital Storage Scope You Ever Saw  
... At The Saving-est Price. Only \$595.



## The Handy New LogicScope™ 136

True Dual Trace • 10 MHz Real Time Bandwidth • 3 Input Channels • I/O Port  
Digital Waveform Storage • Boolean Waveform Operations • Audio Functions  
8.0 (L) x 4.5 (D) x 1.75 (H) Inches • 1.25 Pounds • 9 Volt Battery/AC Operation

### Consider the LogicScope 136

- The LogicScope 136 is the next logical step in test instrumentation for you. It combines many of the features and capabilities of sophisticated logic analyzers and oscilloscopes . . . and it fits in your hand. Never before has so much technology been available in so small an instrument, at such a low price.
- The pocket-sized LogicScope 136 is made possible by a patented breakthrough in display technology. The conventional CRT has been replaced by a unique array of 400 LED's that permits simultaneous display of two digital waveforms.
- The 136 can be used for viewing single shot events, or repetitive waveforms. It can be operated in real time mode, or in memory mode which permits acquisition and storage of up to 50-100 bit waveforms. These can be recalled, logically compared (AND, OR, EXCLUSIVE OR) to other input waveforms, or output to an external device via an I/O port. This I/O port will also accept future add-on 136 Modules.
- Its very low cost, convenience and ease-of-use make the LogicScope the ideal instrument, for designing, troubleshooting or repairing digital systems. Made in U.S.A.

### Consider its Engineering & Field Service Applications:

- On microprocessor-based systems, check the timing relationship of various parameters relative to the system clock and other key events. Its storage capability allows visual and logical comparison of non-repetitive waveforms to known reference signals. Output in the start-up of the digital device can be compared to reference signals to determine the operating state of the device. Questionable waveforms can be stored for analysis.
- Its light weight and small size make the LogicScope convenient to take on every service call. The 136 provides much more information for trouble shooting a digital system or peripheral than a logic probe or digital counter without having to lug an oscilloscope or logic analyzer along.

Contact us for the name of your local distributor



**POCKET TECHNOLOGY, INC.**

7320 Parkway Drive, Hanover, MD 21076 U.S.A.

301-796-3300 TELEX 908207

Division of Renaissance Technology Corp.

CIRCLE 265 ON FREE INFORMATION CARD



# PERFORMANCE

## SCOPE HAND-HELD DIGITAL CAPACITANCE and MULTIMETERS

- 0.5% DC Accuracy
- Highest Quality
- Highest Performance
- Lowest Prices

# THE ULTIMATE TEST



**Model DCM-602**  
**\$7995**

### Digital Capacitance Meter

8 ranges with full scale values to 2000 uF

**FEATURES** • Broad test range - 1 pF to 2000 uF • LSI circuit provides high reliability and durability • Lower power consumption • Clear readout even in bright light • Crystal time base • Easy to operate, compact, lightweight • Protected from charged capacitors • Frequency range - 800 Hz to 8 Hz



**Model DVM-634**  
**\$4875**

7 functions, 32 ranges.  
Transistor measurement included.

### Digital Multimeters

- DC Voltage 100 uV - 1000 V
- AC Voltage 100 uV - 750 V
- AC/DC Current 200 uA - 10 Amps
- Resistance 20 Megohms
- Capacitance (DVM 636/638) 1 pF - 20 uF



**Model DVM-638**  
**\$7995**

11 functions, 38 ranges.  
Includes logic level detector,  
audible visual continuity,  
capacitance and conductance  
measurement.



**Model DVM-636**  
**\$6275**

8 functions, 37 ranges.  
Capacitance measurement  
included.

**FEATURES** • Overload Protection • Auto-decimal LCD readout • Polarity Indication • 3000 hour battery life with 9V transistor battery • Low battery indication

Charge it with VISA/MASTERCARD. Money orders, checks accepted. C.O.D.'s require 25% deposit.

# Fordham

260 Motor Parkway, Hauppauge, NY 11788

Toll Free  
**800-645-9518**  
In NY State 800-832-1446

Service and Shipping Charge Schedule FOR ORDERS	ADD
\$25-250 .....	\$4.50
\$251-500 .....	\$6.50
\$501-750 .....	\$8.50
\$751-1,000 .....	\$12.50
\$1,001 and up .....	\$15.00