

# Radio- Electronics®

**BUILD A UNIQUE  
ATARI VIDEOGAME CONTROLLER**

\$1.50 FEB. 1983  
U.K. 85p

DGS

**COMPUTERS - VIDEO - STEREO - TECHNOLOGY - SERVICE**

**INSIDE THE NEW  
767 COCKPIT**

Build an automatic

**COMMERCIAL KILLER**

for your VCR

How to

**ETCH PC  
BOARDS**

at home

All about

**ACTIVE  
ANTENNAS**

for

**PLUS Much, Much More**





# The choice is Weller®



Soldering, desoldering, fixed or portable,  
look for Weller!

The DS500 power vacuum desoldering station works with external air system. The DS100 provides identical desoldering performance linked with temperature controlled soldering capability.

The new portable DS600 offers you a compact self-contained vacuum/air pump desoldering unit.

Which one is for you?

Use only genuine soldering tips from Weller.



The Cooper Group PO Box 728 Apex NC 27502 USA Tel (919) 362-7510 Telex 579497

BOKER® CRESCENT® LUFKIN® NICHOLSON® PLUMB® WELLER® WISS® XCELITE®

**CooperTools**

CIRCLE 35 ON FREE INFORMATION CARD





# Cut Your Service Time Absolutely In Half Or Your Money Back.

Sencore SC61 60 MHz Waveform Analyzer

If you use a general purpose oscilloscope for troubleshooting we can cut your present service time in half with the SC61 Waveform Analyzer.

**It's ten times faster—ten times more accurate:** The SC61 is the first and only instrument to integrate the speed and accuracy of a digital readout with the viewing capability of a high performance 60 MHz scope. Connect only one probe and you can view any waveform to 60 MHz. Then, just push a button to read DCV, PPV, frequency and time.

There are no gratitudes to count or calculations to make so every measurement is 10 to 100 times faster than before.

The digital read-out is 10 to 10,000 times more accurate than conventional

scopes as well, for measurements you can trust in today's high precision circuits.

Plus having everything you want to know about a test point, at the push of a button, eliminates guesswork and backtracking

A special Delta function even lets you intensify any part of a waveform and digitally measure the PPV, time or frequency for just that waveform section. This really speeds VCR alignment and calibration procedures.

**And it's neat:** No more tangled

leads, piles of probes or dangling cords. The SC61 is an entire service bench in one unit. You can't get neater than that.

**Cut your service time in half:**

When we say the SC61 will cut your service time in half, we're being conservative. We know of cases where the SC61 has saved much more time than that. Every situation is different, however, so try an SC61 and judge for yourself. Here's our offer.

**Money back guarantee:** If the SC61 does not at least cut your present service time in half during the first thirty days, you may return it for a full refund, including freight both ways.

**Call today.** Get the entire SC61 Waveform Analyzer story. Call toll-free today, and ask for our eight page color brochure. It could be the most time-saving call you make this year!



**\$3275**

**SENCORE**  
3200 Sencore Drive, Sioux Falls, SD 57107

**Phone Toll-Free 800-843-3338**

Alaska, Hawaii, Canada and SD call collect at (605) 339-0100

CIRCLE 4 ON FREE INFORMATION CARD

CIRCLE 89 FOR DEMONSTRATION



**Why use other computer media when you could be using**

# Scotch®

**high quality error free media?**

**Get Scotch Diskettes Directly From Communications Electronics**

There's a lot of valuable data stored on the diskettes in your computer or word processing system. In 1981, a diskette manufacturer calculated that the "true cost of a diskette" was \$186.50 after data loading. With inflation, the actual cost is well over \$200.00 today. That is why you don't want to use just any diskette, you want the high reliability and quality of Scotch diskettes. You can trust Scotch diskettes to deliver that accuracy because each diskette is tested before it leaves the factory and is certified error-free. That means fewer errors and less lost data. Flexible discs may look alike, but they don't all perform alike. Scotch diskettes can deliver all the performance you'll ever need. The low abrasivity of Scotch diskettes, 32% below industry average, saves wear and tear on your read/write heads, which means fewer service calls due to head problems. Longer and more reliable service is yours when you buy Scotch diskettes since they far exceed the industry standard durability tests. Finally, your Scotch diskettes are packaged in units of 10, complete with color-coded labels (except bulk product) to make your filing easier.

**Flexible Disc Quantity Discounts Available**

Scotch diskettes are packed 10 discs to a carton and five cartons to a case. Please order only in increments of 100 units for quantity 100 pricing. We are also willing to accommodate your smaller orders. Quantities less than 100 units are available in increments of 10 units at a 10% surcharge. **Quantity discounts** are also available. Order 500 or more discs at the same time and deduct 1%; 1,000 or more saves you 2%; 2,000 or more saves you 3%; 5,000 or more saves you 4%; 10,000 or more saves you 5%; 25,000 or more saves you 6%; 50,000 or more saves you 7% and 100,000 or more discs earns you an 8% discount off our super low quantity 100 price. Almost all Scotch diskettes are immediately available from CE. Our warehouse facilities are equipped to help us get you the quality product you need, when you need it. If you need further assistance to find the flexible disc that's right for you, call the 3M/Scotch flexible disc compatibility hotline. Dial toll-free 800-328-1300 and ask for the Data Recording Products Division. In Minnesota or outside the United States dial 612-736-9625 between 9 AM to 4 PM Central Time.

**SAVE ON SCOTCH FLEXIBLE DISCS**  
Product Description

Product Description	Part #	CE quant. 100 price per disc (\$)
8" SSSD IBM Compatible (128 B/S, 26 Sectors)	740-0	2.19
8" Same as above, but bulk pack w/o envelope	740-0B	1.99
8" SSSD Shugart Compatible, 32 Hard Sector	740-32	2.19
8" SSSD CPT 8000 Compatible, Soft Sector	740-0-8000	2.89
8" SSDD IBM Compatible (128 B/S, 26 Sectors)	741-0	2.89
8" DSDD Soft Sector (Unformatted)	743-0	3.49
8" DSDD Soft Sector (256 B/S, 26 Sectors)	743-0/256	3.49
8" DSDD Soft Sector (512 B/S, 15 Sectors)	743-0/512	3.49
8" DSDD Soft Sector (1024 B/S, 8 Sectors)	743-0/1024	3.49
5 1/4" SSDD Soft Sector w/Hub Ring	744D-ORH	2.34
5 1/4" Same as above, but bulk pack w/o envelope	744D-ORHB	2.14
5 1/4" SSDD 10 Hard Sector w/Hub Ring	744D-10RH	2.34
5 1/4" SSDD 16 Hard Sector w/Hub Ring	744D-16RH	2.34
5 1/4" DSDD Soft Sector w/Hub Ring	745-ORH	3.09
5 1/4" DSDD 10 Hard Sector w/Hub Ring	745-10RH	3.09
5 1/4" DSDD 16 Hard Sector w/Hub Ring	745-16RH	3.09
5 1/4" SSQD Soft Sector w/Hub Ring (96 TPI)	746-ORH	2.99
5 1/4" DSQD Soft Sector w/Hub Ring (96 TPI)	747-ORH	3.99

SSSD = Single Sided Single Density; SSDD = Single Sided Double Density; DSDD = Double Sided Double Density; SSQD = Single Sided Quad Density; DSQD = Double Sided Quad Density; TPI = Tracks per inch.

**Save on Scotch Static Control Floor Mats**

Scotch Velostat Electrically Conductive Floor Mats, drain static charge before it can cause serious problems with computer or word processing equipment. Order number 1853 is a black 4' x 5' size mat with lip. Cost is \$170.00 each. Order number 9453 is the same mat, but the color is earthtone brown, which is designed to blend with any office decor. Cost on the 9453 mat is \$259.00 each. All Velostat mats come complete with 15 feet of ground cord. All mats are shipped freight collect.

**Save on Scotch Data Cartridges**

Scotch Data Cartridges are available from CE in three different configurations. The DC100A data cartridge is a small version of the DC300A data cartridge. The DC100A contains 140 feet of 0.150" tape in a package measuring 2.4 x 3.2 x 0.5 inches. Cost is \$14.00 each. The DC300A is a pre-loaded tape cartridge containing 300 feet of one mil thick by 1/4" computer tape. The DC300A costs \$18.00 each. The DC300XL is an extra length data cartridge with 450 feet of tape. It is the same size and interchangeable with the DC300A. The DC300XL provides a total storage capacity of 34.5 million bits at 1600 BPI. The cost of the DC300XL is \$22.00 each.

**Scotch Head Cleaning Diskettes - Helps Cut Downtime**

When the read/write heads on information processing machines are dirty, that can cause you a lot of grief. Now...with Scotch brand head cleaning diskettes, you can clean the read/write heads on the diskette drives yourself in just 30 seconds and as often as they need it. Simply apply the cleaning solution to the special white cleaning fabric. Insert the cleaning diskette into the drive and access the heads for 30 seconds. That's all there is to it. Regular use of the head cleaning diskettes can save you much of the grief caused by dirty heads. We recommend you use them once a week, or more often if your system gets heavy use. Each kit contains two head cleaning diskettes, and enough solution for 30 cleanings. Order # 5-CLE is for 5 1/4" drives and order # 8-CLE is for 8" drives. Only \$25.00 each plus \$3.00 shipping per kit.

**Buy with Confidence**

To get the fastest delivery from CE of your Scotch computer products, send or phone your order directly to our Computer Products Division. Be sure to calculate your price using the CE prices in this ad. Michigan residents please add 4% sales tax or supply your tax I.D. number. Written purchase orders are accepted from approved government agencies and most well rated firms at a 30% surcharge for net 30 billing. All sales are subject to availability, acceptance and verification. All sales are final. Prices, terms and specifications are subject to change without notice. All prices are in U.S. dollars. Out of stock items will be placed on backorder automatically unless CE is instructed differently. Minimum *prepaid* order \$50.00. Minimum *purchase order* \$200.00. International orders are invited with a \$20.00 surcharge for special handling in addition to shipping charges. All shipments are F.O.B. Ann Arbor, Michigan. No COD's please. Non-certified and foreign checks require bank clearance.

For **shipping charges** add \$8.00 per 100 diskettes and/or any fraction of 100 8-inch diskettes, or \$6.00 per 100 diskettes and/or any fraction of 100 5 1/4-inch mini-discs. For cleaning kits, add \$3.00 per kit. For tape data cartridges, add \$1.00 per cartridge, for U.P.S. ground shipping and handling in the continental United States.

**Mail orders to:** Communications Electronics, Box 1002, Ann Arbor, Michigan 48106 U.S.A. If you have a Master Card or Visa card, you may call and place a credit card order. Order toll-free in the U.S. Dial 800-521-4414. If you are outside the U.S. or in Michigan, dial 313-994-4444. Order your Scotch computer products from Communications Electronics today.

Copyright ©1982 Communications Electronics™

Ad #120182



**Order Toll-Free!**  
**(800) 521-4414**

In Michigan (313) 994-4444

**3M**

Authorized Distributor

**COMMUNICATIONS ELECTRONICS™**

**Computer Products Division**

854 Phoenix □ Box 1002 □ Ann Arbor, Michigan 48106 U.S.A.  
Call TOLL-FREE (800) 521-4414 or outside U.S.A. (313) 994-4444  
CIRCLE 5 ON FREE INFORMATION CARD



## SPECIAL FEATURE

- 39 **INSIDE THE 757/767 COCKPIT**  
The cockpit of Boeing's new 757/767 airplane is crammed with computer and automated flight systems. Here's a look at those systems and what may be the future trend in commercial aircraft. **Marc Stern**

## BUILD THIS

- 43 **ATARI VIDEOGAME CONTROLLER**  
Unique controller replaces your Atari joysticks and uses position-sensitive mercury switch for a new dimension in game playing. **David J. Sweeney**
- 57 **AUTOMATIC COMMERCIAL EDITOR**  
Part 2—Add-on device for your VCR automatically eliminates commercials from your favorite black-and-white movies. **Gary McClellan**
- 59 **DIGITAL IC TESTER**  
Part 2—A versatile tester that puts digital IC's through their paces and indicates how they function. **Gary McClellan**

## TECHNOLOGY

- 8 **VIDEOGAMES**  
A new column dedicated to the expanding videogame industry, including reviews of specific videogame cartridges.
- 92 **STATE-OF-SOLID-STATE**  
All about switching power supplies and a new IC for controlling them. **Robert F. Scott**

## CIRCUITS AND COMPONENTS

- 46 **ETCH YOUR OWN PC BOARD**  
Part 3—Make even the most complicated PC board following these step-by-step instructions. **Robert Grossblatt**
- 50 **HOW TO INTERFACE R/C SERVOS**  
Doing something mechanical with an electronic circuit usually requires a servo. Here's how to use commonly available radio-control servos to do the job. **Dan and Jeanette Pelton**
- 67 **HOW TO DESIGN ANALOG CIRCUITS**  
Transistor power-amplifier circuits. **Mannie Horowitz**
- 82 **THE DRAWING BOARD**  
If you like designing and building your own circuits, you are sure to like this new column. **Robert Grossblatt**

## VIDEO

- 86 **SERVICE CLINIC**  
The quickest way to find those faulty capacitors. **Jack Darr**
- 86 **SERVICE QUESTIONS**  
R-E's Service Editor solves technicians' problems. **Jack Darr**

## RADIO

- 63 **ALL ABOUT VLF ACTIVE ANTENNAS**  
Good reception at very low frequencies does not necessarily require a very long antenna. **R.W. Burhans**
- 98 **COMMUNICATIONS CORNER**  
Trap antennas for amateur-radio use. **Herb Friedman**

## COMPUTERS

- 96 **COMPUTER CORNER**  
Computers you can fit into a pocket. **Les Spindle**

## EQUIPMENT REPORTS

- 22 **Radio Shack TRS-80 Model 1 Double Density Disk Kit**
- 26 **Video Control ATOC III Video Controller**
- 30 **Heath Model H-25 Printer**

## DEPARTMENTS

- |                           |                            |
|---------------------------|----------------------------|
| 140 Advertising Index     | 76 New Ideas               |
| 141 Free Information Card | 99 New Products            |
| 78 Hobby Corner           | 14 Satellite/Teletext News |
| 20 Letters                | 4 Video Electronics        |
| 110 Market Center         | 6 What's News              |
| 105 New Books             |                            |

## ON THE COVER

Once considered a dream, the computer-controlled airplane has become a reality, with the introduction of the Boeing 757/767 aircraft into commercial service. This month, we'll take you into the cockpit of that fascinating airplane, and show you the systems and features that help make it one of the most sophisticated in the sky.

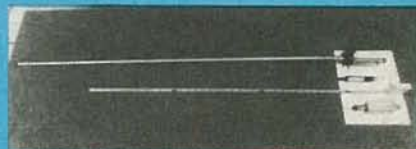

You don't always need a long antenna to get good VLF reception. The active antennas shown here are just one meter long but often outperform ones many times their length. Find out more about active antennas, beginning on page 63.

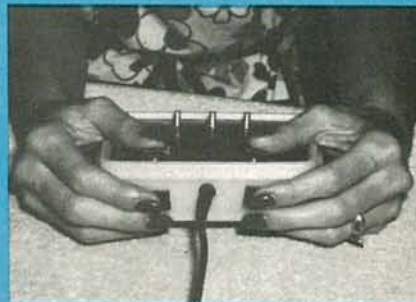

If you are one of those that love to spend hours at a time with your home videogames, your hands are probably taking a beating. Give them and yourself a break, and build this controller for your Atari VCS system. The story starts on page 42.

Radio-Electronics, (ISSN 0033-7862) Published monthly by Gernsback Publications, Inc., 200 Park Avenue South, New York, NY 10003. Second-Class Postage Paid at New York, N.Y. and additional mailing offices. One-year subscription rate: U.S.A. and U.S. possessions, \$14.97, Canada, \$17.97. Other countries, \$22.47 (cash orders only, payable in U.S.A. currency.) Single copies \$1.50. © 1983 by Gernsback Publications, Inc. All rights reserved. Printed in U.S.A.

**Subscription Service:** Mail all subscription orders, changes, correspondence and Postmaster Notices of undelivered copies (Form 3579) to Radio-Electronics Subscription Service, Box 2520, Boulder, CO 80322.

A stamped self-addressed envelope must accompany all submitted manuscripts and/or artwork or photographs if their return is desired should they be rejected. We disclaim any responsibility for the loss or damage of manuscripts and/or artwork or photographs while in our possession or otherwise.



# VIDEO ELECTRONICS

DAVID LACHENBRUCH  
CONTRIBUTING EDITOR



## HOME VCR EDITOR

The era of precise home-videotape editing has arrived with the introduction of small editing controllers by Panasonic (see photo above), Quasar, and Canon, with more similar products to come. The essentially similar machines control 2 VHS recorders, permit access to the desired part of the tape numerically by keyboard, synchronized with the recorders' tape counters. The system has a switch that automatically sets the end point of the editing. Video and audio editing capabilities are independent, permitting the user to dub new audio onto existing video or vice versa. List price is about \$200.

## CAMCORDERS

The hottest thing in broadcast equipment this year is a combination camera/VCR, sometimes called the "camcorder," and the recent National Association of Broadcasters equipment show was dominated by enough of them to spur a call for standardization. All of the camcorders are built around new video-recording systems using consumer videocassettes and broadcast-quality cameras. Many of the new units use the standard VHS quarter-inch cassette, but speeded up to produce a picture of breathtaking quality though limiting recording time to 20 minutes per cassette. RCA and Panasonic worked jointly on that system; RCA calls its camcorder *Hawkeye*, while Panasonic uses the tradename *Recam*. Hitachi and Ikegami also showed combinations using the same system.

Sony's camcorder, *Betacam*, uses a standard Beta cassette, however; again, recording time is 20 minutes. The newest camcorders use the little quarter-inch Funai *CVC* cassette that is used in Technicolor's portable VCR. To improve the picture quality, those camcorders also speed the cassette up, resulting in recording times of from 8 to 15 minutes per quarter-inch cassette. Camcorders using the *CVC* cassette—all incompatible—were shown by Hitachi, Ikegami, and Bosch Fernseh. The Hitachi unit and one by Nippon TV Network used three solid-state MOS image sensors in place of pickup tubes. Hitachi and Ikegami gave prospective customers the choice of quarter-inch and half-inch cassette systems. RCA and Panasonic, meanwhile, have requested that a camcorder VCR standard be established using their VHS-cassette format.

## VHD DISC SUSPENDED

The third—or is it fourth?—postponement of the debut of Japan's VHD grooveless capacitance videodisc system for the American and European markets was announced by developer VHD, citing the state of the economy. The VHD disc plant in California was closed and all personnel of two VHD companies in the United States dismissed. In Europe, where two disc plants were in pilot operation, some minimal activity will continue, according to sources there. JVC was still talking of a possible launch in Japan in 1983 at press time. VHD adherents in the U.S. are GE, JVC, Panasonic, Quasar, and Sharp. No date has been set for introduction of the system here or in Europe.

## BETA HI FI ON WAY

The Beta group has approved the compatible Beta Hi Fi system (see **Radio-Electronics**, September 1982 issue), and recorders and prerecorded tapes for the system will be available here this year. In addition to the standard longitudinal soundtrack, the new format has a high-fidelity stereo FM audio signal contained in the helical video track. **R-E**



# wabash<sup>®</sup> diskettes for as low as \$1.39 each!

## Now... Get High Quality at a Low Price

Wabash means quality products that you can depend on. For over 16 years, Wabash has been making high quality computer products. Wabash diskettes are made to provide error-free performance on your computer system. Every Wabash diskette is individually tested and is 100% certified to insure premium performance.

## Why Wabash is Special

The quality of Wabash diskettes is stressed throughout the entire manufacturing process. After coating, all Wabash diskettes go through a unique burnishing process that gives each diskette a mirror-smooth appearance. Wabash then carefully applies a lubricant that is specially formulated to increase diskette life. This saves you money, since your discs may last longer. It also assists your disk drives in maintaining constant speed which can reduce read and write errors.

## Special Seal...Helps Prevent Contamination

To keep out foreign particles, a unique heat seal bonds the jacket and liner together. A special thermal seal which avoids contamination from adhesives, is then used to fold and seal the jacket. This results in outstanding performance and true reliability. Wabash then packages each diskette, (except bulk pack) in a super strong and tear resistant Tyvek<sup>®</sup> envelope. The final Wabash product is then shrink-wrapped to insure cleanliness and reduce contamination during shipment.

## Each Diskette is 100% Critically Tested

Since each step in the Wabash diskette manufacturing process is subject to strict quality control procedures, you can be sure Wabash diskettes will perform for you. And every Wabash diskette meets the ultra-high standards of ANSI, ECMA, IBM and ISO in addition to the many critical quality control tests performed by Wabash. Wabash does all of this testing to provide you with consistently high quality diskettes. Reliability and data integrity - that's what Wabash quality is all about.

## Flexible Disc Quantity Discounts Available

Wabash diskettes are packed 10 discs to a carton and 10 cartons to a case. The economy bulk pack is packaged 100 discs to a case without envelopes or labels. Please order only in increments of 100 units for quantity 100 pricing. With the exception of bulk pack, we are also willing to accommodate your smaller orders. Quantities less than 100 units are available in increments of 10 units at a 10% surcharge. **Quantity discounts** are also available. Order 500 or more discs at the same time and deduct 1%; 1,000 or more saves you 2%; 2,000 or more saves you 3%; 5,000 or more saves you 4%; 10,000 or more saves you 5%; 25,000 or more saves you 6%; 50,000 or more saves you 7% and 100,000 or more discs earns you an 8% discount off our super low quantity 100 price. Almost all Wabash diskettes are immediately available from CE. Our warehouse facilities are equipped to help us get you the quality product you need, when you need it. If you need further assistance to find the flexible disc that's right for you, call the Wabash diskette compatibility hotline. Dial toll-free 800-323-9868 and ask for your compatibility representative. In Illinois or outside the United States dial 312-593-6363 between 9 AM to 4 PM Central Time.

## SAVE ON WABASH DISKETTES

Product Description	Part #	CE quant. 100 price per disc (\$)
8" SSSD IBM Compatible (128 B/S, 26 Sectors)	F111	1.99
8" Same as above, but bulk pack w/o envelope	F111B	1.79
8" SSSD Shugart Compatible, 32 Hard Sector	F31A	1.99
8" SSDD IBM Compatible (128 B/S, 26 Sectors)	F131	2.49
8" DSDD Soft Sector (Unformatted)	F14A	3.19
8" DSDD Soft Sector (256 B/S, 26 Sectors)	F144	3.19
3" DSDD Soft Sector (512 B/S, 15 Sectors)	F145	3.19
8" DSDD Soft Sector (1024 B/S, 8 Sectors)	F147	3.19
5¼" SSSD Soft Sector w/Hub Ring	M11A	1.59
5¼" Same as above, but bulk pack w/o envelope	M11AB	1.39
5¼" SSSD 10 Hard Sector w/Hub Ring	M41A	1.59
5¼" SSSD 16 Hard Sector w/Hub Ring	M51A	1.59
5¼" SSDD Lanier No-problem compatible	M51F	2.99
5¼" SSDD Soft Sector w/Hub Ring	M13A	1.89
5¼" Same as above, but bulk pack w/o envelope	M13AB	1.69
5¼" SSDD Soft Sector Flippy Disk (use both sides)	M18A	2.79
5¼" SSDD 10 Hard Sector w/Hub Ring	M43A	1.89
5¼" SSDD 16 Hard Sector w/Hub Ring	M53A	1.89
5¼" DSDD Soft Sector w/Hub Ring	M14A	2.79
5¼" DSDD 10 Hard Sector w/Hub Ring	M44A	2.79
5¼" DSDD 16 Hard Sector w/Hub Ring	M54A	2.79
5¼" SSQD Soft Sector w/Hub Ring (96 TPI)	M15A	2.69
5¼" DSQD Soft Sector w/Hub Ring (96 TPI)	M16A	3.79

SSSD = Single Sided Single Density; SSDD = Single Sided Double Density; DSDD = Double Sided Double Density; SSQD = Single Sided Quad Density; DSQD = Double Sided Quad Density; TPI = Tracks per inch.

## Buy with Confidence

To get the fastest delivery from CE of your Wabash computer products, send or phone your order directly to our Computer Products Division. Be sure to calculate your price using the CE prices in this ad. Michigan residents please add 4% sales tax or supply your tax I.D. number. Written purchase orders are accepted from approved government agencies and most well rated firms at a 30% surcharge for net 30 billing. All sales are subject to availability, acceptance and verification. All sales are final. Prices, terms and specifications are subject to change without notice. All prices are in U.S. dollars. Out of stock items will be placed on backorder automatically unless CE is instructed differently. Minimum *prepaid* order \$50.00. Minimum *purchase order* \$200.00. International orders are invited with a \$20.00 surcharge for special handling in addition to shipping charges. All shipments are F.O.B. Ann Arbor, Michigan. No COD's please. Non-certified and foreign checks require bank clearance.

For **shipping charges** add \$8.00 per case or partial-case of 100 8-inch discs or \$6.00 per case or partial-case of 100 5¼-inch mini-discs for U.P.S. ground shipping and handling in the continental United States.

**Mail orders to:** Communications Electronics, Box 1002, Ann Arbor, Michigan 48106 U.S.A. If you have a Master Card or Visa card, you may call and place a credit card order. Order toll-free in the U.S. Dial 800-521-4414. If you are outside the U.S. or in Michigan, dial 313-994-4444. Order your Wabash diskettes from Communications Electronics today.

Copyright © 1982 Communications Electronics™

Ad #110582



Order Toll-Free!  
800-521-4414

In Michigan 313-994-4444

wabash  
error-free  
diskettes

**COMMUNICATIONS  
ELECTRONICS™**

**Computer Products Division**

854 Phoenix □ Box 1002 □ Ann Arbor, Michigan 48106 U.S.A.  
Call TOLL-FREE (800) 521-4414 or outside U.S.A. (313) 994-4444



# WHAT'S NEWS

## Computer know-how taught by tape

A unique "Microcomputer Literacy Program" aimed at "Executives, Managers, and Professionals" is being offered by the McGraw-Hill Continuing Education Center. Designed to make it possible for the student to select the right computer for his business or profession, the course helps the person with little knowledge of computers to avoid picking an instrument too large or elaborate for the job to be done. The student also learns to avoid "the greater mistake of paying too little" and winding up with equipment that is inadequate for his needs, and can gain an understanding of computer technology that will aid him in using the equipment.

The program consists of two large looseleaf binders of printed text and worksheets, nine one-hour cassettes, a 600-page microcomputer dictionary, a detailed microcomputer rating manual, and a computer demonstrator. That unique device consists of a

slotted mask on which a microcomputer program is printed. By sliding the mask down from one program to the next, the progress of a program through the computer is visualized in a way impossible to grasp from a text. The voice instruction via the tapes, plus the printed text and reference material, combine the advantages of a correspondence and a residential course.

The introductory price is \$129.50. Purchasers are allowed a 15-day review period on a money-back basis. More information may be obtained by writing or telephoning David Dasenbrock, McGraw-Hill Continuing Education Center, 3939 Wisconsin Avenue, N.W., Washington, DC 20016 (Telephone 202-244-1600).

## Fuzzbuster seizure challenged in D.C.

Electrolert, Inc., maker of the *Fuzzbuster* radar detector, has sued the District of Columbia, its mayor, and the metropolitan police chief. Joining in the suit are Pop-

tronics Electronics, a Maryland retailer, and George Sadler, a Maryland radar-detector owner whose instrument was seized by the Washington police. The District's Commissioners' Order 61-2026 prohibits simple possession of any device that can detect police radar, or the use or sale of such devices.

The suit charges that the Order is unlawful, discriminatory, arbitrary, and unconstitutional, and cites three clauses of the U.S. Constitution in support.

The Commerce Clause restricts any legislative activity that interferes with interstate commerce. Radar detectors may be purchased and used legally in practically all other jurisdictions of the country, the plaintiffs declare.

Citing the Supremacy Clause, the plaintiffs state that Congress has remanded all authority over radio transmission and reception to the FCC, which has addressed the issue of radar-detection devices and has not introduced legislation prohibiting their use. The plaintiffs therefore charge that state legislative activity in the area of radio reception is unconstitutional.

The complaint also contends that the Order violates the Due Process clause of the Fifth Amendment because it is vague, overbroad, arbitrary, and capricious.

Mr. Sadler, one of the co-plaintiffs, lives in Maryland. He was arrested for possession of a radar detector while passing through the District on one of his business trips. His detector was confiscated and he was fined \$50.

The plaintiffs have asked the Court to declare the Commissioners' Order unconstitutional and illegal, to order the defendants to return his radar detector and the \$50 fine to plaintiff Sadler, and to award the plaintiffs their costs and disbursements.

Electrolert states that since its inception in 1975, it has spent over \$1 million in legal fees to defeat radar-detector bills at the State level, to institute judicial proceedings on behalf of individual motorists, and to institute legislation that calls for minimum performance for police radar. In the past two years, the company reports, it has been responsible for rendering a Virginia radar-detector law un-

enforceable and was instrumental in the introduction of a strict standard for police radar equipment and training in the State of Florida.

## New ferrite material destroys vibration

Nippon Electric Co. has developed a "ferrite composite material" that absorbs vibration about 100 times as effectively as iron or aluminum. The new material is made up of ferrite grains 0.1 to 10  $\mu\text{m}$  in size, and polyester resin.

The new material can be used for many applications that require control of noise or vibration. Those include microfabrication of LSI's, assembly of precision machines, stands for powerful microscopes or electron microscopes, and housings of audio equipment and computer peripherals.

NEC researchers report that the vibration-absorbing action appears to be due to mutual interference between the ferrite grains of high specific gravity and the elastic resin.

## Direct broadcast STV authorized by FCC

In a move that may open a new era of space-age television, the FCC voted 6 to 1 to approve the application of Satellite Television Corp., a subsidiary of Communications Satellite Corp. (COMSAT) to build satellites that will eventually transmit three channels of television to all 50 states for a monthly fee, bypassing local TV stations.

Commissioner Anne Jones, who cast the dissenting vote, stated that the 1962 law that created COMSAT as a quasigovernmental corporation did not envision entering the entertainment field. (COMSAT operates the global communications network and is the U.S. representative to the International Satellite Organization.)

STC's programs would be scrambled and the subscriber would receive a decoder to unscramble the signals from his own rooftop receiver.

The National Association of Broadcasters announced on the same day that it would seek an immediate stay, pending legal appeal of the FCC's action. R-E

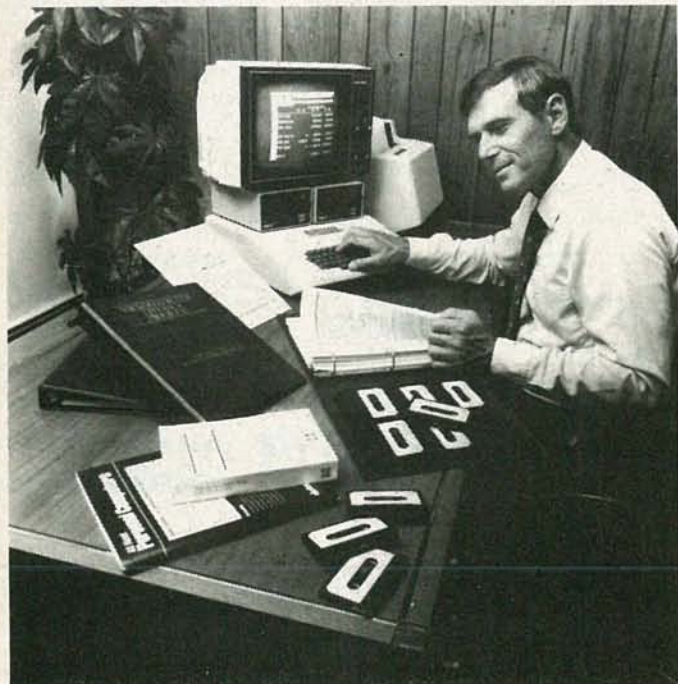

THE COMPUTER LITERACY PROGRAM, by McGraw-Hill, combines the advantages of a residential and a correspondence course by using audio tape and printed material together. The program is designed to teach computer possibilities, potential, and limitations to executives and professionals, enabling them to select and use microcomputers intelligently.



# Now! A 60 MHz Tektronix scope built for your bench.

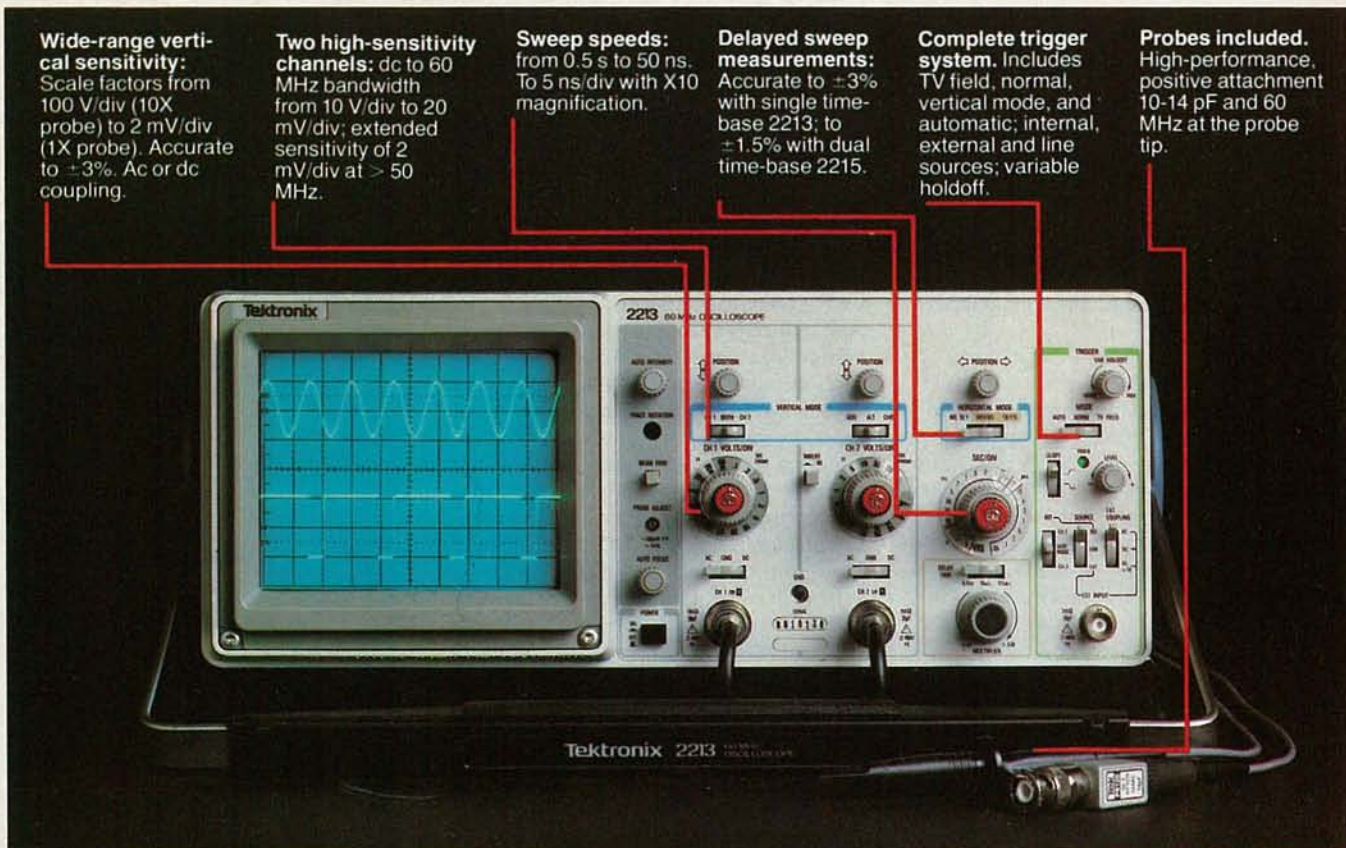

**Wide-range vertical sensitivity:** Scale factors from 100 V/div (10X probe) to 2 mV/div (1X probe). Accurate to  $\pm 3\%$ . Ac or dc coupling.

**Two high-sensitivity channels:** dc to 60 MHz bandwidth from 10 V/div to 20 mV/div; extended sensitivity of 2 mV/div at  $> 50$  MHz.

**Sweep speeds:** from 0.5 s to 50 ns. To 5 ns/div with X10 magnification.

**Delayed sweep measurements:** Accurate to  $\pm 3\%$  with single time-base 2213; to  $\pm 1.5\%$  with dual time-base 2215.

**Complete trigger system.** Includes TV field, normal, vertical mode, and automatic; internal, external and line sources; variable holdoff.

**Probes included.** High-performance, positive attachment 10-14 pF and 60 MHz at the probe tip.

**In 30 years of Tektronix oscilloscope leadership, no other scopes have recorded the immediate popular appeal of the Tek 2200 Series.** The Tek 2213 and 2215 are unapproachable for the performance and reliability they offer at a surprisingly affordable price.

There's no compromise with Tektronix quality: The low cost is the result of a new design concept that cut mechanical parts by 65%. Cut cabling by 90%. Virtually eliminated board electrical connectors. And eliminated the need for a cooling fan.

Yet performance is written all over the front panels. There's the bandwidth for digital and analog circuits. The sensitivity for low signal measurements. The sweep speeds for fast logic families. And delayed sweep for fast, accurate timing measurements.

**The cost: \$1200\* for the 2213. \$1450\* for the dual time base 2215.** You can order, or obtain more information, through the Tektronix National Marketing Center, where technical personnel can answer your questions and expedite delivery. Your direct order includes

probes, operating manuals, 15-day return policy and full Tektronix warranty.

For quantity purchases, please contact your local Tektronix sales representative.

**Order toll free:  
1-800-426-2200  
Extension 44**

In Oregon call collect:  
(503) 627-9000 Ext. 44

\*Price F.O.B. Beaverton, OR. Price subject to change.



# VIDEOGAMES

## What's new in home videogames

DANNY GOODMAN, CONTRIBUTING EDITOR

THIS YEAR HAS SEEN THE INTRODUCTION of a confusing array of new home-videogame systems, as well as enhancements for existing systems, calculated to attract literally millions of new players to the home-videogame market. If you are one of those facing the potentially emotional decision of which system to buy, this new monthly column will be just what you're looking for. In this first one, we will look at some of the things to consider as you twiddle the controllers at the video counter.

### Hardware

Game players today demand more realism from their systems. For sports and similar games that means the ability to input more strategy as well as realistic character, playing-field, and action graphics. In arcade-type games, players demand graphics that approach the color and detail of the high-resolution coin-operated units. While the home color-TV receiver cannot match the resolution of an arcade monitor, a home TV does an admirable graphics job with systems like Coleco's (200 Fifth Ave., New York, NY 10010) *Colecovision*, Video Technology's (68 Sung Wong Toi Road, Tokwawan, Kowloon, Hong Kong) *Creativision* (which was scheduled for December 1982 introduction), Arcadia's (324 Martin Ave., Santa Clara, CA 95050) *Supercharger* for the Atari (1265 Borregas Ave., Sunnyvale, CA 94086) *VCS*, and Atari's *5200* deluxe system. By way of comparison, the *5200* has the same graphics resolution as Atari's *400/800* home-computer systems.

One system that can produce true arcade-type graphics is the cartridge-programmable *Vectrex* vector-scanning home-game from General Consumer Electronics (233 Wilshire Blvd., Santa Monica, CA 90401). That is the only home system, at least until now, capable of reproducing the outline-formed characters used in such arcade games as *Asteroids* and *Tempest*. To accomplish that feat, the game uses its own vector-scanning video monitor (more on the *Vectrex* system next month).

The newer systems all use all-in-one hand controllers. As the *Intellivision* controllers proved, a keypad used in conjunction with a joystick or direction-control disk, is an effective way of communicat-

ing with the game computer. The Atari *5200* also allows you to vary speed using the joystick; for instance, the faster you push the joystick to the right the faster your screen character moves to the right and so on. The effect here is similar to using an arcade-style track ball (such as those found in games like *Centipede* or *Missile Command*).

All manufacturers now realize that the success of their systems depends largely on the amount of games available for it. And if there is one undisputable fact about home-videogames, it is that there is more support for the Atari *VCS* than any other system (and perhaps more than for all of them combined!). The reason is simple: game-cartridge developers have many millions more hungry *VCS*-users to satisfy than users of any other home system. But that large existing library can prove to be a considerable obstacle to any new system that is introduced. After all, few buyers would be willing to invest in a new system with little support, considering what else is on the market. What Coleco has done to offset that problem is come out with a system adapter that will allow their *Colecovision* system to use Atari *VCS* cartridges, and Atari is planning to introduce a similar adapter for their own *5200* system sometime this year.

The introduction of those adapters makes sense for many reasons. First of all, any new system will have only a modest offering of its own games at the outset—one company can do only so much in a limited time. With adapters, the unit is immediately usable with an already existing library of cartridges. Next, for the game owner wanting to upgrade to a more advanced system, a substantial investment in game cartridges (usually much more than the actual cost of the console) won't be wasted when switching to a new unit. If all home game-consoles featured adapters for most other systems, the consoles could compete solely on the basis of features such as controllers, computer add-ons, creative graphics, sound effects, and the like.

There is also suddenly an interest in serving what is known as the videogame hardware aftermarket—otherwise known as add-ons for your videogame. Electronic speech modules (*Intellivision*, *Odyssey 2*, and Atari *5200*) and hand controllers of all kinds (mostly for the *VCS*) are already

joining game organizer-type cases and cartridge racks on your dealer's shelves. Many of the newer systems provide expansion connectors for future add-ons. As with computers, expandability means that a system will be able to grow with you, as well as with changing technology.

### Coleco's Donkey Kong for Colecovision

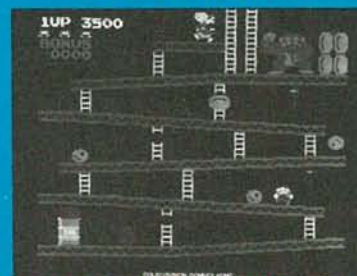

CIRCLE 101 ON FREE INFORMATION CARD

Donkey Kong	Coleco									
GRAPHICS	█	█	█	█	█	█	█	█	█	█
SOUND	█	█	█	█	█	█	█	█	█	█
EASE OF LEARNING	█	█	█	█	█	█	█	█	█	█
CHALLENGE	█	█	█	█	█	█	█	█	█	█
VALUE	█	█	█	█	█	█	█	█	█	█
	1	2	3	4	5	6	7	8	9	10
	Poor		Fair			Good			Excellent	

Coleco's *Colecovision* comes packaged with the home version of the most popular non-combat arcade game since *Pac-Man*: *Donkey Kong*. The game looks simple—move your mustached character, named Mario, up various girders and ladders to rescue a "fair damsel" who has been abducted by the fierce Kong. But successful execution requires split-second coordination, plus an eye for mazes. In that regard, Coleco's cartridge is no different from the original.

Players of the arcade game will be quick to tell Coleco's from the original, however. For one thing, there are only three different boards, instead of four (the easy Mud Factory scene is gone). But

*continued on page 10*



**"No one else gives you as many functions in a handheld DMM.**

**Now you can move up to Fluke."**

We've got great news for people who've been holding out for a high quality, high performance DMM at a moderate price: Fluke's new nine-function model D 804 is now available at select electronics supply stores.

With a suggested U.S. price of only \$249 and features you won't find in any other handheld DMM, the D 804 is an exceptional value. Here's why.

**Logic level and continuity testing:** A real time-saver for troubleshooting passive circuits in pcb's, cables, relay panels and the like. The D 804 has a switch-selectable audible tone and visual symbols to indicate continuity or logic levels.

**Direct temperature readings in °C:** Used with any K-type

thermocouple, the D 804 delivers fully-compensated readings in °C from -20°C to +1265°C, for checking heating and refrigeration systems.

**Peak hold feature captures transients:** A short-term memory in the D 804 captures and holds the peak reading of a motor starting current.

**And more:** 0.1% basic dc accuracy, conductance, 26 measurement ranges, battery, safety-designed test leads and a one year parts and labor warranty. A full line of accessories is also available to extend the measurement capabilities of your DMM.

Ask your dealer about the powerful, versatile D 804 and the rest of Fluke's new Series D line of low-cost digital multimeters.



**From the world leader in DMM's. Now we've designed one for you.**

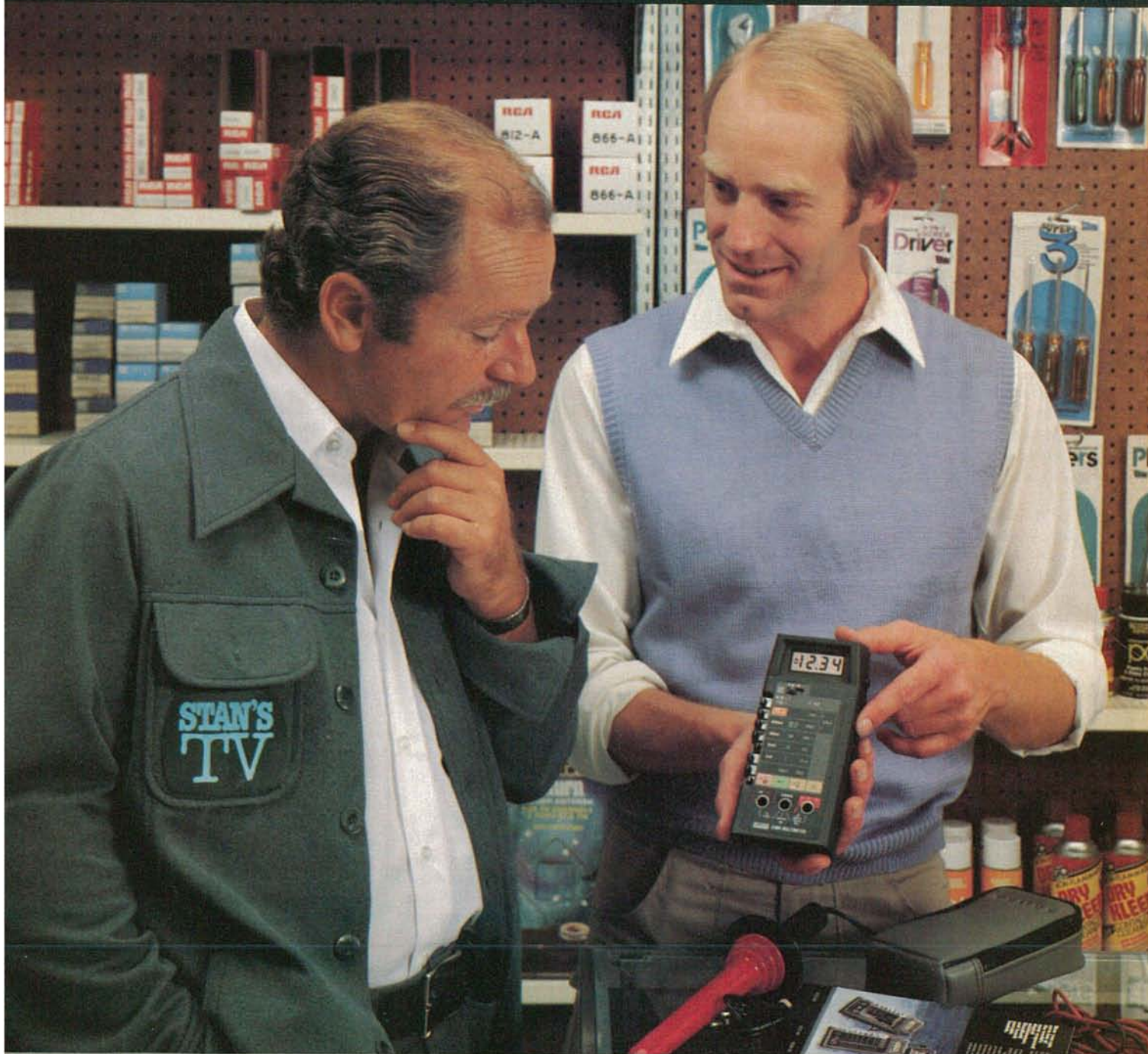

Suggested U.S. list price  
technical data circle No. 51  
RE 2/83 - D804

If your dealer doesn't carry Series D  
Multimeters yet, call this number. We'll be  
happy to tell you who does. 1-800-426-0361

**FLUKE**



# VIDEOGAMES

continued from page 8

even so, the game is perhaps the most true-to-arcade home-videogame cartridge around.

The graphics are outstanding. You not only can see Mario's mustache, but the lattice work in the bright pink girders is crisp, and the color variations and contrast (the black background helps), like Mario's brown coveralls, and the white streaks to indicate cylindrical objects, are unlike that found on any other home game I've seen. And the sound package includes the familiar background rhythm, whistle-like tune when Mario hops over barrels, and more.

One or two (alternating) can play at a time and there are four levels of difficulty; the easiest one starts you off with five Marios, the rest start with three. Completing skill level one (the easiest one) requires rescuing the girl five times. The sequence of board scenes is Ramps, Rivets, Elevators, Rivets, and Elevators. At level one you also get 1000 extra bonus points, which gives you more time to navigate the trickier obstacles (the bonus points decrement as time ticks away) The game can be reset from the hand controllers.

While it's not hard to learn what *Donkey Kong* is all about, the newcomer, nevertheless, will need a lot of practice to get the hang of running and jumping over the moving and stationary obstacles (make a mistake and you lose your Mario). You'll also discover several areas that can be tricky; especially watch out for the edges of girders (Mario can easily fall off to his demise) or the area around Kong.

The Elevators board is the most difficult to get used to. Arcaders may be interested to know that the bouncing hammer obstacles are replaced in the home version by an extra flame at the girder levels surrounding the girl.

While some of the charm of the original—like Kong's grabbing the girl between boards and watching the girders collapse in the Rivets board—had to be sacrificed for the smaller memory of a home game, Coleco managed to keep some of the "cute" effects (Mario can pick up the girl's scattered personal belongings for bonus points) and interest of the original where it counts; while you're playing the game. This first offering for *Colecovision* is certainly a good omen for the rest of their library.

**Activision's  
Pitfall!  
for Atari**



CIRCLE 102 ON FREE INFORMATION CARD

Pitfall!	Activision									
GRAPHICS										
SOUND										
EASE OF LEARNING										
CHALLENGE										
VALUE										
	1	2	3	4	5	6	7	8	9	10
	Poor		Fair		Good					Excellent

I wouldn't have believed it could come from an Atari VCS if I hadn't been watching it with my own eyes: a comic-book human character is running across a jungle-like scene, swinging on vines over a pond, leaping over pit-like traps, climbing up and down ladders, and finally tiptoeing across a lagoon on the heads of hungry crocodiles.

The game is *Pitfall!* from Activision (3255-2 Scott Blvd., Santa Clara, CA 95051), and the character's name is Pitfall Harry. What Harry is doing is searching the jungle for as many of the lost treasures of Enarc as he can in twenty minutes without giving up his own life to scorpions, quicksand, and those darned crocodiles, to name a few. Every time he runs off the screen, a new scene appears with different hazards—in fact, 256 different scenes have been programmed into the cartridge.

Design of this solitary game is attributed to Activision's David Crane (thus the

treasures of Enarc) and is one of the most original and graphically interesting VCS cartridges available. The sound package even includes an electronic Tarzan call while Harry swings on a vine. The novice player will need some time to get the coordination down to run and jump for swinging vines, race over vanishing pits, jump over several obstacles, and gingerly dance across the crocodile lagoons.

What's most interesting about this game is that no matter how good you get at avoiding obstacles, you're never quite sure that you haven't missed some underground passage shortcut (jump over scorpions down there) or have found the fastest way to overcome an obstacle (like making it over the crocodile lagoon in one mad rush while the crocodiles' mouths are shut). Expert players will be glued to the set for hours, experimenting and memorizing successful patterns.

You'll have to work hard to reach the first treasure (a money bag)—perhaps a minute and a half—but the longer you keep Harry alive, the quicker he'll find the others (rings, silver/gold bars, etc.). So be prepared for a twenty-minute adventure each time you reset.

Also available from Activision is a version of *Pitfall!* for Intellivision game systems. Although the graphics might be a letdown when compared to other Intellivision games, the game play certainly won't be. *Pitfall!* is a stimulating adventure game on any system. **R-E**





# VIC20™ PERSONAL COMPUTER

(List Price \$299)

## SALE!

# \$149<sup>00</sup>

(when you buy 6 tape programs at sale prices)



We Have Commodore 64 Computers In Stock

- We Love Our Customers Our Prices and Service Prove It!
- One Day Delivery Express Mail

- Commodore 64 Programmers Reference Guides Free With Purchase
- Over 500 Programs To Choose From
- Free Catalogs

You get the COMMODORE VIC-20 Computer for only \$149.00 when you buy 6 tape programs on sale for only \$69.00. These 6 tape programs list for \$96.00 to \$132.00! You can choose one of these three tape program packs: 6 GAME program pack \$69.00 (Alien Invasion, Target Command, Artillery, Chase, Snake Out, Cattle Round Up). 6 HOME FINANCE program pack \$69.00 (Check Book, Calculator, The Budgeter, Home Inventory, Income Tax, Utility Bill Saver). 6 SMALL BUSINESS program pack \$69.00 (Accountant, Accounts Receivable and Payable, Inventory, Order Tracker, Estimating and Bidding, Appointments).

### 33K COMMODORE VIC \$239 WITH 2½ TIMES MORE POWER

For only \$239.00 you get the COMMODORE VIC-20 Computer plus WE ADD 8,000 BYTES OF USER MEMORY to give you 2½ TIMES MORE PROGRAMMING POWER! This powerful full-sized extra featured computer includes the 6502 microprocessor (LIKE APPLE) 20,000 bytes ROM with a 16K extended LEVEL II Microsoft BASIC, 13,000 bytes RAM, a total of 33,000 bytes memory, plug in expandable to 60,000 bytes, 66 key typewriter professional expanded keyboard with graphic symbols on keys, color command keys, high resolution graphics, 512 displayable characters, text display is 22 lines 23 characters, sound and music, real time, upper lower case, full screen editing cursor, floating point decimal and trig functions, string arrays, scrolling, multi statement lines, file management, PEEK AND POKE. Assembly machine language is available. We have easy to use self teaching books and programs. Accepts TAPE-DISK AND PLUG IN CARTRIDGES, connects to any TV, includes AD adaptor, R.F. modulator, switch box, self teaching instruction book, comes in a beautiful console case.

### 41K COMMODORE VIC \$279 WITH FOUR TIMES MORE POWER

For only \$279.00 you get the 41K COMMODORE VIC with 400% MORE PROGRAMMING POWER THAN VIC-20! We add 16,000 bytes user memory to the VIC-20. You get a total of 41,000 bytes memory (20,000 bytes ROM, 21,000 bytes RAM and extended LEVEL II BASIC) plus all the extra features listed!

### 49K COMMODORE VIC \$319 WITH SIX TIMES MORE POWER

For only \$319.00 you get the SUPER POWERED 49K COMMODORE VIC with 600% MORE PROGRAMMING POWER than VIC-20! We add 24,000 bytes user memory to the VIC-20. You get a total of 49,000 bytes memory (20,000 bytes ROM, 29,000 bytes RAM and extended LEVEL II BASIC) plus all the extra features listed!

### TRACTOR-FRICTION PRINTER \$399

This all new COM-STAR deluxe line printer, prints 8½" x 11" letter quality full size, single sheet, roll or fan fold computer paper, labels, etc. 40, 66, 80, 132 columns. Impact dot matrix, bi-directional, 80 CPS. Includes special cable that plugs direct into the VIC-20 printer port — no other costly interface is needed! List \$599. Sale \$399.

### SUPER 10" COM-STAR PRINTER \$499

Has all the features of the COM-STAR printer shown above, PLUS! 10" carriage, 100 CPS, Dot addressable bit image graphics, 2.3 buffer, 18 character sets, 40, 48, 66, 80, 96, 132 columns, prints true descender, super and subscript, underlining. Includes special cable to plug in to the VIC-20 printer port. List \$699. Sale \$499.

### 60K MEMORY EXPANDER \$89

Allows memory expansion to 60K total (20K ROM and 40K RAM). Has six slots to add six cartridges — you can switch select any combination of memory or programs. Stop and start any program with reset button, you don't have to remove cartridges or turn off computer. This expander is a must to get the most out of your VIC-20 Computer!

### PLAY ATARI GAMES ON VIC-20 \$79.

WOW !! Plug in our new "GAME LOADER" and you can play all ATARI video game cartridges, Activision, Imagic M-Network on your VIC-20 computer. List \$99. Sale \$79.

### LOW COST PLUG IN EXPANSION

Accessories plug in direct to this computer, extra RAM memory, data cassette, telephone modem \$99.00, deluxe 80 column printer \$399.00, 170K disk drive \$349.00 all plug in direct! You do not have to buy an expensive expansion interface!!

### WE HAVE THE LOWEST PRICES

We sell direct to customers and you save the profit margin normally made by computer stores, department stores and distributors, we are willing to take a smaller margin to develop volume. WE LOVE OUR CUSTOMERS — OUR PRICES PROVE IT!

### IMMEDIATE REPLACEMENT WARRANTY

If your computer fails because of warranty defect within 90 days from date of purchase, you simply send your computer to us via United Parcel Service prepaid. We will "immediately" send you a replacement computer at no charge via United Parcel Service prepaid. This warranty applies to all products we sell because WE LOVE OUR CUSTOMERS!!

### 15 DAY FREE TRIAL

#### DON'T MISS THIS SALE - ORDER NOW

- VIC-20 for only \$149. plus \$69. for 6 pack of programs Specify pack wanted \_\_\_\_\_
- 33K-VIC for only \$239.
- 41K-VIC for only \$279.
- 49K-VIC for only \$319.
- Tractor Friction Printer \$399.
- Super 10 Printer \$499.
- 60K Memory Expander \$89.
- Game Loader—Atari \$79.

We ship C.O.D. and honor Visa and Master Card.

Name \_\_\_\_\_

Address \_\_\_\_\_

City \_\_\_\_\_

State \_\_\_\_\_ Zip Code \_\_\_\_\_

VISA  MASTER CARD  C.O.D.

Credit Card No. \_\_\_\_\_

Expiration Date \_\_\_\_\_

Add \$10.00 for shipping, handling and insurance. Illinois residents please add 6% tax. Add \$20.00 for CANADA, PUERTO RICO, HAWAII orders. WE DO NO EXPORT TO OTHER COUNTRIES.

Enclose Cashiers Check, Money Order or Personal Check. Allow 14 days for delivery, 2 to 7 days for phone orders, 1 day express mail! Canada orders must be in U.S. dollars.

**GET \$150 FREE SOFTWARE WHEN YOU BUY A COMMODORE 64 COMPUTER!!**

# PROTECTO ENTERPRISES

(FACTORY-DIRECT)

BOX 550, BARRINGTON, ILLINOIS 60010  
Phone 312/382-5244 to order

CIRCLE 39 ON FREE INFORMATION CARD





TRIPLETT

KEITHLEY

LEADER



Non-Linear Systems

**BK PRECISION** 15 MHz TRIGGERED SWEEP SCOPE

MODEL 1477



CALL FOR OUR GRAND OPENING PRICES

- Mode automatically shifts between CHOP and ALTERNATE
- Bright P31 blue phosphor
- Front-panel X-Y operation
- Differential input capability
- 19 calibrated sweeps—.5 $\mu$ SEC/cm to .5SEC/cm
- Sweep to .1 $\mu$ SEC/cm with 5x; 1.5SEC/cm with uncalibrated vernier

PRICE DOES NOT INCLUDE PROBES

**BK PRECISION** 30 MHz TRIGGERED SCOPE

MODEL 1479B



CALL FOR OUR GRAND OPENING PRICES

- Built-in signal delay line permits view of leading edge of high frequency pulse rise time.
- Triggers on signals up to 50MHz
- Rectangular CRT with P31 phosphor
- Mode automatically shifts between CHOP and ALTERNATE

PRICE DOES NOT INCLUDE PROBES

**BK PRECISION** 70 MHz. Dual Time BASE SCOPE

MODEL 1570



CALL FOR OUR GRAND OPENING PRICES

- 1 mV/division sensitivity to 70 MHz
- 500  $\mu$ V/division cascade sensitivity
- Four-input operation provides trigger view on 4 separate inputs.
- Alternate time base operation
- Switching power supply delivers best efficiency and regulation at lowest weight

PRICE DOES NOT INCLUDE PROBES



4 1/2 DIGIT MULTIMETERS

MODEL 8060A



- Frequency measurements to 200KHz
- dB measurements
- Relative measurements
- True RMS
- High-speed Beeper

**\$349<sup>00</sup>**

MODEL 8062A

- .05% accuracy
- True RMS
- 30KHz bandwidth
- Relative measurements
- Beeper

**\$279<sup>00</sup>**



FUNCTION GENERATORS

MODEL 3010

**\$179<sup>95</sup>** was \$220.



SWEEP FUNCTION MODEL 3020

**\$299<sup>95</sup>** was \$379.

- Four instruments in one package—sweep generator, function generator, pulse generator, tone-burst generator
- Covers 0.02Hz-2MHz
- 1000:1 tuning range
- Low-distortion high-accuracy outputs

- Sine, square and triangle output
- Variable and fixed TTL outputs
- 0.1 Hz to 1MHz in six ranges
- Push button range and function selection
- Typical sine wave distortion under 0.5% from 1 Hz to 100kHz



100MHz DUAL TRACE DUAL TIME BASE

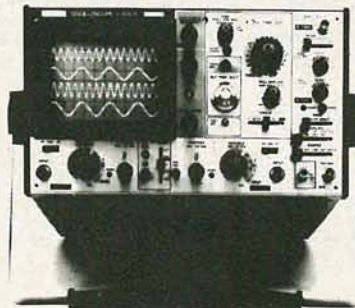

MODEL 1050

QUAD TRACE ABILITY. A INTENSIFIED BY B

**\$1499<sup>95</sup>**

PRICE DOES NOT INCLUDE PROBES



CAPACITANCE METERS

**\$149<sup>95</sup>** was \$185.



MODEL 820

- Resolves to 0.1pF
- 4 digit easy-to-read LED display
- Fuse protected against charged capacitors
- Overrange indication

ORDERING INFORMATION

We don't just take orders we ship orders  
*Advance Electronics* endeavors to keep everything we advertise in stock for immediate delivery.



- Mastercharge & Visa shipped within 24 hours.
  - Bank checks or Money Orders shipped within 24 hours.
  - Personal checks — please allow 3 weeks for check to clear.
  - All prices plus shipping charges. Please call for appropriate charges. Use our toll free number.
  - New York State residents add appropriate sales tax.
  - PRICES SUBJECT TO CHANGE WITHOUT NOTICE.
- Quantities are limited



**BK PRECISION****HITACHI****VIZ** formerly **RGA****HICKOK****DATA PRECISION****FLUKE****DORIC**

*With great pride and profound thanks — **Advance Electronics** is pleased to announce —*

# **WE HAVE MOVED!**

*Thank you so much — readers of Radio-Electronics — for your support and continued patronage. It is an important part of the growth that has made it necessary for us to seek larger quarters.*

*In celebration we have many grand — opening specials. Our prices are so low that many of our manufacturers have asked us not to list their names. Call us about oscilloscopes, voltmeters, power supplies or any test equipment you need. It's all on sale.*



**TOLL FREE HOT LINE**  
**800-223-0474**

**THE TEST EQUIPMENT SPECIALISTS**

26 WEST 46th STREET, NEW YORK, N.Y. 10036 • 212-730-7030

# **ADVANCE ELECTRONICS**



# SATELLITE/TELETEXT NEWS

GARY ARLEN  
CONTRIBUTING EDITOR

## DBS SERVICE PLANNED

Direct Broadcast Satellite service is getting off to an earlier-than-expected start thanks to a number of recent actions, some of which could put the first DBS signals on the air this year. In the wake of the recent FCC interim action authorizing DBS service, several companies have plunged ahead with projects involving a number of innovative approaches. For example, United Satellite Television plans to use 10 transponders on Canada's Anik C satellite for at least a year until its transmissions can be moved to a new GTE GSTAR bird, due to be launched in 1984. Initial use of Anik C means that signals can be picked up by fairly small, inexpensive earth stations in the U.S. USTV, a joint venture among Pop Satellite Inc., General Instruments, and Citicom Broadcasting, plans to offer five channels for each East and West feed, including two pay-TV channels, a broadcast retransmission signal, and two ad-supported channels.

Another familiar satellite-industry name—Satellite Syndicated Systems (best known for its Satellite Programming Network and as the retransmission carrier of Superstation WTBS)—has come up with its own plan for a DBS system to be operative by the late 1980's. The 4-satellite, 6-channel system will primarily offer pay-per-view programming, as well as education, teletext, and audio services. The 4-phase SSS plan relies upon substantial participation from the cable industry; by 1986 SSS proposes an Eastern time zone DBS service and the company plans to launch its own DBS bird by 1988.

Meanwhile, Satellite TV Corp., the Comsat subsidiary that pioneered the DBS concept, is moving ahead with its own plans for a major DBS service. The company is planning to build its major hub of DBS activity at a new uplink near Las Vegas. The STC center, which will employ about 100 people, will handle all program scheduling, editing, reproduction, and technical quality control. It will be in operation by STC's proposed 1986 launch date.

## VIDEOTEX STANDARD PROPOSED

A compromise standard for international videotex and teletext—tentatively called UPL (*Unified Presentation Layer*)—has been proposed by a group of U.S. business and government officials, who are trying to hammer out a U.S. position on a technical format. The proposal, developed at a State Department meeting, is a variant of the North American Presentation Level Protocol, which was proposed by AT&T. Among the technical compromises in the UPL is one that would permit use of display standards of either 40 rows by 24 lines (the European preference) or 40 by 20 (the format adopted by AT&T, Canada's Telidon, and other services).

The compromise format urges U.S. equipment manufacturers to include UPL IC's in their products which would make videotex/teletext terminals compatible with any format. The IC's—if and when they become available—would automatically switch between formats, depending on which was being transmitted at the time. However, foes of the compromise suggest that the UPL IC's—if they can be built—would cost more than 20 times as much as conventional single-standard microprocessors.

## AROUND THE SATELLITE CIRCUIT

**SPACE**, the Society for Private and Commercial Earth Stations, has restructured its organization to reflect all aspects of the earth station industry more fully. Under the revisions, SPACE now has a consumer section composed of individuals who own and use earth stations; dues for members of that group are \$35 per year, compared to fees ranging from \$300 to \$3600 per year for SPACE members in Manufacturing, Dealer, Distributor and Satellite-Master Antenna TV sections. (SPACE, 1920 N Street NW, Suite 510, Washington DC 20036).

**Britain's first DBS satellite**, Unisat, which is scheduled for 1986 launch, will carry data communications within Europe and possibly a sidebeam to North America. Each Unisat bird will have either two DBS and four data channels, or one DBS circuit and six telecommunications channels. British Broadcasting Corp. will probably run the video-programming service of movies and other entertainment.

**Satellite and aerospace technicians** are enthusiastic about last November's launches of two satellites from *Space Shuttle V*. An SBS bird (for business-data communications) and an Anik bird (for multipurpose Canadian communications) were lofted into geostationary orbits from the Shuttle. More such launches are planned for future flights.

R-E



The COEX

# Anatomy of a Printer

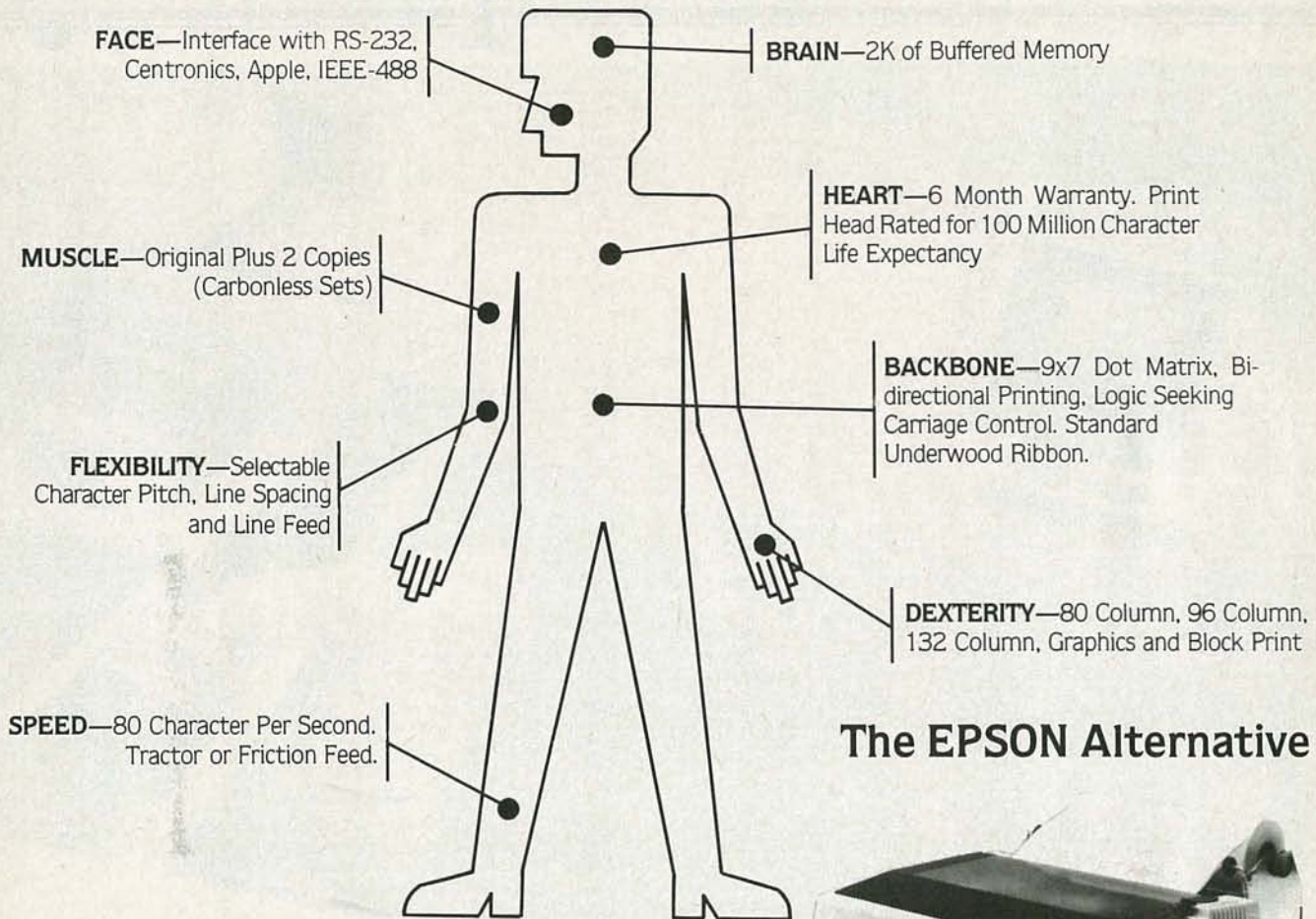

## The EPSON Alternative



Best of all, the price . . .

# \$349<sup>00</sup>

COEX 80-FT

**OPTIONS:**

COEX Interface Card to Apple . . . . . **\$49.95**

Demo Disc for Apple Available to Dealers

**Dealer Inquiries Invited**

**SPECIFICATIONS:**

CHARACTER FORMATION PROCESS . . .	Serial, impact dot matrix
STANDARD FONT . . . . .	9 x 7 (7 needles), 6 x 6 for graphics printing
PRINTING DIRECTION . . . . .	Bi-directional
NUMBER OF COLUMNS . . . . .	80, 96 or 132. (40, 48 or 66 for enlarged characters)
CHARACTER SIZE . . . . .	2.57 mm (.101") x 2.0 mm (.079") for standard 80-column line
CHARACTER DENSITY . . . . .	5 CPI for 40 column, 10 CPI for 80 column, 12 CPI for 96 column and 16.7 CPI for 132 column
LINE SPACING . . . . .	1/6", 1/8" and 1/12"
PRINTING SPEED . . . . .	80 characters per second
NUMBER OF COPIES . . . . .	2 (original plus 2 copies for carbonless sets)
PAPER WIDTH . . . . .	8" to 10" for friction-fed paper and 3" to 10" sprocket-fed paper
INKED RIBBON . . . . .	Standard Underwood spool type 1/2" (13 mm) wide by 11.5 yards (10.5 m) long
DIMENSIONS . . . . .	387 mm (15.3") wide by 309 mm (12.2") deep by 124 mm (4.9") high. With tractor-feed assy, height is 171 mm (6.7")
POWER CONSUMPTION . . . . .	90 watts maximum operation 25 watts standby
WEIGHT . . . . .	8.5 Kg (19 lbs.)

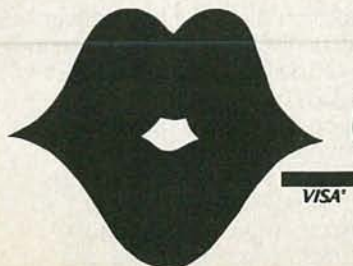

"Have You Kissed Your Computer Lately?"

# Components Express, Inc.

1380 E. Edinger • Santa Ana, Calif. 92705 • 714/558-3972

**Terms of Sale:** Cash, Checks, Credit Cards, M.O., C.O.D. Calif. residents add 6% sales tax.



CIRCLE 8 ON FREE INFORMATION CARD



MASTER THE "NEW ELECTRONICS" WITH MCGRAW-HILL'S

# Contemporary

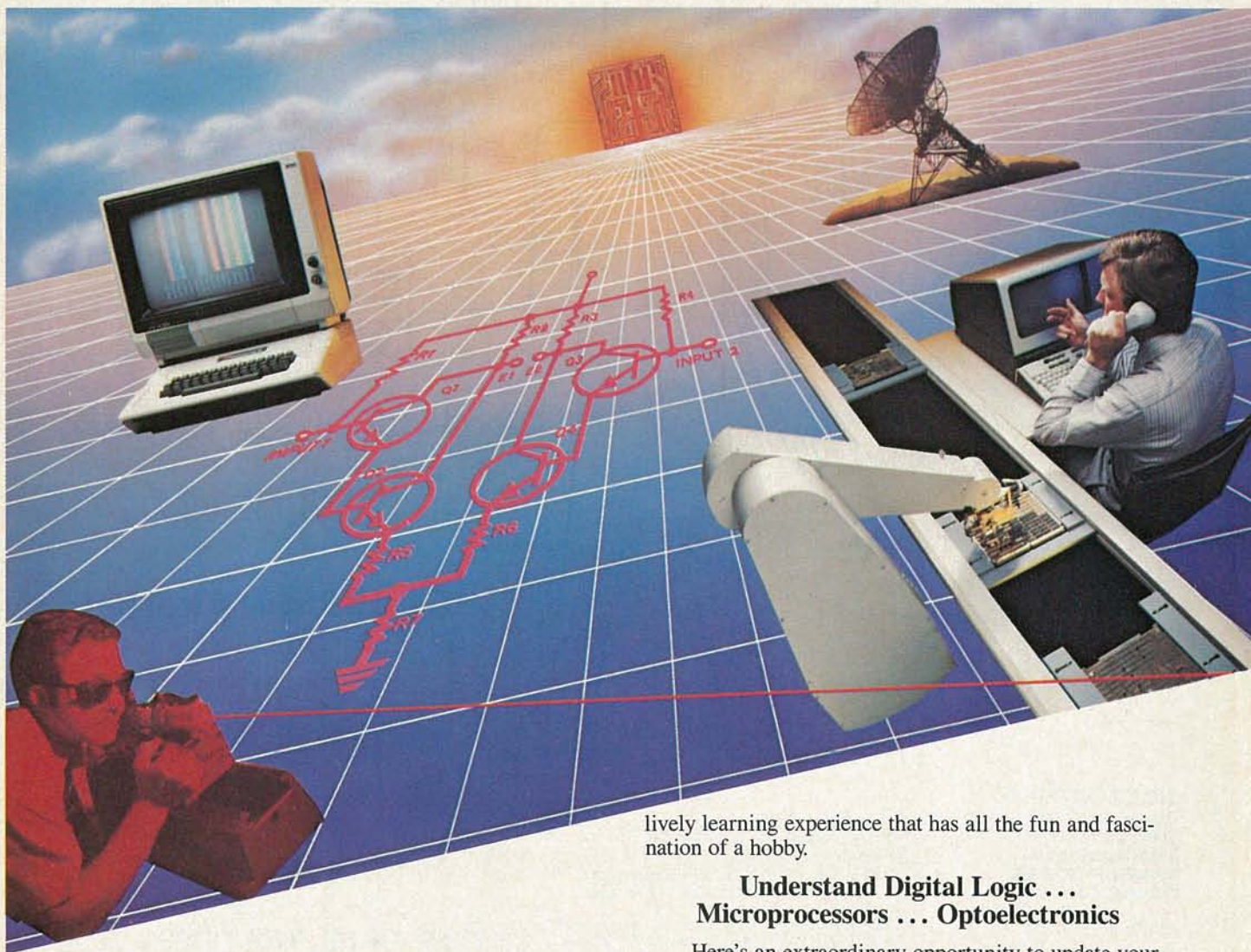

**Now you can meet the challenges of today's incredibly rapid changes in electronics quickly and easily. This professional level electronics learning series is as innovative as the circuitry it explains and as fascinating as the experiments you build and explore!**

From digital logic to the latest 16-bit microprocessor, you master one subject at a time with McGraw-Hill Concept Modules sent to you one at a time, once a month, to make up the complete CONTEMPORARY ELECTRONICS SERIES. Each module of the fifteen in the Series is a unique blend of "hands-on" experience, interactive audio cassettes, and vividly illustrated printed support materials. Together they will prepare you for tomorrow's better jobs or advancement in your present position by staying current with today's electronics revolution. Professional in every respect, yet it's a

lively learning experience that has all the fun and fascination of a hobby.

### **Understand Digital Logic ... Microprocessors ... Optoelectronics**

Here's an extraordinary opportunity to update your understanding of today's most important technological changes in electronics. You can start from scratch or use the Series to update yourself. You cover the latest integrated circuits, including TTL, CMOS, and ECL digital circuits; op-amps; phase-locked loops; microprocessors; and opto devices such as LEDs and LCDs.

### **Perform Electronic Experiments**

With your first module you'll use the latest digital integrated circuits to build an oscillator circuit that demonstrates digital signals—verified visually by the flash of light emitting diodes (LEDs) and audibly by tones produced through the mini-speaker that is provided.

You'll know the differences (and similarities) between electronics and electricity, learn the concepts applicable to all electronic circuits. With the first module, you will be able to identify the major passive components, like resistors, capacitors, inductors, diodes and



# Electronics Series

transformers, and active components such as transistors and integrated circuits.

Each Concept Module goes right to the heart of the matter. You waste no time on extraneous material or outdated history. It's a fast, efficient, and lively learning experience, a nontraditional approach to the most modern of subject matter.

## Construct and Use a Prototyping/Design Laboratory

What's more, when you reach the midpoint of your

### YOU COVER EVERY SUBJECT IN CONTEMPORARY ELECTRONICS

- Digital logic
- Digital gates (TTL, CMOS, ECL, NMOS)
- Flip flops, counters and registers. Op-amps and applications
- Power supplies (plus IC and switching regulators)
- Combinational logic circuits (ROMs, PLAs, decoders, etc.)
- Circuit analysis. AC theory. LCR networks
- Transistors (bipolar and FETs), diodes, thyristors
- Integrated circuits (linear and digital)
- Oscillators and function generators
- Modulation and demodulation
- Optoelectronics
- Digital multimeters and scopes
- Microprocessors

Series, you will have constructed a professional Prototyping/Design Laboratory which will become a valuable learning tool throughout the remainder of your studies.

This Prototyping/Design Lab contains a signal generator, logic switches, pushbuttons, and LED indicators. It rivals professional instruments that are widely used in industrial laboratories for electronic design and development as well as testing and measuring. Because of its versatility, it is an instrument that you will use again and again, even after you have completed your Contemporary Electronics Series.

With each new module you'll receive a McGraw-Hill Action-Audio Cassette, a proven successful method of programmed, interactive instruction. Each tape creates a dynamic dialogue that not only quickly communicates the facts, but makes you feel that you're participating, as you respond to questions and listen to problems being solved.

Your ability to rapidly make this knowledge your own is further aided by a strikingly original technique for using diagrams, illustrations, and schematics to drive home points made as you listen to the cassette. The same carefully indexed binder that contains this material also includes the instructions

to guide you through hands-on experiments. Finally, having completed the Series, you can be awarded a Certificate of Achievement from the McGraw-Hill Continuing Education Center upon passing an optional final examination.

## Update Your Knowledge of the New Electronics

This program is for you whether you're a scientist who can use electronics to improve or speed up your investigations... a teacher who'd benefit from a refresher in contemporary components, circuits and applications... a manager or supervisor in an electronics related industry or business... an engineer in another field who finds electronics playing an ever more important role in your work... someone looking to find new direction in this wide open field... or the kind of person who wants to understand what's going on in the world around you.

McGraw-Hill's Contemporary Electronics Series offers you the quickest and probably least expensive learning method available today, and the only one with "hands-on" experience.

## No Risk, No Obligation

And we invite you to prove all this to your own satisfaction—without risk and without committing yourself in any way.

Return the reply card and we'll send you the first module and other materials for a free 14-day examination. If you're not absolutely satisfied, and certain that this is an enjoyable as well as highly effective way to learn, simply return the module to us along with the unpaid bill and that will be the end of it.

If you wish to continue, we'll ship the remaining modules automatically, about once a month. Remember, each module comes on the same 14-day free examination basis, with no obligation to pay for any module you don't want to keep.

Return the reply card now. It'll bring you the first module Contemporary Electronic Components and Circuits... your first step in becoming an expert in the "new electronics." There's no risk or obligation.

If the card is missing write to:



Contemporary Electronics Series  
McGraw-Hill Continuing Education Center  
3939 Wisconsin Avenue, NW  
Washington, DC 20016



*With your first module you'll receive this professional solderless breadboarding system. It enables you to connect components and build electronic circuits easily and quickly. It's used throughout the series and can be used later to design, build and test your own circuits.*





# LETTERS

Address your comments to: Letters, **Radio-Electronics**,  
200 Park Avenue South, New York, NY 10003

## ABOUT "HOBBY CORNER"

As a reader for the past six years, I have noted the appropriate trends in your publication toward topics of current interest. That is, you have changed your emphasis in keeping with the direction of the electronics field and the interests of your readers. However, I am concerned enough about the future of a particular department so that I am compelled to write to you for the first time.

The department in question is Earl "Doc" Savage's "Hobby Corner." Somehow, I get the feeling that Doc may be in danger of being edged out of the picture, and I feel that that would be a great loss. I am a physician who reads *BYTE*, *Scientific American*, *Popular Computing*, *Audio Amateur*, and half a dozen professional journals cover to cover each month, and one of my favorite columns is Doc's in **Radio-Electronics**. He covers an area that is very important to me, and I like his style. Though I have built many of the feature projects in your and other publications, I have learned more about electronics on the basic level from Doc than from anyone else.

If you have no intention of discontinuing his column, great. If you are considering substituting yet another software review or video-information column, or whatever, please don't do it.

JOHN H. HOLTkamp, M.D.  
New York, NY

*Rest assured, we have no intention of discontinuing "Hobby Corner."*—Editor

## MAIL-ORDER COMPONENTS

"Buying Mail-Order Components" in the September and November 1982 **Radio-Electronics** should be on everyone's "must read" list. Where it didn't add to my knowledge, it verified points that I'd learned the hard way.

Only one important point was missing: the junkboxes should be obtained *before* the parts arrive. Then, when the parts arrive, they should *immediately* be categorized and stored in identifying compartments. Frequently, those parts are identified by the supplier according to *his* number, rather than the generic identity. If a few days or months go by, and the flyer, catalog, etc., has been discarded or misplaced, then the identity is gone with it. That is especially true of items frequently not marked, such as diodes. I've had to scrap several great deals, because I had not yet learned that lesson and couldn't take a chance with mismatched components.

Another point, which is a bit more obvious but perhaps still worth mentioning, is comparative shopping. Price and/or quality of a particular item might be outstanding in one

catalog, but that same supplier might be undersold by someone else for other items. In fact, sometimes local suppliers can undersell the wheeler-dealers.

JOHN L. ANDERSON  
Danbury, CT

## EDUCATIONAL PROGRAMS

We regret that in your article "Software in the Home," (**Radio-Electronics**, October 1982) you did not mention our 1100 titles of half-hour educational programs, 300 of which have been or are being sold by Atari and Tandy, and nearly all of which are available from us here in Norman, Oklahoma.

We have full-chapter-length programs, 16 to the course, 68 courses, in reading at all levels, math from kindergarten to college, science, social studies, technical and vocational skills, and liberal arts. Reviewers have told us that we may have more tutorial programs than all the other firms combined, but we don't have games, tests, drills, and simulations.

DORSETT EDUCATIONAL SYSTEMS, INC.  
Goldsby Airport,  
Box 1226, Norman, OK 73070  
Lloyd G. Dorsett, President

## COPYING PC FOIL PATTERNS

I read the letter from Mr. Constan in the October 1982 issue of **Radio-Electronics** and can understand his frustrations.

I found a print shop in my local area which is set up with a large copy camera. The cost of copying the PC foil pattern is about \$6.00, whether it is one small pattern or many which have been scotch-taped to two sheets of paper—taped together to make an 11 × 17-inch sheet.

One lesson I've learned is to wait at least three issues before putting together a project. That allows time for corrections to be printed.

I enjoy **Radio-Electronics** very much, buying nearly every issue. I've particularly enjoyed the current "Picture Phone" series.

Question: Can the Picture Phone be modified to copy 120 lpm FAX signals, such as weather maps, Chinese and Japanese press, etc? Those services generally use two tones separated for 800 Hz for black and white.

JIM HILL  
Vancouver, WA

*Unfortunately, the Picture Phone cannot be modified to handle such signals.*—Editor

## OOOOOOPS

Let me start by saying thank you for the kind mention of our OMNITERM intelligent

terminal program in the "Computer Buyer's Guide" in your October 1982 issue. Unfortunately, you forgot to include our address in your listing of terminal software suppliers.

In addition to the OMNITERM terminal program for the *TRS-80 Model I* and *Model III* mentioned, we also have versions of the OMNITERM for the *TRS-80 Model II/Model 16* and *IBM Personal Computer*. The *TRS-80 Model I/III* version is \$95.00; the *Model II/Model 16* version is \$175.00, and the *IBM PC* version is \$195.00. If any of your readers are interested in any of those programs, they can obtain a free information package from us at the address below:

Lindbergh Systems, 41 Fairhill Road, Holden, MA 01520. Telephone: (607) 852-0233; Source: TCA818; CompuServe: 70310,267.  
DAVID J. LINDBERGH,  
President, Lindbergh Systems

## COMMERCIAL EDITOR

Several errors seem to have crept into my "Automatic Commercial Editor" in the December 1982 issue of **Radio-Electronics**.

In Fig. 2, the REMOTE jack, J1, should be shown connected to the emitter and collector leads of transistor Q1. Also, capacitor C6 should be shown as having a value of 150 pF, not 130 pF (it's correct in the Parts List).

Finally, in Fig. 6, J1 should be connected to the large pads just below Q1. Those pads can be seen clearly in Fig. 5.

GARY McCLELLAN

## TESTING POTENTIOMETERS

In his article "The Ins and Outs of Buying Mailorder Components" (**Radio-Electronics**, November, 1982), Karl T. Thuber describes the use of a multimeter to evaluate surplus or suspect potentiometers. But that testing method can damage or destroy the pot under test by exceeding the power rating of a portion of the pot element, or by exceeding the maximum allowable wiper current. Only a DVM is suitable for performing such measurements, due to its low-voltage resistance-measurement capability. Further, if a potentiometer is to be operated or tested as a variable resistor, the wiper should be "tied" to the unused side of the pot element.

Speaking from experience, I've had them "smoking" on the bench by ignoring the above considerations. If you must measure potentiometer resistance parameters, use a DVM and be careful.

ALAN CAMPBELL  
East Ridge, TN

*That one is new to us, but if any of our other readers have had similar experiences would like to hear about them*—Editor

R-E





# The \$7 Push Button Phone

**Plug in and start pushing. Now you can have highly automated phones with no monthly service charges for just \$7 each. But, there's a catch.**

Send back your dumb phones. Now instead of paying monthly service charges you can have push button dialing, last number redial, mute, and ringer off.

You can forget big clunky phones. You can also forget dials. This phone works perfectly whether you now have rotary or push button phones.

Now for just \$7 you'll have the latest technology at a price that'll let you have a phone in every room in your home. But, don't forget there's a catch.

## NOTHING TO INSTALL

Simply plug this phone into any standard modular phone jack and start talking. If you don't already have jacks, call your phone company.

They may even put them in free for

quality speaker instead of the old diaphragm 'thing' that's been in phones for 20 years. Even the electronic ring is new.

But, the nicest part of all are the push buttons. Once you've started using buttons you'll hate dialing the old way.

With this phone you can push the buttons as fast as you want. Then the phone sends out pulses on your line that work with virtually any phone system.

So this phone works anywhere. You can unplug it and move it from room to room or house to house in seconds.

The phone automatically hangs up when you set it down or you can push its 'hang up' button. It comes complete with an 8 foot cord, coiled at the phone end, and a limited warranty.

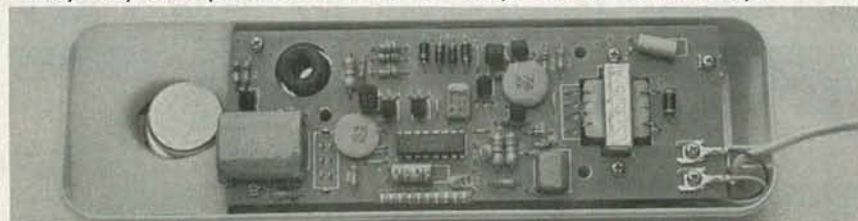

It's built more like a HiFi than a telephone. Modern electronics have finally come to phones.

you. Due to the recent Supreme Court ruling, soon they'll probably be selling you your own phones anyway. And, at worst, there's just a small one time fee.

## LAST NUMBER REDIAL PLUS

It's really neat. If you call a number and it's busy this phone will automatically redial the number for you each time you touch 'redial'. There's no need to keep dialing over and over again.

When you need to speak privately to someone with you, you don't have to cover the mouth piece. Just press the mute button and the person on the line will be cut off for privacy.

When you want to take a nap, just switch the ring off and the phone won't ring. There's never a need to take your phone off the hook again.

The quality is great. A high quality condenser microphone lets the person you talk to hear you loud and clear.

And you hear them through a high

## THE CATCH

Frankly we are losing our shirts on the automated phone, but we're looking for audiophiles who use audio cassettes.

If you buy top name TDK and Maxell cassettes, you probably pay \$3.50 to \$4.50 each for a 90 minute cassette.

We want you to try DAK's new Gold Label MLX ultra high energy, normal bias cassettes. Not at \$4.50 or even at \$3.50 each, but at a factory direct price of just \$2.49 for a 90 minute cassette.



We challenge you to compare the frequency response, dynamic range and signal to noise ratio of our new Gold Label MLX to Maxell UDXL or TDK SA. If they win, we'll not only give you back your money, we'll give you a free gift for your trouble. And, DAK's come with a deluxe hard plastic box, index insert card and a limited 1 year warranty.

## WHY, YOU MAY BE ASKING?

You're very valuable to us in the form of future business. Over 150,000 customers have responded to bonuses like this. We find most of you keep buying once you've tried our cassettes and our prices; and that's a gamble worth taking.

## NOT A BAD CATCH

DAK manufactures a cassette with no problems and great sound. We've been hot on the heels of the frequency responses of Maxell and TDK. The tape we made last year had a great frequency response up to 14,000hz.

Now our new Gold Label MLX is second to none. We have a frequency response to 19,500hz and we'll go head to head against any tape on the market.

## TRY NEW DAK MLX90 CASSETTES RISK FREE

To get the automated phone for just \$7, try 10 MLX high energy cassettes. If you aren't 100% satisfied, return only 9 of the 10 cassettes and the phone in its original box within 30 days for a refund. The 10th cassette is a gift for your time.

To order your 10 Gold Label DAK MLX 90 minute cassettes and get the automated phone for only \$7 with your credit card, call the DAK toll free hot line or send your check for only \$24.90 for the tapes, plus \$7 for the phone and \$3 for postage and handling for each group. Order No. 9416. CA res add 6%.

An automated Phone for \$7 and DAK's new improved MLX. Time to stock up.



**DAK**  
INDUSTRIES INCORPORATED

TOLL-FREE 1-800-423-2636

If busy, after hours, on weekends or in CA  
CALL TOLL-FREE . . . 1-800-228-1234  
10845 Vanowen St., N. Hollywood CA 91605



# EQUIPMENT REPORTS

## Radio Shack TRS-80 Model I Double-Density Disk Kit



CIRCLE 103 ON FREE INFORMATION CARD

Radio Shack Double-Density Kit		1	2	3	4	5	6	7	8	9	10
OVERALL PRICE											
EASE OF USE											
INSTRUCTION MANUAL											
PRICE/VALUE											
		Poor	Fair	Good	Excellent						

RADIO SHACK'S (ONE TANDY CENTER, FT. Worth, TX 76102) TRS-80 Double-Density Disk Kit (catalog number 26-1143) is a retrofit for their Model I com-

puter that expands the storage per disk by 80% to 100%. A double-density DOS (Disk Operating System) provided with the kit features new commands that allow

the Model I to function almost as if it were a Model III computer, and includes enhancements that were not formerly available on that earlier model.

The kit, which is priced at \$149.95, consists of a somewhat complex printed-circuit board assembly, a disk with the new DOS, and documentation—called an "owner's manual"—for the double-density disk system.

Though sold directly to the user through Radio Shack stores, the circuit must be installed by a Radio Shack technician; the service charge for that is \$17.50. The user can either leave the computer in the store for free forwarding to, and return from, the service center, or he can take the kit and the computer directly to the center. Either way, the service charge is the same.

## 2300 MHz VARIABLE DOWN CONVERTER

### ANTENNA KIT

\$16.95

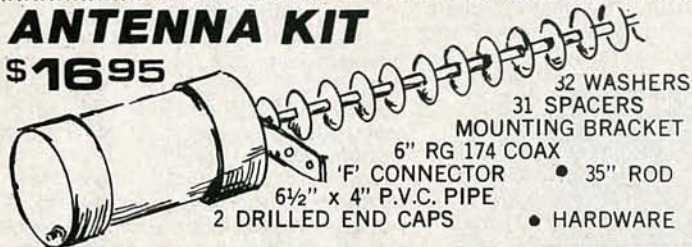

- 32 WASHERS
- 31 SPACERS
- MOUNTING BRACKET
- 6" RG 174 COAX
- 'F' CONNECTOR
- 6 1/2" x 4" P.V.C. PIPE
- 2 DRILLED END CAPS
- 35" ROD
- HARDWARE

### POWER SUPPLY KIT

\$16.95



- POWER TRANSFORMER
- COURSE TUNE POT.
- FINE TUNE POT.
- 3 'F' CONNECTORS
- RESISTORS & CAPS
- LED WITH HOLDER
- TERMINAL STRIP

- P.C. BOARD
- RF CHOKE
- KNOB
- WIRE
- 2 SWITCHES
- 4 DIODES
- LM 317 REG.

WOOD GRAIN CABINET WITH SILK SCREENED front and back \$10.95 Extra  
BUILT POWER SUPPLY \$34.95

Complete Down Converter System  
INCLUDES ANTENNA KIT  
POWER SUPPLY KIT  
CONVERTER KIT  
**SPECIAL \$49.95**

QUANTITY DISCOUNTS  
Any Price in Adv.  
10 pcs. 12% off  
25 pcs. 18% off  
50 pcs. 25% off  
100 pcs. 30% off  
1000 pcs. 35% off  
No Mixing for Quantity Discount

### PARTS

- Converter P.C. Board Plated through holes for stability.....\$4.95
- Power Supply P.C. Board.....2.95
- MRF 901.....2.00
- NEO2135.....4.95
- 2835 Diodes......95
- .001 Chip Caps..... 10/3.95
- Choke Set of 4.....1.95
- LM 317 Regulator 1.25
- 'F' Connectors Chassis......50
- Wall Transformer 12 VAC 700 MA...4.95
- 'U' Bolt......95
- BALUN 75 to 300 ohm.....1.95
- BALUN for rabbit ears...2.95
- \*RG 59/U COAX WITH CONNECTORS FACTORY MADE
- 100 Ft. ....\$17.50
- 50 Ft. .... 9.50
- 25 Ft. .... 5.75
- 3 Ft. .... 2.50

### CONVERTER KIT

\$16.95



P.C. BOARD PRE-DRILLED SOLDER PLATED WITH PLATED THROUGH HOLES FOR A MORE STABLE PICTURE.

- NEW!! 2137 HOT TRANS...
- 3 MRF 901 TRANSISTOR
- 2 HP 2835 Diodes
- 6 .001 Chip Caps.
- 9 Resistors
- 4 Prewound chokes
- 1 Electrolytic Cap.
- 1 Pre Made Probe

★ WIRED P.C. BOARD TESTED, READY TO CONNECT TO CAN WITH PROBE & CABLE CONNECTOR ATTACHED.  
\$24.95

We will tune converter board for \$12.50  
trouble shoot add .....7.50  
trouble shoot power supply..\$12.50  
plus any parts needed.

We will accept telephone orders for Visa & Mastercard  
No C.O.D. Orders  
**To Order Call 800-428-3500 317-291-7262**  
Complete Kit Weighs 10 pounds. Please add Sufficient Postage  
6254 La Pas Trail  
Indianapolis, Indiana 46268

# ELECTRONIC RAINBOW



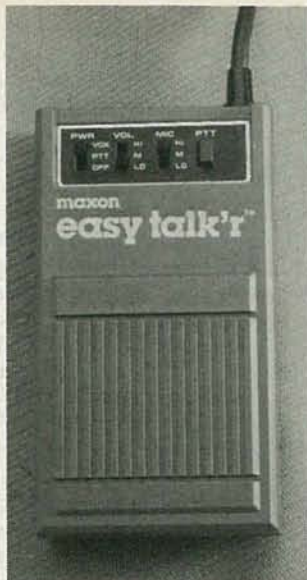

# Think Speak

**On the job, on the field, or on the road. Now you can talk and listen hands free at a new breakthrough price.**

SWAT teams use them. So do quarterbacks and firemen. Now you too can talk and listen to people near and far totally hands free while you are jogging, riding a bike, or hiking.

Both at work and at home this unique communications system with a range up to 1/2 mile will let you keep in touch.

You'll keep in close contact with your hunting partners when you hunt, and you'll communicate for ease and safety on construction sites.

Plus, you can effortlessly perform tasks like fine tuning your TV antenna when you need to communicate with someone on the ground or out of sight.

## NOT A WALKIE TALKIE

This is no toy. The Think Speak is totally automated. When you speak, a special voice activated circuit (VOX) automatically engages the transmitter so you are broadcasting. When you stop speaking, it automatically returns to 'stand by' to await a reply.

It is virtually noise free because it uses a quartz crystal locked dual conversion superheterodyne communication circuit that operates on an FM band.

So, your communication won't sound like a CB or an AM radio. You'll speak and hear with the full power and clarity you'd expect from an FM radio station.

## HERE'S WHAT IT IS

You wear the Think Speak just like a personal stereo. There is an adjustable headphone that you wear on either your right or left ear. The other ear is clear to hear the outside world for safety.

A flexible boom microphone lets you speak normally while you transmit. The entire shaft of the boom mike is adjustable and will retain any position you set.

All of the electronics are contained in a small 6½ oz. case that easily clips to your belt or with its removable clip fits

into your pocket. And, what controls.

The voice activation circuit has a 3 level sensitivity switch. If you're riding a motorcycle or breathing hard while you jog, you can set the sensitivity to low so that you won't transmit in error.

If you are hunting or fishing and you can't talk much over a whisper, you can set the sensitivity to high. Plus the headphone has a 3 level volume control too.

In addition to the VOX voice operated circuit, you have 'PTT' which means Push to Talk. When you want to talk, you just push the PTT button.

This is a really great feature when you want to whisper very quietly below the threshold of even the high sensitivity setting of the Voice Operated Circuit. You may be into surveillance or photographing wildlife. When you can only whisper, you'll especially appreciate the super quiet FM reception of this system.

## SOME SPECIFICS

You can expect long battery life from a standard 9V battery (not included). In the 'stand by' mode, the Think Speak only consumes 13.5 milliamps of power while it's ready to transmit or receive.

The antenna is conveniently clipped to the headband for normal use. For full range use, the antenna pops up.

The system operates on the 49 mhz band using FM so you shouldn't be bothered by any other radio transmissions as you are with CBs and Walkie Talkies.

There are 5 channels (A-E) allotted to the Think Speak to further prevent interference. We will ship all units ordered on each order with the same channel.

The transmission output is a full RF of 10,000uV/m @ 3 meters max. No FCC license is required. And, the FM hum and noise is almost good enough for a high fidelity system at 40db min. The case is 4-9/16" x 2¼" x 15/16".

## PERSONAL OR GROUP

You can talk to 1 or even 10 people with Think Speaks. So, if you're the head of a Search and Rescue team you can talk to everyone at once and get responses from one at a time.

The Think Speak is great if you're skiing with a friend, using two boats on a lake or at sea, hiking in the mountains or just jogging around the block.

If you're a pitcher you can talk to your catcher or the coach. If you're on a loading dock, you can talk to the man in the truck or on the forklift. If you're a security guard, you'll never be alone.

The Think Speak is manufactured and backed by a limited warranty from Maxxon Electronics, the two way specialists.

## TRY A THINK SPEAK RISK FREE

Walk around the block. Take a bike ride and really test the range of this breakthrough in personal communication. If you aren't 100% satisfied with the incredible sound quality or the range, return it in its original box within 30 days for a courteous refund.

To order your Think Speak risk free with your credit card, call the DAK toll free hotline or send your check for the incredible breakthrough price of only \$49.95 each (minimum of 2 required). Plus \$2.50 each for postage and handling. Order Number 9415. CA res. please add 6% sales tax.

When you think out loud, people will listen. Try a Think Speak risk free today.



**DAK**  
INDUSTRIES INCORPORATED

TOLL-FREE 1-800-423-2636  
If busy, after hours, on weekends or in CA  
CALL TOLL-FREE . . . 1-800-228-1234  
10845 Vanowen St., N. Hollywood CA 91605



Though Radio Shack does not support their double-density kit in any way, with it installed, the computer will still be able to use the Radio Shack single-density DOS. That means that most Radio Shack software, as well as any software written in a BASIC that used the Radio Shack DOS and was recorded on a single-density disk, can still be run.

If the system is booted with the new double-density DOS disk, the computer goes into the double-density mode with the new expanded operating system. When operating in the double-density mode, only the DIR and COPY commands are supported for single-density disks; that is, you can read the directory of a single-density disk, or copy a single-density file to a double-density disk; there are some problems here, however, and we'll get to those in a short while.

In the double-density mode, the user can format disks for either 35- or 40-track operation—depending on the capability of the disk drives. The Radio Shack disk drives manufactured by Shugart (and also supplied by some aftermarket computer-equipment dealers) are limited to 35 tracks. If the disk drive has a "-1" after the serial number, it was manufactured by Tandon or Texas Peripherals and can be configured for 40-track operation. A 35-track double-density disk has a capacity of 152K; a 40-track double-density disk has a capacity of 184K.

As for enhancements, just about every important feature of the new *Model III* computer becomes available on the *Model I* if the kit is installed. For example: there is a DUAL command for a simultaneous screen and line printer display. A disk space map is provided by the FREE command. Then there's a DO command with an auto start-up created through a BUILD file (in some systems that is called "job control"). Finally, what is already an excellent single-density BASIC is enhanced when the kit is installed.

Essentially, the double-density kit gives a *Model I* many of the advanced features offered by the *Model III*, and with no fuss at all, because it takes only one disk to boot up into double-density. The documentation is superb. It is clear, easily understood even by the novice or newcomer to personal computing, and is well organized—which is a lot more than we can say for most documentation supplied with personal-computer equipment. (However, there is a minor but important error. Do not follow the instructions and attempt a BACKUP command with a write-protect tab in place. You must remove the write-protect tab on the disk being backed up.)

For those who use only Radio Shack software or programs written in BASIC there will be no problems other than slow response with the double-density DOS. For example, a communications-terminal

program that takes 8.5 seconds to load using the single-density DOS, requires 30 seconds using the double-density DOS, but that is one of the more severe cases. Also, Radio Shack does not provide any double-density software, but you can generally run single-density software in a single-density mode without modifications if it won't copy as a usable double-density disk.

Unfortunately, the same cannot be said of some of the most popular non-Radio Shack software. Once the double-density kit is installed you no longer can use your *Newdos 80 Version 1* disk at all; it won't boot. *Newdos 80 Version 2* disks will boot, but won't run in double-density. If you are a registered owner of *Newdos 80* software you can write Apparat for the patches (software corrections), and by all means do it. In particular, *Newdos 80 Version 2* is dynamite with Radio Shack's double-density kit.

Worse yet, neither *Superscript* with the Epson *MX-80* printer driver nor the Hexagon Systems spelling checker—two of the best pieces of software ever written for the *Model I*—will run in the double-density mode. In fact, it's as if most of the good software has been deliberately trapped out of double-density operation (which is not the case with non-Radio Shack double-density adapters for the *Model I*). The only non-Radio Shack software that appears to work consistently in

We accept VISA, MC, C.O.D., CHECK or M.O.

## FIRST QUALITY COMPONENTS - NOT MAIL ORDER "SECONDS"

Min. order \$10.00 - add 5% Shpg and \$1.00 Ins

### ARIES ZERO INSERTION FORCE SOCKETS



cam actuated, true zero insertion - tin plated solder tail pins - capable of being plugged into dip sockets, including wire wrap.

Stock No.	No. Pins	1-24	25	50
11055	24	\$ 4.35	\$3.90	\$3.60
11056	28	4.50	4.05	3.75
11057	40	5.95	5.35	4.95
11058	64	10.50	9.45	8.70

### RESISTOR ASSORTMENT 82508 - 700 pcs. (1 each below assort'd) \$22.50

Stock No. 82501 10 ea. of 10-12-15-18-22-27-33-39-47-56 OHM \$3.95 each for any assortment  
 Stock No. 83502 10 ea. of 68-82-100-120-150-180-220-270-330-390 OHM  
 Stock No. 82503 10 ea. of 470-560-680-820-1K-1.2K-1.5K-1.8K-2K-2.2K-2.7 OHM  
 Stock No. 82504 10 ea. of 3.3K-3.9K-4.7K-5.6K-6.8K-8.2K-10K-12K-15K-18K OHM  
 Stock No. 82505 10 ea. of 22K-27K-33K-39K-47K-56K-68K-82K-100K-120K OHM  
 Stock No. 82506 10 ea. of 150K-180K-220K-270K-330K-390K-470K-560K-680K-820K OHM  
 Stock No. 82507 10 ea. of 1M-1.2M-1.5M-1.8M-2.2M-2.7M-3.3M-3.9M-4.7M-5.6M OHM

### WILD ROVER 60/40 ROSIN CORE SOLDER

Touch switch capsule. Operating motion is .005" without the use of a levered arm. Extremely fast on and off with low noise. Normally open - rated 115 VAC, 1.6 amp-30 milliohm resistance - .615 radius by .160 thick.



Stock No.	1-9	10	25
12098	\$ 1.28	\$ 1.12	\$ .95

Stock No.	Dia.	Length (feet)	Weight (oz.)	Price
50075	.062	9	1.5	\$1.16
50076	.062	25	4	2.39
50077	.062	50	8	4.25
50078	.032	33	1.5	1.31
50079	.032	88	4	2.47
50080	.032	175	8	4.57

### TI WIRE WRAP SOCKETS



Tin plated phosphor bronze contact - 3 wrap

Stock No.	No. Pins	1-24	25	100
11301	8	\$ .45	\$ .40	\$ .36
11302	14	.66	.59	.54
11303	16	.72	.64	.58
11304	18	.82	.73	.66
11305	20	1.11	.99	.90
11306	22	1.26	1.12	1.02
11307	24	1.41	1.25	1.14
11308	28	1.71	1.52	1.38
11309	40	2.31	2.05	1.86

### TI LOW PROFILE SOCKETS



Tin plated phosphor bronze contact pins with gas tight seal

Stock No.	No. Pins	1-24	25	100
11201	8	\$ .15	\$ .13	\$ .12
11202	14	.18	.15	.14
11203	16	.21	.18	.16
11204	18	.24	.21	.19
11205	20	.27	.24	.21
11206	22	.30	.26	.23
11207	24	.33	.30	.25
11208	28	.38	.34	.29
11209	40	.53	.45	.40

### ELPAC POWER SUPPLIES - DC/DC CONVERTERS

SINTEC Stock No.	ELPAC Part No.	Input Voltage (VDC)	Output Voltage (VDC)	Current (mA)	Dimensions (HxWxD) in inches	Price
13825	CB3801	3-0-7.0	12-0-6	0-25	48x51x3.05	\$ 7.95
13826	CB3811	3-0-7.0	12-0-6	0-25	48x51x3.05	7.95
13827	CB3802	3-0-7.0	15-0-7	0-20	48x51x3.05	7.95
13828	CB3812	3-0-7.0	15-0-7	0-20	48x51x3.05	7.95
13829	CB3804	3-0-7.0	28-0-7	0-10	48x51x3.05	7.95
13830	CB3814	3-0-7.0	28-0-7	0-10	48x51x3.05	7.95

1.5 W TYPE

Stock No.	Part No.	Input Voltage (VDC)	Output Voltage (VDC)	Current (mA)	Dimensions (HxWxD) in inches	Price
13831	CL3801	4-0-7.0	12-0-6	125	65x112x1.77	\$24.95
13832	CL3811	4-0-7.0	12-0-6	125	65x112x1.77	24.95
13833	CL3802	4-0-7.0	15-0-7	100	65x112x1.77	24.95
13834	CL3812	4-0-7.0	15-0-7	100	65x112x1.77	24.95
13835	CL3804	4-0-7.0	28-1-4	50	65x112x1.77	24.95
13836	CL3814	4-0-7.0	28-1-4	50	65x112x1.77	24.95

13801-1 Data Sheet for 13801 \$ .25  
 13825-1 DATA SHEET FOR DC/DC CONVERTERS 25

### ELPAC POWER SUPPLIES - SOLV SERIES FULLY REGULATED

SINTEC Stock No.	ELPAC Part No.	Output Voltage	Output Current Rating	Dimensions (HxWxD) in inches	OVP	Price
13802	SOLV15-5	5	3.0A	4.7/18x4.2	Fixed included	\$39.95
13803	SOLV15-12	12	1.5A	4.7/18x4.2	Fixed included	39.95
13804	SOLV15-15	15	1.2A	4.7/18x4.2	Fixed included	39.95
13806	SOLV15-24	24	0.75A	4.7/18x4.2	Fixed included	39.95
13808	SOLV30-5	5	6.0A	5.5/8x7/8x3-1/16	OVP-A	\$9.95
13809	SOLV30-12	12	4.0A	5.5/8x7/8x3-1/16	OVP-A	59.95
13810	SOLV30-15	15	3.3A	5.5/8x7/8x3-1/16	OVP-A	59.95
13812	SOLV30-24	24	2.0A	5.5/8x7/8x3-1/16	OVP-A	59.95

13802-1 Data Sheet for SOLV Series 25

### OK MACHINE AND TOOL

**IC INSERTION/EXTRACTION KIT**  
 Includes DIP IC extractors and inserters to accommodate all ICs from 14 to 40 pins. Tools that engage conductive surfaces are CMOS safe and include groundable tips. Stock No. \$37.74 13309

**SOCKET WRAP ID**  
 DIP socket-sized plastic panels with numbered holes in pin locations. Slip onto socket before wire wrapping to identify pins. Also write on them for location, IC part number, function, etc. Simples initial wire wrapping, troubleshooting and repair. \$1.82 per pack 13295

### Special of the Month!

**IC-KOOLERS™** from UNITRACK™ dissipate over 2 watts of heat from IC's producing longer life and better performance. Just push IC-Kooler on - heat is collected from top and bottom of IC and dissipated. Won't shake loose!



Stock No.	No. Pins in IC	Price
22225	14	\$ .25
22226	16	.25
22227	18	.25
22228	20	.25

**PIN FORMING TOOL**  
 puts IC's on their true row to row spacing. One side is for 300 centers. Flip tool over for devices on 600 centers. Put device in tool and squeeze.  
 ONE TOOL DOES 8 Thru 40 PINS!  
 Stock No. 11059 \$12.95

### IC EXTRACTOR

One-piece, spring steel construction. Will extract all LSI, MSI and SSL devices with 8 to 24 pins.  
 Stock No. 13313 \$2.10

### MODUTEC

**Miniclamp AC Volt-Ammeter** allows singling one conductor out of many without disarrangement.  
 Stock No. AC Amperes Price  
 13730 0-25A \$39.50  
 13731 0-50A 39.50  
 13732 0-100A 39.50

**ACCESSORY LINE SPLITTER** allows fast readings of AC power consumption of plug in equipment without separation of leads.  
 Stock No. 13727 \$9.95

**POCKET SIZED BATTERY TESTER** for all types of small batteries from 1.35v to 4.5v  
 Stock No. 13733 \$13.95

**VOLT-ICATOR** automotive diagnostic meter plugs into lighter socket and indicates battery condition and charging rates.  
 Stock No. 13736 \$15.95

**AC VOLTAGE TESTER** plugs into any 110v service receptacle to check time voltage over 50-150 VAC  
 Stock No. 13735 \$14.95

**VOM-MULTITESTER** versatile Volt-Ohm-Milliammeter in small package  
 Stock No. 13729 \$13.95





# THE POMONA PROMISE

We provide the design engineer with the best  
patch cords made in this country.  
Or anywhere.

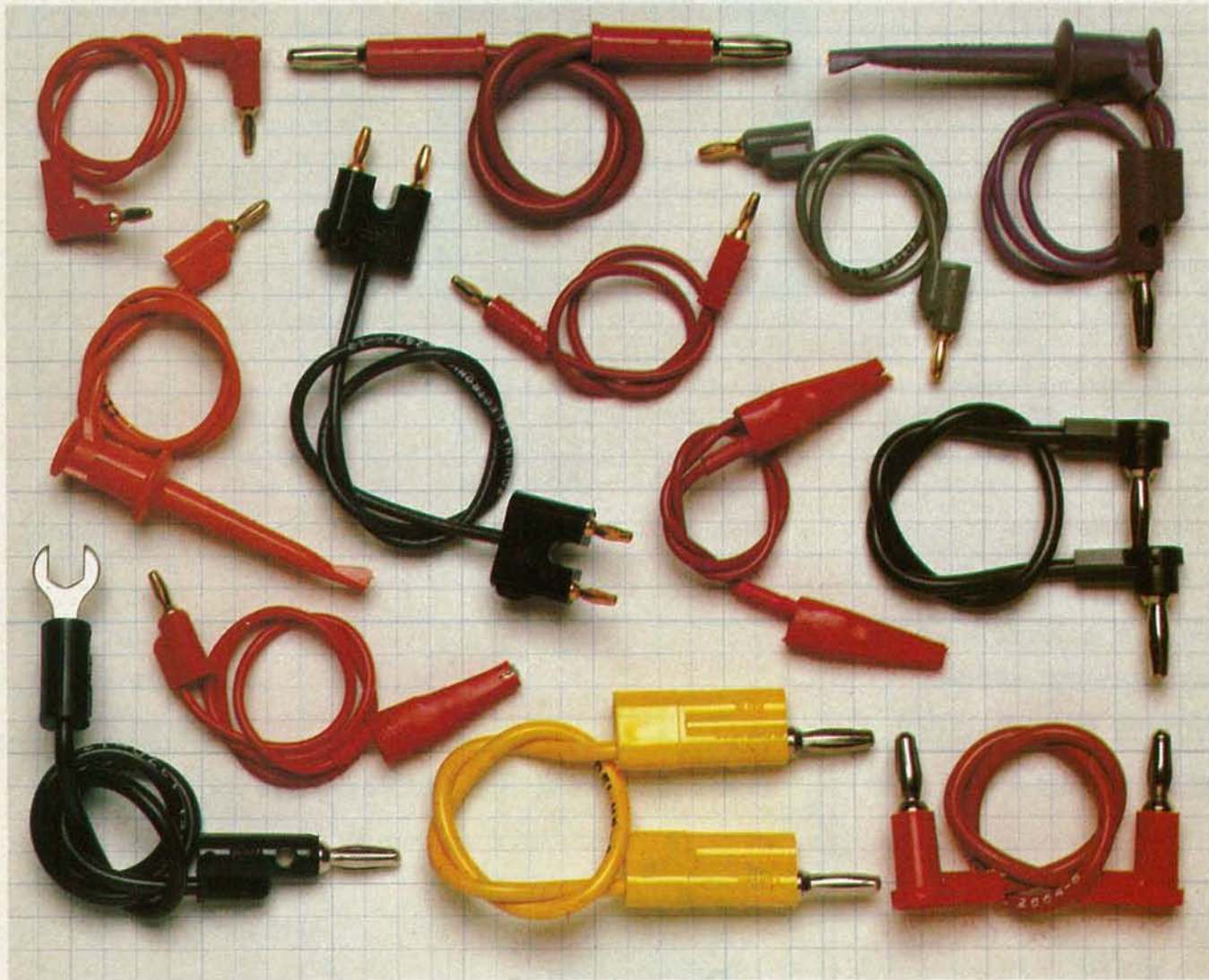

Quite a promise, you say?

Well, quite a promise it is.

It was made before we designed our first patch cord. We decided our patch cords would occupy only one position in the market. The top.

Right now, there isn't a knowing professional in the electronics business who won't tell you we kept our promise.

Today, we offer you a variety of patch cords so extensive we feel we've got just the kind you need. And you know what, if we don't,

we'll design one for you.

At ITT Pomona Electronics, we know there is no such thing as standing pat. We also know that your needs change and your expectations become greater as the demands become more severe. To this end we will continue to create a better way. A better product.

That's a promise.

All of our products are described and illustrated in our General Catalog, and it's free. Just call (714) 623-3463 or 623-6751. TWX 910-581-3822. Write to us at

CIRCLE 7 ON FREE INFORMATION CARD

ITT Pomona Electronics, a Division of International Telephone and Telegraph Corporation, 1500 E. Ninth St., Pomona, CA 91766.

In Europe: ITT CANNON BELGIUM S.A./N.V. Rue Colonel Bourg Str. 105 Space A (B.3) 1140 Brussels, Belgium. Phone: 02-735-6094.

Our products are available through your favorite electronics parts distributor.

**ITT** Pomona Electronics



the double-density mode are some game-type programs.

Essentially then, the double-density kit is mostly valuable if you use Radio Shack software, or programs you write yourself. However, if you want to run most of the top quality non-Radio Shack software, and/or have the full power of double-density, you must use the *LDOS* disk-operating system, Version 5.1. That is what Radio Shack should have supplied to begin with, and what they now sell as an accessory for \$129. You can run *Superscript* and Hexagon's upgraded version of *Hexspell* under *LDOS*; in fact, you can even convert *Model III* software to run on a double-density *Model I* (only *LDOS* does this). *LDOS* is so extensive it's a bit of a pain to learn and use, but it's the only way to use *Model III* disks on a *Model I*.

If you use a *Model I* primarily to write your own programs, the double-density kit is an unquestioned value. But if you have substantial sophisticated non-Radio Shack software and operating systems, think twice about the kit because the software might not run in either single- or double-density modes unless you use a different DOS, and even then there are no guarantees. If you have a substantial investment in software you simply cannot afford to give up, try to locate someone using the double-density kit and try your software on their computer. **R-E**

## Video Control ATOC III Video Controller



CIRCLE 104 ON FREE INFORMATION CARD

Video Control		ATOC III	
OVERALL PRICE	10	10	10
EASE OF USE	10	10	10
INSTRUCTION MANUAL	10	10	10
PRICE/VALUE	10	10	10
	1	2	3
	4	5	6
	7	8	9
	10		
	Poor	Fair	Good
			Excellent

THE ONGOING VIDEO REVOLUTION HAS changed not only the way we watch TV, but also how we evaluate what we watch. By the last we don't only mean the content of the programming, but instead its video and audio quality. It's not surprising then that in addition to VCR's and videotape, the video revolution has given birth to another type of equipment. We're speaking about video accessories.

Video accessories is a term used to

describe a wide variety of devices used to improve the audio and video quality of what you watch, as well those used to improve the flexibility of your setup. Those devices range from switch boxes and RF modulators to sophisticated broadcast-quality video processors.

The latest entry in the field is the *ATOC III* from Video Control (3314 H St., Vancouver, WA 98663). Rather than one accessory, however, that unit combines four of the most wanted and useful accessories into a single device. Let's now look at what it can do

### Video enhancer

One of the chief problems with home videotaping is the cost of the tape itself. That's one reason why VCR's are now capable of cramming 5, 6, and even 8 hours of recording onto a single tape. But to do that, slower recording speeds must be used, which results in reduced picture quality. What's more, for a variety of reasons, picture detail and clarity can suffer when making recordings even if top-quality tape and top recording-speeds are used. That's where a video enhancer comes in handy. It amplifies the high-frequency video information, which in turn increases the apparent resolution of the video image.

The video enhancer section in *ATOC III* is easy to use. It is turned on by placing the B + W/COLOR/BYPASS switch in the

## TRITON MARKETING Corp.

679 REMSEN AVENUE

BROOKLYN, N.Y. 11236

We Accept Mastercard and Visa

## TOLL FREE HOT LINE

1-800-221-6535

1-212-345-8000

## MICROWAVE TV



### DCV - 200

- Ideal for Medium Signal Areas
- 46 dB System Gain
- 1.0-2.7 GHz
- Built in A/B Switch
- All Cable & Hardware

\$129.95

### MDC - 23D

- Commercial Styling
- 2 Microwave Stages
- 53 dB System Gain
- 2.1-2.6 GHz
- Built in A/B Switch
- All Cable & Hardware

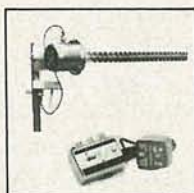

\$149.95

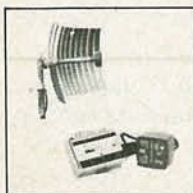

### MDC - 23P

- 3.75 sq. ft. Parabolic
- 2 Microwave Stages
- 57 dB System Gain
- 2.1-2.6 GHz
- Built in A/B Switch
- All Cable & Hardware

\$199.95

WE CARRY A COMPLETE LINE OF  
CABLE TV CONVERTERS & DECODERS

## SATELLITE TELEVISION SYSTEMS



TRITON:

A NEW APPROACH  
TO  
SATELLITE TV .....

DON'T BUY LESS SYSTEM THAN YOU WANT, OR MORE THAN YOU NEED. ONE PHONE CALL WILL INSURE THAT YOUR SATELLITE DOLLARS ARE WELL SPENT.

ALL TRITON SYSTEMS ARE EXPANDABLE. START WITH THE "ADVENTURER" AND YOU CAN ADD COMPONENTS AS YOUR NEEDS CHANGE.

NO SYSTEM IS COMPLETE UNTIL YOU DECIDE IT IS.....

ADVENTURER: 10' fiberglass with pole polar mount, Avantek 120<sup>0</sup>K LNA, Gillaspie 7600A receiver, electronic scaler feed, 100' wire and instructions. **\$ 2275.00**

STARGAZER: The "ADVENTURER" plus East/West motor drive. **2625.00**

STATESMAN: The "ADVENTURER" plus a programable motor drive. **3025.00**

PERFORMER: The "STATESMAN" with a stereo processor for all stereo formats. **3375.00**

EXECUTIVE: The ultimate system with wireless remote control. Featuring a 10' fiberglass reflector, pole polar mount, IR remote, auto polarization of Avantek 100<sup>0</sup>K LNA, all stereo formats, programable motor drive. **3750.00**

URBANA: A true roof mountable system weighing only 160 pounds. With an Avantek 120<sup>0</sup>K LNA, Gillaspie 7600A receiver, scaler feed and rotator, East/West motor drive, 100' wire and instructions. **3300.00**

CIRCLE 76 ON FREE INFORMATION CARD



When it's vital  
to make  
a hole in one!

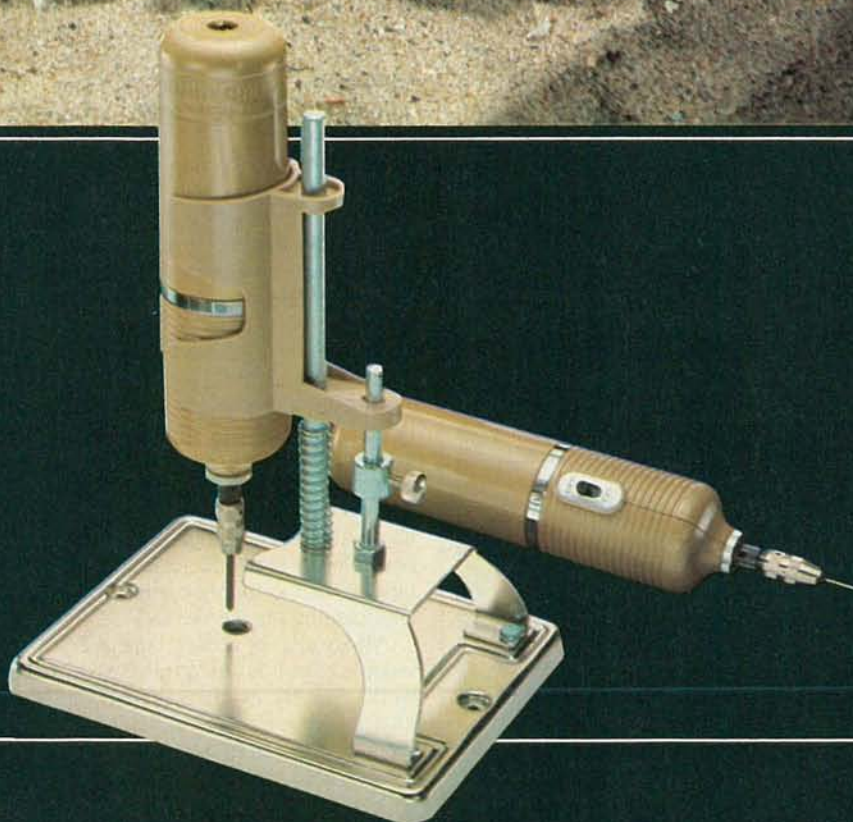

**MINI DRILL PD-3**

This lightweight, versatile portable hand drill is suitable for most light drilling applications and is especially appropriate for circuit board drilling. The PD-3 runs at 2,500 RPM on 4 "AA" batteries (not included). It will accept drills from .019 to .058 diameter. Comes supplied with one .039 diameter drill bit.

**REPLACEMENT DRILL BITS RDB-4**

2 each of .040 and .060 diameter

**DRILL STAND STD-50**

The STD-50 drill stand is designed specifically to hold the PD-3, allowing the tool to be used like a drill press for precise hole drilling.

3455 Conner Street, Bronx, New York, 10475, U.S.A.  
Telex 125091 OK NYK. Telex 232395 OK NY UR.  
Phone (212) 994-6600.

OK  
Industries  
Inc.



CIRCLE 52 ON FREE INFORMATION CARD



appropriate position. The SHARPNESS control is then simply rotated to provide the degree of enhancement you prefer. One problem here, however, is that enhancing the high-frequency video information will also increase the high-frequency noise. That noise shows up in the picture as snow. That's the purpose of the FILTER control—when adjusted properly, it will get rid of the majority of that snow leaving you with the best possible picture.

To a great degree, the overall effect of the enhancer is determined by the system (TV, VCR, tape, etc.) that it is used with. In any event, however, the picture quality will be better than it would be without the

device. The enhancer can also be used for recording. According to the manufacturer, if that is done, and if the SHARPNESS and FILTER controls are set fully clockwise, the enhancer will boost video signals about 10 dB at 2 MHz.

#### Stabilizer

Another effect of the rise of interest in home video is the corresponding rise in video piracy. That's not too surprising considering the high cost of pre-recorded tapes. What's also not too surprising is that tape distributors took strong steps to minimize that piracy as soon as they realized what was going on.

As a result, many schemes that alter the

sync pulse-train came about. What those schemes do is make a tape copied from the original almost unwatchable, as the video will roll and/or jitter. The original, however, can still be viewed on a standard TV receiver.

At least that's what's supposed to happen. As it turns out, however, even the original can be unwatchable if it's viewed on a TV-set with a limited range vertical hold, or on some pre-1977 models. That's where the stabilizer on the video control comes in. It eliminates the roll and jitter associated with tapes recorded using such anti-copy systems. It's use is again very easy—just turn it on using the ON/BYPASS switch, and rotate the LOCK control until the picture "locks in."

#### RF modulator/distribution amplifier

The video controller also features a full-range RF modulator, as well as a distribution amplifier capable of driving up to three VCR's. The modulator has separate LEVEL and CONTRAST controls, and its output is front-panel switchable between Channel 3 and Channel 4. The LEVEL control varies the amount of signal coming from the unit, while the CONTRAST control sets the picture's contrast.

The inclusion of the distribution amplifier allows copying videotapes (even up to three copies at a time) while minimizing the losses usually associated with that procedure.

The ATOC III is housed in a single, compact, brushed-aluminum cabinet. Input and output connections are done using a series of rear-panel phono plugs. One minor problem here is that a lot of pieces of video equipment use "F"-connectors rather than phone plugs. But, all that means is that, if your cables are already terminated with "F"-connectors you'll need to purchase a couple of inexpensive adaptors.

The unit requires 12-volts DC for power. Because of that, it can be used for field or remote applications as it can be powered from a portable VCR's batteries. A 12-volt DC wall-plug-type power supply is provided for home use.

The manual provides simple step-by-step instructions to get the unit up and running in a matter of minutes. It also gives a very brief discussion of the various functions and illustrates four sample applications. But, unfortunately, that is about all that's included. It would have been nice to see some technical information, as well as more on some of the other applications for the device.

All-in-all, however, the ATOC III video control is an attractive unit that works exactly as claimed. And another nice feature is its price. If you were to buy separate units to do all of the things that this one does, you could easily spend over \$400.00, and wind up with a rat's nest of wiring. On the other hand, the suggested list price of the ATOC III is just \$279.95, and it's well worth it.

R-E

Be a VIC expert! Our VIC 20 PROGRAMMERS REFERENCE GUIDE provides you with a complete VIC 20 BASIC vocabulary guide, a section on machine-language programming, another on VIC 20 input/output operations, and hundreds of tips on improving your programming skills! Ask for No. 21948, only \$16.95.

Speak Sinclair fluently with practical, usable BASIC programming help from Sams ZX-81 BASIC BOOK, No. 21957, for only \$12.95. Continue the conversation, in Sinclair machine code this time, with ZX-81 USER'S HANDBOOK, a useful reference that also teaches you the details of ZX-81 hardware and interfacing, and more. Ask for No. 22012, only \$13.95 (tentative).

Learn to use beginning and advanced BASIC on your Commodore 64 computer with Sams COMMODORE 64 USER'S GUIDE. Also shows how to create arcade-type color animation, including music and sound effects! Same book that comes packed with

every Commodore 64 computer. Ask for No. 22010, only \$12.95.

Once you know a little BASIC, you can use your computer to play checkers, predict human choices, make deductions from stored data, generate poetry, and simulate counseling by a psychiatrist! EXPERIMENTS IN ARTIFICIAL INTELLIGENCE FOR SMALL COMPUTERS shows you how, and helps you translate the programs into the BASIC version you need. Ask for No. 21785, only \$6.95.

**To order these Sams Books or to get the name of your local Sams retailer, call 800-428-3696 toll-free or 317-298-5566 and refer to our ad #AD250**

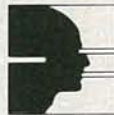

**SAMS BOOKS**  
HOWARD W. SAMS & CO., INC.  
4300 West 62nd Street  
P.O. Box 7092  
Indianapolis, IN 46206

## SAMS BRINGS YOU BASIC ANSWERS FOR COMMODORE AND SINCLAIR

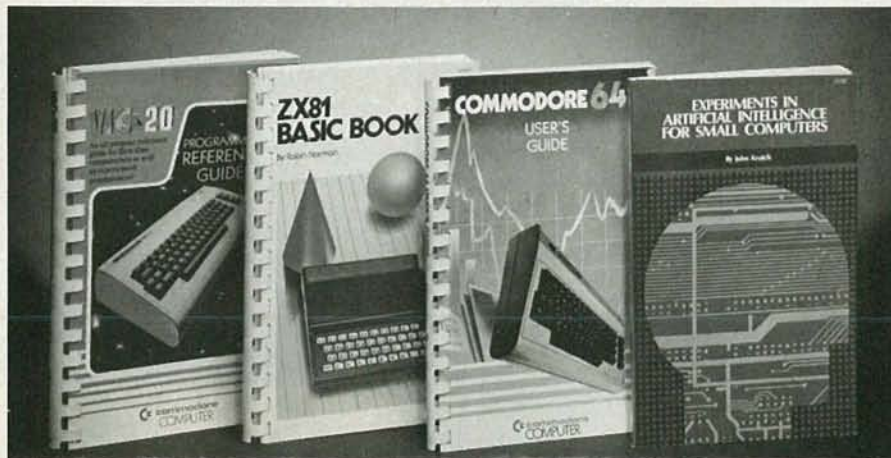

Offer good in USA only and expires 5/31/83. Prices subject to change without notice. In Canada, contact Lenbrook Industries, Ltd., Scarborough, Ontario.

CIRCLE 36 ON FREE INFORMATION CARD



# Picture where you can go with a \$99.<sup>95</sup> computer.

Remember when they said all computers would be affordable someday? Well, here they are. All one of them.

## The only \$99.95 computer.

Now you don't have to spend hundreds or even thousands of dollars to enjoy some really useful and interesting software programs.

You can own a full powered TS1000 personal computer for only \$99.95. And you can buy it directly from Sinclair Research, the company that pioneered the affordable computer. Only Sinclair has made this revolutionary new technology possible, with a unique Master Chip which replaces as many as 18 chips used in other personal computers.

The TS1000 is the lowest priced personal computer on the market. In addition to being very affordable, it's very expandable.

You can select from a number of 1K software programs for the basic computer. You can also learn how to write your own programs.

## The 16K Memory Module. More power to you.

For only \$49.95 more, you can purchase our 16K Memory Module and use even more sophisticated software. Choose from a wider selection of games, educational programs and business/household applications.

The 16K Memory Module plugs right onto the back of the Timex/Sinclair 1000 and provides 8 times more memory capacity. The perfect way to expand your system without emptying your wallet.

## A computer even the merely curious can afford.

The TS1000 is designed precisely for you. Anyone can afford it. Anyone can learn how to use it.

So now even the curious can take advantage of our many software cassettes, which work with a standard cassette recorder.

The TS1000 comes with a complete software catalog and a comprehensive instruction book written in clear, simple English. And the computer hooks up to your TV for video display.

No wonder the TS1000 is the fastest selling personal computer ever. And Sinclair will let you try it in your home for 10 days at no risk.

## Buy three cassettes, get one free. A good reason to order now.

The fact that computers are here to stay is probably reason enough to order now.

However, we also feature a special software offering. When you buy three cassettes, you get a free cassette. It's as simple as that. And now you can buy the computer and both 1K programs and 16K programs right from your home. No crowds, no waiting lines, no parking worries. Selecting from such a large variety of software has never been easier or more convenient.

But you have to order right away, this is a limited time offer.

## How to order today.

Call our toll free number and use your MasterCard or VISA. Or send the coupon with a check or money order.

Then try out the Timex/Sinclair 1000 for

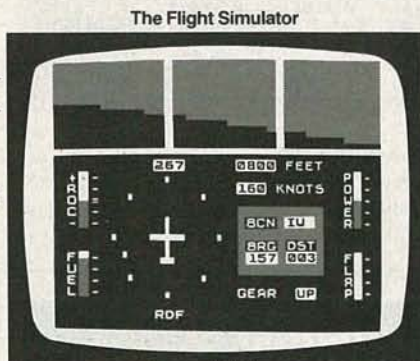

The Flight Simulator

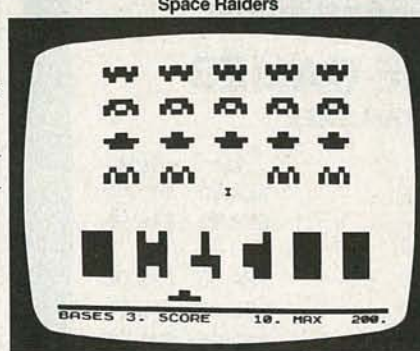

Space Raiders

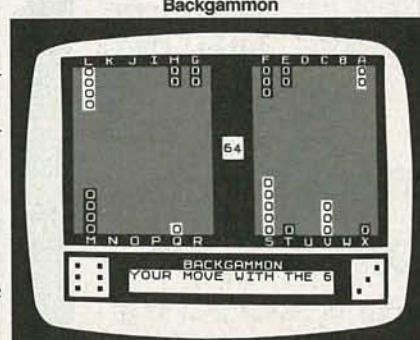

Backgammon

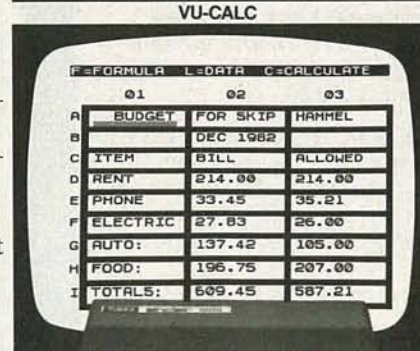

VU-CALC



**sinclair**

10 days. If you're not entirely satisfied, just return it to us and we will refund your money. (Sorry, no refunds on software.)

Call toll free: 800-543-3000. Ask for operator 509. In Ohio call: 800-582-1364. Ask for operator 509. In Canada call 513-729-4300, operator 509. Have your MasterCard or VISA ready when calling. Phones open 24 hours a day, 7 days a week. These numbers are for orders only.

If you want information, please write: Sinclair Research Ltd., 2 Sinclair Plaza, Nashua, NH 03061.

Call toll free

# 800-543-3000

(operator 509)

Ad code: B2RE01 Mail to: Sinclair Research, Ltd.  
One Sinclair Plaza, Nashua, NH 03061

Check or Money Order enclosed, payable to Sinclair Research.

Check the boxes of all software cassettes you want. If you buy any three cassettes, get any fourth one free. You must circle the one cassette you wish to receive free.

	Price	Qty.	Amount*
TS1000 Computer	\$99.95		
16K RAM	\$49.95		
1K Cassettes	\$ 9.00		
16K Cassettes	\$15.00		
Shipping/Handling	\$ 4.95		\$4.95

\*U.S. Dollars Total:

1K Cassettes for basic computer: \$9.00 each

- |  |  |
|--|--|
| <input type="checkbox"/> 1) Statistics<br>Includes Statistics, Regression and Trend, CHI Squared Text and Graphics Plot    | <input type="checkbox"/> 3) Super Program 2<br>Rings Around Saturn, Secret Code, Mind Boggling, Silhouette, Memory Test, Metric Conversion |
| <input type="checkbox"/> 2) Super Program 1<br>Invasion from Jupiter, Skittles, Magic Square, Doodle, Kim, Liquid Capacity | <input type="checkbox"/> 4) Super Program 7<br>Racetrack, Chase, Nim, Tower of Hanoi, Docking the Spaceship, Golf                          |

Cassettes for 16K Module: \$15.00 each

- |  |  |
|--|--|
| <input type="checkbox"/> 5) Space Raiders, Bomber<br>The popular Arcade games                                  | to catalog, maintain records, keep track of accounts   |
| <input type="checkbox"/> 6) The Flight Simulator<br>Control a highly maneuverable light aircraft               | <input type="checkbox"/> 11) VU-CALC<br>Financial analysis, budget and projection tables; a powerful analytical tool         |
| <input type="checkbox"/> 7) Chess<br>Six levels of difficulty  | <input type="checkbox"/> 12) The Coupon Manager<br>List coupons by store or type   |
| <input type="checkbox"/> 8) Backgammon and Dice  | <input type="checkbox"/> 13) The Stock Option Analyzer<br>Calculate last trading day; evaluate ROI, annual ROI and NET worth |
| <input type="checkbox"/> 9) The Cube Game<br>One, two or three dimensional cube puzzle solving                 | <input type="checkbox"/> 14) Super Math<br>Five levels of difficulty   |
| <input type="checkbox"/> 10) The Organizer<br>General purpose information storage and retrieve program. Use it |  |

Name \_\_\_\_\_  
Street \_\_\_\_\_  
City \_\_\_\_\_  
State \_\_\_\_\_ Zip \_\_\_\_\_



## Heath Model H-25 Printer



CIRCLE 105 ON FREE INFORMATION CARD

Heath		H-25									
OVERALL PRICE											
EASE OF USE											
INSTRUCTION MANUAL											
PRICE/VALUE											
		1	2	3	4	5	6	7	8	9	10
		Poor		Fair		Good		Excellent			

MOST READERS OF RADIO-ELECTRONICS have assembled at least one Heathkit, and are familiar with their "goof-proof" instructions, large illustrations, and easy-

to-comprehend steps. Up until very recently, the emphasis was towards electronic devices ranging from simple test equipment to full-function, digital

computers—with a host of things in between. The H-25 Dot Matrix Printer is not your usual step-by-step, solder R13 to J4 on P9 type of manual or kit; instead, it is primarily a mechanical assembly with, to say the least, very little electronics assembly involved.

If you have ever examined the inside of a printer, be it a daisy-wheel or dot matrix, you were immediately aware of the fact that, regardless of the manufacturer, the printer was heavily oriented towards mechanical assemblies, and perhaps compressed the electrical/electronics section to a small printed-circuit board.

Essentially, we have just described the "generic" printer, but there is nothing "garden-variety" or plain about the H-25. It is specified as a high-speed dot-matrix printer capable of speeds of up to 150 characters-per-second and handles paper from label size to the oversized forms we are used to seeing in commercial computer installations. What sets this printer apart from the standard Heathkit line is the fact that the H-25 kit, like other printers currently available, is primarily mechanically intensive in design and assembly.

The kit comes in two boxes, one small and one large. The smaller box, by the way is the heavier of the two. The large box contains the molded cabinet, chassis, and power transformer. The smaller box contains the internal workings and parts that make up the final printer. Of particular interest is the method in which those boxes are packed and the parts identified. There is a chart that you will find as soon as you open the box with a "map" of sorts telling you precisely where each pack of parts is located and its identification number. That permits you to unpack only those components you will be working with, and allows the kit-builder the option of using any convenient work surface—even the kitchen table—to build the printer on.

Assembly is broken into small-easy-to-handle stages with the first being the assembly of the Circuit Control Board. That small printed-circuit board contains the control panel that allows you to select: on/off line; forms alignment; top of form; buffer clear, and reset. The board is probably the most electronic-intensive portion of the entire kit, and requires less than an hour to complete. There really isn't all that much to it as it consists of a few LED's, an IC, and some switches, together with a flat cable assembly.

The electronics assembly is now essentially over. The first phase of the mechanical assembly centers around the assembly of the carriage, with the bearings and other components that form the mechanics of the carriage and stepper-motor for the print-head assembly. Those were no surprises and the mechanical assembly was well-supported by an almost lavish use of illustrations.

Moving right along, the assembly steps

## VIC20 PERSONAL COMPUTER

### TOP 10 ARCADE GAMES VIC-20 TAPE PROGRAM SALE!!

Rank	Name	List	Sale
1.	Super Paratrooper (Fantastic)	\$24.95	\$19.95
2.	Exterminator-Plus (Better than Centipede)	\$24.95	\$19.95
3.	Cricket (Better than Frogger)	\$24.95	\$19.95
4.	3-D Hackman (3-Dimensional)	\$24.95	\$19.95
5.	Snackman (Better than Packman)	\$19.95	\$15.95
6.	Bug Blast (Creepy)	\$19.95	\$16.95
7.	Anti Matter Splatter (Nuclear Disaster)	\$24.95	\$19.95
8.	Bombs Away (Great)	\$18.95	\$15.95
9.	3-D Maze-Escape	\$16.95	\$14.95
10.	Krazy Kong	\$16.95	\$14.95

**BUY ANY FOUR — DEDUCT 10% MORE**

### VIC-20 ACCESSORY SALE!!

**1. TRACTION-FRICTION LINE PRINTER** This new COM-STAR deluxe printer, prints 8 1/2" x 11" full size letter quality single, roll or fan fold paper, labels and etc. Impact dot matrix bi-directional 40, 66, 80, 132 columns. Includes interface cable that plugs direct into the VIC-20 computer, no other costly interface is needed. List \$599.00 — Sale \$399.00.

**2. UP TO 60K EXPANSION MODULE** Aero Space designed—6 slot—add up to 6 cartridges— switch select any program. Start and stop any program with reset button—not necessary to remove cartridges or turn off computer, saves time, television and computer (one year warranty) List \$149.00 — Sale \$89.00.

- 10 DAY FREE TRIAL
- WE HAVE THE LOWEST PRICES
- ONE DAY DELIVERY EXPRESS MAIL
- FREE CATALOGS
- WE LOVE OUR CUSTOMERS!

# PROTECTO ENTERPRIZES (FACTORY-DIRECT)

BOX 550, BARRINGTON, ILLINOIS 60010  
Phone 312/382-5244 to order

CIRCLE 40 ON FREE INFORMATION CARD



# NEW FROM SOLTEC®

## SERIES 500 Oscilloscopes

- DC - 15, 20 & 30MHz (probe(s) included)
- 1mV Sensitivity

- Auto Fix Triggering
- 2 Year Warranty, Parts and Labor

### 30MHz



**\$895**

Model 530  
30MHz, Dual Trace

### 20MHz



**\$695**

Model 520  
20MHz, Dual Trace

### 15MHz

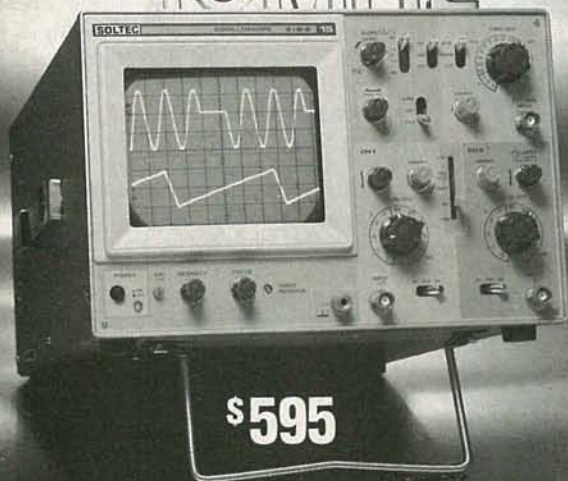

**\$595**

Model 515-2  
15MHz, Dual Trace

### 15MHz



**\$495**

Model 515-1  
15MHz, Single Trace

Available through your local SOLTEC® distributor

Write or call for full details. Toll free (800) 423-2344 • In California (213) 767-0044

# SOLTEC®

## CORPORATION

11684 Pendleton Street • Sun Valley, California 91352

CIRCLE 43 ON FREE INFORMATION CARD



to the printer chassis where, besides mechanical construction, you do have some opportunity to use a soldering iron, although only to make up some interconnecting plugs. Here the soldering will involve spring clips that will be inserted into connectors. It would be wise to have some sort of a protective covering on your work surface to prevent scratching both the painted chassis and the surface you are working on. A ruler becomes quite useful and some caution as to insuring that you have selected the correct factory-assembly cable is in order. You also get a chance to use a ruler and pliers, while aligning shafts, installing pulleys, belts, and a number of other purely me-

chanical components.

The last phase of the purely mechanical assembly involves the Paper Drive Unit. That unit has a unique sensor that uses a mechanical disk rotating between an LED and a photo-transistor that forms an audible alarm to alert you to either a paper jam or "out-of-paper" condition. The sensor-disk is a plastic casting and according to the instructions could have burrs. We strongly recommend that you follow the cautions and suggestions as to inspection and deburring to insure that the disk will rotate freely. If you fail to follow those steps, there is a possibility that the sensor system will fail to operate.

The assembly stage is completed with

the installation and alignment of the tractor bars and rather sturdy (yet plastic-molded) sprockets. Following that alignment procedure, the previously assembled stages are integrated into a hinged printer configuration that allows the assemblies to tilt-out for maintenance as well as paper loading.

The electronics section is now wired, if you can call making a few connections to a bridge rectifier and terminating cable assemblies wiring. The three factory-wired-and-tested printed-circuit boards containing the logic, driver and printer-motor controls are installed and interconnecting cables are terminated. At that point, there are two different levels of tests you can make. One relies on the LED indicators on the circuit boards; the other assumes that you own a VOM, and consists of a series of voltage and resistance tests.

With the mechanical and electronic/electrical assembly out of the way, your attention is directed to the cabinet, where you will assemble the two halves into a very functional and attractive cabinet. Despite the fact that the cabinet is molded plastic, an interesting construction technique is used, whereby you gently heat threaded brass inserts with a soldering iron. Those heated inserts work their way into pre-drilled holes in the cabinet halves and form the threaded "bases" for the final assembly.

Perhaps the best part of the H-25 Printer, is not the printer itself, but rather the detailed and complete documentation. The two manuals cover assembly, test trouble shooting, an excellent section on configuring the printer, as well as your operating system. The printer operates with virtually any computer with an RS-232C interface and it also offers a TTY-type 20-mA current-loop interface as a standard feature.

A built-in self test allows you to test and adjust the printer whenever the need arises, and a variety of type sizes, are available under either software or hardware-control (a series of DIP switches located on the rear panel allow custom-applications programming). There is an empty IC socket that will soon be used to hold a special character ROM to further enhance the already impressive characteristics. The printer is capable of printing the full ASCII character and the H-19 graphic set.

Considering the complexities involved in printer design and manufacture, it is quite novel to see and experience firsthand the first and probably only commercial grade dot-matrix printer available anywhere in kit form, which was obviously designed in such a manner that the printer could literally and actually be assembled on a kitchen table. There isn't another printer selling for under \$1000.00 that can make that statement. The model H-25 printer sells for \$899.00 in kit form.

R-E

## BY SPECIAL ARRANGEMENT WITH MANUFACTURER MUST LIQUIDATE AT BELOW DEALER COST!



### DIALER KIT INCLUDES:

- advanced microprocessor
- 2 integrated circuits
- programmable keyboard
- solid-state power supply
- two-sided printed circuit board
- all other necessary parts for completion

**BRAND NEW!  
FACTORY PERFECT!**

**SPECIAL  
COMBINATION OFFER**

## AUTOMATIC PHONE DIALER KIT PLUS...

**YOUR  
CHOICE OF ONE PIECE OR  
CORDLESS PHONE**

Foreign price cutting has forced this leading manufacturer to liquidate stock of phone dialer kits and fully-assembled telephones. Dialers operate with any standard phone, store up to 11 phone numbers, call any one at the touch of a button. Phones are first quality, sold by leading retail stores and catalogs throughout the U.S. Together, it's an unbeatable buy. PLEASE NOTE — Phone dialer is an intermediate kit requiring soldering wire connections. A great one-evening project. All parts and complete, clear instructions included. No electronic knowledge necessary.

### QUALITY PHONES FCC APPROVED

**Cordless Phone  
PLUS Auto Dialer Kit**  
Retail Value \$225  
**NOW ONLY \$89.95**

**One Piece Phone  
PLUS Auto Dialer Kit**  
Retail Value \$125  
**NOW ONLY \$39.95**

**TO ORDER:** Send check or money order to The Baystar Company at our address below. Credit card holders can speed delivery by using our toll free number. Md. residents add 5% tax.

**CALL TOLL FREE (800) 638-6170**

Monday thru Friday 9 a.m. - 5 p.m. Eastern Time

all other times

**(800)257-7850**

Md. residents call  
**363-4304**

Dept. 03D

110 Painters Mill Rd. Owings Mills, MD. 21117

**Baystar**

### GUARANTEE OF SATISFACTION:

We guarantee complete satisfaction on all phones and kits. If not completely satisfied within 30 days, return phones in good condition and all kit materials unused. Purchase price will be promptly refunded.

©1983 The Baystar Company



# GILLASPIE

IMPROVES YOUR IMAGE . . .

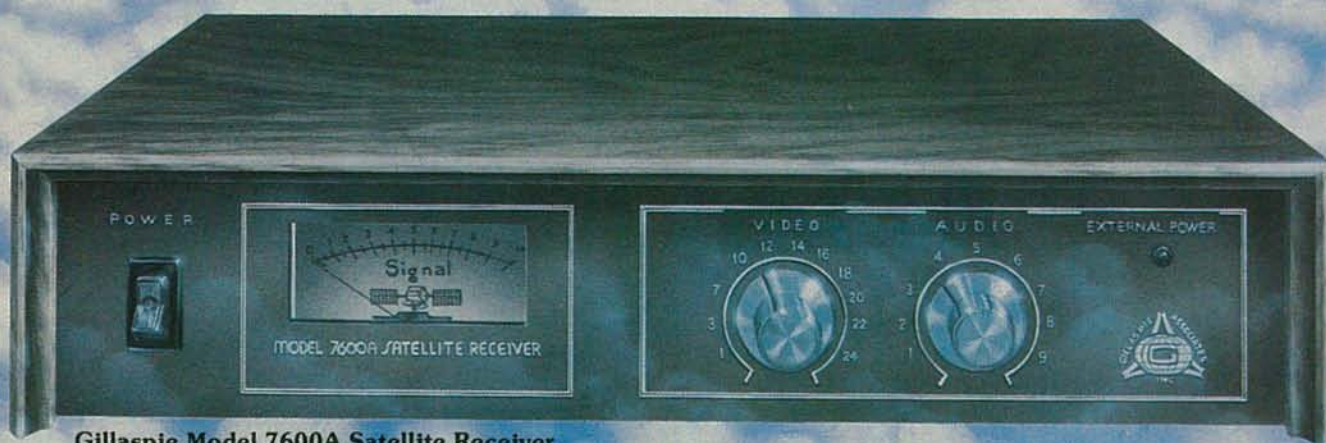

Gillaspie Model 7600A Satellite Receiver

Engineered to meet your highest specifications in audio and video satellite receiving. Backed by dependable and authoritative factory service, to assist you in reliable installations.

Whether your needs are cable, industrial, multi-terminal or home satellite receiving, Gillaspie products will earn your confidence.

## GILLASPIE DISTRIBUTORS

North American Satellite  
4873 North Blackstone  
Fresno, California 93726  
(209) 227-0171

Nevada Satellite  
4092 Olive  
Las Vegas, Nevada 89104  
(702) 452-5509  
(702) 452-6975

Satellite Communications, Corp.  
Kiro Corner  
Silverlake, Kansas 66539  
(800) 255-2408

Multivision  
1001 Kingston Pike  
Knoxville, Tennessee 37922  
(615) 691-9087

**(408) 730-2500**

GILLASPIE & ASSOCIATES INC., 365 SAN ALESO AVE., SUNNYVALE, CA 94086  
CIRCLE 6 ON FREE INFORMATION CARD



**Learning  
electronics  
is no picnic.**

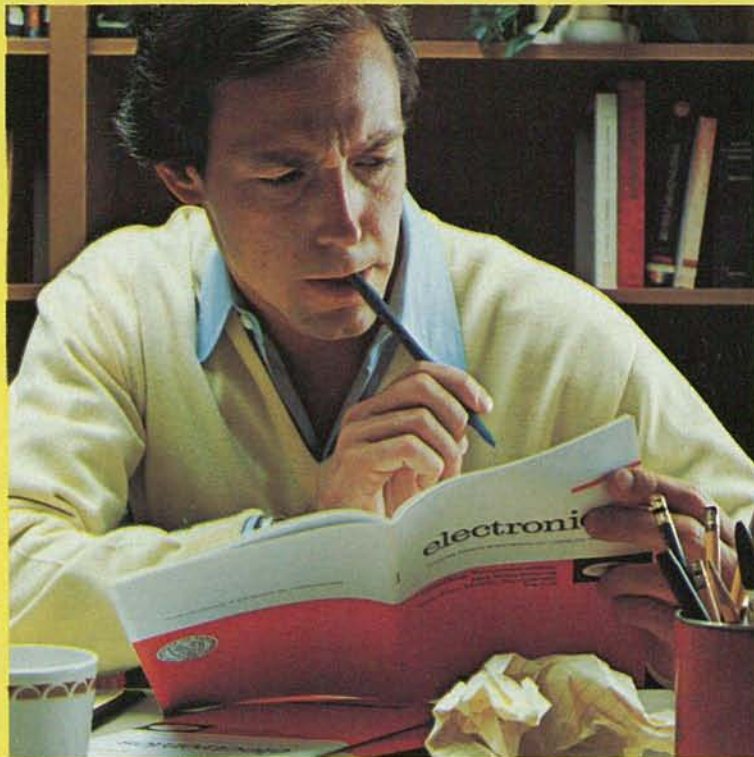

**At any level it  
takes work and  
a few sacrifices.  
But with CIE,  
it's worth it.**



Whoever said, "The best things in life are free," was writing a song, not living a life. Life is not just a bowl of cherries, and we all know it.

You fight for what you get. You get what you fight for. If you want a thorough, practical, working knowledge of electronics, come to CIE.

You can learn electronics at home by spending just 12 hard-working hours a week, two hours a day. Or, would you rather go bowling? Your success is up to you.

At CIE, you *earn* your diploma. It is not handed to you simply for putting in hours. But the hours you do put in will be on your schedule, not ours. You don't have to go to a classroom. The classroom comes to you.

### Why electronics training?

Today the world depends on technology. And the "brain" of technology is electronics. Every year, companies the world over are finding new ways to apply the wonders of electronics to control and program manufacturing, processing... even to create new leisure-time products and services. And the more electronics applications there are, the greater the need will be for trained technicians to keep sophisticated equipment finely tuned and operating efficiently. That means career opportunities in the eighties and beyond.

### Which CIE training fits you?

Beginner? Intermediate? Advanced? CIE home study courses are designed for ambitious people at all entry levels. People who may have:

1. No previous electronics knowledge, but do have an interest in it;
2. Some basic knowledge or experience in electronics;
3. In-depth working experience or prior training in electronics.

You can start where you fit and fit where you start, then go on from there to your Diploma, FCC License and career.

### Many people can be taught electronics.

There is no mystery to learning electronics. At CIE you simply start with what you know and build on it to develop the knowledge and techniques that make you a specialist. Thousands of CIE graduates have learned to master the simple principles of electronics and operate or maintain even the most sophisticated electronics equipment.

### CIE specializes exclusively in electronics.

Why CIE? CIE is the largest independent home study school that specializes exclusively in electronics. Nothing else. CIE has the electronics course that's right for you.

Learning electronics is a lot more than memorizing a laundry list of

facts about circuits and transistors. Electronics is interesting! It is based on recent developments in the industry. It's built on ideas. So, look for a program that starts with ideas and builds on them. Look to CIE.

### Programmed learning.

That's exactly what happens with CIE's Auto-Programmed® Lessons. Each lesson uses famous "programmed learning" methods to teach you important principles. You explore them, master them completely, before you start to apply them. You thoroughly understand each step before you go on to the next. You learn at your own pace.

And, beyond theory, some courses come fully equipped with electronics gear (the things you see in technical magazines) to actually let you perform hundreds of checking, testing, and analyzing projects.

### Experienced specialists work closely with you.

Even though you study at home, you are not alone! Each time you return a completed lesson, you can be sure it will be reviewed, graded and returned with appropriate instructional help. When you need additional individual help, you get it fast and in writing from the faculty technical specialist best qualified to

answer your question in terms you can understand.

### CIE prepares you for your FCC License.

For some jobs in electronics, you must have a Federal Communications Commission (FCC) License. For others, some employers tend to consider your license a mark in your favor. Either way, your license is government-certified proof of your knowledge and skills. It sets you apart from the crowd.

More than half of CIE's courses prepare you to pass the government-administered exam. In continuing surveys, nearly 4 out of 5 graduates who take the exam get their licenses! You can be among the winners.

### Associate Degree

Now, CIE offers an Associate in Applied Science Degree in Electronics Engineering Technology. In fact, all or most of every CIE Career Course is directly creditable towards the Associate Degree.

### Today is the day. Send now.

Fill in and return the postage-free card attached. If some other ambitious person has removed it, cut out and mail the coupon. You'll get a FREE school catalog plus complete information on independent home study. For your convenience, we'll try to have a CIE representative contact you to answer any questions you may have.

Mail the card or the coupon or write CIE (mentioning name and date of this magazine) at: 1776 East 17th Street, Cleveland, Ohio 44114.



Pattern shown on oscilloscope screen is simulated.

## CIE Cleveland Institute of Electronics, Inc.

1776 East 17th Street, Cleveland, Ohio 44114

Accredited Member National Home Study Council

**YES...** I want to learn from the specialists in electronics—CIE. Send me my FREE CIE school catalog...including details about the Associate Degree program...plus my FREE package of home study information.

Print Name \_\_\_\_\_

Address \_\_\_\_\_ Apt. \_\_\_\_\_

City \_\_\_\_\_

State \_\_\_\_\_ Zip \_\_\_\_\_

Age \_\_\_\_\_ Phone (area code) \_\_\_\_\_

Check box for G.I. Bill bulletin on Educational Benefits:  Veteran  Active Duty

**MAIL TODAY!**

RE-54





## NEW Tech VOM WV-547C

Drop-proof. Fuse protected.  
High impact ABS plastic case.

Rugged,  
accurate taut-band meter.

Sensitivity  
20,000 ohms-per volt DC  
9,000 ohms-per volt AC

21 color coded ranges.

Snap action,  
dual detent range switch.

Temperature scale  
(optional accessory)

User oriented  
"right angle" test leads.

# For \$35.50 Here's your best VOM value.



It's compact, drop-proof (3 feet) and provides 21 color-coded ranges—volts, milliamps, ohms, temperature scale and decibels. True quality instrument for your portable applications. Tough, accurate, taut-band meter, fuse-protected. Sensitivity 20,000 ohms/volt DC. High-impact case, colored bright orange. Snap action, dual-detent range switch. Range limits: 1000V DC and AC, 250 mA DC, one megohm, +200°C. Battery Test provision. Meter OFF position. Temperature scale (special probe optional).

WV-547D. Same instrument in impact-resistant carrying case. Handle converts to tilt stand.

**\$39.95**

Want full technical details and a demonstration? Call toll-free, 1-800-523-3696, for the VIZ distributor near you.

# VIZ

**Look to VIZ for value, quality, availability.  
Over 70 instruments in the line—PLUS full accessories.**

VIZ Mfg. Co., 335 E. Price St., Philadelphia, PA 19144

CIRCLE 73 ON FREE INFORMATION CARD



# NEW TECHNOLOGY

## INSIDE A



## 757-767 COCKPIT

*State-of-the-art technology, in the form of an Automatic Flight Control system, has been incorporated into the Boeing 757/767 aircraft. Here's a look at the new system and what happens behind closed cockpit doors when you fly the new plane.*

"THIS IS YOUR CAPTAIN SPEAKING! WELCOME ABOARD AUTO AIRLINES Flight 203. This aircraft is entirely computer controlled, so relax and enjoy the flight. This system has been engineered so that nothing can go wrong, go wrong, go wrong...."

Everyone has probably heard a version of this rib-tickler, after all it's been around in one form or another since the early days of the computer revolution. And, just as likely, most people have probably chuckled at it and put it out of their minds. If it was thought of, it was probably dismissed as science fiction.

But, today it has become science fact with the introduction to regular service of the Boeing 757/767 series of wide-bodied airliners. Microcomputers can fly this plane from takeoff to destination.

The electronic componentry that the 757/767 sports makes those airliners not only the easiest to fly, but also the most fuel-efficient, sophisticated, and safest in the air.



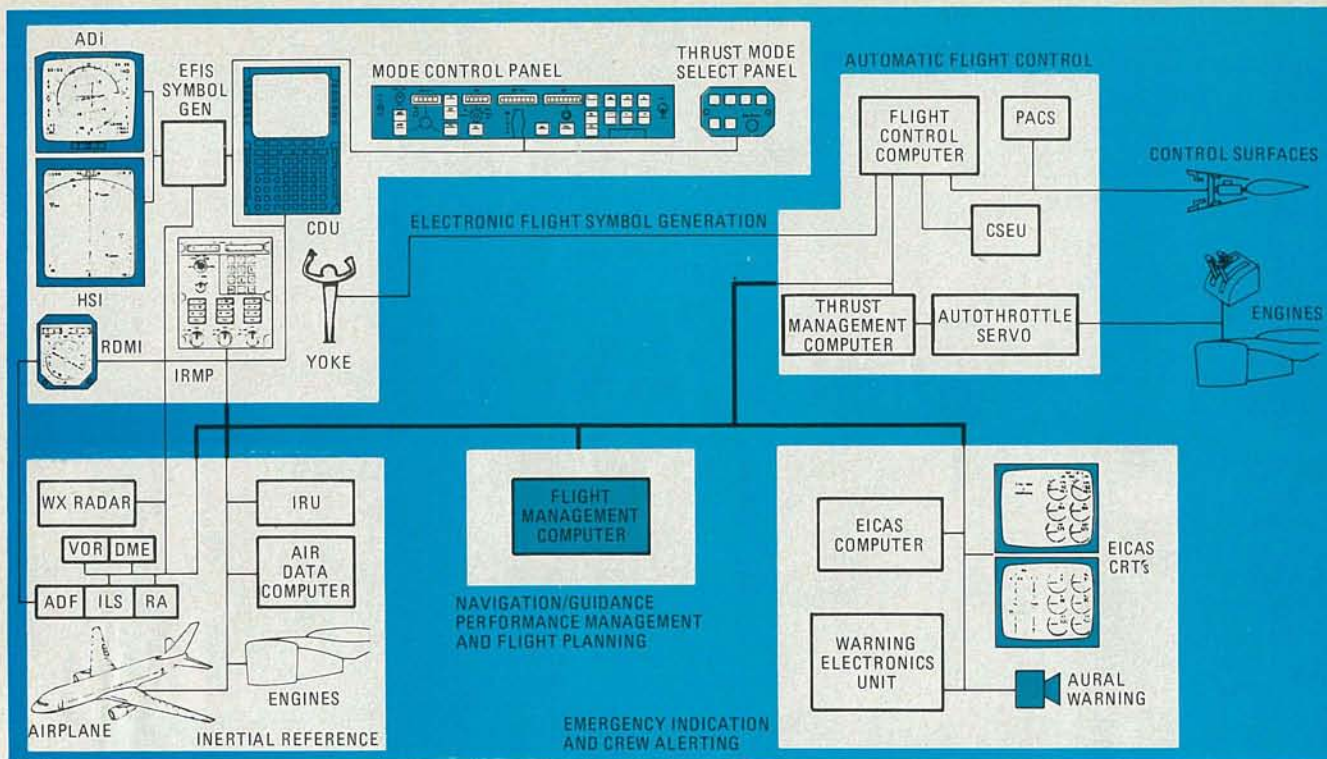

FIG. 1—THE MAJOR SYSTEMS and subsystems of the Automatic Flight Control System on the Boeing 757/767 aircraft.

## In the beginning

Impetus for this concept came with the first oil embargo 10 years ago. The airline industry found itself with a fleet of fuel-hungry jetliners and it had to find some way to make its aircraft more efficient. Thus the research for the new aircraft began.

Luckily, the time was right for the airline industry. The digital microprocessor revolution was exploding. Earlier digital computers had been both too large and costly for installation aboard the average airliner. Almost immediately, researchers saw the possibilities of the new computers and began working with them.

Some of the groundwork was already laid with the digital avionics package slated for the SST (SuperSonic Transport) that was later scrubbed. It was continued during the NASA/FAA Advanced Avionics Program that aimed at developing advanced displays and flight-management systems. A Boeing 737 was configured into a test vehicle.

Work on the research 737 incorporated digital flight controls, a digital navigation and guidance computer, and digital instrument displays. The program also gave the first practical demonstration of four-dimensional navigation, in which an airliner's flight in all spatial planes, as well as speed, were controlled. That allowed the time of arrival at specific locations to be calculated precisely.

Military work on the YC-14 Advanced Medium STOL prototype and the B-1 bomber further advanced the computerized flight deck. It provided experi-

ence with an advanced attitude direction indicator that had many of the features now built into the 757/767 system. It further aided the integration of all the systems, including software.

## Early problems

According to Boeing, the most troublesome problem in the early development was the lack of an acceptable interface for the major subsystems. Thus, much research focused on finding a standard through which all the control systems could be interfaced.

That task was given to Aeronautical Radio Inc., an airline industry-sponsored think-tank, which in its earliest days was responsible for standardizing avionic communications. ARINC began its work and eventually developed the necessary standard.

Called ARINC Standard 429, it is a serial communications bus designed for the requirements of commercial airliners. That standard operates at 12.5 and 100 kHz over 122 twisted, shielded-pair interconnections.

It carries information to and from the system components asynchronously. Data is sent one bit after another, with the appropriate start and stop bit ahead and behind each digital instruction.

That network ties together all the pieces of the Boeing Flight Management System. Through it, data can be fed to the master component, the Flight Management Computer (FMC). The FMC "listens" to and "talks" with all the other members of the avionics management

system and interprets the information fed to it.

Each major subsystem uses a separate interface bus. For instance, the Flight Management Computer and the Electronic Flight Instrument System each listen on 23 buses. Thus a unit may have anywhere between 11 and 23 transmitters and receivers incorporated within its integrated circuitry. Non-FMS digital systems, such as the anti-skid and flap control systems, also use the ARINC system.

Additionally, another ARINC standard—453—runs at a higher data rate, 1 MHz. Capable of handling more information more quickly, it is much like Standard-429 and links the weather radar receiver/transmitter with the Electronic Flight Instrument System (EFIS) Symbol Generators. EFIS generates the display data on each pilot's high-level, color graphics CRT display unit. Those displays replace many of the traditional readouts associated with an airliner's instrument panel.

The data flowing back and forth on those buses constantly update not only the FMC, but also each linked subsystem as needed. Each electronics package "hears" only data intended for it on the party-line system. The network has been engineered so that each byte of data is encoded with special start and stop bits. Only those segments of the system that are capable of decoding those bits are affected by a particular command.

Thus, if a data byte is supposed to be used only by the Automatic Flight Control System, the other major subsystems will ignore it.



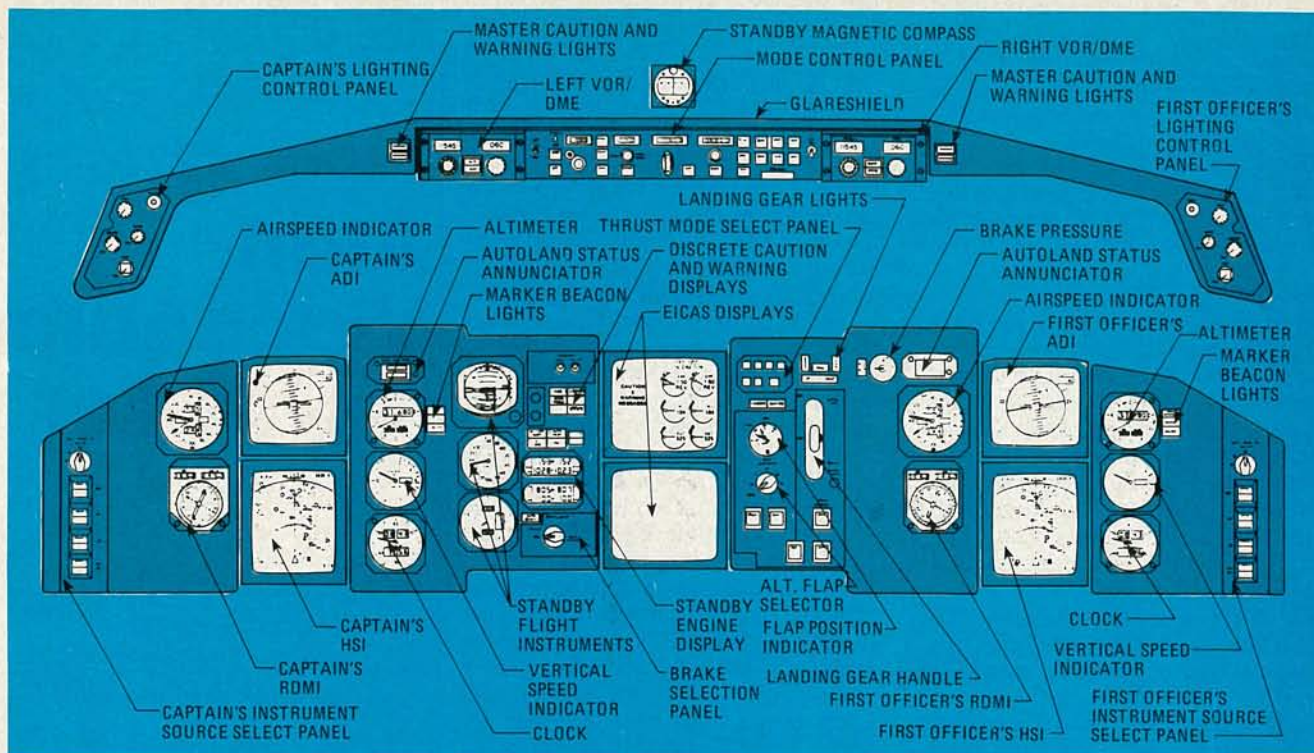

FIG. 2—THE INSTRUMENT PANEL inside the cockpit of the 757/767 aircraft.

### The major subsystems

The entire Flight Management System is made up of four major subsystems, as shown in Fig. 1. These four major subsystems are the Automatic Flight Control System, the Inertial Reference System (navigation), the Emergency Indication and Crew Alerting System, and the Electronic Flight Symbol Generation System. Each major subsystem, in turn, has its own microprocessor-controlled subsystems.

Each of the major subsystems is able not only to communicate with the FMC, but it is also able to communicate with other subsystems of its own system. Thus, you can appreciate the complexity of the total package.

Not only is the total Flight Management System characterized by state-of-the-art subsystems; it is also characterized, as noted, by high-level graphic displays. No longer is there a multiplicity of dials and gauges staring at the pilots. Instead, there are no less than five major CRT displays facing the pilots. (The primary responsibility of the Electronic Flight Control System is to generate the complex graphics for the CRT displays.)

One CRT display—the Control Display Unit (CDU)—details the information from the Flight Management Computer. That includes information about the status of the flight in progress, including such things as climb and cruise modes, radio tuning, NAVAID tuning, and departure and arrival times. A second display—the Horizontal Situation Indicator (HSI)—displays a roadmap of the

airliner's flight path. It can also overlay such functions as the weather radar display. Together, both displays allow the flight crew to make the fullest use of the Flight Management Computer's ability to determine the best and most economical paths for climbing, cruising, and descending.

A third CRT display, the Attitude Direction Indicator (ADI), is very much like the common non-electronic unit in that it displays the plane's pitch, yaw, and roll. The ADI display is located directly above the HSI, and both are located directly in front of the pilot. Duplicate ADI and HSI displays are located in front of the co-pilot. Figure 2 shows the location of all the displays on the instrument panel. Both CDU displays (one each for the co-pilot and pilot) are located on the center console between the pilot and co-pilot and are not shown in Fig. 2.

The fourth and fifth CRT displays are for the Engine Indicator and Crew Alerting System and those are located on the instrument panel between the pilot and co-pilot. Those display the engine indicators and such things as the gear not down, forward cargo fire, aft cargo fire, etc.

Of particular note is the level of interaction possible between the computer and the pilot. The CDU not only features fixed-function command keys, but also another alphanumeric keyboard with which the pilot or co-pilot can input data.

Once that data has been input, it is digested by the 16-bit (Texas Instruments TMS9900) microprocessor-driven FMC

and the changes are displayed on the HSI.

At that point, the changes to a flight plan are not cast in stone. The pilot can then reconfigure the flight plan and look at the new parameters. If he likes them, he hits the EXECUTE key and the new parameters are used to fly the aircraft.

Interestingly, the captain or first officer can address the CDU with terms similar to those used in Air Traffic Control, so there is no great amount of language re-learning necessary, making the system user-friendly.

To handle those chores, the basic Flight Management Computer incorporates a 4-million bit non-volatile memory that stores the performance and navigation databases and operating programs.

The navigation database is capable of storing an aircraft's flight path, including both the current one and any planned revision, together with airport terminal-area procedures. Growth capability has also been incorporated for future advances without the necessity of changing hardware. For real-time updates, the FMC also contains a read-write disk memory.

Another of the primary interfaces between the pilot and computer is the Mode Control Panel, located on the pilots' glare-shield. That provides a centralized panel for all autopilot control functions. Heading, altitude, vertical speed selection, and hold modes are available, as well as the backup pushbutton selectors necessary if the system should fail entirely. It also allows automatic tracking of the flight plan in lateral and or vertical dimensions.



One of the most notable features of the computerized flight deck is its level of redundancy. For instance, not only is there one FMC for the pilot, but there is another for the co-pilot. The plane can fly with either FMC or manually.

If a major failure should occur, then backup liquid-crystal-display gauges and dials take over and provide critical readouts in place of the FMC.

#### Other subsystems

While the linchpin of the system is the FMC, there are other subsystems that are also important. Take the Flight Control Computer, for example. It receives inputs from the Inertial Reference System (IRU), the Flight Management Computer, the Thrust Management Computer, the Air Data Computer, the Radio Altimeter (RA), the Instrument Landing System (ILS), and the Control Wheel force transducers.

The Flight Control Computer commands the airliner's control surfaces (flaps, etc.) and engines, and responds to changing conditions by automatically altering their settings. Thus, if it appears that it would be more economical to fly over a storm than through it, the Flight Control Computer causes the plane to climb and bank in response to the new inputs.

While that is taking place, another segment of the system—the Thrust Management Computer—is computing and displaying autothrottle functions. It integrates signals from the engines, Air Data Computer, Thrust Mode Selector Panel, Flight Management Computer, and the throttle to provide autothrottle functions for all flight conditions.

For instance, with the throttles at full forward, the Thrust Management Computer provides maximum allowable engine power without exceeding operating limits. Further, performance management functions are performed in concert with the FMC, Autopilot Flight Director System, and other systems. Throttle changes during command operations, such as flight level changes, are performed automatically. And, in the event of a missed approach, the Thrust Management Computer provides the maximum allowable thrust when go-around is commanded by the flight crew.

Of even more interest from a technical standpoint is the new Inertial Reference Unit (IRU). While many people are somewhat familiar with the typical gyrocompass, the IRU uses a laser-controlled gyro for positioning. Unlike the traditional gimbaled gyrocompass, there is only one moving part.

Called a Ring Laser Gyro, it uses a split laser-beam travelling in opposite directions around a closed triangular path. When angular motion is introduced, a frequency difference is detected and measured by photodiodes. That is converted to a digital output for use in the

IRU computer. Three laser gyros are required for each IRU system, one for each axis.

In the align mode, the IRU is able to align itself to the local vertical, true north and an estimated latitude by gyrocompassing. No heading reference is required, because the IRU analyzes the spin vector generated by the earth's rotation to compute true north. Initial positioning must be entered through the Inertial Reference Mode Panel (IRMP). However, the last position of the previous flight can also be used to allow the IRU to compute a magnetic heading. The IRU also provides similar functions for navigation and attitude.

From all of that you can appreciate the level of sophistication needed not only in the hardware, but also the software. The programming for the Flight Management Computer alone took more than 100 man-years to create, test, and debug. It was then sent through exhaustive testing not only by the Boeing Co., but also by the Federal Aviation Administration.

It is a highly structured program, says Larry Bowe, head of engineering for Sperry Flight Systems, developer of the FMC. It's also a very capable one. It's possible for a pilot to program route and destination into the FMC and then let the computer fly the plane from takeoff to touchdown. Further, it will also alert the crew via the Engine Indication and Crew Alerting System that something is amiss in time for the pilot to take over.

The beauty of the total package is that it frees the pilot from many of the chores that he used to do manually. No longer does he have to compute the weight, temperature, weather, wind, and other parameters for a takeoff. With a few button pushes, the system does it for him. Long, in-flight computations are also eliminated. Thus, the pilot can now become a flight manager.

#### Pilot reaction

Pilots are ecstatic about the results. They like the displays and the possibility of using less fuel. They also like the Boeing "quiet, dark cockpit" concept, in which indications of system operations are reserved for conditions that require actions by the flight crew. There are very few distracting lights that signify normal operation on the flight deck.

In addition, the major functions of operation, status, and maintenance have been separated so they may be brought to the attention of the flight and ground crews selectively as they are needed.

So, what began as an attempt to save fuel by the airline industry has now turned into possibly the best aircraft in the air. In fact, if you fly on it, you'll never know whether the computer or the captain is doing the work.

Next month we'll present a detailed description of the displays and major subsystems of this system.

R-E

# BUILD

## Atari Videogame Controller

*Add excitement and high scores to your home videogame. This easy-to-build joystick replacement for your Atari VCS gives you improved control plus a rapid-fire option and a tilt-activated fire switch.*

DAVID J. SWEENEY

IF YOU ARE THE PROUD OWNER OF AN Atari VCS home videogame, you've probably spent more than a few evenings at home nursing a pair of rather sore hands. The reason why is that the Atari joysticks, which despite their shortcomings are still considered to be among the best available, are built to endure the excitement and pressure generated while shooting down those Space Invaders, or what have you, but your hands most certainly are not. Partially because of that, and partially because videogame players are always on the lookout for anything that might help improve their score, a whole industry (although, granted, a small one) devoted to supplying aftermarket game controllers has sprung up. Most of those, however, are simply better (we hope!) joysticks. What about a different approach? The joystick replacement described here, which, incidentally, does not resemble a joystick in any way, will add a new dimension to your home videogame action. Among its advantages are that it is easily built, comfortable to use, and adds a couple of features not found in the standard Atari units—those are repeat-fire action and a tilt-controlled switch. What's more, the project is very economical to build and operate.



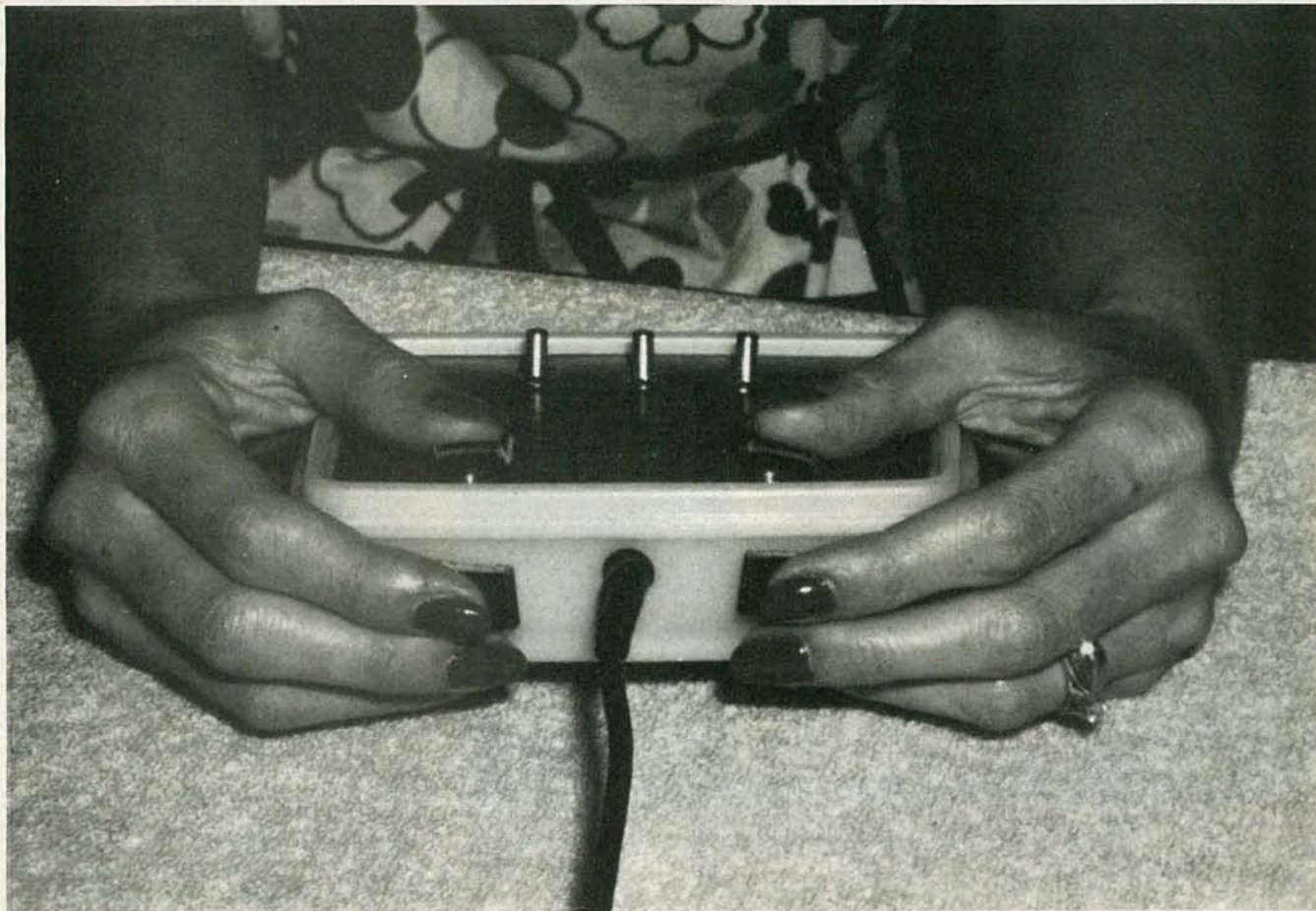

A SANDWICH BOX covered with wood-grained paper makes an inexpensive case.

### Comparing the controllers.

The controller that is supplied with the Atari videogame system (see Fig. 1-a) uses five compression switches to control the game action. Four of those switches are operated by the joystick; the fifth is controlled by the red FIRE button; for simplicity's sake, we'll call those five switches UP, DOWN, LEFT, RIGHT, and FIRE (see Fig. 1-b). All of the switches are momentary, normally open, SPST types. Game software is designed so that the action on the screen is controlled by the opening and closing of those switches, which, in turn, is controlled by the movement of the joystick. In other words, if you move the joystick to the left, it will close the LEFT compression switch (more on that shortly), and the software will move the appropriate object (gun, ship, Pac-Man, etc.) to the left; moving the joystick up will move the object on the screen up, etc. Moving the joystick diagonally closes two switches at once, moving the object diagonally.

Any joystick substitute must also provide an arrangement of five switches. This device uses four pushbutton momentary SPST switches and one internal tilt-controlled mercury switch. Figure 1-c shows the location and function of those



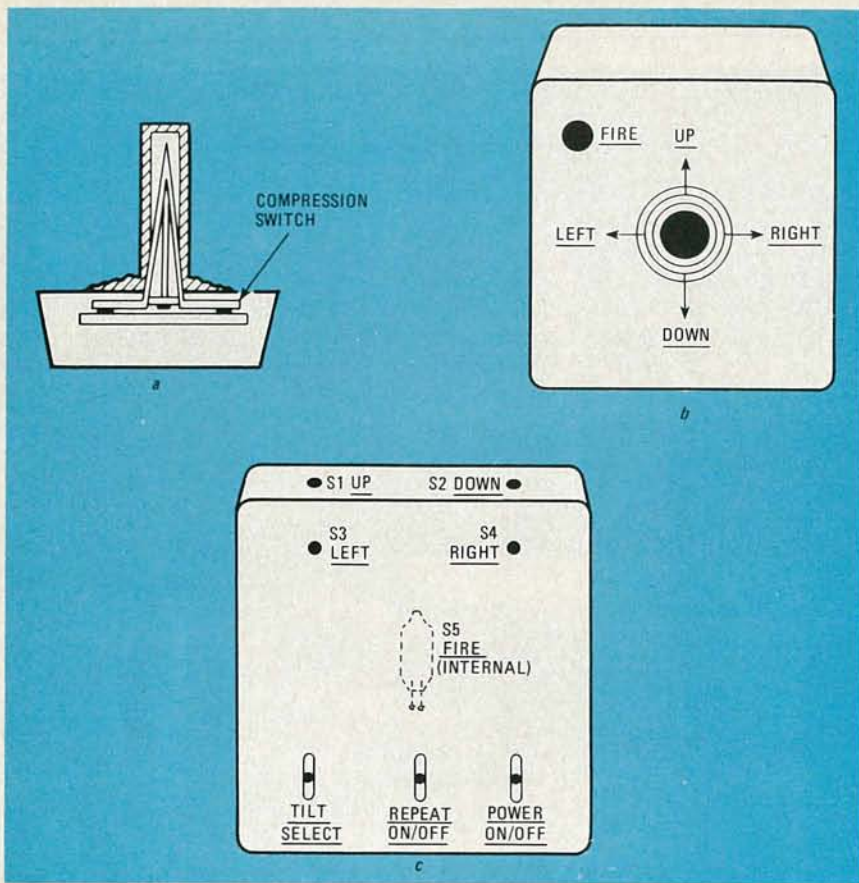

FIG. 1—ONCE YOU GET USED to the switch positions on the controller you're likely to throw your original joysticks away!

TABLE 1

	Switch	Location/Function	Joystick equivalent
Game switches	S1	Left forefinger	Up or Fire*
	S2	Right forefinger	Down
	S3	Right thumb	Left
	S4	Left thumb	Right
	S5	Internal	Up or Fire*
Setup switches	S6	Power on/off	—
	S7	Repeat on/off	—
	S8	Tilt select	—

\*Selected by S8

switches, as well as the unit's three others—POWER ON/OFF, TILT SELECT, and REPEAT ON/OFF. Note that the Atari joystick's UP, DOWN, LEFT, RIGHT, and FIRE switches are replaced in our new controller by S1, S2, S3, S4, and S5 respectively. However, the function of two of those switches (S1 and S5) can be interchanged by using the TILT SELECT switch. That lets you choose whether you want to use the tilt switch (S5) to control firing or the upward movement of the object on the screen. Needless to say, whichever function is not controlled by the tilt switch will be controlled by S1. The switch functions/locations of our substitute controller, and their corresponding joystick functions, are summarized in Table 1.

As you can see in Fig. 1-c and the photos, S1-S4 are located so that they can be easily pushed by your forefingers and thumbs when the controller box is held. You're sure to find that this setup will make playing almost any game less tiring, and more enjoyable.

### The circuit

The schematic diagram of the replacement controller is shown in Fig. 2. Aside from the switches we've already discussed, the bulk of the circuitry involves the repeat mode. Switch S7 is used to select either that or the single-shot mode.

In the repeat mode, you no longer need to push a button each time you want to fire a shot. Instead, each time you press the FIRE button or tilt the controller, depend-

ing on how the TILT SELECT switch is set, shots are fired at a rate of about 10-per-second for as long as the fire switch is pressed or the unit is tilted. The circuit used to do that is relatively simple, involving mainly a 555 IC oscillator and a reed relay. Basically, the oscillator is configured to open and close the relay at a rate of 10 Hz which, is about the fastest rate that you achieve manually. There is one other thing we should point out here: some games limit the number of shots you can take at a time—in Space Invaders, for instance, you can not take a second shot until the first has completely cleared the screen. Our controller can not override the software and change that.

### Construction

Building our videogame controller is almost easier than describing it; it involves little more than installing the switches and repeat-mode circuitry into a suitable case. Let's turn our attention to that case for a moment. Considering the simplicity and low cost of our controller, it would seem a waste to house it in something that would cost more than the device itself. But, on the other hand, some sort of attractive case would be desirable. We decided upon a rather nice, if unlikely, compromise. The case you see in the photographs is nothing more than a refrigerator sandwich box, the kind that you can get in any discount store or supermarket; we dressed it up a little by putting some wood-grained self-adhesive paper on the lid. In use, we found that the case is easy on the hands and that it stands up well to the stress and perspiration sure to be generated when playing any videogame. In fact, the case has withstood eight months of hard use by a variety of players with no visible bad effects.

One problem did develop concerning the switches. First of all, they are rather small and easy to miss in the heat of "battle." Also, use over extended periods of time resulted in quite a bit of wear and tear on the fingers. The solution to both those problems was rather simple—an old belt was cut into strips that were used as switch covers. The strips (which measure  $1 \times \frac{1}{2}$  inch) are installed simply by punching a hole in one end and screwing them down next to the pushbuttons so that they lie over them.

The repeat-mode oscillator can be built using any construction technique and parts placement is not critical. The oscillator used in the prototype was built on perforated construction board and point-to-point wiring was used. The mercury TILT SELECT switch is mounted on the oscillator circuit board using a Velcro fastener as shown in Fig. 3. That mounting technique was used to allow for easy switch replacement in the event that it ever becomes necessary. The battery holder was made from a strip of aluminum that was shaped to fit the battery and secured as shown.



## PARTS LIST

All resistors 1/4-watt, 5%, unless otherwise specified

R1, R2—150 ohms

R3—47,000 ohms

R4—10,000 ohms

### Capacitors

C1—2.2  $\mu$ F, 50 volts, electrolytic

### Semiconductors

IC1—555 timer

RY1—5-volts DC relay (Radio Shack 275-240 or similar)

S1—S4—SPST normally-open pushbutton  
S5—mercury switch (Radio Shack 275-027 or similar)

S6—SPST toggle

S7—SPDT toggle

S8—DPDT toggle

B1—9-volt battery

**Miscellaneous:** cord from Atari joystick, case, perforated construction board, hardware, strain relief, battery clip and holder, etc.

Before installing the oscillator in the case, check it for proper operation. The easiest way to do that is to apply power and check to see if the relay opens and closes at a rate of between 8 and 10 times-per-second. Also, it is very important to make sure that there are no shorts in the circuit. Keep things as neat as possible—if the nine-volts from the battery were somehow applied to the controller's outputs, costly damage to the Atari console might result.

### Hooking it up

To attach the controller to the console, you can use the cable and plug from an old controller, or you can make up your own 6-conductor cable. If you would rather not cannibalize a controller and wish to make your own connector, the pinout diagram shown in Fig. 4 can be used to help you wire a standard DB-9S socket for direct connection to your Atari console. (Note that both black wires in Fig. 2 are connected to the same terminal on the

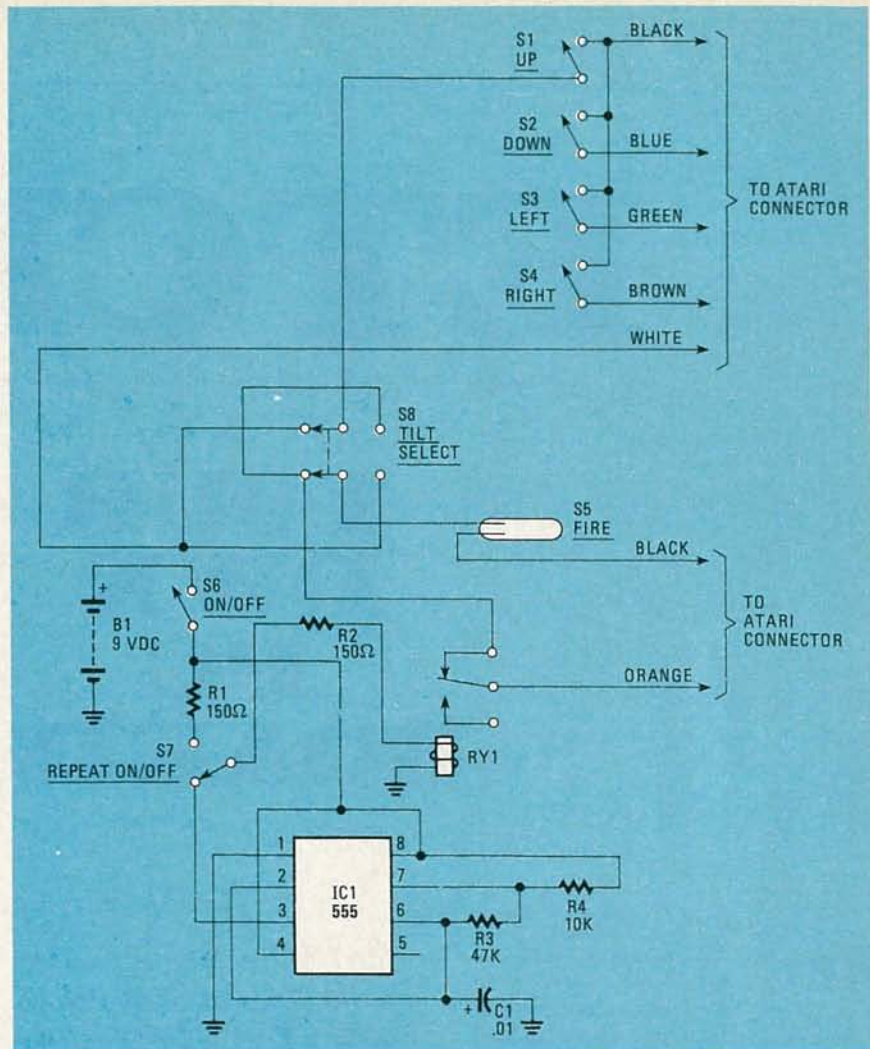

FIG. 2—HOOKUP OF THE CONTROLLER is easy because the Atari cable is color coded.

DB-9S.) In either event, the multi-conductor cable should be connected to a terminal strip as shown in Fig. 3, and all subsequent connections should be made from that strip. As always, be sure to provide some type of strain relief for the cable where it enters the case.

Aside from the relief the controller pro-

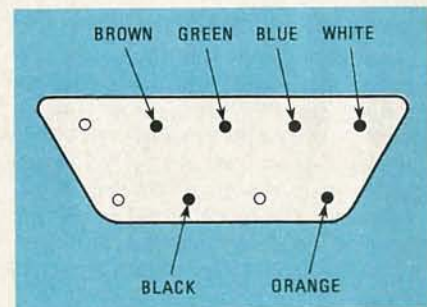

FIG. 4—THIS PINOUT of the socket on the Atari joystick cable can help you to wire your own DB-9S socket.

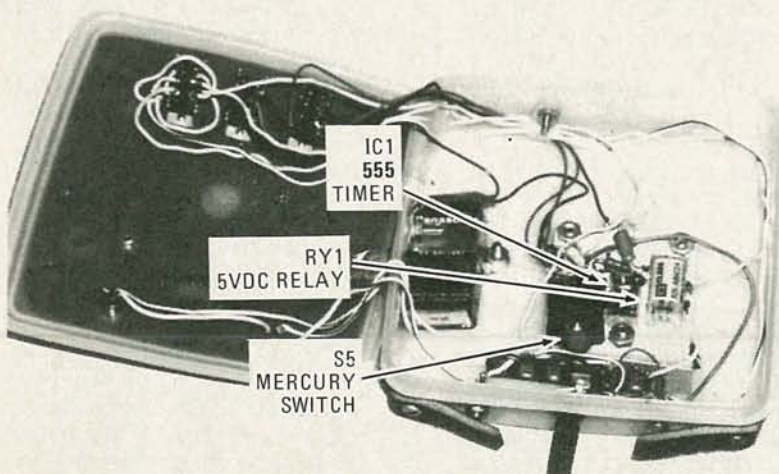

FIG. 3—TILT-SWITCH SENSITIVITY can be made adjustable by mounting the Velcro fastener on the wall of the case instead of on the circuit board.

vides for your hands, the tilt switch and the repeat function allow you to play almost any game more aggressively. The sensitivity of the controller could pose a problem in games that require a light touch, such as Activision's *Skiing*, but should help you get higher scores when you play most other Atari-compatible games. You'll need a bit of practice to master the different motions required by the controller, but once you do, and once you see the kind of scores you'll be running up, you'll probably never go back to the standard Atari joysticks. R-E



# ETCH

## YOUR OWN PC BOARDS

**Part 3** WE HAVE ALREADY shown you how to design a PC board layout and how to make a photo mask. Now we are ready to make the foil mask—the first step in transferring the pattern onto the PC board.

### Making the foil mask

One of the things you'll need to make the foil mask—the film that's used to produce the PC board—is a contact frame. You have two options here. You can either spend a lot of money and get one in a camera shop or you can buy a cheap picture frame—the kind into which you slide a photograph; once the photograph is in place, it's held tight against the glass.

Working under the safelight, cut a piece of black paper to fit the inside of the frame and put a fresh sheet of film on top of it, emulsion-side-up. Put the positive you've just made on top of it, emulsion-side-down. Sandwich the whole thing together in the frame and use the light from the slide projector to make the exposure. If you are using a picture frame, be sure that the film is pressed tightly against the positive and that the positive is pressed tightly against the glass; if needed you can use cardboard inserts to accomplish that. Keep everything as dust free as possible.

The length of the exposure should be the same as the one you used in the last step, (see Part 2 in January's **Radio-**

*Don't let the fear of making PC boards stop your project cold. Let us show you the easy way to make even complicated boards.*

ROBERT GROSSBLATT

**Electronics**) as long as you keep the distance to the slide projector the same. After you develop that piece of film you will have a full-size negative of your foil pattern. The only thing you need to do with it is to check the clear areas and scrape them clean.

Hold the negative over a strong light to make sure that the black areas are completely opaque and that there aren't any pinholes in them. (Pinholes are tiny clear areas that are caused by dust getting trapped between the two pieces of film when the exposure is made.) Although there are special dyes available to correct pinholes, I've found that the white correction-fluid used to fix typing errors works well for small ones (see Fig. 14). Use a very fine brush and dab on a tiny drop of the fluid to cover the holes. Once you're satisfied that the holes have been covered and the traces (the clear areas) are clean, the negative is finished. If your board is single-sided you

can start preparing the circuit-board blank, but if you're making a double-sided board, you still have a bit more work to do with the film.

Put the original 35mm film of the second side of the board into the slide projector. Tape the positive (black-on-white) film of the first side of the board to the wall and project the image of the second side on to it. You'd think that if you adjusted the size the way you did for the first side the two would be the same. Well, it never works. Slight differences in measurement can wreak absolute havoc with the registration of the two negatives. The only way to be absolutely sure that the masks for the two sides of the board will be in perfect registration is to measure one against the other.

Adjust the projected image to match the film you've pinned to the wall. There are two things to check: size and alignment. You can use the IC pads to check for both purposes. Adjust the projected image so the IC-pad spacing is the same as that on the film you've taped to the wall. Once you've done that, make sure that both images are in register at the top and bottom.

If you've made registration marks on the artwork use those; otherwise use the IC pads and the feedthrough points as references for alignment. You may find that you have to tilt the projector and distort the image to make everything line up properly. Pay careful attention to that part of the process because, if the two





images aren't in register, you're going to have a lot of problems drilling holes once the board is etched. Obviously there's some leeway in all this—even when it comes to drilling the holes. As a general rule, however, if the size or alignment is off by more than about  $\frac{1}{32}$  inch you're going to have real problems.

Errors have a nasty habit of adding to each other rather than cancelling out, and that's the reason you have to measure one side of the board against the other instead of using a grid for both of them. After the

exposure has been made and the film developed, tape the two positives together to make sure the registration is correct. Try to line up the holes at both edges. If they're off you're going to have to do the second side of the board again. The chances are, however, that if you've been careful all along the registration will be correct.

Once you're satisfied that everything is lined up properly, make the actual negative (white-on-black) exposure mask for the second side of the board, check it one

more time, and put all of the negatives safely away.

#### Board and processing materials

There are different types of copper-clad PC-board material available. The differences have to do with the weight of the copper and the material the board is

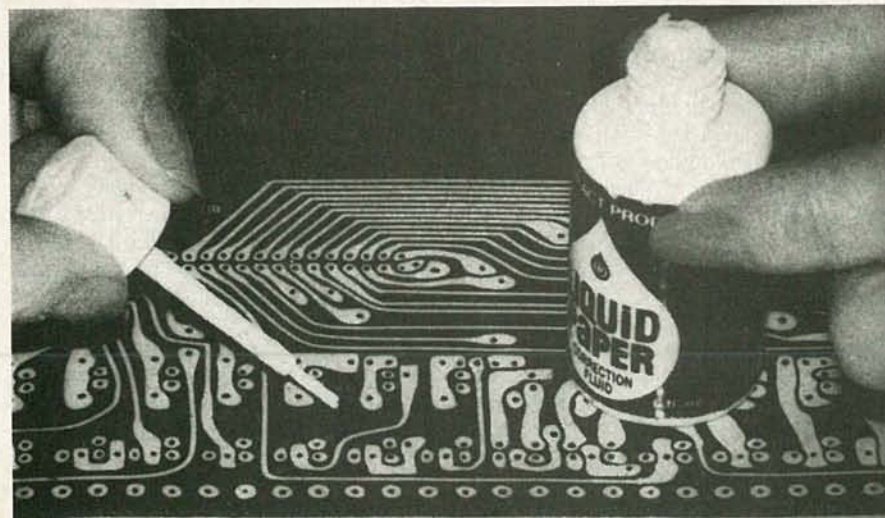

FIG. 14—TYPEWRITER CORRECTION FLUID can be used to get rid of pinholes in the finished negative.

#### SUPPLIES

##### Layout

- 20 × 24 inch sheets of  $\frac{1}{16}$ -inch grid graph paper (non-repro blue)
- Non-repro blue pencils
- Fine-line black felt-tip pens
- Double-size PC-drafting aids (IC pads, doughnuts, etc.)
- Ruler and caliper
- Black layout-tape of different thicknesses
- Transfer-type lettering

##### Mask

- 35mm camera
- 250-watt floodlights (2)
- 35mm slide projector
- 35mm glass slide mounts
- Contact frame
- Ortho (litho) film (35mm and large enough for the actual-size mask)
- Ortho (litho) developer, stop bath, and fixer
- Red gel and safelight

##### Board

- PC-board blanks
- Spray-sensitizer and developer
- Glass trays
- 250-watt sunlamp or 40-watt fluorescent lamp
- Etchant



made from. The weight of the copper refers to the thickness of metal on the board and is expressed in ounces. The best all-around choice is one-ounce board. The copper is not so thick that it causes problems when you etch it, but is still thick enough to allow traces as thin as  $\frac{1}{32}$  inch. Not only that, but a  $\frac{1}{16}$ -inch-thick trace of one-ounce copper can safely handle up to five amps; thicker traces can handle proportionately more.

The best board material is glass-epoxy laminate; anything else is not as good, and some types of board, such as phenolic board, are really junk. There's a difference in price, of course, but the quantities you're likely to be using are so small that the actual difference in cost is not going to be significant.

Once you've picked out your board, the next step is to sensitize it; the chemicals for that are available from a wide variety of sources. While it's possible to buy presensitized board, it's much cheaper to do it yourself. (Besides, if anything goes wrong and you have to redo the board, you'll have to resensitize it anyway.)

There are two types of sensitizers, and each has its own type of developer. Sensitizers are either "negative" or "positive." Negative sensitizers leave resist wherever they are struck by light, while positive sensitizers leave resist where they are protected from light.

I recommend using the negative process for several reasons. First, the additional mask-making step allows you to make corrections more easily to both foil and etched areas. You can make corrections on the white-on-black film with both an X-ACTO knife and dye or correction fluid, and corrections on the black-on-white one with the knife.

Second, if, for some reason, the mask does not make perfect contact with the sensitized board when you expose it (see below), light may "leak" under the edges of the opaque areas of the film and cause copper that you need to be etched away. If you were using the positive process, you might lose some of your thin traces. With the negative process, however, you would be more likely just to increase slightly the amount of copper that would not be etched; you might have to remove a little copper from traces that ran close together, but removing copper from a PC board is a lot easier than trying to put it back.

### Making the board

Cut the copper-clad board large enough to allow at least a one-inch border around the negative. If you're making a double-sided board, tape one of your negatives to the board, emulsion-side-down; make sure that the negative is well centered. Pick four feedthroughs—one near each edge of the board—and drill holes through the negative and the board as shown in Fig. 15. Mark the corner of the

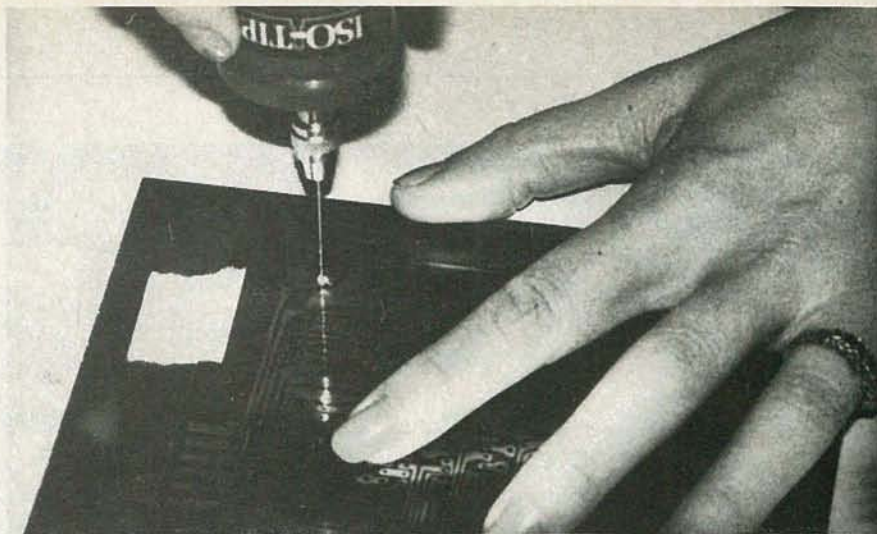

FIG. 15—IF THE BOARD IS DOUBLE SIDED, tape one of the negatives to the board and drill out four of the feedthrough holes. Those holes will be used later to make sure that the two sides of the board are in register.

board by scratching the copper so you'll be able to tell which is the top.

Turn the board over and line up the other negative with the holes you just drilled; they should line up perfectly. Drill holes in this negative for the four feedthroughs. Mark this side of the board as well, and make sure you'll be able to tell which negative goes with which side.

Clean the copper-clad board by scrubbing it with a piece of fine steel-wool and household cleanser—a soap pad is perfect. The copper probably has some oxidation on it and you want to make sure you get it all off. To test whether the board is clean enough, run water over it—if it's good and clean, the water will bead, and not spread out over the copper. (You can see the same effect on a freshly waxed car.) Dry the board with paper towels and **be sure to keep your hands off it.** The sensitizer won't adhere well to any areas of the board contaminated with skin oils.

Several companies package sensitizers, but only a few mix them with a dye. We recommend using that type as the sensitizer itself is just about colorless; the dye makes it easier to see the board during developing, which makes it easier to tell when the process is finished.

The sensitizer comes in an aerosol can and is, of course, light sensitive. For that reason, it has to be handled like the unexposed film—under a safelight.

Be sure to spread lots of newspaper around because you can't really keep the spray from going beyond the immediate area of the board. Then, rest the board at a 45° angle and, still working under a safelight, apply the sensitizer, holding the can about 10 to 12 inches from the surface of the board. The technique here is the same used in applying spray paint. Keep the nozzle moving back and forth over the board and move from top to bottom. Don't apply too heavy a coat of sensitizer or it will run. On the other hand, too thin a

coat will disappear in the developer. When you've applied the sensitizer to the entire board, lay it down flat and leave it alone for about 10 minutes to allow the sensitizer to smooth out and thicken.

You can dry the board either by letting it sit overnight, or you can force-dry it in an oven. If you use an oven, **don't let the temperature get above 110°F.** If you do, the board will get heat-fogged and be useless—the effect is similar to what happens when you expose photographic film to X-rays. Thirty minutes or so is all you need to oven-dry the board. If you're making a double-sided board you'll have to spray the other side of the board and repeat the drying procedure. If you're not sure whether the board is dry, smell it; the drying agents in the spray have a distinctive odor that will be present as long as the board is the least bit wet.

If you're making a single-sided board, all you have to do next is lay the negative emulsion-side-down on the sensitized board, put it in the contact frame, and make the exposure (see below).

A double-sided board has to be prepared differently to make sure that the two sides remain in register. Get a slab of stiff styrofoam—the white packing material used to cushion radios, etc. during shipping (you can also find it at many florists—they use it to prepare flower arrangements). Put a wire brad, point-side-up, through each of the holes that you drilled in the copper-clad board. Then lay the negative on top with the brads through its registration holes. Place the board, negative and brads on the styrofoam and take a piece of glass larger than the board and push it down over the board. The brads will be pushed into the styrofoam, and the negative will be tightly sandwiched between the glass and the copper-clad board.

The sensitizer reacts to ultraviolet light. Ordinary light-bulbs or a slide pro-



**TABLE 1—TROUBLESHOOTING GUIDE**

<b>Problem</b>	The pattern appears on the board but is washed away by the developer.
<b>Cause</b>	1. The sensitizer is sprayed on too thinly 2. The board wasn't completely dried 3. The board wasn't well cleaned before the sensitizer was sprayed on
<b>Problem</b>	No image appears when the board is developed.
<b>Cause</b>	1. The exposure was insufficient 2. The board was overheated in the oven when it was dried 3. The developer is exhausted
<b>Problem</b>	The pattern is evident but the etchant has no effect on it.
<b>Cause</b>	1. The etchant is exhausted 2. The developer is exhausted 3. The exposure was too long 4. The mask wasn't completely opaquex
<b>Problem</b>	The pattern is attacked by the etchant.
<b>Cause</b>	1. The sensitizer was sprayed on too thinly 2. The exposure was inadequate
<b>Problem</b>	The pattern blisters and flakes away in either the developer or the wash.
<b>Cause</b>	1. The board wasn't clean when it was sprayed 2. The board wasn't completely dried 3. The sensitizer was sprayed on too thickly

jector don't put out a whole lot of energy in that part of the spectrum, but a sun lamp does. If you don't have one, you can use a fluorescent lamp, but the exposure times will be longer. I use a mercury-vapor type home sun lamp. With that, I keep the light about three feet from the board and use an exposure of about four minutes. If you use a fluorescent lamp-fixture with two 20-watt bulbs in it, try ten minutes as a starting point and keep the distance between the bulbs and the board about ten inches. You will have to experiment a bit to find the correct exposure time.

If you are making a double-sided board, you'll need to repeat the process for the other side. Working under the safelight, remove the brads, turn the board over, position the second-side negative, and re-insert the brads; the rest of the procedure is the same as that for the first side of the board.

The next step is to develop the board; that must also be done working under a safelight. Make sure the developer you get is made for the negative-type sensitizer. Don't use a plastic tray, because the solvent action of the developer will eat right through most plastics—use a glass or metal tray to avoid winding up with a ruined board and a lap full of exotic esters and ketones. Also, to make your work easier, be sure that the tray is large enough to provide a few inches of finger room all around the board.

Fill the tray with developer to a depth of ½ inch. If you are making a single-sided board, you can simply lay it on the bottom of the tray, pattern side up. With a double-sided board, however, you'll have to hold the board **by the edges** to keep it suspended above the bottom of the tray. That's because the resist gets really soft when it's in the developer and if it

rubs against anything (including your fingers) its going to smear and ruin a lot of work. Gently agitate the solution and you will see the circuit appear after about thirty seconds.

You can check to see how things are proceeding by removing the board from the solution; be sure to hold the board so that any developer that remains on the board when you remove it can drain back into the tray. If the pattern appears clearly on the board, let the developer drain off and then dunk the board repeatedly in water. Don't let running water hit the board for the first twenty seconds or so because you run the risk of smearing the resist—remember that it's very soft and easy to ruin. If you've used a sensitizer with a dye, the pattern will be easy to see. If not, you'll only be able to see the pattern by holding the board so that the light from the safe light will hit it at an angle. With the resist still swollen with developer, the pattern will be easy to see. As the developer evaporates or is washed away, however, the pattern will disappear. Just remember to keep the pattern from touching anything.

After you've washed the developer off, blow and shake the excess water off the board (**do not wipe it off**) and reimmerse it in the developer. Give it another 30 or 40 seconds of gentle agitation and then wash it again. The best time to tell if the board will etch well or not is when it's in the water but the resist is still full of developer. Every place that was covered by the mask will shine brilliantly because the copper won't be covered by any resist—it will look really clean and polished. If the pattern is mottled, or the resist won't clear from the areas of the board where it's not wanted, you'll have to scrub the board clean and go through the whole process again.

## Etching the board

Once the board has been developed completely, a safelight is no longer needed. Etching the board is the easiest part of the whole process. Ferric chloride is a popular etchant, but use whichever one is most convenient for you.

The first step is to heat the etchant up to 125°, since the hotter the etchant is the faster it works. Pour the warm solution into a tray (glass or plastic, as the etchant will react with almost any metal). Then, drill a hole in one corner of the board and slip a piece of heavy-duty thread through it. Tie it and use the thread to agitate the board in the etchant.

When you first immerse the board you can get a good idea of how easily it will etch because all the unprotected areas of the board will turn black as the etchant attacks the copper. If that doesn't happen, agitate the board for a few minutes and then take it out and rinse it off in running water. The pattern should be shiny and protected under the resist, but the rest of the board should be a dull copper color because of the action of the etchant. Examine the board closely and if you spot any problem areas or unwanted blobs of resist you can scrape them away with an *X-ACTO* knife. Constant agitation should etch the average board in about fifteen minutes. Take the board out and examine it periodically. If you spot breaks in the pattern you can dry the board and cover the breaks with tape. If one side of the board etches faster than the other, don't take the chance of having the faster side being undercut by the etchant. Dry the whole board and cover the areas you want to protect with spray acrylic, electrical tape, or just about anything waterproof.

When the etching process is finished, **don't scrub off the resist**. Wash the board and dry it with paper towelling. Drill the holes for the components and then use a saw to trim the board to size.

If you're making a double-sided board, drill the first few holes somewhere on the board where there is room for error so that you'll be able to see whether the alignment is exact or not. Since you made the patterns by laying one image over the other, you can be sure that the size is correct, but sometimes the negative for one side of the board can get shifted slightly and throw the alignment slightly off. You can usually correct for that by drilling the hole at an angle, rather than straight through the board. If you make your first few holes in a place on the board where things aren't so cramped, and you drill from the foil side to the component side, you'll be able to see whether such a tactic is needed. Since the negatives were made in register, if *one* hole is off to one side, *all* the holes will be off. That, however, can usually be corrected by drilling in the proper direction and you'll never probably find any correction other than that to be necessary.

*continued on page 104*



# HOW TO

## Interface R/C Servos

*R/C servos are good for more than controlling model planes and cars. Here's a description of how they work, and some ideas on how you can use them.*



DAN and JEANETTE PELTON

RADIO-CONTROL (R/C) SERVOS ARE GOOD for much more than just operating model aircraft or boats. They can be used to keep a signal generator on frequency, steer a small robot, govern your lawnmower, interface a computer to run a strip-chart recorder—in fact, those miniature servos provide just about the ideal electrical-to-mechanical interface. They are simple to use and cost-effective, and the circuits needed to drive them are simple, and easy to build—you can even put them together on prototyping boards.

### How servos work

Servos are slow-running electric motors that can be stopped and started almost instantaneously. As long as they receive a control signal they run; when it stops, so do they. That makes them well suited for use in proportional-control systems, such as are used in model airplanes, boats, and cars. The control signals can be sent by radio, or fed directly to the servo-control circuits.

R/C servos generally operate from TTL logic-level voltages—about five volts—which makes them very convenient to interface with computer or other TTL circuits. The devices—which may generate several pounds of thrust—draw a maximum of 400 mA to 1000 mA, depending on the particular type used. Servo-control signals are pulses whose widths vary from one to two milliseconds in length; the servos convert that pulse-width-modulated signal into a precise mechan-

ical movement.

Inside the servo housing is an IC that provides all the functions needed to convert the width of a pulse into the signals needed to drive the servo motor so that the output shaft is correctly positioned. Figure 1 shows a block diagram of a typical servo-driver IC and its connections to the servo motor. The output shaft of the servo motor is attached to a potentiometer. As the output shaft is driven by the motor, the voltage across the potentiometer varies. The amplitude of that voltage is directly related to the position of the output shaft, and the voltage is fed back to the servo-driver IC where it controls the time duration of an internal one-shot pulse generator.

When a logic-level input pulse reaches the servo-driver IC, two things happen. First, the internal one-shot pulse generator previously mentioned is triggered. The time duration of the one-shot's output pulse is controlled by the feedback voltage from the potentiometer on the output

shaft of the motor. The duration of the output pulse is compared to that of the input pulse by two NAND gates. The result of the comparison will trigger one of the two pulse stretchers; that in turn will either set or reset the directional flip-flop.

(The pulse stretchers are required because in many servo applications—model aircraft, for example—as many as eight channels can be in use at the same time with information being transmitted sequentially to as many as eight servos. Under those circumstances, as many as 25 milliseconds may pass before a particular servo receives another input pulse. The pulse stretchers keep the servo motor running for most of the time between input pulses, keeping "chatter" to a minimum and allowing greater speed and efficiency.)

The output of the flip-flop will cause the servo motor to be driven by one or the other of the motor-drive circuits; the circuit selected will determine the direction in which the motor will turn. The motor



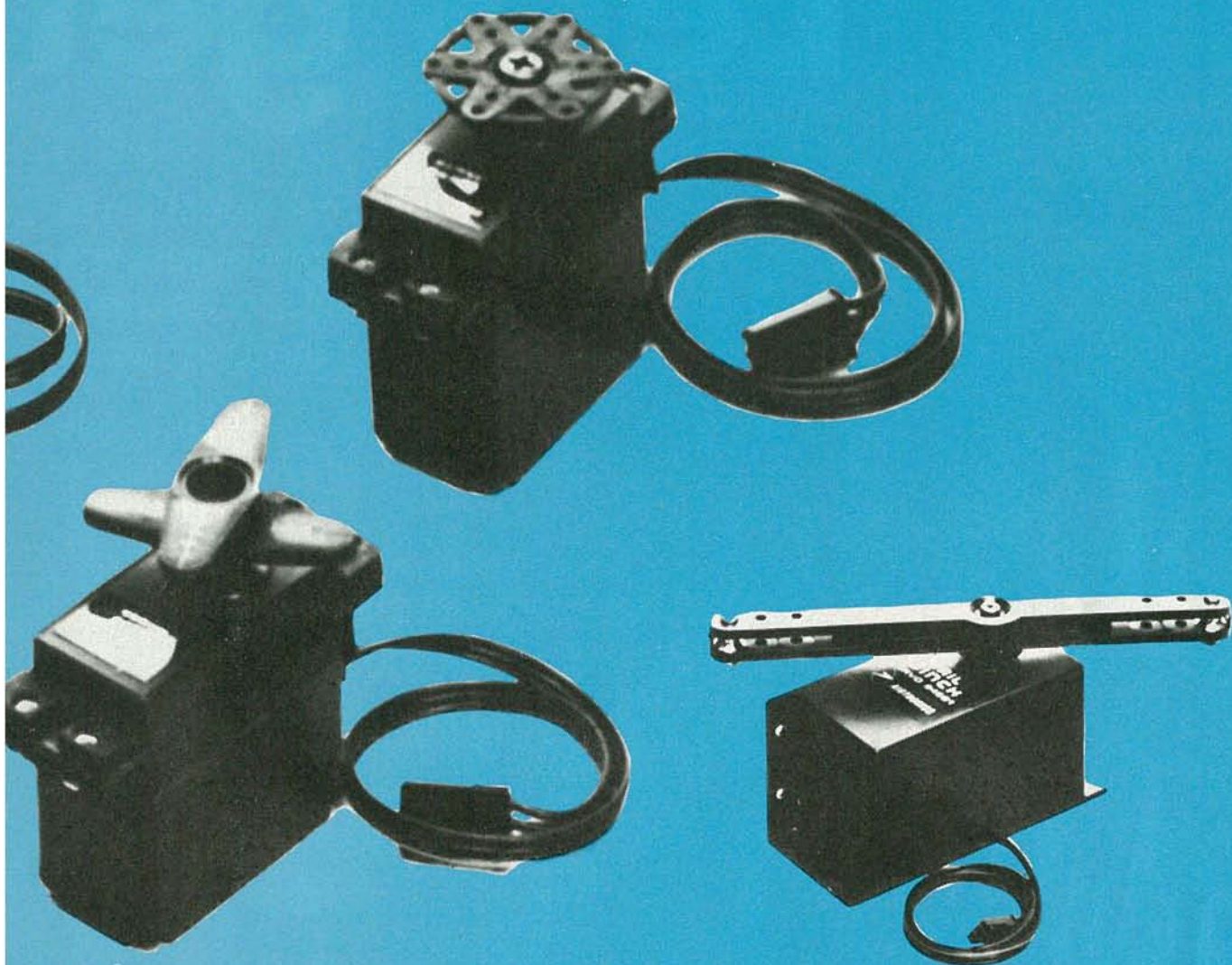

will turn the output shaft until it reaches a position that causes the input pulse and the pulse from the one-shot to be of equal durations.

A one-millisecond input pulse will drive the output shaft of the servo motor to one extreme, and a two-millisecond pulse will drive it to the other.

#### A servo-control circuit

In most applications, you will need to convert the amplitude of a DC voltage into a pulse-width-modulated signal that can be used to drive the servo motor. For example, you may have a remote TV camera that you want to be able to aim from your monitoring location. Your control console could have a joystick for that purpose which, when moved, would move the shaft of a potentiometer.

The output of the potentiometer would be a DC voltage related to the position of the joystick and would have to be translated into a pulse-width-modulated signal that could be used to control the servo.

That signal can be generated by a single quad op-amp (one IC containing four separate op-amps) like National Semiconductor's LM324.

An easy-to-build PWM (Pulse Width Modulation) circuit using that IC is shown in Fig. 2. Two sections of the IC (IC1-a and IC1-b) function as a ramp generator whose output is a sawtooth waveform. Op-amp IC1-c is a conditioner that limits the DC level and peak-to-peak swing of the input signal. The last section of the IC (IC1-d) compares the output of the signal conditioner with the ramp (triangle) waveform. The signal conditioner is adjusted to provide a comparator output that is compatible with the servo's requirements.

The heart of the ramp generator is IC1-b. It operates as an integrating amplifier with capacitor C1 acting as the integrating- or feedback-element of the circuit. If the output of IC1-a is negative, a current will flow through R4 and try to pull the inverting input of IC1-b down. In

response, the current output of IC1-b will increase so the current flow through C1 continues to equal the current flow through the input resistor R4.

That charges C1 and, if nothing else were to happen, IC1-b's output would reach its positive limit and stay at that level. However, IC1-a is configured as a Schmitt trigger that monitors the output of IC1-b, and when IC1-b's output voltage reaches a certain point, IC1-a changes state (it goes high). Current then flows through D1 and R3, and the input of IC1-b goes high and its output drops rapidly. When it drops to a certain point, IC1-a changes state again, and the whole cycle repeats. The repetitive cycle generates a sawtooth waveform with a positive going ramp.

#### Adjustment

After you've built the circuit, if you have an oscilloscope available, connect its probe to the output of the comparator (IC1-d). Set the OFFSET potentiometer,



# Let's get

try out the in-stock selection of Heath/Zenith microcomputers, peripherals, accessories and software.

Now available at your nearby Heathkit Electronic Center, or through the Heathkit mail order catalog.

You get more with a Heath/Zenith personal microcomputer system! We offer:

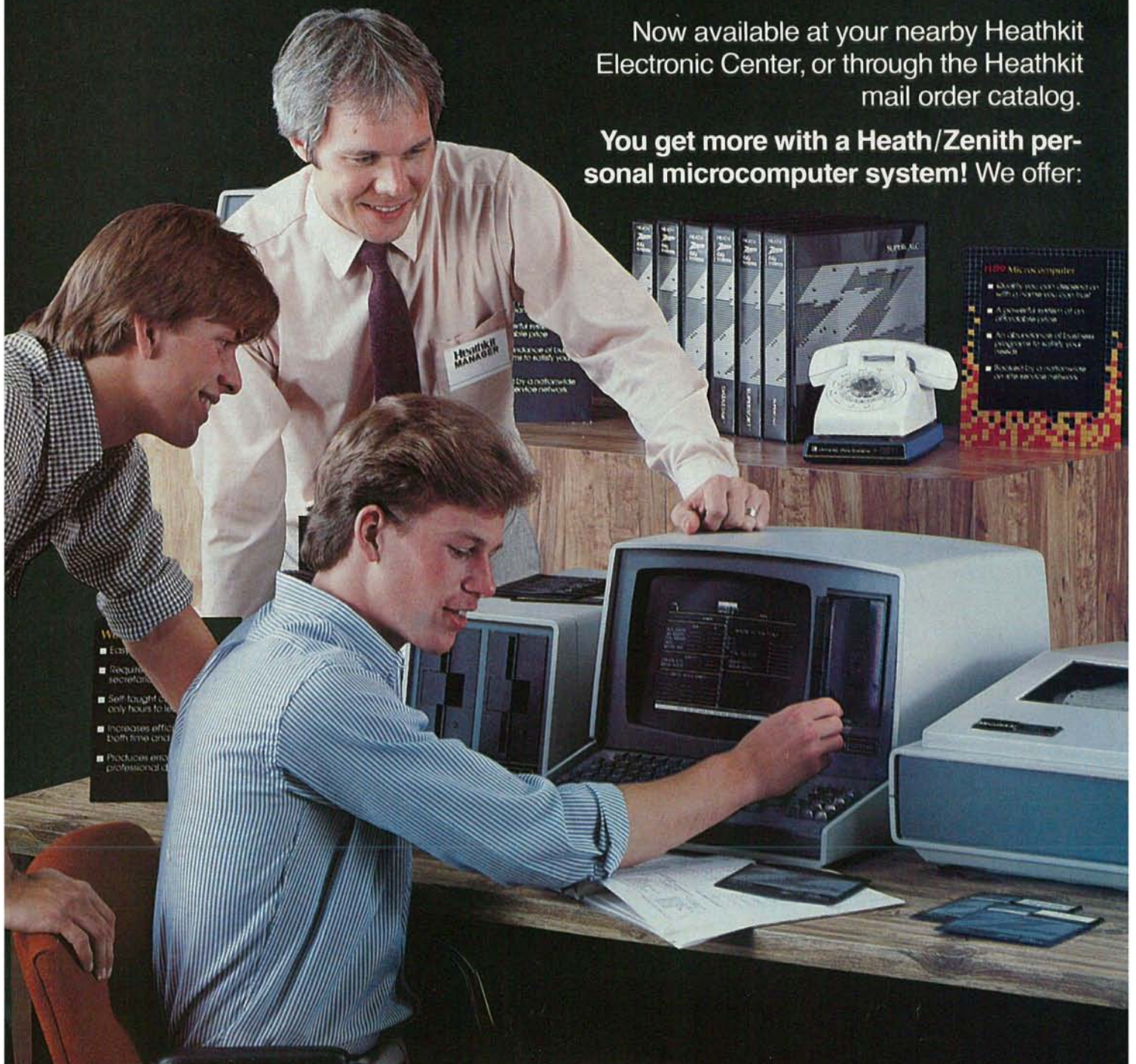

Heathkit  
MANAGER

1100 Microcomputers  
■ Easily use your microcomputer with a network system that  
■ A powerful system of an affordable price  
■ An extensive line of software programs to suit your needs  
■ Backed by a nationwide computer network

Why  
■ Easy  
■ Frequent  
■ Self-taught  
■ Increases efficiency  
■ Produces more professional



# personal...

- 1. Proven, high-performance hardware:** Thousands of our microcomputers are proving themselves daily, in the field.
- 2. Vast software library:** Three operating systems (including CP/M), languages, word processors, an electronic spreadsheet, versatile utilities and the 500-program Heath Users' Group software library.
- 3. Self-instruction courses:** Evaluation and programming courses from Heathkit/Zenith Educational Systems.
- 4. Service support:** Before and after the sale — consultation by phone, carry-in service.

**Test run one of our microcomputers at any of the more than 60 convenient Heathkit Electronic Centers in the U.S.**

## Heathkit<sup>®</sup> ELECTRONIC CENTERS\*

See the white pages of your telephone book for store locations and telephone numbers.



\*Units of Veritechnology Electronics Corporation in the U.S.



Or if you prefer, send to the address below for a

### FREE catalog:

Heath Company  
Dept. 020-984  
Benton Harbor, MI 49022

In Canada: Heath Company  
1480 Dundas St. E.  
Mississauga, ONT L4X 2R7

Please send my free catalog, describing your complete line of microcomputer products!

Name \_\_\_\_\_

Address \_\_\_\_\_

City \_\_\_\_\_ State \_\_\_\_\_

CP-214 \_\_\_\_\_ Zip \_\_\_\_\_

CIRCLE 37 ON FREE INFORMATION CARD



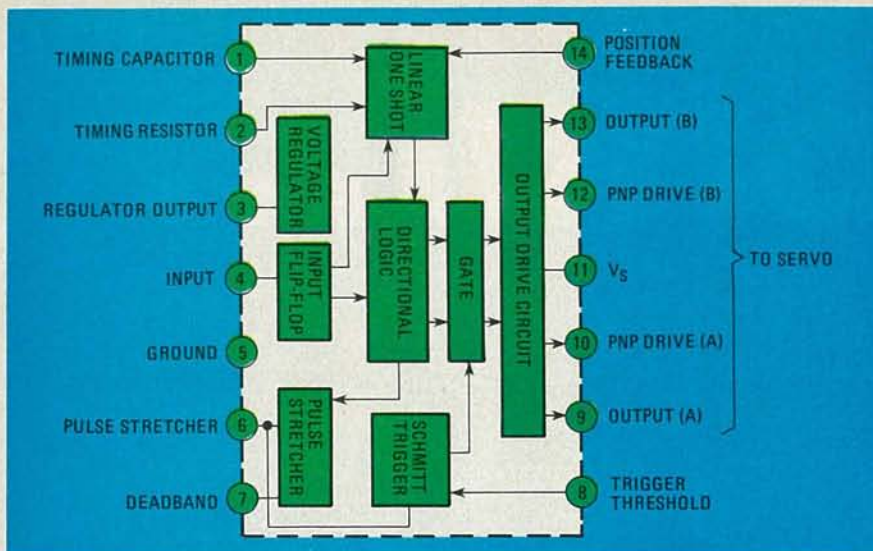

FIG. 1—SERVO-DRIVER IC DECODES input pulses and outputs signals that cause the servo motor to turn in one direction or the other.

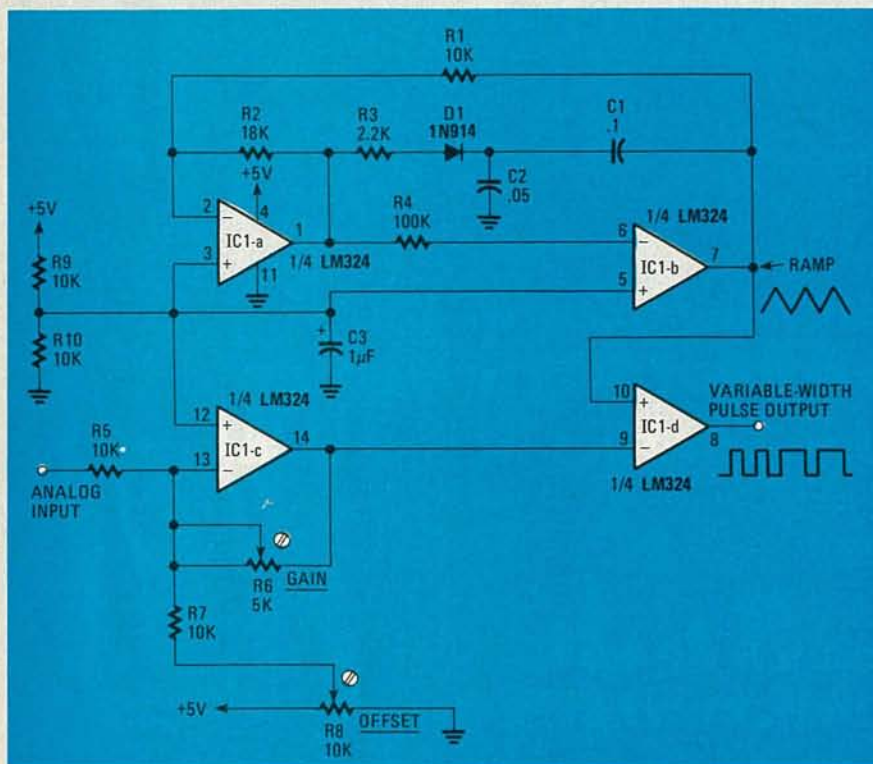

FIG. 2—ANALOG-TO-PULSE-WIDTH CONVERTER senses DC-voltage level and outputs a corresponding variable-width pulse-string to servo-driver IC.

R8, for a pulse width of about 3 ms. At the signal input (R5) apply the lowest voltage you are likely to use and observe the duration of the pulse on the scope (still connected to the output of IC1-d). Then apply the highest-level signal you expect to use and observe the pulse-width. Set R6 (GAIN) so that changing from one input-voltage extreme to the other results in a one-ms change in pulse duration. Once that is achieved, apply the lower-level signal to the input and adjust R8 for a two-ms pulse width. A high-level signal should then cause a one-ms pulse to be generated.

Connect your servo to the pulse-width output. The black or green lead of the

servo is ground; red is the positive supply-voltage, and the remaining lead is for the pulse signal.

Apply the control signals from your generator and be sure the servo doesn't jam. A jamming condition is best determined by measuring the current drawn by the servo. If the current draw exceeds the midrange idle-current at either extreme of the servo's travel, adjust R8 slightly. (Midrange idle-current can be measured when the servo is at any position other than an extreme.) If the servo jams at both travel extremes, adjust R6 to eliminate the problem. If your servo requires negative-going pulses, they can be obtained by adjusting R8.

## PARTS LIST

All resistors 1/4-watt, 5%, unless otherwise specified

- R1, R5, R7, R9, R10—10,000 ohms
  - R2—18,000 ohms
  - R3—2200 ohms
  - R4—100,000 ohms
  - R6—5000 ohms, trimmer potentiometer
  - R8—10,000 ohms, trimmer potentiometer
- Capacitors**
- C1—0.1 $\mu$ F
  - C2—0.05 $\mu$ F
  - C3—1 $\mu$ F, tantalum
- IC1—LM324  
D1—1N914

**Miscellaneous:** perforated construction board, wire, 5-volt power supply, IC socket, cable and connector for computer's parallel port, servos and linkages, etc.

Servos can be purchased at most "hobby shops" that sell R/C equipment. Check your local Yellow Pages under "Hobby & Model Construction Supplies." They are also available mail order; check the ads in modelling magazines.

## Computer control

To control a servo with a home computer, all you need is one line of a parallel port and a program with a timing loop that will provide pulse signals of one to two ms in length that repeat every 20 milliseconds. The pulses will have to be repeated enough times to ensure that the servo has reached the desired position—usually half a second is enough to go from one extreme to the other. Servos are apt to cause power supply noise, so it might be a good idea to add a 0.01- $\mu$ F capacitor across the servo's power-supply terminals.

## Applications

The output wheel on the servo's shaft can be attached directly to a pen or pointer for use in a strip-chart recorder. It can be directly hooked to a robot arm using model-aircraft linkages. For steerable devices, borrow the front-end parts from model-aircraft nosegear. To govern the speed of a lawnmower, hook an arm from the servo shaft directly to the lawnmower engine's throttle plate; that should give you nearly instant control.

R/C servos have dozens of uses, whether or not you use a computer to control them. Give them a try in your next project.

R-E



"I'd tape toy commercials and play them for Mom and Dad just before my birthday."



# BUILD THIS AUTOMATIC

## COMMERCIAL EDITOR

*With this handy accessory you can make commercial-free tapes of your favorite black-and-white movie classics and TV programs.*



## FOR YOUR VCR

GARY McCLELLAN

**Part 2** NOW THAT YOUR COMMERCIAL editor is almost complete, you can begin the final adjustments and assembly.

### Adjustments

Before making the final adjustments use an alignment tool to preset the L1 and L2 coil-slugs to mid-position; that's close to the correct adjustment for them.

There are two ways you can make your adjustments. One method is to use an RF signal-generator with an output at 3.579 MHz along with an analog voltmeter. The other method, which is just as good, is to use a low-cost calibration tool designed specifically for this application together with the analog voltmeter. That tool, a simple single-frequency RF signal generator, will be described in the section on "Options."

Do not attempt to use an off-the-air video signal to make the adjustments—the signal level varies too much for accurate results. With that precaution in mind, let us proceed.

Both methods use the same easy-to-perform procedure. Start by plugging T1 into a nearby AC outlet; then turn on S1. The relay should click if all is well. Connect your analog voltmeter across R4 and set it to the 1-VOLT DC range. The meter must read zero with no signal applied. Then connect either your RF signal gener-

ator or the calibration tool to P1 (VIDEO IN). Set the RF signal generator for 3.579 MHz. The calibration tool requires no adjustment, but you'll need a nine-volt battery to power it.

Adjust the RF-level control on either signal source for about 0.1- to 0.3-volt-DC on the meter; then slowly adjust L1 for maximum output. Be sure to use a nonmetallic alignment tool for this; metal causes detuning, which can lead to misadjustment. As necessary, reduce the RF level so that the output stays at or below 0.3 volt. You should be able to get a sharp peak.

Next, carefully adjust L2 for maximum output, again reducing the RF level as necessary to keep the meter reading at or below 0.3 volt. That adjustment should also peak-up nicely. If you have any problems making the adjustments, send a self-addressed, stamped envelope to the supplier indicated in the Parts List. You'll receive a free troubleshooting guide, which should solve your problems. Finish by carefully touching up L1, and then L2. When you are satisfied that both coils are peaked, you are finished. Remove the analog voltmeter and the signal source.

### Final assembly

If you like, you can now install the completed unit in a suitable case. A small plastic clock-cabinet works well. We do

not recommend that you attempt to install the editor inside your recorder, because most machines don't have enough room for it.

### Options

There are two simple accessories you can build for use with your commercial editor. The first is a 3.58-MHz signal generator to help in adjusting the unit and the other is an adaptor that allows you to use the editor with a VCR that has a pushbutton PAUSE control (the device was designed for VCR's with slide-switch controls).

The schematic of the signal generator is shown in Fig. 7. It's a very simple device; the only critical part is the crystal, which should be cut for 3.579545 MHz  $\pm 0.01\%$ , parallel-resonant (20 pF). A crystal in an HC6/U case will fit nicely on the PC board shown in Fig. 8. Parts placement for the signal generator is shown in Fig. 9; the editor's input-cable plugs into J1.

If your VCR has a pushbutton remote control, you'll need the adaptor shown in Fig. 10. In use, photocell PC1 is placed over the PAUSE LED on the VCR. When relay RY1 closes—indicating that a commercial is being broadcast—pin 2 of EXCLUSIVE-OR gate IC1-a goes high (pin 1 is low at that point) and the output of that section of the IC also goes high. That



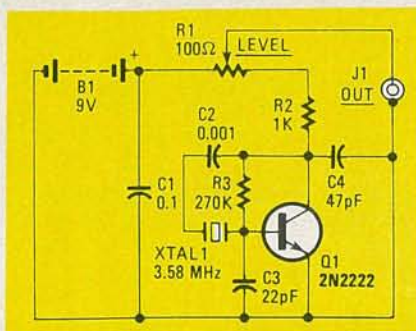

FIG. 7—IF YOU DON'T HAVE a signal generator, you can build this one to align the editor.

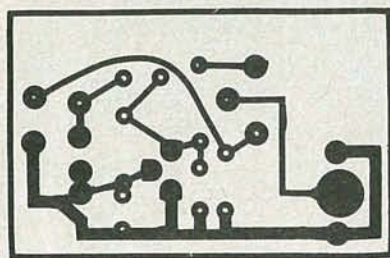

FIG. 8—FULL-SIZE foil pattern for signal generator.

#### PARTS LIST—PUSHBUTTON PAUSE-CONTROL

All resistors 1/4-watt, 5% unless otherwise specified

- R1, R2—27,000 ohms
- R3—1 megohm
- R4—10 megohms
- R5—1000 ohms
- R<sub>x</sub>—see text

#### Capacitors

- C1—0.1 μF, ceramic disc
- C2—0.1 μF, Mylar

#### Semiconductors

- IC1—4070 CMOS quad EXCLUSIVE-OR gate
- Q1, Q2—VN10KM FET (Radio Shack 276-2070 or equivalent)
- LED1—jumbo LED
- D1—1N4148
- PC1—photoresistor (Radio Shack 276-116 or equivalent)

**Miscellaneous:** perforated construction board, 9-volt battery, plug (PL1) and jack to fit recorder and editor, etc.

triggers the 2-Hz oscillator formed by IC1-b and IC1-c, which in turn, causes switching transistor Q1 to output a pulse to the VCR's PAUSE jack.

That pulse is interpreted by the VCR's microprocessor as a signal to stop the machine and to light the PAUSE LED. The illuminated LED causes 9 volts to flow through PC1, taking pin 1 of IC1-a high, and stopping the pulse generator. When the relay opens after the commercial(s), pin 3 of IC1-a goes high again (pin 1 is high and pin 2 is low) and another pulse is generated that causes the recorder to start up. Transistor Q2 and LED1 are optional—they substitute for the covered-up LED on the VCR to indicate when the

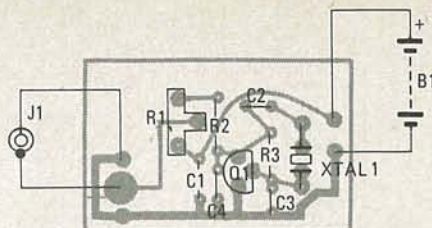

FIG. 9—OUTPUT JACK, J1, can be mounted on PC board by drilling out large foil pad completely and running resistor lead to trace leading to it.

machine is in a pause state.

Resistor R<sub>x</sub> is required by many systems. To find out whether you need to include it, measure the resistance across the plug of your remote control with its

#### PARTS LIST—SIGNAL GENERATOR

All resistors 1/4-watt, 5% unless otherwise specified

- R1—100 ohms
- R2—1000 ohms
- R3—270,000 ohms

#### Capacitors

- C1—0.1 μF, ceramic disc
- C2—0.001 μF, ceramic disc
- C3—22 pF, ceramic disc
- C4—47 pF, ceramic disc

#### Semiconductors

- Q1—2N2222
- XTAL1—3.579545-MHz, parallel-resonant (20pF), HC6/U case
- J1—PC-mount RCA phono jack

**Miscellaneous:** PC board, 9-volt battery, solder, etc.

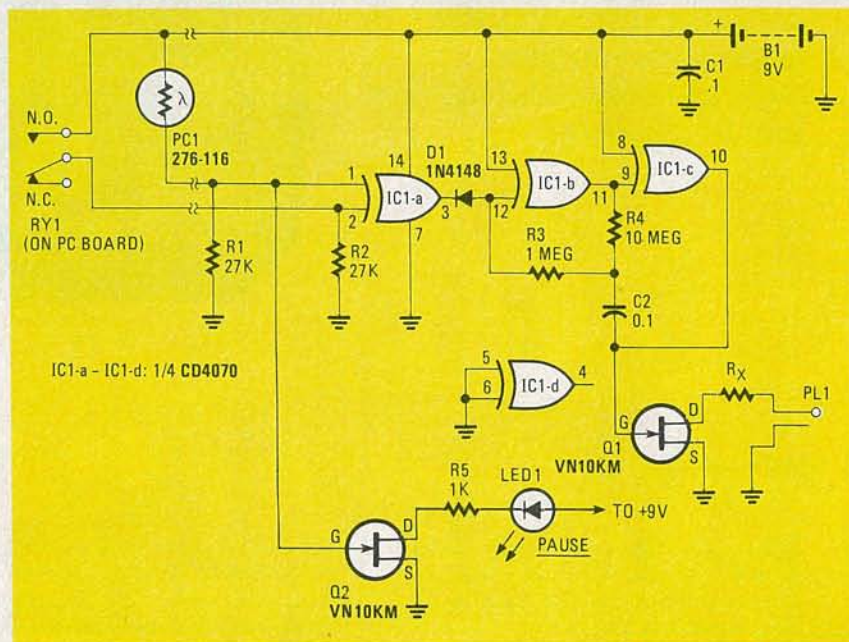

FIG. 10—BUILD THIS PAUSE-CONTROL converter if your VCR uses pushbutton-type controls.

The following are available from Technico Services, 1920 W. Commonwealth Ave., Box 20HC, Fullerton, CA 92633: kit of all parts, less case, (CK-2), \$54.00 plus \$3.50 postage & handling (nonrefundable); PC board only (CK-1), \$10.00, postpaid; assembled and tested calibration tool (3.58-MHz signal generator) (CAL-3), \$10.00, postpaid. California residents please add 6% tax.

#### Use

Operation of the editor is simplicity itself. Plug P1 into the VIDEO OUT jack on your recorder; then plug P2 into the PAUSE jack on the machine. If you have a remote pause-control, and wish to use it, plug it into J2 on the editor. If you are using the pushbutton-control option, follow the instructions in the "Options" section.

To record a black-and-white movie without commercials, perform the following steps in the order given. First turn on the editor using S1. That is done because the relay momentarily closes upon power-up, and that can stop the recorder unnecessarily. Then turn the recorder on, tune to the channel you want, and push the RECORD lever or button. The VCR will now automatically stop during color commercials, and then restart when the movie resumes. That is all there is to it.

To tape commercial-free programs while you're away, simply leave the editor on and set the recorder's timer and channel-selector, and put the recorder in-

continued on page 104



# BUILD THIS

## Digital IC Tester

An IC tester like the Programma III can make work a lot easier for you. Here in Part 2 we'll continue with the construction of the device

GARY McCLELLAN



**Part 2** IN THE FIRST PART OF this article we finished one side of the display-board portion of the IC tester. Let's now start on the other side.

### Display board: other side

Turn the display board over, position it as shown in Fig. 6 and install the 7805 voltage regulator, IC5, at the bottom right corner. Note that the tab faces left. Once it is in place, turn the board over and solder the leads; then clip off any excess. Note that although there are two large pads by the voltage regulator, nothing will be mounted on them.

The next step is to install the resistors. Start with R4 through R19. They're the 100K units around SO1, and you'll need 16 of them. Install the R12-R19 units first, then solder the leads on the other side of the board and clip off the excess. Turn the board back over so the resistors are visible and solder them to the foil in four places at the edge of the board (the pads can be seen in Fig. 5, (see January 1983 issue of *Radio-Electronics*) at the bottom of the board). That step is important because it connects the ground foils on both sides of the board together, so don't forget to do it.

After that, install R4-R11 in the same way. Move to the foil side of the CD4011, and solder two 10K resistors, R1 and R2, across the IC pins. Connect R1 between pin 8 and pin 1, then connect R2 between pin 8 and pin 7. Move to the bottom, and install a 68 ohm, 1-watt resistor at R36. Note that it mounts vertically. Solder the lead closer to the middle of the board, and to both the top and bottom sides of the

board; that gets the power to the IC's. Moving on, install a 1K resistor at R40. Then move left and install an 8.2K resistor at R37. Finish up the resistors by installing a 3.3K unit at R38, and a 2.2K unit at R39. Check your work carefully. If you had any problem installing a resistor, chances are it is in the wrong place! Check to be sure. When you are sure all the resistors are installed properly, you can continue.

Next, SO1 and the jumpers can be installed. Do not omit the socket; it's the connector for the wiring from the panel board. Install SO1 as shown, and turn the board over to solder it in. Turn the board back over and install a jumper between the two points to the left of the socket and resistors. A leftover resistor lead will work fine. After the jumper is soldered in, position it away from the copper foil nearby to prevent shorts.

The capacitors finish up this phase of the wiring. Turn to the voltage regulator, and install 0.1  $\mu$ F ceramic discs above and below it at C6 and C7. Clip off the excess leads and you are done. Figures 7 and 8 show how the completed component- and foil-sides of the display board should appear.

Next, position the display board so that the IC's are facing up and, referring to Fig. 9, install the six jumpers from SO2 to the IC's. Use short lengths of insulated hookup wire.

The next step is to install connector SO1. Refer to Fig. 10 for details. Note that the wires are all inserted from the "foil" side of the board. First, cut eleven pieces of hookup wire, each about four inches long. Prepare one end of each wire, and insert a wire into each of the holes indicated in the illustration. Then route the wires for pins 1, 10, and 11 of

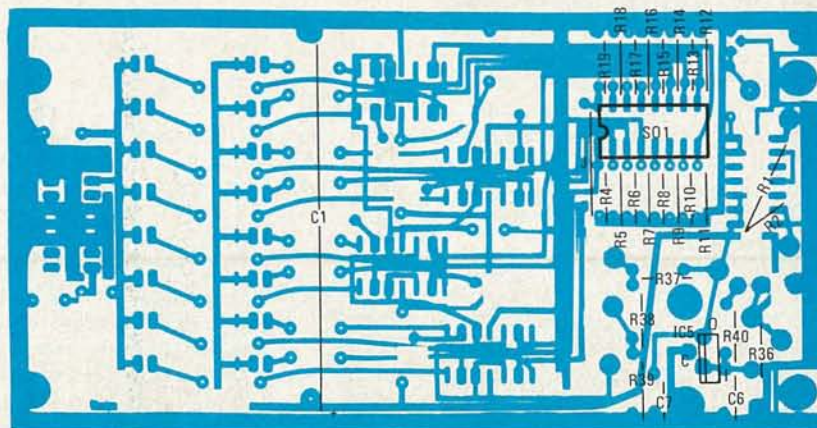

FIG. 6—PARTS PLACEMENT on "foil-side" of display board. Resistor R2 (at right) is soldered to pads on opposite sides of board.



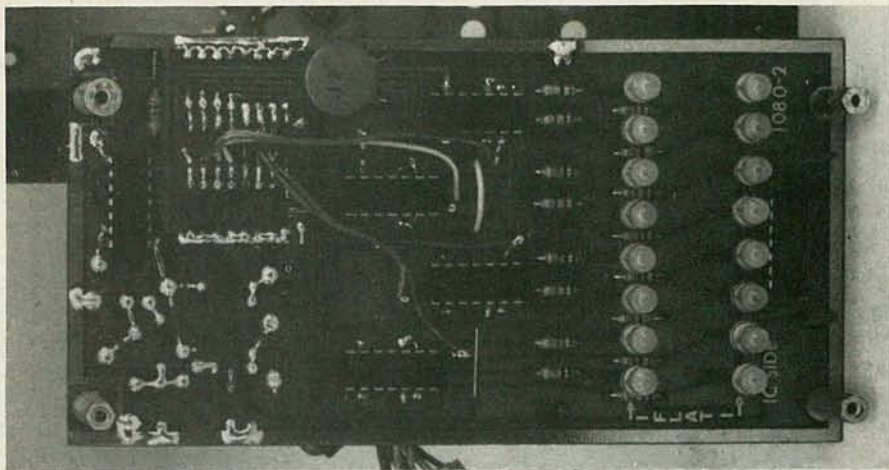

FIG. 7—"COMPONENT-SIDE" of display board. Mounting of LED's will be described in next part of article—don't install them without reading it.

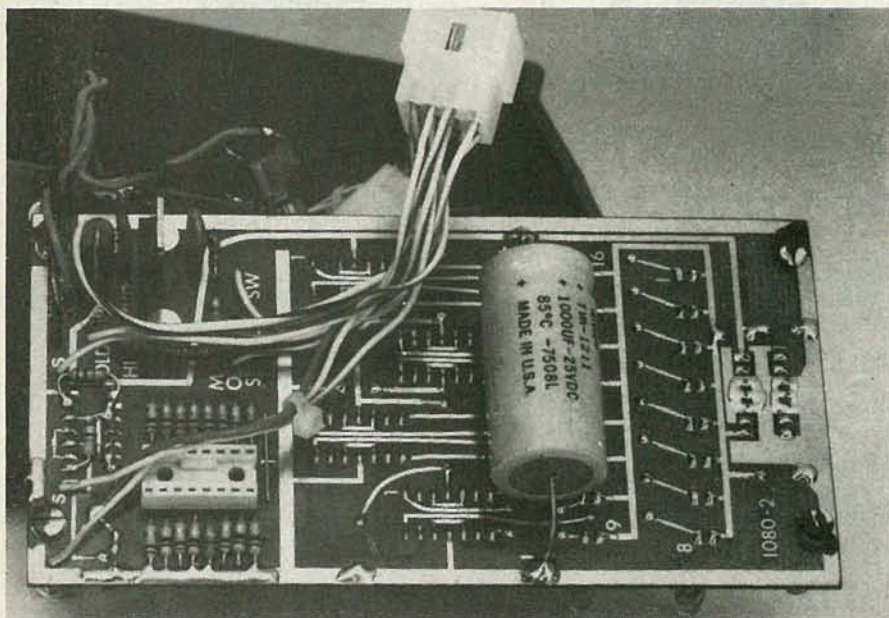

FIG. 8—"FOIL-SIDE" of display board. Multi-wire assembly connects to components on panel board.

the connector over the voltage regulator and group them with the others. That will make a neat cable.

Trim the ends of the wires so that the total cable is about three inches long. Then prepare each wire end, and install the connector. Note the pin identifications in the illustration. I used a Molex 12-pin nylon connector for P102, but almost anything with the correct number of pins will work. After the wires are connected to the pins, check your work for errors and correct any you may find. If you like, lace the wires together to give a professional appearance.

Now for the power cable. Prepare two 1-foot lengths of hookup wire. If possible, use one red, and one black, wire. Connect the wires to the board as shown in Fig. 10. The red wire should go to the hole indicated by a "+," and the black one to the one indicated by a "-." Twist the wires together.

The final step (with the exception of

installing the LED's) is to install capacitor C1. Be sure that it's oriented properly. Push the leads through the foil, and solder. Be sure to solder the negative terminal on *both* sides of the board.

#### LED installation

If you didn't buy the double-sided panel board, you'll want to make one up using the foil patterns shown in Figs. 11 and 12. You can then install the LED's on the display board (however, you need the panel board to do that) and be done with it.

Place the panel board in front of you so that you can read the lettering on it. Notice the sixteen positions below the label "LOGIC LEVEL INDICATORS." They are for the LED's and will have to be drilled and/or filed to a diameter of 0.200 ( $\frac{2}{10}$ )-inch. You may want to use several increasingly larger drill-bit sizes to do that. Stop and check the hole size from time to time using one of your LED's until

the fit is snug. Make another hole the same size at the position above the "OVERLOAD" label using the same procedure.

At the edges of the board there are seven large positions marked, and, slightly inboard of them, four smaller ones (those four are for mounting the display board). All eleven should be drilled to  $\frac{1}{8}$ -inch for 4-40 hardware. Then, turn the panel board over and install a  $\frac{3}{4}$ -inch threaded spacer at each of the four "inboard" holes. (If you can't find the spacers, you can make a substitute for them with 4-40  $\times$  1 bolts and nuts. First, install a bolt and secure it to the panel with a nut. Then, add another nut, but screw it down only until the distance between the panel and the side of the nut away from the panel is  $\frac{3}{4}$  inch.) Now you're ready to install the LED's.

Refer back to Fig. 5 (in Part 1), and note the positioning of the LED's. The flat spot on the package (or the shorter lead) indicates the cathode, and should point to the left. Insert the top row of LED's, LED9-LED16, in the display board, but don't solder the leads. Place the panel board on the top of the spacers on the display board, and temporarily secure it in place with the 4-40 hardware. Push each LED forward so that it seats in the appropriate hole on the panel board. After all the LED's are in place, solder their leads to the foil, and clip off the excess. Separate the display board and the panel board, and install the bottom row of LED's, LED1-LED8. Again, temporarily install the display board on the panel board and push the LED's through the holes. Solder the leads in place and clip off the excess lengths. That completes the LED installation, so remove the display board.

#### Panel board

The rest of the work on the panel board consists mainly of installing jacks and wiring two cables. The schematic in Fig. 13 will help you understand what has to be done. It's routine work, but you'll get the best results if you take your time.

The first thing is to drill more holes. Position the board so you can read the legend "PROGRAMMA III." First, drill all the "HI," "PULSE," and "LO" holes to a diameter of 0.230-inch (a little less than  $\frac{1}{4}$  inch). A few tips on drilling PC-board material: To avoid tearing the foil, use at least three smaller drill sizes before you get to 0.230-inch. Better yet, start small and use a file or reamer to enlarge the holes. Use one of the jacks that will be installed to check hole size periodically. Carefully enlarge each hole until a jack fits snugly in it. Then deburr the holes, working from both sides of the board; use a sharp knife like an X-ACTO knife.

Next come the holes for the two switches. They, of course, are between the "TTL" and "MOS" legends, and just below the word "PULSE." Using the same



technique as you did for the jack holes, enlarge the switch holes to 0.250-inch.

Now, the small parts can be mounted on the panel board. They include the IC test socket (SO101), the switches, and the OVERLOAD LED. The jacks will be installed later. Install the test socket first, from the front side of the board (the side with the lettering). After that, install a SPDT toggle switch at the TTL/MOS hole. Then install an SPDT pushbutton switch in the PULSE hole. Finish up this phase of construction by installing an LED in the OVERLOAD hole, from the rear of the board. Use quick-setting epoxy on the rear side of the board to secure the LED in place. Allow the epoxy to dry before you continue.

Now for the jacks. Refer to Fig. 14 for details, and note how the lugs on the jack bodies are oriented on the rear side of the board. For easiest installation, start at the top of the board with the "HI" row. Install the jacks, one by one, positioning the bodies as shown and then tightening the hardware. After that row is completed, continue with the "PULSE" row just below it. After that, move down to the "LO" row, and repeat the whole process. When you've finished the three rows, check for loose hardware and tighten things up as required. Then install the other three rows of jacks in the same fashion.

#### Panel board wiring

The jack wiring comes next. Note that only one lug of each jack will be used; the ground connections have already been made by attaching the jacks mechanically to the foil on the board. Again, refer to Fig. 14 for the wiring. Start with the pin-16 series of jacks (HI, PULSE, and LO), and tie the three terminals together with a

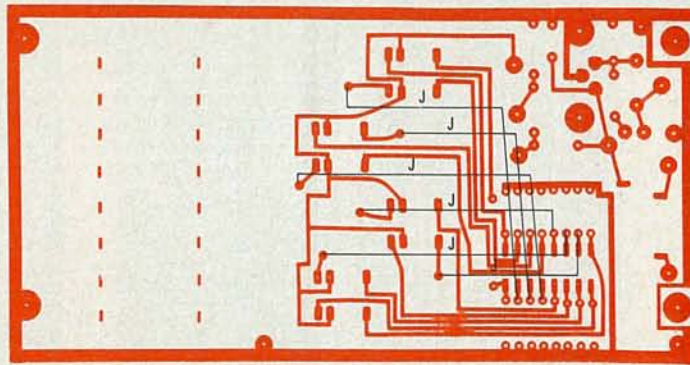

FIG. 9—RUN SIX JUMPERS between the zero-insertion-force test socket and the appropriate pads on the component-side of the board.

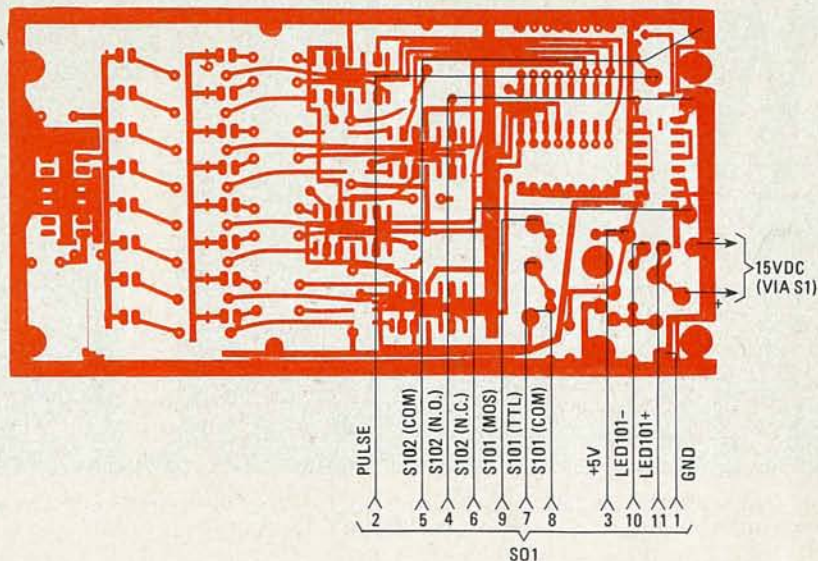

FIG. 10—MAKE UP AN 11-WIRE cable to connect SO1 to the circuit board at the points shown.

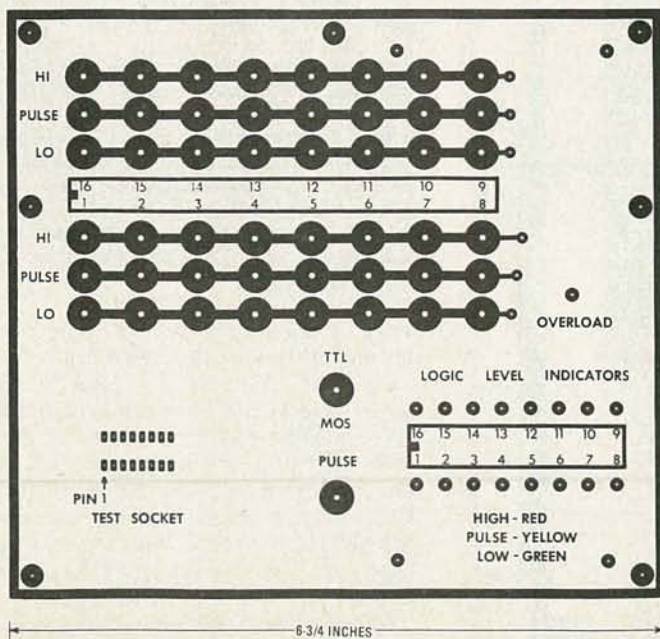

FIG. 11—TOP OF PANEL BOARD. Drill out holes at large foil pads as described in text.

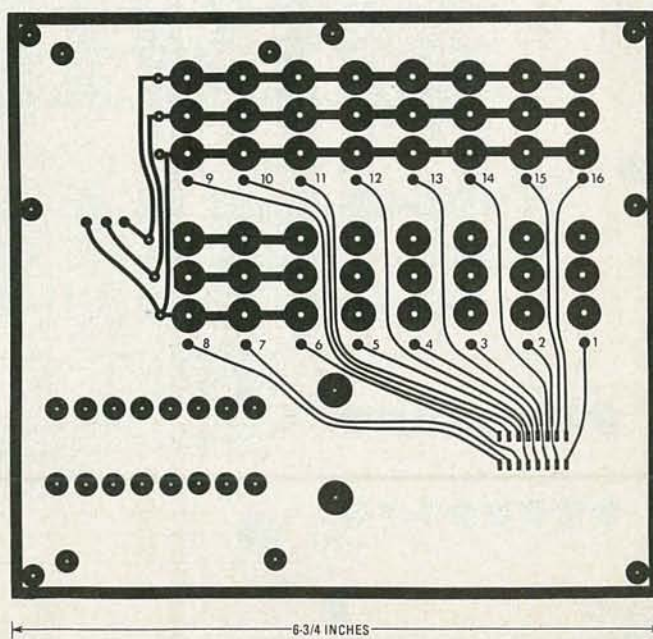

FIG. 12—FOIL SIDE OF panel board. Holes for 16 LED's are at lower left.



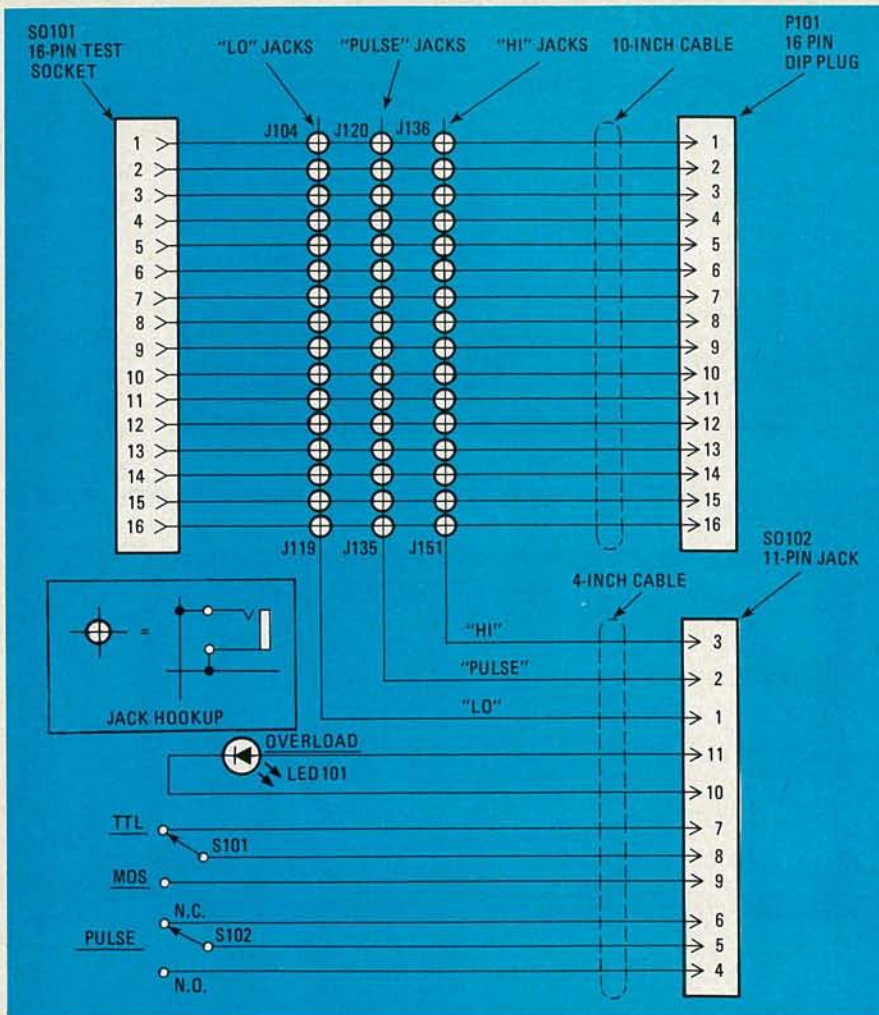

FIG. 13—PANEL BOARD SCHEMATIC shows jack array J104–J151. Inset shows how jacks are connected. Note that switch S102 is actually an SPDT pushbutton type.

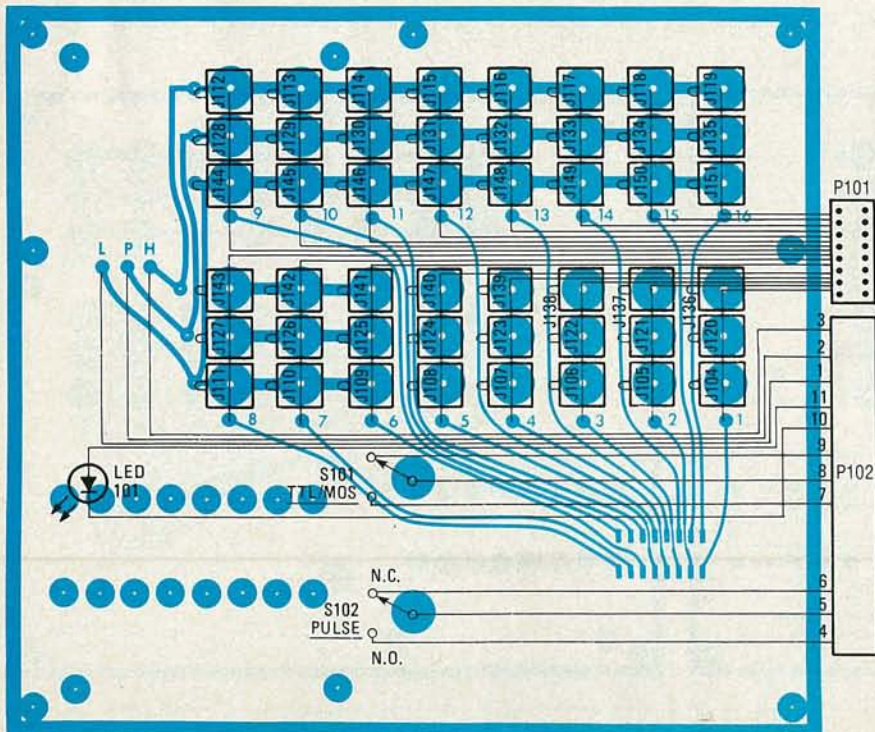
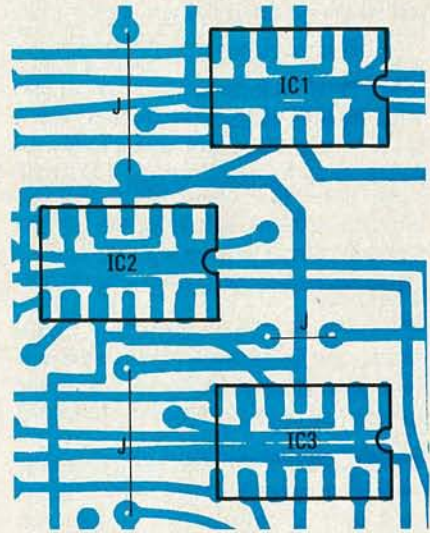

FIG. 14—CENTER PINS of the HI, LO, and PULSE jacks for each IC pin are bused together. No wires are connected to ground lugs.

## OOOOOOOPS

The center jumper in Fig. 5 of Part 1 was shown incorrectly. The correct portion of that parts-placement diagram is shown below.



## PARTS LIST—PANEL BOARD

### Semiconductors

- LED101—jumbo red LED lamp
- P101—16-pin DIP header with 10-inch (minimum) cable
- P102—12 pin Molex nylon connector
- S0101—16 pin ZIF (Zero Insertion Force) socket (Welcon ZIF—16 or similar)
- SO102—12-pin socket to mate with P102 from display board
- J104–J151—miniature phone jack
- J201—two-conductor polarized jack (a phone jack is OK)
- S101—SPDT mini toggle switch
- S102—SPDT mini pushbutton switch (push-on/push off)
- S201—SPST toggle switch

**Miscellaneous:** cabinet, hookup wire, 4-40 hardware, 3/4-inch threaded spacers, phone plugs, etc.

The following is available from Technico Services, PO Box 20HC, Orangehurst, Fullerton, CA 92633: set of two etched & drilled PC boards (IC-1), \$30.00. Available from ABC Electronics, 2033 W. La Habra Boulevard, La Habra, CA 90631 is a set of all parts, *excluding PC boards (IC-1P)*, \$85.00. CA residents please add sales tax; foreign orders please add \$3.00 for postage & handling.

piece of uninsulated bus wire. Connect the end of the wire to the pad below the "LO" jack. Then move to the pin-15 series of jacks, and connect them in the same manner. Keep going until all the jacks are tied together and connected to the appropriate pads on the PC board. Check your work carefully. It's very easy to make a mistake here. Watch for shorts, especially, and correct any errors you find.

When we continued this article, we'll finish up the panel-board wiring and complete the assembly. Then we'll make sure the tester operates properly. **R-E**



# ALL ABOUT

GENERAL-COVERAGE COMMUNICATIONS receivers that are capable of continuously tuning from 10 kHz to 30 MHz are becoming ever more popular. However, users are often disappointed with their performance at the extreme low end of the spectrum—but it's not always the receiver that's to blame. Often, poor VLF (Very Low Frequency) performance is due to the use of an untuned, random-length antenna. Such antennas are often used because of the difficulty of building a full-size VLF antenna. As, we'll soon see, however, full size antennas, aren't always necessary for good reception at low frequencies.

This series of articles will introduce you to practical active-antenna systems that are physically very short. For example, Fig. 1 shows some experimental wide-band active antennas using whips that are just one-meter long. The casual SWL or VLF-LF listener with an appropriate receiver will get good results using those—provided that appropriate attention is paid to such things as antenna location, interference considerations, circuit construction, and ground systems.

## Active antenna basics

In this discussion, we will restrict ourselves to active systems using vertical whips. Loop antennas are very useful but tuning, coil changing, and an entirely different type of circuitry are needed for that type of active antenna system. Short whips are usually easier to make and operate, but have the disadvantage of being more sensitive to local noise (power-line noise, for example). Loop antennas are directional—they have to be oriented with respect to the signal for best sensitivity. On the other hand, vertical whips are omni-directional—sensitivity is not

# VLF Active Antennas

*Because of poor antenna performance, the low frequencies are, as a rule, neglected by shortwave listeners. This series of articles will show you how you can overcome those problems and hear what you've been missing. The principles we'll discuss can even be used for reception up to 30 MHz.*

R.W. BURHANS

affected by the antenna's orientation.

Typical active antenna preamplifiers operate primarily as impedance converters or current amplifiers—they convert a small input-signal voltage at a high-impedance input to nearly the same voltage at a low-impedance output. A coaxial cable is connected from the output to the receiver's low-impedance antenna input (typically 50 to 500 ohms). As is common in many TV antenna-mounted preamplifiers, the power for operating the active preamplifier uses that same coaxial cable. There are, however, basic differences between the VLF-HF systems and the TV-type active preamps. For example, the VLF-HF active antenna must have a higher input impedance and more attention must be paid to the details of the amplifier's dynamic range and distortion. Another difference is that the frequency range covered by the VLF-HF preamplifier is a couple of orders of magnitude greater than that covered by the TV-FM units.

Active antenna preamplifiers mounted at the base of a short whip antenna are most often used at low frequencies (10 kHz to 100 kHz). There, the antenna length is much less than .001 wavelength. The general rule in airborne or marine VLF communications, or Omega and Loran-C navigation systems is to use a short active-antenna system.

## Antenna sensitivity

Let's now introduce the concept of *effective length* ( $l_e$ ). (In low-frequency usage, that is sometimes referred to as effective height). The effective length of an antenna is equal to the ratio of the voltage at the antenna output terminals to the field strength of the input signal (measured in volts/meter). In equation

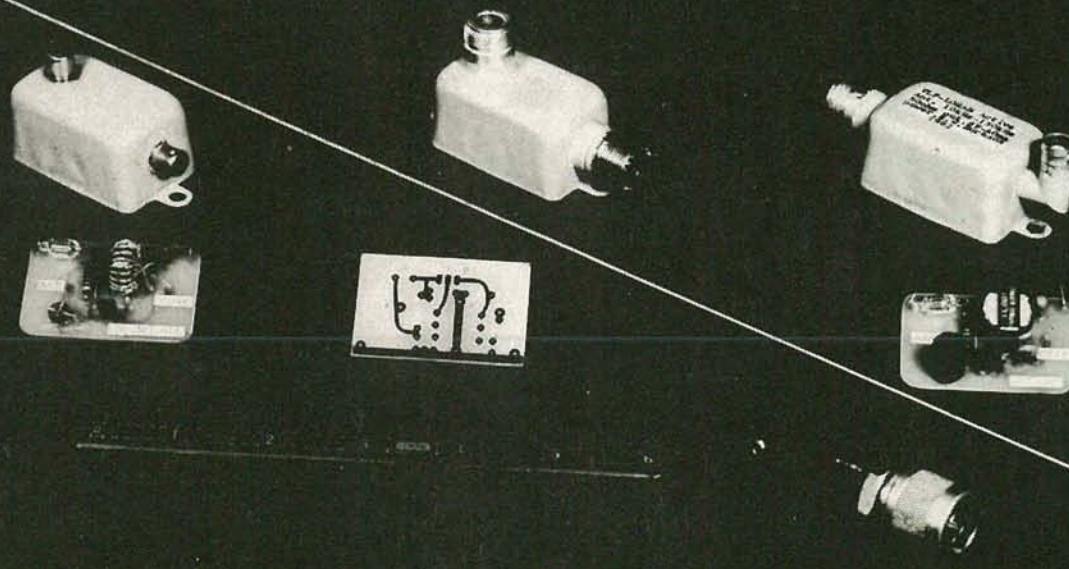



form that is stated as:

$$\frac{V_{OUT}}{E_i} = l_e$$

The ratio of the effective length to the physical length ( $l$ ) is a measure of the antenna efficiency. For example, an antenna with a physical length of 100 cm could have an effective length of 20 cm. The resulting output signal strength  $E_o$  would then be only one fifth that of the input.

The effective-length-per-unit-length of an active antenna can be estimated by determining the input capacitance of the system. That input capacitance includes the antenna-mount capacitance,  $C_m$ ; the input-wiring capacitance,  $C_g$ ; and the antenna-whip capacitance,  $C_a$ . (See Fig. 2-b.) The relationship is:

$$\frac{l_e}{l} = \frac{C_a}{C_a + C_m + C_g} \quad (1)$$

A typical one-meter long whip antenna might have a measured  $C_a$  of about 10 pF over a flat ground plane. Also, an antenna mount might have a fixed capacitance of  $C_m = 5$  pF and the input wiring and active circuit capacitance might be  $C_g = 8$  pf. The efficiency for a system with those values would be:

$$\frac{10}{10 + 5 + 8} K = \frac{10}{23} K = 0.434 K \quad (2)$$

The factor  $K$  (which was assumed to be equal to 1 in equation 1) is a measure of the nearby shielding or coupling effect of the local ground plane (trees, structures, buildings, etc.). In practice,  $K$  is always less than one. A value of 0.75 might be obtained with a top-hat capacitive-loaded vertical antenna mounted on a pole or structure such that the local ground plane slopes away from the antenna on all sides. Values of  $K$  as low as 0.1 might be possible for a low horizontal wire with trees or buildings close to and higher than it. For example, let's presume that the  $K$  of equation 2 was equal to 0.5. The effective length would then be  $0.434 \times 0.5 = 0.217$  meters. That is typical of what is actually observed with a medium-quality active antenna with a length of 1 meter. Another way of thinking about that antenna is to say that its efficiency, in terms of converting the input field strength to a corresponding level at the output terminal, is about 21.7%.

Because of the coupling factor, an active antenna mounted up in the clear will generally outperform an antenna mounted near obstructions. At VLF frequencies, a hill or mountain 0.5 km away from the antenna can reduce the antenna's sensitivity. Precision measurements of the phase and amplitude of 100-kHz Loran-C signals, made while flying over hilly terrain at low altitudes, can yield information about the variations of ground conductivity and terrain contours, which are related to  $K$ .

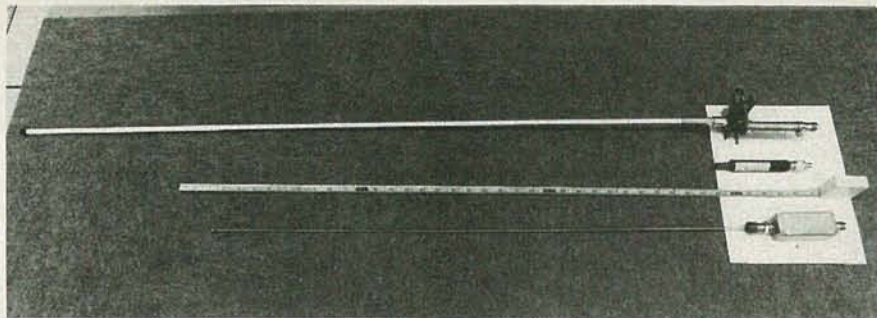

FIG. 1—EXPERIMENTAL WIDE-BAND ACTIVE ANTENNAS. The ones shown here are approximately one meter (39.47 inches) long. The tape measure is pulled out to 41 inches.

### Input impedance

Active antenna receiving preamplifiers at frequencies of about 10 kHz have a high input impedance (greater than 1 megohm). That is because of the low antenna capacitance ( $C_a$ ). Thus, the whip antenna can be considered to be a voltage source with a high internal impedance when coupled to the preamplifier input terminal (see Fig. 2). That internal impedance becomes lower as the frequency of operation is raised—reaching a value around 10,000 ohms at the AM broadcast band (1-MHz region).

If a short whip were connected directly to a 500-ohm receiver input terminal, a LF signal would be greatly attenuated as a result of the mismatch. For example, let's look at what would happen to a 10 kHz signal. The reactance of  $C_a$  for a 1-meter whip would be about 1.6 megohms at 10 kHz. Without an active preamplifier, the attenuation would be about  $500 / (1.6 \times 10^6 + 500)$  ohms, or roughly -72 dB! If, on the other hand, an active preamplifier were used, the same 1-meter whip would provide ample signal at 10 kHz, as the source would be much more closely matched to the load.

The effective capacitance of a wire antenna is approximately 10 pF/meter. Thus, at 10 kHz, a 30-meter wire antenna directly connected to a 500-ohm receiver-input terminal is a 50,000-ohm reactance. Another way of looking at that is to say that the antenna efficiency is 500/50,000

= .01, or 1%. At 10 kHz, our 21.7%, 1-meter active antenna looks much better than that 30-meter wire.

As we go higher in frequency, up to the 30-MHz region, the impedance of the 1-meter whip decreases to the point where it could be connected directly to a low-impedance receiver input. Hence, active, high-input-impedance antenna systems are most useful at the VLF-LF range (usually below 500 kHz); at those frequencies they can perform as well as a very-long-wire antenna that is connected directly to the receiver's low-impedance input.

### Antenna noise levels

In airborne applications, for aerodynamic considerations and to minimize interference, it is desirable to use as small an antenna as possible in the VLF range. A recent FAA report suggests a minimum effective length of about 20 cm when operating at 100 kHz (Loran-C). An active antenna with a 20 cm  $l_e$  will provide an output signal level of 20  $\mu$ V across a 50-ohm receiver input terminal when it is immersed in a 100  $\mu$ V/meter electric field.

The antenna noise level found in a receiver is a function of the receiver bandwidth. A typical Loran-C receiver might have a noise level of perhaps 1000  $\mu$ V/m. Thus, a weak Loran-C signal may be buried in noise to the 100  $\mu$ V/1000  $\mu$ V, or -20dB S/N level at the antenna input,

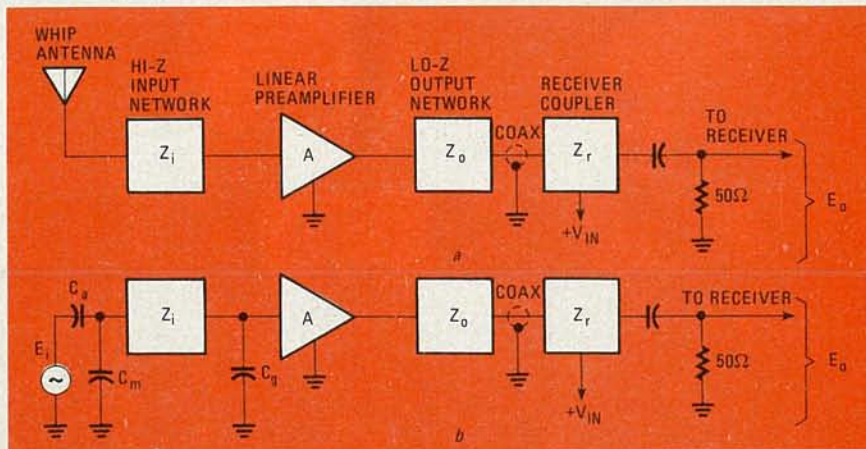

FIG. 2—BLOCK DIAGRAM OF AN ACTIVE ANTENNA is shown in a. The whip antenna is replaced by its equivalent circuit in b.



even though the total signal and noise level (S+N) is quite high at the preamp output. That is a general characteristic of most VLF-LF receiver systems. The antenna noise is much larger than the receiver-circuit noise levels by at least an order of magnitude.

Figure 3 is a chart that shows the magnitude of the atmospheric noise level (in the midwestern United States at 170 kHz) as a function of the receiver bandwidth. Summer afternoons are dominated by the noise of thundershower spherics. They produce a typical noise level of  $100 \mu\text{V/m}$  (40 dB above  $1 \mu\text{V/m}$ ) in a receiver with a 400-Hz bandwidth. In the morning, summer noise levels are lower. Lower still are the winter noise levels, which are usually less than  $1 \mu\text{V/m}$ . However, in the winter, the antenna becomes less sensitive despite the reduced noise level. That is due to the lower conductivity of ice and frozen ground. For example, propagation of VLF signals is very poor over a large ice mass like the Greenland ice cap. The action is similar to that of a carbon wedge inserted into a microwave waveguide.

### Intermodulation distortion

We want an active-antenna system that will ensure that the signal heard on the receiver is not some spurious response of the preamplifier or the receiver itself. That may be rather difficult in some urban areas, where the general RF-“pollution” level is high over the entire VLF through HF spectrum. We do not want our antenna system to amplify strong signals that are in the passband of the active antenna but *not* on the frequency we are interested in receiving.

Achieving those goals is difficult in practical wide-range semiconductor preamplifier circuits. That’s because they suffer from problems caused by second- and third-order intermodulation distortion products that are created by small non-linearities in the active preamp.

### Second order distortion

Suppose we have an active-antenna system connected to a receiver tuned to 370 kHz in the LF beacon band. Let’s also suppose that there are local broadcast-band transmitters on 1340 kHz and 970 kHz that produce a difference frequency of  $1340 - 970 = 370$  kHz. If the active-antenna preamplifier is not perfectly linear—and it never is in practice—then at some high signal level, a mixture of the two broadcast-band AM signals will be superimposed on the desired 370-kHz beacon signals. If the listener is located close to the AM transmitters, the interference signal level might be quite high. It increases by 20 dB every time that the strength of the signals causing the interference increases by 10 dB. The problem can be reduced by using semiconductor circuitry that is more linear, or by using high-impedance traps and low-

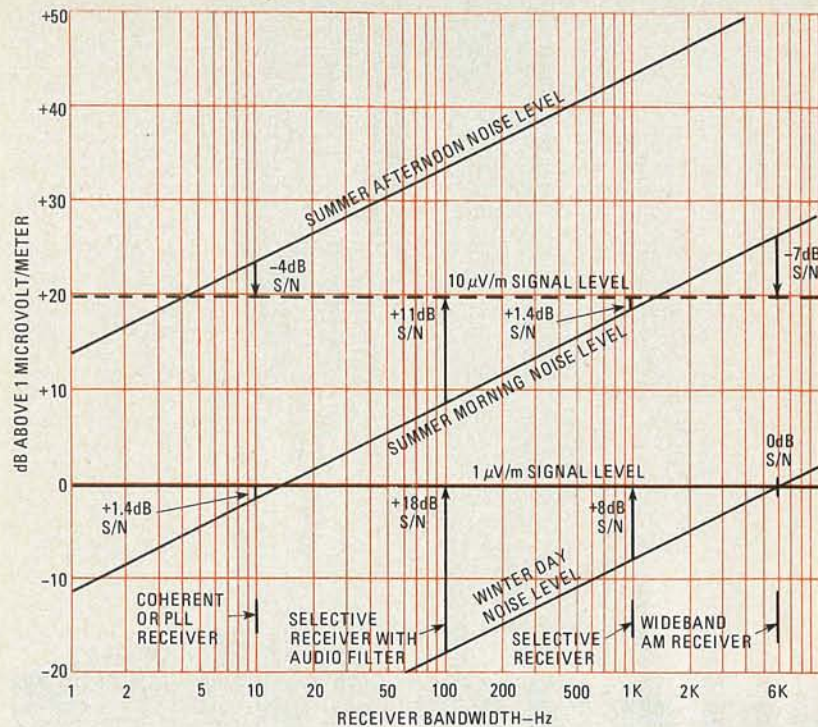

FIG. 3—ANTENNA NOISE LEVELS are a function of the receiver’s bandwidth and differ from season to season as well as with the time of day.

pass filters connected directly to the active-antenna input circuitry.

### Third order distortion

Third order distortion can be a more severe problem. It occurs when a strong local AM broadcast-band signal mixes or multiplies with a weaker signal producing interference frequencies of  $2f_1 - f_2$  or  $2f_2 - f_1$ . Suppose  $f_1$  is a weaker signal on 700

kHz and  $f_2$  is a strong local signal on 1340 kHz. Then  $2f_1 - f_2 = 60$  kHz and  $2f_2 - f_1 = 1980$  kHz. If we tune our receiver to each of those frequencies, signals will be heard faintly in the receiver. The one at 60 kHz is particularly troublesome, since it is right on top of a normal VLF time signal from WWVB and produces annoying fading that coincides with the signal variations from the broadcast stations.

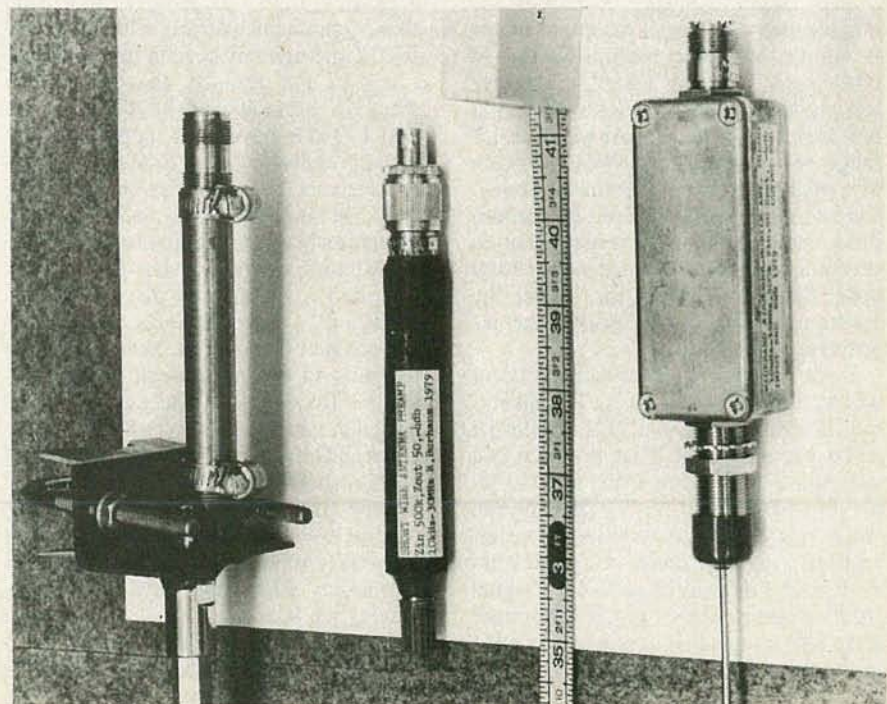

ACTIVE ANTENNA PREAMPLIFIERS can be made very small.





An active-antenna system presents few mounting-problems.

That type of two-tone interference increases by 30 dB for every 10 dB increase in the level of the two interference signals. The large number of broadcast-band stations, and the thousands of LF beacons in the continental United States (as well as the world), means that there are many potential interference sources that could cause problems for VLF-LF receiving setups.

#### Harmonics and overload

Another common type of interference that plagues all types of reception setups is simple harmonic multiplication. In other words, a strong signal on 250 kHz can produce weaker harmonic signals at 500 kHz, 750 kHz, etc. At the VLF-LF range, that problem is usually not as much of a concern as those mentioned above, since the interference caused by second, third, etc. harmonics is usually not as severe as that caused by second or third order distortion. Also, the higher the harmonic number, the weaker the interference signal will be.

Input preamplifier overload can occur when a locally strong station is transmitting at a frequency that falls within the antenna's passband. That problem can sometimes be cured by using traps or input low-pass filters, or by shorting the whip to ground with a remote, weatherproof, low-capacitance relay. However, it is very difficult to get rid of a signal from a nearby amateur or CB transmitter if the active antenna is designed to operate in the same frequency band.

#### Other interference

Most TV receivers radiate some horizontal-oscillator signal (15.734 kHz); that problem is especially severe in modern solid state and IC sets. The harmonics from that source, up through 400 kHz, can often be heard in a VLF-LF receiver. A list of the TV-oscillator harmonic frequencies up to 409.091 kHz range is shown in Table 1. If your communications receiver lacks a precision digital readout, those interference signals can be used for frequency markers in the VLF-LF range. Sometimes, however, those signals can interfere with the reception of an important beacon. In the case of Loran-C, for instance, the interference from TV harmonics at 94.406 kHz and 110.140 kHz have been reported to disturb the operation of some marine Loran-C receivers near marinas in populated areas; in such situations, audio or notch filters can be used to reduce that problem.

Harmonics from 60-Hz power-line-operated systems can also cause interference. For instance, the 170th harmonic of 60 Hz is 10.200-kHz, which happens to be the Omega navigation-system frequency. That, as you might imagine, can cause problems, especially when an Omega receiver is poorly located with respect to power lines or faulty power-line ground systems. Rusty marine vessels that use 60-Hz power systems have reported problems with those harmonics when operating Omega receivers while at sea.

In some cases, better grounding of house-wiring systems can help reduce interference from power systems. Active antennas work best when some ground

TABLE 1  
Harmonic number Frequency—kHz

1	15.734
2	31.468
3	47.203
4	62.937
5	78.671
6	94.406
7	110.140
8	125.874
9	141.608
10	157.343
11	173.077
12	188.811
13	204.545
14	220.279
15	236.014
16	251.748
17	267.482
18	283.217
19	298.951
20	314.685
21	330.419
22	346.154
23	361.888
24	377.622
25	393.357
26	409.091

reference is provided at the antenna base. That's because any antenna that is very much shorter than one-quarter wavelength acts like an electric field probe that measures the potential difference between itself and its ground plane. Thus, good grounds are always a necessity and they can eliminate many reception problems. As to what type of ground system to use, a cold-water copper-pipe system or deep-driven copper rods and heavy conductors will do; but a large number of copper radial-wires laid out around even a short pole-mounted whip will provide marked improvement in VLF reception.

A wide variety of other types of interference are often heard throughout the VLF-HF region; their sources include garage-door openers, microwave ovens, motor controllers, personal computers, and TV-set remote tuners. The active circuitry contained in such devices often radiates signals at frequencies between 40 and 200 kHz. Many microcomputer systems radiate strong harmonic energy in the 1- to 30-MHz range. Some control systems are vibration-sensitive and can be frequency- and amplitude-modulated by room or household noises. Those signals cause interference that is independent of the type of active or passive antenna used on the receiver.

Active-antenna systems may not be the ultimate answer to a single small receiving antenna covering all frequency ranges, but they can provide very satisfactory performance with proper attention to the details that we've covered in this article. The next article in this series will present some practical circuit details of active-antenna systems for the experimenter, SWL or casual listener. **R-E**



## How to Design Analog Circuits —Power Amplifiers

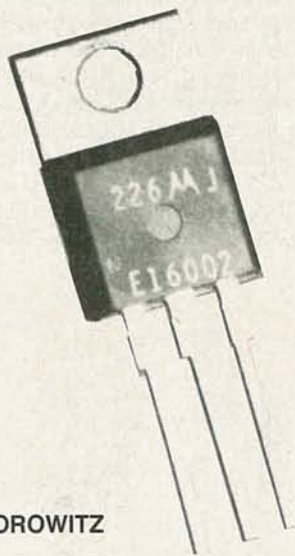

MANNIE HOROWITZ

*The various types of power amplifiers, and some important factors to consider when designing those circuits, are the topics we'll cover in this month's article.*

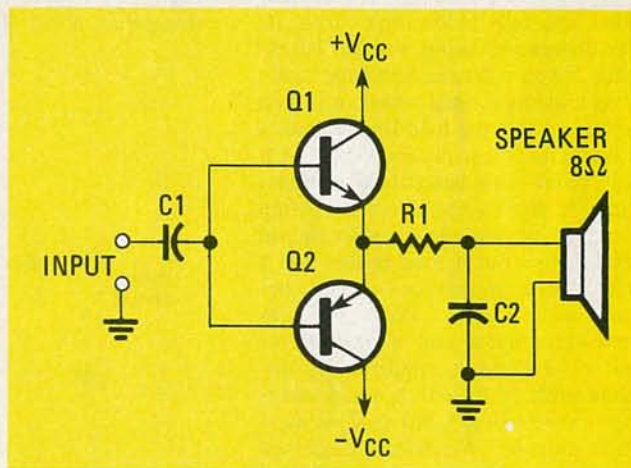

A TRANSISTOR DELIVERS POWER TO THE load or device connected to it. If we're looking at a DC amplifier, the power delivered is, of course, equal to the load resistance multiplied by the square of the DC current flowing through that load.

In the case of an AC amplifier, however, things get a little more complicated. Should a full cycle appear across the load, the relationship of power to current and resistance remains the same as in the DC case, but now the effective current is the peak current in the cycle divided by the square root of 2. If, on the other hand, only one-half of the cycle appears (with zero output during the other), the effective current now becomes the peak current divided by 2. When more than one-half of a cycle of current flows but there is less than a full cycle, the effective current in the resistor is somewhere between the two.

The portion of the cycle that appears across the output load is determined by the class of operation of the amplifier being used. Large signal transistor power-amplifiers operate in Class-A through -H. Most audio and RF circuits, however, are designed for Class-A, -AB, -B and -C operation. Special con-

siderations are involved when a design calls for a circuit to operate in the Class-D through -H modes. In this discussion, therefore, we will briefly look at the latter classes, but concentrate on designs involving the four more-popular ones.

In Class-A circuits, current flows through the transistor over the complete cycle and bias is set at the center of the transistor's load line. In Class-B circuits, the current flows only during one half of a cycle and the transistor's bias current is set for  $I_C = 0$ . In Class-AB operation, current flows through the transistor during one half of the cycle and part of the other one. Finally, in Class-C operation, current flows through the transistor for less than one half cycle.

### Class-A amplifiers

Class-A amplifiers that are designed to reproduce low-power signals are usually biased at the center of their load line. Class-A power amplifiers are also ideally biased at that point but some additional factors must be considered. For one thing, to deliver power, a transistor must dissipate power. Despite the size of the load, the product of the collector current and collector-to-emitter voltage at any

point on the load line, must be less than the power dissipation rating of the transistor if the device is not to be destroyed. That condition will be met if the load line for the device is chosen so that it falls below the maximum permissible power-dissipation curve of the device.

Let's now look at how that power-dissipation curve is derived and how it is used in determining the load line. As an example, assume that the circuit we are designing uses a transistor that can dissipate 10 watts and handle a maximum collector current of 1 amp. If you were now to calculate the maximum allowable voltage for currents of from zero- to one-amp, you would wind up with the data shown in Table 1. Plotting that data as shown in Fig. 1 gives you the maximum

TABLE 1

Current (amps)	Voltage (volts)
0	$\infty$
0.1	100
0.2	50
0.4	25
0.5	20
0.8	12.5
1	10



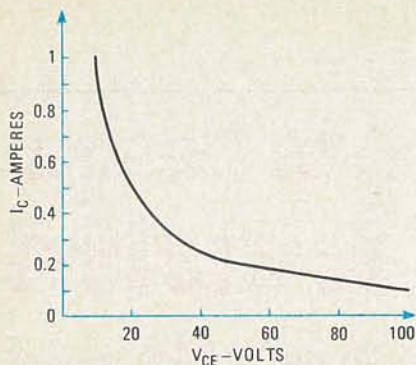

FIG. 1—THE MAXIMUM POWER dissipation curve for a transistor is plotted here using the data from Table 1.

power-dissipation curve for the device. As long as the transistor is biased so that its load line falls below that curve, its power-dissipation rating will not be exceeded. If you want the transistor to deliver its maximum rated power, it should be biased so that the load line intersects the maximum power-dissipation curve at just one point—the center of the load line.

Class-A power amplifiers are often used to provide power to a loudspeaker in a small radio. But a loudspeaker has a relatively low impedance—usually between 4 and 16 ohms. Thus, if it is to present a reasonable load to the collector circuit of a Class-A amplifier its impedance must be raised. A transformer, such as the one shown in Fig. 2, is ideal for that purpose. We briefly discussed transformer principals in the article that appeared in the December 1982 issue of **Radio-Electronics**. As stated there, the impedance of the primary is related to the impedance of the secondary by  $Z_p/Z_s = (N_p/N_s)^2$ . Thus, if an amplifier circuit has an output impedance of 72 ohms but you wish to use the circuit to drive an 8-ohm speaker, you'll need an impedance-matching transformer with a turns ratio equal to  $\sqrt{Z_p/Z_s} = \sqrt{72/8}$ , or 3:1.

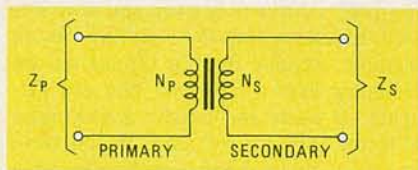

FIG. 2—A TRANSFORMER is used to alter the impedance of the load seen by the transistor.

When a transformer is used between the loudspeaker and transistor in a Class-A amplifier, the maximum efficiency of the overall circuit is 50%. That is, the maximum sinusoidal power that can be delivered to the load is equal to 50% of the power that must be supplied by the power source and dissipated by the transistor when idling. Thus, while a transistor can be biased to demand a maximum of 10 watts from a supply, only 5 watts would be delivered to the load over a cycle; the

remaining power is dissipated by the transistor.

While that 50% sounds low, in reality the efficiency is even 20% to 40% lower because of the losses and limits of the circuit and transformer. As bad as that is, it could be worse. If you attempted to place the load directly in the collector circuit instead of using a transformer, DC power would be dissipated by the load as well, limiting the maximum efficiency to about 25%. That will still be reduced by the same 20% to 40% we mentioned earlier, leaving us with an efficiency of about 20%, if we are lucky.

Let's now assume that you want to design a Class-A amplifier to deliver 4 watts to an 8-ohm loudspeaker. If a transformer is used in the circuit as shown in Fig. 3-a, the transistor must be capable of dissipating about 10 watts. If you use a

living safely.

The AC load line is determined by the impedance reflected into the primary of the transformer, but it must pass through the quiescent point established by the DC-bias conditions. Because it must vary around that point, the collector voltage may swing from 0 to double the supply voltage, or to 50 volts. Similarly, the collector current can vary through a cycle from 0 to double the quiescent current, or to 0.8 amps. Consequently, the impedance seen by the transistor in the primary winding of the transformer, is  $(50 - 0)/(0.8 - 0) = 62.5$  ohms. Because the loudspeaker's impedance is 8 ohms, the turns ratio of the transformer must equal  $\sqrt{62.5/8} = 2.8:1$ . All points on the AC load line must, of course, be at or below the maximum permissible power dissipation curve of the transistor.

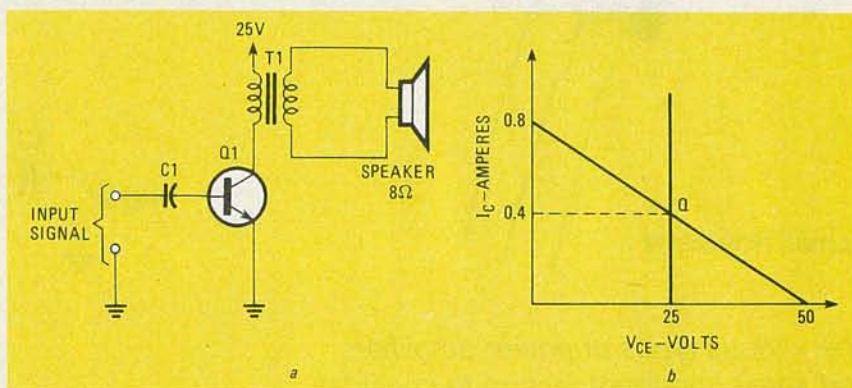

FIG. 3—A CLASS-A AMPLIFIER is shown in a; the load lines for the circuit are shown in b.

25-volt power supply, your load lines will look like those shown in Fig. 3-b.

(As mentioned in the December issue of **Radio-Electronics**, when a transformer couples a load to the transistor circuit, the collector sees DC load that consists of the winding resistance of the transformer primary along with any other resistance in the collector circuit. It also sees an AC load due to the reflection through the transformer of the load in the secondary. The quiescent operating point for the circuit is where those two load lines cross.)

Start the design by drawing the DC load line. The slope of that line equals the total DC resistance in the collector circuit. In our example, that is assumed to be close to 0 as the only element in the collector circuit is the primary of the transformer. The DC load-line is therefore a vertical line at  $V_{ce}$  equals 25 volts. Because the maximum power the transistor can dissipate is 10 watts, the maximum current that may flow through the transistor with 25 volts applied is  $10/25 = 0.4$  amps. Therefore, the Q or quiescent point is 25 volts, 0.4 amps. Any bias current below that level may have been chosen on the DC load line, but the delivered power would not have been less than the maximum that the transistor is capable of de-

### Class-B amplifiers

Since in Class-B operation a transistor is biased at the point where the quiescent or idling current is equal to zero, in that mode of operation current flows during just one-half of a cycle. Thus, assuming an NPN transistor for example, the only time current flows through the device is when the positive portion of the cycle is applied to its base. No current flows during the other half of the cycle. A simple Class-B amplifier is shown in Fig. 4.

If you want a Class-B amplifier to reproduce the entire input cycle, two transistors must be used in the circuit. One of those reproduces one half of the cycle while the other reproduces the second half of the cycle. The two halves are recom-

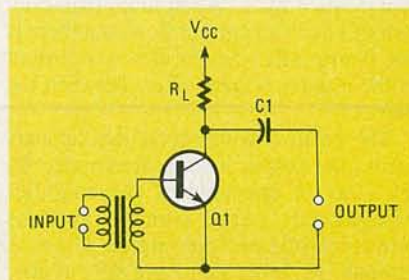

FIG. 4—IN A CLASS-B AMPLIFIER, current flows only during one half of a cycle.



combined across the load to produce an amplified version of the input waveform. Such a circuit, called a push-pull amplifier, is shown in Fig. 5. It gets its name from the fact that when one transistor conducts, the other is off. In Fig. 5, the relative phases of the applied signals are shown at the bases of the transistors; the outputs are shown along the leads from the collectors. Note that the lower device is turned on during the first half of each cycle while the upper transistor is turned on during the second half.

Considering the transformer circuit in Fig. 5 along with the loudspeaker load resistance, the impedance reflected from the secondary into the primary of the transformer is  $R_L' = (N_P/N_S)^2 R_L$ , where  $R_L$  and  $R_L'$  are the resistance of the loudspeaker and the impedance reflected back from the secondary into the full primary winding, respectively, and  $N_P/N_S$  is the ratio of the number of turns in the primary winding to the number of turns in the secondary winding. From that, it can be determined that the impedance each transistor sees,  $R_L''$ , is equal to  $R_L'/4$ .

The power required to operate the circuit shown in Fig. 5 over an entire cycle is equal to  $I_{CMAX} V_{CC}/1.57$ . The maximum power that the circuit can deliver to the load is 78.5% of the full-cycle power demanded from the supply. Power delivered to the load over the complete cycle, is double the maximum instantaneous power each transistor dissipates during the cycle, or  $V_{CC} I_{CMAX}/2$ .

We noted in our discussion of Class-A amplifiers that the load line of a transistor must not cross or go above the maximum-power-dissipation curve. That does not hold for Class-B operation because the transistors conduct for just one-half of each cycle and the total power dissipation is found by averaging over a complete cycle. Considering that, the load line may cross the power-dissipation curve, or a portion of it may even lie above that curve, provided that the average power dissipated by the transistor during the complete cycle does not exceed the transistor's stated maximum power-dissipation rating.

The amount of power actually dissipated by a transistor, depends upon the portion of the maximum output power that is actually delivered to the load. When the power across the load is 40% of the maximum output signal that can be supplied by the circuit, maximum power is dissipated by the transistor. If the output is more or less than 40% of the maximum, the transistor will demand less than the maximum power from the supply.

To check the temperature rise of the output transistors, set the amplifier up so that it delivers 40% of the maximum power to the load. Allow the circuit to operate that way for several hours, then check to see if the temperature of the transistor has exceeded its upper limit and whether or

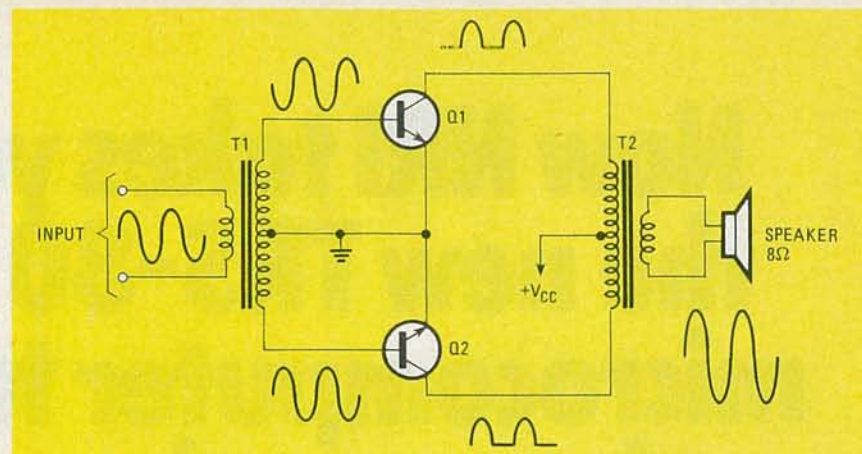

FIG. 5—IF YOU WANT a Class-B amplifier to reproduce an entire cycle, two transistors must be used in a push-pull configuration as shown here. Note that the relative phases of the signal at various points in the circuit are also shown.

not the device is still working.

Although two transistors are used in a push-pull circuit, the design revolves around one device at a time. The first step is to decide how much power,  $P_{RL''}$ , must be delivered by the overall circuit. Each device, then, must deliver one half of that power; the overall circuit is arrived at by designing the appropriate circuit for each transistor.

The first step is to select transistors that are capable of handling the amount of power that they will be called on to dissipate. If the supply voltage is  $V_{CC}$ , the load,  $R_L''$ , seen by one transistor is  $V_{CC}^2/4P_{RL''}$ . The maximum average power dissipated by the transistor is found from  $P_{MAX} = V_{CC}^2/\pi^2 R_L''$ . That is, of course, the power dissipated when 40% of the maximum output is developed at the output. Select a transistor that is capable of dissipating that power.

Turning to the transformers, they are chosen as discussed in the December 1982 issue of *Radio-Electronics* (see that issue for a full discussion of the technique). Bear in mind that the impedance that must be seen across the entire primary winding of transformer T2 is  $4R_L''$ . Thus, if the impedance presented by the load to the secondary winding is  $R_L$ , the transformer turns ratio should be equal to  $\sqrt{4R_L''/R_L}$ . Also, the primary must be center-tapped.

### Class AB amplifiers

In Class-A operation, the output transistor is biased at the center of the load line, while in Class-B, it is biased at the point where no collector current flows when the transistor is in the quiescent or idling state. In Class-AB operation, the transistor is biased to operate at a point somewhere between Class-A and Class-B. In that mode, some collector current flows when the device is idling. Although that decreases the efficiency of the circuit, Class-AB operation is useful where good and reliable reproduction of the input signal is required.

As noted in our earlier discussions of

diodes and transistors, no (or very little) conduction takes place through those devices unless somewhat more than a specific minimum voltage is applied to their terminals. Essentially no current flows through the base-emitter junction of a germanium transistor if less than about 0.2 or 0.3 volt is applied. Similarly, a minimum of between 0.5 and 0.7 volt must be applied to the junction of a silicon device before any current will flow.

If we rely only on a signal at the input of the circuit to turn on a transistor, it will not be turned on until that input exceeds the required minimum voltage. A sine-wave at the input will therefore be distorted after being amplified by a Class-B circuit as is shown in Fig. 6. Here, there is no signal at the crossover point during the time when one transistor of the push-pull pair stops conducting and the second one

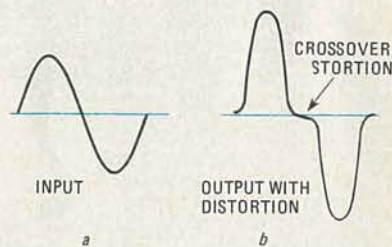

FIG. 6—CROSSOVER DISTORTION, shown in b, occurs because a transistor does not conduct at low input-signal levels.

begins.

Although that distortion is undesirable, it may be acceptable for some applications. But what may be even more critical in Class-B operation is that when a transistor is cut off at a rapid rate, large transient voltages develop in the circuit. As a result, the transistor may break down.

To avoid breakdown while minimizing distortion, the transistor is biased so that some collector current flows when the circuit is idling. That current is usually



# Now NRI takes you inside the new TRS-80 Model III microcomputer to train you at home as the new breed of computer specialist!

NRI teams up with Radio Shack advanced technology to teach you how to use, program, and service state-of-the-art microcomputers.

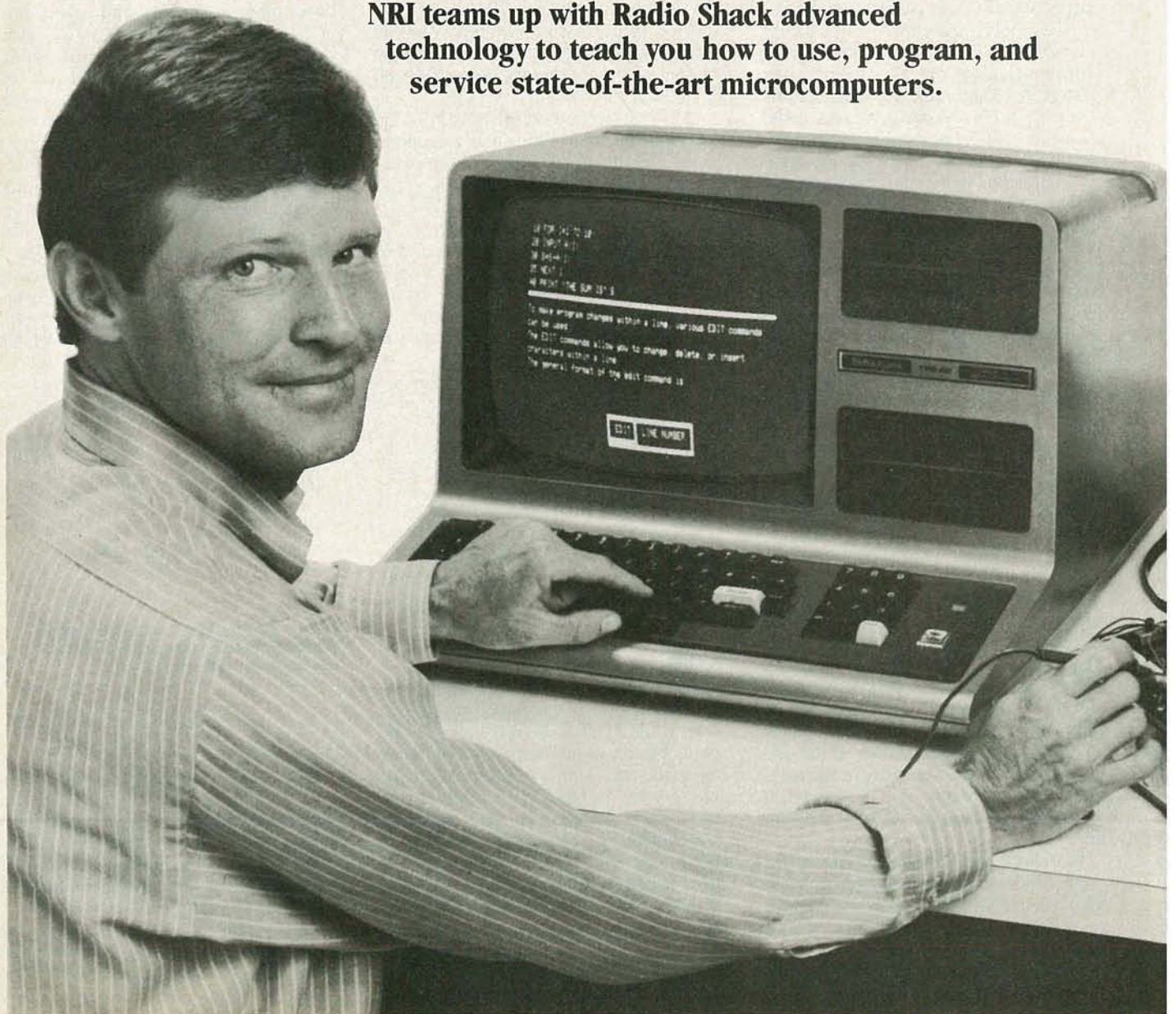



It's no longer enough to be just a programmer or a technician. With microcomputers moving into the fabric of our lives (over 250,000 of the TRS-80™ alone have been sold), interdisciplinary skills are demanded. And NRI can prepare you with the first course of its kind, covering the complete world of the microcomputer.

### Learn at Home in Your Spare Time

With NRI training, the programmer gains practical knowledge of hardware, enabling him to design simpler, more effective programs. And, with advanced programming skills, the technician can test and debug systems quickly and easily.

Only NRI gives you both kinds of training with the convenience of home study. No classroom pressures, no night school, no gasoline wasted. You learn at your convenience, at your own pace. Yet you're always backed by the NRI staff and your instructor, answering questions, giving you guidance, and available for special help if you need it.

### You Explore the New TRS-80 Model III Inside and Out

NRI training is hands-on training, with practical experiments and demonstrations as the very foundation of your knowledge. You not only learn to program your computer, you learn all about it . . . how circuits interact . . . interface with other systems . . .

gain a real insight into its nature.

You also work with a professional 4-function multimeter, featuring full portability and a 3½-digit liquid crystal display. Using it along with the exclusive NRI

advanced microcomputers is yours to learn with, yours to keep and use for your own personal programs, business use, and other applications.

### Computer Assisted Instruction

Your TRS-80 even helps train you. You receive 8 special lesson tapes in BASIC computer language. Using them in your microcomputer, you "talk" to it as you progress. Errors are explained, graphics and animation drive home key points. Within a matter of minutes, you'll be able to write simple programs yourself.

### Send for Free Catalog...No Salesman Will Call

Get all the details on this exciting course in NRI's free, 100-page catalog.

It shows all equipment, lesson outlines, and facts on other electronics courses such as Electronic Design, Industrial Electronics, TV/Audio/Video Servicing...11 different career opportunities in all.

Send today, no salesman will ever bother you. Keep up with the latest technology as you learn on the world's most popular computer. If postcard has been used, write to NRI Schools, 3939 Wisconsin Ave., Washington, D.C. 20016.



**Training includes the TRS-80 Model III microcomputer, professional LCD multimeter, the NRI Discovery Lab, Computer Assisted Instruction programs and hundreds of demonstrations and experiments.**

Discovery Lab® and your TRS-80, you perform over 60 separate experiments. You learn how to troubleshoot and gain greater understanding of the information your testing procedures give you.

### Advanced Technology Microcomputer Is Yours to Keep

As part of your training, NRI sends you the new, state-of-the-art TRS-80 Model III microcomputer. This functional unit is complete with 65-key keyboard and 12" display in one desk-top unit. It features high-speed cassette loading, built-in interface for parallel printer, and provisions for optional disk drive. Its 16K RAM is internally expandable to 48K and its BASIC language is compatible with most Model I software.

Along with your multimeter and the NRI Discovery Lab, this latest concept in



**NRI** NRI Schools  
McGraw-Hill Continuing  
Education Center  
3939 Wisconsin Ave.  
Washington, D.C. 20016  
**We'll give you tomorrow.**

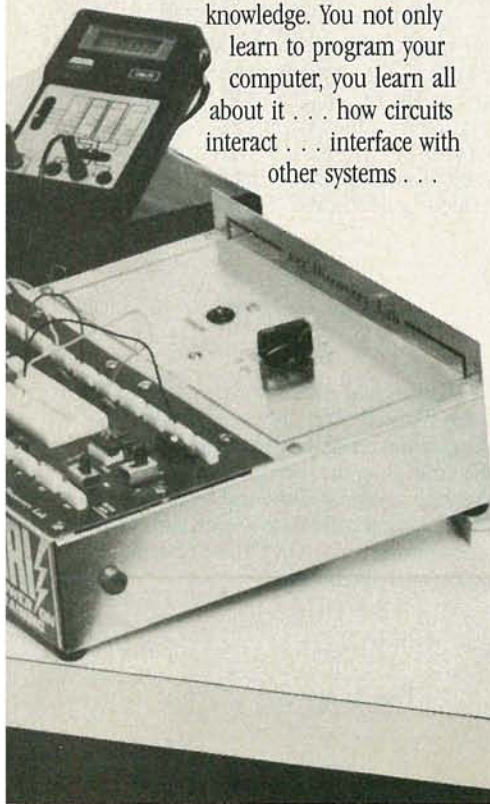

(TRS-80 is a trademark of the Radio Shack division of Tandy Corp.)



between 10 and 25 mA, although idling current as high as 300 mA can be used in high-power designs. Distortion can be reduced farther by using a diode in series with each emitter load in the transistors of the push-pull circuit. That diode rounds off the crossover point to a greater degree than is possible when only the junction of the transistor is in the circuit.

### Class-C amplifiers

In the Class-C mode of operation, the transistor is biased so that it conducts for less than one-half of a cycle. To do that using an NPN device, the base is biased negative with respect to the emitter. As the output is obviously in the form of pulses, the efficiency in some cases can be as high as 85%.

Although not useful in audio applications, the Class-C amplifier is frequently used in RF circuits. A resonant L-C circuit is placed at its output. Each time a signal is applied to the amplifier's input, a full cycle is generated across the L-C circuit, provided that circuit is tuned for the frequency (or a multiple of the frequency) of the signal applied to the amplifier's input.

### Class-D through Class-H amplifiers

We could devote quite a bit of space to detailing the various other classes of operation, and how to design circuits using those modes of operation. Because the usefulness of those modes is limited mainly to special circuits and applications, we will just briefly note what they are. Each class is characterized by high efficiency and some boast excellent fidelity.

Class-D amplifiers are used to convert audio signals to pulses. In some designs, up to one-half million of those pulses are produced each second. When audio is converted to pulses, the width of each pulse is related to the instantaneous amplitude of the audio signal. When reproduced through an amplifier, the pulses are fed to a push-pull circuit. The output from the circuit is connected through a resistor to a loudspeaker that is shunted by a capacitor, as shown in Fig. 7. You'll note that no transformer is used between the load and transistors; instead, the transistors feed the amplified pulse signals directly

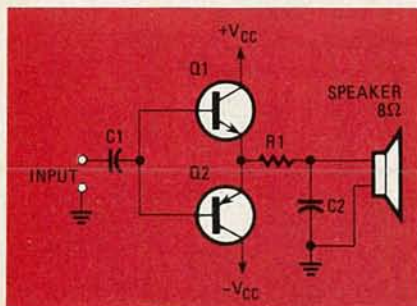

FIG. 7—IN A CLASS-D AMPLIFIER an audio input is converted to pulses and then reconverted to amplified audio.

to the loudspeaker through resistor R1. Resistor R1 and capacitor C2 form an integrator circuit where the width of each pulse determines the voltage developed across C2 and hence across the loudspeaker. That converts the pulses back to audio, which is output through the speaker.

Class-E, -F, and -G amplifiers are quite similar. In each half of the push-pull circuit, two transistors are connected in series. When the input signal is low, only one of the transistors in each half of the push-pull circuit conducts current, while no voltage is applied to the remaining devices. When the input signal is high, the transistors in both halves of the push-pull circuits are turned on. Since all the transistors conduct only during the peaks in the audio input signal, efficiency is quite high.

Class-H amplifiers use logic circuits in an otherwise standard push-pull amplifier. Normal or average levels of audio are reproduced in the usual Class-AB fashion. When input signals are large, however, the logic circuit activates the power supply to provide high voltages to the push-pull transistors. Because the supply voltage and hence the power dissipation are both low during the greater part of the audio cycle, the efficiency of the circuit is high.

The various classes of operation described here, are not the only means of improving distortion and efficiency. Bi-amplification can be added to the list. In that arrangement, the entire audio signal is fed to a filter such as the one shown in Fig. 8. At its outputs, the audio bandwidth is split into two bands—a band of high frequencies and a band of low frequencies—and each is amplified by a different push-pull amplifier. Each amplifier is designed to reproduce a particular band most efficiently. The crossover frequency,  $f_1$ , is usually chosen to be anywhere between 400 and 800 Hz. At  $f_1$ , gain has decreased somewhat on the low frequency band and increased an equal amount on the high frequency band. The values of the inductors and capacitors in the circuit can be found using the formula given in the figure; R is the resistance presented to the filter by the input circuit of the amplifier.

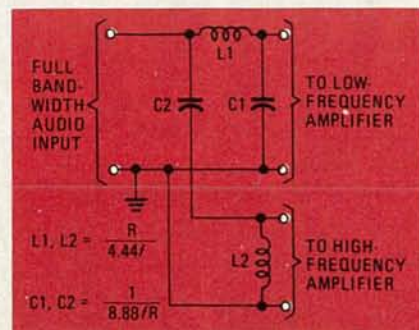

FIG. 8—USING A FILTER and bi-amplification, as shown here, can improve efficiency and reduce distortion.

### VFET's and MOSFETS

Although bipolar power-amplifiers were considered in detail, the power FETs—the VFET and MOSFET—are now becoming popular. Those devices are used in push-pull circuits similar to those using bipolar devices. Just as the base-emitter current of the bipolar device was adjusted for a predetermined idling collector current, the gate-source voltage of the FET power amplifiers must be adjusted for a desirable idling drain-current level. Power FET circuits may be considered to operate in the Class-AB mode, but it is not unusual for the drain current to be set to a level as high as 500 mA. Distortion is low because the amplification characteristics of those devices are essentially linear.

### Solutions to thermal problems

When a transistor dissipates power, it gets hot. That heat must be removed from the transistor if it is not to overheat and be destroyed. If heat is not removed from a bipolar device, its collector current builds up. If that build-up is not controlled and limited, the current level and power dissipated by the device may become excessive and exceed safe levels of operation, resulting in breakdown. Although that type of current build-up does not occur in the drain circuit of the VFET as its temperature rises, the VFET can break down if excess heat is not removed from the device at a reasonable pace. Here, we will describe methods of removing heat from the bipolar device. The discussion, of course, also applies to FET's.

There is a thermal resistance that impedes the dissipation of heat from the junction of the transistor to the surrounding air. That resistance, called  $\theta_{JA}$ , is in units of  $^{\circ}\text{C}/\text{watt}$ . The temperature of the junction,  $T_J$ , depends upon the temperature of the air,  $T_A$ , around the transistor and the average power,  $P_{\text{diss}}$ , being dissipated by the device over a relatively short period of time. Those factors are related to each other by the equation:

$$P_{\text{diss}} = \frac{T_J - T_A}{\theta_{JA}} \quad (1)$$

The thermal resistance  $\theta_{JA}$  consists of three thermal resistances. Those are  $\theta_{JC}$ , the thermal resistance from the junction to the case,  $\theta_{CS}$ , the thermal resistance from the case to a heat sink, and  $\theta_{SA}$ , the thermal resistance from the heat sink to the surrounding air. Using those resistances, equation 1 becomes:

$$P_{\text{diss}} = \frac{T_J - T_A}{\theta_{JC} \theta_{CS} + \theta_{SA}}$$

continued on page 104



# New LM-4. The 40-Channel Logic Monitor you hold in your hand.

Now, there's a unique new way to speed and simplify your work with complex digital circuits. By simultaneously monitoring up to 40 points in a logic system with a compact, easy-to-use instrument that's faster than a scope and safer than a voltmeter. Our new multi-family LM-4. At \$199.00,\* it's one of the best buys in logic today!

Simply slip its 40-pin IC test clip over your CMOS or TTL ROM, RAM, microprocessor or MSI/LSI chip and instantly see the logic state of each pin on a big, easy-to-read liquid crystal display.

But that's only the beginning. You can wire the LM-4 into a computer bus; fit it with two 16-pin test clips or sockets for comparing known good and questionable ICs; use it as a clip-on display for micros, minis and other computers during design, setup, testing, troubleshooting... there's no limit to the ways LM-4 can save you time and money!

Measuring just 5.9 x 3.2 x 1.2", the pocket-sized LM-4 comes with a 24" 40-conductor ribbon cable terminated in a 40-pin IC test clip, plus instructions/applications manual and high-impact carrying case. (An optional Universal Cable Kit is also available for special interfacing requirements, priced at \$75.00\*.)

So whatever the job—in design, production or service—simplify your testing with the power of 40-channel monitoring: Order your LM-4 today.



Call toll-free for details

**1-800-243-6077**

During business hours

## GLOBAL SPECIALTIES CORPORATION

70 Fulton Terr., New Haven, CT 06509 (203) 624-3103, TWX 710-465-1227.  
OTHER OFFICES: San Francisco (415) 648-0611, TWX 910-372-7992,  
Europe: Phone Saffron-Walden 0799-21682, TLX 817477,  
Canada: Len Finkler Ltd., Downsview, Ontario.

\* U.S. Resale only; price, specifications subject to change without notice.  
© Copyright 1981 Global Specialties Corporation.

CIRCLE 71 ON FREE INFORMATION CARD

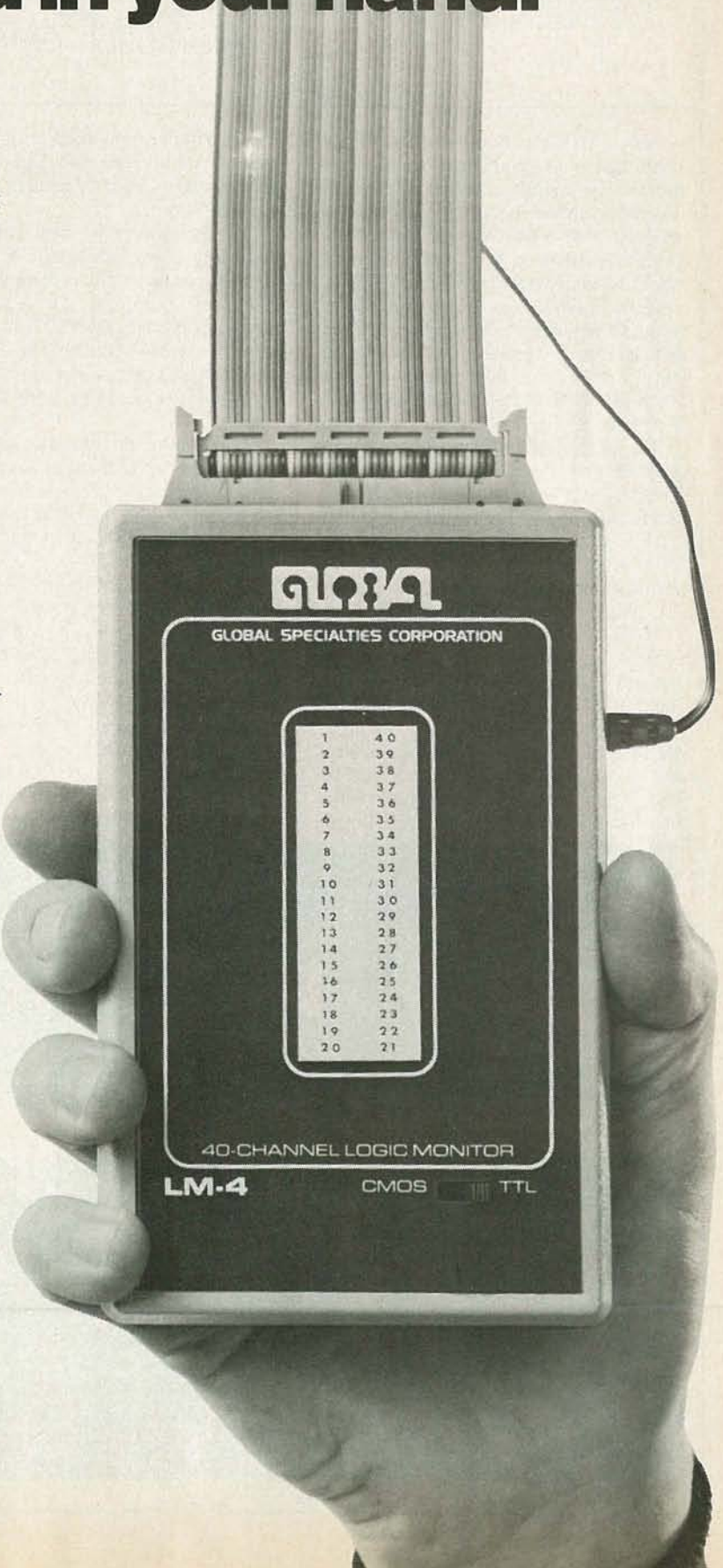

GLOBAL SPECIALTIES CORPORATION

1	40
2	39
3	38
4	37
5	36
6	35
7	34
8	33
9	32
10	31
11	30
12	29
13	28
14	27
15	26
16	25
17	24
18	23
19	22
20	21

40-CHANNEL LOGIC MONITOR

LM-4

CMOS  TTL



# NEW IDEAS

## Air-motion detector

A WIND DETECTOR AND INDICATOR could be put to good use by many hobbyists. For example, those with radio-controlled model boats or planes could use such a device to help make go/no-go flight decisions; a ham radio operator could use one to warn him that his antenna system was in danger of crashing down around him; a kite flyer could use such an indicator to announce good kite-flying days. I'm sure that by the time you have read this far, you've already come up with your own application for a wind sensor.

The sensing circuit can be built to detect either steady or fluctuating air flows. The heart of the circuit (shown in Fig. 1) is a Radio Shack piezo buzzer (part number 273-060) and an LM324 quad op-amp. Note that the red wire from the piezo element should be connected to capacitor C1, and the black wire to ground.

When a current of air hits the piezo element, a small signal is generated and is fed through C1 and R1 to the inverting input (pin 2) of one section of the LM324. That causes the output (pin 1) to go high. Resistor R3 is used to adjust the sensitivity of the detector. The circuit can be made sensitive enough to detect the wave of a hand or the sensitivity can be set so

low that blowing on the element as hard as you can will produce no output. Resistor R2 is used to adjust the level of the output voltage at pin 1.

The detector circuit can be used in various control applications. For example, an SCR can be used to control 117-volt AC loads as shown in Fig. 2-a. Also, an NPN transistor, such as a TIP29, can be used to control loads as shown in Fig. 2-b. I have driven such loads as incandescent lamps, solenoids, and relays with the setups shown.

The control circuits discussed above work well when there is a constant air flow. However, in situations where the air flow fluctuates—because the output will fluctuate with the wind source—a latch-type circuit may be necessary. One such circuit is shown in Fig. 3. The fluctuating output of the NPN transistor activates the 555 timer, and allows the load to be driven for a certain length of time—as determined by the setting of potentiometer R2—without an input.

There are a great number of possible applications for the air detector circuit and it also makes a great building block for more complex circuits. For example, a solid-state weather vane could be con-

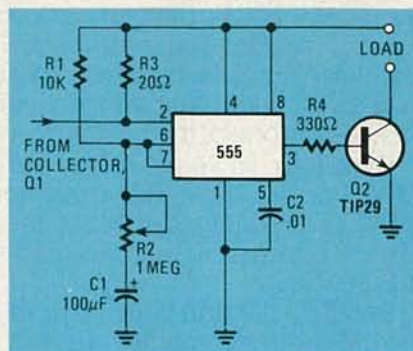

FIG. 3

structed using a group of sensors—each facing a different direction—to turn on direction-indicating lights or LED's. A digital wind-speed indicator could also be built.—Chris Mabry

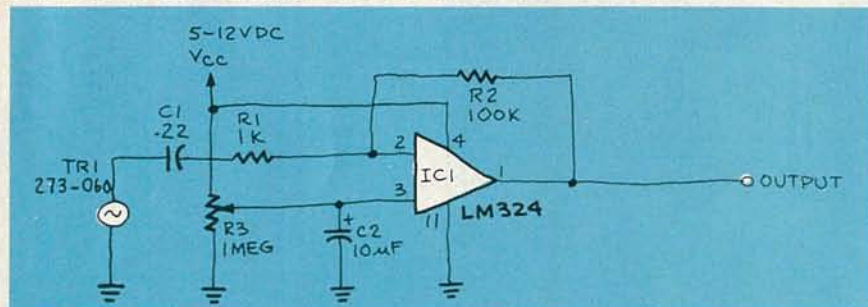

FIG. 1

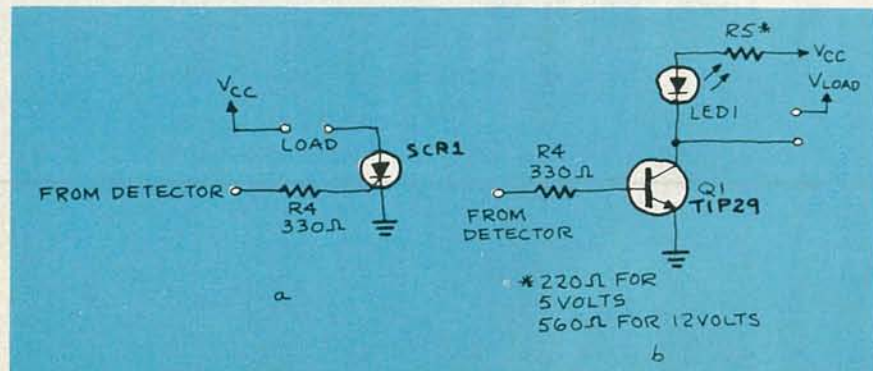

FIG. 2

### NEW IDEAS

This column is devoted to new ideas, circuits, device applications, construction techniques, helpful hints, etc.

All published entries, upon publication, will earn \$25. In addition, Panavise will donate their model 333—The Rapid Assembly Circuit Board Holder, having a retail price of \$39.95. It features an eight-position rotating adjustment, indexing at 45-degree increments, and six positive lock positions in the vertical plane, giving you a full ten-inch height adjustment for comfortable working.

I agree to the above terms, and grant Radio-Electronics Magazine the right to publish my idea and to subsequently republish my idea in collections or compilations of reprints of similar articles. I declare that the attached idea is my own original material and that its publication does not violate any other copyright. I also declare that this material has not been previously published.

Title of Idea

Signature

Print Name

Date

Street

City

State

Zip

Mail your idea along with this coupon to: **New Ideas Radio-Electronics**, 200 Park Ave. South, New York, NY 10003



## SWD-1 VIDEO CONVERTER

FOR CABLE TV



The SWD-1 Video Converter is utilized on cable TV systems to remove the KHz's signal from a distorted video (channel 3 in/out) and also pass thru the normal undistorted/detected audio signal. Rocker switch selects operating mode to remove KHz's distortion from the video or pass all other channels normally. Simple to assemble—less than 30 minutes. Pre-tuned. Input/output Channel 3. Impedance 75 ohms. 117VAC.

SWD-1 Video Converter Kit ..... \$69.95

## VTR ACCESSORIES

### SIMPLE SIMON VIDEO STABILIZER



Simple Simon Video Stabilizer, Model VS-125, eliminates the vertical roll and jitter from "copy guard" video tapes when playing through large screen projectors or on another VTR. Simple to use, just adjust the lock control for a stable picture. Once the control is set, the tape will play all the way through without further adjustments. Includes 12V power supply.

VS-125 Video Stabilizer, wired ..... Reg. \$4.95 ... **\$39.95**

### NEW VCR Quality

## MODULATOR

Not a Game Type Modulator

The MPS-1 Kit converts Video/Audio signals to a crystal controlled RF output for TV Channels 3 and 4. The MPS-1 Modulator inputs are designed to match all TV Cameras and VCR's and features a voltage regulated power supply, power switch and LED indicator. No Tuning Required. Operates on 117VAC.

Assembly Time Approximately 5 Minutes

MPS-1 Kit ..... \$39.95

## UHF ANTENNAS and ACCESSORIES

### MDS-AMATEUR-ETV 32 ELEMENT

#### YAGI ANTENNA



- Not A Kit
- 1.9-2.5 GHz
- 38 1/2" Long
- 23dB Average Gain
- Commercial Grade
- Die Cast Waterproof Housing with 4 1/4" x 2 1/2" Area for Electronics
- Includes P.C. Probe, F-61 Connector and Mounting Hardware

MAE-2 32 Element YAGI Antenna ..... \$23.95

### Kato Sons' Down Converter Kit ★1.9 - 2.5GHz★

Designed for Simple Simon by former Japanese CQ Amateur Magazine's UHF Editor/Engineer. Unit utilizes new ingenious Printed Circuit Probe for maximum gain. Circuit board fits inside MAE-2 antenna housing. Requires 1 hour assembly. IC and capacitors pre-soldered.

Model KSDC-KIT 1.9 - 2.5GHz Down Converter Kit ..... \$34.95

### Kato Sons' Regulated Variable DC Power Supply

For use with KSDC-KIT 1.9 - 2.5GHz Down Converter. Completely assembled with Attractive Cabinet, TV/Converter Mode Switch, Frequency Control and LED Indicator.

Model KSPS-1A Assembled Power Supply ..... \$23.95

**SPECIAL INTRODUCTORY SAVINGS**

### ORDER ALL THREE ITEMS

MAE-2, KSDC-KIT and KSPS-1A for Only. **\$74.95**

Regular price if ordered separately \$82.85

— CO-AX CABLES ARE NOT INCLUDED —

## ZYZZX VHF-UHF Wideband Antenna Amplifier



### Revolutionary New HYBRID IC Broadband Amplifiers

50 MHz - 900 MHz  
Model ALL-1 12dB Gain  
Model ALL-2 35dB Gain

These units are not available anywhere else in the world. Each unit will serve many purposes and is available in Kit or Assembled form. Ideal for outdoor or indoor use. I/O impedance is 75 ohms. Amplifiers include separate co-ax feed power supply. Easily assembled in 25 minutes. No coils, capacitors to tune or adjust.

ALL-1 Complete kit w/power supply \$24.95 ALL-1 Wired/Tested w/pwr supply \$34.95  
ALL-2 Complete kit w/power supply 34.95 ALL-2 Wired/Tested w/pwr supply 44.95

## Our New STVA 14.5dB GAIN, 14 ELEMENT CORNER REFLECTOR YAGI ANTENNA



STVA-3 Yagi Antenna, 14.5dB Gain, Selectable 75 or 300 ohm Channel 60-80. \$19.95

STVA-4 Yagi Antenna, 14.5dB Gain, Selectable 75 or 300 ohm Channel 44-52. \$19.95

RG-59/U 75 ohm Low Loss Coax Cable. \$1.2p/ft. F-59 Coax Connector. \$ .39 ea.

MT-1 Special UHF 75-300 ohm Matching Transformer. \$1.45 ea.

# Switch to Bambi™!

## Electronically

Bambi Electronic Video Switch ... makes switching of your VCR/VTR, Pay TV Decoders, Cable TV, Video Discs, Video Games, Closed Circuit TV, Antennae and Microcomputer as easy as pushing buttons.

The Bambi Electronic Video Switch is an electronic switching network which can accept up to six different sources of video signals and provide the flexibility of directing the inputs to any or all of the three outputs.

Now you can eliminate ... the drudgery of disconnecting and reconnecting your video equipment each time you use it ... the tangled mess of cables which are impossible to trace out ... not being able to use more than one function at a time.

Bambi lets you enjoy using your video equipment the way it should be ... electronically and on line at the push of a button.

Model BEVS-1 Completely Wired and Assembled. Includes comprehensive Instruction/Operation Manual and Decal Set for customizing your Video Switch installation.

**\$129.95**



**FREE Bambi Poster with any purchase**



Bambi's front panel was designed with the user in mind. Computer styled construction, with soft-touch keyboard (rated for over 10 million operations), arranged in matrix form allows easy input/output selection without referring to charts. Functions selected through the keyboard are immediately displayed on the 18 LED status indicators.



Check the quality of Bambi against that of much higher priced competition. All solid state electronic switching provides low attenuation (3dB), wide frequency response (40-890 MHz), and excellent isolation between signal sources (each I/O section individually shielded for 65dB min. isolation).

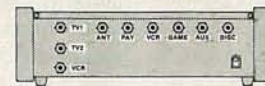

### Bambi's Specifications:

- Input/Output Impedance 75 ohm
- Signal Loss 3dB ±1dB
- Noise 4dB ±1dB
- Input Return Loss 12dB min.
- Isolation 65dB min.
- Power Req. 117VAC 60 Hz, 2W
- Dimensions 10 1/4" W x 6 1/2" D x 3 1/4" H
- Weight 4 1/2 lbs

## 7+11 PWD PARTS KITS

### INTRODUCING OUR 7+11 PWD PARTS KITS



KIT No	PART No	DESCRIPTION	PRICE
1	1VT1-PWD	Varactor UHF Tuner, Model UES-A56F	\$24.95
2	2CB1-PWD	Printed Circuit Board, Pre-drilled	18.95
3	3TP11-PWD	PCB Potentiometers 4-20K, 1-5K, 2-10K, 2-5K, 1-1K, and 1-50K. (11 pieces)	8.95
4	4FR-31-PWD	Resistor Kit, 1/4W, 5% 29-pcs, 1/2 W 2-pcs	4.95
5	5PT1-PWD	Power Transformer, PRI-117VAC, SEC-24VAC at 500ma	9.95
6	6PP2-PWD	Panel Mount Potentiometers and Knobs, 1-1KBT and 1-5KAT with switch	5.95
7	7SS17-PWD	IC's 7-pcs, Diodes 4-pcs, Regulators 2-pcs Transistors 2-pcs, Heat Sinks 2-pcs	29.95
8	8CE14-PWD	Electrolytic Capacitor Kit, 14-pieces	6.95
9	9CC20-PWD	Ceramic Disk Capacitor Kit, 50 WV, 20-pcs	7.95
10	10CT5-PWD	Variable Ceramic Trimmer Capacitor, 5-65pfd, 5-pieces	4.95
11	11L5-PWD	Coil Kit, 18mhs 3-pcs, 22µhs 1-piece (prewound inductors) and 2 T37-12 Ferrite Toroid cores with 6 ft. #26 wire	6.00
12	12ICS-PWD	IC Sockets, Tin inlay, 8 pin 4-pcs, 14 pin 1-pc and 16 pin 2-pcs	2.95
13	13SR-PWD	Enclosure with PM Speaker and Pre-drilled Backpanel for mounting PCB and Ant. Terms	14.95
14	14MISC-PWD	Misc. Parts Kit, Includes Hardware, (6/32, 8/32 Nuts & Bolts), Hookup Wire, Solder, Ant. Terms DPDT Ant. Switch, Fuse, Fuseholder, etc	9.95
15	15MCC16-PWD	Mylar Capacitors, 14-pcs and Silver Mica Capacitors 2-pieces	7.95
When Ordering All Items, (1-15), Total Price			159.95

# GRAB-BAG ELECTRONIC PARTS

Reg. \$139.95



**CUSTOMER NOTICE:** BUY WITH CONFIDENCE... BEWARE OF LOW QUALITY IMITATORS. All of our kits consist of New, 1st Class, RF Quality, Parts Engineered for Optimum Operation, not factory seconds or stock close-outs. We service your completed kits that you've purchased and built. You will never get stuck with a BAG OF PARTS when ordering from Simple Simon.

**SIMPLE SIMON ELECTRONIC KITS,™ Inc.**  
3871 S. Valley View, Suite 12, Dept. R, Las Vegas, NV 89103

NEED OR MORE OF AN ITEM? WRITE FOR QUANTITY DISCOUNTS

In Nevada Call: **702-871-2892**

**1-800-782-3716**

Outside Nevada Call:

Available by Mail Order Only. Send Check\* or Money Order. Minimum Order: \$16.95. Add 10% Shipping and Handling on orders under \$40.00. For orders over \$40.00, add 5%. Minimum Shipping and Handling \$2.00. Cat. \$1.00 — VISA and Mastercard Acceptable — \*Check orders will be held 30 days before shipping.



# HOBBY CORNER

Here's our new look

EARL "DOC" SAVAGE, K4SDS, HOBBY EDITOR

THIS IS THE FIRST "HOBBY CORNER" in the new format that we have been promising. Don't expect the changeover to be immediate—neither Rome nor magazine columns are built in a day. Gradually, though, we'll ease into full stride.

As we begin, you should be aware of the "rules of the game." First, of course, is what we have stated before—that this column cannot provide new circuit designs for esoteric applications. There simply isn't enough time in the month. Second, keep in mind that there is only one Jack Darr—and I am not him. Unlike Jack, I am unable to troubleshoot your equipment by remote control, even on those occasions when you provide what appears to be sufficient information. At best, I may be able to offer a suggestion for an approach to solving your problem, as is the case with George Santana (see below).

Next, as many questions as possible will be answered here in the column. Those questions will be the ones which have the widest interest. Please do not expect an individual reply in the mail. Once again, there just isn't enough time.

From time to time, I will provide a reference to an article or book. You will have to dig up the material. Copyright laws prevent our selling or even giving

away copies of a few pages of this or that. Possible sources are the original publishers, your local library, and friends who squirrel away magazines year after year.

I want to thank those of you who have already sent inquiries, and those who will send them. Keep them coming and remember that it may be several months before your question appears.

## High-voltage generator

Twelve-year-old Eric Jackson (Ontario, Canada) sent the diagram of a battery-operated high-voltage generator and asks how to make a smaller one. Well, Eric, let's talk a bit about how and why the device works. Then you can try various components until you get what you need.

The circuit in Fig. 1 shows a basic circuit of the type you have. A transformer, as you know, is a device that increases or decreases voltage, as determined by the ratio of the number of turns of wire on each side. The one shown is connected as a *step-up* transformer—there are more turns on the output side than on the input side, and the output voltage is higher than the input voltage.

A transformer will not work on DC—it depends on the electromagnetic field

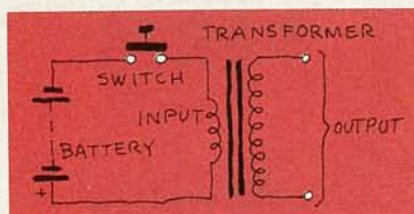

FIG. 1

changing; that's just what happens when AC is applied. The object, then, is to convert the DC from the battery to AC so the transformer can operate.

The normally-open momentary switch will convert the DC into a type of AC—but it won't be AC as we normally think of it. It will just be a current that alternates between on and off—not a nice, neat sine-wave. When you press the switch, current flows through the input side of the transformer, causing a magnetic field to build up. That *change* (from there being no field to the presence of one) induces a higher voltage on the output side.

Release the switch and the current

stops. That causes the field to collapse. Because that is another change, it induces another shot of higher voltage at the output.

You can get pretty tired of pushing that switch. What you need is something to make and break the circuit for you. We'll substitute a relay for the switch, as shown

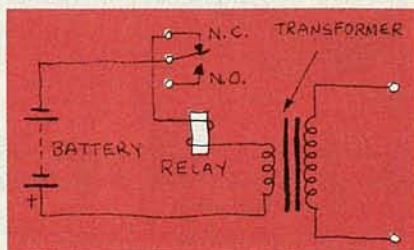

FIG. 2

in Fig. 2. When power is first applied, the relay contacts are closed and there is a current flow through the circuit—the relay coil and the input side of the transformer. The resulting magnetic field in the input winding induces a higher voltage in the output winding. At the same time, the magnetic field at the relay core pulls the armature and breaks the contact—it opens the switch and stops the current flow. That, of course, causes the magnetic field at the transformer to collapse, just as it did when you released the manual switch.

The magnetic field at the relay collapses, too, releasing the armature, which completes the circuit again. Thus, the cycle is repeated. The current starts and stops; the magnetic field builds up and collapses, and a shot of high voltage is produced at the output for each change.

The level of the output depends upon several factors. First, there is the ratio of output turns to input turns in the transformer. The higher the ratio, the higher the output voltage. Then, a higher battery voltage (and, thus, current) creates stronger fields, so the amount of change is greater and the output level increases. Finally, the faster the relay operates (within certain limits) the higher the output will be.

As far as parts selection is concerned, almost anything will do. I recall building this circuit when I was about your age, Eric. I used an audio transformer from an old radio and a door buzzer for the relay. I also remember getting shocked—but fortunately, the current was extremely low.

## AN INVITATION

To better meet your needs, "Hobby Corner" will undergo a change in direction. It will be changed to a question-and-answer form in the near future. You are invited to send us questions about general electronics and its applications. We'll do what we can to come up with an answer or, at least, suggest where you might find one.

If you need a basic circuit for some purpose, or want to know how or why one works, let us know. We'll print those of greatest interest here in "Hobby Corner." Please keep in mind that we cannot become a circuit-design service for esoteric applications; circuits must be as general and as simple as possible. Please address your correspondence to:

Hobby Corner  
Radio-Electronics  
200 Park Ave. South  
New York, NY 10003



# Savings Spectacular

ORDER BEFORE MAR. 15th AND GET A FREE GIFT! 1-800-243-6953

## LOW OHM METER MODULE, DM-10

Measures resistance from 10 milliOhms to 20 Ohms. Now you can measure resistance down to 10 milliOhms with this low cost, easy to use DVM module. Check coil resistance, transformers, relays, chokes, printed circuit board copper paths and ground cables. Special zero balance control nulls out input cable resistance to insure accurate readings. Your DVM has to be set to 2V range during operation.



- Resistance range 10 milliOhms to 20 Ohms
  - Zero Calibration control
  - Battery powered (push to read battery saver circuit). Requires 9 Volt Battery (not included)
  - Size 6.25" x 3.75" x 2"
  - Incl. Model 336 Test Clips
- \$55<sup>95</sup>**



## REGULATED TRIPLE POWER SUPPLY, LOW PRICED! DM-6



A fully assembled and tested triple benchtop power supply. Includes fixed 5V @ 1 Amp, 5V to 15V @ 0.5 Amp and -5V to -15V @ 0.5 Amp—all supplies regulated, short proof. Each supply has a power on indicator LED. Complete and ready for use in a durable (8" x 6" x 3 1/2") metal case.

**\$99<sup>95</sup>**

## 8 CHANNEL SCOPE MULTIPLEXER, DM-12

Convert your single channel scope into a 4 or 8 channel instrument; just connect the DM-12, 8 channel scope multiplexer to your scope, clip the 8 input probes to the signals you want to view. Simple, easy, fast—can handle logic level TTL signals from DC to 3MHz. Features separate spacing and trace amplitude controls and selectable sampling rate—all to insure easy clear scope display.



COMPLETELY ASSEMBLED AND TESTED! READY TO USE!



VIEW 8 CHANNELS AT ONCE!

**\$74<sup>95</sup>**

- 8 TTL compatible input channels (1 TTL load per channel) can drive 50 Ohm scope cable.
- Maximum full screen amplitude 1.6 Volts adjustable.
- Trace amplitude and spacing controls.
- 4 or 8 channel selector switch.
- 8 color coded input cable, 24" long with insulated alligator clips.
- External 9 VDC power supply included (Model MMAC-2).
- Size 6.25" x 3.75" x 2"
- BNC Output Cable Accessory (Model PSA-2 add \$14.95).

## LOW COST CAPACITANCE METER MODULE, DM-8



Connect this high quality low cost Capacitance Meter Module, DM-8 to your digital Volt Meter and turn it into a Digital Capacitance Meter—the Low Cost Way!

COMPLETELY ASSEMBLED AND TESTED! READY TO USE!

**\$79<sup>95</sup>**

- 2V Output
- Accuracy better than 5%
- Push to read range (button) from 1 pF to 20,000 μF
- Zero Calibration control
- In one easy to use, self-contained package
- Battery powered, with "push to read" battery saver circuit (9V batteries not included)
- Size 6.25" x 3.75" x 2"
- Includes Model 336 Test Clips

## PORTABLE SELF-CONTAINED CIRCUIT DESIGNER, DM-5

Contains 8 LEDs and 8 logic switches.

- Control switches and buffered LED logic indicators
- Plug your ICs into solderless breadboards, tie in power and ground, connect your logic switches and LED indicators
- All interconnections between LEDs, switches and circuits via 22-26 solid wire
- Self-powered, in compact, durable carrying case
- Battery (4 1 1/2 Volt C cells\*) or AC powered providing economical bench use or convenient portable use. Available in two models



Also available in 4 LEDs and 4 logic switches. MODEL DM-5A

\*Batteries not included

**\$69<sup>95</sup>**



## LOW COST HIGH FREQUENCY COUNTER



MODEL NO. DM-7

The Albia Model DM-7, 8 Digit High Frequency Counter is easy to use, switch selectable time base input by a single BNC, nothing to build!

- 5 Hz to 550 MHz
- 8 big easy-to-read .43" high intensity LED display
- Crystal (±3 ppm @ 25°C) controlled 0.1 or 1.0 sec. gate times
- Convenient benchtop size (7"x10"x3") durable attractive case

COMPLETELY ASSEMBLED PRE-CALIBRATED PRE-TESTED

**\$149<sup>95</sup>**

PRICES & SPECIFICATIONS SUBJECT TO CHANGE • SPECIAL ENDS MAR. 31st.



FOR FASTER SERVICE USE YOUR CREDIT CARD.



44 KENDALL STREET  
NEW HAVEN, CT. 06512



ALBIA'S FAMOUS WARRANTY.

9 AM  
5 PM  
EST

CALL TOLL FREE 1-800-243-6953



So I got shocked, but wasn't hurt. Be careful, though—don't tempt fate.

### High current

George Santana (NJ) wrote in to describe his troubles with a stereo receiver. Briefly, it seems that the radio started cutting off and on for periods of 15 to 20 minutes, and later it began blowing fuses.

Well, I can't give George a definitive answer on his equipment, but thinking through some of the possibilities here may be of help to him now, and to you later, should you experience similar problems. His problem sounds like one bad component causing additional troubles.

Almost all modern equipment contains a crowbar circuit of one sort or another. That is nothing but an automatic switch that shuts down the power supply when either too much current is drawn and/or the equipment overheats. It closes everything down before the unusual condition causes more serious problems.

The crowbar circuit may be a discrete circuit in or near the power supply or it may be built into one of the components. Many solid-state voltage regulators have built-in protective circuits. When the power supply cuts off, something's wrong and the equipment should not be used until the problem is found and corrected.

George's description of the on-again, off-again receiver surely sounds like a

protective crowbar-circuit in an overcurrent/overheated condition.

Let's suppose that—unnoticed as time goes by—papers and books and whatever get stacked up around and on top of a piece of gear. That could prevent proper circulation of air around the components, and poor ventilation will produce high temperatures—sometimes high enough to trigger the crowbar.

It is more likely, however, that another component has changed value or has failed altogether. When that happens, it can cause a change in current—it may increase or decrease. The latter situation does not activate the protective circuit, but it makes its presence known by changing the way the equipment operates.

In this case, I suspect that a component change has caused an increase in current (and heat). That would cause the crowbar circuit to cut the power. Later, when things have cooled down, the crowbar circuit allows the power to return. If permitted to, that cycle repeats until there is more serious component damage.

What do you do when things have reached that stage? First, I would look for a short, and then for a component that has changed appearance. Specifically, I'd examine the resistors in a power stage—they are frequent culprits. If one shows signs of having overheated (it will probably look darker than the others) you may have found the problem.

If that test fails, you can begin measuring component values and testing transistors. An alternative is to "bull" your way, and turn the equipment on to see whether you can find a part other than the crowbar device that gets too warm—or hot! That's called the burned-finger test. If a component is too hot to keep your finger on it, there's something wrong.

The next procedure would be to measure the voltages at various points. Those values are compared with the normal ones (information provided by the manufacturer) or, lacking that information, with what you think should be normal at those particular points. If the gear won't operate so that voltage measurements can be made, I would disconnect the various stages of the circuit and then connect them one at a time until I got to the one that triggered the crowbar circuit.

There's nothing really scientific in all that, except for the thought process. The object is to identify the faulty part. If you can't spot it right off, then narrow down the possibilities until it is located. That approach applies not only to George's receiver, but to troubleshooting any piece of gear—electronic or otherwise.

### An invitation

The mailbox is waiting; What would you like to know? Send me a question and I'll see if I can find the answer. **R-E**

## SATELLITE TELEVISION RECEIVER



## KITS

*Rainbow makes  
a top-of-the-line  
Receiver affordable*

The Electronic Rainbow Receiver consists of a receiver with an external down-converter that mounts at the antenna, feeds the voltage to the LNA through the coax cable. The 4GHz signal is down converted to 70 MHz and is fed through the RG59/U coax to the receiver.

Rainbow Kits are supplied with simple step by step instructions. All the circuits that you need expensive test equipment to do are pre wired and tested. All printed circuit boards have the outline of each part printed on them.

### RECEIVER FEATURES

Built in RF modulator • Detent Tuning-3.7 to 4.2 GHz • Variable Audio-5.5 to 7.5 MHz • Invert Video • Channel Scan • Voltage monitoring • Meter output • Remote Tuning

### SPECIFICATIONS:

Single Conversion Image Rejection Downconverter • Threshold 8 db CNR • IF Bandwidth 24MHz • Output IV Audio and Video • IF Frequency 70MHz • Video Bandwidth 4.5MHz • Size 3½"Hx8½"Dx11¼"W

### Complete Satellite TV Receiver

#### KIT #1 — Contains:

- Mainboard • Tuning Board • Down-converter Board • Modulator Board
- All parts needed to complete receiver
- Down Converter built in case.
- Cabinet, attractive black brushed anodized metal with silk screened front and back for a professional look
- 70 MHz Filter is pre-wired and tested.
- Complete instruction Manual. **\$395.00**

#### KIT #2 — Board Kit Contains:

- Main Board • Tuning Board • Down-converter board • Modulator Board
- Parts List, assembly and alignment manual
- 4GHz local oscillator and 70MHz filter is pre-wired and tested. **\$129.00**

Instruction manual. Contains printed circuit board layouts, parts placement, and alignment instructions. **\$25.00**

*Ask about  
guaranteed  
to play*

We will accept telephone orders for Visa & Mastercard  
No C.O.D. Orders

**To Order Call** 800-428-3500 317-291-7262  
Complete Kit Weighs 10 pounds. Please add Sufficient Postage  
6254 La Pas Trail  
Indianapolis, Indiana 46268

**ELECTRONIC  
RAINBOW**  146



# Interested in the IBM Personal Computer?



**I**f you're interested in the IBM Personal Computer then you need PC magazine. PC magazine is the Independent Guide to IBM Personal Computers. Each issue is packed with information for everyone interested in IBM Personal Computers.

PC magazine tells you how to put together the best IBM "PC" system and then how to get the most out of it. Each issue brings you hundreds of colorful pages of evaluations, insights, and straight talk from respected experts—professionals in computer science as well as writers, businessmen, lawyers, educators, and many others.

PC covers software, hardware, applications and most every topic of importance to the thousands of IBM Personal Computer users who read it. To ensure that we give you the information you need, PC includes a special "User-to-User" section, as well as a "PC Wish List", and news about IBM Personal

Computer clubs, events and publications.

For a limited time, you can subscribe to PC at NO RISK and still receive a 25% discount off the newsstand price. Enter your subscription

now. If not fully satisfied when you receive your first copy of PC, simply return your mailing label within 15 days for a full refund.

**This is the  
magazine  
that tells you  
all about it.**



Name \_\_\_\_\_  
 Address \_\_\_\_\_  
 City \_\_\_\_\_ State \_\_\_\_\_ Zip \_\_\_\_\_  
 6 issues/\$14.50     12 issues/\$27.00     24 issues/\$46.00  
 Check enclosed     VISA     MasterCard     Bill me  
 Card # [ ] expires \_\_\_\_\_

Rates apply to U.S. and Canada only. All others double.

**Dept. 0092**  
 PC Magazine  
 1528 Irving St.,  
 S.F., CA 94122

**Phone Credit Card Orders to:**  
 (Toll Free Number)  
 California: 800/792-0990, ext. 1136  
 All Other States: 800/227-3800, ext. 1136

0092



# THE DRAWING BOARD

## Designing a keyboard encoder

ROBERT GROSSBLATT

BEING ABLE TO TURN A CONCEPT FROM A vague idea into a working piece of hardware is one of the greatest joys of electronics. The increased complexity of modern electronics can give people second thoughts about deciding whether to build or to buy. The same dilemma had to be faced, though, when transistors replaced vacuum tubes—and you know what happened then.

This department is dedicated to those of you who like to get your hands dirty—the same people who can't resist the temptation to take the cover off a piece of new equipment to "see what's inside." We'll be discussing original design techniques, shortcuts, pitfalls, and breakthroughs. There will be an equal balance of theory and application so you'll learn not only what to do, but why you're doing it and how to adapt the ideas presented here for your own purposes.

And, if you know a better way to do something, or catch me in a mistake, let me know. I'm as fallible as any of you.

### Design criteria

Complex circuits are made up of lots of discrete sections. That seemingly trivial statement is one of the keys to original design. You can bet your new pair of white tennis shoes that the 12-page schematic that came with the last kit you built started life as doodlings on someone's  $8\frac{1}{2} \times 11$  pad of paper. The first part of any original design is a list of design criteria—in other words, what you want the circuit to do and how you want to make it do it. Let's suppose we want to design a circuit that will allow us to enter data from a keypad. Our design criteria would be something like this:

1. Up to 10 digits will be entered from a keypad.
2. Data will be placed on a Tri-state bus.
3. Any data on the bus will be displayed on LED readouts.
4. Each keypad entry will generate an audible signal.
5. The keypad will have two-key roll-over (two keys may be pressed "simultaneously," but the state of the second will not be read until the first has been released).
6. The circuit will have power-on reset.
7. The data bus will be able to be reset from the keyboard.
8. Operation will be glitch-free.

9. The entire circuit will use standard parts that are inexpensive and easily available in single-unit quantities.

Once the criteria have been set, the next thing we need is a block diagram that breaks the circuit into separate sections that can be designed individually. Figure 1 is a block diagram of the circuit that was described by our criteria. In order to meet criterion number 8, we'll use CMOS

technology. Not only will its noise-immunity make the circuit as glitch free as possible, but the low power-requirements of that logic family will help a lot if you decide to run the circuit from batteries.

### A keypad encoder

Since the BCD (Binary Coded Decimal) encoder is obviously the heart of the

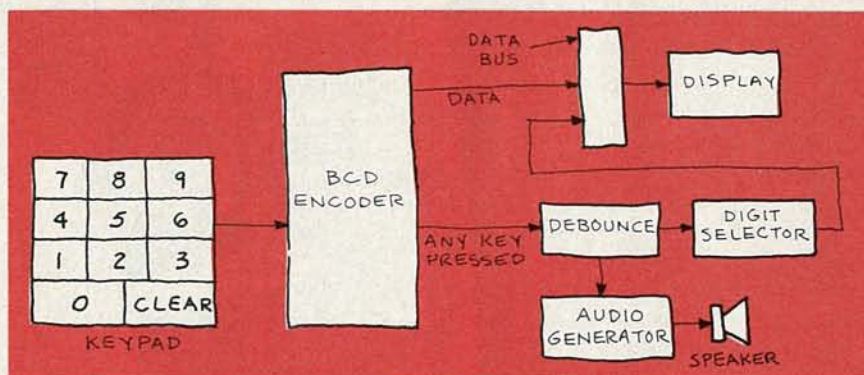

FIG. 1

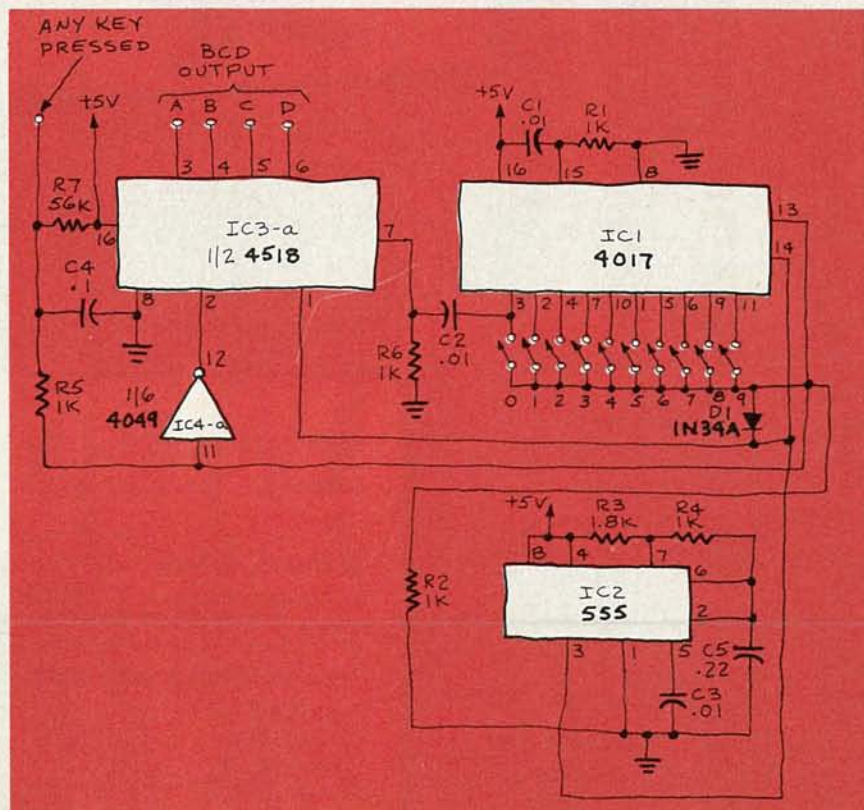
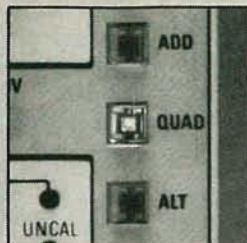

FIG. 2





SOFT TOUCH  
FULL-LOGIC  
CONTROLS

DUAL INDEPENDENT  
TIME BASE (1590 ONLY)



CALIBRATED  
DELAYED SWEEP



4 VERTICAL  
INPUT CHANNELS

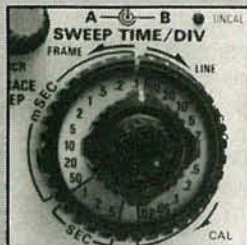

DUAL TIME BASE



EXCLUSIVE  
V MODE

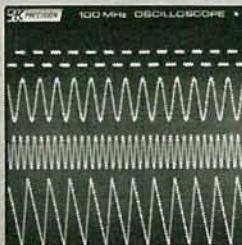

8-TRACE DISPLAY

SWITCHABLE  
INPUT IMPEDANCE (1590 ONLY)

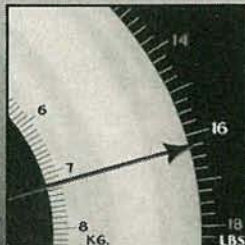

LIGHT WEIGHT  
16.25 LBS

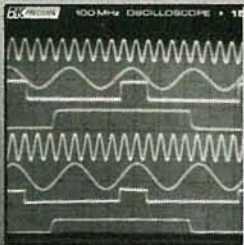

# Looking for a 70 or 100MHz scope? B&K-PRECISION just eliminated the competition.

100MHz 1590  
\$1995

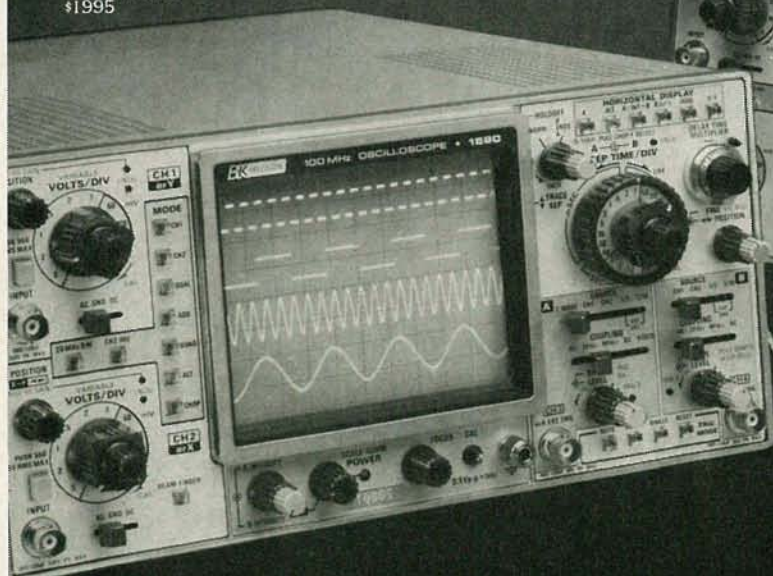

70MHz 1570  
\$1395

To learn more about how  
B&K-PRECISION has eliminated the competition,  
see your local distributor or call toll-free  
**1-800-621-4627** [in Illinois 1-312-889-9087]  
Available for immediate delivery or 10 day free trial.

**B&K PRECISION** DYNASCAN CORPORATION

6460 West Cortland Street • Chicago, Illinois 60635 • 312/889-9087  
Intl. Sls., 6460 W. Cortland St., Chicago, IL 60635  
• Canadian Sales, Atlas Electronics, Ontario  
South and Central American Sales, Empire Exporters, Plainview, NY 11803

FEBRUARY 1983



circuit, we'll start with that. There are lots of different schemes that can be used to design such an encoder, but they all usually decode the output of a running counter. The approach we'll take is shown in Fig. 2. A 555 is set up as a signal source running at about 2 kHz. That clock is used to drive both a 4017 decade counter and a 4518 binary counter. The 4017 gives us decoded one-of-ten outputs at the same time that the 4518 counts up in BCD. The trick to getting the circuit to operate properly is to make sure that both IC's run in sync. We'll do that by using the reset pins on each IC.

The reset pin on the 4017 has to be held low for normal counting but we want to make sure that the count starts with zero when the circuit is first turned on. Therefore, resistor R1 holds the reset pin low so the IC can count, while C1 provides a positive pulse at power-up to reset the counter to zero. We can handle the 4518 in a similar fashion. The reset pin (pin 7) is held low by R6 and the count is started at zero by C2. When the "zero" output on the 4017 goes high it sends a positive pulse through C2 and on to the reset pin of the 4518. That does two things for us. Not only does it make sure that the two IC's are in sync at power-up, but it keeps them in sync; it does that by resetting the 4518 to zero every time the 4017's count hits zero.

Resistor R2 keeps the 4017 enabled as

long as none of the keypad switches are closed. When a switch is closed, the IC is disabled and the count stops. The high signal generated by the key closure is also inverted by IC4-a and disables the 4518. At the same time, diode D1 conducts, making sure that the clock stops. The result of all that is that when you close a numbered switch on the keypad, the corresponding BCD code appears at the outputs of the 4518.

The circuit has two-key rollover because scanning starts up again at the instant that the keypad switch is released. When the second switch-closure is reached, scanning stops once again and the 4518 outputs the BCD equivalent of the second number. We also get an "any key pressed" output that is debounced by C4 and R7.

The circuit uses the 4017 as a one-of-ten decoder, and that means that all the keypad switches have one side tied together. It's just as easy to build a BCD encoder that uses switches in a row-and-column matrix, and there are even keyboard-encoder IC's such as the 74C922 that have the clock, counter, and all the rest of the circuitry on a single chip to take care of all the housekeeping chores that we performed with resistors and capacitors.

The reason for our design is given by criterion number 9. The IC's we're using are common ones that are available from

almost any supplier (see the ads at the back of this magazine). They cost about a dollar apiece. Keyboard-encoder ICs aren't as readily available, and cost at least five times as much. If none of that impresses you, there's an even more basic reason.

There isn't very much you can learn by plugging a black box into the wall and turning it on so it can do whatever it was designed to do. And the more specialized an IC, the more it begins to resemble a black box. Thus, one of the best reasons I can think of for designing a circuit from the ground up is to understand how it works and to be able to correct any problems that crop up. Also, the more basic the components in the circuit, the more flexibility you have in design. Although that isn't readily apparent yet in our circuit, as we add the other sections shown in the block diagram, we'll see how really flexible the circuit is. And unless you have an understanding of how basic circuits work, it's impossible to understand more complicated ones. You can't learn to program a computer by buying game cartridges.

Now that we have our keyboard encoder operating and putting out a four-bit code, we can concentrate on the rest of the circuit. Next time we'll continue our project by adding the digit selector and display so we can encode up to ten digits sequentially. R-E

## Radio-Electronics REPRINT BOOKSTORE

- |  |         |  |        |
|--|---------|--|--------|
| <input type="checkbox"/> Build Your Own Satellite TV Receiver .....    | \$7.00  | <input type="checkbox"/> Radio-Electronics back issues (1978-79) ..... | \$4.00 |
| <input type="checkbox"/> 8-Ball Satellite TV Antenna .....             | \$5.00  | (October, November 1978 not available)                                 |        |
| <input type="checkbox"/> Build Your Own Robot .....                    | \$12.00 | <input type="checkbox"/> Write in issues desired .....                 | _____  |
| <input type="checkbox"/> TV Descrambler (January, February 1981) ..... | \$3.00  | <input type="checkbox"/> Special Projects (Winter 1980) .....          | \$4.00 |
| <input type="checkbox"/> Video Entertainment (January 1982) .....      | \$2.00  | <input type="checkbox"/> Special Projects (Spring 1981) .....          | \$4.00 |
| <input type="checkbox"/> Your Own Computer (October 1981) .....        | \$3.00  | <input type="checkbox"/> Special Projects #4 (Summer 1982) .....       | \$4.00 |
| <input type="checkbox"/> Radio-Electronics back issues (1982) .....    | \$3.00  | <input type="checkbox"/> Special Projects #5 (Winter 1983) .....       | \$3.00 |
| <input type="checkbox"/> Radio-Electronics back issues (1981) .....    | \$3.50  | <input type="checkbox"/> Radio-Electronics Annual 1983 .....           | \$2.50 |
| (March, December 1981 not available)                                   |         | <input type="checkbox"/> How to Make PC Boards .....                   | \$2.00 |
| Write in issues desired .....  |         | <input type="checkbox"/> All About Kits .....                          | \$2.00 |
| <input type="checkbox"/> Radio-Electronics back issues (1980) .....    | \$4.00  |  |        |
| (March, May 1980 not available)  |         |  |        |
| Write in issues desired .....  |         |  |        |

To order any of the items indicated above, check off the ones you want. Complete the order form below, include your payment, check or money order (DO NOT SEND CASH), and mail to Radio-Electronics, Reprint Department, 200 Park Ave. South, New York, NY 10003. Please allow 4-6 weeks for delivery.

If you need a copy of an article that is in an issue we indicate is unavailable you can order it directly from us. We charge 50¢ per page. Indicate the issue (month & year), pages and article desired. Include payment in full, plus shipping and handling charge.

ARTICLE \_\_\_\_\_  
 MONTH \_\_\_\_\_ YEAR \_\_\_\_\_  
 PAGES \_\_\_\_\_  
 TOTAL PAGES @ 50¢ each \_\_\_\_\_ TOTAL PRICE \_\_\_\_\_

MAIL TO: **Radio-Electronics** 2/83  
 Reprint Department, 200 Park Ave. South, New York, NY 10003 **All payments must be in U.S. funds**

Total price of order ..... \$ \_\_\_\_\_  
 Sales Tax (New York State Residents only) ..... \$ \_\_\_\_\_  
 Shipping & Handling (U.S. & Canada only) (Includes FIRST CLASS POSTAGE) \$1.00 per item ..... \$ \_\_\_\_\_  
 All other (\$2.00 per item, sea mail) ..... \$ \_\_\_\_\_  
 (\$4.00 per item, air mail) ..... \$ \_\_\_\_\_  
 Total Enclosed ..... \$ \_\_\_\_\_

Name \_\_\_\_\_  
 Address \_\_\_\_\_  
 City \_\_\_\_\_ State \_\_\_\_\_ Zip \_\_\_\_\_

### MOVING?

Don't miss a single copy of **Radio-Electronics**. Give us:

Six weeks' notice

Your old address and zip code

Your new address and zip code

ATTACH LABEL HERE

name \_\_\_\_\_ (please print)  
 address \_\_\_\_\_  
 city \_\_\_\_\_ state \_\_\_\_\_ zip code \_\_\_\_\_

Mail to: **Radio-Electronics**  
**SUBSCRIPTION DEPT., P.O. BOX 2520,**  
**BOULDER, COLO. 80322**



# American and Metric 62-Piece Heavy Duty Industrial Tool Chest \$28

Before Midnight Feb. 27

We will send to each reader of this publication who reads and responds to this test before Feb. 27, a 62-piece American and Metric Heavy Duty Industrial tool set and metal storage chest containing all the basic and special tools necessary to service and repair domestic and foreign trucks, tractors, autos, and all heavy industrial machinery. Consists of: Seven American 3/8 inch drive sockets, (3/8"), (7/16"), (1/2"), (9/16"), (5/8"), (11/16"), (3/4"). Nine American 1/4 inch drive sockets, (3/16"), (7/32"), (1/4"), (9/32"), (5/16"), (11/32"), (3/8"), (7/16"), (1/2"). Nine Metric 3/8 inch drive sockets, (9MM), (10MM), (11MM), (12MM), (13MM), (14MM), (16MM), (17MM), (19MM). Nine Metric 1/4 inch drive sockets, (4.5MM), (5MM), (6MM), (7MM), (8MM), (9MM), (10MM), (11MM), (12MM). A 3/8 inch fine tooth ratchet with quick release drive combination-forward and reversible, a 1/4 inch x 3/8 inch adapter, a 3/8 inch drive extension bar 3 inch. A 3/8 inch spark plug socket with oil resistant in-

sert and speed installation and removal. An 18-piece industrial steel ignition wrench set, complete set of spark plug and gap setting gauges for any type of spark plug. One "1/4-drive" heavy screwdriver, (1) One large set of feeler gauges, an industrial "Phillips" heavy duty and "regular" screwdriver. All tools are drop forged alloy steel for durable heavy duty repair work, and will be accompanied with a LIFETIME Guarantee that it must perform 100% or it will be replaced free. Add \$7 handling and crating for each Tool Chest requested, we pay all shipping. Should you wish to return your tools, you may do so for a full refund. And letter post-marked later than Feb. 27, will be returned. LIMIT: Six (6) sets per address, no exceptions. Send appropriate sum together with your name and address to Tool Test Dept. #109CW, Viking Ind., 6314 Santa Monica Blvd., Los Angeles, CA., 90038, or for fastest service from any part of the country, call collect before midnight 7 days a week.

CALL COLLECT (213) 462-1914

(Ask operator for)  
TOOL TEST #109CW  
Before midnight, 7 days a week  
Have credit card ready

## PRINTED CIRCUIT KITS MAKE CARDS QUICKLY



ONLY Vector kits contain:

- Positive photo-resist coated AND uncoated copper laminate—no messy photo-reversal—no spraying, dipping, or baking.
- 4 types of art aids: rub transfers, ink, tape, cut and peel—use 1 or all.
- 1:1 circuit art rub transfers—IC sets, pads, lines, connectors, symbols, letters, and numbers.
- Everything included—just add water and sunlamp or bright sunshine.
- Liquid etchant and developer—no dry chemical mixing problems. AND
- Process choices—make circuit on copper and etch for 1 card. Make circuit on film, expose, develop and etch for 1 or many cards.

ART AIDS + mylar film + sunlamp + developer & etchant = 1 or many PC's  
+ card + etchant = 1PC

32XA1 kit makes 7 PC cards, \$50.59, 32X1 starter kit makes 2 cards, \$21.11  
If not available locally factory order include \$3.00 shipping, U.S. only  
Prices subject to change without notice

510177

Vector Electronic Co., 12460 Gladstone Av., Sylmar, CA 91342

CIRCLE 41 ON FREE INFORMATION CARD

## FOR ONLY \$129.95 Learn Computing From The Ground Up

Build a Computer kit that grows with you, and can expand to 64k RAM, Microsoft BASIC, Text Editor/Assembler, Word Processor, Floppy Disks and more.

### EXPLORER/85

Here's the low cost way to learn the fundamentals of computing, the all-important basics you'll need more and more as you advance in computer skills. For just \$129.95 you get the advanced-design Explorer/85 motherboard, with all the features you need to learn how to write and use programs. And it can grow into a system that is a major step up from any personal computer on the market. Look at these features: 8085 Central Processing Unit, the microprocessor "heart" of the Explorer/85. (Join the millions who will buy and use the 8080/8085 this year alone.) Plus 20 two-pin input/output ports from which you can input and output your programs, as well as control exterior switches, relays, lights, etc. a cassette interface that lets you store and reload programs you've learned to write. A deluxe 2,000 byte operating system/memory makes it easy to learn computing in several important ways. It allows simpler, faster writing and entering of programs. It permits access by you to all parts of the system so you can check on the status of any point in the program. It allows tracing each program step by step, with provision for displaying all the contents of the CPU (registers, flags, etc.) and it does much more!

You get all this in the starting level (Level A) of the Explorer/85 for only \$129.95. Increased To use, just plug in your AVDC power supply and terminal or keyboard/display — if you don't have them, see our special offers below.

Level A computer kit (Terminal Version) \$129.95 plus \$3 P&H\*

Level A kit (Hex Keypad/Display Version) \$129.95 plus \$3 P&H\*

Level B — This "building block" converts the motherboard into a two-slot S100 bus (industry standard) computer. Now you can plug in any of the hundreds of S100 cards available.

Level B kit \$49.95 plus \$2 P&H\*

S100 bus connectors (two required) \$4.85 each, postpaid.

Level C — Add still more computing power, this "building block" mounts directly on the motherboard and expands the S100 bus to six slots.

Level C kit \$39.95 plus \$2 P&H\*

S100 bus connectors (five required) \$4.85 each, postpaid.

Level D — When you reach the point in learning that requires more memory, we offer two choices: either add 4k of a memory directly on the motherboard, or add 16k to 64k of memory by means of a single S100 card, our famous "JAWS."

Level D kit (CHECK ONE) 4k on-board \$48.95 plus \$2 P&H\* 16k S100 "JAWS" \$148.95 plus \$2 P&H\* 32k S100 "JAWS" \$199.95 plus \$2 P&H\* 48k S100 "JAWS" \$249.95 plus \$2 P&H\* 64k S100 "JAWS" \$299.95 plus \$2 P&H\*

Level E — An important "building block," it activates the 8k ROM/EPROM space on the motherboard. Now just plug in our 8k Microsoft BASIC or your own custom programs.

Level E kit \$5.95 plus 50¢ P&H\*

Microsoft BASIC — It's the language that allows you to talk English to your computer! It is available three ways:

8k cassette version of Microsoft BASIC (requires Level B and 12k of RAM minimum, we suggest a 16k S100 "JAWS" — see above) \$64.95 postpaid.

8k ROM version of Microsoft BASIC (requires Level B A Level E and 4k RAM, just plug into your Level E sockets. We suggest either the 4k Level D RAM expansion or a 16k S100 "JAWS") \$99.95 plus \$2 P&H\*

Disk version of Microsoft BASIC (requires Level B, 32k of RAM, floppy disk controller, 8" floppy disk drive) \$325 postpaid.

TEXT EDITOR/ASSEMBLER — The editor/assembler is a software tool (a program) designed to simplify the task of writing programs. As your programs become longer and more complex, the assembler can save you many hours of programming time. This software includes an editor program that enters the programs you write, makes changes, and saves the programs on cassettes. The assembler performs the clerical task of translating symbolic code into the computer-readable object code. The editor/assembler program is available either in cassette or a ROM version.

Editor/Assembler (Cassette version, requires Level B and 8k (min) of RAM — we suggest 16k "JAWS" — see above) \$59.95 plus \$2 P&H\*

Editor/Assembler (ROM version, supplied on an S100 card, requires Level B and 4k RAM (min) — we suggest either Level D or 16k "JAWS") \$99.95 plus \$2 P&H\*

8" FLOPPY DISK — A remarkable "building block" — Add our 8" floppy disk when you need faster operation, more convenient program storage (perhaps a business application, and access to the literally thousands of programs and program languages available today). You simply plug them into your Explorer/85 disk system — it accepts all IBM-formatted CP/M programs.

8" Floppy Disk Drive \$49.95 plus \$12 P&H\*

Floppy Controller Card \$199.95 plus \$2 P&H\*

Disk Drive Cabinet & Power Supply \$69.95 plus \$3 P&H\*

Drive Cables (set up for two drives) \$25.00 plus \$5 P&H\*

CP/M 2.2 Disk Operating System, includes Text Editor/Assembler, dynamic debugger, and other features that give your Explorer/85 access to thousands of existing CP/M-based programs \$150.00 postpaid.

NEED A POWER SUPPLY? Consider our AP-1. It can supply all the power you need for a fully expanded Explorer/85 (note, disk drives have their own power supply). Plus the AP-1 fits neatly into the attractive Explorer steel cabinet (see below).

AP-1 Power Supply kit (8V @ 5 amps) in deluxe steel cabinet \$39.95 plus \$2 P&H\*

NEED A TERMINAL? We offer you choices: the least expensive one is our Hex Keypad/Display kit that displays the information on a calculator-type screen. The other choice is our ASCII Keyboard/Computer Terminal kit, that can be used with either



1. Plug in Level E form: inserts Microsoft BASIC or Editor/Assembler in ROM Keypad/Display
2. Add Level B to convert to 8085 (optional item)
3. Add 4k RAM
4. Plug in Level F form: inserts Microsoft BASIC or Editor/Assembler in ROM Keypad/Display
5. Add two S100 boards
6. Add your own custom circuit (optional item)
7. Connect terminal

a CRT monitor or a TV set (if you have an RF modulator)

Hex Keypad/Display kit \$69.95 plus \$2 P&H\*

FASTERM - 64 TERMINAL KIT — Featuring a 56 key ASCII Keyboard, 128 character set upper and lower case, 75 ohm output, 8 baud rates, 150 to 19,200 (switch selectable), RS232 C or 20 MA output, 32 or 64 character by 16 line format, complete with Deluxe Steel Cabinet and Power Supply \$199.95 plus \$3 P&H\*

RF Modulator kit (allows you to use your TV set as a monitor) \$6.95 postpaid

12" Video Monitor (10MHz bandwidth) \$139.95 plus \$5 P&H\*

Deluxe Steel Cabinet for the Explorer/85 \$49.95 plus \$3 P&H\*

Fan for cabinet \$15.00 plus \$1.50 P&H\*



### ORDER A SPECIAL-PRICE EXPLORER/85 PAK — THERE'S ONE FOR EVERY NEED.

Beginner Pak (Save \$26.00) — You get Level A (Terminal Version) with Monitor Source Listing (\$25 value) AP-1, 5-amp power supply, Intel 8085 User Manual (Reg. \$109.95) SPECIAL \$109.95 plus \$4 P&H\*

Experimenter Pak (Save \$53.40) — You get Level A (Hex Keypad/Display Version) with Hex Keypad/Display, Intel 8085 User Manual, Level A Hex Monitor Source Listing and AP-1, 5-amp power supply (Reg. \$279.95) SPECIAL \$219.95 plus \$6 P&H\*

Special Microsoft BASIC Pak (Save \$103.00) — You get Levels A (Terminal Version), B, D (4k RAM), E, 8k Microsoft in ROM, Intel 8085 User Manual, Level A Monitor Source Listing, and AP-1, 5-amp power supply (Reg. \$439.70) SPECIAL \$339.95 plus \$7 P&H\*

Add a Rom-Version Text Editor/Assembler (Requires levels B and D or S100 Memory) \$99.95 plus \$2 P&H\*

Starter 8" Disk System — Includes Level A, B floppy disk controller, one CDC 8" disk-drive two-drive cable, two S100 connectors, just add your own power supplies, cabinets and hardware (Reg. \$1065.00) SPECIAL \$999.95 plus \$13 P&H\*

32k Starter System \$1049.95 plus \$13 P&H\*

48k Starter System \$1145.95 plus \$13 P&H\*

Add to any of above Explorer steel cabinet, AP-1, 5-amp power supply, Level C with two S100 connectors, disk drive cabinet and power supply, two sub-D connectors for connecting your printer and terminal (Reg. \$225.95) SPECIAL \$199.95 plus \$13 P&H\*

Complete 64k System — Wired & Tested \$1650.00 plus \$26 P&H\*

Special Complete Business Software Pak (Save \$625.00) — Includes CP/M 2.2 Microsoft BASIC, General Ledger, Accounts Receivable, Accounts Payable, Payroll Package (Reg. \$1325) SPECIAL \$699.95 postpaid.

\*P&H stands for "postage & insurance." For Canadian orders, double this amount.

Continental Credit Card Buyers Outside Connecticut:

TO ORDER  
Call Toll Free:  
800-243-7428

To Order From Connecticut,  
or For Technical Assistance,  
Call (203) 354-9375

CP/M is a reg. trademark of Digital Research

★ (Clip and mail entire ad) ★

SEND ME THE ITEMS CHECKED ABOVE

Total Enclosed (Conn. Residents add sales tax) \$

Paid by

Personal Check  Cashier's Check/Money Order

VISA  MASTER CARD (Bank No. \_\_\_\_\_)

Acct. No. \_\_\_\_\_ Exp. Date \_\_\_\_\_

Signature \_\_\_\_\_

Print Name \_\_\_\_\_

Address \_\_\_\_\_

City \_\_\_\_\_

State \_\_\_\_\_ Zip \_\_\_\_\_

NETRONICS Research & Development Ltd.  
333 Litchfield Road, New Milford, CT 06776

FEBRUARY 1983



# SERVICE CLINIC

## Super-fast capacitor checks

JACK DARR, SERVICE EDITOR

OVER THE YEARS, I'VE GOTTEN MILLIONS of letters (well, thousands, at least) asking "What's the best capacitor tester?" That's one of my favorite questions—because I know the answer! For background on what capacitors do, read the November 1982 "Service Clinic." Stated as simply as possible, capacitors are mainly used for one thing—to move signals. Mostly, they take them away from places where they aren't wanted (as with filter and bypass capacitors) or take them from one circuit to another without upsetting the DC levels (as with coupling capacitors). Figure 1 shows an example of the use of each type of capacitor.

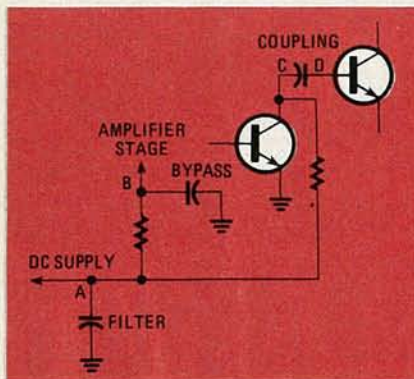

FIG. 1

What's the best way to test capacitors? Why, check to see whether they're doing their job with the signals. Those tests can be made in-circuit, during actual operation—the best test for anything. What's the only test instrument that will show you signals? The oscilloscope. The beauty of testing capacitors with a scope is that there is practically no "setup," or adjustments to make...although you do have to turn the scope on.

You don't have to set up the sweep for any given frequency—just pick up the probe and touch it to any point which is bypassed or filtered. Even if the scope's horizontal-sweep frequency is far away from the normal operating frequency of the circuit, you'll see some vertical deflection if there are any signals—and, if you do, that normally means trouble. You can adjust the vertical gain of the scope to see what the actual peak-to-peak amplitude of the signal is.

For filters in higher-voltage supplies in tube sets, the ripple (signal) should not be

more than about 1.5 volts P-P at the filter output (point "A" in Fig. 1). In solid-state sets, the ripple should be much less or should not be there at all.

For cases where the complaint is distortion, poor sync, unstable color or hold, etc., start by checking all points in the circuit that have bypass capacitors (point "B" in Fig. 1). In practically all sets showing "mysterious" symptoms, and especially in those that show multiple symptoms, look for an open bypass-capacitor. In many cases, an open bypass capacitor will allow a feedback loop (or loops) to be set up, and trouble will be caused by the resulting cancelling or adding effect of the unwanted, unbypassed signal. An open bypass-capacitor on an AGC bus can cause more problems than you can shake the proverbial stick at.

The best test for any possibly-open capacitor is to bridge a good one across the suspect one. (Turn the power off in all solid-state sets when you do that.) If that removes the undesired signal, the fault has been pinned down. Incidentally, that test will also tell you whether or not the capacitor in the circuit is the correct value! If it's too small, it will not bypass all of the undesired signal or take out enough of the ripple. In general, the values of bypass and filter capacitors are not at all critical, as long as they're large enough! Those capacitors are used to take out undesired signals, and, as long as they do the job, you're OK. If the markings on the suspect capacitor are unreadable, and no schematic is available, "guesstimate" the value of the substitute and then check for signals at the bypassed point. If you tried a .01  $\mu$ F capacitor and still had some signal, try a .02, then a .05, etc. until you get the signal out.

### Coupling capacitors

Coupling capacitors are easy to test. If you see a signal on the input of a circuit but not on the output (points "C" and "D" in Fig. 1), the coupling capacitor is open. That type of test is far easier and more efficient than taking the capacitor out of the circuit, checking it on a bridge, and then replacing it. If the original capacitor is a tiny, low-voltage electrolytic, in most cases the heat of unsoldering it will heal the bad contact, and it will work when replaced! If you leave it there, you're just replacing the trouble! Save yourself a headache—replace it with a

new one. A clean signal at the input with distortion at the output can be due to a leaky capacitor; that's common enough with low-voltage electrolytics.

### More filter problems

The raster can often tell you where to look for the cause of a problem. If you see one or two horizontal bars across the raster, they are probably hum bars caused by a weak or open filter capacitor in a rectified-line DC supply. But what if you have what seems to be hum-bars, but they're vertical, there are five or six of them, and they're on the left side of the screen? That's easy—those are also hum bars, and are caused by insufficient filtering of a DC power supply. However, the symptoms point unmistakably to the fact that the DC power in this case is coming from the flyback, where a rectifier and small filter capacitor develop a low DC-voltage for one or more of the transistor stages. The multiple bars are the result of normal ringing during the flyback interval, and are due to an open filter-capacitor on the output of the rectifier.

A problem like that can show up especially when the boost voltage is used to power anything in a set, and its filter capacitor is open. The vertical hum bars are the clue here, and you can use your scope to verify your suspicions instantly by checking the DC output of the supply for ripple.

Your scope is the ideal "quick-check" instrument for capacitors, and it can save you a lot of time. If you don't know exactly what's causing the problems you're seeing, just grab the scope and start looking through the set until you find a signal where it ought not to be. It should be easy to find out why it's there. Just look for the nearest bypass or filter capacitor and bridge it. R-E

## SERVICE QUESTIONS

### HELPFUL HINTS

In the Quasar II chassis (all the ones that use the 84C70120A08 or FA front panel), if the picture repeatedly collapses and expands vertically, resistor R32 (270 ohms, 1/2 watt) is bad. For best results,



replace it with a one or two-watter, preferably a glass-film type. I've never had a callback on sets where I've done this.

If you find the 220K resistor in the horizontal-oscillator plate circuit of an RCA CTC-53 out of tolerance, replace it, and the 120K resistor in the same circuit. They are both commonly responsible for failures and you can tell they're bad by the fact that they'll be discolored.

Thanks to Douglas P. Hoff of Vacaville, CA for that information.

### FLAG-WAVING VDP

*My uncle just bought a new Zenith videodisc player and hooked it up to his 25MC38 Zenith chassis, a 1967 model that is working well despite its age. The problem is that vertical lines wiggle, and the overall picture is not too stable. The videodisc player works fine on a later solid-state set. I'm puzzled.—R.R., Kingston, NY*

That sounds like the familiar flag-waving problem often found when using VCR's and other such equipment with older sets. The "stock" cure is to speed up the time constant of the horizontal AFC by using smaller capacitors. In your set, try C65 and C67, both of which are on the bottom of the AFC-diode unit. Try a value that is about half of the original value.

*(Feedback: It was right where you said! I replaced C47, the .047- $\mu$ F capacitor on the AFC grid of the 6U10 with a .001- $\mu$ F capacitor. That did the trick and the set works nicely on both videodisc and TV signals. My uncle is very happy!*

### SPOT OF INTERFERENCE

Here's an odd problem with a Zenith 14B38Z—a round spot of interference in the center of the screen with vertical lines from top to bottom. Looking at the chassis, an "eyeball check" showed a .01 disc capacitor that was cracked. Replacing it cured the interference. It was a coupling capacitor from the flyback to the AFC diode. It must have been radiating RFI that got into the video.

Thanks to James S. McIntyre of Pettus, WV for that information.

### LOW HIGH-VOLTAGE

Ray Nielson, who didn't give his address, says that a bad fail-safe circuit led to a high voltage of only 6 KV on a Sony SCC-110B. The horizontal-oscillator control, Q951, was biased on, and it shouldn't have been. Zener diode D505 checked out good out-of-circuit, but a new one fixed the problem. It apparently was leaky under load. And here's a "no-no"—Don't turn those sets on unless everything is hooked up. When he had a board removed and applied power, he blew a regulator and SCR!

R-E

# Radio-Electronics

# mini-ADS

## CALL NOW AND RESERVE YOUR SPACE

- 6x rate \$550 per each insertion.
- Reaches 220,500 readers.
- Fast reader service cycle.
- Short lead time for the placement of ads.
- We typeset and layout the ad at no additional charge.

Call 212-777-6400 to reserve space. Ask for Arline Fishman. Limited number of pages available. Mail materials to: mini-ADS, RADIO-ELECTRONICS, 200 Park Ave. South, New York, NY 10003.

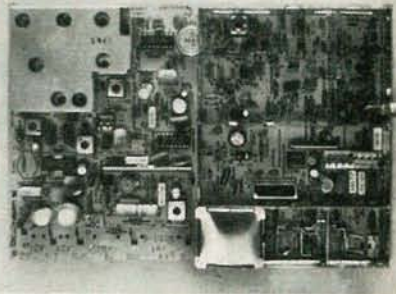

**TELEVISION MODULE** includes VHF, UHF, and CABLE-TV TUNER, IF AMPLIFIER and VIDEO DETECTOR, SOUND DETECTOR and AMPLIFIER, SYNC and SCAN PROCESSOR: **\$95.00**. TELEVISION SIGNAL PROCESSING MANUAL explores standard and non-standard television: **\$15.95**. Add 5% shipping and handling. Informative catalog: **\$2.00**. VISA and M.C. accepted. **ABEX, P.O. Box 26601-RT, San Francisco, CA 94126.**

CIRCLE 85 ON FREE INFORMATION CARD

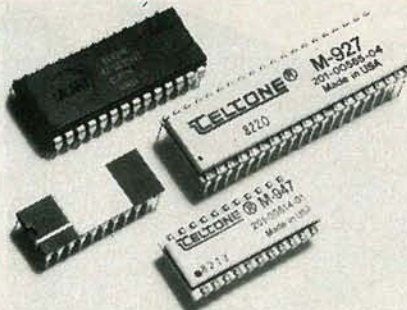

### Turn telephones into control devices

Tel-tone offers 10 DTMF Receivers. The largest selection in the industry. With them you can turn the phone system into a control network. They outperform other receivers in noisy environments and operate over a wide dynamic range. For PABX's, radio-to-phone, computer, and peripheral interfaces specify Tel-tone DTMF Receivers. Call: 800/227-3800 X 1130. (In CA 800/792-0990 X 1130).

CIRCLE 88 ON FREE INFORMATION CARD

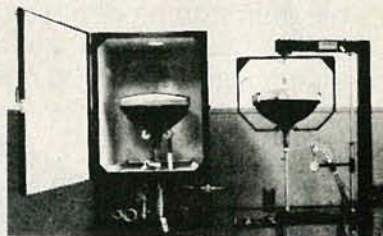

### ONE MAN CRT FACTORY, easy operation.

Process new or rebuild old CRT's for tv's, bus. machines, monitors, scopes, etc. Color, b&w, 20mm, foreign or domestic. 3x6 ft. space required. Profits??? Average CRT rebuilding cost — \$5. Sell for \$100 = \$95 profit; x 5 CRT's = \$475 daily; x 5 days = \$2375 weekly profit. Higher profits outside U.S.A. Investigate this opportunity today. We service the entire world. Write or call:

**CRT Factory, 1909 Louise St., Crystal Lake, Il. 60014, (815) 459-0666.**

CIRCLE 86 ON FREE INFORMATION CARD

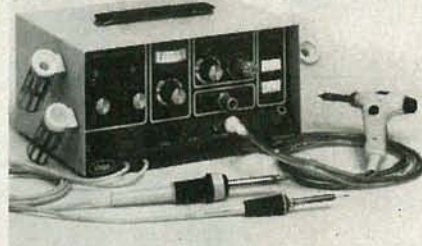

Ungar's new portable Extensive Care Unit features: two soldering irons, vacuum desoldering system, variable speed drilling-deburring tool, a 3V AC variable power supply. Outlets: for soldering tweezer, thermal wire stripper; 12V DC for plating and power tools; 5A, 115V AC for other equipment. 4900 sells for \$1,165. Demo at your Ungar Distributor, or contact Ungar, P.O. Box 6005, Compton, CA 90220, (213) 774-5950, 1-800-421-1538.

CIRCLE 87 ON FREE INFORMATION CARD

## AMATEUR MICROWAVE RECEIVER

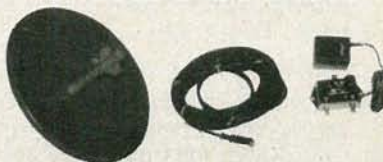

**ONLY \$89.95** complete with the following  
 \* 75 to 300-ohm balun \* balun for rabbit ears  
 \* 20" fiberglass parabolic dish \* low noise probe/down converter \* 60 ft. factory made coax \* 3 ft. coax \* power supply \* mounting hardware and instructions. All for only \$89.95 plus \$5.00 shipping & handling Visa, MasterCard or C.O.D. cash or certified check. **NATIONWIDE G.H.Z., 6825 N. 16th St., Phoenix, AZ 85016 (602) 274-1199.**

CIRCLE 84 ON FREE INFORMATION CARD



# EQUIPMENT AND TRAINING NO OTHER SCHOOL CAN MATCH.

**NTS HOME TRAINING INVITES YOU TO EXPLORE MICROCOMPUTERS,  
DIGITAL SYSTEMS AND MORE, WITH STATE-OF-THE-ART EQUIPMENT  
YOU ASSEMBLE AND KEEP.**

Without question, microcomputers are the state of the art in electronics. And NTS is the only home study school that offers you training for this booming field with a choice of 3 production-model micro computers.

We'll explain the principles of troubleshooting and testing your microcomputer and, best of all, we'll show you how to program it to do what you want.

You'll use a digital multimeter, a digital logic probe and other sophisticated testing gear to learn how to localize problems and solve them.

Send for the full color catalog in the electronics area of your choice—discover *all* the advantages of home study with NTS!

NTS also offers courses in Auto Mechanics, Air Conditioning and Home Appliances. Check card for more information.



We believe that training on production-model equipment, rather than home-made learning devices, makes home study more exciting and relevant. That's why you'll find such gear in most of NTS's electronic programs.

For instance, to learn Color TV Servicing you'll build and keep the 25" (diagonal) NTS/HEATH digital color TV.

In Communications Electronics you'll be able to assemble and keep your own NTS/HEATH 2-meter FM transceiver, plus test equipment.

But no matter which program you choose, NTS's Project Method of instruction helps you quickly acquire practical know-how.





Simulated TV Reception

4.

3. The NTS/Heath HN-89A Microcomputer features floppy disk storage, "smart" video terminal, two Z80 microprocessors, with 32K RAM Memory, expandable to 64K on board. 4. The NTS/Heath GR 2001 Digital Color TV (25" diagonal) features specialized AGC-SYNC muting, filtered color and new solid-state high voltage tripler rectifier.

## NTS NATIONAL TECHNICAL SCHOOLS

TECHNICAL-TRADE TRAINING SINCE 1905  
Resident and Home-Study Schools  
4000 SO. FIGUEROA ST., LOS ANGELES, CA. 90037



1. The NTS/Rockwell AIM 65 Dedicated Microcomputer A Single board unit featuring on board printer and display—4K RAM (expandable). Application Functions: Central processor—Controller/Monitor—Development System. 2. "The NTS/SYM-1 Microcomputer" 6502 Based CPU—4K bytes ROM (expandable)—1K RAM (expandable). 51 active I/O lines for versatile interfacing: disk drives, ASCII key boards, cassette tape, etc.

**NATIONAL TECHNICAL SCHOOLS**  
4000 South Figueroa Street, Dept. 206-023  
Los Angeles, California 90037

Please rush FREE color catalog on course checked below

- |   |   |
|---|---|
| <input type="checkbox"/> MicroComputers/MicroProcessors | <input type="checkbox"/> Auto Mechanics     |
| <input type="checkbox"/> Communications Electronics     | <input type="checkbox"/> Air Conditioning   |
| <input type="checkbox"/> Digital Electronics            | <input type="checkbox"/> Home Appliances    |
| <input type="checkbox"/> Industrial Technology          | <input type="checkbox"/> Color TV Servicing |

Name \_\_\_\_\_ Age \_\_\_\_\_

Address \_\_\_\_\_

Apt. \_\_\_\_\_ City \_\_\_\_\_

State \_\_\_\_\_ Zip \_\_\_\_\_

- Check if interested in G.I. information.  
 Check if interested ONLY in classroom training in Los Angeles.



# STATE OF SOLID STATE

## A switch-mode power supply controller

ROBERT F. SCOTT, SEMICONDUCTOR EDITOR

THE GROWING POPULARITY OF THE switch-mode or switching-type power supplies has—in the last six or seven years—led to the development of more specialized component-types than any other electronic circuit since the early days of radio. It has involved the development of special types of rectifier diodes, inductors, and a wide variety of dedicated IC's.

### Switching power supplies

Before taking a look at the Signetics NE5561 switch-mode power supply controller IC that we're covering this month, let's take a look at Fig. 1 and see what a switching power supply is all about. Basically, a switch-mode power supply can be thought of as a type of series voltage-regulator in which the pass (series) transistor has been replaced by a solid-state switch and a series inductor.

The switch-mode power supply controller—enclosed by dashed lines—has four major sections: a precision free-running multivibrator or clock, an electronic power-switch, a pulse-width modulator (PWM), and an error amplifier.

The *multivibrator* supplies the clock frequency and any timing signals required by the exterior circuit design or application. It drives one input gate of the PWM and, in some applications, pro-

vides the switching drive-voltage in transformer-type flybacks and DC-to-DC converters. The *electronic switch* is closed and opened (switched between saturation and cutoff) at a rate and duty cycle that keeps the supply's output constant.

The *pulse-width modulator* accepts signals from the clock multivibrator and the error amplifier. Its output is a pulse train whose duty cycle is determined by the output of the error amplifier in the feedback path between the power supply output and the PWM. The *error amplifier* compares the voltage tapped from the power supply output with a precision reference-voltage, and develops an error voltage based on the difference between the input signals.

The error voltage varies the switching-pulse duty cycle (the ratio of the on-time to the total time period) as a function of the input voltage and the output load conditions. The switch's on-time is increased if the sample voltage tapped from the supply output is low compared to the reference voltage. If the output sample is higher than the reference voltage, the error voltage narrows the switching pulse, decreasing the switch on-time.

Commutating diode D1 is also called the "catch" or "free-wheeling" diode. Its action is similar to that of a damper diode in TV-flyback power supplies. The

abrupt turn-off of the switch causes the choke's magnetic field to collapse and develop a counter electromotive force (emf) that tends to keep current flowing through the choke. During that period, D1 conducts, permitting the counter-emf current to maintain the charge on C1.

### The NE5561

Small DC-motors have been used for years in automotive and aircraft applications, and are finding many new uses as more and more electronic and computer controls are added.

The circuit in Fig. 2 shows how the Signetics NE5561 switch-mode power supply controller can be used in a DC motor-control application. The circuit is efficient and does not present the heat and power-dissipation problems that are inherent in linear speed-controllers.

The NE5561 provides constant motor-speed through pulse-proportional drive based on feedback from a tachometer that is driven by the motor. A switching circuit consisting of transistor Q1 and commutating diode D1 delivers the programmed pulse energy to the motor. The motor drive-current is in the form of constant-frequency, variable-width power pulses.

The heart of the NE5561 is the saw-tooth generator that drives the PWM and the SET terminal of an R-S flip-flop latch. The oscillator frequency, determined by  $R_1C_1$ , is set at 20 kHz, a frequency high enough to eliminate the audio noise associated with lower-frequency switching drives. The output of the DC tachometer is proportional to the motor speed and should be 2.7 volts per 1000 rpm. The tachometer output is applied as negative feedback to the input of the error amplifier through a voltage divider that delivers 3.75-volts DC to ensure servo lock.

### Duty cycle control

The motor-speed controller feeds a chain of 12-volt pulses to the motor. The duty cycle of the pulses is directly proportional to the load-torque demand. The circuit can be modified for torque-limiting by feeding a derivative of the motor return current (typical current drawn might be 0.3-amp no-load, and 0.6-amp full-load) back into the CURRENT SENSE terminal, pin 6.

An external method of preventing the

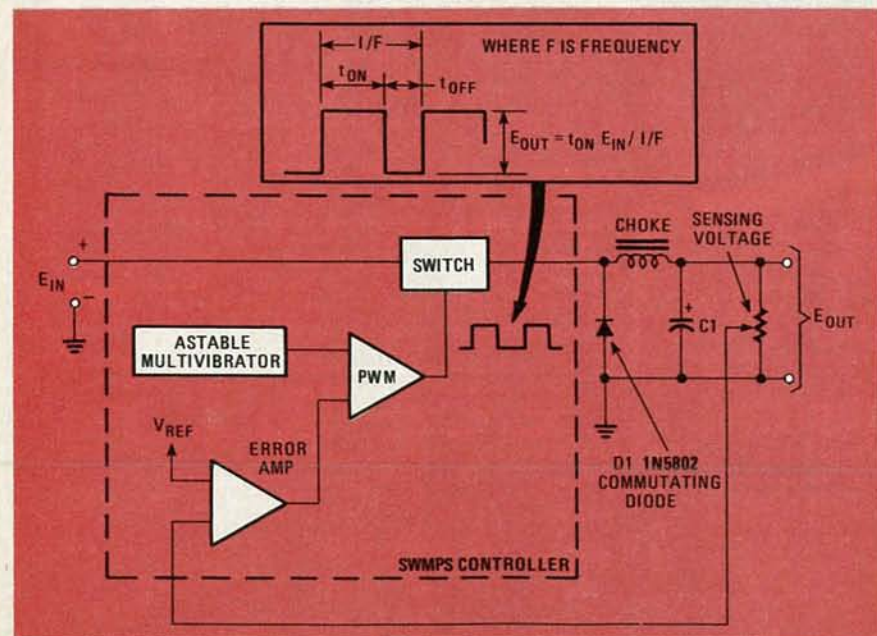

FIG. 1



# Slashes Fordham Lowers Prices on **B&K PRECISION** Test Equipment

Now Fordham is passing on to customers the hugest savings possible on test instruments. To help celebrate the opening of our new 40,000 square foot facility on Long Island, we've purchased an extra large inventory of B&K Precision products.

We're offering the quality of name brand products and the benefits of our volume purchasing power. While supplies last we guarantee these unbelievably low prices.

## 3 1/2 Digit LCD Autoranging DMM

Model 2845  
Reg. \$175.00

Now **\$79<sup>95</sup>** each

**B&K PRECISION**

- Fully automatic, autoranges on all functions.
- Range lock holds any range.
- 0.1% accuracy.
- Fast reading.
- 0.5" LCD display.
- Autozeroing.
- Autopolarity on all ranges.
- Audible continuity indicator.
- Varistor and fuse overload protection.
- RF shielded.
- Meets UL 1244 safety standards.



## 8-Trace, 4 Channel 100 MHz Dual Time Base Scope

Model 1500

Reg. \$2575.00

Now **\$1489<sup>00</sup>** each

**B&K**

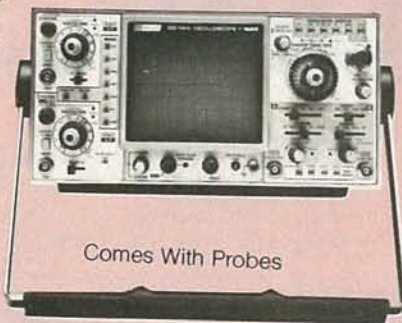

Comes With Probes

- 100 MHz response, 3.5nS rise time • 2nS/div. sweep rate with 10X magnifier • Trigger views or four separate inputs • Dual time base • 1 M ohm inputs or 50 ohm inputs • 1 mV/div sensitivity to 100 mHz • CH 1 frequency counter output • Delayed sweep, 20 nS to 0.5 seconds • Alternate timebase
- Switching power supply • Selectable chop frequencies • Voltage and current probe calibrators.

## Low Distortion Function Generator

Model 3010  
Reg. \$220.00

Now

**\$187<sup>50</sup>** each



- Generates sine, square and triangle waveforms • Variable amplitude and fixed TTL squarewave outputs • 0.1 Hz to 1 mHz in six ranges • Typical sine wave distortion under 0.5% from 0.1 Hz to 100 kHz • Variable DC offset for engineering applications
- VCO external input for sweep-frequency tests.

## Dynapeak Transistor Tester

Model 520B  
Reg. \$239.00

Now

**\$199<sup>75</sup>** each



- Fast testing • Hi/Lo drive • Works in-circuit when others won't • Identifies leads of bipolars and FET's • Random lead connection • Audible test OK 'beep'
- Automatic NPN/PNP and Si/Ge identification.

## CRT Restorer/Analyzer

Model 467  
Reg. \$495.00

Now

**\$420<sup>75</sup>** each



- Restores color and b/w picture tubes like new! Uses the most powerful restoration method known with minimal danger to the CRT • Exclusive multiplex test technique tests all three guns of color CRT's simultaneously under actual operating conditions, even CRT's with common G1 and G2, with real dynamic tests • Instant, automatic tracking.

**FOR ORDERING OR PRICING ON OTHER TEST EQUIPMENT**

**Call Toll Free  
(800) 645-9518  
N.Y.S. (800)832-1446**

**FORDHAM**

260 Motor Parkway, Hauppauge, N.Y. 11788



■ Master Charge ■ VISA ■ COD  
■ Money Order ■ Check  
\$50.00 minimum order  
COD's extra (required 25% deposit)

N.Y. State residents add appropriate sales tax.

ADD FOR SHIPPING AND INSURANCE	
\$251.00 to \$500.00	\$4.50
501.00 to 750.00	8.50
751.00 to 1000.00	12.50
over 1000.00	15.00



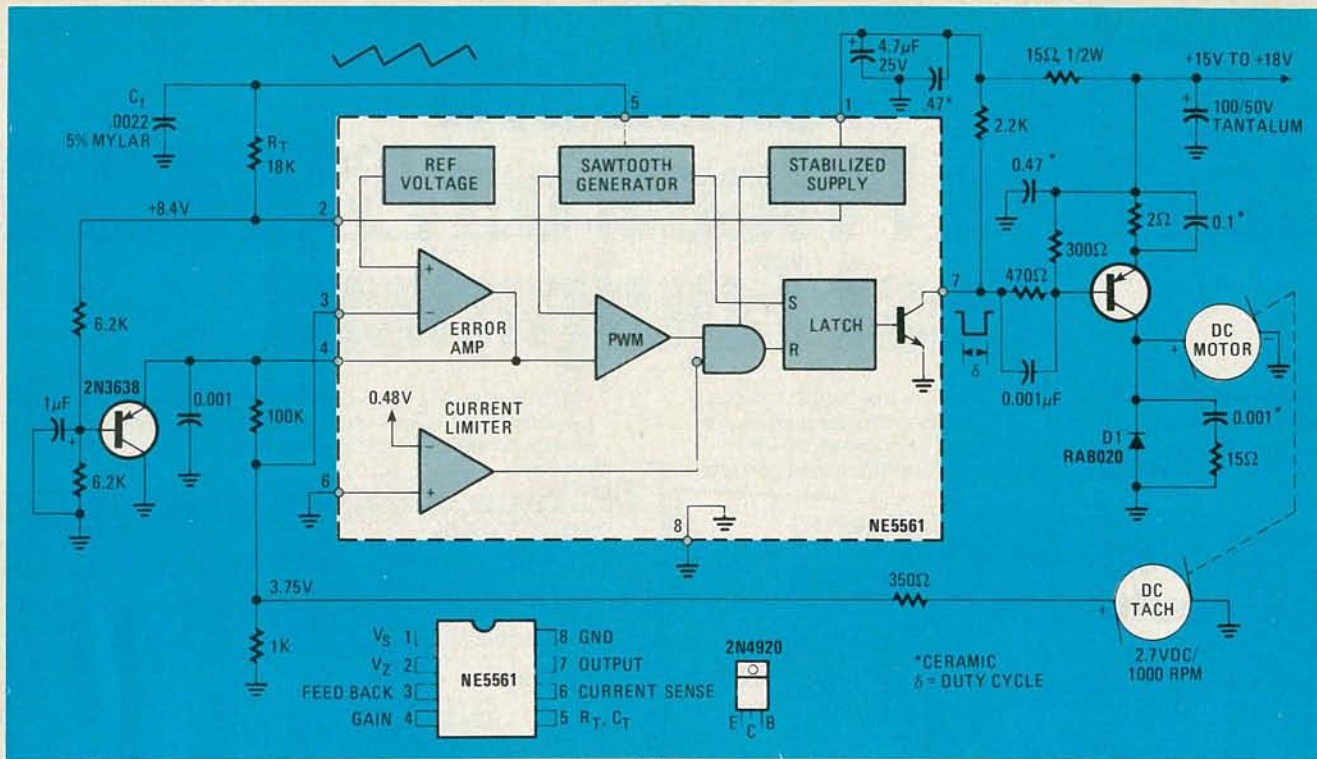

FIG. 2

duty cycle from immediately rising to its maximum is required at the initial start-up of most circuits driven by the NE5561. Without cycle-limiting, at initial turn-on, the DC feedback voltage at pin 3 of the IC

is zero. That causes the error amplifier's output to go high and force the PWM to its maximum duty cycle.

This circuit was taken from the NE5561 data sheet. For additional in-

formation and some interesting power-supply circuits, refer to that data sheet and *Switch Mode Power Supply Circuits*, from Signetics Corp., PO Box 409, Sunnyvale, CA 94086. **R-E**

## Remove Vocals

Remove the lead vocal and substitute your own voice with most stereo recordings using our new, low cost VOCAL ZAPPER™. Great for practice, professional demos or just for fun.

WITH THE  
**VOCAL ZAPPER™**



CHARGE TO VISA OR MC TOLL-FREE  
1-800-654-8657 9AM to 5PM CST MON-FRI

DIRECT INQUIRIES TO:

**PAIA Electronics, Inc.**

1020 W. Wilshire, Oklahoma City, OK 73116 (405)843-9626

- Rush my Vocal Zapper Kit, \$24.95 plus \$3 postage & handling enclosed.  
 Send assembled Vocal Zapper, \$39.95 plus \$3 postage enclosed.  Send Free Catalog

name \_\_\_\_\_  
address \_\_\_\_\_  
city \_\_\_\_\_ state \_\_\_\_\_ zip \_\_\_\_\_  
PAIA Electronics, dept 2R 1020 W. Wilshire, Okla. City, OK 73116

CIRCLE 12 ON FREE INFORMATION CARD

## CABLE TV CONVERTERS DESCRAMBLERS

BUY DIRECT & SAVE



36 CHANNEL  
REMOTE CONTROL  
CABLE CONVERTER  
**\$88.00**

### AMATEUR MICROWAVE ANTENNA

- 26 DB Gain
- Advanced Down Converter
- Complete-Ready to Install

**\$119.00**



### LINDSEY JET I WIRELESS THE ULTIMATE CABLE T.V. CONVERTER



58 CHANNEL INFRARED  
REMOTE CONTROL  
COMPLETELY  
PROGRAMMABLE  
**\$169.00**

Send \$1 for Complete Catalog  
VISA • MASTERCARD • COD

## DIRECT VIDEO SALES

P.O. BOX 1329  
JEFFERSONVILLE, INDIANA 47130

CALL TOLL FREE  
1-800-626-5533

CIRCLE 50 ON FREE INFORMATION CARD

## ATTENTION TECHNICIANS

ARE YOU TIRED  
of being

"only a serviceman"  
or  
"just a technician"?

THE LETTERS "CET  
AFTER YOUR NAME SPELLS  
"PRIDE"

TRY IT.



Take pride in  
your profession—  
Decide to be a CET

For information about: \_\_\_ exam dates;  
\_\_\_ requirements, \_\_\_ study guides;  
other \_\_\_\_\_

Send to: NESDA/ISCET  
2708 W. Berry St.  
Fort Worth, TX 76109  
(817) 921-9101

Name \_\_\_\_\_

Address \_\_\_\_\_

City \_\_\_\_\_ St. \_\_\_\_\_ Zip \_\_\_\_\_



# VIDEO EQUIPMENT

## QUALITY • LOW PRICES

### OFF-THE-SHELF DELIVERY

#### from FORDHAM of course.

**BUY OF THE MONTH**



MODEL V-1880

#### BP STABILIZER/IMAGE ENHANCER/RF CONVERTER/VIDEO FADER/2-WAY DISTRIBUTION AMPLIFIER

OUR PRICE **\$135.00** each

Most versatile video processor. Contains five units in one: stabilizer (video guard remover); image enhancer, video to RF converter, video fader, and dual output distribution amplifier.

**Stabilizer** Will correct entire range of copy guard distortion such as jitter, vertical roll or black bar travelling through picture.

**Enhancer** Lets you attain best picture for your own preference.

**RF Converter** Allows your TV set to receive video and audio signals from your image enhancer, guard stabilizer, video camera, computer, VCR, etc. The direct video signal from any video component can be fed into the V-1880 and converted to a usable RF signal that can go to your TV antenna terminals.

**Video Fader** Used to produce professional fade ins and fade outs.

#### BP VIDEO GUARD STABILIZER

MODEL V-1875



OUR PRICE **\$45.00** each

Has self contained A&B and bypass switch. Many movies, concerts and special programs for sale or rental are copy guarded. This removes copy guard and allows you to make copies. Many TV sets will not play prerecorded tapes because copy guard causes picture to roll and jitter, turn to snow or disappear. Video Guard Stabilizer removes copy guard from signal.

#### BP VIDEO GUARD STABILIZER/RF CONVERTER

MODEL V-1877



OUR PRICE **\$69.95** each

Same as above but with a built-in RF Converter that gives the model V-1877 an RF output which can be fed directly to the antenna terminals of a TV set. This enables you to remove the copy guard from a pre-recorded tape and view it on a TV using only a VCR.

**Use as an RF Converter only.** Used in conjunction with your TV, you can feed direct audio and video signals from any video device such as video camera, computer, portable VCR, etc.

#### BP VIDEO COMMAND CENTER

MODEL V-4803

OUR PRICE **\$59.95** each

A switcher that can accept 6 inputs and direct them to 3 outputs. Utilizes switch similar to one used on home VCR's. You avoid signal loss incurred by using splitters.



#### JERROLD 60 CHANNEL CORDLESS TV CONVERTER

MODEL DRX-3-105

OUR PRICE **\$110.00** each



- Receive up to 60 TV channels
- Remote TV Control
- Attach to any age or model TV in minutes.
- No tools required.
- On/Off button.
- Channel selection.
- Channel Stepping.
- Fine Tuning.

#### JERROLD JRX TV REMOTE CONVERTER

MODEL JRX-3C105 (SWITCH)

OUR PRICE **\$79.95** each

Consists of two units - a receiver and transmitter. 20 ft. connecting cord is detachable at one end to help you position the unit. May be attached to any age or model TV in minutes. No tools required.

- Receive up to 36 channels.
- Remote TV control.



#### BP VIDEO CONTROL CENTER

MODEL V-4802

OUR PRICE **\$19.95** each

Provides remote control access of all Video, TV or Cable inputs to TV or Big Screen TV from one location by flipping switch.

- One output, your TV set or Big Screen TV
- Four inputs
- Completely passive, i.e. no AC power required to operate
- Auxiliary input and output provides added flexibility.



#### BP UHF CONVERTER FOR TV AND VTR

MODEL V-5736

OUR PRICE **\$24.95** each  
5 FOR **\$100.00**

Use your VCR to its maximum capability. Record VHF, UHF, Cable or Pay TV while watching any other mode.

- FEATURES**
- 36 channels
- Allows complete programming of VTR
- Super color quality
- Watch or record any combination of selectable channels.
- Receives midband, superband/Pay and all VHF channels on UHF.
- For Beta/VHS type recorders or TV set
- Record and use TV's remote control.



#### BP IMAGE ENHANCER

MODEL V-1860

Dramatically improves performance of video cameras and VCR's (off-the-air or second generation recordings), by compensating for deterioration of detail and sharpness. Includes video distribution amplifier with two video outputs, allowing you to make two copies at once without loss in signal level.



OUR PRICE **\$59.95** each

#### BP RF CONVERTER/MODULATOR

MODEL V-1885

OUR PRICE **\$39.95** each

Allows your TV to receive video and audio signals from image enhancer, guard stabilizer, video camera, computer, VCR, etc. The outputs of many video components cannot be directly hooked up to the VHF antenna terminals on your TV set. This problem is solved by using the Model V-1885 RF Converter. Converts video signal from any video component to adjustable RF signal at antenna terminals. Allows your VCR output to feed two TV sets at the same time, with virtually no signal loss.



**FORDHAM**  
260 Motor Parkway, Hauppauge, N. Y. 11788

- Master Charge
- VISA
- COD
- Money Order
- Check

N. Y. State residents add appropriate sales tax.

ADD FOR SHIPPING AND INSURANCE	
\$250.00 to 500.00	\$4.50
501.00 to 750.00	6.50
751.00 to 1000.00	12.50
over 1000.00	15.00

COD's extra (required 25% deposit)

**TOLL FREE (800) 645-9518**  
in N. Y. State call 800-832-1446



# COMPUTER CORNER

## Handheld computers

LES SPINDLE\*

IN PREVIOUS COLUMNS, WE EXPLORED the miniaturization of computers from minis to micros to portable micros. Now we will look at yet another category of small computers—the handheld micro. When first introduced, the name “pocket computer” was frequently attached to those small units. However, when equipped with a printer, cassette interface, and other peripherals, the devices can scarcely be toted in the average pocket. “Briefcase computer” might evolve as a logical terminology—as the smaller portable computers (such as the recently-announced Hewlett-Packard *HP-75*) and the larger handhelds (such as the Radio Shack *PC-2*) move closer together in size and capabilities.

Who are those handheld computers best suited for, and what are their capabilities? Hobbyists form one large group of enthusiasts, but the handheld computer can also be recognized as a highly convenient solution to many data-processing problems faced by the professional person. Field engineers, surveyors, inventory clerks, and building contractors are all likely users, as are salesmen on business trips, and college students, stockbrokers, insurance-claim adjusters and tax advisors.

The handheld's key asset is still, of course, portability. As the technology matures, and as more and more handheld units are equipped with modems and data-communications software, the devices will become even more practical. Accessing the office from wherever you happen to be—and having the capability to transmit data files from remote locations—will open a whole new vista of professional applications.

What are the currently available products, and which one is best for your individual needs? Let's start by taking a look at the Sharp *PC1211* (also packaged by Tandy as the Radio Shack *PC-1*).

### Radio Shack/Sharp handhelds

The overriding advantage to the *PC-1/PC1211* is its portability. It's one of the lightest (six ounces) and smallest of the pocket computers. But the tradeoff is that it does not offer some of the more sophisticated or advanced capabilities of its successors.

\*Managing Editor, *Interface Age* magazine



FIG. 1

The computer is equipped with a 1.9K memory for programs and data. For \$160, or less, the user is supplied with the basic unit, a 125-page manual, and a beginner's guide to BASIC programming. The computer will run for approximately 300 hours on a set of four mercury batteries. The *PC1211* will accept program lines of up to 80 characters in length, and display them on a 24-character liquid crystal dot-matrix display that scrolls automatically for lines with more than 24 characters. Full cursor-control allows scrolling up or down, left or right, and simple editing.

A printer/cassette interface is available for \$130. The printer will print 16 characters per line at a rate of 60 lines-per-minute. A useful set of practical programs is available—including engineering, mathematics and business packages.

Though the *PC1211* lacks the memory capacity and bells-and-whistles features of more recent units, it is a good one for beginners.

Another Sharp handheld computer is the recently-introduced *1500* (also sold as the Radio Shack *PC-2*). Its outstanding features are its 8-bit microprocessor—allowing some capabilities that rival desktop micros—and its expandability via a 60-pin connector. As a bonus, programs written for the *PC-1211* will also run on the *1500*.

The *1500* comes with 2.6K bytes of user-memory and is expandable through plug-in modules to 4, 8, or 16K. The operating system and BASIC are stored in a 16K-byte ROM. The computer includes a real-time clock and operates at 1.3 MHz. The *1500* is powered by four “AA” batteries that should let it run for about 50 hours.

A printer/plotter/dual-cassette interface is available for \$240. That unit is powered by rechargeable nickel-cadmium batteries, but it includes an AC adapter/charger and will also power the *1500* computer. With that interface, 25 statements for easy plotting and printing are added to the computer's BASIC. Both upper- and lower-case characters are available, and four colors of graphics and nine sizes of text can be printed. The printed display is from 4 to 36 characters wide (depending on the type size chosen). Programs or data can be saved or loaded to or from cassette tapes using either one or two recorders.

For those who require simple graphics, ample programming capabilities, and future expansion from their handheld computer, the Sharp *1500* is a good choice.

### Casio

Another handheld, the Casio *FX702P* will be of special interest to those with



mathematical applications. Its extensive set of built-in functions includes trigonometric and hyperbolic functions, statistics, degree-to-decimal conversion and vice versa, random-number generation, natural logs, and many more functions that you would expect to find on a high quality scientific calculator.

The keyboard is laid-out alphabetically (as opposed to the typewriter-style "QWERTY" arrangement) and the numeric keys are to the right of the alphabetic ones.

A set of 73 programs is provided in the manual, and include scientific, mathematical, and business applications, as well as games. Several hundred additional programs are expected to be introduced in the near future.

The liquid-crystal display allows up to 20 characters at a time to be displayed. The maximum line-size is 30 characters—the display will automatically shift when 20-30 characters are in use.

Its simple BASIC subset of commonly-used variables, numerous mathematical functions, and portability (it weighs 6.3 ounces and measures  $\frac{3}{8} \times 6\frac{1}{2} \times 3\frac{1}{4}$ -inches) will make the Casio FX-702P an attractive alternative for many users. The price for the basic unit is just under \$200. A cassette interface is available for \$49.95, and the printer is available for \$89.95.

### The Panasonic/Quasar handheld

In many respects, the Panasonic HHC (Quasar sells a functionally similar handheld in a slightly different package) is the most useful pocket computer currently available for serious applications. Three versions are available: the RL-H1000, which comes equipped with 2K of RAM (\$325); the RL-H1400, with 4K (\$380); and the RL-1800 with 8K of RAM (\$480).

A large selection of software packages is available for the Panasonic system including *Portacalc* (a *VisiCalc*-like spreadsheet program) and *Portawriter*, a word-processing program. Many popular programming languages are also available. Several modes of operation provide versatile independent functions: a four-function calculator mode, a calendar-alarm mode for appointments, and a text mode (allowing creation of an 80-character record in free-format). Up to three 16K-byte ROM modules can be loaded at once.

Peripherals available include an I/O adapter, 15- or 40-character-per-line printers, a four-color plotter, an RS-232 interface, a modem, and a modem with a cassette interface for sending or receiving programs.

A color-TV interface is also available. With that, you can use a TV to display up to 16 lines (up to 32 characters per line) or up to  $48 \times 64$  graphic elements in eight colors plus black.

R-E

**A 10 HOUR TAPE RECORDER** WAS \$125.00  
**NOW only \$95.00\*** LONG PLAY

Modified Panasonic Slimline high quality AC-DC Recorder provides 5 continuous hrs. of recording & play back of top quality sound on each side of cassette for a total of 10 hrs. Built-in features include:

- Voice level control
- Digital counter, etc.
- TDK DC-180 Cassette included.



**PHONE RECORDING ADAPTER**

Records calls automatically. All Solid state connects to your telephone jack and tape recorder. Starts recording when phone is lifted. Stops when you hang up.

\$24.50\*

FCC APPROVED

**VOX VOICE ACTIVATED CONTROL SWITCH**

Solid state. Self contained. Adjustable sensitivity. Voices or other sounds automatically activate and recorder or remote mike.

\$24.95\*

\*Add for ship. & hdg. Phone Call Adapter & VOX \$1.50 ea—Recorder \$4.00. Cal. Res. add tax. Mail order. VISA, M/C, cod's ok. Qty. disc. avail. Money back guar. Free data. Dir. inc. inv.

AMC SALES, Dept. A. 9335 Lubec St., Box 928, Downey, CA (213) 90241 Phone 869-8519

CIRCLE 13 ON FREE INFORMATION CARD

## OPPORTUNITY WITHOUT RISK.

The biggest improvement in 40 years has made U.S. Savings Bonds an ideal investment.

A variable interest rate lets you share in rates offered by today's securities market. No limit on how much you might earn.

What makes this improved Bond ideal is that you're protected by a guaranteed minimum. And if the Bond is held to maturity, you'll double your money.

Take another look at this opportunity without risk.

Take stock in America.

Ad Council

A public service of this publication and The Advertising Council.

## If you need QUARTZ CRYSTALS

—one or hundreds—

### YOU NEED JAN

- high stability
- prompt service
- cost savings

JAN CRYSTALS

- General Communication
- Industry
- Marine VHF
- Scanners
- Amateur Bands
- CB Standard
- CB Special
- Microprocessor

Call or Write

JAN CRYSTALS

P.O. Box 06017  
Fl. Myers, Fl. 33906-6017  
All Phones (813) 936-2397

CIRCLE 11 ON FREE INFORMATION CARD



For Home or Business  
WHAT...WHEN...HOW...

## LEARN HOW TO USE A COMPUTER

Train at home in spare time! No previous experience needed! Now you can learn it all! Computer programming...computer applications...computer games...everything you ever wanted to know about computer operations! Write your own computer programs or use hundreds of programs already available...budgeting, real estate, bookkeeping, expenses, investments, interest, taxes, shopping lists, vacation planning, addresses, phone numbers, routing...even foreign languages and graphics.

You'll know what really happens when you have a computer problem with a bank, store, loan company, oil company, utility or anyone else. You'll be able to talk their language...understand why and how things happen...to be able to take the offensive when you're the victim of a computer error. Experts explain everything in easy-to-understand language with step-by-step directions.

- TIMEX COMPUTER INCLUDED WITH YOUR TRAINING • Plugs into any TV
- SEND FOR FREE FACTS!

ICS COMPUTER TRAINING, Dept. DE013  
Scranton, Pennsylvania 18515

Please rush me free facts and color brochure that tells how I can learn computer applications, programming and operation at home in spare time. No cost. No obligation.

Name \_\_\_\_\_ Age \_\_\_\_\_  
Address \_\_\_\_\_  
City/State/Zip \_\_\_\_\_

FEBRUARY 1983

97



# COMMUNICATIONS CORNER

## Multi-band trap-antennas

HERB FRIEDMAN, COMMUNICATIONS EDITOR

WHILE RECENT ADVANCES IN ELECTRONICS have improved transmitter and receiver performance tremendously, all that fancy high technology does very little good if you can't get a signal out (or in). Remember the old ham adage: "You can't work 'em if you can't hear 'em." We have yet to come up with a high-tech solid state antenna that is superior to a wire!

Current technology has made it possible to put full 3-30-MHz coverage in a transceiver not much larger than a shoebox. Band-hopping is so easy that most amateurs who operate HF can shift bands with a twist of the wrist. But, what's the advantage of a high-tech, full-coverage, broadband rig if it takes 10 minutes to tune up the antenna on a new frequency? For maximum convenience when band-hopping, many amateurs use multi-band antennas—dipoles, verticals, or directional beams. However, the fact remains that those multi-band HF antennas have not been improved much by high technology. They still use old-fashioned *traps*, a trap being an ordinary parallel-resonant circuit.

Let's look at a typical situation. Our new amateur has just purchased a Whiz-Banger All-Band Solid-State Digitized Signal Squirrel, and to get his money's worth he wants full coverage with beams for 10, 15, and 20 meters, and dipoles for 40 and 80; all that on a 20-by-100-foot city house-lot. Because of the lack of space, and because the neighbors aren't too happy seeing a tower loaded with antenna elements swinging close to their homes, our all-band amateur cuts his antenna hardware down to a minimum—just two antennas for five bands.

### How it's done

Imagine a quarter-wave dipole antenna for the 10 meter band. It measures about 16 feet end-to-end, and can be made of aluminum rod or thinwall tubing supported at the center feedpoint. Alternately, it can be made from wires strung from end-supporting insulators.

If we want to cover a lower frequency—say on 15 or 20 meters—with the same type of antenna, we need a length of approximately 23 feet for 15 meters and 35 feet for 20 meters. It seems that no single length will work for all three bands; yet we can purchase antennas

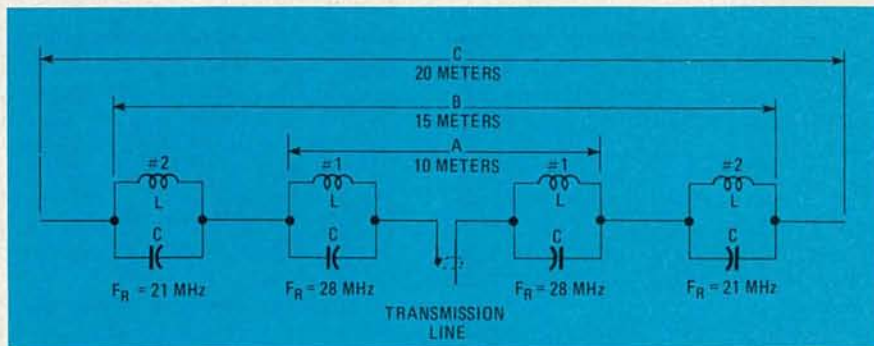

FIG. 1

where a single element serves for 10, 15 and 20 meters, or 40 and 80 meters, or even 80 through 10 meters.

The "magic" is performed by the traps we mentioned earlier, which make a single antenna element appear to be the correct electrical length for several bands. Let's look at Fig. 1, which illustrates how traps work for a three-band 10/15/20-meter dipole. (You can carry the idea through to a 5-band antenna.)

Antenna-segment "A" is the correct length for a 10-meter (28-MHz) quarter-wave dipole. The parallel-resonant "#1" L-C traps at the ends of that segment are tuned to the center of the 10-meter band and electrically isolate the "A" section of the antenna from the remaining wire. As far as the transmitter is concerned it "sees" only the dipole antenna represented by "A."

If the transmitter's output is changed to 15 meters (21 MHz) the "#1" L-C traps are no longer resonant at the operating frequency; they appear as a slight inductance in a dipole now having a total length "B." The "#2" traps at the ends of the "B" segment are tuned to the center of the 15-meter band and isolate "B" from the remaining wire length. Because of the slight inductive effect of the "#1" traps, the end-to-end length of the "B" antenna is slightly less than the calculated dipole length for 15 meters.

When the transmitter's output is changed to 20 meters (14 MHz) both the "#1" and "#2" traps are no longer resonant at the operating frequency; they appear as small inductances in a dipole of length "C." The total length "C," again because of the small inductive effects of the traps, is slightly less than what would ordinarily be calculated for a 20-meter dipole antenna.

Because of those inductive effects, it gets a little tricky to adjust element lengths for the lower frequencies—it's usually done by a final tweaking of the section lengths—but the process can be carried through two more sets of traps (for 20 and 40 meters), resulting in a five-band antenna covering 80 through 10 meters. Often, the 40 meter antenna is used on 15 meters. (But, when traps are used, the 40-meter antenna isn't all that great on 15 meters).

### Trapped beams

While we have illustrated traps using dipole antennas, the same theory applies to any other elements used in a directional beam, whether driven or parasitic. For example, the typical 10/15/20 meter beam is a parasitic array with a non-driven director and reflector. Each parasitic element is tuned to the band in use by means of traps, just like the driven dipole-antenna.

If you get the urge to build your own trap antenna keep these rules in mind: The traps must be "rock-stable." That means that they must be enclosed in a weatherproof housing so that moisture won't change their characteristics. Also remember that there is a very high RF-voltage present at the ends of the antenna, so low-voltage receiver-grade components mustn't be used. The inductors must be wound using heavy wire such as you would use for a transmitter tank-circuit, and the capacitors should be of the type known as "transmitting" micas. (There are lots of surplus transmitting micas around.) If you're not into building your own traps, it's possible to purchase commercial traps for home-brew amateur antennas. Inquire at any of the larger amateur-equipment distributors. **R-E**



# NEW PRODUCTS

For more details use the free information card inside the back cover

**LOUDSPEAKER**, the *Mini-Mesa 100*, is a 100-watt RMS, three-way speaker system that has a 1-inch soft dome tweeter, and 3½-inch mid-range, and an 8-inch rubber surround woofer. The system measures only 14 inches high × 9½ inches wide × 6¾ inches deep and is available in walnut-grained cabinetry.

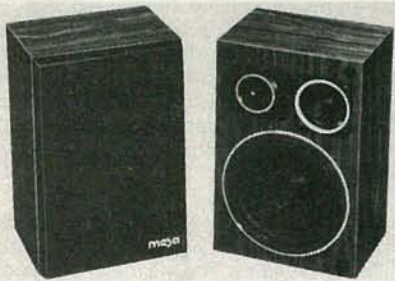

CIRCLE 121 ON FREE INFORMATION CARD

The *Mini-Mesa 100* is priced at \$175.00 each.—**Mesa Electronics Sales, Ltd.**, 2940 Malmo Drive, Arlington Heights, IL 60005.

**FLOPPY DISK CONTROLLER**, *Model UFDC-1*, S-100 IEEE-696-designed board is capable of connecting up to four floppy-disk drives. Any combination of 5¼- or 8-inch drives with ANSI standard interfaces may be connected. Supported by the *Model UFDC-1* are single/double density formats and single/double-sided drives.

The *Model UFDC-1* synchronizes the processor to disk transfers by means of wait states. Data transfer, drive select, density, disk side and wait-state circuitry are all selected by means of external I/O control and status ports. It also uses 9216 digital-data circuitry for write precompensation and read data separation. A synchronous clock-distribution scheme is used so that the 1795 and all data-circuitry clocks are derived from the same source.

A unique feature of the S-100 bus controller is its ability to read and write differently sized and formatted disks. That is done by placing the CP/M boot program in ROM and the CP/M disk translation tables on the disk

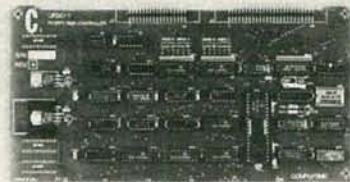

CIRCLE 122 ON FREE INFORMATION CARD

sector normally containing the boot program. That allows automatic mixing of disk densities and the ability to read various types of formatted disks. There is also the capability of creating the user's own types of formats, because the source listing of the format pro-

PAT. #4,259,705

**DON'T BLAME THE SOFTWARE!**

ISO-3

Power Line Spikes and Hash often cause memory loss or erratic operation. Often floppies, printer & processor interact!

OUR patented ISOLATORS eliminate equipment interaction AND curb damaging Power Line Spikes, Surges and Hash.

Filtered 3-prong sockets and integral Spike Suppression. 125 VAC, 15 Amp, 1875 W Total - 1 KW per socket.

ISO-1 ISOLATOR. 3 Filtered Sockets; 1000 Amp 8/20 usec Spike Suppressor ..... \$76.95

ISO-4 ISOLATOR. 6 Filtered Sockets; 1000 Amp 8/20 usec Spike Suppressor ..... \$128.95

ISO-3 SUPER-ISOLATOR. 3 DUAL filtered Sockets; 2000 Amp 8/20 usec Spike Suppressor ..... \$115.95

ISO-7 SUPER-ISOLATOR. 5 DUAL filtered Sockets; 2000 Amp 8/20 usec Spike Suppressor ..... \$186.95

Master-Charge, Visa, American Express  
TOLL FREE ORDER DESK 1-800-225-4876  
(except AK, HI, MA, PR & Canada)

**Electronic Specialists, Inc.**  
171 South Main Street, Natick, MA 01760  
Technical & Non-800: 1-617-655-1532

CIRCLE 15 ON FREE INFORMATION CARD

## ENCLOSURES CUSTOM & STOCK

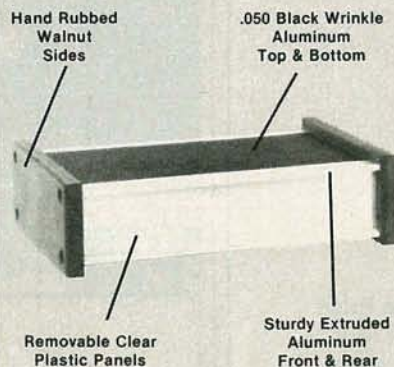

### BEAUTIFUL ELECTRONIC CABINETS

Stock No.	Inside Dimensions	Price
EA2•020805	1¼" H x 8-1/8" W x 5-1/8" D	\$18.54
EA2•021209	1¼" H x 12" W x 9" D	\$24.90
EA3•030805	2¼" H x 8-1/8" W x 5-1/8" D	\$22.27
EA3•031209	2¼" H x 12" W x 9" D	\$30.97

TO ORDER: Enclose Check, MasterCard or VISA No. Add \$3.00 Shipping & Handling. Contact the Factory for quantity pricing, custom enclosures, and our full line catalog. Distributors and O.E.M. inquiries welcome.

**RHOADES**  
NATIONAL CORPORATION

FABTRON Div.  
P.O. Box 925  
Columbia, TN 38401  
Phone: (615) 381-1143

CIRCLE 14 ON FREE INFORMATION CARD

## FREE Socket Sample Pak

A \$2.19 VALUE

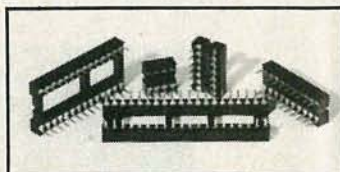

You can now receive nine phosphor bronze IC sockets absolutely **FREE**. It is our way of introducing you to the quality parts we offer.

**Sample Pak** 3 ea. S-247013-14 (14 pin)  
3 ea. S-247013-16 (16 pin)  
**Includes:** 3 ea. S-247040-40 (40 pin)

YES, please send me a **FREE SOCKET SAMPLE PAK**, plus your brochure on additional products available.

Please include \$1.00 to help cover postage and handling.

Name \_\_\_\_\_

Address \_\_\_\_\_

City \_\_\_\_\_

State \_\_\_\_\_ Zip \_\_\_\_\_

**ETRONIX**

14803 N.E. 40th Dept. RE023  
Redmond, WA 98052

CIRCLE 45 ON FREE INFORMATION CARD



gram is included with the board.

The *Model UFDC-1* is available assembled and tested for \$325.00; kit \$295.00 or bare board \$60.00.—**GSR Computers**, 60-10 69th Street, Maspeth, NY 11378.

**SATELLITE VIDEO RECEIVER**, *model RCV-650*, is an antenna-mount receiver with remote-control capability, digital channel select, and a self-contained LNA power supply.



CIRCLE 123 ON FREE INFORMATION CARD

The channel select allows the user to set the channel and read it on the LED readout. The MGC/AGC switch, control and test-point allows the user to align the antenna to insure the best antenna position. The *model RCV-650* is priced at \$2275.00.—**Comtech Data Corporation**, 613 South Rockford Drive, Tempe, AZ 85281.

**VIDEO SWITCHER**, *Model 0770*, permits the connection of four signal sources to two TV sets and one VCR. The completely passive switcher (no power is required) replaces bunches of cables, multiple switches, and splitters, and eliminates such problems as double images, herringbones, and seeing an adjacent channel's picture superimposed over the desired one. Each switch is completely shielded and impedance-matched to ensure



CIRCLE 124 ON FREE INFORMATION CARD

isolation between all ports.

The *Model 0770* can accept any combination of the following components: outdoor antenna, pay-TV, VCR, videogames, satellite earth station, videodisc, and home computer. The user plugs in the components to produce a home-video system comparable to those used by professionals. The *Model 0770* has a suggested retail price of \$49.95.—**Channel Master**, Division of Avnet, Inc., Ellenville, NY 12428.

**PULSE/FUNCTION GENERATOR**, *Model 524D*, contains two complete generators in one benchtop instrument, with each section having a broad range of capabilities.

The function-generator section offers sine, square, triangle, variable symmetry, trigger, and gate operation with output waveforms of up to 30 volts P-P. It operates from 0.001 Hz to 20 MHz and offers 80 dB of step attenuation, variable DC offset, VCF (Voltage Controlled Frequency) input, and sync output. The frequency/period dial has a coarse and fine control, and the frequency/period is read out on a large, bright, 6-digit display with

overranging capability. Frequency accuracy is  $\pm$  (0.01% of setting + 1 digit).

The pulse-generator section offers single pulse, double pulse, and delayed pulse over a frequency range of 0.001 to Hz to 40 MHz. The frequency/period dial sets the repetition rate and/or period. The period is adjustable



CIRCLE 125 ON FREE INFORMATION CARD

from 1000 seconds to 25 nanoseconds. Pulse width and delay are both adjustable from 10 milliseconds to 10 nanoseconds.

The *Model 524D* provides most of the waveforms required on the lab bench for both analog and digital work, plus a convenient frequency/period counter. It is priced at \$1795.00 F.O.B.—**Exact Electronics**, 2000 Arrowhead Dr., PO Box 1925, Carson City, NV 89701.

**DESKTOP HOLDER**, the *Disk-O-Tier*, holds up to 11 floppy diskettes, either the 5¼-inch or the 8-inch types. The staircase design of the holder displays all diskette titles, or ID numbers, for rapid disk location.

The open design is unusual, because most

## Hitachi Scope Sale!



Model	Sale Price
V-152F 15 Meg D.T.	\$499 <sup>00</sup>
V-202F 20 Meg D.T.	579 <sup>00</sup>
V-302F 30 Meg D.T.	669 <sup>00</sup>
V-352F 35 Meg D.T.	749 <sup>00</sup>
V-650F 60 Meg D.T.	1069 <sup>00</sup>
V-1050F 100 Meg D.T.	1589 <sup>00</sup>

**Barlow Sales Co.**  
1742 Second Ave, Suite 209  
New York, NY 10028  
Tel. # 212-410-5573

N.Y. Res. add 8¼% Sale Tax  
Add 12<sup>50</sup> shipping & handling

For Free Catalog,  
Write to above address.

CIRCLE 32 ON FREE INFORMATION CARD

## This publication is available in microform.



### University Microfilms International

Please send additional information

Name \_\_\_\_\_  
Institution \_\_\_\_\_  
Street \_\_\_\_\_  
City \_\_\_\_\_  
State \_\_\_\_\_ Zip \_\_\_\_\_

300 North Zeeb Road  
Dept. P.R.  
Ann Arbor, Mi. 48106  
U.S.A.

30-32 Mortimer Street  
Dept. P.R.  
London WIN 7RA  
England



It's like having X-ray ears...

# Tiny, powerful electronic "ears" let you hear whispers through walls, conversations 2 miles away.

## The Dyna-Mike Transmitter

It's smaller than a quarter. But DYNA-MIKE will transmit every sound in a room to an FM radio tuned to the proper unused frequency, from 1/3 mile to 2 miles away.

If you're at a neighbor's home a block from your own, you can hear your baby's cry, or you can tell the instant your spouse comes home. If two of you are driving tandem in two cars, one or both of you can communicate with the other even if other cars drive between you.

DYNA-MIKE has as many uses as your imagination can think of. For a business conference, let the tiny microphone sit unobtrusively on the table or concealed on a shelf, and you'll be able to record every word. For businesses, you can put an FM receiver in a warehouse or remote office and "broadcast" instructions or orders to be filled.

Public speakers never had a better friend than the DYNA-MIKE. No wires or setup — just turn on one or more radios and your speech will come through with perfect fidelity. Put one on the front porch. If you hear a suspicious sound, turn on the radio and you'll hear the doorbell or the ring of the telephone.

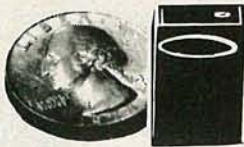

### Choose Your Model

New Horizons is introducing three models of the DYNA-MIKE supersensitive broadcast microphone. Model IC-18 is the world's smallest microphone — it's a miracle of electronic miniature power, with a high-fidelity range of 1800 feet. Introductory price is \$129.95 (two for only \$119.95 each).

Model X-18 is the longest-range microphone, with an unbelievable two-mile range. Introductory price is \$149.95 (two for only \$139.95 each).

Model X-3 is the most sensitive microphone. It broadcasts perfect-quality sound even from low-levels or whispers, up to 1,500 feet. Introductory price is \$99.95 (two for only \$89.95 each).

Each microphone is fully wired, complete with standard HC-1.35v. battery, good for 100 hours of continuous use and easily and inexpensively replaceable.

Of course you're protected by the New Horizon guarantee: use any DYNA-MIKE transmitter microphone for 30 days, with the right to return it for a full refund if you're not delighted.

## The Super-Ear

You'll hear it all.

Effortlessly, you can hear not just a baby's cries, but quiet breathing, through a concrete wall a foot thick. Put the SUPER-EAR earphone in your ear and place the speaker on the wall. That's all there is to it.

SUPER-EAR hears everything, and even more astounding, hears it clearly. It's as though the wall weren't there. If you're coming home late at night and think intruders are in your residence, let SUPER-EAR find out for you. Want to know if the meeting is over in the room with the closed door? SUPER-EAR will tell you in a second.

SUPER-EAR is undetectable from the other side of the wall. The quality of sound has amazing fidelity—good enough to record, and SUPER-EAR has its own built-in recorder jack.

Because SUPER-EAR is the ultimate listening device, you can use it to pinpoint hidden squeaks in your car or the source of mysterious engine noises.

Construction experts use it to check for flaws or cracks in buildings.

### It Works Anywhere!

Ever put your ear to a railroad track to try to hear the train? Try it with SUPER-EAR. You'll hear that train many miles away. Use it as a powerful stethoscope on yourself, a friend, or a pet. You can even hear a bird's breathing.

The only source for SUPER-EAR is New Horizons. Choose from two models — Model SB-5, with ultrasensitive microphone, \$139.95 (two for only \$129.95 each); or Model SB-1, with suction-type microphone, \$99.95 (two for only \$89.95 each).

Use your SUPER-EAR for 30 days. If for any reason you're not delighted, the absolute New Horizons guarantee means you can return it for a prompt refund.



## The Phone Answerer Recorder

The PHONE ANSWERER/RECORDER connects in seconds between any tape recorder and your telephone. When you're away it automatically delivers a message up to 20 seconds to anyone who calls: when you'll return, when to call back, where you are.

When you're there, the ANSWERER/RECORDER starts any cassette recorder automatically when you pick up the phone and shuts off when you hang up.



It records both sides of the conversation with astonishing clarity, giving you a permanent record of every call, preventing unauthorized use of your phone, and eliminating misunderstandings over what was said. It's specially wired to extend recording time on your tape recorder. Needs no batteries - it's always "alive".

The PHONE ANSWERER/RECORDER is a masterpiece of miniaturization. It's yours for \$49.95 (two for only \$44.95 each). PHONE RECORDER unit alone, records but doesn't answer, \$29.95 (two for \$24.95 each). Every instrument has the unbeatable New Horizons guarantee.

For immediate service on credit card orders, call toll-free 24 hours a day, seven days a week:

**1-800-227-1617**  
Ask for operator NO. 110  
in California: 800-772-3545

We Absolutely Guarantee! Use any electronic instrument acquired from us for up to 30 days. If you decide for any reason that you don't want to keep it, return it for a 100% refund.

## NEW HORIZONS

245 Fifth Avenue  
New York, N.Y. 10016

### NEW HORIZONS, 245 Fifth Ave., Dept. RE-2, New York, N.Y. 10016

Please ship at once, with 30-day money-back guarantee:

- Super-Ear Model SB-5, \$139.95
- 2 for \$129.95 each
- Super-Ear Model SB-1, \$99.95
- 2 for \$89.95 each
- Dyna-Mike Model IC 18, \$129.95
- 2 for \$119.95 each
- Dyna-Mike Model X-18, \$149.95
- 2 for \$139.95 each
- Dyna-Mike Model X-3, \$99.95
- 2 for \$89.95 each
- Phone Answerer/Recorder, \$49.95
- Phone Recorder, \$29.95
- 2 for \$24.95 each

Indicate payment method:

Check enclosed

Bill to  VISA  Master Card

No. \_\_\_\_\_

Expires \_\_\_\_\_ Signature \_\_\_\_\_

Name \_\_\_\_\_

Address \_\_\_\_\_

City \_\_\_\_\_ State \_\_\_\_\_ Zip \_\_\_\_\_

Please add \$1.75 per total order for shipping.

PHONE OR USE THIS COUPON



diskette storage devices have dust covers. However, dust covers are generally useless when diskettes are stored in the same area as the computer system. The diskette's own jacket is adequate protection; if dust were a problem, the computer would be damaged before the diskettes were affected.

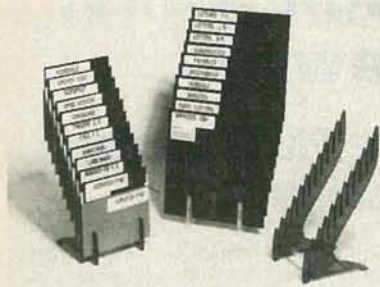

CIRCLE 126 ON FREE INFORMATION CARD

The *Disk-O-Tier* is made of smoked thermoplastic and is priced at \$9.50. (Add \$2.00 postage if ordering direct; a twin-pak carton costs \$19.00, which includes shipping charges.)—**Electronic Time Service Center**, PO Box 651 35026-A Turtle Trail, Willoughby, OH 44094.

**SCREEN CLEANER.** *CLR* provides quick cleaning combined with long-lasting anti-static properties. Airborne, static-charged particles mix with dirt and grime particles in the air, and are attracted to the CRT screen magnetically. When a film of such grime builds on the CRT screen, data-entry errors can be the result, due to poor visibility to the

operator. *CLR* offers an anti-static chemical, originally designed for the Apollo space program, to slow down the buildup of those particles.



CIRCLE 127 ON FREE INFORMATION CARD

*CLR* is packaged in a 4-ounce spray-top dispenser for easy storage near the CRT terminal. It is priced at \$5.95.—**Adamark, Incorporated**, PO Box 234, Ada, MI 49301.

**AMPLIFIERS.** *Model BA-3082* (shown), and *Model BA-7082*, are back-of-the-set TV amplifiers designed to improve reception where signal levels are low and pictures are snowy. They are also valuable for reception

problems caused by adding couplers, splitters, and switches to systems, combining signals from several sources, or operating more than one set or receiver. They also provide sharp pictures for high VCR recording quality.

The *Model BA-3082* has a 300-ohm input and output, while the *Model BA-7082* has a 75-ohm input and output; either can be used with any outdoor or indoor antenna. Both are CATV compatible and amplify all VHF, mid, and super band channels, FM, and UHF channels 14 through 83.

There is also an FM version—*Model FM-3000*—that cleans up fading distant FM stations and provides excellent stereo reception. It features 300-ohm input and output and amplifies 88-108 MHz. All three models attach out of sight, behind the TV set or FM tuner, and feature a UL-approved, calculator-type power supply, which plugs directly into an AC receptacle.

The suggested retail price for *Model BA-3082* and *Model BA-7082* is \$29.95. *Model*



CIRCLE 128 ON FREE INFORMATION CARD

## ACTIVE RECEIVING ANTENNA

Gives excellent reception, 50 KHz to 30 MHz.

New MFJ-1024 Active Receiving Antenna mounts outdoors away from electrical noise for maximum signal. Gives excellent reception of 50 KHz to 30 MHz signals. Equivalent to wire hundreds of feet long. Use any SWL, MW, BCB, VLF or Ham receiver.

High dynamic range RF amplifier. 54 in. whip. 50 foot coax. 20 dB attenuator prevents receiver overload. Switch between two receivers. Select auxiliary or active antenna. Gain control. "ON" LED. Remote unit, 3x2x4 in. Control, 6x2x5 in. 12 VDC or 110 VAC with optional adapter. MFJ-1312, \$9.95.

**\$129.95** (+\$4.00 shipping)

Order from MFJ and try it. If not delighted, return within 30 days for refund (less shipping). One year unconditional guarantee.

Order today. Call TOLL FREE 800-647-1800. Charge VISA, MC. Or mail check, money order. Write for free catalog. Over 100 products.

**CALL TOLL FREE 800-647-1800**

Call 601-323-5869 in Miss., outside continental USA, tech/order/repair info. TELEX 53-4590.

**MFJ ENTERPRISES, INCORPORATED**  
Box 494, Mississippi State, MS 39762

CIRCLE 78 ON FREE INFORMATION CARD

## Put Professional Knowledge and a COLLEGE DEGREE in your Electronics Career through HOME STUDY

### Earn Your DEGREE

No commuting to class. Study at your own pace, while continuing your present job. Learn from easy-to-understand lessons, with help from your home-study instructors whenever you need it.

In the Grantham electronics program, you first earn your A.S.E.T. degree, and then your B.S.E.T. These degrees are accredited by the Accrediting Commission of the National Home Study Council.

Our free bulletin gives full details of the home-study program, the degrees awarded, and the requirements for each degree. Write for *Bulletin R-83*.

**Grantham College of Engineering**  
2500 So. LaCienega Blvd.  
Los Angeles, California 90034

## Vital protection for PC Boards



Be safe. Desolder PC components with Endeco irons. Get proper HEAT TO MELT and strong VACUUM ACTION TO LIFT solder and cool both PC board and component without damage.

These PC components replaced fast with Endeco desoldering or soldering tools.



Endeco professional features include safety light that denotes high, low and off on switch models. SS construction for long life, light weight and balance for easy use.

Contact your distributor for Endeco desoldering and soldering irons, kits and equipment—or write us today.

**Enterprise Development Corp.**  
5127 East 65th Street  
Indianapolis, IN 46220  
Phone: (317) 251-1231

CIRCLE 74 ON FREE INFORMATION CARD



FM-3000 lists for \$34.95.—**Winegard Company**, 3000 Kirkwood Street, PO Box 1007, Burlington, IA 52601.

**AUTORANGING CAPACITANCE METER.**

*Model 3002*, combines the precision, range, and flexibility of benchtop models with the convenience and efficiency of a handheld portable unit. The unit weighs only twelve ounces and measures  $7.6 \times 3.75 \times 1.72$  inches. The digital LCD readout provides direct readings of capacitance from 1 pF to 199,900  $\mu$ F, with 8 automatically selected ranges providing accurate measurements of capacitance without manual switching. Designed with dual threshold detectors, the *Model 3002* is accurate to  $0.2\% \pm 1$  count in the 1 pF to 199.9  $\mu$ F range and  $1.0\% \pm 1$



CIRCLE 129 ON FREE INFORMATION CARD

count in the 200  $\mu$ F to 19.99 mF range.

The dual threshold measurement technique eliminates reading errors due to dielectric absorption. By using DC charging characteristics to determine true capacitance, the *Model 3002* can determine capacitance in cables, switches, and other electronics components and hardware, in addition to capacitors and capacitor networks. The front panel contains power ON/OFF and zero-calibration thumbwheel controls and both banana jacks and special low-insertion-force jacks. Low power consumption (maximum 75 mA) assures long battery life (16 hours of continuous operation).

The *Model 3002* operates on 6 AA batteries, or may be powered by an optional AC adapter/charger. A flip-up leg allows the user to see the LCD readout and operate controls easily while the unit is on a work bench. The *Model 3002* is priced at \$210.00.—**Global Specialties Corporation**, 70 Fulton Terrace, PO Box 1942, New Haven, CT 06509.

**JOYSTICK SYSTEM.** *Game Mate 2*, is a remote-control joystick system for Atari, Sears, and Commodore videogames and home computers. The system lets you play videogames from 20 feet away, without requiring wires running along the floor. It is easily installed; just plug it in.

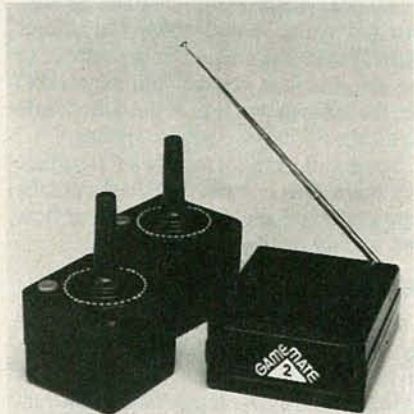

CIRCLE 130 ON FREE INFORMATION CARD

The *Game Mate 2* has a suggested retail price of \$99.95.—**Cynex Manufacturing Corp.**, 28 Sager Place, Hillside, NJ 07205.

**SOLDERING SYSTEM.** *Model 9000*, allows tip temperature to be varied from 420° to 800°F with a resolution of  $\pm 10$  degrees. Solid-state circuitry, including the newest microcircuit IC's, sample the tip temperature 120 times-per-second. LED's on the temperature controller instantly display each 20-degree temperature increment reached, creating a bar chart that clearly represents the tip temperature to within  $\pm 10^\circ$ F.

The heating element, which combines a heater and sensitive tip-temperature sensor, recovers tip temperature after each solder joint. The smaller heating element also makes possible a thinner handle that is cooler than other models.



CIRCLE 131 ON FREE INFORMATION CARD

Electronic circuitry in the controller prevents tip-temperature overshoot that could easily cause faulty soldering. The controller can be calibrated by a front-panel adjustment, using room temperature as a reference. For ultra-precise soldering, any temperature within the temperature range can be calibrated to be accurate within 5°F.

The *Model 9000* is priced at \$150.00.—**Ungar Division**, Eldon Industries, 100 W. Manville St., Compton, CA 90220. R-E

Electronic Troubleshooting

**WINNER**



Hickok's MX333 with VARI-PITCH® and LOGI-TRAK®

Instantaneous VARI-PITCH speeds:

- Voltage tracing
- Troubleshooting in hard-to-reach locations
- Tuning type adjustments
- Resistance checks
- Digital logic troubleshooting

And . . . Detects signal characteristics and abnormalities not possible with digital or analog meters.

LOGI-TRAK replaces the best 100MHz logic probes and offers:

- Eyes on the probe tip, HI/LO indication
- Instant identification of marginal states and fault conditions
- 100MHz response
- 5n sec pulse detection

LISTEN to what the MX333 can do for you. Ask about our NO RISK 30 day Free Trial.



THE HICKOK ELECTRICAL INSTRUMENT CO.  
10514 Dupont Avenue • Cleveland, Ohio 44108  
(216) 541-8060

CIRCLE 49 ON FREE INFORMATION CARD



## ANALOG CIRCUITS

continued from page 74

To keep a transistor from overheating, it's usually mounted on a metal surface known as a heat sink. Air flows over that surface, cooling it. In turn, it cools the case of the transistor. The heat sink reduces the thermal resistance from the case to the air,  $\theta_{CA}$ . As  $\theta_{CA} = \theta_{CS} + \theta_{SA}$ , equation 1 can also be written as:

$$P_{diss} = \frac{T_J - T_A}{\theta_{JC} + \theta_{CA}}$$

The upper limit of  $P_{diss}$  that a transistor can tolerate is provided by the manufacturer of the device and can be found on the device's data sheet. That specification is usually given at a particular case temperature. The amount of power that the device can dissipate safely does not increase if the case temperature drops below that given in the specifications, but does drop if the temperature exceeds it. Curves may also be supplied to indicate the maximum power that the transistor can dissipate at different temperatures. When the curve is not made available, the manufacturer will supply a derating factor, given in watts/°C. That derating factor indicates how much the power dissipation rating must be reduced for every degree the temperature is above that specified in the maximum dissipation rating. Most often, the power dissipation is given at a case temperature of 25°C.

Let's look at an example of how to select and design a heat sink. Assume that the transistor you are using is specified as being capable of dissipating 115 watts when the case temperature is 25°C. If the derating factor is 0.8 watts/°C at a case temperature of 90°C, then the power-dissipation capability of the device drops to  $115 - 60 = 55$  watts. Your circuit should be designed so that no more than 55 watts is dissipated by the transistor.

Using that information, assume that a silicon device with a maximum permissible junction temperature of 175°C is used. If the temperature of the air is 30°C,  $\theta_{JA}$  is equal to:

$$\theta_{JA} = \frac{175^\circ\text{C} - 30^\circ\text{C}}{55 \text{ watts}} = 2.6^\circ\text{C/watt}$$

If  $\theta_{JC}$  is 1.25°C/watt,  $\theta_{CA} = \theta_{JA} - \theta_{JC} = 2.6 - 1.25 = 1.35^\circ\text{C/watt}$ .

As  $\theta_{CA}$  consists of  $\theta_{CS} + \theta_{SA}$ , it is desirable to make both factors as small as possible.  $\theta_{CS}$  can be made very small by putting heat-conducting compound such as silicon grease between the case and sink. If the case is directly on the sink through that grease,  $\theta_{CS}$  can become as low as 0.1°C/watt. Frequently, the case

must be insulated from the sink with a mica washer. Now,  $\theta_{CA}$  can rise to 0.4°C/watt.

Assume that a mica washer must be used. In our example,  $\theta_{SA}$  becomes  $1.35 - 0.4 = 0.95^\circ\text{C/watt}$ . It is possible to buy sinks with a similar or lower  $\theta_{SA}$  resistance. A makeshift sink can be constructed from 1/8-inch-thick flat aluminum. If the total area on both surfaces of the metal is kept vertical and exposed to air, the areas of one side of the sink should be at least  $750/\theta_{SA}^2$  square inches.

Some sinks are not merely a flat surface but have fins. Those sinks should be mounted in a location with good air flow and so that the fins are vertical.

### Other important factors

In addition to case temperature, there are many other factors that affect the survival of a transistor. For one thing, over its lifetime, the case temperature of a transistor will rise and fall many times. There is a limit, however, to the number of times that can occur before the device will break down. That thermal cycling data is supplied by some manufacturers in the form of curves relating the power dissipated by the transistor, the amount the case-temperature rises, and the number of times this temperature can rise and fall, before the transistor may break down. A proper heat sink can help prevent that breakdown.

Another type of breakdown phenomenon in bipolar devices is when the base loses control of the collector current. Despite any drops in  $V_{CE}$ , the collector current keeps rising until the transistor is destroyed. To minimize that problem, select a transistor that will perform up to the highest frequency you need in your design but not above it and do not use a higher collector-emitter voltage than you absolutely require.

One final point: do not ignore the voltage, current, and power limits set for the bipolar or FET device you are using. Do not ignore transients—especially if an inductor is used in the circuit. Also, remember that the transistor will tolerate a higher collector-emitter voltage when the resistor shunting the base-emitter circuit of the transistor is at its lowest value. So keep that resistance small and keep some collector current flowing at all times.

### Practical circuits

The information presented here can be used to design many different types of power amplifiers. Transformer coupling was used in the circuits described in this article because the essential operating characteristics of the different amplifier classes can be most easily described using those circuits. Most audio and other power amplifiers, however, do not use transformer coupling. Next time, we'll discuss modern power amplifier circuits, and how to keep them from breaking down in use. **R-E**

## PC BOARDS

continued from page 49

The reason you've left the resist on the copper is because it saves you the trouble of tinning the board to keep the copper from oxidizing. The resist protects the copper and when you solder to the board, it vaporizes. It's really similar to the neoprene covering on wire-wrap wire. The hot solder will vaporize the resist and a good joint will be made, but the copper traces will remain untarnished and protected from moisture.

Making printed-circuit boards is like a lot of things in life—it sounds much harder than it actually is. If you try to describe everything you have to do when you drive a car, that will sound incredibly complicated, too. Persevere, and a little experience will have you doing perfectly what is essentially an easily repeatable mechanical process. The trickiest part of the whole procedure is the spraying and exposing of the copper blank. If you can get that down pat, you've got it made. If you have difficulty, take a look at Table 1; it should help you overcome most of the common problems.

Get used to the idea that you're going to make a mistake somewhere the first time you try to make your own boards. You'll probably be able to make good masks, but the procedure from there to etching is a matter of patience and experience. Notice that we do not say that it is hard—it isn't. Once you find a system that works, it will always work. And, being able to make your own boards gives your projects a professional touch, regardless of how complex they are. **R-E**

## COMMERCIAL EDITOR

continued from page 58

to the RECORD mode (note that in many machines the latter will be done automatically for you). At the preset time the recorder will start and tape the movie, but without the commercials. If you happened to select a color program, the editor will delete the first 4½ to 5 minutes of it, then tape the rest without stopping for commercials.

Finally, a few closing words about using the editor. Sometimes, when several commercials are shown in sequence, the color-burst signal is turned off between them. Also, the color burst may sometimes be present during those rare black-and-white commercials. Those circumstances depend on the particular practices of the TV station, and may result in the recorder starting and stopping several times during the commercials. In that case, you may see several very brief bursts of commercials on playback of your tape. That's to be expected, and does not indicate that there is anything wrong with the editor. **R-E**



# NEW BOOKS

For more details use the free information card inside the back cover

**PASCAL**, by David L. Heiserman, Tab Books, Inc., Blue Ridge Summit, PA 17214; 350 pages, including appendix and index; 5 x 8 inches; softcover; \$9.95.

Learning to use a new programming language for a computer is never easy, and this book does not pretend that it is. However, PASCAL, the newest of computer languages, is rewarding to learn because it has taken the best elements of all the other computer languages and eliminated their drawbacks. However, unless a computer system has been designed specifically to work in PASCAL, at least 32K of RAM, and two disc drives are required.

That problem has been overcome by the development of a scaled-down version of PASCAL, that is now commonly known as Tiny PASCAL. Tiny PASCAL, the subject of this book, fits into a 16K personal computing system. The author covers it in depth, showing how it can be loaded easily into a TRS-80 computer and used for virtually any purpose:

practice program development, math problem-solving, unusual games, etc.

Starting with an explanation of how to load a Tiny PASCAL cassette into a TRS-80 system, the author goes through all the steps necessary for the reader to become proficient in the language. There is an explanation of how to read syntax diagrams; use WRITE statements to print characters and do TRS-80 graphics; enter integers with READ statements; use logic with AND, OR, and NOT; write and use REPEAT...UNTIL loops, etc. It's all here for Tiny PASCAL and Supersoft Tiny PASCAL, as well as for the standard version. Step-by-step data make it easier to learn.

CIRCLE 151 ON FREE INFORMATION CARD

**DIGITAL LOGIC: Operation and Analysis (Second Edition)**, by Jefferson C. Boyce. Prentice-Hall, Inc., Englewood Cliffs, NJ 07632. 492 pages, including appendices, bibliography, and index; 6½ x 9½ inches; hardcover; \$24.95.

This book has been completely revised and updated because so much has happened since publication of the first edition, when digital logic was in its infancy. Chapters 1 and 2 are introductory and discuss the basic concepts of digital logic, numbers, and counting. The fundamentals of combinational logic (gates) are presented in chapters 3 and 4; chapters 5 and 6 discuss algebraic and graphical simplification of logic expressions, and chapter 7 summarizes combinational logic and goes into troubleshooting flow charts.

Chapter 8 investigates sequential (time-department) logic. Chapter 9 deals with troubleshooting circuits that contain both combinational and sequential logic elements.

The remaining chapters discuss specific types of logic circuits: counters, registers, adders, comparators, multiplexers, etc. An overview of the complete digital field is presented in the final chapter (16).

R-E  
CIRCLE 152 ON FREE INFORMATION CARD

## VIDEOGAME CONTEST WINNERS

Due to the large number of entries to the Videogame Concert Contest that appeared in our July and August 1982 issues, we decided to extend our entry deadline for several weeks. At last, here are the winners.

Each of the following winners was judged as the best entry for each of the four categories and each winner will receive a Kenwood KV901 14-day programmable VCR, a Kenwood KVA-502 Audio/Video Amplifier, and ten Kenwood videocassettes:

### Atari:

George Sakona

### Mattel:

Craig Lichter

### Magnavox:

L. King

### Personal Computer:

L. Schaffner

The following was judged to be the best overall entry in terms of musical score and the winner will receive a Kenwood KR-1000 Stereo Computer Receiver and a pair of Kenwood LS-1000 speakers:

Jeff Shapiro

The following was judged to be the best overall entry in terms of originality and will receive a Kenwood DC-20 integrated stereo system:

Ben Selvin

SEE YOUR DEALER TODAY

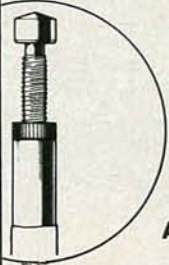

FROM

**Firestik®**  
ANTENNAS  
ACCESSORIES

HERE'S A TIP  
THAT'S PERFECT!

AM/FM AUTO RADIO  
AND CB

**Firestik® II**

GOLDEN SERIES

BARE-HANDS TUNABLE  
"NO TOOLS NEEDED"  
HIGH PERFORMANCE ANTENNAS

ALSO ANTENNAS FOR  
CORDLESS TELEPHONES  
MONITOR SCANNERS

Dealer & Distributor Inquiries Invited  
SEND FOR FREE CATALOG

Firestik® Antenna Company  
2614 East Adams/Phoenix, AZ 85034

Name \_\_\_\_\_  
Street \_\_\_\_\_  
City \_\_\_\_\_  
State \_\_\_\_\_ Zip \_\_\_\_\_

Serving the CB and  
Communications Market Since 1962.

5-YEAR REPLACEMENT WARRANTY

CIRCLE 56 ON FREE INFORMATION CARD

## Be an FCC LICENSED ELECTRONIC TECHNICIAN!



No costly School. No commuting to class. The Original Home-Study course that prepares you for the FCC Radio-telephone license exam in your spare time! Passing the exam is your "ticket" to thousands of exciting opportunities in Communications, Broadcasting, Mobile two-way systems, Microwave stations, Radar installations, Aerospace and more.

**NO NEED TO QUIT YOUR JOB OR GO TO SCHOOL**

You learn how to pass the FCC License exam at home at your own pace with this easy-to-understand, proven course. Within a few short weeks you could be on your way to being one of the highest paid workers in the electronics field. It's that easy! U.S. Federal law requires you to have an FCC License if you want to operate and maintain *virtually any communications system* — you don't need a College degree to qualify, but you DO need an FCC License. With this Home-Study course, you'll be ready to pass the FCC Government licensing exam in a remarkably short time. Send for FREE facts now. No obligation. No salesman will call. **MAIL COUPON TODAY!**

### COMMAND PRODUCTIONS

FCC LICENSE TRAINING, Dept. E  
P.O. Box 2223, San Francisco, CA 94126

Rush FREE facts on how I can prepare for my FCC License at home in my spare time.

NAME \_\_\_\_\_  
ADDRESS \_\_\_\_\_  
CITY \_\_\_\_\_ STATE \_\_\_\_\_ ZIP \_\_\_\_\_

CIRCLE 79 ON FREE INFORMATION CARD



# Go with McGraw-Hill's EXPERIENCE!

TAKE ANY 3 BOOKS  
FOR ONLY \$100 EACH  
when you join McGraw-Hill's  
**Electronics and Control Engineers'  
Book Club** (Values up to \$87.00)\*

*McGraw-Hill's long-established club that saves you BIG money on the important new books of all publishers!*

\*If you join now for a trial period and agree to purchase three more books—at handsome discounts—over the next year. (Publishers' prices shown)

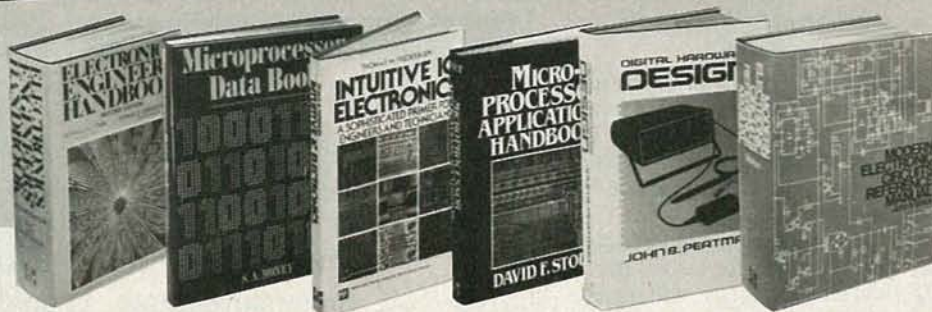

**INTUITIVE IC ELECTRONICS: A Sophisticated Primer for Engineers and Technicians.** By T. M. Frederiksen. 208 pp., illus. Covering both the simplest and the most complicated IC designs, this lively, easy-to-read volume provides a sophisticated, nonmathematical explanation of the basic internal mechanisms common to all semiconductor devices.  
219/230 \$18.50

**RADIO HANDBOOK, 22/e.** By W. Orr. 1,136 pp., more than 1,300 illus. Here's the latest edition of what is universally regarded as the most useful reference in the industry. It's a "course" in communications, a fact-packed reference, and a how-to guide—all in a single book!  
582442-6B \$39.95  
(Counts as 2 of your 3 books)

**MICROWAVE SEMICONDUCTOR ENGINEERING.** By J. F. White. 558 pp., 319 illus. Packed with an awesome amount of never-before-published material, this reference contains a wealth of formulas, constants, and practical design techniques needed by everyone who works in the field of microwave engineering.  
582553-8 \$28.50

**MANUAL OF ACTIVE FILTER DESIGN, 2/e.** By J. L. Hilburn and D. E. Johnson. 225 pp., 157 easy-to-use design graphs. This ingenious manual enables you to design filter circuits for virtually any application in minutes—without making a single computation! Covers all the latest designs.  
287/694B \$37.50  
(Counts as 2 of your 3 books)

**MICROPROCESSOR DATA BOOK.** By S. A. Money. 350 pp., 220 illus. Easily the most comprehensive collection of data on microprocessors and their support chips available anywhere! Provides important facts on a wide range of popular devices from American, European, and Japanese manufacturers.  
427/062B \$35.00  
(Counts as 2 of your 3 books)

**HANDBOOK OF SEMICONDUCTOR AND BUBBLE MEMORIES.** By W. A. Triebel and A. D. Chu. 416 pp., illus., over 50 worked-out problems. This detailed, comprehensive guide brings you right up to the minute on such newly developed devices as the PLA, FIFO, CAM, CCD, and magnetic bubble memory—as well as all the standard storage devices from ROMs and RAMs to shift registers.  
582376-4 \$24.95

**INTRODUCTION TO RADAR SYSTEMS, 2/e.** By M. I. Skolnik. 698 pp., 244 illus. This new edition of a widely used text on radar from the systems engineer's point of view brings you full discussions of the many major changes that have occurred in the field recently.  
579/091B \$38.50  
(Counts as 2 of your 3 books)

**MAGNETIC CORE SELECTION FOR TRANSFORMERS AND INDUCTORS: A User's Guide to Practice and Specifications.** By W. T. McLyman. 768 pp., 400 illus. This giant volume is brimming with time-saving tips to help you select the right magnetic core for virtually any application.  
582494-9A \$65.00  
(Counts as 3 of your 3 books)

**ELECTRONIC COMMUNICATION, 4/e.** By R. L. Shrader. 801 pp., 870 illus. This thoroughly updated edition offers all the theory and fundamentals you need to prepare yourself for the FCC commercial and amateur grade license examinations—and pass them the first time!  
571/503 \$24.10

**DIGITAL HARDWARE DESIGN.** By J. B. Peatman. 428 pp., over 400 illus. Taking you beyond the microcomputer, this guide reexamines traditional techniques and focuses on the design of circuitry too fast for the microcomputer alone.  
491/321B \$33.00  
(Counts as 2 of your 3 books)

**MICROPROCESSOR APPLICATIONS HANDBOOK.** Editor-in-Chief, D. F. Stout. 472 pp., 284 illus. At last—a reference guide to microprocessor applications to help you make your systems timely, versatile, and cost-effective.  
617/988B \$35.00  
(Counts as 2 of your 3 books)

**SIGNALS AND SYSTEMS.** By A. Oppenheim, A. Willsky, and I. Young. 869 pp., more than 350 illus. This unique volume presents a comprehensive discussion of methods for analyzing discrete-time systems. Includes a look at feedback, convolution, and other concepts not treated in depth elsewhere.  
582674-7B \$32.50  
(Counts as 2 of your 3 books)

**MODERN ELECTRONIC CIRCUITS REFERENCE MANUAL.** By J. Markus. 1,264 pp., 3,666 circuit diagrams. Complete with values of components and suggestions for revisions, plus the original source of each circuit in case you want additional performance or construction details.  
404/461A \$67.95  
(Counts as 3 of your 3 books)

**ELECTRONICS ENGINEERS' HANDBOOK, 2/e.** Edited by D. G. Fink & D. Christiansen. 2,272 pp., 2,189 illus. This updated and enlarged edition covers the latest knowledge in the field, including new advances in integrated circuits, pulsed and logic circuits, laser technology, telecommunications, and much more.  
209/812A \$75.00  
(Counts as 3 of your 3 books)

**PCM AND DIGITAL TRANSMISSION SYSTEMS.** By R. Owen. 320 pp., 186 illus. This useful volume allows newcomers to the field to familiarize themselves with its problems and equipment in two weeks, instead of the three months it would ordinarily take.  
479/542B \$30.00  
(Counts as 2 of your 3 books)

**ANTENNA THEORY: Analysis and Design.** By C. A. Balanis. 816 pp., illus. Packed with equations, design procedures, and plenty of nuts-and-bolts know-how, this is the first place to turn for answers to all your antenna design questions.  
582493-0B \$39.50  
(Counts as 2 of your 3 books)



**ELECTRONICS ENGINEERING FOR PROFESSIONAL ENGINEERS' EXAMINATIONS.** By C. R. Hafer. 336 pp., more than 200 illus. Actually two books in one—a quick preparation manual to help you pass your P.E. exams on the first try and a rich source of practical electronics engineering information and know-how.  
254/303 \$27.50

**16-BIT MICROPROCESSOR SYSTEMS.** By Texas Instruments, Inc. 576 pp., illus. This broad-based guide presents a comprehensive overview—from basic concepts to advanced design principles. Covers programming methods, instruction sets, I/O design, memory design, and much more.  
637/601B \$45.00  
(Counts as 2 of your 3 books)

**OPTICAL FIBER SYSTEMS: Technology, Design, and Applications.** By C. K. Kao. 197 pp., illus. From a basic explanation of optical fiber systems to the economic ramifications of their use, this volume provides full coverage of a rapidly developing field.  
332/770 \$26.00

**DIGITAL CIRCUITS AND MICRO-PROCESSORS.** By H. Taub. 608 pp., heavily illus. This fast-paced, carefully written guide gives you thorough explanations of all the basic principles of digital systems and logic design—plus a solid introduction to microprocessors and micro-processor-based designs.  
629/455 \$29.95

**McGraw-Hill's NATIONAL ELECTRICAL CODE® HANDBOOK, 17/e.** By J. F. McPartland. 1,162 pp., 1,096 illus. Bigger and better than ever! This mammoth reference explains and clarifies the many complex provisions of the current (1981) Code® to help you meet rules exactly and pass inspections the very first time.  
456/933 \$26.50

**INTEGRATED CIRCUIT FABRICATION TECHNOLOGY.** By D. J. Elliott. 480 pp., 220 illus. Covering every step in the transformation of a silicon chip to an integrated circuit, this is the first book to combine, in a single volume, a cohesive examination of the equipment, materials, and techniques of IC fabrication.  
192/383 \$27.50

**NETWORK SYSTEMS.** By R. Sharma, P. DeSousa, and A. Ingle. 321 pp., illus. Here's the first book to describe, concisely and comprehensively, all current stored program-controlled (SPC) telecommunication network systems that use integrated modeling, analysis, and design techniques. Gives you the know-how you need to meet design specifications.  
582557-0 \$29.95

**HANDBOOK OF ELECTRONIC PACKAGING DESIGN AND ENGINEERING.** By B. Matisoff. 480 pp., 312 illus. This handy volume examines the broad array of packaging techniques available today, providing the data you need to select the best one for a given application. Stresses the interplay between design criteria.  
582515-5B \$32.50  
(Counts as 2 of your 3 books)

**STANDARD HANDBOOK FOR ELECTRICAL ENGINEERS, 11/e.** By D. G. Fink and H. Beaty. 2,448 pp., 1,414 illus. Today's most widely used source of electrical engineering information and data serves you as no other single work when you need detailed, timely, and reliable facts  
209/74XA \$65.95  
(Counts as 3 of your 3 books)

## Be sure to consider these important titles as well!

**RADAR TRANSMITTERS.** By G. W. Ewell.  
198/438 \$24.50

**USER'S GUIDEBOOK OF DIGITAL CMOS INTEGRATED CIRCUITS.** By E. R. Hnatek  
290/679 \$26.90

**ELECTRONIC CIRCUITS NOTEBOOK: Proven Designs for Systems Applications.** Edited by S. Weber.  
192/448B \$32.50  
(Counts as 2 of your 3 books)

**ELECTRONIC FILTER DESIGN HANDBOOK.** By A. B. Williams.  
704/309B \$41.50  
(Counts as 2 of your 3 books)

**INTRODUCTION TO THE THEORY AND DESIGN OF ACTIVE FILTERS.** By L. P. Huelsman & P. E. Allen.  
308/543B \$32.50  
(Counts as 2 of your 3 books)

**MICROELECTRONICS.** By J. Millman.  
423/27XB \$34.00  
(Counts as 2 of your 3 books)

**HANDBOOK OF OPERATIONAL AMPLIFIER CIRCUIT DESIGN.** By D. E. Stout & M. Kaufman.  
617/97XB \$38.00  
(Counts as 2 of your 3 books)

**MICROCOMPUTER-BASED DESIGN.** By J. Peatman.  
491/380B \$32.50  
(Counts as 2 of your 3 books)

**BIT-SLICE MICROPROCESSOR DESIGN.** By J. Mick & J. Brick.  
417/814 \$29.50

**DESIGNING WITH FIELD-EFFECT TRANSISTORS.** By Siliconix, Inc.  
574/499 \$26.90

**ENGINEERING MATHEMATICS HANDBOOK, 2/e.** By J. J. Tuma.  
654/298B \$31.25  
(Counts as 2 of your 3 books)



### MAIL THIS COUPON TODAY

McGraw-Hill Book Clubs  
**Electronics and Control Engineers' Book Club**  
P.O. Box 582, Hightstown, New Jersey 08520

Please enroll me as a member and send me the three choices I have listed below. Bill me only \$3.00 plus local tax, postage, and handling. If not satisfied, I may return the books within 10 days and my membership will be canceled. I agree to purchase a minimum of three additional books during my first year of membership as outlined under the Club plan described in this ad. A shipping and handling charge is added to all shipments. Indicate below by number the books you want. A few expensive books (noted in the descriptions) count as more than one choice.

Name \_\_\_\_\_

Address/Apt. \_\_\_\_\_

City/State/Zip \_\_\_\_\_

This order subject to acceptance by McGraw-Hill. All prices subject to change without notice. Offer good only to new members. Orders from outside the U.S. cannot be accepted.

E33579

## Why YOU should join now!

■ **BEST AND NEWEST BOOKS IN YOUR FIELD!** Books are selected from a wide range of publishers by expert editors and consultants to give you continuing access to the best and latest books in your field.

■ **BIG SAVINGS!** Build your library and save money too! Savings ranging up to 30% or more off publishers' list prices—usually 20% to 25%.

**BONUS BOOKS!** You will immediately begin to participate in our Bonus Book Plan that allows you savings of between 70%-80% off the publishers' prices of many professional and general interest books!

■ **CONVENIENCE!** 12-14 times a year [about once every 3-4 weeks] you receive the Club Bulletin FREE. It fully describes the Main Selection and alternate selections. A dated Reply Card is included. If you want the Main Selection, you simply do nothing—it will be shipped automatically. If you want an alternate selection—or no book at all—you simply indicate it on the Reply Card and return it by the date specified. You will have at least 10 days to decide. If, because of late delivery of the Bulletin you receive a Main Selection you do not want, you may return it for credit at the Club's expense.

As a Club Member you agree only to the purchase of three additional books during your first year of membership. Membership may be discontinued by either you or the Club at any time after you have purchased the three additional books.

**Other McGraw-Hill Book Clubs:** Accountants' and Controllers' Book Club • Architects' Book Club • Byte Book Club • Chemical Engineers' Book Club • Civil Engineers' Book Club • Mechanical Engineers' Book Club

For more information, write to:

McGraw-Hill Book Clubs • P.O. Box 582, Hightstown, NJ 08520



# MARKET CENTER

## FOR SALE

**THE Intelligence Library.** Restricted technical secrets—books on **electronic surveillance, lock-picking, demolitions, investigation,** etc. Free brochures: **MENTOR**, Dept. Z, 135-53 No. Blvd., Flushing, NY 11354

**RESISTORS** 1/4W, 1/2W 5% carbon films 3c ea. **NO MINIMUMS.** Cabinet assortments, 1% metal films. Request details. Bulk pricing available. **JR INDUSTRIES** 5834-C Swancreek, Toledo, OH 43614

**SAVE** up to 50% on name brand test equipment. Free catalog and price list. **SALEN ELECTRONICS**, Box 82-G, Skokie, IL 60077

**SCANNER** monitor accessories—kits and factory assembled. Free catalog. **CAPRI ELECTRONICS**, Route 1R, Canon, GA 30520

**CABLE TV Secrets**—the outlaw publication the cable companies tried to ban. HBO, Movie Channel, Showtime, descramblers, converters, etc. Suppliers list included. Send \$7.95 to **CABLE FACTS**, Box 711-R Pataskala, OH 43062

**POWER-AMP sub-assemblies**, 100 watts rms. .05% distortion, **completely** assembled and tested. Quantity pricing available, free brochure. **CLAXTON AUDIO**, 3174 Periwinkle, Memphis, TN 38127

**PCB** 15c sq-in. Free drilling. Quantity discount. **INTERNATIONAL ENTERPRISE**, 6452 Hazel Circle, Simi Valley, CA 93063

 **WRITE FOR**  
**McGEE'S**  
**SPEAKER & ELECTRONICS CATALOG**  
1001 BARGAINS IN SPEAKERS  
Tel.: 1 (816) 842 5092  
1901 MCGEE STREET KANSAS CITY, MO. 64108

**ANIK** noise filter eliminates unwanted audio noise from Canadian Satellite fully assembled and guaranteed. \$65.00 & \$2.00 shipping. **ARK ELECTRONICS**, PO Box 5689, Toledo, OH 43612

**PRINTED circuit boards:** single side, prototype and quantity runs, quick delivery. Send positive, free quotes. **FABTRON**, Box 925, Columbia, TN 38401, (615) 381-1143

**GREAT prices on surplus electronic!** Free flyer. **ELECTRONIX LTD.**, 3214 South Norton, Sioux Falls, SD 57105

**MICROWAVE** antennas 2100-2600 MHz, downconverter probe, 18" parabolic dish 50' cable, power supply, 6-month warranty. **MDS ASSOCIATES**, 2116-2nd Ave. No., Mpls, MI 55405. **Just \$109.95.**

**COMPUTER** software for Sinclair ZX81. Ask information to **TINSAVE SOFTWARE**, 2820 Augusta Ave., Ontario, CA 91761

**UNUSUAL** UHF subscription TV kits. Also microwave downconverters. Catalog 50c. **TROJAN**, 2920 Shelby, Indianapolis, IN 46203

**FREE catalog** of surplus electronic parts and hardware. **UNIVERSAL SOUND**, RES. 2253 Ringling Blvd., Sarasota, FL 33577, (813) 953-5363

**FREE speaker catalog!** Woofers, mids, tweeters, hardware, crossovers, grille clothe, kits, information, much more. **Discount prices.** **UNIVERSAL SOUND**, Dept. RE 2253 Ringling Blvd., Sarasota, FL 33577 (813) 953-5363

**MILITARY** communications receiver: R-174/GRR-5, tunes 1.5-18 MHz SSB-CW-AM, shortwave, amateur, military frequencies: \$47.50 mint; \$27.50 good. ARC-27 aircraft guard receiver assembly, receivers 238 MHz AM, mint: \$12.50. Specifications, schematics included. 45 day guarantee. Add \$7.50 shipping. **BAYTRONICS**, Dept. RE, Box 591, Sandusky, OH 44870

**TUBES.** Large selection. Unused, in original cartons. SASE brings list. **FALA ELECTRONICS**, Box 041 34-2, Milwaukee, WI 53204

**HIGHLY PROFITABLE**  
**ELECTRONIC FACTORY**  
Investment unnecessary, knowledge not required, sales handled by professionals. Ideal home business. Write today for facts!  
**Postcard will do, Barta-RE-X, Box 248, Walnut Creek, CA 94597.**

**ADVENT TV** parts. All models, all parts. **BONTRONICS**, 499 Medford, Somerville, MA 02145 (617) 623-5039

**CABLE TV** products, Jerrold, Hamlin, and Oak converters. Send \$2.00 for catalog. **ADDITIONAL OUTLET CORP.**, 231 E. Commercial Blvd., Ft. Lauderdale, FL 33334

**SUBSCRIPTION TV** manual, covers both sine wave and gated sync system, only \$12.95. Includes theory, circuits, waveforms and trouble shooting hints. Information \$2.00, refundable. **D&S ENTERPRISES**, Box 09292, Cleveland, OH 44109

THE BEST PLACE to BUY, SELL or TRADE NEW and USED EQUIPMENT  
**NUTS & VOLTS MAGAZINE**  
BOX 11111-E • PLACENTIA, CA 92670  
(714) 632-7721  
Join Thousands of Readers Nationwide Every Month  
**ONE YEAR U.S. SUBSCRIPTIONS**  
\$7.00 - 3rd Class • \$12.50 - 1st Class  
\$25.00 - Lifetime - 3rd Class

**NUTS & VOLTS**  
HAM GEAR  
COMPUTERS  
SOFTWARE  
SCANNERS • OPTICS  
TEST EQUIPMENT  
MICROWAVE  
SATELLITE  
AUDIO VISUAL  
NEW PRODUCTS  
COMPONENTS • KITS  
ANTIQUE ELECT.  
PUBLICATIONS  
PLANS • SERVICES

## WANTED

**WANTED:** 16GP4 CRT round metal tube. Write **JOHNSON**, 2453 Apt. A-1 Coronet Way, Atlanta, GA 30318

To run your own classified ad, put one word on each of the lines below and send this form along with your check for \$1.90 per word (minimum 15 words) to:  
**Radio-Electronics, 200 Park Avenue South, N.Y., N.Y. 10003**

## ORDER FORM

PLEASE INDICATE in which category of classified advertising you wish your ad to appear. For special headings, there is a surcharge of \$15.00.

( ) Plans/Kits ( ) Business Opportunities ( ) For Sale  
( ) Education/Instruction ( ) Wanted ( ) Satellite Television

**Special Category: \$15.00**

PLEASE PRINT EACH WORD SEPARATELY, IN BLOCK LETTERS.)

1	2	3	4	5
6	7	8	9	10
11	12	13	14	15
16	17	18	19	20
21	22	23	24	25
26	27	28	29	30
31	32	33	34	35

PLEASE INCLUDE FOR OUR FILES YOUR PERMANENT ADDRESS AND PHONE NUMBER.

**CLASSIFIED COMMERCIAL RATE** for firms or individuals offering commercial products or services. \$1.90 per word prepaid (no charge for zip code)...**MINIMUM 15 WORDS.** 5% discount for 6 issues, 10% for 12 issues within one year, if prepaid.

**NON-COMMERCIAL RATE** (for individuals who want to buy or sell a personal item) \$1.25 per word prepaid...no minimum.

**ONLY FIRST WORD AND NAME** set in bold caps. Additional bold face (not available as all caps) at 15c per word. All copy subject to publisher's approval. **ADVERTISEMENTS USING P.O. BOX ADDRESS WILL NOT BE ACCEPTED UNTIL ADVERTISER SUPPLIES PUBLISHER WITH PERMANENT ADDRESS AND PHONE NUMBER.** Copy to be in our hands on the 26th of the third month preceding the date of the issue (i.e., August issue closes May 26). When normal closing date falls on Saturday, Sunday, or a holiday, issue closes on preceding working day.

## Govt. SURPLUS ELECTRONIC EQUIPMENT CATALOG

New ITEMS. . . New BARGAINS!  
**FREE UPON REQUEST!**  
Send today for FREE copy of NEW CATALOG WS • Address: Dept. RE

**FAIR RADIO SALES**  
1016 E. EUREKA • Box 1105 • LIMA, OHIO • 45802



## CB RADIO

GET more CB channels and range! Frequency expanders, boosters, speech processors, FM converters, PLL slider tricks, how-to books, plans, modifications. Catalog \$2.00. **CB CITY**, Box 31500RE, Phoenix, AZ 85046

## REEL TO REEL TAPES

TRUCKLOAD sale Ampex high quality open reel tape, 1800' or 2400' on 7" reels, used once. Case of 40, \$45.00. Cassettes available. **VALTECH ELECTRONICS**, Box 6-RE, Richboro, PA 18954

## SYNTHESIZERS

AMAZING synthesizer kits! Professional laboratory quality, polyphonic, duophonic, monophonic. Plans from \$5.00. Write **SYNTHLAB**, PO Box 4291, Helena, MT 59601

## WIRELESS MICROPHONE

PROFESSIONAL quality, ultra-miniature, ultra-powerful wireless microphones and transmitters. Models as small as 7/8"! Also, miniature wireless FM telephone transmitter and FM long-play radio recorder that tapes up to 9 hours of transmission on one standard tape. Free brochure: **EXTENDO-TAPE SYSTEMS**, Box 16000LC, Temple Terrace, FL 33687

## UHF CONVERTERS

DELUXE sine wave UHF converter. Sound out of TV like normal with only antenna connection to TV or VCR. True A.G.C. Plans SASE. Parts \$175.00. Quantity discounts. 1-312/267-3455 **LSR ENGINEERING**, PO Box 6075, Chicago, IL 60680

## LONG-PLAY RECORDERS

RECORD up to 15 hours on a single standard cassette! Our large selection of modified, quality name-brand recorders offers the longest recording times! Models as small as 1 1/2 pounds, as economical as \$69.99. Compare before you buy! Free catalog: **EXTENDO-TAPE SYSTEMS**, Box 16000LC, Temple Terrace, FL 33687

## COMMUNICATIONS EQUIPMENT

VIDEOSCAN 1000 Slow Scan TV—HIGH RESOLUTION (amateur, phone line, surveillance, teleconferencing). CODE\*STAR—DECODE Morse, RTTY, ASCII. LARGE LED's or connect computer/printer. MORSE-A-KEYER—CW keyboard. TRI-VOLTAGE POWER SUPPLY. Kits/Assembled. FREE brochures. **MICROCRAFT CORP.**, Box 513-RE, Thiensville, WI 53092. (414) 241-8144.

## COMPUTERS

SAVE 90%. Build your own 68000, 8086, Z80A, or 8080 microcomputer or minicomputer system. Free details. **DIGATEK CORPORATION**, Suite E., 2723 West Butler Drive, Phoenix, AZ 85021

## EDUCATION & INSTRUCTION

UNIVERSITY degrees by mail! Bachelors, Masters, Ph.D.'s ... Free revealing details. **COUNSELING**, Box 317-RE 2, Tustin, CA 92680

YOUR own radio station! AM, FM, cable, licensed, unlicensed. Low cost transmitter kits, free info. **BROADCASTING**, Box 130-F2, Paradise, CA 95969

SPACEPOST! An exciting new game for your VIC-20. Hours of play. Send \$5.95 to **T & R PROGRAMMING**, PO Box 54, Kingstons, WA 98346. Add \$1.50 postage and handling.

## ATTENTION ELECTRONIC TECHNICIANS



Highly Effective Home Study BSEE Degree Program for Experienced Electronic Technicians. Our New Advanced Placement Program grants Credit for previous Schooling & Professional Experience. Advance Rapidly! Our 36th Year FREE DESCRIPTIVE LITERATURE!

Cook's Institute of Electronics Engineering  
DESK 15, P.O. BOX 20345, JACKSON, MS 39209

## BUSINESS OPPORTUNITIES

**LAWYER** Business litigation, patents, appeals. **JEROME FIELD**, B 292, Brooklyn 11230. Phone (212) 434-0781. Eves. 434-1825

**ATARI** repair business. Start your own. Send \$5.00 for more information to: **IRATA REPAIRS**, 2562 East Glade, Mesa AZ, 85204

**MECHANICALLY** inclined individuals desiring ownership of Small Electronics Manufacturing Business—without investment. Write: **BUSINESSES**, 92-R, Brighton 11th, Brooklyn, NY 11235

**MAKE** money selling electronics. Wholesale dealer catalog \$5.00 (redeemable). **ETCO**, Dept. 533, Box 840, Champlain, NY 12919

**DEALERS** wanted: MATV/CATV, antennas, needles, films, free catalog. 212-897-0509. **D & WR**, 66-19 Booth, Flushing, NY 11374

**PROFITABLE** electronic construction projects, "bug detector," "pen transmitter," "telephone scramblers," "telephone bugs," and automatic monitoring equipment, many more, send \$5.00 US to cover information package to **HODGINS**, RR#1, Smiths Falls, Ontario, Canada K7A5B8

**1200% PROFIT TV projector! No investment.** Complete dealer's information FREE. Write (post-card OK) **SPECIAL PRODUCTS ENTERPRISES**, Dept RE62, Box 164, Spring Valley, IL 61362

**EDUCATE** yourself — security alarm business. 98% of homes do not have burglar alarms. Excellent employment - business opportunities. Send \$2.00 for information. **SECURITY ELECTRONICS INTERNATIONAL**, PO Box 1456-E, Grand Rapids, MI 49501

## SATELLITE TELEVISION

**DRAKE** satellite receiver with modulator installed only \$969.00. Satellite and microwave catalog \$1.00. **TEM MICROWAVE**, 22518 97th Ave. No., Corcoran, MN 55374 (612) 498-8014

**SATELLITE** equipment catalog. Over 25 of the best manufacturers and suppliers. LNA's, receivers, antennas, and complete systems covered in four different sections. A satellite aiming chart and microwave interference handbook. (\$10.00 value) included free. Send \$9.95 U.S. **TMS CO.**, PO Box 8369, Roseville, MN 55113

**SATELLITE** receiver IF sweep generator 70 MHz IF. Sweeps 40 to 100 MHz—\$79.95. **HEAD END SYSTEMS**, PO Box 8758, Portland, OR 97207

**SATELLITE** polar mounted antenna break through. Build best with 42dB gain. Under \$160.00. **PROTOTYPE ENGINEERS**, Box 1812, Deming, NM 88031

**INTERESTED** in home satellite television — Don't buy anything until you've read **Homesat Handbook & Buyers Guide**. Our book tells everything about home satellite TV and may save you hundreds, even thousands of dollars in your selection and installation of a system! \$10.00: **H & G HOMESAT SERVICES**, Box 422, Seaford, NY 11783

**SATELLITE** cables, connectors: Type-N UG21D/U \$3.00, Elbow \$4.95, UG57B/U \$5.25, UG29B/U \$3.90, F59A 10/2.15, RG6 U 12c/ft, RG59 U copper 12c/ft, RG213 U 36c/ft, RG214U \$1.35/ft, shipping 10% \$3 min. Free catalog — wholesale welcome — **NEMAL ELECTRONICS**, 1325 NE 119 St., N. Miami, FL 33161 (305) 893-3924

## RELIABLE MICROWAVE TV ANTENNAS

2.1 to 2.6 GHz  
Frequency Range

34db System Gain (or Greater)  
Complete System (pictured) \$149.95  
Down Converter (Probe Style)  
Assembled & Tested \$ 64.95  
Power Supply (12V to 16V DC)  
Assembled & Tested \$ 59.95

## PETERSON ELECTRONICS

4558 Auburn Blvd.  
Sacramento, CA 95841  
(916) 486-9071

SPECIAL QUANTITY PRICING  
Dealers Wanted - COO'S



1 YEAR WARRANTY  
PARTS & LABOR



## SATELLITE TV MAGAZINE

An absolute must if you want to know what's going on in Satellite TV

TESTS-INFORMATION-EQUIPMENT  
\$6.95 + \$1.50 POSTAGE & HANDLING  
6 Issues \$29.95 — save 40%  
Call Toll Free 1-800-438-2020  
P.O. Box 2384 · Shelby, N.C. 28150



## HIGH BLOOD PRESSURE Treat it...and live.

The National High Blood Pressure Education Program,  
U.S. Department of Health, Education, and Welfare.

## PLANS & KITS

**CABLE** TV converters and equipment. Plans and parts. Build or buy. For information send \$2.00. **C & D ELECTRONICS**, PO Box 21, Jenison, MI 49428

**OVER 200** projects and kits, send stamp for list. **MATCO ELECTRONICS**, Box 316R, Cadillac, MI 49601

**SINE** wave decoder reference manual includes theory, alignment, antenna hook-up, trouble shooting, improvements. \$15.00. **SIGNAL**, Box 2512-R, Culver City, CA 90230

**TAILGATERS** beware! Clever device ends this hassle. Quick, easy installation. Kit \$4.95, two for \$8.95. **TAILGUARD**, 8 Alpine Place, Franklin, MA 02038

**RF MODULATORS**  
for the video industry

Satellite modulators from channel 2 thru UHF!  
Kits & assembled models for all microcomputers...including our new Apple-verter designed to mount inside computer. Also an extensive line of monitors, cameras and kits. FREE CATALOG.

PHONE (402) 987-3771  
**ATV Research**  
13-B BROADWAY  
DAKOTA CITY, NE 68721

## FREE KIT Catalog

FUNCTION GENERATOR KIT \$59.95  
Auto-Ranging Cap-meter kit \$79.95

Phone 415 - 447 - 3433

Write or Phone for FREE CATALOG.  
Average 1 minute Saturday call is 21¢.

contains TEST & EXPERIMENTER'S EQUIP.

**DAGE** SCIENTIFIC INSTRUMENTS  
BOX 1054R LIVERMORE CA 94550

## SEE THE WEATHER AND SAVE \$1,000!



A leading manufacturer of commercial weather chart recorders has developed a facsimile Weather Chart Recorder Kit for use by hobbyists, amateurs, pilots, and educators.

All you need is a stable HF general-coverage receiver to tune in weather facsimile frequencies—your recorder will print out accurate weather charts. Major components in this easy-to-build kit are pre-assembled and tested. And the recorder is backed by a limited warranty against defects. Special kit price is \$995. Add \$5 for shipping and handling in the U.S. and Canada. (For Massachusetts delivery, add \$49.75 sales tax.) Master Card and Visa accepted. Call or write for more information.

## ALDEN ELECTRONICS

10 Washington Street, Westborough, MA 01581  
(617) 366-8851



## PLANS & KITS

**DIGITAL UHF STV kit \$250.00.** Deluxe sine wave kit \$153.00. Others. STVCO, Box 18039, Orlando, FL 32860

**PORTABLE** digital capacitance meter with 1% accuracy—range 1pf to 10,000 µf. Uses readily available components. Plans, etched and drilled PCB and calibration components \$14.95. Kit as above including parts (less case) \$59.95. **DRISCOLL ELECTRONICS**, 57 Scofield Ave., Bridgeport, CT 06605



### ELECTRONIC ORGAN KITS

3-4 Manuals

THEATER and CLASSICAL

Refundable Parts  
Brochure \$2.00 Catalog \$2.00

Wurlitzer reproductions  
**DEVTRONIX ORGANS, INC.**, Dept 60  
6101 WAREHOUSE WAY, SACRAMENTO, CA 95826

**DESCRAMBLER MDS systems.** Simplest and most complicated systems used today. Call or write for orders, info or catalog. (301) 882-9362 **SATELLITE ELECTRONICS**, POB 9534, Baltimore, MD 21237

**CONVERT your TV to an oscilloscope a simple, fun, plans \$5.00 to L.S.E., Box 8402, Madison, WI 53708**

**ATARI 400/800** full-travel extension keyboard and keypad kits. Brochure (send 50¢ refundable). **S/WARE**, 1341-H Quail Hollow Road, Harrisburg, PA 17112

**MAKE own PC's.** Large manual. (It's good.) Best DIY methods. All steps, layout to finished PC. No risk! Satisfied or refund! \$12.00 CK MO. **ZOWTIAK**, 750 Little Matterhorn, Salt Lake City, UT 84107

**NEW: single board control computer** based on Z8671. Has eight A to D inputs, four Triac outputs, 16K memory, and more. **Low price.** Write **H.H.S. MICROCONTROLLERS**, 5876 Old State Road, Edinboro, PA 16412

## SUBSCRIPTION TV KITS

**UHF Gated Pulse Kit.....\$39.00**  
**UHF Sinewave Kit.....\$37.00**  
**Special Both Kits.....\$59.00**  
**Informative Catalog.....\$ 2.00**

Kits include all parts, manual and an etched & drilled PC board. Send for our "Informative Catalog" and find out what type you need.

**J & W ELECTRONICS, INC.**

P. O. BOX 61-B

CUMBERLAND, RI. 02864

**NEW!** Repair any TV .... Easy. Anyone can do it. Write **RESEARCH**, Box 517E, Brea, CA 92621

**MICROWAVE television "downconverters."** Exclusive new five stage design. Easily assembled. Catalogue: \$2.00 (refundable). **NDS**, Box 12652-R, Dallas, TX 75225

**SAVE steps, money.** Use your telephones as an intercom. Plans \$5.00. **dB Enterprises**, Box 453R, Westwood, NJ 07675

**COMPONENT TV receiver.** Build from standard parts. Brochure \$2.00, plans \$8.00. **DRM PRODUCTS**, Box 327, Syracuse, NY 13215-0327

**CATALOG—transmitters, linears, MDS downconverters, scramblers, broadcasting, CB, hobby plans & kits.** \$1.00. **PANAXIS**, Box 130-F2, Paradise, CA 95969

**APPLE builders—Send stamp for our flyer of Apple parts, IC sets, ROM sets, connectors, Shugart to Apple modification kits, etc.** **ELECTROVALUE INDUSTRIAL, INC.**, Box 157-R, Morris Plains, NJ 07950

# SJB DISTRIBUTORS. THE MOST COMPETITIVE PRICES ON COMMODORE.



### MONITORS--GREAT RESOLUTION (64 or VIC)

Panasonic 13" 1320V (Also a great color TV).....	\$489
Amdel Color I.....	329
Nec JB 1201M, 12" Color.....	329
Nec JB 1201, 12" Green Phosphor.....	159
Amdel Video 300L.....	159
Transtar (High Resolution).....	143
Video/Audio Cable.....	25

### Arcade Joysticks--Heavy duty with 2 firing buttons! Great for the VIC or 64.....

SuperPET (5 languages, 2 processors).....	\$1409
CBM 8032 Computer, 80 column.....	1029
CBM Memory Expansion, 64K.....	359
PET 4032, 40 column.....	950
CBM 8050, 1 Mg. Dual Drive.....	1259
CBM D9060, 5 Mg. Hard Disk.....	2240
CBM D9090, 7.5 Mg. Hard Disk.....	2600
CBM 4040, 340K Dual Drive.....	919
CBM 2031, 170K Single Drive.....	489
DC Hayes Smart Modem.....	220

### PRINTERS--LETTER QUALITY

CBM 8300, 40cps.....	\$1450
Diablo B20, 25cps.....	995
Nec Spinwriter 7700, 55cps.....	2350
Nec Spinwriter 3500, 35cps.....	1600

### PRINTERS--DOT MATRIX

CBM 4022, 80cps/graphics.....	\$395
CBM 8023, 150cps/graphics.....	599
Okidata 82A, 120cps/serial or par.....	449
Nec 8023A (parallel).....	499
Epson MX 50 F+.....	529
IDS Micropism.....	539

### BUSINESS SOFTWARE

WordPro 4+ or 5+.....	309
Administrator (Awesome Database).....	489
VisiCalc (expanded).....	199
The Manager (database).....	199
Legal Time Accounting.....	400
BPI A/R, G/L, Job Cost, Inventory, Payroll.....	325 pkg.

SJB will service any VIC or CBM64.

### MasterCard, Visa, Money Order, Bank Check

COD (add \$5) accepted.  
Add 3% surcharge for credit cards.  
In stock items shipped within 48 hours, F.O.B. Dallas, TX  
All products shipped with manufacturer's warranty.

### TO ORDER CALL TOLL FREE

800-527-4893 800-442-1048 (Within Texas)

SJB will meet any competitive price under similar in-stock conditions.

### SOFTWARE FOR CBM 64K

Word Processing (Word, Palabra).....	\$85
WordPac.....	70
COCO (great computer tutoring game).....	44
COCO II (build your own games easily).....	49
Home Finance Package.....	25
General Ledger, A/R, Inv.....	175 pkg.
CBM EasyCalc.....	90
CBM Easy Finance.....	50
CBM Easy Schedule.....	80
Data Manager.....	70
Pet Emulator (emulates 4.0 basic).....	30
Sprite-Magic (build sprites on screen with Joystick, save to disk or cassette).....	\$19
Assembler Package for CBM 64 (cassette) Editor (creates and updates source code) Assembler, Loader, Disassembler.....	50
Mail Mate.....	45
IEEE Interface (64).....	95
Parallel Interface (Epson, Okidata, IDS, Nec).....	80
RS232 Printer Interface (Okidata etc).....	65
Apple Loader.....	100
Programming Reference Guide.....	18

### VIC PRODUCTS

VIC 20 Computer, 5K.....	\$179
VIC Datasheet Recorder.....	60
VIC 1541 Disk Drive.....	395
VIC MODEM (for CBM 64).....	95
VIC 1525 Graphic Printer (for CBM 64).....	325
8K Memory Expansion Cartridge.....	49
16K RAM.....	99
24K RAM.....	155
IEEE Interface (VIC).....	85
VIC 3 slot Expander.....	43
VIC 6 slot Expander.....	83
RS232 Printer Interface.....	65
Cassette Interface.....	27
Intro to Basic I or II.....	23
Home Finance Package.....	48
Turtle Graphics.....	35
Heswriter (great wp).....	35

### VIC GAMES

Choplifter (cartridge).....	37
Apple Panic.....	37
Trashman.....	37
Blackhole.....	37
Sargon II.....	30
Satellites & Meteorites.....	38
Seawolf.....	23
Cosmic Cruncher.....	23

### SJB DISTRIBUTORS, INC.

10520 Plano Road, Suite 206  
Dallas, Texas 75238  
(214) 343-1328

Business Hours  
M-F 8 to 6  
Sat. 10-2

Prices are subject to change without notice.

\*\*\*\*\*  
**QUALITY MICROWAVE TV SYSTEMS**  
 \*\*\*\*\*  
**Complete Systems From \$69<sup>95</sup>**  
**1.9 to 2.5 GHz Antennas**  
 \*\*\*\*\*  
**Galaxy Electronics**  
**6007 N. 61st Ave.**  
**Glendale, Az.**  
**85301**  
**(602) 247-1151**  
 \*\*\*\*\*  
**COD's Dealers Wanted**  
 \*\*\*\*\*  
  
  
 \*\*\*\*\*  
  
  
  
  
 \*\*\*\*\*

### SATELLITE TV WEEK

The most complete weekly listings. We cover more than just SATCOM 3. Send \$1 for sample copy.

## Satellite TV Week

P.O. Box 308, Fortuna, California 95540

Call toll free: (800) 358-9997 • California (707) 725-2476



Support the  
**March of Dimes**  
 BIRTH DEFECTS FOUNDATION



# There's No Place Like the Parts Place™

## Big Selection! High Quality! In Stock!

### 21-Range, 30,000 Ohms/Volt Micronta® Multitester



Built-in  
"Beep"  
Continuity  
Indicator

Fused and  
Overload  
Protected

**49.95**

#### Big 5" Color-Coded Scale

Our best analog multitester. Measures to 1000 volts DC in seven ranges, to 1000 volts AC in five ranges, DC current to 10 amps in five ranges, resistance to 10 megs in four ranges and dB in five ranges. With leads. Requires 9V and "C" batteries. 22-210 ..... 49.95

### Sound Switch Module

Whistle Activated!



Application Notes  
Included

**NEW**

**1.99**

Whistle for on,  
again for off!  
Control a relay,  
motor, LED,  
even a radio or  
TV. 6 to 9VDC.  
277-1011 . . . 1.99

### Varactor UHF-TV Tuner

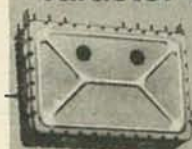

Brand New,  
Not Surplus!  
Stable!

**24.95**

UES-A56F. Perfect for your  
video projects. 0 to 28VDC  
control voltage. 75 ohms.  
12VDC. 277-220 ..... 24.95

### IF Amp, FM & Video ICs

Low As

**1.79**



D



E

D MC1330 Video Detector. For many solid-state TV circuits. Replaces 3rd IF detector, video/AFC buffers. 10-24VDC. 8-pin. 276-1757 ..... 2.49

D MC1350 Universal IF Amp With AGC. For TV, radio. DC to over 60 MHz. Gain at 45 MHz: 50 dB typ. 12VDC. 8-pin. 276-1758 ..... 2.19

E MC1358/CA3065 FM Detector. Converts CBs, receivers to pick up NBFM. 100 kHz to 5.5 MHz IFs. 10-24VDC. 14-pin DIP. 276-1759 ..... 1.79

### FM Stereo Decoder



**2.49**

LM1800. Tunes with  
one pot—no coils  
needed. 30 dB (min.)  
separation. 16-pin.  
276-1719 ..... 2.49

### Design/Letter Templates

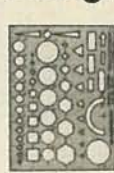

A



B

**NEW**

**2.99**  
Each



For Diagrams,  
Blueprints

- A General Purpose. 53 shapes, sizes. 276-181  
B Perfect Circles. 1/32" to 2". 276-182  
C Lettering Guide. 1/8" to 1/4". 276-183

### DPDT 5VDC Relay

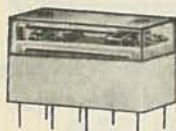

**4.49**

Fits 16-pin DIP socket, or mount  
on PC board. Contacts: 1 amp  
at 125VAC. Coil: 100 mA, 50  
ohms. 275-215 ..... 4.49

### Versatile Solar Cell



**3.95**

Harness the sun for "free" energy  
to drive projects, charge  
batteries, much more! 2.5 x 5  
cm. Generates 0.42 volt at  
160 mA. 276-124 ..... 3.95

### Toy Hobby Motor



**NEW**

**79¢**

Reliable power source at a low  
price—great for projects, toys,  
more! 3.0 to 15VDC.  
273-221 ..... 79¢

### DIP Switches

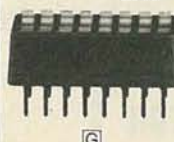

G

Low As  
**1.49**



H

For digital and low current uses.

- G 8-Position. 16-pin DIP. 275-1301 ..... 1.99  
H 4-Position. 8-pin DIP. 275-1304 ..... 1.49

### Sound Synthesizer



**38%  
Off**

Reg. 2.49  
**1.55**

SN94281. Add a few parts and  
create sounds galore. 125 mW  
amp drives speaker. 7.5-10VDC.  
16-pin. 276-1767 ..... Sale 1.55

### Push-In Neon Lamps



**1.99**

Pkg. of 2

One red, one green.  
Built-in dropping  
resistors for 120VAC  
use. Require 7/16"  
mounting holes. Sol-  
der lugs. 272-709 ..... 1.99

### 40k Joystick Pot

Dual  
Linear  
Taper Controls

**4.95**



40k. Max. displacement, 30°.  
1" shaft. Body, 17/16" sq. Solder  
lugs. 271-1706 ..... 4.95  
100k Pot. 271-1705 ..... 4.95

### Operational Amplifiers

Frequency  
Compensated

Use for Control,  
Computing and  
Instrumentation!  
One Trillion Ohms  
Input Sensitivity!

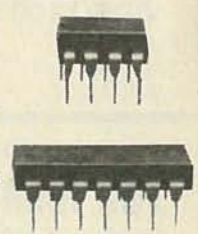

#### NFET Op Amps

Type	DIP	Cat. No.	Each
TL091 (Single)	8-pin	276-1745	1.79
TL092 (Dual)	8-pin	276-1746	2.29
TL094 (Quad)	14-pin	276-1747	4.49

#### CMOS Op Amps. 1 picoamp input.

Type	DIP	Cat. No.	Each
ICL7611 (Single)	8-pin	276-2330	2.49
ICL7621 (Dual)	8-pin	276-2331	3.79
ICL7641 (Quad)	14-pin	276-2332	4.99

### Deluxe Plastic Project Enclosure

Cut 25%

Reg. 7.95

**5.95**

Dress up and protect that prized  
project. Stylish two-tone color,  
easy-to-drill end panels. 2 1/4 x  
5 x 5 1/4". 270-218 ..... Sale 5.95

### Panel Lettering

**2.59**

Label your  
project controls. Rub-on  
letters, numbers, sym-  
bols transfer to metal,  
plastic sur-  
faces. Four  
sheets.  
270-201 ..... 2.59



### Piezo Buzzer

**2.99**



For projects that call for sound.  
Super-loud 4.8 kHz signal. 1.5  
to 20VDC. Great for battery-  
powered circuits—draws just  
12 mA at 9V. With leads.  
273-060 ..... 2.99

# Radio Shack®

A DIVISION OF TANDY CORPORATION • OVER 8500 LOCATIONS WORLDWIDE

Retail prices may vary at individual stores and dealers.

CIRCLE 20 ON FREE INFORMATION CARD



# JAPANESE SEMICONDUCTORS

**SANYO  
STK-435**

**\$4<sup>10</sup>**



**SANYO  
STK-437**

**\$6<sup>50</sup>**



**ZENER DIODE KIT  
ZDK-23**  
Most popular zener diodes in kit of 23  
Plastic Cabinet

**\$11<sup>95</sup>**



**SANYO**



**2SC1308K  
\$1<sup>99</sup>**

**TOSHIBA**



**2SC1172B  
\$1<sup>99</sup>**

TRANSISTORS	A808 3.18	B697 3.23	C789 1.20	D1212A 58	C1959 30	D470A 2.51	HA1138 1.36	STK0029 3.88	TA7222AP 1.87	UPC1185H 3.11
2SA329 32	A840 1.44	Z5C352A 2.73	C799 1.50	C1213 18	C1973 61	D471 25	HA1151 1.82	STK0050 5.87	TA7227PK 4.04	UPC1186H 1.56
A473 56	A906 10.47	C371 32	C829 14	C1315 28	C2028 58	D525 90	HA1156W 1.26	STK0080 10.60	TA7310P 1.02	UPC2002 1.43
A483 3.57	A909 10.51	C372 16	CB30H 2.71	C1226A 40	C2029 1.53	D526 81	HA1196 1.36	STK013 7.70	TC4081P 5.8	UPC14305 1.74
A489 1.54	Z5B27 25	C380A 14	C838 36	C1239 1.50	C2074 97	D555 4.51	HA1197 1.28	STK015 3.20	TC5080P 5.42	UPC0857 6.50
A490 81	B75 28	C381 28	C839 20	C1279 40	C2166 97	D588A 10	HA1198 1.43	STK032 7.60	TC5081P 2.19	UPC0858 6.50
A495 16	B173 32	C382 40	C840 1.62	C1306 97	Z5D24Y 80	D588A 1.71	HA1201 76	STK040 7.42	TC5082P 2.19	UPC0861C 5.87
A496 45	B202 1.04	C383 46	C867A 2.80	C1307 1.72	D72 85	D600 45	HA1202 94	STK043 8.80	UHC001 4.07	DIODES
A509 36	B220 1.00	C387A 34	C895 5.09	C1308K 1.99	D92 1.86	D613 60	HA1206W 2.08	STK078 7.75	UHC003 4.07	GH3F 89
A545 41	B257 32	C388A 52	C900 20	C1316 3.40	D93 1.72	D733K 2.50	HA1319 2.75	STK080 7.85	UHC004 4.07	SID30-15 1.39
A606 1.99	B303 32	C394 18	C941 25	C1318 1.8	D157 2.51	D823 94	HA1329 1.82	STK430 5.50	UHC005 4.07	IN60 14.100
A626 3.86	B367 1.85	C486 99	C999 1.17	C1345 16	D180 1.89	D823 94	HA1338A 1.84	STK433 4.00	UHC01C 2.19	IN4001 10.100
A627 2.03	B407 1.22	C495 52	C960 1.10	C1346 43	D201 2.49	D823 94	HA1342A 1.84	STK435 4.10	UHC004 4.07	IN4002 12.100
A634 64	B426 1.22	C496 45	C1012 1.36	C1364 25	D266A 1.43	D823 94	HA1361 2.08	STK437 6.50	UHC005 4.07	IN4003 12.100
A661 36	B449 1.72	C497 56	C1025 90	C1383 27	D266A 1.43	D823 94	HA1366W 1.89	STK439 6.85	UHC005H 4.07	IN4004 12.100
A682 50	B474 1.12	C509 32	C1034 5.80	C1384 29	D235 82	AN2140 1.50	HA1366WR 1.89	STK463 9.85	UHC006 2.44	IN4005 15.100
A684 32	B507 60	C517 4.40	C1047 1.8	C1403A 3.21	D287A 2.97	AN239 5.43	HA1396 4.22	STK503 7.50	UHC007 2.44	IN4006 16.100
A699A 64	B509 2.15	C537 16	C1050 1.71	C1433A 4.97	D313 45	AN247 2.99	HA1396 4.22	STK503 7.50	UHC007 2.44	IN4007 20.100
A709 58	B511 64	C563 63	C1061 56	C1419 56	D315 1.02	AN274 2.25	LA3350 1.10	TA7060P 70	UHC008 2.44	SILICONE RECTIFIER
A706 1.26	B528 66	C627 1.28	C1096 45	C1448 1.20	D350 3.99	AN313 2.79	LA4032P 1.66	TA7061AP 90	UHC009 2.44	2.5 Amp-1000 Volts SL 100 10.100
A719 20	B529 66	C642A 1.86	C1114 3.45	C1567A 50	D353 2.82	AN315 2.00	LA4400 1.80	TA7063 56	UHC010 2.44	
A722 20	B536 90	C696 1.36	C1115 4.06	C1664A 2.00	D357 61	AN362 1.41	LA4430 1.36	TA7074P 2.05	UHC011 2.44	
A738 43	B537 90	C708 1.51	C1188A 4.13	C1675 14	D358 66	AN374 99	M51513L 1.89	TA7075P 2.05	UHC012 2.44	
A740 2.35	B541 2.77	C710 16	C1124 99	C1678 1.05	D381 76	AN612 1.35	M51515BL 3.05	TA7076P 3.39	UHC013 2.44	
A745A 6.84	B555 3.09	C732 14	C1127 1.90	C1728 81	D386A 79	AN7145 2.46	MB3705 1.54	TA7120P 58	UHC014 2.44	
A747 7.02	B556 5.35	C733 14	C1181 1.95	C1760 82	D424 3.03	AN7150 2.33	MB3712 1.51	TA7130P 97	UHC015 2.44	
A747A 7.50	B557 2.93	C735 28	C1186 50	C1815 11	D425 3.03	BA511A 1.44	MB3730 3.18	TA7201P 2.03	UHC016 2.44	
A748 90	B561 18	C756A 40	C1169 5.69	C1826 2.26	D426 2.82	BA521 1.23	MB3756 1.99	TA7203P 2.30	UHC017 2.44	
A750 14	B595 1.24	C781 1.99	C1172B 1.99	C1885 36	D438 34	BA532 1.62	MBB719 4.78	TA7204P 1.35	UHC018 2.44	
A762 4.15	B617A 1.36	C784 28	C1173 52	C1904 36	D467 16	BA1310 1.56	PL101A 3.66	TA7205AP 1.20	UHC019 2.44	
A771 2.08	B656A 3.84	C785 28	C1209 28	C1951 1.44	D468 16	HA1137W 1.12	PL102A 6.34	TA7214P 3.41	UHC020 2.44	

## OMNITRON

**ELECTRONICS**  
770 Amsterdam Ave., New York, NY 10025

➤ Also ask for Free 100 Page Catalog ◀

Send Purchase Order, Check or Money Order  
or Call Toll Free 800-223-0826

in NY STATE (212) 865-5580  
All ORDERS SHIPPED UPS/COD F.O.B., N.Y.C.

MASTER CARD • VISA

CIRCLE 62 ON FREE INFORMATION CARD

### 12" B&W MONITOR

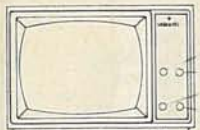

Contrast  
Power/Bright  
V-Hold  
H-Hold

VIDEO 100 by AMDEK

FULL  
FACTORY  
WARRANTY **\$79<sup>95</sup>**

for APPLE

### 16K RAM CARD

Language Transparent  
COEX FACTORY WARRANTY **\$69<sup>95</sup>**

### 5 1/4" Floppy DISKETTES

All Certified-100% Guaranteed

BOX of 100... **\$149<sup>00</sup>**  
Above with  
Hub Rings... **\$169.00**

### FLOPPY DISK DRIVE

From Fourth Dimension Systems  
with • Track Zero Micro Switch  
• DOS 3.2.1 & DOS 3.3  
• CP/M and PASCAL

DESIGNED  
FOR YOUR  
APPLE™ ..... **\$287<sup>95</sup>**

Controller Card  
for above..... **\$99.00**

## COEX 80-FT DOT MATRIX PRINTER

- Interface with Apple™, Centronics RS-232, IEEE-488
- 9x7 Dot Matrix, 80 CPS, Bi-Directional Printing
- 2K Buffered Memory
- 80, 96, 132 Columns, Graphics and Block Printing
- Selectable Char Pitch, Line Spacing and Feed



COEX Interface Card to APPLE **\$49.95**

**\$349<sup>00</sup>**

## VISION-80® \$249<sup>00</sup>

80x24 Video Display Card  
Vista Computer Company's new Vision-80 board is a sophisticated yet easy to use video display card for the Apple™ computer.

### EXTENDER CARDS

for APPLE... **\$16.95**  
for I.B.M.... **\$19.95**

### PROTOTYPING CARDS

for APPLE... **\$19.95**  
for I.B.M.... **\$49.95**

### PARALLEL INTERFACE EPSON TO APPLE

New From **\$49<sup>95</sup>** CABLE INCLUDED

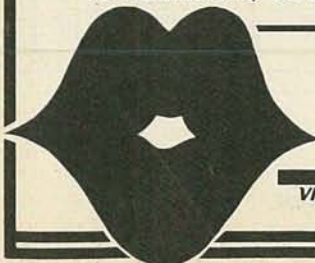

VISA

# "Have You Kissed Your Computer Lately?" Components Express, Inc.

1380 E. Edinger • Santa Ana, Calif. 92705 • 714/558-3972  
Terms of Sale: Cash, Checks, Credit Cards, M.O., C.O.D. Calif. residents add 6% sales tax.

master charge



# Electronics Paperback Books

## Quality Paperbacks at Affordable Prices

### BUY 12 PAY FOR 10—TAKE 2 FREE!



- 30 SOLDERLESS BREADBOARD PROJECTS BOOK-1. \$5.75. Whenever possible the same parts are used in several projects. Even a first-time builder can complete these circuits.
- HOW TO GET YOUR ELECTRONIC PROJECTS WORKING. \$5.00. Helps you troubleshoot and repair home-built projects of every description.
- MINI-MATRIX BOARD PROJECTS. \$5.00. A variety of projects that can all be built upon a mini-matrix board that has 10 strips and is 24 holes long.
- MODERN OP-AMP PROJECTS. \$5.00. Wide range of specialized op-amp circuits including low-noise, low-distortion, ultra-hi input impedance, etc.
- MULTI-CIRCUIT BOARD PROJECTS. \$5.00. 21 fairly simple projects that can all be built on a single printed-circuit board. All are powered by a 9V battery.
- IC PROJECTS FOR BEGINNERS. \$5.00. Inexpensive digital and linear ICs are used to assemble this selection of circuits intended for the beginner.



- ART OF PROGRAMMING THE 1K ZX81. \$6.25. Topics include full screen, scrolling, PEEK & POKE, plus actual working programs.
- ART OF PROGRAMMING THE 1K ZX81. \$5.00. How to use the features of the ZX81 in programs that fit the 1K machine and are still fun to use.
- INTRODUCTION TO BASIC PROGRAMMING TECHNIQUES. \$5.00. Based on author's own experience in learning BASIC and helping others to learn to program.
- A MICROPROCESSOR PRIMER. \$4.50. Painless approach to computing for the beginner. Step-by-step explains computer operations and assembly.
- THE 6809 COMPANION. \$5.00. Written for the average assembly language programmer. A discussion of 6809 features & reference work for the 6809 programmer.
- PRACTICAL COMPUTER EXPERIMENTS. \$4.50. Fills in background to microprocessor by constructing typical computer circuits using discrete logic components.

- FIRST BOOK OF HI-FI SPEAKER ENCLOSURES. \$4.50.
- SOLID STATE NOVELTY CIRCUITS. \$3.50.
- 28 TESTED TRANSISTOR PROJECTS. \$4.25.
- SOLID-STATE SHORTWAVE RECEIVERS FOR BEGINNERS. \$4.50.
- 50 PROJECTS USING IC CA 3130. \$4.50.
- 50 CMOS IC PROJECTS. \$4.50.
- HOW TO BUILD ADVANCED SHORTWAVE RECEIVERS. \$5.00.
- BEGINNERS GUIDE TO BUILDING ELECTRONIC PROJECTS. \$5.00.
- ESSENTIAL THEORY FOR THE ELECTRONICS HOBBYIST. \$5.00.
- FIRST BOOK OF TRANSISTOR EQUIVALENTS & SUBSTITUTES. \$3.75.
- PRACTICAL COMPUTER EXPERIMENTS. \$4.50.
- ENGINEERS & MACHINISTS REFERENCE TABLES. \$3.50.
- SECOND BOOK OF TRANSISTOR EQUIVALENTS & SUBSTITUTES. \$4.50.
- 52 PROJECTS USING IC 741. \$4.00.
- BEGINNERS GUIDE TO MICROPROCESSORS & COMPUTING. \$4.50.
- VMOS PROJECTS. \$5.00.
- HOW TO USE OP-AMPS. \$5.75.
- AUDIO PROJECTS. \$5.00.
- MODEL RAILWAY PROJECTS. \$5.00.
- CB PROJECTS. \$5.00.
- HOW TO GET YOUR ELECTRONIC PROJECTS WORKING. \$5.00.
- MULTI-CIRCUIT BOARD PROJECTS. \$5.00.
- ELECTRONICS SIMPLIFIED CRYSTAL SET CONSTRUCTION. \$4.50.
- ELECTRONIC HOUSEHOLD PROJECTS. \$4.50.

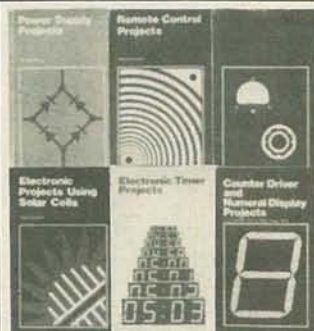

- POWER SUPPLY PROJECTS. \$4.50. Contains designs and construction details for almost any power supply the experimenter is likely to need.
- REMOTE CONTROL PROJECTS. \$5.00. Radio-control infra-red, visible light, & ultrasonic systems are all included, along with methods of applying them.
- ELECTRONIC TEST EQUIPMENT CONSTRUCTION. \$4.50. Construction details of a wide range of test equipment the experimenter can build at home.
- ELECTRONIC PROJECTS USING SOLAR CELLS. \$5.00. Simple circuits that have numerous applications around the home.
- ELECTRONIC TIMER PROJECTS. \$5.00. Timing circuits for almost any application the experimenter might need. A most valuable reference.
- COUNTER DRIVER & NUMERICAL-DISPLAY PROJECTS. \$4.50. Features applications & projects using various types of numerical-display devices.



- PRACTICAL ELECTRONICS CALCULATIONS AND FORMULAE. \$7.50. A basic reference work that bridges the gap between complicated technical theory & cut and tried methods.
- INTERNATIONAL DIODE EQUIVALENTS GUIDE. \$5.75. Helps you find substitutes for the many different types of semiconductor diodes in use today.
- INTERNATIONAL TRANSISTOR EQUIVALENTS GUIDE. \$7.50. Products of more than 100 manufacturers are listed & cross-referenced with possible replacements.
- HOW TO MAKE WALKIE-TALKIES. \$5.00. Describes equipment for low-power handheld operation. 112 pages of must reading for the dedicated experimenter.
- ELECTRONIC CALCULATOR USERS HANDBOOK. \$3.95. Presents formulae, data, methods of calculation, conversion factors & more from the view of the calculator user.
- IC EQUIVALENTS AND PIN CONNECTIONS. \$8.25. Shows equivalents & pin connections of a popular user-oriented selection of ICs.

- ELECTRONIC SYNTHESIZER PROJECTS. \$4.50.
- 50 CIRCUITS USING GERMANIUM, SILICON & ZENER DIODES. \$3.75.
- 50 PROJECTS USING RELAYS, SCRS & TRIACS. \$5.00.
- 50 (FET) FIELD-EFFECT TRANSISTOR PROJECTS. \$4.50.
- 50 SIMPLE LED CIRCUITS. \$4.25.
- 50 CIRCUITS USING 7400 SERIES IC'S. \$4.50.
- 50 SIMPLE LED CIRCUITS BOOK 2. \$3.95.
- PROJECTS USING 555 IC'S. \$5.00.
- PROJECTS USING LM3900 IC'S. \$4.75.
- RADIO CONTROL FOR BEGINNERS. \$4.50.
- ELECTRONIC GAMES. \$4.50.
- SINGLE IC PROJECTS. \$4.25.
- RADIO CIRCUITS USING IC'S. \$4.50.
- ELECTRONIC MUSIC & CREATIVE TAPE RECORDING. \$5.00.
- ELECTRONIC SECURITY DEVICES. \$5.00.
- HOW TO BUILD YOUR OWN SOLID-STATE OSCILLOSCOPE. \$5.00.
- SECOND BOOK OF CMOS IC PROJECTS. \$4.25.
- PRACTICAL CONSTRUCTION OF PRE-AMPS, TONE CONTROLS, FILTERS AND ATTENUATORS. \$3.75.
- BEGINNERS GUIDE TO DIGITAL TECHNIQUES. \$3.75.
- ELECTRONIC HOUSEHOLD PROJECTS. \$4.50.
- ELECTRONIC MUSIC PROJECTS. \$4.50.
- POPULAR ELECTRONIC PROJECTS. \$3.75.
- PROJECTS IN OPTO-ELECTRONICS. \$5.00.



- ANTENNA PROJECTS. \$5.00. Covers practical antenna designs including active, loop & ferrite types that are easy & inexpensive to build.
- RADIO STATIONS GUIDE. \$4.75. Comprehensive listing of transmitters around the world. Presents location, frequency, power.
- LONG DISTANCE TV RECEPTION (TVDX) FOR THE ENTHUSIAST. \$5.00. Practical & authoritative introduction to this unusual aspect of electronics.
- CB PROJECTS. \$5.00. A number of useful and interesting designs for CB accessories. Speech processor, interference filter & more.
- CRYSTAL SET CONSTRUCTION. \$4.50. Packed full of easy to duplicate designs for crystal radio receivers.
- AN INTRODUCTION TO RADIO DXING. \$5.00. Listen in your home, to broadcasts originating thousands of miles away. Tells how you can do it.

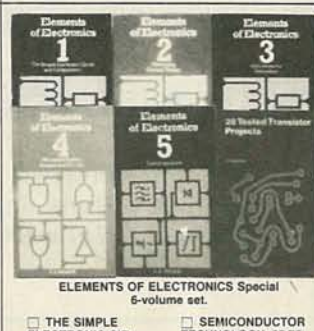

- THE SIMPLE ELECTRONIC CIRCUIT & COMPONENTS. \$5.75. All the fundamental theory needed to lead to a full understanding of the simple electronic circuit and its components.
- ALTERNATING CURRENT THEORY. \$5.75. Alternating current theory without which there can be no comprehension of speech, music, radio, or Television.
- MICROPROCESSING SYSTEM & CIRCUITS. \$7.50. A truly comprehensive guide to all of the elements of a microprocessing system.
- SEMICONDUCTOR TECHNOLOGY. \$5.75. Everything you always needed to know about solid-state devices in one volume.
- COMMUNICATIONS. \$7.50. Covers most modern communication systems. Line, microwave, submarine, satellite, digital multiplex, radio & telegraphy.
- AUDIO. \$9.00. Chapter after chapter investigates every important aspect of audio circuitry.
- SPECIAL OFFER—Complete set of all six volumes—a bargain that saves you \$6.25—SPECIAL PRICE \$35.00 FOR THE COMPLETE SET.

ELECTRONIC TECHNOLOGY TODAY INC.  
P.O. Box 83, Massapequa Park, NY 11762

Number of books ordered

Total Price of Books ..... \$ .....

Sales Tax (NY State Residents) .....

Shipping (75c 1st two books, 30c ea additional) .....

TOTAL ENCLOSED ..... \$ .....

Name.....

Address.....

City..... State..... ZIP.....

Prices good until March 30, 1983



# CEI Consolidated Electronics, Inc

**STOP!**  
**DON'T CALL THE WRONG NUMBER**  
**CALL CEI**



**YOUR COMPLETE ELECTRONIC PARTS SOURCE**

**MOST ORDERS SHIPPED WITHIN 24 HOURS**

**1-800-543-3568**

NATIONAL WATS LINE  
 705 WATERVLIE T AVE. DAYTON, OHIO 45420



**CALL NOW & GET YOUR FREE  
 1983 CATALOG TODAY!**

**1-800-762-3412**

OHIO WATS LINE  
 IN DAYTON OHIO CALL 252-5662

CIRCLE 22 ON FREE INFORMATION CARD

## Syntron Computer

\* 48K RAM \* Runs Apple  
 Hardware & Software  
**\$669.<sup>95</sup>**

## RANA Systems Apple Drives

\$435.<sup>00</sup> w/controller  
 \$385.<sup>00</sup> w/o controller

**SUPER 3.5amp. POWER SUPPLY  
 for APPLE \$98.<sup>50</sup>**

## Diskette Storage BOX

5 1/4 in. > 5/8" : 8 in. > 5/8"  
 \$2.50 ea. \$10.00 : \$3.50 : \$15.00

## Bare Bones **APPLE II** EURO

w/o Keyboard = 48K RAM =  
**\$399.<sup>00</sup>**  
 w/o Pwr. Supply

Microswitch: Power Supply: APPLE  
 Keyboard: w/ Purchase: Reference Manl.  
 \$79.95 : \$105.00 : \$18.00

## \*SPECIALS\*

3inch Mini FAN → \$8.95  
 2111 → \$2.45  
 8155 → \$11.50  
 ER2501 → \$4.95  
 AY5 1013A → \$2.95  
 8202 → \$29.95  
 6522 → \$5.25  
 8255 → \$4.50  
 8748-B → \$31.00  
 MC6800 → \$7.75  
 MC6802 → \$14.95  
 MC6850 → \$4.50  
 MC6821 → \$4.95  
 6331 → \$1.25

4116-2 → 8/10.<sup>00</sup>  
 2716(5v) → 3.75 ea.  
 2732(5v) → 8.75 ea.  
 2532(5v) → 8.75 ea.  
 Z80 A CPU → 5.25 ea.  
 1982 I.C.  
 (2vol.) Master  
 \$59.95

## Diskette SALE!!

"Wabash"  
 5 1/4 8 inch  
 SS/SD \$22.00 \$25.00  
 SS/DD 27.40 30.40  
 DS/SD 0 34.90  
 DS/DD 32.40 37.40

## CONCORD COMPUTER PRODUCTS

2910 B E LA PALMA  
 ANAHEIM CA 92806  
**(714) 632-6790** CHECK - M O  
 NO C.O.D.  
 10 MIN ORDER. C.A. RES. ADD. 6. ALL OW. M.S. DEL. 111  
 FREIGHT. PERSONAL CHECK'S SENT

## MONITORS

### ZENITH # ZVM-121

12in. 15MHz./GREEN Phos.  
**\$ 107.00**

### BMC # BM-1200SU

12in. 18MHz./GREEN Phos.  
 Non-Glare Screen **\$125.<sup>50</sup>**

### BMC # BM-12A

12in. 15MHz./GREEN Phos.  
**\$ 84.50**

### BMC # BM-1400CL

13in. "COLOR" **\$325.00**

## REAL-TIME CLOCK CALENDAR (MSM 5832)

Description: Mono Metal Gate CMOS I C  
 Features:  
 Time: Month, Date, Year, &  
 Day of Week  
 \*Bus Oriented  
 \*1 Bit Data Bus  
 \*1 Bit Address  
 \*R/W Hold Select.  
**\$6.45**  
 W/SPIC:  
 \*Inter Signal XTAL.  
 \*32.768KHz. xtal Control \$ 1.50  
 \*5v Pow Sup  
 \*Low Power Dissipation

## COMPONENTS

7400 SERIES		74S SERIES	
74LS00	24	74S00	35
74LS01	24	74S01	38
74LS02	24	74S02	38
74LS03	24	74S03	38
74LS04	24	74S04	45
74LS05	24	74S05	65
74LS06	24	74S06	40
74LS07	24	74S07	55
74LS08	24	74S08	55
74LS09	24	74S09	55
74LS10	24	74S10	55
74LS11	24	74S11	55
74LS12	24	74S12	55
74LS13	24	74S13	55
74LS14	24	74S14	55
74LS15	24	74S15	55
74LS16	24	74S16	55
74LS17	24	74S17	55
74LS18	24	74S18	55
74LS19	24	74S19	55
74LS20	24	74S20	55
74LS21	24	74S21	55
74LS22	24	74S22	55
74LS23	24	74S23	55
74LS24	24	74S24	55
74LS25	24	74S25	55
74LS26	24	74S26	55
74LS27	24	74S27	55
74LS28	24	74S28	55
74LS29	24	74S29	55
74LS30	24	74S30	55
74LS31	24	74S31	55
74LS32	24	74S32	55
74LS33	24	74S33	55
74LS34	24	74S34	55
74LS35	24	74S35	55
74LS36	24	74S36	55
74LS37	24	74S37	55
74LS38	24	74S38	55
74LS39	24	74S39	55
74LS40	24	74S40	55
74LS41	24	74S41	55
74LS42	24	74S42	55
74LS43	24	74S43	55
74LS44	24	74S44	55
74LS45	24	74S45	55
74LS46	24	74S46	55
74LS47	24	74S47	55
74LS48	24	74S48	55
74LS49	24	74S49	55
74LS50	24	74S50	55
74LS51	24	74S51	55
74LS52	24	74S52	55
74LS53	24	74S53	55
74LS54	24	74S54	55
74LS55	24	74S55	55
74LS56	24	74S56	55
74LS57	24	74S57	55
74LS58	24	74S58	55
74LS59	24	74S59	55
74LS60	24	74S60	55
74LS61	24	74S61	55
74LS62	24	74S62	55
74LS63	24	74S63	55
74LS64	24	74S64	55
74LS65	24	74S65	55
74LS66	24	74S66	55
74LS67	24	74S67	55
74LS68	24	74S68	55
74LS69	24	74S69	55
74LS70	24	74S70	55
74LS71	24	74S71	55
74LS72	24	74S72	55
74LS73	24	74S73	55
74LS74	24	74S74	55
74LS75	24	74S75	55
74LS76	24	74S76	55
74LS77	24	74S77	55
74LS78	24	74S78	55
74LS79	24	74S79	55
74LS80	24	74S80	55
74LS81	24	74S81	55
74LS82	24	74S82	55
74LS83	24	74S83	55
74LS84	24	74S84	55
74LS85	24	74S85	55
74LS86	24	74S86	55
74LS87	24	74S87	55
74LS88	24	74S88	55
74LS89	24	74S89	55
74LS90	24	74S90	55
74LS91	24	74S91	55
74LS92	24	74S92	55
74LS93	24	74S93	55
74LS94	24	74S94	55
74LS95	24	74S95	55
74LS96	24	74S96	55
74LS97	24	74S97	55
74LS98	24	74S98	55
74LS99	24	74S99	55
74LS100	24	74S100	55
74LS101	24	74S101	55
74LS102	24	74S102	55
74LS103	24	74S103	55
74LS104	24	74S104	55
74LS105	24	74S105	55
74LS106	24	74S106	55
74LS107	24	74S107	55
74LS108	24	74S108	55
74LS109	24	74S109	55
74LS110	24	74S110	55
74LS111	24	74S111	55
74LS112	24	74S112	55
74LS113	24	74S113	55
74LS114	24	74S114	55
74LS115	24	74S115	55
74LS116	24	74S116	55
74LS117	24	74S117	55
74LS118	24	74S118	55
74LS119	24	74S119	55
74LS120	24	74S120	55
74LS121	24	74S121	55
74LS122	24	74S122	55
74LS123	24	74S123	55
74LS124	24	74S124	55
74LS125	24	74S125	55
74LS126	24	74S126	55
74LS127	24	74S127	55
74LS128	24	74S128	55
74LS129	24	74S129	55
74LS130	24	74S130	55
74LS131	24	74S131	55
74LS132	24	74S132	55
74LS133	24	74S133	55
74LS134	24	74S134	55
74LS135	24	74S135	55
74LS136	24	74S136	55
74LS137	24	74S137	55
74LS138	24	74S138	55
74LS139	24	74S139	55
74LS140	24	74S140	55
74LS141	24	74S141	55
74LS142	24	74S142	55
74LS143	24	74S143	55
74LS144	24	74S144	55
74LS145	24	74S145	55
74LS146	24	74S146	55
74LS147	24	74S147	55
74LS148	24	74S148	55
74LS149	24	74S149	55
74LS150	24	74S150	55
74LS151	24	74S151	55
74LS152	24	74S152	55
74LS153	24	74S153	55
74LS154	24	74S154	55
74LS155	24	74S155	55
74LS156	24	74S156	55
74LS157	24	74S157	55
74LS158	24	74S158	55
74LS159	24	74S159	55
74LS160	24	74S160	55
74LS161	24	74S161	55
74LS162	24	74S162	55
74LS163	24	74S163	55
74LS164	24	74S164	55
74LS165	24	74S165	55
74LS166	24	74S166	55
74LS167	24	74S167	55
74LS168	24	74S168	55
74LS169	24	74S169	55
74LS170	24	74S170	55
74LS171	24	74S171	55
74LS172	24	74S172	55
74LS173	24	74S173	55
74LS174	24	74S174	55
74LS175	24	74S175	55
74LS176	24	74S176	55
74LS177	24	74S177	55
74LS178	24	74S178	55
74LS179	24	74S179	55
74LS180	24	74S180	55
74LS181	24	74S181	55
74LS182	24	74S182	55
74LS183	24	74S183	55
74LS184	24	74S184	55
74LS185	24	74S185	55
74LS186	24	74S186	55
74LS187	24	74S187	55
74LS188	24	74S188	55
74LS189	24	74S189	55
74LS190	24	74S190	55
74LS191	24	74S191	55
74LS192	24	74S192	55
74LS193	24	74S193	55
74LS194	24	74S194	55
74LS195	24	74S195	55
74LS196	24	74S196	55
74LS197	24	74S197	55
74LS198	24	74S198	55
74LS199	24	74S199	55
74LS200	24	74S200	55
74LS201	24	74S201	55
74LS202	24	74S202	55
74LS203	24	74S203	55
74LS204	24	74S204	55
74LS205	24	74S205	55
74LS206	24	74S206	55
74LS207	24	74S207	55
74LS208	24	74S208	55
74LS209	24	74S209	55
74LS210	24	74S210	55
74LS211	24	74S211	55
74LS212	24	74S212	55



# "The Deluxe II"

Is The Ultimate In UHF Sine Wave Converter Technology

**PC BOARD & PLANS \$20.00**

With purchase of COMPLETE SET OF PARTS & ENCLOSURE

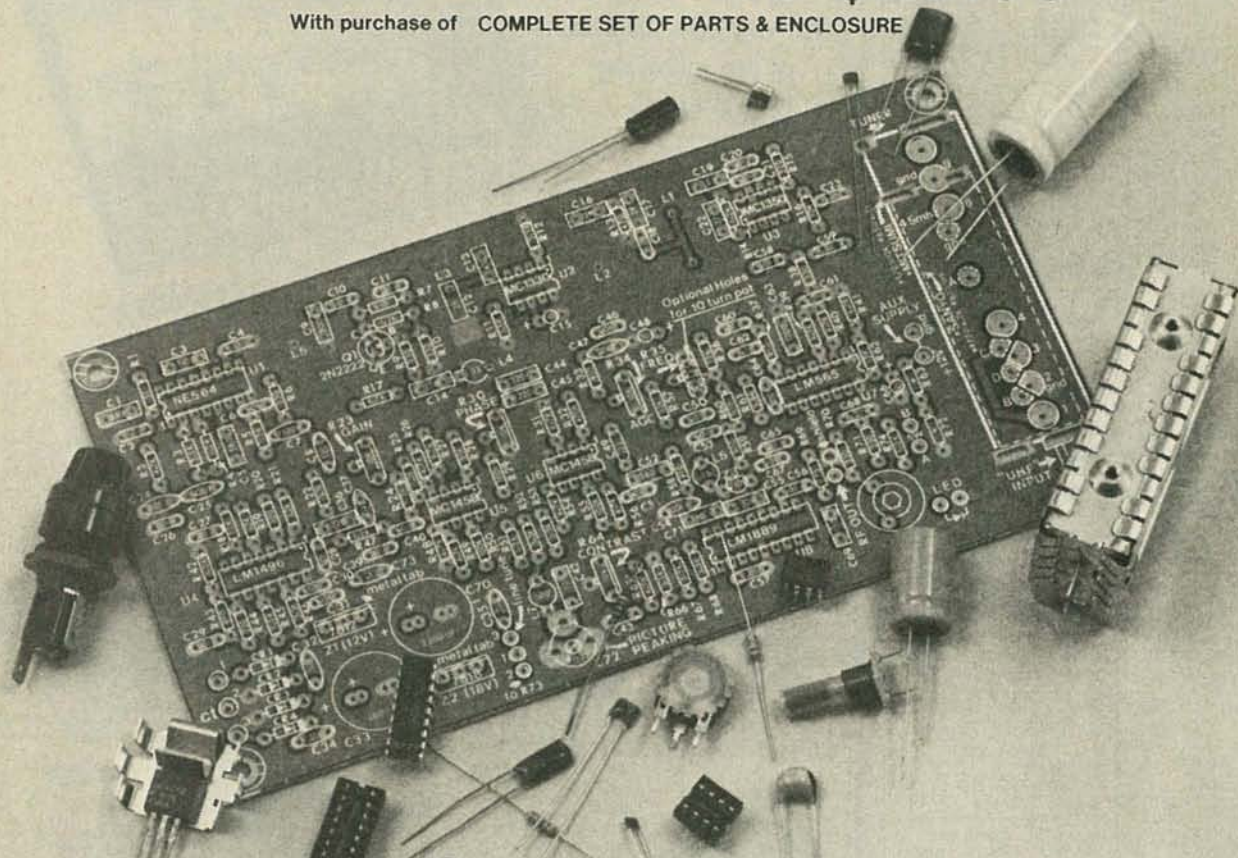

The latest state of the art electronics combined with the excellence in printed circuit manufacturing creates this high performance UHF Sine Wave Converter kit that outperforms the imitations by a long shot. Engineered for reliable stability and outstanding reception clarity, uninterrupted modulated audio and fully illustrated instructions with the amateur in mind.

BETA ELECTRONICS, 1700 E. DESERT INN ROAD, SUITE 222, LAS VEGAS, NEVADA, 89109 **TOLL FREE 1-800-782-2701**

QTY	DESCRIPTION OF ITEM	COST EACH	SHIPPING EACH	TOTAL
	PC BOARD, PLANS, PARTS & ENCLOSURE	\$152.99	\$4.95	
	PARTS & ENCLOSURE ONLY	\$132.99	\$4.95	
	PC BOARD & PLANS ONLY	\$30.00	\$1.50	
GRAND TOTAL				\$

PLEASE PRINT CLEARLY

SEND THIS ORDER FORM

NAME \_\_\_\_\_

ADDRESS \_\_\_\_\_

CITY/STATE/ZIP \_\_\_\_\_ ORDER DATE \_\_\_\_\_

VISA  MST. CARD CARD NO. \_\_\_\_\_ EXP. DATE \_\_\_\_\_

FOR IMMEDIATE DELIVERY MONEY ORDERS OR CERTIFIED CHECKS PREFERRED PERSONAL CHECKS ALLOW 4 WEEKS FOR DELIVERY



# ARIZONA ELECTRONIC SURPLUS

Wholesale - Retail - Surplus  
Electronic Parts

6835 N. 16th Street • Phoenix, AZ 85016

The Most Unbelievable Electrolytic Sale in the USA!

AXIAL		RADIAL	
33/6.3	12/1.00	15/10	20/1.00*
100/6.3	10/1.00	1000/10	12/1.00
220/6.3	20/1.00*	10/16	30/1.00*
470/6.3	10/1.00	47/16	30/1.00*
220/10	15/1.00	220/16	25/1.00*
47/15	15/1.00	470/16	20/1.00*
1000/16	10/1.00*	47/25	20/1.00*
2200/16	8/1.00*	1/100	15/1.00
47/35	12/1.00	47/100	5/1.00
220/35	10/1.00	100/100	4/1.00
3300/35	1.00 each	4.7/160	10/1.00
4000/35	1.00 each	10/160	10/1.00
15/50	20/1.00*	22/160	10/1.00
22/50	20/1.00*	4.7/250	10/1.00
47/50	20/1.00*	10/250	8/1.00
100/50	10/1.00	22/250	5/1.00
150/50	8/1.00	1/350	8/1.00
220/50	8/1.00	3.3/350	6/1.00
10/75	12/1.00	10/350	6/1.00
47/100	5/1.00*		
1500/100	2/1.00*		
2.2/150	12/1.00		
3.3/150	12/1.00		
47/200	5/1.00	100/10	10/1.00
1/250	15/1.00	4/50	10/1.00
2.2/250	12/1.00	10/50	10/1.00
1/250	15/1.00	22/50	8/1.00
150/350	2/1.00*	4.7/75	4/1.00
1/500	12/1.00	10/75	4/1.00

**BI-POLAR**

100/10	10/1.00
4/50	10/1.00
10/50	10/1.00
22/50	8/1.00
4.7/75	4/1.00
10/75	4/1.00

**• \$1.00 SPECIALS**

YES, All Prices are Correct! • \$5.00 Minimum Order on All Above Capacitors • Some Quantity Pricing Available

## MORE \$1.00 SPECIALS

1N4152 ... 25/*1.00 Similar to 1N914	1N5239 ... 20/*1.00 9 V. ZENER
1N4001 ... 15/*1.00	1N4007 ... 10/*1.00
TIP 3055 ... 3/*1.00	2N3055 ... 3/*1.00
MJ 3000 ... *1.00 Pwr Darlington TO3	2N6055 ... *1.00 Pwr Darlington TO3
TRIAC 200 V. 30A. Stud mnt. ... *1.00	7 Seg. LED Readout HP 5082-7650 5/*1.00
4 Pos DIP switch 3/*1.00	DIP Relay D.P.S.T. Diode Protect. 2/*1.00
D.P.D.T. Rocker Sw 4 A. 120 VAC 3/*1.00	Horz P.C. Trimpots 250Ω, 500Ω, 5kΩ, 10kΩ ... 4/*1.00
2N2142	MC3420P ... *1.00
2N3905	SN75150 ... *1.00
2SC828 5/*1.00	LM3909 ... *1.00
2SC644	RED LED ... 8/*1.00
SPS7390/ECG123P	Transformer ... *1.00 12 V.C.T. 250 MA
5 V. DIP Relay	TO39 Heat Sinks 3/*1.00
SPST ... 5/*1.00	
7805	
7812 ... 2/*1.00	
MINI D.P.D.T. Slide ... 4/*1.00	

~~39.95~~ **MICROWAVE DOWN CONVERTER KIT (HMR II type)**  
**\$24.95**

PC Bd., 3-MRF901's, 2-MBD 101's  
1 Thermistor, 1 Choke, 3-Chip Caps,  
1 "F" Connector, 8 Resistors + Instructions

**DOWN CONVERTER PWR. SUPPLY**  
8-12 V.D.C. or 12-18 V.D.C.

**\$24.95** **NEW!**

ITEMS MC, VISA, COD VIA UPS  
(Plus Shipping/Handling)

# Fujitech Model M-64 Programmer

- Very Easy to Operate
- Various test, check and protection functions for correct programming
- Programs 10 pieces of the following at one time:
  - 2716
  - 2732
  - 2732A
  - 2764

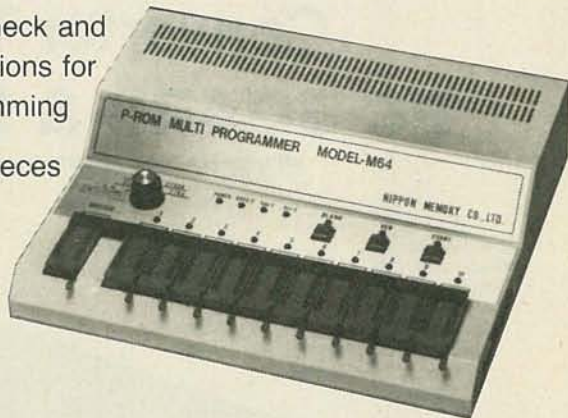

(models for other types of EPROM's also available)

- Lowest price in the industry: \$999.00
- Write for brochure

## MONARCHY ENGINEERING INC.

380 Swift Ave. #21  
So. San Francisco, CA 94080

# BEC BULLET ELECTRONICS

P.O. BOX 401244R GARLAND, TX. 75040 (214) 487-9031

## Sound Effects Kit \$18.50



assembly manual, programming charts, and detailed 76477 chip specifications. It runs on a 9V battery (not included). On board 100mA amp will drive a small speaker directly or the unit can be connected to your stereo with incredible results. Speaker not included! 76477 is included. Available separately for \$3.15 each

## The Super Music Maker REVISION 2 \$24.95 (Basic Kit)



- Comes with 25 pre-programmed tunes
- On board 7 watt amplifier drives 8 ohm speaker directly
- Works on 12VAC or 12 VDC
- Uses either 2708 or 2716 EPROM for expanded tune playing capability. Listing available pre-programmed ROM's.

A true electronic music maker based on a microprocessor chip. The Super Music Maker is the only kit that allows easy addition of pre-programmed tunes by plugging in one memory chip (ROM). Over 20 different ROM's with over 500 tunes are available. Use the kit for a Car Horn, Doorbell, Door Announcer, etc. If you have an EPROM programmer our manual tells you how to program your own tunes. Kit includes quality plated and drilled PC Board and all components.

OPTIONAL ACCESSORIES	
DIP SWITCHES One 8 pos. one 5 pos. for tune address	2.00/set
WALLPLUG TRANSFORMER For operation on 117VAC house current	3.00
INJECTION MOLDED PLASTIC CASE w/custom front & rear panels, hardware and 2 five pos. rotary switches (replaces DIP switches)	8.00
HORN SPEAKER 8 watt, 8 Ohm with mounting bracket	6.25

**SPECIAL OFFER**  
Buy a Super Music Maker kit for \$24.95 and get FREE, a 2708 ROM pre-programmed with 35 popular tunes. This offer gives you over 60 songs to choose from!

## 7 Watt Audio Amp Kit \$6.95

SMALL, SINGLE HYBRID IC AND COMPONENTS FIT ON A 2" x 3" PC BOARD (INCLUDED), RUNS ON 12VDC, GREAT FOR ANY PROJECT THAT NEEDS AN INEXPENSIVE AMP. LESS THAN 3% THD @ 5 WATTS. COMPATIBLE WITH SE-01 SOUND KIT.

## Doomsday Alarm Kit \$9.95

If you have trouble sleeping and you would like the rest of the neighborhood to share your misery then this little kit will be for you! There is no way to accurately describe the unearthly howls, screams and tones that come out of this kit. Four separate tone oscillators are mixed, cancelled and stepped at a varying rate. 10 Watts of crazy sounds. A great fun kit or a practical burglar alarm. Complete with PC board and all necessary components less speaker. For 6-12 VDC. ORDER DA-02

## THE PRESIDENT SAYS: "HOGWASH!!"

After taking one look at the TRIPUD POWER SUPPLY our engineer declared that the units were worth several hundred dollars each. He pointed out the engineering, high quality construction and state-of-the-art integrated design in support of his position. The President of BEC more pragmatically pointed out the already full warehouse and the two trailer truck loads of power supplies waiting in the parking lot, and set the price to move them QUICKLY!

3 OUTPUTS  
12V @ 8A (12A Int.)  
5V @ 10A  
-12V @ 5A  
INPUT 105 - 125VAC

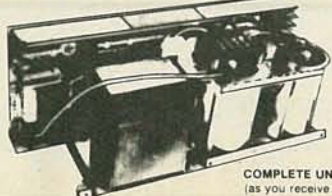

COMPLETE UNIT (as you receive it)

**62.50**

Plus \$5.00 Freight

21 lbs. 8 x 5 1/2 x 12

ONE TIME OFFER! LIMIT TWO (2) SUPPLIES PER CUSTOMER.

- COD MINIMUM \$20.00 • ADD \$2.50 FOR COD'S
- UPS DELIVERY ADDRESS MUST ACCOMPANY ALL COD ORDERS
- \$1.00 HANDLING ON ORDERS UNDER \$10.00
- VISA, MC CARDS OR CHECK
- ADD 6% FOR SHIPPING
- TEXAS RESIDENTS ADD 5% STATE SALES TAX
- ALL FOREIGN ORDERS ADD 25% FOR SHIPPING (CANADA 15%) NO FOREIGN COD'S
- CALL (214) 278-3553 TO PLACE CREDIT CARD OR COD ORDER

- UNIT IS COMPLETELY ASSEMBLED
- Fused primary and DC sections
- HUGE SHIELDED TRANSFORMER
- 2% Load & Line Regulation
- Low Ripple <100mV
- Short Circuit Protection
- Overvoltage Protection on all three outputs
- 25A Bridge Rectifier
- Over 60,000 mfd of filter
- High Efficiency Switching Regulator reduces heatsink area
- Schematics and service guide included
- Thermal Shutdown
- Status LEDs (3)



**MORE GAIN  
Than a  
Mitsumi Tuner  
DSW10-140  
Parts Kit**

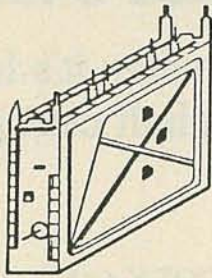

MODEL ELC 1045  
FREQ. RANGE  
UHF 470-889 MHZ  
CHANNEL 14-83  
OUTPUT CHANNEL 3  
75 OHM INPUT

Part No.		
DSW10	Philips UHF Tuner ELC 1045	\$23.95
DSW20	Printed Circuit Board, Predrilled Glass Epoxy	\$15.00
DSW30	P.C.B. Potentiometers 5-10K, 1-5K	\$5.95
DSW40	Resistor Kit 1/4 watt 5% Carbon Resistors 32 pcs.	\$4.95
DSW50	Panel Mount Potentiometers 2-10K and Knobs	\$2.95
DSW60	IC's 7 pcs., 1 Rectifier, 2 Regulators & 1 Heat Sink	\$15.95
DSW70	Electrolytic Cap Kit, 8 pcs.	\$4.95
DSW80	Ceramic Cap Kit, 33 pcs.	\$6.95
DSW90	Variable Trimmer Kit, 4 pcs.	\$3.95
DSW100	Coil Kit, 2-18 uh, 1 variable 33 uh + 1 - + 37-12 Toroid + 26 wire	\$1.95
DSW110	I.C. Sockets 5-8 pins, 2-14 pin	\$4.95
DSW120	Power Transformer PRI-117Vac, SEC 24Vac, 1 amp	\$5.95
DSW130	Speaker, Oval 8 ohm	\$3.00
DSW140	Misc. Parts, Hardware & Hookwire Ant. Term, Switch Dpdt, Fuse, Fuseholder, Line Cord, etc.	\$7.95
<b>When Ordering All Items</b>		
DSW10-D140		<b>Total Price \$99.95</b>

**R.F. Modulator**

Combine both audio and video output onto channel 3 or 4 of your T.V. set. Single I.C. chip (MC 1374) makes for quick and easy assembly. Single adjustment control! A must for every video recording or computer enthusiast.

VH-0 Kit ..... \$19.95

**UHF T.V. Preamp**

- Features:**
- 25 dB gain!
  - Kit

Your reception will dramatically improve! This unit will enable you to pull in signals you never knew were there!

For both indoor and outdoor use. Input and output impedance 75 ohm. No adjustment! Easy assembly.

JH-0 Kit ..... \$22.95

**Tired of getting up to change channels? Get rid of that mechanical cable controller. Relax with . . . PHILIPS CTC8R Remote Cable Converter**

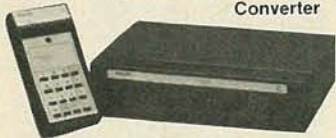

- Micro computer technology
- Quartz controlled IC's lock in picture & prevent drift
- 60 channel selections
- Programmable time on and off
- Favorite channel memory and recall, plus scan
- Wireless hand held "infra-red" transmitter system (25 ft.)
- Automatic fine tune
- Adaptable to any brand television
- One year warranty service

CTC8R ..... \$139.95  
CTC9R (with 24 hr. LED digital clock) ..... \$149.95

**AUDIBLE**

**DIGITAL  
MULTIMETER  
MIC-6000Z**



- 3 1/2 Digits
- DC 0.5% Accuracy
- DCA and ACA up to 10A
- OHM up to 20 M OHM
- Audible Continuity Test
- Diode Check
- Leads and Battery Included

The MIC-6000Z is a professional Multimeter at an inexpensive price.

The 6000Z works up to 1000 hours on a common battery, also can withstand 1000 VDC loads. Resistance ranges are protected up to 400 VDC. For your added convenience the MIC-6000Z has a built-in 10 amp current capacity, so you don't need an accessory shunt.

MIC-6000Z Assembled ..... \$89.95  
Carrying Case ..... \$ 9.95

**ADJUSTABLE  
POWER  
SUPPLY KIT**



- Adjustable Positive & Negative Supplies
- Positive and negative 1.2 VDC to 15 VDC
- Power Output (Each Supply) 5 VDC @ 500 ma, 10 VDC @ 750 ma, 12 VDC @ 750 ma, 15 VDC @ 175 ma
- Two 3 Terminal Adjustable Regulators with Overload Protection
- LED on indicator
- P.C. Board Construction
- 120 VAC Input

RM1 Kit ..... \$24.95



**NEW PWD KIT!!!**

Part No.	Description	Price
PWD10	Philips UHF Tuner ELC 1045	\$23.95
PWD20	Glass Epoxy Circuit Board, Predrilled	\$16.95
PWD30	P.C.B. Pots, 4-20K, 2-1K, 2-10K, 2-100K	\$9.95
PWD40	Resistor Kit 1/4 watt 5%	\$4.95
PWD50	Panel Mount Pots 2-5K	\$3.95
PWD60	IC's 7 pcs., 1 Rectifier, 2-Heat Sinks & Sockets	\$11.95
PWD70	Ceramic Disc Caps — 37 pcs & Misc. Type Capacitors	\$11.95
PWD80	Electrolytic Caps 18 pcs.	\$5.95
PWD90	Variable Trimmer Capacitor 5- 5-35 pF	\$4.95
PWD100	Coil Kit, 2-T37-12 Ferrite cores Toroid 4-Prewound Inductors	\$2.95
PWD110	Misc. Parts—Hookup Wire, Ant. Terminals, Fuse, Fuseholder Dpdt Switch, Line Cord etc.	\$8.95
PWD120	Power Transformer Primary-117 Vac, Secondary 24 Vac, 1 amp	\$5.95
PWD130	Speaker, Oval 8 ohm	\$2.95
PWD140	Cabinet, Prepunched & Drilled	\$13.95
<b>When Ordering All Items</b>		
PWD10-PWD140		<b>Total Price \$124.95</b>



**Digital Multimeter  
MIC-3300A**

- Kit Form • 3 1/2 Digits
- DC .5% Accuracy
- DCA up to 10 Amps • OHM up to 20 M OHM
- hFE measurement • Floating decimal point
- Leads + battery included • Easy instructions

A high quality Digital Meter Kit at an affordable price. Educational and enjoyable to build, the MIC 3300A is a high quality meter for all hobbyists and maintenance work.

MIC-3300A Kit Form ..... \$59.95  
Carrying Case ..... \$ 9.95

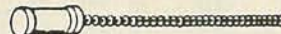

**Microwave Receiver  
1.9-2.5 GHZ**

- PS-1 Assembled 32 element antenna . . . \$19.95
  - PS-2 20 dB gain microwave receiver kit with variable power supply kit . . . \$50.00
  - PS-3 Complete package PS-1 & PS-2 . . . \$65.00
- Mounting Hardware Included**

**Microwave Preamp!!!**

Use with PS-3 Kit. Adds 20-25 db gain to boost reception distance.

- Low Noise
- High Gain
- Can be used with all existing stop sign board receivers!!!!
- 1.9-2.5 GHz Freq. Range

PS-4 ..... \$34.95

**Stavis Electronics, Inc.**

912 W. Touhy, Park Ridge, IL 60068

**Illinois Residents  
(312) 564-0104  
Orders Only  
Toll Free # (800) 323-1327**

Minimum order \$15.00. Add 10% shipping on orders under \$35.00. Orders over \$35.00, add 5%. Illinois residents add 6% Sales Tax. Catalog — \$1.00

VISA and MasterCard Acceptable







# ADVANCED COMPUTER PRODUCTS

SEND \$2.00 for 104 PAGE CATALOG

## 16K Apple™ Ramcard

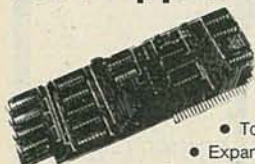

LIST 195  
ACP  
\$69.95

- Full 1 year warranty
- Top quality — gold fingers
- Expand Apple II 48K to 64K
- Compatible with Z-80 Softcard™
- Allows system to run with CP/M™, PASCAL, DOS3.3, COBAL, Visicalc, etc.
- Supplied with extra 16K RAM & has (2) LED's

## 32K STATIC RAM



2 or 4 MHz  
Expandable  
Uses  
2114L's

- 16K 4 MHz KIT \$159.95
- 16K 4 MHz A&T \$217.95
- 32K 4 MHz KIT \$199.95
- 32K 4 MHz A&T \$339.00
- BARE BOARD 39.95
- Bare Bd w/all parts less mem. 99.95

## UV "EPROM" ERASER



Model S-52T \$325.00

## 16K Memory Expansion Kits for Apple/TRS-80

8 pcs 4116 16K 200/250ns  
Specify computer  
CALL FOR VOLUME PRICING

## "D" SUB CONNECTORS

Unreal price. DB37 male, DB25 female. Gold PC mount with mounting holes. Mig. AMP. Specify 25 or 37 pins.

DB37 \$2.50 DB25 \$1.95

## Astec RF Modulator for COLOR & B/W



P/N 1082 Channel 3 or 4 \$6.95

## 1200 BAUD MODEM IC

SL1200 \$129.00

## PARALLEL ALPHA NUMERIC PRINTER



19 Column Printer prints 16 numerical columns plus 3 columns which have math, alpha and other notations. Each wheel has 12 positions with position 12 blank. Position 11 on numerical columns have decimal point or #. Utilizes 2.75" wide adding machine tape and a dual color ink ribbon. Input data parallel with four bit BCD comparator circuit (schematic provided). Print rate, 3 lines per second. Operating voltage 22-28VDC with typical cycle time of 340ms. Size 6 1/2" W x 3 1/2" H x 5 1/2" Dp. New. \$17.50 ea. 3/545

## 64K CMOS RAM

S100 (200ns)  
Uses 2716's \$349.00 or 6116's  
Assembled & Tested \$399.00



200,000 pieces in stock — priced to move. Same as MK4027 except 1mS refresh. MK4015 4Kx1 RAM.

## STEPPER MOTOR

Operates by applying 12VDC in one direction and then reversing polarity (or square wave). Uses 12VDC, Clock Wise Rotation, Rated 3 RPM at 4 P.P.S. with a 5 degree stepping angle.

ACP PRICE \$4.95 ea. 10 for \$39.95

## 4K STATIC RAM

SELL-OFF 10/\$9.90  
Same as TMS4044 but designed specifically for Z-80 based systems. This is a full-spec 4Kx1 RAM, 450ns. Order P/N Zilog 6104-4 while supply lasts.

## Zilog Z8 CPU with TINY BASIC

Debug prog. \$49.95  
Plus 6132 companion quasi-static RAM 29.95

## Stepper Motor

USED IN DATA PRODUCTS PRINTER \$19.95 ea.

## CONNECTORS

DB25P (RS232) \$3.25  
DB25S Female 3.75  
Hood 1.25  
Set with Hood, Sale 7.50  
22/44 S/T, KIM 2.95  
43/86 S/T, MOT 6.50  
50/100 S-100 Connector W/W 4.95  
50/100 S-100 Connector S/T 3.95

## MICROPROCESSORS

Z8001	\$99.00	8008P-1	\$14.95	8008P	14.95
Z8002	99.00	2901	9.90	8035	14.95
Z80	9.95	2901A	14.95	8039	12.95
Z80A	11.95	8070A	49.95	8070A	94.95
F-8 (3850)	16.95	8502	9.95	8765	49.95
2650	16.95	8502A	16.95	8748	49.95
1802	9.75	MM100	23.95	8800	39.95
8008A	4.75	8800B	11.75	8800	49.95
8005	14.05	8800B	19.95	8800M	129.95

## RAMS

6116/2016	\$7.95	2147	\$5.99	5290	\$1.99
8264-64K	8.50	411	5.99	5298	1.40
4116-2	1.99	414	4.69	5508	4.50
4116-2	8/12.95	1101	99	6518	6.79
2101	3.99	1103	99	6561	3.79
2102	7.9	4027	4.69	6904	3.99
2102-2	1.49	4044	3.99	6905	7.99
11202-4	1.29	4050	4.69	9130	8.99
2111	3.49	4060	4.99	9140	8.99
2112	3.49	4096	3.99	93415	6.99
2114	1.99	4115	4.49	93425	6.99
2114L-2	3.25	4200	7.95		
2114L-4	2.29	4402	1.99		
2125	6.99	5280	4.60		

## SUPPORT

8155	\$9.95	8259	\$8.95	69047	\$22.95
8156	9.95	8275	19.95	69488	19.95
8202	29.95	8279	9.50	65505	22.95
8205	2.69	6810	4.75	6520	6.95
8212	2.75	6820	6.50	6522	9.95
8214	4.95	6821	6.50	6530-X	24.95
8216	2.75	6828	10.50	6532	17.95
8218	1.95	6844	10.95	6551	19.95
8226	2.95	6845	22.95	Z80-PIO	6.50
8228	3.95	6847	27.95	Z80A-PIO	9.50
8243	9.50	6850	5.25	Z80A-CTC	6.50
8250	14.95	6852	5.25	Z80A-CTC	9.50
8251	6.50	6890	10.95	Z80-DMA	10.95
8253	11.95	6892	10.95	Z80-DMA	27.95
8255	4.50	6875	5.95	Z80-SIO	24.95
8257	9.50	6880	2.49	Z80A-SIO	29.95

## MOS PROMS

2764 (8Kx8) TS	\$69.95	2708 (450ns)	\$5.75
2732 (4Kx8) TS	12.95	2708 (650ns)	5.25
2716/2516: 5V	17.02A	1702A	5.75
(2Kx8) TS	7.95	MM5203AQ	14.50
TMS2716, 5V, 12V	17.95	MM5204Q	9.95
2758, 5V, (450ns)	3.50		

## HI-TECH

2513-001 (SV) Upper	\$9.50	DAC08	\$9.95
2513-005 (SV) Lower	10.95	DAC100	4.95
2513-ADM3 (SV) Lower	14.95	8038 Function Generator	9.50
MC68710 ASCII Shifted	12.95	MC4024 VCO	2.95
MC68740 Main Symbol	13.95	LM556 VCO	1.95
MC68750 Alpha Control	13.45	XR2208 Function Generator	5.25
1771-01 8" & MiniFloppy	24.95	TR16028 (5V, 12V)	3.95
1781 Dual Floppy	29.95	AY51013 (5V, 12V)	4.95
1791-01 Dual Floppy	35.95	AY51014A/1612 (5-14V)	6.95
1791-02 Dual Floppy	44.95	AY51015A/1863 (5V)	6.95
1791-03 05 Floppy	44.95	IM4025	7.95
1787 20, 05 Floppy	54.95	IM4043	8.95
1691 Data Separator	18.95	2350 USRT	9.95
2143 Clock Generator	18.95	18718 Astros	24.95
8700 8 bit Binary	13.95	MC14411	11.95
8701 10 bit Binary	22.00	475	14.95
8703 8 bit TS	13.50	WD1941	8.95
9400 Volt to Freq Conv	7.25	COM5016	16.95
8750 3 1/2 Dig BCD	13.95	IN8250	15.95
1408L8 6 bit	13.95	AYS-2376	13.75
1408L8 8 bit	15.95	AYS-3660	13.75
JAC01 D to A	5.95	MM5740AC	8.95

## SOCKETS

8 pin LP	.16	.15	.14
14 pin LP	.20	.19	.18
16 pin LP	.22	.21	.20
18 pin LP	.29	.28	.27
20 pin LP	.34	.32	.30
22 pin LP	.29	.27	.24
24 pin LP	.38	.37	.36
28 pin LP	.45	.44	.43
40 pin LP	.60	.59	.58

## LOW PROFILE SOCKETS (TIN)

1-24	25-49	50-100	
8 pin WW	.55	.54	.49
10 pin WW (Tin)	.65	.63	.58
14 pin WW	.75	.73	.67
16 pin WW	.80	.77	.70
18 pin WW	.95	.90	.81
20 pin WW	1.15	1.09	.99
22 pin WW	1.45	1.35	1.23
24 pin WW	1.35	1.26	1.14
28 pin WW	1.60	1.53	1.38
40 pin WW	2.20	2.09	1.89

## 3L WIREWRAP SOCKETS (GOLD)

1-24	25-49	50-100	
ULN2003	2/81.99	2N6121	3/81.00
8080A CPU	2.95	5027 CRT	69.95
2102 RAM	.75	11C24	6.95
2106 RAM	1.49	95H03	2.89
8X300 CPU	14.95	MM5320	5.99
74S387	1.96	9131 RAM	1.99
2708 EPROM	6/29.95	2EM4402	4.99
74LS93	3/1.00	1103 RAM	3/1.50
8700 D/A	8/14.50	8700 D/A	2/16.95

## SUPER IC CLOSETOUT SPECIALS

TOLL FREE 800-854-8230  
Retail: 1310E E. Edinger, Santa Ana CA 92705 (714) 558-8813  
542 W. Trimble, San Jose, CA 95131 (408) 946-7010

## LINEAR

78H05K	\$5.95	LM1414N	\$1.90
78M06	1.49	LM1458CN/N	.49
78M.G	1.49	MC1488N	.99
LM108AH	2.95	MC1498N	.99
LM300	.99	LM1498A	.99
LM301CN	.35	LM1556N	1.50
LM304H	1.98	LM1820N	.95
LM305H	1.89	LM1850N	.95
LM306H	3.25	LM1899N	3.10
LM307CN	.23	LM2111N	1.75
LM306CN	.98	LM2900N	.99
LM309K	1.49	LM2901N	2.50
LM310CN	1.25	LM2917N	2.95
LM311D/CN	.89	CA3013T	2.19
LM312H	1.75	CA3018T	1.99
LM317T	1.70	CA3021T	3.49
LM318CN	1.49	CA3023T	2.99
LM319H/N	1.25	CA3035T	2.75
LM320C-XX*	1.35	CA3039T	1.29
LM320T-XX*	1.39	CA3049N	1.29
LM320H-XX*	1.25	LM3053N	1.40
LM323K	4.95	CA3059N	3.19
LM324N	.95	CA3060N	3.19
LM337K	5.95	CA3062N	4.95
LM338K	.95	LM3065N	1.49
LM339N	6.95	CA3080T	1.29
LM340C-XX*	1.75	CA3081N	1.59
LM340T-XX*	1.25	CA3082N	1.69
LM340H-XX*	1.25	CA3083N	1.55
LM344H	1.95	CA3089N	.80
LM348N	1.20	CA3089N	2.99
LM350K	5.60	CA3089N	3.49
LM359CN	.98	CA3097N	1.59
LM360N	1.49	CA3130T	1.30
LM372N	1.95	CA3140T	1.19
LM376N	3.75	CA3148N	2.49
LM377N	2.75	CA3180T	1.95
LM380CN/N	1.95	CA3190N	1.99
LM381N	1.79	CA3410N	.99
LM383T	1.95	MC3423N	1.49
LM386N	1.25	MC3480N	3.95
LM387N	1.40	SG8524N	3.95
LM390N	1.95	CA3600N	3.39
LM390V/T	3.75	CA3611N	3.75
NE555V	.99	LM3905N	1.19
NE556N	.98	LM3909N	.98
NE561T	19.95	LM3914N	3.75
NE565N/H	1.25	LM3915N	3.95
NE590N/V	1.75	LM3918N	3.75
NE592N	1.59	RC4131N	2.95
NE92N	2.75	RC4136N	1.10
LM702H	1.99	RC4151N	3.70
LM709H/N	.29	RC4194TK	4.95
LM710H/N	.75	RC4195TK	5.40
LM711H/N	1.25	LM2001	1.25
LM715N	1.95	ULN2003	1.50
LM723H/N	.65	SN75450N	.59
LM733H/N	.98	SN75451N	.35
LM739N	1.15	SN75452N	.49
LM741CN/H	.33	SN75453N	.49
LM742CN/H	1.19	SN75454N	.49
LM747H/N	.75	SN75491N	.89
LM748H/N	.39	SN75492N	.89
LM760CN	2.95	SN75493N	.89
LM131			



**FREE** THE WORLD FAMOUS **ETCO** CATALOG OF ELECTRONICS

**GREAT BUILDS** **CABLE TV STORE** **SAVE**

- VIDEO
- TELEPHONE
- CABLE TV
- PARTS
- AUDIO
- ELECTRONICS
- and much much more!

1000's OF FASCINATING FACTORY CLEAROUTS. SURPLUS SPECIALS AND BARGAIN OFFERS NOT FOUND IN STORES OR CATALOGS ANYWHERE!

**ETCO ELECTRONICS**  
DEPT. 582  
Mailing List Control Center  
Box 840  
Champlain, N.Y. 12919

**NOW 96 PAGES**

I Enclose \_\_\_\_\_ (cash OK);  
Please rush postpaid

\$1 for 1 year subscription to the world famous ETCO catalog.

\$3 Canadian & Foreign 1 year subscription to the ETCO catalog.

304 page handbook "BUILD YOUR OWN EARTH STATION". (TA025) \$10.00

360 page MASTER HANDBOOK OF TELEPHONES. (TA001) \$11.00

FREE - sample copy of the bargain packed ETCO catalog.

Name \_\_\_\_\_  
Address \_\_\_\_\_  
City \_\_\_\_\_  
State \_\_\_\_\_ Zip \_\_\_\_\_

**BAYONET Lamp SOCKETS**  
SNAP-IN SOCKET FITS BAYONET BASE LAMPS (SEE B-2576, BELOW). SNAPS INTO A 5/8" HOLE. HAS 6" LONG WIRE LEADS. B-2575

15¢ 10"/\$20 100/\$10.  
WT 4 OZ WT 1 1/2 LB

**BAYONET 13V BULBS**  
WRN GE 1B15 330 MA T-3/4 LIST PRICE IS 10/27.70

25¢ EA. 10"/\$2 2 OZ  
B-2576 100/\$15 3/4 LB

**2-1/4" 8Ω SPEAKER**  
MINIATURE UNIT MFD BY QUAM IN USA. HAS 5/8" VOICE COIL IS IDEAL FOR REPAIR, SQUEAKING OR VOICE PROJECT. 1" DEEP

3 OZ B-1445 99¢

**VHF/UHF CHANNEL A-I MIDDAND Varactor TUNER**  
HI-GAIN, BRAND NEW, FOR UPGRADE OR CONVERTER USE. IF OUTPUT, USES +12V AND +24V SUPPLY. T-1195 WT 1/2 LB

\$11.95

**Brand New I15 VAC 8 Track TAPE DECK WITH PLAYBACK AMP**

3 LB X-6950 \$6.95

COMPLETE 8 TRACK TRANSPORT

QUALITY BUILT BY MOTOROLA WITH AUTO TURN ON, END OF TAPE SENSOR, AUTO TRACK CHANGE, 115 VAC CAPACITOR START MOTOR, STEREO R/P HEAD AND +12 VDC PLAY BACK ELECTRONICS. GREAT FOR HOMEBREW PHONE ANSWERERS, ROBOTS, ETC

OUTSIDE USA SEND \$4 FOR CATALOG

**DIP SOCKETS**

8 PIN 16¢  
5-0800

14 PIN 18¢  
5-1400

16 PIN 20¢  
5-1600

18 PIN 25¢  
5-1800

24 PIN 38¢  
5-2400

28 PIN 45¢  
5-2800

40 PIN 55¢  
5-4000

**BCD Thumbwheel SWITCH**  
WITH COMPLIMENT GOLD CONTACTS STD SIZE CAN BE STACKED TO ANY WIDTH OUTPUT IS 1-2-4-8 WITH COMPLIMENT

B-2124 99¢

**Active FILTER PC BOARDS**  
CONTAINS TWO LM310'S 120 MHz BW, 20V/μs SLEW RATE. CONFIGURED AS A FOURTH ORDER LINEAR PHASE LOW PASS FILTER USING 1% FILM CAPS AND RESISTORS. SORRY, NO CHOICE OF FREQUENCY (WE HAVE TOO MANY) BUT R'S & C'S ARE EASILY SCALABLE TO ANY FREQ. OPERATE FROM 25V TO 80VDC. ALL ARE MARKED WITH CUTOFF FREQ.

DATA SHEET INCLUDES BOARD LAYOUT, SCHEMATIC, FORMULAS FOR BOTH MAXIMALLY FLAT RESPONSE OR LINEAR PHASE OPERATION. 25¢

X-1010 99¢

**3 AG FUSES**  
F-0102 WT 1 OZ

**35A 32V**  
MFD BY LITTLEFUSE

F-0101 WT 1 OZ

**1-1/2A 250V**  
MFD BY BUSS

ANY QUANTITY 10¢ EACH YOUR CHOICE

**99¢ 2 OZ** MFD BY VIKING

\* GOLD \* BIFURCATED CONTACTS

**28/56 EDGE Connector**  
\* GOLD WW 3-LEVEL PINS \*  
C-0356 10/\$9, 1 LB  
6 LB 100/\$80, 60 LB  
1000/\$750.

**B-5020 3 LB \$9.50** WOW!

**6 VOLT 5 AMP-HR RECHARGEABLE SEALED BATTERY**  
LEAD ACID  
SIZE: 5-3/8" X 3-1/8" X 1-7/8"

**12" CRT FILTER**  
NICE LOOKING FILTERS ENHANCE CONTRAST, CUT GLARE DRAMATICALLY, 1/16" SCRATCH RESISTANT PLASTIC

3 OZ \$2.50

GREY YOUR CHOICE - X-1375

**TRANSFORMER 13V 350 mA**  
1-5/8" X 1-1/4" X 1-1/4"

T-1350 6 OZ \$1.50

**PILOT LIGHTS**  
14V OPERATION SNAP-IN DESIGN LOOKS GREAT IN CAR OR BOAT

3 OZ FITS 1/2 X 1" HOLE

B-1193 RED 50¢ EA  
B-1194 BLUE

**PC BOARD SUPPLIES** BEST QUALITY LOWEST PRICES

WE HAVE EVERYTHING YOU NEED!!

**PC BOARD**  
1/16" G-10 Copper Clad  
GREAT STUFF AT A FRACTION OF IT'S NORMAL COST. EASILY CUT WITH HAND SHEARS, WON'T CRACK OR CHIP. GOOD VARIETY OF SIZES, NONE LESS THAN 3" X 3". INCLUDES SOME DOUBLE SIDED

1 LB PC-10 \$4.95  
LOVER 200 SO IN 1

**ETCHANT**  
Ammonium Persulfate

FAST & EASY TO USE. MIX A HALF POUND TO A GALLON. 1 OZ TO 1 PINT OF WATER AND ETCH! THE WHITE CRYSTALS MAKE A CLEAR SOLUTION THAT TURNS BLUE WHEN FULL OF COPPER. 1 LB MAKES 2 GALLONS.

H-2240 \$1.95  
1 LB 10 LB @ \$175 EA

**SOLID CARBIDE PC DRILL BITS**  
Last 1000's of times longer than std bits!

STOCK #	SIZE
D-0400	#60 .0400
D-0420	#58 .0420
D-0465	#56 .0465
D-0520	#55 .0520
D-0595	#53 .0595

\$1.69 each 10/\$15

**ALARM MATS**  
CLOSES SWITCH WHEN STEPPED ON. TAPESWITCH MODEL CVP #23 IS UL APPROVED

SIZE 6" X 23"  
OUTPUT IS 2 PIN MOLEX

X-7950 \$7.95

**DIAMONDBACK ELECTRONICS COMPANY**  
PO BOX 12085  
SARASOTA, FL 33570

Phone Orders 813-953-2829

CONTINENTAL US ADD \$1.60 FOR THE FIRST LB & 50¢ FOR EACH EXTRA LB. WEST COAST ADD \$1.80 FOR THE FIRST LB & 50¢ FOR EACH ADDITIONAL LB. \*7 MINIMUM ORDER \$15 CREDIT CARD

CIRCLE 44 ON FREE INFORMATION CARD

CIRCLE 81 ON FREE INFORMATION CARD

# DISCOUNT TEST EQUIPMENT

LOWEST PRICES AND IMMEDIATE DELIVERY FOR OVER 40 YEARS

**KEITHLEY**

**130** 3 1/2 Digit • 5 Functions • 0.5% DCV Accuracy \$122

**135** 4 1/2 Digit • 0.05% DCV Accuracy • 5 Functions \$229

**B & K**

**1405** 5 MHz 3" Scope • 10mV/Division Vertical Sensitivity • More \$285

**1479BP** Dual Trace 30 MHz Triggered • 11.7ns Rise Time • 5mV/cm Vertical Sensitivity • Probes • More \$697

**FLUKE**

**8024B** 3 1/2 Digit • 11 Functions • 0.1% DC Accuracy • Safety Designed Test Leads \$229

**8062A** 4 1/2 Digit • Full Functions And Ranges • True RMS to 30 kHz • 0.05% DC Accuracy \$269

**SOAR**

**8050** 30 ranges • Over load Protection • 8 Functions • Continuity Beeper • Leads • Bat • Fuse \$89.95

**8080** 3 1/2 Digit Auto Zero • Decimal • Polarity & Low Battery • Full Overload Protection • Bat • Leads • Fuse \$75

**LEADER**

**LBO 522** New Model • 20 MHz Dual Trace • 0.5 mV Sensitivity • More \$740

**LBO 524L** New Model • 35 MHz Dual Trace • 0.5 mV Sensitivity • More \$1206

**HICKOCK**

**LX303** 3 1/2 Digit • 19 Ranges And Functions • Auto Zero • 1% DC Accuracy \$91

**LX304** All Features of LX303 • Auto Decimal • Low Battery Indicator • Diode And Transistor Test \$96

**WM. B. ALLEN SUPPLY**  
1601 Basin Street, New Orleans, LA 70116

Over 70,000 electronic items in stock for immediate delivery.

VISA MasterCard

CALL TOLL FREE  
**800 535-9593**  
LOUISIANA TOLL FREE 800 462-9520

RADIO-ELECTRONICS

CIRCLE 80 ON FREE INFORMATION CARD



ramsey

# the first name in Counters!

## 9 DIGITS 600 MHz \$129<sup>95</sup> WIRED



**PRICES:**

CT-90 wired, 1 year warranty	\$129.95
CT-90 Kit, 90 day parts warranty	
AC-1 AC adapter	109.95
BP-1 Nicad pack + AC Adapter/Charger	3.95
OV-1, Micro-power Oven time base	12.95
External time base input	49.95
	14.95

The CT-90 is the most versatile, feature packed counter available for less than \$300.00! Advanced design features include: three selectable gate times, nine digits, gate indicator and a unique display hold function which holds the displayed count after the input signal is removed. Also, a 10MHz TCXO time base is used which enables easy zero beat calibration checks against WWV. Optionally, an internal nicad battery pack, external time base input and Micro-power high stability crystal oven time base are available. The CT-90, performance you can count on!

**SPECIFICATIONS:**

Range:	20 Hz to 600 MHz
Sensitivity:	Less than 10 MV to 150 MHz Less than 50 MV to 500 MHz
Resolution:	0.1 Hz (10 MHz range) 1.0 Hz (60 MHz range) 10.0 Hz (600 MHz range)
Display:	9 digits 0.4" LED
Time base:	Standard-10.000 mHz, 1.0 ppm 20-40°C, Optional Micro-power oven-0.1 ppm 20-40°C
Power:	8-15 VAC @ 250 ma

## 7 DIGITS 525 MHz \$99<sup>95</sup> WIRED



**SPECIFICATIONS:**

Range:	20 Hz to 525 MHz
Sensitivity:	Less than 50 MV to 150 MHz Less than 150 MV to 500 MHz
Resolution:	1.0 Hz (5 MHz range) 10.0 Hz (50 MHz range) 100.0 Hz (500 MHz range)
Display:	7 digits 0.4" LED
Time base:	1.0 ppm TCXO 20-40°C
Power:	12 VAC @ 250 ma

The CT-70 breaks the price barrier on lab quality frequency counters. Deluxe features such as, three frequency ranges - each with pre-amplification, dual selectable gate times, and gate activity indication make measurements a snap. The wide frequency range enables you to accurately measure signals from audio thru UHF with 1.0 ppm accuracy - that's .0001%! The CT-70 is the answer to all your measurement needs, in the field, lab or ham shack.

**PRICES:**

CT-70 wired, 1 year warranty	\$99.95
CT-70 Kit, 90 day parts warranty	
AC-1 AC adapter	84.95
BP-1 Nicad pack + AC adapter/charger	3.95
	12.95

## 7 DIGITS 500 MHz \$79<sup>95</sup> WIRED



**PRICES:**

MINI-100 wired, 1 year warranty	\$79.95
AC-Z Ac adapter for MINI-100	3.95
BP-Z Nicad pack and AC adapter/charger	12.95

Here's a handy, general purpose counter that provides most counter functions at an unbelievable price. The MINI-100 doesn't have the full frequency range or input impedance qualities found in higher price units, but for basic RF signal measurements, it can't be beat! Accurate measurements can be made from 1 MHz all the way up to 500 MHz with excellent sensitivity throughout the range, and the two gate times let you select the resolution desired. Add the nicad pack option and the MINI-100 makes an ideal addition to your tool box for "in-the-field" frequency checks and repairs.

**SPECIFICATIONS:**

Range:	1 MHz to 500 MHz
Sensitivity:	Less than 25 MV
Resolution:	100 Hz (slow gate) 1.0 KHz (fast gate)
Display:	7 digits, 0.4" LED
Time base:	2.0 ppm 20-40°C
Power:	5 VDC @ 200 ma

## 8 DIGITS 600 MHz \$159<sup>95</sup> WIRED



**SPECIFICATIONS:**

Range:	20 Hz to 600 MHz
Sensitivity:	Less than 25 mv to 150 MHz Less than 150 mv to 600 MHz
Resolution:	1.0 Hz (60 MHz range) 10.0 Hz (600 MHz range)
Display:	8 digits 0.4" LED
Time base:	2.0 ppm 20-40°C
Power:	110 VAC or 12 VDC

The CT-50 is a versatile lab bench counter that will measure up to 600 MHz with 8 digit precision. And, one of its best features is the Receive Frequency Adapter, which turns the CT-50 into a digital readout for any receiver. The adapter is easily programmed for any receiver and a simple connection to the receiver's VFO is all that is required for use. Adding the receiver adapter in no way limits the operation of the CT-50, the adapter can be conveniently switched on or off. The CT-50, a counter that can work double-duty!

**PRICES:**

CT-50 wired, 1 year warranty	\$159.95
CT-50 Kit, 90 day parts warranty	
RA-1, receiver adapter kit	119.95
RA-1 wired and pre-programmed (send copy of receiver schematic)	14.95
	29.95

NEW  
READ  
RECEIVER  
FREQUENCY

## DIGITAL MULTIMETER \$99<sup>95</sup> WIRED



**PRICES:**

DM-700 wired, 1 year warranty	\$99.95
DM-700 Kit, 90 day parts warranty	79.95
AC-1, AC adapter	3.95
BP-3, Nicad pack + AC adapter/charger	19.95
MP-1, Probe kit	2.95

The DM-700 offers professional quality performance at a hobbyist price. Features include: 26 different ranges and 5 functions, all arranged in a convenient, easy to use format. Measurements are displayed on a large 3 1/2 digit, 1/2 inch LED readout with automatic decimal placement, automatic polarity, overrange indication and overload protection up to 1250 volts on all ranges, making it virtually goof-proof. The DM-700 looks great, a handsome, jet black, rugged ABS case with convenient retractable tilt bail makes it an ideal addition to any shop.

**SPECIFICATIONS:**

DC/AC volts:	100uV to 1 KV, 5 ranges
DC/AC current:	0.1uA to 2.0 Amps, 5 ranges
Resistance:	0.1 ohms to 20 Megohms, 6 ranges
Input impedance:	10 Megohms, DC/AC volts
Accuracy:	0.1% basic DC volts
Power:	4°C cells

### AUDIO SCALER

For high resolution audio measurements, multiplies UP in frequency.

- Great for PL tones
- Multiplies by 10 or 100
- 0.01 Hz resolution!

\$29.95 Kit \$39.95 Wired

### ACCESSORIES

Telescopic whip antenna - BNC plug	\$ 7.95
High impedance probe, light loading	15.95
Low pass probe, for audio measurements	15.95
Direct probe, general purpose usage	12.95
Tilt bail, for CT 70, 90, MINI-100	3.95
Color burst calibration unit, calibrates counter against color TV signal	14.95

### COUNTER PREAMP

For measuring extremely weak signals from 10 to 1,000 MHz. Small size, powered by plug transformer-included.

- Flat 25 db gain
- BNC Connectors
- Great for sniffing RF with pick-up loop

\$34.95 Kit \$44.95 Wired

ramsey electronics, inc.

2575 BAIRD RD. • PENFIELD, NY 14526



PHONE ORDERS  
CALL 716-586-3950

**TERMS**

Satisfaction guaranteed - examine for 10 days, if not pleased return in original form for refund. Add 5% for shipping - insurance to a maximum of \$10. Overseas add 15%. COD add \$2. Orders under \$10, add \$1.50. NY residents, add 7% tax.



**4164** 64K DYNAMIC \$625  
200 NS

**TMM2016** 2KX8 STATIC \$415  
200 NS

ALL MERCHANDISE 100% GUARANTEED!

CALL US FOR VOLUME QUOTES

**STATIC RAMS**

2101	256 x 4 (450ns)	1.95
5101	256 x 4 (450ns) (cmos)	3.95
2102-1	1024 x 1 (450ns)	.89
2102L-4	1024 x 1 (450ns) (LP)	1.29
2102L-2	1024 x 1 (250ns) (LP)	1.69
2111	256 x 4 (450ns)	2.99
2112	256 x 4 (450ns)	2.99
2114	1024 x 4 (450ns)	8/14.95
2114L-4	1024 x 4 (450ns) (LP)	8/15.25
2114L-3	1024 x 4 (300ns) (LP)	8/15.45
2114L-2	1024 x 4 (200ns) (LP)	8/15.95
2147	4096 x 1 (55ns)	4.95
TMS4044-4	4096 x 1 (450ns)	3.49
TMS4044-3	4096 x 1 (300ns)	3.99
TMS4044-2	4096 x 1 (200ns)	4.49
MK4118	1024 x 8 (250ns)	9.95
TMM2016-200	2048 x 8 (200ns)	4.15
TMM2016-150	2048 x 8 (150ns)	4.95
TMM2016-100	2048 x 8 (100ns)	6.15
HM6116-4	2048 x 8 (200ns) (cmos)	4.95
HM6116-3	2048 x 8 (150ns) (cmos)	5.95
HM6116-2	2048 x 8 (120ns) (cmos)	8.95
HM6116LP-4	2048 x 8 (200ns) (cmos)(LP)	6.95
HM6116LP-3	2048 x 8 (150ns) (cmos)(LP)	8.95
HM6116LP-2	2048 x 8 (120ns) (cmos)(LP)	10.95
Z-6132	4096 x 8 (300ns) (Qstat)	34.95

LP = Low Power Qstat = Quasi-Static

**DYNAMIC RAMS**

TMS4027	4096 x 1 (250ns)	1.99
UPD411	4096 x 1 (300ns)	3.00
MM5280	4096 x 1 (300ns)	3.00
MK4108	8192 x 1 (200ns)	1.95
MM5298	8192 x 1 (250ns)	1.85
4116-300	16384 x 1 (300ns)	8/11.75
4116-250	16384 x 1 (250ns)	8/11.95
4116-200	16384 x 1 (200ns)	8/13.95
4116-150	16384 x 1 (150ns)	8/15.95
4116-120	16384 x 1 (120ns)	8/29.95
2118	16384 x 1 (150ns) (5v)	4.95
4164-200	65536 x 1 (200ns) (5v)	6.25
4164-150	65536 x 1 (150ns) (5v)	7.25

5V = single 5 volt supply

**EPROMS**

1702	256 x 8 (1us)	4.50
2708	1024 x 8 (450ns)	3.95
2758	1024 x 8 (450ns)(5v)	5.95
2716	2048 x 8 (450ns)(5v)	3.95
2716-1	2048 x 8 (350ns)(5v)	6.25
TMS2516	2048 x 8 (450ns)(5v)	5.50
TMS2716	2048 x 8 (450ns)	7.95
TMS2532	4096 x 8 (450ns)(5v)	7.95
2732	4096 x 8 (450ns)(5v)	4.95
2732-250	4096 x 8 (250ns)(5v)	12.95
2732-200	4096 x 8 (200ns)(5v)	16.95
2764	8192 x 8 (450ns)(5v)	16.95
2764-250	8192 x 8 (250ns)(5v)	18.95
2764-200	8192 x 8 (200ns)(5v)	24.95
TMS2564	8192 x 8 (450ns)(5v)	24.95
MC68764	8192 x 8 (450ns)(5v)(24 pin)	39.95

5v = Single 5 Volt Supply

**EPROM ERASERS**

	Timer	Capacity Chip	Intensity (uW/Cm <sup>2</sup> )	
PE-14		6	5,200	83.00
PE-14T	X	6	5,200	119.00
PE-24T	X	9	6,700	175.00
PL-265T	X	20	6,700	255.00
PR-125T	X	16	15,000	349.00
PR-320	X	32	15,000	595.00

**DISC CONTROLLERS**

1771	16.95
1791	29.95
1793	38.95
1795	54.95
1797	54.95
6843	34.95
8272	39.95
UPD765	39.95
1691	18.95
2143	18.95

**INTERFACE**

8T26	1.69
8T28	2.49
8T95	.99
8T96	.99
8T97	.99
8T98	.99
DM8131	2.95
DP8304	2.29
DS8835	1.99
DS8836	.99

**MISC.**

3242	7.95
3341	4.95
MC3470	4.95
MC3480	9.00
11C90	13.95
95H90	7.95
2513-001 UP	9.95
2513-002 LOW	9.95

**SOUND CHIPS**

76477	3.95
76489	8.95
AY3-8910	12.95
MC3340	1.49

**CRT CONTROLLERS**

6845	14.95
68B45	35.95
HD46505SP	15.95
6847	12.25
MC1372	6.95
68047	24.95
8275	29.95
7220	99.95
CRT5027	39.95
CRT5037	49.95
TMS9918A	39.95
DP8350	49.95

**BIT-RATE GENERATORS**

MC14411	11.95
BR1941	11.95
4702	12.95
COM5016	16.95
COM8116	10.95
MM5307	10.95

**UARTS**

AY3-1014	6.95
AY5-1013	3.95
AY3-1015	6.95
PT1472	9.95
TR1602	3.95
2350	9.95
2651	8.95
TMS6011	5.95
IM6402	7.95
IM6403	8.95
INS8250	14.95

**KEYBOARD CHIPS**

AY5-2376	11.95
AY5-3600	11.95

**CLOCK CIRCUITS**

MM5314	4.95
MM5369	3.95
MM5375	4.95
MM58167	8.95
MM58174	11.95
MSM5832	6.95

**Z-80 2.5 Mhz**

Z80-CPU	3.95
Z80-CTC	5.95
Z80-DART	15.25
Z80-DMA	17.50
Z80-PIO	5.75
Z80-SIO/0	18.50
Z80-SIO/1	18.50
Z80-SIO/2	18.50
Z80-SIO/9	16.95

**4.0 Mhz**

Z80A-CPU	6.00
Z80A-CTC	8.65
Z80A-DART	18.75
Z80A-DMA	27.50
Z80A-PIO	6.00
Z80A-SIO/0	22.50
Z80A-SIO/1	22.50
Z80A-SIO/2	22.50
Z80A-SIO/9	19.95

**6.0 Mhz**

Z80B-CPU	17.95
Z80B-CTC	15.50
Z80B-PIO	15.50

**ZILOG**

Z6132	34.95
Z8671	39.95

**CRYSTALS**

32.768 khz	1.95
1.0 mhz	4.95
1.8432	4.95
2.0	3.95
2.097152	3.95
2.4576	3.95
3.2768	3.95
3.579535	3.95
4.0	3.95
5.0	3.95
5.0688	3.95
5.185	3.95
5.7143	3.95
6.0	3.95
6.144	3.95
6.5536	3.95
8.0	3.95
10.738635	3.95
14.31818	3.95
15.0	3.95
16.0	3.95
17.430	3.95
18.0	3.95
18.432	3.95
20.0	3.95
22.1184	3.95
32.0	3.95

**DATA ACQUISITION**

ADC0800	15.55
ADC0804	3.49
ADC0809	4.49
ADC0817	9.95
DAC0800	4.95
DAC0806	1.95
DAC0808	2.95
DAC1020	8.25
DAC1022	5.95
MC1408L6	1.95
MC1408L8	2.95

**8000**

8035	5.95
8039	6.95
INS-8060	17.95
INS-8073	24.95
8080	3.95
8085	5.95
8085A-2	11.95
8086	29.95
8087	CALL
8088	39.95
8089	89.95
8155	7.95
8156	8.95
8185	29.95
8185-2	39.95
8741	39.95
8748	29.95
8755	32.00

**8200**

8202	29.95
8203	39.95
8205	3.50
8212	1.80
8214	3.85
8216	1.75
8224	2.25
8226	1.80
8228	3.49
8237	19.95
8238	4.49
8243	4.45
8250	10.95
8251	4.49
8253	6.95
8253-5	7.95
8255	4.49
8255-5	5.25
8257	7.95
8257-5	8.95
8259	6.90
8259-5	7.50
8271	39.95
8272	39.95
8275	29.95
8279	8.95
8279-5	10.00
8282	6.50
8283	6.50
8284	5.50
8286	6.50
8287	6.50
8288	25.00
8289	49.95

**FUNCTION GENERATORS**

MC4024	3.95
LM566	1.49
XR2206	3.75
8038	3.95

**INTERSIL**

ICL7103	9.50
ICL7106	9.95
ICL7107	12.95
ICL7660	2.95
ICL8038	3.95
ICM7207A	5.59
ICM7208	15.95

**6800**

68000	59.95
6800	4.95
6802	7.95
6808	13.90
6809E	19.95
6809	12.95
6810	2.95
6820	4.95
6821	3.25
6828	14.95
6840	12.95
6843	34.95
6844	25.95
6845	14.95
6847	12.25
6850	3.45
6852	5.75
6860	9.95
6862	11.95
6875	6.95
6880	2.25
6883	24.95
68047	24.95
68488	19.95

**6800 = 1MHZ**

68B00	10.95
68B02	22.25
68B09E	29.95
68B09	29.95
68B10	7.95
68B21	12.95
68B45	35.95
68B50	12.95

**68B00 = 2 MHz**

**6500 1 MHz**

6502	5.95
6504	6.95
6505	8.95
6507	9.95
6520	4.35
6522	8.75
6532	11.25
6545	22.50
6551	11.85

**2 MHz**

6502A	9.95
6522A	11.70
6532A	12.40
6545A	28.50
6551A	12.95

**3 MHz**

6502B	14.95
-------	-------

**EXAR**

XR 2206	3.75
XR 2207	3.85
XR 2208	3.90
XR 2211	5.25
XR 2240	3.25

**9000 SERIES**

9316	1.00
9334	2.50
9368	3.95
9401	9.95
9601	.75
9602	1.50
96S02	1.95



**JDR MICRODEVICES, INC.**

1224 S. Bascom Avenue  
San Jose, CA 95128  
800-538-5000 • 800-662-6279 (CA)  
(408) 995-5430 • Telex 171-110

© 1982 JDR MICRODEVICES, INC.

— NEW HOURS —  
M-W-F, 9-5  
T-Th., 9-9 Sat. 11-3

PLEASE USE YOUR CUSTOMER NUMBER WHEN ORDERING

TERMS: For shipping include \$2 for UPS Ground or \$3 for UPS Blue Label Air. Items over 5 pounds require additional shipping charges. Foreign orders



**2716** 16K EPROMS **\$3.95** EACH

ALL MERCHANDISE 100% GUARANTEED!

**2732** 32K EPROMS **\$4.95** EACH

CALL US FOR VOLUME QUOTES

**74LS00**

74LS00	.24	74LS86	.39	74LS169	1.75	74LS323	3.50
74LS01	.25	74LS90	.55	74LS170	1.49	74LS324	1.75
74LS02	.25	74LS91	.89	74LS173	.69	74LS352	1.29
74LS03	.25	74LS92	.55	74LS174	.55	74LS353	1.29
74LS04	.24	74LS93	.55	74LS175	.55	74LS363	1.35
74LS05	.25	74LS95	.75	74LS181	2.15	74LS364	1.95
74LS08	.28	74LS96	.89	74LS189	8.95	74LS365	.49
74LS09	.29	74LS107	.39	74LS190	.89	74LS366	.49
74LS10	.25	74LS109	.39	74LS191	.89	74LS367	.45
74LS11	.35	74LS112	.39	74LS192	.79	74LS368	.45
74LS12	.35	74LS113	.39	74LS193	.79	74LS373	.99
74LS13	.45	74LS114	.39	74LS194	.69	74LS374	.99
74LS14	.59	74LS122	.45	74LS195	.69	74LS377	1.39
74LS15	.35	74LS123	.79	74LS196	.79	74LS378	1.18
74LS20	.25	74LS124	2.90	74LS197	.79	74LS379	1.35
74LS21	.29	74LS125	.49	74LS220	.95	74LS385	1.90
74LS22	.25	74LS126	.49	74LS240	.95	74LS386	.45
74LS26	.29	74LS132	.59	74LS241	.99	74LS390	1.19
74LS27	.29	74LS133	.59	74LS242	.99	74LS393	1.19
74LS28	.35	74LS136	.39	74LS243	.99	74LS395	1.19
74LS30	.25	74LS137	.99	74LS244	.99	74LS399	1.49
74LS32	.29	74LS138	.55	74LS245	1.49	74LS424	2.95
74LS33	.55	74LS139	.55	74LS247	.75	74LS447	.37
74LS37	.35	74LS145	1.20	74LS248	.99	74LS490	1.95
74LS38	.35	74LS147	2.49	74LS249	.99	74LS624	3.99
74LS40	.25	74LS148	1.35	74LS251	.59	74LS668	1.69
74LS42	.49	74LS151	.55	74LS253	.59	74LS669	1.89
74LS47	.75	74LS153	.55	74LS257	.59	74LS670	1.49
74LS48	.75	74LS154	1.90	74LS258	.59	74LS674	9.65
74LS49	.75	74LS155	.69	74LS259	2.75	74LS682	3.20
74LS51	.25	74LS156	.69	74LS260	.59	74LS683	3.20
74LS54	.29	74LS157	.65	74LS266	.55	74LS684	3.20
74LS55	.29	74LS158	.59	74LS273	1.49	74LS685	3.20
74LS63	1.25	74LS160	.69	74LS275	3.35	74LS688	2.40
74LS73	.39	74LS161	.65	74LS279	.49	74LS689	3.20
74LS74	.35	74LS162	.69	74LS280	1.98	74LS783	24.95
74LS75	.39	74LS163	.65	74LS283	.69	81LS95	1.49
74LS76	.39	74LS164	.69	74LS290	.89	81LS96	1.49
74LS78	.49	74LS165	.95	74LS293	.89	81LS97	1.49
74LS83	.60	74LS166	1.95	74LS295	.99	81LS98	1.49
74LS85	.69	74LS168	1.75	74LS298	.89	25LS2521	2.80
				74LS299	1.75	25LS2569	4.25

**IC SOCKETS**

8 pin ST	.13	.11
14 pin ST	.15	.12
16 pin ST	.17	.13
18 pin ST	.20	.18
20 pin ST	.29	.27
22 pin ST	.30	.27
24 pin ST	.30	.27
28 pin ST	.40	.32
40 pin ST	.49	.39
64 pin ST	4.25	call
ST = SOLDERTAIL		
8 pin WW	.59	.49
14 pin WW	.69	.52
16 pin WW	.69	.58
18 pin WW	.99	.90
20 pin WW	1.09	.98
22 pin WW	1.39	1.28
24 pin WW	1.49	1.35
28 pin WW	1.69	1.49
40 pin WW	1.99	1.80
WW = WIREWRAP		
16 pin ZIF	6.75	call
24 pin ZIF	9.95	call
28 pin ZIF	10.95	call
ZIF = TEXT TOOL (Zero Insertion Force)		

**CONNECTORS**

RS232 MALE	2.95
RS232 FEMALE	3.50
RS232 FEMALE	
RIGHT ANGLE	5.25
RS232 HOOD	1.25
S-100 ST	3.95
S-100 WW	4.95

**DIP SWITCHES**

4 POSITION	.85
5 POSITION	.90
6 POSITION	.90
7 POSITION	.95
8 POSITION	.95

**7400**

7400	.19	74132	.45
7401	.19	74136	.50
7402	.19	74141	.65
7403	.19	74142	2.95
7404	.19	74143	2.95
7405	.25	74145	.60
7406	.29	74147	1.75
7407	.29	74148	1.20
7408	.24	74150	1.35
7409	.19	74151	.55
7410	.19	74152	.65
7411	.25	74153	.55
7412	.30	74154	1.25
7413	.35	74155	.75
7414	.49	74156	.65
7416	.25	74157	.55
7417	.25	74159	1.65
7420	.19	74160	.85
7421	.35	74161	.69
7422	.35	74162	.85
7423	.29	74163	.69
7425	.29	74164	.85
7426	.29	74165	.85
7427	.29	74166	1.00
7428	.45	74167	2.95
7430	.19	74170	1.65
7432	.29	74172	5.95
7433	.45	74173	.75
7437	.29	74174	.89
7438	.29	74175	.89
7440	.19	74176	.89
7442	.49	74177	.75
7443	.65	74178	1.15
7444	.69	74179	1.75
7445	.69	74180	.75
7446	.69	74181	2.25
7447	.69	74182	.75
7448	.69	74184	2.00
7450	.19	74185	2.00
7451	.23	74186	18.50
7453	.23	74190	1.15
7454	.23	74191	1.15
7460	.23	74192	.79
7470	.35	74193	.79
7472	.29	74194	.85
7473	.34	74195	.85
7474	.33	74196	.79
7475	.45	74197	.75
7476	.35	74198	1.35
7480	.59	74199	1.35
7481	1.10	74221	1.35
7482	.95	74246	1.35
7483	.50	74247	1.25
7485	.59	74248	1.85
7486	.35	74249	1.95
7489	2.15	74251	.75
7490	.35	74259	2.25
7491	.40	74265	1.35
7492	.50	74273	1.95
7493	.35	74276	1.25
7494	.65	74279	.75
7495	.55	74283	2.00
7496	.70	74284	3.75
7497	2.75	74285	3.75
74100	1.75	74290	.95
74107	.30	74293	.75
74109	.45	74298	.85
74110	.45	74351	2.25
74111	.55	74365	.65
74116	1.55	74366	.65
74120	1.20	74367	.65
74121	.29	74368	.65
74122	.45	74376	2.20
74123	.49	74390	1.75
74125	.45	74393	1.35
74126	.45	74425	3.15
74128	.55	74426	.85
		74490	2.55

**CMOS**

4000	.29	4527	1.95
4001	.25	4528	1.19
4002	.25	4531	.95
4006	.89	4532	1.95
4007	.29	4538	1.95
4008	.95	4539	1.95
4009	.39	4541	2.64
4010	.45	4543	1.19
4011	.25	4553	5.79
4012	.25	4555	.95
4013	.38	4556	.95
4014	.79	4581	1.95
4015	.39	4582	1.95
4016	.39	4584	.75
4017	.69	4585	.75
4018	.79	4702	12.95
4019	.39	74C00	.35
4020	.75	74C02	.35
4021	.79	74C04	.35
4022	.79	74C08	.35
4023	.29	74C10	.35
4024	.65	74C14	.59
4025	.29	74C20	.35
4026	1.65	74C30	.35
4027	.45	74C32	.39
4028	.69	74C42	1.29
4029	.79	74C48	1.99
4030	.39	74C73	.65
4034	1.95	74C74	.65
4035	.85	74C76	.80
4040	.75	74C83	1.95
4041	.75	74C85	1.95
4042	.69	74C86	.39
4043	.85	74C89	4.50
4044	.79	74C90	1.19
4046	.85	74C93	1.75
4047	.95	74C95	.99
4049	.35	74C107	.89
4050	.35	74C150	5.75
4051	.79	74C151	2.25
4053	.79	74C154	3.25
4060	.89	74C157	1.75
4066	.39	74C160	1.19
4068	.39	74C161	1.19
4069	.29	74C162	1.19
4070	.35	74C163	1.19
4071	.29	74C164	1.39
4072	.29	74C165	2.00
4073	.29	74C173	.79
4075	.29	74C174	1.19
4076	.79	74C175	1.19
4078	.29	74C192	1.49
4081	.29	74C193	1.49
4082	.29	74C195	1.39
4085	.95	74C200	5.75
4086	.95	74C221	1.75
4093	.49	74C373	2.45
4098	2.49	74C374	2.45
4099	1.95	74C901	.39
14409	12.95	74C902	.85
14410	12.95	74C903	.85
14411	11.95	74C905	10.95
14412	12.95	74C906	.95
14419	7.95	74C907	1.00
14433	4.18	74C908	2.00
4502	.95	74C909	2.75
4503	.65	74C911	8.95
4508	1.95	74C912	8.95
4510	.85	74C914	1.95
4511	.85	74C915	1.19
4512	.85	74C918	2.75
4514	1.25	74C920	17.95
4515	1.79	74C921	15.95
4516	1.55	74C922	4.49
4518	.89	74C923	4.95
4519	.39	74C925	5.95
4520	.79	74C926	7.95
4522	1.25	74C928	7.95
4526	1.25	74C929	19.95

**Prices Slashed!**  
**74S00**

74S00	.32	74S163	1.95
74S02	.35	74S168	3.95
74S03	.35	74S169	3.95
74S04	.35	74S174	.95
74S05	.35	74S175	.95
74S08	.35	74S181	3.95
74S09	.40	74S182	2.95
74S10	.35	74S188	1.95
74S11	.35	74S189	6.95
74S15	.35	74S194	1.49
74S20	.35	74S195	1.49
74S22	.35	74S196	1.49
74S30	.35	74S197	1.49
74S32	.40	74S201	6.95
74S37	.88	74S225	7.95
74S38	.85	74S240	2.20
74S40	.35	74S241	2.20
74S51	.35	74S244	2.20
74S64	.40	74S251	.95
74S65	.40	74S253	.95
74S74	.50	74S257	.95
74S85	1.99	74S258	.95
74S86	.50	74S260	.79
74S112	.50	74S274	19.95
74S113	.50	74S275	19.95
74S114	.55	74S280	1



## LINEAR

LM301	.34	LM348	.99	NE564	2.95	LM1496	.85
LM301H	.79	LM350K	4.95	LM565	.99	LM1558H	3.10
LM307	.45	LM350T	4.60	LM566	1.49	LM1800	2.37
LM308	.69	LM358	.69	LM567	.89	LM1812	8.25
LM308H	1.15	LM359	1.79	NE570	3.95	LM1830	3.50
LM309H	1.95	LM376	3.75	NE571	2.95	LM1871	5.49
LM309K	1.25	LM377	1.95	NE592	2.75	LM1872	5.49
LM310	1.75	LM378	2.50	LM703	.89	LM1877	3.25
LM311	.64	LM379	4.50	LM709	.59	LM1889	1.95
LM311H	.89	LM380	.89	LM710	.75	LM1896	1.75
LM312H	1.75	LM380N-8	1.10	LM711	.79	LM2877	2.05
LM317K	3.95	LM381	1.60	LM723	.49	LM2878	2.25
LM317T	1.19	LM382	1.60	LM723H	.55	LM2900	.85
LM318	1.49	LM383	1.95	LM733	.98	LM2901	1.00
LM318H	1.59	LM384	1.95	LM741	.35	LM3900	.59
LM319H	1.90	LM386	.89	LM741N-14	.35	LM3905	1.25
LM319	1.25	LM387	1.40	LM741H	.40	LM3909	.98
LM320 (see 7900)	LM389	1.35	LM747	.69	LM3911	2.25	
LM322	1.65	LM390	1.95	LM748	.59	LM3914	3.95
LM323K	4.95	LM392	.69	LM1014	1.19	LM3915	3.95
LM324	.59	LM394H	4.60	LM1303	1.95	LM3916	3.95
LM329	.65	LM399H	5.00	LM1310	1.49	MC4024	3.95
LM331	3.95	NE531	2.95	MC1330	1.69	MC4044	4.50
LM334	1.19	NE536	6.00	MC1349	1.89	RC4136	1.25
LM335	1.40	NE555	.34	MC1350	1.19	RC4151	3.95
LM336	1.75	NE556	.65	MC1358	1.69	LM4250	1.75
LM337K	3.95	NE558	1.50	MC1372	6.95	LM4500	3.25
LM337T	1.95	NE555	.34	LM1414	1.59	LM13080	1.29
LM338K	6.95	NE556	.65	LM1458	.59	LM13600	1.49
LM339	.99	NE558	1.50	LM1488	.69	LM13700	1.49
LM340 (see 7800)	NE561	24.95	LM1489	.69			

H = TO-5 CAN

T = TO-220

K = TO-3

## RCA

CA 3023	2.75	CA 3082	1.65
CA 3039	1.29	CA 3083	1.55
CA 3046	1.25	CA 3086	.80
CA 3059	2.90	CA 3089	2.99
CA 3060	2.90	CA 3096	3.49
CA 3065	1.75	CA 3130	1.30
CA 3080	1.10	CA 3140	1.15
CA 3081	1.65	CA 3146	1.85
		CA 3160	1.19

## TI

TL494	4.20	75365	1.95
TL496	1.65	75450	.59
TL497	3.25	75451	.39
75107	1.49	75452	.39
75110	1.95	75453	.39
75150	1.95	75454	.39
75154	1.95	75491	.79
75188	1.25	75492	.79
75189	1.25	75493	.89
		75494	.89

## BI FET

TL071	.79	TL084	2.19
TL072	1.19	LF347	2.19
TL074	2.19	LF351	.60
TL081	.79	LF353	1.00
TL082	1.19	LF355	1.10
TL083	1.19	LF356	1.10
		LF357	1.40

## VOLTAGE REGULATORS

7805T	.89	7905T	.99
7808T	.89	7908T	.99
7812T	.89	7912T	.99
7815T	.89	7915T	.99
7824T	.89	7924T	.99
7805K	1.39	7905K	1.49
7812K	1.39	7912K	1.49
7815K	1.39	7915K	1.49
7824K	1.39	7924K	1.49
78L05	.69	79L05	.79
78L12	.69	79L12	.79
78L15	.69	79L15	.79
78H05K	9.95	LM323K	4.95
78H12K	9.95	UA78S40	1.95

T = TO-220 K = TO-3

L = TO-92

## DISK DRIVES

### TANDON

TM100-1	5 1/4" (FOR IBM) SS/DD	229.00
TM100-2	5 1/4" (FOR IBM) DS/DD	295.00

### SHUGART

SA 400L	5 1/4" (40 TRACK) SS/DD	199.95
---------	-------------------------	--------

### SIEMENS

FD100-8	8" SS/DD (801 REPLACEMENT)	259.00
---------	----------------------------	--------

### PERTEC

FD-200	5 1/4" SS/DD	179.95
FN-250	5 1/4" DS/DD	199.95

## RIBBON CABLE

CONTACTS	SINGLE COLOR		COLOR CODED	
	1'	10'	1'	10'
10	.50	4.40	.83	7.30
20	.65	5.70	1.25	11.00
26	.75	6.60	1.32	11.60
34	.98	8.60	1.65	14.50
40	1.32	11.60	1.92	16.80
50	1.38	12.10	2.50	22.00

**WE HAVE THE COMPLETE LINE OF IDC AND D-SUBMINIATURE CONNECTORS**

## WIREWRAP CARDS

FR-4 Epoxy Glass Laminate  
With Gold Plated Contact Fingers

### S-100 BUSS

P100-1	Bare — No Foil Pads	15.95
P100-2	Horizontal BUSS	22.95
P100-3	Vertical BUSS	22.95
P100-4	Single Foil Pads Per Hole	23.95

### APPLE

P500-1	Bare — No Foil Pads	15.95
P500-3	Horizontal BUSS	22.95
P500-4	Single Foil Pads Per Hole	23.95

### IBM

IBM-PR	BUSS Lines + Pads	55.00
--------	-------------------	-------

### GENERAL PURPOSE

22/44 PIN (.156" SPACING)

P441-3	Vertical BUSS, 4.5" x 6"	13.95
P442-3	Vertical BUSS, 4.5" x 9"	14.95

36/72 PIN (.1" SPACING)

P721-3	Vertical BUSS, 4.5" x 6"	13.95
P722-3	Vertical BUSS, 4.5" x 9"	14.95

## BEST SELLING BOOKS

### OSBORNE/MC GRAW-HILL

Apple II User's Guide	16.95
CRT Controller's Handbook	9.95
68000 Assembly Language Programming	16.99
CBASIC User Guide	15.00

### SYBEX

Your First Computer	8.95
The CP/M Handbook	14.95
The PASCAL Handbook	18.95
Microprocessor Interfacing Techniques	17.95

## MICROCOMPUTER HARDWARE HANDBOOK

FROM ELCOMP — \$14.95

Over 800 pages of manufacturers data sheets on most commonly used IC's.

Includes:

- \* TTL — 74/74LS and 74F
- \* CMOS
- \* Voltage Regulators
- \* Memory — RAM, ROM, EPROM
- \* CPU's — 6800, 6500, Z80, 8080, 8085, 8086/8
- \* MPU support & interface — 6800, 6500, Z80, 8200, etc.

## BYPASS CAPS

.01 UF DISC	100/6.00
.1 UF DISC	100/8.00
.1 UF MONOLITHIC	100/15.00

**WE NOW STOCK A COMPLETE LINE OF DISC, ELECTROLYTIC, MONOLITHIC AND TANTALUM CAPACITORS**

## RESISTORS

1/4 WATT 5% CARBON FILM ALL STANDARD VALUES

FROM 1 OHM TO 10 MEG OHM	
50 PCS. SAME VALUE	.025 EA.
100 PCS. SAME VALUE	.02 EA.
1000 PCS. SAME VALUE	.015 EA.

**VISIT OUR RETAIL STORE** — NEW HOURS —  
M-W-F, 9-5  
T-Th., 9-9 Sat. 11-3  
PLEASE USE YOUR CUSTOMER NUMBER WHEN ORDERING

TERMS: For shipping include \$2 for UPS Ground or \$3 for UPS Blue Label Air. Items over 5 pounds require additional shipping charges. Foreign orders include sufficient amount for shipping. There is a \$10 minimum order. Bay Area and Los Angeles Counties add 6% Sales Tax. Other California residents add 6% Sales Tax. We reserve the right to substitute manufacturer. Not responsible for typographical errors. Prices are subject to change without notice. We will match or beat any competitor's price provided it is not below our cost.

## JDR MICRODEVICES, INC.

1224 S. Bascom Avenue  
San Jose, CA 95128

800-538-5000 • 800-662-6279 (CA)  
(408) 995-5430 • Telex 171-110

© 1982 JDR MICRODEVICES, INC.

CIRCLE 57 ON FREE INFORMATION CARD



# 4116 16K DYNAMIC RAMS 250NS 8/\$11<sup>95</sup> SET

ALL MERCHANDISE 100% GUARANTEED!

CALL US FOR VOLUME QUOTES

## NEW VIEWMAX 80

A **Full Function** 80 column card for Apple II\* — Compare these features with any other:

- ★ 7x9 dot matrix; Upper and lower case with true descenders
- ★ Soft Video switch
- ★ Inverse video characters
- ★ Shift key support
- ★ Fully compatible with Apple\* DOS, CP/M\*, PASCAL, and most popular word processors
- ★ **2 YEAR WARRANTY**

**\$219<sup>95</sup>**

## DISK DRIVE

- ★ Fully Apple\* compatible
- ★ 35 Track — Will read half tracks!
- ★ Use with our controller (call for price) or with your Apple controller
- ★ Price includes case and cable — ready to plug in
- ★ Attractive cabinet matches Apple drive
- ★ 90-Day Warranty

**\$299<sup>95</sup>**

## JDR 16K RAMCARD

For Apple II\*

- ★ Expand your 48K Apple to 64K
- ★ Fully compatible with Apple Language System — Use in place of Apple Language card
- ★ Provides extra memory for Visicalc™
- ★ Run PASCAL, FORTRAN, Integer Basic with appropriate software
- ★ Highest quality card features: gold edge connector, sockets for all IC's

**NOW WITH 2 YEAR WARRANTY**

ASSEMBLED & TESTED WITH WARRANTY ..... **\$44<sup>95</sup>**

KIT — INCLUDES ALL PARTS & INSTRUCTIONS... **\$40<sup>95</sup>**

BARE PC CARD WITH INSTRUCTIONS..... **\$14<sup>95</sup>**



## JDR COOLING FAN FOR YOUR APPLE II

- ★ Easy installation — no modification of Apple required
- ★ Eliminates overheating problems
- ★ Switch on front controls fan, Apple, and extra outlet
- ★ Rotron whisper fan is the quietest, most reliable on the market

**\$69<sup>95</sup>**

**ORDER TOLL FREE**

**800-538-5000**

**800-662-6279**

(CALIFORNIA RESIDENTS)

*IF YOU CAN FIND A PRICE LOWER ELSEWHERE, LET US KNOW AND WE'LL MEET OR BEAT THEIR PRICE! (SEE TERMS BELOW)*

- ★ **Computer managed inventory—virtually no back orders!**
- ★ **Very competitive prices!**
- ★ **Friendly staff!**
- ★ **Fast service — most orders shipped within 24 hours!**

## MONITORS

GREEN PHOSPHOR

**NEC** JB1201M **\$169<sup>00</sup>**

**ZENITH** ZVM-121 **\$119<sup>00</sup>**

COLOR

**AMDEK** COLOR 1 **\$335<sup>00</sup>**

## OKIDATA PRINTERS

- ★ 120 cps, 9x9 Dot Matrix
- ★ 50% faster than EPSON
- ★ Parallel and Serial interfaces are standard

**ML-82A** ..... **\$479<sup>50</sup>**

**ML-83A** ..... **\$699<sup>95</sup>**

**ML-84** PARALLEL . . . **\$1059<sup>00</sup>**

CALL FOR PRICES ON 82A TRACTOR OPTION AND 82A, 83A GRAPHICS OPTION. CABLES AND INTERFACE CARDS AVAILABLE

## 5 1/4" DISKETTES

**ATHANA** SS SD SOFT . . . **24.95**

**MEMOREX** SS SD SOFT **26.95**

**VERBATIM** SS DD SOFT **29.95**

**VERBATIM** 10 SECT. HARD **29.95**

## NASHUA

**TOP QUALITY — LOW PRICE!**

Single Sided, Single Density Soft Sected with Hub Ring

**\$19.95 BOX OF 10**

## NEWPORT PROSTICK

- ★ Professional Quality Atari-Type Joystick
- ★ **Extremely Rugged** — Actual Arcade game Joystick
- ★ All parts are replaceable
- ★ **6 Month Warranty**

**\$31<sup>00</sup> EA \$59<sup>95</sup> PR**



## POWER SUPPLY \$39<sup>95</sup>

MOUNTED ON PC BOARD  
MANUFACTURED BY CONVER  
+5 VOLT 4 AMP  
±12 VOLT 1 AMP

**SPECIAL THANKS TO MARC AND AL FOR THEIR HARD WORK AND DEDICATION**



# QUALITY parts at DISCOUNT PRICES

## MINI BSR



\$17.50 each

## AUTOMATIC RECORD CHANGER

\* B.S.R. MODEL C135R/C/3  
\* PLAYS 33/45/78 RECORDS  
\* MINI SIZE: 8 1/4" X 12"

INCLUDES DUST COVER AND PLASTIC CASE (NOT PICTURED) WITH FRONT CUT OUT TO FIT STEREO UNIT (NOT INCLUDED).

## COMPUTER GRADE CAPACITOR

1700 mfd. 150VDC \$2.00  
2 1/2" DIA X 4 3/4" HIGH  
3,400 mfd. 40VDC \$1.00  
1 3/8" DIA. X 3" HI  
6,400 mfd. 60VDC \$2.50  
1 3/8" DIA. X 4 1/4" HI  
12,000 mfd. 40VDC \$3.00  
2" DIA X 4 1/4" HIGH  
18,000 mfd. 75VDC \$4.00  
2 1/2" DIA X 4 1/2" HIGH  
22,000 mfd. 15VDC \$2.00  
2" DIA X 2 1/2" HIGH  
22,000 mfd. 40VDC \$3.00  
2" DIA. X 6" HIGH  
24,000 mfd. 30VDC \$3.50  
1 3/4" DIA X 4" HI  
31,000 mfd. 15VDC \$2.50  
1 3/4" DIA X 4" HI  
72,000 mfd. 15VDC \$3.50  
2" DIA. X 4" HIGH

COMPUTER GRADE CAPACITOR SPECIAL  
180,000 mfd. at 6V  
2 1/2" DIA X 4" HIGH \$1.50  
CLAMPS TO FIT CAPACITORS 50c ea.

## DC TRANSFORMER

ALL ARE 115 VAC PLUG IN

4 VDC at 70 MA \$2.50  
5.8 VDC at 125 MA \$2.50  
9 VDC at 100 MA \$2.00  
9 VDC at 225 MA \$3.00  
22 VDC at 60 MA \$2.50

## TRANSFORMERS

120 volt primaries

5.6 VOLTS at 750 MA \$3.00  
6 VOLTS at 150 MA \$1.25  
16.5 V. at 3 AMPS \$6.50  
18 VOLTS at 350 MA \$2.00  
18 VOLTS at 1 AMP \$4.50  
18 V.C.T. at 2 AMP \$5.50  
24 VOLTS at 250 ma \$2.50  
24 VCT at 1 AMP \$4.50  
42 V.C.T. at 1.2 AMP \$4.50  
65 V.C.T. at 2 AMP \$5.50

## L.E.D.'s

STANDARD JUMBO DIFFUSED

RED 10 FOR \$1.50  
GREEN 10 FOR \$2.00  
YELLOW 10 FOR \$2.00

FLASHER LED 5 VOLT OPERATION RED JUMBO SIZE \$1.00 EACH  
BI POLAR LED 2 FOR \$1.70  
SUB MINI LED RED .079" X .098" 10 FOR \$1.00  
20 mA at 1.75v \$1.00  
200 FOR \$18.00

## LED HOLDERS

TWO PIECE HOLDER FOR JUMBO LED 10 FOR 65¢ 200 FOR \$10.00

## CRYSTALS

CASE STYLE HC33/U

2 MHZ: COLORBURST 3579, 545 KC \$1.00 EACH

## JOYSTICK

PRECISION DEVICE... CONTAINS 4 50K CENTER TAPPED ALPS POTS. \$4.75 ea

## BLACK PLASTIC CASE

PAC-TEC SERIES C

BLACK PLASTIC ENCLOSURE ADJUSTABLE HEIGHT FROM 1.63" TO 2.93"; WIDTH 6.85"; DEPTH 8". BUILT-IN STAND OFFS FOR P.C. BOARDS... FRONT AND BACK PANELS NOT INCLUDED... \$5.25 PER CASE

## VARIABLE DIODE

16 PF  
MV2205 1 FOR \$1.00  
100 FOR \$30.00  
BB-103 4 FOR \$1.00  
100 FOR \$22.50

## PHOTO-FLASH CAPACITORS

35 MFD 330 VOLT 1" X 5/8" DIA. 45¢ EACH... 10 FOR \$4.00  
170 MFD 330 VOLT 1 1/8" X 7/8" 2 FOR \$1.50/10 FOR \$7.00  
600 MFD 360 VOLT 3 1/2" HIGH X 1" DIA. \$1.00 EA. 10 FOR \$9.00

## BRIDGE RECTIFIER

GENERAL INSTRUMENT # KBP04  
1 1/2 AMP 400 P.I.V. 2 FOR \$1.30

## 0-15 VDC METER

THIS 2 1/4" SQUARE METER MEASURES 0-15 VDC. \$4.50 EACH

FREE! SEND FOR OUR NEW 1983 40 PAGE CATALOG FREE!

## MINIATURE 6VDC RELAY

SUPER SMALL SPDT RELAY; GOLD COBALT CONTACTS... RATED 1 AMP at 30 VDC; HIGHLY SENSITIVE, TTL DIRECT DRIVE POSSIBLE, OPERATES FROM 4.3 TO 6 V, COIL RES. 220 OHM, 1 3/16" X 13/32" X 7/16" AROMAT # RSD-6V \$1.50 EACH 10 FOR \$13.50

## 4PDT RELAY

14 pin style  
3 amp contacts  
24 volt a.c. coil  
Used but fully tested  
\$1.70 EACH  
specify coil voltage  
LARGE QUANTITIES AVAILABLE  
SOCKETS FOR RELAY 50¢ each

## 4 WATT STEREO AMP

ASSEMBLY INCLUDES VOLUME, BALANCE AND TONE CONTROLS, CERAMIC PHONE INPUT, LINE INPUT AND 8 OHM OUTPUT FOR SPEAKER OR HEADPHONES. OPERATES ON 12 VAC @ 500MA. OUR ABOVE 12 VOLT TRANSFORMER IS IDEAL FOR THIS APPLICATION \$4.50 EACH

## MINI-PUSH BUTTON

S.P.S.T. MOMENTARY NORMALLY OPEN 1/4" BUSHING 35¢ EACH 10 FOR \$3.25 100 FOR \$30.00 SPECIFY COLOR: RED, BLACK, WHITE, GREEN, YELLOW.

## EDGE CONNECTOR

ALL ARE .156" SPACING  
15/30 GOLD SOLDER EYELET \$2.00 EACH  
18/36 GOLD SOLDER EYELET \$2.00 EACH  
22/44 GOLD SOLDER TAIL (P.C. STYLE) \$2.50 EA 10 FOR \$22.50  
22/44 GOLD SOLDER EYELET \$2.50 EACH

## 6 VDC RELAY

MINIATURE D.P.D.T. 3 AMP CONTACTS FUJITSU # FBR321D006 \$1.75 EA 10 / 16.00

## 13 VDC RELAY

CONTACT: S.P.N.C. 10 AMP @ 120 VAC ENERGIZE COIL TO OPEN CONTACT... 11V COIL: 13 VDC 650 OHMS SPECIAL PRICE \$1.00 EACH

## KEY SWITCH

S.P.S.T. 4 AMPS @ 125 VAC KEY REMOVES BOTH POSITIONS \$3.50 EA

## BLACK LIGHT (ULTRAVIOLET)

G.E. # F6T5BL \$2.50 each

## 2 CHANNEL LIGHT ORGAN

EASILY HOOKS INTO STEREO SPEAKERS AND ALLOWS 110 VAC LIGHTS TO DANCE WITH MUSIC. TWO SEPARATE 110 VAC OUTPUTS FOR HIGH AND LOW FREQUENCY AUDIO SIGNALS. USE TWO ORGANS FOR STEREO... \$6.50 PER UNIT  
COLOR LIGHT STRING AVAILABLE \$1.75 EA

## FOOT CONTROL WITH SIDE SWITCH

MEASURES 4 3/4" X 9 3/4" WITH 100 K LINEAR POT AND MOMENTARY S.P.D.T. SWITCH. \$6.50 EACH

## LIGHTED PUSH BUTTON

RED LIGHTED 120 VAC 10 AMP. S.P.S.T. "POWER" PRINTED ON FACE. HOLES IN 7/8" SQUARE HOLE... \$1.50 EA 10/ \$13.50

## AM/FM/MPX CHASSIS

THIS AM / FM / STEREO CHASSIS IS COMPLETE AND READY TO PLUG IN EXCEPT FOR THE SPEAKERS... HAS CONNECTIONS FOR UP TO 4 SPEAKERS, A TUNABLE, RECORDING OUTPUT AND HEADPHONES. IDEAL FOR MOUNTING INTO YOUR CUSTOM CABINET... \$12.50 EACH

## SLIDE POTS

500K linear taper  
2 7/8" LG. - 75¢ EACH  
1 3/4" TRAVEL \$1.50 EACH  
DUAL 100 K AUDIO TAPER SLIDEPOT  
3 1/2" LONG \$1.50 EACH  
2 1/2" TRAVEL \$1.50 EACH

## KEYBOARD w/ case

16 KEY KEYBOARD MATRIX ENCODED  
TERMINATES TO FLEXIBLE CABLE WITH CONTACTS ON .100 CENTERS. EDGE CONNECTOR INCLUDED... \$4.50 PER KEYBOARD, CASE, AND CONNECTOR.....

## EQUIPMENT SLIDES

CHASSIS-TRAK MODEL C3005  
3 SECTION. LENGTH 22" CLOSED. HOLDS TO 85 LBS, EXTENDS 23" \$5.00 PER PAIR SOME HARDWARE INCLUDED

## METAL OXIDE VARISTOR

G.E. # V822A12 50 VOLTS, NOMINAL D.C. VOLTAGE. 5/8" DIAMETER. 2 FOR \$1.50

# ALL ELECTRONICS CORP.

TOLL FREE ORDERS ONLY 1-800-826-5432 (ORDER ONLY)  
ALASKA, HAWAII, CALIF OR INFORMATION (213) 380-8000  
905 S. Vermont Ave. P.O. BOX 20406 Los Angeles, Calif. 90006

## KITS KITS KITS KITS KITS KITS

ELECTRONIC KITS  
We have one of the largest selections of inexpensive electronic kits (over 60 available!) and we have been providing quality kits for over 10 years to thousands of schools, hobbyists and engineers worldwide. Remember, all of our kits contain all parts and quality PC board (no need to buy the PC board extra). Compare our prices, extra features and completeness—you just won't find any other kits that compare!

ATTENTION DEALERS  
We are looking for dealers to sell our line of kits. We provide liberal discounts and prices that beat any competition. Less than \$100 gets you started! Write or call for more information.

**NEW** 120VAC LIGHT SEQUENCER KIT  
Great for discos, billboards, special effects, roof top Christmas displays, etc. This reliable IC and SCR kit sequences 10 outputs. The board has 10 output pads and each output pad can light up to 150 watts of 120VAC lamps (your choice) connected to it. Features variable speed and fused input. Kit comes with all parts, PC board and instructions. Size of board: 4" x 8". Operates from 120 VAC. C4725 \$11.95

**NEW** 10 NOTE SOUND SYNTHESIZER KIT  
Very unique simple music synthesizer features 10 adjustable notes, variable pitch, variable speed, flashing LED and individual or flowing notes. Make "robot" sounds, space war computer effects, etc. One of the most unusual kits. Circuit features 3 IC's and 12 trimmer resistors. Complete with all parts, PC board and instructions. Size of board: 2.8" x 4". Operates from 9V battery (not included). C4722 \$11.95

**NEW** ELECTRONIC SLOT MACHINE KIT  
Realistic action slot machine features sound effects, digital readouts and flashing LED. Has 3 different symbols that "roll" and "come up" one at a time. When all symbols are the same a special "winner" note sounds. Circuit uses 7 IC's and 12 resistors. Kit complete with all parts, PC board and instructions. Size of board: 5.5" x 7". Operates from 9V battery (not included). C4723 \$29.95

**NEW** ELECTRONIC DIGITAL DICE KIT  
Fun and exciting—this kit replaces conventional dice. Features bright jumbo LEDs and "roll" sound. Speed of roll is fully adjustable and dice stop individually! Circuit uses 4 IC's and 10 resistors. Kit complete with all parts, PC board and instructions. Size of board: 4" x 4.8". Operates from 9V battery (not included). C4724 \$15.95

CHANEY electronics inc  
P.O. BOX 27038 DENVER, COLORADO 80227 303-781-6750

Phone Orders 303-781-6750  
Minimum AD Order \$9.00  
Please include \$1.50 for postage (UPS)  
VISA, MC accepted  
Phone orders are welcome  
Send for our free catalog of unique items

CIRCLE 69 ON FREE INFORMATION CARD

# SCR™

## Free Buyers Guide

84 pages of the latest in components, tools and instruments — a must for DESIGNERS, instructors and maintenance engineers.

## NEW ZENITH ZXM 121

High legibility 12" green phosphor monitor. 15 Mhz bandwidth, 40 or 80 character selectable full compatibility... \$99.95

## SPECIALS

25 PIN DB PLUG AMP P/N 205737-2 Any Quantity \$1.97

9 PIN DB PLUG RIGHT ANGLE FOR HOME COMPUTERS & GAMES! AMP P/N 207456-2 Any Quantity \$.85¢

## RESISTOR BUYOUT

MOST STANDARD VALUES  
1/4 WATT 5% RESISTORS 1 OHM TO 10 MEG OHM 2 K MIN. BUY 1 K MIN. PER VALUE \$6.50 Per 1,000

## UHF/VHF Conversion Kit

with Genuine Mitsumi Tuner... \$119.95

## CALL OUR HOT LINES

IN CALIF. (714) 527-2554  
OUTSIDE CAL. (800) 854-8660

## SCR ELECTRONICS CENTER

5303 Lincoln Ave., Cypress, CA 90630

CIRCLE 33 ON FREE INFORMATION CARD



# Do Kay Computer Products, Inc.

VISIT OUR RETAIL STORE  
AND RECEIVE A 5% DISCOUNT!

3250 KELLER STREET, #9 • SANTA CLARA, CA 95050

### EPROMS

1702	(1ns)	3.00
2708	(45ns)	2.99
2716	(5v 450ns)	3.49
2716-1	(5v 350ns)	7.85
2532	(5v 450ns)	7.85
2732	(5v 450ns)	6.49
2764	(5v 450ns)	Call

### STATIC RAMS

2101	(450ns)	1.85
21L02	(250ns LP)	1.55
2111	(450ns)	2.49
2114	(450ns)	1.75
2114L-3	(300ns LP)	1.85
2114L-2	(200ns LP)	1.95
TMM2016	(200ns)	5.49
TMM2016	(150ns)	6.49
TMM2016	(100ns)	7.49
HM6116	(200ns)	Call
HM6116	(150ns)	Call
HM6116	(120ns)	Call

### DYNAMIC RAMS

4027	(250ns)	2.00
4116	(200ns)	1.25
4116	(150ns)	1.75
4164	(200ns)	Call

LP = Low Power

### Z80

Z80 A CPU	4.95
Z80 A PIO	4.95
Z80 A CTC	6.95

Call for Complete List

**MICROPROCESSOR  
REAL-TIME CLOCK  
MSM 5832  
6.90**

**WE WILL BEAT  
ANY COMPETITOR'S  
PRICES!  
Call before you buy**

### 8000

8035	6.95	8239	4.75
8039	7.59	8243	4.75
8080A	3.90	8250	14.90
8085A	7.95	8251	4.50
8088	34.95	8253	8.75
8155	7.75	8253-5	9.75
8156	8.75	8255	4.50
8185	29.00	8255-5	5.20
8741	39.00	8257	8.50
8748	14.95	8259	6.85
8755	29.95	8272	39.00
8202	27.95	8275	29.00
8205	3.45	8279	9.25
8212	1.80	8279-5	9.95
8214	3.75	8282	6.50
8216	1.75	8283	6.50
8224	2.45	8284	5.50
8226	1.80	8286	6.50
8228	4.50	8287	6.50
8237	19.00	8288	25.00
8238	4.75	8289	49.00

### 16K APPLE RAM CARD

Upgrade your 48K Apple II  
to full 64K

BARE BOARD	14.00
KIT	39.90
ASSEMBLED & TESTED	45.00

### LEDS

Jumbo Red	10/1.00
Jumbo Green	6/1.00
Jumbo Yellow	6/1.00

### 6500

6502	5.49
6502A	9.45
6504	6.90
6505	7.65
6507	9.90
6520	4.35
6522	7.95
6532	9.95
6551	11.75

### UPGRADE YOUR APPLE or TRS-80

**4116 200ns  
8/10.00**

### CONNECTORS

RS 232	Male	3.00
RS 232	Female	3.50
RS 232	Hood	1.20

### CRYSTALS

32.768 KHZ	1.90	5.185	3.90
1.0 MHZ	4.50	5.7143	3.90
1.8432	4.50	6.5536	3.90
2.0	3.90	8.0	3.00
2.097152	3.90	10.0	3.00
2.4576	3.90	14.31818	3.90
3.2768	3.90	18.0	3.00
3.579545	3.00	18.432	3.00
4.0	3.00	20.0	3.00
5.0	3.00	22.1184	3.00
5.0688	3.90	32.0	3.90

### 74LS00 SERIES

74LS00	.24	74LS123	.95	74LS253	.80
74LS01	.24	74LS124	2.90	74LS257	.80
74LS02	.24	74LS125	.95	74LS258	.80
74LS03	.24	74LS126	.79	74LS259	2.80
74LS04	.24	74LS132	.75	74LS260	.60
74LS05	.24	74LS136	.49	74LS266	.49
74LS08	.24	74LS137	.95	74LS273	1.60
74LS10	.24	74LS138	.75	74LS275	3.25
74LS11	.30	74LS139	.75	74LS279	.49
74LS12	.30	74LS145	1.10	74LS280	1.95
74LS13	.40	74LS147	2.20	74LS283	.95
74LS14	.89	74LS148	1.20	74LS290	1.20
74LS15	.30	74LS151	.75	74LS293	1.79
74LS20	.24	74LS153	.75	74LS295	.99
74LS21	.30	74LS154	1.75	74LS298	.99
74LS22	.24	74LS155	.89	74LS324	1.75
74LS26	.30	74LS156	.89	74LS352	1.49
74LS27	.24	74LS157	.75	74LS353	1.49
74LS28	.30	74LS158	.75	74LS363	1.49
74LS30	.24	74LS160	.95	74LS364	1.95
74LS32	.36	74LS161	.95	74LS365	.89
74LS33	.55	74LS162	.95	74LS366	.89
74LS37	.55	74LS163	.95	74LS367	.69
74LS38	.35	74LS164	.95	74LS368	.69
74LS40	.30	74LS165	.95	74LS373	.99
74LS42	.45	74LS166	1.95	74LS374	1.69
74LS47	.75	74LS168	1.69	74LS377	1.40
74LS48	.75	74LS169	1.69	74LS378	1.15
74LS49	.75	74LS170	1.69	74LS379	1.35
74LS51	.30	74LS173	.75	74LS385	1.89
74LS54	.35	74LS174	.89	74LS386	.59
74LS55	.35	74LS175	.89	74LS390	1.79
74LS63	1.20	74LS181	1.99	74LS393	1.79
74LS73	.39	74LS189	9.50	74LS395	1.59
74LS74	.44	74LS190	.89	74LS399	1.59
74LS75	.49	74LS191	.89	74LS424	2.89
74LS76	.39	74LS192	.89	74LS447	.75
74LS78	.49	74LS193	.89	74LS490	1.89
74LS83	.75	74LS194	.89	74LS668	1.65
74LS85	.95	74LS195	.89	74LS669	1.85
74LS86	.39	74LS196	.79	74LS670	2.10
74LS90	.65	74LS197	.79	74LS674	9.50
74LS91	.79	74LS221	1.10	74LS682	2.99
74LS92	.65	74LS240	.95	74LS683	2.39
74LS93	.59	74LS241	.95	74LS684	2.39
74LS95	.79	74LS242	1.79	74LS685	2.39
74LS96	.79	74LS243	1.79	74LS688	2.39
74LS107	.39	74LS244	.95	74LS689	2.39
74LS109	.39	74LS245	1.89		
74LS112	.39	74LS247	.79	81LS95	1.65
74LS113	.39	74LS248	1.20	81LS96	1.65
74LS114	.49	74LS249	.89	81LS97	1.65
74LS122	.45	74LS251	1.25	81LS98	1.65

### Disc Controller

1771	16.00
1791	27.95
1793	29.95
1795	49.95
1797	49.95

### Interface

8T26	1.65
8T28	1.95
8T95	.95
8T96	.95
8T97	.95
8T98	.95
DM8131	2.90
DS8836	1.25

### IC Sockets ST W/W

4000	.25
4001	.30
4002	.30
4006	.90
4007	.25
4008	.90
4009	.45
4010	.45
4011	.30
4012	.30
4013	.45
4014	.90
4015	.90
4016	.45

ST = Solderetail  
W/W = Wirewrap

### LINEAR

LM301	.32	LM741	.29
LM308	.75	LM747	.75
LM309K	1.25	LM748	.49
LM311	.64	LM1310	2.45
LM317T	1.65	MC1330	1.69
LM317K	1.70	MC1350	1.25
LM318	1.49	MC1358	1.69
LM323K	3.75	LM1414	1.49
LM324	.59	LM1458	.55
LM337K	3.90	LM1488	.95
LM339	.79	LM1489	.95
LM377	2.25	LM1800	2.45
LM380	1.25	LM1889	2.45
LM386	1.00	LM3900	.59
LM555	.38	LM3909	.95
LM556	.65	LM3914	3.70
LM565	.95	LM3915	3.70
LM566	1.45	LM3916	3.70
LM567	.99	75451	.35
LM723	.49	75452	.35
LM733	.95	75453	.35

**ORDER TOLL FREE  
(800) 538-8800  
(800) 848-8008**

(CALIFORNIA RESIDENTS)  
ALL MERCHANDISE IS 100% GUARANTEED

### CMOS

4017	1.15	4082	.30
4018	.90	4085	.90
4019	.45	4086	.90
4020	.90	4093	.90
4021	.90	4098	2.49
4022	1.10	4099	1.90
4023	.35	4502	.90
4024	.75	4503	.60
4025	.35	4508	1.90
4026	1.60	4510	.90
4027	.60	4511	.90
4028	.75	4512	.90
4029	.90	4514	1.20
4030	.45	4515	2.20
4034	2.90	4516	1.50
4035	.85	4518	1.20
4040	.90	4519	1.20
4041	1.20	4520	1.20
4042	.75	4522	1.20
4043	.75	4526	1.20
4044	.75	4527	1.90
4046	.90	4528	1.20
4047	.90	4531	.90
4049	.50	4532	1.90
4050	.50	4538	1.90
4015	.90	4539	1.90
4053	.90	4543	2.70
4060	1.39	4555	.90
4066	.75	4556	.90
4068	.39	4581	1.90
4069	.30	4582	1.90
4070	.35	4584	.90
4071	.30	4585	.90
4072	.30		
4073	.30	80C07	.90
4075	.30	80C95	.90
4076	.30	80C96	.90
4078	.30	80C97	.90
4081	.30	80C98	1.15

**Do Kay Computer Products, Inc.**  
3250 Keller Street, #9  
Santa Clara, CA 95050  
(800) 538-8800  
Local Calif. Residents (408) 988-0697

STORE HOURS:  
MON-FRI 8:30 A.M.-6:00 P.M.  
SAT 10:00 A.M.-3:00 P.M.



TERMS: For shipping include \$2.00 for UPS Ground. \$3.00 for UPS Blue Label Air. \$10.00 minimum order. Bay Area residents add 6 1/2% Sales Tax. California residents add 6% Sales Tax. We reserve the right to limit quantities and substitute manufacturer. Prices subject to change without notice. Send SASE for complete list.





# 7400

\*\*Number of Pins at each I.C. for easy selection

Part No.	*Pins	Price
SN7400N	14	19
SN7401N	14	19
SN7402N	14	25
SN7403N	14	25
SN7404N	14	25
SN7405N	14	25
SN7406N	14	29
SN7407N	14	29
SN7408N	14	25
SN7409N	14	25
SN7410N	14	25
SN7411N	14	25
SN7412N	14	35
SN7413N	14	35
SN7414N	14	39
SN7415N	14	39
SN7416N	14	39
SN7417N	14	39
SN7418N	14	39
SN7419N	14	39
SN7420N	14	39
SN7421N	14	39
SN7422N	14	39
SN7423N	16	59
SN7424N	14	29
SN7425N	14	29
SN7426N	14	29
SN7427N	14	29
SN7428N	14	29
SN7429N	14	29
SN7430N	14	29
SN7431N	14	29
SN7432N	14	29
SN7433N	14	29
SN7434N	14	29
SN7435N	14	29
SN7436N	14	29
SN7437N	14	29
SN7438N	14	29
SN7439N	14	29
SN7440N	14	29
SN7441N	16	59
SN7442N	16	59
SN7443N	16	59
SN7444N	16	59
SN7445N	16	59
SN7446N	16	59
SN7447N	16	59
SN7448N	16	59
SN7449N	16	59
SN7450N	14	19
SN7451N	14	19
SN7452N	14	19
SN7453N	14	19
SN7454N	14	19
SN7455N	14	19
SN7456N	14	19
SN7457N	14	19
SN7458N	14	19
SN7459N	14	19
SN7460N	14	19
SN7461N	14	19

Part No.	*Pins	Price
SN7472N	14	23
SN7473N	14	35
SN7474N	14	35
SN7475N	14	35
SN7476N	14	35
SN7477N	14	35
SN7478N	14	35
SN7479N	14	35
SN7480N	14	35
SN7481N	14	35
SN7482N	14	35
SN7483N	14	35
SN7484N	14	35
SN7485N	14	35
SN7486N	14	35
SN7487N	14	35
SN7488N	14	35
SN7489N	14	35
SN7490N	14	35
SN7491N	14	35
SN7492N	14	35
SN7493N	14	35
SN7494N	14	35
SN7495N	14	35
SN7496N	14	35
SN7497N	14	35
SN7498N	14	35
SN7499N	14	35
SN7500N	14	35
SN7501N	14	35
SN7502N	14	35
SN7503N	14	35
SN7504N	14	35
SN7505N	14	35
SN7506N	14	35
SN7507N	14	35
SN7508N	14	35
SN7509N	14	35
SN7510N	14	35
SN7511N	14	35
SN7512N	14	35
SN7513N	14	35
SN7514N	14	35
SN7515N	14	35
SN7516N	14	35
SN7517N	14	35
SN7518N	14	35
SN7519N	14	35
SN7520N	14	35
SN7521N	14	35
SN7522N	14	35
SN7523N	14	35
SN7524N	14	35
SN7525N	14	35
SN7526N	14	35
SN7527N	14	35
SN7528N	14	35
SN7529N	14	35
SN7530N	14	35
SN7531N	14	35
SN7532N	14	35
SN7533N	14	35
SN7534N	14	35
SN7535N	14	35
SN7536N	14	35
SN7537N	14	35
SN7538N	14	35
SN7539N	14	35
SN7540N	14	35
SN7541N	14	35
SN7542N	14	35
SN7543N	14	35
SN7544N	14	35
SN7545N	14	35
SN7546N	14	35
SN7547N	14	35
SN7548N	14	35
SN7549N	14	35
SN7550N	14	35
SN7551N	14	35
SN7552N	14	35
SN7553N	14	35
SN7554N	14	35
SN7555N	14	35
SN7556N	14	35
SN7557N	14	35
SN7558N	14	35
SN7559N	14	35
SN7560N	14	35
SN7561N	14	35
SN7562N	14	35
SN7563N	14	35
SN7564N	14	35
SN7565N	14	35
SN7566N	14	35
SN7567N	14	35
SN7568N	14	35
SN7569N	14	35
SN7570N	14	35
SN7571N	14	35
SN7572N	14	35
SN7573N	14	35
SN7574N	14	35
SN7575N	14	35
SN7576N	14	35
SN7577N	14	35
SN7578N	14	35
SN7579N	14	35
SN7580N	14	35
SN7581N	14	35
SN7582N	14	35
SN7583N	14	35
SN7584N	14	35
SN7585N	14	35
SN7586N	14	35
SN7587N	14	35
SN7588N	14	35
SN7589N	14	35
SN7590N	14	35
SN7591N	14	35
SN7592N	14	35
SN7593N	14	35
SN7594N	14	35
SN7595N	14	35
SN7596N	14	35
SN7597N	14	35
SN7598N	14	35
SN7599N	14	35
SN7600N	14	35

Part No.	*Pins	Price
SN74154N	16	20
SN74157N	16	69
SN74158N	16	69
SN74159N	16	69
SN74160N	16	69
SN74161N	16	69
SN74162N	16	69
SN74163N	16	69
SN74164N	16	69
SN74165N	16	69
SN74166N	16	69
SN74167N	16	69
SN74168N	16	69
SN74169N	16	69
SN74170N	16	69
SN74171N	16	69
SN74172N	16	69
SN74173N	16	69
SN74174N	16	69
SN74175N	16	69
SN74176N	16	69
SN74177N	16	69
SN74178N	16	69
SN74179N	16	69
SN74180N	16	69
SN74181N	16	69
SN74182N	16	69
SN74183N	16	69
SN74184N	16	69
SN74185N	16	69
SN74186N	16	69
SN74187N	16	69
SN74188N	16	69
SN74189N	16	69
SN74190N	16	69
SN74191N	16	69
SN74192N	16	69
SN74193N	16	69
SN74194N	16	69
SN74195A	16	69
SN74196A	16	69
SN74197N	14	89
SN74198N	14	89
SN74199N	14	89
SN74200N	14	89
SN74201N	14	89
SN74202N	14	89
SN74203N	14	89
SN74204N	14	89
SN74205N	14	89
SN74206N	14	89
SN74207N	14	89
SN74208N	14	89
SN74209N	14	89
SN74210N	14	89
SN74211N	14	89
SN74212N	14	89
SN74213N	14	89
SN74214N	14	89
SN74215N	14	89
SN74216N	14	89
SN74217N	14	89
SN74218N	14	89
SN74219N	14	89
SN74220N	14	89
SN74221N	14	89
SN74222N	14	89
SN74223N	14	89
SN74224N	14	89
SN74225N	14	89
SN74226N	14	89
SN74227N	14	89
SN74228N	14	89
SN74229N	14	89
SN74230N	14	89
SN74231N	14	89
SN74232N	14	89
SN74233N	14	89
SN74234N	14	89
SN74235N	14	89
SN74236N	14	89
SN74237N	14	89
SN74238N	14	89
SN74239N	14	89
SN74240N	14	89
SN74241N	14	89
SN74242N	14	89
SN74243N	14	89
SN74244N	14	89
SN74245N	14	89
SN74246N	14	89
SN74247N	14	89
SN74248N	14	89
SN74249N	14	89
SN74250N	14	89
SN74251N	14	89
SN74252N	14	89
SN74253N	14	89
SN74254N	14	89
SN74255N	14	89
SN74256N	14	89
SN74257N	14	89
SN74258N	14	89
SN74259N	14	89
SN74260N	14	89
SN74261N	14	89
SN74262N	14	89
SN74263N	14	89
SN74264N	14	89
SN74265N	14	89
SN74266N	14	89
SN74267N	14	89
SN74268N	14	89
SN74269N	14	89
SN74270N	14	89
SN74271N	14	89
SN74272N	14	89
SN74273N	14	89
SN74274N	14	89
SN74275N	14	89
SN74276N	14	89
SN74277N	14	89
SN74278N	14	89
SN74279N	14	89
SN74280N	14	89
SN74281N	14	89
SN74282N	14	89
SN74283N	14	89
SN74284N	14	89
SN74285N	14	89
SN74286N	14	89
SN74287N	14	89
SN74288N	14	89
SN74289N	14	89
SN74290N	14	89
SN74291N	14	89
SN74292N	14	89
SN74293N	14	89
SN74294N	14	89
SN74295N	14	89
SN74296N	14	89
SN74297N	14	89
SN74298N	14	89
SN74299N	14	89
SN74300N	14	89

# MICROPROCESSOR COMPONENTS

Part No.	*Pins	Price
CDP1802	40	89
MPU	40	95
CDP1803	40	89
MPU	40	95
CDP1804	40	89
MPU	40	95
CDP1805	40	89
MPU	40	95
CDP1806	40	89
MPU	40	95
CDP1807	40	89
MPU	40	95
CDP1808	40	89
MPU	40	95
CDP1809	40	89
MPU	40	95
CDP1810	40	89
MPU	40	95
CDP1811	40	89
MPU	40	95
CDP1812	40	89
MPU	40	95
CDP1813	40	89
MPU	40	95
CDP1814	40	89
MPU	40	95
CDP1815	40	89
MPU	40	95
CDP1816	40	89
MPU	40	95
CDP1817	40	89
MPU	40	95
CDP1818	40	89
MPU	40	95
CDP1819	40	89
MPU	40	95
CDP1820	40	89
MPU	40	95
CDP1821	40	89
MPU	40	95
CDP1822	40	89
MPU	40	95
CDP1823	40	89
MPU	40	95
CDP1824	40	89
MPU	40	95
CDP1825	40	89
MPU	40	95
CDP1826	40	89
MPU	40	95
CDP1827	40	89
MPU	40	95
CDP1828	40	89
MPU	40	95
CDP1829	40	89
MPU	40	95
CDP1830	40	89
MPU	40	95
CDP1831	40	89
MPU	40	9



**ATARI**

**JOYSTICKS**  
JSA (2) ... \$6.95/pair

**PADDLES**  
JSP (2) ... \$4.95/pair

**TV GAME SWITCH**  
Switches TV to video game or computer operation. Use on Atari.  
TGS-1 ... \$2.95 ea.

**JOYSTICKS**

JS-5K	5K Linear Taper Pots	\$5.25
JS-100K	100K Linear Taper Pots	\$4.95
JS-150K	150K Linear Taper Pots	\$4.75
JVC-40	40K (2) Video Controller in Case	\$4.95
JS KNOB	Knob for JS5K,100K,150K	\$.99 ea.
JVC KNOB	Knob for JVC-40	\$.99 ea.

**RADIO CONTROL CIRCUITS**

Ideal to use for:  
• Toys, hobby crafts, robots, trains  
• Burglar alarms - IR data link  
• Remote slide projector control  
• Consumer remote data links  
• Energy-saving, remotely switched lighting systems

A complete 6-channel digital encoder and RF transmitter, low power, at frequency of 27MHz or 49MHz, a field strength of 1000uV/meter at 3 meters. 9V operation on chip RF oscillator/transmitter, on chip 4.6 regulator. Up to 80MHz carrier frequency operation.

**LM1871N RC Encoder/Transmitter Chip** ... \$1.95

A complete RF receiver/decoder, used at either 27MHz, 49MHz or 72MHz. It provides 4 independent channels when used with LM1871 (2 analog, 2 dig) operates from four 1.5V cells. Crystal controlled.

**LM1872N RC Receiver/Decoder Chip** ... \$2.49

**SRX1504** 49.435MHz Crystal (LM1872N) ... \$3.95

**SRX1505** 49.890MHz Crystal (LM1872N) ... \$3.95

**Jameco Digital Thermometer Kit**

Dual sensors - switch controls for indoor/outdoor or dual monitoring - can be extended to 500 feet. Continuous LED 8" ht. display. Range: -40°F to 199°F, -40°C to 100°C. Accuracy ±1° nominal. Calibrates for Fahrenheit/Celsius. Simulated walnut case. AC wall adapter included. Size: 6 1/2" x 3 1/2" x 1 1/2".

**JE300** ... \$39.95

**BOOKS**

**NATIONAL SEMICONDUCTOR - INTERSIL - INTEL**

30001	National CMOS Data Book (1981) (640 pages) 74C, CD4000, and A/D Converters	\$6.95
30002	National Interface Data Book (1980) (704 pages) DP, DS8000, DS3600, DS5700, etc.	\$6.95
30003	National Linear Data Book (1982) (1376 pages) LM, LF, AD, DAC, LM Series	\$11.95
30004	National Series 80 - Board Level Computer (1980) (224 pages)	\$4.95
30005	National TTL Logic Data Book (1981) (624 pages) 7400, LS, LHS, and DM8000 Series	\$9.95

**30006 Above (3) 30001,3,5 as set** ... \$24.95

30006	National Memory Data Book (1980) (464 pages) RAMs, ROMs, PROMs, EPROMs Series	\$6.95
30009	Intersil Data Book (1983) (1356 pages) Complete line.	\$9.95
30010	National Audio/Radio Handbook (1980) (240 pages) Pre-Amps, AM, FM & FM Stereo, Power Amps	\$5.95
30011	National Linear Application Handbook (1980) (705 pages) Application Notes, Linear Briefs, etc.	\$15.95
30012	National PAL Data Book (1982) (176 pages) Data Sheet, PAL Design	\$5.95
30013	Zilog Data Book (1983) (641 pages) Microprocessors and Support Chips	\$7.95
101040	Intel Component Data Book (1982) (1405 pg.) Full data sheets for Intel's products incl. mem. devices, microproc., periph. & ind./mil. products	\$14.95
205610	Intel Peripheral Design Handbook (1981) (828 pages) Full data sheets, application notes for Intel peripheral device components	\$9.95

**Universal Computer Keyboard Enclosures**

"DE" Blank Desk-Top Enclosures are designed for easy modification. High strength epoxy molded and priced in mocha brown finish. Sliding rear/bottom panel for service component access. Top/bottom panels 0.00" thick alum. anodize type 1200 finish (gold tint color) for best paint adhesion after modification. Vented top & bottom panels for cooling efficiency. Rigid construction provides unlimited applications. Assembly instructions included.

DTE-8	Panel Width 7.5"	\$24.95
DTE-11	Panel Width 10.13"	\$27.95
DTE-14	Panel Width 13.5"	\$29.95
DTE-20	Panel Width 19.25"	\$34.95

**Mostek DC/DC Converter +5 Volts Output to 9 VOLTS**  
Input: +5V. Output: 9V (regulated) @ 30mA. Printed circuit mounting. Specifications incl. DC10 ... \$2.95 ea. or 2/\$4.95

**Battery Checker**

Easy-to-use hand-held battery checker tests AA, AAA, C, D, and 216 batteries. A multi-colored meter shows if battery is good, weak or needs replacing. Size: 6 1/4" L x 2 1/4" W x 1 7/8" H.

**BC-1** ... \$6.95 ea.

**POWER SUPPLIES - KEYBOARDS**

**POWER SUPPLY +5VDC @ 1 AMP REGULATED** Transaction Tech  
Output +5VDC @ 1A (plus +25VDC) reg. Input 115VAC 60Hz. 2-3oz (black/beige) self-enclosed case. 8 ft. 3 cond. black power cord. 9 1/2" W x 7 1/2" D x 2 1/2" H. 3 ft. Data sheet incl.  
Part No. PS51194 ... \$19.95 each

**POWER SUPPLY +5VDC @ 1 AMP REGULATED** B Industries  
Output +5VDC @ 1 amp, +25-42VDC adj. 400mA or less. 30VDC (inst.) @ 1.5 amp. Input 115VAC 60Hz. Case: black. 9 1/2" x 7 1/2" x 2 1/2" H. 3 cond. blk. pow. cord. 9 1/2" W x 7 1/2" D x 2 1/2" H. 3 ft. Data sheet included.  
Part No. PS407D ... \$24.95 each

**POWER SUPPLY +5VDC @ 3 AMP REGULATED** Deltron  
Input: 115VAC, 47-440Hz. Output: 5VDC Adjustable @ 3 amp, 5VDC @ 2.5 amp. Adjustable current limit. Ripple & Noise: 1MV rms. 5MV p-p - 2 mounting surfaces. UL recognized. Size: 4" W x 4 1/2" L x 2 1/2" H. Wt. 2 lbs. Data sheet included.  
Part No. QPS-1 ... \$29.95 each

**POWER SUPPLY +5VDC @ 7.5 AMP, 12VDC @ 1.5 AMP SWITCHING** Power  
Input: 115VAC, 50-60Hz; @ 3 amp/230VAC, 50Hz; @ 1.6 amp. Fan vol./power supply select switches (115/230VAC). Output: 5VDC @ 7.6 amp, 12VDC @ 1.6 amp. 8 ft. blk. pow. cord. 11 1/2" W x 13 1/2" D x 3 1/2" H. Wt. 6 lbs.  
Part No. PS94V0 ... \$49.95 each

**POWER SUPPLY 4-Channel Switching Power Supply** Microprocessor, mini-computer, terminal, medical equipment and process control applications. Input: 90-130VAC 47-440Hz. Output: +5VDC @ 5A, -5VDC @ 1A, +12VDC @ 1A, -12VDC @ 1A. Line reg. ±0.5%. Ripple: 20mV p-p. Load reg. ±1%. Overcurrent protection. Adj. 5V main output +10%, 0.5V/10% - 1.7V/8% w/ 4-15/17V/18V. Wt. 1 1/2 lbs.  
Part No. FCS-604A ... \$69.95 each

**POWER SUPPLY Adjustable Switching 4-24VDC to 5 Amps** Adj. 4-24VDC. 5VDC @ 5A, 5VDC @ 4A, 12VDC @ 4.1A, 12VDC @ 3.3A, 18VDC @ 1.9A, 24VDC @ 5A. Overvoltage Protection. Input: 115VAC 50/60Hz. Output variations within 20mV. 8.25" L x 4.25" W x 2 1/2" H. Wt. 3.25 lbs.  
JE224R ... \$79.95 each  
JE224A Assembled & Tested ... \$99.95 each

**MICRO SWITCH 69-KEY KEYBOARD** Data Entry Keyboard. Encoded Output. 8-bit Parallel EBC DIC. Switching: Half Effect. 24-pin Edge Card Connection. Complete w/ Pin Connection. Can easily be modified to ASCII code.  
Part No. KB69SD12-2 (Fits into DTE-20 Enclosure) ... \$19.95 each

**MICRO SWITCH 85-KEY KEYBOARD** Word Processing Keyboard. 29 Pin Edge Card Connection. Supply Voltage +5VDC. Main Keyboard is QWERTY. Additional Key Pads for Cursor and word processing functions.  
Part No. 85SD18-1 ... \$29.95 each

**MICRO SWITCH 88-KEY KEYBOARD (PARALLEL)** Data Entry keyboard used in Datalite 1540 Terminal. Supply Voltage: +5V, -12V. Switching: Half Effect - 10-pin Edge Card Connection. Schematic included. Uses 8048 Encoder Chip.  
Part No. 88SD22 (Fits into DTE-20 Enclosure) ... \$69.95 each

**HI-TEK 58-KEY KEYBOARD** SPST Switching, mechanical, monolithic housing, charcoal grey keycaps. Keyboard is not mounted on circuit board (each key is individually accessible). Used to replace touch-membrane found on Sinclair, Atari & TRS-80 computers.  
Part No. K-58 ... \$19.95

**84-Key Keyboard CONTROL DATA**  
Data Entry Keyboards  
RS232C Interface  
FT2 Shielded Base  
SPST Switching  
Momentary Contact Keyswitches  
30" Interface Cable  
Attractive Case

**CA153A** ... \$69.95

**CA148** ... \$99.95

**95-Key Keyboard**  
**CA154A** ... \$79.95

**104-Key Keyboard**  
**CA150C** ... \$89.95

**80-Key Keyboard**  
**CA150C** ... \$89.95

Color; keycaps: black, blue, red - cover: black w/beige base. 2 1/2" x 9" x 3 1/2". 6 lbs.

**BUG BOX™ STORAGE SYSTEMS**

**BUG BOX™** - 30 individual compartments • Stores 60 8-pin or 30 14- or 16-pin DIPs • Heavy-duty injection molded plastic • Clear top, cover, sides & locks • Cover marked with numbers 1-30 • Compartment size: 1" x 3.75" x 5" deep • Box size: 4.9" x 3.3" x 5.0"

**BUG BOX™** Please specify color code: (B) Blue, (R) Red, (W) White, (Y) Yellow  
Part No./Color Code QTY PRICE  
BGX-001- ( ) 1 \$ 3.29  
BGX-010- ( ) 10 19.99

**BUG BOX™** ANTI-STATIC  
BGX-001- (IAS) 1 \$ 3.29  
BGX-010- (IAS) 10 28.89

**BUG CAGET™** - 12 locations store Bug Boxes, Big Bug Boxes or Bug Trays • Modular and interlocking • Heavy duty injection molded plastic • Each cage has 6 slip-on locations • 2 cages per pkg. • Cage size: 5-1/8" x 5" x 3-7/8" • 4 colors available - please specify color code: (B) Blue, (R) Red, (W) White, (Y) Yellow  
Part No./Color Code Price  
BGC-001- ( ) 2 Cages (6 loc. ea.) \$11.95/pkg.

**BUG TRAY™** - Stores in Bug Cage • Molded plastic • Three styles: Open (1 compartment 3.05" x 4.5" x 0.7") Vertical (6 compartments 4" x 4.0" x 0.7") and Horizontal (8 compartments 4" x 3.95" x 0.7") • Ideal for tools, hardware, components, etc. • Tray size: 3.55" x 5.05" x .6" • Black color only  
Part No. Description Price  
BTM-001 Horizontal Bug Tray \$1.95  
BTM-001 Vertical Bug Tray 1.95  
BTM-001 Open Bug Tray 1.95  
BTM-003 1 of each Bug Tray (3) 4.98

**LSI BIG BUG BOX™** - Designed to store large ICs. Resistors, Capacitors and Diodes • Divided into three compartments measuring 1" x 4.15" x .5" deep • Three vertical and three horizontal dividers included • Heavy duty injection molded plastic • Box size: 4.9" x 3.3" x 6" • Weight: 1.75 oz.

**LSI BIG BUG BOX™** Please specify color code: (B) Blue, (R) Red, (W) White, (Y) Yellow  
Part No./Color Code QTY PRICE  
BLX-001- ( ) 1 \$ 3.29  
BLX-010- ( ) 10 28.79

**BLX-001- (IAS) ANTI-STATIC** 1 \$ 4.29  
**BLX-010- (IAS)** 10 37.89

**BACK PACK™** - Self-adhesive labels for the back of IC's • Shows exact internal logic in relation to IC pins • 532 labels in each package (including several blank labels) • Each package for 8, 14, 16, 24, 28 and 40-pin IC's • Combo package including 1,068 labels for TTL and CMOS IC's • Microprocessor package contains 744 labels  
Part No. Description Price  
BPT-012 TTL \$7.95  
BPC-012 CMOS 8.95  
BPM-012 Combo 14.95  
BPU-012 Microprocessor 9.95

**JUMPER AND CABLE ASSEMBLIES**

**STANDARD DIP JUMPERS**  
All jumpers use low profile dip plugs with heavy duty pins for repeated disconnect applications.

JAMECO Part No.	AP Code Reference	No. Pins	Description	Wire Length	Price
DJ40-1	924122-12	40	single end	12"	5.39
DJ40-2	924122-24	40	single end	24"	6.19
DJ40-3	924122-36	40	single end	36"	6.89
DJ40-140	924126-12	40	double end	12"	8.49
DJ40-240	924126-24	40	double end	24"	10.29
DJ40-340	924126-36	40	double end	36"	10.95

**STANDARD DB25 SERIES CABLES**  
Now you can order DB25 P or S connectors with the cable necessary to fit your application. Choose from our standard flat cable in 4-foot lengths. Call today.

Part No.	Cable Length	Connectors	Price
DB25P-4	4 feet	1 DB25P	7.95
DB25S-4	4 feet	1 DB25S	8.49
DB25P-4-P	4 feet	2 DB25P	13.49
DB25P-4-S	4 feet	1 DB25P/1 DB25S	13.75
DB25S-4-S	4 feet	2 DB25S	13.95

**\$10.00 Minimum Order - U.S. Funds Only**  
California Residents Add 6 1/2% Sales Tax  
Postage - Add 5% plus \$1.50 Insurance  
Send S.A.S.E. for Monthly Sales Flyer!

Spec Sheets - 30c each  
Send \$1.00 Postage for your  
**FREE 1983 JAMECO CATALOG**  
Prices Subject to Change

Call for Quantity Discounts

**Jameco Electronics**  
1983 Jameco Calendar Poster 16 1/2" x 21 1/2" \$3.95

1355 SHOREWAY ROAD, BELMONT, CA 94002  
2183 PHONE ORDERS WELCOME - (415) 592-8097 Telex: 176043

**EXPAND YOUR MEMORY**

**TRS-80 to 16K, 32K, or 48K**

**\*\*Model 1 =** From 4K to 16K Requires (1) One Kit  
**Model 3 =** From 4K to 48K Requires (3) Three Kits  
**Color =** From 4K to 16K Requires (1) One Kit

**\*\*Model 1 equipped with Expansion Board up to 48K Two Kits Required - One Kit Required for each 16K of Expansion -**

**TRS-16K3 \*200ns for Color & Model III** ... \$12.95  
**TRS-16K4 \*250ns for Model I** ... \$10.95

**TRS-80 Color 32K or 64K Conversion Kit**

Kit comes complete with 8 each 4164-2 (200ns) 64K dynamic RAMs and conversion documentation. Converts TRS-80 color computers with Revision boards and 1.1 ROMs to 32K of memory. Minor modifications of 32K memory will allow the use of all 64K of the dynamic RAM.

**TRS-64K2 (200ns)** ... \$54.95

**5 1/4" Mini-Floppy Disk Drive**

FOR TRS-80 MODEL I (Industry Standard)  
Features single or double density. Recording mode: FM single, MFM double density. Power: +12VDC @ 0.8V/1.6A max., +5VDC @ 0.25V/0.8A max. Unit as pic. at left; does not incl. case, power supply, cables, 30-pg. data book incl. 100 5 1/4" disks. Size: 5 1/4" W x 8 1/2" D x 1 1/4" H.

**FD200** Single-sided, 40 tracks, 250K bytes capacity ... \$179.95  
**FD250** Double-sided, 35 tracks, 438K bytes capacity ... \$199.95

**Siemens 8" Floppy Disk Drive**

- Single-Sided
- 77 Tracks
- 400/800 Bytes Capacity
- Industry Standard

**FDD100-8" Floppy Disk Drive (Industry Standard)** features single or double density. Recording mode: FM single, MFM double density. Transfer rate: 250K bits/sec. single density; 500K bits/sec. double density. The FDD100-8 is designed to work with the single-sided soft-sectored IBM Diskette I, or eq. disk cartridge. Hard-sectored option available. Power: 115/230VAC @ 50/60Hz. +24VDC @ 1.7 amps max., +5VDC @ 1.2 amps max. Unit as pictured above (does not include case, power supply, or cables). Size: 8.55" W x 14" L x 4.5" H. Weight: 12 lbs. incl. 50-pg. manual.

**FDD100-8 Buy 1 for** ... \$269.95 each  
**FDD100-8 Buy 2 for** ... \$259.95 each  
**FDD100-8 Buy 10 for** ... \$249.95 each

**2708, 2716, 2732 & 2764 EPROM Programmer**

**J6664 EPROM PROGRAMMER**  
8K TO 64K EPROMS - 24 AND 28 PIN PACKAGES  
Self-Contained - Requires No Additional Systems for Operation

**NEW!**

**J6664-A EPROM Programmer** ... \$995.00  
Assembled & Tested (includes JM16A Module)

**J6665 - RS232C INTERFACE OPTION** - The J6665 RS232C interface option implements computer access to the J6664-A RAM. Sample software written in BASIC provided for TRS-80 Model I. Level II Computer. Baud rate: 9600. Word Length: 8 bits - odd parity. Stop bits: 2. Option may be adapted to other computers.

**J6664-ARS EPROM Prog. w/J6665 Option** ... \$1195.00  
Assembled & Tested (includes JM16A Module)

**EPROM JUMPER MODULES** - The J6664's JUMPER MODULE (Personality Module) is a plug-in Module that pre-tests J6664 for proper programming to the EPROM & configures EPROM socket connections for that particular EPROM

Part No.	EPROM	EPROM MANUFACTURER	PRICE
JM68A	2708	AMD, Motorola, National, Intel, TI	\$14.95
JM16A	2716, 1M52516	Intel, Motorola, National, NEC, TI	\$14.95
JM16B	1M52716	Motorola, TI (+5,-12, +12)	\$14.95
JM32A	1M52532	Motorola, TI	\$14.95
JM32B	2732	AMD, Fujitsu, NEC, Hitachi, Intel	\$14.95
JM64A	1MCM8764, MCM681764	Motorola	\$14.95
JM48B	2764	Intel	\$14.95
JM64C	1M52554	TI	\$14.95

**UV-EPROM Eraser**

**8 Chips - 51 Minutes**

**1 Chip - 37 Minutes**

Erases 2708, 2716, 2732, 2764, 2516, 2532, 2564. Erases up to 8 chips within 51 minutes (1 chip in 37 minutes). Maintains constant exposure distance of one inch. Special conductive foam liner eliminates static build-up. Built in safety lock to prevent UV exposure. Compact - only 8.00" x 3.70" x 2.00". Complete with holding tray for 8 chips.

**UVS-11EL Replacement Bulb** ... \$16.95

**DE-4 UV-EPROM Eraser** ... \$79.95

**Sprite-style Fan**

- 36cfm free air delivery
- 3.125" sq. x 1.665" depth
- 10 yrs. cont. duty at 20°C
- 115V 50/60Hz

**PWS2107U** Cleaned & tested (used) ... \$ 9.95 ea.  
**PWS2107F** New ... \$14.95 ea.

**Muffin-style Fan**

- 105cfm free air delivery
- 4.68" sq. x 1.50" depth
- 10 yrs. cont. duty at 20°C
- Impedance protected, ambient to 70°C
- 115V 50/60Hz 14W Wt. 17 oz.

**MU2A-1U** Cleaned & tested (used) ... \$9.95 ea.  
**\*MU2A-1N** New ... \$14.95 ea.



## MORE GAIN THAN A VARACTOR UHF TUNER



**SATISFACTION GUARANTEED \$15.00**

Freq. Range UHF470-889MHz Channels 14-83 Output Channel 3.

Available on request: Ch 2 or 4.

Part No. B20

Modified High Gain Tuner. . . . . **\$15.00**

1. The first thing we do is change the standard diode found in every tuner to a Hot Carrier Diode.
2. The tuners output is then measured and compared to our computer derived chart from which we determine the correct value coil to add across the IF output for maximum Pre-Peaked gain.
3. The tuner is fed a standard 10db antenna input, and while monitoring the output on our Spectrum Analyzer, the tuner is tuned to the desired channel and its oscillator is offset for the desired output frequency as follows:

Ch. 2:58Mhz Ch. 3: 63Mhz Ch. 4: 68Mhz

We call this step peaking because the tuners output looks like a peak on our spectrum analyzer and the highest point of that peak is actually adjusted for the desired output.

4. Finally, we measure the tuners output one more time which is again compared to our computer derived performance chart to ascertain the correct value of the second coil which is added to the tuners internal connections.

This procedure was developed by GILCO and its our computer derived performance charts that make our tuner better. That's because almost every tuner gets a different value coil before it's peaked and then a different value coil after it's peaked. The combinations are endless and the way we determine the values is our secret.

### PRINTED CIRCUIT BOARDS

Part No. B21 Printed Circuit Board. . . . . **\$17.00**

1. This Printed Circuit Board uses only one jumper, others use 9.
2. The component layout is screen printed on the Component side of the pre-drilled P/C Board.
3. The solder side of the P/C Board is covered with High Temperature Solder Resist for ease of assembly.
4. This P/C board was designed to take advantage of the Gilco High Gain Tuner which means its circuitry is simpler and more efficient than those circuits that require inferior Varactor Tuners.

### ELECTRONIC PARTS KITS

Part No. B22 Complete Parts Kit. . . . . **\$80.00**

All resistors (30), Potentiometers (1-5K, 3-10K), Panel Mount Potentiometer (10K), Electrolytic Capacitors (6), Ceramic and Mylar Disc Capacitors (35), Variable Capacitors (4), All Integrated Circuits (7), Voltage Regulator, Heat Sink, Diodes (4), IC Sockets (4-8 pin, 3-14 pin), Power Transformer (24V/1A), Coil Kit with No. 26 wire (4), Speaker (4" 3 Oz.), Standoffs, Coaxial cable, All misc. Hardware, etc. All parts are individually packaged and labeled.

All components including the wire, Hardware, Coaxial Cable and heat sinks are included in the parts kit. This means your assembly time from start to finish is only 4 hours.

Order all 3, B20, B21, B22. . . . . **110.00**

Order 5 each, B20, B21, B22. . . . . **95.00/set**

### ACCESSORIES: AMPLIFIERS

Part No.	Description	Kit Price
A02	New 2 Stage Low Noise 28db gain RF Amplifier Specially designed for kit builders	<b>Kit \$18.00</b>
A03	New 1 Stage Low Noise 14db gain Amplifier	<b>Kit \$10.50</b>
A04	75-300 OHM matching Transformer.	<b>\$1.00</b>
F59	Coaxial Connectors. . .	<b>.30</b>

Mail order only. Send check or money order to:

**GILCO INTERNATIONAL, INC.**

P. O. Box 8817, Coral Gables, FL 33124

Tel. (305) 823-5891 For C.O.D. orders add 10% shipping and handling or for orders over \$50, add 5%.

FL residents add 5% sales tax. Please write for more information



**ELECTRONICS CO., INC.**

# FREE CATALOG

32 pages with 47 exciting, low cost electronic projects! **at your local electronics store**

CALL for store nearest you  
**1-800-453-1708**



**SEE**

these electronic kits in Kit Centers throughout the U.S.A.



Combo-Lock

Digital Slot Machine

801 Pocket Dice	842 12-volt Color Organ
802 Signal Injector	844 T.V. Jammer
803 Space War Gun	846 12-volt Strobe Stick
804 Metal Detector	850 Whooper Alarm
805 Logic Probe	852 Combination Lock/Alarm Central
806 Burglar Alarm	855 Electronic Tumbler
808 Decision Maker	858 Digital Roulette
809 LED Pendulum Metronome	860 5-24 Volt Regulated Power Supply
811 Double Decision Maker	861 Big Sound Portable Organ
812 Siren Oscillator	862 Full-wave Motor Speed Control
814 Robot Blinker	866 Digital Slot Machine
816 Mini-wink	868 Digital Dice
818 Fish Caller	870 Nerve Tester
820 Shimmer Lights	875 6-digit Digital Clock
821 Christmas Tree	878 Digital Bird
822 One Channel Color Organ	880 12-volt, 2-amp Regulated Power Supply
824 Automatic Siren	882 Musical Horn
826 Fax Box	884 Sound Activated Color Organ, 1-channel
828 9-Volt Power Supply	885 Audio Amp/Intercom
830 Multi-purpose Power Supply	888 Librarian Terminator
834 Color Organ 3-channel, 1-central	890 Step-action Timing Tester
836 3-channel, 4-control Color Organ	892 Telephone Hold Button
840 Variable Strobe Light	894 Phaser Gun/Sound Generator
	898 Binary Clock

Also available

**PPG's Basic Electronics Course**

# NEW BODY BLINKER

from PPG Electronics

**available NOW!**  
for only **\$5.95**

Allow 2 weeks for delivery of your **FREE 1982-83 PPG CATALOG.**

**PPG ELECTRONICS CO., INC.**  
791 Red Rock Road, St. George, UT 84770  
**1-801-628-3627**

**SPARTAN Electronics Inc.**



CALL (516) 499-9500 MAIL

6094 Jericho Tpke. Commack, N.Y. 11725

**VIC-20**

**\$205<sup>00</sup>**

Vic 20 Personal Computer	205.00
Vic 1540 Single Disk Drive	349.00
Datasette Cassette I/O Unit	69.00
Vic 1515 Graphic Printer	349.00
Vic Super Expander	65.00
3K Ram Cartridge	34.50
8K Ram Cartridge	55.00
16K Ram Cartridge	115.00
Vic IEEE-488 interface	79.00
Vic RS-232C Terminal interface	39.00
Vic Modem	100.00
6-slot Expander	115.00

### CABLE TV ACCESSORIES

2 set coupler	2.95
3 set coupler	3.95
4 set coupler	4.50
F Connectors	.25
Matching transformer	.99
TV Game Switch	3.95
VHF-UHF AMP-28DB	29.95



**POPEYE**  
One-piece Phone  
**\$59.95**

### DELUXE 40 CHANNEL VHF to UHF Block Converter \$38.95 ea.

Features accessible fine tuning knob included: matching X former and two cables

### SCOTCH DISKETTES

5 1/4 SSDD Soft  
Box 10 **\$29.95**

**Refurbished Monitors** 12" diagonal  
Quantity Ltd. **39.95**

9" Commercial Grade **\$59.95**



Atari 800 (48K)	659.00
Atari 400 (16K)	279.00
410 Program Recorder	79.00
810 Disk Drive	439.00
850 Interface Module	169.00
Epson cable for 850 module	34.00
Atari Joysticks (pair)	20.00
32K module	99.95
Atari 16K Module by Microtek	69.00
VisiCalc for Atari (Disk)	185.00
Pac-Man (cartridge)	34.50
Centipede (cartridge)	34.50
Asteroids (cartridge)	34.50
Missile Command (cartridge)	34.50
Star Raiders (cartridge)	39.50
Space Invaders (cartridge)	34.50
Caverna of Mars (disk)	34.50
Assembler/Editor (cartridge)	49.50

We carry all ATARI software and hardware

### Jerrold 36 Channel Remote CATV Converter

w/on/off Fine Tuning **\$94.95**

### 40 Channel VHF to UHF Block Converter

**28.95 Ea.**  
**24.95 4 & up**

### Volume Discounts

Min. Order \$25.00	to 75.00	\$2.50
International Shipping Add'l.	76.00 to 250.00	\$4.50
Prices subject to change without notice.	251.00 to 500.00	\$6.00
COD 2.00 Extra	501.00 to 750.00	\$8.50
*Add'l. shipping for monitors	751.00 to 1000.00	\$12.00
	Over 1000.00	\$12.50

(516) 499-9500 Mon Th 9-8 Tu W F 9-6 Sa 9:30-5



# AMAZING DEVICES

**PHASOR PAIN FIELD** — Patented and recently developed in our labs is being tested by Gov't for riot control. Soon to come under weapons restrictions as an infernal machine. Easily hand-held. Hazardous if NOT USED WITH DISCRETION.

PPF-1 PLANS (sold for animal control) **\$15.00**

**INVISIBLE PAIN FIELD GENERATOR** — Produces a directional field of moderately intense pain to back of head up to 50'. Cigarette pack size enclosure is easily hidden.

IPG-3 PLANS **\$7.00** IPG-3K KIT & PLANS **\$44.50**

IPG-30 (assembled for animal control) **\$59.50**

**PHASOR STUN/BURNING WAND** — Produces sufficient electrical energy capable of burning flesh. Intended as a personal defense device.

PSW-3 PLANS **\$8.00** PSW-3K KIT & PLANS **\$59.50**

**RUBY LASER RAY PISTOL** — Intense visible red, burns, hazardous, with parts sources.

RUBY PLANS (includes all part sources) **\$15.00**

**CARBON DIOXIDE LASER** — Generates 20-40 watts of continuous power capable of burning, cutting, hazardous. (with all part sources) **\$15.00**

**LASER RIFLE** — Produces 200-3000 pulses of 30 watt optical energy. Portable and easily hand-held.

LRG-3 PLANS **\$10.00**

LRG-3K KIT PLANS (minus diode) **\$129.50**

**POCKET LASER** — For the beginner, visible red optical version, non-hazardous.

LHC-2 **\$5.00** LHC-2K KIT & PLANS **\$24.50**

**HIGH POWERED PORTABLE ENERGY SOURCE FOR LASERS AND MAGNETIC WEAPONS** — Exploding wires, shockwave, etc. Miniature size.

HPS-1 PLANS **\$8.00** HPS-1K KIT & PLANS **\$49.50**

**PARTICLE BEAM WEAPON** — PLANS **\$15.00**

**INFINITY XMTR** — Uses telephone lines for selective home or office listening while away on business or vacation.

INF-1 PLANS **\$15.00**

**SEE IN DARK** — Long range, total darkness.

SD-4 PLANS **\$10.00**

**LONG RANGE WIRELESS MIKE** — Crystal clear quality — miniature.

FBT-7 PLANS **\$7.00** FBT-7K PLANS & KIT **\$34.50**

**WIRELESS TELEPHONE TRANSMITTER** — Long range, automatic.

VWPM-5 PLANS **\$10.00** VWPM-5K PLANS & KIT **\$34.50**

Send for **FREE** catalog description of above plus hundreds more plans, kits and completed items. We accept MC or Visa or when ordering, send check or money order. We pay shipping charges on orders over \$50.00, otherwise include 10% with remittance.

SEND TO: **SCIENTIFIC SYSTEMS**  
DEPT. R8, BOX 716, AMHERST, N.H. 03031

# CABLE TV

## CONVERTERS DESCRAMBLERS

**Largest Selection of Equipment Available**  
Buy Warehouse Direct & Save \$

**36 channel converter**  
**\$4595**

**36 channel wired remote converter only**  
**\$8895**

Send \$2 for complete catalog of converters and unscramblers

Quantity Discounts • Visa • Master Charge  
Add 5% shipping — Mich. residents add 4% sales tax

**C&D Electronics, Inc.**  
P.O. Box 21, Jenison, MI 49428  
(616) 669-2440

### CPU'S & SUPPORT CHIPS

8039	6.95	8251	4.00
8085A	2.75	8253	4.95
8085A	5.75	8255	4.95
AMD 2901	8.95	8259	5.95
8202	18.95	8267 (AM9517)	7.95
8212	1.80	8268	15.00
8214	3.00	8262	5.75
8216	1.75	280A CPU	3.75
8224	2.25	280A S10	12.95
8226	1.90	280A P10	3.75
8228	3.50	280 CTA C	3.75
8195	3.50	TMS 9927 NL	9.95
8196	8.95	8275	16.95
8227	14.00	8284	13.95
3242	6.00	6910	2.50
8795	29.95	6880	2.95

### RAM's

21L02-3	70	2708	2.95
928-422	5.95	2718 1/2V	4.25
2101-1	1.85	2722	8.95
2111AL	1.95	2532	7.95
2114L-3	1.65	2794	15.95
2147-3	4.95	82523	1.95
TMS3409	1.95	82513	4.00
MK4008P	1.95	82512 (6331)	1.95
MK4027-3	1.95	825129	1.95
TMS4096NL	2.95	825130	1.95
MK4096-11	1.95	3638A-3	3.00
4116-2	1.00	AM8214C	2.95
4116-3	1.30	8256-57(188A)	1.25
4116-15	1.95	745387	1.75
5101E	2.95	745474	3.95
26104-4	2.50		
6116-3	5.50		
6264(4164-2)	6.25		

### INTERFACE & DRIVERS

1488	65	MM1402	1.75
1489	65	MM1403	1.75
8130	2.50	MM1404	1.75
8830	2.50	MM5013	1.75
8131	2.50	MM5055	2.50
8833	2.50	MM5056	2.50
8834	2.50	MM5057	2.50
8837	2.00	MM5050	2.50
MM5307	7.95		
8R1941L	8.95		
MM5321	2.50		
MM5308	2.50		
TR1028	3.95		

### SHIFT REGISTERS

14 PIN HEADERS	3/41.00
24 PIN HEADERS	7.50
40 PIN HEADERS	1.10
50 PIN EDGEBOARD CONN.	3.95
25 PIN EDGEBOARD CONN.	2.50
50 PIN ANGLE CONN.	3.95
20 PIN RIGHT ANGLE CONN.	2.25

### 50 PIN RIBBON CONNECTORS

24 PIN RIBBON CABLE CONN.	13.25
20 PIN RIBBON CABLE CONN.	13.25
10 PIN RIBBON CABLE CONN.	11.90

PRINTED CIRCUIT BOARD  
4" x 6" DOUBLE SIDED EPOXY BOARD 1/16" THICK  
8.00 ea.

### EPOXY GLASS VECTOR BOARD

1/16" thick with 1/10" spacing  
4 1/2" x 6 1/2" **\$1.95**

CRYSTALS	2.95 ea.		
1.000	4.000	6.144	18.000
2.000	5.000	8.000	18.432
3.000	6.000	10.000	20.000

### 7 WATT LD 65 LASER DIODE (R) \$8.95

25 watt Infra Red Pulse (SG 2006 equiv.)  
Laser Diode (Spec sheet included) \$24.95

2N3820 P FET	4.45
2N 5457 N FET	4.45
2N2646 UJT	4.45
ER 900 TRIGGER DIODES	4/1.00
2N 6028 PROG. UJT	6.55

### DISC CAPACITORS

1UF 16V	10/91.00	100/68.00
01UF 35V	16/91.00	100/85.00

### IN4148 (IN914) 15/1.00

### TANTALUM CAPACITORS

22UF 35V 5/91.00	10UF 20V	8.40
47UF 35V 5/91.00	22UF 10V	8.30
68UF 35V 5/91.00	15UF 16V	3/91.00
1UF 20V 5/91.00	30UF 6V	5/91.00
2.2UF 20V 5/91.00	33UF 10V	4.40
3.3UF 20V 4/91.00	47UF 20V	8.85
4.7UF 35V 4/91.00	68UF 10V	9.00
6.8UF 35V 3/91.00	120UF 6V	6.75
	200UF 20V	6/75

### DIP SOCKETS

8 PIN	.13	20 PIN	.25
14 PIN	.15	24 PIN	.30
16 PIN	.17	28 PIN	.40
18 PIN	.20	40 PIN	.50

### RS232 CONNECTORS

DB 25P male	62.75
DB 25S female	3.75
HOODS	1.25

POSTAGE ADD 10% FOR ORDERS UNDER \$25.00  
RATES ADD 5% FOR ORDERS BETWEEN \$25.00 AND \$50.00  
ADD 3% FOR ORDERS ABOVE \$50.00

### C/MOS

4001	25	4008	35	4091	25	74C12	30
4002	25	4009	35	4082	25	74C42	1.00
4006	35	4026	35	4083	45	74C73	85
4007	27	4034	1.75	4089	1.75	74C74	50
4008	70	4038	65	4090	85	74C75	70
4010	45	4042	65	4011	85	74C86	39
4011	35	4043	65	4014	1.25	74C88	1.40
4012	32	4044	85	4015	1.25	74C89	1.25
4013	35	4045	85	4016	1.25	74C94	2.50
4014	70	4047	95	4018	85	74C157	75
4015	38	4048	35	4020	70	74C190	1.20
4016	30	4050	35	4023	1.25	74C191	1.15
4017	80	4051	80	4024	2.75	74C193	1.15
4018	50	4052	85	4025	30	74C172	95
4019	39	4053	75	4026	75	74C174	1.15
4020	70	4054	35	4027	27	74C176	1.15
4021	30	4055	35	4028	25	74C178	1.15
4022	35	4056	35	4029	35	74C191	29
4023	35	4057	35	4030	35	74C192	75
4024	45	4058	25	74C120	27	74C194	1.75
4025	35	4072	20	74C124	38	74C201	75
4026	95	4077	65	74C20	27		
4027	40	4078	35				

### DOUBLE SIDED DIP RIBBON CABLE JUMPER ASSEMBLIES

16 PIN 4" LONG **\$ 2.00**  
14 PIN 12" LONG **\$ 2.50**

### RS 232 CABLE

10 Conductor, #22 color coded wire, gray PVC outer cover, 3/8" diameter  
40 per ft. — 100/430.00  
Add 20% postage for orders under 100'.  
Add 10% postage for orders over 100'.

### SPECIALS

#### CPU's

6502	66.00
8080A	2.75
280A	3.75
68000L8	90.00

#### CRT Controllers

TMS9827NL	\$ 9.95
6845	13.95
8275	16.95

#### ROM's

2732	\$ 7.95
2716	4.00
MC8764C	19.95

#### RAM's

2114L-4	\$1.35
4116-2	1.60
MK4802-3J-2KX8	8.95
83L422 BIPOLAR	5.95
4104-2-64K	7.95
2147-3	4.95
4118-4	6.95

#### DISC Controllers

1771	16.50
1791	35.00
1793	35.00
1795	45.00
1797	45.00
0765C	25.00

ALL RECTIFIERS 10% OFF  
SPECIALS GOOD THRU FEB. 1983

### NO. 30 WIRE WRAP WIRE

SINGLE STRAND  
100' — \$1.40

### DIP SWITCHES

CTS 206 4 4 POSITION 1.25  
CTS 206 7 7 POSITION 1.40  
CTS 206 8 8 POSITION 1.50  
CTS 206 10 10 POSITION 1.95

### TOGGLE SWITCHES

1050	SPDT	1.10
2060	DPDT	1.50
2069	DPDT	CENTER OFF 1.75

### SCR's

1.5A	6A	35A	110A
100	.30	.40	1.40
200	.40	.50	1.90
400	.60	.70	2.60
600	1.00	3.00	15.00

### TRIAC's

PRV 1A	10A	25A
100	.35	.60
200	.50	.80
400	.70	1.00
600	1.00	1.20

### 20KV 250MA DIODE \$1.90

### SILICON POWER RECTIFIERS

PRV 1A	3A	12A	50A	125A	240A
100	.05	.12	.35	.90	4.25
200	.06	.17	.50	1.30	5.25
400	.09	.25	.65	1.50	6.50
600	.11	.30	.80	2.00	8.50
800	.13	.35	1.00	2.50	10.00
1000	.15	.45	1.25	3.00	12.50

### FLAT RIBBON CABLE

26 conductor . . . 60/ft 28 gauge  
40 conductor . . . 90/ft  
50 conductor . . . 1.00

### .5V at 800mA SOLAR CELLS

3" diameter **\$4.35**

### 7 SEGMENT DISPLAYS

FSC8024-4 digit	DL-707 C.A. 3"	62.75
C.C. 8" display	FND810.8" CA	61.95
FND 359	FND803.8" CC	61.95
FND 503 C.C. 5"	MAN 84 C.C. Green	6.75
DL-704 3" C.C.	MAN 82 C.A. Yellow	6.75

### TRANSISTOR SPECIALS

2N1307 PNP GET-5	4.40
2N4004 PNP GET-5	3/41.00
HEP 0004 - PNP GET-3	247
TIP 111	80
TIP 145	35
2N3772 NPN SWITCHING POWER	41.95
MHT-800M CDM TRANSISTOR POWER	41.95
2N3772 NPN SI TO-3	41.00
2N3772 PNP SI TO-3	41.00
TIP 3055 PNP SI	41.00
2N2922 NPN SI TO-18	10/41.00
2N2927 PNP SI TO-18	10/41.00
2N3069 PNP SI TO-3	41.00
2N3069 NPN SI TO-3	9/41.00
2N3068 PNP SI TO-320	41.00
2N3068 NPN SI TO-320	41.00
TIP 3208 PNP SI TO-320	39
TIP 34 PNP SI	39
TIP 321 PNP SI U84	39
TIP 141 PNP SI U84	11.00
8L005	17.75

### TTL IC SERIES

7400	17	7472	30	74612	80
7401	17	7473	35	74163	60
7402	17	7474	32	74164	60
7403	17	7475	40	74165	60
7404	24	7476	35	74166	70
7405	24	7480	45	74170	1.00
7406	28	7483	50	74171	1.00
7407	28	7485	55	74174	65
7408	24	7486	35	74175	80
7409	18	7489	1.00	74176	75
7410	35	7492	60	74180	1.00
7411	22	7493	45	74182	45
7412	30	7492	45	74190	70
7413	35	7493	35	74191	75
7414	45	7494	60	74193	79
7416	25	7495	55	74194	85
7417	25	7496	60	74195	45
7420	17	74107	30	74196	75
7426	25	74116	50	74199	1.00
7428	25	74121	29	74273	85
7427	25	74122	39	74279	80
7430	17	74123	42	74298	65
7432	45	74124	60	74300	65
7437	27	74145	60	74367	65
7438	2				





# FORMULA INTERNATIONAL INC.

12603 Crenshaw Blvd., Hawthorne, CA 90250  
For information (213) 973-1921 • Orders Only (outside Calif.) (800) 672-8758



# pineapple™

The Alternative! The Compatible!  
The Affordable! 48K Color Computer!  
Fully Assembled!



**\$645<sup>00</sup>**  
EACH

(please add 5% shipping and handling)

### FEATURES:

- ★ Fully compatible with Apple® II+
- ★ Singleboard for easy assembly
- ★ Popular 6502 MPU for large amount of software
- ★ Game paddle connector on both sides of case
- ★ Built in 2-watt amplifier for realistic sound effect with volume control
- ★ 8 on board peripheral connectors for expansion
- ★ 14 key numeric key-pad
- ★ 5-amp switching power supply

Easy to assemble! All components are clearly silk-screened on the high quality double-sided mother board. All integrated circuits, IC sockets, peripheral connectors, keyboard, switching power supply and the professional high impact plastic case are included.

### High Quality 16K RAM Card Kit

(no cable required)

Same feature as the one we've been selling but without the mess of Dip-wire for Apple® & Pineapple™. **\$59.95** per kit

### 5 1/4" Flexible Disc Sale

Why buy other brands when you can buy WABASH discs for much less and backed by 1-year factory warranty.

All discs come with Hub Rings

<b>M13A411X</b>	5 1/4" SSDD Soft Sector	<b>\$2.25</b>	} 10-99
<b>M43A411X</b>	5 1/2" SSDD 10 Hard Sector	<b>\$2.25</b>	
<b>M53A411X</b>	5 1/4" SSDD 16 Hard Sector	<b>\$2.25</b>	
<b>M14A411X</b>	5 1/4" DSDD Soft Sector	<b>\$3.65</b>	
<b>F111111X</b>	8" SSSD IBM compatible	<b>\$2.45</b>	
<b>F131211X</b>	8" SSSD 26 sectors 128 bytes	<b>\$3.05</b>	

### 16K RAM Card Kit For Your Apple® & Pineapple™ Computer



Kit includes:

- High Quality P.C. Board • 8 ea. 4116 (200ns)
- All the IC's & parts • 16-pin Dip wire • Easy to assemble. You can do it in less than 30 minutes!

**\$49.95** per kit

### 5 1/4" Disc Drive 100% Apple® & Pineapple™ Compatible



We did it once, response was great! Now we are doing it again, don't miss it!  
**\$295.00** ea. w/o controller  
**\$385.00** ea w/controller

### Replacement Keyboard For Your Apple® II Computer

Got a bad Keyboard? Here's the alternative!

- ★ Full ASCII code
- ★ N-key rollover function
- ★ TTL level output
- ★ On-Off indicator
- ★ Low power consumption
- ★ With upper/lower case function



**\$99.95** ea.

### At last! Here's the computer case everyone has been looking for!

Ideal for your homebrew  
\*AP-II 6502 MPU based computer.  
Made with high impact plastic.  
Color and shape are compatible with the standard Apple II computers.



Introductory Offer  
**\$150.00** ea.

Keyboard not included see our Ad in this page.

MODEL: AP-II

\*AP-II model is compatible with Apple II but not manufactured by Apple Computers, Inc. ®Apple or Apple II is a registered trade mark of Apple Computers, Inc.

### 6502 MPU Based Computer Motherboard! You ask for it, you got it!

- ★ 48K on board memory (4116)
- ★ 12K on board EPROM memory (2716 or 2732)
- ★ 8 expansion slots for peripheral cards
- ★ Composite-video output
- ★ size: 14 1/4" x 8 1/2"



**\$99.95** ea.

### Switching Power Supply For Apple®, AP-II, and Pineapple Computer

Compact size switching power supply.

Specification:	<b>4006A</b>	<b>4007A</b>
+5V at	<b>3A</b>	<b>5A</b>
-5V at	<b>2A</b>	<b>3A</b>
+12V at	<b>.5A</b>	<b>1A</b>
-12V at	<b>.5A</b>	<b>1A</b>



4006A ..... **\$99.00** ea.

4007A ..... **\$145.00** ea.

Size: Width 3 1/2", Depth 9 3/4", Height 2 1/4"

Size and mounting holes will be same as the one used in Apple II.

\* Apple is a registered trademark of APPLE COMPUTERS, INC.

SHIPPING AND HANDLING CHARGES	
Under \$50.00 Purchase	Over \$50.00 Purchase
10%	5%
15%	10%
25%	20%

Minimum Order \$10.00 / Calif. Residents add 6.5% Sales Tax. Phone Orders Accepted on VISA or MC ONLY, NO C.O.D.'s. Prices subject to change without notice.



STORE HOURS  
MON-FRI — 10-7  
SAT — 10-6

Inside California  
Outside Calif. (incl. Mexico & Canada)  
Overseas





# FORMULA INTERNATIONAL INC.

12603 Crenshaw Blvd., Hawthorne, CA 90250  
For information (213) 973-1921 • Orders Only (outside Calif.) (800) 672-8758



## TR-747 DC SERVO POWER SUPPLY FOR TA-2000



DC Servo feedback circuit makes this power supply a must for our TA-2000 amplifier. The TR-747 will monitor the operating conditions of the TA-2000 power amplifiers. MODEL TR-747 \$24.95 per kit



### LASER SUPER LANTERN

Brilliant fluorescent lantern with 9" 6 watt fluorescent tube. Features include: Powerful direct beam spotlight with 9V prefocus bulb; Buzzer horn - either constant or time intervals of sonic alarm; Twin blinker - red amber flashing or red & amber flashing on red intervals; fully adjustable nylon strap. Operates from D size batteries or plugs into vehicle cigar lighter socket.

SPECIAL \$16.50



### POCKET LIGHT

Complete with 5" fluorescent tube, powerful bulb and handy Strap. Runs on 3 pcs. 15 V "C" size batteries (not included). It's a practical, convenient, powerful spotlight and fluorescent light. Its superior quality is ideal for indoor or outdoor use.

LOW PRICE \$7.50

### REGULATED DUAL VOLTAGE SUPPLY KIT

±10-30 VDC @ 250 mA adjustable, fully regulated. Kit includes all electronic parts, filter capacitors, IC's, heat sinks and PC Board.

\$12.50 per kit

### MARK IV — 15 STEP LED POWER LEVEL INDICATOR KIT

This new stereo level indicator kit consists of 36 4-color LED's (15 per channel) to indicate the sound level output of your amplifier from -36dB to +3dB. Comes with a well designed silk screen printed plastic panel and has a selector switch to allow floating or gradual output indicating. Power supply is 6-12VDC with THG on board input sensitivity controls. This unit can work with any amplifier from 1W to 200W! Kit includes 70 pcs driver transistors, 38 pcs matched 4-color LED's, all other electronic components, PC Board and front panel.

MARK IV KIT \$31.50



### SUPER FM WIRELESS MIC KIT — MARK III

This new designed circuit uses high FREQ FET transistors with 2 stage pre-amp. Transmits FM range (88-120MHz) up to 2 blocks away and with the ultra sensitive condenser microphone that comes with the kit allows you to pick up any sound within 15 ft. away. Kit includes all electronic parts. OSC coils and PC Board. Power supply 9VDC.

FMC-105 \$11.50 Per Kit

### 6-WAY A/C ADAPTOR

Input 110VAC Output 3V 4.5V 6V 7.5V & 12VDC Current 300mA

OUR LOW PRICE \$5.50 each

### 19" RACK MOUNT CABINETS

Black anodized front panel with black textured case

WIDTH	DEPTH	HEIGHT	PRICE
17"	11 1/2"	3"	\$25.50
17"	11 1/2"	5"	\$31.50
17"	11 1/2"	7"	\$39.50

### PROFESSIONAL FM WIRELESS MICROPHONE

Made by one of the leading Japanese manufacturers. This factory assembled FM wireless microphone is powered by two AA size batteries. It transmits in the range of 88-108 MHz. Element is built in a plastic tube type case with an omni-directional electronic condenser microphone unit. By using a standard FM radio, signal can be heard anywhere on a one-acre lot. Sound quality was judged "very good." MODEL WEM-38

ON SALE WAS \$16.50 8.25 each

### No Fcc License Required. OUR PRICE \$49.50

Additional Microphone (Transmitter) Available AT \$28.00 each MURA WMS-49



### CRYSTAL CONTROLLED WIRELESS MICROPHONE SYSTEM

Transmitter: FET mic for flat 30Hz-18KHz response. X'tal controlled 49 MHz AM Band for drift-free performance. 100 MW output (range approx. 1/4 mile) for reliable long range transmission. Powered by a 9V radio battery (included).

Receiver: X'tal controlled locks on 49 MHz transmitter signal. On panel VU meter, monitors the signal strength from the microphone. Standard phone jack outlet connection to a P.A. or other phone input. 9V battery included. This professional set is ideal for on stage, in field, church, in house or outdoor use.

### SANYO UHF VARACTOR TUNER FOR UHF CHANNEL 14-83

Tuning voltage +1-28VDC. Input impedance 75Ω. IF band width 7-16MHz. Noise figure 11.5dB Max. Size 2 1/4" x 1 1/4" x 3/4". Supply voltage 15VDC. Model 115-B-403A, Video IF 45.0MHz Model 115-B-405A, Video IF 62.5MHz \$35.00 ea.

Tuner is the most important part of the circuit. Don't let those \$19.00 tuners fool you. All units are brand new from Sanyo. When ordering please specify model number.



### LOW TIM DC STEREO PRE-AMP KIT TA-1020

Incorporates brand-new DC design that gives a frequency response from 0-100KHz ±0.5dB. Added features like tone defeat and loudness control let you tailor your own frequency supplies to eliminate power fluctuations! Specifications: • THD/TIM less than .005% • Frequency response DC to 100KHz ±0.5dB • RIAA deviation ±0.2dB • S/N ratio better than 70dB • Sensitivity Phono 2mV 47K/Aux 100mV 100K • Output level 1.3V • Max output 15V • Tone controls Bass ±10dB @ 50Hz/Treble ±10dB @ 15Hz • Power supply ±24VDC @ 0.5A. Kit comes with regulated power supply, all you need is a 48VCT transformer @ 0.5A.

Only \$44.50 X'former \$4.50 ea.



### GOOD NEWS FOR HI-FI NUTS!

Introducing our TA-2000 200 watts P.P. Super Mirror Amplifier Kit.

By using four stages of modern P.P. Super Mirror Circuit, THD and TIM are kept under 0.01% at rated output! SPECIFICATIONS: 200W RMS into 4 or 8Ω

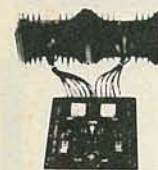

- 0 to 100,000 Hz (at 1W) +0dB, -1dB
- S/N better than 100dB
- Less than 0.01% total Harmonic Distortion.

MODEL TA-2000 \$83.95 per kit



A GOOD BUY AT \$65.00 TA-800

### AUDIO FREQUENCY SPECTRUM ANALYSER KIT TA-2900

This Audio Frequency Spectrum Analyser analyses audio signals in 10 octaves over a dynamic range of 30dB. The technique allows the sound coloration introduced by unwanted room and speaker resonances to be substantially eliminated.

The TA-2900 provides a visual presentation of the changing spectrum thru 100 red LED displays, so you can actually see proof of the equalized sound you've achieved. The TA-2900 kit comes with all the electronic components, IC's, predrilled PC board, the instructions and a 19" Rack Mount type metal cabinet with professional silk-screen printed front panel.

- Input Sensitivity Tape Monitor/10mV - 18mV 50K Ω
- Display Level Range (all octaves) 2dB per step/-14dB to -4dB
- Delay Time (1KHz) Fast/18dB/s Slow/6dB/s
- Power Input 117V or 220V AC 50/60 Hz.
- Power Consumption 36W
- Dimensions 482(W) x 102(H) x 250(D) mm.

\$99.50 per kit



★SPECIAL★ EXCELLENT PRICE! MODEL 001-0034 \$29.50 Per Kit Transformer \$10.50 ea.

### SANYO ANTENNA SIGNAL BOOSTER

This Booster is specially designed for UHF Channels (14-83). After installing (between the antenna input cable and the UHF tuner), this unit will provide a minimum of 10dB gain, that is approximately 2 times better than you are seeing now. Ideal for those who live in apartments that can not put up an outdoor antenna. Small in size, only 2" x 1 1/2" x 1". Supply voltage is 15 VDC. Back In Stock.

★ NEW ITEM ★ MODEL 001-0076 \$12.50 ea.



### 120W PURE DC POWER STEREO AMP KIT

Getting power hungry from your small amp? Have to watch your budget? Here's a good solution! The TA-800 is a pure DC amplifier with a built in pre-amp. All coupling capacitors are eliminated to give you a true reproduction of the music. On board tone and volume controls combined with built in power supply make the TA-800 the most compact stereo amp available. Specifications: 60W x 2 into 8Ω. Freq. range: 0Hz-100KHz ±3dB. THD .01% or better. S/N ratio: 80dB. Sensitivity: 3mV into 47K. Power Requirement: ±24-40 Volts.

### "FISHER" 30 WATT STEREO AMP

MAIN AMP (15W x 2). Kit includes 2 pcs. Fisher PA 301 Hybnd IC, all electronic parts with PC Board. Power supply ±16VDC (not included). Power band with KF 1% ±3dB. Voltage gain 33dB. 20Hz-20KHz.

Super Buy Only \$18.50

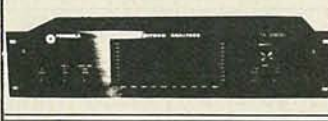

### WHISTLE ACTIVATED SWITCH BOARD

All boards are pre-assembled and tested. Your whistle to its FET condenser microphone from a distance, as far as 30 feet away (sensitivity can be easily adjusted), will turn the switch on and if you whistle again, it will turn off. Ideal for remote control toys, electrical appliance such as lights, coffee pots, TV, Hi-Fi, radio or other projects. Unit works on 9VDC.

MODEL 968 \$4.50 ea.

### TA-1000 KIT

\$51.95 Power Transformer \$24.00 ea.

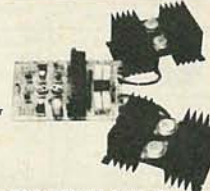

### 100W CLASS A POWER AMP KIT

Dynamic Bias Class "A" circuit design makes this unit unique in its class. Crystal clear, 100 watts power output will satisfy the most picky fans. A perfect combination with the TA-1020 low TIM stereo pre-amp. Specifications: • Output power 100W RMS into 8Ω. 125W RMS into 4Ω. • Frequency response 10Hz-100KHz • THD less than 0.01% • S/N ratio better than 80dB • Input sensitivity 1V max. • Power supply ±40V @ 5A.

### PROFESSIONAL REGULATED VARIABLE DC POWER SUPPLY KIT

All solid state circuitry with high efficiency power transistor 2SD388 and IC voltage regulator MC1733. Output voltage can be adjusted from 0-30V at 1A current limited or 0-15V at 2A current limited. Internal resistance is less than 0.005Ω, ripple and noise less than 1mV, dual on panel meters for voltage and amp reading, also with on board LED and audible over load indicator. Kit comes with pre-drilled PC Board, instructions, all necessary electronic components, transformer and a professional looking metal cabinet. The best project for school and the most useful instrument for repairmen. Build one today!



MODEL TR88A 0-15VDC @ 2A MODEL TR88B 0-30VDC @ 1A

\$59.50 Per Kit

### Apple is a registered trademark of APPLE COMPUTERS, INC.

SHIPPING AND HANDLING CHARGES  
Under \$50.00 Purchase Over \$50.00 Purchase

Inside California	10%	5%
Outside Calif. (Incl. Mexico & Canada)	15%	10%
Overseas	25%	20%

Minimum Order \$10.00 / Calif. Residents add 6.5% Sales Tax. Phone Orders Accepted on VISA or MC ONLY. NO C.O.D.'s. Prices subject to change without notice.



STORE HOURS  
MON-FRI — 10-7  
SAT — 10-6



# MICRO MART

508 Central Ave.  
Westfield, N.J. 07090  
(201) 654-8008

## SANYO AFFORDABLE, HIGH PERFORMANCE COMPUTER



MBC1000

- SPECIAL SOFTWARE PACKAGE INCLUDED**
- 280 CPU
  - 64 KB RAM
  - 328 KB FLOPPY
  - 12" GREEN SCREEN (80 x 25)
  - CENTRONICS/EPSON PORT
  - RS 232C PORT
  - CP/M
  - S BASIC
  - WORDSTAR
  - CALCSTAR

**SPECIAL \$1,995**  
Plus Shipping

## LOW PRICES EPSON PRINTERS/BMC MONITORS CALL FOR RAPID QUOTATIONS

- MOTION DETECTOR CIRCUIT BOARDS**  
(ULN) 2322 \$2.99 5/5/10.00  
IC ONLY (Not mounted on Board) \$1.75 10/\$10.00
- CRYSTALS-3.57945 MHZ±9% 0.9 MHZ±2.95**  
JURKO LEP'S  
Green, 7/1.00; Yellow, 7/1.00; Red, 10/1.00  
100/13.00 100/13.00 100/9.00
- MOUNTING CLIPS - 12/1.00**
- SUPER SUB MINI LYTICS**  
1000uf 50V 75c or 10/6.00  
47uf 25V 10/\$1.00  
47uf 40V 10/\$1.00
- 3 VOLT RES. 78L05 5/\$1.00**
- 33UF 100V DIP NYLON/RAA 6/\$1.00**
- 8PS 6571 8PS SILICON TRANSISTOR 10/\$1.00**
- 13V 1W ZENER DIODE (GLASS) 20/\$1.00**
- 22UF 50V MINI EPOXY DISC 20/99c**
- COMPUTER GRADE CAPACITOR (MALLORY), 11000UF 50V \$1.99**
- FORD Replacement Automotive Electronic Ignition Control Module**  
\$39.95/Blue Grommet AY-184, Green Grommet AY-166 and Black Grommet AY-157
- GM Replacement Automotive Electronic Ignition Control Module \$34.95/BM 1906 4 Prong, BM 1957-7 Prong**

## UHF-TV PREAMP

(As featured in Radio Electronics March/May articles, 1982)

This inexpensive antenna mounted preamp can add more than 25 dB of gain to your system. Lots of satisfied customers and repeat orders for this high quality kit, which includes all component parts, PC BD, Case, Power Supply and Balun. .... \$34.50  
Assembled Version \$57.50

## APPLE HEART RATE MONITOR

- Measures pulse rate through finger attached sensor
  - Low cost, one evening kit assembly
  - Machine language program source code included
  - Attaches to Apple game port
  - Great for experimenters or health enthusiasts
  - Includes all components, PC BDS, Cable
- KIT—\$39.95

## VOLTAGE-MATE Switching Regulator Kit with Adjustable DC/DC Voltage Conversion

- TYPICAL USES:**
- Battery powered projects
  - Op amp designs
  - Electronics in autos, vans & trucks
  - Microprocessor applications
  - RS-232 interface voltages
  - +25v in EPROM programmers
  - Music circuits
  - Portable equipment
  - Dynamic RAM substrate voltage
  - Any application needing higher efficiency
- FEATURES:**
- Three modes of operation: step-up, step-down, inversion
  - Jumpers-selectable modes of operation
  - Input voltages: 5 to 15 VDC
  - Output voltages: —24 to +30 VDC
  - Current draw: 30 to 250 ma, higher currents with an external pass transistor
  - High efficiency design
- PRICE \$22.50

# SURPLUS COMPUTER BARGAINS!!! 8" FLOPPY DRIVE BARGAINS

## SHUGART SA-901



- Single sided, single density
- Approx. 1/4 Mb capacity
- IBM compatible
- Schematics inc. less power supply case
- Untested, complete

Plus Shipping **2/\$1990**

## MPI/CDC 9404



- Single sided, single density
- Removed from equipment to install DSDD drives
- Includes data & schematics
- Untested, complete

Plus Shipping **2/\$1990**

## CENTRONICS 501 Printers



- Unused in original package
- Parallel 'Centronics' interface
- 2 wire serial interface
- 165 cps, 132 columns

NEW ONLY  
Plus Packaging and Shipping **\$650.00**

## "SELECTRIC" 745 I/O Printers



- No time to test 'em
- Complete w/TTL driver inputs
- IBM model 745 I/O printer
- Use as a typewriter or printer

JUST **\$299.00**  
Cleaned & Adjusted Fully Operational ..... **\$399.00**  
Plus Shipping (\$20.00 ea. Pkg.)

WRITE or CALL NOW for our EXCITING BARGAIN-PACKED PERIPHERALS FLYER!!!

Computer  
Peripherals &  
Unlimited



WAREHOUSE: 18 Granite St. Haverhill, Mass. 01830  
MAIL ORDERS: Box 204, Newton, New Hampshire 03858

**617/372-8637**

Sorry, No Collect Calls  
MasterCard & VISA Accepted



Terms: MICRO-MART accepts Visa, MC and telephone COD's. Minimum order \$10.00. Shipping—U.S. orders, \$2.00. Canada and other countries \$3.50 (includes ins.). Shipping rate adjusted where applicable. NJ residents add 5% sales tax.

MICRO-MART • 508 CENTRAL AVE., WESTFIELD, N.J. 07090 • (201) 654-8008

CIRCLE 68 ON FREE INFORMATION CARD

CIRCLE 67 ON FREE INFORMATION CARD

### TUSA

A WHOLE NEW WORLD OF TV VIEWING WITH TUSA'S NEW MODEL CVU-40, 40 CHANNEL CABLE TV CONVERTER. Receive all the EXTRA CABLE TV "MIDBAND" & SUPERBAND CHANNELS on your UHF DIAL. Eliminates the need for renting or leasing. This stable and reliable system converts extra cable TV channels so they can be received on the UHF tuner of your TV set.

**Now \$28.95 ea.**

**NOW AVAILABLE  
NEW TUNEABLE DELUX MODEL CVU-1000 \$34.95 ea.**

### UHF Tuners

White They Last

Continuous Tune Model

3.50 ea.  
5 or more \$2.25 ea.

### POPULAR IC's

TYPE	DESCRIPTION	1-9	10-UP
LM-300N	2 watt Audio Power Amp	\$1.49	\$1.12
LM-306N-3	Low Voltage Audio Amp .500W/5V	1.59	1.19
NE-564N	Digital Phase Locked Loop	3.50	2.89
LM-560N	Phase Locked Loop	1.49	1.12
LM-733N	Video Amp	1.69	1.27
MC-1330	Video Detector	2.49	1.87
MC-1349	Video II Amp	2.06	1.55
MC-1350	Video II Amp	1.75	1.31
MC-1352	Video II Amp AGC	2.69	2.09
MC-1358	Audio II Amp	1.95	1.46
MC-1374P	R.F. Modulator	3.19	2.39
MC-1468	Dual Comp. Op Amp	.88	.66
LM-1496N	Balanced Mod/Demodulator	1.79	1.34
LM-1800	PLL Stereo Decoder	4.49	3.37
LM-1809	Video Modulator	2.95	2.21
<b>LINEAR VOLTAGE REGULATORS</b>			
LM-7805	5 Volt Positive Volt. Reg.	1.30	1.04
LM-7808	8 Volt Positive Volt. Reg.	1.30	1.04
LM-7812	12 Volt Positive Volt. Reg.	1.30	1.04
LM-7815	15 Volt Positive Volt. Reg.	1.30	1.04
LM-7818	18 Volt Positive Volt. Reg.	1.30	1.04
LM-7824	24 Volt Positive Volt. Reg.	1.30	1.04

### WINEGARD

75 OHM UHF YAGI ANTENNAS

12 dB GAIN  
CHANNELS 44-52  
\$8.95 EA.  
6 OR MORE \$6.95 EA.

### BRAND NEW UHF VARACTOR TUNERS

Sanyo YOUR CHOICE  
45 MHz Output \$24.95 ea.  
Mitsumi 45 MHz Output \$24.95 ea.

### AC LINE CORDS

Gray 18 ga. wire  
6 ft. long cable  
Prestripped and tinned ends for easy installation.

1-9 59c ea.  
10-99 49c ea.  
AC-6G 100-Up 39c ea.

### SPEAKER CABINET

Popular speaker cabinets for those famous home brew TV circuits. Speakers included.

Cabinet Dimensions:  
7 1/4" wide x 9 1/2" high x 5 1/2" deep. Removable 18" thick back cover.

SC001 \$10.95 ea.  
2 or more \$8.95 ea.

### Special Purchase

MV-2109  
33pf Tuning Diode  
1-9 \$5.69 ea.  
10-Up \$3.99 ea.

5% MICA CAPS 5%  
10pf 42c ea. 500pf. 66c ea.  
43pf 36c ea. 1200pf. 89c ea.  
110pf 36c ea. 3000pf. 1.39 ea.

### Radial Lead Caps

10 mfd @ 35V 1-11 \$2.25 ea.  
12 or more 16c ea.  
1 mfd @ 35V 1-11 25c ea.  
12 or more 16c ea.  
470 mfd @ 35V 1-11 50c ea.  
12 or more 49c ea.  
1000 mfd @ 35V 1-11 89c ea.  
12 or more 89c ea.  
2200 mfd @ 35V 1-11 1.29 ea.  
12 or more 1.09 ea.  
2200 mfd @ 50V 1-11 1.69 ea.  
12 or more 1.39 ea.

### Axial Lead Caps

1000 mfd @ 50V 1-11 \$9.99 ea.  
12 or more 7.99 ea.  
2200 mfd @ 35V 1-11 1.39 ea.  
3300 mfd @ 35V 12 or more 1.19 ea.  
100V = 10% Polyester Film (Mylar) 10-99 100-999

001mf 20 15 08  
0022mf 20 15 08  
01mf 20 15 08  
047mf 20 15 08  
1mf 20 15 08  
22mf 30 27 22

### POWER TRANSFORMER

24V CT, 400 mA.  
Made in U.S.A.

\$3.69 ea. 10-49 \$2.75 ea. 50 or more \$2.25 ea.

### POPULAR MICROWAVE PARTS

MRF-901 ..... \$2.75  
9-Up ..... 2.19  
MRF-911 ..... 3.46  
9-Up ..... 3.12  
MBO-101 ..... .98  
CHIP CAPS -.001 mfd 50  
25-Up ..... .30  
2N6603 (formerly MRF-902) 11.90

### PROJECT BOXES

Woodgrain

This box is 1 1/4" W - 4 1/4" H - 6 1/2" D with a removable aluminum U-shaped chassis 11" W - 3 1/2" H - 6" D inside.

\$12.50 ea.  
4 or more \$10.95 ea.

### UHF - VHF - FM SPLITTER

40-900 MHz

For TV

Low Loss 3.5-4 db. Low VSWR  
Waterproof 1-9 \$2.49 ea.  
Housing 10-Up \$1.89 ea.

### 3-POSITION COAXIAL PUSH-BUTTON SWITCH

For TV & video cassette recorders. Heavily shielded. Provides maximum isolation. 4 "F" connectors accept 75-ohm coaxial cable with F59 fittings. Push button switches are top mounted. Cutouts for flush wall mounting. 3.75-ohm resistors properly terminate any unused position. Size: 3.9" x 2.4" x 2".

SW003 Now \$6.95 ea.

### SURPLUS AUDIO & VIDEO RF MODULATORS

Hook up sheet included

Now \$5.49 ea.

### WINEGARD DELUXE A-B SWITCH TV-1051

For CATV - MATV - VCR  
75 ohm - 90 db Isolation  
While They Last \$6.95 ea.

### POPULAR MISCELLANEOUS PARTS

10K Volume Control with DPDT switch ..... \$1.49  
10-Up ..... \$1.19  
1/4w 10K Thumbwheel pots 1-12 39  
13-Up 29  
Toroids - T30-12 46  
20-Up 25  
Toroids - T37-2 38  
20-Up 25

ORDER NOW TOLL FREE  
800-854-4655  
OUTSIDE CALIFORNIA  
714-635-5090  
INSIDE CALIFORNIA

R.F. ELECTRONICS  
1056 N. STATE COLLEGE BLVD., DEPT. R  
ANAHEIM, CALIFORNIA 92806

PERSONAL CHECKS HELD FOR CLEARANCE  
MAIL ORDERS WELCOME - INCLUDE POSTAGE - SHIPPED SAME DAY RECEIVED - NO MINIMUM ORDER

OPEN TUES - FRI 10-6  
SAT 10-5  
CLOSED SUN & MON

RADIO-ELECTRONICS

CIRCLE 66 ON FREE INFORMATION CARD

CIRCLE 70 ON FREE INFORMATION CARD

# Tiger TECH ELECTRONIC COMPONENTS

PO BOX 576  
BROOMFIELD, COLO. 80020

FREE Catalog with order (70c without)  
ADD \$2.00 for postage  
US MONEY ONLY PLEASE

# 10 AMP POWERHORSE !!

5VDC Computer power supply. 120 VAC  
50-400 HZ input. External sense  
LIMITED QUANTITY US\$78.95!

## INSTRUMENT CASE

Beautiful solid anodized aluminum case with insert that holds up to six 1"x4" cards. Two lense colors!  
US\$8.39 1-1/2"x4-1/2"x3-1/2"d



Burglar/Fire Alarms

# FREE CATALOG

over 2000 products

CCTV controls alarm systems passive infra reds motion detectors ultrasonic detectors magnetic contacts smoke detectors vehicle alarms accessories remotes tools

**mountain west™**

425 N. 16th Street Dept. RE-2  
Phoenix, AZ 85016  
1-800-528-6169 toll-free

CIRCLE 31 ON FREE INFORMATION CARD

# Graymark Electronic Kits

Quality Products for 18 Years

## Sound Operated Switch

Switch AC ON or OFF with just a clap of your hands. Latching Circuit with Sensitivity Control. AC operated. Includes all necessary parts, PCB and instructions.

Order Model 147A

Only \$13.20 each



## Digital Car Clock

4 digit mini-LED display, adjustable crystal time base for accuracy, IC clock chip, 12V operation. PCB, instructions and all parts included.

Order Model 139A

Only \$19.30 each



## Double Fuzz Box

Hook between amplifier and guitar for expanded sound. Select different Fuzz 1 or Fuzz 2 sounds. Battery operated. Parts, PCB and instructions are all included.

Order Model 138A

Only \$16.60 each



## Battery Checker

Unique bar graph LED readout shows condition of 1.5V or 9V batteries. Precision resistance ladder. Battery operated. Comes complete with parts, instructions and PCB.

Order Model 136A

Only \$11.90 each



## FM Wireless Mic

Broadcast through any FM radio or listen without being seen. High sensitivity. Battery operated. Comes complete with parts, PCB and instructions.

Order Model 143A

Only \$9.70 each



MC & VISA orders only call Toll Free

**800-854-7393**

(In CA 714-540-5480)

CA residents add sales tax • We pay shipping on orders over \$25.00, otherwise add \$2.50. Sorry no COD.

Send \$1.00 for Catalog [over 60 Kits]  
(Refundable with 1st Order)

# Graymark

Box 17359 • Irvine, CA 92713

SATISFACTION GUARANTEED

## TECHNICIANS REPAIRMEN • HOBBIEIST

WE CAN SUPPLY YOU ALL YOUR NEED FOR YOUR MAINTENANCE, REPAIR WORK & DESIGN.

AMERICAN, JAPANESE, EUROPEAN TYPES REPLACEMENT FOR ECG®

### CHECK THIS! (Min. 5 pcs. each)

ECG® Type No.	YOUR PRICE	ECG® Type No.	YOUR PRICE
123A .....	.28	500A .....	8.95
152 .....	.60	523 .....	10.75
153 .....	.65	526A .....	10.95
165 .....	2.25	HIDIV-1® .....	3.75
238 .....	2.25	HIDIV-3® .....	3.75

3 YEARS WARRANTY ON EXR PARTS

### SPECIAL (Min. 5 pcs. each)

2SC867A ....	2.95	AN214Q .....	1.50
2SC1034 .....	5.95	STK439 .....	7.25
2SC1114 .....	3.45	UPC1181H...	1.95
2SC1308K...	2.25	UPC1182H...	1.95

Call Toll-Free **800-526-4928**

COD ORDERS WELCOME (Min. order \$25)

CALL OR WRITE FOR OUR 1982 PRICE LIST

## DIGITRON ELECTRONIC

110 Hillside Avenue, Springfield, N.J. 07081  
201-379-9016, 379-9019

ECG IS A TRADE MARK OF PHILIPS ECG.  
DIGITRON IS NOT ASSOCIATED IN ANY WAY WITH PHILIPS ECG.

CIRCLE 28 ON FREE INFORMATION CARD

QUALITY SERVICE AVAILABILITY



ACTIVE, YOUR NUMBER ONE CHOICE

# Active Electronic

## Active Electronics

Your one stop source for the widest variety of factory fresh electronic components

## FEATURING

THE 1982 I.C. MASTER \$39.95

WHILE QUANTITIES LAST

## Extensive Product Offering

Semiconductors, Integrated Circuits, Micro-computer Boards, Microprocessor and Support Circuits, Transistors, Diodes, Capacitors, Resistors, Optoelectronics, Potentiometers, Relays, Multimeters, Switches, Knobs, Connectors, Sockets, P.C. Boards, Enclosures, Data and Reference Books, Soldering Aids, AND MUCH MORE

## Superior Service

Greater choice. Easier, faster ordering and more reliable deliveries. Active's all NEW comprehensive Fall/Winter catalog is now available — FREE OF CHARGE. Circle No. 3 on free information card or write to: P.O. Box 8000, Westboro, MASS. 01581 U.S.A.

Call Toll Free **800-343-0874**

MASS. customers call (617) 366-0500

CIRCLE 3 ON FREE INFORMATION CARD



# DIGI-KEY 80-346-144

**NATIONAL SEMICONDUCTOR • PANASONIC • QUALITY** - Name brand products from nationally recognized manufacturers. **CHEMICALS • ARIES • PLESSEY • MOLEY • E**  
**AAVID • CHEMVIK • BISHOP GRAPHICS • MACHINE • DIAMOND TOOL • LANGAR • GC CH**  
**ARIES • PLESSEY • MOLEY • AAVID • E. F. J. MACHINE • LANGAR • GC CHEMICALS • A**  
**NATIONAL SEMICONDUCTOR • PANASONIC • SAVINGS** - Volume Discounts • OEM Quality Pricing • Toll Free 800 Number **CHEMICALS • ARIES • PLESSEY • MOLEY • E**

### INTEGRATED CIRCUITS

Part No.	Price	Part No.	Price	Part No.	Price
7400 TTL	...	741500 TTL	...	745000 TTL	...
7401	...	741501	...	745001	...
7402	...	741502	...	745002	...
7403	...	741503	...	745003	...
7404	...	741504	...	745004	...
7405	...	741505	...	745005	...
7406	...	741506	...	745006	...
7407	...	741507	...	745007	...
7408	...	741508	...	745008	...
7409	...	741509	...	745009	...
7410	...	741510	...	745010	...
7411	...	741511	...	745011	...
7412	...	741512	...	745012	...
7413	...	741513	...	745013	...
7414	...	741514	...	745014	...
7415	...	741515	...	745015	...
7416	...	741516	...	745016	...
7417	...	741517	...	745017	...
7418	...	741518	...	745018	...
7419	...	741519	...	745019	...
7420	...	741520	...	745020	...
7421	...	741521	...	745021	...
7422	...	741522	...	745022	...
7423	...	741523	...	745023	...
7424	...	741524	...	745024	...
7425	...	741525	...	745025	...
7426	...	741526	...	745026	...
7427	...	741527	...	745027	...
7428	...	741528	...	745028	...
7429	...	741529	...	745029	...
7430	...	741530	...	745030	...
7431	...	741531	...	745031	...
7432	...	741532	...	745032	...
7433	...	741533	...	745033	...
7434	...	741534	...	745034	...
7435	...	741535	...	745035	...
7436	...	741536	...	745036	...
7437	...	741537	...	745037	...
7438	...	741538	...	745038	...
7439	...	741539	...	745039	...
7440	...	741540	...	745040	...
7441	...	741541	...	745041	...
7442	...	741542	...	745042	...
7443	...	741543	...	745043	...
7444	...	741544	...	745044	...
7445	...	741545	...	745045	...
7446	...	741546	...	745046	...
7447	...	741547	...	745047	...
7448	...	741548	...	745048	...
7449	...	741549	...	745049	...
7450	...	741550	...	745050	...

### IC SOCKETS

Accommodates standard IC leads to DIP, SMD and SOIC. Contact is designed per standard to insure proper connection. Socket is made of high quality brass with chrome plating.

### SOLDER TAIL DIP SOCKETS

- Single lead
- Low profile
- YOUR CHOICE TIN OR GOLD

### TIN PLATED SOLDER TAIL

Part No. Description Price

CS10	10 pin solder tail, tin	1.18
CS12	12 pin solder tail, tin	1.46
CS14	14 pin solder tail, tin	1.74
CS16	16 pin solder tail, tin	2.02
CS18	18 pin solder tail, tin	2.30
CS20	20 pin solder tail, tin	2.58
CS22	22 pin solder tail, tin	2.86
CS24	24 pin solder tail, tin	3.14
CS26	26 pin solder tail, tin	3.42
CS28	28 pin solder tail, tin	3.70
CS30	30 pin solder tail, tin	3.98
CS32	32 pin solder tail, tin	4.26
CS34	34 pin solder tail, tin	4.54
CS36	36 pin solder tail, tin	4.82
CS38	38 pin solder tail, tin	5.10
CS40	40 pin solder tail, tin	5.38
CS42	42 pin solder tail, tin	5.66
CS44	44 pin solder tail, tin	5.94
CS46	46 pin solder tail, tin	6.22
CS48	48 pin solder tail, tin	6.50
CS50	50 pin solder tail, tin	6.78
CS52	52 pin solder tail, tin	7.06
CS54	54 pin solder tail, tin	7.34
CS56	56 pin solder tail, tin	7.62
CS58	58 pin solder tail, tin	7.90
CS60	60 pin solder tail, tin	8.18
CS62	62 pin solder tail, tin	8.46
CS64	64 pin solder tail, tin	8.74
CS66	66 pin solder tail, tin	9.02
CS68	68 pin solder tail, tin	9.30
CS70	70 pin solder tail, tin	9.58
CS72	72 pin solder tail, tin	9.86
CS74	74 pin solder tail, tin	10.14
CS76	76 pin solder tail, tin	10.42
CS78	78 pin solder tail, tin	10.70
CS80	80 pin solder tail, tin	10.98
CS82	82 pin solder tail, tin	11.26
CS84	84 pin solder tail, tin	11.54
CS86	86 pin solder tail, tin	11.82
CS88	88 pin solder tail, tin	12.10
CS90	90 pin solder tail, tin	12.38
CS92	92 pin solder tail, tin	12.66
CS94	94 pin solder tail, tin	12.94
CS96	96 pin solder tail, tin	13.22
CS98	98 pin solder tail, tin	13.50
CS100	100 pin solder tail, tin	13.78

### 150 CAPACITORS

Price includes component and shipping. Price is per unit.

### NEW KIT

### 316 DISC CAPACITORS

Price includes component and shipping. Price is per unit.

### NEW KIT

### 316 DISC CAPACITORS

Price includes component and shipping. Price is per unit.

### DISC CAPACITORS

Price includes component and shipping. Price is per unit.

### NEW KIT

### 316 DISC CAPACITORS

Price includes component and shipping. Price is per unit.

### PANASONIC RESIN BOND TANTALUM CAPACITORS

Price includes component and shipping. Price is per unit.

### NEW KIT

### 316 DISC CAPACITORS

Price includes component and shipping. Price is per unit.

### INTEGRATED CIRCUITS

Part No.	Price	Part No.	Price	Part No.	Price
7400 TTL	...	741500 TTL	...	745000 TTL	...
7401	...	741501	...	745001	...
7402	...	741502	...	745002	...
7403	...	741503	...	745003	...
7404	...	741504	...	745004	...
7405	...	741505	...	745005	...
7406	...	741506	...	745006	...
7407	...	741507	...	745007	...
7408	...	741508	...	745008	...
7409	...	741509	...	745009	...
7410	...	741510	...	745010	...
7411	...	741511	...	745011	...
7412	...	741512	...	745012	...
7413	...	741513	...	745013	...
7414	...	741514	...	745014	...
7415	...	741515	...	745015	...
7416	...	741516	...	745016	...
7417	...	741517	...	745017	...
7418	...	741518	...	745018	...
7419	...	741519	...	745019	...
7420	...	741520	...	745020	...
7421	...	741521	...	745021	...
7422	...	741522	...	745022	...
7423	...	741523	...	745023	...
7424	...	741524	...	745024	...
7425	...	741525	...	745025	...
7426	...	741526	...	745026	...
7427	...	741527	...	745027	...
7428	...	741528	...	745028	...
7429	...	741529	...	745029	...
7430	...	741530	...	745030	...
7431	...	741531	...	745031	...
7432	...	741532	...	745032	...
7433	...	741533	...	745033	...
7434	...	741534	...	745034	...
7435	...	741535	...	745035	...
7436	...	741536	...	745036	...
7437	...	741537	...	745037	...
7438	...	741538	...	745038	...
7439	...	741539	...	745039	...
7440	...	741540	...	745040	...
7441	...	741541	...	745041	...
7442	...	741542	...	745042	...
7443	...	741543	...	745043	...
7444	...	741544	...	745044	...
7445	...	741545	...	745045	...
7446	...	741546	...	745046	...
7447	...	741547	...	745047	...
7448	...	741548	...	745048	...
7449	...	741549	...	745049	...
7450	...	741550	...	745050	...

### WIRE WRAP DIP SOCKETS

- Universal mounting and pinching
- Synthetic insulating and protecting
- Wire wrap compatible
- Your choice tin or gold

### TEXAS INSTRUMENTS SCOT EDGEBORD CONNECTORS

Part No. Description Price

CS10	10 pin wire wrap, gold	1.18
CS12	12 pin wire wrap, gold	1.46
CS14	14 pin wire wrap, gold	1.74
CS16	16 pin wire wrap, gold	2.02
CS18	18 pin wire wrap, gold	2.30
CS20	20 pin wire wrap, gold	2.58
CS22	22 pin wire wrap, gold	2.86
CS24	24 pin wire wrap, gold	3.14
CS26	26 pin wire wrap, gold	3.42
CS28	28 pin wire wrap, gold	3.70
CS30	30 pin wire wrap, gold	3.98
CS32	32 pin wire wrap, gold	4.26
CS34	34 pin wire wrap, gold	4.54
CS36	36 pin wire wrap, gold	4.82
CS38	38 pin wire wrap, gold	5.10
CS40	40 pin wire wrap, gold	5.38
CS42	42 pin wire wrap, gold	5.66
CS44	44 pin wire wrap, gold	5.94
CS46	46 pin wire wrap, gold	6.22
CS48	48 pin wire wrap, gold	6.50
CS50	50 pin wire wrap, gold	6.78
CS52	52 pin wire wrap, gold	7.06
CS54	54 pin wire wrap, gold	7.34
CS56	56 pin wire wrap, gold	7.62
CS58	58 pin wire wrap, gold	7.90
CS60	60 pin wire wrap, gold	8.18
CS62	62 pin wire wrap, gold	8.46
CS64	64 pin wire wrap, gold	8.74
CS66	66 pin wire wrap, gold	9.02
CS68	68 pin wire wrap, gold	9.30
CS70	70 pin wire wrap, gold	9.58
CS72	72 pin wire wrap, gold	9.86
CS74	74 pin wire wrap, gold	10.14
CS76	76 pin wire wrap, gold	10.42
CS78	78 pin wire wrap, gold	10.70
CS80	80 pin wire wrap, gold	10.98
CS82	82 pin wire wrap, gold	11.26
CS84	84 pin wire wrap, gold	11.54
CS86	86 pin wire wrap, gold	11.82
CS88	88 pin wire wrap, gold	12.10
CS90	90 pin wire wrap, gold	12.38
CS92	92 pin wire wrap, gold	12.66
CS94	94 pin wire wrap, gold	12.94
CS96	96 pin wire wrap, gold	13.22
CS98	98 pin wire wrap, gold	13.50
CS100	100 pin wire wrap, gold	13.78

### TEXAS INSTRUMENTS SCOT EDGEBORD CONNECTORS

Part No. Description Price

CS10	10 pin wire wrap, gold	1.18
CS12	12 pin wire wrap, gold	1.46
CS14	14 pin wire wrap, gold	1.74
CS16	16 pin wire wrap, gold	2.02
CS18	18 pin wire wrap, gold	2.30
CS20	20 pin wire wrap, gold	2.58
CS22	22 pin wire wrap, gold	2.86
CS24	24 pin wire wrap, gold	3.14
CS26	26 pin wire wrap, gold	3.42
CS28	28 pin wire wrap, gold	3.70
CS30	30 pin wire wrap, gold	3.98
CS32	32 pin wire wrap, gold	4.26
CS34	34 pin wire wrap, gold	4.54
CS36	36 pin wire wrap, gold	4.82
CS38	38 pin wire wrap, gold	5.10
CS40	40 pin wire wrap, gold	5.38
CS42	42 pin wire wrap, gold	5.66
CS44	44 pin wire wrap, gold	5.94
CS46	46 pin wire wrap, gold	6.22
CS48	48 pin wire wrap, gold	6.50
CS50	50 pin wire wrap, gold	6.78
CS52	52 pin wire wrap, gold	7.06
CS54	54 pin wire wrap, gold	7.34
CS56	56 pin wire wrap, gold	7.62
CS58	58 pin wire wrap, gold	7.90
CS60	60 pin wire wrap, gold	8.18
CS62	62 pin wire wrap, gold	8.46
CS64	64 pin wire wrap, gold	8.74
CS66	66 pin wire wrap, gold	9.02
CS68	68 pin wire wrap, gold	9.30
CS70	70 pin wire wrap, gold	9.58
CS72	72 pin wire wrap, gold	9.86
CS74	74 pin wire wrap, gold	10.14
CS76	76 pin wire wrap, gold	10.42
CS78	78 pin wire wrap, gold	10.70
CS80	80 pin wire wrap, gold	10.98
CS82	82 pin wire wrap, gold	11.26
CS84	84 pin wire wrap, gold	



# REGENT CORPORATION

In Mn., Ak., H. Call 218-681-6674

**QUALITY** - Name brand products from nationally recognized manufacturers. **SERVICE** - Computerized order processing and inventory control. **SAVINGS** - Volume Discounts • OEM Quantity Pricing • Toll Free 800 Number

### 3 AMP SILICON RECTIFIERS

#### ZENER DIODES

##### 3 AMP SILICON RECTIFIER

Part No. Price

3A1	1.19
3A2	1.19
3A3	1.19
3A4	1.19
3A5	1.19
3A6	1.19
3A7	1.19
3A8	1.19
3A9	1.19
3A10	1.19
3A11	1.19
3A12	1.19
3A13	1.19
3A14	1.19
3A15	1.19
3A16	1.19
3A17	1.19
3A18	1.19
3A19	1.19
3A20	1.19
3A21	1.19
3A22	1.19
3A23	1.19
3A24	1.19
3A25	1.19
3A26	1.19
3A27	1.19
3A28	1.19
3A29	1.19
3A30	1.19
3A31	1.19
3A32	1.19
3A33	1.19
3A34	1.19
3A35	1.19
3A36	1.19
3A37	1.19
3A38	1.19
3A39	1.19
3A40	1.19
3A41	1.19
3A42	1.19
3A43	1.19
3A44	1.19
3A45	1.19
3A46	1.19
3A47	1.19
3A48	1.19
3A49	1.19
3A50	1.19

### IT SILICON ZENER DIODES

Part No. Price

IT1	1.19
IT2	1.19
IT3	1.19
IT4	1.19
IT5	1.19
IT6	1.19
IT7	1.19
IT8	1.19
IT9	1.19
IT10	1.19
IT11	1.19
IT12	1.19
IT13	1.19
IT14	1.19
IT15	1.19
IT16	1.19
IT17	1.19
IT18	1.19
IT19	1.19
IT20	1.19
IT21	1.19
IT22	1.19
IT23	1.19
IT24	1.19
IT25	1.19
IT26	1.19
IT27	1.19
IT28	1.19
IT29	1.19
IT30	1.19
IT31	1.19
IT32	1.19
IT33	1.19
IT34	1.19
IT35	1.19
IT36	1.19
IT37	1.19
IT38	1.19
IT39	1.19
IT40	1.19
IT41	1.19
IT42	1.19
IT43	1.19
IT44	1.19
IT45	1.19
IT46	1.19
IT47	1.19
IT48	1.19
IT49	1.19
IT50	1.19

### 3AG "NORMAL-LO" FUSES

Part No. Price

F300	0.10
F301	0.10
F302	0.10
F303	0.10
F304	0.10
F305	0.10
F306	0.10
F307	0.10
F308	0.10
F309	0.10
F310	0.10
F311	0.10
F312	0.10
F313	0.10
F314	0.10
F315	0.10
F316	0.10
F317	0.10
F318	0.10
F319	0.10
F320	0.10
F321	0.10
F322	0.10
F323	0.10
F324	0.10
F325	0.10
F326	0.10
F327	0.10
F328	0.10
F329	0.10
F330	0.10
F331	0.10
F332	0.10
F333	0.10
F334	0.10
F335	0.10
F336	0.10
F337	0.10
F338	0.10
F339	0.10
F340	0.10
F341	0.10
F342	0.10
F343	0.10
F344	0.10
F345	0.10
F346	0.10
F347	0.10
F348	0.10
F349	0.10
F350	0.10

### 3AG SLO-BLO FUSES

Part No. Price

F300	0.10
F301	0.10
F302	0.10
F303	0.10
F304	0.10
F305	0.10
F306	0.10
F307	0.10
F308	0.10
F309	0.10
F310	0.10
F311	0.10
F312	0.10
F313	0.10
F314	0.10
F315	0.10
F316	0.10
F317	0.10
F318	0.10
F319	0.10
F320	0.10
F321	0.10
F322	0.10
F323	0.10
F324	0.10
F325	0.10
F326	0.10
F327	0.10
F328	0.10
F329	0.10
F330	0.10
F331	0.10
F332	0.10
F333	0.10
F334	0.10
F335	0.10
F336	0.10
F337	0.10
F338	0.10
F339	0.10
F340	0.10
F341	0.10
F342	0.10
F343	0.10
F344	0.10
F345	0.10
F346	0.10
F347	0.10
F348	0.10
F349	0.10
F350	0.10

### 3AG PANEL FUSEHOLDER

Part No. Price

F300	0.10
F301	0.10
F302	0.10
F303	0.10
F304	0.10
F305	0.10
F306	0.10
F307	0.10
F308	0.10
F309	0.10
F310	0.10
F311	0.10
F312	0.10
F313	0.10
F314	0.10
F315	0.10
F316	0.10
F317	0.10
F318	0.10
F319	0.10
F320	0.10
F321	0.10
F322	0.10
F323	0.10
F324	0.10
F325	0.10
F326	0.10
F327	0.10
F328	0.10
F329	0.10
F330	0.10
F331	0.10
F332	0.10
F333	0.10
F334	0.10
F335	0.10
F336	0.10
F337	0.10
F338	0.10
F339	0.10
F340	0.10
F341	0.10
F342	0.10
F343	0.10
F344	0.10
F345	0.10
F346	0.10
F347	0.10
F348	0.10
F349	0.10
F350	0.10

### National Semiconductor

#### MA1026 Temp.-Temp. Clock Module

Glent 7 Inch 4-Digit LED Display

Part No. Price

MA1026	1.19
MA1027	1.19
MA1028	1.19
MA1029	1.19
MA1030	1.19
MA1031	1.19
MA1032	1.19
MA1033	1.19
MA1034	1.19
MA1035	1.19
MA1036	1.19
MA1037	1.19
MA1038	1.19
MA1039	1.19
MA1040	1.19
MA1041	1.19
MA1042	1.19
MA1043	1.19
MA1044	1.19
MA1045	1.19
MA1046	1.19
MA1047	1.19
MA1048	1.19
MA1049	1.19
MA1050	1.19

### MA1026 Temp.-Temp. Clock Module

Glent 7 Inch 4-Digit LED Display

Part No. Price

MA1026	1.19
MA1027	1.19
MA1028	1.19
MA1029	1.19
MA1030	1.19
MA1031	1.19
MA1032	1.19
MA1033	1.19
MA1034	1.19
MA1035	1.19
MA1036	1.19
MA1037	1.19
MA1038	1.19
MA1039	1.19
MA1040	1.19
MA1041	1.19
MA1042	1.19
MA1043	1.19
MA1044	1.19
MA1045	1.19
MA1046	1.19
MA1047	1.19
MA1048	1.19
MA1049	1.19
MA1050	1.19

### MA1026 Temp.-Temp. Clock Module

Glent 7 Inch 4-Digit LED Display

Part No. Price

MA1026	1.19
MA1027	1.19
MA1028	1.19
MA1029	1.19
MA1030	1.19
MA1031	1.19
MA1032	1.19
MA1033	1.19
MA1034	1.19
MA1035	1.19
MA1036	1.19
MA1037	1.19
MA1038	1.19
MA1039	1.19
MA1040	1.19
MA1041	1.19
MA1042	1.19
MA1043	1.19
MA1044	1.19
MA1045	1.19
MA1046	1.19
MA1047	1.19
MA1048	1.19
MA1049	1.19
MA1050	1.19

### DIGI-CLOCK KIT

Part No. Price

DC1	1.19
DC2	1.19
DC3	1.19
DC4	1.19
DC5	1.19
DC6	1.19
DC7	1.19
DC8	1.19
DC9	1.19
DC10	1.19
DC11	1.19
DC12	1.19
DC13	1.19
DC14	1.19
DC15	1.19
DC16	1.19
DC17	1.19
DC18	1.19
DC19	1.19
DC20	1.19
DC21	1.19
DC22	1.19
DC23	1.19
DC24	1.19
DC25	1.19
DC26	1.19
DC27	1.19
DC28	1.19
DC29	1.19
DC30	1.19
DC31	1.19
DC32	1.19
DC33	1.19
DC34	1.19
DC35	1.19
DC36	1.19
DC37	1.19
DC38	1.19
DC39	1.19
DC40	1.19
DC41	1.19
DC42	1.19
DC43	1.19
DC44	1.19
DC45	1.19
DC46	1.19
DC47	1.19
DC48	1.19
DC49	1.19
DC50	1.19

### DIGI-CLOCK KIT

Part No. Price

DC1	1.19
DC2	1.19
DC3	1.19
DC4	1.19
DC5	1.19
DC6	1.19
DC7	1.19
DC8	1.19
DC9	1.19
DC10	1.19
DC11	1.19
DC12	1.19
DC13	1.19
DC14	1.19
DC15	1.19
DC16	1.19
DC17	1.19
DC18	1.19
DC19	1.19
DC20	1.19
DC21	1.19
DC22	1.19
DC23	1.19
DC24	1.19
DC25	1.19
DC26	1.19
DC27	1.19
DC28	1.19
DC29	1.19
DC30	1.19
DC31	1.19
DC32	1.19
DC33	1.19
DC34	1.19
DC35	1.19
DC36	1.19
DC37	1.19
DC38	1.19
DC39	1.19
DC40	1.19
DC41	1.19
DC42	1.19
DC43	1.19
DC44	1.19
DC45	1.19
DC46	1.19
DC47	1.19
DC48	1.19
DC49	1.19
DC50	1.19

### 3-WATT 5% CARBON FILM RESISTOR ASSIGNMENT

Part No. Price

R300	0.10
R301	0.10
R302	0.10
R303	0.10
R304	0.10
R305	0.10
R306	0.10
R307	0.10
R308	0.10
R309	0.10
R310	0.10
R311	0.10
R312	0.10
R313	0.10
R314	0.10
R315	0.10
R316	0.10
R317	0.10
R318	0.10
R319	0.10
R320	0.10
R321	0.10
R322	0.10
R323	0.10
R324	0.10
R325	0.10
R326	0.10
R327	0.10
R328	0.10
R329	0.10
R330	0.10
R331	0.10
R332	0.10
R333	0.10
R334	0.10
R335	0.10
R336	0.10
R337	0.10
R338	0.10
R339	0.10
R340	0.10
R341	0.10
R342	0.10
R343	0.10
R344	0.10
R345	0.10
R346	0.10
R347	0.10
R348	0.10
R349	0.10
R350	0.10

### Silicon Transistors

Part No. Price

2N101	1.19
2N102	1.19
2N103	1.19
2N104	1.19
2N105	1.19
2N106	1.19
2N107	1.19
2N108	1.19
2N109	1.19
2N110	1.19
2N111	1.19
2N112	1.19
2N113	1.19
2N114	1.19
2N115	1.19
2N116	1.19
2N117	1.19
2N118	1.19
2N119	1.19
2N120	1.19
2N121	1.19
2N122	1.19
2N123	1.19
2N124	1.19
2N125	1.19





**MP SYSTEMS**  
**MP SYSTEMS**  
**MP SYSTEMS**  
**MP SYSTEMS**

**Fast, Reliable Service is Our Specialty.**

**MP SYSTEMS**

**WILL IMPROVE  
 YOUR MEMORY . . .**

16K EXPANSION KIT    64K EXPANSION KIT  
 8 pcs 4116 200 ns    9 pcs 4164 200 ns  
**\$11.95                    \$74.25**

**AND DRIVE YOU**

IMI's™ Industry Standard 5 1/4" Winchester Disk Drive  
 6 mb ..... \$865.00  
 Siemens™ 8" Floppy Disk Drive  
 FDD 100-8 ..... \$300.00

**FRANKLIN ACE 1000  
 \$1350.00**

**APPLE CLOCKCHIP**

MM58167AN ..... \$ 15.00

**EPROMS**

2708 ..... 5.65 2716 ..... 5.50  
 2732 ..... 9.00 2532 ..... 12.00

**DB CONNECTOR**

DB25P (RS232) ..... \$2.95  
 DB25S (Female) ..... 4.25  
 Hood ..... 1.80  
 DB9P ..... 2.50  
 DB9S ..... 3.37  
 Cover ..... 1.10  
 DB15P ..... 3.77  
 DB15S ..... 4.21  
 Cover ..... 1.25

**6500 FAMILY**

R6502P ..... \$ 6.95  
 R6511P ..... 34.55  
 R6520P ..... 4.00  
 R6522P ..... 6.20  
 R6532P ..... 8.55  
 R6545P ..... 17.65  
 R6551P ..... 8.75

**LPS II®**

High resolution, high speed light pen for Apple II™ computers. Compatible with Franklin Ace 1000  
**\$349.00**

**ASK FOR FREE FLYER  
 ASK FOR QUANTITY PRICING**

\$100.00 minimum order.  
 Terms C.O.D. Prepaid or credit to rated firms.  
 F.O.B.: Laguna Hills, CA.  
 Shipping charges will be added.  
 All pricing subject to change without notice.  
 Call for quantity pricing.  
 Bank cards accepted: MasterCard, Visa



**MP SYSTEMS**  
 23341 DEL LAGO  
 LAGUNA HILLS, CA 92653  
 (714) 770-6411

**ADVERTISING INDEX**

RADIO-ELECTRONICS does not assume any responsibility for errors that may appear in the index below.

Free Information Number	Page		Page
85	Abex .....	87	33
3	Active Electronic Sales Corp.....	137	4.89
—	Advance Electronics .....	12-13	—
58	Advanced Computer Products.....	121	—
72	Albia Electronics .....	79	—
61	All Electronics Corp.....	128	9
13	AMC Sales .....	97	82
24	Arizona Electronic Surplus.....	118	60
32	Barlow Sales Co .....	100	43
—	Baystar .....	32	64
53	Beckman Instruments, Inc .....	Cover IV	75
59	Beta Electronics .....	117	—
46	B&K Precision Dynascan Corp.....	83	88
—	Bullet Electronics .....	118	70
—	C&D Electronics, Inc. ....	133	—
69	Chaney Electronics Inc. ....	128	76
—	CIE, Cleveland Institute of Electronics .....	34-37	87
79	Command Productions .....	105	41
5,42	Communications Electronics .....	2.5	—
8, —	Component Express Inc. ....	15,114,120	73
67	Computer Products & Peripherals Unlimited.....	136	80
63	Concord Computer Products .....	116	—
22	Consolidated Electronics, Inc.....	116	—
35	Cooper Tools .....	Cover II	—
86	CRT Factory .....	87	—
—	DAK Industries Incorporated .....	21,23	—
81	Diamondback Electronics Co .....	122	—
17	Digi-Key Corporation .....	138-139	—
28	Digitron Electronics .....	137	—
50	Direct Video Sales .....	94	—
23	Dokay Computer Products, Inc.....	129	—
47,48	Electronic Rainbow Inc. ....	22,80	—
15	Electronic Specialists, Inc. ....	99	—
—	Electronic Technology Today .....	115	—
74	Enterprise Development Corp.....	102	—
44	Eteo Electronics .....	122	—
45	Etronix .....	99	—
56	Firestick Antenna Company .....	105	—
51	Fluke .....	9	—
—	Fordham Radio .....	93,95	—
18	Formula International Inc. ....	134-135	—
83	Gilco International, Inc. ....	132	—
6	Gillaspie & Associates, Inc. ....	33	—
71	Global Specialists Corp.....	75	—
—	Grantham College of Engineering ..	102	—
—	Graymark .....	137	—
29	Hal-tronix .....	140	—
37,38	Heath Company .....	52-55, Cover III	—
49	Hickok Electrical Instrument Co ..	103	—
—	ICS, Computer Training .....	97	—
—	Information Unlimited .....	133	—
16	Jameco Electronics .....	130-131	—
11	Jan Crystal .....	97	—
57	JDR Microdevices, Inc .....	124-127	—
—	McGraw Hill Book Company .....	106-109	—
—	McGraw Hill Continuing Education.....	16-19	—
78	MFJ Enterprises .....	102	—
68	Micro-Mart .....	136	—
—	Monarchy Engineering, Inc. ....	118	—
31	Mountain West .....	137	—
26	MP Systems.....	140	—
84	Nationwide .....	87	—
—	Netronics .....	85	—
—	Nesda .....	94	—
—	New Horizons .....	101	—
—	NRI Schools .....	70-73	—
—	NTS Schools .....	88-91	—
62	Omnitron Electronics .....	114	—
52	OK Industries Inc. ....	27	—
12	Paia Electronics, Inc .....	94	—
54	PC Magazine .....	81	—
7	Pomona Electronics .....	25	—
25	PPG .....	132	—
39, 40	Protecto Enterprises .....	11,30	—
21	Quest Electronics .....	120	—
20	Radio Shack .....	113	—
19	Ramsey Electronics, Inc. ....	123	—
66	R.F. Electronics .....	136	—
14	Rhoades National Corporation .....	99	—
36	Sams Books .....	28	—
—	SCR Electronics Center .....	128	—
—	Sencore .....	1	—
—	Simple Simon Electronic Kits, Inc .....	77	—
—	Sinclair Research Ltd .....	29	—
9	Sintec Co .....	24	—
—	SJB Distributors, Inc .....	112	—
—	Solid State Sales .....	133	—
—	Soltec Corporation .....	31	—
—	Spartan Electronics Inc .....	132	—
—	Stavis Electronics, Inc. ....	119	—
—	Tektronix .....	7	—
—	Teltone Corp. ....	87	—
—	Tiger Tech Electronic Components .....	136	—
—	Triton Marketing Corp.....	26	—
—	Ungar .....	87	—
—	Vector Electronic Co .....	85	—
—	Viking Ind. ....	85	—
—	VIZ Mfg. Co. ....	38	—
—	Wm. B. Allen Supply .....	122	—

**USE YOUR  
 WILL POWER TO  
 FIGHT CANCER**

For information about  
 bequests, call the

**AMERICAN CANCER SOCIETY**



THIS SPACE CONTRIBUTED AS A PUBLIC SERVICE

**ELECTRONIC KITS  
 FROM HAL-TRONIX**

2304 MHZ DOWN CONVERTERS. TUNES IN ON CHANNELS 2 TO 7 ON YOUR OWN HOME T.V. HAS FREQUENCY RANGE FROM 2000 MHZ TO 2500 MHZ. EASY TO CONSTRUCT AND COMES COMPLETE WITH ALL PARTS INCLUDING A DIE-CAST ALUM. CASE AND COAX FITTINGS. REQUIRE A VARIABLE POWER SUPPLY AND ANTENNA (Antenna can be a dish type or coffee can type depending on the signal strength in your area.)

2304 MOD 1 (Basic Kit) ..... \$19.95  
 (Less case & fittings)  
 2304 MOD 2 (Basic Pre-amp) ..... \$29.95  
 (Less case & fittings)  
 2304 MOD 3 (Hi-Gain Pre-amp) ..... \$39.95  
 (Includes case & fittings)  
 POWER SUPPLY FOR EITHER MODEL ABOVE IS AVAILABLE. COMES COMPLETE WITH ALL PARTS, CASE, TRANSFORMER, ANTENNA SWITCH AND CONNECTORS (Kit) \$24.95  
 Assembled..... \$34.95  
 Slotted Microwave Antenna For Above  
 Downverters..... \$39.95

**PREAMPLIFIERS**

HAL PA-19—1.5 mhz to 150 mhz. 19db gain operates on 8 to 18 volts at 10ma. Complete unit \$8.95.  
 HAL PA-1.4—3 mhz to 1.4 ghz. 10 to 12 db gain operates on 8 to 18 volts at 10 ma. Complete unit \$12.95.  
 (The above units are ideal for receivers, counters, etc.)

16 LINE TOUCH TONE DECODE KIT WITH P.C. BOARD AND PARTS ..... \$69.95  
 12 LINE TOUCH TONE DECODER KIT WITH P.C. BOARD AND PARTS ..... \$39.95  
 16 LINE ENCODER KIT, COMPLETE WITH CASE, PAD AND COMPONENTS..... \$39.95  
 12 LINE ENCODER KIT, COMPLETE WITH CASE, PAD AND COMPONENTS..... \$29.95

Complete Sets of P.C. Boards Available For: Unicorn Robot Project and Heart-A-Matic Project.  
**MANY, MANY OTHER KITS AVAILABLE**

Send 25 cents stamp or S.A.S.E. for information and flyer on other HAL-TRONIX products. To order by phone: 1-313-285-1782.



**HAL-TRONIX**  
 P.O. Box 1101  
 Southgate, MI 48195

SHIPPING INFORMATION: ORDERS OVER \$25.00 WILL BE SHIPPED POSTPAID EXCEPT ON ITEMS WHERE ADDITIONAL CHARGES ARE REQUESTED ON ORDERS LESS THAN \$25.00 PLEASE INCLUDE ADDITIONAL \$2.00 FOR HANDLING AND MAILING CHARGES.

**CIRCLE 29 ON FREE INFORMATION CARD**